

	<b>Pictorial index</b>	Search by illustration	
1	<b>For safety and security</b>	Make sure to read through them	
2	<b>Instrument cluster</b>	How to read the gauges and meters, the variety of warning lights and indicators, etc.	
3	<b>Operation of each component</b>	Opening and closing the doors and windows, adjustment before driving, etc.	
4	<b>Driving</b>	Operations and advice which are necessary for driving	
5	<b>Lexus Display Audio system</b>	Operating the Lexus Display Audio system	
6	<b>Interior features</b>	Usage of the interior features, etc.	
7	<b>Maintenance and care</b>	Caring for your vehicle and maintenance procedures	
8	<b>When trouble arises</b>	What to do in case of malfunction or emergency	
9	<b>Vehicle specifications</b>	Vehicle specifications, customizable features, etc.	
10	<b>For owners</b>	Reporting safety defects for U.S. owners, and seat belt and SRS airbag instructions for Canadian owners	
	<b>Index</b>	Search by symptom	
		Search alphabetically	

## 2 TABLE OF CONTENTS

---

For your information.....	8
Reading this manual.....	12
How to search.....	13
Pictorial index.....	14

### 1 For safety and security

<b>1-1. For safe use</b>	
Before driving.....	26
For safe driving .....	28
Seat belts.....	30
SRS airbags.....	35
Front passenger occupant classification system.....	44
Safety information for children .....	50
Child restraint systems .....	51
Installing child restraints.....	55
Exhaust gas precautions.....	64
<b>1-2. Theft deterrent system</b>	
Engine immobilizer system.....	65
Alarm .....	67

### 2 Instrument cluster

<b>2. Instrument cluster</b>	
Warning lights and indicators.....	70
Gauges and meters.....	74
Multi-information display .....	78
Fuel consumption information .....	84

### 3 Operation of each component

<b>3-1. Key information</b>	
Keys.....	90
<b>3-2. Opening, closing and locking the doors and trunk</b>	
Doors.....	93
Trunk.....	99
Smart access system with push-button start.....	106
<b>3-3. Adjusting the seats</b>	
Front seats.....	114
Driving position memory.....	115
Head restraints .....	119
<b>3-4. Adjusting the steering wheel and mirrors</b>	
Steering wheel.....	122
Inside rear view mirror .....	124
Outside rear view mirrors.....	126
<b>3-5. Opening, closing the windows and moon roof</b>	
Power windows.....	129
Moon roof.....	132

## 4 Driving

### 4-1. Before driving

Driving the vehicle .....	138
Cargo and luggage.....	145
Vehicle load limits .....	148
Trailer towing .....	149
Dinghy towing .....	150

### 4-2. Driving procedures

Engine (ignition) switch.....	151
Automatic transmission .....	156
Turn signal lever .....	159
Parking brake .....	160

### 4-3. Operating the lights and wipers

Headlight switch .....	161
Automatic High Beam.....	164
Fog light switch .....	168
Windshield wipers and washer .....	169

### 4-4. Refueling

Opening the fuel tank cap .....	173
---------------------------------	-----

### 4-5. Using the driving support systems

Lexus Safety System+ .....	176
PCS (Pre-Collision System) .....	183
LDA (Lane Departure Alert with steering control).....	196
Dynamic radar cruise control.....	205
Cruise control .....	217
Intuitive parking assist.....	220
Lexus parking assist monitor .....	229
Driving mode select switch.....	245
BSM (Blind Spot Monitor).....	247
• Blind Spot Monitor function .....	250
• Rear Cross Traffic Alert function .....	252
Driving assist systems .....	255

### 4-6. Driving tips

Winter driving tips .....	260
---------------------------	-----

**5 Lexus Display Audio system**

**5-1. Basic Operations**

Lexus Display Audio System ..... 266

Steering wheel audio switches ..... 273

USB/AUX ports ..... 274

**5-2. Setup**

Setup menu ..... 276

General settings ..... 277

Voice settings ..... 281

Display settings ..... 282

**5-3. Using the audio system**

Selecting the audio source ..... 284

Optimal use of the audio system ..... 285

Audio settings ..... 286

Audio menu screen operation ..... 289

**5-4. Using the radio**

Radio operation ..... 292

**5-5. Playing an audio CD and MP3/WMA/AAC discs**

CD player operation ..... 299

**5-6. Using an external device**

Listening to an iPod ..... 306

Using USB memory device ..... 310

Using the AUX port ..... 314

**5-7. Connecting Bluetooth®**

Steps for using Bluetooth® devices ..... 315

Registering a Bluetooth® device ..... 317

Selecting a Bluetooth® device ..... 318

Connecting a Bluetooth® audio player ..... 319

Connecting a Bluetooth® phone ..... 320

Displaying a Bluetooth® device details ..... 321

Detailed Bluetooth® settings ..... 322

**5-8. Bluetooth® Audio**

Listening to Bluetooth® Audio ..... 323

**5-9. Bluetooth® Phone**

Using a Bluetooth® Phone ..... 325

Making a call ..... 327

Receiving a call ..... 330

Speaking on the phone ..... 331

Using a Bluetooth® phone message ..... 334

Using the steering wheel switches ..... 336

Bluetooth® phone settings ..... 337

<b>5-10. Phonebook</b>	
Contact settings .....	339
Messaging setting .....	342
<b>5-11. Bluetooth®</b>	
What to do if... (Troubleshooting) .....	343
Bluetooth® .....	346
<b>5-12. Other function</b>	
"Information" screen .....	351
USB photo .....	353
Weather information .....	355
Voice command system .....	356
Mobile Assistant .....	360
LEXUS Enform Remote .....	362

## 6 Interior features

<b>6-1. Using the air conditioning system and defogger</b>	
Automatic air conditioning system .....	364
Heated steering wheel/ seat heaters/seat ventilators .....	373
<b>6-2. Using the interior lights</b>	
Interior lights list .....	375
• Interior lights .....	376
• Personal lights .....	376

<b>6-3. Using the storage features</b>	
List of storage features .....	378
• Glove box .....	379
• Console box .....	379
• Cup holders .....	380
• Auxiliary box .....	381
Trunk features .....	382
<b>6-4. Using the other interior features</b>	
Other interior features .....	384
• Sun visors .....	384
• Vanity mirrors .....	384
• Clock .....	385
• Power outlets .....	385
• Armrest .....	386
• Rear sunshade/rear door sunshades .....	387
• Trunk storage extension .....	389
• Coat hooks .....	390
• Assist grips .....	390
Garage door opener .....	391
Compass .....	398
LEXUS Enform Safety Connect .....	402

**7** Maintenance and care

**7-1. Maintenance and care**  
 Cleaning and protecting the vehicle exterior .....408  
 Cleaning and protecting the vehicle interior..... 411

**7-2. Maintenance**  
 Maintenance requirements .....414  
 General maintenance..... 417  
 Emission inspection and maintenance (I/M) programs..... 420

**7-3. Do-it-yourself maintenance**  
 Do-it-yourself service precautions.....421  
 Hood ..... 423  
 Positioning a floor jack.....424  
 Engine compartment ..... 425  
 Tires..... 436  
 Tire inflation pressure ..... 444  
 Wheels .....447  
 Air conditioning filter ..... 449  
 Electronic key battery..... 451  
 Checking and replacing fuses..... 453  
 Light bulbs ..... 456

**8** When trouble arises

**8-1. Essential information**  
 Emergency flashers ..... 468  
 If your vehicle has to be stopped in an emergency.... 469

**8-2. Steps to take in an emergency**  
 If your vehicle needs to be towed.....470  
 If you think something is wrong..... 474  
 Fuel pump shut off system.....475  
 If a warning light turns on or a warning buzzer sounds..... 476  
 If a warning message is displayed ..... 482  
 If you have a flat tire .....485  
 If the engine will not start..... 496  
 If the shift lever cannot be shifted from P ..... 498  
 If the electronic key does not operate properly..... 499  
 If the battery is discharged..... 501  
 If your vehicle overheats.....505  
 If the vehicle becomes stuck .....508

## 9 Vehicle specifications

### 9-1. Specifications

Maintenance data (fuel, oil level, etc.) .....	512
Fuel information.....	521
Tire information.....	524

### 9-2. Customization

Customizable features .....	533
-----------------------------	-----

### 9-3. Initialization

Items to initialize .....	543
---------------------------	-----

## 10 For owners

Reporting safety defects for U.S. owners.....	546
Seat belt instructions for Canadian owners (in French).....	547
SRS airbag instructions for Canadian owners (in French).....	548

## Index

What to do if.. (Troubleshooting).....	556
Alphabetical index .....	560

For vehicles with navigation system, refer to the “NAVIGATION SYSTEM OWNER’S MANUAL” for information regarding the equipment listed below.

- Navigation system
- Lexus parking assist monitor
- Audio/video system
- Lexus Enform

## For your information

### Main Owner's Manual

The Owner's Manual provides instructions on the proper operation of this vehicle. The driver should read the Owner's Manual prior to driving the vehicle. Failure to follow the instructions in the Owner's Manual could lead to an accident, resulting in death or serious injury.

Please note that this manual applies to all models and explains all equipment, including options. Therefore, you may find some explanations for equipment not installed on your vehicle.

All specifications provided in this manual are current at the time of printing. However, because of the Lexus policy of continual product improvement, we reserve the right to make changes at any time without notice.

Depending on specifications, the vehicle shown in the illustrations may differ from your vehicle in terms of color and equipment.

### Noise from under vehicle after turning off the engine

Approximately five hours after the engine is turned off, you may hear sound coming from under the vehicle for several minutes. This is the sound of a fuel evaporation leakage check and, it does not indicate a malfunction.

### Accessories, spare parts and modification of your Lexus

A wide variety of non-genuine spare parts and accessories for Lexus vehicles are currently available in the market. You should know that Toyota does not warrant these products and is not responsible for their performance, repair, or replacement, or for any damage they may cause to, or adverse effect they may have on, your Lexus vehicle.

This vehicle should not be modified with non-genuine Lexus products. Modification with non-genuine Lexus products could affect its performance, safety or durability, and may even violate governmental regulations. In addition, damage or performance problems resulting from the modification may not be covered under warranty.

### Installation of a mobile two-way radio system

The installation of a mobile two-way radio system in your vehicle could affect electronic systems such as:

- Multiport fuel injection system/sequential multiport fuel injection system
- Dynamic radar cruise control system
- Cruise control system
- Anti-lock brake system
- SRS airbag system
- Seat belt pretensioner system

Be sure to check with your Lexus dealer for precautionary measures or special instructions regarding installation of a mobile two-way radio system.



## Vehicle data recordings

Your Lexus is equipped with several sophisticated computers that will record certain data, such as:

- Engine speed
- Accelerator status
- Brake status
- Vehicle speed
- Shift position

The recorded data varies according to the vehicle grade level and options with which it is equipped. Furthermore, these computers do not record conversations, sounds or pictures.

### ● Data usage

Lexus may use the data recorded in these computers to diagnose malfunctions, conduct research and development, and improve quality.

Lexus will not disclose the recorded data to a third party except:

- With the consent of the vehicle owner or with the consent of the lessee if the vehicle is leased
- In response to an official request by the police, a court of law or a government agency
- For use by Lexus in a lawsuit
- For research purposes where the data is not tied to a specific vehicle or vehicle owner

### ● Usage of data collected through Safety Connect / Lexus Enform (U.S. mainland only)

If your Lexus has Safety Connect or Lexus Enform and if you have subscribed to those services, please refer to the Safety Connect / Lexus Enform Telematics Subscription Service Agreement for information on data collected and its usage.

## Event data recorder

This vehicle is equipped with an event data recorder (EDR). The main purpose of an EDR is to record, in certain crash or near crash-like situations, such as an air bag deployment or hitting a road obstacle, data that will assist in understanding how a vehicle's systems performed. The EDR is designed to record data related to vehicle dynamics and safety systems for a short period of time, typically 30 seconds or less.

The EDR in this vehicle is designed to record such data as:

- How various systems in your vehicle were operating;
- Whether or not the driver and passenger safety belts were buckled/fastened;
- How far (if at all) the driver was depressing the accelerator and/or brake pedal; and,
- How fast the vehicle was traveling.

These data can help provide a better understanding of the circumstances in which crashes and injuries occur.

NOTE: EDR data are recorded by your vehicle only if a nontrivial crash situation occurs; no data are recorded by the EDR under normal driving conditions and no personal data (e.g., name, gender, age, and crash location) are recorded. However, other parties, such as law enforcement, could combine the EDR data with the type of personally identifying data routinely acquired during a crash investigation.

To read data recorded by an EDR, special equipment is required, and access to the vehicle or the EDR is needed. In addition to the vehicle manufacturer, other parties, such as law enforcement, that have the special equipment, can read the information if they have access to the vehicle or the EDR.

### ● Disclosure of the EDR data

Lexus will not disclose the data recorded in an EDR to a third party except when:

- An agreement from the vehicle's owner (or the lessee for a leased vehicle) is obtained
- In response to an official request by the police, a court of law or a government agency
- For use by Lexus in a lawsuit

However, if necessary, Lexus may:

- Use the data for research on vehicle safety performance
- Disclose the data to a third party for research purposes without disclosing information about the specific vehicle or vehicle owner

## Scrapping of your Lexus

The SRS airbag and seat belt pretensioner devices in your Lexus contain explosive chemicals. If the vehicle is scrapped with the airbags and seat belt pretensioners not deployed, this may cause an accident such as fire. Be sure to have the systems of the SRS airbag and seat belt pretensioner removed and disposed of by a qualified service shop or by your Lexus dealer before you scrap your vehicle.

## Perchlorate Material

Special handling may apply, See [www.dtsc.ca.gov/hazardouswaste/perchlorate](http://www.dtsc.ca.gov/hazardouswaste/perchlorate).

Your vehicle has components that may contain perchlorate. These components may include airbag, seat belt pretensioners, and wireless remote control batteries.

### WARNING

#### ■ General precautions while driving

- Obey all traffic laws
- The driver is responsible for the proper operation of the vehicle, including evaluation of weather conditions and road conditions.

Driving under the influence: Never drive your vehicle when under the influence of alcohol or drugs that have impaired your ability to operate your vehicle. Alcohol and certain drugs delay reaction time, impair judgment and reduce coordination, which could lead to an accident that could result in death or serious injury.

Defensive driving: Always drive defensively. Anticipate mistakes that other drivers or pedestrians might make and be ready to avoid accidents.

Driver distraction: Always give your full attention to driving. Anything that distracts the driver, such as adjusting controls, talking on a cellular phone or reading can result in a collision causing death or serious injury to you, your occupants or others.

#### ■ General precaution regarding children's safety

Never leave children unattended in the vehicle, and never allow children to have or use the key.

Children may be able to start the vehicle or shift the vehicle into neutral. There is also a danger that children may injure themselves by playing with the windows, the moon roof, or other features of the vehicle. In addition, heat build-up or extremely cold temperatures inside the vehicle can be fatal to children.

## Reading this manual

 **WARNING:**  
Explains something that, if not obeyed, could cause death or serious injury to people.

 **NOTICE:**  
Explains something that, if not obeyed, could cause damage to or a malfunction in the vehicle or its equipment.

**1 2 3**... Indicates operating or working procedures. Follow the steps in numerical order.

 Indicates the action (pushing, turning, etc.) used to operate switches and other devices.

 Indicates the outcome of an operation (e.g. a lid opens).

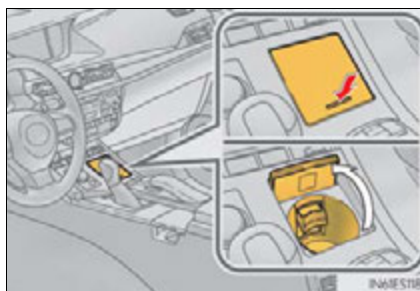

 Indicates the component or position being explained.

 Means "Do not", "Do not do this", or "Do not let this happen".

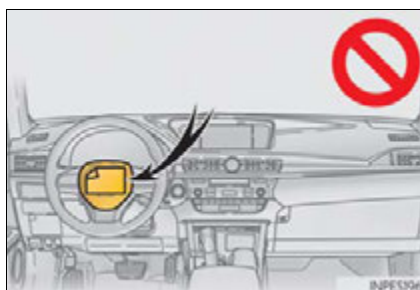

## How to search

### ■ Searching by name

- Alphabetical index.....P. 560

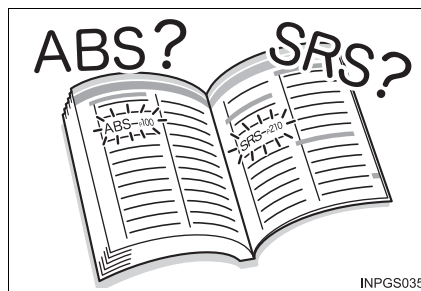

### ■ Searching by installation position

- Pictorial index.....P. 14

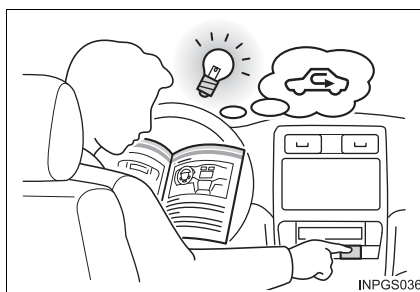

### ■ Searching by symptom or sound

- What to do if...  
(Troubleshooting).....P. 556



### ■ Searching by title

- Table of contents.....P. 2

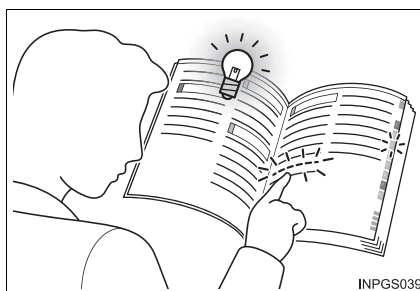

## Pictorial index

### ■ Exterior

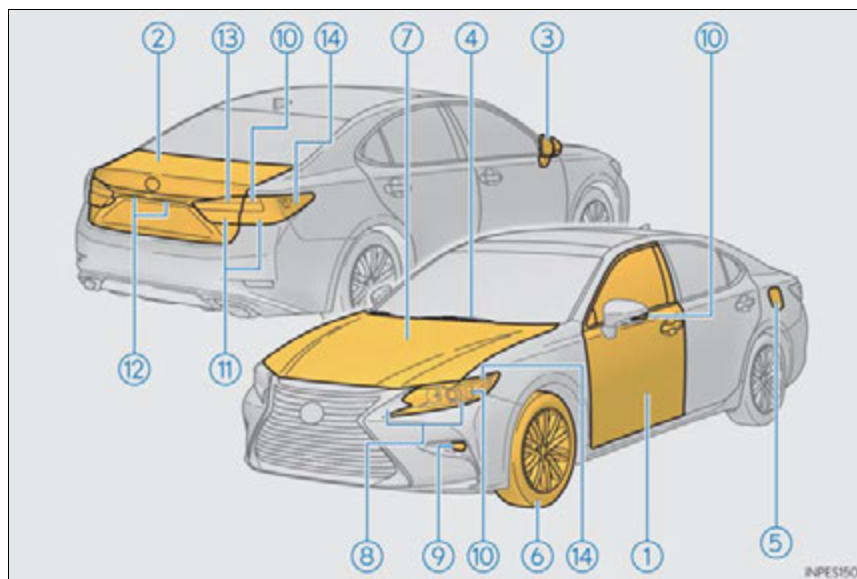

①	<b>Doors</b> .....	<b>P. 93</b>
	Locking/unlocking .....	P. 93
	Opening/closing the door glasses .....	P. 129
	Locking/unlocking by using the mechanical key .....	P. 499
	Warning lights/warning messages .....	P. 482
②	<b>Trunk</b> .....	<b>P. 99</b>
	Opening from inside .....	P. 99
	Opening from outside .....	P. 99
	Opening by using the mechanical key .....	P. 499
	Warning lights/warning messages .....	P. 482
③	<b>Outside rear view mirrors</b> .....	<b>P. 126</b>
	Adjusting the mirror angle .....	P. 126
	Folding the mirrors .....	P. 126
	Driving position memory* .....	P. 115
	Defogging the mirrors .....	P. 368

④	<b>Windshield wipers</b> .....	<b>P. 169</b>
	Precautions against winter season .....	P. 260
	To prevent freezing (windshield wiper de-icer)* .....	P. 369
	Precautions against car wash .....	P. 409
⑤	<b>Fuel filler door</b> .....	<b>P. 173</b>
	Refueling method .....	P. 173
	Fuel type/fuel tank capacity .....	P. 514
⑥	<b>Tires</b> .....	<b>P. 436</b>
	Tire size/inflation pressure .....	P. 518
	Winter tires/tire chain .....	P. 260
	Checking/rotation/tire pressure warning system .....	P. 436
	Coping with flat tires .....	P. 485
⑦	<b>Hood</b> .....	<b>P. 423</b>
	Opening .....	P. 423
	Engine compartment cover .....	P. 426
	Engine oil .....	P. 514
	Coping with overheat .....	P. 505
	Warning messages .....	P. 482

**Light bulbs of the exterior lights for driving**  
(Replacing method: P. 456, Watts: P. 520)

⑧	<b>Headlights/parking lights/daytime running lights</b> .....	<b>P. 161</b>
⑨	<b>Fog lights</b> .....	<b>P. 168</b>
⑩	<b>Turn signal lights</b> .....	<b>P. 159</b>
⑪	<b>Stop/tail lights</b> .....	<b>P. 161</b>
⑫	<b>License plate lights</b> .....	<b>P. 161</b>
⑬	<b>Back-up lights</b>	
	Shifting the shift lever to R .....	P. 156
⑭	<b>Side marker lights</b> .....	<b>P. 161</b>

\*: If equipped

■ Instrument panel

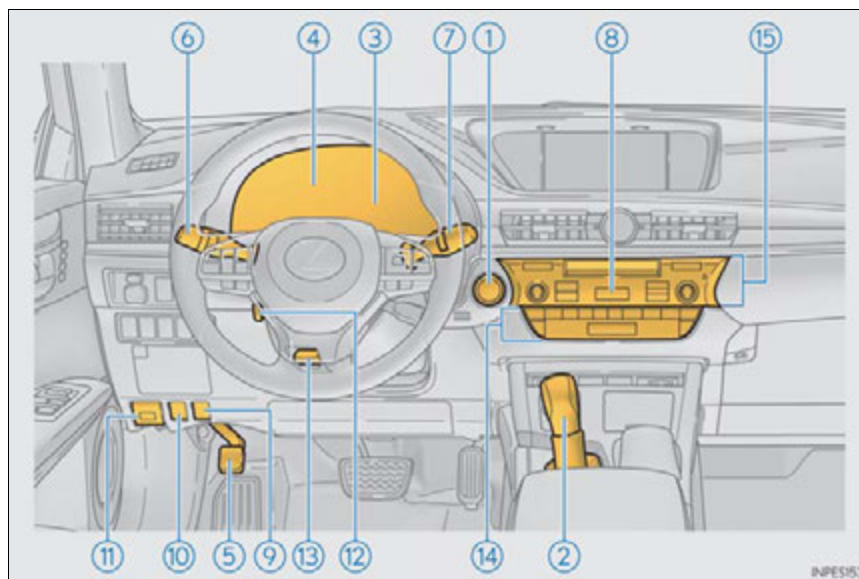

①	<b>Engine switch</b> .....	<b>P. 151</b>
	Starting the engine/changing the modes .....	P. 151
	Emergency stop of the engine .....	P. 469
	When the engine will not start .....	P. 496
	Warning messages .....	P. 482
②	<b>Shift lever</b> .....	<b>P. 156</b>
	Changing the shift position .....	P. 156
	Precautions against towing .....	P. 470
	When the shift lever does not move .....	P. 498
③	<b>Meters</b> .....	<b>P. 74</b>
	Reading the meters/adjusting the instrument panel light .....	P. 74
	Warning lights/indicator lights .....	P. 70
	When the warning lights come on .....	P. 476



④	<b>Multi-information display</b> .....	<b>P. 78</b>
	Display .....	P. 78
	When the warning messages are displayed .....	P. 482
⑤	<b>Parking brake</b> .....	<b>P. 160</b>
	Applying/releasing .....	P. 160
	Precautions against winter season .....	P. 261
	Warning buzzer/message .....	P. 160, 482
⑥	<b>Turn signal lever</b> .....	<b>P. 159</b>
	<b>Headlight switch</b> .....	<b>P. 161</b>
	Headlights/parking lights/tail lights/daytime running lights .....	P. 161
	Fog lights .....	P. 168
⑦	<b>Windshield wiper and washer switch</b> .....	<b>P. 169</b>
	Usage .....	P. 169
	Adding washer fluid .....	P. 435
	Warning messages .....	P. 482
⑧	<b>Emergency flasher switch</b> .....	<b>P. 468</b>
⑨	<b>Fuel filler door opener</b> .....	<b>P. 174</b>
	Refueling method .....	P. 173
	Fuel type/fuel tank capacity .....	P. 514
⑩	<b>Trunk opener</b> .....	<b>P. 99</b>
⑪	<b>Hood lock release lever</b> .....	<b>P. 423</b>
⑫	<b>Tilt and telescopic steering control switch</b> *1 .....	<b>P. 122</b>
	Driving position memory *1 .....	P. 115
⑬	<b>Tilt and telescopic steering lock release lever</b> *1 .....	<b>P. 122</b>
⑭	<b>Air conditioning system</b> .....	<b>P. 364</b>
	Usage .....	P. 364
	Rear window and outside rear view mirror defoggers .....	P. 368
⑮	<b>Audio system</b> *2 .....	<b>P. 266</b>
	Hands-free system .....	P. 325

\*1: If equipped

\*2: For vehicles with navigation system, refer to  
"NAVIGATION SYSTEM OWNER'S MANUAL".

■ Switches

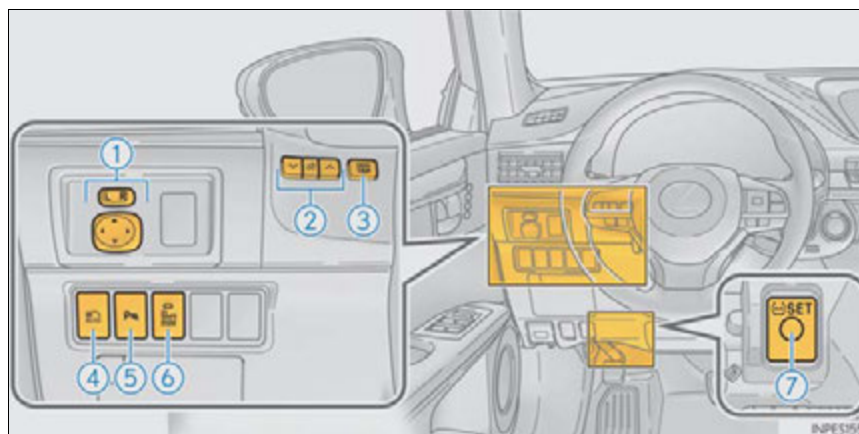

- ① Outside rear view mirror switches ..... P.126
- ② Instrument panel light control switches ..... P.75
- ③ Odometer/trip meter and trip meter reset button ..... P.75
- ④ Automatic High Beam switch\* ..... P.164
- ⑤ Intuitive parking assist switch\* ..... P.220
- ⑥ BSM (Blind Spot Monitor) main switch\* ..... P.247
- ⑦ Tire pressure warning reset switch ..... P.438

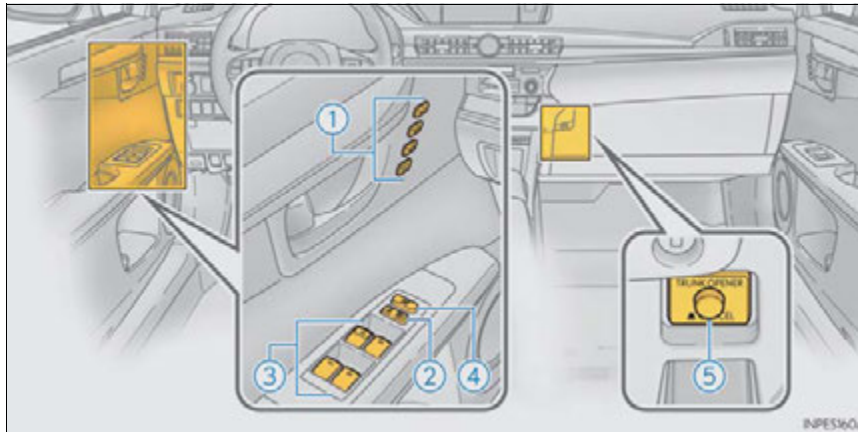

- ① Driving position memory switches\* ..... P.115
- ② Door lock switch..... P.95
- ③ Power window switches ..... P.129
- ④ Window lock switch ..... P.129
- ⑤ Trunk opener main switch ..... P.100

\*: If equipped

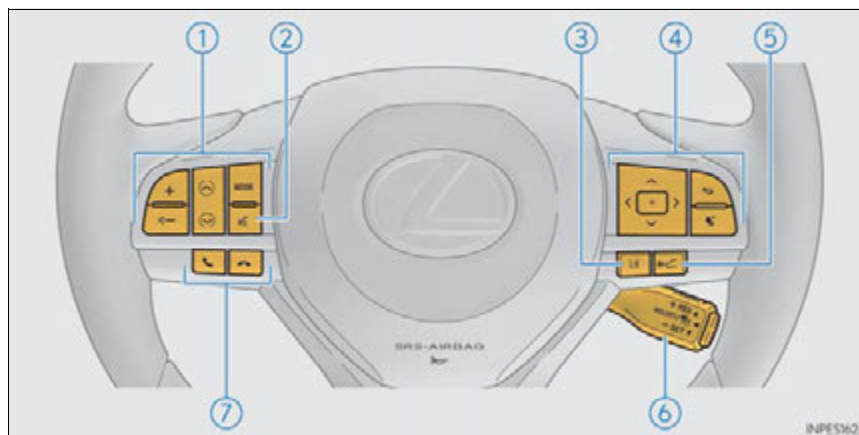

- ① Audio remote control switches<sup>\*1</sup> ..... P.273
- ② Talk switch<sup>\*1</sup> ..... P.336
- ③ LDA (Lane Departure Alert with steering control) switch<sup>\*2</sup> ..... P.196
- ④ Meter control switches ..... P.79
- ⑤ Vehicle-to-vehicle distance button<sup>\*2</sup> ..... P.205
- ⑥ Cruise control switch
  - Cruise control<sup>\*2</sup> ..... P.217
  - Dynamic radar cruise control<sup>\*2</sup> ..... P.205
- ⑦ Telephone switches<sup>\*1</sup> ..... P.336

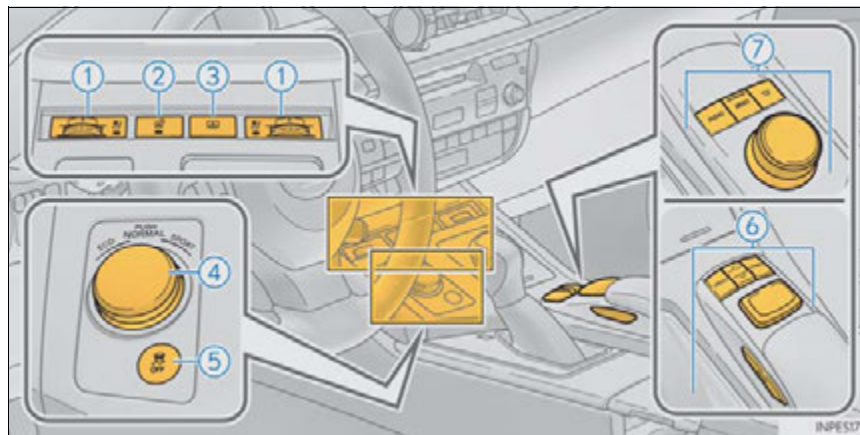

- ① Seat heater and ventilator switches<sup>\*2</sup> ..... P. 374
- ② Heated steering wheel switch<sup>\*2</sup> ..... P. 374
- ③ Rear sunshade switch<sup>\*2</sup> ..... P. 387
- ④ Driving mode select switch ..... P. 245
- ⑤ VSC OFF switch ..... P. 256
- ⑥ Remote Touch<sup>\*1</sup>
- ⑦ Lexus Display Audio controller<sup>\*2</sup> ..... P. 268

<sup>\*1</sup>: For vehicles with navigation system, refer to "NAVIGATION SYSTEM OWNER'S MANUAL".

<sup>\*2</sup>: If equipped

■ Interior

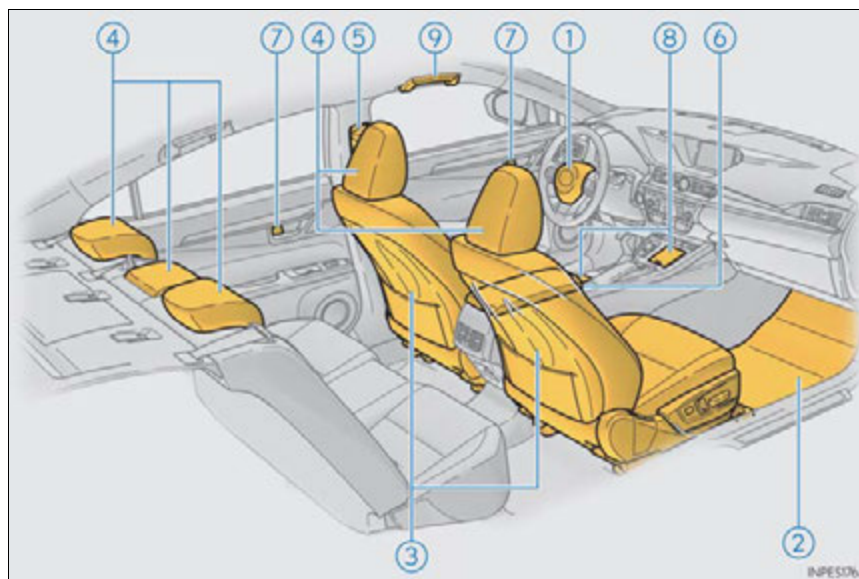

① SRS airbags.....	P. 35
② Floor mats.....	P. 26
③ Front seats.....	P. 114
④ Head restraints.....	P. 119
⑤ Seat belts.....	P. 30
⑥ Console box.....	P. 379
⑦ Inside lock buttons.....	P. 95
⑧ Cup holders.....	P. 380
⑨ Assist grips.....	P. 390

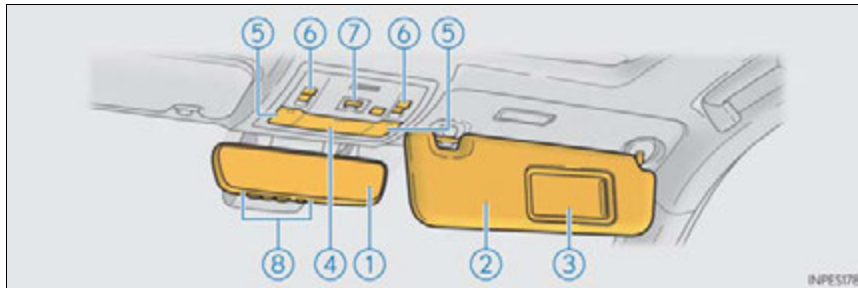

- |   |                                   |        |
|---|-----------------------------------|--------|
| ① | Inside rear view mirror .....     | P. 124 |
| ② | Sun visors .....                  | P. 384 |
| ③ | Vanity mirrors.....               | P. 384 |
| ④ | Interior lights *1 .....          | P. 376 |
| ⑤ | Personal lights *1 .....          | P. 376 |
| ⑥ | Moon roof switches .....          | P. 132 |
| ⑦ | “SOS” button *2 .....             | P. 402 |
| ⑧ | Garage door opener switches ..... | P. 391 |

\*1: The illustration shows the front, but they are also equipped in the rear.

\*2: If equipped





- 1-1. **For safe use**
  - Before driving..... 26
  - For safe driving..... 28
  - Seat belts .....30
  - SRS airbags ..... 35
  - Front passenger occupant classification system..... 44
  - Safety information for children.....50
  - Child restraint systems .....51
  - Installing child restraints..... 55
  - Exhaust gas precautions ..... 64
- 1-2. **Theft deterrent system**
  - Engine immobilizer system..... 65
  - Alarm .....67

## Before driving

### Floor mat

Use only floor mats designed specifically for vehicles of the same model and model year as your vehicle. Fix them securely in place onto the carpet.

- 1 Insert the retaining hooks (clips) into the floor mat eyelets.

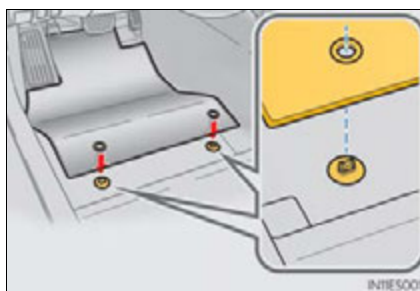

- 2 Turn the upper knob of each retaining hook (clip) to secure the floor mats in place.

\*: Always align the  $\triangle$  marks.

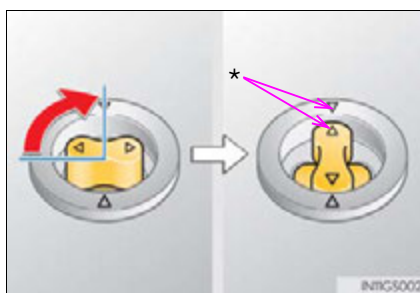

The shape of the retaining hooks (clips) may differ from that shown in the illustration.

**⚠ WARNING**

Observe the following precautions.

Failure to do so may cause the driver's floor mat to slip, possibly interfering with the pedals while driving. An unexpectedly high speed may result or it may become difficult to stop the vehicle. This could lead to an accident, resulting in death or serious injury.

**■ When installing the driver's floor mat**

- Do not use floor mats designed for other models or different model year vehicles, even if they are Lexus Genuine floor mats.
- Only use floor mats designed for the driver's seating position.
- Always install the floor mat securely using the retaining hooks (clips) provided.
- Do not use two or more floor mats on top of each other.
- Do not place the floor mat bottom-side up or upside-down.

**■ Before driving**

- Check that the floor mat is securely fixed in the correct place with all the provided retaining hooks (clips). Be especially careful to perform this check after cleaning the floor.
- With the engine stopped and the shift lever in P, fully depress each pedal to the floor to make sure it does not interfere with the floor mat.

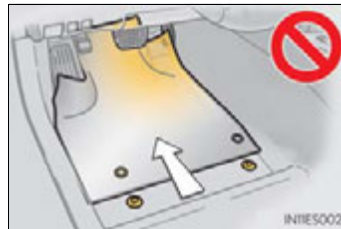

## For safe driving

For safe driving, adjust the seat and mirror to an appropriate position before driving.

### Correct driving posture

- ① Adjust the angle of the seatback so that you are sitting straight up and so that you do not have to lean forward to steer. (→P. 114)
- ② Adjust the seat so that you can depress the pedals fully and so that your arms bend slightly at the elbow when gripping the steering wheel. (→P. 114)
- ③ Lock the head restraint in place with the center of the head restraint closest to the top of your ears. (→P. 119)
- ④ Wear the seat belt correctly. (→P. 30)

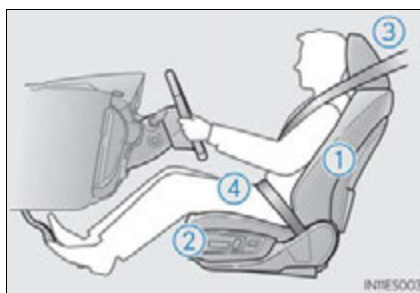

### Correct use of the seat belts

Make sure that all occupants are wearing their seat belts before driving the vehicle. (→P. 30)

Use a child restraint system appropriate for the child until the child becomes large enough to properly wear the vehicle's seat belt. (→P. 51)

### Adjusting the mirrors

Make sure that you can see backward clearly by adjusting the inside and outside rear view mirrors properly. (→P. 124, 126)

 **WARNING**

Observe the following precautions.

Failure to do so may result in death or serious injury.

- Do not adjust the position of the driver's seat while driving.  
Doing so could cause the driver to lose control of the vehicle.
- Do not place a cushion between the driver or passenger and the seatback.  
A cushion may prevent correct posture from being achieved, and reduce the effectiveness of the seat belt, head restraint and other safety systems, increasing the risk of death or serious injury to the occupant.
- Do not place anything under the front seats.  
Objects placed under the front seats may become jammed in the seat tracks and stop the seat from locking in place. This may lead to an accident and the adjustment mechanism may also be damaged.
- When driving over long distances, take regular breaks before you start to feel tired.  
Also, if you feel tired or sleepy while driving, do not force yourself to continue driving and take a break immediately.

## Seat belts

Make sure that all occupants are wearing their seat belts before driving the vehicle.

### Correct use of the seat belts

- Extend the shoulder belt so that it comes fully over the shoulder, but does not come into contact with the neck or slide off the shoulder.
- Position the lap belt as low as possible over the hips.
- Adjust the position of the seatback. Sit up straight and well back in the seat.
- Do not twist the seat belt.

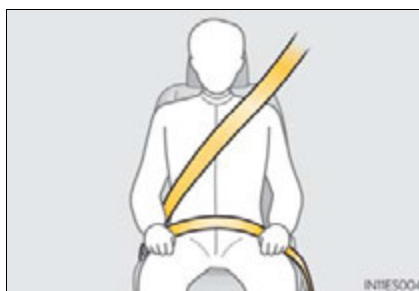

### Fastening and releasing the seat belt

- ① To fasten the seat belt, push the plate into the buckle until a click sound is heard.
- ② To release the seat belt, press the release button.

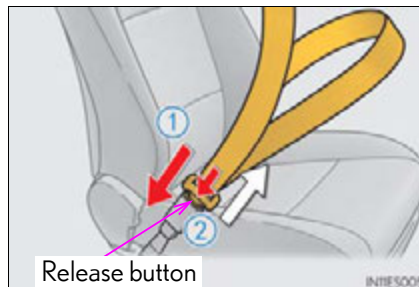

### Adjusting the seat belt shoulder anchor height (front seats)

- ① Push the seat belt shoulder anchor down while pressing the release button.
- ② Push the seat belt shoulder anchor up.

Move the height adjuster up and down as needed until you hear a click.



### Seat belt pretensioners (front and outboard rear seats)

The pretensioners help the seat belts to quickly restrain the occupants by retracting the seat belts when the vehicle is subjected to certain types of severe frontal collision or a vehicle roll-over.

The front seat belt pretensioners also activate when the vehicle is subjected to certain types of severe side collision.

The pretensioners do not activate in the event of a minor frontal impact, a minor side impact or a rear impact.

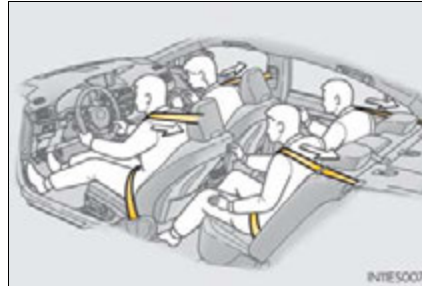

#### ■ Emergency locking retractor (ELR)

The retractor will lock the belt during a sudden stop or on impact. It may also lock if you lean forward too quickly. A slow, easy motion will allow the belt to extend so that you can move around fully.

#### ■ Automatic locking retractor (ALR)

When a passenger's shoulder belt is completely extended and then retracted even slightly, the belt is locked in that position and cannot be extended. This feature is used to hold the child restraint system (CRS) firmly. To free the belt again, fully retract the belt and then pull the belt out once more. (→P. 55)

#### ■ Child seat belt usage

The seat belts of your vehicle were principally designed for persons of adult size.

- Use a child restraint system appropriate for the child, until the child becomes large enough to properly wear the vehicle's seat belt. (→P. 51)
- When the child becomes large enough to properly wear the vehicle's seat belt, follow the instructions regarding seat belt usage. (→P. 30)

#### ■ Replacing the belt after the pretensioner has been activated

If the vehicle is involved in multiple collisions, the pretensioner will activate for the first collision of sufficient severity, but will not activate for the second or subsequent collisions. The seat belt must be replaced if the pretensioner has been activated.

#### ■ Seat belt extender

If your seat belts cannot be fastened securely because they are not long enough, a personalized seat belt extender is available from your Lexus dealer free of charge.

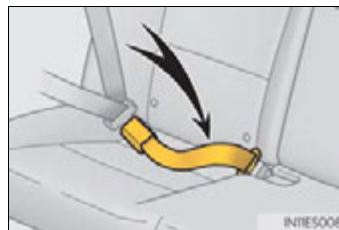

**⚠ WARNING**

Observe the following precautions to reduce the risk of injury in the event of sudden braking, sudden swerving or an accident. Failure to do so may cause death or serious injury.

**■ Wear a seat belt**

- Ensure that all passengers wear a seat belt.
- Always wear a seat belt properly.
- Each seat belt should be used by one person only. Do not use a seat belt for more than one person at once, including children.
- Lexus recommends that children be seated in the rear seat and always use a seat belt and/or an appropriate child restraint system.
- To achieve a proper seating position, do not recline the seat more than necessary. The seat belt is most effective when the occupants are sitting up straight and well back in the seats.
- Do not wear the shoulder belt under your arm.
- Always wear your seat belt low and snug across your hips.

**■ Pregnant women**

Obtain medical advice and wear the seat belt in the proper way. (→P. 30)

Women who are pregnant should position the lap belt as low as possible over the hips in the same manner as other occupants, extending the shoulder belt completely over the shoulder and avoiding belt contact with the rounding of the abdominal area.

If the seat belt is not worn properly, not only the pregnant woman, but also the fetus could suffer death or serious injury as a result of sudden braking or a collision.

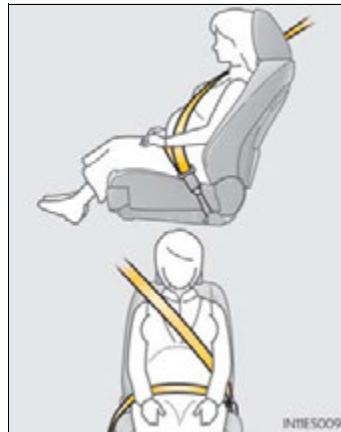



**⚠ WARNING****■ People with medical conditions**

Obtain medical advice and wear the seat belt in the proper way. (→P. 30)

**■ When children are in the vehicle**

Do not allow children to play with the seat belt. If the seat belt becomes twisted around a child's neck, it may lead to choking or other serious injuries that could result in death. If this occurs and the child cannot be released from the seat belt, scissors should be used to cut the belt.

**■ Seat belt pretensioners**

- Do not place anything, such as a cushion, on the front passenger's seat. Doing so will disperse the passenger's weight, which prevents the sensor from detecting the passenger's weight properly. As a result, the seat belt pretensioner for the front passenger's seat may not activate in the event of a collision.
- If the pretensioner has activated, the SRS warning light will come on. In that case, the seat belt cannot be used again and must be replaced at your Lexus dealer.

**■ Adjustable shoulder anchor**

Always make sure the shoulder belt is positioned across the center of your shoulder. The belt should be kept away from your neck, but not falling off your shoulder. Failure to do so could reduce the amount of protection in an accident and cause death or serious injuries in the event of a sudden stop, sudden swerve or accident. (→P. 30)

**■ Seat belt damage and wear**

- Do not damage the seat belts by allowing the belt, plate, or buckle to be jammed in the door.
- Inspect the seat belt system periodically. Check for cuts, fraying, and loose parts. Do not use a damaged seat belt until it is replaced. Damaged seat belts cannot protect an occupant from death or serious injury.
- Ensure that the belt and plate are locked and the belt is not twisted.  
If the seat belt does not function correctly, immediately contact your Lexus dealer.
- Replace the seat assembly, including the belts, if your vehicle has been involved in a serious accident, even if there is no obvious damage.
- Do not attempt to install, remove, modify, disassemble or dispose of the seat belts. Have any necessary repairs carried out by your Lexus dealer. Inappropriate handling may lead to incorrect operation.

**■ Using a seat belt extender**

- Do not wear the seat belt extender if you can fasten the seat belt without the extender.
- Do not use the seat belt extender when installing a child restraint system because the belt will not securely hold the child restraint system, increasing the risk of death or serious injury in the event of an accident.
- The personalized extender may not be safe on another vehicle, when used by another person, or at a different seating position other than the one originally intended.

 NOTICE**■ When using a seat belt extender**

When releasing the seat belt, press on the buckle release button on the extender, not on the seat belt.

This helps prevent damage to the vehicle interior and the extender itself.

## SRS airbags

The SRS airbags inflate when the vehicle is subjected to certain types of severe impacts that may cause significant injury to the occupants. They work together with the seat belts to help reduce the risk of death or serious injury.

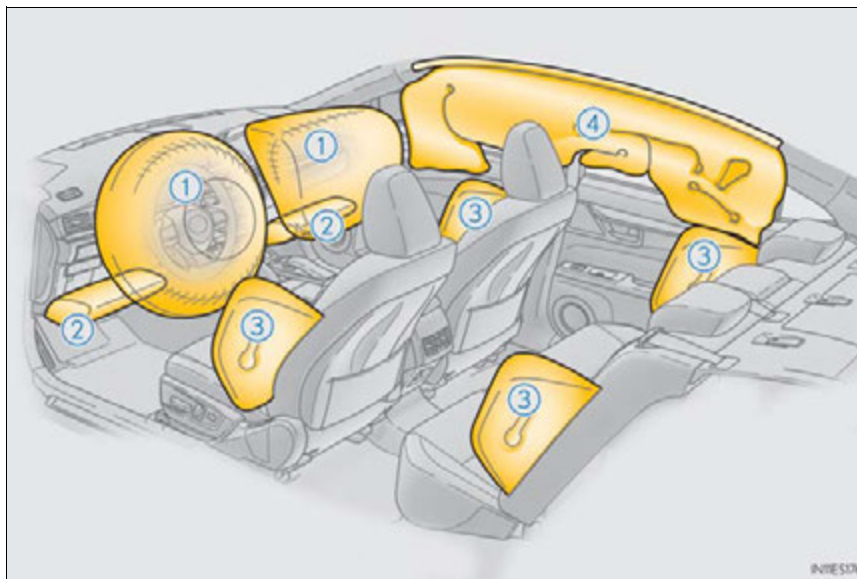

### ◆ SRS front airbags

- ① SRS driver airbag/front passenger airbag  
Can help protect the head and chest of the driver and front passenger from impact with interior components
- ② SRS knee airbags  
Can help provide driver and front passenger protection

### ◆ SRS side and curtain shield airbags

- ③ SRS front side airbags  
Can help protect the torso of the front seat occupants
- SRS rear side airbags  
Can help protect the torso of occupants in the rear outer seats

- ④ SRS curtain shield airbags
  - Can help protect primarily the head of occupants in the outer seats
  - Can prevent the occupants from being thrown from the vehicle in the event of vehicle rollover

### SRS airbag system components

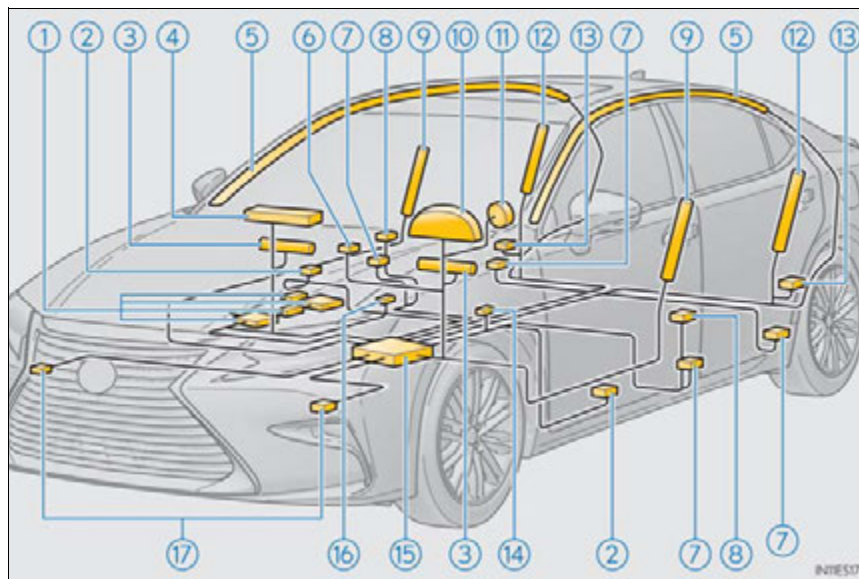

- |  |   |
|--|---|
| ① Front passenger occupant classification system (ECU and sensors) | ⑧ Side impact sensors (front)               |
| ② Side impact sensors (front doors)                                | ⑨ Front side airbags                        |
| ③ Knee airbags   | ⑩ SRS warning light                         |
| ④ Front passenger airbag   | ⑪ Driver airbag                             |
| ⑤ Curtain shield airbags   | ⑫ Rear side airbags                         |
| ⑥ "AIR BAG ON" and "AIR BAG OFF" indicator lights                  | ⑬ Side impact sensors (rear)                |
| ⑦ Seat belt pretensioners and force limiters                       | ⑭ Driver's seat belt buckle switch          |
|  | ⑮ Airbag sensor assembly                    |
|  | ⑯ Front passenger's seat belt buckle switch |
|  | ⑰ Front impact sensors                      |

Your vehicle is equipped with ADVANCED AIRBAGS designed based on the US motor vehicle safety standards (FMVSS208). The airbag sensor assembly (ECU) controls airbag deployment based on information obtained from the sensors etc. shown in the system components diagram above. This information includes crash severity and occupant information. As the airbags deploy, a chemical reaction in the inflators quickly fills the airbags with non-toxic gas to help restrain the motion of the occupants.

 **WARNING**

■ **SRS airbag precautions**

Observe the following precautions regarding the SRS airbags.  
Failure to do so may cause death or serious injury.

- The driver and all passengers in the vehicle must wear their seat belts properly.  
The SRS airbags are supplemental devices to be used with the seat belts.
- The SRS driver airbag deploys with considerable force, and can cause death or serious injury especially if the driver is very close to the airbag. The National Highway Traffic Safety Administration (NHTSA) advises:

Since the risk zone for the driver's airbag is the first 2 - 3 in. (50 - 75 mm) of inflation, placing yourself 10 in. (250 mm) from your driver airbag provides you with a clear margin of safety. This distance is measured from the center of the steering wheel to your breastbone. If you sit less than 10 in. (250 mm) away now, you can change your driving position in several ways:

- Move your seat to the rear as far as you can while still reaching the pedals comfortably.
- Slightly recline the back of the seat.  
Although vehicle designs vary, many drivers can achieve the 10 in. (250 mm) distance, even with the driver seat all the way forward, simply by reclining the back of the seat somewhat. If reclining the back of your seat makes it hard to see the road, raise yourself by using a firm, non-slippery cushion, or raise the seat if your vehicle has that feature.
- If your steering wheel is adjustable, tilt it downward. This points the airbag toward your chest instead of your head and neck.

The seat should be adjusted as recommended by NHTSA above, while still maintaining control of the foot pedals, steering wheel, and your view of the instrument panel controls.

**⚠ WARNING**

■ **SRS airbag precautions**

- If the seat belt extender has been connected to the front seat belt buckle but the seat belt extender has not also been fastened to the latch plate of the seat belt, the SRS front airbags will judge that the driver and front passenger are wearing the seat belt even though the seat belt has not been connected. In this case, the SRS front airbags may not activate correctly in a collision, resulting in death or serious injury in the event of a collision. Be sure to wear the seat belt with the seat belt extender.



- The SRS front passenger airbag also deploys with considerable force, and can cause death or serious injury especially if the front passenger is very close to the airbag. The front passenger seat should be as far from the airbag as possible with the seatback adjusted, so the front passenger sits upright.
- Improperly seated and/or restrained infants and children can be killed or seriously injured by a deploying airbag. An infant or child who is too small to use a seat belt should be properly secured using a child restraint system. Lexus strongly recommends that all infants and children be placed in the rear seats of the vehicle and properly restrained. The rear seats are safer for infants and children than the front passenger seat. (→P. 51)

- Do not sit on the edge of the seat or lean against the dashboard.



- Do not allow a child to stand in front of the SRS front passenger airbag unit or sit on the knees of a front passenger.
- Do not allow the front seat occupants to hold items on their knees.

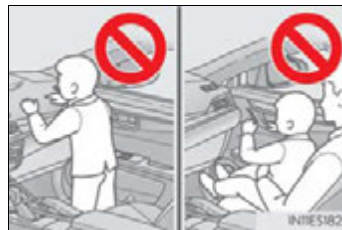

**⚠ WARNING**

■ **SRS airbag precautions**

- Do not lean against the door, the roof side rail or the front, side and rear pillars.



- Do not allow anyone to kneel on the passenger seats toward the door or put their head or hands outside the vehicle.



- Do not attach anything to or lean anything against areas such as the dashboard, steering wheel pad, lower portion of the instrument panel and door of the glove box. These items can become projectiles when the SRS driver, front passenger and knee airbags deploy.

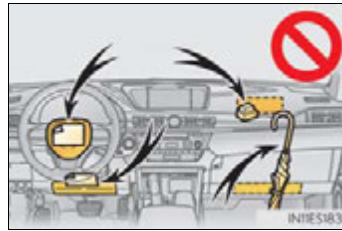

- Do not attach anything to areas such as a door, windshield glass, side door glass, front or rear pillar, roof side rail and assist grip.

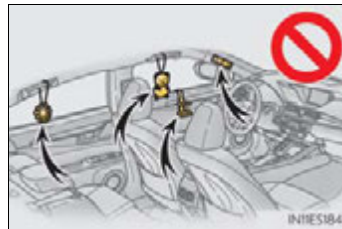

- Do not hang coat hangers or hard objects on the coat hooks. All of these items could become projectiles and may cause death or serious injury, should the SRS curtain shield airbags deploy.
- If a vinyl cover is put on the area where the SRS knee airbag will deploy, be sure to remove it.
- Do not use seat accessories which cover the parts where the SRS side airbags inflate as they may interfere with inflation of the airbags. Such accessories may prevent the side airbags from activating correctly, disable the system or cause the side airbags to inflate accidentally, resulting in death or serious injury.

 **WARNING****■ SRS airbag precautions**

- Do not strike or apply significant levels of force to the area of the SRS airbag components.  
Doing so can cause the SRS airbags to malfunction.
- Do not touch any of the component parts immediately after the SRS airbags have deployed (inflated) as they may be hot.
- If breathing becomes difficult after the SRS airbags have deployed, open a door or window to allow fresh air in, or leave the vehicle if it is safe to do so. Wash off any residue as soon as possible to prevent skin irritation.
- If the areas where the SRS airbags are stored, such as the steering wheel pad and front and rear pillar garnishes are damaged or cracked, have them replaced by your Lexus dealer.

**■ Modification and disposal of SRS airbag system components**

Do not dispose of your vehicle or perform any of the following modifications without consulting your Lexus dealer. The SRS airbags may malfunction or deploy (inflate) accidentally, causing death or serious injury.

- Installation, removal, disassembly and repair of the SRS airbags
- Repairs, modifications, removal or replacement of the steering wheel, instrument panel, dashboard, glove box, seats or seat upholstery, front, side and rear pillars or roof side rails
- Repairs or modifications of the front fender, front bumper, or side of the occupant compartment
- Installation of a grille guard (bull bars, kangaroo bar, etc.), snow plows, winches or roof luggage carrier
- Modifications to the vehicle's suspension system
- Installation of electronic devices such as mobile two-way radios and CD players
- Modifications to your vehicle for a person with a physical disability

**■ If the SRS airbags deploy (inflate)**

- Slight abrasions, burns, bruising etc., may be sustained from SRS airbags, due to the extremely high speed deployment (inflation) by hot gases.
- A loud noise and white powder will be emitted.
- Parts of the airbag module (steering wheel hub, airbag cover and inflator) as well as the seats, parts of the front and rear pillars, and roof side rails may be hot for several minutes. The airbag itself may also be hot.
- The windshield may crack.
- For Lexus Enform Safety Connect subscribers, if the SRS airbags deploy or in the event of a severe rear-end collision, the system is designed to send an emergency call to the response center, notifying them of the vehicle's location (without needing to push the "SOS" button) and an agent will attempt to speak with the occupants to ascertain the level of emergency and assistance required. If the occupants are unable to communicate, the agent automatically treats the call as an emergency and helps to dispatch the necessary emergency services. (→P. 402)



### ■ SRS airbag deployment conditions (SRS front airbags)

- The SRS front airbags will deploy in the event of an impact that exceeds the set threshold level (the level of force corresponding to an approximately 12 - 18 mph [20 - 30 km/h] frontal collision with a fixed wall that does not move or deform).

However, this threshold velocity will be considerably higher in the following situations:

- If the vehicle strikes an object, such as a parked vehicle or sign pole, which can move or deform on impact
- If the vehicle is involved in an underride collision, such as a collision in which the front of the vehicle "underrides", or goes under, the bed of a truck

- Depending on the type of collision, it is possible that only the seat belt pretensioners will activate.

- The SRS front airbags for the front passenger will not activate if there is no passenger sitting in the front passenger seat. However, the SRS front airbags for the front passenger may deploy if luggage is put in the seat, even if the seat is unoccupied. (→P. 44)

### ■ SRS airbag deployment conditions (SRS side and curtain shield airbags)

- The SRS side and curtain shield airbags will deploy in the event of an impact that exceeds the set threshold level (the level of force corresponding to the impact force produced by an approximately 3300 lb. [1500 kg] vehicle colliding with the vehicle cabin from a direction perpendicular to the vehicle orientation at an approximate speed of 12 - 18 mph [20 - 30 km/h]).

- The SRS curtain shield airbags will deploy in the event of vehicle rollover.

- The SRS side and curtain shield airbags may also deploy in the event of a severe frontal collision.

### ■ Conditions under which the SRS airbags may deploy (inflate), other than a collision

The SRS front airbags and SRS curtain shield airbag may also deploy if a serious impact occurs to the underside of your vehicle. Some examples are shown in the illustration.

- Hitting a curb, edge of pavement or hard surface
- Falling into or jumping over a deep hole
- Landing hard or falling

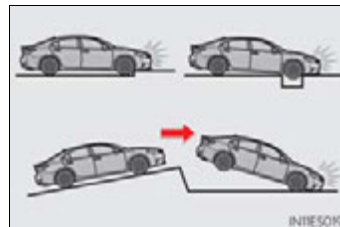

The SRS curtain shield airbags may also deploy under the situations shown in the illustration.

- The angle of vehicle tip-up is marginal.
- The vehicle skids and hits a curb stone.

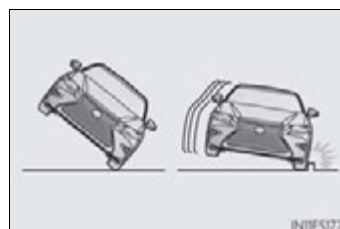

### ■ Types of collisions that may not deploy the SRS airbags (SRS front airbags)

The SRS front airbags do not generally inflate if the vehicle is involved in a side or rear collision, if it rolls over, or if it is involved in a low-speed frontal collision. But, whenever a collision of any type causes sufficient forward deceleration of the vehicle, deployment of the SRS front airbags may occur.

- Collision from the side
- Collision from the rear
- Vehicle rollover

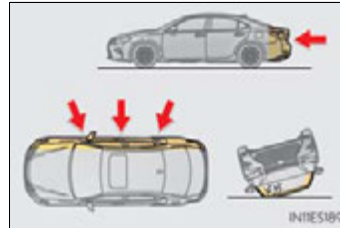

### ■ Types of collisions that may not deploy the SRS airbags (SRS side and curtain shield airbags)

The SRS side and curtain shield airbags may not activate if the vehicle is subjected to a collision from the side at certain angles, or a collision to the side of the vehicle body other than the passenger compartment.

- Collision from the side to the vehicle body other than the passenger compartment
- Collision from the side at an angle

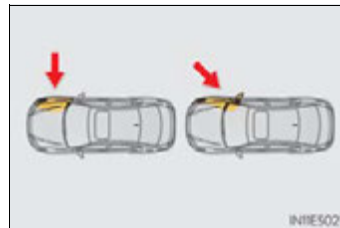

The SRS side airbags do not generally inflate if the vehicle is involved in a rear collision, if it rolls over, or if it is involved in a low-speed side or low-speed frontal collision.

- Collision from the rear
- Vehicle rollover

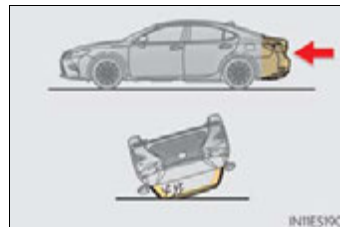

The SRS curtain shield airbags do not generally inflate if the vehicle is involved in a rear collision, if it pitches end over end, or if it is involved in a low-speed side or low-speed frontal collision.

- Collision from the rear
- Pitching end over end

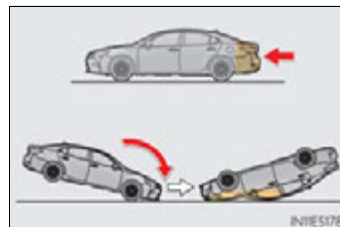

### ■ When to contact your Lexus dealer

In the following cases, the vehicle will require inspection and/or repair. Contact your Lexus dealer as soon as possible.

- Any of the SRS airbags have been inflated.
- The front of the vehicle is damaged or deformed, or was involved in an accident that was not severe enough to cause the SRS front airbags to inflate.
- A portion of a door or its surrounding area is damaged or deformed, or the vehicle was involved in an accident that was not severe enough to cause the SRS side and curtain shield airbags to inflate.
- The pad section of the steering wheel, dashboard near the front passenger airbag or lower portion of the instrument panel is scratched, cracked, or otherwise damaged.
- The surface of the seats with the side airbag is scratched, cracked, or otherwise damaged.
- The portion of the front pillars, rear pillars or roof side rail garnishes (padding) containing the curtain shield airbags inside is scratched, cracked, or otherwise damaged.

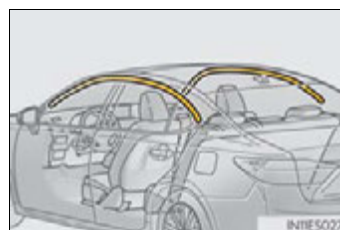
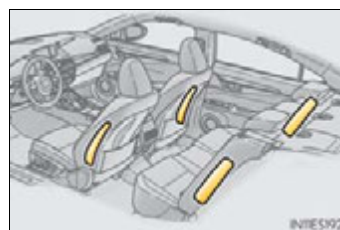
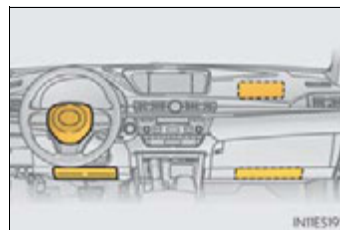
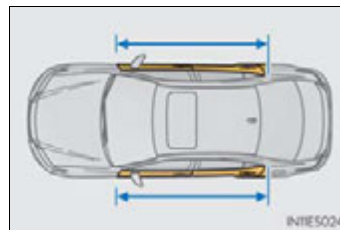
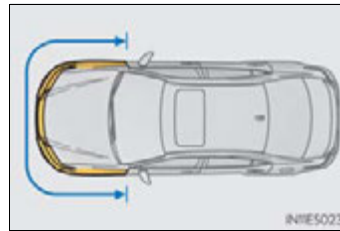

## Front passenger occupant classification system

Your vehicle is equipped with a front passenger occupant classification system. This system detects the conditions of the front passenger seat and activates or deactivates the devices for the front passenger.

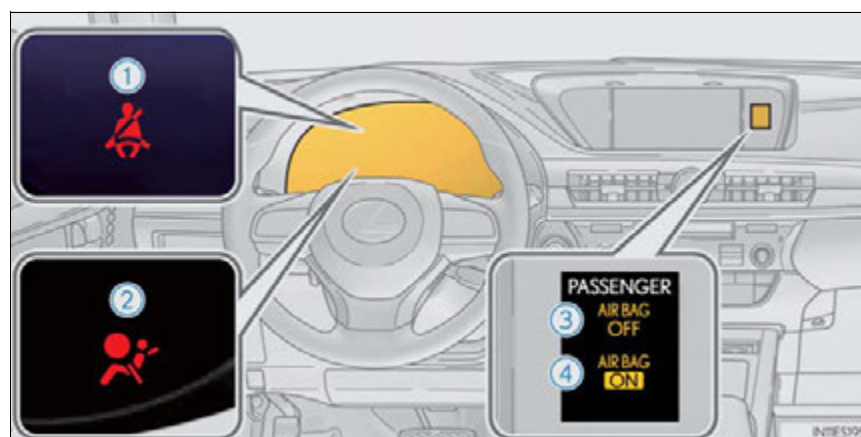

- ① Seat belt reminder light
- ② SRS warning light
- ③ "AIR BAG OFF" indicator light
- ④ "AIR BAG ON" indicator light

### Condition and operation in the front passenger occupant classification system

#### ■ Adult\*<sup>1</sup>

Indicator/ warning light	"AIR BAG ON" and "AIR BAG OFF" indicator lights	"AIR BAG ON"
	SRS warning light	Off
	Seat belt reminder light	Off* <sup>2</sup> or flashing* <sup>3</sup>
Devices	Front passenger airbag	Activated
	Side airbag on the front passenger seat	
	Curtain shield airbag in the front passenger side	
	Front passenger knee airbag	
	Front passenger's seat belt pretensioner	

#### ■ Child\*<sup>4</sup>

Indicator/ warning light	"AIR BAG ON" and "AIR BAG OFF" indicator lights	"AIR BAG OFF" or "AIR BAG ON"* <sup>4</sup>
	SRS warning light	Off
	Seat belt reminder light	Off* <sup>2</sup> or flashing* <sup>3</sup>
Devices	Front passenger airbag	Deactivated or activated* <sup>4</sup>
	Side airbag on the front passenger seat	Activated
	Curtain shield airbag in the front passenger side	
	Front passenger knee airbag	Deactivated or activated* <sup>4</sup>
	Front passenger's seat belt pretensioner	Activated

1

For safety and security

■ Child restraint system with infant<sup>\*5</sup>

Indicator/ warning light	"AIR BAG ON" and "AIR BAG OFF" indicator lights	"AIR BAG OFF" <sup>*6</sup>
	SRS warning light	Off
	Seat belt reminder light	Off <sup>*2</sup> or flashing <sup>*3</sup>
Devices	Front passenger airbag	Deactivated
	Side airbag on the front passenger seat	Activated
	Curtain shield airbag in the front passenger side	
	Front passenger knee airbag	Deactivated
	Front passenger's seat belt pretensioner	Activated

■ Unoccupied

Indicator/ warning light	"AIR BAG ON" and "AIR BAG OFF" indicator lights	"AIR BAG OFF"
	SRS warning light	Off
	Seat belt reminder light	
Devices	Front passenger airbag	Deactivated
	Side airbag on the front passenger seat	Activated
	Curtain shield airbag in the front passenger side	
	Front passenger knee airbag	Deactivated
	Front passenger's seat belt pretensioner	Activated

■ There is a malfunction in the system

	"AIR BAG ON" and "AIR BAG OFF" indicator lights	"AIR BAG OFF"
Indicator/ warning light	SRS warning light	On
	Seat belt reminder light	
Devices	Front passenger airbag	Deactivated
	Side airbag on the front passenger seat	Activated
	Curtain shield airbag in the front passenger side	
	Front passenger knee airbag	Deactivated
	Front passenger's seat belt pretensioner	Activated

\*1: The system judges a person of adult size as an adult. When a smaller adult sits in the front passenger seat, the system may not recognize him/her as an adult depending on his/her physique and posture.

\*2: In the event the front passenger is wearing a seat belt.

\*3: In the event the front passenger does not wear a seat belt

\*4: For some children, child in seat, child in booster seat or child in convertible seat, the system may not recognize him/her as a child. Factors which may affect this can be the physique or posture.

\*5: Never install a rear-facing child restraint system on the front passenger seat. A forward-facing child restraint system should only be installed on the front passenger seat when it is unavoidable. (→P. 51)

\*6: In case the indicator light is not illuminated, consult this manual on how to install the child restraint system properly. (→P. 55)

 **WARNING****■ Front passenger occupant classification system precautions**

Observe the following precautions regarding the front passenger occupant classification system.

Failure to do so may cause death or serious injury.

- Wear the seat belt properly.
- Make sure the front passenger's seat belt plate has not been left inserted into the buckle before someone sits in the front passenger seat.
- Make sure the "AIR BAG OFF" indicator light is not illuminated when using the seat belt extender for the front passenger seat. If the "AIR BAG OFF" indicator light is illuminated, disconnect the extender tongue from the seat belt buckle, and reconnect the seat belt. Reconnect the seat belt extender after making sure the "AIR BAG ON" indicator light is illuminated. If you use the seat belt extender while the "AIR BAG OFF" indicator light is illuminated, the SRS airbags for front passenger will not activate, which could cause death or serious injury in the event of a collision.
- Do not apply a heavy load to the front passenger seat or equipment (e.g. seatback pockets).
- Do not put weight on the front passenger seat by putting your hands or feet on the front passenger seat seatback from the rear passenger seat.
- Do not let a rear passenger lift the front passenger seat with their feet or press on the seatback with their legs.
- Do not put objects under the front passenger seat.



 **WARNING****■ Front passenger occupant classification system precautions**

- Do not recline the front passenger seatback so far that it touches a rear seat. This may cause the "AIR BAG OFF" indicator light to be illuminated, which indicates that the SRS airbags for front passenger will not activate in the event of a severe accident. If the seatback touches the rear seat, return the seatback to a position where it does not touch the rear seat. Keep the front passenger seatback as upright as possible when the vehicle is moving. Reclining the seatback excessively may lessen the effectiveness of the seat belt system.
- If an adult sits in the front passenger seat, the "AIR BAG ON" indicator light is illuminated. If the "AIR BAG OFF" indicator is illuminated, ask the passenger to sit up straight, well back in the seat, feet on the floor, and with the seat belt worn correctly. If the "AIR BAG OFF" indicator still remains illuminated, either ask the passenger to move to the rear seat, or if that is not possible, move the front passenger seat fully rearward.
- When it is unavoidable to install a forward-facing child restraint system on the front passenger seat, install the child restraint system on the front passenger seat in the proper order. (→P. 55)
- Do not modify or remove the front seats.
- Do not kick the front passenger seat or subject it to severe impact. Otherwise, the SRS warning light may come on to indicate a malfunction of the front passenger occupant classification system. In this case, contact your Lexus dealer immediately.
- Child restraint systems installed on the rear seat should not contact the front seatbacks.
- Do not use a seat accessory, such as a cushion and seat cover, that covers the seat cushion surface.
- Do not modify or replace the upholstery of the front seat.

## Safety information for children

Observe the following precautions when children are in the vehicle.

Use a child restraint system appropriate for the child, until the child becomes large enough to properly wear the vehicle's seat belt.

- It is recommended that children sit in the rear seats to avoid accidental contact with the shift lever, wiper switch etc.
- Use the rear door child-protector lock or the window lock switch to avoid children opening the door while driving or operating the power window accidentally. (→P. 96, 129)
- Do not let small children operate equipment which may catch or pinch body parts, such as the power window, hood, trunk, seats etc.

### WARNING

Never leave children unattended in the vehicle, and never allow children to have or use the key.

Children may be able to start the vehicle or shift the vehicle into neutral. There is also a danger that children may injure themselves by playing with the windows, the moon roof or other features of the vehicle. In addition, heat build-up or extremely cold temperatures inside the vehicle can be fatal to children.

## Child restraint systems

A child restraint system for a small child or baby must itself be properly restrained on the seat with the LATCH anchors or the lap portion of the lap/shoulder belt.

The laws of all 50 states of the U.S.A. and Canada now require the use of child restraint systems.

### Points to remember

Studies have shown that installing a child restraint on a rear seat is much safer than installing one on the front passenger seat.

- Choose a child restraint system that suits your vehicle and is appropriate to the age and size of the child.
- For installation details, follow the instructions provided with the child restraint system.

General installation instructions are provided in this manual. (→P. 55)

### Types of child restraints

Child restraint systems are classified into the following 3 types according to the age and size of the child:

- ▶ Rear facing — Infant seat/convertible seat
- ▶ Forward facing — Convertible seat

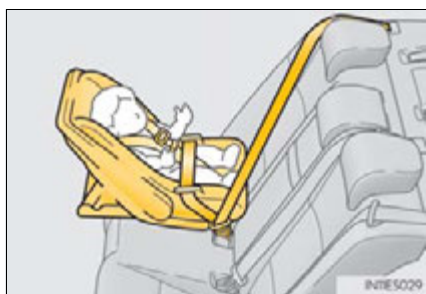

- ▶ Booster seat



#### ■ Selecting an appropriate child restraint system

- Use a child restraint system appropriate for the child until the child becomes large enough to properly wear the vehicle's seat belt.
- If the child is too large for a child restraint system, sit the child on a rear seat and use the vehicle's seat belt. (→P. 30)

 **WARNING****■ Child restraint precautions**

- For effective protection in automobile accidents and sudden stops, a child must be properly restrained, using a seat belt or child restraint system depending on the age and size of the child. Holding a child in your arms is not a substitute for a child restraint system. In an accident, the child can be crushed against the windshield, or between you and the vehicle's interior.
- Lexus strongly urges the use of a proper child restraint system that conforms to the size of the child, installed on the rear seat. According to accident statistics, the child is safer when properly restrained in the rear seat than in the front seat.
- Never install a rear-facing child restraint system on the front passenger seat even if the "AIR BAG OFF" indicator light is illuminated.  
In the event of an accident, the force of the rapid inflation of the front passenger airbag can cause death or serious injury to the child if the rear-facing child restraint system is installed on the front passenger seat.
- A forward-facing child restraint system may be installed on the front passenger seat only when it is unavoidable. A child restraint system that requires a top tether strap should not be used in the front passenger seat since there is no top tether strap anchor for the front passenger seat. Adjust the seatback as upright as possible and always move the seat as far back as possible even if the "AIR BAG OFF" indicator light is illuminated, because the front passenger airbag could inflate with considerable speed and force. Otherwise, the child may be killed or seriously injured.
- Do not use the seat belt extender when installing a child restraint system on the front or rear passenger seat. If installing a child restraint system with the seat belt extender connected to the seat belt, the seat belt will not securely hold the child restraint system, which could cause death or serious injury to the child or other passengers in the event of a sudden stop, sudden swerve or accident.
- Do not allow the child to lean his/her head or any part of his/her body against the door or the area of the seat, front and rear pillars or roof side rails from which the SRS side airbags or SRS curtain shield airbags deploy even if the child is seated in the child restraint system. It is dangerous if the SRS side airbags and curtain shield airbags inflate, and the impact could cause death or serious injury to the child.
- Make sure you have complied with all installation instructions provided by the child restraint manufacturer and that the system is properly secured. If it is not secured properly, it may cause death or serious injury to the child in the event of a sudden stop, sudden swerve or accident.

**WARNING****■ When children are in the vehicle**

Do not allow children to play with the seat belt. If the seat belt becomes twisted around a child's neck, it may lead to choking or other serious injuries that could result in death. If this occurs and the child cannot be released from the seat belt, scissors should be used to cut the belt.

**■ When the child restraint system is not in use**

- Keep the child restraint system properly secured on the seat even if it is not in use. Do not store the child restraint system unsecured in the passenger compartment.
- If it is necessary to detach the child restraint system, remove it from the vehicle or store it securely in the trunk. This will prevent it from injuring passengers in the event of a sudden stop, sudden swerve or accident.

## Installing child restraints

Follow the child restraint system manufacturer's instructions. Firmly secure child restraints to the seats using the LATCH anchors or a seat belt. Attach the top tether strap when installing a child restraint.

The lap/shoulder belt can be used if your child restraint system is not compatible with the LATCH (Lower Anchors and Tethers for Children) system.

### Child restraint LATCH anchors

LATCH anchors are provided for the outboard rear seats. (Buttons displaying the location of the anchors are attached to the seats.)

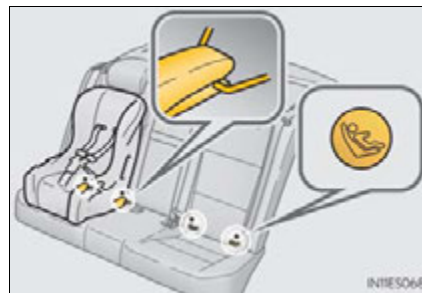

Seat belts equipped with a child restraint locking mechanism (ALR/ELR belts except driver's seat belt) (→P. 31)



### Anchor brackets (for top tether strap)

An anchor bracket is provided for each rear seat.

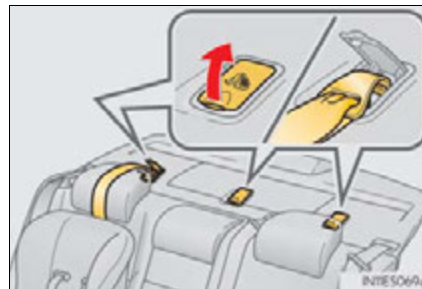

**Installation with LATCH system**

- 1 Lower the head restraint in place at the lowest position.

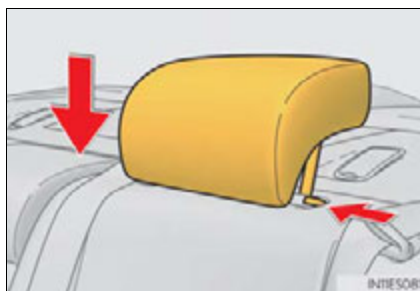

- 2 Widen the gap between the seat cushion and seatback slightly.

► Type A

- 3 Latch the hooks of the lower straps onto the LATCH anchors. If the child restraint has a top tether strap, the top tether strap should be latched onto the top tether strap anchor.

For owners in Canada:

The symbol on a child restraint system indicates the presence of a lower connector system.

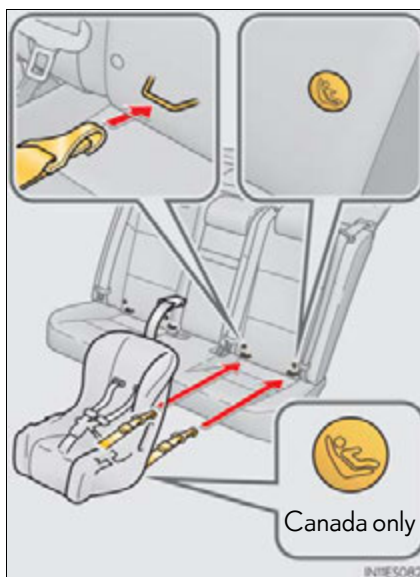



## ▶ Type B

- 3 Latch the buckles onto the LATCH anchors. If the child restraint has a top tether strap, the top tether strap should be latched onto the top tether strap anchor.

For owners in Canada:

The symbol on a child restraint system indicates the presence of a lower connector system.

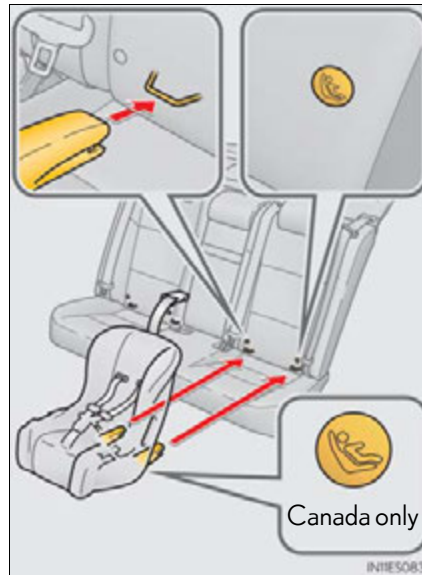

1

For safety and security

### Installing child restraints using a seat belt (child restraint lock function belt)

#### ■ Rear-facing—Infant seat/convertible seat

- 1 Place the child restraint system on the rear seat facing the rear of the vehicle.



- 2 Run the seat belt through the child restraint system and insert the plate into the buckle. Make sure that the belt is not twisted.

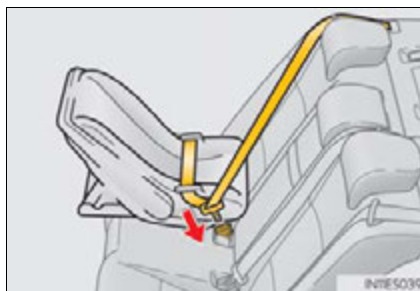

- 3 Fully extend the shoulder belt and allow it to retract to put it in lock mode. In lock mode, the belt cannot be extended.



- 4 While pushing the child restraint system down into the rear seat, allow the shoulder belt to retract until the child restraint system is securely in place.

After the shoulder belt has retracted to a point where there is no slack in the belt, pull the belt to check that it cannot be extended.

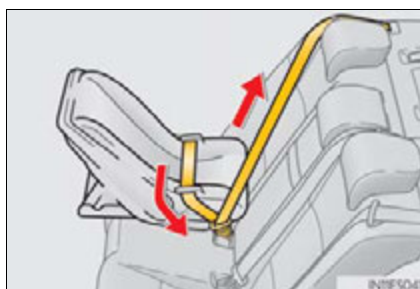

**■ Forward-facing— Convertible seat**

- 1 Lower the head restraint in place at the lowest position.

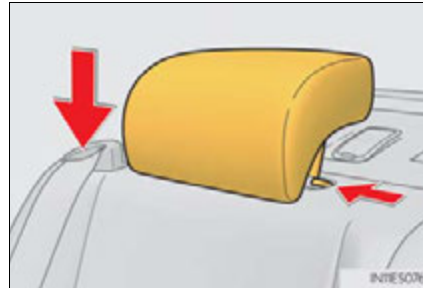

- 2 Place the child restraint system on the seat facing the front of the vehicle.



- 3 Run the seat belt through the child restraint system and insert the plate into the buckle. Make sure that the belt is not twisted.



- 4 Fully extend the shoulder belt and allow it to retract to put it in lock mode. In lock mode, the belt cannot be extended.



- 5 While pushing the child restraint system into the rear seat, allow the shoulder belt to retract until the child restraint system is securely in place.

After the shoulder belt has retracted to a point where there is no slack in the belt, pull the belt to check that it cannot be extended.



- 6 If the child restraint has a top tether strap, the top tether strap should be latched onto the top tether strap anchor. (→P. 61)

#### ■ Booster seat

- 1 Place the child restraint system on the seat facing the front of the vehicle.



- 2 Sit the child in the child restraint system. Fit the seat belt to the child restraint system according to the manufacturer's instructions and insert the plate into the buckle. Make sure that the belt is not twisted.

Check that the shoulder belt is correctly positioned over the child's shoulder and that the lap belt is as low as possible. (→P. 30)



### Removing a child restraint installed with a seat belt

Push the buckle release button and fully retract the seat belt.

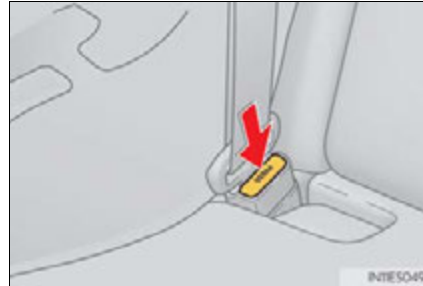

### Child restraint systems with a top tether strap

- 1 Lower the head restraint in place at the lowest position.

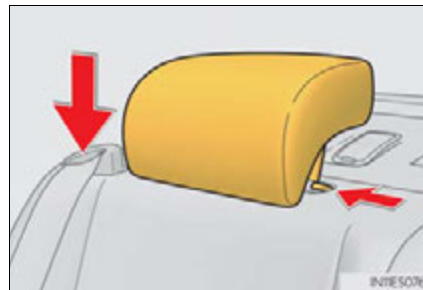

- 2 Secure the child restraint system using the seat belt or LATCH anchors.



- 3 Open the anchor bracket cover, latch the hook onto the anchor bracket and tighten the top tether strap.

Make sure the top tether strap is securely latched.

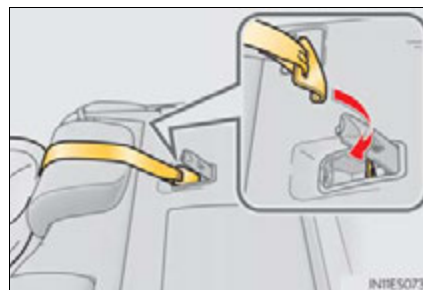

### ■ Laws and regulations pertaining to anchorages

The LATCH system conforms to FMVSS225 or CMVSS210.2.

Child restraint systems conforming to FMVSS213 or CMVSS213 specifications can be used.

This vehicle is designed to conform to the SAE J1819.

### ⚠ WARNING

#### ■ When installing a booster seat

To prevent the belt from going into ALR lock mode, do not fully extend the shoulder belt. ALR mode causes the belt to tighten only. This could cause injury or discomfort to the child. (→P. 31)

#### ■ When installing a child restraint system

Follow the directions given in the child restraint system installation manual and fix the child restraint system securely in place.

If the child restraint system is not correctly fixed in place, the child or other passengers may be seriously injured or even killed in the event of sudden braking, sudden swerving or an accident.

- If the driver's seat interferes with the child restraint system and prevents it from being attached correctly, attach the child restraint system to the right-hand rear seat.
- Adjust the front passenger seat so that it does not interfere with the child restraint system.

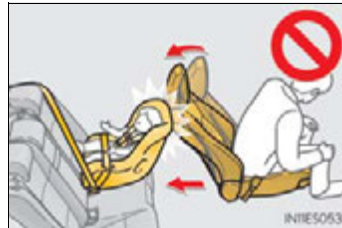

- Only put a forward-facing child restraint system on the front seat when unavoidable. When installing a forward-facing child restraint system on the front passenger seat, move the seat as far back as possible even if the "AIR BAG OFF" indicator light is illuminated. Failure to do so may result in death or serious injury if the airbags deploy (inflate).



 **WARNING****■ When installing a child restraint system**

- When a booster seat is installed, always ensure that the shoulder belt is positioned across the center of the child's shoulder. The belt should be kept away from the child's neck, but not so that it could fall off the child's shoulder. Failing to do so may result in death or serious injury in the event of sudden braking, sudden swerving or an accident.
- Ensure that the belt and plate are securely locked and the seat belt is not twisted.
- Shake the child restraint system left and right, and forward and backward to ensure that it has been securely installed.
- If the seat is adjusted, reconfirm the security of the child restraint system.
- Follow all installation instructions provided by the child restraint system manufacturer.
- When securing some types of child restraint systems in rear seat, it may not be possible to properly use the seat belts in positions next to the child restraint without interfering with it or affecting seat belt effectiveness. Be sure your seat belt fits snugly across your shoulder and low on your hips. If it does not, or if it interferes with the child restraint, move to a different position. Failure to do so may result in death or serious injury.

**■ Do not use a seat belt extender**

If a seat belt extender is used when installing a child restraint system, the seat belt will not securely hold the child restraint system, which could cause death or serious injury to the child or other passengers in the event of sudden braking, sudden swerving or an accident.

**■ To correctly attach a child restraint system to the anchors**

When using the LATCH anchors, be sure that there are no foreign objects around the anchors and that the seat belt is not caught behind the child restraint system. Make sure the child restraint system is securely attached, or it may cause death or serious injury to the child or other passengers in the event of sudden braking, sudden swerving or an accident.

## Exhaust gas precautions

Harmful substance to the human body is included in exhaust gases if inhaled.

### WARNING

Exhaust gases include harmful carbon monoxide (CO), which is colorless and odorless. Observe the following precautions. Failure to do so may cause exhaust gases enter the vehicle and may lead to an accident caused by light-headedness, or may lead to death or a serious health hazard.

#### ■ Important points while driving

- Keep the trunk lid closed.
- If you smell exhaust gases in the vehicle even when the trunk lid is closed, open the windows and have the vehicle inspected at your Lexus dealer as soon as possible.

#### ■ When parking

- If the vehicle is in a poorly ventilated area or a closed area, such as a garage, stop the engine.
- Do not leave the vehicle with the engine running for a long time. If such a situation cannot be avoided, park the vehicle in an open space and ensure that exhaust fumes do not enter the vehicle interior.
- Do not leave the engine running in an area with snow build-up, or where it is snowing. If snowbanks build up around the vehicle while the engine is running, exhaust gases may collect and enter the vehicle.

#### ■ Exhaust pipe

The exhaust system needs to be checked periodically. If there is a hole or crack caused by corrosion, damage to a joint or abnormal exhaust noise, be sure to have the vehicle inspected and repaired by your Lexus dealer.



## Engine immobilizer system

The vehicle's keys have built-in transponder chips that prevent the engine from starting if a key has not been previously registered in the vehicle's on-board computer.

**Never leave the keys inside the vehicle when you leave the vehicle.**

This system is designed to help prevent vehicle theft but does not guarantee absolute security against all vehicle thefts.

The indicator light flashes after the engine switch has been turned off to indicate that the system is operating.

The indicator light stops flashing after the engine switch has been turned to ACCESSORY or IGNITION ON mode to indicate that the system has been canceled.

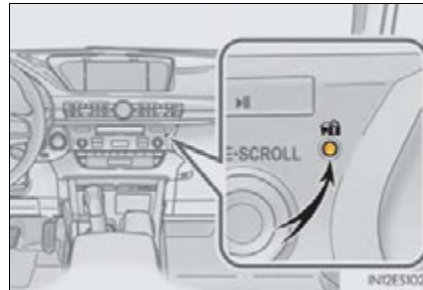

### ■ System maintenance

The vehicle has a maintenance-free type engine immobilizer system.

### ■ Conditions that may cause the system to malfunction

- If the grip portion of the key is in contact with a metallic object
- If the key is in close proximity to or touching a key to the security system (key with a built-in transponder chip) of another vehicle

■ **Certifications for the engine immobilizer system**

- ▶ For vehicles sold in the U.S.A., Hawaii, NATO Germany, Guam and Puerto Rico

**FCC ID: NI4TMIMB-3**

This device complies with part 15 of the FCC Rules. Operation is subject to the following two conditions: (1) This device may not cause harmful interference, and (2) this device must accept any interference received, including interference that may cause undesired operation.

Changes or modifications not expressly approved by the party responsible for compliance could void the user's authority to operate the equipment.

- ▶ For vehicles sold in Canada

This device complies with Industry Canada licence-exempt RSS standard(s). Operation is subject to the following two conditions: (1) this device may not cause interference, and (2) this device must accept any interference, including interference that may cause undesired operation of the device.

Le présent appareil est conforme aux CNR d'Industrie Canada applicables aux appareils radio exempts de licence. L'exploitation est autorisée aux deux conditions suivantes : (1) l'appareil ne doit pas produire de brouillage, et (2) l'utilisateur de l'appareil doit accepter tout brouillage radioélectrique subi, même si le brouillage est susceptible d'en compromettre le fonctionnement.

 **WARNING**

■ **Certifications for the engine immobilizer system**

Changes or modifications not expressly approved by the party responsible for compliance could void the user's authority to operate the equipment.

 **NOTICE**

■ **To ensure the system operates correctly**

Do not modify or remove the system. If modified or removed, the proper operation of the system cannot be guaranteed.

## Alarm

### The alarm

The alarm uses light and sound to give an alert when an intrusion is detected. The alarm is triggered in the following situations when the alarm is set:

- A locked door or trunk is unlocked or opened in any way other than using the entry function, wireless remote control or mechanical key. (The doors will lock again automatically.)
- The hood is opened.

### Setting the alarm system

Close the doors, trunk and hood, and lock all the doors. The system will be set automatically after 30 seconds.

The indicator light changes from being on to flashing when the system is set.

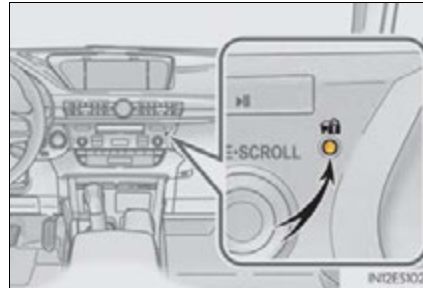

### Deactivating or stopping the alarm

Do one of the following to deactivate or stop the alarms:

- Unlock the doors or open the trunk.
- Turn the engine switch to ACCESSORY or IGNITION ON mode, or start the engine. (The alarm will be deactivated or stopped after a few seconds.)

**■ System maintenance**

The vehicle has a maintenance-free type alarm system.

**■ Items to check before locking the vehicle**

To prevent unexpected triggering of the alarm and vehicle theft, make sure of the following:

- Nobody is in the vehicle.
- The windows and moon roof are closed before the alarm is set.
- No valuables or other personal items are left in the vehicle.

**■ Triggering of the alarm**

The alarm may be triggered in the following situations:  
(Stopping the alarm deactivates the alarm system.)

- A person inside the vehicle opens a door, the trunk or hood, or unlocks the vehicle using an inside lock button.

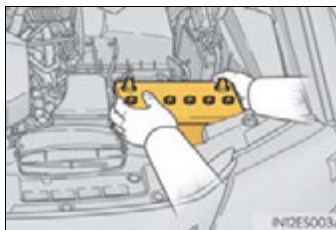

- The battery is recharged or replaced when the vehicle is locked. (→P. 503)

**■ Alarm-operated door lock**

In the following cases, the door may automatically lock:

- When a person remaining in the vehicle unlocks the door and the alarm is activated.
- While the alarm is activated, a person remaining in the vehicle unlocks the door.
- When recharging or replacing the battery.

 **NOTICE****■ To ensure the system operates correctly**

Do not modify or remove the system. If modified or removed, the proper operation of the system cannot be guaranteed.

<b>2. Instrument cluster</b>	
Warning lights and indicators .....	70
Gauges and meters .....	74
Multi-information display .....	78
Fuel consumption information .....	84

## Warning lights and indicators









The warning lights and indicators on the instrument cluster and center panel inform the driver of the status of the vehicle's various systems. For the purpose of explanation, the following illustration displays all warning lights and indicators illuminated.



The units used on the speedometer and some indicators may differ depending on the target region or grade/type.

## Warning lights

Warning lights inform the driver of malfunctions in the indicated vehicle's systems.





















<sup>*1</sup>  (U.S.A.)	Brake system warning light (→P. 476)	<sup>*1</sup> 	Electric power steering system warning light (→P. 477)
<sup>*1</sup>  (Canada)	Brake system warning light (→P. 476)	<sup>*1</sup> 	Slip indicator light (→P. 477)
<sup>*1</sup>  (U.S.A.)	Malfunction indicator lamp (→P. 476)		Low fuel level warning light (→P. 477)
<sup>*1</sup>  (Canada)	Malfunction indicator lamp (→P. 476)		Seat belt reminder light (→P. 477)
<sup>*1</sup> 	SRS warning light (→P. 476)	<sup>*1</sup> 	Master warning light (→P. 477)
<sup>*1</sup>  (U.S.A.)	ABS warning light (→P. 476)	<sup>*1</sup> 	Tire pressure warning light (→P. 478)
<sup>*1</sup>  (Canada)	ABS warning light (→P. 476)	<sup>*1,2</sup>  (if equipped)	"AFS OFF" indicator (→P. 478)
<sup>*1,2</sup>  (if equipped)	PCS warning light (→P. 477)		

<sup>\*1</sup>: These lights turn on when the engine switch is turned to IGNITION ON mode to indicate that a system check is being performed. They will turn off after the engine is on, or after a few seconds. There may be a malfunction in a system if a light does not come on, or turn off. Have the vehicle inspected by your Lexus dealer.

<sup>\*2</sup>: The light flashes to indicate a malfunction.

### Indicators

The indicators inform the driver of the operating state of the vehicle's various systems.

	Turn signal indicator (→P. 159)		Intuitive parking assist indicator (→P. 220) (if equipped)
	Headlight indicator (→P. 161) (U.S.A.)		<sup>*1,2</sup> Slip indicator light (→P. 256)
	Tail light indicator (→P. 161) (Canada)		<sup>*1</sup> VSC OFF indicator (→P. 257)
	Headlight high beam indicator (→P. 162)		<sup>*1,3</sup> PCS warning light (→P. 187) (if equipped)
	Automatic High Beam indicator (→P. 164) (if equipped)		<sup>*4,5</sup> BSM outside rear view mirror indicators (→P. 247) (if equipped)
	Fog light indicator (→P. 168)		<sup>*1,6</sup> "AIR BAG ON/OFF" indicator (→P. 44)
	<sup>*1</sup> Eco Driving Indicator Light (→P. 82)		
	Cruise control indicator (→P. 213, 217)		Parking brake indicator (→P. 160) (U.S.A.)
	Radar cruise control indicator (→P. 205) (if equipped)		Parking brake indicator (→P. 160) (Canada)
	Cruise control "SET" indicator (→P. 217)		<sup>*7</sup> Low outside temperature indicator (→P. 74)
	"LDA" (Lane Departure Alert with steering control) indicator (→P. 196) (if equipped)		



- \*1: These lights turn on when the engine switch is turned to IGNITION ON mode to indicate that a system check is being performed. They will turn off after the engine is on, or after a few seconds. There may be a malfunction in a system if a light does not come on, or turn off. Have the vehicle inspected by your Lexus dealer.
- \*2: The light flashes to indicate that the system is operating.
- \*3: The light turns on when the system is turned off.
- \*4: In order to confirm operation, the BSM outside rear view mirror indicators illuminate in the following situations:
- When the engine switch is turned to IGNITION ON mode while the BSM main switch is set to ON.
  - When the BSM main switch is set to ON while the engine switch is in IGNITION ON mode.
- If the system is functioning correctly, the BSM outside rear view mirror indicators will turn off after a few seconds.
- If the BSM outside rear view mirror indicators do not illuminate or do not turn off, there may be a malfunction with the system. If this occurs, have the vehicle inspected by your Lexus dealer.
- \*5: This light illuminates on the outside rear view mirrors.
- \*6: This light illuminates on the center panel.
- \*7: When the outside temperature is approximately 37°F (3°C) or lower, the indicator will flash for approximately 10 seconds, then stay on.

**⚠ WARNING****■ If a safety system warning light does not come on**

Should a safety system light such as the ABS and SRS warning light not come on when you start the engine, this could mean that these systems are not available to help protect you in an accident, which could result in death or serious injury. Have the vehicle inspected by your Lexus dealer immediately if this occurs.

## Gauges and meters

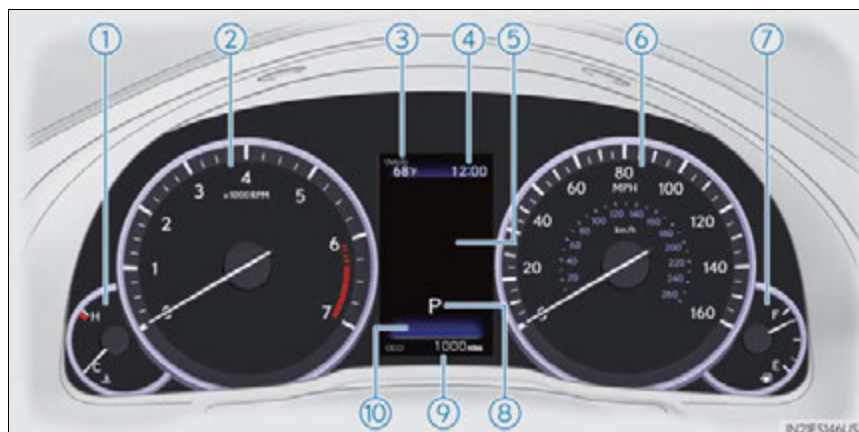

The units used on the speedometer may differ depending on the target region.

- ① Engine coolant temperature gauge  
Displays the engine coolant temperature
- ② Tachometer  
Displays the engine speed in revolution per minute
- ③ Outside temperature  
Displays the outside temperature within the range of  $-40^{\circ}\text{F}$  ( $-40^{\circ}\text{C}$ ) to  $122^{\circ}\text{F}$  ( $50^{\circ}\text{C}$ ). Low outside temperature indicator comes on when the ambient temperature is  $37^{\circ}\text{F}$  ( $3^{\circ}\text{C}$ ) or lower.
- ④ Clock  
Time can be adjusted or a clock format can be set from  (settings display) of the multi-information display. (→P. 78)
- ⑤ Multi-information display  
Presents the driver with a variety of vehicle data (→P. 78)  
Displays warning messages in case of a malfunction (→P. 482)
- ⑥ Speedometer  
Displays the vehicle speed
- ⑦ Fuel gauge  
Displays the quantity of fuel remaining in the tank
- ⑧ Shift position and shift range  
Displays the selected shift position or selected shift range (→P. 156)

⑨ Odometer, trip meter and maintenance required information display

Odometer:

Displays the total distance the vehicle has been driven

Trip meter:

Displays the distance the vehicle has been driven since the meter was last reset.

Trip meters "A" and "B" can be used to record and display different distances independently.

Maintenance required information:

- Displays the maintenance required information when the engine switch is in IGNITION ON mode.

- It can be reset from  (settings display) of the multi-information display. (→P. 78)

⑩ Background color of drive mode

Background color changes according to the drive mode. (→P. 245)

- Sport mode: Red
- Eco drive mode: Blue

When in Normal mode, the background color is Black.

### Changing the display

Switches between odometer, trip meter and maintenance required information displays. When the trip meter is displayed, pressing and holding the button will reset the trip meter.

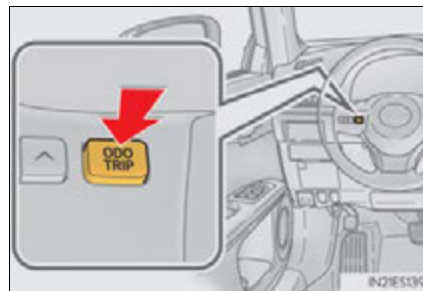

### Instrument panel light control

The brightness of the instrument panel lights can be adjusted.

- ① Darker
- ② Brighter

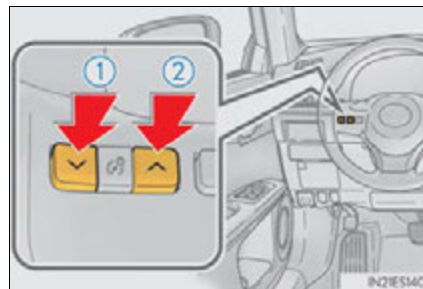

#### ■ The meters and display illuminate when

The engine switch is in IGNITION ON mode.

#### ■ Instrument panel brightness adjustment

The instrument panel brightness levels when the tail lights are on and off can be adjusted individually. However, when the surroundings are bright (daytime, etc.), turning on the tail lights will not change the instrument panel brightness. At this time, any adjustments made to the instrument panel brightness levels will be applied to both settings at once.

#### ■ Limitation of brightness adjustment

The brightness of the instrument panel lights is automatically adjusted based on the light sensor detecting how bright the surroundings are. However, if the instrument panel brightness has been manually set to either the brightest or darkest setting, the automatic adjustment will not be performed.

#### ■ Outside temperature display

- In the following situations, the correct outside temperature may not be displayed, or the display may take longer than normal to change.
  - When stopped, or driving at low speeds (less than 12 mph [20 km/h])
  - When the outside temperature has changed suddenly (at the entrance/exit of a garage, tunnel, etc.)
  - When the vehicle is parked in direct sunlight
- When "--" or "E" is displayed, the system may be malfunctioning.  
Take your vehicle to your Lexus dealer.

#### ■ Pop-up display

In some situations, a pop-up display will be temporarily displayed on the multi-information display or the odometer/trip meter/maintenance required information screen. The pop-up display function can be set on/off. (→P. 534)

#### ■ Liquid crystal display

Small spots or light spots may appear on the display. This phenomenon is characteristic of liquid crystal displays, and there is no problem continuing to use the display.

#### ■ Customization

The meter display can be customized on the multi-information display. (Customizable features →P. 533)



#### WARNING

#### ■ The information display at low temperatures

Allow the interior of the vehicle to warm up before using the liquid crystal information display. At extremely low temperatures, the information display monitor may respond slowly, and display changes may be delayed. For example, there is a lag between the driver's shifting and the new gear number appearing on the display. This lag could cause the driver to downshift again, causing rapid and excessive engine braking and possibly an accident resulting in personal death or injury.

 NOTICE**■ To prevent damage to the engine and its components**

- Do not let the indicator needle of the tachometer enter the red zone, which indicates the maximum engine speed.
- The engine may be overheating if the engine coolant temperature gauge is in the red zone (H); or "Engine Coolant Temp High" is shown on the multi-information display. In this case, immediately stop the vehicle in a safe place, and check the engine after it has cooled completely. (→P. 505)

## Multi-information display

### Display contents

The multi-information display presents the driver with a variety of vehicle data.

Displays the following information when an icon is selected. (→P. 79)



#### Drive information

Select to display various drive data. (→P. 79)



#### Navigation system-linked display (if equipped)

Select to display the following navigation system-linked information.

- Route guidance
- Compass display (north-up display/heading-up display)



#### Audio system-linked display

Select to enable selection of an audio source or track on the display using the meter control switches.



#### Driving assist information

Select to display the cruise control or dynamic radar cruise control/LDA (Lane Departure Alert with steering control) information, when the system is used. (→P. 196, 205, 217)



#### Warning message display

Select to display warning messages and measures to be taken if a malfunction is detected. (→P. 482)



#### Settings display

Select to change the meter display settings. (→P. 534)

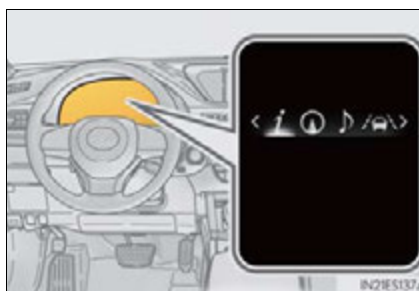

### Operating the meter control switches

The multi-information display is operated using the meter control switches.

- ① Select an item/change pages
- ② Enter/Set
- ③ Return to the previous screen
- ④ Press:

Displays the screen registered to 

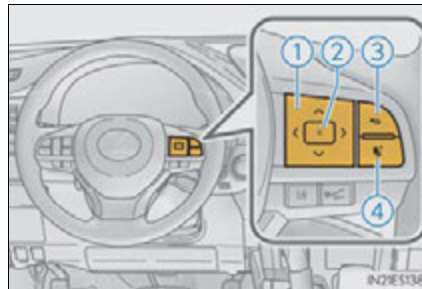





When no screen has been registered, the drive information screen will be displayed.

Press and hold:

Registers the currently displayed screen to  (→P. 534)

The registration confirmation screen is displayed. If the selected screen cannot be registered, a registration failure message will be shown.

### Drive information

Items displayed can be switched by pressing  or  of the meter control switches to select  and pressing  or .

#### ■ Current fuel consumption\*<sup>1</sup>

Displays the current rate of fuel consumption

#### ■ Average fuel economy (after reset\*<sup>2</sup>/after start/after refuel)\*<sup>1</sup>

Displays the average fuel consumption since the function was reset, the engine was started, and the vehicle was refueled, respectively

Use the displayed average fuel consumption as a reference.

#### ■ Average speed (after reset\*<sup>2</sup>/after start)\*<sup>1</sup>

Displays the average vehicle speed since the function was reset and the engine was started, respectively

#### ■ Elapsed time (after reset\*<sup>2</sup>/after start)\*<sup>1</sup>

Displays the elapsed time since the function was reset and the engine was started, respectively

■ **Distance (range/after start)\*1**

Displays the estimated maximum distance that can be driven with the quantity of fuel remaining and the distance driven after the engine was started respectively.

- This distance is computed based on your average fuel consumption. As a result, the actual distance that can be driven may differ from that displayed.
- When only a small amount of fuel is added to the tank, the display may not be updated.

When refueling, turn the engine switch off. If the vehicle is refueled without turning the engine switch off, the display may not be updated.

■ **Eco Driving Indicator Zone Display**

→P. 82

■ **Tire inflation pressure**

Displays inflation pressure of each tire.

The inflation pressure of the spare tire will not be displayed.

■ **LDA (Lane Departure Alert with steering control) vehicle sway warning (if equipped)**

→P. 196

■ **Display off**

A blank screen is displayed

\*1: Displayed when the item is set in "Drive Info 1", "Drive Info 2" or "Drive Info 3".  
(→P. 534)





\*2: The function can be reset by pressing the  of the meter control switches for longer than 1 second when the item to reset is displayed.  
If there is more than one item that can be reset, the item selection screen will appear.



## Settings display

The settings of the following items can be changed, refer to P. 533

For functions that can be enabled or disabled, the function switches between on and off each time  is pressed.

-  LDA (Lane Departure Alert with steering control) (if equipped) (→P. 196)
-  PCS (Pre-Collision System) (if equipped) (→P. 183)
- AFS (Adaptive Front-lighting System) (if equipped) (→P. 162)
- Clock
  - Adjusts the hour and minute of the clock on the multi-information display.
- Ambient illumin.
  - Select to turn the ornament lights on and off.
- Vehicle Settings
  - Scheduled Maintenance (→P. 415)
  - Oil Maintenance (→P. 429)
- Meter Settings
  - Language
    - Select to change the language on the display.
  - Units
    - Select to change the unit of measure.
  - Eco Driving Indicator Light
    - Select to activate/deactivate the Eco Driving Indicator Light
  -  switch
    - Displays a procedure to register a desired screen to .
    - You can register 1 screen as a shortcut, which can be displayed by pressing .
  - Drive information 1/2/3
    - Select to select up to 2 items that will be displayed on a Drive information screen, up to 3 Drive information screens can be set.
  - Pop-up display
    - Select to set the pop-up displays, which may appear in some situations, on/off.
  - Accent color
    - Select to change the accent colors on the screen, such as the cursor color.
  - Default settings
    - Registered or changed meter settings will be deleted or returned to their default setting.

### ■ System check display

After turning the engine switch to IGNITION ON mode, opening image is displayed while system operation is checked. When the system check is complete, the normal screen will return.

### ■ Eco Driving Indicator

- ① Eco Driving Indicator Light  
During Eco-friendly acceleration (Eco driving), the Eco Driving Indicator Light will turn on. When the acceleration exceeds the Zone of Eco driving, or when the vehicle is stopped, the light turns off.
- ② Eco Driving Indicator Zone Display  
Suggests the Zone of Eco driving with current Eco driving ratio based on acceleration.
- ③ Eco driving ratio based on acceleration  
If the acceleration exceeds the Zone of Eco driving, the right side of the Eco Driving Indicator Zone Display will illuminate.  
When this happens, the Eco Driving Indicator Light will turn off.
- ④ Zone of Eco driving



Eco Driving Indicator will not operate under the following conditions:

- The engine is not running.
- The shift lever is in any position other than D.
- Neither normal mode nor Eco drive mode is selected. (→P. 245)
- The vehicle speed is approximately 80 mph (130 km/h) or higher.

Settings of the display and non-display of the Eco Driving Indicator Light can be changed.

### ■ Suspension of the settings display

In the following situations, the settings display using the meter control switches will be suspended.

- When a warning message appears on the multi-information display
- When the vehicle begins to move

### ■ Tire inflation pressure

- It may take a few minutes to display the tire inflation pressure after the engine switch is turned to IGNITION ON mode. It may also take a few minutes to display the tire inflation pressure after inflation pressure has been adjusted.
- “---” may be displayed if the tire information cannot be determined due to unfavorable radio wave conditions.
- Tire inflation pressure changes with temperature. The displayed values may also be different from the values measured using a tire pressure gauge.

**■ When disconnecting and reconnecting battery terminals**

The drive information will be reset.

**■ Liquid crystal display**

→P.76

**⚠ WARNING****■ Caution for use while driving**

For safety, avoid operating the meter control switch while driving as much as possible, and do not look continuously at the multi-information display while driving. Stop the vehicle and operate the meter control switch. Failure to do so may cause a steering wheel operation error, resulting in an unexpected accident.

**■ Cautions during setting up the display**

As the engine needs to be operating during setting up the display, ensure that the vehicle is parked in a place with adequate ventilation. In a closed area such as a garage, exhaust gases including harmful carbon monoxide (CO) may collect and enter the vehicle. This may lead to death or a serious health hazard.

**⚠ NOTICE****■ During setting up the display**

To prevent battery discharge, ensure that the engine is operating while setting up the display features.

## Fuel consumption information

Fuel consumption information can be displayed on the navigation system screen or Lexus Display Audio system screen.

- ① Navigation system screen or Lexus Display Audio system screen
  - ▶ Navigation system
- ② "MENU" button
- ③ Remote Touch knob
  - For use of Remote Touch, refer to the "NAVIGATION SYSTEM OWNER'S MANUAL".
  - ▶ Lexus Display Audio system
- ④ "MENU" button
- ⑤ Lexus Display Audio controller (→P. 268)

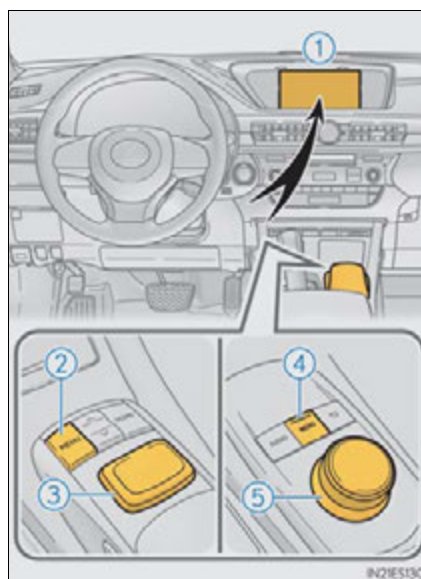

### Trip information

- ▶ Navigation system screen

Press the "MENU" button on the Remote Touch, then select "Info" on the "Menu" screen, and then select "Fuel Consumption".

If the "Trip Information" screen does not appear, select "Trip Information".

- ① Resetting the consumption data
- ② Fuel consumption in the past 15 minutes
- ③ Current fuel consumption
- ④ Average vehicle speed since the engine was started
- ⑤ Elapsed time since the engine was started
- ⑥ Cruising range (→P. 87)



- ▶ Lexus Display Audio screen

Press the "MENU" button on the Lexus Display Audio controller, then select "Info" on the "Menu" screen, and then select "Fuel Consumption".

If the "Trip Information" screen does not appear, move the controller to the right and select "Trip Information".

- ① Fuel consumption in the past 15 minutes
- ② Current fuel consumption
- ③ Average vehicle speed since the engine was started
- ④ Elapsed time since the engine was started
- ⑤ Cruising range (→P. 87)



Average fuel consumption for the past 15 minutes is divided by color into past averages and averages attained since the engine switch was last turned to IGNITION ON mode. Use the displayed average fuel consumption as a reference.

The image is an example only.

### Past record

- ▶ Navigation system screen

Press the "MENU" button on the Remote Touch, then select "Info" on the "Menu" screen, and then select "Fuel Consumption".

If the "Past Record" screen does not appear, select "Past Record".

- ① Resetting the past record data
- ② Best recorded fuel consumption
- ③ Average fuel consumption
- ④ Previous fuel consumption record
- ⑤ Updating the average fuel consumption data



- ▶ Lexus Display Audio screen

Press the "MENU" button on the Lexus Display Audio controller, then select "Info" on the "Menu" screen, and then select "Fuel Consumption".

If the "Past Record" screen does not appear, move the controller to the right and select "Past Record".

- ① Previous fuel consumption record
- ② Current fuel consumption
- ③ Best recorded fuel consumption



The average fuel consumption history is divided by color into past averages and the average fuel consumption since the last updated. Use the displayed average fuel consumption as a reference.

The image is an example only.

**■ Updating the past record data**

- ▶ Vehicles with navigation system

Update the average fuel consumption by selecting "Update" to measure the current fuel consumption again.

- ▶ Vehicles with Lexus Display Audio system

Update the average fuel consumption by moving the controller to the left and select "Update" to measure the current fuel consumption again.

**■ Resetting the data**

- ▶ Vehicles with navigation system

The fuel consumption data can be deleted by selecting "Clear".

- ▶ Vehicles with Lexus Display Audio system

The fuel consumption data can be deleted by moving the controller to the left and select "Clear".

**■ Cruising range**

Displays the estimated maximum distance that can be driven with the quantity of fuel remaining.

This distance is computed based on your average fuel consumption.

As a result, the actual distance that can be driven may differ from that displayed.





<b>3-1. Key information</b>	
Keys .....	90
<b>3-2. Opening, closing and locking the doors and trunk</b>	
Doors .....	93
Trunk.....	99
Smart access system with push-button start .....	106
<b>3-3. Adjusting the seats</b>	
Front seats.....	114
Driving position memory .....	115
Head restraints .....	119
<b>3-4. Adjusting the steering wheel and mirrors</b>	
Steering wheel .....	122
Inside rear view mirror.....	124
Outside rear view mirrors.....	126
<b>3-5. Opening, closing the windows and moon roof</b>	
Power windows .....	129
Moon roof.....	132

## Keys

### The keys

The following keys are provided with the vehicle.

- ① Electronic keys
  - Operating the smart access system with push-button start (→P. 106)
  - Operating the wireless remote control function
- ② Mechanical keys
- ③ Key number plate

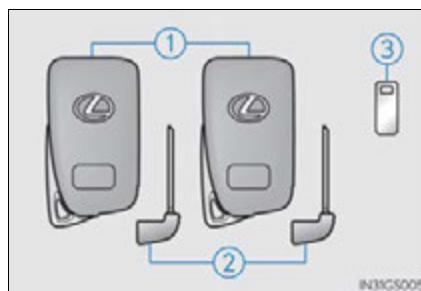

### Wireless remote control

- ① Locks the doors (→P. 93)
- ② Unlocks the doors (→P. 93)
- ③ Opens the windows and moon roof\* (→P. 93)
- ④ Opens the trunk (→P. 99)
- ⑤ Sounds the alarm (→P. 91)

\*: This setting must be customized at your Lexus dealer.

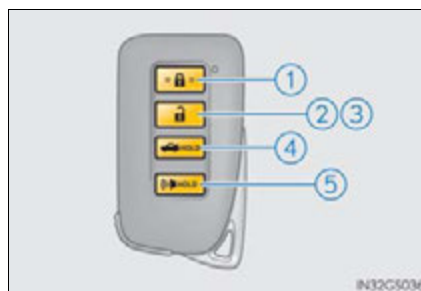

### Using the mechanical key

To take out the mechanical key, push the release button and take the key out.

The mechanical key can only be inserted in one direction, as the key only has grooves on one side. If the key cannot be inserted in a lock cylinder, turn it over and re-attempt to insert it.

After using the mechanical key, store it in the electronic key. Carry the mechanical key together with the electronic key. If the electronic key battery is depleted or the entry function does not operate properly, you will need the mechanical key. (→P. 499)

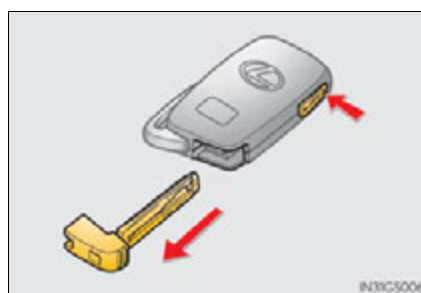

### ■ Panic mode

When  is pressed for longer than about one second, an alarm will sound intermittently and the vehicle lights will flash to deter any person from trying to break into or damage your vehicle.

To stop the alarm, press any button on the electronic key.



### ■ When required to leave the vehicle's key with a parking attendant

Turn the trunk opener main switch off and lock the glove box as circumstances demand. (→P. 100, 379)

Remove the mechanical key for your own use and provide the attendant with the electronic key only.

### ■ If you lose your mechanical keys

New genuine mechanical keys can be made by your Lexus dealer using the other mechanical key and the key number stamped on your key number plate. Keep the plate in a safe place such as your wallet, not in the vehicle.

### ■ When riding in an aircraft

When bringing an electronic key onto an aircraft, make sure you do not press any buttons on the electronic key while inside the aircraft cabin. If you are carrying an electronic key in your bag etc., ensure that the buttons are not likely to be pressed accidentally. Pressing a button may cause the electronic key to emit radio waves that could interfere with the operation of the aircraft.

### ■ Electronic key battery depletion

- The standard battery life is 1 to 2 years.
- If the battery becomes low, an alarm will sound in the cabin when the engine stops. (→P. 451)
- As the electronic key always receives radio waves, the battery will become depleted even if the electronic key is not used. The following symptoms indicate that the electronic key battery may be depleted. Replace the battery when necessary. (→P. 451)
  - The smart access system with push-button start or the wireless remote control does not operate.
  - The detection area becomes smaller.
  - The LED indicator on the key surface does not turn on.
- To avoid serious deterioration, do not leave the electronic key within 3 ft. (1 m) of the following electrical appliances that produce a magnetic field:
  - TVs
  - Personal computers
  - Cellular phones, cordless phones and battery chargers
  - Recharging cellular phones or cordless phones
  - Table lamps
  - Induction cookers

### ■ If "Key Battery Low" is displayed on the multi-information display

The electronic key has a low battery. Replace the electronic key battery. (→P. 451)

■ **Replacing the battery**

→P. 451

■ **Confirmation of the registered key number**

The number of keys already registered to the vehicle can be confirmed. Ask your Lexus dealer for details.

■ **If a wrong key is used**

The key cylinder rotates freely to isolate inside mechanism.

 **NOTICE**

■ **To prevent key damage**

- Do not drop the keys, subject them to strong shocks or bend them.
- Do not expose the keys to high temperatures for long periods of time.
- Do not get the keys wet or wash them in an ultrasonic washer etc.
- Do not attach metallic or magnetic materials to the keys or place the keys close to such materials.
- Do not disassemble the keys.
- Do not attach a sticker or anything else to the surface of the electronic key.
- Do not place the keys near objects that produce magnetic fields, such as TVs, audio systems and induction cookers, or medical electrical equipment, such as low-frequency therapy equipment.

■ **Carrying the electronic key on your person**

Carry the electronic key 3.9 in. (10 cm) or more away from electric appliances that are turned on. Radio waves emitted from electric appliances within 3.9 in. (10 cm) of the electronic key may interfere with the key, causing the key to not function properly.

■ **In case of a smart access system with push-button start malfunction or other key-related problems**

Take your vehicle with all the electronic keys provided with your vehicle to your Lexus dealer.

■ **When an electronic key is lost**

If the electronic key remains lost, the risk of vehicle theft increases significantly. Visit your Lexus dealer immediately with all remaining electronic keys that was provided with your vehicle.

## Doors

### Unlocking and locking the doors from the outside

#### ◆ Smart access system with push-button start

Carry the electronic key to enable this function.

- ① Grip the driver's door handle to unlock the door. Grip the passenger's door handle to unlock all the doors.\*

Make sure to touch the sensor on the back of the handle.

The doors cannot be unlocked for 3 seconds after the doors are locked.

\*: The door unlock settings can be changed. (→P. 537)

- ② Touch the lock sensor (the indentation on the upper part of the door handle) to lock all the doors.

Check that the door is securely locked.

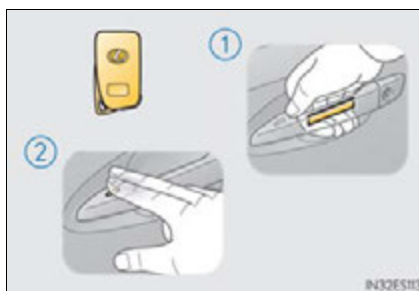

#### ◆ Wireless remote control

- ① Locks all the doors

Check that the door is securely locked.

- ② Unlocks all the doors

Pressing the button unlocks the driver's door. Pressing the button again within 5 seconds unlocks the other doors.

Press and hold to open the windows and moon roof\*

\*: This setting must be customized at your Lexus dealer.

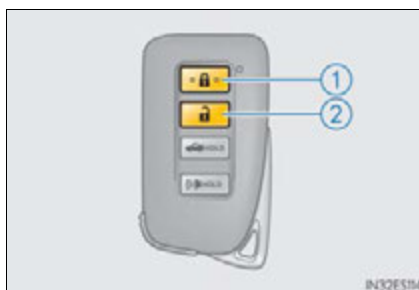

**■ Operation signals**

A buzzer sounds and the emergency flashers flash to indicate that the doors have been locked/unlocked. (Locked: Once; Unlocked: Twice)

Windows and moon roof:

A buzzer sounds to indicate that the windows and moon roof are opening.

**■ Security feature**

If a door is not opened within approximately 60 seconds after the vehicle is unlocked, the security feature automatically locks the vehicle again.

**■ Welcome light illumination control**

The side marker, parking, tail and license plate lights automatically turn on at night when the doors are unlocked using the entry function or wireless remote control if the light switch is in the "AUTO" position.

**■ When the door cannot be locked by the lock sensor on the upper part of the door handle**

If the door will not lock even when the topside sensor area is touched, try touching both the topside and underside sensor areas at the same time.

**■ Door lock buzzer**

If an attempt to lock the doors is made when a door is not fully closed, a buzzer sounds continuously for 5 seconds. Fully close the door to stop the buzzer, and lock the vehicle once more.

**■ Setting the alarm**

Locking the doors will set the alarm system. (→P. 67)

**■ If the smart access system with push-button start or the wireless remote control does not operate properly**

- Use the mechanical key to lock and unlock the doors. (→P. 499)
- Replace the key battery with a new one if it is depleted. (→P. 451)

### Unlocking and locking the doors from the inside

#### ◆ Door lock switch

- ① Locks all the doors
- ② Unlocks all the doors

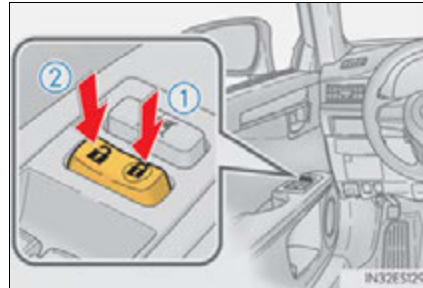

#### ◆ Inside lock buttons

- ① Locks the door
- ② Unlocks the door

The front doors can be opened by pulling the inside handle even if the lock buttons are in the lock position.

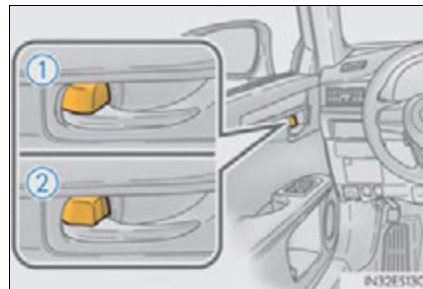

### Locking the front doors from the outside without a key

- 1 Move the inside lock button to the lock position.
- 2 Close the door.

The door cannot be locked if the engine switch is in ACCESSORY or IGNITION ON mode, or the electronic key is left inside the vehicle.

The key may not be detected correctly and the door may be locked.

3

Operation of each component

### Rear door child-protector lock

The door cannot be opened from inside the vehicle when the lock is set.

- ① Unlock
- ② Lock

These locks can be set to prevent children from opening the rear doors. Push down on each rear door switch to lock both rear doors.

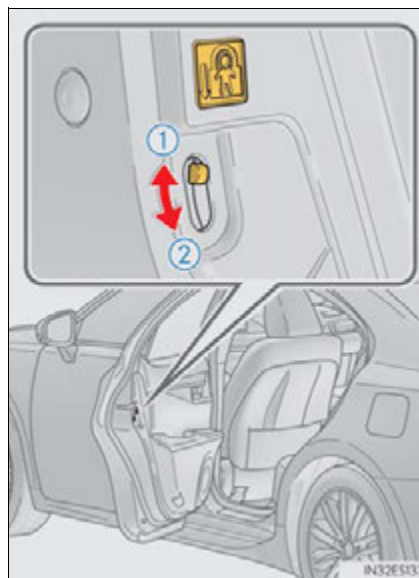

### Automatic door locking and unlocking systems

The following functions can be set or canceled:





For instructions on customizing, refer to P. 533.

Function	Operation
Shift position linked door locking function	Shifting the shift lever out of P locks all doors.
Shift position linked door unlocking function	Shifting the shift lever to P unlocks all doors.
Speed linked door locking function	All doors are locked when the vehicle speed is approximately 12 mph (20 km/h) or higher.
Driver's door linked door unlocking function	All doors are unlocked when the driver's door is opened within 45 seconds after turning the engine switch off.





### ■ Switching the door unlock function

It is possible to set which doors the entry function unlocks using the wireless remote control.

- 1 Turn the engine switch off.
- 2 When the indicator light on the key surface is not on, press and hold  ,  or  for approximately 5 seconds while pressing and holding .

The setting changes each time an operation is performed, as shown below. (When changing the setting continuously, release the buttons, wait for at least 5 seconds, and repeat step 2.)

Multi-information display	Unlocking function	Beep
	Holding the driver's door handle unlocks only the driver's door.	Exterior: Beeps 3 times Interior: Pings once
	Holding a passenger's door handle unlocks all the doors.	
	Holding a door handle unlocks all the doors.	Exterior: Beeps twice Interior: Pings once

To prevent unintended triggering of the alarm, unlock the doors using the wireless remote control and open and close a door once after the settings have been changed. (If a door is not opened within 60 seconds after  is pressed, the doors will be locked again and the alarm will automatically be set.)

In case that the alarm is triggered, immediately stop the alarm. (→P. 67)

### ■ Impact detection door lock release system

In the event that the vehicle is subject to a strong impact, all the doors are unlocked. Depending on the force of the impact or the type of accident, however, the system may not operate.

### ■ Using the mechanical key

The doors can also be locked and unlocked with the mechanical key. (→P. 499)

### ■ Conditions affecting the operation of the smart access system with push-button start or wireless remote control

→P. 108

### ■ Customization

Settings (e.g. unlocking function using a key) can be changed.  
(Customizable features: →P. 533)

**⚠ WARNING****■ To prevent an accident**

Observe the following precautions while driving the vehicle.

Failure to do so may result in a door opening and an occupant throwing out of the vehicle, resulting in death or serious injury.

- Ensure that all doors are properly closed and locked.
- Do not pull the inside handle of the doors while driving.  
Be especially careful for the front doors, as the doors may be opened even if the inside lock buttons are in locked position.
- Set the rear door child-protector locks when children are seated in the rear seats.

## Trunk

The trunk can be opened using the trunk opener, entry function or wireless remote control.

If the vehicle is equipped with a power trunk opener and closer, the trunk can be closed using the trunk closer.

### Opening the trunk from inside the vehicle

Press the opener switch.

If the vehicle is equipped with a power trunk opener and closer, the trunk lid automatically opens fully.

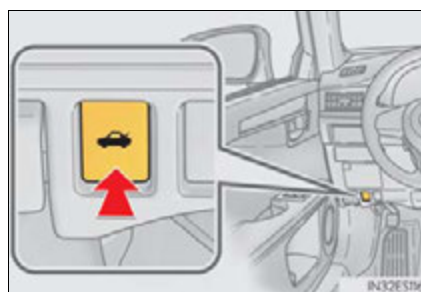

### Opening the trunk from outside the vehicle

#### ◆ Smart access system with push-button start

While carrying the electronic key, press the button on the trunk lid.

When all the doors are unlocked with the power door lock system, the trunk can be opened without carrying the electronic key.

If the vehicle is equipped with power trunk opener and closer, the trunk lid automatically opens fully.

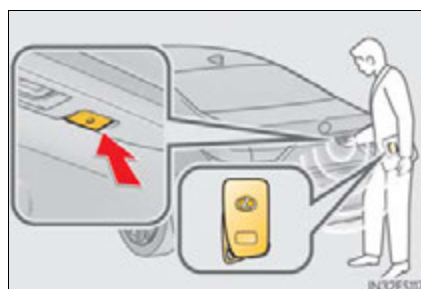

#### ◆ Wireless remote control

Press and hold the switch

If the vehicle is equipped with a power trunk opener and closer, the trunk lid automatically opens fully.



### Trunk closer switch (vehicles with power trunk opener and closer)

Pressing the switch closes the trunk lid automatically. (A buzzer sounds.)

Pressing the switch while the trunk lid is closing opens the trunk lid again.



### When closing the trunk

Using the trunk grip, lower the trunk without applying force to the side and push the trunk down from the outside to close it.



### Luggage security system

The trunk opener switch can be temporarily disabled to protect luggage stored in the trunk against theft.

Turn the main switch in the glove box off to disable the trunk opener.

- ① On
- ② Off

The trunk lid cannot be opened even with the wireless remote control or the entry function.

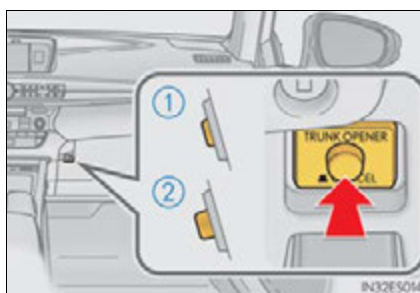

### ■ Trunk light

The trunk light turns on when the trunk is opened.

### ■ Trunk easy closer (vehicles with power trunk opener and closer)

In the event that the trunk lid is left slightly open, the trunk easy closer will automatically close it to the fully closed position.

### ■ Function to prevent the trunk being locked with the electronic key inside

- When all doors are being locked, closing the trunk lid with the electronic key left inside the trunk will sound an alarm.  
In this case, the trunk lid can be opened pressing the trunk release button on the trunk lid.
- Even when the spare electronic key is put in the trunk with all the doors locked, the key confinement prevention function can be activated so the trunk can be opened. In order to prevent theft, take all electronic keys with you when leaving the vehicle.
- Even when the electronic key is put in the trunk with all the doors are locked, the key may not be detected depending on the places and the surrounding radio wave conditions. In this case, the key confinement prevention function cannot be activated, causing the doors to lock when the trunk is closed. Make sure to check where the key is before closing the trunk.
- The key confinement prevention function cannot be activated if any one of the doors is unlocked. In this case, open the trunk using the trunk opener.

### ■ Overload protection function (vehicles with power trunk opener and closer)

The trunk lid will not operate when excessive load is present on the top of the trunk lid.

### ■ Fall-down protection function (vehicles with power trunk opener and closer)

While the trunk lid is opening automatically, applying excessive force to it will stop the opening operation to prevent the trunk lid from rapidly falling down.

### ■ Jam protection function (vehicles with power trunk opener and closer)

While the trunk lid is closing automatically, the trunk lid will stop closing and open if something gets caught.

### ■ Internal trunk release lever

The trunk lid can be opened by pulling the glow-in-the-dark lever located on the inside of the trunk lid to the side.

The lever will continue to glow for some time after the trunk lid is closed.

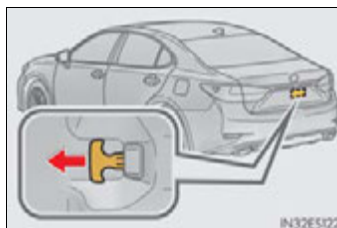

- **Using the mechanical key**  
The trunk can be also opened using the mechanical key. (→P. 499)
- **When leaving a key to the vehicle with a parking attendant**  
→P. 91
- **If the smart access system with push-button start or the wireless remote control does not operate properly**
  - Use the mechanical key to unlock the trunk. (→P. 499)
  - Replace the key battery with a new one if it is depleted. (→P. 451)
- **Customization**  
The trunk unlocking operation can be changed. (Customizable features: →P. 536)

 **WARNING**

Observe the following precautions.  
Failure to do so may result in death or serious injury.

■ **Before driving**

- Make sure that the trunk lid is fully closed. If the trunk lid is not fully closed, it may open unexpectedly while driving and hit near-by objects or luggage in the trunk may be thrown out, causing an accident.
- Do not allow children to play in the trunk.  
If a child is accidentally locked in the trunk, they could suffer from heat exhaustion, suffocation or other injuries.
- Do not allow a child to open or close the trunk lid.  
Doing so may cause the trunk lid to open unexpectedly, or cause the child's hands, head, or neck to be caught by the closing trunk lid.

■ **Important points while driving**

Never let anyone sit in the trunk. In the event of sudden braking or a collision, they are susceptible to death or serious injury.

**⚠ WARNING****■ Using the trunk**

Observe the following precautions.

Failure to do so may cause parts of the body to be caught, resulting in serious injury.

- Remove any heavy loads, such as snow and ice, from the trunk lid before opening it. Failure to do so may cause the trunk lid to suddenly shut again after it is opened.
- When opening or closing the trunk lid, thoroughly check to make sure the surrounding area is safe.
- If anyone is in the vicinity, make sure they are safe and let them know that the trunk is about to open or close.
- Use caution when opening or closing the trunk lid in windy weather as it may move abruptly in strong wind.
- Vehicles without power trunk opener and closer: The trunk lid may suddenly shut if it is not opened fully. It is more difficult to open or close the trunk lid on an incline than on a level surface, so beware of the trunk lid unexpectedly opening or closing by itself. Make sure that the trunk lid is fully open and secure before using the trunk.



- When closing the trunk lid, take extra care to prevent your fingers etc. from being caught.
- Vehicles without power trunk opener and closer: When closing the trunk lid, make sure to press it lightly on its outer surface. If the trunk grip is used to fully close the trunk lid, it may result in hands or arms being caught.



- Do not attach any accessories other than genuine Lexus parts to the trunk lid. Such additional weight on the trunk lid may cause the lid to suddenly shut again after it is opened.

**⚠ WARNING**

■ **Trunk easy closer (vehicles with power trunk opener and closer)**

In the event that the trunk lid is left slightly open, the trunk easy closer will automatically close it to the fully closed position. It takes several seconds before the trunk easy closer begins to operate. Be careful not to catch fingers or anything else in the trunk lid, as this may cause bone fractures or other serious injuries.



■ **Power trunk opener and closer (if equipped)**

Observe the following precautions when operating the power trunk opener and closer. Failure to do so may cause serious injury.

- Check the safety of the surrounding area to make sure there are no obstacles or anything that could cause any of your belongings to get caught.
- If anyone is in the vicinity, make sure they are safe and let them know that the trunk is about to open or close.
- If the trunk closer switch is pressed while the trunk lid is opening during automatic operation, the trunk lid stops opening. Take extra care when on an incline, as the trunk lid may open or close suddenly.
- On an incline, the trunk lid may suddenly shut after it opens automatically. Make sure the trunk lid is fully open and secure before using the trunk.
- In the following situations, the power trunk opener and closer may detect an abnormality and automatic operation may be stopped. In this case, the trunk lid has to be operated manually. Take extra care in this situation, as the stopped trunk lid may suddenly shut, causing an accident.
  - When the trunk lid contacts an obstacle
  - When the battery voltage suddenly drops, such as when the engine switch is turned to IGNITION ON mode or the engine is started during automatic operation
- Do not attach any accessories other than genuine Lexus parts to the trunk lid. The power trunk opener and closer may not operate, causing itself to malfunction, or the trunk lid may suddenly shut again after it is opened.

■ **Jam protection function (vehicles with power trunk opener and closer)**

Observe the following precautions. Failure to do so may cause serious injury.

- Never use any part of your body to intentionally activate the jam protection function.
- The jam protection function may not work if something gets caught just before the trunk lid fully closes. Be careful not to catch fingers or anything else in the trunk lid.
- The jam protection function may not work depending on the shape of the object that is caught. Be careful not to catch fingers or anything else.



 NOTICE

■ **To prevent trunk easy closer malfunctions (vehicles with power trunk opener and closer)**

Do not apply force to the trunk lid while the trunk easy closer is operating.

■ **To prevent damage to the power trunk opener and closer (vehicles with power trunk opener and closer)**

● Make sure that there is no luggage or snow on the trunk lid before operating the power trunk opener and closer. In addition, make sure that there is no ice between the trunk lid and frame that prevents movement of the trunk lid. Operating the power trunk opener and closer when excessive load is present on the trunk lid may cause a malfunction.

● Do not apply excessive force to the trunk lid while the power trunk opener and closer is operating.

3

Operation of each component

## Smart access system with push-button start

The following operations can be performed simply by carrying the electronic key on your person, for example in your pocket. The driver should always carry the electronic key.

- Locks and unlocks the doors (→P. 93)
- Opens the trunk (→P. 99)
- Starts the engine (→P. 151)

### ■ Antenna location

- ① Antennas outside the cabin
- ② Antennas inside the cabin
- ③ Antenna outside the trunk
- ④ Antenna inside the trunk

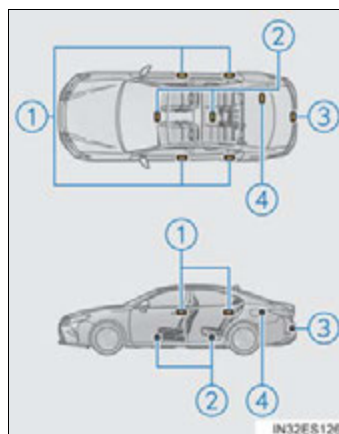

### ■ Effective range (areas within which the electronic key is detected)

- When locking or unlocking the doors  
The system can be operated when the electronic key is within about 2.3 ft. (0.7 m) of an outside door handle. (Only the doors detecting the key can be operated.)

- When opening the trunk  
The system can be operated when the electronic key is within about 2.3 ft. (0.7 m) of the trunk release button.

- When starting the engine or changing engine switch modes  
The system can be operated when the electronic key is inside the vehicle.

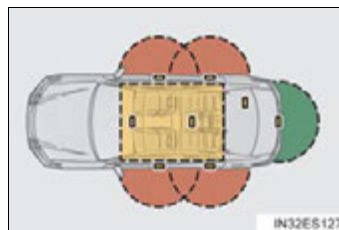

### ■ Alarms and warning indicators

An alarm sounds and warning message displays shown on the multi-information display are used to protect against unexpected accidents or theft of the vehicle resulting from erroneous operation. When a warning message is displayed, take appropriate measures based on the displayed message. (→P. 482)

When only an alarm sounds, circumstances and correction procedures are as follows.

Alarm	Situation	Correction procedure
Exterior alarm sounds once for 5 seconds	The trunk was closed while the electronic key was still inside the trunk and all the doors were locked.	Retrieve the electronic key from the trunk and close the trunk lid.
	An attempt was made to lock the vehicle while a door was open.	Close all of the doors and lock the doors again.
Interior alarm sounds continuously	The engine switch was turned to ACCESSORY mode while the driver's door was open (or the driver's door was opened while the engine switch was in ACCESSORY mode).	Turn the engine switch off and close the driver's door.



### ■ Battery-saving function

The battery-saving function will be activated in order to prevent the electronic key battery and the vehicle battery from being discharged while the vehicle is not in operation for a long time.

- In the following situations, the smart access system with push-button start may take some time to unlock the doors.
  - The electronic key has been left in an area of approximately 6 ft. (2 m) of the outside of the vehicle for 10 minutes or longer.
  - The smart access system with push-button start has not been used for 5 days or longer.
- If the smart access system with push-button start has not been used for 14 days or longer, the doors cannot be unlocked at any doors except the driver's door. In this case, take hold of the driver's door handle, or use the wireless remote control or the mechanical key, to unlock the doors.

■ **Electronic Key Battery-Saving Function**

When battery-saving mode is set, battery depletion is minimized by stopping the electronic key from receiving radio waves.

Press  twice while pressing and holding . Confirm that the electronic key indicator flashes 4 times.

While the battery-saving mode is set, the smart access system with push-button start cannot be used. To cancel the function, press any of the electronic key buttons.

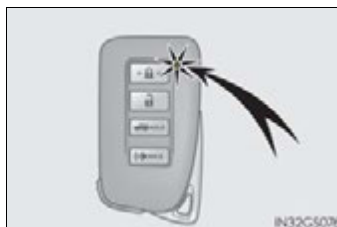

■ **Conditions affecting operation**

The smart access system with push-button start uses weak radio waves. In the following situations, the communication between the electronic key and the vehicle may be affected, preventing the smart access system with push-button start, wireless remote control and engine immobilizer system from operating properly.  
(Ways of coping: →P. 499)

- When the electronic key battery is depleted
- Near a TV tower, electric power plant, gas station, radio station, large display, airport or other facility that generates strong radio waves or electrical noise
- When carrying a portable radio, cellular phone, cordless phone or other wireless communication device
- When the electronic key is in contact with, or is covered by the following metallic objects
  - Cards to which aluminum foil is attached
  - Cigarette boxes that have aluminum foil inside
  - Metallic wallets or bags
  - Coins
  - Hand warmers made of metal
  - Media such as CDs and DVDs
- When other wireless keys (that emit radio waves) are being used nearby
- When carrying the electronic key together with the following devices that emit radio waves
  - Another vehicle's electronic key or a wireless key that emits radio waves
  - Personal computers or personal digital assistants (PDAs)
  - Digital audio players
  - Portable game systems
- If window tint with a metallic content or metallic objects are attached to the rear window

**■ Note for the entry function**

- Even when the electronic key is within the effective range (detection areas), the system may not operate properly in the following cases:
  - The electronic key is too close to the window or outside door handle, near the ground, or in a high place when the doors are locked or unlocked.
  - The electronic key is near the ground or in a high place, or too close to the rear bumper center when the trunk is opened.
  - The electronic key is on the instrument panel, rear package tray or floor, or in the door pockets or glove box when the engine is started or engine switch modes are changed.
- Do not leave the electronic key on top of the instrument panel or near the door pockets when exiting the vehicle. Depending on the radio wave reception conditions, it may be detected by the antenna outside the cabin and the doors will become lockable from the outside, possibly trapping the electronic key inside the vehicle.
- As long as the electronic key is within the effective range, the doors may be locked or unlocked by anyone. However, only the doors detecting the electronic key can be used to unlock the vehicle.
- Even if the electronic key is not inside the vehicle, it may be possible to start the engine if the electronic key is near the window.
- The doors may unlock or lock if a large amount of water splashes on the door handle, such as in the rain or in a car wash when the electronic key is within the effective range. (The doors will automatically be locked after approximately 60 seconds if the doors are not opened and closed.)
- If the wireless remote control is used to lock the doors when the electronic key is near the vehicle, there is a possibility that the door may not be unlocked by the entry function. (Use the wireless remote control to unlock the doors.)
- Touching the door lock or unlock sensor while wearing gloves may prevent lock or unlock operation.
- If the door handle becomes wet while the electronic key is within the effective range, the door may lock and unlock repeatedly. In that case, follow the following correction procedures to wash the vehicle:
  - Place the electronic key in a location 6 ft. (2 m) or more away from the vehicle. (Take care to ensure that the key is not stolen.)
  - Set the electronic key to battery-saving mode to disable the smart access system with push-button start. (→P. 108)
- If the electronic key is inside the vehicle and a door handle becomes wet during a car wash, a message may be shown on the multi-information display and a buzzer will sound outside the vehicle. To turn off the alarm, lock all the doors.
- The lock sensor may not work properly if it comes into contact with ice, snow, mud, etc. Clean the lock sensor and attempt to operate it again, or use the lock sensor on the lower part of the door handle.
- A sudden approach to the effective range or door handle may prevent the doors from being unlocked. In this case, return the door handle to the original position and check that the doors unlock before pulling the door handle again.
- Gripping the door handle when wearing a glove may not unlock the door.
- If there is another electronic key in the detection area, it may take slightly longer to unlock the doors after the door handle is gripped.

**■ When the vehicle is not driven for extended periods**

- To prevent theft of the vehicle, do not leave the electronic key within 6 ft. (2 m) of the vehicle.
- The smart access system with push-button start can be deactivated in advance. (→P. 533)

**■ To operate the system properly**

- Make sure to carry the electronic key when operating the system. Do not get the electronic key too close to the vehicle when operating the system from the outside of the vehicle.

Depending on the position and holding condition of the electronic key, the key may not be detected correctly and the system may not operate properly. (The alarm may go off accidentally, or the door lock prevention function may not operate.)

- Do not leave the electronic key inside the trunk.  
The key confinement prevention function may not operate, depending on the location of the key (close to a spare tire, the inside edge of the trunk), conditions (inside a metal bag, close to metallic objects) and the radio waves in the surrounding area. (→P. 101)

**■ If the smart access system with push-button start does not operate properly**

- Locking and unlocking the doors and opening the trunk: Use the mechanical key. (→P. 499)
- Starting the engine: →P. 500

**■ Customization**

Settings (e. g. smart access system with push-button start) can be changed. (Customizable features: →P. 533)

**■ If the smart access system with push-button start has been deactivated in a customized setting**

- Locking and unlocking the doors and opening the trunk:  
Use the wireless remote control or mechanical key. (→P. 93, 499)
- Starting the engine and changing engine switch modes: →P. 500
- Stopping the engine: →P. 152

**■ Certification for the smart access system with push-button start**

- ▶ For vehicles sold in the U.S.A., Hawaii, NATO Germany, Guam and Puerto Rico

**FCC ID: NI4TMLF10-51**

This device complies with part 15 of the FCC Rules. Operation is subject to the following two conditions: (1) This device may not cause harmful interference, and (2) this device must accept any interference received, including interference that may cause undesired operation.

Changes or modifications not expressly approved by the party responsible for compliance could void the user's authority to operate the equipment.

**FCC ID: NI4TMLF10-54**

This device complies with part 15 of the FCC Rules. Operation is subject to the following two conditions: (1) This device may not cause harmful interference, and (2) this device must accept any interference received, including interference that may cause undesired operation.

Changes or modifications not expressly approved by the party responsible for compliance could void the user's authority to operate the equipment.

FCC ID: HYQ23AAB FCC ID: HYQ14FBA
--------------------------------------

**NOTE:**

This device complies with part 15 of the FCC Rules. Operation is subject to the following two conditions: (1) This device may not cause harmful interference, and (2) this device must accept any interference received, including interference that may cause undesired operation.

**FCC WARNING:**

Changes or modifications not expressly approved by the party responsible for compliance could void the user's authority to operate the equipment.

- ▶ For vehicles sold in Canada

This device complies with Industry Canada licence-exempt RSS standard(s). Operation is subject to the following two conditions: (1) this device may not cause interference, and (2) this device must accept any interference, including interference that may cause undesired operation of the device.

Le présent appareil est conforme aux CNR d'Industrie Canada applicables aux appareils radio exempts de licence. L'exploitation est autorisée aux deux conditions suivantes : (1) l'appareil ne doit pas produire de brouillage, et (2) l'utilisateur de l'appareil doit accepter tout brouillage radioélectrique subi, même si le brouillage est susceptible d'en compromettre le fonctionnement.

**NOTE:**

This device complies with Industry Canada licence-exempt RSS standard(s). Operation is subject to the following two conditions: (1) this device may not cause interference, and (2) this device must accept any interference, including interference that may cause undesired operation of the device.

**NOTE:**

Le présent appareil est conforme aux CNR d'Industrie Canada applicables aux appareils radio exempts de licence. L'exploitation est autorisée aux deux conditions suivantes: (1) l'appareil ne doit pas produire de brouillage, et (2) l'utilisateur de l'appareil doit accepter tout brouillage radioélectrique subi, même si le brouillage est susceptible d'en compromettre le fonctionnement.



 **WARNING****■ Caution regarding interference with electronic devices**

- People with implantable cardiac pacemakers, cardiac resynchronization therapy-pacemakers or implantable cardioverter defibrillators should keep away from the smart access system with push-button start antennas. (→P. 106)

The radio waves may affect the operation of such devices. If necessary, the entry function can be disabled. Ask your Lexus dealer for details, such as the frequency of radio waves and timing of the emitted radio waves. Then, consult your doctor to see if you should disable the entry function.

- Users of any electrical medical device other than implantable cardiac pacemakers, cardiac resynchronization therapy-pacemakers or implantable cardioverter defibrillators should consult the manufacturer of the device for information about its operation under the influence of radio waves.

Radio waves could have unexpected effects on the operation of such medical devices.

Ask your Lexus dealer for details on disabling the entry function.

## Front seats

### Adjustment procedure

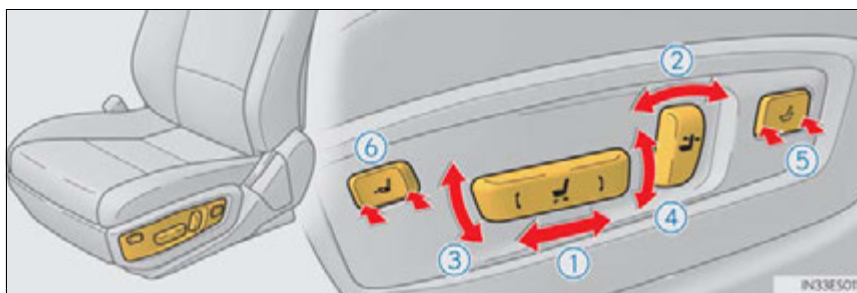

- |  |   |
|--|---|
| ① Seat position adjustment switch              | ④ Vertical height adjustment switch                                     |
| ② Seatback angle adjustment switch             | ⑤ Lumbar support adjustment switch                                      |
| ③ Seat cushion (front) angle adjustment switch | ⑥ Seat cushion length adjustment switch (if equipped for driver's side) |

#### ■ Power easy access system

The driver's seat and steering wheel (power adjustment type) move in accordance with engine switch mode and the driver's seat belt condition. (→P. 115)

#### ⚠ WARNING

##### ■ When adjusting the seat position

- Take care when adjusting the seat position to ensure that other passengers are not injured by the moving seat.
- Do not put your hands under the seat or near the moving parts to avoid injury. Fingers or hands may become jammed in the seat mechanism.
- Make sure to leave enough space around the feet so they do not get stuck.

##### ■ Seat adjustment

To reduce the risk of sliding under the lap belt during a collision, do not recline the seat more than necessary.

If the seat is too reclined, the lap belt may slide past the hips and apply restraint forces directly to the abdomen, or your neck may contact the shoulder belt, increasing the risk of death or serious injury in the event of an accident.

Adjustments should not be made while driving as the seat may unexpectedly move and cause the driver to lose control of the vehicle.

## Driving position memory\*

This feature automatically adjusts the front seats, steering wheel (power adjustment type) and outside rear view mirrors to make entering and exiting the vehicle easier or to suit your preferences.

### Power easy access system

The seat and steering wheel are automatically adjusted to allow the driver to enter and exit the vehicle easily.

When all of the following have been performed, the driver's seat and steering wheel are automatically adjusted to a position that allows driver to enter and exit the vehicle easily.

- The shift lever has been shifted to P.
- The engine switch has been turned off.
- The driver's seat belt has been unfastened.

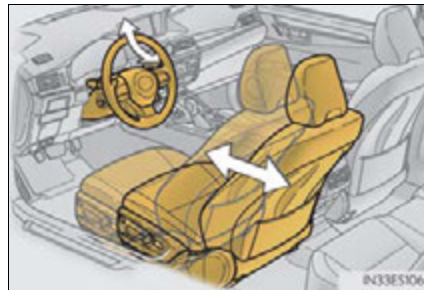

When any of the following has been performed, the driver's seat and steering wheel automatically return to their original positions.

- The engine switch has been turned to ACCESSORY mode or IGNITION ON mode.
- The driver's seat belt has been fastened.

#### ■ Operation of the power easy access system

When exiting the vehicle, the power easy access system may not operate if the seat is already close to the rearmost position, etc.

#### ■ Customization

The seat movement amount settings of the power easy access system can be customized. (Customizable features: →P. 533)

3

Operation of each component

\*: If equipped

### Driving position memory

Your preferred driving position (the position of the driver's seat, steering wheel and outside rear view mirrors) can be recorded and recalled by pressing a button.

Three different driving positions can be recorded into memory.

#### ■ Recording procedure

- 1 Check that the shift lever is in P.
- 2 Turn the engine switch to IGNITION ON mode.
- 3 Adjust the driver's seat, steering wheel, and outside rear view mirrors to the desired positions.
- 4 While pressing the "SET" button, or within 3 seconds after the "SET" button is pressed, press button "1", "2" or "3" until the buzzer sounds.

If the selected button has already been preset, the previously recorded position will be overwritten.

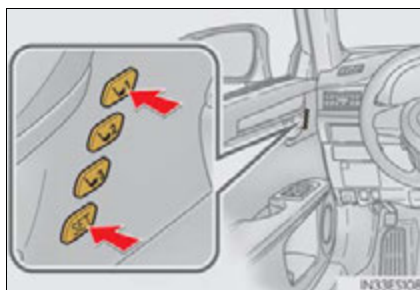

Vehicles with the driving position memory for the front passenger's seat: To record the position of the front passenger's seat, adjust the front passenger's seat to the desired position and perform step 4 using the buttons on the front passenger's side.

#### ■ Recall procedure

- 1 Check that the shift lever is in P.
- 2 Turn the engine switch to IGNITION ON mode.
- 3 Press one of the buttons for the driving position you want to recall until the buzzer sounds.

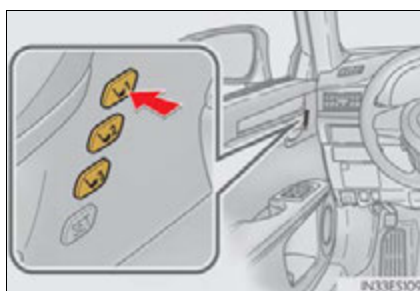

#### ■ To stop the position recall operation part-way through

Perform any of the following:

- Press the "SET" button.
- Press button "1", "2" or "3".
- Operate any of the seat adjustment switches (only cancels seat position recall).
- Operate the tilt and telescopic steering control switch (only cancels steering wheel position recall).

#### ■ Seat positions that can be memorized (→P. 114)

The adjusted positions other than the position adjusted by lumbar support switch can be recorded.

#### ■ Operating the driving position memory after turning the engine switch off

Driver's seat:

Recorded seat positions can be activated up to 180 seconds after the driver's door is opened and another 60 seconds after it is closed again.

Front passenger's seat:

Recorded seat positions can be activated up to 180 seconds after the front passenger's door is opened.

#### ■ In order to correctly use the driving position memory function

If a seat position is already in the furthest possible position and the seat is operated in the same direction, the recorded position may be slightly different when it is recalled.

### Memory recall function (driver's side only)

Each electronic key can be registered to recall your preferred driving position.

#### ■ Registering procedure

Record your driving position to button "1", "2" or "3" before performing the following:

Carry only the key you want to register, and then close the driver's door.

If 2 or more keys are in the vehicle, the driving position cannot be recorded properly.

- 1 Check that the shift lever is in P.
- 2 Turn the engine switch to IGNITION ON mode.
- 3 Recall the driving position that you want to record.
- 4 While pressing the recalled button, press and hold the door lock switch (either lock or unlock) until the buzzer sounds.

If the button could not be registered, the buzzer sounds continuously for approximately 3 seconds.

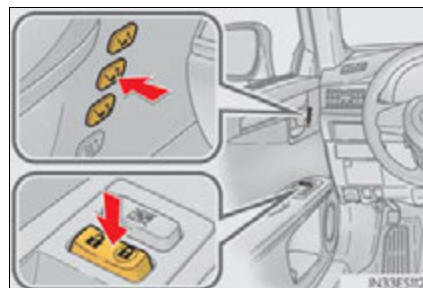

**■ Recall procedure**

- 1 Carry the electronic key that has been registered to the driving position, and then unlock and open the driver's door using the smart access system with push-button start or wireless remote control.

The driving position will move to the recorded position (not including the steering wheel). However, the seat will move to a position slightly behind the recorded position in order to make entering the vehicle easier.

If the driving position is in a position that has already been recorded, the seat and outside rear view mirrors will not move.

- 2 Turn the engine switch to ACCESSORY mode or IGNITION ON mode, or fasten a seat belt.

The seat and steering wheel will move to the recorded position.

**■ Cancellation procedure**

Carry only the key you want to cancel and then close the driver's door.

If 2 or more keys are in the vehicle, the driving position cannot be canceled properly.

- 1 Turn the engine switch to IGNITION ON mode.
- 2 While pressing the "SET" button, press and hold the door lock switch (either lock or unlock) until the buzzer sounds twice.

If the button could not be canceled, the buzzer sounds continuously for approximately 3 seconds.

**■ Recalling the driving position using the memory recall function**

- Different driving positions can be registered for each electronic key. Therefore, the driving position that is recalled may be different depending on the key being carried.
- If a door other than the driver's door is unlocked with the smart access system with push-button start, the driving position cannot be recalled. In this case, press the driving position button which has been set.

**■ Customization**

The unlock door settings of the memory recall function can be customized. (Customizable features: →P. 533)

**WARNING****■ Seat adjustment caution**

Take care during seat adjustment so that the seat does not strike the rear passenger or squeeze your body against the steering wheel.

## Head restraints

Head restraints are provided for all seats.

### Front seats

#### ◆ Vertical adjustment

- ① Up  
Pull the head restraints up.
- ② Down  
Push the head restraint down while pressing the lock release button.

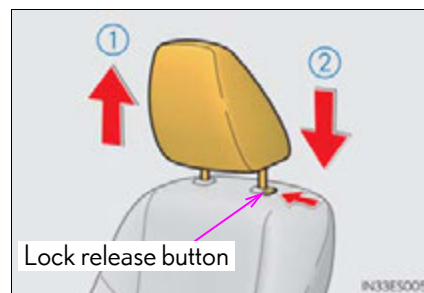

#### ◆ Horizontal adjustment

The position of the head restraint can be adjusted forward in 4 stages.

If the head restraint is pulled forward from the foremost position, it will return to the rearmost position.

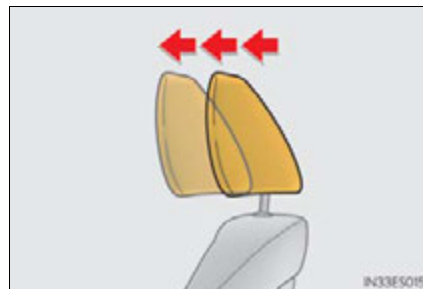

3

Operation of each component

### Rear seats

► Outboard

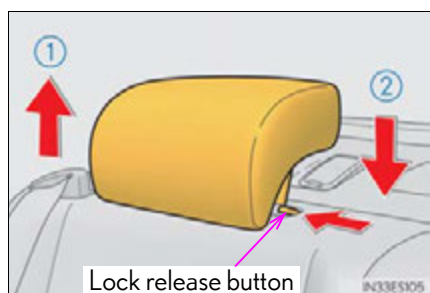

► Center

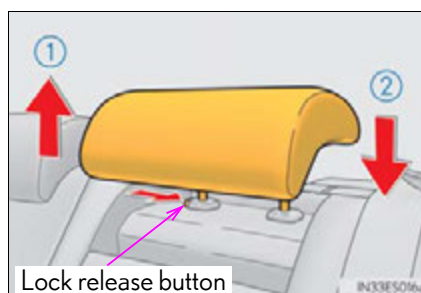

- ① Up  
Pull the head restraints up.
- ② Down  
Push the head restraint down while pressing the lock release button.

#### ■ Removing the head restraints

Pull the head restraint up while pressing the lock release button.





### ■ Installing the head restraints

#### ▶ Front seats

Align the head restraint with the installation holes and push it down to the lock position. Press and hold the lock release button when lowering the head restraint.

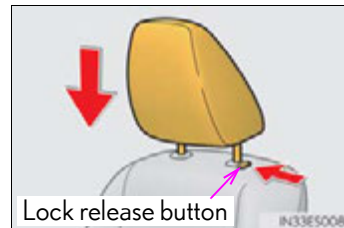

#### ▶ Rear seats

Align the head restraint with the installation holes and push it down to the lowest lock position while pressing the lock release button.

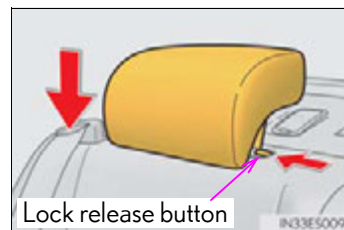

### ■ Adjusting the height of the head restraints

Make sure that the head restraints are adjusted so that the center of the head restraint is closest to the top of your ears.

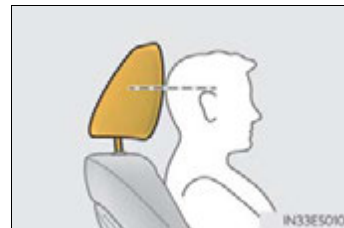

### ■ Adjusting the rear seat head restraint

Always raise the head restraint one level from the stowed position when using.

#### ⚠ WARNING

#### ■ Head restraint precautions

Observe the following precautions regarding the head restraints. Failure to do so may result in death or serious injury.

- Use the head restraints designed for each respective seat.
- Adjust the head restraints to the correct position at all times.
- After adjusting the head restraints, push down on them and make sure they are locked in position.
- Do not drive with the head restraints removed.

## Steering wheel

### Adjustment procedure

- ▶ Manual adjustment type

- 1 Hold the steering wheel and pull the lever down.

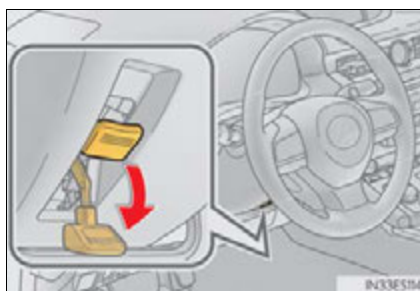

- 2 Adjust to the ideal position by moving the steering wheel horizontally and vertically.

After adjustment, pull the lever up to secure the steering wheel.

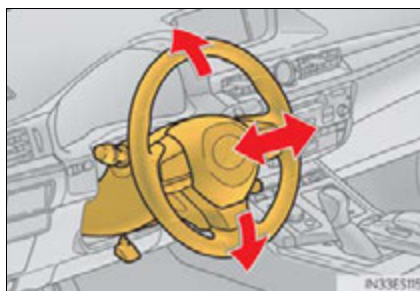

- ▶ Power adjustment type

Operating the switch moves the steering wheel in the following directions:

- 1 Up
- 2 Down
- 3 Toward the driver
- 4 Away from the driver

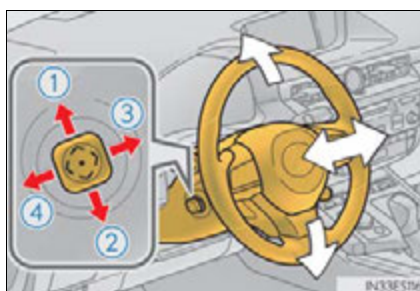

## Horn

To sound the horn, press on or close to the  mark.

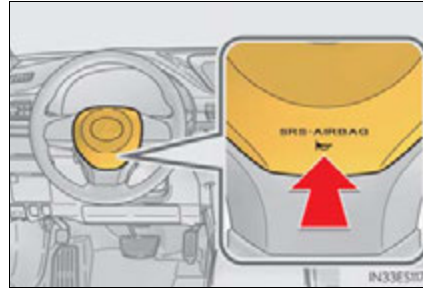

### ■ The power adjustment type steering wheel can be adjusted when

The engine switch is in ACCESSORY or IGNITION ON mode\*.

\*: If the driver's seat belt is fastened, the steering wheel can be adjusted regardless of engine switch mode.

### ■ Automatic adjustment of the steering position (power adjustment type)

A desired steering position can be entered to memory and recalled automatically by the driving position memory system. (→P. 115)

### ■ Power easy access system (power adjustment type)

The steering wheel and driver's seat move in accordance with engine switch mode and the driver's seat belt condition. (→P. 115)

### ■ After adjusting the steering wheel (manual adjustment type)

Make sure that the steering wheel is securely locked.  
The horn may not sound if the steering wheel is not securely locked.

## ⚠ WARNING

### ■ Caution while driving

Do not adjust the steering wheel while driving.  
Doing so may cause the driver to mishandle the vehicle and cause an accident, resulting in death or serious injury.

### ■ After adjusting the steering wheel (manual adjustment type)

Make sure that the steering wheel is securely locked.  
Otherwise, the steering wheel may move suddenly, possibly causing an accident, and resulting in death or serious injury.

## Inside rear view mirror

The rear view mirror's position can be adjusted to enable sufficient confirmation of the rear view.

### Adjusting the height of rear view mirror

The height of the rear view mirror can be adjusted to suit your driving posture.

Adjust the height of the rear view mirror by moving it up and down.

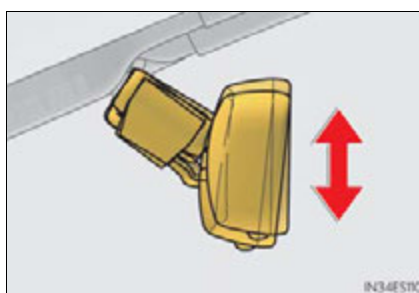

### Anti-glare function

Responding to the level of brightness of the headlights of vehicles behind, the reflected light is automatically reduced.

Changing automatic anti-glare function mode

ON/OFF

When the automatic anti-glare function is in ON mode, the indicator illuminates. The function will set to ON mode each time the engine switch is turned to IGNITION ON mode.

Pressing the button turns the function to OFF mode. (The indicator also turns off.)

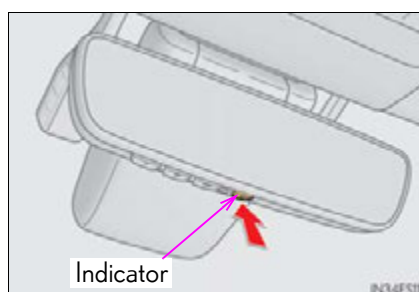

**■ To prevent sensor error**

To ensure that the sensors operate properly, do not touch or cover them.

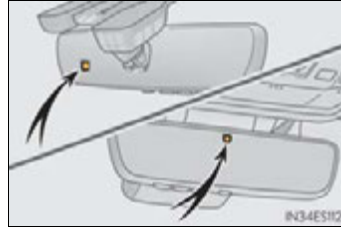
**⚠ WARNING**

Do not adjust the position of the mirror while driving.  
Doing so may lead to mishandling of the vehicle and cause an accident, resulting in death or serious injury.

3

Operation of each component

## Outside rear view mirrors

### Adjustment procedure

**1** To select a mirror to adjust, press the switch.

- ① Left
- ② Right

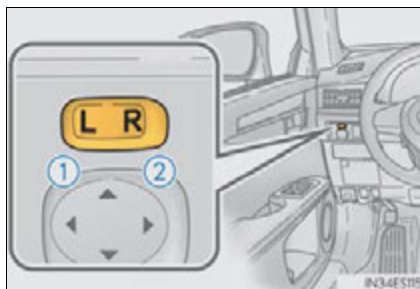

**2** To adjust the mirror, press the switch.

- ① Up
- ② Right
- ③ Down
- ④ Left

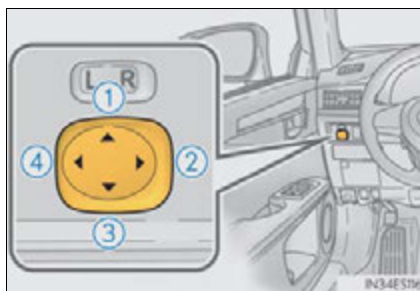

### Folding the mirrors

Push the mirror back in the direction of the vehicle's rear.

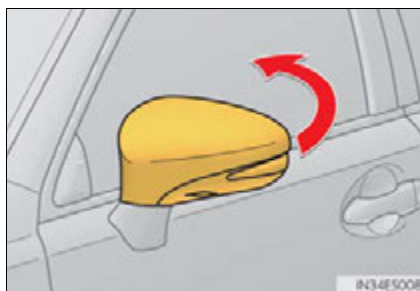

### Linked mirror function when reversing

When the mirror select switch is in the L or R position, the outside rear view mirrors will automatically angle downwards when the vehicle is reversing in order to give a better view of the ground.

To disable this function, move the mirror select switch to the neutral position (between L and R).

#### ■ Adjusting the mirror angle when the vehicle is reversing

With the shift lever in R, adjust the mirror angle at a desired position. The adjusted angle will be memorized and the mirror will automatically tilt to the memorized angle whenever the shift lever is shifted to R from next time.

The memorized downward tilt position of the mirror is linked to the normal position (angle adjusted with the shift lever in other than R). Therefore, if the normal position is changed after adjustment, the tilt position will also change. When the normal position is changed, readjust the angle in reversing.

---

#### ■ Mirror angle can be adjusted when

The engine switch is in ACCESSORY or IGNITION ON mode.

#### ■ When the mirrors are fogged up

The outside rear view mirrors can be cleared using the mirror defoggers. Turn on the rear window defogger to also defog the outside rear view mirrors. (→P. 368)

#### ■ Automatic adjustment of the mirror angle

A desired mirror face angle can be entered to memory and recalled automatically by the driving position memory. (→P. 115)

#### ■ Auto anti-glare function

When the anti-glare inside rear view mirror is set to automatic mode, the outside rear view mirrors will activate in conjunction with the anti-glare inside rear view mirror to reduce reflected light. (→P. 124)

**WARNING****■ Important points while driving**

Observe the following precautions while driving.

Failure to do so may result in loss of control of the vehicle and cause an accident, resulting in death or serious injury.

- Do not adjust the mirrors while driving.
- Do not drive with the mirrors folded.
- Both the driver and passenger side mirrors must be extended and properly adjusted before driving.

**■ When a mirror is moving**

To avoid personal injury and mirror malfunction, be careful not to get your hand caught by the moving mirror.

**■ When the mirror defoggers are operating**

Do not touch the rear view mirror surfaces, as they can become very hot and burn you.



## Power windows

### Opening and closing procedures

The power windows can be opened and closed using the switches.

Operating the switch moves the windows as follows:

- ① Closing
- ② One-touch closing\*
- ③ Opening
- ④ One-touch opening\*

\*: To stop the window partway, operate the switch in the opposite direction.

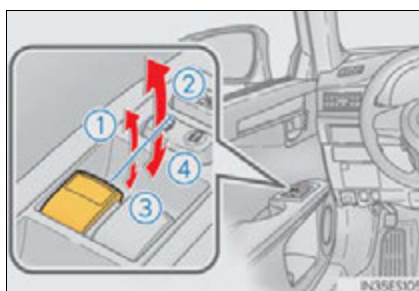

### Window lock switch

Press the switch to lock the passenger window switches.

Use this switch to prevent children from accidentally opening or closing a passenger window.

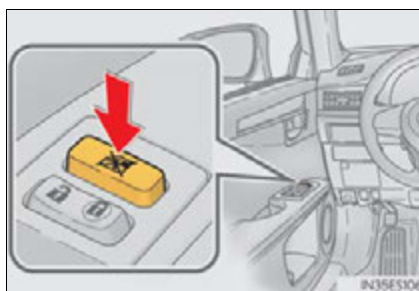

#### ■ The power windows can be operated when

The engine switch is in IGNITION ON mode.

#### ■ Operating the power windows after turning the engine off

The power windows can be operated for approximately 45 seconds even after the engine switch is turned to ACCESSORY mode or turned off. They cannot, however, be operated once either front door is opened.

#### ■ Jam protection function

If an object becomes jammed between the window and the window frame while the window is closing, window movement is stopped and the window is opened slightly.

#### ■ Catch protection function

If an object becomes caught between the door and window while the window is opening, window movement is stopped.

**■ When the window cannot be opened or closed**

When the jam protection function or catch protection function operates unusually and the door window cannot be opened or closed, perform the following operations with the power window switch of that door.

- Stop the vehicle. With the engine switch in IGNITION ON mode, within 4 seconds of the jam protection function or catch protection function activating, continuously operate the power window switch in the one-touch closing direction or one-touch opening direction so that the door window can be opened and closed.
- If the door window cannot be opened and closed even when performing the above operations, perform the following procedure for function initialization.
  - 1 Turn the engine switch to IGNITION ON mode.
  - 2 Pull and hold the power window switch in the one-touch closing direction and completely close the door window.
  - 3 Release the power window switch for a moment and then resume pulling and holding the switch in the one-touch closing direction for approximately 4 seconds.
  - 4 Press and hold the power window switch in the one-touch opening direction. After the door window is completely opened, continue holding the switch for an additional 1 second or more.
  - 5 Pull and hold the power window switch in the one-touch closing direction again. After the door window is completely closed, continue holding the switch for a further 1 second or more.

If you release the switch while the window is moving, start again from the beginning.

If the window reverses and cannot be fully closed or opened, have the vehicle inspected by your Lexus dealer.

**■ Door lock linked window operation**

- The power windows can be opened and closed using the mechanical key.\* (→P. 499)
  - The power windows can be opened using the wireless remote control.\* (→P. 93)
- \*: These settings must be customized at your Lexus dealer.

**■ When the battery is disconnected**

The window lock switch is disabled. If necessary, press the window lock switch after reconnecting the battery.

**■ Power windows open warning buzzer**

The buzzer sounds and a message is shown on the multi-information display in the instrument cluster when the engine switch is turned off and the driver's door is opened with the power windows open.

**■ Customization**

Settings (e.g. linked door lock operation) can be changed.  
(Customizable features: →P. 533)

 **WARNING**

Observe the following precautions.  
Failure to do so may result in death or serious injury.

**■ Closing the windows**

- The driver is responsible for all the power window operations, including the operation for the passengers. In order to prevent accidental operation, especially by a child, do not let a child operate the power windows. It is possible for children and other passengers to have body parts caught in the power window. Also, when riding with a child, it is recommended to use the window lock switch. (→P. 129)
- Check to make sure that all passengers do not have any part of their body in a position where it could be caught when a window is being operated.
- When using the mechanical key and operating the power windows, operate the power window after checking to make sure that there is no possibility of any passenger having any of their body parts caught in the window. Also do not let a child operate window by the mechanical key. It is possible for children and other passengers to get caught in the power window.
- When exiting the vehicle, turn the engine switch off, and take the key with you. Do not leave children unattended in the vehicle. There may be accidental operation, due to mischief, etc., that may possibly lead to an accident.

**■ Jam protection function**

- Never use any part of your body to intentionally activate the jam protection function.
- The jam protection function may not work if something gets jammed just before the window is fully closed.

**■ Catch protection function**

- Never use hands, arms, clothing, etc., to intentionally activate the catch protection function.
- The catch protection function may not operate if something gets caught just before the window is fully opened. Be careful not to get hands, arms, clothing, etc., caught in the window.

## Moon roof

Use the overhead switches to open and close the moon roof and tilt it up and down.

### Opening and closing

#### ► Standard type

##### ① Opens the moon roof\*

The moon roof stops slightly before the fully open position to reduce wind noise. Press the switch again to fully open the moon roof.

##### ② Closes the moon roof\*

\*: Lightly press either way of the moon roof switch to stop the moon roof part-way.

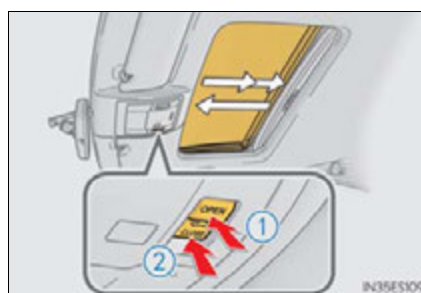

#### ► Glass type

##### ① Opens the moon roof

##### ② Closes the moon roof (push and hold)\*

\*: The moon roof stops once. Push and hold the switch again to fully close.

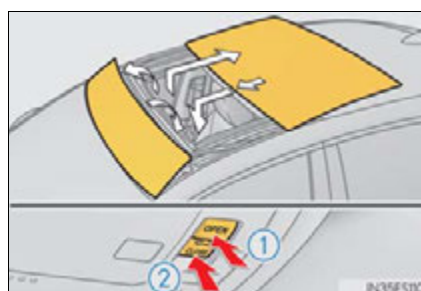

### Tilting up and down

#### ▶ Standard type

- ① Tilts the moon roof up\*
- ② Tilts the moon roof down\*

\*: Lightly press either way of the moon roof switch to stop the moon roof part-way.



#### ▶ Glass type

- ① Tilts the moon roof up\*
- ② Tilts the moon roof down (push and hold)

\*: Lightly press either way of the moon roof switch to stop the moon roof part-way.

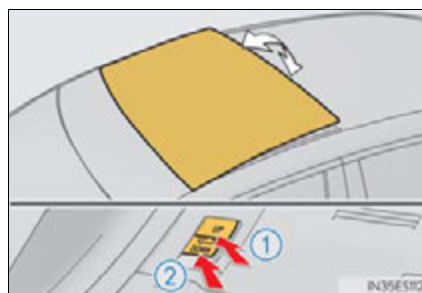

#### ■ The moon roof can be operated when

The engine switch is in IGNITION ON mode.

#### ■ Operating the moon roof after turning the engine off

The moon roof can be operated for approximately 45 seconds after the engine switch is turned to ACCESSORY mode or turned off. It cannot, however, be operated once either front door is opened.

#### ■ Jam protection function

If an object is detected between the moon roof and the frame while the moon roof is closing or tilting down, travel is stopped and the moon roof opens slightly.

#### ■ Sunshade (standard type)

The sunshade can be opened and closed manually. However, the sunshade will open automatically when the moon roof is opened.

#### ■ Front/rear sunshades (glass type)

The sunshades can be opened and closed manually. However, the front sunshade will open automatically when the moon roof is opened.

#### ■ Door lock linked moon roof operation

- The moon roof can be opened and closed using the mechanical key.\* (→P. 499)
- The moon roof can be opened using the wireless remote control.\* (→P. 93)

\*: These settings must be customized at your Lexus dealer.

**■ When the moon roof does not close normally**

Perform the following procedure:

- If the moon roof closes but then re-opens slightly

- 1 Stop the vehicle.
- 2 Press and hold the "CLOSE" switch.\*1  
The moon roof will close, reopen and pause for approximately 10 seconds.\*2 Then it will close again, tilt up and pause for approximately 1 second. Finally, it will tilt down, open and close.
- 3 Check to make sure that the moon roof is completely closed and then release the switch.

- If the moon roof tilts down but then tilts back up

- 1 Stop the vehicle.
- 2 Press and hold the "UP" switch\*1 until the moon roof moves into the tilt up position and stops.
- 3 Release the "UP" switch once and then press and hold the "UP" switch again.\*1  
The moon roof will pause for approximately 10 seconds in the tilt up position.\*2 Then it will adjust slightly and pause for approximately 1 second. Finally, it will tilt down, open and close.
- 4 Check to make sure that the moon roof is completely closed and then release the switch.

\*1: If the switch is released at the incorrect time, the procedure will have to be performed again from the beginning.

\*2: If the switch is released after the above mentioned 10 second pause, automatic operation will be disabled. In that case, press and hold the "CLOSE" or "UP" switch, and the moon roof will tilt up and pause for approximately 1 second. Then it will tilt down, open and close. Check to make sure that the moon roof is completely closed and then release the switch.

If the moon roof does not fully close even after performing the above procedure correctly, have the vehicle inspected by your Lexus dealer.

**■ Moon roof open warning buzzer**

The buzzer sounds and a message is shown on the multi-information display in the instrument cluster when the engine switch is turned off and the driver's door is opened with the moon roof open.

**■ Customization**

Settings (e.g. linked door lock operation) can be changed.  
(Customizable features: →P. 533)

 **WARNING**

Observe the following precautions.  
Failure to do so may cause death or serious injury.

**■ Opening the moon roof**

- Do not allow any passengers to put their hands or heads outside the vehicle while it is moving.
- Do not sit on top of the moon roof.

**■ Closing the moon roof**

- The driver is responsible for moon roof opening and closing operations. In order to prevent accidental operation, especially by a child, do not let a child operate the moon roof. It is possible for children and other passengers to have body parts caught in the moon roof.
- Check to make sure that all passengers do not have any part of their body in a position where it could be caught when the moon roof is being operated.
- When using the mechanical key and operating the moon roof, operate the moon roof after checking to make sure that there is no possibility of any passenger having any of their body parts caught in the moon roof. Also do not let a child operate moon roof by the mechanical key. It is possible for children and other passengers to get caught in the moon roof.
- When exiting the vehicle, turn the engine switch off, carry the key and exit the vehicle along with the child. There may be accidental operation, due to mischief, etc., that may possibly lead to an accident.

**■ Jam protection function**

- Never use any part of your body to intentionally activate the jam protection function.
- The jam protection function may not work if something gets caught just before the moon roof fully closes.





<b>4-1. Before driving</b>	
Driving the vehicle.....	138
Cargo and luggage.....	145
Vehicle load limits .....	148
Trailer towing.....	149
Dinghy towing.....	150
<b>4-2. Driving procedures</b>	
Engine (ignition) switch .....	151
Automatic transmission.....	156
Turn signal lever .....	159
Parking brake.....	160
<b>4-3. Operating the lights and wipers</b>	
Headlight switch.....	161
Automatic High Beam.....	164
Fog light switch .....	168
Windshield wipers and washer.....	169
<b>4-4. Refueling</b>	
Opening the fuel tank cap .....	173
<b>4-5. Using the driving support systems</b>	
Lexus Safety System+ .....	176
PCS (Pre-Collision System).....	183
LDA (Lane Departure Alert with steering control) .....	196
Dynamic radar cruise control.....	205
Cruise control .....	217
Intuitive parking assist .....	220
Lexus parking assist monitor .....	229
Driving mode select switch .....	245
BSM (Blind Spot Monitor).....	247
• Blind Spot Monitor function .....	250
• Rear Cross Traffic Alert function .....	252
Driving assist systems.....	255
<b>4-6. Driving tips</b>	
Winter driving tips .....	260

## Driving the vehicle

The following procedures should be observed to ensure safe driving:

### Starting the engine

→P. 151

### Driving

- 1 With the brake pedal depressed, shift the shift lever to D. (→P. 156)
- 2 Release the parking brake. (→P. 160)
- 3 Gradually release the brake pedal and gently depress the accelerator pedal to accelerate the vehicle.

### Stopping

- 1 With the shift lever in D, depress the brake pedal.
- 2 If necessary, set the parking brake.  
If the vehicle is to be stopped for an extended period of time, shift the shift lever to P or N. (→P. 156)

### Parking the vehicle

- 1 With the shift lever in D, depress the brake pedal.
- 2 Shift the shift lever to P. (→P. 156)
- 3 Set the parking brake. (→P. 160)
- 4 Press the engine switch to stop the engine.
- 5 Lock the door, making sure that you have the electronic key on your person.  
If parking on a hill, block the wheels as needed.

### Starting off on a steep uphill

- 1 Make sure that the parking brake is set and shift the shift lever to D.
- 2 Gently depress the accelerator pedal.
- 3 Release the parking brake.

#### ■ When starting off on a uphill

The hill-start assist control will activate. (→P. 255)

#### ■ Driving in the rain or adverse weather conditions

- Drive carefully, because visibility may be reduced, the windows may become fogged-up, and the road will be slippery.
- Drive carefully when it gets wet or icy, because the road surface will be especially slippery.
- Slow down when water is present on the roadway, because there may be a layer of water between the tires and the road surface, preventing the steering and brakes from operating properly.

#### ■ Engine speed while driving

In the following conditions, the engine speed may become high while driving. This is due to automatic up-shifting control or down-shifting implementation to meet driving conditions. It does not indicate sudden acceleration.

- The vehicle is judged to be driving uphill or downhill
- When the accelerator pedal is released

#### ■ Restraining the engine output (Brake Override System)

- When the accelerator and brake pedals are depressed at the same time, the engine output may be restrained.
- A warning message is displayed on the multi-information display while the system is operating. If a warning message is shown on the multi-information display, read the message and follow the instructions.

#### ■ Breaking in your new Lexus

To extend the life of the vehicle, observing the following precautions is recommended:

- For the first 186 miles (300 km):  
Avoid sudden stops.
- For the first 621 miles (1000 km):
  - Do not drive at extremely high speeds.
  - Avoid sudden acceleration.
  - Do not drive continuously in low gears.
  - Do not drive at a constant speed for extended periods.

#### ■ Drum-in-disc type parking brake system

Your vehicle has a drum-in-disc type parking brake system. This type of brake system needs bedding-down of the brake shoes periodically or whenever the parking brake shoes and/or drum are replaced. Have your Lexus dealer perform the bedding down operation.

#### ■ Operating your vehicle in a foreign country

Comply with the relevant vehicle registration laws and confirm the availability of the correct fuel. (→P. 521)

#### ■ Eco-friendly driving

→P. 82

#### ■ Customization

Setting of Eco Driving Indicator Light can be changed.  
(Customizable features: →P. 533)

 **WARNING**

Observe the following precautions.  
Failure to do so may result in death or serious injury.

**■ When starting the vehicle**

Always keep your foot on the brake pedal while stopped with the engine running. This prevents the vehicle from creeping.

**■ When driving the vehicle**

- Do not drive if you are unfamiliar with the location of the brake and accelerator pedals to avoid depressing the wrong pedal.
  - Accidentally depressing the accelerator pedal instead of the brake pedal will result in sudden acceleration that may lead to an accident.
  - When backing up, you may twist your body around, leading to a difficulty in operating the pedals. Make sure to operate the pedals properly.
  - Make sure to keep a correct driving posture even when moving the vehicle only slightly. This allows you to depress the brake and accelerator pedals properly.
  - Depress the brake pedal using your right foot. Depressing the brake pedal using your left foot may delay response in an emergency, resulting in an accident.
- Do not drive the vehicle over or stop the vehicle near flammable materials. The exhaust system and exhaust gases can be extremely hot. These hot parts may cause a fire if there is any flammable material nearby.
- During normal driving, do not turn off the engine. Turning the engine off while driving will not cause loss of steering or braking control, but the power assist to these systems will be lost. This will make it more difficult to steer and brake, so you should pull over and stop the vehicle as soon as it is safe to do so.  
However, in the event of an emergency, such as if it becomes impossible to stop the vehicle in the normal way: →P. 469
- Use engine braking (downshift) to maintain a safe speed when driving down a steep hill.  
Using the brakes continuously may cause the brakes to overheat and lose effectiveness. (→P. 157)
- Do not adjust the positions of the steering wheel, the seat, or the inside or outside rear view mirrors while driving.  
Doing so may result in a loss of vehicle control.
- Always check that all passengers' arms, heads or other parts of their body are not outside the vehicle.
- Do not drive in excess of the speed limit. Even if the legal speed limit permits it, do not drive over 85 mph (140 km/h) unless your vehicle has high-speed capability tires. Driving over 85 mph (140 km/h) may result in tire failure, loss of control and possible injury. Be sure to consult a tire dealer to determine whether the tires on your vehicle are high-speed capability tires or not before driving at such speeds.

**⚠ WARNING**

Observe the following precautions.  
Failure to do so may result in death or serious injury.

■ **When driving on slippery road surfaces**

- Sudden braking, acceleration and steering may cause tire slippage and reduce your ability to control the vehicle.
- Sudden acceleration, engine braking due to shifting, or changes in engine speed could cause the vehicle to skid, resulting in an accident.
- After driving through a puddle, lightly depress the brake pedal to make sure that the brakes are functioning properly. Wet brake pads may prevent the brakes from functioning properly. If the brakes on only one side are wet and not functioning properly, steering control may be affected.

■ **When shifting the shift lever**

- Do not let the vehicle roll backward while the shift lever is in a driving position, or roll forward while the shift lever is in R.  
Doing so may cause the engine to stall or lead to poor brake and steering performance, resulting in an accident or damage to the vehicle.
- Do not shift the shift lever to P while the vehicle is moving.  
Doing so can damage the transmission and may result in a loss of vehicle control.
- Do not shift the shift lever to R while the vehicle is moving forward.  
Doing so can damage the transmission and may result in a loss of vehicle control.
- Do not shift the shift lever to a driving position while the vehicle is moving backward.  
Doing so can damage the transmission and may result in a loss of vehicle control.
- Shifting the shift lever to N while the vehicle is moving will disengage the engine from the transmission. Engine braking is not available when N is selected.
- Be careful not to shift the shift lever with the accelerator pedal depressed. Shifting the shift lever to a gear other than P or N may lead to unexpected rapid acceleration of the vehicle that may cause an accident and result in death or serious injury.

■ **If you hear a squealing or scraping noise (brake pad wear limit indicators)**

Have the brake pads checked and replaced by your Lexus dealer as soon as possible. Rotor damage may result if the pads are not replaced when needed. It is dangerous to drive the vehicle when the wear limits of the brake pads and/or those of the brake discs are exceeded.

 **WARNING**

Observe the following precautions.  
Failure to do so may result in death or serious injury.

**■ When the vehicle is stopped**

- Do not race the engine.  
If the vehicle is in any gear other than P or N, the vehicle may accelerate suddenly and unexpectedly, causing an accident.
- In order to prevent accidents due to the vehicle rolling away, always keep depressing the brake pedal while the engine is running, and apply the parking brake as necessary.
- If the vehicle is stopped on an incline, in order to prevent accidents caused by the vehicle rolling forward or backward, always depress the brake pedal and securely apply the parking brake as needed.
- Avoid revving or racing the engine.  
Running the engine at high speed while the vehicle is stopped may cause the exhaust system to overheat, which could result in a fire if combustible material is nearby.

**■ When the vehicle is parked**

- Do not leave glasses, cigarette lighters, spray cans, or soft drink cans in the vehicle when it is in the sun.  
Doing so may result in the following:
  - Gas may leak from a cigarette lighter or spray can, and may lead to a fire.
  - The temperature inside the vehicle may cause the plastic lenses and plastic material of glasses to deform or crack.
  - Soft drink cans may fracture, causing the contents to spray over the interior of the vehicle, and may also cause a short circuit in the vehicle's electrical components.
- Do not leave cigarette lighters in the vehicle. If a cigarette lighter is in a place such as the glove box or on the floor, it may be lit accidentally when luggage is loaded or the seat is adjusted, causing a fire.
- Do not attach adhesive discs to the windshield or windows. Do not place containers such as air fresheners on the instrument panel or dashboard. Adhesive discs or containers may act as lenses, causing a fire in the vehicle.
- Do not leave a door or window open if the curved glass is coated with a metallized film such as a silver-colored one. Reflected sunlight may cause the glass to act as a lens, causing a fire.
- Always apply the parking brake, shift the shift lever to P, stop the engine and lock the vehicle.  
Do not leave the vehicle unattended while the engine is running.
- Do not touch the exhaust pipes while the engine is running or immediately after turning the engine off.  
Doing so may cause burns.

 **WARNING**

Observe the following precautions.  
Failure to do so may result in death or serious injury.

**■ When taking a nap in the vehicle**

Always turn the engine off. Otherwise, if you accidentally move the shift lever or depress the accelerator pedal, this could cause an accident or fire due to engine overheating. Additionally, if the vehicle is parked in a poorly ventilated area, exhaust gases may collect and enter the vehicle, leading to death or a serious health hazard.

**■ When braking**

- When the brakes are wet, drive more cautiously.  
Braking distance increases when the brakes are wet, and this may cause one side of the vehicle to brake differently than the other side. Also, the parking brake may not securely hold the vehicle.
- If the power brake assist function does not operate, do not follow other vehicles closely and avoid hills or sharp turns that require braking.  
In this case, braking is still possible, but the brake pedal should be depressed more firmly than usual. Also, the braking distance will increase. Have your brakes fixed immediately.
- Do not pump the brake pedal if the engine stalls.  
Each push on the brake pedal uses up the reserve for the power-assisted brakes.
- The brake system consists of 2 individual hydraulic systems; if one of the systems fails, the other will still operate. In this case, the brake pedal should be depressed more firmly than usual and the braking distance will increase. Have your brakes fixed immediately.

 NOTICE**■ When driving the vehicle**

- Do not depress the accelerator and brake pedals at the same time during driving, as this may restrain the engine output.
- Do not use the accelerator pedal or depress the accelerator and brake pedals at the same time to hold the vehicle on a hill.

**■ When parking the vehicle**

Always shift the shift lever to P. Failure to do so may cause the vehicle to move or the vehicle may accelerate suddenly if the accelerator pedal is accidentally depressed.

**■ Avoiding damage to vehicle parts**

- Do not turn the steering wheel fully in either direction and hold it there for an extended period of time.  
Doing so may damage the power steering motor.
- When driving over bumps in the road, drive as slowly as possible to avoid damaging the wheels, underside of the vehicle, etc.

**■ If you get a flat tire while driving**

A flat or damaged tire may cause the following situations. Hold the steering wheel firmly and gradually depress the brake pedal to slow down the vehicle.

- It may be difficult to control your vehicle.
- The vehicle will make abnormal sounds or vibrations.
- The vehicle will lean abnormally.

Information on what to do in case of a flat tire (→P. 485)

**■ When encountering flooded roads**

Do not drive on a road that has flooded after heavy rain etc. Doing so may cause the following serious damage to the vehicle:

- Engine stalling
- Short in electrical components
- Engine damage caused by water immersion

In the event that you drive on a flooded road and the vehicle is flooded, be sure to have your Lexus dealer check the following:

- Brake function
- Changes in quantity and quality of oil and fluid used for the engine, automatic transmission, etc.
- Lubricant condition for the bearings and suspension joints (where possible), and the function of all joints, bearings, etc.



## Cargo and luggage

Take notice of the following information about storage precautions, cargo capacity and load:

### Capacity and distribution

Cargo capacity depends on the total weight of the occupants.

(Cargo capacity) = (Total load capacity) – (Total weight of occupants)

#### Steps for Determining Correct Load Limit—

- (1) Locate the statement “The combined weight of occupants and cargo should never exceed XXX kg or XXX lbs.” on your vehicle’s placard.
- (2) Determine the combined weight of the driver and passengers that will be riding in your vehicle.
- (3) Subtract the combined weight of the driver and passengers from XXX kg or XXX lbs.
- (4) The resulting figure equals the available amount of cargo and luggage load capacity.  
For example, if the “XXX” amount equals 1400 lbs. and there will be five 150 lb passengers in your vehicle, the amount of available cargo and luggage load capacity is 650 lbs. (1400 – 750 (5 × 150) = 650 lbs.)
- (5) Determine the combined weight of luggage and cargo being loaded on the vehicle. That weight may not safely exceed the available cargo and luggage load capacity calculated in Step 4.
- (6) If your vehicle will be towing a trailer, load from your trailer will be transferred to your vehicle. Consult this manual to determine how this reduces the available cargo and luggage load capacity of your vehicle. (→P. 148)

Lexus does not recommend towing a trailer with your vehicle. Your vehicle is not designed for trailer towing.

### Calculation formula for your vehicle

- ① Cargo capacity
- ② Total load capacity (vehicle capacity weight) (→P. 512)

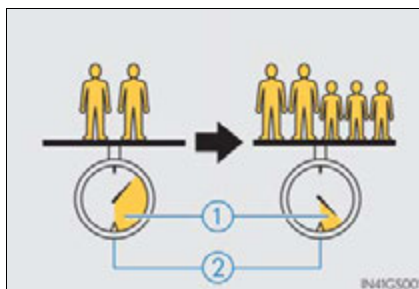

When 2 people with the combined weight of A lb. (kg) are riding in your vehicle, which has a total load capacity (vehicle capacity weight) of B lb. (kg), the available amount of cargo and luggage load capacity will be C lb. (kg) as follows:

$$B^{*2} \text{ lb. (kg)} - A^{*1} \text{ lb. (kg)} = C^{*3} \text{ lb. (kg)}$$

\*1: A = Weight of people

\*2: B = Total load capacity

\*3: C = Available cargo and luggage load

In this condition, if 3 more passengers with the combined weight of D lb. (kg) get on, the available cargo and luggage load will be reduced E lb. (kg) as follows:

$$C \text{ lb. (kg)} - D^{*4} \text{ lb. (kg)} = E^{*5} \text{ lb. (kg)}$$

\*4: D = Additional weight of people

\*5: E = Available cargo and luggage load

As shown in the example above, if the number of occupants increases, the cargo and luggage load will be reduced by an amount that equals the increased weight due to the additional occupants. In other words, if an increase in the number of occupants causes an excess of the total load capacity (combined weight of occupants plus cargo and luggage load), you must reduce the cargo and luggage on your vehicle.

 **WARNING****■ Things that must not be carried in the trunk**

The following things may cause a fire if loaded in the trunk:

- Receptacles containing gasoline
- Aerosol cans

**■ Storage precautions**

Observe the following precautions.

Failure to do so may prevent the pedals from being depressed properly, may block the driver's vision, or may result in items hitting the driver or passengers, possibly causing an accident.

- Stow cargo and luggage in the trunk whenever possible.
- Do not place cargo or luggage in or on the following locations.
  - At the feet of the driver
  - On the front passenger or rear seats (when stacking items)
  - On the package tray
  - On the instrument panel
  - On the dashboard
  - In front of the navigation system screen or Lexus Display Audio system screen
- Secure all items in the occupant compartment.

**■ Capacity and distribution**

- Do not exceed the maximum axle weight rating or the total vehicle weight rating.
- Even if the total load of occupant's weight and the cargo load is less than the total load capacity, do not apply the load unevenly. Improper loading may cause deterioration of steering or braking control which may cause death or serious injury.

## Vehicle load limits

Vehicle load limits include total load capacity, seating capacity, towing capacity and cargo capacity.

◆ **Total load capacity (vehicle capacity weight):** →P. 512

Total load capacity means the combined weight of occupants, cargo and luggage.

◆ **Seating capacity: 5 occupants (Front 2, Rear 3)**

Seating capacity means the maximum number of occupants whose estimated average weight is 150 lb. (68 kg) per person.

◆ **Towing capacity**

Lexus does not recommend towing a trailer with your vehicle.

◆ **Cargo capacity**

Cargo capacity may increase or decrease depending on the weight and the number of occupants.

■ **Total load capacity and seating capacity**

These details are also described on the tire and loading information label. (→P. 444)

 **WARNING**

■ **Overloading the vehicle**

Do not overload the vehicle.  
It may not only cause damage to the tires, but also degrade steering and braking ability, resulting in an accident.

## Trailer towing

Lexus does not recommend towing a trailer with your vehicle. Lexus also does not recommend the installation of a tow hitch or the use of a tow hitch carrier for a wheelchair, scooter, bicycle, etc. Your vehicle is not designed for trailer towing or for the use of tow hitch mounted carriers.



4

Driving

## Dinghy towing

Your vehicle is not designed to be dinghy towed (with 4 wheels on the ground) behind a motor home.

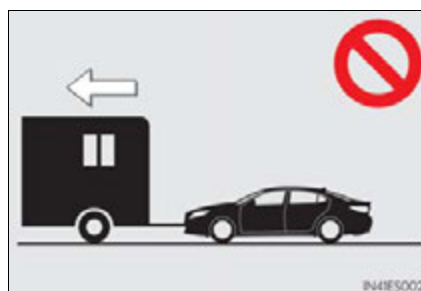

 NOTICE

- **To avoid serious damage to your vehicle**  
Do not tow your vehicle with the four wheels on the ground.

## Engine (ignition) switch

Performing the following operations when carrying the electronic key on your person starts the engine or changes engine switch modes.

### Starting the engine

- 1 Check that the parking brake is set.
- 2 Check that the shift lever is set in P.
- 3 Firmly depress the brake pedal.



will be displayed on the multi-information display.

If it is not displayed, the engine cannot be started.

- 4 Press the engine switch.

The engine will crank until it starts or for up to 30 seconds, whichever is less.

Continue depressing the brake pedal until the engine is completely started.

The engine can be started from any engine switch mode.

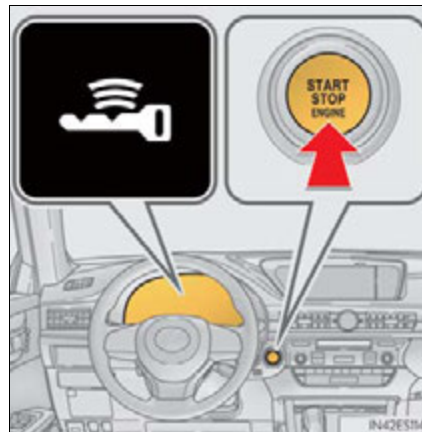

4

Driving

### Stopping the engine

- 1 Stop the vehicle.
- 2 Shift the shift lever to P.
- 3 Set the parking brake. (→P. 160)
- 4 Press the engine switch.
- 5 Release the brake pedal and check that “POWER ON” on the multi-information display is off.

### Changing engine switch modes

Modes can be changed by pressing the engine switch with brake pedal released. (The mode changes each time the switch is pressed.)

Off\*

The emergency flashers can be used.

ACCESSORY mode

Some electrical components such as the audio system can be used.

“POWER ON” will be displayed on the multi-information display.

IGNITION ON mode

All electrical components can be used.

“POWER ON” will be displayed on the multi-information display.

\*: If the shift lever is in a position other than P when turning off the engine, the engine switch will be turned to ACCESSORY mode, not to off.

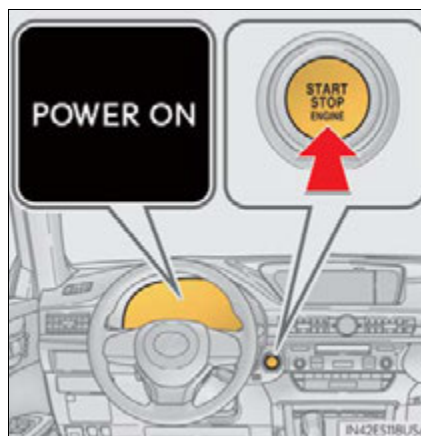



**When stopping the engine with the shift lever in a position other than P**

If the engine is stopped with the shift lever in a position other than P, the engine switch will not be turned off but instead be turned to ACCESSORY mode. Perform the following procedure to turn the switch off:

- 1 Check that the parking brake is set.
- 2 Shift the shift lever to P.
- 3 Check that "Turn Off Vehicle" is displayed on the multi-information display and then press the engine switch once.
- 4 Check that "Turn Off Vehicle" on the multi-information display is off.

**■ Auto power off function**

If the vehicle is left in ACCESSORY mode for more than 20 minutes or IGNITION ON mode (the engine is not running) for more than an hour with the shift lever in P, the engine switch will automatically turn off. However, this function cannot entirely prevent battery discharge. Do not leave the vehicle with the engine switch in ACCESSORY or IGNITION ON mode for long periods of time when the engine is not running.

**■ Electronic key battery depletion**

→P. 91

**■ Conditions affecting operation**

→P. 108

**■ Notes for the entry function**

→P. 109

**■ If the engine does not start**

- The engine immobilizer system may not have been deactivated. (→P. 65)  
Contact your Lexus dealer.
- Check that the shift lever is securely set in P. The engine may not start if the shift lever is displaced out of P. "Shift to P position to Start" will be displayed on the multi-information display.

**■ Steering lock**

After turning the engine switch off and opening and closing the doors, the steering wheel will be locked due to the steering lock function. Operating the engine switch again automatically cancels the steering lock.

■ **When the steering lock cannot be released**

“Steering Lock active” will be displayed on the multi-information display.

Check that the shift lever is set in P. Press the engine switch while turning the steering wheel left and right.



■ **Steering lock motor overheating prevention**

To prevent the steering lock motor from overheating, the motor may be suspended if the engine is turned on and off repeatedly in a short period of time. In this case, refrain from operating the engine. After about 10 seconds, the steering lock motor will resume functioning.

■ **When “Check Access System with Elec. Key” is displayed on the multi-information display**

The system may be malfunctioning. Have the vehicle inspected by your Lexus dealer immediately.

■ **If the electronic key battery is depleted**

→P. 451

■ **Operation of the engine switch**

- When operating the engine switch, one short, firm press is enough. If the switch is pressed improperly, the engine may not start or the engine switch mode may not change. It is not necessary to press and hold the switch.
- If attempting to restart the engine immediately after turning the engine switch off, the engine may not start in some cases. After turning the engine switch off, please wait a few seconds before restarting the engine.

■ **If the smart access system with push-button start has been deactivated in a customized setting**

→P. 499

■ **Odometer and trip meter display**

When the engine switch is turned off, the odometer or trip meter display will extinguish after approximately 30 seconds.

**⚠ WARNING****■ When starting the engine**

Always start the engine while sitting in the driver's seat. Do not depress the accelerator pedal while starting the engine under any circumstances.

Doing so may cause an accident resulting in death or serious injury.

**■ Caution while driving**

If engine failure occurs while the vehicle is moving, do not lock or open the doors until the vehicle reaches a safe and complete stop. Activation of the steering lock in this circumstance may lead to an accident, resulting in death or serious injury.

**■ Stopping the engine in an emergency**

If you want to stop the engine in an emergency while driving the vehicle, press and hold the engine switch for more than 2 seconds, or press it briefly 3 times or more in succession. (→P. 469)

However, do not touch the engine switch while driving except in an emergency. Turning the engine off while driving will not cause loss of steering or braking control, but the power assist to these systems will be lost. This will make it more difficult to steer and brake, so you should pull over and stop the vehicle as soon as it is safe to do so.

**⚠ NOTICE****■ To prevent battery discharge**

- Do not leave the engine switch in ACCESSORY or IGNITION ON mode for long periods of time without the engine running.
- If "POWER ON" is displayed on the multi-information display, the engine switch is not off. Exit the vehicle after turning the engine switch off.
- Do not stop the engine when the shift lever is in a position other than P. If the engine is stopped in another shift lever position, the engine switch will not be turned off but instead be turned to ACCESSORY mode. If the vehicle is left in ACCESSORY mode, battery discharge may occur.

**■ When starting the engine**

- Do not race a cold engine.
- If the engine becomes difficult to start or stalls frequently, have your vehicle checked by your Lexus dealer immediately.

**■ Symptoms indicating a malfunction with the engine switch**

If the engine switch seems to be operating somewhat differently than usual, such as the switch sticking slightly, there may be a malfunction. Contact your Lexus dealer immediately.

## Automatic transmission

### Shifting the shift lever

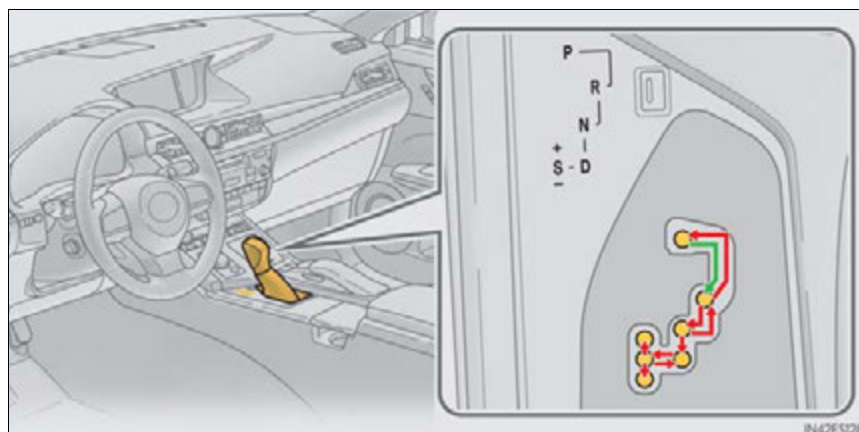

← While the engine switch is in IGNITION ON mode, move the shift lever with the brake pedal depressed.

When shifting the shift lever between P and D, make sure that the vehicle is completely stopped.

### Shift position purpose

Shift position	Objective or function
P	Parking the vehicle/starting the engine
R	Reversing
N	Neutral
D	Normal driving <sup>*1</sup>
S	S mode driving <sup>*2</sup> (→P. 157)

<sup>\*1</sup>: Shifting to the D position allows the system to select a gear suitable for the driving conditions.

Setting the shift lever to the D position is recommended for normal driving.

<sup>\*2</sup>: Selecting shift ranges using S mode restricts the upper limit of the possible gear ranges, controls engine braking force, and prevents unnecessary upshifting.

### Selecting gears in the S position

When the shift lever is in the S position, the shift lever can be operated as follows:

- ① Upshifting
- ② Downshifting

The selected shift range, from 1 to 6, will be displayed in the meter.

The initial shift range in S mode is set automatically to 5 or 4 according to vehicle speed. But, the initial shift range may be set to 3 if AI-SHIFT has operated while the shift lever was in the D position. (→P.158)

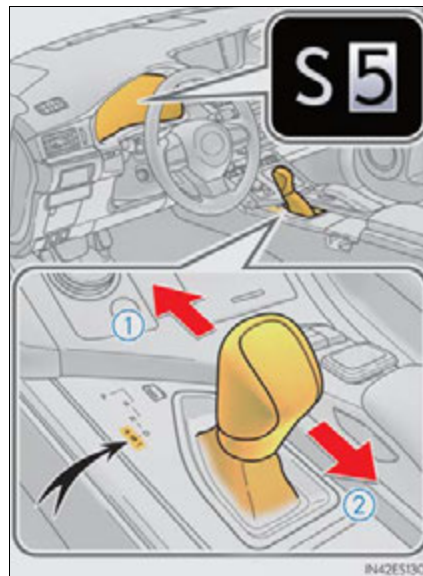

#### ■ Shift ranges and their functions

- Automatically selecting gears between 1 and 6 according to vehicle speed and driving conditions. But, the gear is limited according to selected shift range.
- You can choose from 6 levels of engine braking force.
- A lower shift range will provide greater engine braking force than a higher shift range, and the engine speed will also increase.

■ **S mode**

- When the shift range is 4 or lower, holding the shift lever toward “+” sets the shift range to 6.
- To prevent excessive engine speed, a function was adopted that automatically selects a higher shift range before the engine speed becomes too high.
- To protect the automatic transmission, a function is adopted that automatically selects a higher shift range when the fluid temperature is high.

■ **When driving with cruise control or dynamic radar cruise control activated**

Even when performing the following actions with the intent of enabling engine braking, the engine brake will not operate in the S mode, even when downshifting to 5 or 4. (→P. 217)

■ **Downshifting restrictions warning buzzer**

To help ensure safety and driving performance, downshifting operation may sometimes be restricted. In some circumstances, downshifting may not be possible even when the shift lever is operated. (A buzzer will sound twice.)

■ **If the S indicator does not come on even after shifting the shift lever to the S position**

This may indicate a malfunction in the automatic transmission system. Have the vehicle inspected by your Lexus dealer immediately. (In this situation, the transmission will operate in the same manner as when the shift lever is in the D position.)

■ **If the shift lever cannot be shifted from P**

→P. 498

■ **AI-SHIFT**

AI-SHIFT automatically selects the suitable gear according to driver performance and driving conditions.

AI-SHIFT automatically operates when the shift lever is in D. (Shifting the shift lever to S cancels the function.)

 **WARNING**

■ **When driving on slippery road surfaces**

Do not accelerate or shift gears suddenly. Sudden changes in engine braking may cause the vehicle to spin or skid, resulting in an accident.

## Turn signal lever

### Operating instructions

- ① Right turn
- ② Lane change to the right (move the lever partway and then release it)  
The right hand signals will flash 3 times.
- ③ Lane change to the left (move the lever partway and then release it)  
The left hand signals will flash 3 times.
- ④ Left turn

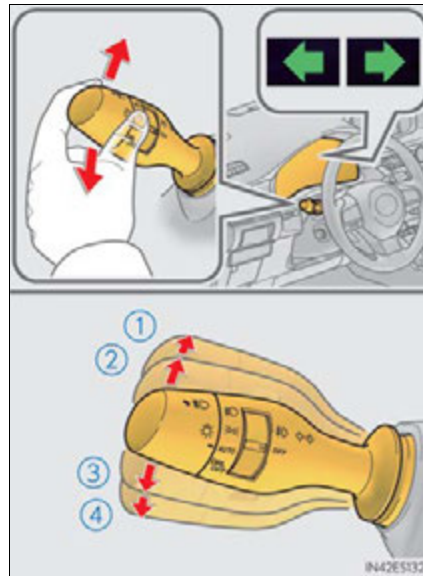

4

Driving

- **Turn signals can be operated when**  
The engine switch is in IGNITION ON mode.
- **If the indicator flashes faster than usual**  
Check that a light bulb in the front or rear turn signal lights has not burned out.
- **If the turn signals stop flashing before a lane change has been performed**  
Operate the lever again.
- **To discontinue flashing of the turn signals during a lane change**  
Operate the lever in the opposite direction.
- **Customization**  
The number of times the turn signals flash during a lane change can be changed.  
(→P. 533)

## Parking brake

To set the parking brake, fully depress the parking brake pedal with your left foot while depressing the brake pedal with your right foot.

(Depressing the pedal again releases the parking brake.)

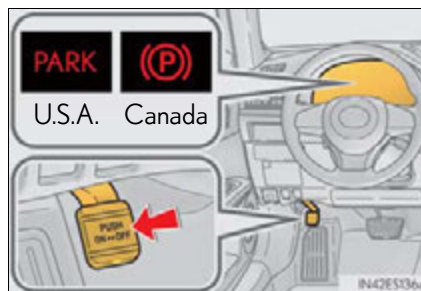

### ■ Parking brake engaged warning buzzer

A buzzer will sound if the vehicle is driven with the parking brake engaged. "Release Parking Brake" is displayed on the multi-information display.

### ■ Usage in winter time

→P. 261

### ⚠ NOTICE

#### ■ Before driving

Fully release the parking brake.

Driving the vehicle with the parking brake set will lead to brake components overheating, which may affect braking performance and increase brake wear.





## Headlight switch

The headlights can be operated manually or automatically.

### Operating instructions

Turning the end of the lever turns on the lights as follows:

- ①  The side marker, parking, daytime running (→P. 162), tail, license plate and instrument panel lights turn on.
- ②  The headlights, parking and all lights listed above (except daytime running lights) turn on.
- ③ **AUTO** The headlights, daytime running lights (→P. 162) and all the lights listed above turn on and off automatically. (When the engine switch is in IGNITION ON mode.)
- ④ **DRL** Off  
**OFF**  
(U.S.A.)
  - The daytime running lights turn on. (→P. 162)  
(Canada)

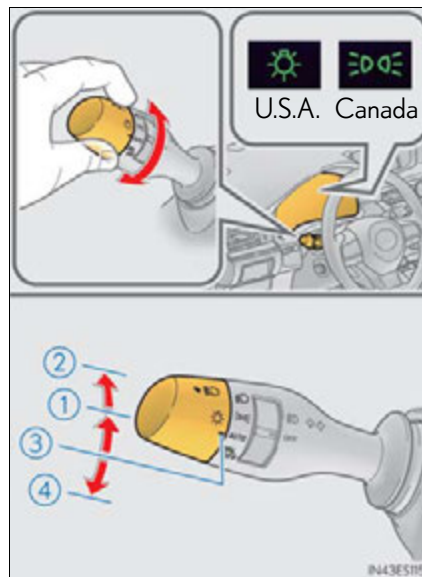

### Turning on the high beam headlights

- ① With the headlights on, push the lever away from you to turn on the high beams.

Pull the lever toward you to the center position to turn the high beams off.

- ② Pull the lever toward you and release it to flash the high beams once.

You can flash the high beams with the headlights on or off.

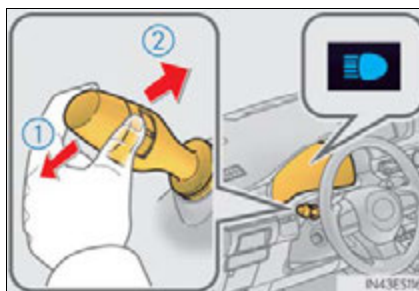

### AFS (Adaptive Front-lighting System) (if equipped)

AFS (Adaptive Front-lighting System) improves visibility at intersections and on curves by automatically adjusting the lateral angle of the headlights according to vehicle speed and the degree of the tire angle that are controlled by steering input.

Operates at speed of 6 mph (10 km/h) or higher.

#### ■ Deactivating AFS

- ① Select "AFS" on  (settings display) of the multi-information display. (→P. 79)
- ② Press the meter control switch.

#### ■ Daytime running light system

- To make your vehicle more visible to other drivers during daytime driving, the daytime running lights turn on automatically whenever the engine is started and the parking brake is released. (Illuminate brighter than the parking lights.) Daytime running lights are not designed for use at night.  
For the U.S.A.: Daytime running lights can be turned off by operating the switch.
- Compared to turning on the headlights, the daytime running light system offers greater durability and consumes less electricity, so it can help improve fuel economy.

#### ■ Headlight control sensor

The sensor may not function properly if an object is placed on the sensor, or anything that blocks the sensor is affixed to the windshield. Doing so interferes with the sensor detecting the level of ambient light and may cause the automatic headlight system to malfunction.



#### ■ Automatic light off system

When the light switch is in **AUTO**, **☰** or **☷**: The headlights and tail lights turn off 30 seconds after the engine switch is turned to **ACCESSORY** mode or turned off and a door is opened and all of the doors and trunk are closed. (The lights turn off immediately if **🔑** on the key is pressed twice after all the doors are closed.)

To turn the lights on again, turn the engine switch to **IGNITION ON** mode, or turn the light switch off once and then back to **☰** or **☷**.

If any of the doors or trunk lid is kept open, the lights automatically turn off after 20 minutes.

#### ■ Light reminder buzzer

A buzzer sounds when the engine switch is turned off or turned to **ACCESSORY** mode and the driver's door is opened while the lights are turned on.

#### ■ Automatic headlight leveling system (if equipped)

The level of the headlights is automatically adjusted according to the number of passengers and the loading condition of the vehicle to ensure that the headlights do not interfere with other road users.

#### ■ If "Headlight System Malfunction Visit Your Dealer" is displayed on the multi-information display

The system may be malfunctioning. Have the vehicle inspected by your Lexus dealer.

#### ■ Customization

Settings (e.g. light sensor sensitivity) can be changed.  
(Customizable features: →P. 533)



#### NOTICE

#### ■ To prevent battery discharge

Do not leave the lights on longer than necessary when the engine is not running.

## Automatic High Beam \*

The Automatic High Beam uses an in-vehicle camera sensor to assess the brightness of streetlights, the lights of vehicles ahead, etc., and automatically turns the high beam on or off as necessary.

### WARNING

#### ■ Limitations of the Automatic High Beam

Do not rely on the Automatic High Beam. Always drive safely, taking care to observe your surroundings and turning the high beam on or off manually if necessary.

#### ■ To prevent incorrect operation of the Automatic High Beam system

Do not overload the vehicle.

### Activating the Automatic High Beam system

- 1 Push the lever away from you with the headlight switch in the AUTO or  position.

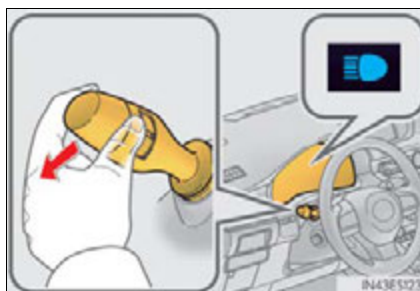

- 2 Press the Automatic High Beam switch.

The Automatic High Beam indicator will come on when the headlights are turned on automatically to indicate that the system is active.

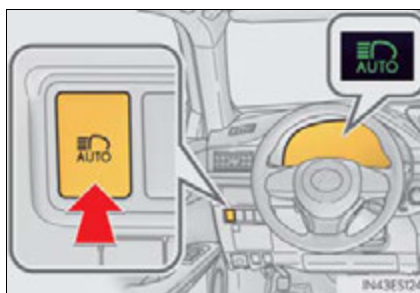

\*: If equipped

### Turning the high beam on/off manually

#### ■ Switching to low beam

Pull the lever to the original position.

The Automatic High Beam indicator will turn off.

Push the lever away from you to activate the Automatic High Beam system again.

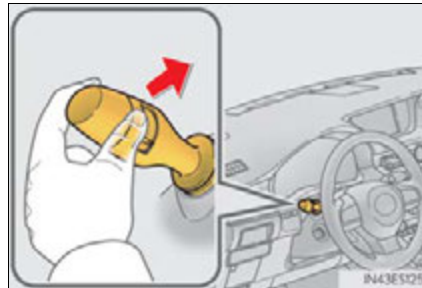

#### ■ Switching to high beam

Press the Automatic High Beam switch.

The Automatic High Beam indicator will turn off and the high beam indicator will turn on.

Press the switch to activate the Automatic High Beam system again.

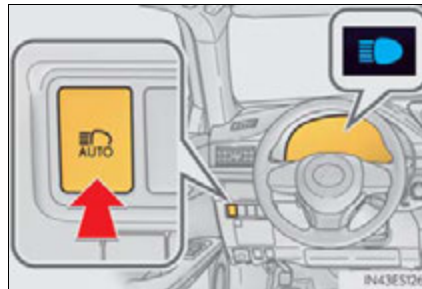

4

Driving

#### ■ High beam automatic turning on or off conditions

- When all of the following conditions are fulfilled, the high beam will be automatically turned on:
  - Vehicle speed is above approximately 21 mph (34 km/h).
  - The area ahead of the vehicle is dark.
  - There are no vehicles ahead with headlights or tail lights turned on.
  - There are few streetlights on the road ahead.
- If any of the following conditions are fulfilled, the high beam will be automatically turned off:
  - Vehicle speed drops below approximately 17 mph (27 km/h).
  - The area ahead of the vehicle is not dark.
  - Vehicles ahead have headlights or tail lights turned on.
  - There are many streetlights on the road ahead.

**■ Camera sensor detection information**

- The high beam may not be automatically turned off in the following situations:
  - When oncoming vehicles suddenly appear from a curve
  - When the vehicle is cut in front of by another vehicle
  - When vehicles ahead are hidden from sight due to repeated curves, road dividers or roadside trees
  - When vehicles ahead appear from the faraway lane on wide road
  - When vehicles ahead have no lights
- The high beam may be turned off if a vehicle ahead that is using fog lights without using the headlights is detected.
- House lights, street lights, traffic signals, and illuminated billboards or signs may cause the high beam to switch to the low beams, or the low beams to remain on.
- The following factors may affect the amount of time taken to turn the high beam on or off:
  - The brightness of headlights, fog lights, and tail lights of vehicles ahead
  - The movement and direction of vehicles ahead
  - When a vehicle ahead only has operational lights on one side
  - When a vehicle ahead is a two-wheeled vehicle
  - The condition of the road (gradient, curve, condition of the road surface etc.)
  - The number of passengers and amount of luggage
- The high beam may be turned on or off when the driver does not expect it.
- Bicycles or similar objects may not be detected.
- In the situations shown below, the system may not be able to accurately detect surrounding brightness levels. This may cause the low beams to remain on or the high beams to cause problems for pedestrians, vehicles ahead or other parties. In these cases, manually switch between the high and low beams.
  - In bad weather (rain, snow, fog, sandstorms etc.)
  - The windshield is obscured by fog, mist, ice, dirt etc.
  - The windshield is cracked or damaged.
  - The camera sensor is deformed or dirty.
  - The camera sensor temperature is extremely high.
  - Surrounding brightness levels are equal to those of headlights, tail lights or fog lights.
  - Vehicles ahead have headlights or tail lights that are either switched off, dirty, are changing color, or are not aimed properly.
  - When driving through an area of intermittently changing brightness and darkness.
  - When frequently and repeatedly driving ascending/descending roads, or roads with rough, bumpy or uneven surfaces (such as stone-paved roads, gravel tracks etc.).
  - When frequently and repeatedly taking curves or driving on a winding road.
  - There is a highly reflective object ahead of the vehicle, such as a sign or a mirror.
  - The back of a vehicle ahead is highly reflective, such as a container on a truck.
  - The vehicle's headlights are damaged or dirty, or are not aimed properly.
  - The vehicle is listing or tilting due to a flat tire, a trailer being towed, etc.
  - The high beam and low beam are repeatedly being switched between in an abnormal manner.
  - The driver believes that the high beam may be causing problems or distress to other drivers or pedestrians nearby.

**■ Temporarily lowering sensor sensitivity**

The sensitivity of the sensor can be temporarily lowered.

- 1 Turn the engine switch off while the following conditions are met.
  - The headlight switch is in AUTO or .
  - The headlight switch lever is in high beam position.
  - Automatic High Beam switch is on.
- 2 Turn the engine switch to IGNITION ON mode.
- 3 Within 30 seconds after 2, repeat pulling the headlight switch lever to the original position then pushing it to the high beam position quickly 10 times, then leave the lever in high beam position.
- 4 If the sensitivity is changed, the Automatic High Beam indicator is turn on and off three times.

Automatic High Beam (headlights) may turn on even the vehicle is stopped.

## Fog light switch

The fog lights enhance visibility in difficult driving conditions, such as in rain and fog.

- ① OFF (U.S.A.) or ○ (Canada)  
Turns the fog lights off
- ②  Turns the fog lights on

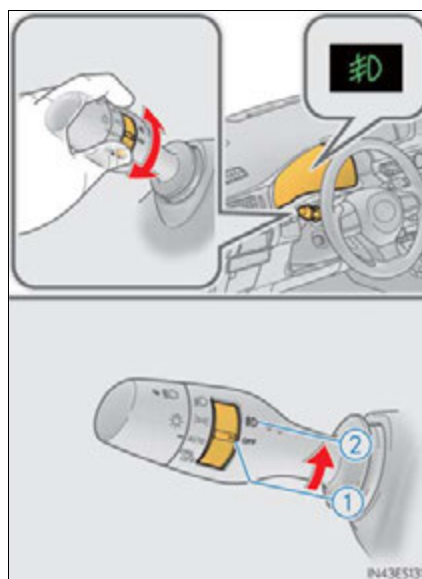

- Fog lights can be used when  
The headlights are on in low beam.



## Windshield wipers and washer

### Operating the wiper lever

The wiper operation is selected by moving the lever as follows.

► Intermittent windshield wipers with interval adjuster

- ① Temporary operation
- ② Intermittent operation
- ③ Low speed operation
- ④ High speed operation

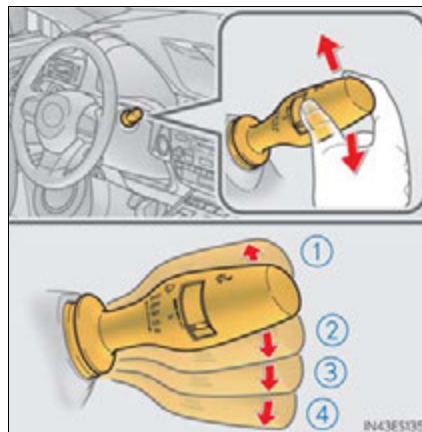

Wiper intervals can be adjusted when intermittent operation is selected.

- ⑤ Increases the intermittent windshield wiper frequency
- ⑥ Decreases the intermittent windshield wiper frequency

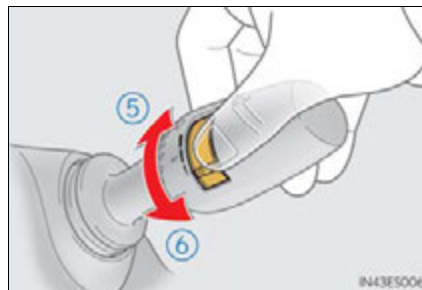

- ⑦ Washer/wiper dual operation  
Wipers will automatically operate a couple of times after the washer squirts.



► Rain-sensing windshield wipers

- ① Temporary operation
- ② Rain-sensing wiper operation (AUTO)
- ③ Low speed operation
- ④ High speed operation

When AUTO is selected, the wipers will operate automatically when the sensor detects falling rain. The system automatically adjusts wiper timing in accordance with rain volume and vehicle speed.

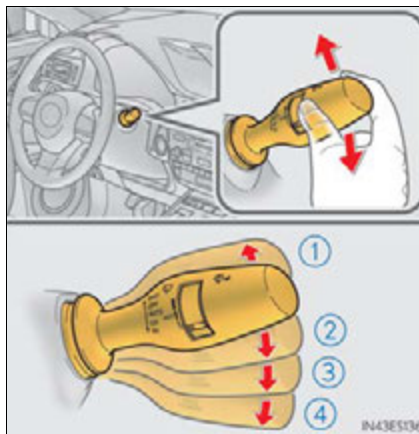

The sensor sensitivity can be adjusted when AUTO is selected.

- ⑤ Increases the sensitivity
- ⑥ Decreases the sensitivity

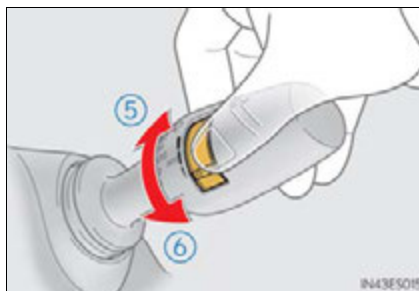

- ⑦ Washer/wiper dual operation
- Wipers will automatically operate a couple of times after the washer squirts.



■ The windshield wiper and washer can be operated when  
The engine switch is in IGNITION ON mode.

#### ■ Raindrop sensor (vehicles with rain-sensing windshield wipers)

- The raindrop sensor judges the amount of raindrops.

An optical sensor is adopted. It may not operate properly when sunlight from the rising or setting of the sun intermittently strikes the windshield, or if bugs etc. are present on the windshield.

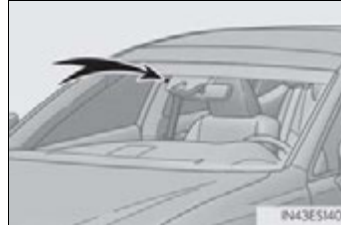

- If the wiper switch is turned to AUTO position while the engine switch is in IGNITION ON mode, the wipers will operate once to show that AUTO mode is activated.
- When the sensor sensitivity ring is turned toward high while in AUTO mode, the wipers will operate once to indicate that the sensor sensitivity is enhanced.
- If the temperature of the raindrop sensor is 185°F (85°C) or higher, or -22°F (-30°C) or lower, automatic operation may not occur. In this case, operate the wipers in any mode other than AUTO mode.

#### ■ If no windshield washer fluid sprays

Check that the washer nozzles are not blocked if there is washer fluid in the windshield washer fluid reservoir.



#### WARNING

##### ■ Caution regarding the use of windshield wipers in AUTO mode (vehicles with rain-sensing windshield wipers)

The windshield wipers may operate unexpectedly if the sensor is touched or the windshield is subject to vibration in AUTO mode. Take care that your fingers or anything else do not become caught in the windshield wipers.

##### ■ Caution regarding the use of washer fluid

When it is cold, do not use the washer fluid until the windshield becomes warm. The fluid may freeze on the windshield and cause low visibility. This may lead to an accident, resulting in death or serious injury.

 NOTICE

■ **When the windshield is dry**

Do not use the wipers, as they may damage the windshield.

■ **When there is no washer fluid spray from the nozzle**

Damage to the washer fluid pump may be caused if the lever is pulled toward you and held continually.

■ **When a nozzle becomes blocked**

In this case, contact your Lexus dealer.

Do not try to clear it with a pin or other object. The nozzle will be damaged.

■ **When standing the windshield wipers up**

Raise the wipers in line with the windshield. (→P. 262)

Failure to do so may result in damage to the wipers and/or the hood.

## Opening the fuel tank cap

Perform the following steps to open the fuel tank cap:

### Before refueling the vehicle

- Turn the engine switch off and ensure that all the doors and windows are closed.
- Confirm the type of fuel.

#### ■ Fuel types

→P. 521

#### ■ Fuel tank opening for unleaded gasoline

To help prevent incorrect fueling, your vehicle has a fuel tank opening that only accommodates the special nozzle on unleaded fuel pumps.

### WARNING

#### ■ When refueling the vehicle

Observe the following precautions while refueling the vehicle. Failure to do so may result in death or serious injury.

- After exiting the vehicle and before opening the fuel door, touch an unpainted metal surface to discharge any static electricity. It is important to discharge static electricity before refueling because sparks resulting from static electricity can cause fuel vapors to ignite while refueling.
- Always hold the grips on the fuel tank cap and turn it slowly to remove it. A whooshing sound may be heard when the fuel tank cap is loosened. Wait until the sound cannot be heard before fully removing the cap. In hot weather, pressurized fuel may spray out the filler neck and cause injury.
- Do not allow anyone that has not discharged static electricity from their body to come close to an open fuel tank.
- Do not inhale vaporized fuel. Fuel contains substances that are harmful if inhaled.
- Do not smoke while refueling the vehicle. Doing so may cause the fuel to ignite and cause a fire.
- Do not return to the vehicle or touch any person or object that is statically charged. This may cause static electricity to build up, resulting in a possible ignition hazard.

#### ■ When refueling

Observe the following precautions to prevent fuel overflowing from the fuel tank:

- Securely insert the fuel nozzle into the fuel filler neck.
- Stop filling the tank after the fuel nozzle automatically clicks off.
- Do not top off the fuel tank.

 NOTICE

■ Refueling

Do not spill fuel during refueling. Doing so may damage the vehicle, such as causing the emission control system to operate abnormally or damaging fuel system components or the vehicle's painted surface.

**Opening the fuel tank cap**

- 1 Press the opener switch to open the fuel filler door.

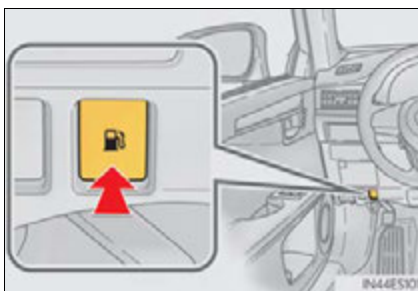

- 2 Turn the fuel tank cap slowly to open and hang it on the back of the fuel filler door.

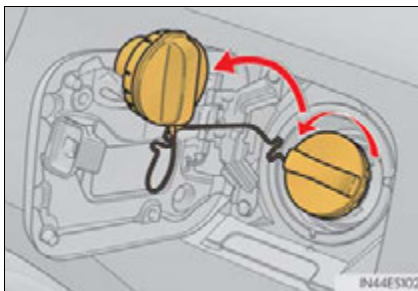

**■ When the fuel filler door cannot be opened by pressing the inside switch**

Remove the cover inside the trunk and pull the lever.

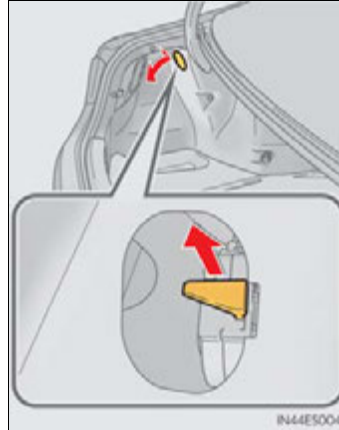
**Closing the fuel tank cap**

After refueling, turn the fuel tank cap until you hear a click. Once the cap is released, it will turn slightly in the opposite direction.

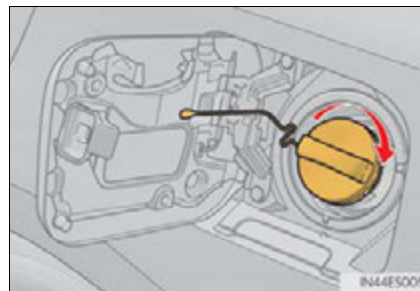

4

Driving

**⚠ WARNING****■ When replacing the fuel tank cap**

Do not use anything but a genuine Lexus fuel tank cap designed for your vehicle. Doing so may cause a fire or other incident which may result in death or serious injury.

## Lexus Safety System+\*

The Lexus Safety System+ consists of the following drive assist systems and contributes to a safe and comfortable driving experience:

◆ PCS (Pre-Collision System)

→P.183

◆ LDA (Lane Departure Alert with steering control)

→P.196

◆ Dynamic radar cruise control

→P.205

◆ AHB (Automatic High Beam)

→P.164

 **WARNING**

■ **Lexus Safety System+**

The Lexus Safety System+ is designed to operate under the assumption that the driver will drive safely, and is designed to help reduce the impact to the occupants and the vehicle in the case of a collision or assist the driver in normal driving conditions.

As there is a limit to the degree of recognition accuracy and control performance that this system can provide, do not overly rely on this system. The driver is always responsible for paying attention to the vehicle's surroundings and driving safely.

\*: If equipped



### Vehicle data recording

The pre-collision system is equipped with a sophisticated computer that will record certain data, such as:

- Accelerator status
- Brake status
- Vehicle speed
- Operation status of the pre-collision system functions
- Information (such as the distance and relative speed between your vehicle and the vehicle ahead or other objects)

Additionally, if the pre-collision braking function is operating, image information from the camera sensor will also be recorded. The pre-collision system does not record conversations, sounds or pictures.

#### ● Data usage

Lexus may use the data recorded in this computer to diagnose malfunctions, conduct research and development, and improve quality.

Lexus will not disclose the recorded data to a third party except:

- With the consent of the vehicle owner or with the consent of the lessee if the vehicle is leased
- In response to an official request by the police, a court of law or a government agency
- For use by Lexus in a lawsuit
- For research purposes where the data is not tied to a specific vehicle or vehicle owner

#### ● Recorded image information can be erased using a specialized device.

The image information recording function can be disabled. However, if the function is disabled, data from when the pre-collision system operates will not be available.

### Sensors

Two types of sensors, located behind the front grille and windshield, detect information necessary to operate the drive assist systems.

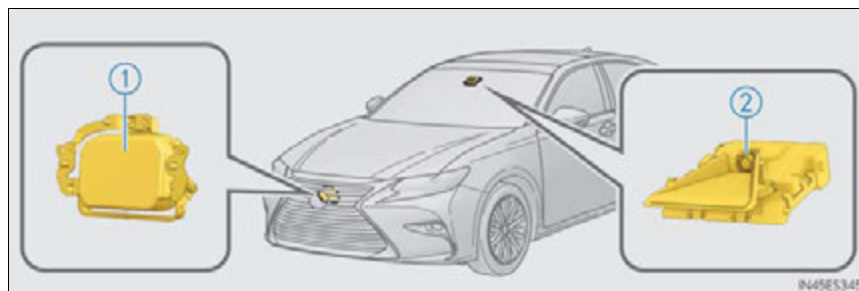

① Radar sensor

② Camera sensor

**⚠ WARNING****■ To avoid malfunction of the radar sensor**

Observe the following precautions.

Otherwise, the radar sensor may not operate properly, possibly leading to an accident resulting in death or serious injury.

- Keep the radar sensor and front grille emblem clean at all times.

- ① Radar sensor
- ② Front grille emblem

If the front of the radar sensor or the front or back of the front grille emblem is dirty or covered with water droplets, snow, etc., clean it.

Clean the radar sensor and front grille emblem with a soft cloth so you do not mark or damage them.

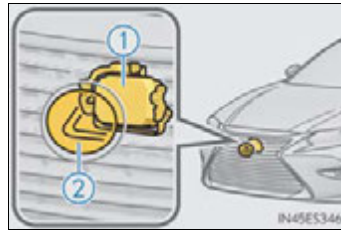

- Do not attach accessories, stickers (including transparent stickers) or other items to the radar sensor, front grille emblem or surrounding area.
- Do not subject the radar sensor or surrounding area to a strong impact. If the radar sensor, front grille, or front bumper has been subjected to a strong impact, have the vehicle inspected by your Lexus dealer.
- Do not disassemble the radar sensor.
- Do not modify or paint the radar sensor, front grille emblem or surrounding area.
- If the radar sensor, front grille, or front bumper needs to be removed and installed, or replaced, contact your Lexus dealer.
- The radar sensor complies with relevant radio wave regulations, as shown by the label attached to the sensor. Do not remove the label. Additionally, disassembly or modification of the radar sensor may be prohibited by law.

**■ To avoid malfunction of the camera sensor**

Observe the following precautions.

Otherwise, the camera sensor may not operate properly, possibly leading to an accident resulting in death or serious injury.

- Keep the windshield clean at all times. If the windshield is dirty or covered with an oily film, water droplets, snow, etc., clear the windshield. If the inner side of the windshield where the camera sensor is installed is dirty, contact your Lexus dealer.

**⚠ WARNING**

- Do not install an antenna or attach stickers (including transparent stickers) or other items to the area of the windshield in front of the camera sensor (shaded area in the illustration).

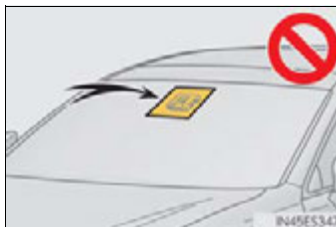

- If the part of the windshield in front of the camera sensor is fogged up or covered with condensation or ice, use the windshield defogger to remove the fog, condensation or ice. (→P. 368)
- Do not apply glass coating agents to the area of the windshield in front of the camera sensor.  
Glass coating agents can be applied to the windshield in areas other than in front of the camera sensor. However, it will still be necessary to use the wipers if the area of the windshield in front of the camera sensor is covered with water droplets.
- If water droplets cannot be properly removed from the area of the windshield in front of the camera sensor by the windshield wipers, replace the wiper rubber or wiper blade.  
If the wiper inserts or wiper blades need to be replaced, contact your Lexus dealer.
- Do not attach window tinting to the windshield.
- Replace the windshield if it is damaged or cracked.  
If the windshield needs to be replaced, contact your Lexus dealer.
- Do not get the camera sensor wet.
- Do not allow bright lights to shine into the camera sensor.
- Do not dirty or damage the camera sensor.  
When cleaning the inside of the windshield, do not allow glass cleaner to contact the lens. Also, do not touch the lens.  
If the lens is dirty or damaged, contact your Lexus dealer.
- Do not subject the camera sensor to a strong impact.
- Do not change the installation position or direction of the camera sensor or remove it.
- Do not disassemble the camera sensor.
- Do not install an electronic device or device that emits strong electric waves near the camera sensor.
- Do not modify any components of the vehicle around the camera sensor (inside rear view mirror, sun visors, etc.) or ceiling.
- Do not attach any accessories that may obstruct the camera sensor to the hood, front grille or front bumper. Contact your Lexus dealer for details.
- If a surfboard or other long object is to be mounted on the roof, make sure that it will not obstruct the camera sensor.
- Do not modify the headlights or other lights.

**■ Certification**

- ▶ For vehicles sold in the U.S.A., Hawaii, Guam, Saipan, Puerto Rico and NATO Germany

**FCC ID: HYQDNMWR008**

**NOTE:**

This device complies with part 15 of the FCC Rules. Operation is subject to the following two conditions: (1) This device may not cause harmful interference, and (2) this device must accept any interference received, including interference that may cause undesired operation.

**FCC WARNING:**

Changes or modifications not expressly approved by the party responsible for compliance could void the user's authority to operate the equipment.

**Radiofrequency radiation exposure Information:**

This equipment complies with FCC radiation exposure limits set forth for an uncontrolled environment. This equipment should be installed and operated with minimum distance of 20 cm between the radiator (antenna) and your body. This transmitter must not be co-located or operating in conjunction with any other antenna or transmitter.

- ▶ For vehicles sold in Canada

**NOTE:**

This device complies with Industry Canada licence-exempt RSS standard(s). Operation is subject to the following two conditions: (1) this device may not cause interference, and (2) this device must accept any interference, including interference that may cause undesired operation of the device.

This equipment complies with IC radiation exposure limits set forth for an uncontrolled environment and meets RSS-102 of the IC radio frequency (RF) Exposure rules. This equipment should be installed and operated keeping the radiator at least 20 cm or more away from person's body.

**NOTE:**

Le présent appareil est conforme aux CNR d'Industrie Canada applicables aux appareils radio exempts de licence. L'exploitation est autorisée aux deux conditions suivantes: (1) l'appareil ne doit pas produire de brouillage, et (2) l'utilisateur de l'appareil doit accepter tout brouillage radioélectrique subi, même si le brouillage est susceptible d'en compromettre le fonctionnement.

Cet équipement est conforme aux limites d'exposition aux rayonnements énoncées pour un environnement non contrôlé et respecte les règles d'exposition aux fréquences radioélectriques (RF) CNR-102 de l'IC. Cet équipement doit être installé et utilisé en gardant une distance de 20 cm ou plus entre le dispositif rayonnant et le corps.

## PCS (Pre-Collision System)\*

The pre-collision system uses a radar sensor and camera sensor to detect vehicles and pedestrians\*<sup>1</sup> in front of your vehicle. When the system determines that the possibility of a frontal collision with a vehicle or pedestrian is high, a warning operates to urge the driver to take evasive action and the potential brake pressure is increased to help the driver avoid the collision. If the system determines that the possibility of a frontal collision with a vehicle or pedestrian is extremely high, the brakes are automatically applied\*<sup>2</sup> to help avoid the collision or help reduce the impact to the vehicle occupants and the vehicle in the collision.

The pre-collision system can be disabled/enabled and the warning timing can be changed. (→P.187)

\*<sup>1</sup>: Depending on the region in which the vehicle was sold, the pedestrian detection function may not be available. Contact your Lexus dealer for details.

\*<sup>2</sup>: Depending on the region in which the vehicle was sold, the pre-collision braking function (automatic braking function) may not be available. Contact your Lexus dealer for details.

4

Driving

### ◆ Pre-collision warning

When the system determines that the possibility of a frontal collision is high, a buzzer will sound and a warning message will be displayed on the multi-information display to urge the driver to take evasive action.

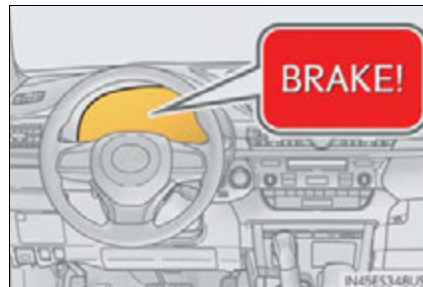

### ◆ Pre-collision brake assist

When the system determines that the possibility of a frontal collision is high, the system applies greater braking force in relation to how strongly the brake pedal is depressed.

\*: If equipped

◆ **Pre-collision braking**<sup>\*3</sup>

When the system determines that the possibility of a frontal collision is high, the system warns the driver. If the system determines that the possibility of a collision is extremely high, the brakes are automatically applied to help avoid the collision or reduce the collision speed.

<sup>\*3</sup>: Depending on the region in which the vehicle was sold, the pre-collision braking function may not be available.



**⚠ WARNING****■ Limitations of the pre-collision system**

- The driver is solely responsible for safe driving. Always drive safely, taking care to observe your surroundings.  
Do not use the pre-collision system instead of normal braking operations under any circumstances. This system will not prevent collisions or lessen collision damage or injury in every situation. Do not overly rely on this system. Failure to do so may lead to an accident, resulting in death or serious injury.
- Although this system is designed to help avoid and reduce the impact of a collision, its effectiveness may change according to various conditions, therefore the system may not always be able to achieve the same level of performance.  
Read the following conditions carefully. Do not overly rely on this system and always drive carefully.
  - Conditions under which the system may operate even if there is no possibility of a collision: →P. 190
  - Conditions under which the system may not operate properly: →P. 193
- Do not attempt to test the operation of the pre-collision system yourself, as the system may not operate properly, possibly leading to an accident.

**■ Pre-collision braking <sup>\*3</sup>**

- The pre-collision braking function may not operate if certain operations are performed by the driver. If the accelerator pedal is being depressed strongly or the steering wheel is being turned, the system may determine that the driver is taking evasive action and possibly prevent the pre-collision braking function from operating.
- In some situations, while the pre-collision braking function is operating, operation of the function may be canceled if the accelerator pedal is depressed strongly or the steering wheel is turned and the system determines that the driver is taking evasive action.
- A large amount of braking force is applied while the pre-collision braking function is operating. Additionally, as the vehicle may creep if it has been stopped by the pre-collision braking function, the driver should depress the brake pedal as necessary.
- If the brake pedal is being depressed, the system may determine that the driver is taking evasive action and possibly delay the operation timing of the pre-collision braking function.

<sup>\*3</sup>: Depending on the region in which the vehicle was sold, the pre-collision braking function may not be available.

 **WARNING****■ When to disable the pre-collision system**

- In the following situations, disable the system, as it may not operate properly, possibly leading to an accident resulting in death or serious injury:
  - When the vehicle is being towed
  - When your vehicle is towing another vehicle
  - When transporting the vehicle via truck, boat, train or similar means of transportation
  - When the vehicle is raised on a lift with the engine running and the tires are allowed to rotate freely
  - When inspecting the vehicle using a drum tester such as a chassis dynamometer or speedometer tester, or when using an on vehicle wheel balancer
  - When a strong impact is applied to the front bumper or front grille, due to an accident or other reasons
  - If the vehicle cannot be driven in a stable manner, such as when the vehicle has been in an accident or is malfunctioning
  - When the vehicle is driven in a sporty manner or off-road
  - When the tires are not properly inflated
  - When the tires are very worn
  - When tires of a size other than specified are installed
  - When tire chains are installed
  - When a compact spare tire or an emergency tire puncture repair kit is used
  - If the suspension is modified
  - If the front of the vehicle is raised or lowered, such as when loaded with heavy luggage

## Changing settings of the pre-collision system

### ■ Enabling/disabling the pre-collision system

The pre-collision system can be enabled/disabled on  (→P. 78) of the multi-information display.

The system is automatically enabled each time the engine switch is turned to IGNITION ON mode.

If the system is disabled, the PCS warning light will turn on and a message will be displayed on the multi-information display.



### ■ Changing the pre-collision warning timing

The pre-collision warning timing can be changed on  (→P. 78) of the multi-information display.

The operation timing setting is retained when the engine switch is turned off.

- ① Far  
The warning will begin to operate earlier than with the default timing.
- ② Middle  
This is the default setting.
- ③ Near  
The warning will begin to operate later than with the default timing.

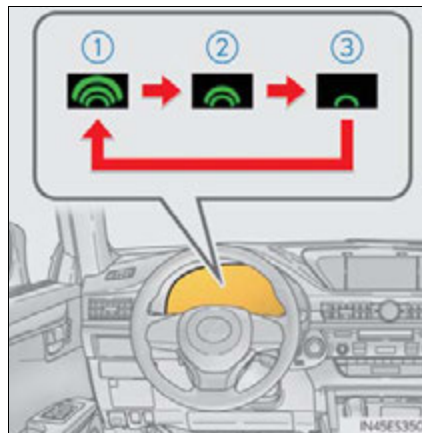

■ **Operational conditions**

- ▶ For vehicles sold in regions where the pedestrian detection function and pre-collision braking function are available\*4

The pre-collision system is enabled and the system determines that the possibility of a frontal collision with a vehicle or pedestrian is high.

Each function is operational at the following speeds:

- Pre-collision warning:
  - Vehicle speed is approximately 7 mph (10 km/h) or more. (For detecting a pedestrian, vehicle speed is between approximately 7 and 50 mph (10 and 80 km/h).)
  - The relative speed between your vehicle and the vehicle or pedestrian ahead is approximately 7 mph (10 km/h) or more.
- Pre-collision brake assist:
  - Vehicle speed is approximately 19 mph (30 km/h) or more. (For detecting a pedestrian, vehicle speed is between approximately 19 and 50 mph (30 and 80 km/h).)
  - The relative speed between your vehicle and the vehicle or pedestrian ahead is approximately 19 mph (30 km/h) or more.
- Pre-collision braking:
  - Vehicle speed is approximately 7 mph (10 km/h) or more. (For detecting a pedestrian, vehicle speed is between approximately 7 and 50 mph (10 and 80 km/h).)
  - The relative speed between your vehicle and the vehicle or pedestrian ahead is approximately 7 mph (10 km/h) or more.

The system may not operate in the following situations:

- If a battery terminal has been disconnected and reconnected and then the vehicle has not been driven for a certain amount of time
- If the shift lever is in R
- If VSC is disabled (only the pre-collision warning function will be operational)
- If the PCS warning light is flashing or illuminated

- ▶ For vehicles sold in regions where the pedestrian detection function is not available and the pre-collision braking function is available<sup>\*4</sup>

The pre-collision system is enabled and the system determines that the possibility of a frontal collision with a vehicle is high.

Each function is operational at the following speeds:

- Pre-collision warning:
  - Vehicle speed is approximately 10 mph (15 km/h) or more.
  - The relative speed between your vehicle and the vehicle or pedestrian ahead is approximately 7 mph (10 km/h) or more.
- Pre-collision brake assist:
  - Vehicle speed is approximately 19 mph (30 km/h) or more.
  - The relative speed between your vehicle and the vehicle or pedestrian ahead is approximately 19 mph (30 km/h) or more.
- Pre-collision braking:
  - Vehicle speed is approximately 10 mph (15 km/h) or more.
  - The relative speed between your vehicle and the vehicle or pedestrian ahead is approximately 7 mph (10 km/h) or more.

The system may not operate in the following situations:

- If a battery terminal has been disconnected and reconnected and then the vehicle has not been driven for a certain amount of time
- If the shift lever is in R
- If VSC is disabled (only the pre-collision warning function will be operational)
- If the PCS warning light is flashing or illuminated
- ▶ For vehicles sold in regions where the pedestrian detection function and pre-collision braking function are not available<sup>\*4</sup>

The pre-collision system is enabled and the system determines that the possibility of a frontal collision with a vehicle is high.

Each function is operational at the following speeds:

- Pre-collision warning:
  - Vehicle speed is approximately 10 mph (15 km/h) or more.
  - The relative speed between your vehicle and the vehicle or pedestrian ahead is approximately 7 mph (10 km/h) or more.
- Pre-collision brake assist:
  - Vehicle speed is approximately 19 mph (30 km/h) or more.
  - The relative speed between your vehicle and the vehicle or pedestrian ahead is approximately 19 mph (30 km/h) or more.

The system may not operate in the following situations:

- If a battery terminal has been disconnected and reconnected and then the vehicle has not been driven for a certain amount of time
- If the shift lever is in R
- If VSC is disabled (only the pre-collision warning function will be operational)
- If the PCS warning light is flashing or illuminated

<sup>\*4</sup>: Depending on the region in which the vehicle was sold, the pedestrian detection function and pre-collision braking function may not be available.

■ **Pedestrian detection function** \*5

The pre-collision system detects pedestrians based on the size, profile, and motion of a detected object. However, a pedestrian may not be detected depending on the surrounding brightness and the motion, posture, and angle of the detected object, preventing the system from operating properly. (→P. 194)



\*5: Depending on the region in which the vehicle was sold, the pedestrian detection function may not be available.

■ **Cancelation of the pre-collision braking** \*3

- If either of the following occur while the pre-collision braking function is operating, it will be canceled:
  - The accelerator pedal is depressed strongly.
  - The steering wheel is turned sharply or abruptly.
- If the vehicle is stopped by the operation of the pre-collision braking function, the operation of the pre-collision braking function will be canceled after the vehicle has been stopped for approximately 2 seconds.

\*3: Depending on the region in which the vehicle was sold, the pre-collision braking function may not be available.

■ **Conditions under which the system may operate even if there is no possibility of a collision**

- In some situations such as the following, the system may determine that there is a possibility of a frontal collision and operate.
  - When passing a vehicle or pedestrian \*5
  - When changing lanes while overtaking a preceding vehicle
  - When overtaking a preceding vehicle that is changing lanes
  - When overtaking a preceding vehicle that is making a left/right turn

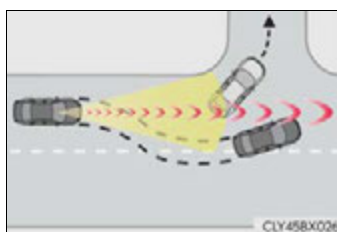

- When passing a vehicle in an oncoming lane that is stopped to make a right/left turn



- When driving on a road where relative location to vehicle ahead in an adjacent lane may change, such as on a winding road

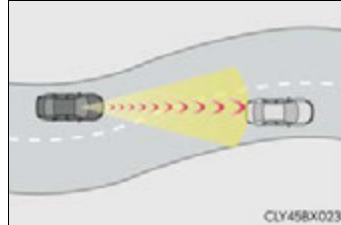

- When a preceding vehicle suddenly decelerates
- If the front of the vehicle is raised or lowered, such as when the road surface is uneven or undulating
- When approaching objects on the roadside, such as guardrails, utility poles, trees, or walls
- When there is a vehicle, pedestrian<sup>\*5</sup>, or object by the roadside at the entrance of a curve

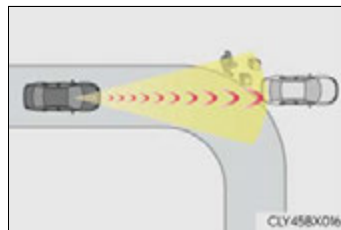

- When driving on a narrow path surrounded by a structure, such as in a tunnel or on an iron bridge
- When there is a metal object (manhole cover, steel plate, etc.), steps, or a protrusion on the road surface or roadside
- When a crossing pedestrian approaches very close to the vehicle<sup>\*5</sup>

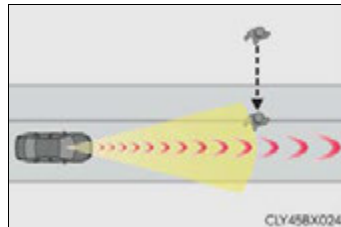

- When passing through a place with a low structure above the road (low ceiling, traffic sign, etc.)

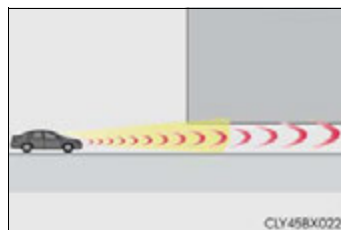

**192** 4-5. Using the driving support systems

---

- When passing under an object (billboard, etc.) at the top of an uphill road

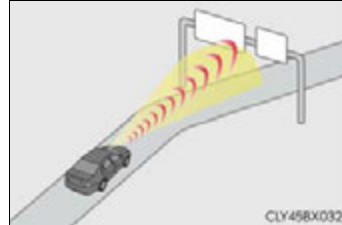

- When rapidly closing on an electric toll gate barrier, parking area barrier, or other barrier that opens and closes
- When using an automatic car wash
- When driving through or under objects that may contact the vehicle, such as thick grass, tree branches, or a banner

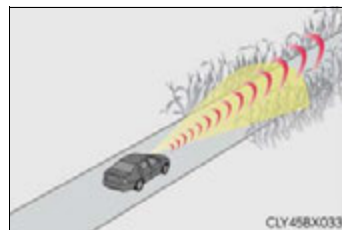

- When the vehicle is hit by water, snow, dust, etc. from a vehicle ahead
- When driving through steam or smoke
- When there are patterns or paint on the road or a wall that may be mistaken for a vehicle or pedestrian<sup>\*5</sup>
- When driving near an object that reflects radio waves, such as a large truck or guardrail
- When driving near a TV tower, broadcasting station, electric power plant, or other location where strong radio waves or electrical noise may be present

<sup>\*5</sup>: Depending on the region in which the vehicle was sold, the pedestrian detection function may not be available.



#### ■ Situations in which the system may not operate properly

- In some situations such as the following, a vehicle may not be detected by the radar sensor and camera sensor, preventing the system from operating properly:

- If an oncoming vehicle is approaching your vehicle
- If a vehicle ahead is a motorcycle or bicycle
- When approaching the side of a vehicle
- If a preceding vehicle has a small rear end, such as an unloaded truck
- If a preceding vehicle has a low rear end, such as a low bed trailer

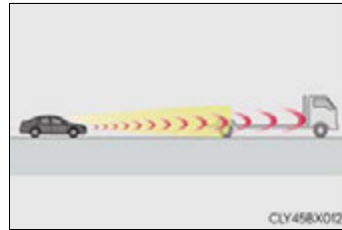

- If a vehicle ahead is carrying a load which protrudes past its rear bumper
- If a vehicle ahead has extremely high ground clearance

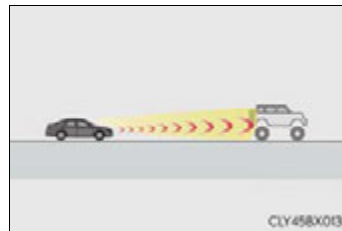

- If a vehicle ahead is irregularly shaped, such as a tractor or side car
- If the sun or other light is shining directly on a vehicle ahead
- If a vehicle cuts in front of your vehicle or emerges from beside a vehicle
- If a vehicle ahead makes an abrupt maneuver (such as sudden swerving, acceleration or deceleration)
- When suddenly cutting behind a preceding vehicle
- When a vehicle ahead is not directly in front of your vehicle

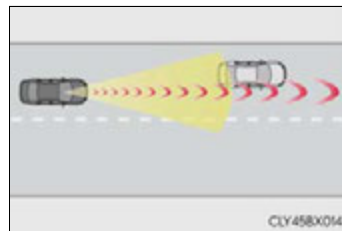

- When driving in inclement weather such as heavy rain, fog, snow or a sandstorm
- When the vehicle is hit by water, snow, dust, etc. from a vehicle ahead
- When driving through steam or smoke
- When driving in a place where the surrounding brightness changes suddenly, such as at the entrance or exit of a tunnel
- When a very bright light, such as the sun or the headlights of oncoming traffic, shines directly into the camera sensor
- When the surrounding area is dim, such as at dawn or dusk, or while at night or in a tunnel

- After the engine has started the vehicle has not been driven for a certain amount of time
- While making a left/right turn and for a few seconds after making a left/right turn
- While driving on a curve and for a few seconds after driving on a curve
- If your vehicle is skidding
- If the front of the vehicle is raised or lowered, such as when the road surface is uneven or undulating
- If the wheels are misaligned
- If a wiper blade is blocking the camera sensor
- If the headlights or other lights have been modified
- The vehicle is wobbling.
- The vehicle is being driven at extremely high speeds.
- When driving on a hill
- In some situations such as the following, sufficient braking force may not be obtained, preventing the system from performing properly:
  - If the braking functions cannot operate to their full extent, such as when the brake parts are extremely cold, extremely hot, or wet
  - If the vehicle is not properly maintained (brakes or tires are excessively worn, improper tire inflation pressure, etc.)
  - When the vehicle is being driven on a gravel road or other slippery surface
- Some pedestrians such as the following may not be detected by the radar sensor and camera sensor, preventing the system from operating properly<sup>\*5</sup>:
  - Pedestrians shorter than approximately 3.2 ft. (100 cm) or taller than approximately 6.5 ft. (2 m)
  - Pedestrians wearing oversized clothing (a rain coat, long skirt, etc.), making their silhouette obscure
  - Pedestrians who are carrying large baggage, holding an umbrella, etc., hiding part of their body
  - Pedestrians who are bending forward or squatting
  - Pedestrians who are pushing a stroller, wheelchair, bicycle or other vehicle
  - Groups of pedestrians which are close together
  - Pedestrians who are wearing white and look extremely bright
  - Pedestrians in the dark, such as at night or while in a tunnel
  - Pedestrians whose clothing appears to be nearly the same color or brightness as their surroundings
  - Pedestrians near walls, fences, guardrails, or large objects
  - Pedestrians who are on a metal object (manhole cover, steel plate, etc.) on the road
  - Pedestrians who are walking fast
  - Pedestrians who are changing speed abruptly
  - Pedestrians running out from behind a vehicle or a large object
  - Pedestrians who are extremely close to the side of the vehicle (outside rear view mirror, etc.)

<sup>\*5</sup>: Depending on the region in which the vehicle was sold, the pedestrian detection function may not be available.

**■ If the PCS warning light flashes and a warning message is displayed on the multi-information display**

The pre-collision system may be temporarily unavailable or there may be a malfunction in the system.

- In the following situations, the warning light will turn off, the message will disappear and the system will become operational when normal operating conditions return:
  - When the radar sensor or camera sensor or the area around either sensor is hot, such as in the sun
  - When the radar sensor or camera sensor or the area around either sensor is cold, such as in an extremely cold environment
  - When the radar sensor or front grille emblem is dirty or covered with snow, etc.
  - If the camera sensor is obstructed, such as when the hood is open or a sticker is attached to the windshield near the camera sensor
- If the PCS warning light continues to flash or the warning message does not disappear, the system may be malfunctioning. Have the vehicle inspected by your Lexus dealer immediately.

**■ If VSC is disabled**

- If VSC is disabled (→P. 257), the pre-collision brake assist and pre-collision braking functions are also disabled.
- The PCS warning light will turn on and "VSC Turned Off Pre-collision Brake System Unavailable" will be displayed on the multi-information display.

## LDA (Lane Departure Alert with steering control)\*

### Summary of functions

When driving on highways and freeways with white or yellow lines, this function alerts the driver when the vehicle might depart from its lane and provides assistance by operating the steering wheel to keep the vehicle in its lane.

The LDA system recognizes visible white or yellow lines with the camera sensor on the upper portion of the front windshield.



### Functions included in LDA system

#### ◆ Lane departure alert function

When the system determines that the vehicle might depart from its lane, a warning is displayed on the multi-information display, and either the warning buzzer sounds or the steering wheel vibrates to alert the driver.

When the warning buzzer sounds or the steering wheel vibrates, check the surrounding road situation and carefully operate the steering wheel to move the vehicle back to the center within the white (yellow) lines.

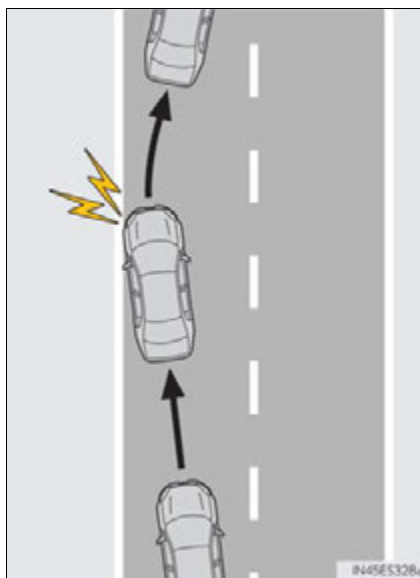

\*: If equipped

#### ◆ Steering control function

When the system determines that the vehicle might depart from its lane, the system provides assistance as necessary by operating the steering wheel in small amounts for a short period of time to keep the vehicle in its lane.

If the system detects that the steering wheel has not been operated for a fixed amount of time or the steering wheel is not being firmly gripped, a warning is displayed on the multi-information display and the function is temporarily canceled.

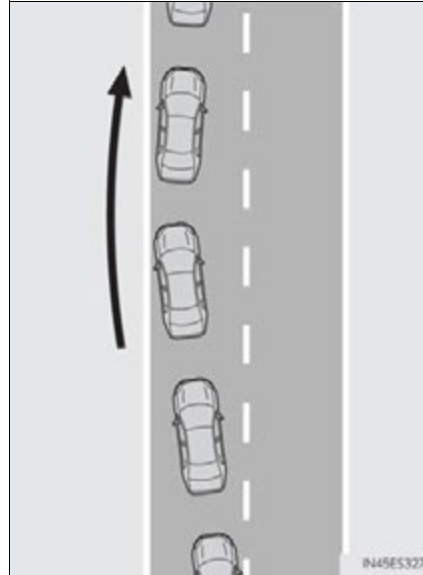

#### ◆ Vehicle sway warning

When the vehicle is swaying or appears as if it may depart from its lane multiple times, the warning buzzer sounds and a message is displayed on the multi-information display to alert the driver.

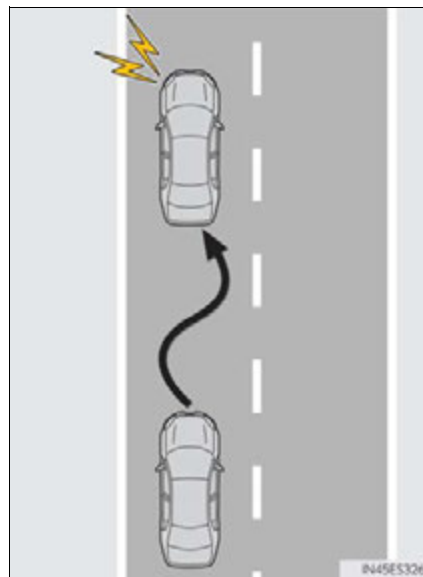

 **WARNING****■ Before using LDA system**

Do not rely solely upon the LDA system. LDA is not a system which automatically drives the vehicle or reduces the amount of attention that must be paid to the area in front of the vehicle. The driver must always assume full responsibility for driving safely by always paying careful attention to the surrounding conditions and operate the steering wheel to correct the path of the vehicle. Also, make sure to take adequate breaks when fatigued, such as from driving for a long period of time.

Failure to perform appropriate driving operations and pay careful attention may lead to an accident, resulting in death or serious injury.

**■ To avoid operating LDA by mistake**

When not using the LDA system, use the LDA switch to turn the system off.

**■ Situations unsuitable for LDA**

Do not use the LDA system in the following situations.

The system may not operate properly and lead to an accident, resulting in death or serious injury.

- A spare tire, tire chains, etc., are equipped.
- When the tires have been excessively worn, or when the tire inflation pressure is low.
- Tires which differ by structure, manufacturer, brand or tread pattern are used.
- Objects or patterns that could be mistaken for white (yellow) lines are present on the side of the road (guardrails, curbs, reflective poles, etc.).
- Vehicle is driven on a snow-covered road.
- White (yellow) lines are difficult to see due to rain, snow, fog, dust, etc.
- Asphalt repair marks, white (yellow) line marks, etc., are present due to road repair.
- Vehicle is driven in a temporary lane or restricted lane due to construction work.
- Vehicle is driven on a road surface which is slippery due to rainy weather, fallen snow, freezing, etc.
- Vehicle is driven in traffic lanes other than on highways and freeways.
- Vehicle is driven in a construction zone.
- Vehicle is towing a trailer or another vehicle.

**■ Preventing LDA system malfunctions and operations performed by mistake**

- Do not modify the headlights or place stickers, etc., on the surface of the lights.
- Do not modify the suspension etc. If the suspension etc. needs to be replaced, contact your Lexus dealer.
- Do not install or place anything on the hood or grille. Also, do not install a grille guard (bull bars, kangaroo bar, etc.).
- If your windshield needs repairs, contact your Lexus dealer.

### Turning LDA system on

Press the LDA switch to turn the LDA system on.

The LDA indicator illuminates and a message is displayed on the multi-information display.

Press the LDA switch again to turn the LDA system off.

When the LDA system is turned on or off, operation of the LDA system continues in the same condition the next time the engine is started.

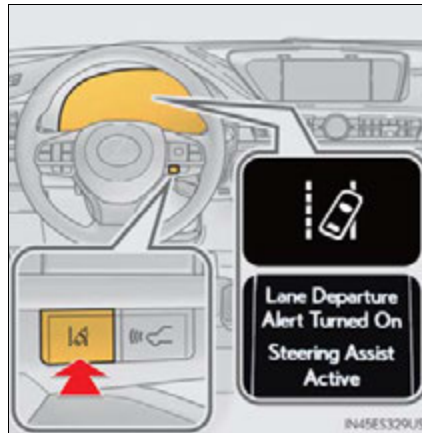

Indications on multi-information display

① LDA indicator

The illumination condition of the indicator informs the driver of the system operation status.

Illuminated in white:  
LDA system is operating.

Illuminated in green:  
Steering wheel assistance of the steering control function is operating.

Flashing in orange:  
Lane departure alert function is operating.

② Operation display of steering wheel operation support

Indicates that steering wheel assistance of the steering control function is operating.

③ Lane departure alert function display

Displayed when the multi-information display is switched to the driving assist system information screen.

▶ Inside of displayed white lines is white

▶ Inside of displayed white lines is black

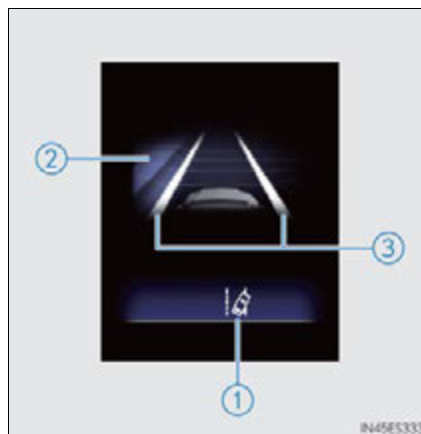

Indicates that the system is recognizing white (yellow) lines. When the vehicle departs from its lane, the white line displayed on the side the vehicle departs from flashes orange.



Indicates that the system is not able to recognize white (yellow) lines or is temporarily canceled.



### ■ Operation conditions of each function

#### ● Lane departure alert function

This function operates when all of the following conditions are met.

- LDA is turned on.
- Vehicle speed is approximately 32 mph (50 km/h) or more.
- System recognizes white (yellow) lines.
- Width of traffic lane is approximately 9.8 ft. (3 m) or more.
- Turn signal lever is not operated.
- Vehicle is driven on a straight road or around a gentle curve with a radius of more than approximately 492 ft. (150 m).
- No system malfunctions are detected. (→P. 203)

#### ● Steering control function

This function operates when all of the following conditions are met in addition to the operation conditions for the lane departure alert function.

- Setting for "Steering Assist" in  (Settings display) of the multi-information display is set to "On". (→P. 78)
- Vehicle is not accelerated or decelerated by a fixed amount or more.
- Steering wheel is not operated with a steering force level suitable for changing lanes.
- ABS, VSC, TRAC and PCS are not operating.
- Hands off steering wheel alert is not displayed. (→P. 201)

#### ● Vehicle sway warning

This function operates when all of the following conditions are met.

- Setting for "Sway Warning" in  (Settings display) of the multi-information display is set to "On". (→P. 78)
- Vehicle speed is approximately 32 mph (50 km/h) or more.
- Width of traffic lane is approximately 9.8 ft. (3 m) or more.
- No system malfunctions are detected. (→P. 203)

### ■ Temporary cancellation of functions

When operation conditions are no longer met, a function may be temporarily canceled. However, when the operation conditions are met again, operation of the function is automatically restored. (→P. 201)

### ■ Steering control function

Depending on the vehicle speed, lane departure situation, road conditions, etc., the operation of the functions may not be recognized or the functions may not operate.

### ■ Lane departure alert function

The warning buzzer may be difficult to hear due to external noise, audio playback, etc. Also, it may be difficult to feel steering wheel vibrations due to the road conditions, etc.

### ■ Hands off steering wheel alert

When the system determines that the driver has removed their hands from the steering wheel while the steering control function is operating, a warning message is displayed on the multi-information display.

If the driver continues to keep their hands off of the steering wheel, the buzzer sounds, a warning message is displayed and the function is temporarily canceled. This alert also operates in the same way when the vehicle is driven with the steering wheel lightly gripped. However, depending on the road conditions, etc., the function may not cancel.

**■ White (yellow) lines are only on one side of road**

The LDA system will not operate for the side on which white (yellow) lines could not be recognized.

**■ Conditions in which functions may not operate properly**

In the following situations, the camera sensor may not detect white (yellow) lines and various functions may not operate normally.

- There are shadows on the road that run parallel with, or cover, the white (yellow) lines.
- The vehicle is driven in an area without white (yellow) lines, such as in front of a tollgate or checkpoint, or at an intersection etc.
- The white (yellow) lines are cracked, or cat's eyes (reflective markers) or stones are present.
- The white (yellow) lines cannot be seen or are difficult to see due to sand, etc.
- The vehicle is driven on a road surface that is wet due to rain, puddles, etc.
- The traffic lines are yellow (which may be more difficult to recognize than lines that are white).
- The white (yellow) lines cross over a curb, etc.
- The vehicle is driven on a bright surface, such as concrete.
- The vehicle is driven on a surface that is bright due to reflected light, etc.
- The vehicle is driven in an area where the brightness changes suddenly, such as at the entrances and exits of tunnels, etc.
- Light from the headlights of an oncoming vehicle, the sun, etc., enters the camera.
- The vehicle is driven where the road diverges, merges, etc.
- The vehicle is driven on a slope.
- The vehicle is driven on a road which tilts left or right, or a winding road.
- The vehicle is driven on an unpaved or rough road.
- The vehicle is driven around a sharp curve.
- The traffic lane is excessively narrow or wide.
- The vehicle is extremely tilted due to carrying heavy luggage or having improper tire pressure.
- The distance to the preceding vehicle is extremely short.
- The vehicle is moving up and down a large amount due to road conditions during driving (poor roads or road seams).
- The headlight lenses are dirty and emit a faint amount of light at night, or the beam axis has deviated.
- The vehicle is struck by a crosswind.
- The vehicle has just changed lanes or crossed an intersection.
- Snow tires, etc., are equipped.

■ **Warning message**

If the following warning message is displayed on the multi-information display and the LDA indicator illuminates in orange, follow the appropriate troubleshooting procedure.

Warning message	Details/Actions
“Lane Departure Alert Malfunction Visit Your Dealer”	The system may not be operating properly. → Have the vehicle inspected at your Lexus dealer.
“Forward Camera System Unavailable Clean Windshield”	Dirt, rain, condensation, ice, snow, etc., are present on the windshield in front of the camera sensor. → Turn the LDA system off, remove any dirt, rain, condensation, ice, snow, etc., from the windshield, and then turn the LDA system back on.
“Forward Camera System Unavailable”	The LDA system is temporarily canceled due to high temperatures around the camera sensor. → Turn the LDA system off, wait for the area around the camera sensor to cool, and then turn the LDA system back on.
“Lane Departure Alert Unavailable”	The LDA system is temporarily canceled due to a malfunction in a sensor other than the camera sensor. → Turn the LDA system off and follow the appropriate troubleshooting procedures for warning messages. Afterward, drive the vehicle for a short time, and then turn the LDA system back on.
“Lane Departure Alert Unavailable Below Approx 32 MPH”	The LDA system cannot be used as the vehicle speed is approximately 32 mph (50 km/h) or less. → Drive the vehicle at approximately 32 mph (50 km/h) or more.

If a different warning message is displayed, follow the instructions displayed on the screen.

■ **Customization**

The following settings can be changed.

Function	Setting details
Lane departure alert	Adjust alert sensitivity
	Adjust alert type
Steering control function	Turn steering wheel assistance on and off
Vehicle sway warning	Turn function on and off
	Adjust alert sensitivity

For how to change settings, refer to P. 533.

## Dynamic radar cruise control\*

### Summary of functions

In vehicle-to-vehicle distance control mode, the vehicle automatically accelerates and decelerates to match the speed changes of the preceding vehicle even if the accelerator pedal is not depressed. In constant speed control mode, the vehicle runs at a fixed speed.

Use the dynamic radar cruise control on freeways and highways.

- Vehicle-to-vehicle distance control mode (→P. 208)
- Constant speed control mode (→P. 213)

- ① Display
- ② Set speed
- ③ Indicators
- ④ Vehicle-to-vehicle distance button
- ⑤ Cruise control switch

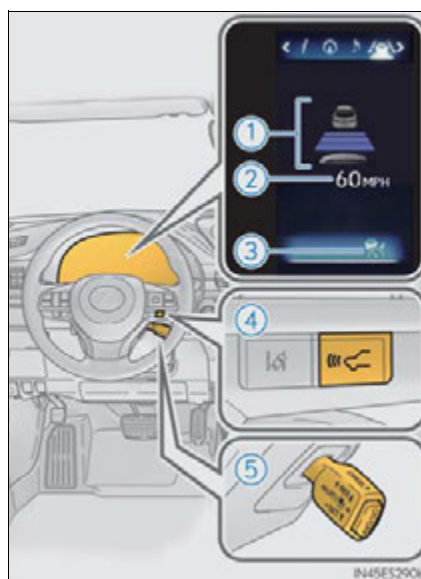

4

Driving

\*: If equipped

 **WARNING****■ Before using dynamic radar cruise control**

Driving safely is the sole responsibility of the driver. Do not rely solely on the system, and drive safely by always paying careful attention to your surroundings.

The dynamic radar cruise control provides driving assistance to reduce the driver's burden. However, there are limitations to the assistance provided.

Even when the system is functioning normally, the condition of the preceding vehicle as detected by the system may differ from the condition observed by the driver. Therefore, the driver must always remain alert, assess the danger of each situation and drive safely. Relying on this system or assuming the system ensures safety while driving can lead to an accident, resulting in death or serious injury.

**■ Cautions regarding the driving assist systems**

Observe the following precautions, as there are limitations to the assistance provided by the system.

Failure to do so may cause an accident resulting in death or serious injury.

**● Assisting the driver to measure following distance**

The dynamic radar cruise control is only intended to help the driver in determining the following distance between the driver's own vehicle and a designated vehicle traveling ahead. It is not a mechanism that allows careless or inattentive driving, and it is not a system that can assist the driver in low-visibility conditions. It is still necessary for driver to pay close attention to the vehicle's surroundings.

**● Assisting the driver to judge proper following distance**

The dynamic radar cruise control determines whether the following distance between the driver's own vehicle and a designated vehicle traveling ahead is appropriate or not. It is not capable of making any other type of judgement. Therefore, it is absolutely necessary for the driver to remain vigilant and to determine whether or not there is a possibility of danger in any given situation.

**● Assisting the driver to operate the vehicle**

The dynamic radar cruise control has limited capability to prevent or avoid a collision with a vehicle traveling ahead. Therefore, if there is ever any danger, the driver must take immediate and direct control of the vehicle and act appropriately in order to ensure the safety of all involved.

**■ To avoid inadvertent dynamic radar cruise control activation**

Switch the dynamic radar cruise control off using the "ON/OFF" button when not in use.

 **WARNING****■ Situations unsuitable for dynamic radar cruise control**

Do not use dynamic radar cruise control in any of the following situations. Doing so may result in inappropriate speed control and could cause an accident resulting in death or serious injury.

- Roads where there are pedestrians, cyclists, etc.
- In heavy traffic
- On roads with sharp bends
- On winding roads
- On slippery roads, such as those covered with rain, ice or snow
- On steep downhill, or where there are sudden changes between sharp up and down gradients  
Vehicle speed may exceed the set speed when driving down a steep hill.
- At entrances to freeways and highways
- When weather conditions are bad enough that they may prevent the sensors from detecting correctly (fog, snow, sandstorm, heavy rain, etc.)
- When there is rain, snow, etc. on the front surface of the radar sensor or camera sensor
- In traffic conditions that require frequent repeated acceleration and deceleration
- When your vehicle is towing a trailer or during emergency towing
- When an approach warning buzzer is heard often

### Driving in vehicle-to-vehicle distance control mode

This mode employs a radar sensor to detect the presence of vehicles up to approximately 400 ft. (120 m) ahead, determines the current vehicle-to-vehicle following distance, and operates to maintain a suitable following distance from the vehicle ahead.

Note that vehicle-to-vehicle distance will close in when traveling on long downhill slopes.

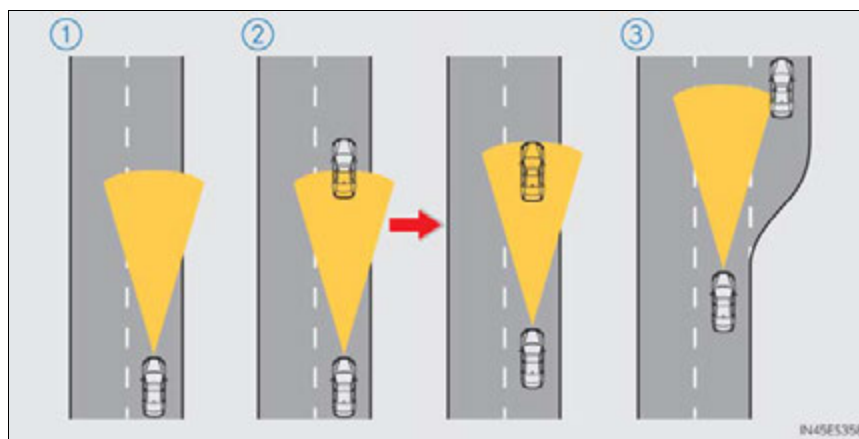

- ① Example of constant speed cruising  
When there are no vehicles ahead

The vehicle travels at the speed set by the driver. The desired vehicle-to-vehicle distance can also be set by operating the vehicle-to-vehicle distance control.

- ② Example of deceleration cruising and follow-up cruising  
When a preceding vehicle driving slower than the set speed appears

When a vehicle is detected running ahead of you, the system automatically decelerates your vehicle. When a greater reduction in vehicle speed is necessary, the system applies the brakes (the stop lights will come on at this time). The system will respond to changes in the speed of the vehicle ahead in order to maintain the vehicle-to-vehicle distance set by the driver. Approach warning warns you when the system cannot decelerate sufficiently to prevent your vehicle from closing in on the vehicle ahead.

- ③ Example of acceleration  
When there are no longer any preceding vehicles driving slower than the set speed

The system accelerates until the set speed is reached. The system then returns to constant speed cruising.



**Setting the vehicle speed (vehicle-to-vehicle distance control mode)**

- 1** Press the “ON/OFF” button to activate the cruise control.

Radar cruise control indicator will come on and a message will be displayed on the multi-information display.

Press the button again to deactivate the cruise control.

If the “ON/OFF” button is pressed and held for 1.5 seconds or more, the system turns on in constant speed control mode. (→P. 213)

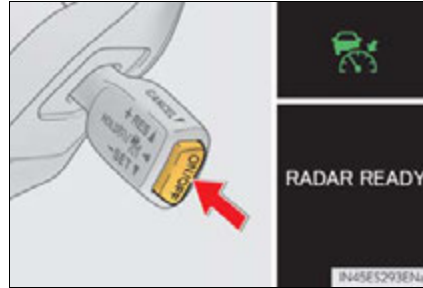

- 2** Accelerate or decelerate, with accelerator pedal operation, to the desired vehicle speed (above approximately 30 mph [50 km/h]) and push the lever down to set the speed.

Cruise control “SET” indicator will come on.

The vehicle speed at the moment the lever is released becomes the set speed.

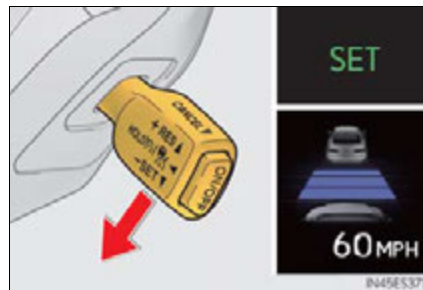

### Adjusting the set speed

To change the set speed, operate the lever until the desired set speed is displayed.

- ① Increases the speed
- ② Decreases the speed

Fine adjustment: Momentarily move the lever in the desired direction.

Large adjustment: Hold the lever up or down to change the speed, and release when the desired speed is reached.

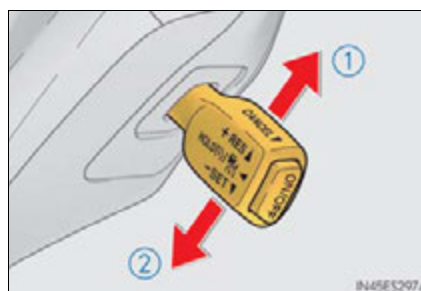

In the vehicle-to-vehicle distance control mode, the set speed will be increased or decreased as follows:

Fine adjustment: By 1 mph (1.6 km/h)<sup>\*1</sup> or 1 km/h (0.6 mph)<sup>\*2</sup> each time the lever is operated

Large adjustment: Increases or decreases in 1 mph (1.6 km/h)<sup>\*1</sup> or 1 km/h (0.6 mph)<sup>\*2</sup> increments for as long as the lever is held

In the constant speed control mode (→P. 213), the set speed will be increased or decreased as follows:

Fine adjustment: By 1 mph (1.6 km/h)<sup>\*1</sup> or 1 km/h (0.6 mph)<sup>\*2</sup> each time the lever is operated

Large adjustment: The speed will continue to change while the lever is held.

\*1: When the set speed is shown in "MPH"

\*2: When the set speed is shown in "km/h"

### Changing the vehicle-to-vehicle distance (vehicle-to-vehicle distance control mode)

Pressing the button changes the vehicle-to-vehicle distance as follows:

- ① Long
- ② Medium
- ③ Short

The vehicle-to-vehicle distance is set automatically to long mode when the engine switch is turned to IGNITION ON mode.

If a vehicle is running ahead of you, the preceding vehicle mark will also be displayed.

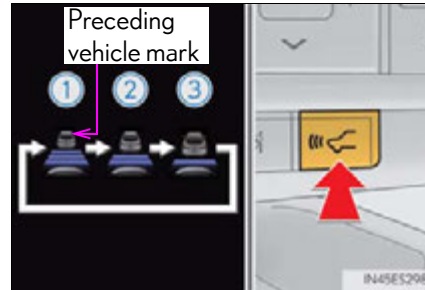

### Vehicle-to-vehicle distance settings (vehicle-to-vehicle distance control mode)

Select a distance from the table below. Note that the distances shown correspond to a vehicle speed of 50 mph (80 km/h). Vehicle-to-vehicle distance increases/decreases in accordance with vehicle speed.

Distance options	Vehicle-to-vehicle distance
Long	Approximately 160 ft. (50 m)
Medium	Approximately 130 ft. (40 m)
Short	Approximately 100 ft. (30 m)

### Canceling and resuming the speed control

- ① Pulling the lever toward you cancels the speed control.  
The speed setting is also canceled when the brake pedal is depressed.
- ② Pushing the lever up resumes the cruise control and returns vehicle speed to the set speed.

However, cruise control does not resume when the vehicle speed is approximately 25 mph (40 km/h) or less.

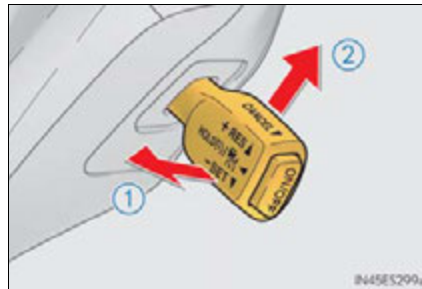

### Approach warning (vehicle-to-vehicle distance control mode)

When your vehicle is too close to a vehicle ahead, and sufficient automatic deceleration via the cruise control is not possible, the display will flash and the buzzer will sound to alert the driver. An example of this would be if another driver cuts in front of you while you are following a vehicle. Depress the brake pedal to ensure an appropriate vehicle-to-vehicle distance.



#### ■ Warnings may not occur when

In the following instances, warnings may not occur even when the vehicle-to-vehicle distance is small.

- When the speed of the preceding vehicle matches or exceeds your vehicle speed
- When the preceding vehicle is traveling at an extremely slow speed
- Immediately after the cruise control speed was set
- When depressing the accelerator pedal

### Selecting constant speed control mode

When constant speed control mode is selected, your vehicle will maintain a set speed without controlling the vehicle-to-vehicle distance. Select this mode only when vehicle-to-vehicle distance control mode does not function correctly due to dirt, etc.

- 1 With the cruise control off, press and hold the "ON/OFF" button for 1.5 seconds or more.

Immediately after the "ON/OFF" button is pressed, the radar cruise control indicator will come on. Afterwards, it switches to the cruise control indicator.

Switching to constant speed control mode is only possible when operating the lever with the cruise control off.

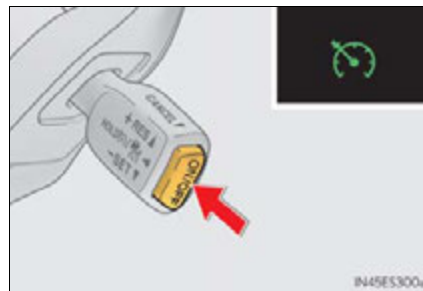

- 2 Accelerate or decelerate, with accelerator pedal operation, to the desired vehicle speed (above approximately 30 mph [50 km/h]) and push the lever down to set the speed.

Cruise control "SET" indicator will come on.

The vehicle speed at the moment the lever is released becomes the set speed.

Adjusting the speed setting: →P. 210

Canceling and resuming the speed setting: →P. 212

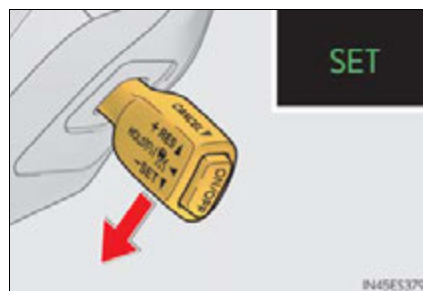

**■ Dynamic radar cruise control can be set when**

- The shift lever is in D or range 4 or higher of S has been selected.
- Vehicle speed is above approximately 30 mph (50 km/h).

**■ Accelerating after setting the vehicle speed**

The vehicle can accelerate by operating the accelerator pedal. After accelerating, the set speed resumes. However, during vehicle-to-vehicle distance control mode, the vehicle speed may decrease below the set speed in order to maintain the distance to the preceding vehicle.

**■ Automatic cancelation of vehicle-to-vehicle distance control mode**

Vehicle-to-vehicle distance control mode is automatically canceled in the following situations. "Radar Cruise Control Unavailable" will be displayed on the multi-information display:

- Actual vehicle speed falls below approximately 25 mph (40 km/h).
- VSC is activated.
- TRAC is activated for a period of time.
- When the VSC or TRAC system is turned off by pressing the VSC OFF switch.
- The sensor cannot detect correctly because it is covered in some way.
- Pre-collision braking is activated.

If vehicle-to-vehicle distance control mode is automatically canceled for any other reason, there may be a malfunction in the system. Contact your Lexus dealer.

**■ Automatic cancelation of constant speed control mode**

Constant speed control mode is automatically canceled in the following situations:

- Actual vehicle speed is more than approximately 10 mph (16 km/h) below the set vehicle speed.
- Actual vehicle speed falls below approximately 25 mph (40 km/h).
- VSC is activated.
- TRAC is activated for a period of time.
- When the VSC or TRAC system is turned off by pressing the VSC OFF switch.
- Pre-collision braking is activated.

If constant speed control mode is automatically canceled for any other reason, there may be a malfunction in the system. Contact your Lexus dealer.

**■ Warning messages and buzzers for dynamic radar cruise control**

Warning messages and buzzers are used to indicate a system malfunction or to inform the driver of the need for caution while driving. If a warning message is shown on the multi-information display, read the message and follow the instructions.

### ■ When the sensor may not be correctly detecting the vehicle ahead

In the case of the following and depending on the conditions, operate the brake pedal when deceleration of the system is insufficient or operate the accelerator pedal when acceleration is required.

As the sensor may not be able to correctly detect these types of vehicles, the approach warning (→P. 212) may not be activated.

- Vehicles that cut in suddenly
- Vehicles traveling at low speeds
- Vehicles that are not moving in the same lane
- Vehicles with small rear ends (trailers with no load on board, etc.)

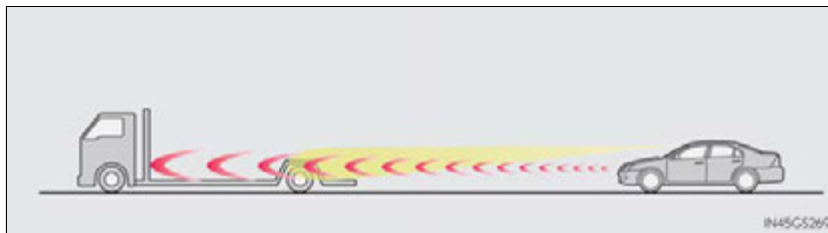

- Motorcycles traveling in the same lane
- When water or snow thrown up by the surrounding vehicles hinders the detecting of the sensor
- When your vehicle is pointing upwards (caused by a heavy load in the luggage compartment, etc.)

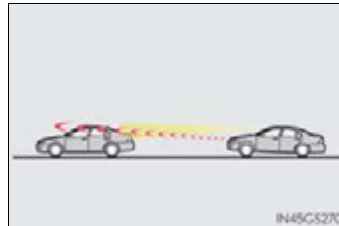

- Preceding vehicle has an extremely high ground clearance

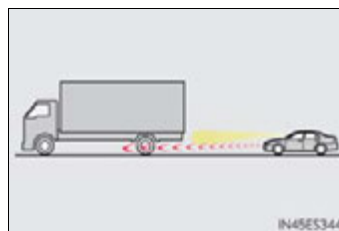

■ **Conditions under which the vehicle-to-vehicle distance control mode may not function correctly**

In the case of the following conditions, operate the brake pedal (or accelerator pedal, depending on the situation) as necessary.  
As the sensor may not be able to correctly detect vehicles ahead, the system may not operate properly.

- When the road curves or when the lanes are narrow

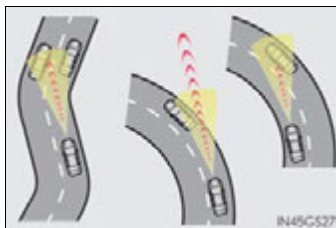

- When steering wheel operation or your position in the lane is unstable

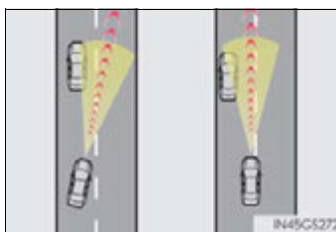

- When the vehicle ahead of you decelerates suddenly



## Cruise control\*

### Summary of functions

Use the cruise control to maintain a set speed without depressing the accelerator pedal.

- ① Set speed
- ② Indicators
- ③ Cruise control switch

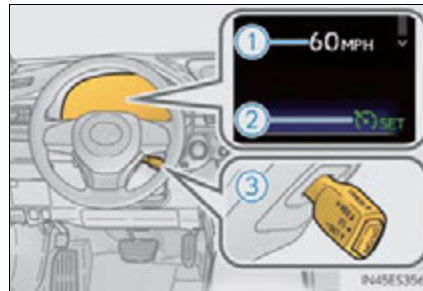

### Setting the vehicle speed

- 1 Press the "ON/OFF" button to activate the cruise control.  
Cruise control indicator will come on.  
Press the button again to deactivate the cruise control.

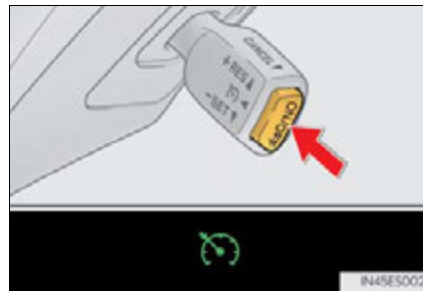

- 2 Accelerate or decelerate the vehicle to the desired speed, and push the lever down to set the speed.  
"SET" indicator will come on.  
The vehicle speed at the moment the lever is released becomes the set speed.

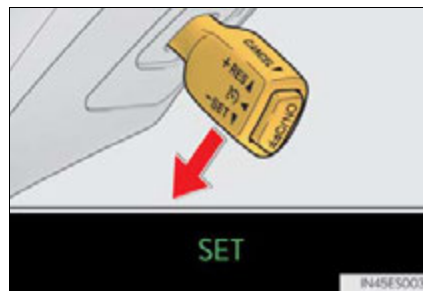

4

Driving

\*: If equipped

### Adjusting the set speed

To change the set speed, operate the lever until the desired set speed is obtained.

- ① Increases the speed
- ② Decreases the speed

Fine adjustment: Momentarily move the lever in the desired direction.

Large adjustment: Hold the lever in the desired direction.

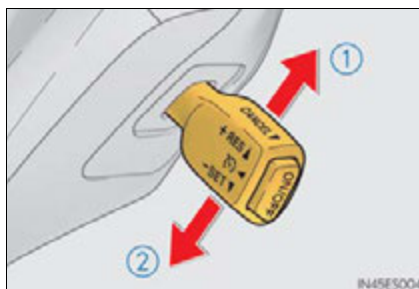

The set speed will be increased or decreased as follows:

Fine adjustment: By 1 mph (1.6 km/h)<sup>\*1</sup> or 1 km/h (0.6 mph)<sup>\*2</sup> each time the lever is operated.

Large adjustment: The set speed can be increased or decreased continually until the lever is released.

\*1: When the set speed is shown in "MPH"

\*2: When the set speed is shown in "km/h"

### Canceling and resuming the constant speed control

- ① Pulling the lever toward you cancels the constant speed control.

The speed setting is also canceled when the brakes are applied.

- ② Pushing the lever up resumes the constant speed control.

Resuming is available when the vehicle speed is more than approximately 25 mph (40 km/h).

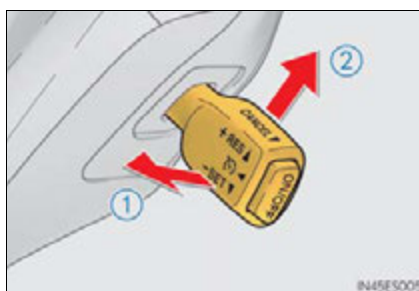

#### ■ Cruise control can be set when

- The shift lever is in D or range 4 or higher of S has been selected.
- Vehicle speed is above approximately 25 mph (40 km/h).

#### ■ Accelerating after setting the vehicle speed

- The vehicle can be accelerated normally. After acceleration, the set speed resumes.
- Even without canceling the cruise control, the set speed can be increased by first accelerating the vehicle to the desired speed and then pushing the lever down to set the new speed.

#### ■ Automatic cruise control cancelation

Cruise control will stop maintaining the vehicle speed in any of the following situations.

- Actual vehicle speed falls more than approximately 10 mph (16 km/h) below the preset vehicle speed.  
At this time, the memorized set speed is not retained.
- Actual vehicle speed is below approximately 25 mph (40 km/h).
- VSC is activated.
- TRAC is activated for a period of time.
- When the VSC or TRAC system is turned off by pressing the VSC OFF switch.

#### ■ If the warning message for the cruise control is shown on the multi-information display

Press the "ON/OFF" button once to deactivate the system, and then press the button again to reactivate the system.

If the cruise control speed cannot be set or if the cruise control cancels immediately after being activated, there may be a malfunction in the cruise control system. Have the vehicle inspected by your Lexus dealer.



#### WARNING

##### ■ To avoid operating the cruise control by mistake

Switch the cruise control off using the "ON/OFF" button when not in use.

##### ■ Situations unsuitable for cruise control

Do not use cruise control in any of the following situations.

Doing so may result in loss of control and could cause an accident resulting in death or serious injury.

- Roads where there are pedestrians, cyclists, etc.
- In heavy traffic
- On roads with sharp bends
- On winding roads
- On slippery roads, such as those covered with rain, ice or snow
- On steep hills  
Vehicle speed may exceed the set speed when driving down a steep hill.
- During emergency towing

## Intuitive parking assist\*

The distance from your vehicle to nearby obstacles when parallel parking or maneuvering into a garage is measured by the sensors and communicated via the multi-information display, navigation system screen or Lexus Display Audio system screen and a buzzer. Always check the surrounding area when using this system.

### Types of sensors

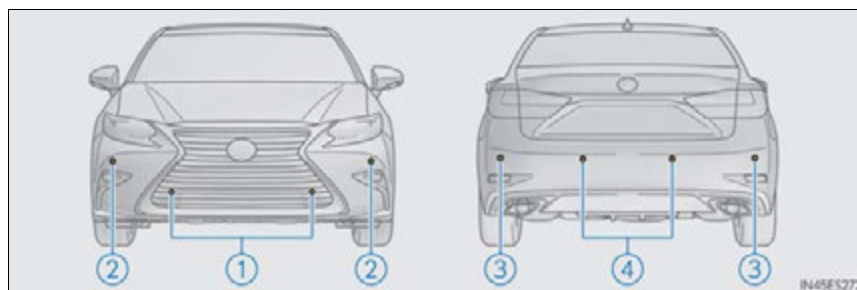

- ① Front center sensors
- ② Front corner sensors
- ③ Rear corner sensors
- ④ Rear center sensors

\*: If equipped

### Intuitive parking assist switch

Turns the intuitive parking assist on/off

When on, the indicator light comes on to inform the driver that the system is operational.

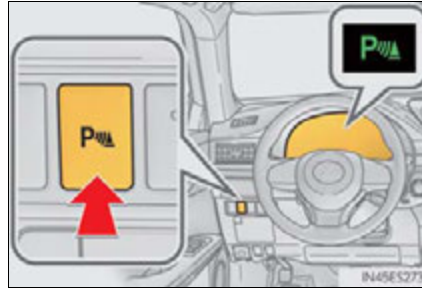

### Display

When the sensors detect an obstacle, a graphic is shown on the multi-information display and navigation system screen or Lexus Display Audio system screen depending on the position and distance to the obstacle.

#### ■ Multi-information display

- ① Front corner sensor detection
- ② Front center sensor detection
- ③ Rear corner sensor detection
- ④ Rear center sensor detection

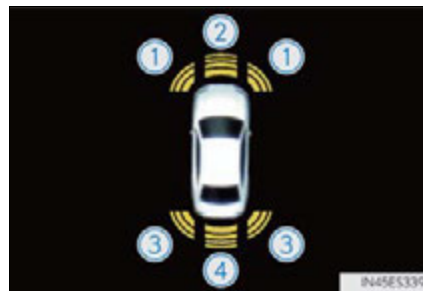

■ Navigation system screen or Lexus Display Audio system screen

- ① When the Lexus parking assist monitor (if equipped) is not displayed

A graphic is automatically displayed when an obstacle is detected. The screen can be set so that the graphic is not displayed. (→P. 225)

: Select to mute the buzzer sounds.

- ② When the Lexus parking assist monitor (if equipped) is displayed (insert display)









A simplified image is displayed on the right upper corner of the navigation system screen or Lexus Display Audio system screen when an obstacle is detected.



**Sensor detection display, obstacle distance**

■ **Distance display**

Sensors that detect an obstacle will illuminate continuously or blink.

Display *1	Insert display	Approximate distance to obstacle		
		Front center sensor	Front and rear corner sensor	Rear center sensor
 (continuous)	 (blinking slowly)	3.3 ft. (100 cm) to 1.7 ft. (50 cm)	—	4.9 ft. (150 cm) to 2.0 ft. (60 cm)
 (continuous)	 (blinking)	1.7 ft. (50 cm) to 1.3 ft. (40 cm)	2.0 ft. (60 cm) to 1.5 ft. (45 cm)	2.0 ft. (60 cm) to 1.5 ft. (45 cm)
 (continuous)	 (blinking rapidly)	1.3 ft. (40 cm) to 1.0 ft. (30 cm)	1.5 ft. (45 cm) to 1.0 ft. (30 cm)	1.5 ft. (45 cm) to 1.1 ft. (35 cm)
 (blinking *2 or continuous *3)	 (continuous)	Less than 1.0 ft. (30 cm)	Less than 1.0 ft. (30 cm)	Less than 1.1 ft. (35 cm)

\*1: The images may differ from that shown in the illustrations. (→P. 221)

\*2: Multi-information display

\*3: Lexus Display Audio or navigation system screen

■ **Buzzer operation and distance to an obstacle**

A buzzer sounds when the sensors are operating.

- The buzzer beeps faster as the vehicle approaches an obstacle. When the vehicle comes within the following distance of the obstacle, the buzzer sounds continuously:
  - Front center sensors: Approximately 1.0 ft. (30 cm)
  - Corner sensors: Approximately 1.0 ft. (30 cm)
  - Rear center sensors: Approximately 1.1 ft. (35 cm)
- When 2 or more obstacles are detected simultaneously, the buzzer system responds to the nearest obstacle. If one or both come within the above distances, the beep will repeat a long tone, followed by fast beeps.

**Detection range of the sensors**

- ① Approximately 3.3 ft. (100 cm)
- ② Approximately 4.9 ft. (150 cm)
- ③ Approximately 2.0 ft. (60 cm)

The diagram shows the detection range of the sensors. Note that the sensors cannot detect obstacles that are extremely close to the vehicle.

The range of the sensors may change depending on the shape of the object etc.

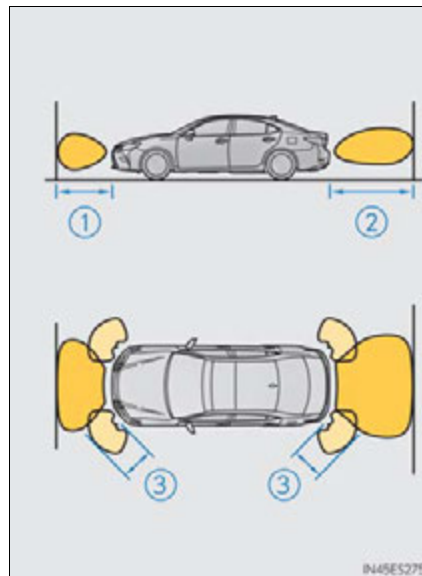



### Setting up intuitive parking assist

You can change the buzzer sounds volume and the screen operating conditions.

▶ Lexus Display Audio system

- 1 Press the "MENU" button on the Lexus Display Audio controller, and then select "Setup" on the screen.
- 2 Select "Vehicle", and then select "LEXUS Park Assist" on the screen.
- 3 Select the desired item.

▶ Navigation system

- 1 Press the "MENU" button on the Remote Touch, and then select "Setup" on the screen.
- 2 Select "Vehicle", and then select "LEXUS Park Assist Settings" on the screen.
- 3 Select the desired item.

▶ Lexus Display Audio screen

▶ Navigation system screen

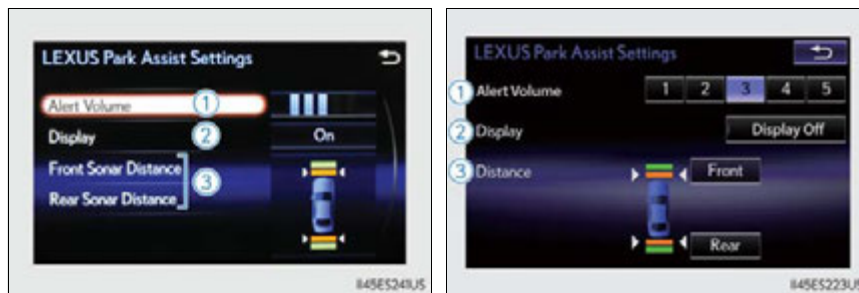

- 1 The buzzer sounds volume can be adjusted.
- 2 On or off can be selected for intuitive parking assist display.
- 3 Front or rear center sensors display and tone indication can be set.

**■ The intuitive parking assist can be operated when**

- Front center sensors:
  - The engine switch is in IGNITION ON mode.
  - The shift lever is in a position other than P or R.
  - The vehicle speed is less than about 6 mph (10 km/h).
- Front corner sensors:
  - The engine switch is in IGNITION ON mode.
  - The shift lever is in a position other than P.
  - The vehicle speed is less than about 6 mph (10 km/h).  
(At any speed when the shift lever is in R)
- Rear corner and rear center sensors:
  - The engine switch is in IGNITION ON mode.
  - The shift lever is in R.

**■ Intuitive parking assist display**

When an obstacle is detected while the rear view monitor system is in use, the warning indicator will appear in the top right of the screen even if the display setting has been set to off.

**■ Sensor detection information**

- The sensor's detection areas are limited to the areas around the vehicle's front corners and rear bumper.
- Certain vehicle conditions and the surrounding environment may affect the ability of the sensor to correctly detect obstacles. Particular instances where this may occur are listed below.
  - There is dirt, snow or ice on the sensor. (Wiping the sensors will resolve this problem.)
  - The sensor is frozen. (Thawing the area will resolve this problem.)  
In especially cold weather, if a sensor is frozen the screen may show an abnormal display, or obstacles may not be detected.
  - The sensor is covered in any way.
  - The vehicle is leaning considerably to one side.
  - On an extremely bumpy road, on an incline, on gravel, or on grass.
  - The vicinity of the vehicle is noisy due to vehicle horns, motorcycle engines, air brakes of large vehicles, or other loud noises producing ultrasonic waves.
  - There is another vehicle equipped with parking assist sensors in the vicinity.
  - The sensor is coated with a sheet of spray or heavy rain.
  - The vehicle is equipped with a fender pole or wireless antenna.
  - Towing eyelets are installed.
  - The bumper or sensor receives a strong impact.
  - The vehicle is approaching a tall or curved curb.
  - In harsh sunlight or intense cold weather.
  - The area directly under the bumpers is not detected.
  - If obstacles draw too close to the sensor.
  - A non-genuine Lexus suspension (lowered suspension etc.) is installed.
  - People may not be detected if they are wearing certain types of clothing.

In addition to the examples above, there are instances in which, because of their shape, signs and other objects may be judged by the sensor to be closer than they are.

- The shape of the obstacle may prevent the sensor from detecting it. Pay particular attention to the following obstacles:
  - Wires, fences, ropes, etc.
  - Cotton, snow and other materials that absorb sound waves
  - Sharply-angled objects
  - Low obstacles
  - Tall obstacles with upper sections projecting outwards in the direction of your vehicle
- The following situations may occur during use.
  - Depending on the shape of the obstacle and other factors, the detection distance may shorten, or detection may be impossible.
  - Obstacles may not be detected if they are too close to the sensor.
  - There will be a short delay between obstacle detection and display. Even at slow speeds, there is a possibility that the obstacle will come within the sensor's detection areas before the display is shown and the warning beep sounds.
  - Thin posts or objects lower than the sensor may not be detected for collision when approached, even if they have been detected once.
  - It might be difficult to hear beeps due to the volume of audio system or air flow noise of air conditioning system.

■ **If “Clean Parking Assist Sensor” is displayed on the multi-information display**

A sensor may be dirty or covered with snow or ice. In such cases, if it is removed from the sensor, the system should return to normal. Also, due to the sensor being frozen at low temperatures, a malfunction display may appear or an obstacle may not be detected. If the sensor thaws out, the system should return to normal.

■ **If “Parking Assist Malfunction” is displayed on the multi-information display**

Depending on the malfunction of the sensor, the device may not be working normally. Have the vehicle inspected by your Lexus dealer.

■ **Certification**

- ▶ For vehicles sold in the U.S.A.

This device complies with Part 15 of the FCC Rules. Operation is subject to the following two conditions; (1) This device may not cause harmful interference, and (2) this device must accept any interference received, including interference that may cause undesired operation.

- ▶ For vehicles sold in Canada

This ISM device complies with Canadian ICES-001.

Cet appareil ISM est conforme à la norme NMB-001 du Canada.

**⚠ WARNING**

■ **When using the intuitive parking assist**

Observe the following precautions.  
Failing to do so may result in the vehicle being unable to be driven safely and possibly cause an accident, resulting in death or serious injury.

- Do not use the sensor at speeds in excess of 6 mph (10 km/h).
- The sensors' detection areas and reaction times are limited. When moving forward or reversing, check the areas surrounding the vehicle (especially the sides of the vehicle) for safety, and drive slowly, using the brake to control the vehicle's speed.
- Do not install accessories within the sensors' detection areas.

 NOTICE

■ **When using intuitive parking assist-sensor**

In the following situations, the system may not function correctly due to a sensor malfunction etc. Have the vehicle checked by your Lexus dealer.

- The intuitive parking assist operation display flashes, and a beep sounds when no obstacles are detected.
- If the area around a sensor collides with something, or is subjected to strong impact.
- If the bumper collides with something.
- If the display shows continuously without a beep.
- If a display error occurs, first check the sensor.  
If the error occurs even if there is no ice, snow or mud on the sensor, it is likely that the sensor is malfunctioning.

■ **Notes when washing the vehicle**

Do not apply intensive bursts of water or steam to the sensor area.

Doing so may result in the sensor malfunctioning.

## Lexus parking assist monitor\*

The parking assist monitor assists the driver by displaying an image of the view behind the vehicle while backing up, for example while parking.

Owners of models equipped with a navigation system should refer to the "NAVIGATION SYSTEM OWNER'S MANUAL".

The screen illustrations used in this text are intended as examples, and may differ from the image that is actually displayed on the screen.

The rear view image is displayed when the shift position is in R and the engine switch is in IGNITION ON mode.

The parking assist monitor system will be deactivated when the shift position is in any position other than R.

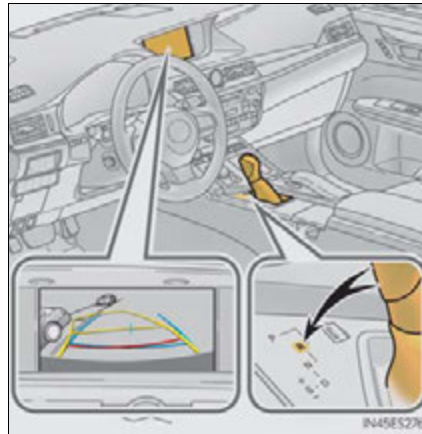

4

Driving

\*: If equipped

### Using the Lexus parking assist monitor

#### ■ Screen display

The parking assist monitor screen will be displayed if the shift position is shifted to R while the engine switch is in IGNITION ON mode.

- Ⓐ Intuitive parking assist display (if equipped)

If an obstacle is detected while the intuitive parking assist is on, a display is shown in the top right corner of the screen.

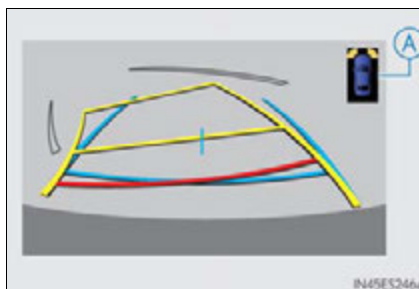

#### ■ Using the system

Use any of the following modes.

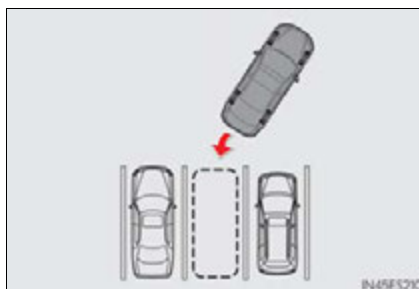

- Estimated course line display mode (→P. 232)

Estimated course lines are displayed which move in accordance with the operation of the steering wheel.

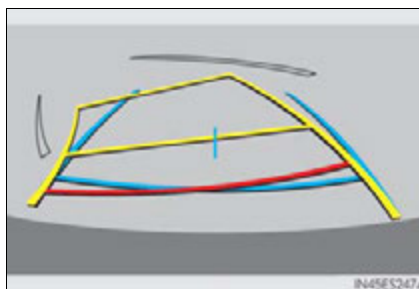

- Parking assist guide line display mode (→P. 234)

The steering wheel return points (parking assist guide lines) are displayed.

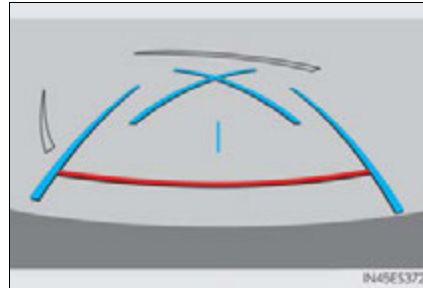

- Distance guide line display mode

Distance guide lines only are displayed.

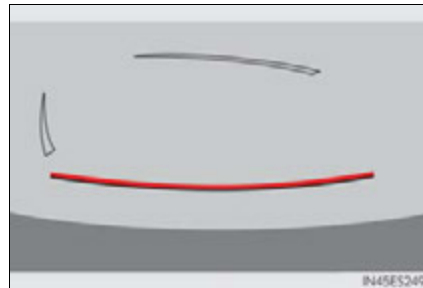

### Switching the display mode

When the shift position is in any position other than R, the display mode can be changed in the following procedure.

- 1 Press the "MENU" button on the Lexus Display Audio controller, and then select "Setup" on the screen.
- 2 Select "Vehicle", and then select "Back Camera Guide Line Setting" on the screen.
- 3 Select the desired display mode.
  - ① Estimated course line display mode (→P. 232)
  - ② Parking assist guide line display mode (→P. 234)
  - ③ Distance guide line display mode  
Distance guide lines only are displayed.

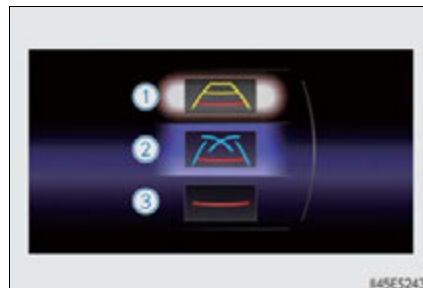

### Estimated course line display mode

■ Screen description

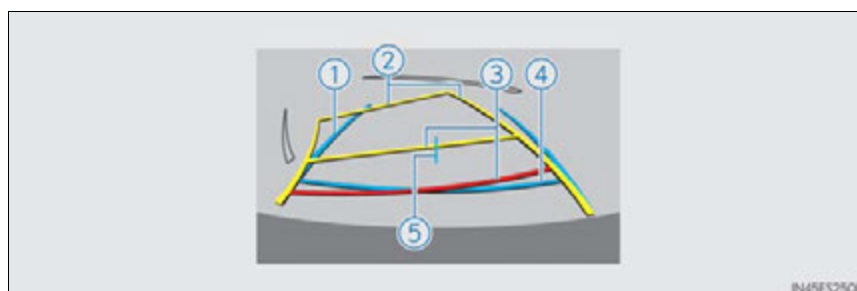

- ① Vehicle width guide line  
The line indicates a guide path when the vehicle is being backed straight up. The displayed width is wider than the actual vehicle width. The line aligns with the estimated course lines when the steering wheel is straight.
- ② Estimated course lines  
The lines show an estimated course when the steering wheel is turned.
- ③ Distance guide line  
The line moves, together with the estimated course lines, in sync with the steering wheel. The line shows points approximately 1.5 ft. (0.5 m) (red) and approximately 3 ft. (1 m) (yellow) from the center of the edge of the bumper.
- ④ Distance guide line  
The line shows distance behind the vehicle, a point approximately 1.5 ft. (0.5 m) (blue) from the edge of the bumper.
- ⑤ Vehicle center guide line  
The line indicates the estimated vehicle center on the ground.



### ■ Parking operation

When parking in a space which is in the reverse direction to the space described in the procedure below, the steering directions will be reversed.

1 Shift the shift position to R position.

2 Turn the steering wheel so that the estimated course lines are within the parking space, and back up slowly.

① Parking space

② Estimated course lines

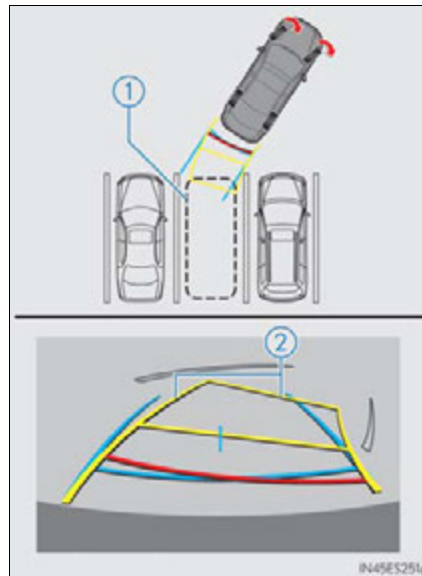

3 When the rear position of the vehicle has entered the parking space, turn the steering wheel so that the vehicle width guide lines are within the left and right dividing lines of the parking space.

③ Vehicle width guide line

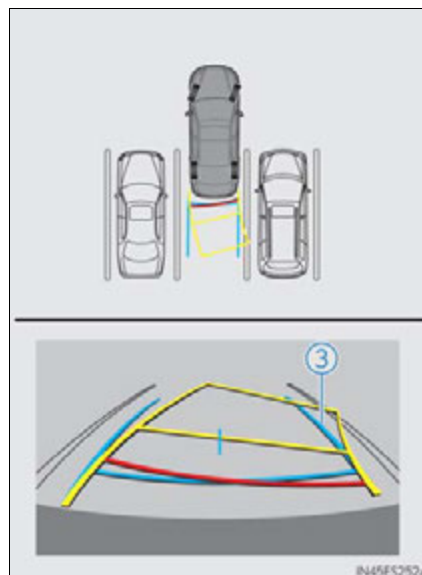

- 4 Once the vehicle width guide lines and the parking space lines are parallel, straighten the steering wheel and back up slowly until the vehicle has completely entered the parking space.
- 5 Stop the vehicle in an appropriate place, and finish parking.

### Parking assist guide line display mode

#### ■ Screen description

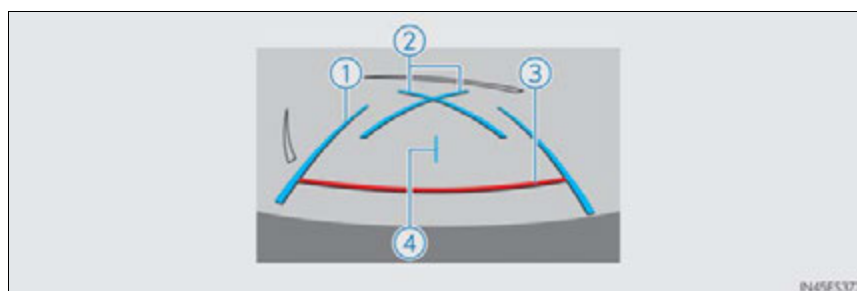

- ① Vehicle width guide lines  
These lines indicate a guide path when the vehicle is being backed straight up. The displayed width is wider than the actual vehicle width.
- ② Parking assist guide lines  
These lines indicate the path of the smallest turn possible behind the vehicle.  
These lines also indicate the approximate position of the steering wheel when parking.
- ③ Distance guide line  
This line (red) indicates points approximately 1.5 ft. (0.5 m) behind the rear bumper of your vehicle.
- ④ Vehicle center guide line  
The line indicates the estimated vehicle center on the ground.

**■ Parking operation**

When parking in a space which is in the reverse direction to the space described in the procedure below, the steering directions will be reversed.

**1** Shift the shift position to R position.

**2** Back up until the parking assist guide line meets the edge of the left-hand dividing line of the parking space.

- ① Parking assist guide line
- ② Parking space dividing line

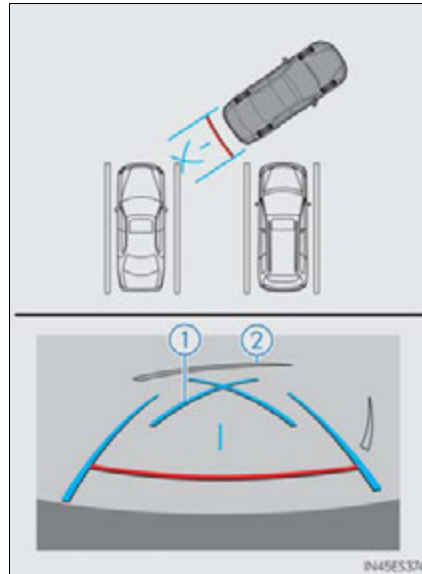

**3** Turn the steering wheel all the way to the right, and back up slowly.

**4** Once the vehicle is parallel with the parking space, straighten the steering wheel and back up slowly until the vehicle has completely entered the parking space.

**5** Stop the vehicle in an appropriate place, and finish parking.

### Lexus parking assist monitor precautions

#### ■ Area displayed on screen

The parking assist monitor displays an image of the view from the bumper of the rear area of the vehicle.

The image on the rear view monitor system screen can be adjusted.

(→P. 282)

- The area displayed on the screen may vary according to vehicle orientation conditions.
- Objects which are close to either corner of the bumper or under the bumper cannot be seen on the screen.
- The camera uses a special lens. The distance of the image that appears on the screen differs from the actual distance.
- Items which are located higher than the camera may not be displayed on the monitor.
- If your vehicle is equipped with a backlit license plate, it may interfere with the display.

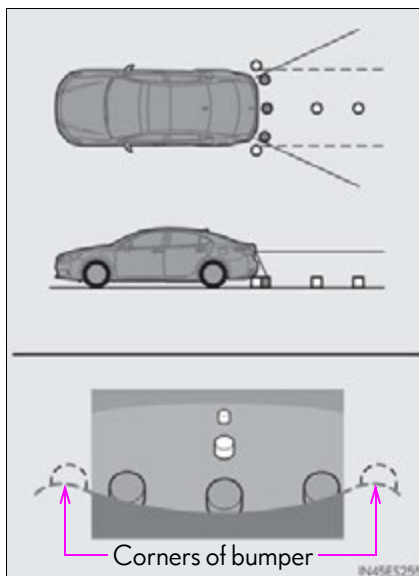

**■ Lexus parking assist monitor camera**

The camera for the parking assist monitor is located above the license plate.

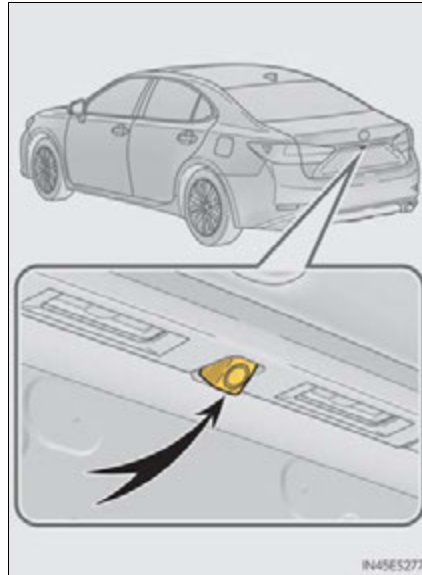
**● Using the camera**

If dirt or foreign matter (such as water droplets, snow, mud etc.) is adhering to the camera, it cannot transmit a clear image. In this case, flush it with a large quantity of water and wipe the camera lens clean with a soft and wet cloth.

**■ Differences between the screen and the actual road**

The distance guide lines and the vehicle width guide lines may not actually be parallel with the dividing lines of the parking space, even when they appear to be so. Be sure to check visually.

The distances between the vehicle width guide lines and the left and right dividing lines of the parking space may not be equal, even when they appear to be so. Be sure to check visually.

The distance guide lines give a distance guide for flat road surfaces. In any of the following situations, there is a margin of error between the guide lines on the screen and the actual distance/course on the road.

- When the ground behind the vehicle slopes up sharply

The distance guide lines will appear to be closer to the vehicle than the actual distance. Because of this, objects will appear to be farther away than they actually are. In the same way, there will be a margin of error between the guidelines and the actual distance/course on the road.

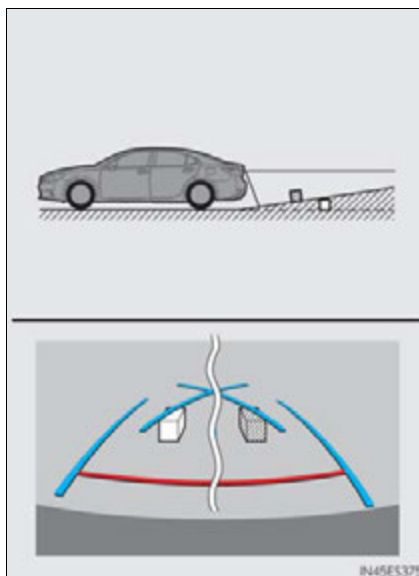

- When the ground behind the vehicle slopes down sharply

The distance guide lines will appear to be further from the vehicle than the actual distance. Because of this, objects will appear to be closer than they actually are. In the same way, there will be a margin of error between the guidelines and the actual distance/course on the road.

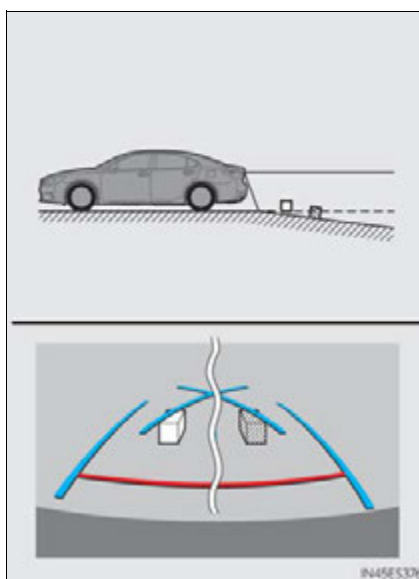

- When any part of the vehicle sags

When any part of the vehicle sags due to the number of passengers or the distribution of the load, there is a margin of error between the guide lines on the screen and the actual distance/course on the road.

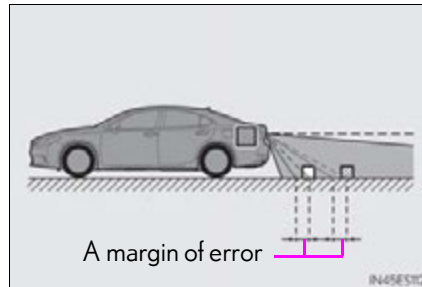

- When approaching three-dimensional objects

The estimated course lines target a flat surfaced objects (such as the road). It is not possible to determine the position of three-dimensional objects (such as vehicles) using the estimated course lines and distance guide lines. When approaching a three-dimensional object that extends outward (such as the flatbed of a truck), be careful of the following.

- Estimated course lines

Visually check the surroundings and the area behind the vehicle. In the case shown in the illustration, the truck appears to be outside of the estimated course lines and the vehicle does not look as if it will hit the truck. However, the rear body of the truck may actually cross over the estimated course lines. In reality if you back up as guided by the estimated course lines, the vehicle may hit the truck.

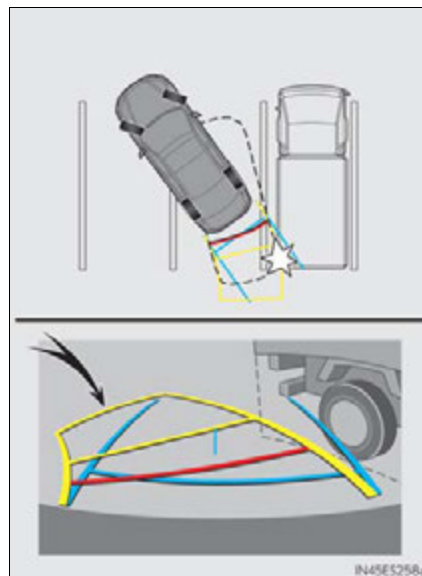

● Distance guidelines

Visually check the surroundings and the area behind the vehicle. On the screen, it appears that a truck is parking at point ②. However, in reality if you back up to point ①, you will hit the truck. On the screen, it appears that ① is closest and ③ is farthest away. However, in reality, the distance to ① and ③ is the same and ② is farther than ① and ③.

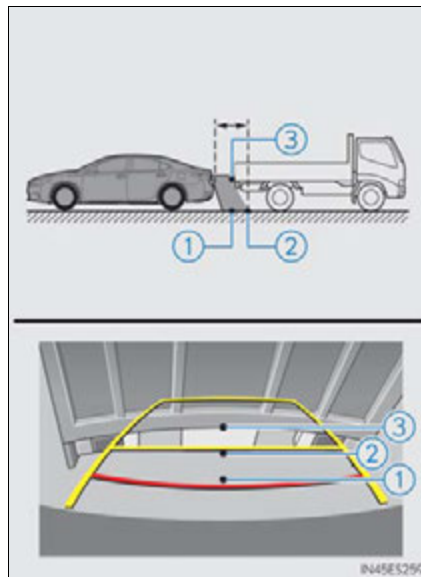



### Things you should know

#### ■ If you notice any symptoms

If you notice any of the following symptoms, refer to the likely cause and the solution, and re-check.

If the symptom is not resolved by the solution, have the vehicle inspected by your Lexus dealer.

Likely cause	Solution
<b>□ The image is difficult to see</b>	
<ul style="list-style-type: none"> <li>• The vehicle is in a dark area</li> <li>• The temperature around the lens is either high or low</li> <li>• The outside temperature is low</li> <li>• There are water droplets on the camera</li> <li>• It is raining or humid</li> <li>• Foreign matter (mud etc.) is adhering to the camera</li> <li>• There are scratches on the camera</li> <li>• Sunlight or headlights are shining directly into the camera</li> <li>• The vehicle is under fluorescent lights, sodium lights, mercury lights etc.</li> </ul>	<p>If this happens due to these causes, it does not indicate a malfunction. Back up while visually checking the vehicle's surroundings. (Use the monitor again once conditions have been improved.)</p> <p>The image on the Lexus parking assist monitor system screen can be adjusted. (→P. 282)</p>
<b>□ The image is blurry</b>	
Dirt or foreign matter (such as water droplets, snow, mud etc.) is adhering to the camera.	Flush the camera with a large quantity of water and wipe the camera lens clean with a soft and wet cloth.
<b>□ The image is out of alignment</b>	
The camera or surrounding area has received a strong impact.	Have the vehicle inspected by your Lexus dealer.

Likely cause	Solution
<b>❑ The guide lines are very far out of alignment</b>	
The camera position is out of alignment.	Have the vehicle inspected by your Lexus dealer.
<ul style="list-style-type: none"> <li>• The vehicle is tilted (there is a heavy load on the vehicle, tire pressure is low due to a tire puncture, etc.)</li> <li>• The vehicle is used on an incline.</li> </ul>	<p>If this happens due to these causes, it does not indicate a malfunction. Back up while visually checking the vehicle's surroundings.</p>
<b>❑ The estimated course lines move even though the steering wheel is straight</b>	
There is a malfunction in the signals being output by the steering sensor.	Have the vehicle inspected by your Lexus dealer.
<b>❑ Guide lines are not displayed</b>	
The trunk is open.	<p>Close the trunk. If this does not resolve the symptom, have the vehicle inspected by your Lexus dealer.</p>
<b>❑ The estimated course lines are not displayed</b>	
<ul style="list-style-type: none"> <li>• Battery power is low.</li> <li>• The steering sensor has been reinstalled.</li> <li>• There is a malfunction in the signals being output by the steering sensor.</li> </ul>	<p>Stop the vehicle, and turn the steering wheel as far as it will go to the left and right. If this does not resolve the symptom, have the vehicle inspected by your Lexus dealer.</p>

**⚠ WARNING****■ When using the Lexus parking assist monitor system**

The parking assist monitor is a supplemental device intended to assist the driver when backing up. When backing up, be sure to check visually behind and all around the vehicle before proceeding.

Observe the following precautions to avoid an accident that could result in death or serious injuries.

- Never depend on the parking assist monitor entirely when backing up. The image and the position of the guide lines displayed on the screen may differ from the actual state.  
Use caution, just as you would when backing up any vehicle.
- Be sure to back up slowly, depressing the brake pedal to control vehicle speed.
- If you seem likely to hit nearby vehicles, obstacles, people or mount the shoulder, depress the brake pedal to stop the vehicle.
- The instructions given are only guidelines.  
When and how much to turn the steering wheel will vary according to traffic conditions, road surface conditions, vehicle condition, etc. when parking. It is necessary to be fully aware of this before using the parking assist system.
- When parking, be sure to check that the parking space will accommodate your vehicle before maneuvering into it.
- Do not use the parking assist monitor in the following cases:
  - On icy or slick road surfaces, or in snow
  - When using tire chains or emergency tires
  - When the trunk is not closed completely
  - On roads that are not flat or straight, such as curves or slopes.
- In low temperatures, the screen may darken or the image may become faint. The image could distort when the vehicle is moving, or you may become unable to see the image on the screen. Be sure to check direct visually and with the mirrors all around the vehicle before proceeding.
- If the tire sizes are changed, the position of the guide lines displayed on the screen may change.
- The camera uses a special lens. The distances between objects and pedestrians that appear in the image displayed on the screen will differ from the actual distances. (→P. 237)
- Estimated course line display mode: If the steering wheel is straight and the vehicle width guide lines and the estimated course lines are not in alignment, have the vehicle inspected by your Lexus dealer.

 NOTICE

■ **How to use the camera**

- The parking assist monitor may not operate properly in the following cases.
  - If the back of the vehicle is hit, the position and mounting angle of the camera may change.
  - As the camera has a water proof construction, do not detach, disassemble or modify it. This may cause incorrect operation.
  - When cleaning the camera lens, flush the camera with a large quantity of water and wipe it with a soft and wet cloth. Strongly rubbing the camera lens may cause the camera lens to be scratched and unable to transmit a clear image.
  - Do not allow organic solvent, car wax, window cleaner or glass coat to adhere to the camera. If this happens, wipe it off as soon as possible.
  - If the temperature changes rapidly, such as when hot water is poured on the vehicle in cold weather, the system may not operate normally.
  - When washing the vehicle, do not apply intensive bursts of water to the camera or camera area. Doing so may result in the camera malfunctioning.
  - When the camera is used under fluorescent lights, sodium light or mercury light etc., the lights and the illuminated areas may appear to flicker.
- Do not expose the camera to strong impact as this could cause a malfunction. If this happens, have the vehicle inspected by your Lexus dealer as soon as possible.

## Driving mode select switch

The driving modes can be selected to suit driving condition.

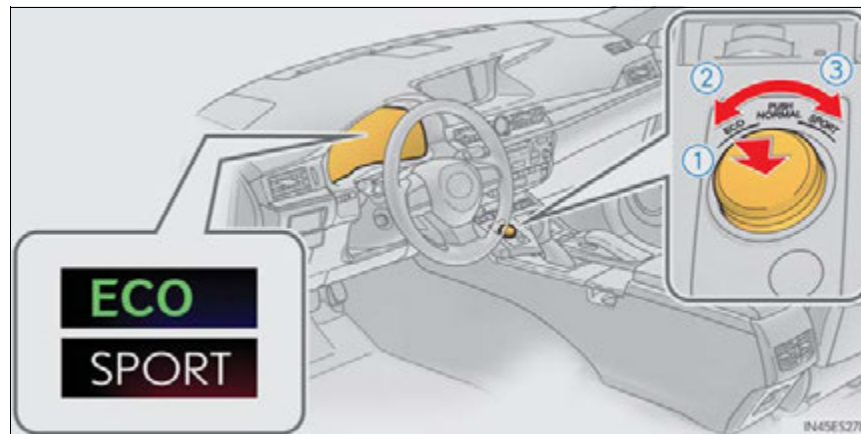

- ① Normal mode  
For normal driving.  
Press the switch to change the driving mode to normal mode when selected to Eco mode or sport mode.
- ② Eco drive mode  
Use Eco mode to help achieve low fuel consumption during trips that involve frequent accelerating.  
When not in Eco drive mode and the driving mode select switch is turned to the left, the "ECO" indicator comes on in the multi-information display.
- ③ Sport mode  
Assists acceleration response by controlling the steering and transmission. Suitable for when precise handling is desirable, for example when driving on mountain roads.  
When not in Sport mode and the driving mode select switch is turned to the right, the "SPORT" indicator comes on in the multi-information display.

■ **Operation of the air conditioning system in Eco drive mode**

Eco drive mode controls the heating/cooling operations and fan speed of the air conditioning system to enhance fuel efficiency (→P. 371). To improve air conditioning performance, adjust the fan speed or turn off Eco drive mode.

■ **Sport mode automatic deactivation**

Sport mode is automatically deactivated if the engine switch is turned off after driving in sport mode.

## BSM (Blind Spot Monitor)\*

### Summary of the Blind Spot Monitor

The Blind Spot Monitor is a system that has 2 functions;

- The Blind Spot Monitor function
  - Assists the driver in making the decision when changing lanes
- The Rear Cross Traffic Alert function
  - Assists the driver when backing up

These functions use same sensors.

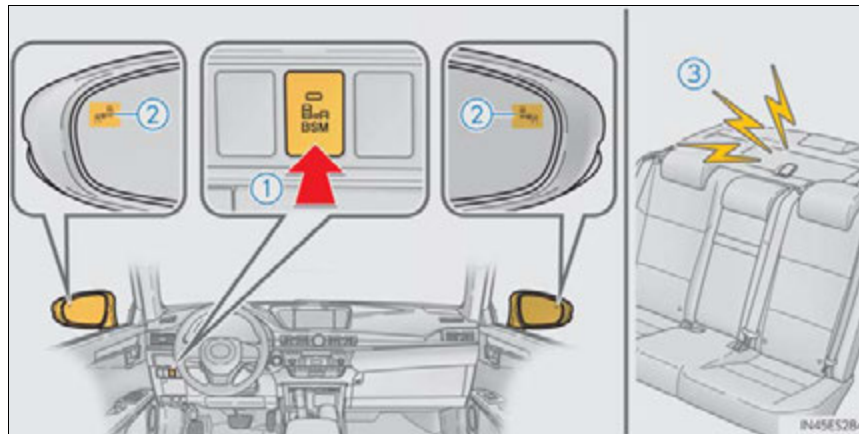

① BSM main switch

Pressing the switch turns the system on or off. When the switch is set to on, the switch's indicator illuminates. Common switch for Blind Spot Monitor function and Rear Cross Traffic Alert function.

② Outside rear view mirror indicator

Blind Spot Monitor function:

When a vehicle is detected in the blind spot, the outside rear view mirror indicator comes on while the turn signal lever is not operated and the outside rear view mirror indicator flashes while the turn signal lever is operated.

Rear Cross Traffic Alert function:

When a vehicle approaching from the right or left rear of the vehicle is detected, the outside rear view mirror indicators flash.

③ Rear Cross Traffic Alert buzzer (Rear Cross Traffic Alert function only)

When a vehicle approaching from the right or left rear of the vehicle is detected, a buzzer sounds from behind the rear seat.

\*: If equipped

■ **The outside rear view mirror indicators visibility**

When under strong sunlight, the outside rear view mirror indicator may be difficult to see.

■ **Rear Cross Traffic Alert buzzer hearing**

Rear Cross Traffic Alert function may be difficult to hear over loud noises such as high audio volume.

■ **When “Blind Spot Monitor Unavailable” is shown on the multi-information display**

Water, snow mud, etc., may be built up in the vicinity of the sensor area of bumper. (→P. 249) Removing the water, snow, mud, etc., from the vicinity of the sensor area bumper should return it to normal. Also, the sensor may not function normally when used in extremely hot or cold weather.

■ **When “Blind Spot Monitor System Malfunction Visit Your Dealer” is shown on the multi-information display**

There may be a sensor malfunction or voltage abnormality. Have the vehicle inspected at a Lexus dealer.

■ **Certification for the Blind Spot Monitor system**

▶ For vehicles sold in the U.S.A.

FCC ID: OAYSRR2A

This device complies with part 15 of the FCC Rules. Operation is subject to the following two conditions:

- (1) This device may not cause harmful interference, and
- (2) this device must accept any interference received, including interference that may cause undesired operation.

FCC Warning

Changes or modifications not expressly approved by the party responsible for compliance could void the user's authority to operate the equipment.

▶ For vehicles sold in Canada

Applicable law: Canada 310

This device complies with Industry Canada licence-exempt RSS standard(s). Operation is subject to the following two conditions: (1) this device may not cause interference, and (2) this device must accept any interference, including interference that may cause undesired operation of the device.

Frequency bands: 24.05-24.25 GHz

Output power: less than 20 milliwatts



**⚠ WARNING****■ Handling the radar sensor**

One Blind Spot Monitor sensor is installed inside the left and right side of the vehicle rear bumper respectively. Observe the following to ensure the Blind Spot Monitor system can function correctly.

- Keep the sensor and its surrounding area on the bumper clean at all times.

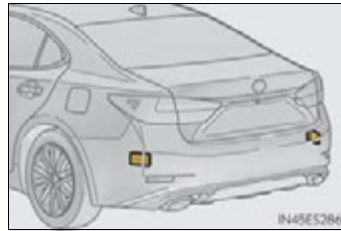

- Do not subject the sensor or surrounding area on the bumper to a strong impact. If the sensor moves even slightly off position, the system may malfunction and vehicles that enter the detection area may not be detected. If the sensor or surrounding area is subject to a strong impact, always have the area inspected by your Lexus dealer.
- Do not disassemble the sensor.
- Do not attach accessories or stickers to the sensor or surrounding area on the bumper.
- Do not modify the sensor or surrounding area on the bumper.
- Do not paint the rear bumper any color other than an official Lexus color.

### The Blind Spot Monitor function

The Blind Spot Monitor function uses radar sensors to detect vehicles that are traveling in an adjacent lane in the area that is not reflected in the outside rear view mirror (the blind spot), and advises the driver of the vehicles existence via the outside rear view mirror indicator.

### The Blind Spot Monitor function detection areas

The areas that vehicles can be detected in are outlined below.

The range of the detection area extends to:

- ① Approximately 11.5 ft. (3.5 m) from the side of the vehicle  
The first 1.6 ft. (0.5 m) from the side of the vehicle is not in the detection area
- ② Approximately 9.8 ft. (3 m) from the rear bumper
- ③ Approximately 3.3 ft. (1 m) forward of the rear bumper

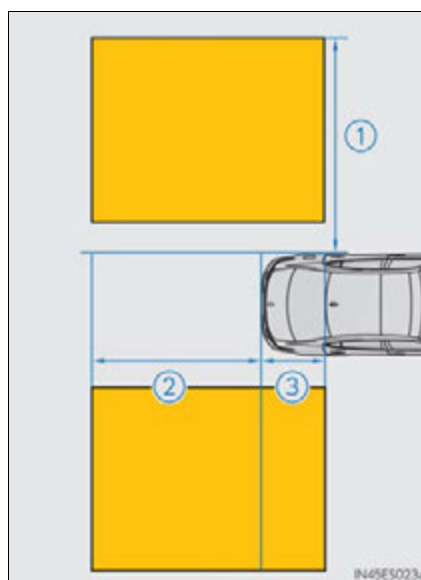

#### **⚠ WARNING**

##### ■ Cautions regarding the use of the system

The driver is solely responsible for safe driving. Always drive safely, taking care to observe your surroundings.

The Blind Spot Monitor function is a supplementary function which alerts the driver that a vehicle is present in the blind spot. Do not overly rely on the Blind Spot Monitor function. The function cannot judge if it is safe to change lanes, therefore over reliance could cause an accident resulting in death or serious injury.

According to conditions, the system does have operational limitations. Therefore the driver's own visual confirmation of safety is necessary.

■ **The Blind Spot Monitor function is operational when**

- The BSM main switch is set to on
- Vehicle speed is greater than approximately 10 mph (16 km/h).

■ **The Blind Spot Monitor function will detect a vehicle when**

- A vehicle in an adjacent lane overtakes your vehicle.
- Another vehicle enters the detection area when it changes lanes.

■ **Conditions under which the Blind Spot Monitor function will not detect a vehicle**

The Blind Spot Monitor function is not designed to detect the following types of vehicles and/or objects:

- Small motorcycles, bicycles, pedestrians etc.\*
- Vehicles traveling in the opposite direction
- Guardrails, walls, signs, parked vehicles and similar stationary objects\*
- Following vehicles that are in the same lane\*
- Vehicles driving 2 lanes across from your vehicle\*

\*: Depending on conditions, detection of a vehicle and/or object may occur.

■ **Conditions under which the Blind Spot Monitor function may not function correctly**

- The Blind Spot Monitor function may not detect vehicles correctly in the following conditions:
  - During bad weather such as heavy rain, fog, snow etc.
  - When ice or mud etc. is attached to the rear bumper
  - When driving on a road surface that is wet due to rain, standing water etc.
  - When there is a significant difference in speed between your vehicle and the vehicle that enters the detection area
  - When a vehicle is in the detection area from a stop and remains in the detection area as your vehicle accelerates
  - When driving up or down consecutive steep inclines, such as hills, a dip in the road etc.
  - When multiple vehicles approach with only a small gap between each vehicle
  - When vehicle lanes are wide, and the vehicle in the next lane is too far away from your vehicle
  - When the vehicle that enters the detection area is traveling at about the same speed as your vehicle
  - When there is a significant difference in height between your vehicle and the vehicle that enters the detection area
  - Directly after the BSM main switch is set to on
  - When items such as a bicycle carrier are installed on the rear of the vehicle
- Instances of the Blind Spot Monitor function unnecessarily detecting a vehicle and/or object may increase under the following conditions:
  - When there is only a short distance between your vehicle and a guardrail, wall etc.
  - When there is only a short distance between your vehicle and a following vehicle
  - When vehicle lanes are narrow and a vehicle driving 2 lanes across from your vehicle enters the detection area
  - When items such as a bicycle carrier are installed on the rear of the vehicle

### The Rear Cross Traffic Alert function

The Rear Cross Traffic Alert functions when your vehicle is in reverse. It can detect other vehicles approaching from the right or left rear of the vehicle. It uses radar sensors to alert the driver of the other vehicle's existence through flashing the outside rear view mirror indicators and sounding a buzzer.

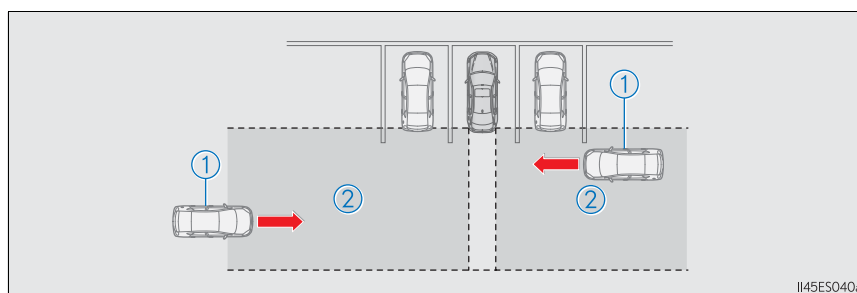

① Approaching vehicles

② Detection areas

#### **⚠ WARNING**

##### ■ Cautions regarding the use of the system

The driver is solely responsible for safe driving. Always drive safely, taking care to observe your surroundings.

The Rear Cross Traffic Alert function is only an assist and is not a replacement for careful driving. Driver must be careful when backing up, even when using Rear Cross Traffic Alert function. The driver's own visual confirmation of behind you and your vehicle is necessary and be sure there are no pedestrians, other vehicles etc. before backing up. Failure to do so could cause death or serious injury.

According to conditions, the system may not function correctly. Therefore the driver's own visual confirmation of safety is necessary.

### The Rear Cross Traffic Alert function detection areas

The areas that vehicles can be detected in are outlined below.

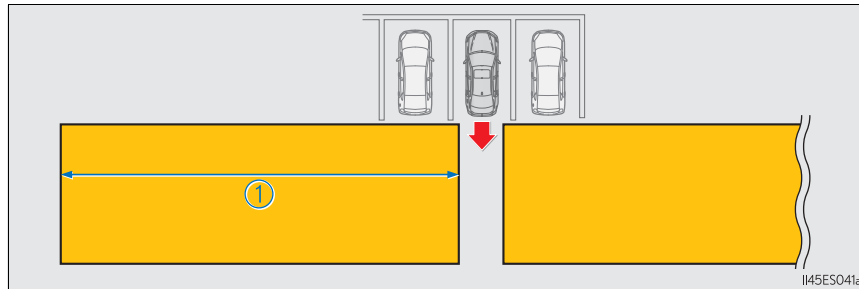

To give the driver a more consistent time to react, the buzzer can alert for faster vehicles from farther away.

Example:

Approaching vehicle	Speed	① Approximate alert distance
Fast	18 mph (28 km/h)	65 ft. (20 m)
Slow	5 mph (8 km/h)	18 ft. (5.5 m)

4

Driving

#### ■ The Rear Cross Traffic Alert function is operational when

- The BSM main switch is set to on.
- The shift lever is in R.
- Vehicle speed is less than approximately 5 mph (8 km/h).
- Approaching vehicle speed is between approximately 5 mph (8 km/h) and 18 mph (28 km/h).

■ **Conditions under which the Rear Cross Traffic Alert function will not detect a vehicle**

The Rear Cross Traffic Alert function is not designed to detect the following types of vehicles and/or objects.

- Small motorcycles, bicycles, pedestrians etc.\*
- Vehicles approaching from directly behind
- Guardrails, walls, signs, parked vehicles and similar stationary objects\*
- Vehicles moving away from your vehicle
- Vehicles approaching from the parking spaces next to your vehicle\*
- Vehicles backing up in the parking space next to your vehicle\*

\*: Depending on conditions, detection of a vehicle and/or object may occur.

■ **Conditions under which the Rear Cross Traffic Alert function may not function correctly**

The Rear Cross Traffic Alert function may not detect vehicles correctly in the following conditions:

- When ice or mud etc. is attached to the rear bumper
- During bad weather such as heavy rain, fog, snow etc.
- When multiple vehicles approach continuously
- Shallow angle parking
- When a vehicle is approaching at high speed
- When parking on a steep incline, such as hills, a dip in the road etc.
- Directly after the BSM main switch is set to on
- Vehicles that the sensors cannot detect because of obstacles

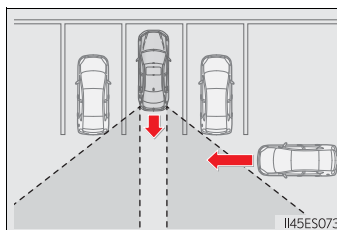

## Driving assist systems

To help enhance driving safety and performance, the following systems operate automatically in response to various driving situations. Be aware, however, that these systems are supplementary and should not be relied upon too heavily when operating the vehicle.

### ◆ ABS (Anti-lock Brake System)

Helps to prevent wheel lock when the brakes are applied suddenly, or if the brakes are applied while driving on a slippery road surface

### ◆ Brake assist

Generates an increased level of braking force after the brake pedal is depressed when the system detects a panic stop situation

### ◆ VSC (Vehicle Stability Control)

Helps the driver to control skidding when swerving suddenly or turning on slippery road surfaces

### ◆ Enhanced VSC (Enhanced Vehicle Stability Control)

Provides cooperative control of the ABS, TRAC, VSC and EPS. Helps to maintain directional stability when swerving on slippery road surfaces by controlling steering performance.

### ◆ TRAC (Traction Control)

Helps to maintain drive power and prevent the drive wheels from spinning when starting the vehicle or accelerating on slippery roads

### ◆ Hill-start assist control

Helps to prevent the vehicle from rolling backward when starting on an incline.

◆ EPS (Electric Power Steering)

Employs an electric motor to reduce the amount of effort needed to turn the steering wheel

**When the TRAC/VSC systems are operating**

The slip indicator light will flash while the TRAC/VSC systems are operating.



**Disabling the TRAC system**

If the vehicle gets stuck in mud, dirt or snow, the TRAC system may reduce power from the engine to the wheels. Pressing  to turn the system off may make it easier for you to rock the vehicle in order to free it.

To turn the TRAC system off, quickly

press and release .

The "Traction Control Turned Off" will be shown on the multi-information display.

Press  again to turn the system back on.

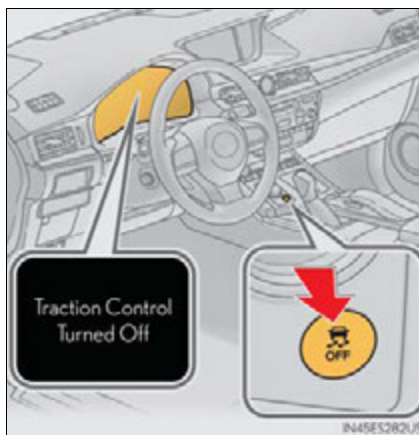



### ■ Turning off both TRAC and VSC systems

To turn the TRAC and VSC systems off, press and hold  for more than 3 seconds while the vehicle is stopped.

The VSC OFF indicator light will come on and the "Traction Control Turned Off" will be shown on the multi-information display.\*

Press  again to turn the systems back on.

\*: On vehicles with pre-collision system, pre-collision brake assist and pre-collision braking will also be disabled. The PCS warning light will come on and the message will be shown on the multi-information display. (→P. 183)

### ■ When the message is displayed on the multi-information display showing that TRAC has been disabled even if the VSC OFF switch has not been pressed

TRAC cannot be operated. Contact your Lexus dealer.

### ■ When the battery is disconnected

The steering wheel may move from its straight forward position, but this will be corrected automatically when driving.

### ■ Sounds and vibrations caused by the ABS, brake assist, TRAC, VSC and hill-start assist control systems

- A sound may be heard from the engine compartment when the brake pedal is depressed repeatedly, when the engine is started or just after the vehicle begins to move. This sound does not indicate that a malfunction has occurred in any of these systems.
- Any of the following conditions may occur when the above systems are operating. None of these indicates that a malfunction has occurred.
  - Vibrations may be felt through the vehicle body and steering.
  - A motor sound may be heard after the vehicle comes to a stop.
  - The brake pedal may pulsate slightly after the ABS is activated.
  - The brake pedal may move down slightly after the ABS is activated.

### ■ EPS operation sound

When the steering wheel is operated, a motor sound (whirring sound) may be heard. This does not indicate a malfunction.

### ■ Automatic reactivation of TRAC and VSC systems

After turning the TRAC and VSC systems off, the systems will be automatically re-enabled in the following situations:

- When the engine switch is turned off
- If only the TRAC system is turned off, the TRAC will turn on when vehicle speed increases.  
If both the TRAC and VSC systems are turned off, automatic re-enabling will not occur when vehicle speed increases.

■ **Operating conditions of hill-start assist control**

When the following four conditions are met, the hill-start assist control will operate:

- The shift lever is in a position other than P or N (when starting off forward/backward on an upward incline).
- The vehicle is stopped.
- The accelerator pedal is not depressed.
- The parking brake is not engaged.

■ **Automatic system cancelation of hill-start assist control**

The hill-start assist control will turn off in any of the following situations:

- The shift lever is moved to P or N.
- The accelerator pedal is depressed.
- The parking brake is engaged.
- Approximately 2 seconds elapse after the brake pedal is released.

■ **Reduced effectiveness of the EPS system**

The effectiveness of the EPS system is reduced to prevent the system from overheating when there is frequent steering input over an extended period of time. The steering wheel may feel heavy as a result. Should this occur, refrain from excessive steering input or stop the vehicle and turn the engine off. The EPS system should return to normal within 10 minutes.

**⚠ WARNING****■ The ABS does not operate effectively when**

- The limits of tire gripping performance have been exceeded (such as excessively worn tires on a snow covered road).
- The vehicle hydroplanes while driving at high speed on wet or slick roads.

**■ Stopping distance when the ABS is operating may exceed that of normal conditions**

The ABS is not designed to shorten the vehicle's stopping distance. Always maintain a safe distance from the vehicle in front of you, especially in the following situations:

- When driving on dirt, gravel or snow-covered roads
- When driving with tire chains
- When driving over bumps in the road
- When driving over roads with potholes or uneven surfaces

**■ TRAC may not operate effectively when**

Directional control and power may not be achievable while driving on slippery road surfaces, even if the TRAC system is operating.

Drive the vehicle carefully in conditions where stability and power may be lost.

**■ Hill-start assist control does not operate effectively when**

- Do not overly rely on the hill-start assist control. The hill-start assist control may not operate effectively on steep inclines and roads covered with ice.
- Unlike the parking brake, hill-start assist control is not intended to hold the vehicle stationary for an extended period of time. Do not attempt to use hill-start assist control to hold the vehicle on an incline, as doing so may lead to an accident.

**■ When the VSC is activated**

The slip indicator light flashes. Always drive carefully. Reckless driving may cause an accident. Exercise particular care when the indicator light flashes.

**■ When the TRAC/VSC systems are turned off**

Be especially careful and drive at a speed appropriate to the road conditions. As these are the systems help ensure vehicle stability and driving force, do not turn the TRAC/VSC systems off unless necessary.

**■ Replacing tires**

Make sure that all tires are of the specified size, brand, tread pattern and total load capacity and have similar tread depths. In addition, make sure that the tires are inflated to the recommended tire inflation pressure level.

The ABS, TRAC and VSC systems will not function correctly if different size tires are installed on the vehicle.

Contact your Lexus dealer for further information when replacing tires or wheels.

**■ Handling of tires and the suspension**

Using tires with any kind of problem or modifying the suspension will affect the driving assist systems, and may cause a system to malfunction.

## Winter driving tips

Carry out the necessary preparations and inspections before driving the vehicle in winter. Always drive the vehicle in a manner appropriate to the prevailing weather conditions.

### Preparation for winter

- Use fluids that are appropriate to the prevailing outside temperatures.
  - Engine oil
  - Engine coolant
  - Washer fluid
- Have a service technician inspect the condition of the battery.
- Have the vehicle fitted with four snow tires or purchase a set of tire chains for the front tires.

Ensure that all tires are the specified size and brand, and that chains match the size of the tires.

### Before driving the vehicle

Perform the following according to the driving conditions:

- Do not try to forcibly open a window or move a wiper that is frozen. Pour warm water over the frozen area to melt the ice. Wipe away the water immediately to prevent it from freezing.
- To ensure proper operation of the climate control system fan, remove any snow that has accumulated on the air inlet vents in front of the windshield.
- Check for and remove any excess ice or snow that may have accumulated on the exterior lights, vehicle's roof, chassis, around the tires or on the brakes.
- Remove any snow or mud from the bottom of your shoes before getting in the vehicle.

### When driving the vehicle

Accelerate the vehicle slowly, keep a safe distance between you and the vehicle ahead, and drive at a reduced speed suitable to road conditions.

**When parking the vehicle**

Park the vehicle and move the shift lever to P without setting the parking brake. The parking brake may freeze up, preventing it from being released. If necessary, block the wheels to prevent inadvertent sliding or creeping.

**Selecting tire chains**

Use the correct tire chain size when mounting the tire chains. Chain size is regulated for each tire size.

## ▶ Side chain

- ① 0.12 in. (3 mm) in diameter
- ② 0.39 in. (10 mm) in width
- ③ 1.18 in. (30 mm) in length

## ▶ Cross chain

- ④ 0.16 in. (4 mm) in diameter
- ⑤ 0.55 in. (14 mm) in width
- ⑥ 0.98 in. (25 mm) in length

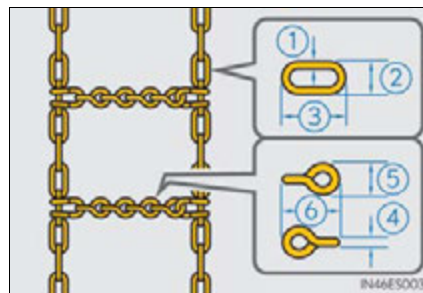

4

Driving

**Regulations on the use of tire chains**

Regulations regarding the use of tire chains vary depending on location and type of road. Always check local regulations before installing chains.

■ **Tire chain installation**

Observe the following precautions when installing and removing chains:

- Install and remove tire chains in a safe location.
- Install tire chains on the front tires. Do not install tire chains on the rear tires.
- Install tire chains on front tires as tightly as possible. Retighten chains after driving 1/4 — 1/2 mile (0.5 — 1.0 km).
- Install tire chains following the instructions provided with the tire chains.

### Shifting the windshield wiper position

If heavy snow or icy condition is expected, shift the rest position manually.  
Grip the hook section of the wiper arm firmly when shifting the wiper position.

#### ■ To rest position

Raise the wiper in line with the windshield until it locks.

You can stand the wipers up for the rest position.

★: More than 3.9 in. (10 cm)

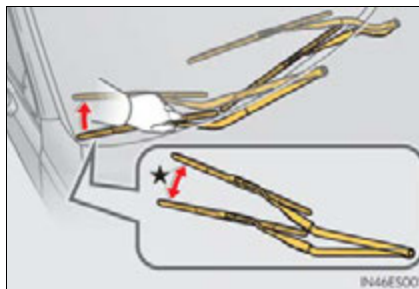

#### ■ To retract position

Lower the wipers by pressing on the upper part of the hook section.

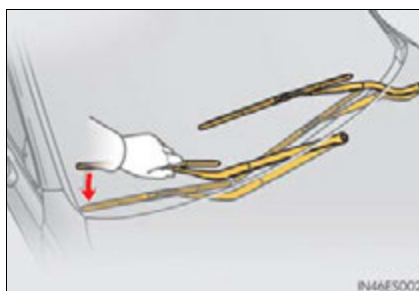

**⚠ WARNING****■ Driving with snow tires**

Observe the following precautions to reduce the risk of accidents.  
Failure to do so may result in a loss of vehicle control and cause death or serious injury.

- Use tires of the specified size.
- Maintain the recommended level of air pressure.
- Do not drive in excess of 75 mph (120 km/h), regardless of the type of snow tires being used.
- Use snow tires on all, not just some wheels.

**■ Driving with tire chains**

Observe the following precautions to reduce the risk of accidents.  
Failure to do so may result in the vehicle being unable to be driven safely, and may cause death or serious injury.

- Do not drive in excess of the speed limit specified for the tire chains being used, or 30 mph (50 km/h), whichever is lower.
- Avoid driving on bumpy road surfaces or over potholes.
- Avoid sudden acceleration, abrupt steering, sudden braking and shifting operations that cause sudden engine braking.
- Slow down sufficiently before entering a curve to ensure that vehicle control is maintained.
- Do not use LDA (Lane Departure Alert with steering control) system. (if equipped)

**⚠ NOTICE****■ Repairing or replacing snow tires**

Request repairs or replacement of snow tires from Lexus dealers or legitimate tire retailers.

This is because the removal and attachment of snow tires affects the operation of the tire pressure warning valves and transmitters.

**■ Fitting tire chains**

The tire pressure warning valves and transmitters may not function correctly when tire chains are fitted.

**■ When standing the windshield wipers up**

Raise the wipers in line with the windshield. (→P. 262)

Failure to do so may result in damage to the wipers and/or the hood.

**5-1. Basic Operations**

Lexus Display Audio System .....	266
Steering wheel audio switches.....	273
USB/AUX ports .....	274

**5-2. Setup**

Setup menu .....	276
General settings.....	277
Voice settings .....	281
Display settings.....	282



## Lexus Display Audio system

### 5

- 5-3. Using the audio system**
  - Selecting the audio source .....284
  - Optimal use of the audio system ..... 285
  - Audio settings.....286
  - Audio menu screen operation .....289
- 5-4. Using the radio**
  - Radio operation .....292
- 5-5. Playing an audio CD and MP3/WMA/AAC discs**
  - CD player operation.....299
- 5-6. Using an external device**
  - Listening to an iPod ..... 306
  - Using USB memory device.....310
  - Using the AUX port..... 314
- 5-7. Connecting Bluetooth®**
  - Steps for using Bluetooth® devices..... 315
  - Registering a Bluetooth® device..... 317
  - Selecting a Bluetooth® device.....318
  - Connecting a Bluetooth® audio player .....319
  - Connecting a Bluetooth® phone ..... 320
  - Displaying a Bluetooth® device details ..... 321
  - Detailed Bluetooth® settings.....322
- 5-8. Bluetooth® Audio**
  - Listening to Bluetooth® Audio ..... 323
- 5-9. Bluetooth® Phone**
  - Using a Bluetooth® Phone.....325
  - Making a call..... 327
  - Receiving a call .....330
  - Speaking on the phone..... 331
  - Using a Bluetooth® phone message.....334
  - Using the steering wheel switches.....336
  - Bluetooth® phone settings ..... 337
- 5-10. Phonebook**
  - Contact settings .....339
  - Messaging setting.....342
- 5-11. Bluetooth®**
  - What to do if.. (Troubleshooting).....343
  - Bluetooth® .....346
- 5-12. Other function**
  - "Information" screen ..... 351
  - USB photo .....353
  - Weather information .....355
  - Voice command system .....356
  - Mobile Assistant.....360
  - LEXUS Enform Remote ..... 362

## Lexus Display Audio System \*

Use the following buttons to start listening to the audio system.

### Lexus Display Audio operation buttons

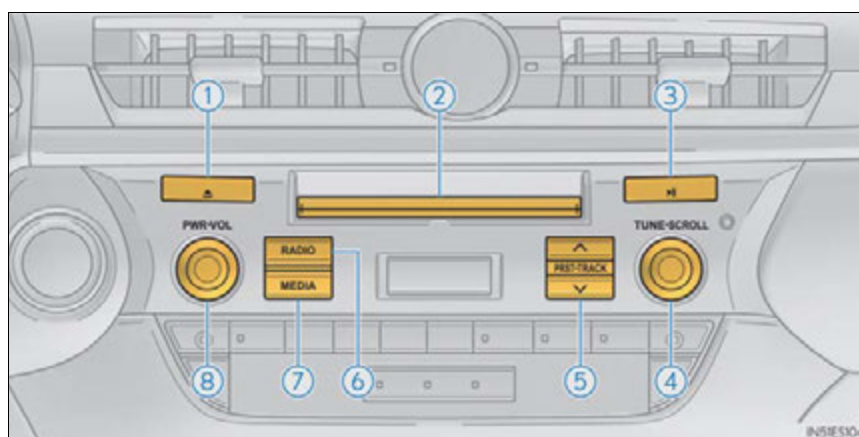

- ① Eject a disc.
- ② Disc slot
- ③ Except radio and A/V mode: Pause or resume playing a track.  
Radio and A/V mode: Turn mute on/off
- ④ “TUNE•SCROLL” knob  
Select a radio station band, track or file.
- ⑤ Selects a preset radio station, or to access a desired track or file.
- ⑥ Display the radio top screen.
- ⑦ Display the media top screen.
- ⑧ “PWR•VOL” knob  
Press to turn the audio system on/off, and turn to adjust the volume.

\*: If equipped

■ **“Menu” screen**

To display the “Menu” screen, press the “MENU” button on the controller unit.

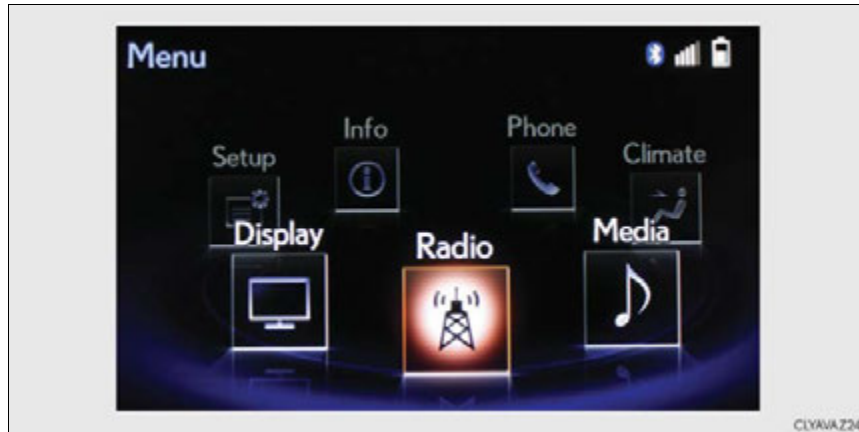

Button	Function
“Radio”	Display the radio top screen (→P. 292)
“Media”	Display the media top screen (→P. 299, 306, 310, 314, 323)
“Climate”	Automatic air conditioning system (→P. 364)
“Phone”	Display the phone top screen (→P. 325)
“Info”	Display the “Information” screen (→P. 351)
“Setup”	Setup menu (→P. 276)
“Display”	Display settings (→P. 282)

### Lexus Display Audio controller

By using the Lexus Display Audio controller, you can control the audio system, hands-free system, etc.

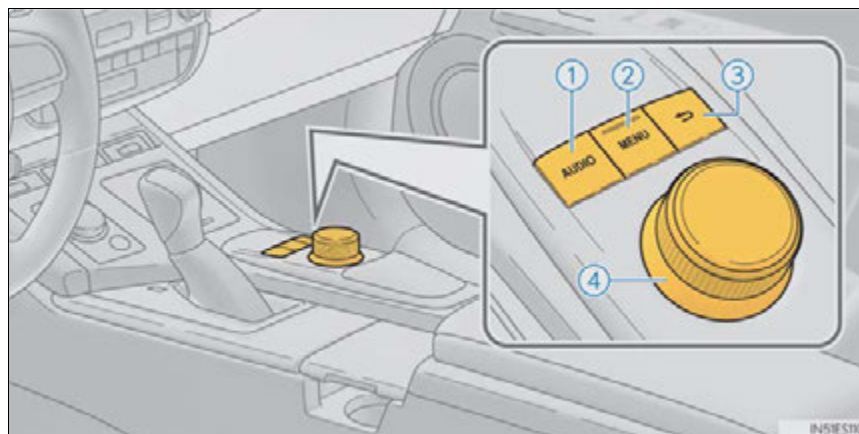

- ① Display the "Source" screen or audio top screen (→P. 284)
- ② Display the "Menu" screen (→P. 267)
- ③ Back button  
Display the previous screen
- ④ Turn or move the controller to select a function and number.  
Move the controller to display the left or right side of the screen.  
Push the controller to enter the selected function and number.

■ Using the Lexus Display Audio controller

- ① Select: Turn or move the controller.
- ② Enter: Push the controller.

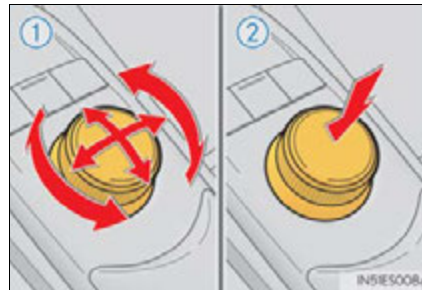

■ Basic screen operation

When a list is displayed, use the appropriate button to scroll through the list.

- ① Indicator turns on when you can select the list by turning the controller.
- ② Indicator turns on when you can return to the previous screen by pressing the back button.
- ③ Indicator turns on when you can move the controller left to view additional screen text.
- ④ Indicator turns on when you can move the controller right to view additional screen text.



## Inputting letters and numbers

### ■ Input mode

Letters and numbers are inputted via the screen.

- ① Turn the controller to select the desired character and press the controller to input the character.
- ② When this indicator is shown, you can change input fields by moving the controller forward.
- ③ When this indicator is shown, you can change character types by moving the controller to the right and then selecting the desired character type.
- ④ Select to erase characters one by one. Select and hold to erase all characters.
- ⑤ Select to complete data input.

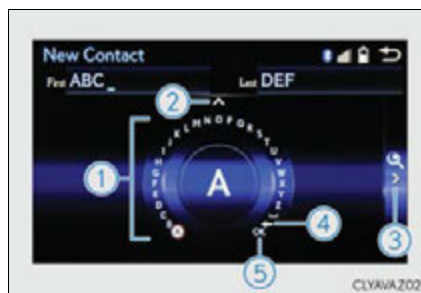

■ **Input field mode**

When in the input field you can move the cursor to the desired position.

- ① Turn the controller to move the cursor left or right.
- ② When this indicator is shown, you can move the cursor to the right input field by moving the controller to the right.
- ③ When this indicator is shown, you can move the cursor to the left input field by moving the controller to the left.
- ④ When this indicator is shown, you can change to input mode by moving the controller backward.



■ **When using the screen**

- Under extremely cold conditions, the Lexus Display Audio controller may react slowly.
- If the screen is cold, the display may be dark, or the system may seem to be operating slightly slower than normal.
- The screen may seem dark and hard to see when viewed through sunglasses. Change your angle of viewing, adjust the display on the "Display" screen (→P. 282) or remove your sunglasses.

■ **Using cellular phones**

Interference may be heard through the audio system's speakers if a cellular phone is being used inside or close to the vehicle while the audio system is operating.

**⚠ WARNING**

■ **Using the Lexus Display Audio controller**  
 Be careful when touching the Lexus Display Audio controller in extreme temperatures as it may become very hot or cold due to the temperature inside the vehicle.

■ **Laser product**

- **CAUTION**  
 USE OF CONTROL OR ADJUSTMENT OR PERFORMANCE OF PROCEDURES OTHER THAN THOSE SPECIFIED HEREIN MAY RESULT IN HAZARDOUS RADIATION EXPOSURE.
- **CAUTION**  
 THE USE OF OPTICAL INSTRUMENTS WITH THIS PRODUCT WILL INCREASE EYE HAZARD.

 NOTICE

■ **To prevent Lexus Display Audio controller malfunction**

- Do not allow the Lexus Display Audio controller to come into contact with food, liquid, stickers or lit cigarettes as doing so may cause it to change color, emit a strange odor or stop functioning.
- Do not subject the Lexus Display Audio controller to excessive pressure or strong impact as the controller may bend or break off.

■ **To prevent battery discharge**

Do not leave the audio system on longer than necessary when the engine is not running.

■ **To avoid damaging the audio system**

Take care not to spill drinks or other fluids on the audio system.



## Steering wheel audio switches

Some audio features can be controlled using the switches on the steering wheel.

Operation may differ depending on the type of audio system or navigation system. For details, refer to the manual provided with the audio system or navigation system.

### Operating the audio system using the steering wheel switches

- ① Volume switch
  - Press: Increases/decreases volume
  - Press and hold: Continuously increases/decreases volume
- ② Radio mode:
  - Press: Selects a radio station
  - Press and hold: Seeks up/down
 CD, MP3/WMA/AAC disc, Bluetooth<sup>®</sup>, iPod or USB mode:
  - Press: Selects a track/file/video
  - Press and hold: Scrolls up/down tracks/files/videos (MP3/WMA/AAC disc, iPod or USB)
- ③ "MODE" switch
  - Press: Turns the power on, selects audio source
  - Press and hold this switch to mute or pause the current operation. To cancel the mute or pause, press and hold.



5

Lexus Display Audio system

#### WARNING

##### To reduce the risk of an accident

Exercise care when operating the audio switches on the steering wheel.

## USB/AUX ports

Connect an iPod, USB memory device or portable audio player to the USB/AUX port as indicated below. Select “iPod”, “USB”, “AUX” or “A/V” on the audio source selection screen and the device can be operated via Lexus Display Audio system.

### Connecting using the USB/AUX port

- 1 Push the knob to release the lock, and lift the armrest to open fully.

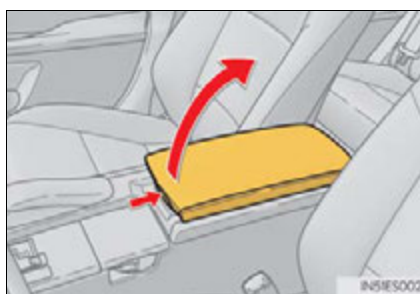

- 2 Open the cover.



#### ■ iPod

Open the cover and connect an iPod using an iPod cable.

Turn on the power of the iPod if it is not turned on.

#### ■ USB memory

Open the cover and connect the USB memory device.

Turn on the power of the USB memory device if it is not turned on.

#### ■ Portable audio player

Open the cover and connect the portable audio player.

Turn on the power of the portable audio player if it is not turned on.

**Using a 4-pole AUX cable**

To view a video on an iPod video or VTR, it is necessary to use a 4-pole AUX cable to connect the portable audio device.

When connecting a portable audio device to the AUX port, use a 4-pole AUX cable with a plug that matches the exact layout shown in the illustration.

- ① Connected device (portable audio device, etc.)
- ② Left audio
- ③ Right audio
- ④ Ground
- ⑤ Video

When using an iPod video, a cable that has a 4-pole AUX plug and a USB connector is necessary. Connect the plug and connector to the AUX and USB ports.

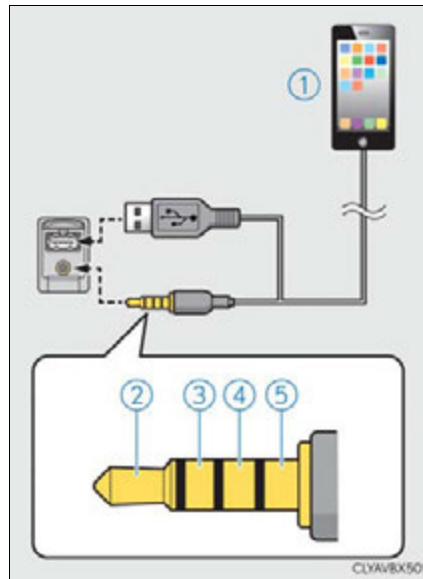

■ **When using a 4-pole AUX cable**

If a 4-pole AUX cable with a different layout is used, audio and/or video may not be output properly.

**⚠ WARNING**

■ **While driving**

Do not connect a device or operate the device controls.

**⚠ NOTICE**

■ **If the armrest cannot be fully closed**

Depending on the size and shape of the USB memory that is connected to the system, the armrest may not close fully. In this case, do not forcibly close the armrest as this may damage the USB memory or the terminal, etc.

## Setup menu

The Lexus Display Audio system can be adjusted to the desired settings.

### Display “Setup” screen

“Setup” screen: “MENU” button → “Setup”

- ① Change the settings for operation sounds, screen animation, etc. (→P. 277)
- ② Adjust the settings for voice guidance volume and voice recognition prompts. (→P. 281)
- ③ Change the settings for registering, removing, connecting and disconnecting Bluetooth® devices. (→P. 316)
- ④ Change the settings for FM radio, iPod, etc. (→P. 286)
- ⑤ Change the settings for vehicle customization. (→P. 533)
- ⑥ Change the settings for phone sound, phonebook, etc. (→P. 337)

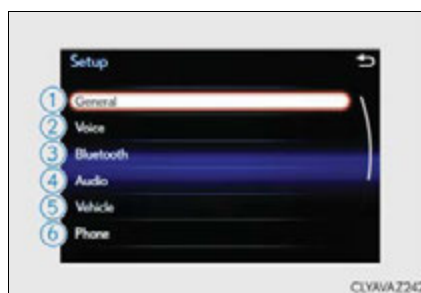

## General settings

Settings are available for adjusting the operation sounds, screen animation, etc.

### Screen for general settings

“General Settings” screen: “MENU” button → “Setup” → “General”

- ① Change language.  
The selectable languages may differ depending on the model or region.
- ② Change the unit of measurement.
- ③ Set the beep sound on/off.
- ④ Change the button color.
- ⑤ Change the startup image and screen off image. (→P. 278)
- ⑥ Set the animation effect on/off.
- ⑦ Delete personal data (→P. 280)
- ⑧ Update program versions.  
For details, contact your Lexus dealer.
- ⑨ Update gracenote database versions.  
For details, contact your Lexus dealer.
- ⑩ Display the open source license.



### Customizing images

- 1 Go to "Customize Images": "MENU" button → "Setup" → "General" → "Customize Images"
- 2 Select "Set Images" and then select the desired image.
  - 1 Set as startup image.
  - 2 Set as screen off image.
  - 3 Set as startup image and screen off image.

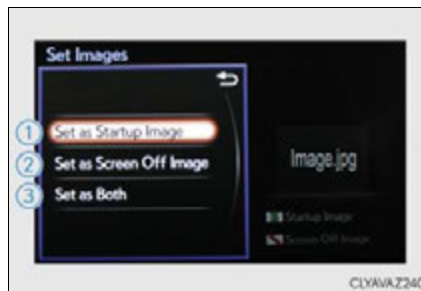

#### ■ Adding an image

- 1 Connect a USB memory device. (→P. 274)
- 2 Select "Copy from USB" on the "Customize Images" screen and then select the desired image.
- 3 Move the controller to the left and then select "Copy".  
Up to 10 images can be downloaded.

#### ■ Deleting images

Select "Delete Images" on the "Customize Images" screen and then select the desired images.

**■ USB memory**

When saving the images to a USB memory device, name the folder that the images are saved to "Image".

**● Compatible device formats**

The following device format can be used:

- USB communication format: USB2.0 FS (480 Mbps)
- File system format: FAT16/32 (Windows)
- Correspondence class: Mass storage class

The following types of files can be used:

- The image's file format must be JPEG.
- The file name may only contain ASCII characters.

**● JPEG file compatibility**

Compatible image size: Maximum 5MB

**NOTICE**

- To prevent damage to the USB memory device or its terminals**

→P. 313

### Deleting personal data

- 1 "MENU" button → "Setup" → "General" → "Delete Personal Data"
- 2 Select "Delete".

Check carefully beforehand, as data cannot be retrieved once deleted.

The following personal data will be deleted or changed to its default settings.

- Phonebook data
- Call history data
- Favorite data
- Bluetooth<sup>®</sup> devices data
- Phone sound settings
- Detailed Bluetooth<sup>®</sup> settings
- Audio/video setting
- Preset switch data
- Last used radio station
- Customized image data
- FM info setting
- iPod tagging information
- Software update history
- Software update detail information
- Phone display setting
- Contact/call history setting
- Messaging setting
- Traffic information map
- Weather information
- Phonebook data for voice recognition
- Music data for voice recognition



## Voice settings

You can adjust the guidance volume setting.

Go to "Voice Settings": "MENU" button → "Setup" → "Voice"

- ① Adjust the voice guidance volume setting.
- ② Set the voice recognition prompts on/off.



### ■ Return to the default settings

Move the controller to the left and select "Default".

## Display settings

Settings are available for adjusting the contrast and brightness of the screen. The display can also be turned off.

### Screen for display settings

Go to "Display": "MENU" button → "Display"

- ① Turn off screen.
- ② Adjust screen quality.
- ③ Adjust screen quality of the rear view monitor camera.
- ④ Change to day mode.

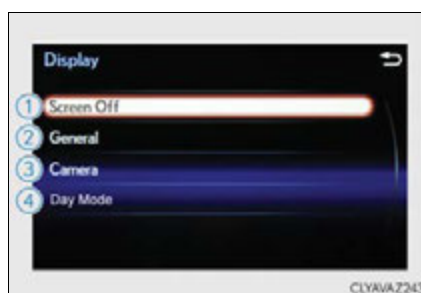

### Screen off

This setting turns the screen off. To turn it on, press any button such as the "AUDIO" button or "MENU" button.

If a screen off image has been set, the set image will be displayed.

### Day mode

When the headlights are turned on, the screen dims.

However, the screen can be switched to day mode by selecting "Day Mode".

The screen will stay in day mode when the headlights are turned on until "Day Mode" is selected again.

**Adjusting the screen quality**

- 1** Select "General" or "Camera" on the "Display" screen or select "Display" on each audio menu screen. (→P. 289)
- 2** Adjust the display as desired by turning the controller clockwise (+) or counterclockwise (-).  
To select "Contrast", "Brightness", "Color" or "Tone", move the controller to the left. ("Colour" and "Tone" are available when "Display" on the audio settings screen for each audio source is selected.)

**■ Changing the sample image (when "General" is selected)**

Move the controller to the right and select the desired sample image.

## Selecting the audio source

Switching between audio sources such as radio and CD are explained in this section.

### Changing audio source

- 1 Press the "AUDIO" button to display the "Source" screen.  
If the "Source" screen is not displayed, press the button again.
- 2 Select the desired audio source.  
The audio source can be selected by pressing the "RADIO" or "MEDIA" button.

### Using the steering wheel switches to change audio sources

Press the "MODE" switch when the audio system is turned on. The audio source changes each time the "MODE" switch is pressed.

---

#### ■ Rearranging the list

The listing order of the source list can be rearranged.

- 1 Move the controller to the left while on the "Source" screen.
- 2 Select "Audio Source Select".
- 3 Select an item you wish to move and then select where to move the item to.

## Optimal use of the audio system

On the “Sound Settings” screen, sound quality (Treble/Mid/Bass), volume balance and DSP settings can be adjusted.

### How to adjust the sound settings and sound quality

1 Audio menu screen. (→P. 289)

2 Select “Sound Settings”.

To change between the sound setting screen and DSP setting screen, move the controller to the right then select the desired screen.

▶ “Sound Settings”

1 2 3 Adjust the treble, mid or bass.

4 Adjust the front/rear audio balance.

5 Adjust the left/right audio balance.

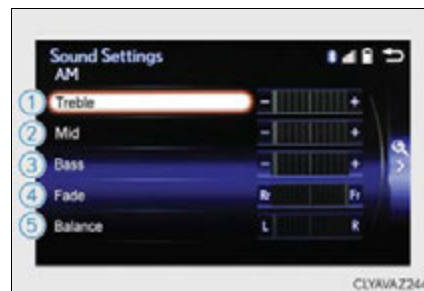

▶ “DSP”

1 Set the automatic sound levelizer (ASL) on/off

2 Set the surround function on/off

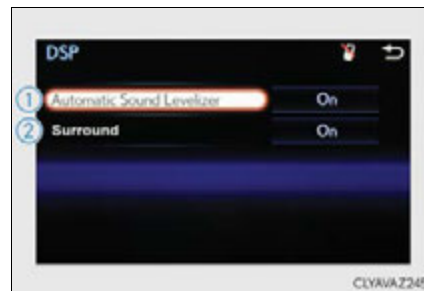

#### ■ The sound quality level is adjusted individually

The treble, mid and bass levels can be adjusted for each audio mode separately.

#### ■ About Automatic Sound Levelizer (ASL)

ASL automatically adjusts the volume and tone quality according to the vehicle speed.

## Audio settings

### Screen for audio settings

Go to "Audio Settings": "MENU" button → "Setup" → "Audio"

- ① Change radio settings (→P. 286)
- ② Change iPod settings (→P. 287)
- ③ Change A/V settings (→P. 287)
- ④ Change the cover art settings (→P. 288)
- ⑤ Change USB settings (→P. 288)

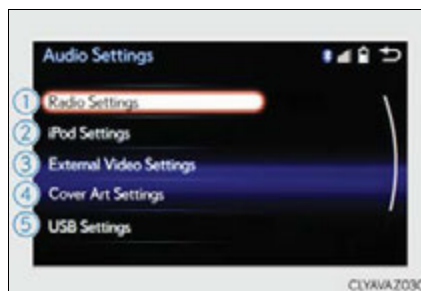

### Changing radio settings

To change radio settings, select "Radio Settings" on the "Audio Settings" screen or radio menu screen. (→P. 289)

- ① Set the displaying RBDS text message on/off
- ② Change the number of radio presets

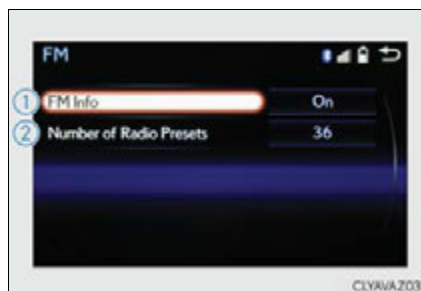

**Changing iPod settings**

To change iPod settings, select “iPod Settings” on the “Audio Settings” screen or iPod menu screen. (→P. 289)

- ① Change the screen size (video mode)
- ② Change the cover art settings (→P. 288)
- ③ Adjust the screen quality (video mode) (→P. 282)
- ④ Change video sound input port

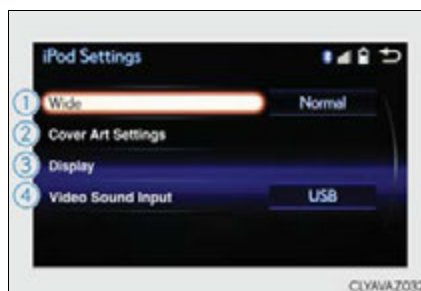
**Changing A/V settings**

To change A/V settings, select “External Video Settings” on the “Audio Settings” screen or A/V menu screen. (→P. 289)

- ① Change the screen size
- ② Change the video signal
- ③ Adjust the screen quality (video mode) (→P. 282)

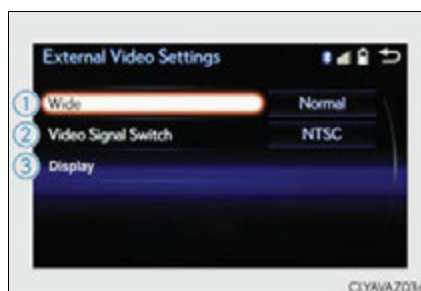

### Changing the cover art settings

To change the cover art settings, select “Cover Art Settings” on the “Audio Settings” screen, CD or MP3/WMA/AAC disc menu screen. (→P. 289)

- ① Select to set the cover art display of the DISC mode on/off.
- ② Select to set the cover art display of the USB mode on/off.
- ③ Change the priority of the Gracenote database of the USB mode.
- ④ Select to set the cover art display of the iPod mode on/off.
- ⑤ Change the priority of the Gracenote database of the iPod mode.

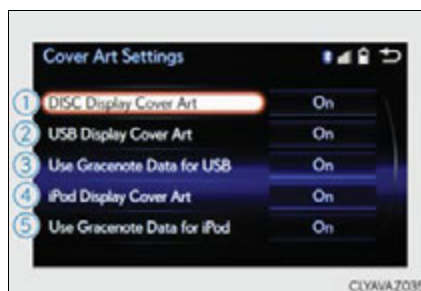

### Changing USB settings

To change USB settings, select “USB Settings” on the “Audio Settings” screen or USB menu screen. (→P. 289)

- ① Change the cover art settings (→P. 288)

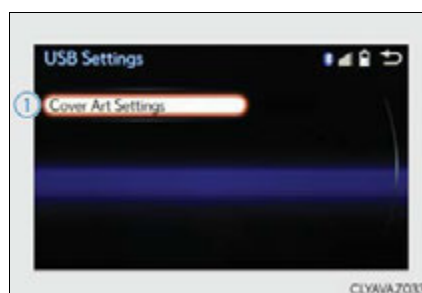



## Audio menu screen operation

You can change the settings and control functions for each audio source.

### Audio menu screen

To display the audio menu screen, move the controller to the left while on an audio top screen.

▶ AM, FM radio or XM Satellite Radio

- ① Scan for receivable stations (AM, FM radio)
- ② Seek a station of the nearest frequency (stops when a station is found) (AM, FM radio)
- ③ Captures the song title and artist name information for potential purchase (when the "HD" indicator on the selected station is appears) (FM radio)
- ④ Changes the channel of HD Radio (HD2, HD3, HD4 where applicable) (FM radio)
- ⑤ Seek a station of the traffic announcement (FM radio)
- ⑥ Select to set the station list shows of HD radio on/off (AM, FM radio)
- ⑦ Change radio settings (→P. 286)
- ⑧ Change sound settings (→P. 285)



5

Lexus Display Audio system

▶ CD, MP3/WMA/AAC disc, iPod, USB or Bluetooth®



- ① Play or pause a track/file
- ② Select a track/file
- ③ Select a folder/album (MP3/WMA/AAC disc or USB)
- ④ Select and hold: Fast-forward or rewind a track/file
- ⑤ Select a repeat mode. (→P. 291)
- ⑥ Select a random/shuffle play mode. (→P. 291)
- ⑦ Select a full screen mode (iPod video mode)
- ⑧ Change iPod settings (iPod) (→P. 287)
- ⑨ Change USB settings (USB) (→P. 288)
- ⑩ Connect a Bluetooth device (Bluetooth®) (→P. 318)
- ⑪ Change the cover art settings (CD or MP3/WMA/AAC disc) (→P. 288)
- ⑫ Change sound settings (→P. 285)

▶ A/V

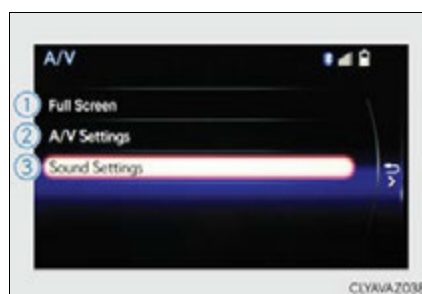

- ① Select full screen mode
- ② Change A/V settings (→P. 287)
- ③ Change sound settings (→P. 285)



**Repeat play**

Mode	Action	Target audio source
	File/track repeat	All media
	Folder repeat	MP3/WMA/AAC disc, USB
	Album repeat	USB, Bluetooth®

**Random/shuffle playback**

Mode	Action	Target audio source
	Random/shuffle play of the disc/ folder/album	All media
	Random play of all folders	MP3/WMA/AAC disc, USB
	Random/shuffle play of all albums	iPod, USB, Bluetooth®

## Radio operation

Select “AM”, “FM” or “SAT” on the audio source selection screen to begin listening to the radio.

### Radio top screen

Pressing the “RADIO” button displays the radio top screen from any screen of the selected source.

- **Menu screen**

→P. 289

### Selecting a station (AM or FM radio)

Tune in to the desired station using one of the following methods.

- **Seek tuning**

Press and hold then release “^” or “v”.

Seek tuning can also be operated on the menu screen. (→P. 289)

The radio will begin seeking up or down for a station of the nearest frequency and will stop when a station is found.

- **Manual tuning**

Turn the “TUNE•SCROLL” knob.

- **Preset stations**

Select the desired preset station by pressing “^” or “v” or controller.

- **Station list**

- 1 Move the controller to the right and selecting “Station List”.

- 2 AM radio: Selecting a desired station.

FM radio: Selecting a desired type of station and selecting a desired station.

To refreshing the station list, select “Refresh”. Select “Source” on the refresh screen, can be change to the other audio source while refreshing.

### Selecting an HD Radio channel

When "HD Radio" is set to "On", available stations with HD Radio channels are marked with "HD".

- 1 In AM or FM mode, select a station marked with "HD".
- 2 Turn the "TUNE•SCROLL" knob to select an HD Radio channel.  
HD Radio channels can also be selected by selecting "Multicast" on the menu screen. (→P. 289)

### Selecting a channel (XM Satellite Radio)

Select in to the desired channel using one of the following methods.

#### ■ Turning up/down the channel

Press and hold "∧" or "∨" or turn the "TUNE•SCROLL" knob.

#### ■ Preset channels

Select the desired preset channel by pressing "∧" or "∨" or controller.

#### ■ Channel list

- 1 Move the controller to the right and selecting "Select a SAT Category".
- 2 Selecting a desired category of channel and selecting a desired channel.

### Setting presets

- 1 Search for desired stations or channel.
- 2 Select and hold one of the preset until you hear a beep.

### Display the text message

#### ■ Display the song information

Move the controller to the right and selecting "Text".

#### ■ Display the Additional information (AM, FM radio)

Move the controller to the right and selecting "Additional Information".

### HD Radio™ Technology

HD Radio™ Technology is the digital evolution of analog AM/FM radio. Your radio product has a special receiver which allows it to receive digital broadcasts (where available) in addition to the analog broadcasts it already receives.

Digital broadcasts have better sound quality than analog broadcasts as digital broadcasts provide free, crystal clear audio with no static or distortion. For more information, and a guide to available radio stations and programming, refer to [www.hdradio.com](http://www.hdradio.com).

“HD Radio features included in Lexus radios:

Digital Sound - HD Radio broadcasts deliver crystal-clear, digital audio quality to listeners.

HD2/HD3 Channels - FM stations can provide additional digital only audio programming with expanded content and format choices on HD2/HD3 channels.

PSD - Program Service Data (PSD) gives you on-screen information such as artist name and song title.

iTunes Tagging - Listeners can tag (store) songs they like for later review and purchase through iTunes.

Artist Experience - Images related to the broadcast are displayed on the radio screen, such as album cover art and station logos.”



HD Radio Technology manufactured under license from iBiquity Digital Corporation. U.S. and Foreign Patents. HD Radio™ and the HD, HD Radio, and “Arc” logos are proprietary trademarks of iBiquity Digital Corp.

■ **HD Radio™ Technology troubleshooting guide**

Experience	Cause	Action
Mismatch of time alignment- a user may hear a short period of programming replayed or an echo, stutter or skip.	The radio stations analog and digital volume are not properly aligned or the station is in ballgame mode.	None, radio broadcast issue. A user can contact the radio station.
Sound fades, blending in and out.	Radio is shifting between analog and digital audio.	Reception issue, may clear-up as the vehicle continues to be driven. Set "HD Radio" to off, can force radio in an analog audio.
Audio mute condition when an HD2/HD3 multicast channel had been playing.	The radio does not have access to digital signals at the moment.	This is normal behavior, wait until the digital signal returns. If out of the coverage area, seek a new station.
Audio mute delay when selecting an HD2/HD3 multicast channel preset.	The digital multicast content is not available until HD Radio™ broadcast can be decoded and make the audio available. This takes up to 7 seconds.	This is normal behavior, wait for the audio to become available.
Text information does not match the present song audio.	Data service issue at the radio broadcaster.	Broadcaster should be notified. Complete the form: <a href="http://www.ibiquity.com/automotive/report_radio_station_experiences">www.ibiquity.com/automotive/report_radio_station_experiences</a> .
No text information shown for the present selected frequency.	Data service issue by the radio broadcaster.	Broadcaster should be notified. Complete the form: <a href="http://www.ibiquity.com/automotive/report_radio_station_experiences">www.ibiquity.com/automotive/report_radio_station_experiences</a> .

**■ Reception sensitivity**

- Maintaining perfect radio reception at all times is difficult due to the continually changing position of the antenna, differences in signal strength and surrounding objects, such as trains, transmitters, etc.
- The radio antenna is mounted inside the rear window. To maintain clear radio reception, do not attach metallic window tinting or other metallic objects to the antenna wire mounted inside the rear window.

**■ XM Radio Services – Descriptions****● Radio and Entertainment**

XM offers more than 170 satellite radio channels of commercial-free music and premier sports, news, talk, and entertainment. XM is broadcast via satellites to millions of listeners across the continental United States. XM subscribers listen to XM on satellite radio receivers for the car, home, and portable use. More information about XM is available online at [www.siriusxm.com](http://www.siriusxm.com) (U.S.A.) or [www.xmradio.ca](http://www.xmradio.ca) (Canada).

**● Satellite tuner**

The tuner supports only Audio Services (Music and Talk) and the accompanying Text Information of XM<sup>®</sup> Satellite Radio.

**■ XM Radio Services – Subscription Instructions**

For XM Services requiring a subscription (such as XM Radio), the following paragraph shall be included.

Required XM Radio monthly subscriptions sold separately after trial period. Subscription fee is consumer only. All fees and programming subject to change. Subscriptions are subject to the Customer Agreement available at [www.siriusxm.com](http://www.siriusxm.com) (U.S.A.) or [www.xmradio.ca](http://www.xmradio.ca) (Canada) XM service only available in the 48 contiguous United States and 10 Canadian provinces. © 2011 Sirius XM Radio Inc. Sirius, XM and all related marks and logos are trademarks of Sirius XM Radio Inc. All other marks, channel names and logos are the property of their respective owners.

For more information, program schedules, and to subscribe or extend subscription after complimentary trial period; more information is available at:

**▶ U.S.A. Customers:**

Visit [www.siriusxm.com](http://www.siriusxm.com) or call 1-877-515-3987

**▶ Canadian Customers:**

Visit [www.xmradio.ca](http://www.xmradio.ca) or call 1-877-438-9677

**● Radio ID**

You will need the radio ID when activating XM service or reporting a problem. If "Ch000" is selected using the "TUNE•SCROLL" knob, the ID code, which is 8 alphanumeric characters, will be displayed. If another channel is selected, the ID code will no longer be displayed. The channel (000) alternates between displaying the radio ID and the specific radio code.



**■ XM Radio Services – Legal Disclaimers and Warnings**

- Fees and Taxes – Subscription fee, taxes, one time activation fee, and other fees may apply. Subscription fee is consumer only. All fees and programming subject to change. Subscriptions subject to Customer Agreement available at [www.siriusxm.com](http://www.siriusxm.com) (U.S.A.) or [www.xmradio.ca](http://www.xmradio.ca) (Canada) XM service only available in the 48 contiguous United States and Canada\*.

\*: Canada – some deterioration of service may occur in extreme northern latitudes. This is beyond the control of XM Satellite Radio.

Explicit Language Notice – Channels with frequent explicit language are indicated with an “XL” preceding the channel name. Channel blocking is available for XM Satellite Radio receivers by notifying XM at;

- ▶ U.S.A. Customers:

Visit [www.siriusxm.com](http://www.siriusxm.com) or calling 1-877-515-3987

- ▶ Canadian Customers:

Visit [www.xmradio.ca](http://www.xmradio.ca) or calling 1-877-438-9677

It is prohibited to copy, decompile, disassemble, reverse engineer, hack, manipulate, or otherwise make available any technology or software incorporated in receivers compatible with the XM Satellite Radio System or that support the XM website, the Online Service or any of its content. Furthermore, the AMBE<sup>®</sup> voice compression software included in this product is protected by intellectual property rights including patent rights, copyrights, and trade secrets of Digital Voice Systems, Inc.

Note: this applies to XM receivers only and not XM Ready devices.

■ If the satellite radio does not operate normally

If a problem occurs with the XM tuner, a message will appear on the screen. Refer to the table below to identify the problem, and take the suggested corrective action.

SAT Check Antenna	The XM antenna is not connected. Check whether the XM antenna cable is attached securely.
	There is a short-circuit in the antenna or the surrounding antenna cable. See a Lexus certified dealer.
SAT Ch Unauthorized	You have not subscribed to XM Satellite Radio. The radio is being updated with the latest encryption code. Contact XM Satellite Radio for subscription information. When a contract is canceled, you can choose "Ch000" and all free-to-air channels.
	The premium channel you selected is not authorized. Wait for about 2 seconds until the radio returns to the previous channel or "Ch001". If it does not change automatically, select another channel. To listen to the premium channel, contact XM Satellite Radio.
SAT No Signal	The XM signal is too weak at the current location. Wait until your vehicle reaches a location with a stronger signal.
SAT Loading	The unit is acquiring audio or program information. Wait until the unit has received the information.
SAT Channel Off Air	The channel you selected is not broadcasting any programming. Select another channel.
-----	There is no song/program title or artist name/feature associated with the channel at that time. No action is required.
SAT Chan Unavailable	The channel you selected is no longer available. Wait for about 2 seconds until the radio returns to the previous channel or "Ch001". If it does not change automatically, select another channel.

Contact the XM Listener Care Center at 1-877-515-3987 (U.S.A.) or 1-877-438-9677 (Canada).

## CD player operation

Insert a disc, press the "MEDIA" button or select "DISC" on the "Source" screen with a disc inserted to begin listening to a CD.

### CD top screen

Pressing the "MEDIA" button displays the CD top screen from any screen of the selected source.

#### ■ Menu screen

→P. 289

#### ■ Selecting a track/file

Press the "∧" or "∨" button or turn the "TUNE•SCROLL" knob to select the desired track/file number.

To fast-forward or rewind, press and hold the "∧" or "∨" button.

#### ■ Selecting the track by the list (CD)

Move the controller to the right and then select the desired track.

#### ■ Selecting a folder (MP3/WMA/AAC disc)

1 Move the controller to the right and then select "Folders".

2 Select the desired folder. Then select a file to begin using the selected folder.

#### ■ Selecting a file by the selected folder (MP3/WMA/AAC disc)

1 Move the controller to the right and then select "Files".

2 Select the desired file.

■ **Error messages**

If the following error messages appear on the screen, refer to the table and take the appropriate measures. If the problem is not rectified, take the vehicle to your Lexus dealer.

Message	Cause	Correction procedures
"Check disc"	<ul style="list-style-type: none"> <li>• The disc is dirty or damaged.</li> <li>• The disc is inserted upside down.</li> <li>• The disc is not playable with the player.</li> </ul>	<ul style="list-style-type: none"> <li>• Clean the disc.</li> <li>• Insert the disc correctly.</li> <li>• Confirm the disc is playable with the player.</li> </ul>
"DISC Error"	There is a malfunction within the system.	Eject the disc.
"No music files found."	No playable data is included on the disc.	Eject the disc.

■ **Discs that can be used**

Discs with the marks shown below can be used. Playback may not be possible depending on recording format or disc features, or due to scratches, dirt or deterioration.



CDs with copy-protection features may not play correctly.

■ **CD player protection feature**

To protect the internal components, playback is automatically stopped when a problem is detected.

■ **If a disc is left inside the CD player or in the ejected position for extended periods**

Disc may be damaged and may not play properly.

■ **Lens cleaners**

Do not use lens cleaners. Doing so may damage the CD player.

**■ MP3, WMA and AAC files**

MP3 (MPEG Audio LAYER3) is a standard audio compression format.

Files can be compressed to approximately 1/10 of their original size by using MP3 compression.

WMA (Windows Media Audio) is a Microsoft audio compression format.

This format compresses audio data to a size smaller than that of the MP3 format.

AAC is short for Advanced Audio Coding and refers to an audio compression technology standard used with MPEG2 and MPEG4.

MP3, WMA and AAC file and media/formats compatibility are limited.

**● MP3 file compatibility**

- Compatible standards  
MP3 (MPEG1 LAYER3, MPEG2 LSF LAYER3)
- Compatible sampling frequencies  
MPEG1 LAYER3: 32, 44.1, 48 (kHz)  
MPEG2 LSF LAYER3: 16, 22.05, 24 (kHz)
- Compatible bit rates (compatible with VBR)  
MPEG1 LAYER3: 32-320 (kbps)  
MPEG2 LSF LAYER3: 8-160 (kbps)
- Compatible channel modes: stereo, joint stereo, dual channel and monaural

**● WMA file compatibility**

- Compatible standards  
WMA Ver. 7, 8, 9 (only compatible with Window Media Audio Standard)
- Compatible sampling frequencies  
32, 44.1, 48 (kHz)
- Compatible bit rates (only compatible with 2-channel playback)  
Ver. 7, 8: CBR 48-192 (kbps)  
Ver. 9: CBR 48-320 (kbps)

**● AAC file compatibility**

- Compatible standards  
MPEG4/AAC-LC
- Compatible sampling frequencies  
11.025/12/16/22.05/24/32/44.1/48 (kHz)
- Compatible bit rates  
16-320 (kbps)
- Compatible channel modes: 1 ch and 2 ch

- Compatible media

Media that can be used for MP3, WMA and AAC playback are CD-Rs and CD-RWs. Playback in some instances may not be possible if the CD-R or CD-RW is not finalized. Playback may not be possible or the audio may jump if the disc is scratched or marked with fingerprints.

- Compatible disc formats

The following disc formats can be used.

- Disc formats: CD-ROM Mode 1 and Mode 2  
CD-ROM XA Mode 2, Form 1 and Form 2
- File formats: ISO9660 Level 1, Level 2, (Romeo, Joliet)  
UDF (2.01 or lower)

MP3, WMA and AAC files written in any format other than those listed above may not play correctly, and their file names and folder names may not be displayed correctly.

Items related to standards and limitations are as follows.

- Maximum directory hierarchy: 8 levels (including the root)
- Maximum length of folder names/file names: 32 characters
- Maximum number of folders: 192 (including the root)
- Maximum number of files per disc: 255

- File names

The only files that can be recognized as MP3/WMA/AAC and played are those with the extension .mp3, .wma or .m4a.

- Discs containing multi-session recordings

As the audio system is compatible with multi session discs, it is possible to play discs that contain MP3, WMA and AAC files. However, only the first session can be played.

- ID3, WMA and AAC tags

ID3 tags can be added to MP3 files, making it possible to record the track title, artist name, etc.

The system is compatible with ID3 Ver. 1.0, 1.1, and Ver. 2.2, 2.3 ID3 tags. (The number of characters is based on ID3 Ver. 1.0 and 1.1.)

WMA tags can be added to WMA files, making it possible to record the track title and artist name in the same way as with ID3 tags.

AAC tags can be added to AAC files, making it possible to record the track title and artist name in the same way as with ID3 tags.

- MP3, WMA and AAC playback

When a disc containing MP3, WMA or AAC files is inserted, all files on the disc are first checked. Once the file check is finished, the first MP3, WMA or AAC file is played. To make the file check finish more quickly, we recommend you do not write any files to the disc other than MP3, WMA or AAC files or create any unnecessary folders.

Discs that contain a mixture of music data and MP3, WMA or AAC format data cannot be played.

- Extensions

If the file extensions .mp3, .wma and .m4a are used for files other than MP3, WMA and AAC files, they may be mistakenly recognized and played as MP3, WMA and AAC files. This may result in large amounts of interference and damage to the speakers.

- Playback

- To play MP3 files with steady sound quality, we recommend a fixed bit rate of at least 128 kbps and a sampling frequency of 44.1 kHz.
- CD-R or CD-RW playback may not be possible in some instances, depending on the characteristics of the disc.
- There is a wide variety of freeware and other encoding software for MP3, WMA and AAC files on the market, and depending on the status of the encoding and the file format, poor sound quality or noise at the start of playback may result. In some cases, playback may not be possible at all.
- When files other than MP3, WMA or AAC files are recorded on a disc, it may take more time to recognize the disc and in some cases, playback may not be possible at all.
- Microsoft, Windows, and Windows Media are the registered trademarks of Microsoft Corporation in the U.S.A. and other countries.

- **The Gracenote® media database**

- Music recognition technology and related data are provided by Gracenote®. Gracenote is the industry standard in music recognition technology and related content delivery. For more information visit [www.gracenote.com](http://www.gracenote.com).
- CD and music-related data from Gracenote, Inc., copyright © 2000 to present Gracenote. Gracenote Software, copyright © 2000 to present Gracenote. One or more patents owned by Gracenote apply to this product and service. See the Gracenote website for a non-exhaustive list of applicable Gracenote patents. Gracenote, CDDb, MusicID, MediaVOCS, the Gracenote logo and logotype, and the "Powered by Gracenote" logo are either registered trademarks or trademarks of Gracenote in the United States and/or other countries.



- **Gracenote® End User License Agreement**

This application or device contains software from Gracenote, Inc. of Emeryville, California ("Gracenote"). The software from Gracenote (the "Gracenote Software") enables this application to perform disc and/or file identification and obtain music-related information, including name, artist, track, and title information ("Gracenote Data") from online servers or embedded databases (collectively, "Gracenote Servers") and to perform other functions. You may use Gracenote Data only by means of the intended End-User functions of this application or device.

You agree that you will use Gracenote Data, the Gracenote Software, and Gracenote Servers for your own personal non-commercial use only. You agree not to assign, copy, transfer or transmit the Gracenote Software or any Gracenote Data to any third party. YOU AGREE NOT TO USE OR EXPLOIT GRACENOTE DATA, THE GRACENOTE SOFTWARE, OR GRACENOTE SERVERS, EXCEPT AS EXPRESSLY PERMITTED HEREIN.

You agree that your non-exclusive license to use the Gracenote Data, the Gracenote Software, and Gracenote Servers will terminate if you violate these restrictions. If your license terminates, you agree to cease any and all use of the Gracenote Data, the Gracenote Software, and Gracenote Servers. Gracenote reserves all rights in Gracenote Data, the Gracenote Software, and the Gracenote Servers, including all ownership rights. Under no circumstances will Gracenote become liable for any payment to you for any information that you provide. You agree that Gracenote, Inc. may enforce its rights under this Agreement against you directly in its own name.

The Gracenote service uses a unique identifier to track queries for statistical purposes. The purpose of a randomly assigned numeric identifier is to allow the Gracenote service to count queries without knowing anything about who you are. For more information, see the web page for the Gracenote Privacy Policy for the Gracenote service.

The Gracenote Software and each item of Gracenote Data are licensed to you "AS IS." Gracenote makes no representations or warranties, express or implied, regarding the accuracy of any Gracenote Data from in the Gracenote Servers. Gracenote reserves the right to delete data from the Gracenote Servers or to change data categories for any cause that Gracenote deems sufficient. No warranty is made that the Gracenote Software or Gracenote Servers are error-free or that functioning of Gracenote Software or Gracenote Servers will be uninterrupted. Gracenote is not obligated to provide you with new enhanced or additional data types or categories that Gracenote may provide in the future and is free to discontinue its services at any time.

GRACENOTE DISCLAIMS ALL WARRANTIES EXPRESS OR IMPLIED, INCLUDING, BUT NOT LIMITED TO, IMPLIED WARRANTIES OF MERCHANTABILITY, FITNESS FOR A PARTICULAR PURPOSE, TITLE, AND NON-INFRINGEMENT. GRACENOTE DOES NOT WARRANT THE RESULTS THAT WILL BE OBTAINED BY YOUR USE OF THE GRACENOTE SOFTWARE OR ANY GRACENOTE SERVER. IN NO CASE WILL GRACENOTE BE LIABLE FOR ANY CONSEQUENTIAL OR INCIDENTAL DAMAGES OR FOR ANY LOST PROFITS OR LOST REVENUES.

copyright © 2000 to present Gracenote



 NOTICE**■ Discs and adapters that cannot be used**

Do not use the following types of discs.

Also, do not use 3 in. (8 cm) disc adapters, DualDiscs or printable discs.

Doing so may damage the player and/or disc insert/eject function.

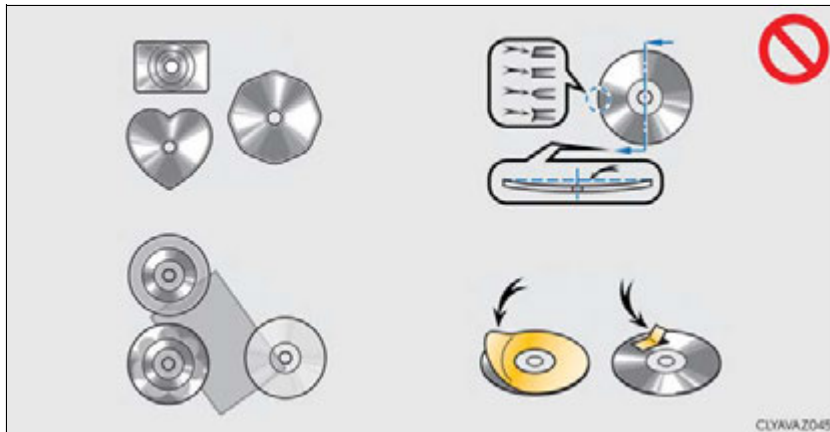

- Discs that have a diameter that is not 4.7 in. (12 cm).
- Low-quality or deformed discs.
- Discs with a transparent or translucent recording area.
- Discs that have tape, stickers or CD-R labels attached to them, or that have had the label peeled off.

**■ Player precautions**

Failure to follow the precautions below may result in damage to the discs or the player itself.

- Do not insert anything other than discs into the disc slot.
- Do not apply oil to the player.
- Store discs away from direct sunlight.
- Never try to disassemble any part of the player.

## Listening to an iPod

Connecting an iPod enables you to enjoy music from the vehicle speakers. Press the “MEDIA” button or select “iPod” on the audio source selection screen.

### Connecting an iPod

→P. 274

### iPod top screen

Pressing the “MEDIA” button displays the iPod top screen from any screen of the selected source.

- **Menu screen**

→P. 289

- **Selecting a song**

Press the “^” or “v” button or turn the “TUNE•SCROLL” knob to select the desired song number.

To fast-forward or rewind, press and hold the “^” or “v” button.

- **Selecting a play mode**

- 1 Move the controller to the right and then select “Browse”.
- 2 Select the desired play mode, and then select a song to begin using the selected play mode.

- **Displaying the now playing list**

Move the controller to the right and then select “Now Playing List”.

### ■ About iPod



- "Made for iPod" and "Made for iPhone" mean that an electronic accessory has been designed to connect specifically to an iPod, or iPhone, respectively, and has been certified by the developer to meet Apple performance standards.
- Apple is not responsible for the operation of this device or its compliance with safety and regulatory standards. Please note that the use of this accessory with iPod or iPhone may affect wireless performance.
- iPhone, iPod, iPod classic, iPod nano and iPod touch are trademarks of Apple Inc., registered in the U.S. and other countries.

### ■ iPod cover art

- Depending on the iPod and songs in the iPod, iPod cover art may be displayed.
- This function can be changed to on/off. (→P. 288)
- It may take time to display iPod cover art, and the iPod may not be operated while the cover art display is in process.

### ■ iPod functions

- When an iPod is connected and the audio source is changed to iPod mode, the iPod will resume play from the same point in which it was last used.
- Depending on the iPod that is connected to the system, certain functions may not be available. If a function is unavailable due to a malfunction (as opposed to a system specification), disconnecting the device and reconnecting it may resolve the problem.
- Depending on the iPod, while connected to the system, the iPod cannot be operated with its own controls. It is necessary to use the controls of the vehicle's audio system instead.
- When the battery level of an iPod is very low, the iPod may not operate. If so, charge the iPod before use.
- Compatible models (→P. 309)

■ **iPod problems**

To resolve most problems encountered when using your iPod, disconnect your iPod from the vehicle iPod connection and reset it. For instructions on how to reset your iPod, refer to your iPod Owner's Manual.

■ **Error messages**

If the following error messages appear on the screen, refer to the table and take the appropriate measures. If the problem is not rectified, take the vehicle to your Lexus dealer.

Message	Cause/Correction procedures
"Connection error."	This indicates a problem in the iPod or its connection.
"There are no songs available for playback."	This indicates that there is no music data in the iPod.
"No items available."	This indicates that songs are not found in a selected playlist.
"Please check the iPod firmware version."	This indicates that the software version is not compatible. Please check the compatible models. (→P. 309)
"iPod authorization failed."	This indicates that the Lexus Display Audio system failed to authorize the iPod. Please check your iPod.

**Compatible models**

The following iPod<sup>®</sup>, iPod nano<sup>®</sup>, iPod classic<sup>®</sup>, iPod touch<sup>®</sup> and iPhone<sup>®</sup> devices can be used with this system.

- Made for
  - iPod touch (5th generation)
  - iPod touch (4th generation)
  - iPod touch (3rd generation)
  - iPod touch (2nd generation)
  - iPod touch (1st generation)
  - iPod classic
  - iPod with video
  - iPod nano (7th generation)
  - iPod nano (6th generation)
  - iPod nano (5th generation)
  - iPod nano (4th generation)
  - iPod nano (3rd generation)
  - iPod nano (2nd generation)
  - iPod nano (1st generation)
  - iPhone 5
  - iPhone 4S
  - iPhone 4
  - iPhone 3GS
  - iPhone 3G
  - iPhone

Depending on differences between models or software versions etc., some models might be incompatible with this system.

**NOTICE****■ To prevent damage to the iPod or its terminals**

- Do not leave the iPod in the vehicle. The temperature inside the vehicle may become high.
- Do not push down on or apply unnecessary pressure to the iPod while it is connected.
- Do not insert foreign objects into the port.

## Using USB memory device

Connecting a USB memory device enables you to enjoy music from the vehicle speakers.

Select "USB1" or "USB2" on the audio source selection screen.

### Connecting a USB memory device

→P. 274

### USB top screen

Pressing the "MEDIA" button displays the USB top screen from any screen of the selected source.

- **Menu screen**

→P. 289

- **Selecting a file**

Press the "∧" or "∨" button or turn the "TUNE•SCROLL" knob to select the desired file number.

To fast-forward or rewind, press and hold the "∧" or "∨" button.

- **Selecting a play mode**

- 1 Move the controller to the right and select "Browse".
- 2 Select the desired play mode, then select a file to begin the selected play mode.

- **Displaying the now playing list**

Move the controller to the right and select "Now Playing List".

### ■ USB memory functions

- Depending on the USB memory device that is connected to the system, the device itself may not be operable and certain functions may not be available. If the device is inoperable or a function is unavailable due to a malfunction (as opposed to a system specification), disconnecting the device and reconnecting it may resolve the problem.
- If the USB memory device still does not begin operation after being disconnected and reconnected, format the device.

### ■ Error messages for USB memory

If the following error messages appear on the screen, refer to the table and take the appropriate measures. If the problem is not rectified, take the vehicle to your Lexus dealer.

Message	Cause/Correction procedures
"Connection error."	This indicates a problem with the USB memory device or its connection.
"There are no files available for playback."	This indicates that no MP3/WMA/AAC files are included on the USB memory device.

### ■ USB memory

- Compatible devices  
USB memory devices that can be used for MP3, WMA and AAC playback.

- Compatible device formats

The following device format can be used:

- USB communication format: USB2.0 FS (480 Mbps)
  - File system format: FAT16/32 (Windows)
  - Correspondence class: Mass storage class
- MP3, WMA and AAC files written to a device with any format other than those listed above may not play correctly, and their file names and folder names may not be displayed correctly.

Items related to standards and limitations are as follows:

- Maximum directory hierarchy: 8 levels
- Maximum number of folders in a device: 3000 (including the root)
- Maximum number of files in a device: 9999
- Maximum number of files per folder: 255

- MP3, WMA and AAC files

MP3 (MPEG Audio LAYER 3) is a standard audio compression format. Files can be compressed to approximately 1/10 of their original size using MP3 compression.

WMA (Windows Media Audio) is a Microsoft audio compression format. This format compresses audio data to a size smaller than that of the MP3 format.

AAC is short for Advanced Audio Coding and refers to an audio compression technology standard used with MPEG2 and MPEG4.

MP3, WMA and AAC file and media/formats compatibility are limited.

- MP3 file compatibility

- Compatible standards  
MP3 (MPEG1 AUDIO LAYERIII, MPEG2 AUDIO LAYERIII)
- Compatible sampling frequencies  
MPEG1 AUDIO LAYERIII: 32, 44.1, 48 (kHz)  
MPEG2 AUDIO LAYERIII: 16, 22.05, 24 (kHz)
- Compatible bit rates (compatible with VBR)  
MPEG1 AUDIO LAYERIII: 32-320 (kbps)  
MPEG2 AUDIO LAYERIII: 8-160 (kbps)
- Compatible channel modes: stereo, joint stereo, dual channel and monaural

- WMA file compatibility

- Compatible standards  
WMA Ver. 7, 8, 9 (only compatible with Window Media Audio Standard)
- Compatible sampling frequencies  
32, 44.1, 48 (kHz)
- Compatible bit rates (only compatible with 2-channel playback)  
Ver. 7, 8: CBR 48-192 (kbps)  
Ver. 9: CBR 48-320 (kbps)

- AAC file compatibility

- Compatible standards  
MPEG4/AAC-LC
- Compatible sampling frequencies  
11.025/12/16/22.05/24/32/44.1/48 (kHz)
- Compatible bit rates  
16-320 (kbps)
- Compatible channel modes: 1 ch and 2 ch

- File names

The only files that can be recognized as MP3/WMA/AAC and played are those with the extension .mp3, .wma or .m4a.



- ID3, WMA and AAC tags

ID3 tags can be added to MP3 files, making it possible to record the track title, artist name, etc.

The system is compatible with ID3 Ver. 1.0, 1.1, and Ver. 2.2, 2.3 ID3 tags. (The number of characters is based on ID3 Ver. 1.0 and 1.1.)

WMA tags can be added to WMA files, making it possible to record the track title and artist name in the same way as with ID3 tags.

AAC tags can be added to AAC files, making it possible to record the track title and artist name in the same way as with ID3 tags.

- MP3, WMA and AAC playback

- When a device containing MP3, WMA or AAC files is connected, all files in the USB memory device are checked. Once the file check is finished, the first MP3, WMA or AAC file is played. To make the file check finish more quickly, we recommend that you do not include any files other than MP3, WMA or AAC files or create any unnecessary folders.

- When a USB memory device is connected and the audio source is changed to USB memory mode, the USB memory device will start playing the first file in the first folder. If the same device is removed and reconnected (and the contents have not been changed), the USB memory device will resume play from the same point in which it was last used.

- Extensions

If the file extensions .mp3, .wma and .m4a are used for files other than MP3, WMA and AAC files, they will be skipped (not played).

- Playback

- To play MP3 files with steady sound quality, we recommend a fixed bit rate of at least 128 kbps and a sampling frequency of 44.1 kHz.

- There is a wide variety of freeware and other encoding software for MP3, WMA and AAC files on the market, and depending on the status of the encoding and the file format, poor sound quality or noise at the start of playback may result. In some cases, playback may not be possible at all.

- Microsoft, Windows, and Windows Media are the registered trademarks of Microsoft Corporation in the U.S.A. and other countries.

 NOTICE

■ To prevent damage to the USB memory device or its terminals

- Do not leave the USB memory device in the vehicle. The temperature inside the vehicle may become high.
- Do not push down on or apply unnecessary pressure to the USB memory device while it is connected.
- Do not insert foreign objects into the port.

## Using the AUX port

To use the AUX port, connect a portable player, press the “MEDIA” button or select “AUX” or “A/V” on the “Source” screen.

### Connecting a portable player

→P. 274

### Top screen

Pressing the “MEDIA” button displays the top screen from any screen of the selected source.

#### ■ Menu screen

→P. 289

#### ■ Operating portable players connected to the audio system

Volume can be adjusted using the vehicle’s audio controls. All other adjustments must be made on the portable player itself.

#### ■ When using a portable player connected to the power outlet

Noise may occur during playback. Use the power source of the portable player.



#### NOTICE

#### ■ To prevent damage to the portable player or its terminal

- Do not leave portable player in the vehicle. The temperature inside the vehicle may become high.
- Do not push down on or apply unnecessary pressure to the portable player while it is connected.
- Do not insert foreign objects into the port.

## Steps for using Bluetooth® devices

The following can be performed using Bluetooth® wireless communication:

- A portable audio player can be operated and listened to via the Lexus Display Audio system
- Hands-free phone calls can be made via a cellular phone

In order to use wireless communication, register and connect a Bluetooth® device by performing the following procedures.

### Device registration/connection flow

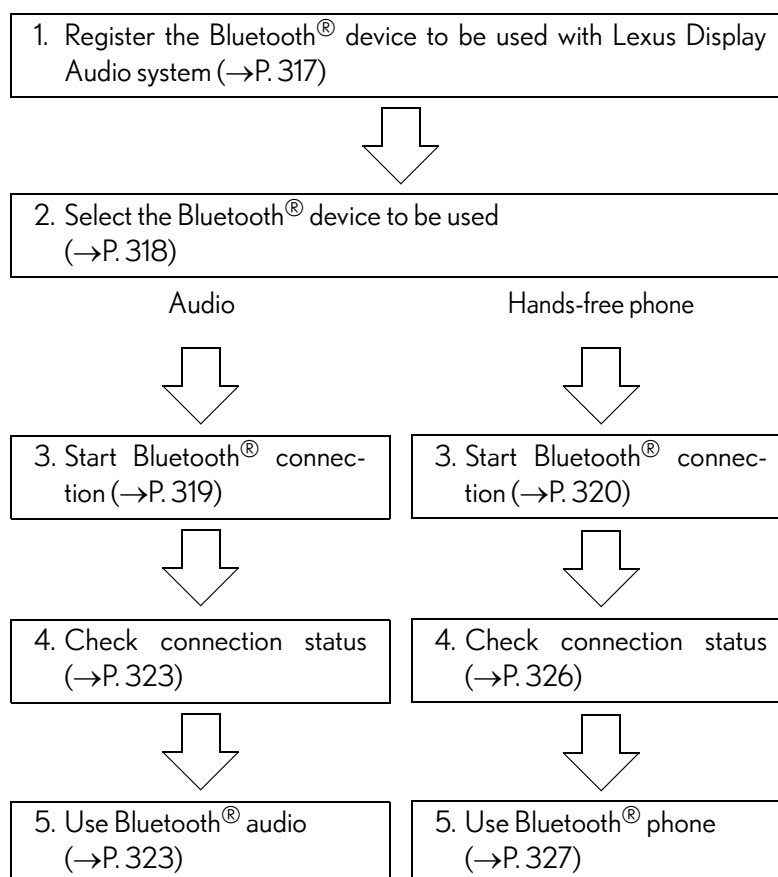

### **“Bluetooth\* Setup” screen**

Go to “Bluetooth\* Setup”: “MENU” button → “Setup” → “Bluetooth\*”

\*: Bluetooth is a registered trademark of Bluetooth SIG, Inc.

---

■ **When displaying “Bluetooth\* Setup” screen from the “Bluetooth\* Audio” screen**

- 1 Display the “Bluetooth\* Audio” screen. (→P. 323)
- 2 Move the controller to the left and select “Connect”.

■ **When displaying “Bluetooth\* Setup” screen from the phone top screen**

- 1 Display the phone top screen. (→P. 325)
- 2 Move the controller to the left and select “Connect Phone”.

\*: Bluetooth is a registered trademark of Bluetooth SIG, Inc.

## Registering a Bluetooth® device

Bluetooth® compatible phones (HFP) and portable audio players (AVP) can be registered simultaneously. You can register up to 5 Bluetooth® devices.

### How to register a Bluetooth® device

- 1 Turn the Bluetooth® connection setting of your device set to on.
- 2 Go to "Bluetooth\* Setup": "MENU" button → "Setup" → "Bluetooth\*"
- 3 Move the controller to the left and then select "Add Device"
- 4 When this screen is displayed, input the passcode displayed on the screen into your Bluetooth® device.  
For operation of the Bluetooth® device, see the manual that comes with your Bluetooth® device.
- 5 Register the Bluetooth® device using your Bluetooth® device.

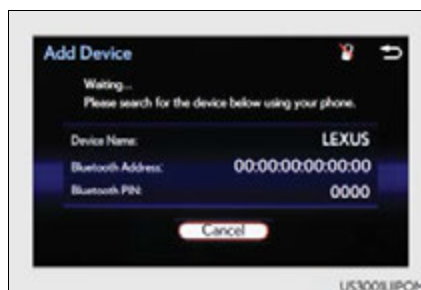

A PIN code are not required for SSP (Secure Simple Pairing) compatible Bluetooth® devices. Depending on the device, you may need to select Yes to register, or No to cancel on the device.

If an error message is displayed, follow the guidance on the screen to try again.

\*: Bluetooth is a registered trademark of Bluetooth SIG, Inc.

### Removing a Bluetooth® device

- 1 Go to "Bluetooth\* Setup": "MENU" button → "Setup" → "Bluetooth\*"
- 2 Move the controller to the left and then select "Remove Device".
- 3 Select the device to remove.

\*: Bluetooth is a registered trademark of Bluetooth SIG, Inc.

## Selecting a Bluetooth® device

If multiple Bluetooth® devices are registered, follow the procedure below to select the Bluetooth® device to be used. You may only use one device at a time.

### How to select a Bluetooth® device

- 1 Go to "Bluetooth\* Setup": "MENU" button → "Setup" → "Bluetooth\*"
- 2 Select the device to connect.
- 3 Select "Connect All", "Connect as a Phone" or "Connect as an Audio Player".

If the desired Bluetooth® device is not displayed, register the device. (→P. 317)

\*: Bluetooth is a registered trademark of Bluetooth SIG, Inc.

## Connecting a Bluetooth® audio player

There are 2 portable audio player connection settings available: connecting from the vehicle and connecting from the portable player.

### Connecting method is set to "Vehicle"

When the portable audio player is in standby for a connection, it will be automatically connected whenever the engine switch is in either ACCESSORY or IGNITION ON mode.

### Connecting method is set to "Device"

Operate the portable player and connect it to the Bluetooth® audio system.

- 1 Go to "Bluetooth\* Setup": "MENU" button → "Setup" → "Bluetooth\*"
- 2 Select the device to connect.
- 3 Select "Connect All" or "Connect as an Audio player".

If the desired Bluetooth® device is not displayed, register the device. (→P. 317)

\*: Bluetooth is a registered trademark of Bluetooth SIG, Inc.

## Connecting a Bluetooth® phone

There are two connecting methods available: automatic and manual.

### Auto connection

When you register a phone, auto connection will be activated. Always set it to this mode and leave the Bluetooth® phone in a place where a connection can be established.

When the engine switch is turned to ACCESSORY or IGNITION ON mode, the system will search for a nearby cellular phone you have registered.

Next, the system automatically connects with the most recent phone that was connected. The connected result is displayed.

### Manual connection

When auto connection has failed or “Bluetooth\* Power” is turned off, you must connect the Bluetooth® device manually.

- 1 Go to “Bluetooth\* Setup”: “MENU” button → “Setup” → “Bluetooth\*”
- 2 Select the device to connect.
- 3 Select “Connect All”, “Connect as a Phone” or “Connect as an Audio player”.

If the desired Bluetooth® device is not displayed, register the device. (→P. 317)

\*: Bluetooth is a registered trademark of Bluetooth SIG, Inc.

### ■ Reconnecting a Bluetooth® phone

If the system cannot connect due to poor signal strength with the engine switch in ACCESSORY or IGNITION ON mode, the system will automatically attempt to reconnect.

If the phone is turned off, the system will not attempt to reconnect. In this case, the connection must be made manually, or the phone must be reselected.

### ■ Connecting a phone while Bluetooth® audio is playing

- Bluetooth® audio will stop temporarily.
- It may take time to connect.



## Displaying a Bluetooth® device details

You can confirm and change the registered device details.

### Bluetooth® device registration status

- 1 Go to "Bluetooth\* Setup": "MENU" button → "Setup" → "Bluetooth\*"
- 2 Select the desired device and then select "Device Info".

- ① Change the name of the device
- ② Change the connection method  
 "Vehicle": Connect the audio system to the portable audio player.  
 "Device": Connect the portable audio player to the audio system
- ③ Device address



- ④ Device telephone number  
Depending on the model of phone, the number may not be displayed.
- ⑤ Compatibility profile of the device

\*: Bluetooth is a registered trademark of Bluetooth SIG, Inc.

#### Restoring the default settings

Move the controller to the left and select "Default" on the "Device Information" screen.

## Detailed Bluetooth® settings

You can confirm and change the detailed Bluetooth® settings.

### How to check and change detailed Bluetooth® settings

- 1 Go to "Bluetooth\* Setup": "MENU" button → "Setup" → "Bluetooth\*"
- 2 Move the controller to the left and then select "System Settings".

① Select to set the Bluetooth® function on/off.

② Change the name of the device.

③ Change the PIN-code.

You can change the PIN-code that is used to register your Bluetooth® devices in the system.

④ Device address

⑤ Select to set the display of the telephone status on/off

You can set the system to show the status confirmation display when connecting a telephone.

⑥ Select to set the display of the audio player status on/off

You can set the system to show the status confirmation display when connecting an audio player.

⑦ Compatibility profile of the system

\*: Bluetooth is a registered trademark of Bluetooth SIG, Inc.



#### Restoring the default settings

Move the controller to the left and select "Default" on the "System Settings" screen.

## Listening to Bluetooth® Audio

The Bluetooth® audio system enables the user to enjoy music played on a portable player from the vehicle speakers via wireless communication.

When a Bluetooth® device cannot be connected, check the connection status on the “Bluetooth\* Audio” screen. If the device is not connected, either register or reconnect the device. (→P. 317, 319)

\*: Bluetooth is a registered trademark of Bluetooth SIG, Inc.

### Status display

You can check indicators, such as, signal strength and battery charge on the screen.







- ① Connection status
- ② Battery charge

Depending on the type of portable audio player used, some titles may not be displayed.



5

Lexus Display Audio system

Indicators	Conditions
Connection status	Good ←————→ Not connected   
Battery charge	Full ←————→ Empty   

**Bluetooth® audio top screen**

Pressing the “MEDIA” button displays the Bluetooth® audio top screen from any screen of the selected source.

**■ Menu screen**

→P. 289

**■ Selecting a song**

Press the “^” or “v” button or turn the “TUNE•SCROLL” knob to select the desired song number.

To fast-forward or reverse, press and hold the “^” or “v” button.

**■ Selecting a play mode**

- 1** Move the controller to the right and then select “Browse”.
- 2** Select the desired play mode, and then select a song to begin using the selected play mode.

**■ Displaying the now playing list**

Move the controller to the right and then select “Now Playing List”.

## Using a Bluetooth® Phone

The hands-free system is a function that allows you to use your cellular phone without touching it.

This system supports Bluetooth®. Bluetooth® is a wireless data system that allows the cellular phone to wirelessly connect to the hands-free system and make/receive calls.

Before making a phone call, check the connection status, battery charge, call area and signal strength. (→P. 326)

If a Bluetooth® device cannot be connected, check the connection status. If the device is not connected, either register or reconnect it. (→P. 317, 320)

### Phone top screen

To display the screen shown below, press the off-hook switch on the steering wheel or select "Phone" on the "Menu" screen.

- ① Phone name
- ② Bluetooth® connection status (→P. 326)
- ③ Display the call history screen (→P. 329)
- ④ Display the favorites screen (→P. 328)
- ⑤ Display the contacts screen (→P. 327)
- ⑥ Display the dial pad screen (→P. 327)
- ⑦ Display the message inbox screen (→P. 334)

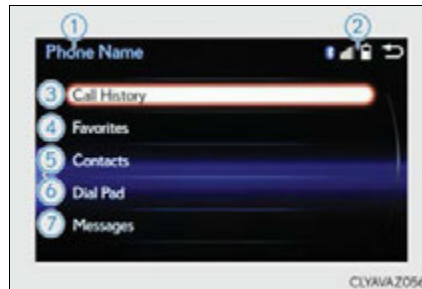

5

Lexus Display Audio system

◆ Telephone switch (→P. 336)

◆ Microphone

The vehicle's built-in microphone is used when talking on the phone.  
The person you are speaking to can be heard from the front speakers.

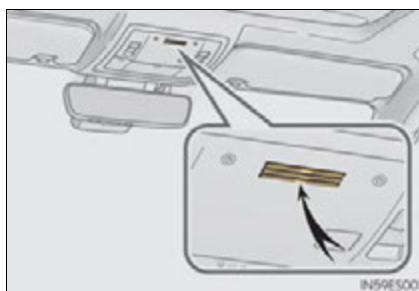







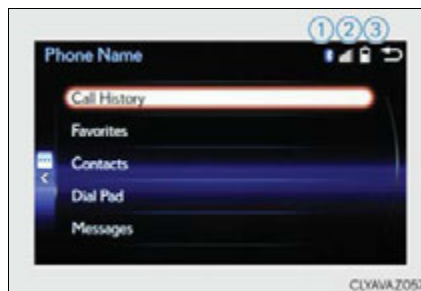

To use the hands-free system, you must register your Bluetooth® phone in the system. (→P. 317)

**Status display**

You can check indicators such as signal strength and battery charge on any screen.

- ① Connection status
- ② Signal strength
- ③ Battery charge



Indicators	Conditions		
	Good	Poor	Not connected
Connection status			
Battery charge			
Signal strength			

## Making a call

Once a Bluetooth® phone is registered, you can make a call using the following procedure:

### Dialing

- 1 Go to "Dial Pad": "MENU" button → "Phone" → "Dial Pad"
- 2 Input a phone number. (→P. 270)
- 3 Press the off-hook switch on the steering wheel or select .

### Dialing from the phonebook

You can dial a number from the phonebook data imported from your cellular phone. The system has one phonebook for each registered telephone. Up to 2500 contacts may be stored in each phonebook. (→P. 328)

- 1 Go to "Contacts": "MENU" button → "Phone" → "Contacts"
- 2 Choose the desired contact to call from the list.
- 3 Choose the number and then press the off-hook switch on the steering wheel or press the controller.

### When the phonebook is empty

You can transfer the phone numbers in a Bluetooth® phone to the system. Operation methods differ between PBAP (Phone Book Access Profile) compatible and PBAP incompatible Bluetooth® phones. If the cellular phone does not support either PBAP or OPP (Object Push Profile) service, you cannot transfer contacts.

- 1 Press the off-hook switch on the steering wheel.

If the phonebook is empty, a message will be displayed.

- ▶ For a PBAP compatible Bluetooth® phone and “Automatic Transfer” is off

- 2 To transfer new contacts from a cellular phone, select “Always” and then enable “Automatic Transfer”. (→P. 339)  
Select “Once” if you want to transfer new contacts from a cellular phone.

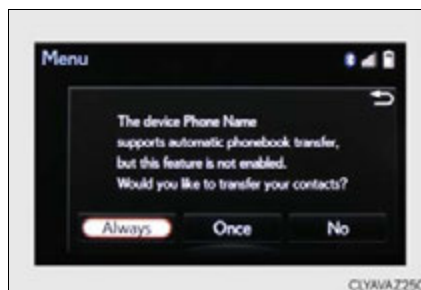

- ▶ For a PBAP incompatible and OPP compatible Bluetooth® phone

- 2 Select “Transfer” and operate your cellular phone to transfer new contacts from a cellular phone.  
Select “Add” if you want to add a new contact manually.

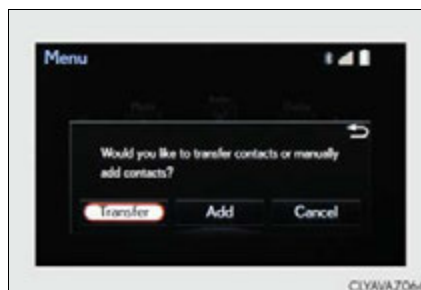

### Dialing from favorites

You can make a call using numbers registered in the favorites.

- 1 Go to “Favorites”: “MENU” button → “Phone” → “Favorites”
- 2 Choose the desired contact to call from the list.
- 3 Choose the number and then press the off-hook switch on the steering wheel or press the controller.



### Dialing from history

You can make a call using the call history.

- 1 Go to "Call History": "MENU" button → "Phone" → "Call History"
- 2 Select the desired entry from the list.
- 3 Press the off-hook switch on the steering wheel or select .

#### ■ Call history list

- If you make a call to or receive a call from a number registered in the phonebook, the name is displayed in the call history.
- If you make multiple calls to the same number, only the last call made is displayed in the call history.

#### ■ International calls

Depending on the mobile phone in use, you may not be able to make international calls.

#### ■ Calling by using the latest call history entry

- 1 Press the off-hook switch on the steering wheel to display the phone top screen.
- 2 Press the switch again to display the "Call History" screen.
- 3 Press the switch again to select the latest call history entry.

## Receiving a call

When a call is received, the following screen is displayed together with a sound.

### To answer the phone

Press the off-hook switch on the steering wheel or select .

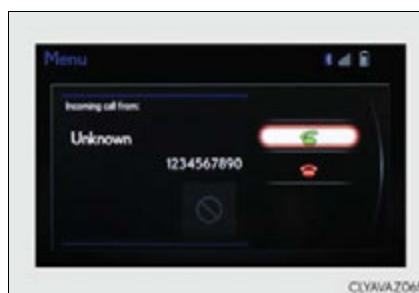

### To refuse a call

Press the on-hook switch on the steering wheel or select .

#### ■ International calls

Depending on the cellular phone in use, received international calls may not be displayed correctly.

## Speaking on the phone

The following screen is displayed when speaking on the phone.

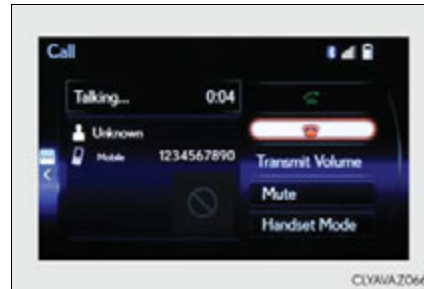

### To adjust the transmit volume

Select "Transmit Volume". To restore default volume, move the controller to the left on the "Transmit Volume" screen and then select "Default".

### To adjust in call volume

Move the controller to the left and then select "In-call Volume". You can also adjust the volume using the "PWR•VOL" knob or the steering switches.

### To prevent the other party from hearing your voice

Select "Mute".

### Inputting tones

When using phone services such as an answering service or a bank, you can store phone numbers and code numbers in the contacts using “p” or “w” symbols (eg. 056133 w 0123p#1).

- ▶ Contact including a phone number only

**1** Move the controller to the left and then select “0-9”.

**2** Input the number.

- ▶ Phone number containing a “p” symbol

When the “p” symbol is dialed in an outgoing call, there will be a pause for 2 seconds before the following digits are dialed automatically.

- ▶ Phone number containing a “w” symbol

When the “w” symbol is dialed in an outgoing call, you need to go to the “Release Tones” screen to dial the following digits. Move the controller to the left and then select “Release Tones”.

### To transfer a call

Select “Handset Mode” to change from a hands-free call to a cellular phone call or vice versa.

### To hang up

Press the on-hook switch on the steering wheel or select .

### Call waiting

When a call is interrupted by a third party while talking, an incoming call message will be displayed.

To talk with the other party:

Press the off-hook switch on the steering wheel or select .

To refuse the call:

Press the on-hook switch on the steering wheel or select .

Every time you press the off-hook switch on the steering wheel or select  during call waiting, you will be switched to the other party.

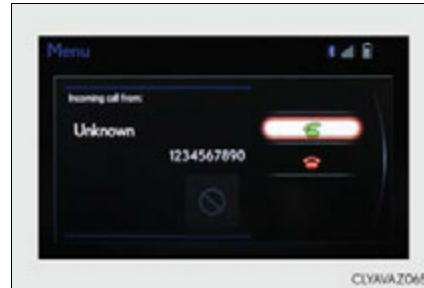

#### ■ Transferring calls

- It is not possible to transfer from hands-free to the cellular phone while driving.
- If you transfer from the cellular phone to hands-free, the hands-free screen will be displayed, and you can operate the system using the screen.
- Transfer method and operation may vary according to the cellular phone used.
- For operation of the cellular phone in use, see the phone's manual.

#### ■ Call waiting operation

Call waiting operation may differ depending on your phone company and cellular phone.

## Using a Bluetooth® phone message

Once a MAP-profile compatible Bluetooth phone is registered, you can check the E-mail/SMS/MMS and reply to a message using the following procedures:

### Checking messages

- 1 Go to message screen: "MENU" button → "Phone" → "Messages"
- 2 Select a message.

Moving the controller to the left while on the message list screen displays the setting screen. (→P. 342)

Move the controller to the right while on the message screen and then select an account to display a message list for the selected account.

### Message screen

Selecting "Next" or "Previous" displays the next or previous message.  
If a message is too long, select "Read More" to display the full text.

#### ■ Option menu

Move the controller to the left while on the message screen.

- 1 Select a prepared message and send a reply message.
- 2 Call a sender.  
If more than one phone number is registered for a sender, a phone number selection screen will be displayed.
- 3 Call a phone number written in a message.

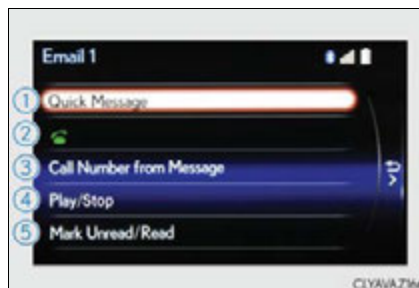

- 4 Select "Play" to have a message read out loud.  
Select "Stop" to stop this function.
- 5 Select "Mark Unread" to mark mail that has been read as unread. Select "Mark Read" to mark mail that has not been read as read.

**Replying to a message**

- 1 Move the controller to the left while on the message screen.
- 2 Select "Quick Message" to display the "Quick Message" screen.
- 3 Select the desired message and then select "Send".

■ **Editing a quick message**

- 1 Move the controller to the left while on the message screen.
- 2 Select "Quick Message" and move the cursor to the desired message.
- 3 Move the controller to the left and select "Edit".

To return to the default message after editing, select "Default".

**Receiving a message popup function**

This function is available when the "E-mail Notification Popup" or "SMS/MMS Notification Popup" are set to on. (→P. 342)

- ▶ "Incoming E-mail Display" or "Incoming SMS/MMS Display" are set to "Drop-Down"

When E-mail/ SMS/MMS are received, the incoming message is displayed on the upper side of the screen with a sound.

- ▶ "Incoming E-mail Display" or "Incoming SMS/MMS Display" are set to "Full Screen"

When E-mail/ SMS/MMS are received, the incoming message screen is displayed with a sound and it can be operated on the screen.

- 1 Check the message.
- 2 Refuse to check the message.
- 3 Call to receive the message sender's phone number.

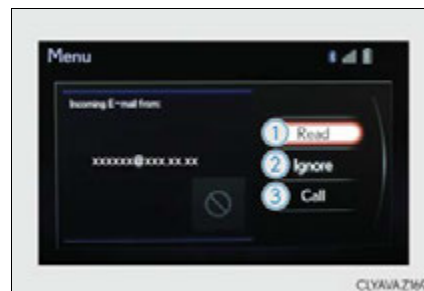

## Using the steering wheel switches

The steering wheel switches can be used to operate a connected cellular phone.

### Operating a telephone using the steering wheel switches

① Volume switch

During an incoming call: Adjusts the ring tone volume

During speaking on the phone: Adjusts in call volume

The voice guidance volume cannot be adjusted using this button.

② Talk switch

Press: Turns the voice command system on

Press and hold: Turns the voice command system off

③ Off-hook switch

- Start call
- Receiving
- Phone top screen display

④ On-hook switch

- End call
- Refuse call

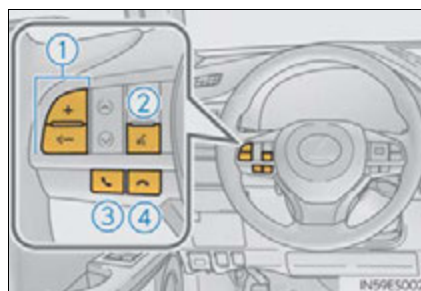



## Bluetooth® phone settings

You can adjust the hands-free system to your desired settings.

### “Phone/Message Settings” screen

Go to “Phone/Message Settings”: “MENU” button → “Setup” → “Phone”

- ① Register and connect a Bluetooth® device. (→P. 316)
- ② Adjust the call volume and message readout volume. (→P. 338)
- ③ Change the contact/call history settings. (→P. 339)
- ④ Change messaging settings. (→P. 342)
- ⑤ Change phone display settings. (→P. 338)

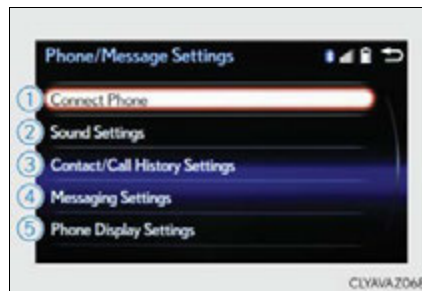

### Sound settings

Go to “Sound Settings”: “MENU” button → “Setup” → “Phone” → “Sound Settings”

- ① Change the ring tone type
- ② Adjust the ring tone volume
- ③ Adjust the message readout volume
- ④ Change the incoming SMS/MMS tone type
- ⑤ Adjust the incoming SMS/MMS tone volume
- ⑥ Change the incoming e-mail tone type
- ⑦ Adjust the incoming e-mail tone volume
- ⑧ Adjust in call tone volume



### Phone display settings

Go to “Phone Display Settings”: “MENU” button → “Setup” → “Phone” → “Phone Display Settings”

- ① Change the incoming call display
- ② Set the phonebook/history transfer status notification display on/off

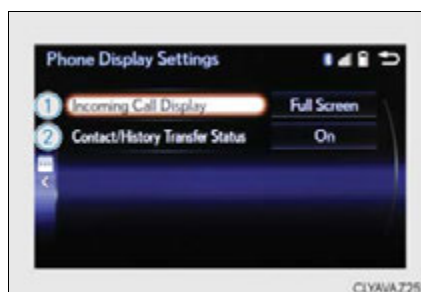

#### ■ To return to the default volume settings

Move the controller to the left and then select “Default”.

## Contact settings

Individual phonebooks can be registered for a maximum of 5 phones in total. The data for 2500 contacts (up to 4 numbers per contact) can be registered in each phonebook.

### “Contact/Call History Settings” screen

Go to “Contact/Call History Settings”: “MENU” button → “Setup” → “Phone” → “Contact/Call History Settings”

- ① Select to set the automatic phonebook download on/off  
With this setting on, phonebook data will be automatically transferred.  
Depending on the cellular phone, call history will be also transferred.
- ② Update contacts
- ③ Change the sort contacts mode
- ④ Add a favorite (→P. 340)
- ⑤ Delete a favorite (→P. 341)
- ⑥ Select to set the display of contact images on/off
- ⑦ Delete call history. (PBAP incompatible Bluetooth® phones, or compatible phones with “Automatic Transfer” off)
- ⑧ Add a new contact (PBAP incompatible Bluetooth® phones, or compatible phones with “Automatic Transfer” off)  
Input the name, phone number and phone number type to add a new contact.
- ⑨ Edit a contact (PBAP incompatible Bluetooth® phones, or compatible phones with “Automatic Transfer” off)  
Select the desired contact to edit.
- ⑩ Delete contacts (→P. 341) (PBAP incompatible Bluetooth® phones, or compatible phones with “Automatic Transfer” off)



#### ■ Return to the default settings

Move the controller to the left and select “Default”.

### Transferring a phone number

You can transfer the phone numbers in your Bluetooth<sup>®</sup> phone to the system. Operation methods differ between PBAP compatible and PBAP incompatible Bluetooth<sup>®</sup> phones. If your cellular phone does not support either PBAP or OPP services, you cannot transfer contacts.

Go to "Transfer Contacts": "MENU" button → "Setup" → "Phone" → "Contact/Call History Settings" → "Update Contacts from Phone"

- ▶ For PBAP compatible Bluetooth<sup>®</sup> phones when "Automatic Transfer" is set to on

Start the update automatically.

- ▶ For PBAP compatible Bluetooth<sup>®</sup> phones when "Automatic Transfer" is set to off and PBAP incompatible Bluetooth<sup>®</sup> phones

- ① Select to transfer the contact from the connected cellular phone and replace the current one.
- ② Select to transfer the desired contact data from the connected cellular phone to add to the current one.

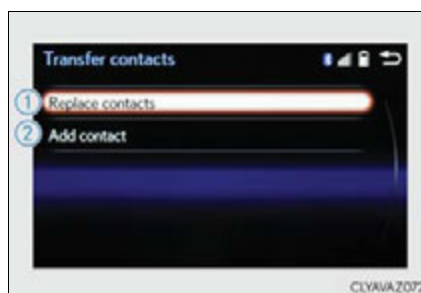

### Registering favorites

You can register the desired contact from the phonebook. Up to 15 contacts per phone can be registered.

- ① Go to "Add Favorite": "MENU" button → "Setup" → "Phone" → "Contact/Call History Settings" → "Add Favorite"
- ② Choose the contact to register.

### Removing favorites

- 1 Go to "Remove Favorite": "MENU" button → "Setup" → "Phone" → "Contact/Call History Settings" → "Remove Favorite"
- 2 Select the desired contacts.  
You can select all contacts by selecting "Select All".
- 3 Move the controller to the left and select "Remove".

### Deleting the contacts data

- 1 Go to "Delete Contacts": "MENU" button → "Setup" → "Phone" → "Contact/Call History Settings" → "Delete Contacts"
- 2 Select the desired contacts.  
You can select all contacts by selecting "Select All".
- 3 Move the controller to the left and select "Delete".

#### ■ Phonebook data

Phonebook data is managed separately for every registered phone. When another phone is connected, you cannot read the registered data.

#### ■ When transferring contacts

Transfer contacts while the engine is running.

If the cellular phone is OPP or PBAP compatible, you may need to input "1234" on the cellular phone for OBEX certification.

#### ■ When you have selected "Replace contacts" or "Add contact" to transfer contacts

If the cellular phone does not support OPP service, you cannot use these functions. You can transfer the phonebook data only by operating your phone.

#### ■ Transferring contacts while Bluetooth® audio is playing

Bluetooth® audio will disconnect. It will reconnect automatically when data transfer finishes. It may not reconnect depending on the phone which is connected.

## Messaging setting

Go to "Messaging Settings": "MENU" button → "Setup" → "Phone" → "Messaging Settings"

- ① Set the message forwarding from cellular phones on/off
- ② Set the automatic message read out function on/off
- ③ Set the new SMS/MMS notification display on/off
- ④ Set the new e-mail notification display on/off
- ⑤ Set the signature function on/off
- ⑥ Set the cellular phone's message read and unread status update function on/off.
- ⑦ Change the incoming SMS/MMS display.
- ⑧ Change the incoming e-mail display.
- ⑨ Change the account name to "Service name" (names from the connected device) or "Fixed name" (pre-defined names).



### ■ Restoring the default settings

Move the controller to the left then select "Default" on the "Messaging Settings" screen.

## What to do if... (Troubleshooting)

If there is a problem with the hands-free system or a Bluetooth® device, first check the table below.

- ▶ When using the hands-free system with a Bluetooth® device

The hands-free system or Bluetooth® device does not work.
The connected device may not be a compatible Bluetooth® cellular phone. → <b>For a list of specific devices which operation has been confirmed on this system, check with your Lexus dealer or the following website:</b> <a href="http://www.lexus.com/MobileLink">http://www.lexus.com/MobileLink</a>
The Bluetooth® version of the connected cellular phone may be older than the specified version. → <b>Use a cellular phone with Bluetooth® version 2.0 or higher (recommended: Ver. 3.0 with EDR or higher). (→P. 348)</b>

- ▶ When registering/connecting a cellular phone

A cellular phone cannot be registered.
An incorrect passcode was entered on the cellular phone. → <b>Enter the correct passcode on the cellular phone.</b>
The registration operation has not been completed on the cellular phone side. → <b>Complete the registration operation on the cellular phone (approve registration on the phone).</b>
Old registration information remains on either this system or the cellular phone. → <b>Delete the existing registration information from both this system and the cellular phone, then register the cellular phone you wish to connect to this system. (→P. 317)</b>
A Bluetooth® connection cannot be made.
Another Bluetooth® device is already connected. → <b>Manually connect the cellular phone you wish to use to this system. (→P. 320)</b>
Bluetooth® function is not enabled on the cellular phone. → <b>Enable the Bluetooth® function on the cellular phone.</b>

- ▶ When making/receiving a call

A call cannot be made/received.
Your vehicle is in a "No Service" area. → <b>Move to where "No Service" no longer appears on the display.</b>

▶ When using the phonebook

Phonebook data cannot be transferred manually/automatically.
The profile version of the connected cellular phone may not be compatible with transferring phonebook data. → For a list of specific devices which operation has been confirmed on this system, check with your Lexus dealer or the following website: <a href="http://www.lexus.com/MobileLink">http://www.lexus.com/MobileLink</a>
Automatic phonebook transfer function on this system is set to off. → Set automatic phonebook transfer function on this system to on. (→P. 339)
Passcode has not been entered on the cellular phone. → Enter the passcode on the cellular phone if requested (default passcode: 1234).
Transfer operation on the cellular phone has not completed. → Complete transfer operation on the cellular phone (approve transfer operation on the phone).
Phonebook data cannot be edited.
Automatic phonebook transfer function on this system is set to on. → Set automatic phonebook transfer function on this system to off. (→P. 339)

▶ When using the Bluetooth® message function

Messages cannot be viewed.
Message transfer is not enabled on the cellular phone. → Enable message transfer on the cellular phone (approve message transfer on the phone).
Automatic transfer function on this system is set to off. → Set automatic transfer function on this system to on. (→P. 342)
New message notifications are not displayed.
Notification of SMS/MMS/E-mail reception on this system is set to off. → Set notification of SMS/MMS/E-mail reception on this system to on. (→P. 342)
Automatic message transfer function is not enabled on the cellular phone. → Enable automatic transfer function on the cellular phone.



## ▶ In other situations

Even though all conceivable measures have been taken, the symptom status does not change.

The cellular phone is not close enough to this system.  
→ **Bring the cellular phone closer to this system.**

The cellular phone is the most likely cause of the symptom.  
→ **Turn the cellular phone off, remove and reinstall the battery pack, and then restart the cellular phone.**  
→ **Enable the cellular phone's Bluetooth® connection.**  
→ **Stop the cellular phone's security software and close all applications.**  
→ **Before using an application installed on the cellular phone, carefully check its source and how its operation might affect this system.**

## Bluetooth®

### ■ When using the Bluetooth® audio system

- In the following situations, the system may not function.
  - If the portable audio player is turned off
  - If the portable audio player is not connected
  - If the portable audio player's battery is low
- There may be a delay if a cellular phone connection is made during Bluetooth® audio play.
- Depending on the type of portable audio player that is connected to the system, operation may differ slightly and certain functions may not be available.

### ■ When using the hands-free system

- The audio system is muted when making a call.
- If both parties speak at the same time, it may be difficult to hear.
- If the received call volume is overly loud, an echo may be heard.  
If the Bluetooth® phone is too close to the system, quality of the sound may deteriorate and connection status may deteriorate.
- In the following situations, it may be difficult to hear the other party:
  - When driving on unpaved roads
  - When driving at high speeds
  - If a window is open
  - If the air conditioning is blowing directly on the microphone
  - If there is interference from the network of the cellular phone
- Depending on the type phone, certain functions may not be available.

### ■ Conditions under which the system will not operate

- If using a cellular phone that does not support Bluetooth®
- If the cellular phone is turned off
- If you are outside of cellular phone service coverage
- If the cellular phone is not connected
- If the cellular phone's battery is low
- When outgoing calls are controlled, due to heavy traffic on telephone lines, etc.
- When the cellular phone itself cannot be used
- When transferring phonebook data from the cellular phone

### ■ Bluetooth® antenna

The antenna is built into the display.

If the portable audio player or cellular phone is behind the seat or in the glove box or console box, or is touching or covered by metal objects, the connection status may deteriorate.

#### ■ Battery charge/signal status

- This display may not correspond exactly with the portable audio player or cellular phone itself.
- This system does not have a charging function.
- The portable audio player or cellular phone battery will be depleted quickly when the device is connected to Bluetooth®.

#### ■ When using the Bluetooth® audio and hands-free system at the same time

The following problems may occur.

- The Bluetooth® audio connection may be interrupted.
- Noise may be heard during Bluetooth® audio playback.

#### ■ About the contact in this system

The following data is stored for every registered cellular phone. When another phone is connecting, you cannot read the registered data.

- Contact data
- Call history
- Favorite
- Message

When removing a Bluetooth® phone from the system, the above-mentioned data is also deleted.

#### ■ About Bluetooth®

The Bluetooth® word mark and logos are registered trademarks owned by Bluetooth SIG, Inc. and any use of such marks by PIONEER Corporation is under license. Other trademarks and trade names are those of their respective owners.



### ■ Compatible models

The Bluetooth® audio system supports portable audio players with the following specifications

- Bluetooth® specifications:  
Ver. 2.0 or higher (Recommended: Ver. 3.0 +EDR or higher)
- Profiles:
  - A2DP (Advanced Audio Distribution Profile) Ver. 1.0, or higher  
(Recommended: Ver. 1.2 or higher)  
This is a profile to transmit stereo audio or high quality sound to the audio system.
  - AVRCP (Audio/Video Remote Control Profile) Ver. 1.0 or higher  
(Recommended: Ver. 1.4 or higher)  
This is a profile to allow remote control the A/V equipment.

However, please note that some functions may be limited depending on the type of portable audio player connected.

The hands-free system supports cellular phones with the following specifications.

- Bluetooth® specification:  
Ver. 2.0 or higher (Recommended: Ver. 3.0 +EDR or higher)
- Profiles:
  - HFP (Hands Free Profile) Ver. 1.0 or higher (Recommended: Ver. 1.6 or higher)  
This is a profile to allow hands-free phone calls using a cellular phone or head set. It has outgoing and incoming call functions.
  - OPP (Object Push Profile) Ver. 1.1 or higher (Recommended: Ver. 1.2)  
This is a profile to transfer phonebook data. When a Bluetooth® compatible cellular phone has both PBAP and OPP, OPP cannot be used.
  - PBAP (Phone Book Access Profile) Ver. 1.0 or higher (Recommended: Ver. 1.1)  
This is a profile to transfer phonebook data.
  - MAP (Message Access Profile) Ver.1.0 or higher  
This is a profile to using phone message.

If the cellular phone does not support HFP, you cannot register it with the hands-free system. OPP, PBAP or MAP services must be selected individually.

### ■ Reconnecting the portable audio player

If the portable audio player is disconnected due to poor reception when the engine switch is in ACCESSORY or IGNITION ON mode, the system automatically reconnects the portable audio player.

If you have switched off the portable audio player yourself, follow the instructions below to reconnect:

- Select the portable audio player again
- Enter the portable audio player

### ■ When you sell your car

Be sure to delete your personal data. (→P. 280)

**■ Certification**

- ▶ For vehicles sold in the U.S.A., Hawaii, Guam and Puerto Rico

**FCC ID: BABFT0043A****CAUTION: Radio Frequency Radiation Exposure**

This equipment complies with FCC radiation exposure limits set forth for an uncontrolled environment and meets the FCC radio frequency (RF) Exposure Guidelines. This equipment should be installed and operated keeping the radiator at least 20cm or more away from person's body in normal use position.

**Co-location:** This transmitter must not be co-located or operated in conjunction with any other antenna or transmitter.

This device complies with part 15 of the FCC Rules. Operation is subject to the following two conditions: (1) This device may not cause harmful interference, and (2) this device must accept any interference received, including interference that may cause undesired operation.

**FCC WARNING**

Changes or modifications not expressly approved by the party responsible for compliance could void the user's authority to operate the equipment.

- ▶ For vehicles sold in Canada

**IC: 2024B-FT0043A**

This device complies with Industry Canada licence-exempt RSS standard(s). Operation is subject to the following two conditions: (1) this device may not cause interference, and (2) this device must accept any interference, including interference that may cause undesired operation of the device.

**CAUTION: Radio Frequency Radiation Exposure**

This equipment complies with IC radiation exposure limits set forth for an uncontrolled environment and meets RSS-102 of the IC radio frequency (RF) Exposure rules. This equipment should be installed and operated keeping the radiator at least 20cm or more away from person's body (excluding extremities: hands, wrists, feet and ankles).

IC: 2024B-FT0043A

Le présent appareil est conforme aux CNR d'Industrie Canada applicables aux appareils radio exempts de licence. L'exploitation est autorisée aux deux conditions suivantes : (1) l'appareil ne doit pas produire de brouillage, et (2) l'utilisateur de l'appareil doit accepter tout brouillage radioélectrique subi, même si le brouillage est susceptible d'en compromettre le fonctionnement.

**ATTENTION:** l'exposition aux rayonnements radiofréquence - Cet équipement est conforme aux limites d'exposition aux rayonnements énoncées pour un environnement non contrôlé et respecte les règles d'exposition aux fréquences radioélectriques (RF) CNR-102 de l'IC. Cet équipement doit être installé et utilisé en gardant une distance de 20cm ou plus entre le dispositif rayonnant et le corps (à l'exception des extrémités : mains, poignets, pieds et chevilles).

 **WARNING**

■ **While driving**

Do not operate the portable audio player, cellular phone or connect a device to the Bluetooth® system.

■ **Caution regarding interference with electronic devices**

- Your audio unit is fitted with Bluetooth® antennas. People with implantable cardiac pacemakers, cardiac resynchronization therapy-pacemakers or implantable cardioverter defibrillators should maintain a reasonable distance between themselves and the Bluetooth® antennas. The radio waves may affect the operation of such devices.
- Before using Bluetooth® devices, users of any electrical medical device other than implantable cardiac pacemakers, cardiac resynchronization therapy-pacemakers or implantable cardioverter defibrillators should consult the manufacturer of the device for information about its operation under the influence of radio waves. Radio waves could have unexpected effects on the operation of such medical devices.

 **NOTICE**

■ **When leaving the vehicle**

Do not leave your portable audio player or cellular phone in the vehicle. The inside of the vehicle may become hot, causing damage to the portable audio player or cellular phone.

## “Information” screen

### Display “Information” screen

Go to “Information”: “MENU” button → “Info”

- ① Display the fuel consumption.  
(→P. 84)
- ② Display the Traffic Map picture.
- ③ Display the “USB Photo” screen.  
(→P. 353)
- ④ Display the weather information.  
(→P. 355)



Available when in a traffic supported HD Radio coverage area

### Traffic information map

Go to “Traffic Map”: “MENU” button → “Info” → “Traffic Incidents”

- ① Current position of your car
- ② Traffic information line

The line color means the following:

Red: Heavy congestion

Yellow: Moderate traffic

Green: Free flowing traffic



**■ Certification for U.S. owners****I. Clear Channel Disclaimers**

\*Total Traffic Network, a division of Clear Channel Broadcasting, Inc., owns or holds the rights to the traffic, news, sports, weather, stocks and other data (the "TOTAL TRAFFIC-HD+ Data") and TOTAL TRAFFIC-HD+ network through which it is delivered, together the "TTN Service". Use of the TTN Service is subject to the terms of these Device End User Terms.

\*The TTN Service is informational only. User assumes all risk of use. Total Traffic Network and its suppliers and licensors make no representations about the accuracy or timeliness of any of the TOTAL TRAFFIC-HD+ Data, including traffic and road conditions, route usability, or speed.\*

\*TOTAL TRAFFIC-HD+ NETWORK DATA IS PROVIDED "AS IS," AND "WHERE IS". TOTAL TRAFFIC NETWORK AND ITS SUPPLIERS AND LICENSORS EXPRESSLY DISCLAIM ALL WARRANTIES WITH RESPECT TO THE DATA (INCLUDING, WITHOUT LIMITATION, THAT THE DATA WILL BE ERROR-FREE, WILL OPERATE WITHOUT INTERRUPTION OR THAT THE DATA WILL BE ACCURATE), EXPRESS, IMPLIED OR STATUTORY, INCLUDING, WITHOUT LIMITATION, THE IMPLIED WARRANTIES OF MERCHANTABILITY, NON-INFRINGEMENT, FITNESS FOR A PARTICULAR PURPOSE, OR THOSE ARISING FROM A COURSE OF DEALING OR USAGE OF TRADE.\*

\*TOTAL TRAFFIC NETWORK AND ITS SUPPLIERS AND LICENSORS WILL NOT BE LIABLE TO YOU FOR ANY INDIRECT, SPECIAL, CONSEQUENTIAL, EXEMPLARY, OR INCIDENTAL DAMAGES (INCLUDING, WITHOUT LIMITATION, LOST REVENUES, ANTICIPATED REVENUES, OR PROFITS RELATING TO THE SAME) ARISING FROM ANY CLAIM RELATING DIRECTLY OR INDIRECTLY TO USE OF THE DATA, WHETHER A CLAIM FOR SUCH DAMAGES IS BASED ON WARRANTY, CONTRACT, TORT (INCLUDING, WITHOUT LIMITATION, NEGLIGENCE OR STRICT LIABILITY) OR ANY OTHER LEGAL THEORY.\*

**II. The Weather Channel's (TWC's) Disclaimers**

THE FOLLOWING TERMS APPLY TO THE USE OF ANY MATERIAL, DATA OR INFORMATION PROVIDED BY THE WEATHER CHANNEL, LLC ("THE WEATHER CHANNEL"), INCLUDING WEATHER-RELATED INFORMATION AND REPORTS, OBTAINED BY YOU OR OTHERS THROUGH THE TTN SERVICE ("THE WC DATA").

**DISCLAIMER OF WARRANTIES.**

YOUR USE OF THE WC DATA IS AT YOUR SOLE RISK. THE WC DATA IS PROVIDED ON AN "AS IS" AND "AS AVAILABLE" BASIS. THE WEATHER CHANNEL EXPRESSLY DISCLAIMS ALL WARRANTIES OF ANY KIND, WHETHER EXPRESS OR IMPLIED, INCLUDING, BUT NOT LIMITED TO THE IMPLIED WARRANTIES OF MERCHANTABILITY, FITNESS FOR A PARTICULAR PURPOSE AND NON-INFRINGEMENT. THE WEATHER CHANNEL MAKES NO REPRESENTATION OR WARRANTY THAT (i) THE WC DATA WILL MEET YOUR REQUIREMENTS, (ii) THE WC DATA WILL BE UNINTERRUPTED, TIMELY, SECURE, OR ERROR-FREE, (iii) THE RESULTS THAT MAY BE OBTAINED FROM THE USE OF THE WC DATA WILL BE ACCURATE OR RELIABLE, OR (iv) ANY ERRORS OR BUGS IN THE WC DATA WILL BE CORRECTED. ACCORDINGLY, THE WEATHER CHANNEL SHALL NOT BE RESPONSIBLE OR LIABLE FOR THE ACCURACY, USEFULNESS OR AVAILABILITY OF THE WC DATA.

**LIMITATION OF LIABILITY.**

YOU EXPRESSLY UNDERSTAND AND AGREE THAT THE WEATHER CHANNEL, ITS SUPPLIERS, ITS LICENSORS AND ITS AFFILIATE COMPANIES SHALL NOT BE LIABLE, UNDER ANY LEGAL THEORY, INCLUDING CONTRACT, TORT, NEGLIGENCE OR STRICT LIABILITY, FOR ANY DIRECT, INDIRECT, INCIDENTAL, SPECIAL, PUNITIVE, CONSEQUENTIAL OR EXEMPLARY DAMAGES, INCLUDING BUT NOT LIMITED TO, DAMAGES FOR LOSS OF PROFITS, GOODWILL, USE, DATA OR OTHER INTANGIBLE LOSSES (EVEN IF THE WEATHER CHANNEL HAS BEEN ADVISED OF THE POSSIBILITY OF SUCH DAMAGES), RESULTING FROM OR ARISING OUT OF YOUR USE OF, OR YOUR INABILITY TO USE, THE WC DATA, THIS AGREEMENT, OR ANY OTHER MATTER RELATING TO THE WC DATA. YOUR SOLE AND EXCLUSIVE REMEDY FOR ANY DISPUTE WITH THE WEATHER CHANNEL RELATED TO THE WC DATA OR CONTENT SHALL BE CANCELLATION OF RECEIPT OF THE WC DATA. SOME JURISDICTIONS DO NOT ALLOW THE EXCLUSION OF CERTAIN WARRANTIES OR THE LIMITATION OR EXCLUSION OF LIABILITY FOR INCIDENTAL OR CONSEQUENTIAL DAMAGES. ACCORDINGLY, SOME OF THE ABOVE LIMITATIONS MAY NOT APPLY TO YOU.



## USB photo

Connecting a USB memory device enables you to enjoy photos on the Lexus Display Audio display.

### USB photo screen

Go to “USB Photo”: “MENU” button → “Info” → “USB1 Photo” or “USB2 Photo”

### Connecting a USB memory device

→P. 274

### Menu screen

Move the controller to the left to display the menu screen.

- ① Change the full screen mode.
- ② Select to set the slide show display on/off.  
Start the slide show at a selected folder.
- ③ Change the play speed.
- ④ Change the play mode.



5

Lexus Display Audio system

### Selecting a folder and a file

- 1 Move the controller to the right and select “Browse”.
- 2 Select the desired folder, and then select a desired file to begin using the selected folder.

■ **USB memory functions**

→P. 311

■ **USB memory**

- **Compatible devices**  
USB memory device that can be used for JPEG display.
- **Compatible device formats**  
The following device format can be used:
  - USB communication format: USB2.0 FS (480 Mbps)
  - File system format: FAT16/32 (Windows)
  - Correspondence class: Mass storage class
- **JPEG file compatibility**
  - Compatible image size: Maximum 10MB
  - Compatible pixel size: Maximum 10,000,000 pixels



**NOTICE**

- **To prevent damage to the USB memory device or its terminals**

→P. 313

## Weather information

Weather information for the selected city is displayed.

Available when in weather supported HD Radio coverage area

### How to check the weather information

**1** Go to "Weather": "MENU" button → "Info" → "Weather"

**2** Select the desired city/location.

- ① Current location of your car
- ② Select of the recently checked location list  
Select the desired location on the recently checked location list.
- ③ Select of the National City list.  
Select the region on the region list and then select the city on the National City list.
- ④ Select of the local location list  
Select the location on the local location list.



**3** Select the time

- ① Display the current weather information.
- ② Display the 3 days weather information.  
You can display detail of a week, move the controller right and then select the desired week.

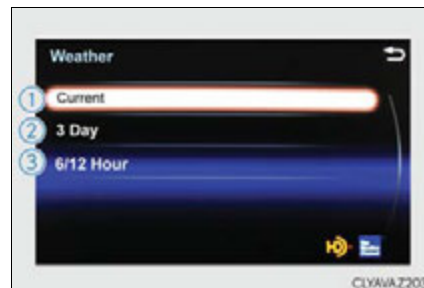

③ Display the 6/12 hour weather information.

5

Lexus Display Audio system

## Voice command system

The voice command system enables the audio and hands-free systems to be operated using voice commands.

Operations of the voice command system can be performed by selecting the menu corresponding to each function on the right part of the screen. Even if any menu is selected, commands displayed on all menus can be operated.

### Using the voice command system

- 1 Press the talk switch.  
To cancel the voice command system, press and hold the talk switch.
- 2 After a beep sounds, say the desired command.  
On the list screen, you can select the desired command.

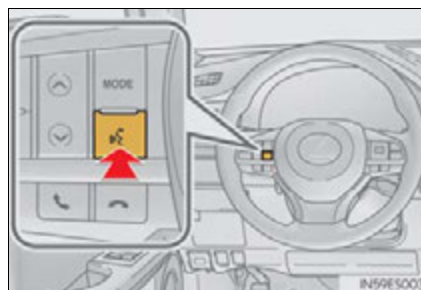

#### ■ Menu screen

To display the menu screen, move the controller to the left.

- ① Offer examples of commands and operation methods
- ② Adjust the settings for voice guidance volume and voice recognition prompts. ("Hints" screen) (→P. 281)
- ③ Start over voice recognition (except "Hints" screen)
- ④ Cancel voice recognition

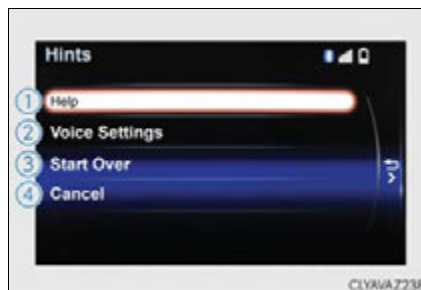

**■ Microphone**

→P. 326

**■ When using the microphone**

- It is unnecessary to speak directly into the microphone when giving a command.
- Wait for the confirmation beep before speaking a command.
- Voice commands may not be recognized if:
  - Spoken too quickly.
  - Spoken at a low or high volume.
  - The roof or windows are open.
  - Passengers are talking while voice commands are spoken.
  - The air conditioning speed is set high.
  - The air conditioning vents are turned towards the microphone.
- In the following conditions, the system may not recognize the command properly and using voice commands may not be possible:
  - The command is incorrect or unclear. Note that certain words, accents or speech patterns may be difficult for the system to recognize.
  - There is excessive background noise, such as wind noise.

**■ When searching for a track**

- A USB memory or iPod must be connected to enable track searching and playback. (→P. 274)
- When a USB memory or iPod is connected, recognition data is created so tracks can be searched using voice commands.
- Recognition data is updated under the following conditions:
  - When the USB memory or iPod data has changed.
  - When the voice recognition language is changed. (→P. 277)
- While the recognition data is being created or being updated, a track search cannot be performed using a voice command.

**■ The Gracenote<sup>®</sup> media database**

→P. 303

### Casual speech recognition

Due to natural language speech recognition technology, this system enables recognition of a command when spoken naturally. However, the system cannot recognize every variation of each command.

In some situations, it is possible to omit the command for the procedure and directly state the desired operation.

This function is available in English, Spanish and French.

#### ■ Expression examples for each function

Command	Expression examples
"Call <name> <type>"	Get me <Robert Brown>. I need to call <Robert Brown> at <Work> right away.
"Dial <number>"	Please dial the number <3334445555>. Ring <3334445555>.
"Play Artist <name>"	Play the artist <XXXXX>. I'd like to hear the band <XXXXX>.*
"Play Album <name>"	Play album <XXXXX>. Music from album <XXXXX>.*

\*: Say the desired artist name or album name in the place of the "<>".

### Command list

Some recognizable voice commands and their actions are shown below as examples.

#### ► Basic

Command	Action
"Help"	Prompts voice guidance to offer examples of commands or operation methods
"Go Back"	Returns to the previous screen
"Go to <tab>"	Displays the command list of the selected tab

## ▶ Phone

Command	Action
"Redial"	Places a call to the phone number of the latest outgoing call
"Call Back"	Places a call to the phone number of latest incoming call
"Show Recent Calls"	Displays the call history screen
"Dial <phone number>"	Places a call to the said phone number
"Call <contacts> <phone types>"	Place a call to the said phone type of the contact from the phone book

## ▶ Audio

Command	Action
"Play Playlist <playlists>"	Plays tracks from the selected playlist
"Play Artist <artist>"	Plays tracks from the selected artist
"Play Song <songs>"	Plays the selected track
"Play Album <albums>"	Plays tracks from the selected album
"Turn Music On/Off"	Turns the audio system on/off
"Play the <audio sources>"	Selects audio source

## ▶ Info

Command	Action
"Show Forecast"	Displays weather information
"Show Traffic"	Displays traffic information

## Mobile Assistant

The Mobile Assistant feature on this system allows the activation of Apple's Siri® Eyes Free mode via the steering wheel switches. To operate the Mobile Assistant, a compatible cellular phone must be registered and connected to this system via Bluetooth®. (→P. 315)

- 1 Press and hold the off hook switch until you hear the beeps that indicate the system is listening.



- 2 The Mobile Assistant can be used only when the "Mobile Assistant" screen is displayed.

To cancel the Mobile Assistant, select "Cancel", or press and hold the off hook switch.

To restart the Mobile Assistant for additional commands, press the off hook switch. Mobile Assistant can only be restarted after the system responds to a voice command. After some phone and music commands, the Mobile Assistant feature will automatically end to complete the requested action.

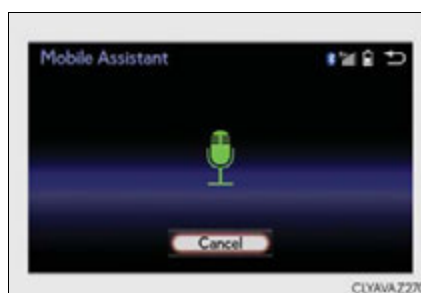

### ■ Adjusting the volume

The volume of the Mobile Assistant can be adjusted using the "PWR•VOL" knob or steering wheel volume switches. The Mobile Assistant and phone call volumes are synchronized.



### ■ Microphone

It is not necessary to speak directly into the microphone when using the Mobile Assistant.

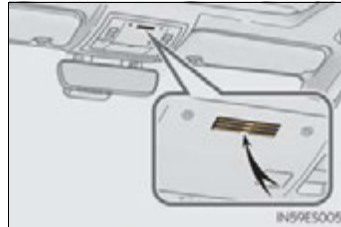

- Wait for the listening beeps before using the Mobile Assistant.
- The Mobile Assistant may not recognize commands in the following situations:
  - When spoken too quickly.
  - When spoken at a low or high volume.
  - When the roof or windows are open.
  - When passengers are talking while the Mobile Assistant is being used.
  - When the air conditioning system's fan speed is set high.
  - When the air conditioning vents are turned toward the microphone.

### ■ Mobile Assistant precautions

- The available features and functions may vary based on the iOS version installed on the connected device.
- Some Siri features are limited in Eyes Free mode. If you attempt to use an unavailable function, Siri will inform you that the function is not available.
- If Siri is not enabled on the cellular phone connected via Bluetooth<sup>®</sup>, an error message will be displayed on the screen.
- While a phone call is active, the Mobile Assistant cannot be used.
- If using the navigation feature of the cellular phone, ensure the active audio source is Bluetooth<sup>®</sup> audio or iPod in order to hear turn by turn direction prompts.

## LEXUS Enform Remote \*

Lexus Enform Remote is a cellular phone application that lets you view and remotely control certain aspects of your vehicle.

For details about the functions and services of this application, refer to <http://www.lexus.com/enform/>.

Function of the Lexus Enform Remote is achieved by using an embedded cellular device in the vehicle (DCM: Data Communication Module).

### Subscription

After you sign the Telematics Subscription Service Agreement, download the Lexus Enform Remote app from your cellular phone's app store, and register within the app (or enroll and complete registration at the dealer), you can begin using these services. (→P. 402)

A variety of subscription terms are available. Contact your Lexus dealer, or call 1-800-25-LEXUS (1-800-255-3987) for further subscription details.

#### ■ Availability of service

Lexus Enform Remote is available in the contiguous United States, Washington D.C. and Alaska.

#### ■ Lexus Enform Remote Information

- Lexus Enform Remote should only be used by authorized users.
- Laws in some communities may require that the vehicle be within view of the user when operating Lexus Enform Remote.  
In some states, use of Lexus Enform Remote may violate state or local laws. Before using Lexus Enform Remote, check your state and local laws.
- Any malfunction of the Lexus should be repaired by your Lexus dealer.
- Lexus Enform Remote is designed to work at temperatures above -22°F (-30°C). This specification is related to the Lexus Enform Remote operation, but is dependent on the vehicle's operating temperature range which may be different.
- Content is subject to change without notice.
- Some features of the Lexus Enform Remote may not be available on some models.
- Additional information can be found at [www.lexus.com/enform/](http://www.lexus.com/enform/).
- Availability of functions of the Lexus Enform service is dependent on network reception level.

#### ■ Safety information for Lexus Enform Remote

→P. 405

\*: If equipped

<b>6-1. Using the air conditioning system and defogger</b>	
Automatic air conditioning system .....	364
Heated steering wheel/ seat heaters/seat ventilators .....	373
<b>6-2. Using the interior lights</b>	
Interior lights list .....	375
• Interior lights .....	376
• Personal lights .....	376
<b>6-3. Using the storage features</b>	
List of storage features .....	378
• Glove box .....	379
• Console box .....	379
• Cup holders .....	380
• Auxiliary box .....	381
Trunk features .....	382
<b>6-4. Using the other interior features</b>	
Other interior features .....	384
• Sun visors .....	384
• Vanity mirrors .....	384
• Clock .....	385
• Power outlets .....	385
• Armrest .....	386
• Rear sunshade/rear door sunshades .....	387
• Trunk storage extension .....	389
• Coat hooks .....	390
• Assist grips .....	390
Garage door opener .....	391
Compass .....	398
LEXUS Enform Safety Connect .....	402

## Automatic air conditioning system

Air outlets and fan speed are automatically adjusted according to the temperature setting.

Vehicles with Lexus Display Audio system: Press the “MENU” button on the Lexus Display Audio controller, then select “Climate” to display the air conditioning operation screen.

For details on the Lexus Display Audio controller, refer to “Lexus Display Audio controller” on P.268.

Vehicles with navigation system: Press the “MENU” button on the Remote Touch, then select “Climate” to display the air conditioning control screen.

For details on the Remote Touch, refer to the “NAVIGATION SYSTEM OWNER’S MANUAL”.

### Control panel



#### ■ Adjusting the temperature setting

Press to increase the temperature and to decrease the temperature.

#### ■ Adjusting the fan speed setting

Press to increase the fan speed and to decrease the fan speed.

Press the “OFF” button to turn the fan off.

#### ■ Change the airflow mode

To change the air outlets, press .

The air outlets used are switched each time the button is pressed.

### Control screen

▶ Vehicles with Lexus Display Audio System

- ① Adjust the left-hand side temperature setting
- ② Adjust the fan speed setting
- ③ "AUTO": Select to set automatic mode on/off

"OFF": Turn the fan off

: Display the option control screen (→P. 367)



- ④ Select the air flow mode

: Air flows to the upper body

: Air flows to the upper body and feet

: Air flows to the feet

: Air flows to the feet and the windshield defogger operates

- ⑤ Adjust the right-hand side temperature setting
- 1 Move the Lexus Display Audio controller left/right to select the desired item (① to ⑤).
  - 2 When ①, ② or ⑤ is selected:  
Move the controller forward/backward or turn it left/right for adjusting.  
When ③ or ④ is selected:  
Move the controller forward/backward or turn it left/right to select a screen button, then press the controller.

▶ Vehicles with navigation system

- ① Adjust the left-hand side temperature setting
- ② Adjust the fan speed setting
- ③ Select the air flow mode



: Air flows to the upper body



: Air flows to the upper body and feet



: Air flows to the feet



: Air flows to the feet and the windshield defogger operates

- ④ Adjust the right-hand side temperature setting
- ⑤ Display the option control screen (→P. 367)
- ⑥ Turn the fan off
- ⑦ Select to set automatic mode on/off

To adjust or select settings, move the Remote Touch knob to select the screen button, and then press the Remote Touch knob to enter the selected function.

### ■ Option control screen

Select **\*\*\*** on the climate screen to display the option control screen. The functions can be switched on and off.

- ▶ Vehicles with Lexus Display ▶ Vehicles with navigation system Audio system



- ① Select to set cooling and dehumidification function on/off
- ② Adjusting the temperature for driver and passenger seats separately ("DUAL" mode) (→P. 368)
- ③ Prevent ice from building up on the windshield and wiper blades (if equipped) (→P. 369)
- ④ Remove pollen from the air (micro dust and pollen filter) (→P. 369)

### Air conditioning controls

#### ■ Using the automatic mode

- 1 Press the "AUTO" button.
- 2 Adjust the temperature setting.
- 3 To stop the operation, press the "OFF" button.

#### ■ Automatic mode indicator

If the fan speed setting or air flow modes are operated, the automatic mode indicator goes off. However, automatic mode for functions other than that operated is maintained.

■ **Adjusting the temperature for driver and passenger seats separately (“DUAL” mode)**

To turn on the “DUAL” mode, perform any of the following procedures:



- Press the “DUAL” button.
- Select “DUAL” on the option control screen.
- Adjust the passenger’s side temperature setting.

The indicator comes on when the “DUAL” mode is on.

**Other functions**

■ **Switching between outside air and recirculated air modes**

Press .

The mode switches among  (recirculated air mode), automatic and  (outside air mode) modes each time the button is pressed.

When the system is switched to automatic mode, the air conditioning system operates automatically.

■ **Defogging the windshield**

Defoggers are used to defog the windshield and front side windows.

Press .

Set  to outside air mode if the recirculated air mode is used. (It may switch automatically.)

To defog the windshield and the side windows early, turn the air flow and temperature up.

To return to the previous mode, press  again when the windshield is defogged.

■ **Defogging the rear window and outside rear view mirrors**

Defoggers are used to defog the rear window and to remove raindrops, dew and frost from the outside rear view mirrors.

Press .

The defoggers will automatically turn off after a period of time.



**■ Micro dust and pollen filter**

Pollen is removed from the air and the air flows to the upper part of the body.

Select  on the option control screen.

When the micro dust and pollen filter is on,  is displayed on the air conditioning control screen.

In order to prevent the windshield from fogging up when the outside air is cold, the dehumidification function may operate.

The pollen is filtered out even if the micro dust and pollen filter is turned off.

**■ Windshield wiper de-icer (if equipped)**

This feature is used to prevent ice from building up on the windshield and wiper blades.

Select  on the option control screen.

When the windshield wiper de-icer is on,  is displayed on the air conditioning control screen.

The windshield wiper de-icer will automatically turn off after a period of time.

**Air outlets****■ Location of air outlets**

The air outlets and air volume change according to the selected air flow mode.

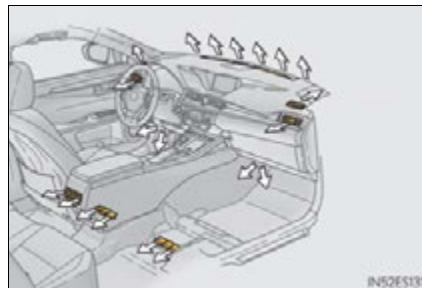

6

Interior features

■ Adjusting the position of and opening and closing the air outlets

▶ Front

▶ Rear

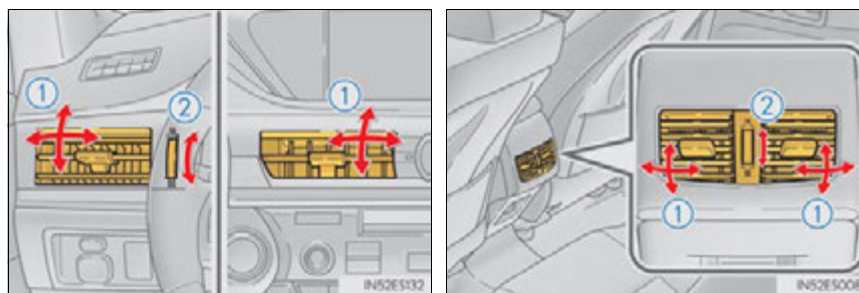

- ① Direct air flow to the left or right, up or down.
- ② Turn the knob to open or close the vent.

■ Registering air conditioning settings to electronic keys

- Unlocking the vehicle using an electronic key and turning the engine switch to IGNITION ON mode will recall that key's registered air conditioning settings.
- When the engine switch is turned off, the current air conditioning settings will automatically be registered to the electronic key that was used to unlock the vehicle.

The system may not operate correctly if more than one electronic key is in the vicinity or if the smart access system is used to unlock a passenger door.

Settings for the electronic key and the corresponding door can be changed.

Contact your Lexus dealer.

■ Using automatic mode

Fan speed is adjusted automatically according to the temperature setting and the ambient conditions.

Immediately after the "AUTO" button is pressed or "AUTO" is selected, the fan may stop for a while until warm or cool air is ready to flow.

■ When the outside temperature exceeds 75°F (24°C) and the air conditioning system is on

- In order to reduce the air conditioning power consumption, the air conditioning system may switch to recirculated air mode automatically. This may also reduce fuel consumption.
- Recirculated air mode is selected as a default mode when the engine switch is turned to IGNITION ON mode.
- It is possible to switch to outside air mode at any time by pressing .

### ■ Fogging up of the windows

- The windows will easily fog up when the humidity in the vehicle is high. Selecting "A/C" on the option control screen will dehumidify the air from the outlets and defog the windshield effectively.
- If you turn "A/C" off, the windows may fog up more easily.
- The windows may fog up if the recirculated air mode is used.

### ■ Outside/recirculated air mode

- When driving on dusty roads, in tunnels, or in heavy traffic, set  to the recirculated air mode. This is effective in preventing outside air from entering the vehicle interior. During cooling operation, setting the recirculated air mode will also cool the vehicle interior effectively.
- Outside/recirculated air mode may automatically switch depending on the temperature setting or the inside temperature.

### ■ When the outside temperature is low



The dehumidification function may not operate even when "A/C" on the option control screen is selected.

### ■ Automatic mode for air intake control

In automatic mode, the system detects exhaust gas and other pollutants and automatically switches between outside air and recirculated air modes.

When the dehumidification function is off, and the fan is operating, turning automatic mode on will activate the dehumidification function.

### ■ Micro dust and pollen filter

- In order to prevent the windshield from fogging up when the outside air is cold, the following may occur:
  - Outside air mode does not switch to  (recirculated air) mode.
  - The dehumidification function operates.
  - The operation cancels after approximately 1 minute.
- In rainy weather, the windows may fog up. Press .
- In extremely humid weather, the windows may fog up.
- The pollen is filtered out even if the micro dust and pollen filter is turned off.

### ■ Operation of the air conditioning system in Eco drive mode

- In the Eco drive mode, the air conditioning system is controlled as follows to prioritize fuel efficiency
  - Engine speed and compressor operation controlled to restrict heating/cooling capacity
  - Fan speed restricted when automatic mode is selected
- To improve air conditioning performance, perform the following operations
  - Adjust the fan speed
  - Turn off Eco drive mode

■ **Ventilation and air conditioning odors**

- To let fresh air in, set the air conditioning system to the outside air mode.
- During use, various odors from inside and outside the vehicle may enter into and accumulate in the air conditioning system. This may then cause odor to be emitted from the vents.
- To reduce potential odors from occurring:
  - It is recommended that the air conditioning system be set to outside air mode prior to turning the vehicle off.
  - Immediately after the air conditioning system is started in automatic mode, the start timing of the blower may be delayed for a short period of time.

■ **Air conditioning filter**

→P. 449

■ **Customization**

Settings (e.g. A/C automatic mode switch operation) can be changed.  
(Customizable features: →P. 540)

**⚠ WARNING**

■ **To prevent the windshield from fogging up**

- Do not use  during cool air operation in extremely humid weather. The difference between the temperature of the outside air and that of the windshield can cause the outer surface of the windshield to fog up, blocking your vision.
- Do not place anything on the instrument panel which may cover the air outlets. Otherwise, air flow may be obstructed, preventing the windshield defoggers from defogging.

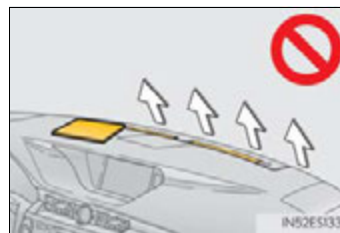

■ **To prevent burns**

- Do not touch the rear view mirror surfaces when the outside rear view mirror defoggers are on.
- Vehicles with windshield wiper de-icer: Do not touch the glass at lower part of the windshield or to the side of the front pillars when the windshield wiper de-icer is on.

**⚠ NOTICE**

■ **To prevent battery discharge**

Do not leave the air conditioning system on longer than necessary when the engine is not running.

## Heated steering wheel\* /seat heaters\* / seat ventilators\*

Heated steering wheel and seat heaters heat the side grips of the steering wheel and seats, respectively. Seat ventilators maintain good airflow by blowing air from the seats.

### WARNING

- Care should be taken to prevent injury if anyone in the following categories comes in contact with the steering wheel and seats when the heater is on:
  - Babies, small children, the elderly, the sick and the physically challenged
  - Persons with sensitive skin
  - Persons who are fatigued
  - Persons who have taken alcohol or drugs that induce sleep (sleeping drugs, cold remedies, etc.)
- Observe the following precautions to prevent minor burns or overheating:
  - Do not cover the seat with a blanket or cushion when using the seat heater.
  - Do not use the seat heater more than necessary.

### NOTICE

- Do not put heavy objects that have an uneven surface on the seat and do not stick sharp objects (needles, nails, etc.) into the seat.
- To prevent battery discharge, do not use the functions when the engine is not running.

\*: If equipped

### Heated steering wheel

Turns the heated steering wheel on/off

The indicator light comes on when the heated steering wheel is operating.

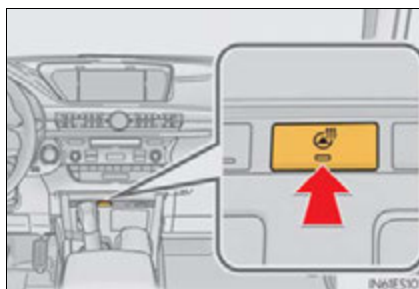

- The heated steering wheel can be used when the engine switch is in IGNITION ON mode.
- The heated steering wheel will automatically turn off after about 30 minutes.

### Seat heaters and ventilators

① Heats the seat

The indicator light comes on.

The higher the number of dots, the warmer the seat becomes.

② Blows air from the seat

The indicator light comes on.

The higher the number of dots, the stronger the airflow becomes.

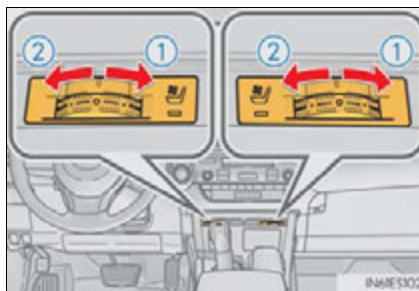

The seat heaters and ventilators can be used when the engine switch is in IGNITION ON mode.

## Interior lights list

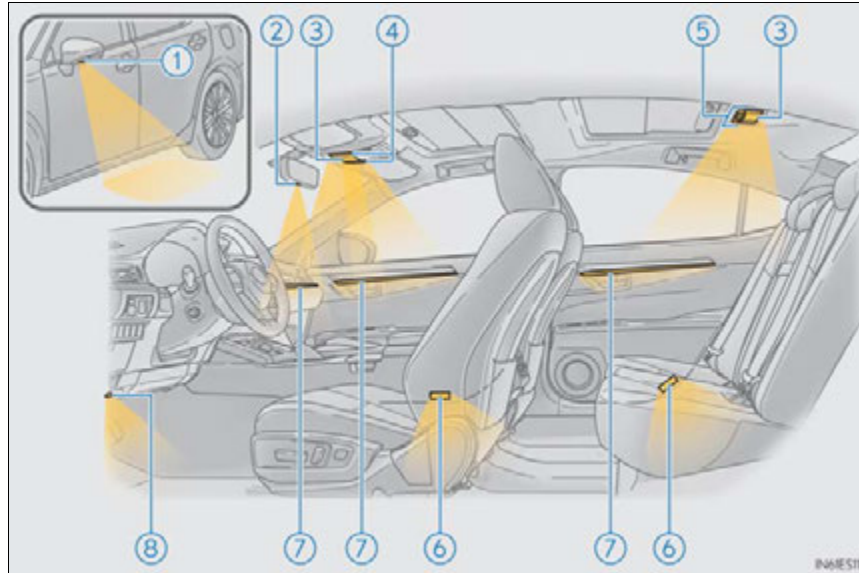

- |                                   |                                  |
|-----------------------------------|----------------------------------|
| ① Outer foot lights               | ⑤ Rear personal lights (→P. 376) |
| ② Shift lever light               | ⑥ Door courtesy lights           |
| ③ Interior lights (→P. 376)       | ⑦ Ornament lights (if equipped)  |
| ④ Front personal lights (→P. 376) | ⑧ Footwell lights                |

When the instrument panel light control switch is turned to minimum and the tail lights are on, the ornament lights and the footwell lights will turn off. (→P. 75)

### Interior lights

Turns the light on/off (touch the light)

The rear interior light also turns on/off.

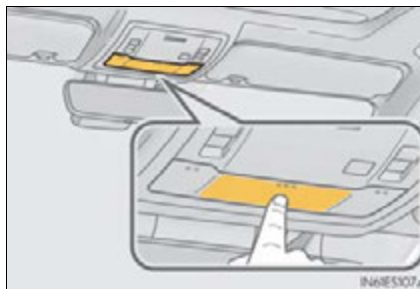

Turns the door position on/off

① On

The front and rear interior lights turn on/off when a door is opened/closed.

② Off

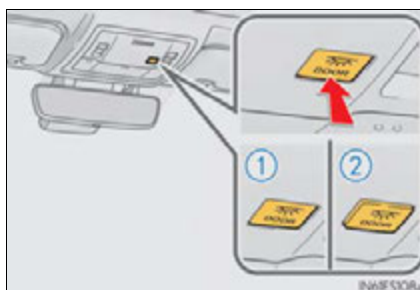

### Personal lights

#### ■ Front

Turns the lights on/off (touch the lights)

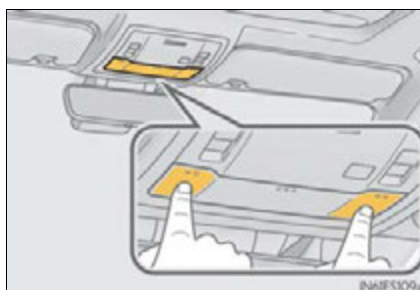

#### ■ Rear

Turns the light on/off

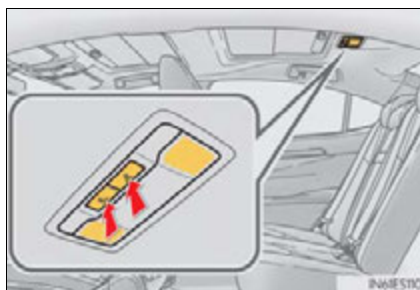



- Illuminated entry system: The lights automatically turn on/off according to engine switch mode, the presence of the electronic key, whether the doors are locked/unlocked, and whether the doors are opened/closed.
- If the following lights remain on when the engine switch is turned off the lights will go off automatically after 20 minutes:
  - Outer foot lights
  - Personal/interior lights
  - Door courtesy lights
  - Ornament lights (if equipped)
  - Footwell lights
- Setting (e.g. the time elapsed before lights turn off) can be changed.  
(Customizable features: →P. 533)

## List of storage features

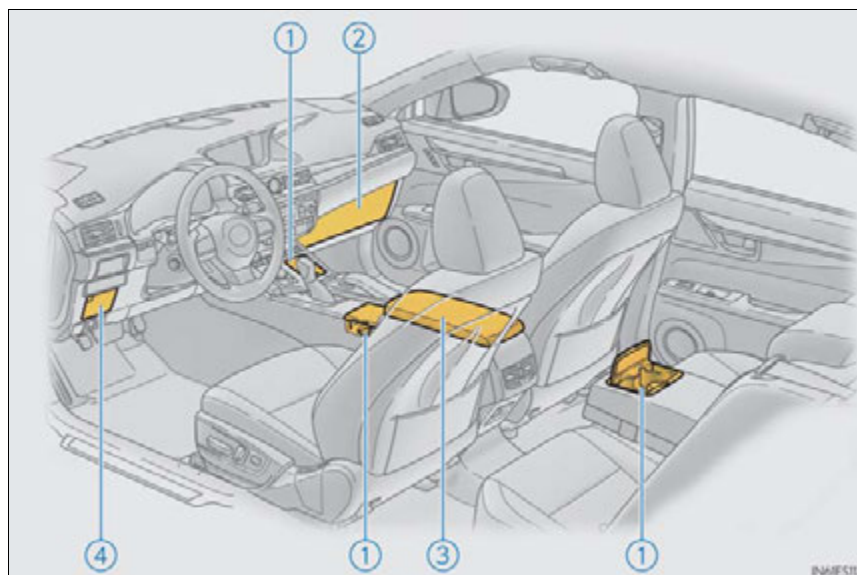

- |               |           |                 |           |
|---------------|-----------|-----------------|-----------|
| ① Cup holders | (→P. 380) | ③ Console box   | (→P. 379) |
| ② Glove box   | (→P. 379) | ④ Auxiliary box | (→P. 381) |

### **⚠ WARNING**

- Do not leave glasses, lighters or spray cans in the storage spaces, as this may cause the following when cabin temperature becomes high:
  - Glasses may be deformed by heat or cracked if they come into contact with other stored items.
  - Lighters or spray cans may explode. If they come into contact with other stored items, the lighter may catch fire or the spray can may release gas, causing a fire hazard.
- When driving or when the storage compartments are not in use, keep the lids closed. In the event of sudden braking, sudden swerving or an accident, an occupant may be struck by an open lid or the items stored inside.

**Glove box**

- ① Open (press the button)
- ② Unlock with the mechanical key
- ③ Lock with the mechanical key

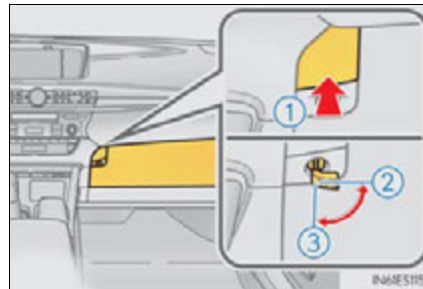

- The glove box light turns on when the tail lights are on.
- The trunk opener main switch is located in the glove box. (→P.100)
- The partition inside the glove box can be removed. (→P.449)

**Console box**

Push the knob to release the lock, and lift the armrest to open fully.

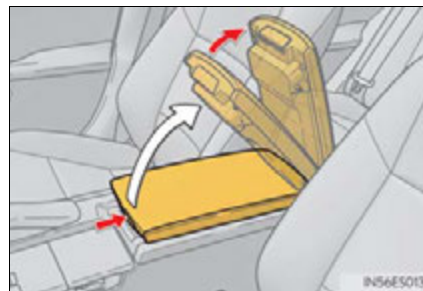

- The tray slides forward/backward and can be removed.

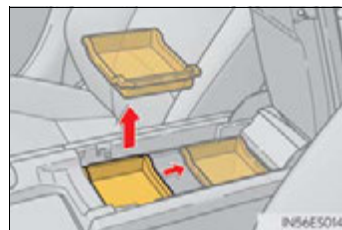

- The console box light turns on when the tail lights are on.

**⚠ WARNING**

When using the console box with half-open, do not apply too much load on the armrest. Doing so may damage the armrest and may cause you to injure yourself.

### Cup holders

#### ■ Driver's side

- ① To open, move the cup holder lid until it locks.
- ② To close, press and release the cup holder lid.

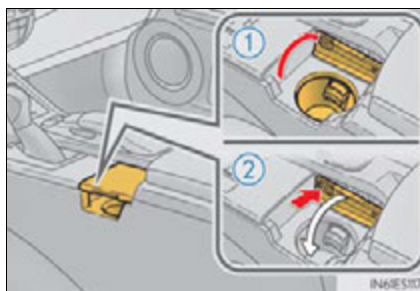

#### ■ Front passenger's side

To open, press down and release the cup holder lid.

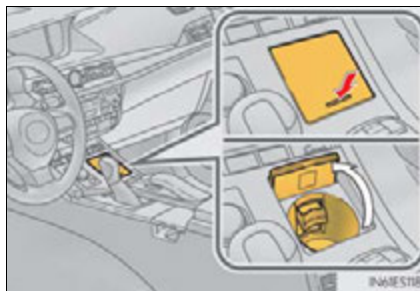

#### ■ Rear

To open, pull down the armrest and press in and release the rear cup holder on the armrest.

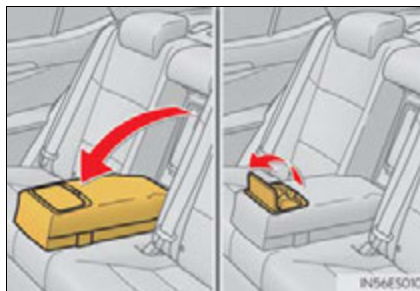

**⚠ WARNING**

- Do not place anything other than cups or beverage cans in the cup holders. Other items may be thrown out of the holders in the event of an accident or sudden braking, causing injury. If possible, cover hot drinks to prevent burns.
- Front passenger's side cup holder only: Do not place anything larger than a 32 oz cup in the cup holder. Doing so may prevent the switches from being operated properly or block the driver's view of the switches, which may cause an accident.

**⚠ NOTICE**

To prevent damage to the rear cup holder, stow the cup holder before stowing the arm-rest.

**Auxiliary box**

Press in the button.

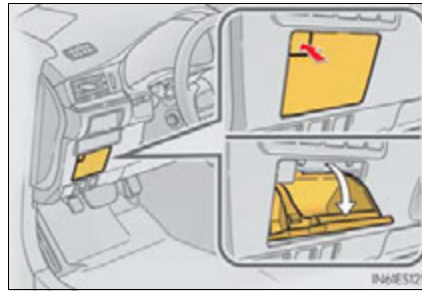

6

Interior features

## Trunk features

### Cargo hooks

Raise the hooks when needed.

The cargo hooks are provided for securing loose items.

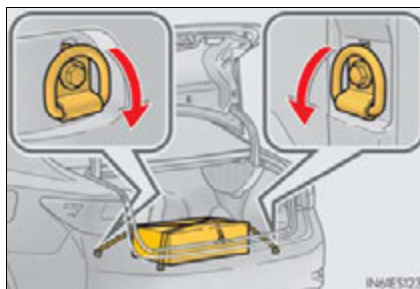

### **⚠** WARNING

To avoid injury, always return the cargo hooks to their stowed positions when not in use.

### Grocery bag hooks



**Luggage mat**

- 1 Pull the lever upwards when lifting the luggage mat up.

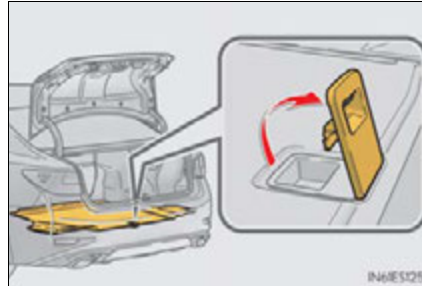

- 2 The lever can be hooked on the edge of the trunk.

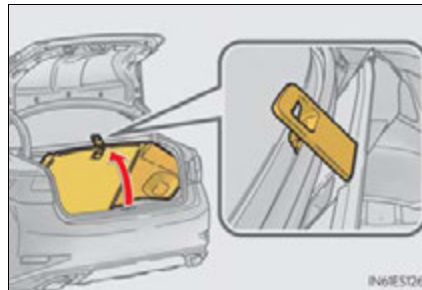
 **NOTICE**

When closing the trunk door, do not leave the luggage mat lever hooked on the edge of the trunk. The luggage mat may get damaged.

## Other interior features

### Sun visors

- ① To set the visor in the forward position, flip it down.
- ② To set the visor in the side position, flip down, unhook, and swing it to the side.
- ③ To use the side extender, place the visor in the side position, then slide it backward.

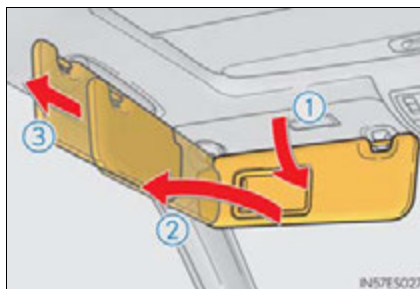

### Vanity mirrors

Slide the cover to open.

The light turns on when the cover is opened.

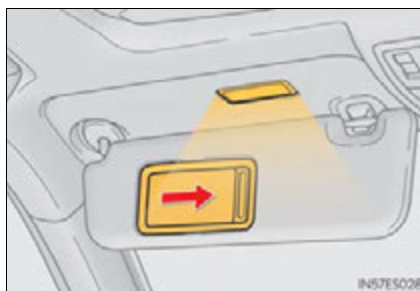

### ⚠ NOTICE

To prevent battery discharge, do not leave the vanity lights on for extended periods while the engine is not running.



### Clock

The clock can be adjusted.

- ① Pressing and holding will move the clock hands backward.
- ② Pressing and holding will move the clock hands forward.

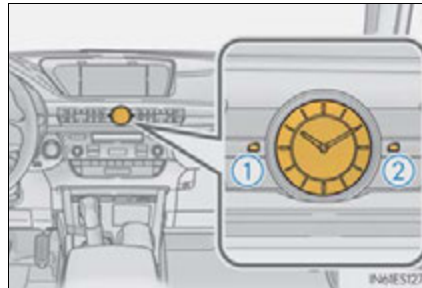

### Power outlets

The power outlets can be used for 12V accessories that run on less than 10A.

#### ■ Front

Open the lid.

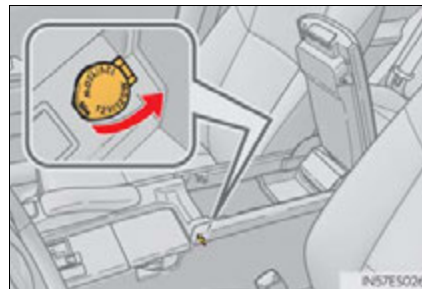

#### ■ Rear

Open the lid.



The power outlets can be used when the engine switch is in ACCESSORY or IGNITION ON mode.

 NOTICE

- To avoid damaging the power outlets, close the power outlet lids when the power outlets are not in use.  
Foreign objects or liquids that enter the power outlets may cause a short circuit.
- To prevent blown fuse, do not use an accessory that uses more than 12V 10A.
- To prevent battery discharge, do not use the power outlets longer than necessary when the engine is not running.

**Armrest**

Fold down the armrest for use.



 NOTICE

To prevent damage to the armrest, do not apply too much load on the armrest.

**Rear sunshade (if equipped)/rear door sunshades (if equipped)****■ Rear sunshade**

The rear sunshade can be raised and lowered by operating the button shown below.

Raise/lower

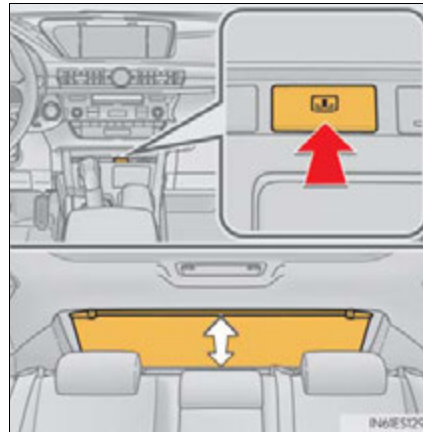
**■ Rear door sunshades**

Pull the tab of the rear door sunshade and hook the sunshade on the anchors.

To retract the rear door sunshade, unhook the sunshade and retract it slowly.

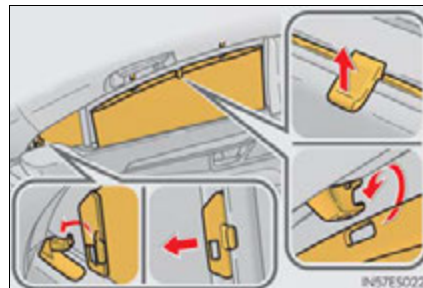

- The rear sunshade can be used when the engine switch is in IGNITION ON mode.
  - The rear sunshade can be operated for approximately 1 minute even after the engine switch is turned to ACCESSORY mode or turned off.
  - Reverse operation feature: To ensure adequate rear visibility, the rear sunshade automatically lowers when the shift lever is shifted to R.  
However, the rear sunshade is raised again if any of the following occurs:
    - The button is pressed again.\*
    - Shift the shift lever to P.
    - The shift lever is shifted out of R, and the vehicle reaches a speed of 9 mph (15 km/h).  
If the engine is not running when the rear sunshade has been lowered due to the reverse operation feature, it will not be raised even when the engine is turned on again and the vehicle reaches a speed of 9 mph (15 km/h). To raise the sunshade again, press the button.
- \*: Occasionally, the reverse function may not be carried out after the switch has been pressed. Repeat the above operation to operate the function.
- Time elapsed before the reverse operation feature activates can be changed.  
(Customizable features: →P. 533)

 **WARNING**

When the rear sunshade is being operated not place fingers or other objects in the fastener section or in the opening. They may get caught, causing injury.

 **NOTICE**

- To prevent battery discharge, do not operate the rear sunshade when the engine is not running.
- To ensure normal operation of the rear sunshade and rear door sunshades, observe the following precautions:
  - Do not place excessive load on the motor or other components of the rear sunshade.
  - Do not place objects where they may hinder opening and closing operations.
  - Do not attach items to the rear sunshade and rear door sunshades.
  - Keep the opening clean and clear of obstructions.
  - Do not operate the rear sunshade continuously for long periods of time.

**Trunk storage extension**

Long objects can be loaded into the vehicle by utilizing the trunk space and rear seat area.

- 1 Fold down the armrest.

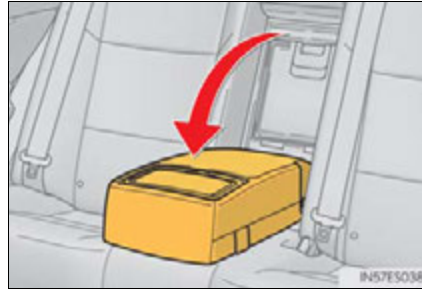

- 2 Fold down the handle and open the armrest door.

**⚠ WARNING**

Ensure that the armrest door is closed when not in use. In the event of sudden braking, items stored in the trunk may be thrown forward into the cabin, resulting in injury.

### Coat hooks

The coat hooks are provided with the rear assist grips.



#### WARNING

Do not hang coat hangers or other hard or sharp objects on the hook. If the SRS curtain shield airbags deploy, these items may become projectiles, causing death or serious injury.

### Assist grips

An assist grip installed on the ceiling can be used to support your body while sitting on the seat.



#### WARNING

Do not use the assist grip when getting in or out of the vehicle or rising from your seat.

#### NOTICE

To prevent damage to the assist grip, do not hang any heavy object or put a heavy load on the assist grip.

## Garage door opener

The garage door opener can be programmed to operate garage doors, gates, entry doors, door locks, home lighting systems, security systems, and other devices.

### Programming HomeLink®

The HomeLink® wireless control system in your vehicle has 3 buttons which can be programmed to operate 3 different devices. Refer to the programming methods on the following pages to determine the method which is appropriate for the device.

- ① HomeLink® indicator light
  - ② Garage door operation indicators
  - ③ HomeLink® icon
  - ④ Buttons
- Illuminates while HomeLink® is operating.

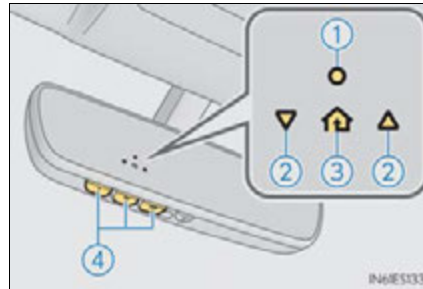

#### ■ Before programming HomeLink®

- During programming, it is possible that garage doors, gates, or other devices may operate. For this reason, make sure that people and objects are clear of the garage door or other devices to prevent injury or other potential harm.
- It is recommended that a new battery be placed in the remote control transmitter for more accurate programming.
- Garage door opener motors manufactured after 1995 may be equipped with rolling code protection. If this is the case, you may need a stepladder or other sturdy, safe device to reach the “Learn” or “Smart” button on the garage door opener motor.

■ Programming HomeLink®

- 1 Press and release the HomeLink® button you want to program and check that the HomeLink® indicator light flashes (orange).

Perform 3 within 60 seconds of 1, or the indicator light will stop flashing and programming will not be able to be completed.

- 2 Point the remote control transmitter for the device at the rear view mirror, 1 to 3 in. (25 to 75 mm) from the HomeLink® buttons.

Keep the HomeLink® indicator light in view while programming.

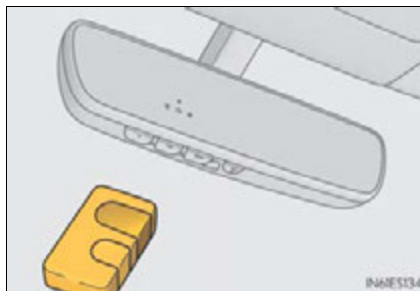

► For U.S.A. owners

- 3 Press and hold the handheld transmitter button until the HomeLink® indicator light changes from slowly flashing orange to rapidly flashing green (rolling code) or continuously lit green (fixed code), then release the button.

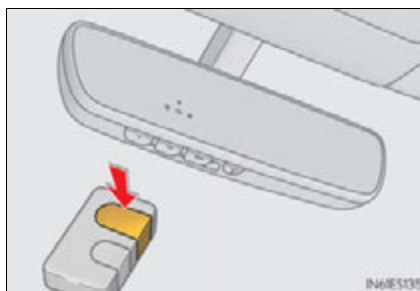

► Programming an entry gate (for U.S.A. owners)/Programming a device in the Canadian market

- 3 Press and release the remote control transmitter button at 2 second intervals, repeatedly, until the HomeLink® indicator light changes from slowly flashing (orange) to rapidly flashing (green) (rolling code) or continuously lit (green) (fixed code).

- 4 Test the HomeLink® operation by pressing the newly programmed button and observing the indicator light:

- Device with fixed code: If the indicator light is solid/continuous, programming has been completed and your garage door or other device should operate when the HomeLink® button is pressed and released.
- Device with rolling code: If the indicator light flashes rapidly, your garage door opener motor (or other device) is equipped with a rolling code. Complete the programming process by firmly pressing and holding the programmed HomeLink® button for 2 seconds and then release the button.



- If the garage door or other device does not operate, proceed to “Programming a rolling code system”.

- 5 Repeat the steps above to program another device for any of the remaining HomeLink® buttons.

■ **Programming a rolling code system**

- 1 Locate the “Learn” or “Smart” button on the garage door opener motor in the garage.

This button can usually be found where the hanging antenna wire is attached to the unit. The name and color of the button may vary by manufacturer. Refer to the owner’s manual supplied with the garage door opener motor for details.

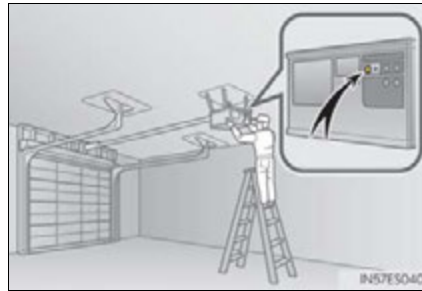

- 2 Press and release the “Learn” or “Smart” button.  
Perform 3 within 30 seconds after performing 2.

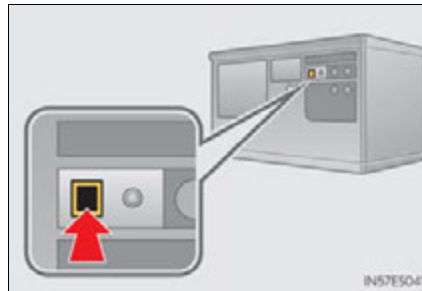

- 3 Press and hold the desired HomeLink® button (inside the vehicle) for 2 seconds and release it. Repeat this sequence (press/hold/release) up to 3 times to complete programming.

If the garage door opener motor operates when the HomeLink® button is pressed, the garage door opener motor recognizes the HomeLink® signal.

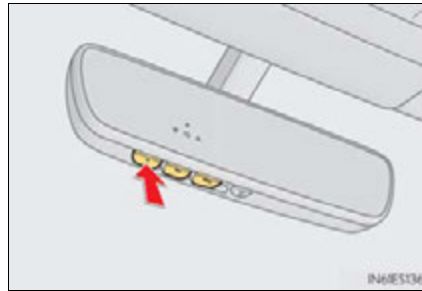

**■ Enabling 2-way communication with a garage door (only available for compatible devices)**

When enabled, 2-way communication allows you to check the status of the opening and closing of a garage door through indicators in your vehicle.

2-way communication is only available if the garage door opener motor used is a compatible device. (To check device compatibility, refer to [www.HomeLink.com](http://www.HomeLink.com).)

- 1 Within 5 seconds after programming the garage door opener has been completed, if the garage door opener motor is trained to HomeLink<sup>®</sup>, both garage door operation indicators will flash rapidly (green) and the light on the garage door opener motor will blink twice, indicating that 2-way communication is enabled.

If the indicators do not flash, perform **2** and **3** within the first 10 presses of the HomeLink<sup>®</sup> button after programming has been completed.

- 2 Press a programmed HomeLink<sup>®</sup> button to operate a garage door.
- 3 Within 1 minute of pressing the HomeLink<sup>®</sup> button, after the garage door operation has stopped, press the “Learn” or “Smart” button on the garage door opener motor. Within 5 seconds of the establishment of 2-way communication with the garage door opener, both garage door operation indicators in the vehicle will flash rapidly (green) and the light on the garage door opener motor will blink twice, indicating that 2-way communication is enabled.

**■ Reprogramming a single HomeLink<sup>®</sup> button**

When the following procedure is performed, buttons which already have devices registered to them can be overwritten:

- 1 With one hand, press and hold the desired HomeLink<sup>®</sup> button.
- 2 When the HomeLink<sup>®</sup> indicator starts flashing (orange), continue to hold the HomeLink<sup>®</sup> button and perform “Programming HomeLink<sup>®</sup>” **1** (it takes 20 seconds for the HomeLink<sup>®</sup> indicator to start flashing).

**Operating HomeLink<sup>®</sup>**

Press the appropriate HomeLink<sup>®</sup> button. The HomeLink<sup>®</sup> indicator light should turn on.

### Garage door operation indicators

The status of the opening and closing of a garage door is shown by the indicators.



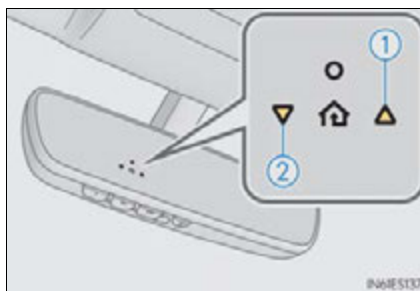

- ① Opening
- ② Closing

This function is only available if the garage door opener motor used is a compatible device. (To check device compatibility, refer to [www.HomeLink.com](http://www.HomeLink.com).)



Color	Status
Orange (flashing)	Currently opening/closing
Green	Opening/closing has completed
Red (flashing)	Feedback signals cannot be received

The indicators can operate within approximately 820 ft. (250 m) of the garage door. However, if there are obstructions between the garage door and the vehicle, such as houses and trees, feedback signals from the garage door may not be received.

To recall the previous door operation status, press and release either HomeLink® buttons  and  or  and  simultaneously. The last recorded status will be displayed for 3 seconds.

### Erasing the entire HomeLink® memory (all three codes)

Press and hold the 2 outside buttons for 10 seconds until the HomeLink® indicator light changes from continuously lit (orange) to rapidly flashing (green).

If you sell your vehicle, be sure to erase the programs stored in the HomeLink® memory.

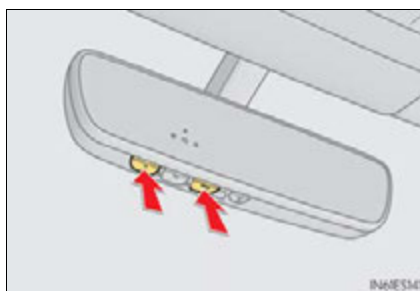

- **Codes stored in the HomeLink<sup>®</sup> memory**
  - The registered codes are not erased even if the battery cable is disconnected.
  - If learning failed when registering a different code to a HomeLink<sup>®</sup> button that already has a code registered to it, the already registered code will not be erased.
- **Before programming**
  - Install a new battery in the transmitter.
  - The battery side of the transmitter must be pointed away from the HomeLink<sup>®</sup>.
- **Certification for the garage door opener**
  - ▶ For vehicles sold in the U.S.A., Hawaii, Guam and Puerto Rico

**This device complies with part 15 of the FCC Rules. Operation is subject to the following two conditions: (1) This device may not cause harmful interference, and (2) this device must accept any interference received, including interference that may cause undesired operation.**

**changes or modifications not expressly approved by the party responsible for compliance could void the user's authority to operate the equipment.**

- ▶ For vehicles sold in Canada

*This device complies with Industry Canada licence-exempt RSS standard(s). Operation is subject to the following two conditions: (1) this device may not cause interference, and (2) this device must accept any interference, including interference that may cause undesired operation of the device.*

*Le présent appareil est conforme aux CNR d'Industrie Canada applicables aux appareils radio exempts de licence. L'exploitation est autorisée aux deux conditions suivantes : (1) l'appareil ne doit pas produire de brouillage, et (2) l'utilisateur de l'appareil doit accepter tout brouillage radioélectrique subi, même si le brouillage est susceptible d'en compromettre le fonctionnement.*

- **When support is necessary**  
Visit on the web at [www.homelink.com](http://www.homelink.com) or call 1-800-355-3515.

 **WARNING****■ When programming a garage door or other remote control device**

The garage door or other device may operate, so ensure people and objects are out of danger to prevent potential harm.

**■ Conforming to federal safety standards**

Do not use the HomeLink<sup>®</sup> compatible transceiver with any garage door opener or device that lacks safety stop and reverse features as required by federal safety standards.

This includes any garage door that cannot detect an interfering object. A door or device without these features increases the risk of death or serious injury.

**■ When operating or programming HomeLink<sup>®</sup>**

Never allow a child to operate or play with the HomeLink<sup>®</sup> buttons.

## Compass\*

The compass on the inside rear view mirror indicates the direction in which the vehicle is heading.

### Operation

To turn the compass on or off, press and hold the switch for 3 second.

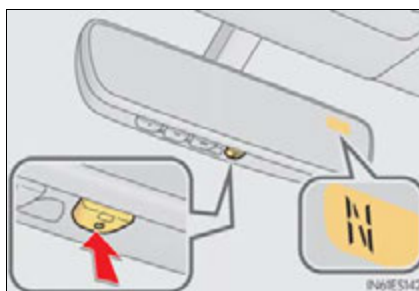

### Displays and directions

Display	Direction
"N"	North
"NE"	Northeast
"E"	East
"SE"	Southeast
"S"	South
"SW"	Southwest
"W"	West
"NW"	Northwest

\*: If equipped

### Calibrating the compass

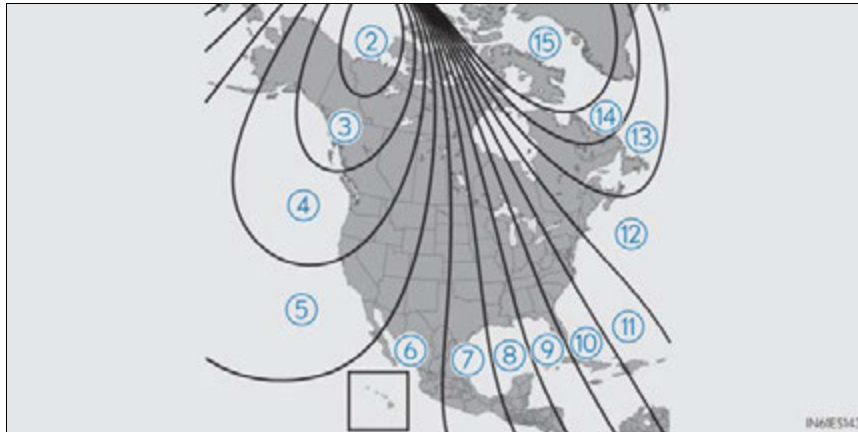

The direction display deviates from the true direction determined by the earth's magnetic field. The amount of deviation varies according to the geographic position of the vehicle.

If you cross over a map boundaries shown in illustration, the compass will deviate. To obtain higher precision or perfect calibration, refer to the following.

#### ■ Deviation calibration

- 1 Stop the vehicle.
- 2 Press and hold the switch for 6 seconds.  
A number (1 to 15) appears on the compass display.

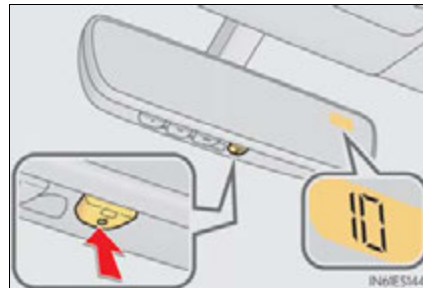

- 3 Press the switch and referring to the map above, select the number of the zone where you are.  
If the direction is displayed several seconds after adjustment, the calibration is complete.

■ **Circling calibration**

- 1 Stop the vehicle in a place where it is safe to drive in a circle.
- 2 Press and hold the switch for 9 seconds.  
"C" appears on the compass display.

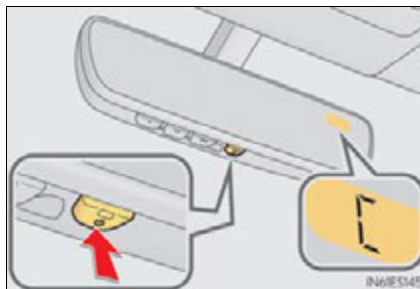

- 3 Drive the vehicle at 5 mph (8 km/h) or less in a circle until a direction is displayed.  
If there is not enough space to drive in a circle, drive around the block until the direction is displayed.

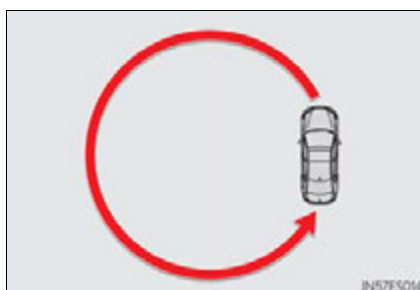

■ **Conditions unfavorable to correct operation**

The compass may not show the correct direction in the following conditions:

- The vehicle is stopped immediately after turning.
- The vehicle is on an inclined surface.
- The vehicle is in a place where the earth's magnetic field is subject to interference by artificial magnetic fields (underground car park/parking lot, under a steel tower, between buildings, roof car park/parking lot, near an intersection, near a large vehicle, etc.).
- The vehicle has become magnetized.  
(There is a magnet or metal object near the inside rear view mirror.)
- The battery has been disconnected.
- A door is open.

<p><b>⚠ WARNING</b></p>
<p>■ <b>While driving the vehicle</b> Do not adjust the display. Adjust the display only when the vehicle is stopped.</p> <p>■ <b>When doing the circling calibration</b> Secure a wide space, and watch out for people and vehicles in the neighborhood. Do not violate any local traffic rules while performing circling calibration.</p>



 NOTICE**■ To avoid the compass malfunctions**

Do not place magnets or any metal objects near the inside rear view mirror.  
Doing this may cause the compass sensor to malfunction.

**■ To ensure normal operation of the compass**

- Do not perform circling calibration of the compass in a place where the earth's magnetic field is subject to interference by artificial magnetic fields.
- During calibration, do not operate electric systems (moon roof, power windows, etc.) as they may interfere with the calibration.

## LEXUS Enform Safety Connect\*

Safety Connect is a subscription-based telematics service that uses Global Positioning System (GPS) data and embedded cellular technology to provide safety and security features to subscribers. Safety Connect is supported by Lexus' designated response center, which operates 24 hours per day, 7 days per week.

Safety Connect service is available by subscription on select, telematics hardware-equipped vehicles.

By using the Safety Connect service, you are agreeing to be bound by the Telematics Subscription Service Agreement and its Terms and Conditions, as in effect and amended from time to time, a current copy of which is available at [Lexus.com](http://Lexus.com). All use of the Safety Connect service is subject to such then-applicable Terms and Conditions.

### System components

- ① "SOS" button
- ② LED light indicators
- ③ Microphone



\*: If equipped

## Services

Subscribers have the following Safety Connect services available:

- Automatic Collision Notification\*  
Helps drivers receive necessary response from emergency service providers.  
(→P. 404)  
\*: U.S. Patent No. 7,508,298 B2
- Stolen Vehicle Location  
Helps drivers in the event of vehicle theft. (→P. 404)
- Emergency Assistance Button (“SOS”)  
Connects drivers to response-center support. (→P. 404)
- Enhanced Roadside Assistance  
Provides drivers various on-road assistance. (→P. 405)

## Subscription

After you have signed the Telematics Subscription Service Agreement and are enrolled, you can begin receiving services.

A variety of subscription terms is available for purchase. Contact your Lexus dealer, call 1-800-25-LEXUS (1-800-255-3987) or push the “SOS” button in your vehicle for further subscription details.

### ■ Safety Connect Services Information

- Phone calls using the vehicles Bluetooth® technology will not be possible during Safety Connect.
- Contact with the Safety Connect response center is dependent upon the telematics device being in operative condition, cellular connection availability, and GPS satellite signal reception, which can limit the ability to reach the response center or receive emergency service support. Enrollment and Telematics Subscription Service Agreement required. A variety of subscription terms is available; charges vary by subscription term selected.
- Automatic Collision Notification, Emergency Assistance and Stolen Vehicle Location will function in the United States, including Hawaii and Alaska, and in Canada, and Enhanced Roadside Assistance will function in the United States (except Hawaii) and in Canada. No Safety Connect services will function outside of the United States in countries other than Canada.
- Safety Connect services are not subject to section 255 of the Telecommunications Act and the device is not TTY compatible.

### ■ Languages

The Safety Connect response center will offer support in multiple languages. The Safety Connect system will offer voice prompts in English and Spanish. Please indicate your language of choice when enrolling.

### ■ When contacting the response center

You may be unable to contact the response center if the network is busy.

### Safety Connect LED light Indicators

When the engine switch is turned to IGNITION ON mode, the red indicator light comes on for 2 seconds then turns off. Afterward, the green indicator light comes on, indicating that the service is active.

The following indicator light patterns indicate specific system usage conditions:

- Green indicator light on = Active service
- Green indicator light flashing = Safety Connect call in process
- Red indicator light (except at vehicle start-up) = System malfunction (contact your Lexus dealer)
- No indicator light (off) = Safety Connect service not active

### Safety Connect services

#### ■ Automatic Collision Notification

In case of either airbag deployment or severe rear-end collision, the system is designed to automatically call the response center. The responding agent receives the vehicle's location and attempts to speak with the vehicle occupants to assess the level of emergency. If the occupants are unable to communicate, the agent automatically treats the call as an emergency, contacts the nearest emergency services provider to describe the situation, and requests that assistance be sent to the location.

#### ■ Stolen Vehicle Location

If your vehicle is stolen, Safety Connect can work with local authorities to assist them in locating and recovering the vehicle. After filing a police report, call the Safety Connect response center at 1-800-25-LEXUS (1-800-255-3987) and follow the prompts for Safety Connect to initiate this service.

In addition to assisting law enforcement with recovery of a stolen vehicle, Safety-Connect-equipped vehicle location data may, under certain circumstances, be shared with third parties to locate your vehicle. Further information is available at Lexus.com.

#### ■ Emergency Assistance Button ("SOS")

In the event of an emergency on the road, push the "SOS" button to reach the Safety Connect response center. The answering agent will determine your vehicle's location, assess the emergency, and dispatch the necessary assistance required.

If you accidentally press the "SOS" button, tell the response-center agent that you are not experiencing an emergency.

### ■ Enhanced Roadside Assistance

Enhanced Roadside Assistance adds GPS data to the already included warranty-based Lexus roadside service.

Subscribers can press the “SOS” button to reach a Safety Connect response-center agent, who can help with a wide range of needs, such as: towing, flat tire, fuel delivery, etc. For a description of the Roadside Assistance services and their limitations, please see the Safety Connect Terms and Conditions, which are available at [Lexus.com](http://Lexus.com).

## Safety information for Safety Connect

Important! Read this information before using Safety Connect.

### ■ Exposure to radio frequency signals

The Safety Connect system installed in your vehicle is a low-power radio transmitter and receiver. It receives and also sends out radio frequency (RF) signals.

In August 1996, the Federal Communications Commission (FCC) adopted RF exposure guidelines with safety levels for mobile wireless phones. Those guidelines are consistent with the safety standards previously set by the following U.S. and international standards bodies.

- ANSI (American National Standards Institute) C95.1 [1992]
- NCRP (National Council on Radiation Protection and Measurement) Report 86 [1986]
- ICNIRP (International Commission on Non-Ionizing Radiation Protection) [1996]

Those standards were based on comprehensive and periodic evaluations of the relevant scientific literature. Over 120 scientists, engineers, and physicians from universities, and government health agencies and industries reviewed the available body of research to develop the ANSI Standard (C95.1).

The design of Safety Connect complies with the FCC guidelines in addition to those standards.

■ **Certification for Lexus Enform (for vehicles sold in the U. S. A.)**

FCC ID: N7NGTM2

FCC WARNING:

This equipment complies with FCC radiation exposure limits set forth for an uncontrolled environment and meets the FCC radio frequency (RF) Exposure Guidelines in Supplement C to OET65. This equipment should be installed and operated keeping the radiator at least 20cm or more away from person's body (excluding extremities: hands, wrists, feet and ankles).

**7-1. Maintenance and care**

Cleaning and protecting  
the vehicle exterior..... 408

Cleaning and protecting  
the vehicle interior..... 411

**7-2. Maintenance**

Maintenance  
requirements.....414

General maintenance.....417

Emission inspection  
and maintenance (I/M)  
programs ..... 420

**7-3. Do-it-yourself maintenance**

Do-it-yourself service  
precautions.....421

Hood ..... 423

Positioning a floor jack..... 424

Engine compartment ..... 425

Tires.....436

Tire inflation pressure ..... 444

Wheels ..... 447

Air conditioning filter ..... 449

Electronic key battery .....451

Checking and replacing  
fuses..... 453

Light bulbs..... 456

## Cleaning and protecting the vehicle exterior

Perform the following to protect the vehicle and maintain it in prime condition:

- Working from top to bottom, liberally apply water to the vehicle body, wheel wells and underside of the vehicle to remove any dirt and dust.
- Wash the vehicle body using a sponge or soft cloth, such as a chamois.
- For hard-to-remove marks, use car wash soap and rinse thoroughly with water.
- Wipe away any water.
- Wax the vehicle when the waterproof coating deteriorates.  
If water does not bead on a clean surface, apply wax when the vehicle body is cool.

### ■ Self-restoring coat

The vehicle body has a self-restoring coating that is resistant to small surface scratches caused in a car wash etc.

- The coating lasts for 5 to 8 years from when the vehicle is delivered from the plant.
- The restoration time differs depending on the depth of the scratch and outside temperature. The restoration time may become shorter when the coating is warmed by applying warm water.
- Deep scratches caused by keys, coins, etc. cannot be restored.
- Do not use wax that contain abrasives.

### ■ Automatic car washes

- Fold the mirrors before washing the vehicle. Start washing from the front of the vehicle. Make sure to extend the mirrors before driving.
- Brushes used in automatic car washes may scratch the vehicle surface and harm your vehicle's paint.
- Rear spoiler (if equipped) may not be washable in some automatic car washes. There may also be an increased risk of damage to vehicle.

### ■ High pressure car washes

- Do not allow the nozzles of the car wash to come within close proximity of the windows.
- Before using the car wash, check that the fuel filler door on your vehicle is closed properly.

### ■ Notes for a smart access system with push-button start

If the door handle becomes wet while the electronic key is within the effective range, the door may lock and unlock repeatedly. In that case, follow the following correction procedures to wash the vehicle:

- Place the key in a position 6 ft. (2 m) or more separate from the vehicle while the vehicle is being washed. (Take care to ensure that the key is not stolen.)
- Set the electronic key to battery-saving mode to disable the smart access system with push-button start. (→P. 108)



### ■ Aluminum wheels

- Remove any dirt immediately by using a neutral detergent. Do not use hard brushes or abrasive cleaners. Do not use strong or harsh chemical cleaners. Use the same mild detergent and wax as used on the paint.
- Do not use detergent on the wheels when they are hot, for example after driving for long distance in the hot weather.
- Wash detergent from the wheels immediately after use.

### ■ Bumpers and side moldings

Do not scrub with abrasive cleaners.

### ⚠ WARNING

#### ■ When washing the vehicle

Do not apply water to the inside of the engine compartment. Doing so may cause the electrical components, etc., to be damaged or catch fire.

#### ■ When cleaning the windshield (vehicles with rain-sensing windshield wipers)

Set the wiper switch to off.  
If the switch is in "AUTO", the wipers may operate unexpectedly in the following situations, and may result in hands being caught or other serious injuries and cause damage to the wiper blades.

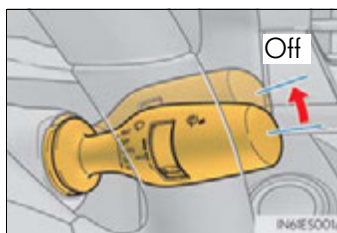

- When the upper part of the windshield where the raindrop sensor is located is touched by hand
- When a wet rag or similar is held close to the raindrop sensor
- If something bumps against the windshield
- If you directly touch the raindrop sensor body or if something bumps into the raindrop sensor

#### ■ Precautions regarding the exhaust pipes and rear bumper diffusers

Exhaust gases cause the exhaust pipes and rear bumper diffusers to become quite hot. When washing the vehicle, be careful not to touch the pipes and diffusers until they have cooled sufficiently, as touching hot exhaust pipes and rear bumper diffusers can cause burns.

#### ■ Precaution regarding the Blind Spot Monitor (if equipped)

If the paint of the rear bumper is chipped or scratched, the system may malfunction. If this occurs, consult your Lexus dealer.

 NOTICE**■ To prevent paint deterioration and corrosion on the body and components (aluminum wheels etc.)**

- Wash the vehicle immediately in the following cases:
  - After driving near the sea coast
  - After driving on salted roads
  - If coal tar or tree sap is present on the paint surface
  - If dead insects, insect droppings or bird droppings are present on the paint surface
  - After driving in an area contaminated with soot, oily smoke, mine dust, iron powder or chemical substances
  - If the vehicle becomes heavily soiled with dust or mud
  - If liquids such as benzene and gasoline are spilled on the paint surface
- If the paint is chipped or scratched, have it repaired immediately.
- To prevent the wheels from corroding, remove any dirt and store in a place with low humidity when storing the wheels.

**■ Cleaning the exterior lights**

- Wash carefully. Do not use organic substances or scrub with a hard brush. This may damage the surfaces of the lights.
- Do not apply wax to the surfaces of the lights. Wax may cause damage to the lenses.

**■ When using an automatic car wash (vehicles with rain-sensing windshield wipers)**

Set the wiper switch to the off position.

If the wiper switch is in "AUTO", the wipers may operate and the wiper blades may be damaged.

**■ When cleaning the windshield**

Raise the wipers in line with the windshield. (→P. 262)

Failure to do so may result in damage to the wipers and/or the hood.

**■ When using a high pressure car wash**

Do not bring the nozzle tip close to boots (rubber or resin manufactured cover), connectors or the following parts. The parts may be damaged if they come into contact with high-pressure water.

- Traction related parts
- Steering parts
- Suspension parts
- Brake parts

## Cleaning and protecting the vehicle interior

The following procedures will help protect your vehicle's interior and keep it in top condition:

### Protecting the vehicle interior

Remove dirt and dust using a vacuum cleaner. Wipe dirty surfaces with a cloth dampened with lukewarm water.

### Cleaning the leather areas

- Remove dirt and dust using a vacuum cleaner.
- Wipe off any excess dirt and dust with a soft cloth dampened with diluted detergent.  
Use a diluted water solution of approximately 5% neutral wool detergent.
- Wring out any excess water from the cloth and thoroughly wipe off all remaining traces of detergent.
- Wipe the surface with a dry, soft cloth to remove any remaining moisture. Allow the leather to dry in a shaded and ventilated area.

### Cleaning the synthetic leather areas

- Remove loose dirt using a vacuum cleaner.
- Apply a mild soap solution to the synthetic leather using a sponge or soft cloth.
- Allow the solution to soak in for a few minutes. Remove the dirt and wipe off the solution with a clean, damp cloth.

■ **Caring for leather areas**

Lexus recommends cleaning the interior of the vehicle at least twice a year to maintain the quality of the vehicle's interior.

■ **Shampooing the carpets**

There are several commercial foaming-type cleaners available. Use a sponge or brush to apply the foam. Rub in overlapping circles. Do not use water. Wipe dirty surfaces and let them dry. Excellent results are obtained by keeping the carpet as dry as possible.

■ **Seat belts**

Clean with mild soap and lukewarm water using a cloth or sponge. Also check the belts periodically for excessive wear, fraying or cuts.

■ **When cleaning the carpeted portions of the glove box, console box, etc.**

If a strong adhesive tape is used, there is a possibility that the surface of the carpet could be damaged.

 **WARNING**

■ **Water in the vehicle**

- Do not splash or spill liquid in the vehicle.  
Doing so may cause electrical components etc. to malfunction or catch fire.
- Do not get any of the SRS components or wiring in the vehicle interior wet. (→P. 36)  
An electrical malfunction may cause the airbags to deploy or not function properly, resulting in death or serious injury.

■ **Cleaning the interior (especially instrument panel)**

Do not use polish wax or polish cleaner. The instrument panel may reflect off the windshield, obstructing the driver's view and leading to an accident, resulting in death or serious injury.

 NOTICE**■ Cleaning detergents**

- Do not use the following types of detergent, as they may discolor the vehicle interior or cause streaks or damage to painted surfaces:
  - Non-seat portions: Organic substances such as benzene or gasoline, alkaline or acidic solutions, dye, and bleach
  - Seats: Alkaline or acidic solutions, such as thinner, benzene, and alcohol
- Do not use polish wax or polish cleaner. The instrument panel's or other interior part's painted surface may be damaged.

**■ Preventing damage to leather surfaces**

Observe the following precautions to avoid damage to and deterioration of leather surfaces:

- Remove any dust or dirt from leather surfaces immediately.
- Do not expose the vehicle to direct sunlight for extended periods of time. Park the vehicle in the shade, especially during summer.
- Do not place items made of vinyl, plastic, or containing wax on the upholstery, as they may stick to the leather surface if the vehicle interior heats up significantly.

**■ Water on the floor**

Do not wash the vehicle floor with water.

Vehicle systems such as the audio system may be damaged if water comes into contact with electrical components such as the audio system above or under the floor of the vehicle. Water may also cause the body to rust.

**■ When cleaning the inside of the windshield (vehicles with Lexus Safety System+)**

Do not allow glass cleaner to contact the lens. Also, do not touch the lens. (→P. 178)

**■ Cleaning the inside of the rear window**

- Do not use glass cleaner to clean the rear window, as this may cause damage to the rear window defogger heater wires or antenna. Use a cloth dampened with luke-warm water to gently wipe the window clean. Wipe the window in strokes running parallel to the heater wires or antenna.
- Be careful not to scratch or damage the heater wires or antenna.

## Maintenance requirements

To ensure safe and economical driving, day-to-day care and regular maintenance are essential. It is the owner's responsibility to perform regular checks. Lexus recommends the following maintenance:

### General maintenance

General maintenance should be performed on a daily basis. This can be done by yourself or by a Lexus dealer.

### Scheduled maintenance

Scheduled maintenance should be performed at specified intervals according to the maintenance schedule.

For details about maintenance items and schedules, refer to the "Warranty and Service Guide", "Owner's Manual Supplement" or "Scheduled Maintenance".

### Do-it-yourself maintenance

You can perform some maintenance procedures by yourself.

Please be aware that do-it-yourself maintenance may affect warranty coverage.

The use of Lexus repair manuals is recommended.

For details about warranty coverage, refer to the separate "Owner's Guide", "Warranty and Service Guide", "Owner's Manual Supplement" or "Warranty Booklet".







### ■ Repair and replacement

It is recommended that genuine Lexus parts be used for repairs to ensure performance of each system. If non-Lexus parts are used in replacement or if a repair shop other than a Lexus dealer performs repairs, confirm the warranty coverage.

### ■ Resetting the message indicating maintenance is required (U.S.A. only)

After the required maintenance is performed according to the maintenance schedule, please reset the message.

To reset the message, follow the procedure described below:

- 1 Press  or  of the meter control switch, select .
- 2 Press  or  of the meter control switch, select "Scheduled Maintenance" and then press .
- 3 Select the "Yes" and press .

A message will be displayed when the reset procedure has been completed.

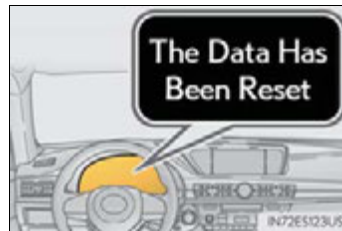

### ■ Allow inspection and repairs to be performed by a Lexus dealer

- Lexus technicians are well-trained specialists and are kept up to date with the latest service information. They are well informed about the operations of all systems on your vehicle.
- Keep a copy of the repair order. It proves that the maintenance that has been performed is under warranty coverage. If any problem should arise while your vehicle is under warranty, your Lexus dealer will promptly take care of it.

 **WARNING**

■ **If your vehicle is not properly maintained**

Improper maintenance could result in serious damage to the vehicle and possible death or serious injury.

■ **Handling of the battery**

- Engine exhaust, some of its constituents, and a wide variety of automobile components contain or emit chemicals known to the State of California to cause cancer and birth defects and other reproductive harm. Work in a well ventilated area.
- Oils, fuels and fluids contained in vehicles as well as waste produced by component wear contain or emit chemicals known to the State of California to cause cancer and birth defects or other reproductive harm. Avoid exposure and wash any affected area immediately.
- Battery posts, terminals and related accessories contain lead and lead compounds which are known to cause brain damage. Wash your hands after handling. (→P. 433)



## General maintenance

Listed below are the general maintenance items that should be performed at the intervals specified in the “Warranty and Service Guide” or “Owner’s Manual Supplement”. It is recommended that any problem you notice should be brought to the attention of your Lexus dealer or qualified service shop for advice.

### Engine compartment

Items	Check points
Battery	Check the battery fluid level and connections. (→P. 433)
Brake fluid	Is the brake fluid at the correct level? (→P. 432)
Engine coolant	Is the engine coolant at the correct level? (→P. 430)
Engine oil	Is the engine oil at the correct level? (→P. 427)
Exhaust system	There should not be any fumes or strange sounds.
Radiator/condenser	The radiator and condenser should be free from foreign objects. (→P. 431)
Washer fluid	Is there sufficient washer fluid? (→P. 435)

**Vehicle interior**

Items	Check points
Accelerator pedal	<ul style="list-style-type: none"> <li>The accelerator pedal should move smoothly (without uneven pedal effort or catching).</li> </ul>
Automatic transmission "Park" mechanism	<ul style="list-style-type: none"> <li>When parked on a slope and the shift lever is in P, is the vehicle securely stopped?</li> </ul>
Brake pedal	<ul style="list-style-type: none"> <li>Does the brake pedal move smoothly?</li> <li>Does the brake pedal have appropriate clearance from the floor? (→P. 517)</li> <li>Does the brake pedal have the correct amount of free play? (→P. 517)</li> </ul>
Brakes	<ul style="list-style-type: none"> <li>The vehicle should not pull to one side when the brakes are applied.</li> <li>The brakes should work effectively.</li> <li>The brake pedal should not feel spongy.</li> <li>The brake pedal should not get too close to the floor when the brakes are applied.</li> </ul>
Head restraints	<ul style="list-style-type: none"> <li>Do the head restraints move smoothly and lock securely?</li> </ul>
Indicators/buzzers	<ul style="list-style-type: none"> <li>Do the indicators and buzzers function properly?</li> </ul>
Lights	<ul style="list-style-type: none"> <li>Do all the lights come on?</li> <li>Are the headlights aimed correctly?</li> </ul>
Parking brake	<ul style="list-style-type: none"> <li>Does the parking brake pedal move smoothly?</li> <li>When parked on a slope and the parking brake is on, is the vehicle securely stopped?</li> </ul>
Seat belts	<ul style="list-style-type: none"> <li>Do the seat belts operate smoothly?</li> <li>The seat belts should not be damaged.</li> </ul>
Seats	<ul style="list-style-type: none"> <li>Do the seat controls operate properly?</li> </ul>
Steering wheel	<ul style="list-style-type: none"> <li>Does the steering wheel rotate smoothly?</li> <li>Does the steering wheel have the correct amount of free play?</li> <li>There should not be any strange sounds coming from the steering wheel.</li> </ul>

**Vehicle exterior**

Items	Check points
Doors/trunk	<ul style="list-style-type: none"> <li>Do the doors/trunk operate smoothly?</li> </ul>
Engine hood	<ul style="list-style-type: none"> <li>Does the engine hood lock system work properly?</li> </ul>
Fluid leaks	<ul style="list-style-type: none"> <li>There should not be any signs of fluid leakage after the vehicle has been parked.</li> </ul>
Tires	<ul style="list-style-type: none"> <li>Is the tire inflation pressure correct?</li> <li>The tires should not be damaged or excessively worn.</li> <li>Have the tires been rotated according to the maintenance schedule?</li> <li>The wheel nuts should not be loose.</li> </ul>
Windshield wipers	<ul style="list-style-type: none"> <li>The wiper blades should not show any signs of cracking, splitting, wear, contamination or deformation.</li> <li>The wiper blades should clear the windshield without streaking or skipping.</li> </ul>

**⚠ WARNING****■ If the engine is running**

Turn the engine off and ensure that there is adequate ventilation before performing maintenance checks.

## Emission inspection and maintenance (I/M) programs

Some states have vehicle emission inspection programs which include OBD (On Board Diagnostics) checks. The OBD system monitors the operation of the emission control system.

### If the malfunction indicator lamp comes on

The OBD system determines that a problem exists somewhere in the emission control system. Your vehicle may not pass the I/M test and may need to be repaired. Contact your Lexus dealer to service the vehicle.

### Your vehicle may not pass the I/M test in the following situations:

- When the battery is disconnected or discharged  
Readiness codes that are set during ordinary driving are erased.  
Also, depending on your driving habits, the readiness codes may not be completely set.
- When the fuel tank cap is loose  
The malfunction indicator lamp comes on indicating a temporary malfunction and your vehicle may not pass the I/M test.

### When the malfunction indicator lamp still remains on after several driving trips

The error code in the OBD system will not be cleared unless the vehicle is driven 40 or more times.

### If your vehicle does not pass the I/M test

Contact your Lexus dealer to prepare the vehicle for re-testing.

## Do-it-yourself service precautions

If you perform maintenance by yourself, be sure to follow the correct procedure as given in these sections.

Items	Parts and tools
Battery condition (→P. 433)	<ul style="list-style-type: none"> <li>• Warm water</li> <li>• Baking soda</li> <li>• Grease</li> <li>• Conventional wrench (for terminal clamp bolts)</li> </ul>
Brake fluid level (→P. 432)	<ul style="list-style-type: none"> <li>• FMVSS No.116 DOT 3 or SAE J1703 brake fluid</li> <li>• Rag or paper towel</li> <li>• Funnel (used only for adding brake fluid)</li> </ul>
Engine coolant level (→P. 430)	<ul style="list-style-type: none"> <li>• "Toyota Super Long Life Coolant" or a similar high quality ethylene glycol-based non-silicate, non-amine, non-nitrite and non-borate coolant with long-life hybrid organic acid technology</li> <li>For the U.S.A.: "Toyota Super Long Life Coolant" is pre-mixed with 50% coolant and 50% deionized water.</li> <li>For Canada: "Toyota Super Long Life Coolant" is pre-mixed with 55% coolant and 45% deionized water.</li> <li>• Funnel (used only for adding coolant)</li> </ul>
Engine oil level (→P. 427)	<ul style="list-style-type: none"> <li>• "Toyota Genuine Motor Oil" or equivalent</li> <li>• Rag or paper towel</li> <li>• Funnel (used only for adding engine oil)</li> </ul>
Fuses (→P. 453)	<ul style="list-style-type: none"> <li>• Fuse with same amperage rating as original</li> </ul>
Light bulbs (→P. 456)	<ul style="list-style-type: none"> <li>• Bulb with same number and wattage rating as original</li> <li>• Phillips-head screwdriver</li> <li>• Flathead screwdriver</li> <li>• Wrench</li> </ul>
Radiator and condenser (→P. 431)	—
Tire inflation pressure (→P. 444)	<ul style="list-style-type: none"> <li>• Tire pressure gauge</li> <li>• Compressed air source</li> </ul>
Washer fluid (→P. 435)	<ul style="list-style-type: none"> <li>• Water or washer fluid containing antifreeze (for winter use)</li> <li>• Funnel (used only for adding water or washer fluid)</li> </ul>

 **WARNING**

The engine compartment contains many components and fluids that may move suddenly, become hot, or become electrically energized. To avoid death or serious injury, observe the following precautions.

**■ When working on the engine compartment**

- Keep hands, clothing and tools away from the moving fan and engine drive belt.
- Be careful not to touch the engine, radiator, exhaust manifold, etc. right after driving as they may be hot. Oil and other fluids may also be hot.
- Do not leave anything that may burn easily, such as paper and rags, in the engine compartment.
- Do not smoke, cause sparks or expose an open flame to fuel or the battery. Fuel and battery fumes are flammable.
- Be extremely cautious when working on the battery. It contains poisonous and corrosive sulfuric acid.

**■ When working near the electric cooling fans or radiator grille**

Be sure the engine switch is off.

With the engine switch in IGNITION ON mode, the electric cooling fans may automatically start to run if the air conditioning is on and/or the coolant temperature is high. (→P. 431)

**■ Safety glasses**

Wear safety glasses to prevent flying or falling material, fluid spray, etc. from getting in your eyes.

 **NOTICE****■ If you remove the air cleaner filter**

Driving with the air cleaner filter removed may cause excessive engine wear due to dirt in the air.

## Hood

Release the lock from the inside of the vehicle to open the hood.

- 1 Pull the hood lock release lever.  
The hood will pop up slightly.

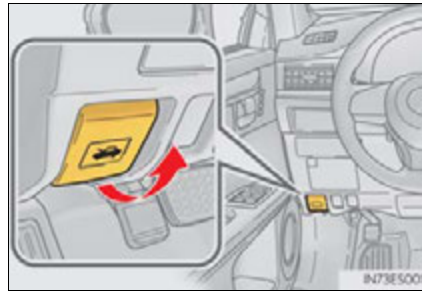

- 2 Pull up the auxiliary catch lever and lift the hood.

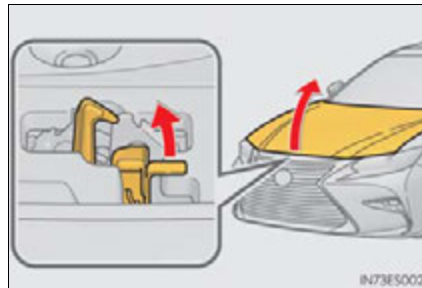

### WARNING

#### ■ Pre-driving check

Check that the hood is fully closed and locked.  
If the hood is not locked properly, it may open while the vehicle is in motion and cause an accident, which may result in death or serious injury.

## Positioning a floor jack

When using a floor jack, follow the instructions in the manual provided with the jack and perform the operation safely.

When raising your vehicle with a floor jack, position the jack correctly. Improper placement may damage your vehicle or cause injury.

### ◆ Front

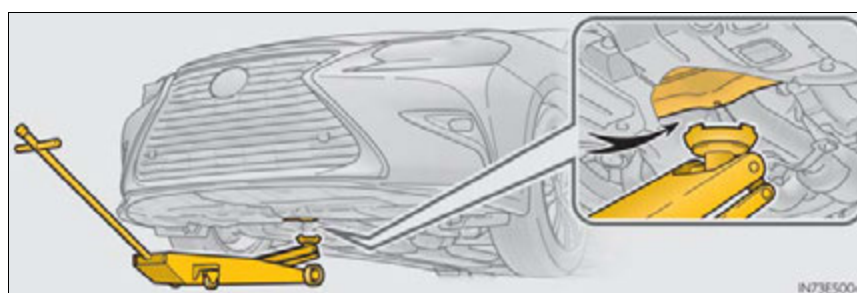

### ◆ Rear

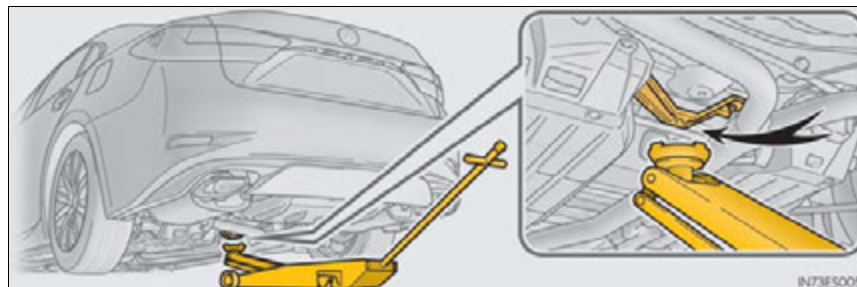



## Engine compartment

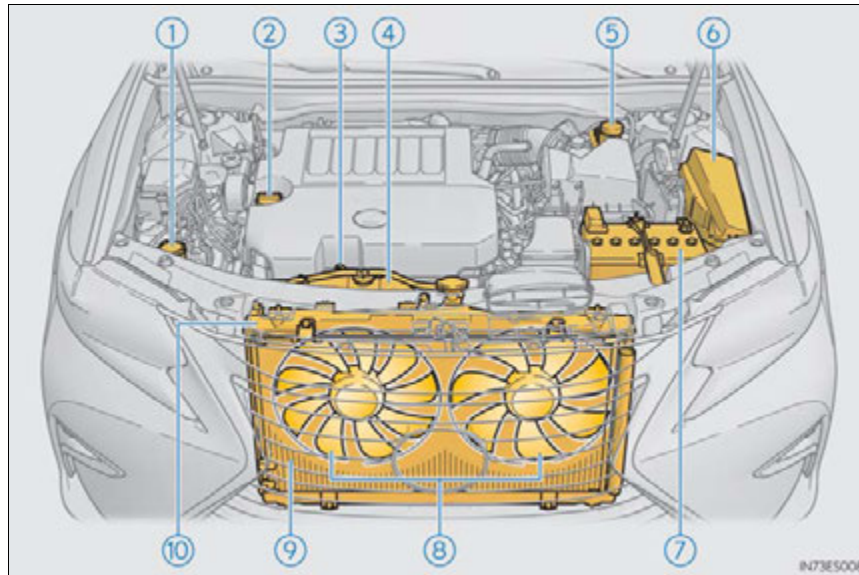

- |                             |           |                         |           |
|-----------------------------|-----------|-------------------------|-----------|
| ① Washer fluid tank         | (→P. 435) | ⑤ Brake fluid reservoir | (→P. 432) |
| ② Engine oil filler cap     | (→P. 428) | ⑥ Fuse box              | (→P. 453) |
| ③ Engine oil level dipstick | (→P. 427) | ⑦ Battery               | (→P. 433) |
| ④ Engine coolant reservoir  | (→P. 430) | ⑧ Electric cooling fans |           |
|                             |           | ⑨ Condenser             | (→P. 431) |
|                             |           | ⑩ Radiator              | (→P. 431) |

### Engine compartment cover

#### ■ Removing the engine compartment cover

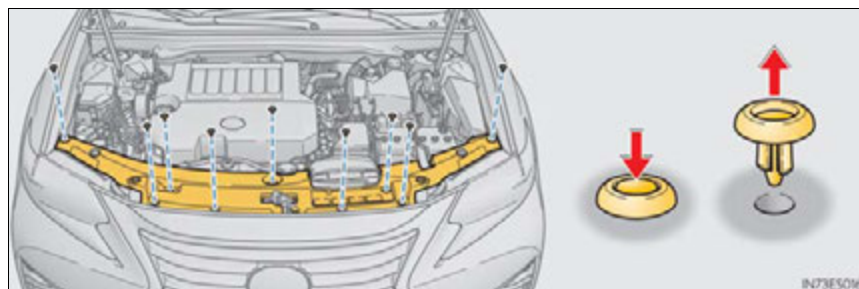

#### ■ Installing the clips

- ① Push up center portion
- ② Insert
- ③ Press

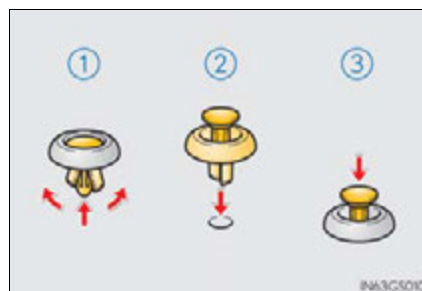

#### ⚠ NOTICE

#### ■ Checking the engine compartment cover after installation

Make sure that the cover is securely installed in its original position.

## Engine oil

With the engine at operating temperature and turned off, check the oil level on the dipstick.

### ■ Checking the engine oil

- 1 Park the vehicle on level ground.

After warming up the engine and turning it off, wait more than 5 minutes for the oil to drain back into the bottom of the engine.

- 2 Holding a rag under the end, pull the dipstick out.

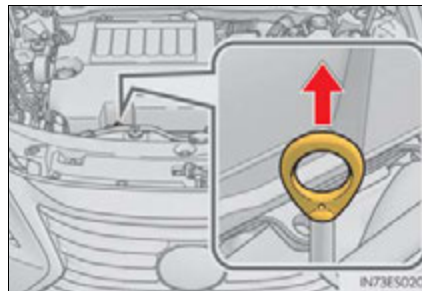

- 3 Wipe the dipstick clean.
- 4 Reinsert the dipstick fully.
- 5 Holding a rag under the end, pull the dipstick out and check the oil level.
  - 1 Low
  - 2 Normal
  - 3 Excessive

#### ► Flat dipstick

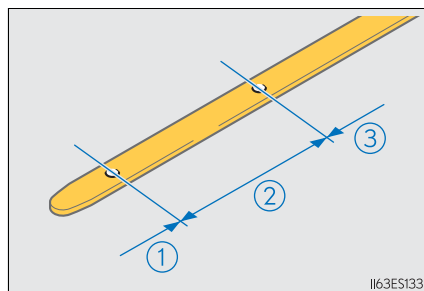

#### ► Non-flat dipstick

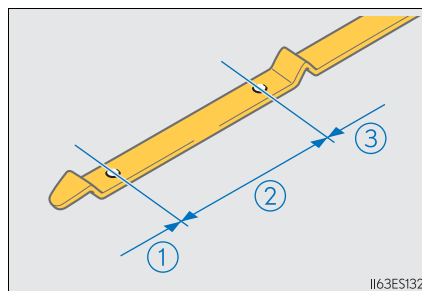

The shape of the dipstick may differ depending on the type of vehicle or engine.

- 6 Wipe the dipstick and reinsert it fully.

■ **Adding engine oil**

If the oil level is below or near the low level mark, add engine oil of the same type as that already in the engine.

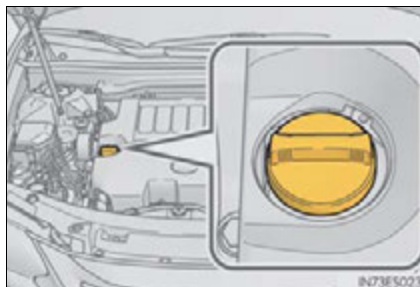

Make sure to check the oil type and prepare the items needed before adding oil.

Engine oil selection	→P. 515
Oil quantity (Low → Full)	1.6 qt. (1.5 L, 1.3 Imp.qt.)
Items	Clean funnel

- 1** Remove the oil filler cap by turning it counterclockwise.
- 2** Add engine oil slowly, checking the dipstick.
- 3** Install the oil filler cap by turning it clockwise.







### ■ Engine oil consumption

A certain amount of engine oil will be consumed while driving. In the following situations, oil consumption may increase, and engine oil may need to be refilled in between oil maintenance intervals.

- When the engine is new, for example directly after purchasing the vehicle or after replacing the engine
- If low quality oil or oil of an inappropriate viscosity is used
- When driving at high engine speeds or with a heavy load, or when driving while accelerating or decelerating frequently
- When leaving the engine idling for a long time, or when driving frequently through heavy traffic

### ■ After changing the engine oil

The engine oil maintenance data should be reset. Perform the following procedures:

- 1 Press  or  of the meter control switch, select .
- 2 Press  or  of the meter control switch, select "Oil Maintenance" and then press .
- 3 Select the "Yes" and press .

A message will be displayed when the reset procedure has been completed.

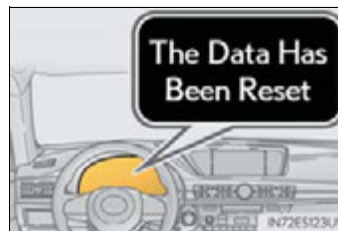

### WARNING

#### ■ Used engine oil

- Used engine oil contains potentially harmful contaminants which may cause skin disorders such as inflammation and skin cancer, so care should be taken to avoid prolonged and repeated contact. To remove used engine oil from your skin, wash thoroughly with soap and water.
- Dispose of used oil and filters only in a safe and acceptable manner. Do not dispose of used oil and filters in household trash, in sewers or onto the ground.  
Call your Lexus dealer, service station or auto parts store for information concerning recycling or disposal.
- Do not leave used engine oil within the reach of children.

 NOTICE

■ **To prevent serious engine damage**

Check the oil level on a regular basis.

■ **When replacing the engine oil**

- Be careful not to spill engine oil on the vehicle components.
- Avoid overfilling, or the engine could be damaged.
- Check the oil level on the dipstick every time you refill the vehicle.
- Be sure the engine oil filler cap is properly tightened.

### Engine coolant

The coolant level is satisfactory if it is between the “FULL” and “LOW” lines on the reservoir when the engine is cold.

- ① Reservoir cap
- ② “FULL” line
- ③ “LOW” line

If the level is on or below the “LOW” line, add coolant up to the “FULL” line.  
(→P. 505)

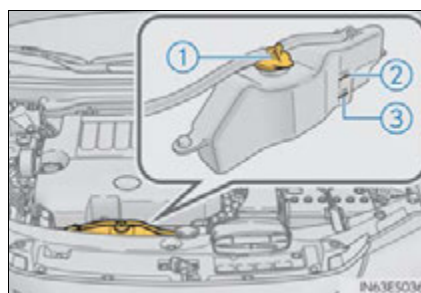

■ **Coolant selection**

Only use “Toyota Super Long Life Coolant” or a similar high quality ethylene glycol based non-silicate, non-amine, non-nitrite, and non-borate coolant with long-life hybrid organic acid technology.

U.S.A.:

“Toyota Super Long Life Coolant” is a mixture of 50% coolant and 50% deionized water.  
(Minimum temperature: -31°F [-35°C])

Canada:

“Toyota Super Long Life Coolant” is a mixture of 55% coolant and 45% deionized water.  
(Minimum temperature: -44°F [-42°C])

For more details about coolant, contact your Lexus dealer.

■ **If the coolant level drops within a short time of replenishing**

Visually check the radiator, hoses, engine coolant reservoir cap, drain cock and water pump.

If you cannot find a leak, have your Lexus dealer test the cap and check for leaks in the cooling system.

**⚠ WARNING****■ When the engine is hot**

Do not remove the engine coolant reservoir cap or the radiator cap. The cooling system may be under pressure and may spray hot coolant if the cap is removed, causing serious injuries, such as burns.

**⚠ NOTICE****■ When adding coolant**

Coolant is neither plain water nor straight antifreeze. The correct mixture of water and antifreeze must be used to provide proper lubrication, corrosion protection and cooling. Be sure to read the antifreeze or coolant label.

**■ If you spill coolant**

Be sure to wash it off with water to prevent it from damaging parts or paint.

**Radiator and condenser**

Check the radiator and condenser and clear away any foreign objects. If either of the above parts is extremely dirty or you are not sure of their condition, have your vehicle inspected by your Lexus dealer.

**⚠ WARNING****■ When the engine is hot**

Do not touch the radiator or condenser as they may be hot and cause serious injuries, such as burns.

### Brake fluid

#### ■ Checking fluid level

The brake fluid level should be between the “MAX” and “MIN” lines on the tank.

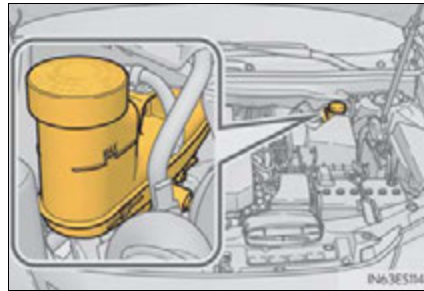

#### ■ Adding fluid

Make sure to check the fluid type and prepare the necessary item.

Fluid type	FMVSS No.116 DOT 3 or SAE J1703 brake fluid
Items	Clean funnel

#### ■ Brake fluid can absorb moisture from the air

Excess moisture in the brake fluid can cause a dangerous loss of braking efficiency. Use only newly opened brake fluid.

#### ⚠ WARNING

##### ■ When filling the reservoir

Take care as brake fluid can harm your hands and eyes and damage painted surfaces. If fluid gets on your hands or in your eyes, flush the affected area with clean water immediately. If you still experience discomfort, see a doctor.

#### ⚠ NOTICE

##### ■ If the fluid level is low or high

It is normal for the brake fluid level to go down slightly as the brake pads wear out or when the fluid level in the accumulator is high. If the reservoir needs frequent refilling, there may be a serious problem.



## Battery

Check the battery as follows.

### ■ Battery exterior

Make sure that the battery terminals are not corroded and that there are no loose connections, cracks, or loose clamps. Make sure that the terminal covers are secured over the battery terminals.

- ① Terminals
- ② Hold-down clamp

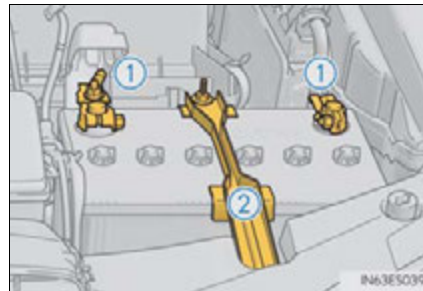

### ■ Before recharging

When recharging, the battery produces hydrogen gas which is flammable and explosive. Therefore, observe the following before recharging:

- If recharging with the battery installed on the vehicle, be sure to disconnect the ground cable.
- Make sure the power switch on the charger is off when connecting and disconnecting the charger cables to the battery.

### ■ After recharging/reconnecting the battery

The engine may not start. Follow the procedure below to initialize the system.

- 1 Shift the shift lever to P.
- 2 Open and close any of the doors.
- 3 Restart the engine.
  - Unlocking the doors using the smart access system with push-button start may not be possible immediately after reconnecting the battery. If this happens, use the wireless remote control or the mechanical key to lock/unlock the doors.
  - Start the engine with the engine switch in ACCESSORY mode. The engine may not start with the engine switch turned off. However, the engine will operate normally from the second attempt.
  - The engine switch mode is recorded by the vehicle. If the battery is reconnected, the vehicle will return the engine switch mode to the status it was in before the battery was disconnected. Make sure to turn off the engine before disconnect the battery. Take extra care when connecting the battery if the engine switch mode prior to discharge is unknown.

If the engine will not start even after multiple attempts, contact your Lexus dealer.

 **WARNING****■ Chemicals in the battery**

Batteries contain poisonous and corrosive sulfuric acid and may produce hydrogen gas which is flammable and explosive. To reduce the risk of death or serious injury, take the following precautions while working on or near the battery:

- Do not cause sparks by touching the battery terminals with tools.
- Do not smoke or light a match near the battery.
- Avoid contact with eyes, skin and clothes.
- Never inhale or swallow electrolyte.
- Wear protective safety glasses when working near the battery.
- Keep children away from the battery.

**■ Where to safely charge the battery**

Always charge the battery in an open area. Do not charge the battery in a garage or closed room where there is insufficient ventilation.

**■ How to recharge the battery**

Only perform a slow charge (5 A or less). The battery may explode if charged at a quicker rate.

**■ Emergency measures regarding electrolyte**

- If electrolyte gets in your eyes  
Flush your eyes with clean water for at least 15 minutes and get immediate medical attention. If possible, continue to apply water with a sponge or cloth while traveling to the nearest medical facility.
- If electrolyte gets on your skin  
Wash the affected area thoroughly. If you feel pain or burning, get medical attention immediately.
- If electrolyte gets on your clothes  
It can soak through clothing on to your skin. Immediately take off the clothing and follow the procedure above if necessary.
- If you accidentally swallow electrolyte  
Drink a large quantity of water or milk. Get emergency medical attention immediately.

 **NOTICE****■ When recharging the battery**

Never recharge the battery while the engine is running. Also, be sure all accessories are turned off.

### Washer fluid

If any washer does not work or the warning message appears on the multi-information display, the washer tank may be empty. Add washer fluid.

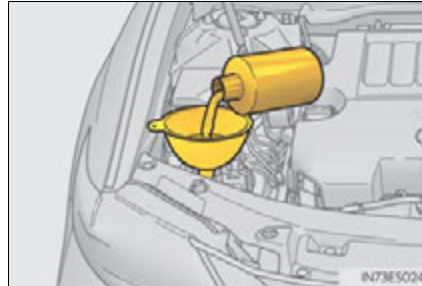

#### WARNING

##### ■ When adding washer fluid

Do not add washer fluid when the engine is hot or running as washer fluid contains alcohol and may catch fire if spilled on the engine etc.

#### NOTICE

##### ■ Do not use any fluid other than washer fluid

Do not use soapy water or engine antifreeze instead of washer fluid. Doing so may cause streaking on the vehicle's painted surfaces.

##### ■ Diluting washer fluid

Dilute washer fluid with water as necessary. Refer to the freezing temperatures listed on the label of the washer fluid bottle.

## Tires

Replace or rotate tires in accordance with maintenance schedules and treadwear.

### Checking tires

Check if the treadwear indicators are showing on the tires. Also check the tires for uneven wear, such as excessive wear on one side of the tread.

Check the spare tire condition and pressure if not rotated.

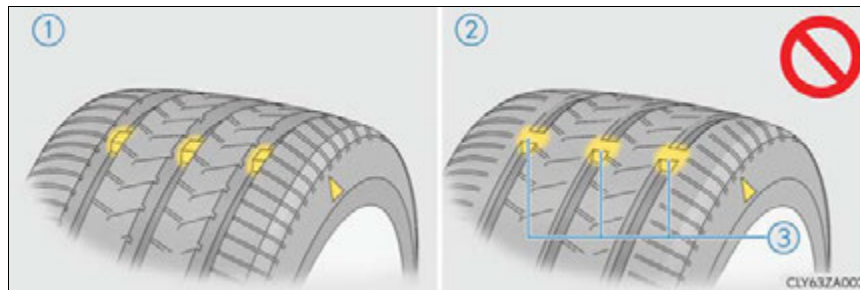

- ① New tread
- ② Worn tread
- ③ Treadwear indicator

The location of treadwear indicators is shown by a "TWI" or "Δ" mark, etc., molded into the sidewall of each tire.

Replace the tires if the treadwear indicators are showing on a tire.

### Tire rotation

Rotate the tires in the order shown.

To equalize tire wear and extend tire life, Lexus recommends that tire rotation is carried out at the same interval as tire inspection.

Do not fail to initialize the tire pressure warning system after tire rotation.

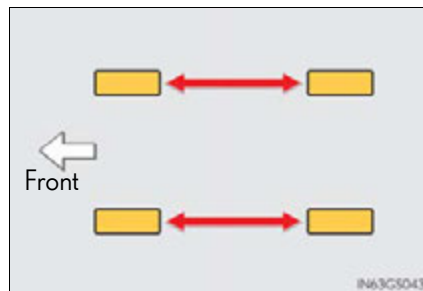

### Tire pressure warning system

Your vehicle is equipped with a tire pressure warning system that uses tire pressure warning valves and transmitters to detect low tire inflation pressure before serious problems arise.

- If the tire pressure drops below a predetermined level, the driver is warned by a screen display and a warning light. (→P. 478)
- The tire pressure detected by the tire pressure warning system can be displayed on the multi-information display. (→P. 78)

The illustration used is intended as an example, and may differ from the image that is actually displayed on the multi-information display.



### ◆ Installing tire pressure warning valves and transmitters

When replacing tires or wheels, tire pressure warning valves and transmitters must also be installed.

When new tire pressure warning valves and transmitters are installed, new ID codes must be registered in the tire pressure warning computer and the tire pressure warning system must be initialized. Have tire pressure warning valve and transmitter ID codes registered by your Lexus dealer. (→P. 438)

### ◆ Initializing the tire pressure warning system

- The tire pressure warning system must be initialized in the following circumstances:
  - When rotating the tires.
  - When the tire inflation pressure is changed such as when changing traveling speed or load weight.

When the tire pressure warning system is initialized, the current tire inflation pressure is set as the benchmark pressure.

**■ How to initialize the tire pressure warning system**

- 1** Park the vehicle in a safe place and turn the engine switch off.

Initialization cannot be performed while the vehicle is moving.

- 2** Adjust the tire inflation pressure to the specified cold tire inflation pressure level. (→P. 518)

Make sure to adjust the tire pressure to the specified cold tire inflation pressure level. The tire pressure warning system will operate based on this pressure level.

- 3** Turn the engine switch to IGNITION ON mode.

- 4** Press and hold the tire pressure warning reset switch until the tire pressure warning light blinks slowly 3 times.

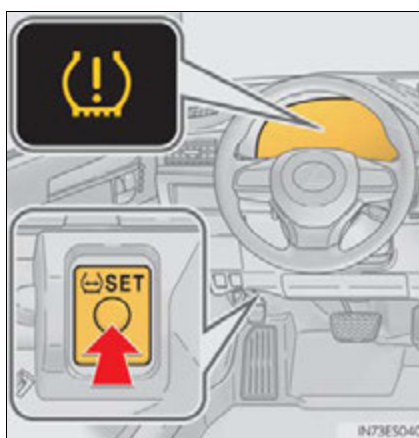

- 5** Wait for a few minutes with the engine switch in IGNITION ON mode and then turn the engine switch off.

**◆ Registering ID codes**

The tire pressure warning valve and transmitter is equipped with a unique ID code. When replacing a tire pressure warning valve and transmitter, it is necessary to register the ID code. Have the ID code registered by your Lexus dealer.

### ■ When to replace your vehicle's tires

Tires should be replaced if:

- The treadwear indicators are showing on a tire.
- You have tire damage such as cuts, splits, cracks deep enough to expose the fabric, and bulges indicating internal damage
- A tire goes flat repeatedly or cannot be properly repaired due to the size or location of a cut or other damage

If you are not sure, consult with your Lexus dealer.

### ■ Replacing tires and wheels

If the ID code of the tire pressure warning valve and transmitter is not registered, the tire pressure warning system will not work properly. After driving for about 20 minutes, the tire pressure warning light blinks for 1 minute and stays on to indicate a system malfunction.

### ■ Tire life

Any tire over 6 years old must be checked by a qualified technician even if it has seldom or never been used or damage is not obvious.

### ■ Routine tire inflation pressure checks

The tire pressure warning system does not replace routine tire inflation pressure checks. Make sure to check tire inflation pressure as part of your routine of daily vehicle checks.

### ■ When rotating the tires

Make sure that the engine switch is off. If the tires are rotated while the engine switch is in IGNITION ON mode, the tire position information will not be updated.

If this accidentally occurs, either turn the engine switch to off and then to IGNITION ON mode, or initialize the system after checking that the tire pressure is properly adjusted.

### ■ Low profile tires (P225/45R18 tires)

Generally, low profile tires will wear more rapidly and tire grip performance will be reduced on snowy and/or icy roads when compared to standard tires. Be sure to use snow tires or tire chains on snowy and/or icy roads and drive carefully at a speed appropriate for road and weather conditions.

### ■ Maximum load of tire

Check that the maximum load of the replacement tire is greater than 1/2 of the Gross Axle Weight Ratings (GAWR) of either the front axle or the rear axle, whichever is greater.

For the GAWR, see the Certification Label. For the maximum load of the tire, see the load limit at maximum cold tire inflation pressure mentioned on the sidewall of the tire.  
(→P. 524)

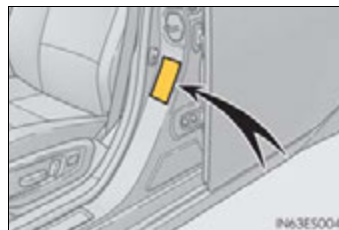

**■ Tire types****● Summer tires**

Summer tires are high-speed performance tires best suited to highway driving under dry conditions. Since summer tires do not have the same traction performance as snow tires, summer tires are inadequate for driving on snow-covered or icy roads. For driving on snow-covered roads or icy roads, the use of snow tires is recommended. When installing snow tires, be sure to replace all four tires.

**● All season tires**

All season tires are designed to provide better traction in snow and to be adequate for driving in most winter conditions as well as for use year-round. All season tires, however, do not have adequate traction performance compared with snow tires in heavy or loose snow. Also, all season tires fall short in acceleration and handling performance compared with summer tires in highway driving.

**● Snow tires**

For driving on snow-covered roads or icy roads, we recommend using snow tires. If you need snow tires, select tires of the same size, construction and load capacity as the originally installed tires. Since your vehicle has radial tires as original equipment, make sure your snow tires also have radial construction. Do not install studded tires without first checking local regulations for possible restrictions. Snow tires should be installed on all wheels. (→P. 260)

**■ If the tread on snow tires wears down below 0.16 in. (4 mm)**

The effectiveness of the tires as snow tires is lost.

**■ Situations in which the tire pressure warning system may not operate properly****● In the following cases, the tire pressure warning system may not operate properly.**

- If non-genuine Lexus wheels are used.
- A tire has been replaced with a tire that is not an OE (Original Equipment) tire.
- A tire has been replaced with a tire that is not of the specified size.
- Tire chains etc. are equipped.
- An auxiliary-supported run-flat tire is equipped.
- If a window tint that affects the radio wave signals is installed.
- If there is a lot of snow or ice on the vehicle, particularly around the wheels or wheel housings.
- If the tire inflation pressure is extremely higher than the specified level.

**● Performance may be affected in the following situations.**

- Near a TV tower, electric power plant, gas station, radio station, large display, airport or other facility that generates strong radio waves or electrical noise
- When carrying a portable radio, cellular phone, cordless phone or other wireless communication device

If tire position information is not correctly displayed due to the radio wave conditions, the display may be corrected by driving and changing the radio wave conditions.

- When the vehicle is parked, the time taken for the warning to start or go off could be extended.
- When tire inflation pressure declines rapidly for example when a tire has burst, the warning may not function.



#### ■ The initialization operation

- Make sure to carry out initialization after adjusting the tire inflation pressure. Also, make sure the tires are cold before carrying out initialization or tire inflation pressure adjustment.
- If you have accidentally turned the engine switch off during initialization, it is not necessary to press the reset switch again as initialization will restart automatically when the engine switch has been turned to IGNITION ON mode for the next time.
- If you accidentally press the reset switch when initialization is not necessary, adjust the tire inflation pressure to the specified level when the tires are cold, and conduct initialization again.

#### ■ When initialization of the tire pressure warning system has failed

Initialization can be completed in a few minutes. However, in the following cases, the settings have not been recorded and the system will not operate properly. If repeated attempts to record tire inflation pressure settings are unsuccessful, have the vehicle inspected by your Lexus dealer.

- When operating the tire pressure warning reset switch, the tire pressure warning light does not blink 3 times.
- After carrying out the initialization procedure, the tire pressure warning light blinks for 1 minute then stays on after driving for 20 minutes.

#### ■ Tire pressure warning system certification

MODEL/FCC IDs:

Transmitter: PAXPMVC010

Initiator: HYQ22AAA

- ▶ For vehicles sold in the U.S.A., Hawaii, Guam, Saipan, American Samoa and Puerto Rico

Note:

This device complies with part 15 of the FCC Rules. Operation is subject to the following two conditions: (1) This device may not cause harmful interference, and (2) this device must accept any interference received, including interference that may cause undesired operation.

FCC WARNING:

Changes or modifications not expressly approved by the party responsible for compliance could void the user's authority to operate the equipment.

- ▶ For vehicles sold in Canada

- Transmitter

NOTE:

Operation is subject to the following two conditions: (1) this device may not cause interference, and (2) this device must accept any interference, including interference that may cause undesired operation of the device.

- Initiator

Note:

This device complies with Industry Canada licence-exempt RSS standard(s). Operation is subject to the following two conditions: (1) this device may not cause interference, and (2) this device must accept any interference, including interference that may cause undesired operation of the device.

**⚠ WARNING**

■ **When inspecting or replacing tires**

Observe the following precautions to prevent accidents. Failure to do so may cause damage to parts of the drive train as well as dangerous handling characteristics, which may lead to an accident resulting in death or serious injury.

- Make sure to install four tires that are of the specified size, and that all four tires are of the same size, same brand, and same tread pattern.
- Do not use tire sizes other than those recommended by Lexus.
- Do not mix differently constructed tires (radial, bias-belted or bias-ply tires).
- If only two tires are replaced, the new tires should be placed on the rear of the vehicle.
- Do not mix summer, all season and snow tires.
- Do not use tires that have been used on another vehicle.  
Do not use tires if you do not know how they were used previously.
- Do not tow if your vehicle has a compact spare tire installed.

■ **When initializing the tire pressure warning system**

Do not operate the tire pressure warning reset switch without first adjusting the tire inflation pressure to the specified level. Otherwise, the tire pressure warning light may not come on even if the tire inflation pressure is low, or it may come on when the tire inflation pressure is actually normal.

■ **Caution regarding interference with electronic devices**

- People with implantable cardiac pacemakers, cardiac resynchronization therapy-pacemakers or implantable cardioverter defibrillators should not come within 17.7 in. (450 mm) of the tire pressure warning system initiators. The radio waves may affect the operation of such devices.



- Users of any electrical medical device other than implantable cardiac pacemakers, cardiac resynchronization therapy-pacemakers or implantable cardioverter defibrillators should consult the manufacturer of the device for information about its operation under the influence of radio waves. Radio waves could have unexpected effects on the operation of such medical devices.

 NOTICE**■ Repairing or replacing tires, wheels, tire pressure warning valves, transmitters and tire valve caps**

- When removing or fitting the wheels, tires or the tire pressure warning valves and transmitters, contact your Lexus dealer as the tire pressure warning valves and transmitters may be damaged if not handled correctly.
- Make sure to install the tire valve caps. If the tire valve caps are not installed, water could enter the tire pressure warning valves and the tire pressure warning valves could be bound.
- When replacing tire valve caps, do not use tire valve caps other than those specified. The cap may become stuck.

**■ To avoid damage to the tire pressure warning valves and transmitters**

When a tire is repaired with liquid sealants, the tire pressure warning valve and transmitter may not operate properly. If a liquid sealant is used, contact your Lexus dealer or other qualified service shop as soon as possible. After use of liquid sealant, make sure to replace the tire pressure warning valve and transmitter when repairing or replacing the tire. (→P. 437)

**■ Driving on rough roads**

Take particular care when driving on roads with loose surfaces or potholes. These conditions may cause losses in tire inflation pressure, reducing the cushioning ability of the tires. In addition, driving on rough roads may cause damage to the tires themselves, as well as the vehicle's wheels and body.

**■ Low profile tires (P225/45R18 tires)**

Low profile tires may cause greater damage than usual to the tire wheel when sustaining impact from the road surface. Therefore, pay attention to the following:

- Be sure to use proper tire inflation pressure. If tires are under-inflated, they may be damaged more severely.
- Avoid potholes, uneven pavement, curbs and other road hazards. Failure to do so may lead to severe tire and wheel damage.

**■ If tire inflation pressure of each tire becomes low while driving**

Do not continue driving, or your tires and/or wheels may be ruined.

## Tire inflation pressure

### Tire inflation pressure

The recommended cold tire inflation pressure and tire size are displayed on the tire and loading information label. (→P. 518)

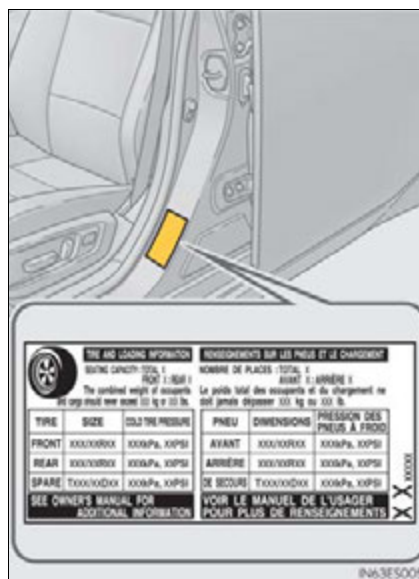

### Inspection and adjustment procedure

- ① Tire valve
- ② Tire pressure gauge

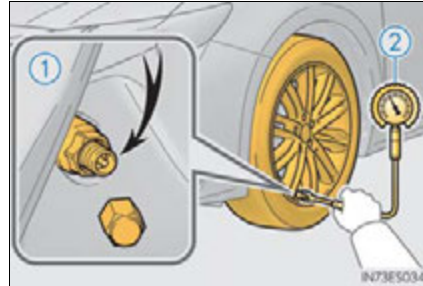

- 1 Remove the tire valve cap.
- 2 Press the tip of the tire pressure gauge onto the tire valve.
- 3 Read the pressure using the gauge gradations.
- 4 If the tire inflation pressure is not at the recommended level, adjust the pressure.  
If you add too much air, press the center of the valve to deflate.
- 5 After completing the tire inflation pressure measurement and adjustment, apply soapy water to the valve and check for leakage.
- 6 Put the tire valve cap back on.

#### ■ Tire inflation pressure check interval

You should check tire inflation pressure every two weeks, or at least once a month. Do not forget to check the spare.

#### ■ Effects of incorrect tire inflation pressure

Driving with incorrect tire inflation pressure may result in the following:

- Reduced fuel economy
- Reduced driving comfort and poor handling
- Reduced tire life due to wear
- Reduced safety
- Damage to the drive train

If a tire needs frequent inflating, have it checked by your Lexus dealer.

■ **Instructions for checking tire inflation pressure**

When checking tire inflation pressure, observe the following:

- Check only when the tires are cold.  
If your vehicle has been parked for at least 3 hours or has not been driven for more than 1 mile or 1.5 km, you will get an accurate cold tire inflation pressure reading.
- Always use a tire pressure gauge.  
It is difficult to judge if a tire is properly inflated based only on its appearance.
- It is normal for the tire inflation pressure to be higher after driving as heat is generated in the tire. Do not reduce tire inflation pressure after driving.
- Never exceed the vehicle capacity weight.  
Passengers and luggage weight should be placed so that the vehicle is balanced.

 **WARNING**

■ **Proper inflation is critical to save tire performance**

Keep your tires properly inflated.  
If the tires are not properly inflated, the following conditions may occur which could lead to an accident resulting in death or serious injury:

- Excessive wear
- Uneven wear
- Poor handling
- Possibility of blowouts resulting from overheated tires
- Air leaking from between tire and wheel
- Wheel deformation and/or tire damage
- Greater possibility of tire damage while driving (due to road hazards, expansion joints, sharp edges in the road, etc.)

 **NOTICE**

■ **When inspecting and adjusting tire inflation pressure**

Be sure to put the tire valve caps back on.  
If a valve cap is not installed, dirt or moisture may get into the valve and cause an air leak, resulting in decreased tire inflation pressure.

## Wheels

If a wheel is bent, cracked or heavily corroded, it should be replaced. Otherwise, the tire may separate from the wheel or cause a loss of handling control.

### Wheel selection

When replacing wheels, care should be taken to ensure that they are equivalent to those removed in load capacity, diameter, rim width and inset\*.

Replacement wheels are available at your Lexus dealer.

\*: Conventionally referred to as "offset".

Lexus does not recommend using the following:

- Wheels of different sizes or types
- Used wheels
- Bent wheels that have been straightened

### Aluminum wheel precautions

- Use only Lexus wheel nuts and wrenches designed for use with your aluminum wheels.
- When rotating, repairing or changing your tires, check that the wheel nuts are still tight after driving 1000 miles (1600 km).
- Be careful not to damage the aluminum wheels when using tire chains.
- Use only Lexus genuine balance weights or equivalent and a plastic or rubber hammer when balancing your wheels.

#### ■ When replacing wheels

The wheels of your vehicle are equipped with tire pressure warning valves and transmitters that allow the tire pressure warning system to provide advance warning in the event of a loss in tire inflation pressure. Whenever wheels are replaced, tire pressure warning valves and transmitters must be installed. (→P. 437)

 **WARNING**

■ **When replacing wheels**

- Do not use wheels that are a different size from those recommended in the Owner's Manual, as this may result in a loss of handling control.
- Never use an inner tube in a leaking wheel which is designed for a tubeless tire. Doing so may result in an accident, causing death or serious injury.

■ **Use of defective wheels prohibited**

Do not use cracked or deformed wheels.  
Doing so could cause the tire to leak air during driving, possibly causing an accident.

 **NOTICE**

■ **Replacing tire pressure warning valves and transmitters**

- Because tire repair or replacement may affect the tire pressure warning valves and transmitters, make sure to have tires serviced by your Lexus dealer or other qualified service shop. In addition, make sure to purchase your tire pressure warning valves and transmitters at your Lexus dealer.
- Ensure that only genuine Lexus wheels are used on your vehicle.  
Tire pressure warning valves and transmitters may not work properly with non-genuine wheels.



## Air conditioning filter

The air conditioning filter must be changed regularly to maintain air conditioning efficiency.

### Removal method

- 1 Turn the engine switch off.
- 2 Open the glove box. Lift and remove the partition.

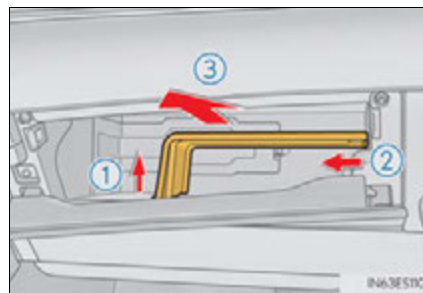

- 3 Remove the glove box cover.

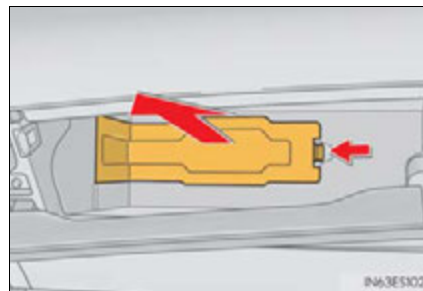

- 4 Remove the filter cover.

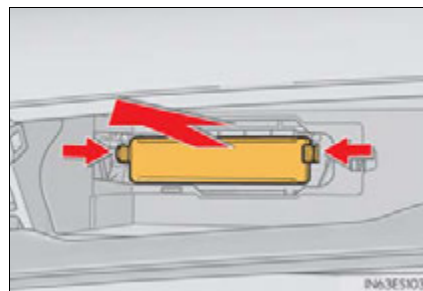

- 5 Slide and pull out the filter. Replace it with a new one.

The “↑UP” marks shown on the filter should be pointing up.

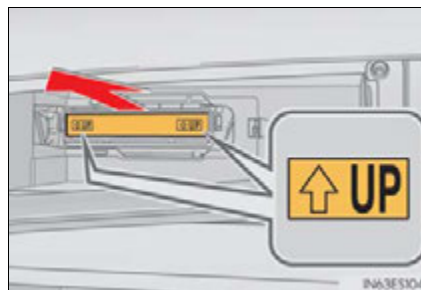

#### ■ Changing interval

Inspect and replace the air conditioning filter according to the maintenance schedule. In dusty areas or areas with heavy traffic flow, early replacement may be required. (For scheduled maintenance information, please refer to the “Owner’s Manual Supplement” or “Scheduled Maintenance”.)

#### ■ If air flow from the vents decreases dramatically

The filter may be clogged. Check the filter and replace if necessary.

#### ■ Air conditioning filter with deodorizing function

When fragrances are placed in your vehicle, the deodorizing effect may become significantly weakened in a short period.

When an air conditioning odor comes out continuously, replace the air conditioning filter.

#### ⚠ NOTICE

##### ■ When using the air conditioning system

Make sure that a filter is always installed.

Using the air conditioning system without a filter may cause damage to the system.

## Electronic key battery

Replace the battery with a new one if it is depleted.

### You will need the following items:

- Flathead screwdriver
- Small flathead screwdriver
- Lithium battery CR2032

### Replacing the battery

- 1** Take out the mechanical key.

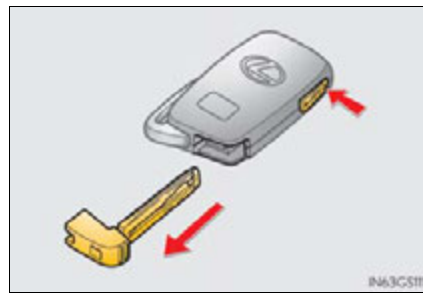

- 2** Remove the cover.

To prevent damage to the key, cover the tip of the screwdriver with a rag.

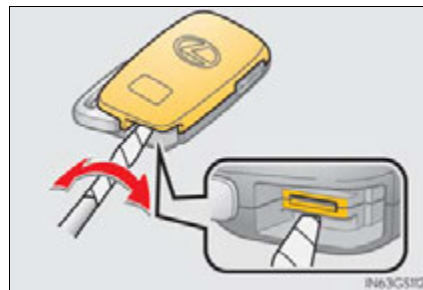

- 3** Remove the depleted battery.

Insert a new battery with the "+" terminal facing up.

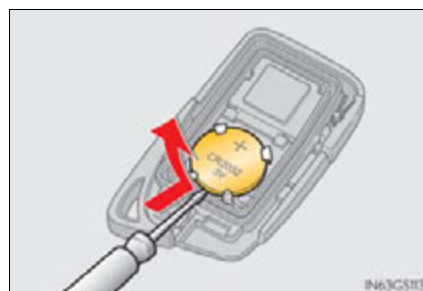

■ **Use a CR2032 lithium battery**

- Batteries can be purchased at your Lexus dealer, local electrical appliance shops or camera stores.
- Replace only with the same or equivalent type recommended by the manufacturer.
- Dispose of used batteries according to local laws.

■ **If the electronic key battery is depleted**

The following symptoms may occur:

- The smart access system with push-button start and wireless remote control will not function properly.
- The operational range will be reduced.

 **WARNING**

■ **Removed battery and other parts**

These parts are small and if swallowed by a child, they can cause choking. Keep away from children. Failure to do so could result in death or serious injury.

 **NOTICE**

■ **For normal operation after replacing the battery**

Observe the following precautions to prevent accidents:

- Always work with dry hands.  
Moisture may cause the battery to rust.
- Do not touch or move any other component inside the remote control.
- Do not bend either of the battery terminals.

## Checking and replacing fuses

If any of the electrical components do not operate, a fuse may have blown. If this happens, check and replace the fuses as necessary.

- 1 Turn the engine switch off.
- 2 Open the Fuse box cover.

► Engine compartment

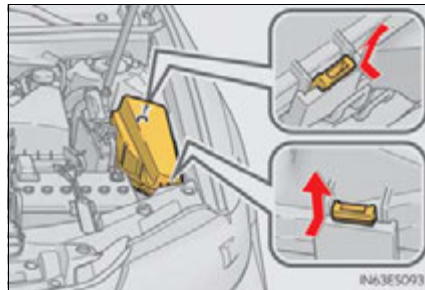

Push the tab in and lift the lid off.

► Driver's side instrument panel

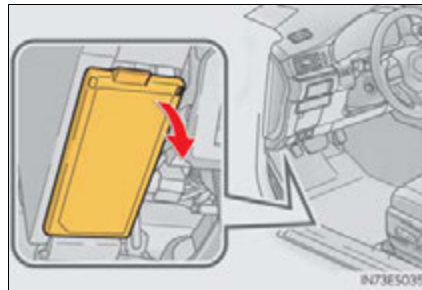

Remove the lid.

- 3 Remove the fuse with the pullout tool.

Only type A fuse can be removed using the pullout tool.

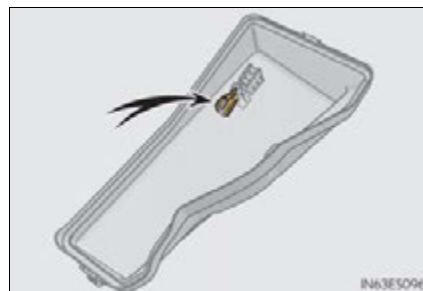

4 Check if the fuse is blown.

- ① Normal fuse
- ② Blown fuse

Type A and B:

Replace the blown fuse with a new fuse of an appropriate amperage rating. The amperage rating can be found on the fuse box lid.

Type C:

Contact your Lexus dealer.

► Type A

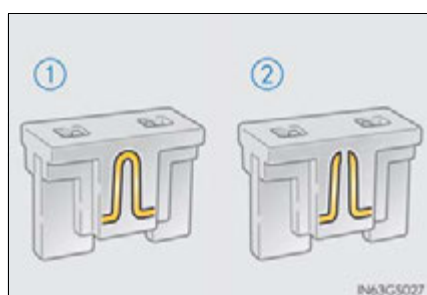

► Type B

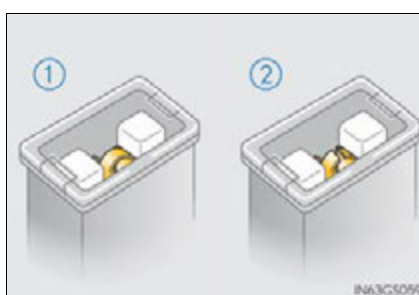

► Type C



■ After a fuse is replaced

- If the lights do not turn on even after the fuse has been replaced, a bulb may need replacement. (→P. 456)
- If the replaced fuse blows again, have the vehicle inspected by your Lexus dealer.

■ If there is an overload in a circuit

The fuses are designed to blow, protecting the wiring harness from damage.

■ When replacing light bulbs

Lexus recommends that you use genuine Lexus products designed for this vehicle. Because certain bulbs are connected to circuits designed to prevent overload, non-genuine parts or parts not designed for this vehicle may be unusable.

 **WARNING****■ To prevent system breakdowns and vehicle fire**

Observe the following precautions.

Failure to do so may cause damage to the vehicle, and possibly a fire or injury.

- Never use a fuse of a higher amperage rating than that indicated, or use any other object in place of a fuse.
- Always use a genuine Lexus fuse or equivalent.  
Never replace a fuse with a wire, even as a temporary fix.
- Do not modify the fuses or fuse boxes.

 **NOTICE****■ Before replacing fuses**

Have the cause of electrical overload determined and repaired by your Lexus dealer as soon as possible.

## Light bulbs

You may replace the following bulbs by yourself. The difficulty level of replacement varies depending on the bulb. If necessary bulb replacement seems difficult to perform, contact your Lexus dealer.

For more information about replacing other light bulbs, contact your Lexus dealer.

### Preparing for light bulb replacement

Check the wattage of the light bulb to be replaced. (→P. 520)

### Removing the engine compartment cover

→P. 426

### Bulb locations

#### ■ Front

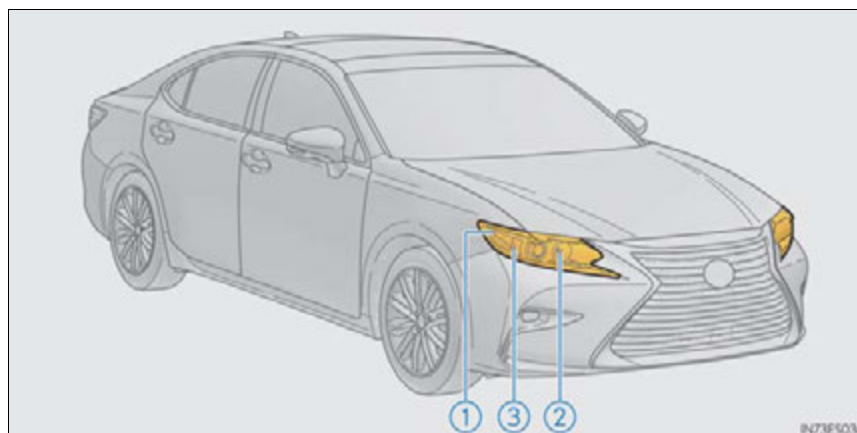

- ① Front side marker light
- ② Headlight high beam (halogen bulb)
- ③ Front turn signal light



■ Rear

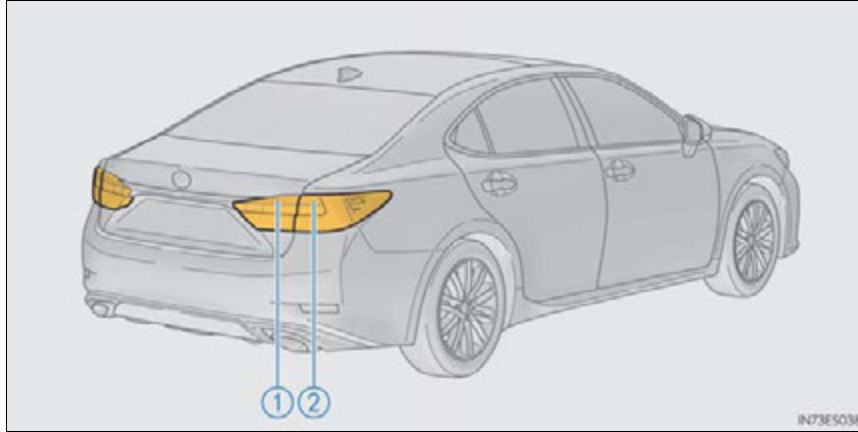

① Back-up light

② Rear turn signal light

### Replacing light bulbs

#### ■ Headlight high beam (halogen bulb)

- 1 Turn the cover counterclockwise and remove it.

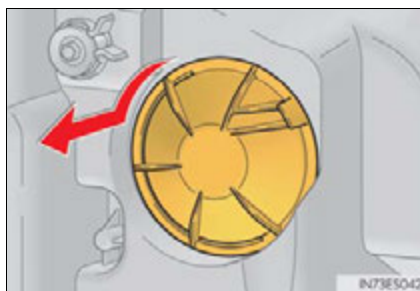

- 2 Unplug the connector while pulling the lock release.

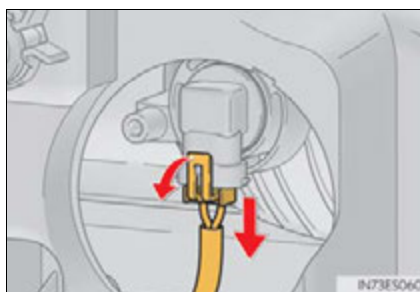

- 3 Turn the bulb base counterclockwise.

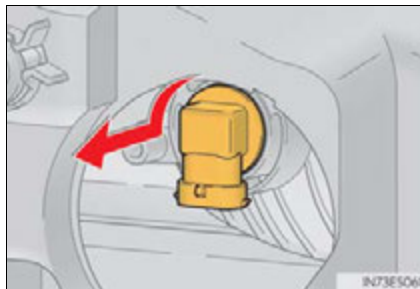

- 4 Set the new light bulb.  
Align the 3 tabs on the light bulb with the mounting, and insert.  
Turn it clockwise to set.

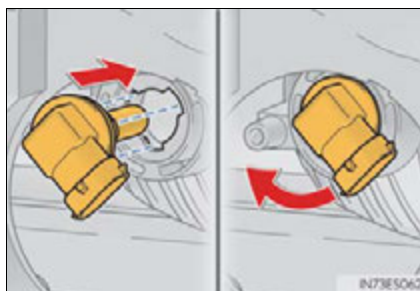

**5** Set the connector.

Shake the bulb base gently to check that it is not loose, turn the headlight high beams on once and visually confirm that no light is leaking through the mounting.

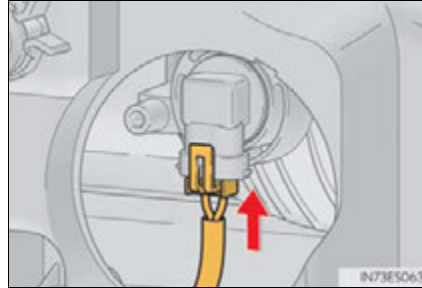
**6** Install the cover and turn it clockwise.

Align the ▲ of the cover to the positioning mark of the lamp body and insert and turn it.

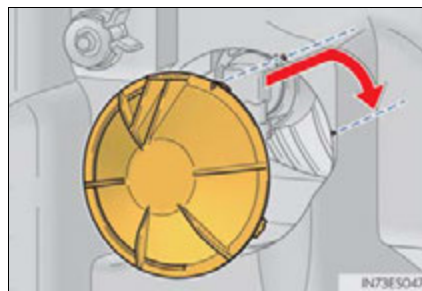
**Front turn signal lights****1** To allow enough working space, turn the steering wheel to the opposite side of the bulb to be replaced.

Remove the 3 fender liner clips and 1 screw.

Turn the steering wheel to the left when replacing the right side light bulb, and turn the steering wheel to the right when replacing the left side light bulb.

To take out the clips, turn the head of the clip to unlock, then remove by pulling.

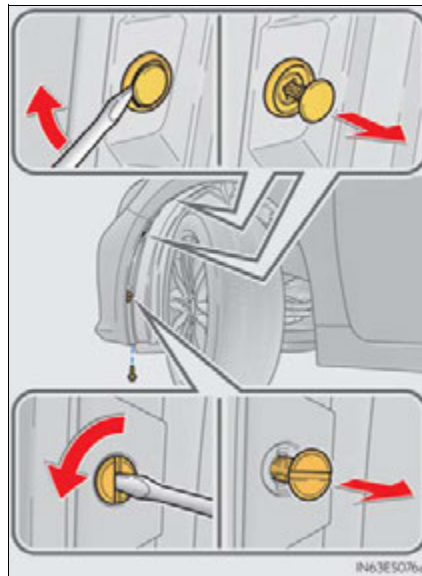

- 2** While holding the clamp open, pull and remove the tabs and open the fender liner.

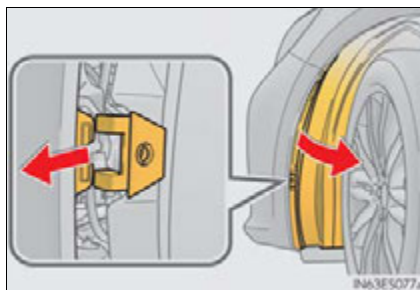

- 3** Turn the bulb base counterclockwise.

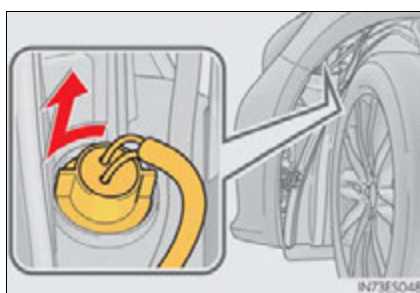

- 4** Remove the light bulb.

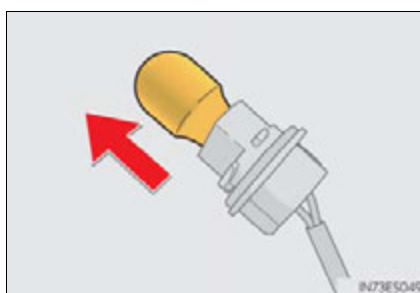

- 5 When installing, reverse the steps listed.

After installing the bulb base, reinstall the fender liner and install the clips and screw.

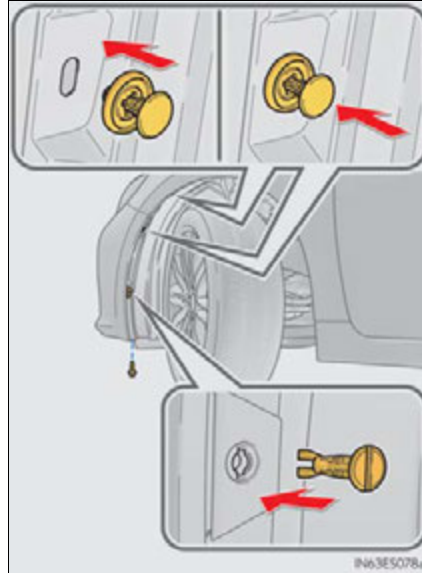

#### ■ Front side marker lights

- 1 Partly remove the fender liner.

Perform the procedure for “Front turn signal lights” from step 1 to 2. (→P. 459)

- 2 Turn the bulb base counterclockwise.

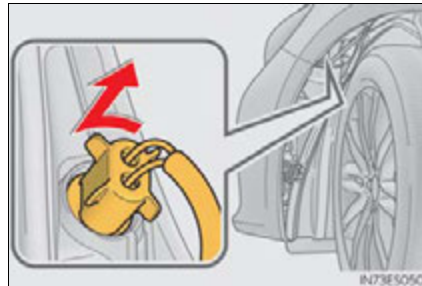

- 3 Remove the light bulb.

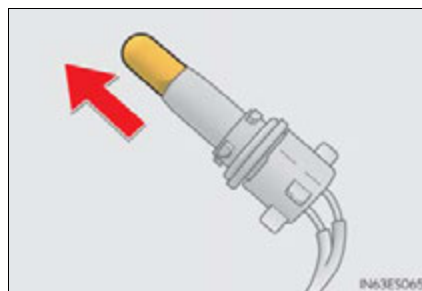

- 4** When installing, reverse the steps listed.

After installing the bulb base, reinstall the fender liner and install the clips and screw.

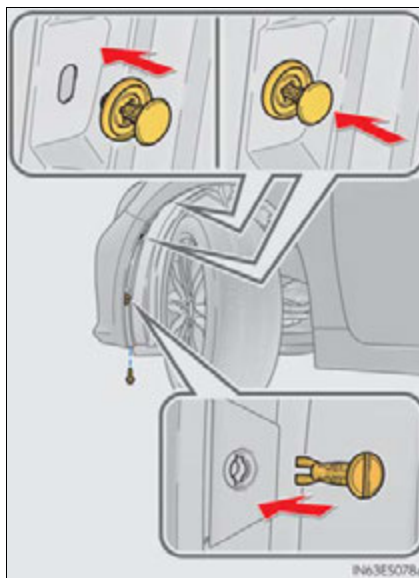

■ **Rear turn signal lights**

- 1** Open the trunk lid and remove the cover.

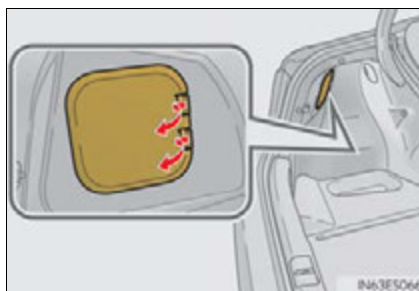

- 2** Turn the bulb base counterclockwise.

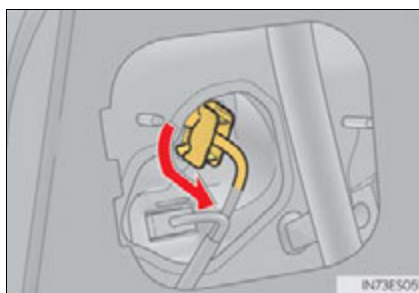

- 3 Remove the light bulb.

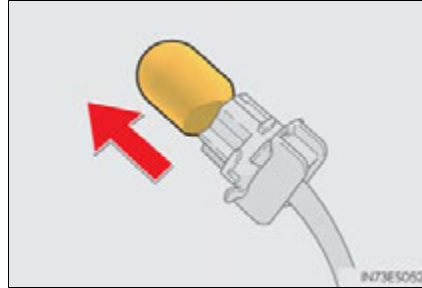

- 4 When installing, reverse the steps listed.

#### ■ Back-up lights

- 1 Open the trunk lid.
- 2 For the left side (vehicles with power trunk opener and closer only): Pry out each side of the trunk closer switch in turn by inserting a screwdriver into the base.
- To prevent damage, cover the tip of the screwdriver with a rag.
- 3 Remove the clips on whichever side you are replacing and open the cover of the trunk lid.

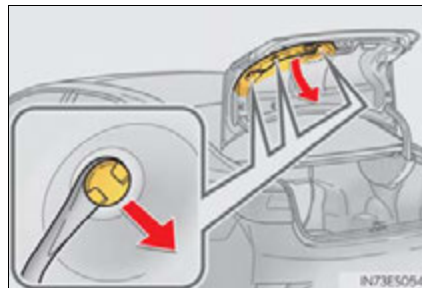
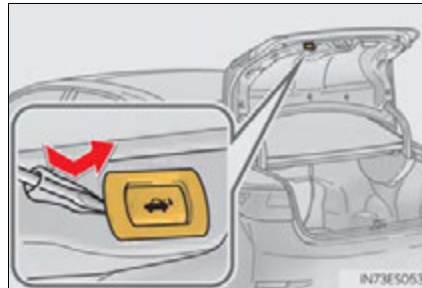

- 4 Turn the bulb base counterclockwise.
- When installing, pass the wire around the connector rib and make sure that it does not rest on top of the connector rib.

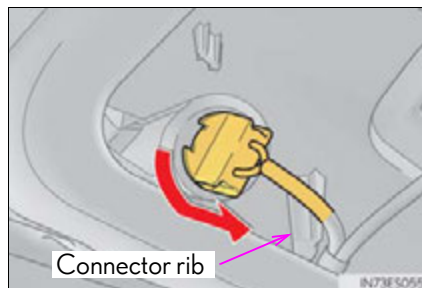

- 5 Remove the light bulb.

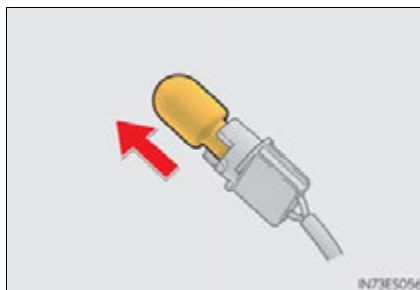

- 6 When installing, reverse the steps listed.

■ Replacing the following bulbs

If any of the lights listed below has burnt out, have it replaced by your Lexus dealer.

- Headlight low beams
- Headlight high beams (LED type)
- Parking lights/daytime running lights
- Side turn signal lights
- Fog lights
- Stop/tail lights
- High mounted stoplight
- License plate lights
- Outer foot lights

■ LED lights

The headlight low beams, headlight high beams (LED type), parking lights/daytime running lights, fog lights, side turn signal lights, stop/tail lights, rear side marker lights, high mounted stoplight and license plate lights consist of a number of LEDs. If any of the LEDs burn out, take your vehicle to your Lexus dealer to have the light replaced.

■ Condensation build-up on the inside of the lens

Temporary condensation build-up on the inside of the headlight lens does not indicate a malfunction. Contact your Lexus dealer for more information in the following situations:

- Large drops of water have built up on the inside of the lens.
- Water has built up inside the headlight.

■ When replacing light bulbs

→P. 454



 **WARNING****■ Replacing light bulbs**

- Turn off the lights. Do not attempt to replace the bulb immediately after turning off the lights.  
The bulbs become very hot and may cause burns.
- Do not touch the glass portion of the light bulb with bare hands. When it is unavoidable to hold the glass portion, use and hold with a clean dry cloth to avoid getting moisture and oils on the bulb.  
Also, if the bulb is scratched or dropped, it may blow out or crack.
- Fully install light bulbs and any parts used to secure them. Failure to do so may result in heat damage, fire, or water entering the headlight unit. This may damage the headlights or cause condensation to build up on the lens.

**■ To prevent damage or fire**

- Make sure bulbs are fully seated and locked.
- Check the wattage of the bulb before installing to prevent heat damage.



**8-1. Essential information**

Emergency flashers ..... 468

If your vehicle has to be  
stopped in an emergency.... 469**8-2. Steps to take in an emergency**If your vehicle needs  
to be towed..... 470If you think  
something is wrong ..... 474

Fuel pump shut off system ..... 475

If a warning light turns on or  
a warning buzzer sounds..... 476If a warning message  
is displayed ..... 482

If you have a flat tire..... 485

If the engine will not start ..... 496

If the shift lever cannot  
be shifted from P ..... 498If the electronic key does not  
operate properly ..... 499

If the battery is discharged ..... 501

If your vehicle overheats ..... 505

If the vehicle becomes  
stuck ..... 508

## Emergency flashers

The emergency flashers are used to warn other drivers when the vehicle has to be stopped in the road due to a breakdown, etc.

Press the switch.

All the turn signal lights will flash.  
To turn them off, press the switch once again.

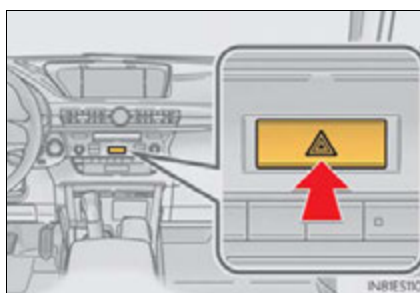

### ■ Emergency flashers

If the emergency flashers are used for a long time while the engine is not operating, the battery may discharge.

## If your vehicle has to be stopped in an emergency

Only in an emergency, such as if it becomes impossible to stop the vehicle in the normal way, stop the vehicle using the following procedure:

- 1 Steadily step on the brake pedal with both feet and firmly depress it.  
Do not pump the brake pedal repeatedly as this will increase the effort required to slow the vehicle.
- 2 Shift the shift lever to N.
  - ▶ If the shift lever is shifted to N
- 3 After slowing down, stop the vehicle in a safe place by the road.
- 4 Stop the engine.
  - ▶ If the shift lever cannot be shifted to N
- 3 Keep depressing the brake pedal with both feet to reduce vehicle speed as much as possible.
- 4 To stop the engine, press and hold the engine switch for 2 consecutive seconds or more, or press it briefly 3 times or more in succession.

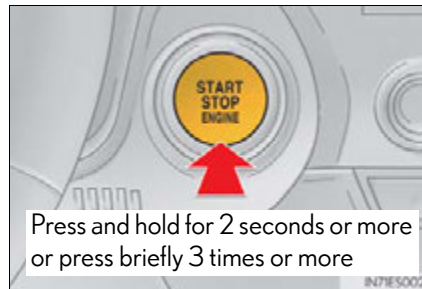

- 5 Stop the vehicle in a safe place by the road.

### WARNING

#### ■ If the engine has to be turned off while driving

Power assist for the brakes and steering wheel will be lost, making the brake pedal harder to depress and the steering wheel heavier to turn. Decelerate as much as possible before turning off the engine.

## If your vehicle needs to be towed

If towing is necessary, we recommend having your vehicle towed by your Lexus dealer or commercial towing service, using a wheel-lift type truck or flat bed truck.

Use a safety chain system for all towing, and abide by all state/provincial and local laws.

### Situations when it is necessary to contact dealers before towing

The following may indicate a problem with your transmission. Contact your Lexus dealer or commercial towing service before towing.

- The engine is running but the vehicle does not move.
- The vehicle makes an abnormal sound.

### Towing with a sling-type truck

Do not tow with a sling-type truck to prevent body damage.

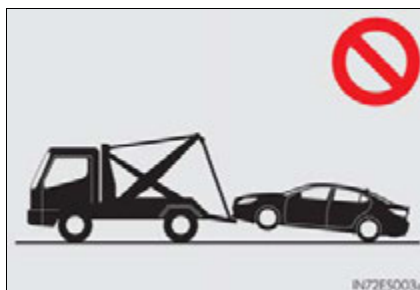

### Towing with a wheel-lift type truck

▶ From the front

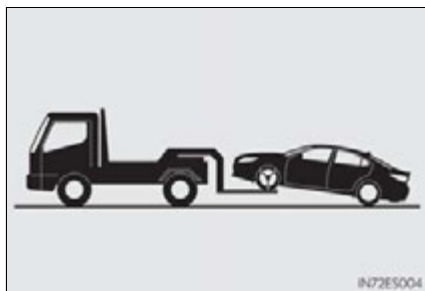

Release the parking brake.

▶ From the rear

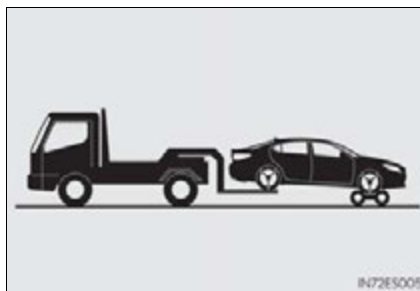

Use a towing dolly under the front wheels.

### Using a flat bed truck

If your vehicle is transported by a flat bed truck, it should be tied down at the locations shown in the illustration.

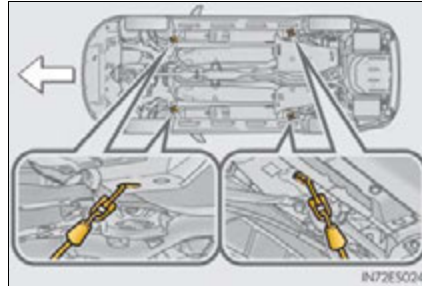

If you use chains or cables to tie down your vehicle, the angles shaded in black must be 45°.

Do not overly tighten the tie downs or the vehicle may be damaged.

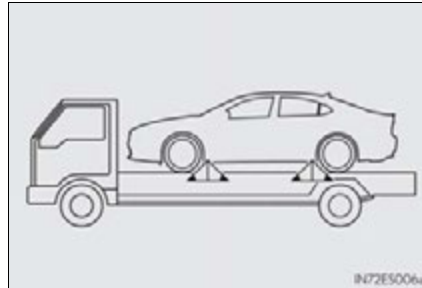

### Emergency towing

If a tow truck is not available in an emergency, your vehicle may be temporarily towed using cables or chains secured to the emergency towing eyelets. This should only be attempted on hard surfaced roads for 50 miles (80 km) at low at under 18 mph (50 km/h).

A driver must be in the vehicle to steer and operate the brakes. The vehicle's wheels, drive train, axles, steering and brakes must be in good condition.

### Emergency towing procedure

- 1 Take out the towing eyelet. (→P. 486)

- 2 Remove the eyelet cover using a flat-head screwdriver.

To protect the bodywork, place a rag between the screwdriver and the vehicle body as shown in the illustration.

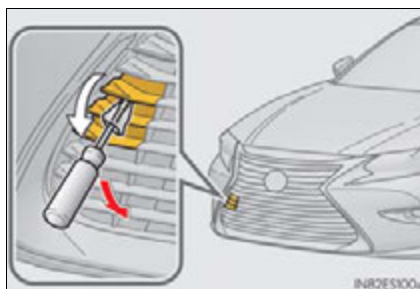

- 3 Insert the towing eyelet into the hole and tighten partially by hand.

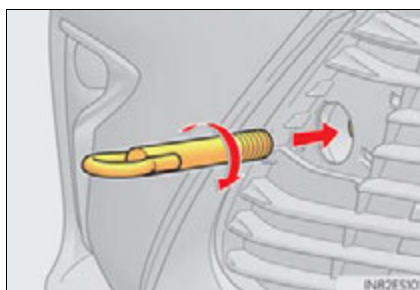

- 4 Tighten down the towing eyelet securely using a wheel nut wrench.

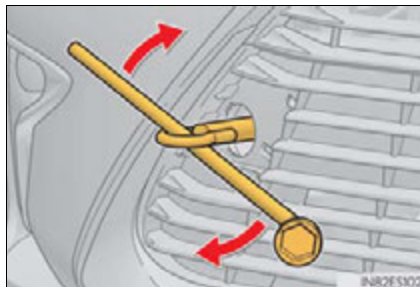

- 5 Securely attach cables or chains to the towing eyelet.

Take care not to damage the vehicle body.

- 6 Enter the vehicle being towed and start the engine.

If the engine does not start, turn the engine switch to IGNITION ON mode

- 7 Shift the shift position to N and release the parking brake.

When the shift lever cannot be shifted: →P. 498



### ■ While towing

If the engine is not running, the power assist for the brakes and steering will not function, making steering and braking more difficult.

### ■ Wheel nut wrench

Wheel nut wrench is installed in trunk. (→P. 486)

## ⚠ WARNING

Observe the following precautions.  
Failure to do so may result in death or serious injury.

### ■ When towing the vehicle

Be sure to transport the vehicle with the front wheels raised or with all four wheels raised off the ground. If the vehicle is towed with the front wheels contacting the ground, the drivetrain and related parts may be damaged.

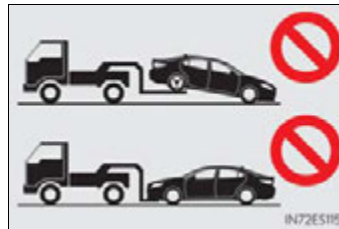

### ■ While towing

- When towing using cables or chains, avoid sudden starts, etc. which place excessive stress on the eyelet, cables or chains. The towing eyelet, cables or chains may become damaged, broken debris may hit people and cause serious damage.
- Do not turn the engine switch off.  
There is a possibility that the steering wheel is locked and cannot be operated.

### ■ Installing towing eyelet to the vehicle

Make sure that towing eyelet is installed securely.  
If not securely installed, towing eyelets may come loose during towing.

## ⚠ NOTICE

### ■ To prevent damage to the vehicle when towing using a wheel-lift type truck

- Do not tow the vehicle from the rear when the engine switch is off. The steering lock mechanism is not strong enough to hold the front wheels straight.
- When raising the vehicle, ensure adequate ground clearance for towing at the opposite end of the raised vehicle. Without adequate clearance, the vehicle could be damaged while being towed.

### ■ To prevent damage to the vehicle when towing with a sling-type truck

Do not tow with a sling-type truck, either from the front or rear.

### ■ To prevent damage to the vehicle during emergency towing

Do not secure cables or chains to the suspension components.

## If you think something is wrong

If you notice any of the following symptoms, your vehicle probably needs adjustment or repair. Contact your Lexus dealer as soon as possible.

### Visible symptoms

- Fluid leaks under the vehicle.  
(Water dripping from the air conditioning after use is normal.)
- Flat-looking tires or uneven tire wear
- Engine coolant temperature gauge needle continually points higher than normal.

### Audible symptoms

- Changes in exhaust sound
- Excessive tire squeal when cornering
- Strange noises related to the suspension system
- Pinging or other noises related to the engine

### Operational symptoms

- Engine missing, stumbling or running roughly
- Appreciable loss of power
- Vehicle pulls heavily to one side when braking
- Vehicle pulls heavily to one side when driving on a level road
- Loss of brake effectiveness, spongy feeling, pedal almost touches the floor

## Fuel pump shut off system

To minimize the risk of fuel leakage when the engine stalls or when an airbag inflates upon collision, the fuel pump shut off system stops the supply of fuel to the engine.

Follow the procedure below to restart the engine after the system is activated.

- 1 Turn the engine switch to ACCESSORY mode or turn it off.
- 2 Restart the engine.

### NOTICE

#### ■ Before starting the engine





Inspect the ground under the vehicle.







If you find that fuel has leaked onto the ground, the fuel system has been damaged and is in need of repair. Do not restart the engine.



## If a warning light turns on or a warning buzzer sounds

Calmly perform the following actions if any of the warning lights comes on or flashes. If a light comes on or flashes, but then goes off, this does not necessarily indicate a malfunction in the system. However, if this continues to occur, have the vehicle inspected by your Lexus dealer.

### Warning light and warning buzzer list

Warning light	Warning light/Details/Actions
 <p>(U.S.A.) (Canada)</p>	<p><b>Brake system warning light (warning buzzer)</b> Indicates that:</p> <ul style="list-style-type: none"> <li>• The brake fluid level is low; or</li> <li>• The brake system is malfunctioning</li> </ul> <p>→ <b>Immediately stop the vehicle in a safe place and contact your Lexus dealer. Continuing to drive the vehicle may be dangerous.</b></p>
 <p>(U.S.A.) (Canada)</p>	<p><b>Malfunction indicator lamp</b> Indicates a malfunction in:</p> <ul style="list-style-type: none"> <li>• The electronic engine control system;</li> <li>• The electronic throttle control system; or</li> <li>• The electronic automatic transmission control system</li> </ul> <p>→ <b>Have the vehicle inspected by your Lexus dealer immediately.</b></p>
	<p><b>SRS warning light</b> Indicates a malfunction in:</p> <ul style="list-style-type: none"> <li>• The SRS airbag system;</li> <li>• The front passenger occupant classification system; or</li> <li>• The seat belt pretensioner system</li> </ul> <p>→ <b>Have the vehicle inspected by your Lexus dealer immediately.</b></p>
 <p>(U.S.A.) (Canada)</p>	<p><b>ABS warning light</b> Indicates a malfunction in:</p> <ul style="list-style-type: none"> <li>• The ABS; or</li> <li>• The brake assist system</li> </ul> <p>→ <b>Have the vehicle inspected by your Lexus dealer immediately.</b></p>

Warning light	Warning light/Details/Actions
	<p><b>Electric power steering system warning light (warning buzzer)</b> Indicates a malfunction in the EPS (Electric Power Steering) system → <b>Have the vehicle inspected by your Lexus dealer immediately.</b></p>
 (Flashes) (If equipped)	<p><b>PCS warning light</b> Indicates a malfunction in the pre-collision system The warning light will operate as follows, even when the system is not malfunctioning:</p> <ul style="list-style-type: none"> <li>• The light will come on when the TRAC and VSC systems are turned off. (→P. 257)</li> <li>• The light will come on when the pre-collision braking is disabled. (→P. 187)</li> <li>• The light will flash when the system cannot temporarily be used. (→P. 195)</li> </ul> <p>→ <b>Have the vehicle inspected by your Lexus dealer immediately.</b></p>
	<p><b>Slip indicator light</b> Indicates a malfunction in:</p> <ul style="list-style-type: none"> <li>• The VSC system;</li> <li>• The TRAC system; or</li> <li>• The hill-start assist control system</li> </ul> <p>→ <b>Have the vehicle inspected by your Lexus dealer immediately.</b> The light will flash when the VSC or TRAC is operating.</p>
	<p><b>Low fuel level warning light</b> Indicates that remaining fuel is approximately 2.6 gal. (9.7 L, 2.1 Imp.gal.) or less → <b>Refuel the vehicle.</b></p>
	<p><b>Seat belt reminder light (warning buzzer)*</b> Warns the driver and/or front passenger to fasten their seat belts → <b>Fasten the seat belt.</b> <b>If the front passenger's seat is occupied, the front passenger's seat belt also needs to be fastened to make the warning light (warning buzzer) turn off.</b></p>
	<p><b>Master warning light</b> A buzzer sounds and the warning light comes on and flashes to indicate that the master warning system has detected a malfunction. → <b>P. 482</b></p>

Warning light	Warning light/Details/Actions
	<p><b>Tire pressure warning light</b>                      When the light comes on:                      Low tire inflation pressure such as</p> <ul style="list-style-type: none"> <li>• Natural causes (→P. 479)</li> <li>• Flat tire (→P. 485)</li> </ul> <p>→ <b>Adjust the tire inflation pressure to the specified level.</b>  <b>The light will turn off after a few minutes. In case the light does not turn off even if the tire inflation pressure is adjusted, have the system checked by your Lexus dealer.</b></p> <p>When the light comes on after blinking for 1 minute:                      Malfunction in the tire pressure warning system (→P. 479)                      → <b>Have the system checked by your Lexus dealer.</b></p>
 <p>(Flashes) (If equipped)</p>	<p><b>“AFS OFF” indicator</b>                      Indicates a malfunction in the adaptive front-lighting system                      → <b>Have the vehicle inspected by your Lexus dealer immediately.</b></p>

\*: Driver's and front passenger's seat belt warning buzzer:

The driver's seat belt warning buzzer sounds to alert the driver that his or her seat belt is not fastened. Once the engine switch is turned to IGNITION ON mode, the buzzer sounds for 6 seconds. If the vehicle reaches a speed of 12 mph (20 km/h), the buzzer sounds once. If the seat belt is still unfastened after 30 seconds, the buzzer will sound intermittently for 10 seconds. Then, if the seat belt is still unfastened, the buzzer will sound in a different tone for 20 more seconds.

The front passenger's seat belt warning buzzer sounds to alert the front passenger that his or her seat belt is not fastened. The buzzer sounds once if the vehicle reaches a speed of 12 mph (20 km/h). If the seat belt is still unfastened after 30 seconds, the buzzer will sound intermittently for 10 seconds. Then, if the seat belt is still unfastened, the buzzer will sound in a different tone for 20 more seconds.

■ **SRS warning light**

This warning light system monitors the airbag sensor assembly, front impact sensors, side impact sensors (front door), side impact sensors (front), side impact sensors (rear), driver's seat position sensor, driver's seat belt buckle switch, front passenger occupant classification system (ECU and sensors), "AIR BAG ON" indicator light, "AIR BAG OFF" indicator light, front passenger's seat belt buckle switch, seat belt pretensioner assemblies, airbags, interconnecting wiring and power sources. (→P. 36)

■ **Front passenger detection sensor, seat belt reminder and warning buzzer**

- If luggage is placed on the front passenger seat, the front passenger detection sensor may cause the warning light to flash and the warning buzzer to sound even if a passenger is not sitting in the seat.
- If a cushion is placed on the seat, the sensor may not detect a passenger, and the warning light may not operate properly.

■ **Electric power steering system warning light (warning buzzer)**

When the battery charge becomes insufficient or the voltage temporarily drops, the electric power steering system warning light may come on and the warning buzzer may sound.

**■ If the malfunction indicator lamp comes on while driving**

First check the following:

- Is the fuel tank empty?  
If it is, fill the fuel tank immediately.
- Is the fuel tank cap loose?  
If it is, tighten it securely.

The light will go off after several driving trips.

If the light does not go off even after several trips, contact your Lexus dealer as soon as possible.

**■ When the tire pressure warning light comes on**

Check the tire inflation pressure and adjust to the appropriate level. Pushing the tire pressure warning reset switch will not turn off the tire pressure warning light.

**■ The tire pressure warning light may come on due to natural causes**

The tire pressure warning light may come on due to natural causes such as natural air leaks and tire inflation pressure changes caused by temperature. In this case, adjusting the tire inflation pressure will turn off the warning light (after a few minutes).

**■ When a tire is replaced with a spare tire**

The compact spare tire is not equipped with a tire pressure warning valve and transmitter. If a tire goes flat, the tire pressure warning light will not turn off even though the flat tire has been replaced with the spare tire.

**■ Conditions that the tire pressure warning system may not function properly**

→P. 440

**■ If the tire pressure warning light frequently comes on after blinking for 1 minute**

If the tire pressure warning light frequently comes on after blinking for 1 minute when the engine switch is turned to IGNITION ON mode, have it checked by your Lexus dealer.

**■ Warning buzzer**

In some cases, the buzzer may not be heard because of noisy place or an audio sound.

 **WARNING****■ If both the ABS and the brake system warning lights remain on**

Stop your vehicle in a safe place immediately and contact your Lexus dealer. The vehicle will become extremely unstable during braking, and the ABS system may fail, which could cause an accident resulting in death or serious injury.

**■ When the electric power steering system warning light comes on**

The steering wheel may become extremely heavy.  
If the steering wheel becomes heavier than usual when operating, hold firmly and operate using more force than usual.

**■ If the tire pressure warning light comes on**

Be sure to observe the following precautions. Failure to do so could cause a loss of vehicle control and result in death or serious injury.

- Stop your vehicle in a safe place as soon as possible. Adjust the tire inflation pressure immediately.
- If the tire pressure warning light comes on even after tire inflation pressure adjustment, it is probable that you have a flat tire. Check the tires. If a tire is flat, change it with the spare tire and have the flat tire repaired by the nearest Lexus dealer.
- Avoid abrupt maneuvering and braking. If the vehicle tires deteriorate, you could lose control of the steering wheel or the brakes.

**■ If a blowout or sudden air leakage should occur**

The tire pressure warning system may not activate immediately.



 **WARNING****■ Maintenance of the tires**

Each tire, including the spare (if provided), should be checked monthly when cold and inflated to the inflation pressure recommended by the vehicle manufacturer on the vehicle placard or tire inflation pressure label (tire and load information label). (If your vehicle has tires of a different size than the size indicated on the vehicle placard or tire inflation pressure label [tire and load information label], you should determine the proper tire inflation pressure for those tires.)

As an added safety feature, your vehicle has been equipped with a tire pressure monitoring system (TPMS-tire pressure warning system) that illuminates a low tire pressure telltale (tire pressure warning light) when one or more of your tires is significantly under-inflated. Accordingly, when the low tire pressure telltale (tire pressure warning light) illuminates, you should stop and check your tires as soon as possible, and inflate them to the proper pressure. Driving on a significantly under-inflated tire causes the tire to overheat and can lead to tire failure. Under-inflation also reduces fuel efficiency and tire tread life, and may affect the vehicle's handling and stopping ability.

Please note that the TPMS (tire pressure warning system) is not a substitute for proper tire maintenance, and it is the driver's responsibility to maintain correct tire pressure, even if under-inflation has not reached the level to trigger illumination of the TPMS low tire pressure telltale (tire pressure warning light).

Your vehicle has also been equipped with a TPMS (tire pressure warning system) malfunction indicator to indicate when the system is not operating properly. The TPMS (tire pressure warning system) malfunction indicator is combined with the low tire pressure telltale (tire pressure warning light). When the system detects a malfunction, the telltale will flash for approximately one minute and then remain continuously illuminated. This sequence will continue upon subsequent vehicle start-ups as long as the malfunction exists. When the malfunction indicator is illuminated, the system may not be able to detect or signal low tire pressure as intended.

TPMS (tire pressure warning system) malfunctions may occur for a variety of reasons, including the installation of replacement or alternate tires or wheels on the vehicle that prevent the TPMS (tire pressure warning system) from functioning properly. Always check the TPMS (tire pressure warning system) malfunction telltale after replacing one or more tires or wheels on your vehicle to ensure that the replacement or alternate tires and wheels allow the TPMS (tire pressure warning system) to continue to function properly.

 **NOTICE****■ To ensure the tire pressure warning system operates properly**

Do not install tires with different specifications or makers, as the tire pressure warning system may not operate properly.

## If a warning message is displayed

The multi-information display shows warnings of system malfunctions, incorrectly performed operations, and messages that indicate a need for maintenance. When a message is shown, perform the correction procedure appropriate to the message.

- ① Master warning light  
The master warning light also comes on or flashes in order to indicate that a message is currently being displayed on the multi-information display.
- ② Multi-information display

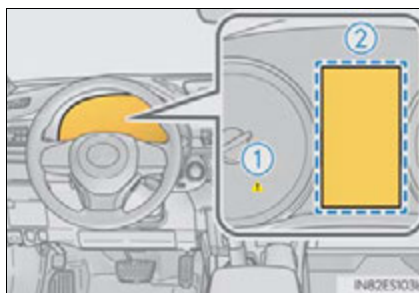

If any of the warning messages are shown again after the following actions have been performed, contact your Lexus dealer.

### Messages and warnings

The warning lights and warning buzzers operate as follows depending on the content of the message. If a message indicates the need for inspection by a dealer, have the vehicle inspected by your Lexus dealer immediately.

	System warning light	Warning buzzer*	Warning
Comes on	—	Sounds	Indicates an important situation, such as when a system related to driving is malfunctioning or that danger may result if the correction procedure is not performed
—	Comes on or flashes	Sounds	Indicates an important situation, such as when the systems shown on the multi-information display may be malfunctioning
Flashes	—	Sounds	Indicates a situation, such as when damage to the vehicle or danger may result

	System warning light	Warning buzzer*	Warning
Comes on	—	Does not sound	Indicates a condition, such as malfunction of electrical components, their condition, or indicates the need for maintenance
Flashes	—	Does not sound	Indicates a situation, such as when an operation has been performed incorrectly, or indicates how to perform an operation correctly

\*: A buzzer sounds the first time a message is shown on the multi-information display.

■ **If “Maintenance Required Soon” is shown (U.S.A. only)**

Indicates that all maintenance according to the driven distance on the maintenance schedule\* should be performed soon.

Comes on approximately 4500 miles (7200 km) after the message has been reset.

If necessary, perform maintenance.

\*: Refer to the separate “Scheduled Maintenance” or “Owner’s Manual Supplement” for the maintenance interval applicable to your vehicle.

■ **If “Maintenance Required Visit Your Dealer” is shown (U.S.A. only)**

Indicates that all maintenance is required to correspond to the driven distance on the maintenance schedule\*.

Comes on approximately 5000 miles (8000 km) after the message has been reset. (The indicator will not work properly unless the message has been reset.)

Perform the necessary maintenance. Please reset the message after the maintenance is performed (→P. 415)

\*: Refer to the separate “Scheduled Maintenance” or “Owner’s Manual Supplement” for the maintenance interval applicable to your vehicle.

■ **If “Oil Maintenance Required Soon” is shown**

Indicates that the engine oil is scheduled to be changed. (The indicator will not work properly unless the oil maintenance data has been reset.)

Check the engine oil, and change if necessary. After changing the engine oil, the oil change system should be reset. (→P. 429)

■ **If “Oil Maintenance Required Visit Your Dealer” is shown**

Indicates that the engine oil should be changed. (After the engine oil is changed and the oil maintenance data has been reset.)

Check and change the engine oil, and oil filter by your Lexus dealer. After changing the engine oil, the oil change system should be reset. (→P. 429)

**■ If “Power Turned Off to Save Battery” is shown**

Power was turned off due to the automatic power off function.

Next time when starting the engine, increase the engine speed slightly and maintain that level for approximately 5 minutes to recharge the battery.

**■ When a message that indicates the need for the shift lever operation is shown**

To prevent the shift lever from being operated incorrectly or the vehicle from moving unexpectedly, a message that requires shifting the shift lever may be shown on the multi-information display. In that case, follow the instruction of the message and shift the shift lever.

**■ If “Visit Your Dealer” is shown**

The system or part shown on the multi-information display is malfunctioning. Have the vehicle inspected by your Lexus dealer immediately.

**■ If “See Owner’s Manual” is shown**

● If the following message is shown, following the instructions, accordingly.

- “Engine Coolant Temp High” (→P. 505)

● If the following message is shown, there may be a malfunction.

Immediately have the vehicle inspected by your Lexus dealer.

- “Check Access System with Elec. Key”

● If the following messages are shown, there may be a malfunction.

Immediately stop the vehicle in a safe place and contact your Lexus dealer. Continuing to drive the vehicle may be dangerous.

- “Braking Power Low Stop in a Safe Place”
- “Charging System Malfunction”
- “Oil Pressure Low Stop in a Safe Place”

**■ Warning buzzer**

In some cases, the buzzer may not be heard because of noisy place or an audio sound.

## If you have a flat tire

Your vehicle is equipped with a spare tire. The flat tire can be replaced with the spare tire.

For details about tires: →P. 436

### WARNING

#### ■ If you have a flat tire

Do not continue driving with a flat tire.

Driving even a short distance with a flat tire can damage the tire and the wheel beyond repair, which could result in an accident.

## Before jacking up the vehicle

- Stop the vehicle on a hard, flat surface.
- Set the parking brake.
- Shift the shift lever to P.
- Stop the engine.
- Turn on the emergency flashers. (→P. 468)

Location of the spare tire, jack and tools

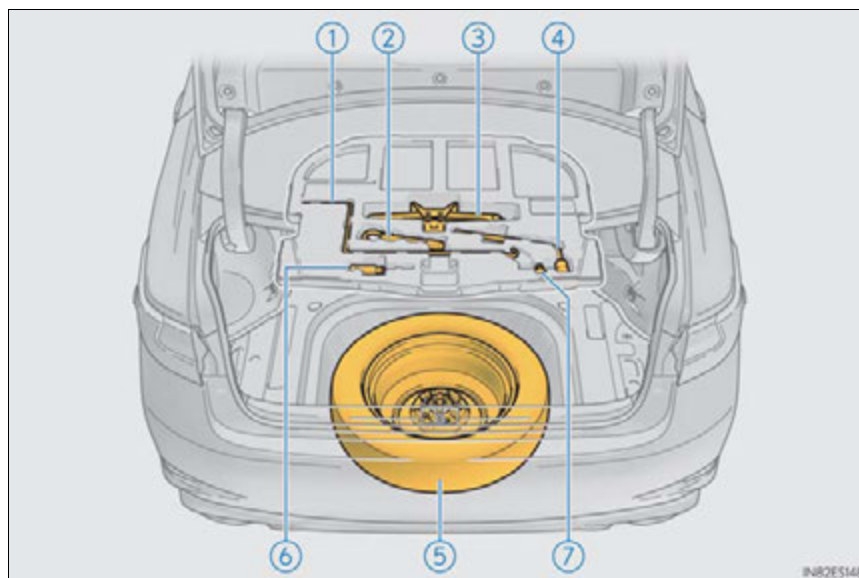

- ① Jack handle
- ② Towing eyelet
- ③ Jack
- ④ Wheel nut wrench
- ⑤ Spare tire
- ⑥ Screwdriver
- ⑦ Wheel lock key\* (if equipped)

\*: Documentation relating to the wheel lock key, such as the registration and I.D. card, is inside the glove box.

 **WARNING****■ Using the tire jack**

Observe the following precautions.

Improper use of the tire jack may cause the vehicle to suddenly fall off the jack, leading to death or serious injury.

- Do not use the tire jack for any purpose other than replacing tires or installing and removing tire chains.
- Only use the tire jack that comes with this vehicle for replacing a flat tire.  
Do not use it on other vehicles, and do not use other tire jacks for replacing tires on this vehicle.
- Put the jack properly in its jack point.
- Do not put any part of your body under the vehicle while it is supported by the jack.
- Do not start the engine or drive the vehicle while the vehicle is supported by the jack.
- Do not raise the vehicle while someone is inside.
- When raising the vehicle, do not put an object on or under the jack.
- Do not raise the vehicle to a height greater than that required to replace the tire.
- Use a jack stand if it is necessary to get under the vehicle.
- When lowering the vehicle, make sure that there is no-one near the vehicle. If there are people nearby, warn them vocally before lowering.

### Wheel lock nut (if equipped)

When replacing tires on a vehicle with wheel lock nuts, use the following procedures to remove and install the wheel lock nuts. The wheel lock key is stored in the tray inside the luggage compartment. Always return the wheel lock key to its original position after use, so that it does not get lost.

#### ■ Removal

For ease of removal, the wheel lock nut should always be the first one loosened.

- 1 Place the wheel lock key on top of the wheel lock nut, turning until the wheel lock key and wheel lock nut patterns engage.
- 2 Place the wheel nut wrench on the wheel lock key, and while applying pressure on the wheel lock key, loosen the wheel lock nut.

#### ■ Installation

For ease of installation, the wheel lock nut should always be the last one tightened.

- 1 By hand, install a wheel lock nut on each wheel.
- 2 Place the wheel lock key on top of the wheel lock nut, turning until the wheel lock key and wheel lock nut patterns engage.
- 3 Place the wheel nut wrench on the wheel lock key, and while applying pressure on the wheel lock key, tighten the wheel lock nut to the recommended torque.

#### NOTICE

Do not use an impact wrench. Using an impact wrench may cause permanent damage to wheel lock nut and wheel lock key. If in doubt about wheel lock application, contact your Lexus dealer.



**Taking out the spare tire**

- 1 Open the luggage mat. (→P. 383)
- 2 Remove the auxiliary boxes.

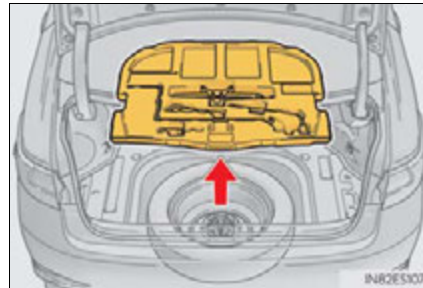

- 3 Loosen the center fastener that secures the spare tire.

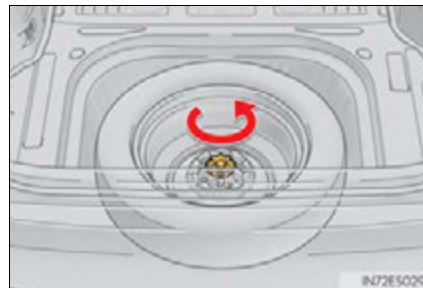
**⚠ WARNING****■ When storing the spare tire**

Be careful not to catch fingers or other body parts between the spare tire and the body of the vehicle.

### Replacing a flat tire

- 1 Chock the tires.

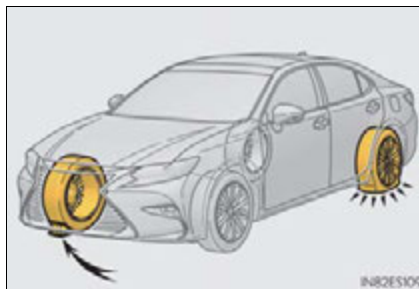

Flat tire		Wheel chock positions
Front	Left-hand side	Behind the rear right-hand side tire
	Right-hand side	Behind the rear left-hand side tire
Rear	Left-hand side	In front of the front right-hand side tire
	Right-hand side	In front of the front left-hand side tire

- 2 Slightly loosen the wheel nuts (one turn).  
For vehicles with wheel lock nuts, loosen the wheel lock nut first.

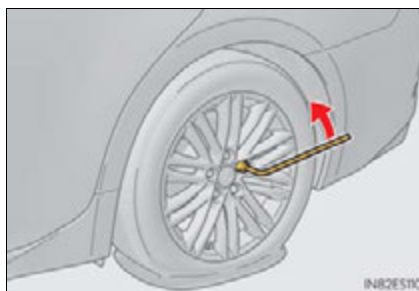

- 3 Turn the tire jack portion (A) by hand until the notch of the jack is in contact with the jack point.

The jack point guides are located under the rocker panel. They indicate the jack point positions.

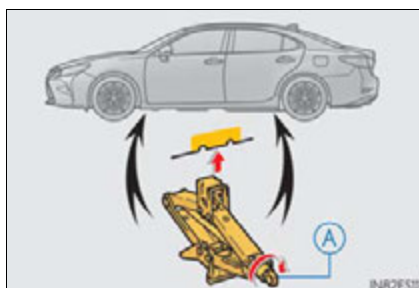

- 4 Raise the vehicle until the tire is slightly raised off the ground.

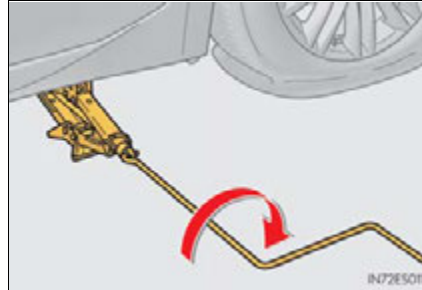

- 5 Remove all the wheel nuts and the tire.

When resting the tire on the ground, place the tire so that the wheel design faces up to avoid scratching the wheel surface.

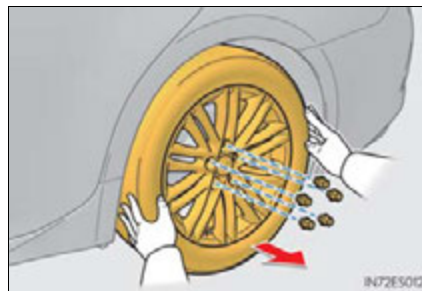

 **WARNING****■ Replacing a flat tire**

- Observe the following precautions.

Failure to do so may result in serious injury:

- Do not try to remove the wheel ornament by hand. Take due care in handling the ornament to avoid unexpected personal injury.
- Do not touch the disc wheels or the area around the brakes immediately after the vehicle has been driven.

After the vehicle has been driven the disc wheels and the area around the brakes will be extremely hot. Touching these areas with hands, feet or other body parts while changing a tire, etc. may result in burns.

- Failure to follow these precautions could cause the wheel nuts to loosen and the tire to fall off, resulting in death or serious injury.
  - Never use oil or grease on the wheel bolts or wheel nuts.  
Oil and grease may cause the wheel nuts to be excessively tightened, leading to bolt or disc wheel damage. In addition, the oil or grease can cause the wheel nuts to loosen and the wheel may fall off, causing a serious accident. Remove any oil or grease from the wheel bolts or wheel nuts.
  - Have the wheel nuts tightened with a torque wrench to 76 ft•lbf (103 N•m, 10.5 kgf•m) as soon as possible after changing wheels.
  - Do not attach a heavily damaged wheel ornament, as it may fly off the wheel while the vehicle is moving.
  - When installing a tire, only use wheel nuts that have been specifically designed for that wheel.
  - If there are any cracks or deformations in the bolt screws, nut threads or bolt holes of the wheel, have the vehicle inspected by your Lexus dealer.

### Installing the spare tire

- 1 Remove any dirt or foreign matter from the wheel contact surface.

If foreign matter is on the wheel contact surface, the wheel nuts may loosen while the vehicle is in motion, causing the tire to come off.

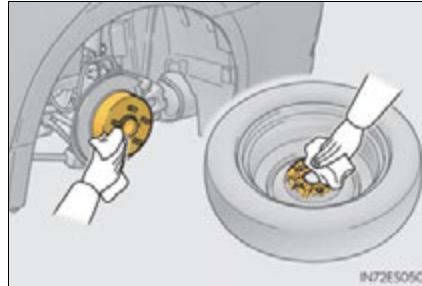

- 2 Install the spare tire and loosely tighten each wheel nut by hand by approximately the same amount.

Tighten the wheel nuts until the tapered portion comes into loose contact with the disc wheel seat.

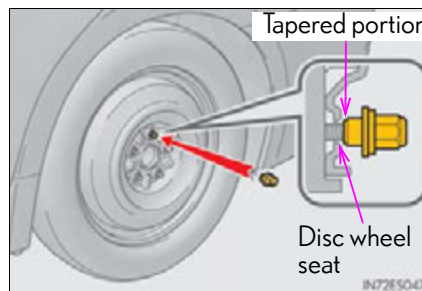

- 3 Lower the vehicle.

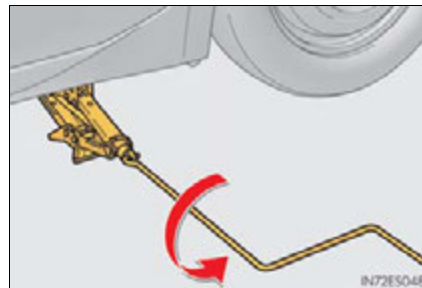

- 4 Firmly tighten each wheel nut two or three times in the order shown in the illustration.

For vehicles with wheel lock nuts, tighten the wheel lock nut last

**Tightening torque:**  
76 ft•lbf (103 N•m, 10.5 kgf•m)

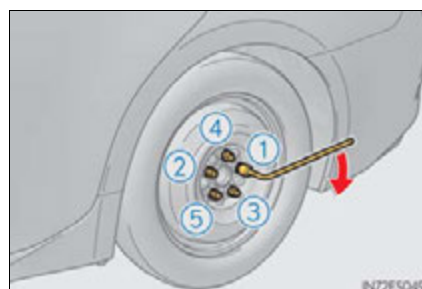

- 5 Stow the flat tire, tire jack and all tools.

■ **The compact spare tire**

- The compact spare tire is identified by the label "TEMPORARY USE ONLY" on the tire sidewall.  
Use the compact spare tire temporarily, and only in an emergency.
- Make sure to check the tire inflation pressure of the compact spare tire. (→P. 518)

■ **When using the compact spare tire**

As the compact spare tire is not equipped with a tire pressure warning valve and transmitter, low inflation pressure of the spare tire will not be indicated by the tire pressure warning system. Also, if you replace the compact spare tire after the tire pressure warning light comes on, the light remains on.

■ **When the compact spare tire is equipped**

The vehicle becomes lower when driving with the compact spare tire compared to when driving with standard tires.

■ **If you have a flat front tire on a road covered with snow or ice**

Install the compact spare tire on one of the rear wheels of the vehicle. Perform the following steps and fit tire chains to the front tires:

- 1 Replace a rear tire with the compact spare tire.
- 2 Replace the flat front tire with the tire removed from the rear of the vehicle.
- 3 Fit tire chains to the front tires.

 **WARNING****■ When using the compact spare tire**

- Remember that the compact spare tire provided is specifically designed for use with your vehicle. Do not use your compact spare tire on another vehicle.
- Do not use more than one compact spare tire simultaneously.
- Replace the compact spare tire with a standard tire as soon as possible.
- Avoid sudden acceleration, abrupt steering, sudden braking and shifting operations that cause sudden engine braking.

**■ When the compact spare tire is attached**

The vehicle speed may not be correctly detected, and the following systems may not operate correctly:

- ABS & Brake assist
- VSC
- TRAC
- Cruise control
- Dynamic radar cruise control (if equipped)
- PCS (if equipped)
- EPS
- LDA (Lane Departure Alert with steering control) (if equipped)
- Rear view monitor system (if equipped)
- Intuitive parking assist (if equipped)
- Navigation system (if equipped)

**■ Speed limit when using the compact spare tire**

Do not drive at speeds in excess of 50 mph (80 km/h) when a compact spare tire is installed on the vehicle.

The compact spare tire is not designed for driving at high speeds. Failure to observe this precaution may lead to an accident causing death or serious injury.

**■ After using the tools and jack**

Before driving, make sure all the tools and jack are securely in place in their storage location to reduce the possibility of personal injury during a collision or sudden braking.

 **NOTICE****■ Driving with tire chains and the compact spare tire**

Do not fit tire chains to the compact spare tire.  
Tire chains may damage the vehicle body and adversely affect driving performance.

**■ When replacing the tires**

When removing or fitting the wheels, tires or the tire pressure warning valve and transmitter, contact your Lexus dealer as the tire pressure warning valve and transmitter may be damaged if not handled correctly.

### If the engine will not start

If the engine will not start even though correct starting procedures are being followed (→P. 151), consider each of the following points:

#### The engine will not start even though the starter motor operates normally.

One of the following may be the cause of the problem:

- There may not be sufficient fuel in the vehicle's tank.  
Refuel the vehicle.
- The engine may be flooded.  
Try to restart the engine again following correct starting procedures.  
(→P. 151)
- There may be a malfunction in the engine immobilizer system. (→P. 65)

#### The starter motor turns over slowly, the interior lights and headlights are dim, or the horn does not sound or sounds at a low volume.

One of the following may be the cause of the problem:

- The battery may be discharged. (→P. 501)
- The battery terminal connections may be loose or corroded.

#### The starter motor does not turn over

The engine starting system may be malfunctioning due to an electrical problem such as electronic key battery depletion or a blown fuse. However, an interim measure is available to start the engine. (→P. 497)

#### The starter motor does not turn over, the interior lights and headlights do not turn on, or the horn does not sound.

One of the following may be the cause of the problem:

- One or both of the battery terminals may be disconnected.
- The battery may be discharged. (→P. 501)
- There may be a malfunction in the steering lock system.

Contact your Lexus dealer if the problem cannot be repaired, or if repair procedures are unknown.



### Emergency start function

When the engine does not start, the following steps can be used as an interim measure to start the engine if the engine switch is functioning normally:

- 1 Set the parking brake.
- 2 Shift the shift lever to P.
- 3 Turn the engine switch to ACCESSORY mode.
- 4 Press and hold the engine switch for about 15 seconds while depressing the brake pedal firmly.

Even if the engine can be started using the above steps, the system may be malfunctioning. Have the vehicle inspected by your Lexus dealer.

## If the shift lever cannot be shifted from P

If the shift lever cannot be shifted with your foot on the brake pedal, there may be a problem with the shift lock system (a system to prevent accidental operation of the shift lever). Have the vehicle inspected by your Lexus dealer immediately.

The following steps may be used as an emergency measure to ensure that the shift lever can be shifted:

- 1 Set the parking brake.
- 2 Turn the engine switch to ACCESSORY mode.
- 3 Depress the brake pedal.

- 4 Pry the cover up with a flathead screwdriver or equivalent tool.

To prevent damage to the cover, cover the tip of the screwdriver with a rag.

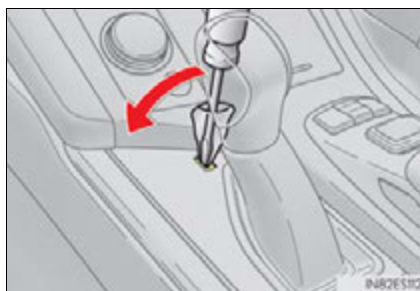

- 5 Press the shift lock override button.

The shift lever can be shifted while the button is pressed.

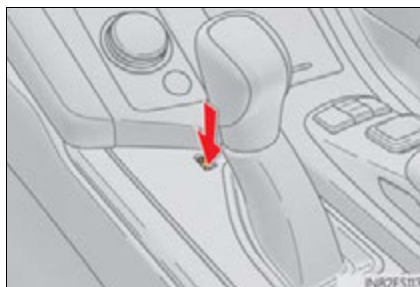

## If the electronic key does not operate properly

If communication between the electronic key and vehicle is interrupted (→P. 108) or the electronic key cannot be used because the battery is depleted, the smart access system with push-button start and wireless remote control cannot be used. In such cases, the doors and trunk can be opened and the engine can be started by following the procedure below.

### Locking and unlocking the doors, unlocking the trunk and key linked functions

#### ■ Doors

Use the mechanical key (→P. 90) in order to perform the following operations:

- ① Locks all the doors
- ② Closes the windows and moon roof (turn and hold)\*
- ③ Unlocks the door

Turning the key rearward unlocks the driver's door. Turning the key once again within 5 seconds unlocks the other doors.

- ④ Opens the windows and moon roof (turn and hold)\*

\*: This setting must be customized at your Lexus dealer.

#### ■ Trunk

Turn the mechanical key clockwise to open.

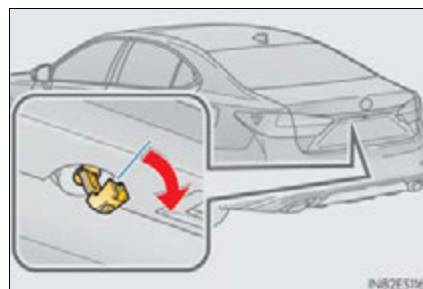
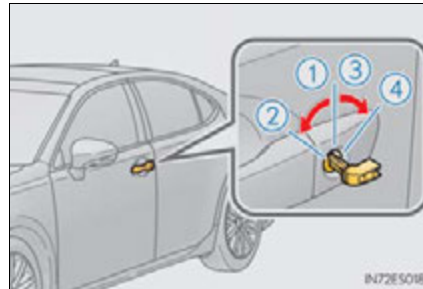

### Starting the engine

1 Ensure that the shift lever is in P and depress the brake pedal.

2 Touch the Lexus emblem side of the electronic key to the engine switch.

The engine switch will turn to IGNITION ON mode.

When the smart access system with push-button start is deactivated in customization setting, the engine switch will turn to ACCESSORY mode.

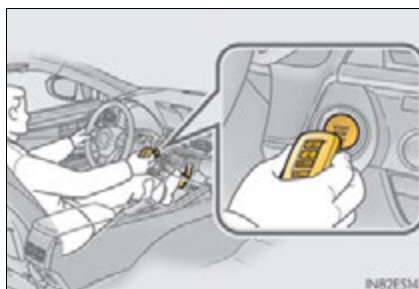

3 Firmly depress the brake pedal and check that  is shown on the multi-information display.

4 Press the engine switch.

In the event that the engine still cannot be started, contact your Lexus dealer.

#### Stopping the engine

Shift the shift lever to P and press the engine switch as you normally do when stopping the engine.

#### Replacing the key battery

As the above procedure is a temporary measure, it is recommended that the electronic key battery be replaced immediately when the battery is depleted. (→P. 451)

#### Changing engine switch modes

Release the brake pedal and press the engine switch in step 3 above.

The engine does not start and modes will be changed each time the switch is pressed. (→P. 152)

#### When the electronic key does not work properly

- Make sure that the smart access system with push-button start has not been deactivated in the customization setting. If it is off, turn the function on. (Customizable features →P. 533)
- Check if battery-saving mode is set. If it is set, cancel the function. (→P. 107)

#### WARNING

##### ■ When using the mechanical key and operating the power windows or moon roof

Operate the power window or moon roof after checking to make sure that there is no possibility of any passenger having any of their body parts caught in the window or moon roof.

Also, do not allow children to operate the mechanical key. It is possible for children and other passengers to get caught in the power window or moon roof.

## If the battery is discharged

The following procedures may be used to start the engine if the vehicle's battery is discharged.

You can also call your Lexus dealer or a qualified repair shop.

If you have a set of jumper (or booster) cables and a second vehicle with a 12-volt battery, you can jump start your vehicle by following the steps below.

- 1 Confirm that the electronic key is being carried.

When connecting the jumper (or booster) cables, depending on the situation, the alarm may activate and doors locked. (→P. 68)

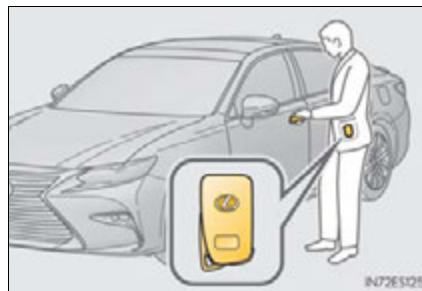

- 2 Open the hood (→P. 423)

- 3 Remove the engine cover.

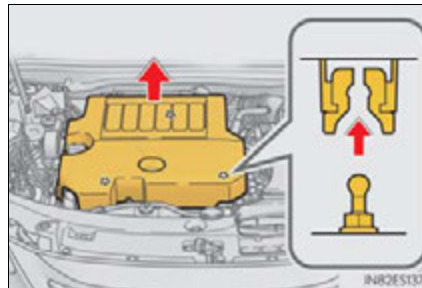

- 4** Connect the jumper cables according to the following procedure:

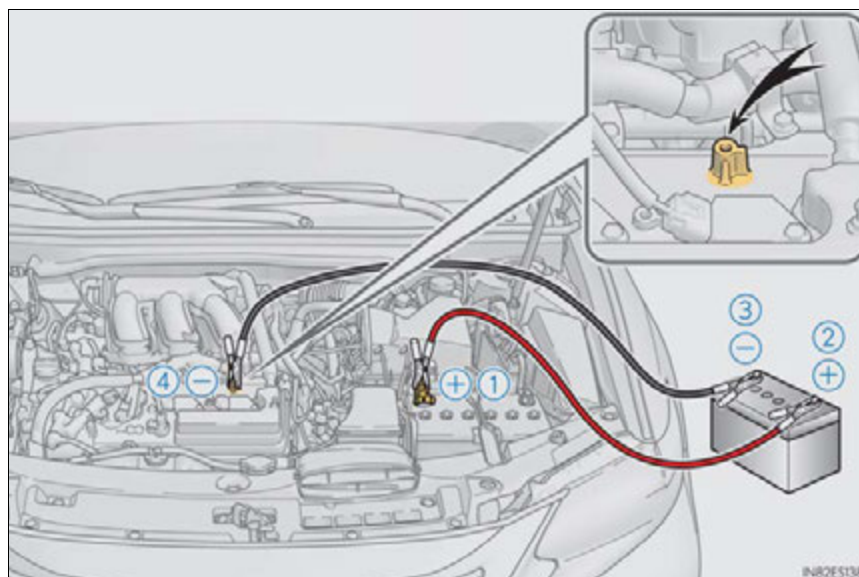

- ① Connect a positive jumper cable clamp to the positive (+) battery terminal on your vehicle.
  - ② Connect the clamp on the other end of the positive cable to the positive (+) battery terminal on the second vehicle.
  - ③ Connect a negative cable clamp to the negative (-) battery terminal on the second vehicle.
  - ④ Connect the clamp at the other end of the negative cable to a solid, stationary, unpainted metallic point away from the battery and any moving parts, as shown in the illustration.
- 5** Start the engine of the second vehicle. Increase the engine speed slightly and maintain at that level for approximately 5 minutes to recharge the battery of your vehicle.
- 6** Open and close any of the doors of your vehicle with the engine switch off.
- 7** Maintain the engine speed of the second vehicle and start the engine of your vehicle by turning the engine switch to IGNITION ON mode.
- 8** Once the vehicle's engine has started, remove the jumper cables in the exact reverse order from which they were connected.

Once the engine starts, have the vehicle inspected at your Lexus dealer as soon as possible.

**■ Starting the engine when the battery is discharged**

The engine cannot be started by push-starting.

**■ To prevent battery discharge**

- Turn off the headlights and the audio system while the engine is stopped.
- Turn off any unnecessary electrical components when the vehicle is running at a low speed for an extended period, such as in heavy traffic.

**■ Charging the battery**

The electricity stored in the battery will discharge gradually even when the vehicle is not in use, due to natural discharge and the draining effects of certain electrical appliances. If the vehicle is left for a long time, the battery may discharge, and the engine may be unable to start. (The battery recharges automatically during driving.)

**■ When recharging or replacing the battery**

- In some cases, it may not be possible to unlock the doors using the smart access system with push-button start when the battery is discharged. Use the wireless remote control or the mechanical key to lock or unlock the doors.
- The engine may not start on the first attempt after the battery has recharged but will start normally after the second attempt. This is not a malfunction.
- The engine switch mode is memorized by the vehicle. When the battery is reconnected, the system will return to the mode it was in before the battery was discharged. Before disconnecting the battery, turn the engine switch off. If you are unsure what mode the engine switch was in before the battery discharged, be especially careful when reconnecting the battery.

 **WARNING**

■ **Avoiding battery fires or explosions**

Observe the following precautions to prevent accidentally igniting the flammable gas that may be emitted from the battery:

- Make sure each jumper cable is connected to the correct terminal and that it is not unintentionally in contact with any other than the intended terminal.
- Do not allow the other end of the jumper cable connected to the “+” terminal to come into contact with any other parts or metal surfaces in the area, such as brackets or unpainted metal.
- Do not allow the + and - clamps of the jumper cables to come into contact with each other.
- Do not smoke, use matches, cigarette lighters or allow open flame near the battery.

■ **Battery precautions**

The battery contains poisonous and corrosive acidic electrolyte, while related parts contain lead and lead compounds. Observe the following precautions when handling the battery:

- When working with the battery, always wear safety glasses and take care not to allow any battery fluids (acid) to come into contact with skin, clothing or the vehicle body.
- Do not lean over the battery.
- In the event that battery fluid comes into contact with the skin or eyes, immediately wash the affected area with water and seek medical attention.  
Place a wet sponge or cloth over the affected area until medical attention can be received.
- Always wash your hands after handling the battery support, terminals, and other battery-related parts.
- Do not allow children near the battery.

 **NOTICE**

■ **When handling jumper cables**

When connecting the jumper cables, ensure that they do not become entangled in the cooling fans or engine drive belt.



## If your vehicle overheats

The following may indicate that your vehicle is overheating.

- The needle of the engine coolant temperature gauge (→P. 74) enters the red zone or a loss of engine power is experienced. (For example, the vehicle speed does not increase.)
- Steam comes out from under the hood.

### Correction procedures

- 1 Stop the vehicle in a safe place and turn off the air conditioning system, and then stop the engine.
- 2 If you see steam:  
Carefully lift the hood after the steam subsides.  
If you do not see steam:  
Carefully lift the hood.

- 3 After the engine has cooled down sufficiently, inspect the hoses and radiator core (radiator) for any leaks.

- ① Radiator
- ② Cooling fans

If a large amount of coolant leaks, immediately contact your Lexus dealer.

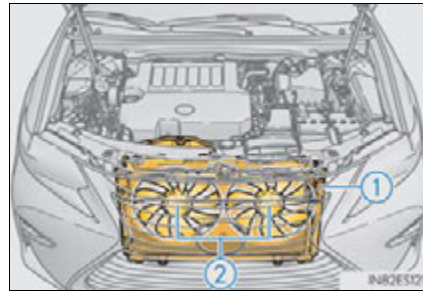

- 4 The coolant level is satisfactory if it is between the "FULL" and "LOW" line on the reservoir.

- ① Reservoir
- ② "FULL"
- ③ "LOW"
- ④ Radiator cap

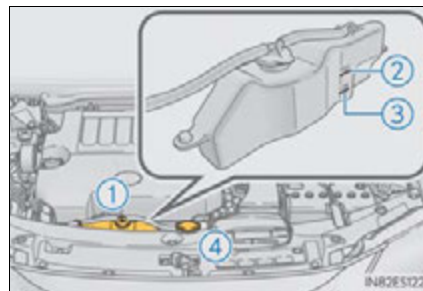

- 5 Add coolant if necessary.  
Water can be used in an emergency if coolant is unavailable.



- 6 Start the engine and turn the air conditioning system on to check that the radiator cooling fans operate and to check for coolant leaks from the radiator or hoses.

The fans operate when the air conditioning system is turned on immediately after a cold start. Confirm that the fans are operating by checking the fan sound and air flow. If it is difficult to check these, turn the air conditioning system on and off repeatedly. (The fans may not operate in freezing temperatures.)

- 7 If the fans are not operating:  
Stop the engine immediately and contact your Lexus dealer.  
If the fans are operating:  
Have the vehicle inspected at the nearest Lexus dealer.

**⚠ WARNING**

**■ When inspecting under the hood of your vehicle**

Observe the following precautions.

Failure to do so may result in serious injury such as burns.

- If steam is seen coming from under the hood, do not open the hood until the steam has subsided. The engine compartment may be very hot.
- Keep hands and clothing (especially a tie, a scarf or a muffler) away from the fans and belts. Failure to do so may cause the hands or clothing to be caught, resulting in serious injury.
- Do not loosen the radiator cap or the coolant reservoir cap while the engine and radiator are hot. High temperature steam or coolant could spray out.

 NOTICE**■ When adding engine coolant**

Add coolant slowly after the engine has cooled down sufficiently. Adding cool coolant to a hot engine too quickly can cause damage to the engine.

**■ To prevent damage to the cooling system**

Observe the following precautions:

- Avoid contaminating the coolant with foreign matter (such as sand or dust etc.).
- Do not use any coolant additives.

## If the vehicle becomes stuck

Carry out the following procedures if the tires spin or the vehicle becomes stuck in mud, dirt or snow:

- 1 Stop the engine. Set the parking brake and shift the shift lever to P.
- 2 Remove the mud, snow or sand from around the front wheels.
- 3 Place wood, stones or some other material under the front wheels to help provide traction.
- 4 Restart the engine.
- 5 Shift the shift lever to D or R and release the parking brake. Then, while exercising caution, depress the accelerator pedal.

### ■ When it is difficult to free the vehicle

Press  to turn off TRAC. (→P. 256)

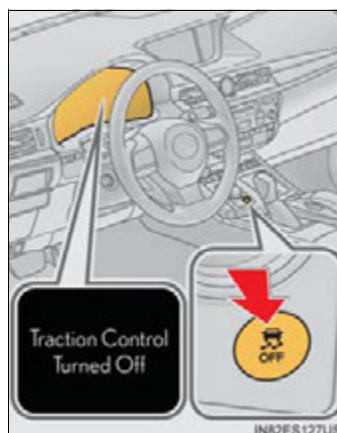

### ⚠ WARNING

#### ■ When attempting to free a stuck vehicle

If you choose to push the vehicle back and forth to free it, make sure the surrounding area is clear to avoid striking other vehicles, objects or people. The vehicle may also lunge forward or lunge back suddenly as it becomes free. Use extreme caution.

#### ■ When shifting the shift lever

Be careful not to shift the shift lever with the accelerator pedal depressed. This may lead to unexpected rapid acceleration of the vehicle that may cause an accident resulting in death or serious injury.

 NOTICE**■ To avoid damaging the transmission and other components**

- Avoid spinning the front wheels and depressing the accelerator pedal more than necessary.
- If the vehicle remains stuck even after these procedures are performed, the vehicle may require towing to be freed.



## Vehicle specifications

### 9

511

#### 9-1. Specifications

Maintenance data (fuel, oil level, etc.).....	512
Fuel information.....	521
Tire information.....	524

#### 9-2. Customization

Customizable features .....	533
-----------------------------	-----

#### 9-3. Initialization

Items to initialize .....	543
---------------------------	-----

**Maintenance data (fuel, oil level, etc.)**

**Dimensions and weight**

Overall length	193.3 in. (4910 mm)	
Overall width	71.7 in. (1820 mm)	
Overall height*	57.1 in. (1450 mm)	
Wheelbase	111.0 in. (2820 mm)	
Tread	Front	62.6 in. (1590 mm)
	Rear	62.0 in. (1575 mm)
Vehicle capacity weight (Occupants + luggage)	905 lb. (410 kg)	

\*: Unladen vehicle



## Vehicle identification

### ■ Vehicle identification number

The vehicle identification number (VIN) is the legal identifier for your vehicle. This is the primary identification number for your Lexus. It is used in registering the ownership of your vehicle.

This number is stamped on the top left of the instrument panel.

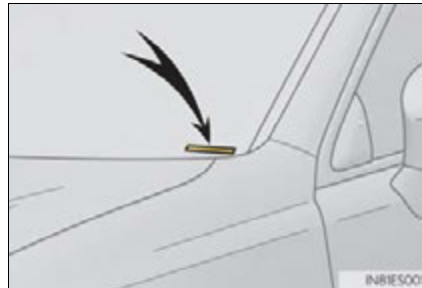

This number is also on the Certification Label.

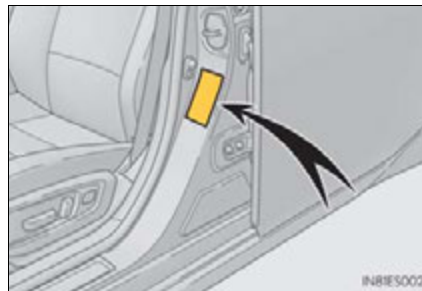

### ■ Engine number

The engine number is stamped on the engine block as shown.

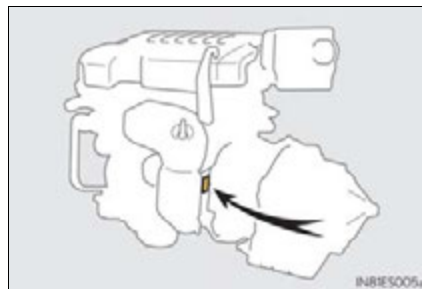

**Engine**

Model	3.5L 6-cylinder (2GR-FE)
Type	6-cylinder V type, 4-cycle, gasoline
Bore and stroke	3.70 × 3.27 in. (94.0 × 83.0 mm)
Displacement	210.9 cu.in. (3456 cm <sup>3</sup> )
Valve clearance	Automatic adjustment
Drive belt tension	

**Fuel**

Fuel type	Unleaded gasoline only
Octane Rating	87 (Research Octane Number 91) or higher
Fuel tank capacity (Reference)	17.0 gal. (64.35 L, 14.2 Imp.gal.)

**Lubrication system**

Oil capacity (Drain and refill — reference <sup>*</sup> )	
With filter	6.4 qt. (6.1 L, 5.4 Imp.qt.)
Without filter	6.0 qt. (5.7 L, 5.0 Imp.qt.)

<sup>\*</sup>: The engine oil capacity is a reference quantity to be used when changing the engine oil. Warm up and turn off the engine, wait more than 5 minutes, and check the oil level on the dipstick.

■ **Engine oil selection**

“Toyota Genuine Motor Oil” is used in your Lexus vehicle. Use Lexus approved “Toyota Genuine Motor Oil” or equivalent to satisfy the following grade and viscosity.

Oil grade: ILSAC GF-5 multigrade engine oil

Recommended viscosity: SAE 0W-20

SAE 0W-20 is the best choice for good fuel economy and good starting in cold weather.

If SAE 0W-20 is not available, SAE 5W-20 oil may be used. However, it must be replaced with SAE 0W-20 at the next oil change.

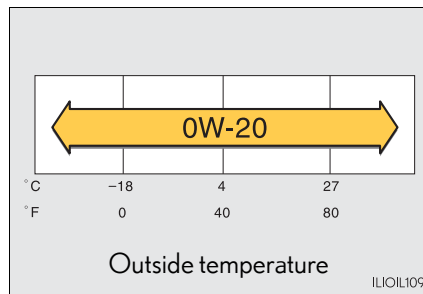

Oil viscosity (0W-20 is explained here as an example):

- The 0W in 0W-20 indicates the characteristic of the oil which allows cold startability. Oils with a lower value before the W allow for easier starting of the engine in cold weather.
- The 20 in 0W-20 indicates the viscosity characteristic of the oil when the oil is at high temperature. An oil with a higher viscosity (one with a higher value) may be better suited if the vehicle is operated at high speeds, or under extreme load conditions.

How to read oil container label:

The International Lubricant Specification Advisory Committee (ILSAC) Certification Mark is added to some oil containers to help you select the oil you should use.



### Cooling system

Capacity	9.7 qt. (9.2 L, 8.1 Imp.qt.)
Coolant type	Use either of the following: <ul style="list-style-type: none"> <li>• “Toyota Super Long Life Coolant”</li> <li>• Similar high-quality ethylene glycol-based non-silicate, non-amine, non-nitrite, and non-borate coolant with long-life hybrid organic acid technology</li> </ul> Do not use plain water alone.

### Ignition system

Spark plug	
Make	DENSO FK20HR11
Gap	0.043 in. (1.1 mm)

 NOTICE

■ Iridium-tipped spark plugs

Use only iridium-tipped spark plugs. Do not adjust the spark plug gap.

### Electrical system

12-volt battery	
Open voltage at 68°F (20°C):	12.6 – 12.8 V: Fully charged 12.2 – 12.4 V: Half charged 11.8 – 12.0 V: Discharged (Voltage is checked 20 minutes after the engine and all lights are turned off.)
Charging rates	5 A max.

### Automatic transmission

Fluid capacity*	6.9 qt. (6.5 L, 5.7 Imp.qt.)
Fluid type	Toyota Genuine ATF WS

\*: The fluid capacity is the quantity of reference.  
If replacement is necessary, contact your Lexus dealer.

 NOTICE

■ **Transmission fluid type**

Using transmission fluid other than “Toyota Genuine ATF WS” may cause deterioration in shift quality, locking up of your transmission accompanied by vibration, and ultimately damage the transmission of your vehicle.

### Brakes

Pedal clearance* <sup>1</sup>	3.54 in. (90 mm) Min.
Pedal free play	0.04 – 0.24 in. (1.0 – 6.0 mm)
Front and rear brake pad wear limit	0.04 in. (1.0 mm)
Parking brake lining wear limit	0.04 in. (1.0 mm)
Parking brake pedal travel* <sup>2</sup>	7 — 10 clicks
Fluid type	SAE J1703 or FMVSS No. 116 DOT 3

\*1: Minimum pedal clearance when depressed with a force of 110.2 lbf (490 N, 50.0 kgf) while the engine is running.

\*2: Parking brake pedal travel when depressed with a force of 67.4 lbf (300 N, 30.6 kgf).

### Steering

Free play	Less than 1.2 in. (30 mm)
-----------	---------------------------

### Tires and wheels

► Type A (For GSV60L-BETGKA model\*<sup>1</sup>)

Tire size	P215/55R17 93V
Tire inflation pressure (Recommended cold tire inflation pressure)	Front tire 33 psi (230 kPa, 2.3 kgf/cm <sup>2</sup> or bar) <sup>*2</sup> 36 psi (250 kPa, 2.5 kgf/cm <sup>2</sup> or bar) <sup>*3</sup> Rear tire 33 psi (230 kPa, 2.3 kgf/cm <sup>2</sup> or bar)
Wheel size	17 × 7J
Wheel nut torque	76 ft·lbf (103 N·m, 10.5 kgf·m)

\*<sup>1</sup>: The model code is indicated on the manufacturer's label or the Certification Regulation label. (→P. 513)

\*<sup>2</sup>: 112 mph (180 km/h) or less

\*<sup>3</sup>: More than 112 mph (180 km/h)

► Type B (For GSV60L-BETGKA model\*<sup>1</sup>)

Tire size	P225/45R18 91V
Tire inflation pressure (Recommended cold tire inflation pressure)	Front tire 33 psi (230 kPa, 2.3 kgf/cm <sup>2</sup> or bar) <sup>*2</sup> 38 psi (260 kPa, 2.6 kgf/cm <sup>2</sup> or bar) <sup>*3</sup> Rear tire 33 psi (230 kPa, 2.3 kgf/cm <sup>2</sup> or bar)
Wheel size	18 × 7 1/2J
Wheel nut torque	76 ft·lbf (103 N·m, 10.5 kgf·m)

\*<sup>1</sup>: The model code is indicated on the manufacturer's label or the Certification Regulation label. (→P. 513)

\*<sup>2</sup>: 99 mph (160 km/h) or less

\*<sup>3</sup>: More than 99 mph (160 km/h)

## ▶ Type C (For GSV60L-CETGKA model\*)

Tire size	P215/55R17 93V
Tire inflation pressure (Recommended cold tire inflation pressure)	Front tire 33 psi (230 kPa, 2.3 kgf/cm <sup>2</sup> or bar) Rear tire 33 psi (230 kPa, 2.3 kgf/cm <sup>2</sup> or bar)
Wheel size	17 × 7J
Wheel nut torque	76 ft•lbf (103 N•m, 10.5 kgf•m)

\*: The model code is indicated on the manufacturer's label or the Certification Regulation label. (→P. 513)

## ▶ Type D (For GSV60L-CETGKA model\*)

Tire size	P225/45R18 91V
Tire inflation pressure (Recommended cold tire inflation pressure)	Front tire 33 psi (230 kPa, 2.3 kgf/cm <sup>2</sup> or bar) Rear tire 33 psi (230 kPa, 2.3 kgf/cm <sup>2</sup> or bar)
Wheel size	18 × 7 1/2J
Wheel nut torque	76 ft•lbf (103 N•m, 10.5 kgf•m)

\*: The model code is indicated on the manufacturer's label or the Certification Regulation label. (→P. 513)

## ▶ Compact spare tire

Tire size	T155/70D17 110M
Tire inflation pressure (Recommended cold tire inflation pressure)	60 psi (420 kPa, 4.2 kgf/cm <sup>2</sup> or bar)
Wheel size	17 × 4T
Wheel nut torque	76 ft•lbf (103 N•m, 10.5 kgf•m)

**Light bulbs**

	Light Bulbs	Bulb No.	W	Type
Exterior	Headlights high beam (halogen bulbs)	—	65	A
	Front turn signal lights	7444NA	28/8	B
	Front side marker lights	W5W	5	C
	Rear turn signal lights	WY21W	21	B
	Back-up lights	W16W	16	C
	Outer foot lights	W5W	5	C
Interior	Door courtesy lights	—	5	C
	Vanity lights	—	8	C
	Trunk light	—	5	C

A: H9 halogen bulbs

B: Wedge base bulbs (amber)

C: Wedge base bulbs (clear)



## Fuel information

**You must only use unleaded gasoline.**

**Select octane rating 87 (Research Octane Number 91) or higher. Use of unleaded gasoline with an octane rating lower than 87 may result in engine knocking. Persistent knocking can lead to engine damage.**

At minimum, the gasoline you use should meet the specifications of ASTM D4814 in the U.S.A..

### ■ Gasoline quality

In very few cases, driveability problems may be caused by the brand of gasoline you are using. If driveability problems persist, try changing the brand of gasoline. If this does not correct the problem, consult your Lexus dealer.

### ■ Gasoline quality standards

- Automotive manufacturers in the U.S.A., Europe and Japan have developed a specification for fuel quality called the World-Wide Fuel Charter (WWFC), which is expected to be applied worldwide.
- The WWFC consists of four categories that are based on required emission levels. In the U.S., category 4 has been adopted.
- The WWFC improves air quality by lowering emissions in vehicle fleets, and improves customer satisfaction through better performance.

### ■ Recommendation of the use of gasoline containing detergent additives

- Lexus recommends the use of gasoline that contains detergent additives to avoid the build-up of engine deposits.
- All gasoline sold in the U.S.A. contains minimum detergent additives to clean and/or keep clean intake systems, per EPA's lowest additives concentration program.
- Lexus strongly recommends the use of Top Tier Detergent Gasoline. For more information on Top Tier Detergent Gasoline and a list of marketers, please go to the official website [www.toptiergas.com](http://www.toptiergas.com).

### ■ Recommendation of the use of cleaner burning gasoline

Gasolines containing oxygenates such as ethers and ethanol, as well as reformulated gasolines, are available in some cities. These fuels are typically acceptable for use, providing they meet other fuel requirements.

Lexus recommends these fuels, since the formulations allow for reduced vehicle emissions.

■ **Non-recommendation of the use of blended gasoline**

- Use only gasoline containing up to 15% ethanol.  
DO NOT use any flex-fuel or gasoline that could contain more than 15% ethanol, including from any pump labeled E30, E50, E85 (which are only some examples of fuel containing more than 15% ethanol).

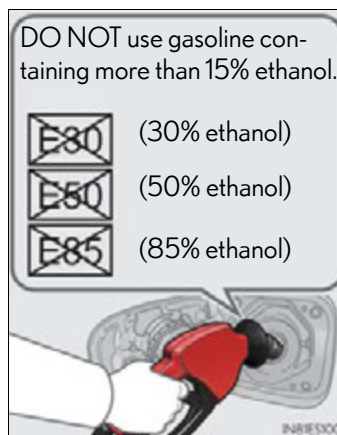

- If you use gasohol in your vehicle, be sure that it has an octane rating no lower than 87.
- Lexus does not recommend the use of gasoline containing methanol.

■ **Non-recommendation of the use of gasoline containing MMT**

Some gasoline contains an octane enhancing additive called MMT (Methylcyclopentadienyl Manganese Tricarbonyl).

Lexus does not recommend the use of gasoline that contains MMT. If fuel containing MMT is used, your emission control system may be adversely affected.

The malfunction indicator lamp on the instrument cluster may come on. If this happens, contact your Lexus dealer for service.

■ **If your engine knocks**

- Consult your Lexus dealer.
- You may occasionally notice light knocking for a short time while accelerating or driving uphill. This is normal and there is no need for concern.

 NOTICE**■ Notice on fuel quality**

- Do not use improper fuels. If improper fuels are used, the engine will be damaged.
- Do not use leaded gasoline.  
Leaded gasoline can cause damage to your vehicle's three-way catalytic converters causing the emission control system to malfunction.
- Do not use gasohol other than the type previously stated.  
Other gasohol may cause fuel system damage or vehicle performance problems.
- Using unleaded gasoline with an octane number or rating lower than the level previously stated will cause persistent heavy knocking.  
At worst, this will lead to engine damage.

**■ Fuel-related poor driveability**

If poor driveability is encountered after using a different type of fuel (poor hot starting, vaporization, engine knocking, etc.), discontinue the use of that type of fuel.

**■ When refueling with gasohol**

Take care not to spill gasohol. It can damage your vehicle's paint.

## Tire information

### Typical tire symbols

► Full-size tire

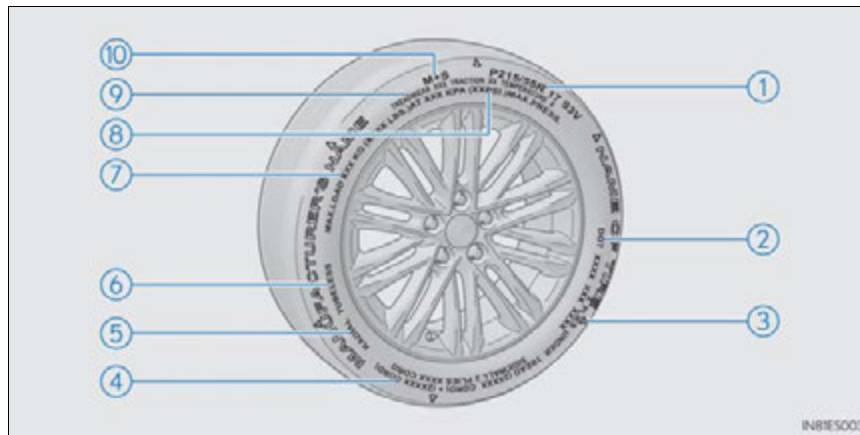

► Compact spare tire

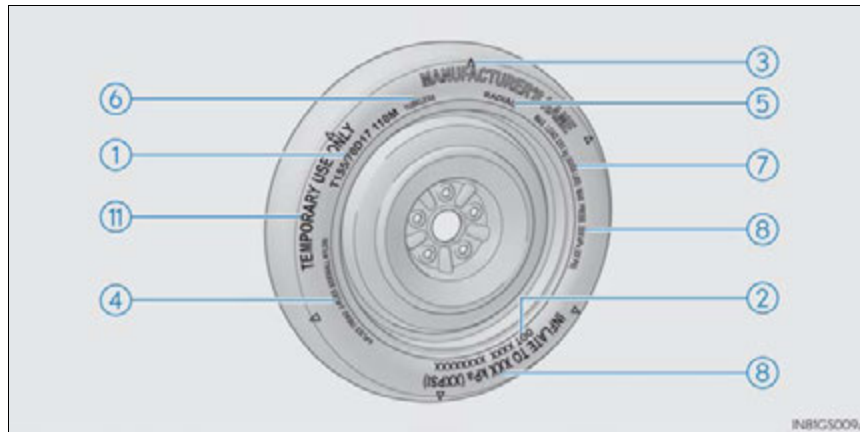

- ① Tire size (→P. 526)
- ② DOT and Tire Identification Number (TIN) (→P. 525)
- ③ Location of treadwear indicators (→P. 436)
- ④ Tire ply composition and materials  
 Plies are layers of rubber-coated parallel cords. Cords are the strands which form the plies in a tire.
- ⑤ Radial tires or bias-ply tires  
 A radial tire has "RADIAL" on the sidewall. A tire not marked "RADIAL" is a bias-ply tire.
- ⑥ TUBELESS or TUBE TYPE  
 A tubeless tire does not have a tube and air is directly put into the tire. A tube type tire has a tube inside the tire and the tube maintains the air pressure.
- ⑦ Load limit at maximum cold tire inflation pressure (→P. 529)
- ⑧ Maximum cold tire inflation pressure (→P. 529)  
 This means the pressure to which a tire may be inflated.
- ⑨ Uniform tire quality grading  
 For details, see "Uniform Tire Quality Grading" that follows.
- ⑩ Summer tires or all season tires (→P. 440)  
 An all season tire has "M+S" on the sidewall. A tire not marked "M+S" is a summer tire.
- ⑪ "TEMPORARY USE ONLY"  
 A compact spare tire is identified by the phrase "TEMPORARY USE ONLY" molded on its sidewall. This tire is designed for temporary emergency use only.

**Typical DOT and Tire Identification Number (TIN)**

- ① DOT symbol\*
- ② Tire Identification Number (TIN)
- ③ Tire manufacturer's identification mark
- ④ Tire size code
- ⑤ Manufacturer's optional tire type code (3 or 4 letters)
- ⑥ Manufacturing week
- ⑦ Manufacturing year

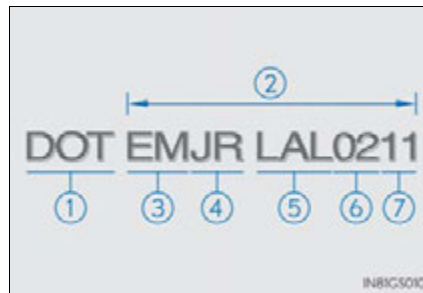

\*: The DOT symbol certifies that the tire conforms to applicable Federal Motor Vehicle Safety Standards.

## Tire size

### ■ Typical tire size information

The illustration indicates typical tire size.

- ① Tire use (P = Passenger car, T = Temporary use)
- ② Section width (millimeters)
- ③ Aspect ratio (tire height to section width)
- ④ Tire construction code (R = Radial, D = Diagonal)
- ⑤ Wheel diameter (inches)
- ⑥ Load index (2 digits or 3 digits)
- ⑦ Speed symbol (alphabet with one letter)



### ■ Tire dimensions

- ① Section width
- ② Tire height
- ③ Wheel diameter

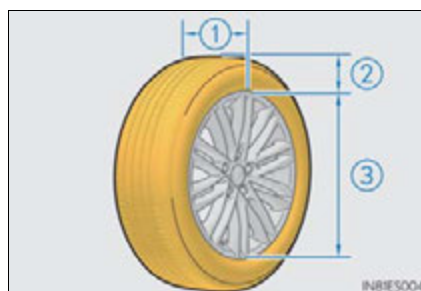

**Tire section names**

- ① Bead
- ② Sidewall
- ③ Shoulder
- ④ Tread
- ⑤ Belt
- ⑥ Inner liner
- ⑦ Reinforcing rubber
- ⑧ Carcass
- ⑨ Rim lines
- ⑩ Bead wires
- ⑪ Chafer

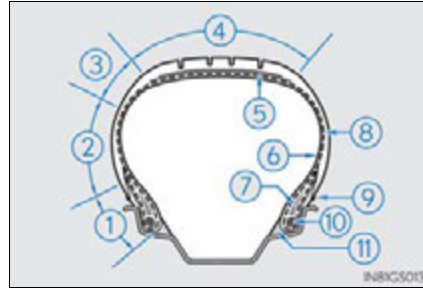
**Uniform Tire Quality Grading**

This information has been prepared in accordance with regulations issued by the National Highway Traffic Safety Administration of the U.S. Department of Transportation.

It provides the purchasers and/or prospective purchasers of Lexus vehicles with information on uniform tire quality grading.

Your Lexus dealer will help answer any questions you may have as you read this information.

- **DOT quality grades**

All passenger vehicle tires must conform to Federal Safety Requirements in addition to these grades. Quality grades can be found where applicable on the tire sidewall between tread shoulder and maximum section width.

For example: Treadwear 200 Traction AA Temperature A

- **Treadwear**

The treadwear grade is a comparative rating based on the wear rate of the tire when tested under controlled conditions on a specified government test course.

For example, a tire graded 150 would wear one and a half (1 - 1/2) times as well on the government course as a tire graded 100.

The relative performance of tires depends upon the actual conditions of their use. Performance may differ significantly from the norm due to variations in driving habits, service practices and differences in road characteristics and climate.

■ **Traction AA, A, B, C**

The traction grades, from highest to lowest, are AA, A, B and C, and they represent the tire's ability to stop on wet pavement as measured under controlled conditions on specified government test surfaces of asphalt and concrete.

A tire marked C may have poor traction performance.

Warning: The traction grade assigned to this tire is based on braking (straight ahead) traction tests and does not include cornering (turning) traction.

■ **Temperature A, B, C**

The temperature grades are A (the highest), B, and C, representing the tire's resistance to the generation of heat and its ability to dissipate heat when tested under controlled conditions on a specified indoor laboratory test wheel.

Sustained high temperature can cause the material of the tire to degenerate and reduce tire life, and excessive temperature can lead to sudden tire failure.

Grade C corresponds to a level of performance which all passenger car tires must meet under the Federal Motor Vehicle Safety Standard No. 109.

Grades B and A represent higher levels of performance on the laboratory test wheel than the minimum required by law.

Warning: The temperature grades of a tire assume that it is properly inflated and not overloaded.

Excessive speed, underinflation, or excessive loading, either separately or in combination, can cause heat buildup and possible tire failure.



**Glossary of tire terminology**

Tire related term	Meaning
Cold tire inflation pressure	Tire pressure when the vehicle has been parked for three hours or more, or has not been driven more than 1 mile or 1.5 km under that condition
Maximum inflation pressure	The maximum cold inflated pressure to which a tire may be inflated, shown on the sidewall of the tire
Recommended inflation pressure	Cold tire inflation pressure recommended by a manufacturer
Accessory weight	The combined weight (in excess of those standard items which may be replaced) of automatic transmission, power steering, power brakes, power windows, power seats, radio and heater, to the extent that these items are available as factory-installed equipment (whether installed or not)
Curb weight	The weight of a motor vehicle with standard equipment, including the maximum capacity of fuel, oil and coolant, and if so equipped, air conditioning and additional weight optional engine
Maximum loaded vehicle weight	The sum of: (a) Curb weight (b) Accessory weight (c) Vehicle capacity weight (d) Production options weight
Normal occupant weight	150 lb. (68 kg) times the number of occupants specified in the second column of Table 1* that follows
Occupant distribution	Distribution of occupants in a vehicle as specified in the third column of Table 1* below
Production options weight	The combined weight of installed regular production options weighing over 5 lb. (2.3 kg) in excess of the standard items which they replace, not previously considered in curb weight or accessory weight, including heavy duty brakes, ride levelers, roof rack, heavy duty battery, and special trim
Rim	A metal support for a tire or a tire and tube assembly upon which the tire beads are seated
Rim diameter (Wheel diameter)	Nominal diameter of the bead seat
Rim size designation	Rim diameter and width
Rim type designation	The industry manufacturer's designation for a rim by style or code

Tire related term	Meaning
Rim width	Nominal distance between rim flanges
Vehicle capacity weight (Total load capacity)	The rated cargo and luggage load plus 150 lb. (68 kg) times the vehicle's designated seating capacity
Vehicle maximum load on the tire	The load on an individual tire that is determined by distributing to each axle its share of the maximum loaded vehicle weight, and dividing by two
Vehicle normal load on the tire	The load on an individual tire that is determined by distributing to each axle its share of curb weight, accessory weight, and normal occupant weight (distributed in accordance with Table 1* below), and dividing by two
Weather side	The surface area of the rim not covered by the inflated tire
Bead	The part of the tire that is made of steel wires, wrapped or reinforced by ply cords and that is shaped to fit the rim
Bead separation	A breakdown of the bond between components in the bead
Bias ply tire	A pneumatic tire in which the ply cords that extend to the beads are laid at alternate angles substantially less than 90 degrees to the centerline of the tread
Carcass	The tire structure, except tread and sidewall rubber which, when inflated, bears the load
Chunking	The breaking away of pieces of the tread or sidewall
Cord	The strands forming the plies in the tire
Cord separation	The parting of cords from adjacent rubber compounds
Cracking	Any parting within the tread, sidewall, or innerliner of the tire extending to cord material
CT	A pneumatic tire with an inverted flange tire and rim system in which the rim is designed with rim flanges pointed radially inward and the tire is designed to fit on the underside of the rim in a manner that encloses the rim flanges inside the air cavity of the tire
Extra load tire	A tire designed to operate at higher loads and at higher inflation pressures than the corresponding standard tire
Groove	The space between two adjacent tread ribs
Innerliner	The layer(s) forming the inside surface of a tubeless tire that contains the inflating medium within the tire

Tire related term	Meaning
Innerliner separation	The parting of the innerliner from cord material in the carcass
Intended outboard sidewall	(a) The sidewall that contains a whitewall, bears white lettering, or bears manufacturer, brand, and/or model name molding that is higher or deeper than the same molding on the other sidewall of the tire, or (b) The outward facing sidewall of an asymmetrical tire that has a particular side that must always face outward when mounted on a vehicle
Light truck (LT) tire	A tire designated by its manufacturer as primarily intended for use on lightweight trucks or multipurpose passenger vehicles
Load rating	The maximum load that a tire is rated to carry for a given inflation pressure
Maximum load rating	The load rating for a tire at the maximum permissible inflation pressure for that tire
Maximum permissible inflation pressure	The maximum cold inflation pressure to which a tire may be inflated
Measuring rim	The rim on which a tire is fitted for physical dimension requirements
Open splice	Any parting at any junction of tread, sidewall, or innerliner that extends to cord material
Outer diameter	The overall diameter of an inflated new tire
Overall width	The linear distance between the exteriors of the sidewalls of an inflated tire, including elevations due to labeling, decorations, or protective bands or ribs
Passenger car tire	A tire intended for use on passenger cars, multipurpose passenger vehicles, and trucks, that have a gross vehicle weight rating (GVWR) of 10,000 lb. or less.
Ply	A layer of rubber-coated parallel cords
Ply separation	A parting of rubber compound between adjacent plies
Pneumatic tire	A mechanical device made of rubber, chemicals, fabric and steel or other materials, that, when mounted on an automotive wheel, provides the traction and contains the gas or fluid that sustains the load
Radial ply tire	A pneumatic tire in which the ply cords that extend to the beads are laid at substantially 90 degrees to the centerline of the tread

Tire related term	Meaning
Reinforced tire	A tire designed to operate at higher loads and at higher inflation pressures than the corresponding standard tire
Section width	The linear distance between the exteriors of the sidewalls of an inflated tire, excluding elevations due to labeling, decoration, or protective bands
Sidewall	That portion of a tire between the tread and bead
Sidewall separation	The parting of the rubber compound from the cord material in the sidewall
Snow tire	A tire that attains a traction index equal to or greater than 110, compared to the ASTM E-1136 Standard Reference Test Tire, when using the snow traction test as described in ASTM F-1805-00, Standard Test Method for Single Wheel Driving Traction in a Straight Line on Snow-and Ice-Covered Surfaces, and which is marked with an Alpine Symbol (  ) on at least one sidewall
Test rim	The rim on which a tire is fitted for testing, and may be any rim listed as appropriate for use with that tire
Tread	That portion of a tire that comes into contact with the road
Tread rib	A tread section running circumferentially around a tire
Tread separation	Pulling away of the tread from the tire carcass
Treadwear indicators (TWI)	The projections within the principal grooves designed to give a visual indication of the degrees of wear of the tread
Wheel-holding fixture	The fixture used to hold the wheel and tire assembly securely during testing

\*: Table 1— Occupant loading and distribution for vehicle normal load for various designated seating capacities

Designated seating capacity, Number of occupants	Vehicle normal load, Number of occupants	Occupant distribution in a normally loaded vehicle
2 through 4	2	2 in front
5 through 10	3	2 in front, 1 in second seat
11 through 15	5	2 in front, 1 in second seat, 1 in third seat, 1 in fourth seat
16 through 20	7	2 in front, 2 in second seat, 2 in third seat, 1 in fourth seat

## Customizable features

Your vehicle includes a variety of electronic features that can be personalized to your preferences. The settings of these features can be changed by using the meter control switches, by using Remote Touch, Lexus Display Audio controller, or at your Lexus dealer.

### Customizing vehicle features

#### ■ Changing by using the Remote Touch or Lexus Display Audio controller

- ▶ Vehicles with Remote Touch

- 1 Press the "MENU" button on the Remote Touch.
- 2 Select "Setup" on the "Menu" screen and select "Vehicle".



Various setting can be changed. Refer to the list of settings that can be changed for details.



- ▶ Vehicles with Lexus Display Audio controller

- 1 Press the "MENU" button on the Lexus Display Audio controller.
- 2 Select "Setup" on the "Menu" screen and select "Vehicle".

Various setting can be changed. Refer to the list of settings that can be changed for details.

#### ■ Changing by using the meter control switches

- 1 Press  or  of the meter control switches, select .

- 2 Press  or  of the meter control switches, select the item or the desired setting, and then press .

To go back to the previous screen, press .





**Customizable features**

Some function settings are changed simultaneously with other functions being customized. Contact your Lexus dealer for further details.

- ① Settings that can be changed using the Remote Touch or Lexus Display Audio controller
- ② Settings that can be changed using the meter control switches
- ③ Settings that can be changed by your Lexus dealer

Definition of symbols: ○ = Available, – = Not available

■ **Multi-information display (→P. 78)**



Function	Default setting	Customized setting	①	②	③
Language	English	French	-	○	-
		Spanish	-	○	-
Units*1	miles (MPG US)	miles (MPG Imperial)	-	○	-
		km (L/100 km)	-	○	-
		km (km/L)	-	○	-
Eco Driving Indicator Light	On	Off	-	○	-
 switch settings	Drive information 1	Desired status screen*2	-	○	-
Drive information screen displayed on the first screen of  (Drive information 1)	Current fuel consumption	*3	-	○	-
	Average fuel economy (after reset)		-	○	-
Drive information screen displayed on the second screen of  (Drive information 2)	Distance (range)	*3	-	○	-
	Average speed (after reset)		-	○	-
Drive information screen displayed on the second screen of  (Drive information 3)	Average fuel economy (after refuel)	*3	-	○	-
	Elapsed time (after start)		-	○	-
Pop-up display	On	Off	-	○	-
Accent color	Color 1	Color 2	○	○	-

\*1: The default setting varies according to countries.



\*2: Some status screens cannot be registered (indicated on the multi-information display)

\*3: 2 of the following items: current fuel consumption, average fuel economy (after reset), average fuel economy (after refuel), average fuel economy (after start), average vehicle speed (after reset), average vehicle speed (after start), distance (driving range), distance (after start), elapsed time (after reset), elapsed time (after start), blank

■ **LDA (Lane Departure Alert with steering control) (if equipped) (→P.196)**

Function	Default setting	Customized setting	①	②	③
Steering Assist	On	Off	–	○	–
Alert means	 (Steering vibration)	 (Buzzer)	–	○	–
Alert sensitivity	Standard	High	–	○	–
Vehicle sway warning	On	Off	–	○	–
Vehicle sway warning sensitivity	Standard	Low	–	○	–
		High			

■ **PCS (Pre-Collision System) (if equipped) (→P.183)**

Function	Default setting	Customized setting	①	②	③
PCS (Pre-Collision System)	On	Off	–	○	–
Alert timing	 (Middle)	 (Far)	–	○	–
		 (Near)			

■ AFS (Adaptive Front-lighting System) (if equipped) (→P. 162)

Function	Default setting	Customized setting	①	②	③
AFS (Adaptive Front-lighting System)	On	Off	-	○	-

■ Door lock (→P. 93, 499)

Function	Default setting	Customized setting	①	②	③
Allows all doors to be unlocked by turning the mechanical key twice in the driver's door	On (Driver's door unlocked in one step, all doors unlocked in two steps)	Off (All doors unlocked in one step)	-	-	○
All doors are automatically locked	Shifting the shift lever to position other than P	Off	○	-	○
		Vehicle speed is approximately 12 mph (20 km/h) or higher			
All doors are automatically unlocked	Shifting the shift lever to P	Off	○	-	○
		Driver's door is opened			
Locking/unlocking of the trunk when all doors are locked/unlocked	On	Off	-	-	○



■ Smart access system with push-button start and wireless remote control (→P. 93)

Function	Default setting	Customized setting	①	②	③
Adjust the volume of buzzer sounds	5	Off	<input type="radio"/>	-	<input type="radio"/>
		1 to 7	<input type="radio"/>	-	<input type="radio"/>
Enable/disable the operation of the emergency flashers when the vehicle is locked or unlocked	On	Off	<input type="radio"/>	-	<input type="radio"/>
Adjust the time elapsed before the automatic door lock function is activated if a door is not opened after being unlocked	60 seconds	Off	<input type="radio"/>	-	<input type="radio"/>
		30 seconds			
		120 seconds			
Operation buzzer (When the vehicle is locked or unlocked)	On	Off	-	-	<input type="radio"/>
Open door reminder buzzer (When locking the vehicle)	On	Off	-	-	<input type="radio"/>

■ Smart access system with push-button start (→P. 93)

Function	Default setting	Customized setting	①	②	③
Smart access system with push-button start can be disabled	On	Off	-	-	<input type="radio"/>
The doors that are unlocked using the smart access system with push-button start can be selected	Driver's door	All the doors	<input type="radio"/>	-	<input type="radio"/>
Number of consecutive door lock operations	2 times	As many as desired	-	-	<input type="radio"/>

■ Wireless remote control (→P. 93)

Function	Default setting	Customized setting	①	②	③
Wireless remote control	On	Off	-	-	○
Allows all doors to be unlocked by pressing  on the electronic key twice	On (Driver's door unlocked in one step, all doors unlocked in two steps)	Off (All doors unlocked in one step)	○	-	○
Trunk unlocking operation	Press and hold (short)	One short press	-	-	○
		Push twice			
		Press and hold (long)			
		Off			
Alarm (panic mode)	On	Off	-	-	○

■ Driving position memory\* (→P. 115)

Function	Default setting	Customized setting	①	②	③
Driver's seat movement when exiting the vehicle	Full	Off	○	-	○
		Partial			
Selecting the door linking driving position memory with door unlock operation	Driver's door	All doors	-	-	○

\*: If equipped

■ Power windows (→P. 129) and moon roof (→P. 132)

Function	Default setting	Customized setting	①	②	③
Mechanical key linked operation	Off	On	-	-	○
Wireless remote control linked operation (Open only)	Off	On	-	-	○
Buzzer sounds if operated using wireless remote control	On	Off	-	-	○

■ Power windows (→P.129)

Function	Default setting	Customized setting	①	②	③
One-touch closing	On	Off	-	-	○

■ Moon roof (→P.132)

Function	Default setting	Customized setting	①	②	③
Linked operation of components when door key is used	Slide only	Tilt only	-	-	○
Linked operation of components when wireless remote control is used	Slide only	Tilt only	-	-	○
Automatic operation	On	Off	-	-	○

■ Turn signal lever (→P.159)

Function	Default setting	Customized setting	①	②	③
Time of flashing of the lane change signal flashers	3	OFF	-	-	○
		4			
		5			
		6			
		7			

■ Automatic light control system (→P. 161)

Function	Default setting	Customized setting	①	②	③
Adjust the sensitivity of the ambient light sensor	0	-2 to 2	<input type="radio"/>	-	<input type="radio"/>
Adjust the time elapsed before the headlights automatically turn off	30 seconds	Off	<input type="radio"/>	-	<input type="radio"/>
		60 seconds			
		90 seconds			
Welcome light illumination control	On	Off	-	-	<input type="radio"/>

■ Lights (→P. 161)

Function	Default setting	Customized setting	①	②	③
Daytime running lights can be disabled*	On	Off	<input type="radio"/>	-	<input type="radio"/>

\*: Except for Canada

■ Intuitive parking assist\* (→P. 220)

Function	Default setting	Customized setting	①	②	③
Detection distance of the front/rear center sensor	Far	Near	<input type="radio"/>	-	<input type="radio"/>
Alert volume can be adjusted	3	1 to 5	<input type="radio"/>	-	<input type="radio"/>
Display setting (when intuitive parking assist is operating)	All sensors displayed	Display off	<input type="radio"/>	-	<input type="radio"/>

\*: If equipped

■ Automatic air conditioning system (→P. 364)

Function	Default setting	Customized setting	①	②	③
A/C Auto switch operation	On	Off	<input type="radio"/>	-	<input type="radio"/>
Exhaust gas sensor sensitivity	0	-3 to 3	<input type="radio"/>	-	<input type="radio"/>

## ■ Illumination (→P. 375)

Function	Default setting	Customized setting	①	②	③
Interior lights illumination control	On	Off	-	-	○
Time elapsed before the interior lights turn off	15 seconds	Off	○	-	○
		7.5 seconds			
		30 seconds			
Operation after the engine switch is turned off	On	Off	-	-	○
Operation when the doors are unlocked	On	Off	-	-	○
Operation when you approach the vehicle with the electronic key on your person	On	Off	-	-	○
Footwell lighting	On	Off	-	-	○
Outer foot lights	On	Off	-	-	○
Time elapsed before the outer foot lights turn off	15 seconds	Off	○	-	○
		7.5 seconds			
		30 seconds			
Enable/disable operation of the ornament lights ("Ambient Illumin.")*	On	Off	-	○	○
Enable/disable operation of the outer foot lights when you approach the vehicle with the electronic key on your person	On	Off	-	-	○
Enable/disable operation of the outer foot lights when the doors are unlocked with the power door lock switch	On	Off	-	-	○

\*: If equipped

■ Rear sunshade\* (→P. 387)

Function	Default setting	Customized setting	①	②	③
Reverse operation	On	Off	-	-	○
Time elapsed before the reverse operation feature activates	0.7 seconds	0 second	-	-	○
		0.9 seconds			
		1.2 seconds			

\*: If equipped

■ Seat belt reminder (→P. 477)

Function	Default setting	Customized setting	①	②	③
Vehicle speed linked seat belt reminder buzzer	On	Off	-	-	○

■ Vehicle customization

- When the smart access system with push-button start is off, the selecting door to unlock cannot be customized.
- When the doors remain closed after unlocking the doors and the automatic door lock function is activated, the signals will be generated in accordance with the operation buzzers and the operation signal (emergency flashers) settings.

■ When customizing using Remote Touch or Lexus Display Audio controller

Stop the vehicle in a safe place, apply the parking brake, and shift the shift lever to P. Also, to prevent battery discharge, leave the engine running while customizing the features.

**⚠ WARNING**

■ **During customization**  
As the engine needs to be running during customization, ensure that the vehicle is parked in a place with adequate ventilation. In a closed area such as a garage, exhaust gases including harmful carbon monoxide (CO) may collect and enter the vehicle. This may lead to death or a serious health hazard.

**⚠ NOTICE**

■ **During customization**  
To prevent battery discharge, ensure that the engine is running while customizing features.

## Items to initialize

The following items must be initialized for normal system operation after such cases as the battery being reconnected, or maintenance being performed on the vehicle:

Item	When to initialize	Reference
Message indicating maintenance is required (U.S.A. only)	<ul style="list-style-type: none"> <li>• After the maintenance is performed</li> </ul>	P. 415
Oil maintenance	<ul style="list-style-type: none"> <li>• After the maintenance is performed</li> </ul>	P. 429
Tire pressure warning system	<ul style="list-style-type: none"> <li>• When rotating the tires</li> <li>• When changing the tire inflation pressure by changing traveling speed or load weight, etc.</li> </ul>	P. 438





For owners

10

545

Reporting safety defects for U.S. owners.....	546
Seat belt instructions for Canadian owners (in French).....	547
SRS airbag instructions for Canadian owners (in French).....	548

## Reporting safety defects for U.S. owners

If you believe that your vehicle has a defect which could cause a crash or could cause injury or death, you should immediately inform the National Highway Traffic Safety Administration (NHTSA) in addition to notifying the Lexus Division of Toyota Motor Sales, U.S.A., Inc. (Toll-free: 1-800-25-LEXUS).

If NHTSA receives similar complaints, it may open an investigation, and if it finds that a safety defect exists in a group of vehicles, it may order a recall and remedy campaign. However, NHTSA cannot become involved in individual problems between you, your dealer, or Lexus Division of Toyota Motor Sales, U.S.A., Inc.

To contact NHTSA, you may call the Vehicle Safety Hotline toll-free at 1-888-327-4236 (TTY: 1-800-424-9153); go to <http://www.safercar.gov>; or write to: Administrator, NHTSA, 1200 New Jersey Ave, S.E., Washington, DC 20590. You can also obtain other information about motor vehicle safety from <http://www.safercar.gov>.

## Seat belt instructions for Canadian owners (in French)

The following is a French explanation of seat belt instructions extracted from the seat belt section in this manual.

See the seat belt section for more detailed seat belt instructions in English.

### Utilisation adéquate des ceintures de sécurité

- Tirez sur la ceinture épaulière jusqu'à ce qu'elle recouvre entièrement l'épaule; elle ne doit cependant pas toucher le cou ni glisser de l'épaule.
- Placez la ceinture abdominale le plus bas possible sur les hanches.
- Réglez la position du dossier. Tenez-vous assis bien au fond du siège, le dos droit.
- Ne vrillez pas la ceinture de sécurité.

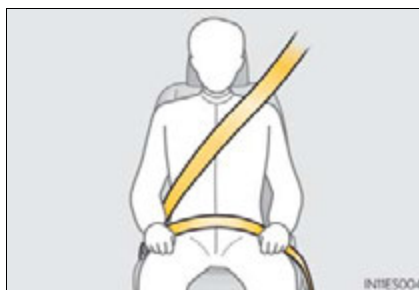

### Entretien et soin

#### ■ Ceintures de sécurité

Avec un chiffon ou une éponge, nettoyez à l'aide d'un savon doux et de l'eau tiède. Vérifiez aussi les ceintures régulièrement pour vous assurer qu'elles ne présentent pas d'usure excessive, d'effilochage ou de coupures.

#### ▲ AVERTISSEMENT

#### ■ Dommages et usure de la ceinture de sécurité

Vérifiez périodiquement le système de ceintures de sécurité. Vérifiez qu'il n'y a pas de coupures, d'effilochures ni de pièces desserrées. N'utilisez pas une ceinture de sécurité endommagée avant qu'elle ne soit remplacée. Les ceintures de sécurité endommagées ne peuvent pas protéger les occupants contre les blessures graves, voire mortelles.

## SRS airbag instructions for Canadian owners (in French)

The following is a French explanation of SRS airbag instructions extracted from the SRS airbag section in this manual.

See the SRS airbag section for more detailed SRS airbag instructions in English.

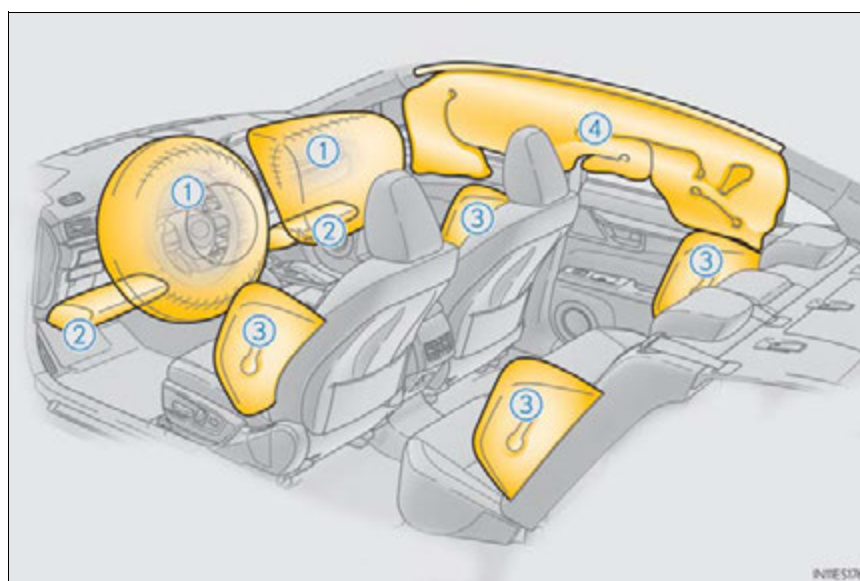

### ◆ Coussins gonflables SRS avant

- ① Coussin gonflable SRS du conducteur/du passager avant  
Peuvent aider à protéger la tête et la poitrine du conducteur et du passager avant contre les impacts avec des composants intérieurs
- ② Coussins gonflables SRS de protection des genoux  
Peuvent aider à protéger le conducteur et le passager avant

---

◆ **Coussins gonflables SRS latéraux et en rideau**

---

- ③ Coussins gonflables SRS latéraux avant  
Peuvent aider à protéger le torse des occupants des sièges avant
- Coussins gonflables SRS latéraux arrière  
Peuvent aider à protéger le torse des occupants des sièges latéraux arrière
- ④ Coussins gonflables SRS en rideau
  - Peuvent aider à protéger principalement la tête des occupants des sièges latéraux
  - Peuvent empêcher les occupants d'être éjectés du véhicule en cas de tonneaux

### Composants du système de coussins gonflables SRS

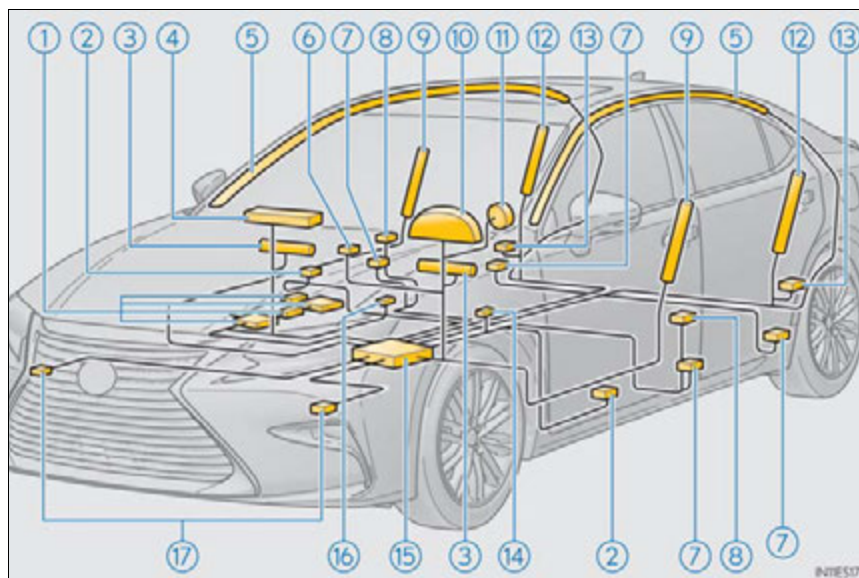

- |  |  |
|--|--|
| ① Système de classification de l'occupant du siège du passager avant (ECU et capteurs) | ⑨ Coussins gonflables latéraux avant                             |
| ② Capteurs de choc latéral (portières avant)   | ⑩ Lampe témoin SRS   |
| ③ Coussins gonflables de protection des genoux   | ⑪ Coussin gonflable du conducteur                                |
| ④ Coussin gonflable du passager avant  | ⑫ Coussins gonflables latéraux arrière                           |
| ⑤ Coussins gonflables en rideau  | ⑬ Capteurs de choc latéral (arrière)                             |
| ⑥ Voyants "AIR BAG ON" et "AIR BAG OFF"  | ⑭ Contacteur de boucle de ceinture de sécurité du conducteur     |
| ⑦ Dispositifs de tension et limiteurs de force des ceintures de sécurité               | ⑮ Module de capteur de coussin gonflable                         |
| ⑧ Capteurs de choc latéral (avant)   | ⑯ Contacteur de boucle de ceinture de sécurité du passager avant |
|  | ⑰ Capteurs de choc avant   |

Votre véhicule est doté de COUSSINS GONFLABLES ÉVOLUÉS dont la conception s'appuie sur les normes de sécurité des véhicules à moteur américains (FMVSS208). Le module de capteur de coussin gonflable (ECU) contrôle le déploiement des coussins gonflables en fonction des informations obtenues des capteurs et d'autres éléments affichés dans le diagramme des composants du système ci-dessus. Ces informations comprennent des données relatives à la gravité de l'accident et aux occupants. Au moment du déploiement des coussins gonflables, une réaction chimique se produit dans les gonfleurs de coussin gonflable et les coussins gonflables se remplissent rapidement d'un gaz non toxique pour aider à limiter le mouvement des occupants.

### AVERTISSEMENT

#### ■ Précautions relatives aux coussins gonflables SRS

Observez les précautions suivantes en ce qui concerne les coussins gonflables SRS. Les négliger pourrait occasionner des blessures graves, voire mortelles.

- Le conducteur et tous les passagers du véhicule doivent porter leur ceinture de sécurité de la manière appropriée.

Les coussins gonflables SRS sont des dispositifs supplémentaires qui doivent être utilisés avec les ceintures de sécurité.

- Le coussin gonflable SRS du conducteur se déploie avec une force considérable et peut occasionner des blessures graves, voire mortelles, notamment lorsque le conducteur se trouve très près du coussin gonflable. La National Highway Traffic Safety Administration (NHTSA), aux États-Unis, fait les recommandations suivantes :

La zone à risque du coussin gonflable du conducteur couvre 2 à 3 in. (50 à 75 mm) de la zone de déploiement du coussin gonflable. Pour assurer une marge de sécurité suffisante, restez à 10 in. (250 mm) du coussin gonflable. Cette distance est mesurée depuis le centre du volant jusqu'à votre sternum. Si maintenant vous vous tenez assis à moins de 10 in. (250 mm), vous pouvez changer votre position de conduite de plusieurs manières :

- Reculez votre siège à la position maximale vous permettant d'atteindre encore aisément les pédales.
- Inclinez légèrement le dossier du siège.  
Même si les véhicules sont conçus différemment, la plupart des conducteurs peuvent maintenir une distance de 10 in. (250 mm), même si le siège se trouve complètement vers l'avant, simplement en inclinant un peu le dossier du siège vers l'arrière. Si la visibilité avant est moindre après avoir incliné le dossier de votre siège, utilisez un coussin ferme et non glissant pour être assis plus haut ou relevez le siège si cette option est disponible sur votre véhicule.
- Si votre volant est réglable en hauteur, inclinez-le vers le bas. Cela vous permet d'orienter le coussin gonflable vers votre buste plutôt que vers votre tête et vers votre cou.

Le siège doit être réglé de la manière recommandée ci-dessus par la NHTSA, tout en gardant le contrôle des pédales et du volant, ainsi que la vue sur les commandes du tableau de bord.

**AVERTISSEMENT**

■ **Précautions relatives aux coussins gonflables SRS**

- Si la rallonge de ceinture de sécurité a été reliée à la boucle des ceintures de sécurité des sièges avant sans avoir été attachée à la plaque de blocage des ceintures de sécurité, les coussins gonflables SRS avant considéreront que le conducteur et le passager avant portent tout de même leur ceinture même si elles ne sont pas attachées. Les coussins gonflables SRS avant peuvent alors ne pas s'activer correctement lors d'une collision, ce qui pourrait occasionner des blessures graves, voire mortelles, en cas de collision. Assurez-vous de toujours porter la ceinture de sécurité avec la rallonge de ceinture de sécurité.



- Le coussin gonflable SRS du passager avant se déploie également avec une force considérable et peut occasionner des blessures graves, voire mortelles, notamment lorsque le passager avant se trouve très près du coussin gonflable. Le siège du passager avant doit se trouver le plus loin possible du coussin gonflable et le dossier doit être réglé de manière à ce que le passager avant soit assis bien droit.
- Le déploiement d'un coussin gonflable risque d'infliger des blessures graves, voire mortelles, aux bébés et aux enfants mal assis et/ou mal attachés. Un bébé ou un enfant trop petit pour utiliser une ceinture de sécurité doit être correctement retenu à l'aide d'un dispositif de retenue pour enfants. Lexus recommande vivement de placer et d'attacher correctement tous les bébés et tous les enfants sur les sièges arrière du véhicule à l'aide de dispositifs de retenue adaptés. Les sièges arrière sont plus sécuritaires pour les bébés et les enfants que le siège du passager avant.

- Ne vous asseyez pas sur le bord du siège et ne vous appuyez pas sur la planche de bord.



- Ne laissez pas un enfant se tenir face au coussin gonflable SRS du passager avant ni s'asseoir sur les genoux d'un passager avant.
- Ne laissez pas les occupants des sièges avant tenir des objets sur leurs genoux.

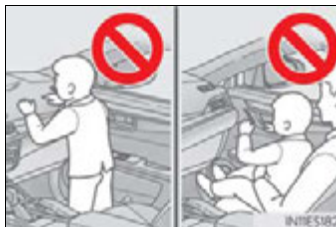



**⚠ AVERTISSEMENT**

■ **Précautions relatives aux coussins gonflables SRS**

- Ne vous appuyez pas sur la portière ou sur le brancard de pavillon, ni sur les montants avant, latéraux ou arrière.



- Ne laissez personne s'agenouiller face à la portière sur les sièges des passagers ni sortir la tête ou les mains à l'extérieur du véhicule.



- Ne fixez et n'appuyez rien sur des zones telles que la planche de bord, le tampon de volant, la partie inférieure du tableau de bord et la porte de la boîte à gants. Ces objets peuvent se transformer en projectiles lorsque les coussins gonflables SRS du conducteur, du passager avant ou de protection des genoux se déploient.

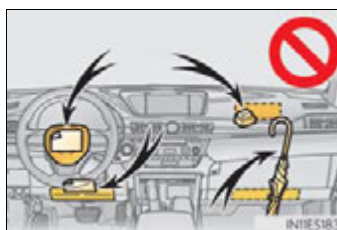

- Ne fixez rien sur des zones telles que les portières, le pare-brise, les glaces de portières, les montants avant ou arrière, le brancard de pavillon et la poignée de maintien.

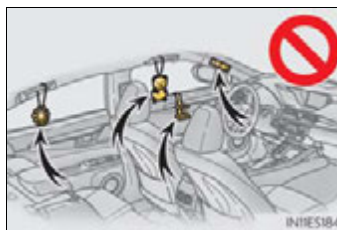

- N'accrochez pas de cintres ni d'objets rigides sur les crochets porte-vêtements. Tous ces objets pourraient se transformer en projectiles et vous occasionner des blessures graves, voire mortelles, en cas de déploiement des coussins gonflables SRS en rideau.
- Si un recouvrement de vinyle est placé sur la zone de déploiement du coussin gonflable SRS de protection des genoux, veillez à le retirer.

 **AVERTISSEMENT****■ Précautions relatives aux coussins gonflables SRS**

- N'utilisez pas d'accessoires recouvrant les parties du siège où les coussins gonflables SRS latéraux se déploient, car ces accessoires pourraient entraver le déploiement des coussins gonflables. De tels accessoires peuvent empêcher les coussins gonflables latéraux de se déployer correctement, rendre le système inopérant ou provoquer accidentellement le déploiement des coussins gonflables latéraux, occasionnant des blessures graves, voire mortelles.
- Ne frappez pas et n'appliquez pas une pression importante à l'emplacement des composants des coussins gonflables SRS.  
Cela peut provoquer un mauvais fonctionnement des coussins gonflables SRS.
- Ne touchez à aucun composant des coussins gonflables SRS immédiatement après leur déploiement (gonflage), car ils pourraient être chauds.
- Si vous avez de la difficulté à respirer après le déploiement des coussins gonflables SRS, ouvrez une portière ou une glace pour laisser entrer l'air, ou quittez le véhicule si vous pouvez le faire en toute sécurité. Dès que possible, nettoyez tous les résidus afin d'éviter les irritations cutanées.
- Si les emplacements de stockage des coussins gonflables SRS, tels que le tampon de volant et les garnitures des montants avant et arrière, sont endommagés ou fissurés, faites-les remplacer par votre concessionnaire Lexus.

**■ Modification et mise au rebut des composants du système de coussins gonflables SRS**

Ne mettez pas votre véhicule au rebut et n'effectuez aucune des modifications suivantes sans d'abord consulter votre concessionnaire Lexus. Les coussins gonflables SRS pourraient fonctionner de manière incorrecte ou se déployer (gonfler) accidentellement, ce qui serait susceptible d'occasionner des blessures graves, voire mortelles.

- Installation, retrait, démontage et réparation des coussins gonflables SRS
- Réparations, modifications, retrait ou remplacement du volant, du tableau de bord, de la planche de bord, de la boîte à gants, des sièges ou du capitonnage des sièges, des montants avant, latéraux et arrière, ou des brancards de pavillon
- Réparations ou modifications de l'aile avant, du pare-chocs avant ou du côté de l'habitacle
- Installation d'une protection de calandre (barre safari, barre kangourou, etc.), de lames de déneigement ou de treuils
- Modifications du système de suspension du véhicule
- Installation d'appareils électroniques tels qu'un émetteur-récepteur radio ou un lecteur de CD
- Modifications à votre véhicule pour une personne aux capacités physiques réduites

## Index

555

What to do if... (Troubleshooting).....	556
Alphabetical index.....	560

For vehicles with navigation system, refer to the “NAVIGATION SYSTEM OWNER’S MANUAL” for information regarding the equipment listed below.

- Navigation system
- Lexus parking assist monitor
- Audio/video system
- Lexus Enform

## What to do if... (Troubleshooting)

If you have a problem, check the following before contacting your Lexus dealer.

### The doors cannot be locked, unlocked, opened or closed



#### You lose your keys

- If you lose your mechanical keys, new genuine mechanical keys can be made by your Lexus dealer. (→P. 91)
- If you lose your electronic keys, the risk of vehicle theft increases significantly. Contact your Lexus dealer immediately. (→P. 92)



#### The doors cannot be locked or unlocked

- Is the electronic key battery weak or depleted? (→P. 451)
- Is the engine switch in IGNITION ON mode?  
When locking the doors, turn the engine switch off. (→P. 152)
- Is the electronic key left inside the vehicle?  
When locking the doors, make sure that you have the electronic key on your person.
- The function may not operate properly due to the condition of the radio wave. (→P.108)



#### The rear door cannot be opened

- Is the child-protector lock set?  
The rear door cannot be opened from inside the vehicle when the lock is set. Open the rear door from outside and then unlock the child-protector lock. (→P. 96)



#### The trunk lid is closed with the electronic key left inside

- The function to prevent the electronic key from being left inside the trunk will operate and you can open the trunk as usual. Take the key out from the trunk. (→P.101)

**If you think something is wrong****The engine does not start**

- Did you press the engine switch while firmly depressing the brake pedal? (→P. 151)
- Is the shift lever in P? (→P. 153)
- Is the electronic key anywhere detectable inside the vehicle? (→P. 106)
- Is the steering wheel unlocked? (→P. 154)
- Is the electronic key battery weak or depleted?  
In this case, the engine can be started in a temporary way. (→P. 500)
- Is the battery discharged? (→P. 501)

**The shift lever cannot be shifted from P even if you depress the brake pedal**

- Is the engine switch in IGNITION ON mode?  
If you cannot release the shift lever by depressing the brake pedal with the engine switch in IGNITION ON mode (→P. 498)

**The steering wheel cannot be turned after the engine is stopped**

- It is locked automatically to prevent theft of the vehicle. (→P. 153)

**The windows do not open or close by operating the power window switches**

- Is the window lock switch pressed?  
The power window except for the one at the driver's seat cannot be operated if the window lock switch is pressed. (→P. 129)

**The engine switch is turned off automatically**

- The auto power off function will be operated if the vehicle is left in ACCESSORY or IGNITION ON mode (the engine is not running) for a period of time. (→P. 153)

 **A warning buzzer sounds during driving**

- The seat belt reminder light is flashing  
Are the driver and the front passenger wearing the seat belts? (→P. 477)
  - The parking brake indicator is on  
Is the parking brake released? (→P. 160)
- Depending on the situation, other types of warning buzzer may also sound. (→P. 476, 482)

 **An alarm is activated and the horn sounds**

- Did anyone inside the vehicle open a door during setting the alarm?  
The sensor detects it and the alarm sounds. (→P. 67)
- To stop the alarm, turn the engine switch to IGNITION ON mode or start the engine.

 **A warning buzzer sounds when leaving the vehicle**

- Is the electronic key left inside the vehicle or the moon roof opened?  
Check the message on the multi-information display. (→P. 482)

 **A warning light turns on or a warning message is displayed**

- When a warning light turns on or a warning message is displayed, refer to P. 476, 482.

**When a problem has occurred**

 **If you have a flat tire**

- Stop the vehicle in a safe place and replace the flat tire with the spare tire. (→P. 485)

 **The vehicle becomes stuck**

- Try the procedure for when the vehicle becomes stuck in mud, dirt, or snow. (→P. 508)



## Alphabetical index

### A

A/C	
Air conditioning filter.....	449
Automatic air conditioning	
system .....	364
Micro dust and pollen	
filter .....	369
<b>ABS (Anti-lock Brake System)</b>	
Function .....	255
Warning light.....	476
<b>Air conditioning filter.....</b>	<b>449</b>
<b>Air conditioning system</b>	
Air conditioning filter.....	449
Automatic air conditioning	
system .....	364
Micro dust and pollen	
filter .....	369
<b>Airbags</b>	
Airbag operating conditions .....	41
Airbag precautions	
for your child .....	37
Airbag warning light .....	476
Correct driving posture.....	28
Curtain shield airbag	
operating conditions .....	41
Curtain shield airbag	
precautions .....	37
Front passenger occupant	
classification system.....	44
General airbag precautions .....	37
Locations of airbags.....	35
Modification and disposal	
of airbags.....	40
Side airbag operating	
conditions .....	41
Side airbag precautions .....	37
Side and curtain shield airbags	
operating conditions .....	41
Side and curtain shield	
airbags precautions .....	37
SRS airbags .....	35
<b>Alarm .....</b>	<b>67</b>
Warning buzzer.....	476
<b>Anchor brackets.....</b>	<b>55</b>
<b>Antennas (smart access system</b>	
with push-button start) .....	106
<b>Anti-lock Brake System (ABS)</b>	
Function.....	255
Warning light.....	476
<b>Approach warning (dynamic</b>	
radar cruise control).....	212
<b>Armrest.....</b>	<b>386</b>



Armrest door .....389

Assist grip .....390

Audio input.....274

Audio system \* .....266

    Audio input.....274

    AUX port.....274

    Bluetooth® audio .....323

    CD player .....299

    iPod.....306

    MP3/WMA disc .....299

    Optimal use .....285

    Portable music player..... 314

    Radio .....292

    Setup menu.....276

    Steering wheel audio  
    switches .....273

    USB memory.....310

Automatic air conditioning  
system .....364

Automatic headlight leveling  
system .....163

Automatic High Beam .....164

Automatic light control  
system .....161

Automatic transmission .....156

    If the shift lever  
    cannot be shifted from P .....498

AUX port \* .....274

Auxiliary box .....381

**B**

Back-up lights

    Replacing light bulbs .....463

    Wattage .....520

Battery .....433

    If the battery  
    is discharged .....501

    Preparing and checking before  
    winter.....260

Bluetooth®\*

    Audio system.....315

    Hands-free system  
    (for cellular phone) .....325

Brake

    Fluid .....432

    Parking brake .....160

    Warning light.....476

Brake assist.....255

Break-in tips .....139

Brightness control

    Instrument panel light control .....75

BSM (Blind Spot Monitor) .....247

**C**

Care

    Aluminum wheels.....409

    Exterior .....408

    Interior.....411

    Seat belts.....412

Cargo capacity .....148

Cargo hooks .....382

CD player \* .....299

Chains.....261

\*: For vehicles with navigation system, refer to the "NAVIGATION SYSTEM OWNER'S MANUAL".

Child restraint system	
Booster seats, definition .....	51
Booster seats, installation.....	60
Convertible seats, definition.....	51
Convertible seats, installation.....	58
Front passenger occupant	
classification system.....	44
Infant seats, definition .....	51
Infant seats, installation .....	58
Installing CRS	
with LATCH anchors .....	56
Installing CRS with seat belts.....	58
Installing CRS	
with top tether strap.....	61
Child safety .....	50
Airbag precautions.....	37
Battery	
precautions.....	434, 504
Child restraint system.....	51
How your child should wear	
the seat belt .....	31
Installing child restraints.....	55
Moon roof precautions.....	135
Power window lock switch.....	129
Power window precautions .....	131
Rear door child-protectors .....	96
Removed electronic	
key battery precautions.....	452
Seat belt extender	
precautions.....	33
Seat belt precautions .....	33
Seat heater precautions.....	373
Trunk precautions.....	102
Child-protectors .....	96
Cleaning	
Aluminum wheels.....	409
Exterior .....	408
Interior .....	411
Seat belts.....	412
Clock.....	385
Coat hooks .....	390
Condenser .....	431
Console box.....	379
Console box light.....	379
Consumption screen.....	84
Cooling system	
Engine overheating.....	505
Cruise control	
Cruise control.....	217
Dynamic radar cruise control .....	205
Cup holders.....	380
Curtain shield airbags .....	35
Customizable features .....	533
<b>D</b>	
Daytime running light system.....	162
Defogger	
Front windshield.....	368
Outside rear view mirrors .....	368
Rear window.....	368
Dimension.....	512
Dinghy towing .....	150
Display	
Dynamic radar cruise control .....	205
LDA (Lane Departure Alert	
with steering control).....	196
Multi-information display.....	78
Trip information .....	85
Warning message.....	482

Display Audio system ..... 266  
 Display settings ..... 282  
 Setup menu ..... 276  
**Do-it-yourself maintenance** ..... 421  
**Door courtesy lights**  
 Location ..... 375  
 Wattage ..... 520  
**Doors**  
 Automatic door locking  
 and unlocking system ..... 96  
 Door glasses ..... 129  
 Door lock ..... 95  
 Outside rear view mirrors ..... 126  
 Rear door child-protector ..... 96  
**Driver's seat position memory** ..... 115  
 Driving position memory ..... 116  
 Memory recall function ..... 117  
 Power easy access system ..... 115  
**Driving**  
 Break-in tips ..... 139  
 Correct driving posture ..... 28  
 Driving mode select switch ..... 245  
 Procedures ..... 138  
 Winter drive tips ..... 260  
**Dynamic radar cruise control**  
 Function ..... 205

**E**

Eco drive mode ..... 245  
 Eco Driving Indicator ..... 82  
 EDR (Event data recorder) ..... 10

**Electric Power Steering (EPS)**  
 Function ..... 256  
 Warning light ..... 477  
**Electronic key** ..... 90  
 Battery-saving function ..... 108  
 If the electronic key does not  
 operate properly ..... 499  
 Replacing the battery ..... 451  
**Emergency, in case of**  
 If a warning buzzer  
 sounds ..... 476  
 If a warning light turns on ..... 476  
 If a warning message  
 is displayed ..... 482  
 If the battery is discharged ..... 501  
 If the electronic key  
 does not operate properly ..... 499  
 If the engine will not start ..... 496  
 If the shift lever  
 cannot be shifted from P ..... 498  
 If you have a flat tire ..... 485  
 If you think something  
 is wrong ..... 474  
 If your vehicle becomes  
 stuck ..... 508  
 If your vehicle has to be  
 stopped in an emergency ..... 469  
 If your vehicle needs  
 to be towed ..... 470  
 If your vehicle overheats ..... 505  
**Emergency flashers** ..... 468

\*: For vehicles with navigation system, refer to the "NAVIGATION SYSTEM OWNER'S MANUAL".

Engine	
Accessory mode.....	152
Compartment.....	425
Engine switch.....	151
Hood.....	423
How to start the engine .....	151
Identification number .....	513
If the engine will not start.....	496
Ignition switch (engine switch).....	151
Overheating.....	505
Engine compartment cover .....	426
Engine coolant	
Capacity.....	516
Checking.....	430
Preparing and checking before winter .....	260
Engine coolant temperature gauge .....	74
Engine immobilizer system .....	65
Engine oil	
Capacity.....	514
Checking.....	427
Preparing and checking before winter .....	260
Enhanced VSC .....	255
EPS	
(Electronic Power Steering)	
Function .....	256
Warning light .....	477
Event data recorder (EDR).....	10
	<b>F</b>
Flat tire.....	485
Floor mats.....	26
Fluid	
Automatic transmission.....	517
Brake.....	517
Washer.....	435
Fog lights	
Switch.....	168
Footwell light.....	375
Front passenger occupant classification system .....	44
Front personal lights .....	376
Front seats	
Adjustment.....	114
Cleaning.....	411
Correct driving posture.....	28
Driving position memory.....	115
Head restraints .....	119
Power easy access system.....	115
Seat heaters.....	374
Seat position memory.....	115
Seat ventilators.....	374
Front side marker lights	
Light switch.....	161
Replacing light bulbs .....	461
Wattage .....	520
Front turn signal lights	
Replacing light bulbs .....	459
Turn signal lever.....	159
Wattage .....	520

**Fuel**

- Capacity ..... 514
- Fuel gauge..... 74
- Fuel pump shut off system.....475
- Information..... 521
- Refueling.....173
- Type ..... 514
- Warning light ..... 477
- Fuel filler door ..... 173**
  - Refueling.....173
  - When the fuel filler door cannot be opened ..... 175
- Fuel pump shut off system..... 475**
- Fuses ..... 453**

**G**

- Garage door opener .....391
- Gauges .....74
- Glove box..... 379
- Grocery bag hooks .....382

**H**

- Hands-free system (for cellular phone) \* ..... 325**
- Head restraints ..... 119**
- Headlights**
  - Light switch.....161
  - Replacing light bulbs..... 458, 464
  - Wattage..... 520

**Heaters**

- Air conditioning system .....364
- Heated steering wheel ..... 374
- Seat heaters.....374
- Outside rear view mirrors .....368
- Hill-start assist control ..... 255**
- Hood .....423**
- Hooks**
  - Cargo hooks .....382
  - Coat hooks.....390
  - Grocery bag hooks .....382
  - Retaining hooks (floor mat)..... 26
- Horn..... 123**

**I**

- I/M test ..... 420
- Identification**
  - Engine .....513
  - Vehicle.....513
- Ignition switch (engine switch) ..... 151**
- Illuminated entry system ..... 377**
- Immobilizer system .....65**
- Indicators .....72**
- Initialization**
  - Maintenance .....415
  - Tire pressure warning system ..... 437
- Initiators (tire pressure warning system) .....442**

\*: For vehicles with navigation system, refer to the "NAVIGATION SYSTEM OWNER'S MANUAL".

Inside rear view mirror .....	124
Instrument panel light control .....	75
Interior light.....	375
Intuitive parking assist	
Function .....	220

**J**

Jack	
Positioning a floor jack.....	424
Vehicle-equipped jack .....	486
Jack handle.....	486
Jam protection function	
Moon roof .....	133
Power trunk opener	
and closer.....	101
Power windows.....	129

**K**

Keyless entry	
Smart access system	
with push-button start.....	93
Wireless remote control.....	93
Keys	
Battery-saving function.....	108
Electronic key .....	90
Engine switch.....	151
If the electronic key	
does not operate properly .....	499
Key number plate .....	90
Keyless entry .....	93
Mechanical key.....	90
Replacing the battery.....	451
Warning buzzer .....	107
Wireless remote control key .....	93
Knee airbags .....	35

**L**

Language	
(multi-information display).....	534
LATCH anchors.....	56
LDA (Lane Departure Alert with	
steering control).....	196
Lever	
Auxiliary catch lever.....	423
Hood lock release lever.....	423
Internal trunk release lever .....	101
Shift lever .....	156
Turn signal lever.....	159
Wiper lever.....	169
Lexus Display Audio system .....	266
Display settings.....	282
Setup menu .....	276
Lexus Enform *	
Lexus Enform Remote * .....	362
Lexus Enform Safety Connect .....	402
Lexus Safety System+ .....	176
License plate lights	
Light switch.....	161
Replacing light bulbs .....	464
Light bulbs	
Replacing.....	456
Wattage .....	520

**Lights**

- Fog light switch.....168
- Headlight switch.....161
- Illuminated entry system.....377
- Interior light.....376
- Interior lights list.....375
- Personal lights.....376
- Replacing light bulbs.....456
- Trunk light.....101
- Turn signal lever.....159
- Vanity lights.....384
- Wattage.....520
- Lock steering column.....153
- Low profile tire.....439
- Luggage security system.....100

**M**

**Maintenance**

- Do-it-yourself maintenance.....421
- General maintenance.....417
- Maintenance data.....512
- Maintenance requirements.....414
- Malfunction indicator lamp.....476
- Master warning light.....477
- Meter.....74
  - Indicators.....72
  - Instrument panel light control.....75
  - Multi-information display.....78
  - Warning lights.....71
- Micro dust and pollen filter.....369

**Mirrors**

- Inside rear view mirror.....124
- Outside rear view mirror
  - defoggers.....368
- Outside rear view mirrors.....126
- Vanity mirrors.....384
- Mobile Assistant\***.....360
- Moon roof**
  - Door lock linked
    - moon roof operation.....133
  - Jam protection function.....133
  - Operation.....132
- MP3 disc\***.....299
- Multi-information display**.....78
  - Drive information.....79
  - Dynamic radar cruise control.....205
  - Language.....534
  - Switching the display.....79
  - Warning message.....482

**N**

- Navigation system\*.....8
- Noise from under vehicle.....8

**O**

- Odometer.....74
- Oil**
  - Engine oil.....514
- Opener**
  - Hood.....423
  - Trunk.....99

\*: For vehicles with navigation system, refer to the "NAVIGATION SYSTEM OWNER'S MANUAL".

Ornament lights.....	375
Outer foot lights	
Outer foot lights.....	375
Wattage.....	520
Outside rear view mirrors	
Adjusting and folding.....	126
Blind spot monitor.....	247
Linked mirror function	
when reversing.....	127
Mirror position memory.....	115
Outside rear view	
mirror defoggers.....	368
Outside temperature display.....	74
Overheating.....	505

## P

Parking assist sensors	
(intuitive parking assist).....	220
Parking brake	
Operation.....	160
Parking brake engaged	
warning buzzer.....	160
Parking lights	
Light switch.....	161
Replacing light bulbs.....	464
PCS (Pre-Collision System)	
Function.....	183
Warning light.....	477
Personal lights.....	376

Power easy access system.....	115
Power outlets.....	385
Power steering (Electric Power	
Steering system).....	256
Warning light.....	477
Power trunk opener and closer.....	99
Power windows	
Door lock linked	
window operation.....	130
Jam protection function.....	129
Operation.....	129
Window lock switch.....	129
Pre-Collision System (PCS)	
Function.....	183
Warning light.....	477

## R

Radar cruise control (dynamic	
radar cruise control).....	205
Radiator.....	431
Radio *.....	292
RCTA (Rear Cross	
Traffic Alert).....	247
Rear personal lights.....	376
Rear side marker lights	
Light switch.....	161
Replacing light bulbs.....	464



Rear door sunshades.....387

Rear sunshade  
     Operation.....387  
     Reverse operation feature.....388

Rear turn signal lights  
     Replacing light bulbs.....462  
     Turn signal lever.....159  
     Wattage.....520

Rear view mirror  
     Inside rear view mirror.....124  
     Outside rear view mirrors.....126

Rear window defoggers.....368

Refueling.....173  
     Capacity.....514  
     Fuel types.....514  
     Opening the fuel tank cap.....174  
     When the fuel filler door  
         cannot be opened.....175

Remote Touch\*

Replacing  
     Electronic key battery.....451  
     Fuses.....453  
     Light bulbs.....456  
     Tires.....485

Reporting safety defects  
     for U.S. owners.....546

Resetting the message indicating  
     maintenance is required.....415

**S**

Safety Connect.....402

Seat belts  
     Adjusting the seat belt.....30  
     Automatic Locking Retractor.....31  
     Child restraint system  
         installation.....58  
     Cleaning and maintaining  
         the seat belt.....412  
     Emergency Locking  
         Retractor.....31  
     How to wear your seat belt.....30  
     How your child should wear  
         the seat belt.....31  
     Pregnant women, proper  
         seat belt use.....32  
     Reminder light and buzzer.....477  
     Seat belt extender.....31  
     Seat belt pretensioners.....31  
     SRS warning light.....476

Seat heaters.....374

Seat position memory.....115

Seat ventilators.....374

Seating capacity.....148

\*: For vehicles with navigation system, refer to the "NAVIGATION SYSTEM OWNER'S MANUAL".

- Seats**
- Adjustment ..... 114
  - Adjustment precautions ..... 114
  - Child seats/child restraint
    - system installation ..... 55
  - Cleaning ..... 411
  - Driving position memory ..... 115
  - Head restraints ..... 119
  - Power easy access system ..... 115
  - Properly sitting in the seat ..... 28
  - Seat heaters ..... 374
  - Seat position memory ..... 115
  - Seat ventilators ..... 374
- Sensor**
- Automatic headlight system ..... 162
  - Inside rear view mirror ..... 125
  - Intuitive parking assist ..... 220
  - Lexus Safety System+ ..... 178
  - Rain-sensing windshield
    - wipers ..... 171
- Service reminder indicators ..... 70**
- Shift lever**
- Automatic transmission ..... 156
  - If the shift lever
    - cannot be shifted from P ..... 498
- Shift lever light ..... 375**
- Shift lock system ..... 498**
- Side airbags ..... 35**
- Side marker lights**
- Light switch ..... 161
  - Replacing light bulbs ..... 461, 464
- Side mirrors**
- Adjusting and folding ..... 126
  - Blind Spot Monitor ..... 247
  - Linked mirror function
    - when reversing ..... 127
  - Mirror position memory ..... 115
- Side turn signal lights**
- Replacing light bulbs ..... 464
  - Turn signal lever ..... 159
- Smart access system**
- with push-button start**
- Antenna location ..... 106
  - Entry functions ..... 93
  - Starting the engine ..... 151
- Snow tires ..... 263**
- Spare tire ..... 485**
- Inflation pressure ..... 519
  - Storage location ..... 486
- Spark plug ..... 516**
- Specifications ..... 512**
- Speedometer ..... 74**
- Steering lock ..... 153**
- Column lock release ..... 154
- Steering wheel**
- Adjustment ..... 122
  - Audio switches \* ..... 273
  - Heated steering wheel ..... 374
  - Power easy access system ..... 115
  - Steering wheel
    - position memory ..... 115
- Stop lights**
- Replacing light bulbs ..... 464
- Storage feature ..... 378**
- Stuck**
- If the vehicle becomes stuck ..... 508

Sun visors .....384

Sun shade

    Rear.....387

    Rear door.....387

    Roof..... 133

Switches

    Audio remote control  
        switches \* .....273

    BSM (Blind spot monitor)  
        switch.....247

    Cruise control switch.....217

    Door lock switch.....95

    Driving mode select switch .....245

    Driving position memory  
        switches.....116

    Dynamic radar cruise  
        control switch ..... 205

    Emergency flashers switch .....468

    Engine switch.....151

    Fog light switch .....168

    Garage door opener  
        switches.....391

    Heated steering wheel  
        switch.....374

    Ignition switch .....151

    Intuitive parking assist switch .....221

    Light switches .....161

    LDA (Lane Departure Alert  
        with steering control) switch ....196

    Meter control switches .....79

    Moon roof switches.....132

    Outside rear view mirror  
        switches.....126

    Power door lock switch .....95

    Power window switches ..... 129

Rear sunshade switch .....387

Rear window and outside  
    rear view mirror defoggers  
        switch .....368

Seat heater switches .....374

Seat ventilator switches .....374

“SOS” button .....402

Talk switch \* .....336

Telephone switches \* .....336

Tilt and telescopic  
    steering control switch.....122

Tire pressure warning reset  
    switch .....438

Trunk closer switch.....100

Trunk opener switch.....99

Trunk opener main switch .....100

Vehicle-to-vehicle distance  
    button.....205

VSC OFF switch.....256

Window lock switch .....129

Windshield wipers  
    and washer switch.....169

**T**

Tachometer .....74

Tail lights

    Light switch.....161

    Replacing light bulbs .....464

Talk switch \* .....336

Telephone switches \* .....336

Theft deterrent system

    Alarm.....67

    Engine immobilizer system .....65

\*: For vehicles with navigation system, refer to the “NAVIGATION SYSTEM OWNER’S MANUAL”.

Tire inflation pressure	
Maintenance data.....	518
Tire inflation pressure display	
function.....	79
Warning light.....	478
<b>Tire information.....</b>	<b>524</b>
Glossary.....	529
Size.....	526
Tire identification number.....	525
Uniform Tire Quality	
Grading.....	527
<b>Tire pressure warning system</b>	
Function.....	437
Initializing.....	437
Installing tire pressure warning	
valves and transmitters.....	437
Registering ID codes.....	438
Tire pressure warning reset	
switch.....	438
Warning light.....	478
<b>Tires</b>	
Chains.....	261
Checking.....	436
If you have a flat tire.....	485
Inflation pressure.....	518
Information.....	524
Replacing.....	485
Rotating tires.....	436
Size.....	518
Snow tires.....	263
Spare tire.....	485
Tire inflation pressure display	
function.....	79
Tire pressure warning system.....	437
Warning light.....	478
<b>Tools.....</b>	<b>486</b>
<b>Top tether strap.....</b>	<b>61</b>
<b>Total load capacity.....</b>	<b>148</b>
<b>Towing</b>	
Dinghy towing.....	150
Emergency towing.....	470
Towing eyelet.....	472
Trailer towing.....	149
<b>TRAC (Traction Control).....</b>	<b>255</b>
<b>Transmission</b>	
Automatic transmission.....	156
Driving mode select switch.....	245
If the shift lever cannot be	
shifted from P.....	498
<b>Trip information.....</b>	<b>85</b>
<b>Trip meters.....</b>	<b>74</b>
<b>Trunk</b>	
Internal trunk release lever.....	101
Jam protection function.....	101
Luggage security system.....	100
Power trunk opener and closer....	99
Smart access system	
with push-button start.....	106
Trunk closer switch.....	100
Trunk easy closer.....	101
Trunk features.....	382
Trunk handle.....	100
Trunk light.....	101
Trunk opener main switch.....	100
Trunk opener switch.....	99
Trunk storage extension.....	389
Wireless remote control.....	93
<b>Trunk light</b>	
Trunk light.....	101
Wattage.....	520

Turn signal lights	
Replacing light bulbs.....	459, 462
Turn signal lever .....	159
Wattage.....	520

**U**

USB memory *	274
--------------	-----

**V**

Vanity lights	
Vanity lights .....	384
Wattage.....	520
Vanity mirrors.....	384
Vehicle data recordings.....	9
Vehicle identification number.....	513
Vehicle Stability Control (VSC).....	255
Ventilators (seat ventilators).....	374
VSC (Vehicle Stability Control).....	255

**W**

Warning buzzers	
Approach warning.....	212
Downshifting .....	158
Seat belt reminder.....	477

Warning lights.....	71
ABS.....	476
Brake system.....	476
Electric power steering.....	477
Low fuel level.....	477
Malfunction indicator lamp.....	476
Master warning light.....	477
Pre-collision system.....	477
Seat belt reminder light.....	477
Slip indicator.....	477
SRS.....	476
Tire pressure.....	478
Warning messages.....	482
Washer	
Checking.....	435
Preparing and checking before winter.....	260
Switch.....	169
Washing and waxing.....	408
Weight	
Cargo capacity.....	148
Load limits.....	148
Weight.....	512
Welcome light illumination control.....	94
Wheels	
Replacing wheels.....	447
Size.....	518

\*: For vehicles with navigation system, refer to the "NAVIGATION SYSTEM OWNER'S MANUAL".

Window glasses .....	129
Window lock switch .....	129
<b>Windows</b>	
Power windows .....	129
Rear window defogger .....	368
Windshield wiper de-icer .....	369
<b>Windshield wipers</b>	
Intermittent windshield wipers with interval adjuster .....	169
Position .....	262
Rain-sensing windshield wipers .....	170
Winter driving tips .....	260
<b>Wireless remote control key</b>	
Battery-Saving Function .....	108
Locking/Unlocking .....	93
Replacing the battery .....	451
WMA disc* .....	299

\*: For vehicles with navigation system, refer to the "NAVIGATION SYSTEM OWNER'S MANUAL".



<b>GAS STATION INFORMATION</b>		
Auxiliary catch lever P. 423	Trunk opener P. 99	Fuel filler door P. 174
Hood lock release lever P. 423	Fuel filler door opener P. 174	Tire inflation pressure P. 518
Fuel tank capacity (Reference)	17.0 gal. (64.35 L, 14.2 Imp.gal.)	
Fuel type	Unleaded gasoline only	P. 514
Cold tire inflation pressure		P. 518
Engine oil capacity (Drain and refill – reference)	With filter Without filter	qt. (L, Imp.qt.) 6.4 (6.1, 5.4) 6.0 (5.7, 5.0)
Engine oil type	“Toyota Genuine Motor Oil” or equivalent Oil grade: ILSAC GF-5 multigrade engine oil Recommended viscosity: SAE 0W-20 <span style="float: right;">P. 514</span>	