

| | |
|--------------------------------------|---|
| Pictorial index | Search by illustration |
| 1 For safety and security | Make sure to read through them |
| 2 Instrument cluster | How to read the gauges and meters, the variety of warning lights and indicators, etc. |
| 3 Operation of each component | Opening and closing the doors and windows, adjustment before driving, etc. |
| 4 Driving | Operations and advice which are necessary for driving |
| 5 Audio system | Operating the audio system and Lexus Display Audio system |
| 6 Interior features | Usage of the interior features, etc. |
| 7 Maintenance and care | Caring for your vehicle and maintenance procedures |
| 8 When trouble arises | What to do in case of malfunction or emergency |
| 9 Vehicle specifications | Vehicle specifications, customizable features, etc. |
| 10 For owners | Reporting safety defects for U.S. owners, and seat belt and SRS airbag instructions for Canadian owners |
| Index | Search by symptom |
| | Search alphabetically |

2 TABLE OF CONTENTS

| | |
|---------------------------|----|
| For your information..... | 10 |
| Reading this manual..... | 14 |
| How to search..... | 15 |
| Pictorial index..... | 16 |

1 For safety and security

| | |
|--|----|
| 1-1. For safe use | |
| Before driving..... | 28 |
| For safe driving | 30 |
| Seat belts..... | 32 |
| SRS airbags..... | 38 |
| Front passenger occupant classification system..... | 47 |
| Safety information for children | 52 |
| Child restraint systems | 53 |
| Installing child restraints..... | 56 |
| Exhaust gas precautions..... | 64 |
| 1-2. Hybrid system | |
| Hybrid system features..... | 65 |
| Hybrid system precautions..... | 69 |
| 1-3. Theft deterrent system | |
| Immobilizer system | 74 |
| Alarm | 76 |
| Theft prevention labels (for U.S.A.)..... | 78 |

2 Instrument cluster

| | |
|--|----|
| 2. Instrument cluster | |
| Warning lights and indicators..... | 80 |
| Gauges and meters..... | 84 |
| Multi-information display | 88 |
| Energy monitor/ consumption screen..... | 91 |

3 Operation of each component

| | |
|--|-----|
| 3-1. Key information | |
| Keys | 100 |
| 3-2. Opening, closing and locking the doors | |
| Side doors..... | 105 |
| Back door | 110 |
| Smart access system with push-button start | 114 |
| 3-3. Adjusting the seats | |
| Front seats..... | 120 |
| Rear seats..... | 122 |
| Driving position memory..... | 124 |
| Head restraints | 127 |

3-4. Adjusting the steering wheel and mirrors

| | |
|--------------------------------|-----|
| Steering wheel | 130 |
| Inside rear view mirror..... | 132 |
| Outside rear view mirrors..... | 135 |

3-5. Opening, closing the windows and moon roof

| | |
|--------------------|-----|
| Power windows..... | 137 |
| Moon roof..... | 140 |

4 Driving**4-1. Before driving**

| | |
|---------------------------|-----|
| Driving the vehicle | 144 |
| Cargo and luggage..... | 150 |
| Vehicle load limits..... | 153 |
| Trailer towing | 154 |
| Dinghy towing..... | 155 |

4-2. Driving procedures

| | |
|-------------------------------|-----|
| Power (ignition) switch | 156 |
| EV drive mode..... | 160 |
| Hybrid transmission..... | 162 |
| Turn signal lever | 167 |
| Parking brake | 168 |

4-3. Operating the lights and wipers

| | |
|------------------------------------|-----|
| Headlight switch | 169 |
| Fog light switch | 172 |
| Windshield wipers and washer | 174 |
| Rear window wiper and washer | 180 |
| Headlight cleaner switch..... | 182 |

4-4. Refueling

| | |
|---------------------------------|-----|
| Opening the fuel tank cap | 183 |
|---------------------------------|-----|

4-5. Using the driving support systems

| | |
|------------------------------------|-----|
| Cruise control | 186 |
| Dynamic radar cruise control | 189 |
| Intuitive parking assist..... | 202 |
| Rear view monitor system..... | 209 |
| Lexus parking assist monitor..... | 219 |
| Driving mode select switch..... | 234 |
| Driving assist systems | 235 |
| PCS (Pre-Collision System) | 239 |

4-6. Driving tips

| | |
|----------------------------------|-----|
| Hybrid vehicle driving tips..... | 244 |
| Winter driving tips..... | 246 |

5 Audio system

5-1. Basic Operations

- Audio system types 252
- Using the steering wheel
audio switches 254
- AUX port/USB port 255

5-2. Using the audio system

- Optimal use of the audio
system 257

5-3. Using the radio

- Radio operation 259

**5-4. Playing audio CDs and
MP3/WMA discs**

- CD player operation 265

5-5. Using an external device

- Listening to an iPod 272
- Listening to a USB memory
device 278
- Using the AUX port 283

5-6. Using Bluetooth® devices

- Bluetooth® audio/phone 284
- Using the steering wheel
switches 291
- Registering a Bluetooth®
audio system for the
first time 292
- Registering a Bluetooth®
phone for the first time 293

5-7. Setup menu

- Setting up a Bluetooth®
enabled portable player 294
- Bluetooth® audio system
setup 298
- Setting a cellular phone 299
- Security and system setup 302
- Using the phone book 305

5-8. Bluetooth® Audio

- Operating a Bluetooth®
enabled portable player 310

5-9. Bluetooth® Phone

- Making a phone call 312
- Receiving a phone call 314
- Speaking on the phone 315

5-10. Bluetooth®

- Bluetooth® 316

| | |
|---|-----|
| 5-11. Basic Operations (Lexus Display Audio System) | |
| Lexus Display Audio System | 320 |
| Steering wheel audio switches..... | 325 |
| USB/AUX ports | 326 |
| 5-12. Setup (Lexus Display Audio System) | |
| Setup menu | 328 |
| General settings..... | 329 |
| Voice settings..... | 332 |
| Display settings..... | 333 |
| 5-13. Using the audio system (Lexus Display Audio System) | |
| Selecting the audio source | 334 |
| Optimal use of the audio system | 335 |
| Audio settings..... | 336 |
| Audio menu screen operation | 338 |
| 5-14. Using the radio (Lexus Display Audio System) | |
| Radio operation | 341 |
| 5-15. Playing an audio CD and MP3/WMA/AAC discs (Lexus Display Audio System) | |
| CD player operation | 347 |
| 5-16. Using an external device (Lexus Display Audio System) | |
| Listening to an iPod..... | 353 |
| Using USB memory device..... | 356 |
| Using the AUX port | 360 |
| 5-17. Connecting Bluetooth® (Lexus Display Audio System) | |
| Steps for using Bluetooth® devices..... | 361 |
| Registering a Bluetooth® device..... | 363 |
| Selecting a Bluetooth® device..... | 364 |
| Connecting a Bluetooth® audio player..... | 365 |
| Connecting a Bluetooth® phone | 366 |
| Displaying a Bluetooth® device details | 367 |
| Detailed Bluetooth® settings | 368 |
| 5-18. Bluetooth® Audio (Lexus Display Audio System) | |
| Listening to Bluetooth® Audio | 369 |

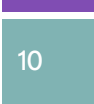
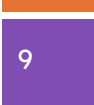
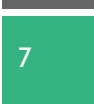
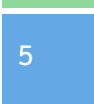

5-19. Bluetooth® Phone (Lexus Display Audio System)
 Using a Bluetooth®
 Phone..... 371
 Making a call.....373
 Receiving a call375
 Speaking on the phone..... 376
 Using a Bluetooth®
 phone message..... 378
 Using the steering wheel
 switches.....380
 Bluetooth® phone settings.... 381

5-20. Phonebook (Lexus Display Audio System)
 Contact settings 383
 Messaging setting..... 386

5-21. Bluetooth® (Lexus Display Audio System)
 What to do if...
 (Troubleshooting)..... 387
 Bluetooth® 390

5-22. Other function (Lexus Display Audio System)
 “Information” screen..... 395
 USB photo397
 Weather information 399
 Voice command system.....400
 Mobile Assistant..... 404
 LEXUS Enform Remote 406

6 Interior features

6-1. Using the air conditioning system and defogger
 Automatic air conditioning system (Vehicles with a navigation system or Lexus Display Audio System) 410
 Automatic air conditioning system (Vehicles without a navigation system or Lexus Display Audio System)418
 Heated steering wheel/
 seat heaters..... 425
 • Heated steering wheel.....426
 • Seat heaters426

6-2. Using the interior lights
 Interior lights list427
 • Personal/interior light
 main switch.....427
 • Front personal/
 interior lights 428
 • Rear interior light..... 428

6-3. Using the storage features

- List of storage features 429
- Glove box 430
- Console box 430
- Cup holders/
bottle holders/
door pockets..... 430
- Auxiliary boxes 432

Luggage compartment
features 434

6-4. Using the other interior features

- Other interior features 439
- Sun visors 439
- Vanity mirrors 439
- Clock 440
- Power outlet 440
- Assist grips 442
- Garage door opener 443
- Compass 449
- LEXUS Enform Safety
Connect..... 455

7 Maintenance and care**7-1. Maintenance and care**

- Cleaning and protecting the
vehicle exterior 462
- Cleaning and protecting the
vehicle interior 465

7-2. Maintenance

- Maintenance
requirements 467
- General maintenance..... 469
- Emission inspection and
maintenance (I/M)
programs..... 472

7-3. Do-it-yourself maintenance

- Do-it-yourself service
precautions..... 473
- Hood..... 475
- Positioning a floor jack..... 477
- Engine compartment..... 478
- 12-volt battery 486
- Tires..... 490
- Tire inflation pressure 497
- Wheels 500
- Air conditioning filter 502
- Electronic key battery..... 504
- Checking and replacing
fuses..... 506
- Light bulbs 509

8 When trouble arises

8-1. Essential information
 Emergency flashers 522
 If your vehicle has to be
 stopped in an emergency... 523

8-2. Steps to take in an emergency
 If your vehicle needs to
 be towed.....524
 If you think something is
 wrong..... 528
 If a warning light turns on
 or a warning buzzer
 sounds 529
 If a warning message is
 displayed 536
 If you have a flat tire 549
 If the hybrid system will not
 start.....558
 If the electronic key does not
 operate properly560
 If the 12-volt battery is
 discharged..... 562
 If your vehicle overheats 566
 If the vehicle becomes
 stuck 570

9 Vehicle specifications

9-1. Specifications
 Maintenance data
 (fuel, oil level, etc.)572
 Fuel information580
 Tire information.....582

9-2. Customization
 Customizable features591

9-3. Initialization
 Items to initialize..... 599

10 For owners

Reporting safety defects for
 U.S. owners..... 602
 Seat belt instructions for
 Canadian owners (in French) 603
 SRS airbag instructions for
 Canadian owners (in French) 604

Index

What to do if...
 (Troubleshooting) 612
 Alphabetical index 616

For vehicles with a navigation system, refer to the “NAVIGATION SYSTEM OWNER’S MANUAL” for information regarding the equipment listed below.

- Navigation system
- Rear view monitor system
- Audio/visual system

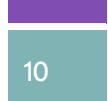
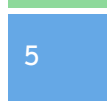
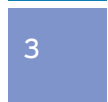

For your information

Main Owner's Manual

The Owner's Manual provides instructions on the proper operation of this vehicle. The driver should read the Owner's Manual prior to driving the vehicle. Failure to follow the instructions in the Owner's Manual could lead to an accident, resulting in death or serious injury.

Please note that this manual applies to all models and explains all equipment, including options. Therefore, you may find some explanations for equipment not installed on your vehicle.

All specifications provided in this manual are current at the time of printing. However, because of the Lexus policy of continual product improvement, we reserve the right to make changes at any time without notice.

Depending on specifications, the vehicle shown in the illustrations may differ from your vehicle in terms of color and equipment.

The manuals for this vehicle can be stored in the auxiliary box beneath the luggage compartment. (→P. 437)

Noise from under vehicle after turning off the hybrid system

Approximately five hours after the hybrid system is turned off, you may hear sound coming from under the vehicle for several minutes. This is the sound of a fuel evaporation leakage check and, it does not indicate a malfunction.

Accessories, spare parts and modification of your Lexus

A wide variety of non-genuine spare parts and accessories for Lexus vehicles are currently available in the market. You should know that Toyota does not warrant these products and is not responsible for their performance, repair, or replacement, or for any damage they may cause to, or adverse effect they may have on, your Lexus vehicle.

This vehicle should not be modified with non-genuine Lexus products. Modification with non-genuine Lexus products could affect its performance, safety or durability, and may even violate governmental regulations. In addition, damage or performance problems resulting from the modification may not be covered under warranty.

Installation of a mobile two-way radio system

The installation of a mobile two-way radio system in your vehicle could affect electronic systems such as:

- Multiport fuel injection system/sequential multiport fuel injection system
- Dynamic radar cruise control system
- Cruise control system
- Anti-lock brake system
- SRS airbag system
- Seat belt pretensioner system

Be sure to check with your Lexus dealer for precautionary measures or special instructions regarding installation of a mobile two-way radio system.

High voltage parts and cables on the hybrid vehicles emit approximately the same amount of electromagnetic waves as the conventional gasoline powered vehicles or home electronic appliances despite of their electromagnetic shielding.

Unwanted noise may occur in the reception of the mobile two-way radio.

Vehicle data recordings

Your Lexus is equipped with several sophisticated computers that will record certain data, such as:

- Engine speed
- Electric motor speed (traction motor speed)
- Accelerator status
- Brake status
- Vehicle speed
- Shift position
- Hybrid battery (traction battery) status

The recorded data varies according to the vehicle grade level and options with which it is equipped. Furthermore, these computers do not record conversations, sounds or pictures.

● Data usage

Lexus may use the data recorded in these computers to diagnose malfunctions, conduct research and development, and improve quality.

Lexus will not disclose the recorded data to a third party except:

- With the consent of the vehicle owner or with the consent of the lessee if the vehicle is leased
- In response to an official request by the police, a court of law or a government agency
- For use by Lexus in a lawsuit
- For research purposes where the data is not tied to a specific vehicle or vehicle owner

● Usage of data collected through Safety Connect / Lexus Enform (U.S. mainland only)

If your Lexus has Safety Connect or Lexus Enform and if you have subscribed to those services, please refer to the Safety Connect / Lexus Enform Telematics Subscription Service Agreement for information on data collected and its usage.

Event data recorder

This vehicle is equipped with an event data recorder (EDR). The main purpose of an EDR is to record, in certain crash or near crash-like situations, such as an air bag deployment or hitting a road obstacle, data that will assist in understanding how a vehicle's systems performed. The EDR is designed to record data related to vehicle dynamics and safety systems for a short period of time, typically 30 seconds or less.

The EDR in this vehicle is designed to record such data as:

- How various systems in your vehicle were operating;
- Whether or not the driver and passenger safety belts were buckled/fastened;
- How far (if at all) the driver was depressing the accelerator and/or brake pedal; and,
- How fast the vehicle was traveling.

These data can help provide a better understanding of the circumstances in which crashes and injuries occur.

NOTE: EDR data are recorded by your vehicle only if a nontrivial crash situation occurs; no data are recorded by the EDR under normal driving conditions and no personal data (e.g., name, gender, age, and crash location) are recorded. However, other parties, such as law enforcement, could combine the EDR data with the type of personally identifying data routinely acquired during a crash investigation.

To read data recorded by an EDR, special equipment is required, and access to the vehicle or the EDR is needed. In addition to the vehicle manufacturer, other parties, such as law enforcement, that have the special equipment, can read the information if they have access to the vehicle or the EDR.

● Disclosure of the EDR data

Lexus will not disclose the data recorded in an EDR to a third party except when:

- An agreement from the vehicle's owner (or the lessee for a leased vehicle) is obtained
- In response to an official request by the police, a court of law or a government agency
- For use by Lexus in a lawsuit

However, if necessary, Lexus may:

- Use the data for research on vehicle safety performance
- Disclose the data to a third party for research purposes without disclosing information about the specific vehicle or vehicle owner

Scraping of your Lexus

The SRS airbag and seat belt pretensioner devices in your Lexus contain explosive chemicals. If the vehicle is scrapped with the airbags and seat belt pretensioners left as they are, this may cause an accident such as fire. Be sure to have the systems of the SRS airbag and seat belt pretensioner removed and disposed of by a qualified service shop or by your Lexus dealer before you scrap your vehicle.

Perchlorate Material

Special handling may apply, See www.dtsc.ca.gov/hazardouswaste/perchlorate. Your vehicle has components that may contain perchlorate. These components may include airbag, seat belt pretensioners, and wireless remote control batteries.

 **WARNING****■ General precautions while driving**

- Obey all traffic laws.
- The driver is responsible for the proper operation of the vehicle, including evaluation of weather conditions and road conditions.

Driving under the influence: Never drive your vehicle when under the influence of alcohol or drugs that have impaired your ability to operate your vehicle. Alcohol and certain drugs delay reaction time, impair judgment and reduce coordination, which could lead to an accident that could result in death or serious injury.

Defensive driving: Always drive defensively. Anticipate mistakes that other drivers or pedestrians might make and be ready to avoid accidents.

Driver distraction: Always give your full attention to driving. Anything that distracts the driver, such as adjusting controls, talking on a cellular phone or reading can result in a collision causing death or serious injury to you, your occupants or others.

■ General precaution regarding children's safety

Never leave children unattended in the vehicle, and never allow children to have or use the key.

Children may be able to start the vehicle or shift the vehicle into neutral. There is also a danger that children may injure themselves by playing with the windows, the moon roof, or other features of the vehicle. In addition, heat build-up or extremely cold temperatures inside the vehicle can be fatal to children.

Reading this manual

 **WARNING:**
Explains something that, if not obeyed, could cause death or serious injury to people.

 **NOTICE:**
Explains something that, if not obeyed, could cause damage to or a malfunction in the vehicle or its equipment.

1 2 3... Indicates operating or working procedures. Follow the steps in numerical order.

 Indicates the action (pushing, turning, etc.) used to operate switches and other devices.

 Indicates the outcome of an operation (e.g. a lid opens).

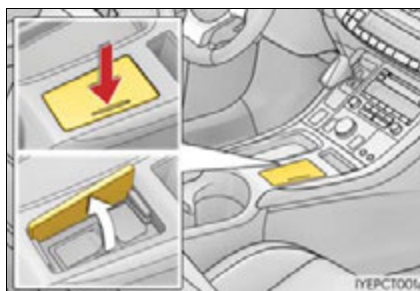

 Indicates the component or position being explained.

 Means "Do not", "Do not do this", or "Do not let this happen".



How to search

■ Searching by name

- Alphabetical index.....P. 616

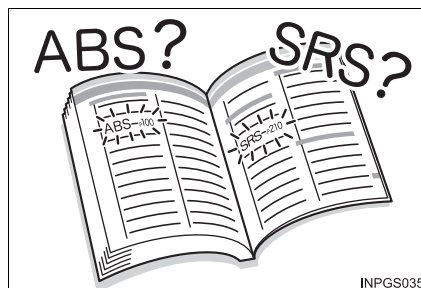

■ Searching by installation position

- Pictorial index.....P. 16

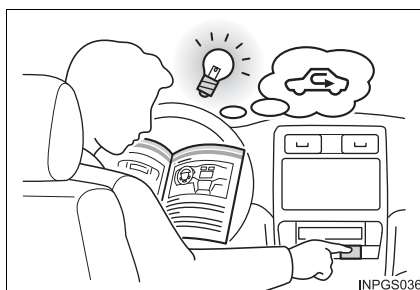

■ Searching by symptom or sound

- What to do if...
(Troubleshooting).....P. 612



■ Searching by title

- Table of contents.....P. 2

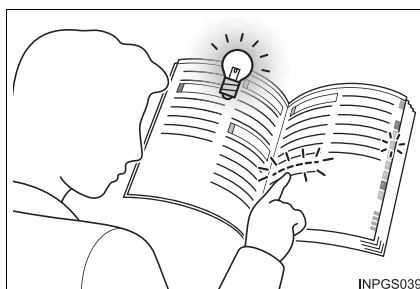

Pictorial index

■ Exterior

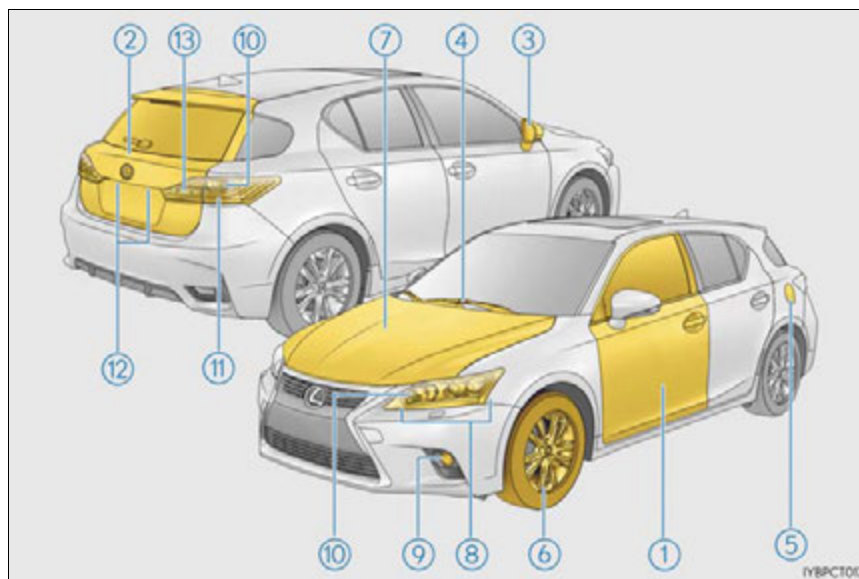

The shape of the headlights may differ depending on the grade, etc. (→P. 509)

| | | |
|---|---|---------------|
| ① | Side doors | P. 105 |
| | Locking/unlocking | P. 105 |
| | Opening/closing the door glasses | P. 137 |
| | Locking/unlocking by using the mechanical key | P. 560 |
| | Warning lights/warning messages | P. 530, 537 |
| ② | Back door | P. 110 |
| | Opening from outside | P. 111 |
| | Warning lights/warning messages | P. 530, 537 |
| ③ | Outside rear view mirrors | P. 135 |
| | Adjusting the mirror angle | P. 135 |
| | Folding the mirrors | P. 135 |
| | Driving position memory * | P. 124 |
| | Defogging the mirrors | P. 414, 420 |

| | | |
|---|---|---------------|
| ④ | Windshield wipers | P. 174 |
| | Precautions against winter season | P. 246 |
| | To prevent freezing (windshield wiper de-icer)* | P. 415, 421 |
| | Precautions against car wash | P. 463 |
| ⑤ | Fuel filler door | P. 183 |
| | Refueling method | P. 183 |
| | Fuel type/fuel tank capacity | P. 573 |
| ⑥ | Tires | P. 490 |
| | Tire size/inflation pressure | P. 577 |
| | Winter tires/tire chain | P. 247 |
| | Checking/rotation/tire pressure warning system | P. 490 |
| | Coping with flat tires | P. 549 |
| ⑦ | Hood | P. 475 |
| | Opening | P. 475 |
| | Engine compartment cover | P. 479 |
| | Engine oil | P. 574 |
| | Coping with overheat | P. 566 |
| | Warning messages | P. 537 |

Light bulbs of the exterior lights for driving
(Replacing method: P. 509, Watts: P. 579)

| | | |
|---|---|---------------|
| ⑧ | Headlights/parking lights/daytime running lights/ side marker lights | P. 169 |
| ⑨ | Fog lights | P. 172 |
| ⑩ | Turn signal lights | P. 167 |
| ⑪ | Stop/tail lights | P. 169 |
| ⑫ | License plate lights | P. 169 |
| ⑬ | Back-up lights | |
| | Shifting the shift lever to R | P. 162 |

*: If equipped

■ Instrument panel

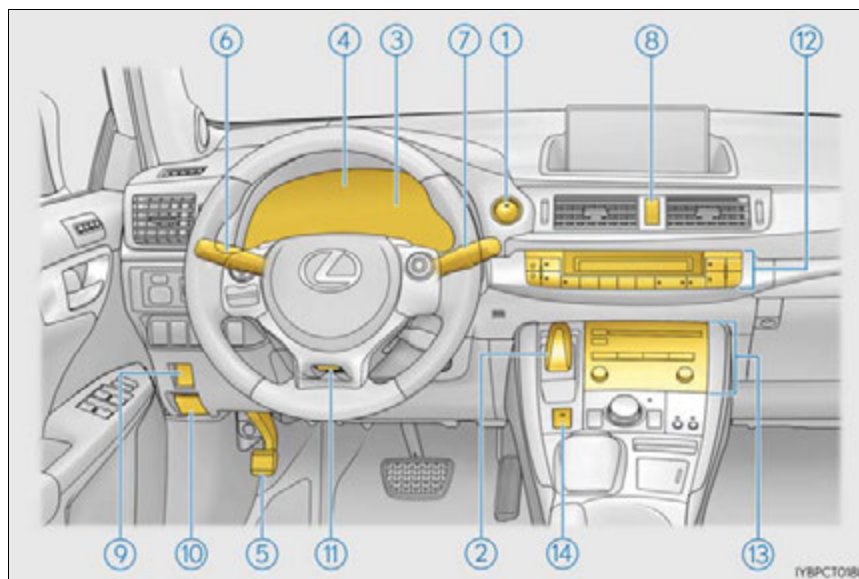

| | | |
|---|--|---------------|
| ① | Power switch | P. 156 |
| | Starting the hybrid system/changing the modes..... | P. 156 |
| | Emergency stop of the hybrid system..... | P. 523 |
| | When the hybrid system will not start..... | P. 558 |
| | Warning messages..... | P. 545 |
| ② | Shift lever | P. 162 |
| | Changing the shift position..... | P. 162 |
| | Precautions against towing..... | P. 524 |
| ③ | Meters | P. 84 |
| | Reading the meters/adjusting the instrument panel light..... | P. 84 |
| | Warning lights/indicator lights..... | P. 80 |
| | When the warning lights come on..... | P. 529 |

| | | |
|---|--|--------------------|
| ④ | Multi-information display | P. 88 |
| | Display | P. 88 |
| | Energy monitor | P. 91 |
| | When the warning messages are displayed | P. 536 |
| ⑤ | Parking brake | P. 168 |
| | Applying/releasing | P. 168 |
| | Precautions against winter season | P. 246 |
| | Warning buzzer/message | P. 529, P. 539 |
| ⑥ | Turn signal lever | P. 167 |
| | Headlight switch | P. 169 |
| | Headlights/parking lights/tail lights/daytime running lights | P. 169 |
| | Fog lights | P. 172 |
| ⑦ | Windshield wiper and washer switch | P. 174 |
| | Rear window wiper and washer switch | P. 180 |
| | Usage | P. 174, 180 |
| | Adding washer fluid | P. 485 |
| | Warning messages | P. 542 |
| ⑧ | Emergency flasher switch | P. 522 |
| ⑨ | Fuel filler door opener | P. 183 |
| ⑩ | Hood lock release lever | P. 475 |
| ⑪ | Tilt and telescopic steering lock release lever | P. 130 |
| ⑫ | Air conditioning system | P. 410, 418 |
| | Usage | P. 410, 418 |
| | Rear window defogger | P. 414, 420 |
| ⑬ | Audio system* | P. 252, 320 |
| | Audio system | P. 252, 320 |
| | Hands-free system | P. 284, 361 |
| ⑭ | P position switch | P. 163 |

*: For vehicles with a navigation system, refer to "NAVIGATION SYSTEM OWNER'S MANUAL".

■ Switches

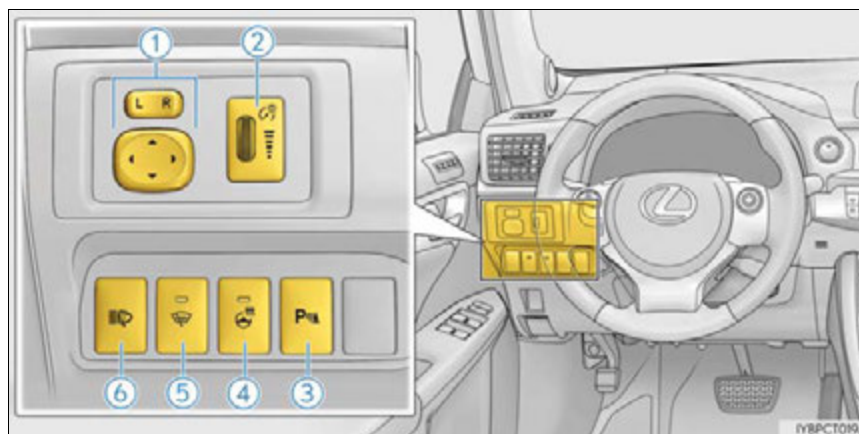

- ① Outside rear view mirror switches P.135
- ② Instrument panel light control dial P. 85
- ③ Intuitive parking assist switch * P. 202
- ④ Heated steering wheel switch * P. 425
- ⑤ Windshield wiper de-icer switch * P. 421
- ⑥ Headlight cleaner switch * P. 182

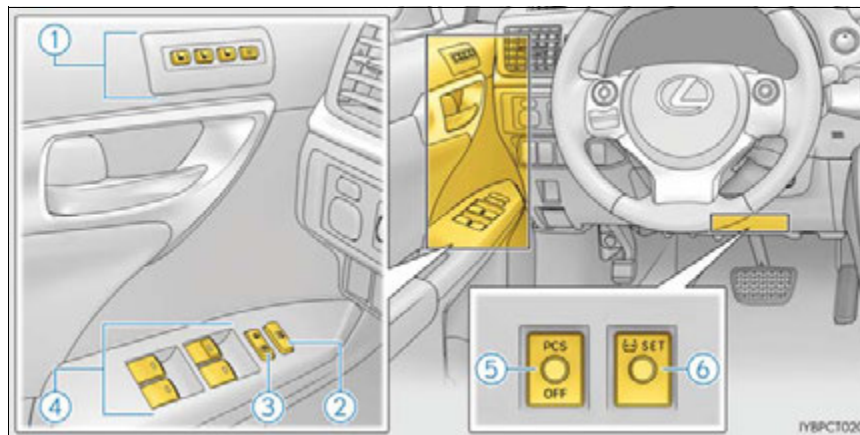

- ① Driving position memory buttons* P. 124
- ② Window lock switch P. 137
- ③ Door lock switches P. 107
- ④ Power window switches P. 137
- ⑤ Pre-collision braking off switch* P. 239
- ⑥ Tire pressure warning reset switch P. 491

*: If equipped



- ① Audio remote control switches^{*1} P. 254, 325
- ② “DISP” switch P. 88
- ③ Cruise control switch
 - Cruise control^{*2} P. 186
 - Dynamic radar cruise control^{*2} P. 189
- ④ Vehicle-to-vehicle distance button^{*2} P. 189
- ⑤ Talk switch^{*1} P. 291, 380, 400
- ⑥ Telephone switches^{*1} P. 291, 380

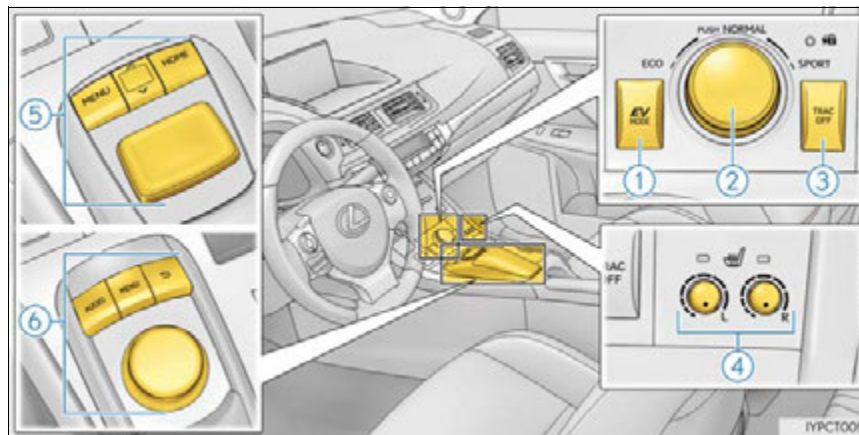

- ① EV drive mode switch P. 160
- ② Driving mode select switch..... P. 234
- ③ TRAC OFF switch..... P. 236
- ④ Seat heater switches^{*2}..... P. 425
- ⑤ Remote Touch^{*2,3} P. 91, 206, 412
- ⑥ Lexus Display Audio controller^{*2} P. 91, 206, 322

*1: For vehicles with a navigation system, refer to "NAVIGATION SYSTEM OWNER'S MANUAL".

*2: If equipped

*3: Refer to "NAVIGATION SYSTEM OWNER'S MANUAL".

■ Interior

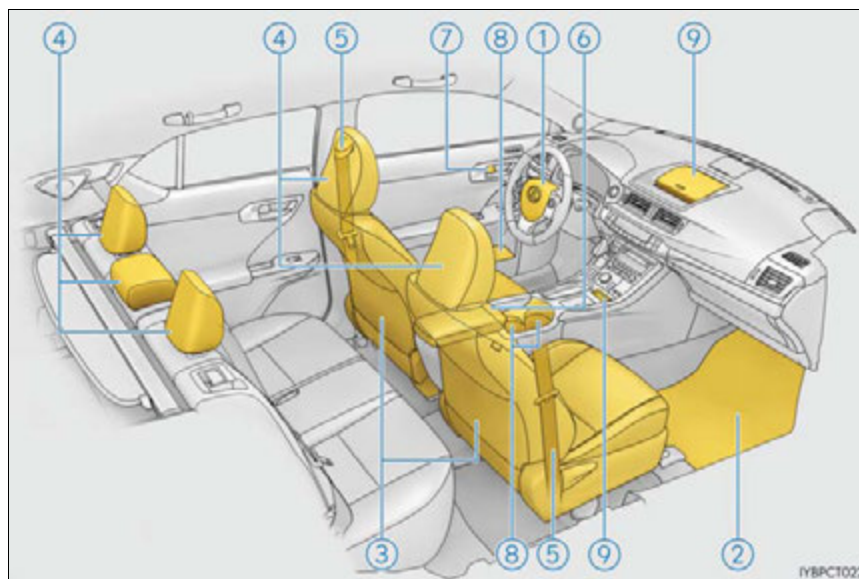

| | |
|---------------------------------------|--------|
| ① SRS airbags..... | P. 38 |
| ② Floor mats..... | P. 28 |
| ③ Front seats..... | P. 120 |
| ④ Head restraints..... | P. 127 |
| ⑤ Seat belts..... | P. 32 |
| ⑥ Console box..... | P. 430 |
| ⑦ Inside lock buttons..... | P. 107 |
| ⑧ Cup holders/bottle holders..... | P. 430 |
| ⑨ Auxiliary boxes* ¹ | P. 432 |

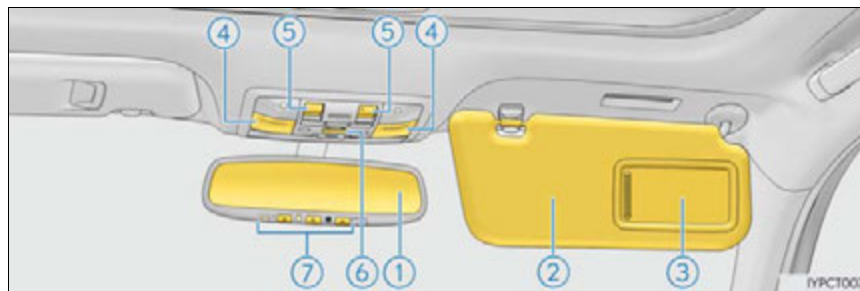

| | |
|--|--------|
| ① Inside rear view mirror | P. 132 |
| ② Sun visors | P. 439 |
| ③ Vanity mirrors..... | P. 439 |
| ④ Interior lights *2 | P. 427 |
| Personal lights | P. 427 |
| ⑤ Moon roof switches *1 | P. 140 |
| ⑥ "SOS" button *1 | P. 455 |
| ⑦ Garage door opener switches *1 | P. 443 |

*1: If equipped

*2: The illustration shows the front, but they are also equipped in the rear.

| | |
|--|----|
| 1-1. For safe use | |
| Before driving..... | 28 |
| For safe driving..... | 30 |
| Seat belts | 32 |
| SRS airbags | 38 |
| Front passenger occupant classification system..... | 47 |
| Safety information for children | 52 |
| Child restraint systems | 53 |
| Installing child restraints..... | 56 |
| Exhaust gas precautions | 64 |
| 1-2. Hybrid system | |
| Hybrid system features..... | 65 |
| Hybrid system precautions | 69 |
| 1-3. Theft deterrent system | |
| Immobilizer system | 74 |
| Alarm | 76 |
| Theft prevention labels (for U.S.A.)..... | 78 |

Before driving

Floor mat

Use only floor mats designed specifically for vehicles of the same model and model year as your vehicle. Fix them securely in place onto the carpet.

- 1 Insert the retaining hooks (clips) into the floor mat eyelets.

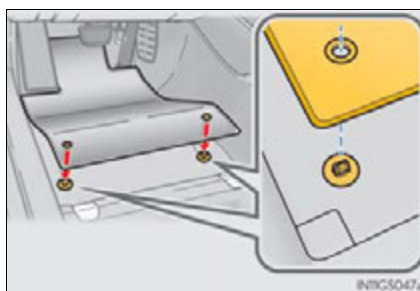

- 2 Turn the upper knob of each retaining hook (clip) to secure the floor mats in place.

*: Always align the \triangle marks.

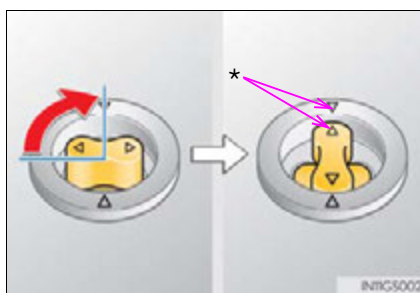

The shape of the retaining hooks (clips) may differ from that shown in the illustration.

⚠ WARNING

Observe the following precautions.

Failure to do so may cause the driver's floor mat to slip, possibly interfering with the pedals while driving. An unexpectedly high speed may result or it may become difficult to stop the vehicle. This could lead to an accident, resulting in death or serious injury.

■ When installing the driver's floor mat

- Do not use floor mats designed for other models or different model year vehicles, even if they are Lexus Genuine floor mats.
- Only use floor mats designed for the driver's seating position.
- Always install the floor mat securely using the retaining hooks (clips) provided.
- Do not use two or more floor mats on top of each other.
- Do not place the floor mat bottom-side up or upside-down.

■ Before driving

- Check that the floor mat is securely fixed in the correct place with all the provided retaining hooks (clips). Be especially careful to perform this check after cleaning the floor.
- With the hybrid system stopped and the shift position in P, fully depress each pedal to the floor to make sure it does not interfere with the floor mat.

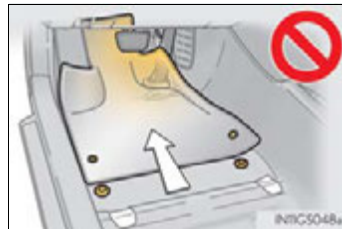

For safe driving

For safe driving, adjust the seat and mirror to an appropriate position before driving.

Correct driving posture

- ① Adjust the angle of the seatback so that you are sitting straight up and so that you do not have to lean forward to steer. (→P. 120)
- ② Adjust the seat so that you can depress the pedals fully and so that your arms bend slightly at the elbow when gripping the steering wheel. (→P. 120)
- ③ Lock the head restraint in place with the center of the head restraint closest to the top of your ears. (→P. 127)
- ④ Wear the seat belt correctly. (→P. 32)

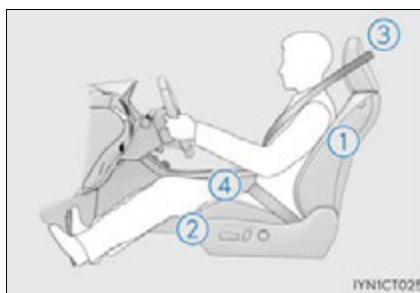

Correct use of the seat belts

Make sure that all occupants are wearing their seat belts before driving the vehicle. (→P. 32)

Use a child restraint system appropriate for the child until the child becomes large enough to properly wear the vehicle's seat belt. (→P. 53)

Adjusting the mirrors

Make sure that you can see backward clearly by adjusting the inside and outside rear view mirrors properly. (→P. 132, 135)

 **WARNING**

Observe the following precautions.
Failure to do so may result in death or serious injury.

- Do not adjust the position of the driver's seat while driving.
Doing so could cause the driver to lose control of the vehicle.
- Do not place a cushion between the driver or passenger and the seatback. A cushion may prevent correct posture from being achieved, and reduce the effectiveness of the seat belt, head restraint and other safety systems, increasing the risk of death or serious injury to the occupant.
- Do not place anything under the front seats.
Objects placed under the front seats may become jammed in the seat tracks and stop the seat from locking in place. This may lead to an accident and the adjustment mechanism may also be damaged.
- When driving over long distances, take regular breaks before you start to feel tired.
Also, if you feel tired or sleepy while driving, do not force yourself to continue driving and take a break immediately.

Seat belts

Make sure that all occupants are wearing their seat belts before driving the vehicle.

Correct use of the seat belts

- Extend the shoulder belt so that it comes fully over the shoulder, but does not come into contact with the neck or slide off the shoulder.
- Position the lap belt as low as possible over the hips.
- Adjust the position of the seatback. Sit up straight and well back in the seat.
- Do not twist the seat belt.



Fastening and releasing the seat belt

- ① To fasten the seat belt, push the plate into the buckle until a click sound is heard.
- ② To release the seat belt, press the release button.

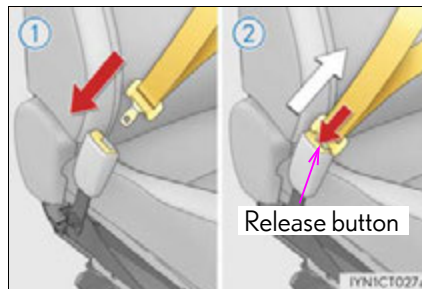

Adjusting the seat belt shoulder anchor height (front seats)

- ① Push the seat belt shoulder anchor down while pressing the release button.
- ② Push the seat belt shoulder anchor up.

Move the height adjuster up and down as needed until you hear a click.

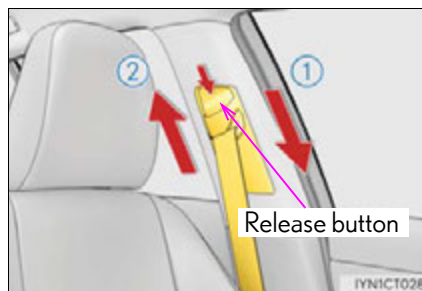

Seat belt pretensioners (front seats)

The pretensioners help the seat belts to quickly restrain the occupants by retracting the seat belts when the vehicle is subjected to certain types of severe frontal or side collision.

The pretensioners do not activate in the event of a minor frontal impact, a minor side impact, a rear impact or a vehicle rollover.

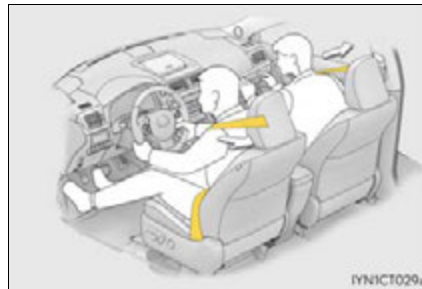

Pre-collision seat belts (front seats of vehicles with pre-collision system)

If the system determines that a collision is unavoidable, the front seat belts will retract before the collision. (→P. 239)

After using the rear center seat belt

Store the buckle into the storage location in the seat cushion.



■ Emergency locking retractor (ELR)

The retractor will lock the belt during a sudden stop or on impact. It may also lock if you lean forward too quickly. A slow, easy motion will allow the belt to extend so that you can move around fully.

■ Automatic locking retractor (ALR)

When a passenger's shoulder belt is completely extended and then retracted even slightly, the belt is locked in that position and cannot be extended. This feature is used to hold the child restraint system (CRS) firmly. To free the belt again, fully retract the belt and then pull the belt out once more. (→P. 56)

■ Child seat belt usage

The seat belts of your vehicle were principally designed for persons of adult size.

- Use a child restraint system appropriate for the child, until the child becomes large enough to properly wear the vehicle's seat belt. (→P. 53)
- When the child becomes large enough to properly wear the vehicle's seat belt, follow the instructions regarding seat belt usage. (→P. 32)

■ Replacing the belt after the pretensioner has been activated

If the vehicle is involved in multiple collisions, the pretensioner will activate for the first collision of sufficient severity, but will not activate for the second or subsequent collisions. The seat belt must be replaced if the pretensioner has been activated.

■ Seat belt extender

If your seat belts cannot be fastened securely because they are not long enough, a personalized seat belt extender is available from your Lexus dealer free of charge.



⚠ WARNING

Observe the following precautions to reduce the risk of injury in the event of sudden braking, sudden swerving or an accident. Failing to do so may cause death or serious injury.

■ Wearing a seat belt

- Ensure that all passengers wear a seat belt.
- Always wear a seat belt properly.
- Each seat belt should be used by one person only. Do not use a seat belt for more than one person at once, including children.
- Lexus recommends that children be seated in the rear seat and always use a seat belt and/or an appropriate child restraint system.
- To achieve a proper seating position, do not recline the seat more than necessary. The seat belt is most effective when the occupants are sitting up straight and well back in the seats.
- Do not wear the shoulder belt under your arm.
- Always wear your seat belt low and snug across your hips.

■ Pregnant women

Obtain medical advice and wear the seat belt in the proper way. (→P. 32)

Women who are pregnant should position the lap belt as low as possible over the hips in the same manner as other occupants, extending the shoulder belt completely over the shoulder and avoiding belt contact with the rounding of the abdominal area.

If the seat belt is not worn properly, not only the pregnant woman, but also the fetus could suffer death or serious injury as a result of sudden braking or a collision.

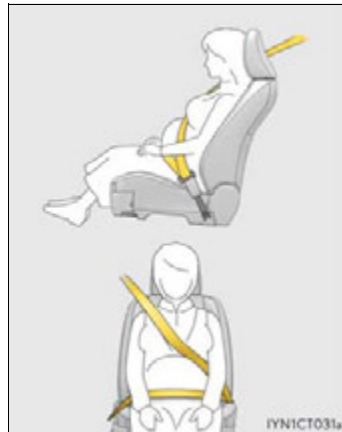

 **WARNING****■ People with medical conditions**

Obtain medical advice and wear the seat belt in the proper way. (→P. 32)

■ When children are in the vehicle

Do not allow children to play with the seat belt. If the seat belt becomes twisted around a child's neck, it may lead to choking or other serious injuries that could result in death. If this occurs and the child cannot be released from the seat belt, scissors should be used to cut the belt.

■ Seat belt pretensioners

- Do not place anything, such as a cushion, on the front passenger's seat. Doing so will disperse the passenger's weight, which prevents the sensor from detecting the passenger's weight properly. As a result, the seat belt pretensioner for the front passenger's seat may not activate in the event of a collision.

- If the pretensioner has activated, the SRS warning light will come on. In that case, the seat belt cannot be used again and must be replaced at your Lexus dealer.

■ Adjustable shoulder anchor

Always make sure the shoulder belt is positioned across the center of your shoulder. The belt should be kept away from your neck, but not falling off your shoulder. Failure to do so could reduce the amount of protection in an accident and cause death or serious injuries in the event of a sudden stop, sudden swerve or accident. (→P. 32)

■ Seat belt damage and wear

- Do not damage the seat belts by allowing the belt, plate, or buckle to be jammed in the door.

- Inspect the seat belt system periodically. Check for cuts, fraying, and loose parts. Do not use a damaged seat belt until it is replaced. Damaged seat belts cannot protect an occupant from death or serious injury.

- Ensure that the belt and plate are locked and the belt is not twisted.

If the seat belt does not function correctly, immediately contact your Lexus dealer.

- Replace the seat assembly, including the belts, if your vehicle has been involved in a serious accident, even if there's no obvious damage.

- Do not attempt to install, remove, modify, disassemble or dispose of the seat belts. Have any necessary repairs carried out by your Lexus dealer. Inappropriate handling may lead to incorrect operation.

■ Using a seat belt extender

- Do not wear the seat belt extender if you can fasten the seat belt without the extender.

- Do not use the seat belt extender when installing a child restraint system because the belt will not securely hold the child restraint system, increasing the risk of death or serious injury in the event of an accident.

- The personalized extender may not be safe on another vehicle, when used by another person, or at a different seating position other than the one originally intended.

 NOTICE**■ When using a seat belt extender**

When releasing the seat belt, press on the buckle release button on the extender, not on the seat belt.

This helps prevent damage to the vehicle interior and the extender itself.

SRS airbags

The SRS airbags inflate when the vehicle is subjected to certain types of severe impacts that may cause significant injury to the occupants. They work together with the seat belts to help reduce the risk of death or serious injury.

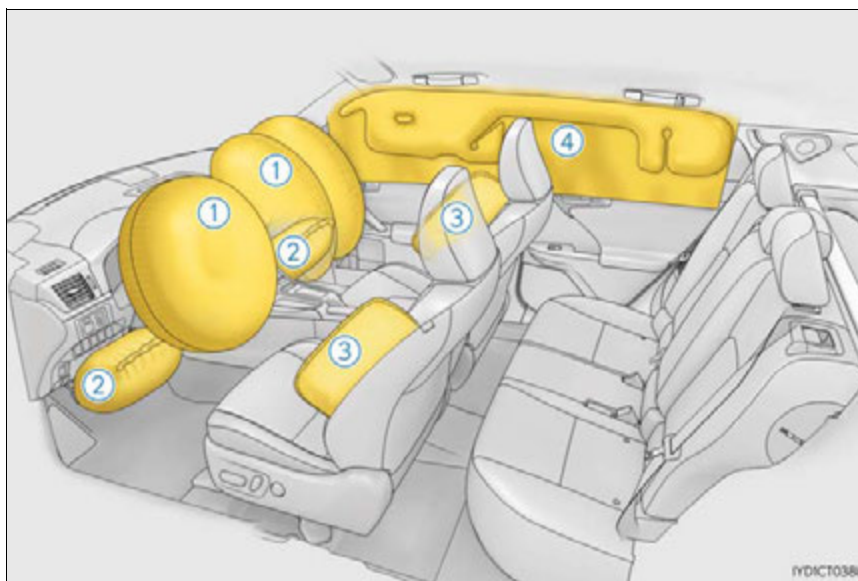

◆ SRS front airbags

- ① SRS driver airbag/front passenger airbag
Can help protect the head and chest of the driver and front passenger from impact with interior components
- ② SRS knee airbags
Can help provide driver and front passenger protection

◆ SRS side and curtain shield airbags

- ③ SRS side airbags
Can help protect the torso of the front seat occupants
- ④ SRS curtain shield airbags
Can help protect primarily the head of occupants in the outer seats

SRS airbag system components

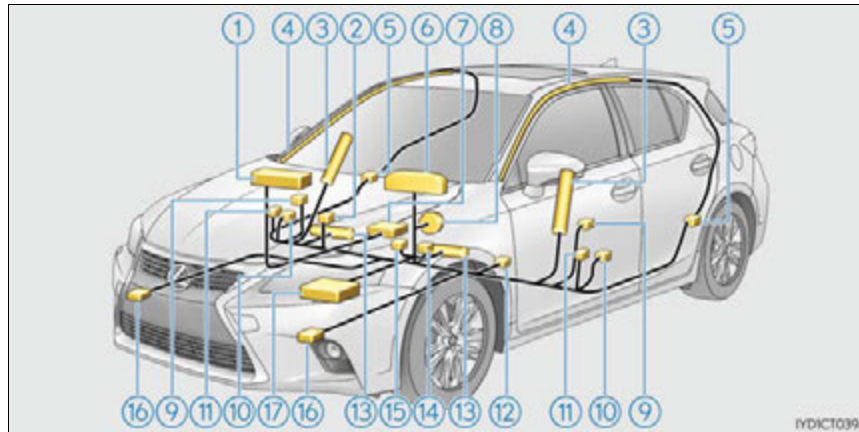

- | | |
|--|--|
| ① Front passenger airbag | ⑨ Side impact sensors (front) |
| ② "AIR BAG ON" and "AIR BAG OFF" indicator lights | ⑩ Seat belt pretensioners and force limiters |
| ③ Side airbags | ⑪ Side impact sensors (front door) |
| ④ Curtain shield airbags | ⑫ Driver's seat position sensor |
| ⑤ Side impact sensors (rear) | ⑬ Knee airbags |
| ⑥ SRS warning light | ⑭ Driver's seat belt buckle switch |
| ⑦ Front passenger occupant classification system (ECU and sensors) | ⑮ Front passenger's seat belt buckle switch |
| ⑧ Driver airbag | ⑯ Front impact sensors |
| | ⑰ Airbag sensor assembly |

Your vehicle is equipped with ADVANCED AIRBAGS designed based on the US motor vehicle safety standards (FMVSS208). The airbag sensor assembly (ECU) controls airbag deployment based on information obtained from the sensors etc. shown in the system components diagram above. This information includes crash severity and occupant information. As the airbags deploy, a chemical reaction in the inflators quickly fills the airbags with non-toxic gas to help restrain the motion of the occupants.

⚠ WARNING

■ **SRS airbag precautions**

Observe the following precautions regarding the SRS airbags. Failure to do so may cause death or serious injury.

- The driver and all passengers in the vehicle must wear their seat belts properly. The SRS airbags are supplemental devices to be used with the seat belts.
- The SRS driver airbag deploys with considerable force, and can cause death or serious injury especially if the driver is very close to the airbag. The National Highway Traffic Safety Administration (NHTSA) advises:

Since the risk zone for the driver's airbag is the first 2 - 3 in. (50 - 75 mm) of inflation, placing yourself 10 in. (250 mm) from your driver airbag provides you with a clear margin of safety. This distance is measured from the center of the steering wheel to your breastbone. If you sit less than 10 in. (250 mm) away now, you can change your driving position in several ways:

- Move your seat to the rear as far as you can while still reaching the pedals comfortably.
- Slightly recline the back of the seat. Although vehicle designs vary, many drivers can achieve the 10 in. (250 mm) distance, even with the driver seat all the way forward, simply by reclining the back of the seat somewhat. If reclining the back of your seat makes it hard to see the road, raise yourself by using a firm, non-slippery cushion, or raise the seat if your vehicle has that feature.
- If your steering wheel is adjustable, tilt it downward. This points the airbag toward your chest instead of your head and neck.

The seat should be adjusted as recommended by NHTSA above, while still maintaining control of the foot pedals, steering wheel, and your view of the instrument panel controls.

- If the seat belt extender has been connected to the front seat belt buckles but the seat belt extender has not also been fastened to the latch plate of the seat belt, the SRS front airbags will judge that the driver and front passenger are wearing the seat belt even though the seat belt has not been connected. In this case, the SRS front airbags may not activate correctly in a collision, resulting in death or serious injury in the event of a collision. Be sure to wear the seat belt with the seat belt extender.



- The SRS front passenger airbag also deploys with considerable force, and can cause death or serious injury especially if the front passenger is very close to the airbag. The front passenger seat should be as far from the airbag as possible with the seatback adjusted, so the front passenger sits upright.
- Improperly seated and/or restrained infants and children can be killed or seriously injured by a deploying airbag. An infant or child who is too small to use a seat belt should be properly secured using a child restraint system. Lexus strongly recommends that all infants and children be placed in the rear seats of the vehicle and properly restrained. The rear seats are safer for infants and children than the front passenger seat. (→P. 53)

⚠ WARNING

■ **SRS airbag precautions**

- Do not sit on the edge of the seat or lean against the dashboard.

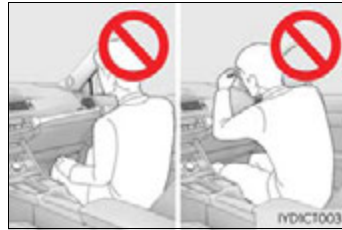

- Do not allow a child to stand in front of the SRS front passenger airbag unit or sit on the knees of a front passenger.
- Do not allow the front seat occupants to hold items on their knees.

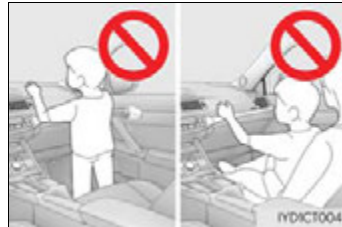

- Do not lean against the door, the roof side rail or the front, side and rear pillars.



- Do not allow anyone to kneel on the passenger seat toward the door or put their head or hands outside the vehicle.



⚠ WARNING

■ **SRS airbag precautions**

- Do not attach anything to or lean anything against areas such as the dashboard, steering wheel pad and lower portion of the instrument panel. These items can become projectiles when the SRS driver, front passenger and knee airbags deploy.

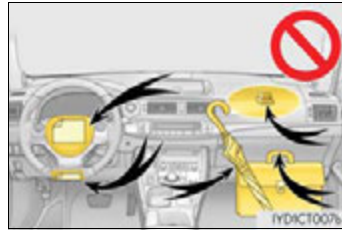

- Do not attach anything to areas such as a door, windshield glass, side door glass, front or rear pillar, roof side rail and assist grip.

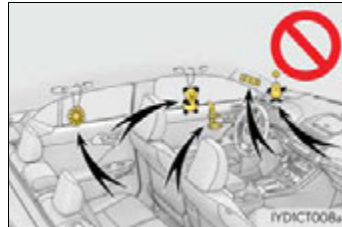

- Do not hang coat hangers or other hard objects on the coat hooks. All of these items could become projectiles and may cause death or serious injury, should the SRS curtain shield airbags deploy.
- If a vinyl cover is put on the area where the SRS knee airbag will deploy, be sure to remove it.
- Do not use seat accessories which cover the parts where the SRS side airbags inflate as they may interfere with inflation of the airbags. Such accessories may prevent the side airbags from activating correctly, disable the system or cause the side airbags to inflate accidentally, resulting in death or serious injury.
- Do not strike or apply significant levels of force to the area of the SRS airbag components. Doing so can cause the SRS airbags to malfunction.
- Do not touch any of the component parts immediately after the SRS airbags have deployed (inflated) as they may be hot.
- If breathing becomes difficult after the SRS airbags have deployed, open a door or window to allow fresh air in, or leave the vehicle if it is safe to do so. Wash off any residue as soon as possible to prevent skin irritation.
- If the areas where the SRS airbags are stored, such as the steering wheel pad and front and rear pillar garnishes, are damaged or cracked, have them replaced by your Lexus dealer.
- Do not place anything, such as a cushion, on the front passenger's seat. Doing so will disperse the passenger's weight, which prevents the sensor from detecting the passenger's weight properly. As a result, the SRS front airbags for the front passenger may not deploy in the event of a collision.

⚠ WARNING**■ Modification and disposal of SRS airbag system components**

Do not dispose of your vehicle or perform any of the following modifications without consulting your Lexus dealer. The SRS airbags may malfunction or deploy (inflate) accidentally, causing death or serious injury.

- Installation, removal, disassembly and repair of the SRS airbags
- Repairs, modifications, removal or replacement of the steering wheel, instrument panel, dashboard, seats or seat upholstery, front, side and rear pillars or roof side rails
- Repairs or modifications of the front fender, front bumper, or side of the occupant compartment
- Installation of a grille guard (bull bars, kangaroo bar, etc.), snow plows or winches
- Modifications to the vehicle's suspension system
- Installation of electronic devices such as mobile two-way radios and CD players
- Modifications to your vehicle for a person with a physical disability

■ If the SRS airbags deploy (inflate)

- Slight abrasions, burns, bruising etc., may be sustained from SRS airbags, due to the extremely high speed deployment (inflation) by hot gases.
- A loud noise and white powder will be emitted.
- Parts of the airbag module (steering wheel hub, airbag cover and inflator) as well as the front seats, parts of the front and rear pillars, and roof side rails, may be hot for several minutes. The airbag itself may also be hot.
- The windshield may crack.
- For Safety Connect subscribers, if the SRS airbags deploy or in the event of a severe rear-end collision, the system is designed to send an emergency call to the response center, notifying them of the vehicle's location (without needing to push the "SOS" button) and an agent will attempt to speak with the occupants to ascertain the level of emergency and assistance required. If the occupants are unable to communicate, the agent automatically treats the call as an emergency and helps to dispatch the necessary emergency services. (→P. 455)

■ SRS airbag deployment conditions (SRS front airbags)

- The SRS front airbags will deploy in the event of an impact that exceeds the set threshold level (the level of force corresponding to an approximately 12 - 18 mph [20 - 30 km/h] frontal collision with a fixed wall that does not move or deform).
However, this threshold velocity will be considerably higher in the following situations:
 - If the vehicle strikes an object, such as a parked vehicle or sign pole, which can move or deform on impact
 - If the vehicle is involved in an underride collision, such as a collision in which the front of the vehicle "underrides", or goes under, the bed of a truck
- Depending on the type of collision, it is possible that only the seat belt pretensioners will activate.
- The SRS front airbags for the front passenger will not activate if there is no passenger sitting in the front passenger seat. However, the SRS front airbags for the front passenger may deploy if luggage is put in the seat, even if the seat is unoccupied. (→P. 47)

■ SRS airbag deployment conditions (SRS side and curtain shield airbags)

- The SRS side and curtain shield airbags will deploy in the event of an impact that exceeds the set threshold level (the level of force corresponding to the impact force produced by an approximately 3300 lb. [1500 kg] vehicle colliding with the vehicle cabin from a direction perpendicular to the vehicle orientation at an approximate speed of 12 - 18 mph [20 - 30 km/h]).
- The SRS curtain shield airbags may also deploy in the event of a severe frontal collision.

■ Conditions under which the SRS airbags may deploy (inflate), other than a collision

The SRS front airbags and SRS side and curtain shield airbags may also deploy if a serious impact occurs to the underside of your vehicle. Some examples are shown in the illustration.

- Hitting a curb, edge of pavement or hard surface
- Falling into or jumping over a deep hole
- Landing hard or falling

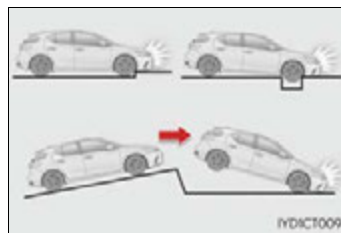

■ Types of collisions that may not deploy the SRS airbags (SRS front airbags)

The SRS front airbags do not generally inflate if the vehicle is involved in a side or rear collision, if it rolls over, or if it is involved in a low-speed frontal collision. But, whenever a collision of any type causes sufficient forward deceleration of the vehicle, deployment of the SRS front airbags may occur.

- Collision from the side
- Collision from the rear
- Vehicle rollover

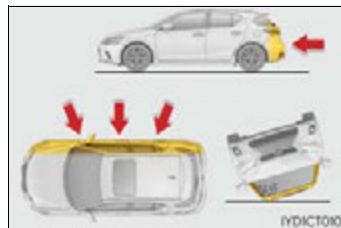

■ Types of collisions that may not deploy the SRS airbags (SRS side and curtain shield airbags)

The SRS side and curtain shield airbags may not activate if the vehicle is subjected to a collision from the side at certain angles, or a collision to the side of the vehicle body other than the passenger compartment.

- Collision from the side to the vehicle body other than the passenger compartment
- Collision from the side at an angle

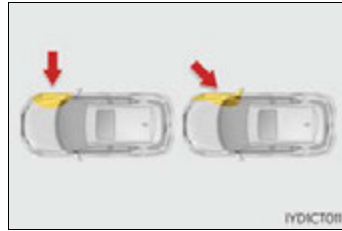

The SRS side and curtain shield airbags do not generally inflate if the vehicle is involved in a rear collision, if it rolls over, or if it is involved in a low-speed side or low-speed frontal collision.

- Collision from the rear
- Vehicle rollover

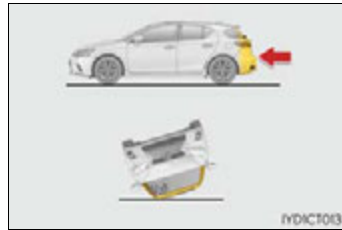

■ When to contact your Lexus dealer

In the following cases, the vehicle will require inspection and/or repair. Contact your Lexus dealer as soon as possible.

- Any of the SRS airbags have been inflated.
- The front of the vehicle is damaged or deformed, or was involved in an accident that was not severe enough to cause the SRS front airbags to inflate.

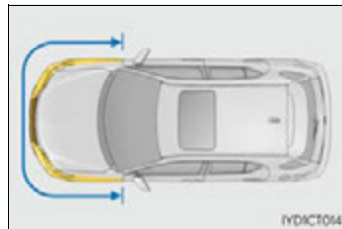

- A portion of a door or its surrounding area is damaged or deformed, or the vehicle was involved in an accident that was not severe enough to cause the SRS side and curtain shield airbags to inflate.

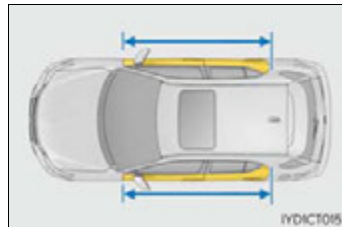

- The pad section of the steering wheel, dashboard near the front passenger airbag or lower portion of the instrument panel is scratched, cracked, or otherwise damaged.



- The surface of the seats with the side airbag is scratched, cracked, or otherwise damaged.



- The portion of the front pillars, rear pillars or roof side rail garnishes (padding) containing the curtain shield airbags inside is scratched, cracked, or otherwise damaged.

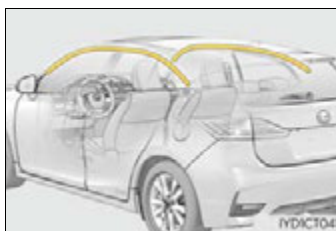

Front passenger occupant classification system

Your vehicle is equipped with a front passenger occupant classification system. This system detects the conditions of the front passenger seat and activates or deactivates the devices for the front passenger.

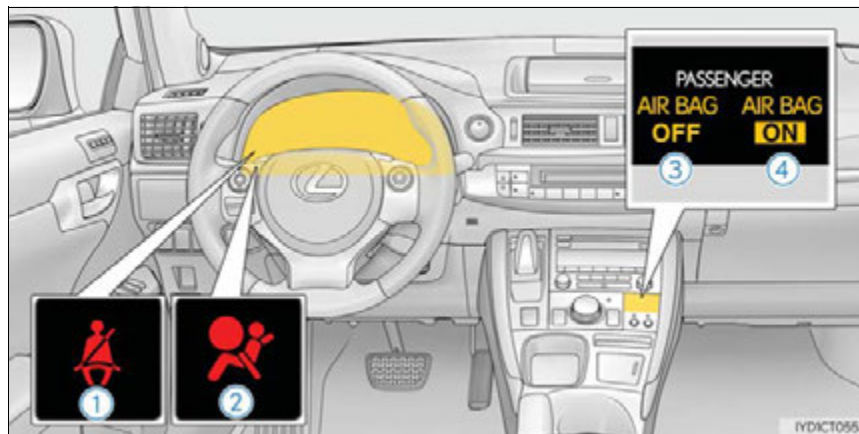

- ① Seat belt reminder light
- ② SRS warning light
- ③ "AIR BAG OFF" indicator light
- ④ "AIR BAG ON" indicator light

Condition and operation in the front passenger occupant classification system

■ Adult*¹

| | | |
|-----------------------------|--|--|
| Indicator/ warning light | "AIR BAG ON" and "AIR BAG OFF" indicator lights | "AIR BAG ON" |
| | SRS warning light | Off |
| | Seat belt reminder light | Off* ² or flashing* ³ |
| Devices | Front passenger airbag | Activated |
| | Side airbag on the front passenger seat | |
| | Curtain shield airbag in the front passenger side | |
| | Front passenger knee airbag | |
| | Front passenger's seat belt pretensioner | |

■ Child*⁴ or child restraint system*⁵

| | | |
|-----------------------------|--|--|
| Indicator/ warning light | "AIR BAG ON" and "AIR BAG OFF" indicator lights | "AIR BAG OFF"* ⁶ |
| | SRS warning light | Off |
| | Seat belt reminder light | Off* ² or flashing* ³ |
| Devices | Front passenger airbag | Deactivated |
| | Side airbag on the front passenger seat | Activated |
| | Curtain shield airbag in the front passenger side | |
| | Front passenger knee airbag | Deactivated |
| | Front passenger's seat belt pretensioner | Activated |

■ Unoccupied

| | | |
|-----------------------------|--|---|
| Indicator/ warning light | "AIR BAG ON" and "AIR BAG OFF" indicator lights | Not illuminated |
| | SRS warning light | Off |
| | Seat belt reminder light | |
| Devices | Front passenger airbag | Deactivated |
| | Side airbag on the front passenger seat | Activated |
| | Curtain shield airbag in the front passenger side | |
| | Front passenger knee airbag | Deactivated |
| | Front passenger's seat belt pretensioner | Activated* ⁷ or deactivated* ⁸ |

■ There is a malfunction in the system

| | | |
|-----------------------------|--|------------------|
| Indicator/ warning light | "AIR BAG ON" and "AIR BAG OFF" indicator lights | "AIR BAG OFF" |
| | SRS warning light | On |
| | Seat belt reminder light | |
| Devices | Front passenger airbag | Deactivated |
| | Side airbag on the front passenger seat | Activated |
| | Curtain shield airbag in the front passenger side | |
| | Front passenger knee airbag | Deactivated |
| | Front passenger's seat belt pretensioner | Activated |

- *1: The system judges a person of adult size as an adult. When a smaller adult sits in the front passenger seat, the system may recognize him/her as a child depending on his/her physique and posture.
- *2: In the event the front passenger is wearing a seat belt.
- *3: In the event the front passenger does not wear a seat belt.
- *4: When a larger child who has outgrown a child restraint system sits in the front passenger seat, the system may recognize him/her as an adult depending on his/her physique or posture.
- *5: Never install a rear-facing child restraint system on the front passenger seat. A forward-facing child restraint system should only be installed on the front passenger seat when it is unavoidable. (→P. 53)
- *6: In case the indicator light is not illuminated, consult this manual on how to install the child restraint system properly. (→P. 56)
- *7: In the event of a side collision.
- *8: In the event of a frontal collision.

 WARNING**■ Front passenger occupant classification system precautions**

Observe the following precautions regarding front passenger occupant classification system.

Failure to do so may cause death or serious injury.

- Wear the seat belt properly.
- Make sure the front passenger's seat belt plate has not been left inserted into the buckle before someone sits in the front passenger seat.
- Make sure the "AIR BAG OFF" indicator light is not illuminated when using the seat belt extender for the front passenger seat. If the "AIR BAG OFF" indicator light is illuminated, disconnect the extender tongue from the seat belt buckle, and reconnect the seat belt. Reconnect the seat belt extender after making sure the "AIR BAG ON" indicator light is illuminated. If you use the seat belt extender while the "AIR BAG OFF" indicator light is illuminated, the SRS airbags for the front passenger will not activate, which could cause death or serious injury in the event of a collision.
- Do not apply a heavy load to the front passenger seat or equipment (e.g. seatback pocket).
- Do not put weight on the front passenger seat by putting your hands or feet on the front passenger seat seatback from the rear passenger seat.
- Do not let a rear passenger lift the front passenger seat with their feet or press on the seatback with their legs.
- Do not put objects under the front passenger seat.

 **WARNING****■ Front passenger occupant classification system precautions**

- Do not recline the front passenger seatback so far that it touches a rear seat. This may cause the "AIR BAG OFF" indicator light to be illuminated, which indicates that the SRS airbags for the front passenger will not activate in the event of a severe accident. If the seatback touches the rear seat, return the seatback to a position where it does not touch the rear seat. Keep the front passenger seatback as upright as possible when the vehicle is moving. Reclining the seatback excessively may lessen the effectiveness of the seat belt system.
- If an adult sits in the front passenger seat, the "AIR BAG ON" indicator light is illuminated. If the "AIR BAG OFF" indicator is illuminated, ask the passenger to sit up straight, well back in the seat, feet on the floor, and with the seat belt worn correctly. If the "AIR BAG OFF" indicator still remains illuminated, either ask the passenger to move to the rear seat, or if that is not possible, move the front passenger seat fully rearward.
- When it is unavoidable to install a forward-facing child restraint system on the front passenger seat, install the child restraint system on the front passenger seat in the proper order. (→P. 56)
- Do not modify or remove the front seats.
- Do not kick the front passenger seat or subject it to severe impact. Otherwise, the SRS warning light may come on to indicate a malfunction of the front passenger occupant classification system. In this case, contact your Lexus dealer immediately.
- Child restraint systems installed on the rear seat should not contact the front seatbacks.
- Do not use a seat accessory, such as a cushion and seat cover, that covers the seat cushion surface.
- Do not modify or replace the upholstery of the front seat.

Safety information for children

Observe the following precautions when children are in the vehicle.

Use a child restraint system appropriate for the child, until the child becomes large enough to properly wear the vehicle's seat belt.

- It is recommended that children sit in the rear seats to avoid accidental contact with the shift lever, wiper switch etc.
- Use the rear door child-protector lock or the window lock switch to avoid children opening the door while driving or operating the power window accidentally. (→P. 108, 137)
- Do not let small children operate equipment which may catch or pinch body parts, such as the power window, hood, back door, seats etc.

WARNING

Never leave children unattended in the vehicle, and never allow children to have or use the key.

Children may be able to start the vehicle or shift the vehicle into neutral. There is also a danger that children may injure themselves by playing with the windows, the moon roof (if equipped) or other features of the vehicle. In addition, heat build-up or extremely cold temperatures inside the vehicle can be fatal to children.

Child restraint systems

A child restraint system for a small child or baby must itself be properly restrained on the seat with the LATCH anchors or the lap portion of the lap/shoulder belt.

The laws of all 50 states of the U.S.A. and Canada now require the use of child restraint systems.

Points to remember

- Choose a child restraint system that suits your vehicle and is appropriate to the age and size of the child.
- For installation details, follow the instructions provided with the child restraint system.
General installation instructions are provided in this manual. (→P. 56)

1

For safety and security

Types of child restraints

Child restraint systems are classified into the following 3 types according to the age and size of the child.

- ▶ Rear facing — Infant seat/convertible seat
- ▶ Forward facing — Convertible seat

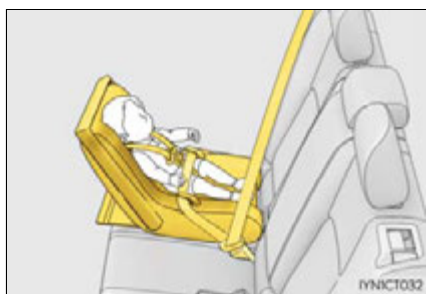

- ▶ Booster seat



■ When installing a child restraint system on the front passenger seat

When you have to use a child restraint system on the front passenger seat, adjust the following:

- The seatback to the most upright position
- The seat cushion to the fully rearward position



■ Selecting an appropriate child restraint system

- Use a child restraint system appropriate for the child until the child becomes large enough to properly wear the vehicle's seat belt.
- If the child is too large for a child restraint system, sit the child on a rear seat and use the vehicle's seat belt. (→P. 32)

 **WARNING****■ Child restraint precautions**

- For effective protection in automobile accidents and sudden stops, a child must be properly restrained, using a seat belt or child restraint system depending on the age and size of the child. Holding a child in your arms is not a substitute for a child restraint system. In an accident, the child can be crushed against the windshield, or between you and the vehicle's interior.
- Lexus strongly urges the use of a proper child restraint system that conforms to the size of the child, installed on the rear seat. According to accident statistics, the child is safer when properly restrained in the rear seat than in the front seat.
- Never install a rear-facing child restraint system on the front passenger seat even if the "AIR BAG OFF" indicator light is illuminated. In the event of an accident, the force of the rapid inflation of the front passenger airbag can cause death or serious injury to the child if the rear-facing child restraint system is installed on the front passenger seat.
- A forward-facing child restraint system may be installed on the front passenger seat only when it is unavoidable. A child restraint system that requires a top tether strap should not be used in the front passenger seat since there is no top tether strap anchor for the front passenger seat. Adjust the seatback as upright as possible and always move the seat as far back as possible even if the "AIR BAG OFF" indicator light is illuminated, because the front passenger airbag could inflate with considerable speed and force. Otherwise, the child may be killed or seriously injured.
- Do not use the seat belt extender when installing a child restraint system on the front or rear passenger seat. If installing a child restraint system with the seat belt extender connected to the seat belt, the seat belt will not securely hold the child restraint system, which could cause death or serious injury to the child or other passengers in the event of a sudden stop, sudden swerve or accident.
- Do not allow the child to lean his/her head or any part of his/her body against the door or the area of the seat, front and rear pillars or roof side rails from which the SRS side airbags or SRS curtain shield airbags deploy even if the child is seated in the child restraint system. It is dangerous if the SRS side and curtain shield airbags inflate, and the impact could cause death or serious injury to the child.
- Make sure you have complied with all installation instructions provided by the child restraint manufacturer and that the system is properly secured. If it is not secured properly, it may cause death or serious injury to the child in the event of a sudden stop, sudden swerve or accident.

■ When children are in the vehicle

Do not allow children to play with the seat belt. If the seat belt becomes twisted around a child's neck, it may lead to choking or other serious injuries that could result in death. If this occurs and the child cannot be released from the seat belt, scissors should be used to cut the belt.

■ When the child restraint system is not in use

- Keep the child restraint system properly secured on the seat even if it is not in use. Do not store the child restraint system unsecured in the passenger compartment.
- If it is necessary to detach the child restraint system, remove it from the vehicle or store it securely in the luggage compartment. This will prevent it from injuring passengers in the event of a sudden stop, sudden swerve or accident.

Installing child restraints

Follow the child restraint system manufacturer's instructions. Firmly secure child restraints to the seats using the LATCH anchors or a seat belt. Attach the top tether strap when installing a child restraint.

The lap/shoulder belt can be used if your child restraint system is not compatible with the LATCH (Lower Anchors and Tethers for Children) system.

Child restraint LATCH anchors

LATCH anchors are provided for the outboard rear seats. (Buttons displaying the location of the anchors are attached to the seats.)



Seat belts equipped with a child restraint locking mechanism (ALR/ELR belts except driver's seat belt) (→P.32)



Anchor brackets (for top tether strap)

An anchor bracket is provided for each rear seat.



Installation with LATCH system

- 1 Open the fasteners on the lower part of the seatback.

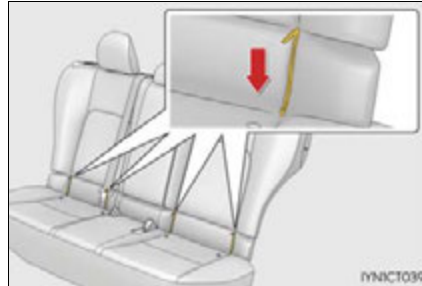

- ▶ Type A

- 2 Latch the hooks of the lower straps onto the LATCH anchors. If the child restraint has a top tether strap, the top tether strap should be latched onto the top tether strap anchor.

For owners in Canada:

The symbol on a child restraint system indicates the presence of a lower connector system.

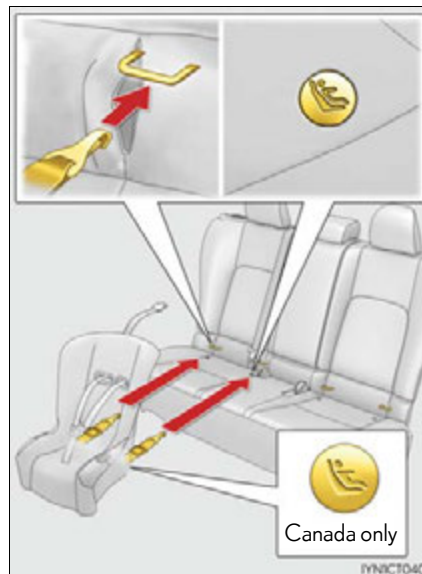

► Type B

- 2** Latch the buckles onto the LATCH anchors. If the child restraint has a top tether strap, the top tether strap should be latched onto the top tether strap anchor.

For owners in Canada:

The symbol on a child restraint system indicates the presence of a lower connector system.

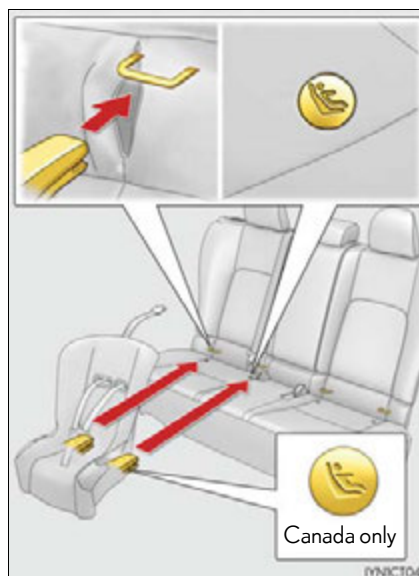

Installing child restraints using a seat belt (child restraint lock function belt)

■ Rear facing — Infant seat/convertible seat

- 1** Place the child restraint system on the rear seat facing the rear of the vehicle.



- 2** Run the seat belt through the child restraint system and insert the plate into the buckle. Make sure that the belt is not twisted.

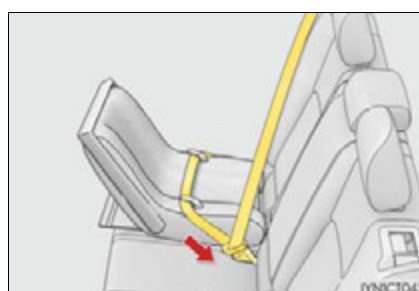

- 3 Fully extend the shoulder belt and allow it to retract to put it in lock mode. In lock mode, the belt cannot be extended.

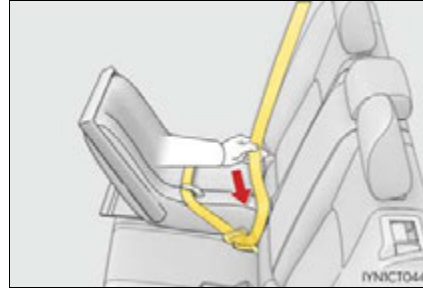

- 4 While pushing the child restraint system down into the rear seat, allow the shoulder belt to retract until the child restraint system is securely in place.

After the shoulder belt has retracted to a point where there is no slack in the belt, pull the belt to check that it cannot be extended.

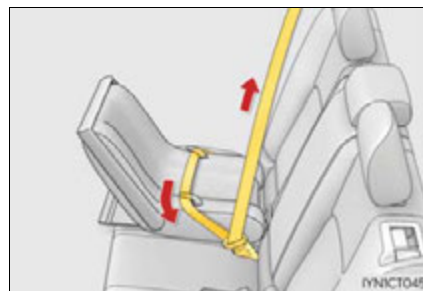

■ Forward-facing — Convertible seat

- 1 Place the child restraint system on the seat facing the front of the vehicle.



- 2 Run the seat belt through the child restraint system and insert the plate into the buckle. Make sure that the belt is not twisted.

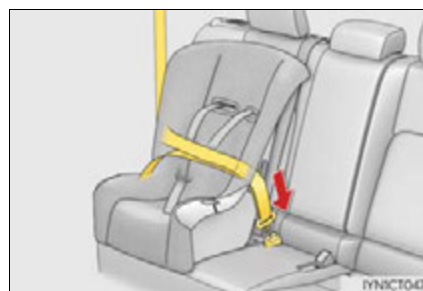

- 3 Fully extend the shoulder belt and allow it to retract to put it in lock mode. In lock mode, the belt cannot be extended.



- 4 While pushing the child restraint system into the rear seat, allow the shoulder belt to retract until the child restraint system is securely in place.

After the shoulder belt has retracted to a point where there is no slack in the belt, pull the belt to check that it cannot be extended.

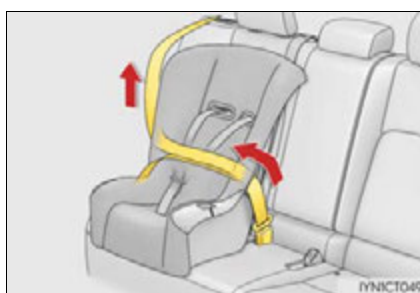

- 5 If the child restraint has a top tether strap, the top tether strap should be latched onto the top tether strap anchor. (→P. 61)

■ Booster seat

- 1 Place the child restraint system on the seat facing the front of the vehicle.



- 2 Sit the child in the child restraint system. Fit the seat belt to the child restraint system according to the manufacturer's instructions and insert the plate into the buckle. Make sure that the belt is not twisted.

Check that the shoulder belt is correctly positioned over the child's shoulder and that the lap belt is as low as possible. (→P. 32)



Removing a child restraint installed with a seat belt

Press the buckle release button and fully retract the seat belt.



Child restraint systems with a top tether strap

- 1 Secure the child restraint system using the seat belt or the LATCH anchors, and raise the head restraint while pressing the lock release button.



- 2 Open the anchor bracket cover, latch the hook onto the anchor bracket and tighten the top tether strap.

Make sure the top tether strap is securely latched.

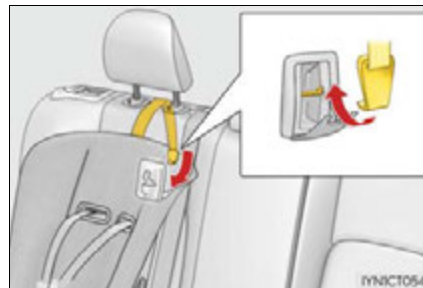

- 3 Outboard only: Adjust the head restraint to the downmost position.

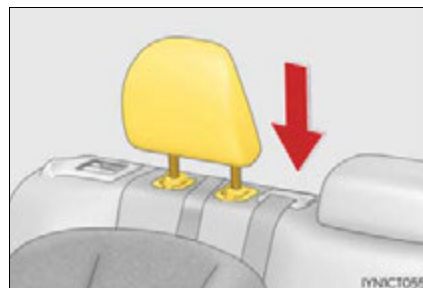

■ Laws and regulations pertaining to anchors

The LATCH system conforms to FMVSS225 or CMVSS210.2.

Child restraint systems conforming to FMVSS213 or CMVSS213 specifications can be used.

This vehicle is designed to conform to the SAE J1819.

⚠ WARNING

■ When installing a booster seat

To prevent the belt from going into ALR lock mode, do not fully extend the shoulder belt. ALR mode causes the belt to tighten only. This could cause injury or discomfort to the child. (→P. 33)

■ When installing a child restraint system

Follow the directions given in the child restraint system installation manual and fix the child restraint system securely in place.

If the child restraint system is not correctly fixed in place, the child or other passengers may be seriously injured or even killed in the event of sudden braking, sudden swerving or an accident.

- If the driver's seat interferes with the child restraint system and prevents it from being attached correctly, attach the child restraint system to the right-hand rear seat.
- Adjust the front passenger seat so that it does not interfere with the child restraint system.



- Only put a forward-facing child restraint system on the front seat when unavoidable. When installing a forward-facing child restraint system on the front passenger seat, move the seat as far back as possible even if the "AIR BAG OFF" indicator light is illuminated. Failure to do so may result in death or serious injury if the airbags deploy (inflate).



- When a booster seat is installed, always ensure that the shoulder belt is positioned across the center of the child's shoulder. The belt should be kept away from the child's neck, but not so that it could fall off the child's shoulder. Failing to do so may result in death or serious injury in the event of sudden braking, sudden swerving or an accident.
- Ensure that the belt and plate are securely locked and the seat belt is not twisted.
- Shake the child restraint system left and right, and forward and backward to ensure that it has been securely installed.
- If the seat is adjusted, reconfirm the security of the child restraint system.
- Follow all installation instructions provided by the child restraint system manufacturer.

 **WARNING****■ Do not use a seat belt extender**

If a seat belt extender is used when installing a child restraint system, the seat belt will not securely hold the child restraint system, which could cause death or serious injury to the child or other passengers in the event of sudden braking, sudden swerving or an accident.

■ To correctly attach a child restraint system to the anchors

When using the LATCH anchors, be sure that there are no foreign objects around the anchors and that the seat belt is not caught behind the child restraint system. Make sure the child restraint system is securely attached, or it may cause death or serious injury to the child or other passengers in the event of a sudden stop, sudden swerve or accident.

Exhaust gas precautions

Harmful substance to the human body is included in exhaust gases if inhaled.

WARNING

Exhaust gases include harmful carbon monoxide (CO), which is colorless and odorless. Observe the following precautions.

Failure to do so may cause exhaust gases enter the vehicle and may lead to an accident caused by light-headedness, or may lead to death or a serious health hazard.

■ Important points while driving

- Keep the back door closed.
- If you smell exhaust gases in the vehicle even when the back door is closed, open the windows and have the vehicle inspected at your Lexus dealer as soon as possible.

■ When parking

- If the vehicle is in a poorly ventilated area or a closed area, such as a garage, stop the hybrid system.
- Do not leave the vehicle with the hybrid system on for a long time.
If such a situation cannot be avoided, park the vehicle in an open space and ensure that exhaust fumes do not enter the vehicle interior.
- Do not leave the hybrid system operating in an area with snow build-up, or where it is snowing. If snowbanks build up around the vehicle while the hybrid system is operating, exhaust gases may collect and enter the vehicle.

■ Exhaust pipe

The exhaust system needs to be checked periodically. If there is a hole or crack caused by corrosion, damage to a joint or abnormal exhaust noise, be sure to have the vehicle inspected and repaired by your Lexus dealer.

Hybrid system features

Your vehicle is a hybrid vehicle. It has characteristics different from conventional vehicles. Be sure you are closely familiar with the characteristics of your vehicle, and operate it with care.

The hybrid system combines the use of a gasoline engine and an electric motor (traction motor) according to driving conditions, improving fuel efficiency and reducing exhaust emissions.

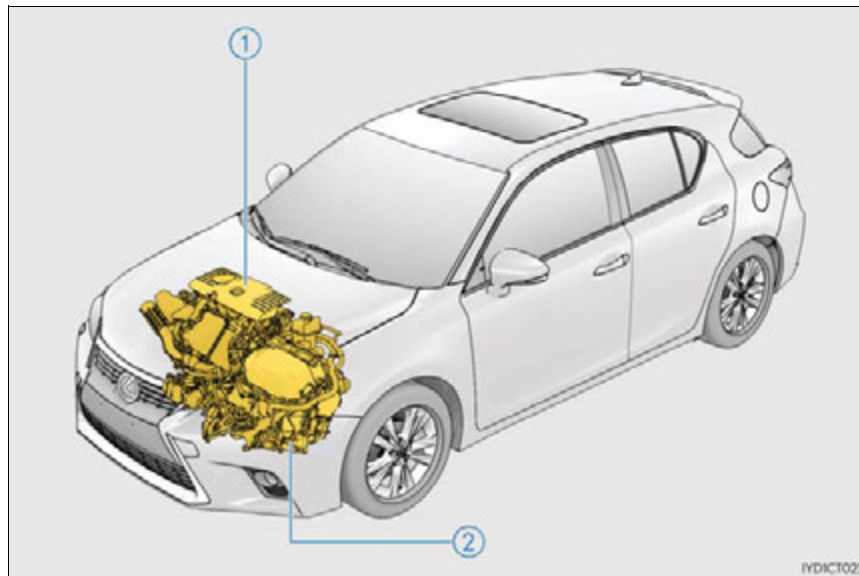

The illustration is an example for explanation and may differ from the actual item.

- ① Gasoline engine
- ② Electric motor (traction motor)

◆ **When stopped/during start off**

The gasoline engine stops* when the vehicle is stopped. During start off, the electric motor (traction motor) drives the vehicle. At slow speeds or when traveling down a gentle slope, the engine is stopped* and the electric motor (traction motor) is used.

When shift position is in N, the hybrid battery (traction battery) is not charged.

When the vehicle is stopped, always put the shift position to P.

Also, even in heavy traffic conditions, drive the vehicle in D or B.

*: When the hybrid battery (traction battery) requires charging or the engine is warming up, etc., the gasoline engine will not automatically stop. (→P. 67)

◆ **During normal driving**

The gasoline engine is predominantly used. The electric motor (traction motor) charges the hybrid battery (traction battery) as necessary.

◆ **When accelerating sharply**

When the accelerator pedal is depressed heavily, the power of the hybrid battery (traction battery) is added to that of the gasoline engine via the electric motor (traction motor).

◆ **When braking (regenerative braking)**

The wheels operate the electric motor as a power generator, and the hybrid battery (traction battery) is charged.

Vehicle proximity notification system

When driving with the gasoline engine stopped, a sound, which changes in accordance with the driving speed, will be played in order to warn people nearby of the vehicle's approach. The sound will stop when the vehicle speed exceeds approximately 15 mph (25 km/h).

■ Regenerative braking

In the following situations, kinetic energy is converted to electric energy and deceleration force can be obtained in conjunction with the recharging of the hybrid battery (traction battery).

- The accelerator pedal is released while driving with the shift position in D or B.
- The brake pedal is depressed while driving with the shift position in D or B.

■ EV indicator

The EV indicator comes on when the vehicle is driven using only the electric motor (traction motor) or the gasoline engine is stopped.



■ Conditions in which the gasoline engine may not stop

The gasoline engine starts and stops automatically. However, it may not stop automatically in the following conditions:

- During gasoline engine warm-up
- During hybrid battery (traction battery) charging
- When the temperature of the hybrid battery (traction battery) is high or low
- When the heater is switched on

■ Charging the hybrid battery (traction battery)

As the gasoline engine charges the hybrid battery (traction battery), the battery does not need to be charged from an outside source. However, if the vehicle is left parked for a long time the hybrid battery will slowly discharge. For this reason, be sure to drive the vehicle at least once every few months for at least 30 minutes or 10 miles (16 km). If the hybrid battery becomes fully discharged and you are unable to start the hybrid system, contact your Lexus dealer.

■ Charging the 12-volt battery

→P. 564

■ After the 12-volt battery has discharged or has been changed or removed

The gasoline engine may not stop even if the vehicle is being driven by the hybrid battery (traction battery). If this continues for a few days, contact your Lexus dealer.

■ Sounds and vibrations specific to a hybrid vehicle

There may be no engine sound or vibration even though the vehicle is able to move with the "READY" indicator is illuminated. For safety, apply the parking brake and make sure to shift the shift position to P when parked.

The following sounds or vibrations may occur when the hybrid system is operating and are not a malfunction:

- Motor sounds may be heard from the engine compartment.
- Sounds may be heard from the hybrid battery (traction battery) behind the rear seats when the hybrid system starts or stops.
- Relay operating sounds such as a snap or soft clank will be emitted from the hybrid battery (traction battery), behind the rear seats, when the hybrid system is started or stopped.
- Sounds may be heard from the transmission when the gasoline engine starts or stops, when driving at low speeds, or during idling.
- Engine sounds may be heard when accelerating sharply.
- Sounds may be heard due to regenerative braking when the brake pedal is depressed or as the accelerator pedal is released.
- Operating sounds or motor sounds that occur when the brake pedal is operated.
- Vibration may be felt when the gasoline engine starts or stops.
- Cooling fan sounds may be heard from the air intake vent on the side of rear right seat-back.

■ Vehicle proximity notification system

In the following cases, the vehicle proximity notification system may be difficult for surrounding people to hear.

- In very noisy areas
- In the wind or the rain

Also, as the vehicle proximity notification system is installed on the front of the vehicle, it may be more difficult to hear from the rear of the vehicle compared to the front.

■ Maintenance, repair, recycling, and disposal

Contact your Lexus dealer regarding maintenance, repair, recycling and disposal. Do not dispose of the vehicle yourself.

■ Customization Settings

Settings (e.g. on/off operation of the EV indicator) can be changed.
(Customizable features: →P. 591)

Hybrid system precautions

Take care when handling the hybrid system, as it is a high voltage system (about 650V at maximum) as well as parts that become extremely hot when the hybrid system is operating. Obey the caution labels attached to the vehicle.

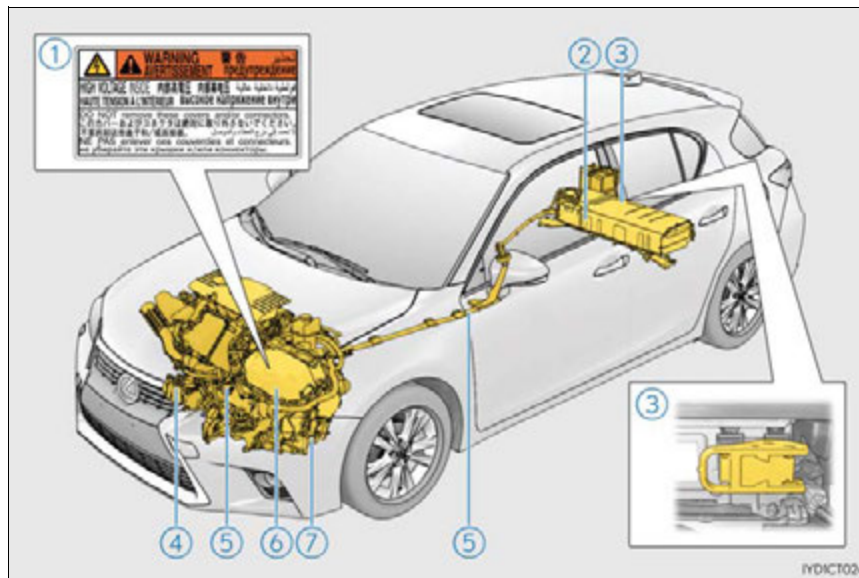

The illustration is an example for explanation and may differ from the actual item.

- ① Caution label
- ② Hybrid battery (traction battery)
- ③ Service plug
- ④ Air conditioning compressor
- ⑤ High voltage cables (orange)
- ⑥ Power control unit
- ⑦ Electric motor (traction motor)

Hybrid battery (traction battery) air vent

There is an air intake vent on the side of the rear right seatback for the purpose of cooling the hybrid battery (traction battery). If the vent becomes blocked, the hybrid battery may overheat, leading to a reduction in hybrid battery output.

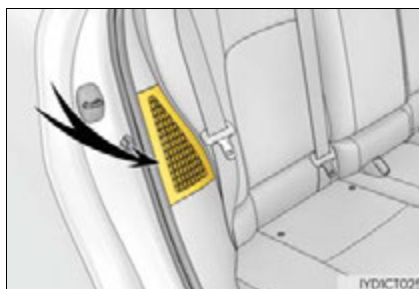

Emergency shut off system

When a certain level of impact is detected by the impact sensor, the emergency shut off system blocks the high voltage current and stops the fuel pump to minimize the risk of electrocution and fuel leakage. If the emergency shut off system activates, your vehicle will not restart. To restart the hybrid system, contact your Lexus dealer.

Hybrid warning message

A message is automatically displayed when a malfunction occurs in the hybrid system or an improper operation is attempted.

If a warning message is shown on the multi-information display, read the message and follow the instructions. (→P. 536)

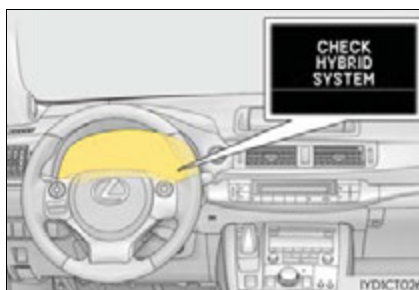

■ **If a warning light comes on, a warning message is displayed, or the 12-volt battery is disconnected**

The hybrid system may not start. In this case, try to start the system again. If the "READY" indicator does not come on, contact your Lexus dealer.

■ **Running out of fuel**

When the vehicle has run out of fuel and the hybrid system cannot be started, refuel the vehicle with at least enough gasoline to make the low fuel level warning light (→P. 531) go off. If there is only a small amount of fuel, the hybrid system may not be able to start. (The minimum amount of fuel to add to make the low fuel level warning light go out is about 3.1 gal. [11.8 L, 2.6 Imp.gal.], when the vehicle is on a level surface. This value may vary when the vehicle is on a slope. Add extra fuel when the vehicle is inclined.)

■ **Electromagnetic waves**

- High voltage parts and cables on hybrid vehicles incorporate electromagnetic shielding, and therefore emit approximately the same amount of electromagnetic waves as conventional gasoline powered vehicles or home electronic appliances.
- Your vehicle may cause sound interference in some third party-produced radio parts.

■ **Hybrid battery (traction battery)**

The hybrid battery (traction battery) has a limited service life. The lifespan of the hybrid battery (traction battery) can change in accordance with driving style and driving conditions.

⚠ WARNING

■ **High voltage precautions**

This vehicle has high voltage DC and AC systems as well as a 12-volt system. DC and AC high voltage is very dangerous and can cause severe burns and electric shock that may result in death or serious injury.

- Never touch, disassemble, remove or replace the high voltage parts, cables or their connectors.
- The hybrid system will become hot after starting as the system uses high voltage. Be careful of both the high voltage and the high temperature, and always obey the caution labels attached to the vehicle.
- Never try to open the service plug access hole located in the luggage compartment. The service plug is used only when the vehicle is serviced and is subject to high voltage.

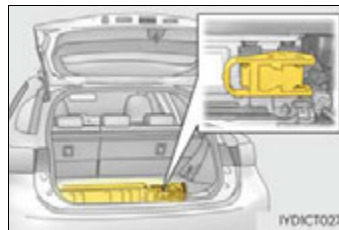

⚠ WARNING**■ Road accident cautions**

Observe the following precautions to reduce the risk of death or serious injury:

- Stop the vehicle in a safe place to prevent subsequent accidents. While depressing the brake pedal, apply the parking brake and shift the shift position to P to stop the hybrid system. Then, slowly release the brake pedal.
- Do not touch the high voltage parts, cables and connectors.
- If electric wires are exposed inside or outside your vehicle, an electric shock may occur. Never touch exposed electric wires.
- If a fluid leak occurs, do not touch the fluid as it may be strong alkaline electrolyte from the hybrid battery (traction battery). If it comes into contact with your skin or eyes, wash it off immediately with a large amount of water or, if possible, boric acid solution. Seek immediate medical attention.
- If a fire occurs in the hybrid vehicle, leave the vehicle as soon as possible. Never use a fire extinguisher that is not meant for electric fires. Using even a small amount of water may be dangerous.
- If your vehicle needs to be towed, do so with front wheels raised. If the wheels connected to the electric motor (traction motor) are on the ground when towing, the motor may continue to generate electricity. This may cause an electricity leakage leading to a fire. (→P. 524)
- Carefully inspect the ground under the vehicle. If you find that liquid has leaked onto the ground, the fuel system may have been damaged. Leave the vehicle as soon as possible.

■ Hybrid battery (traction battery)

- Never resell, hand over or modify the hybrid battery. To prevent accidents, hybrid batteries that have been removed from a disposed vehicle are collected through Lexus dealer. Do not dispose of the battery yourself.

Unless the battery is properly collected, the following may occur, resulting in death or serious injury:

- The hybrid battery may be illegally disposed of or dumped, and it is hazardous to the environment or someone may touch a high voltage part, resulting in an electric shock.
- The hybrid battery is intended to be used exclusively with your hybrid vehicle. If the hybrid battery is used outside of your vehicle or modified in any way, accidents such as electric shock, heat generation, smoke generation, an explosion and electrolyte leakage may occur.

When reselling or handing over your vehicle, the possibility of an accident is extremely high because the person receiving the vehicle may not be aware of these dangers.

- If your vehicle is disposed of without the hybrid battery having been removed, there is a danger of serious electric shock if high voltage parts, cables and their connectors are touched. In the event that your vehicle must be disposed of, the hybrid battery must be disposed of by your Lexus dealer or a qualified service shop. If the hybrid battery is not disposed of properly, it may cause electric shock that can result in death or serious injury.

 NOTICE**■ Hybrid battery air vent**

- Do not put foreign objects near the air vent. The hybrid battery (traction battery) may overheat and be damaged.
- Clean the air vent regularly to prevent the hybrid battery (traction battery) from overheating.
- Do not wet or allow foreign substances to enter the air vent as this may cause a short circuit and damage the hybrid battery (traction battery).
- Do not carry large amounts of water such as water cooler bottles in the vehicle. If water spills onto the hybrid battery (traction battery), the battery may be damaged. Have the vehicle inspected by your Lexus dealer.

1

For safety and security

Immobilizer system

The vehicle's keys have built-in transponder chips that prevent the hybrid system from starting if a key has not been previously registered in the vehicle's on-board computer.

Never leave the keys inside the vehicle when you leave the vehicle.

This system is designed to help prevent vehicle theft but does not guarantee absolute security against all vehicle thefts.

The indicator light flashes after the power switch has been turned off to indicate that the system is operating.

The indicator light stops flashing after the power switch has been turned to ACCESSORY or ON mode to indicate that the system has been canceled.



■ System maintenance

The vehicle has a maintenance-free type immobilizer system.

■ Conditions that may cause the system to malfunction

- If the grip portion of the key is in contact with a metallic object
- If the key is in close proximity to or touching a key registered to the security system (key with a built-in transponder chip) of another vehicle

■ Certification for the immobilizer system

- ▶ For vehicles sold in the U.S.A., Guam, Puerto Rico and NATO Germany

FCC ID: NI4TMIMB-1

This device complies with part 15 of the FCC Rules. Operation is subject to the following two conditions: (1) This device may not cause harmful interference, and (2) this device must accept any interference received, including interference that may cause undesired operation.

Changes or modifications not expressly approved by the party responsible for compliance could void the user's authority to operate the equipment.

- ▶ For vehicles sold in Canada

This device complies with Industry Canada licence-exempt RSS standard(s). Operation is subject to the following two conditions: (1) this device may not cause interference, and (2) this device must accept any interference, including interference that may cause undesired operation of the device.

Le présent appareil est conforme aux CNR d'Industrie Canada applicables aux appareils radio exempts de licence. L'exploitation est autorisée aux deux conditions suivantes : (1) l'appareil ne doit pas produire de brouillage, et (2) l'appareil doit accepter tout brouillage radioélectrique subi, même si le brouillage est susceptible d'en compromettre le fonctionnement.

 **NOTICE****■ To ensure the system operates correctly**

Do not modify or remove the system. If modified or removed, the proper operation of the system cannot be guaranteed.

Alarm

The alarm

The alarm uses light and sound to give an alert when an intrusion is detected.

The alarm is triggered in the following situations when the alarm is set:

- A locked door is unlocked or opened in any way other than using the entry function, wireless remote control or mechanical key. (The doors will lock again automatically.)
- The hood is opened.

Setting the alarm system

Close the doors and hood, and lock all the doors. The system will be set automatically after 30 seconds.

The indicator light changes from being on to flashing when the system is set.



Deactivating or stopping the alarm

Do one of the following to deactivate or stop the alarms:

- Unlock the doors.
- Turn the power switch to ACCESSORY or ON mode, or start the hybrid system. (The alarm will be deactivated or stopped after a few seconds.)

■ System maintenance

The vehicle has a maintenance-free type alarm system.

■ Items to check before locking the vehicle

To prevent unexpected triggering of the alarm and vehicle theft, make sure of the following:

- Nobody is in the vehicle.
- The windows and moon roof (if equipped) are closed before the alarm is set.
- No valuables or other personal items are left in the vehicle.

■ Triggering of the alarm

The alarm may be triggered in the following situations:
(Stopping the alarm deactivates the alarm system.)

- A person inside the vehicle opens a door or hood.



- The 12-volt battery is recharged or replaced when the vehicle is locked. (→P. 564)

**■ Alarm-operated door lock**

In the following cases, depending on the situation, the door may automatically lock to prevent improper entry into the vehicle:

- When a person remaining in the vehicle unlocks the door and the alarm is activated.
- While the alarm is activated, a person remaining in the vehicle unlocks the door.
- When recharging or replacing the 12-volt battery.

 **NOTICE****■ To ensure the system operates correctly**

Do not modify or remove the system. If modified or removed, the proper operation of the system cannot be guaranteed.

Theft prevention labels (for U.S.A.)

These labels are attached to the vehicle to reduce vehicle theft by facilitating the tracing and recovery of parts from stolen vehicles. Do not remove under penalty of law.

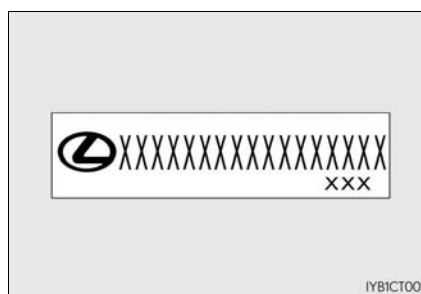

| | |
|---|----|
| 2. Instrument cluster | |
| Warning lights and indicators..... | 80 |
| Gauges and meters | 84 |
| Multi-information display | 88 |
| Energy monitor/ consumption screen | 91 |

Warning lights

Warning lights inform the driver of malfunctions in any of the vehicle's systems.



















| | | | |
|--|--|---|--|
| ^{*1}  (U.S.A.) | Brake system warning light (→P. 529) | ^{*1}  (U.S.A.) | ABS warning light (→P. 530) |
| ^{*1}  (Canada) | Brake system warning light (→P. 529) | ^{*1}  (Canada) | ABS warning light (→P. 530) |
| ^{*1}  | Brake system warning light (→P. 529) | ^{*1}  | Electric power steering system warning light (→P. 530) |
| ^{*1}  | Charging system warning light (→P. 529) | ^{*1,2}  (if equipped) | "PCS" warning light (→P. 530) |
| ^{*1}  | Low engine oil pressure warning light (→P. 529) | ^{*1}  | Slip indicator light (→P. 530) |
| ^{*1}  (U.S.A.) | Malfunction indicator lamp (→P. 529) | ^{*1}  (if equipped) | Automatic headlight leveling system warning light (→P. 530) |
| ^{*1}  (Canada) | Malfunction indicator lamp (→P. 529) | ^{*1}  | High coolant temperature warning light (→P. 530) |
|  | Low fuel level warning light (→P. 531) |  | Open door warning light (→P. 530) |
|  | Seat belt reminder light (→P. 531) | ^{*1}  | Master warning light (→P. 531) |
| ^{*1}  | SRS warning light (→P. 530) | ^{*1}  | Tire pressure warning light (→P. 531) |

*1: These lights turn on when the power switch is turned to ON mode to indicate that a system check is being performed. They will turn off after the hybrid system is on, or after a few seconds. There may be a malfunction in a system if the lights do not turn on, or turn off. Have the vehicle inspected by your Lexus dealer.

*2: The light flashes to indicate a malfunction.

Indicators

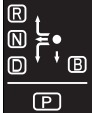
The indicators inform the driver of the operating state of the vehicle's various systems.

| | | | |
|---|---|---|--|
|  | Turn signal indicator (→P. 167) |  | "ECO MODE" indicator (→P. 234) |
|  | Headlight indicator (→P. 169) (U.S.A.) |  | "SPORT MODE" indicator (→P. 234) |
|  | Tail light indicator (→P. 169) (Canada) |  | Cruise control indicator (→P. 186, 189) |
|  | Headlight high beam indicator (→P. 170) |  | Radar cruise control indicator (→P. 189) (if equipped) |
|  | Fog light indicator (→P. 172) |  | Intuitive parking assist indicator (→P. 202) (if equipped) |
|  | "READY" indicator (→P. 156) |  | *1, 2 Slip indicator light (→P. 236) |
|  | EV indicator (→P. 67) |  | *1 "TRAC OFF" indicator (→P. 236) |
|  | EV drive mode indicator (→P. 160) |  | *1, 3 "PCS" warning light (→P. 239) (if equipped) |
|  | Shift position indicators (→P. 162) |  | *1, 4 "AIR BAG ON/ OFF" indicator (→P. 47) |

- *1: These lights turn on when the power switch is turned to the ON mode to indicate that a system check is being performed. They will turn off after the hybrid system is on, or after a few seconds. There may be a malfunction in a system if the lights do not turn on, or turn off. Have the vehicle inspected by your Lexus dealer.
- *2: The light flashes to indicate that the system is operating.
- *3: The light comes on when the system is turned off. The light flashes faster than usual to indicate that the system is operating.
- *4: This light illuminates on the center panel.

 **WARNING****■ If a safety system warning light does not come on**

Should a safety system light such as the ABS and SRS warning light not come on when you start the hybrid system, this could mean that these systems are not available to help protect you in an accident, which could result in death or serious injury. Have the vehicle inspected by your Lexus dealer immediately if this occurs.

Gauges and meters



The units used on the meters may differ depending on the target region.

- ① Hybrid System Indicator
 - Displays hybrid system output or regeneration level
 - Changes to the tachometer depending on the drive mode or setting on the display. (→P. 86, 591)
- ② Tachometer
 - Displays the engine speed in revolutions per minute
 - Changes to Hybrid System Indicator depending on the drive mode or setting on the display. (→P. 86, 591)
- ③ Shift position indicators
 - P. 162
- ④ Speedometer
 - Displays the vehicle speed
- ⑤ ECO lamp and SPORT lamp
 - Changes colors according to driving mode (→P. 86)
- ⑥ Fuel gauge
 - Displays the quantity of fuel remaining in the tank
- ⑦ Multi-information display
 - Presents the driver with a variety of driving-related data (→P. 88)
 - Displays warning messages in case of a malfunction (→P. 536)
- ⑧ Outside temperature
 - The temperature range that can be displayed is from -40°F (-40°C) to 122°F (50°C)

⑨ Odometer and trip meter display

Odometer:

Displays the total distance that the vehicle has been driven

Trip meter:

Displays the distance the vehicle has been driven since the meter was last reset. Trip meters "A" and "B" can be used to record and display different distances independently.

⑩ Odometer/trip meter display change button

→P. 85

Changing the display

Switches between odometer and trip meter displays. When the trip meter is displayed, pressing and holding the button will reset the trip meter.



Instrument panel light control

The brightness of the instrument panel lights can be adjusted by turning the dial.

① Brighter

② Darker

When the headlight switch is turned to ON, the brightness will be reduced slightly unless the control dial is turned fully up.

When the dial is turned fully down, the cup holder light and the footwell lights will turn off. (→P. 427)

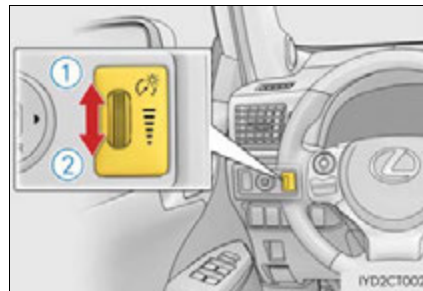

■ The meters and display illuminate when

The power switch is in ON mode.

■ Hybrid System Indicator

- ① Power area
Shows that an Eco-friendly driving range is being exceeded (during full power driving etc.)
- ② Eco area
Shows that the vehicle is being driven in an Eco-friendly manner.
- ③ Hybrid Eco area
Shows that gasoline engine power is not being used very often.
The gasoline engine will automatically stop and restart under various conditions.
- ④ Charge area
Shows that energy is being recovered via the regenerative brake.



- Hybrid System Indicator is displayed when the driving mode is in other than the sport mode.
- By keeping the indicator needle within Eco area, more Eco-friendly driving can be achieved.
- Charge area indicates regeneration* status. Regenerated energy will be used to charge the hybrid battery (traction battery).

*: When used in this manual, "regeneration" refers to the conversion of energy created by the movement of the vehicle into electrical energy.

■ Tachometer

The tachometer is displayed when the driving mode is in the sport mode.

■ ECO lamp and SPORT lamp

- When sport mode is selected, the SPORT lamp (red) will illuminate.
- When all of the following conditions are satisfied and the Eco-friendly driving, the ECO lamp (blue) will illuminate:
 - Driving with the shift position in D
 - Either normal mode or Eco drive mode is selected, and EV drive mode is not in use (→P. 160, 234)
 - The vehicle speed is approximately 80 mph (130 km/h) or below.

■ Engine speed

On hybrid vehicles, engine speed is precisely controlled in order to help improve fuel efficiency and reduce exhaust emissions etc.

There are times when the engine speed that is displayed may differ even when vehicle operation and driving conditions are the same.

■ Outside temperature display

● In the following situations, the correct outside temperature may not be displayed, or the display may take longer than normal to change.

- When stopped, or driving at low speeds (less than 12 mph [20 km/h])
- When the outside temperature has changed suddenly (at the entrance/exit of a garage, tunnel, etc.)

● When "--" or "E" is displayed, the system may be malfunctioning.
Take your vehicle to your Lexus dealer.

■ Customization

Settings (e.g. on/off operation of the ECO lamp) can be changed.
(Customizable features: →P. 591)

 **NOTICE****■ To prevent damage to the engine and its components**

- Do not let the indicator needle of the tachometer enter the red zone, which indicates the maximum engine speed.
- The engine may be overheating if the high coolant temperature warning light comes on or flashes. In this case, immediately stop the vehicle in a safe place, and check the engine after it has cooled completely. (→P. 566)

Multi-information display

Display contents

The multi-information display presents the driver with a variety of vehicle data.

- **Energy monitor**
Displays the status of the hybrid system. (→P. 91)
- **Drive information**
Displays driving range, fuel consumption and other cruising related information. (→P. 88)
- **Setting**
Changes instrument cluster display settings (→P. 591)
- **Intuitive parking assist display (if equipped)**
Automatically displayed when the system is used (→P. 202)
- **Dynamic radar cruise control display (if equipped)**
Automatically displayed when the system is used (→P. 189)
- **Warning messages**
Automatically displayed when a malfunction occurs in one of the vehicle's systems (→P. 536)

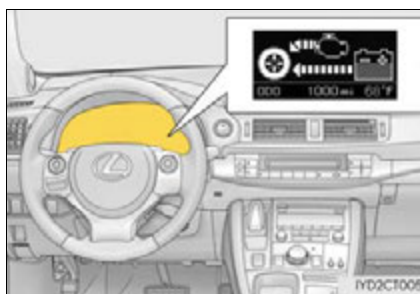

Drive information

Items displayed can be switched by pressing the "DISP" switch.

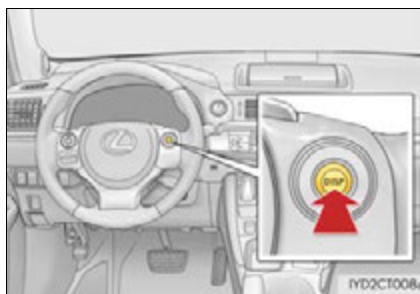

- **Energy monitor**
→P. 91
- **Current fuel consumption/Average fuel consumption after refueling**
Displays the instant fuel consumption and average fuel consumption after refueling.
Use the displayed average fuel consumption as a reference.

■ Average fuel consumption

Displays the average fuel consumption since the function was reset.

- The function can be reset by pressing the “DISP” switch for longer than 1 second when the average fuel consumption is displayed.
- Use the displayed average fuel consumption as a reference.

■ Cruising range

Displays the estimated maximum distance that can be driven with the quantity of fuel remaining.

- This distance is computed based on your average fuel consumption. As a result, the actual distance that can be driven may differ from that displayed.
- When only a small amount of fuel is added to the tank, the display may not be updated. When refueling, turn the power switch off. If the vehicle is refueled without turning the power switch off, the display may not be updated.

■ Elapsed time

Displays the elapsed time since the hybrid system was started or the function was reset.

The function can be reset by pressing the “DISP” switch for longer than 1 second when the elapsed time is displayed.

■ Average vehicle speed

Displays the average vehicle speed since the function was reset

The function can be reset by pushing the “DISP” switch for longer than 1 second when the average vehicle speed is displayed.

■ Setting

→P. 591

■ Display off

A blank screen is displayed

■ System check display

After turning the power switch to ON mode, opening image is displayed while system operation is checked. When the system check is complete, the normal screen will return.

■ When disconnecting and reconnecting 12-volt battery terminals

The drive information will be reset.

■ Liquid crystal display

Small spots or light spots may appear on the display. This phenomenon is characteristic of liquid crystal displays, and there is no problem continuing to use the display.

 NOTICE**■ The multi-information display at low temperatures**

Allow the interior of the vehicle to warm up before using the liquid crystal information display. At extremely low temperatures, the information display monitor may respond slowly, and display changes may be delayed.

Energy monitor/consumption screen

You can view the status of your hybrid system on the multi-information display and the navigation system (if equipped)/Lexus Display Audio system (if equipped).

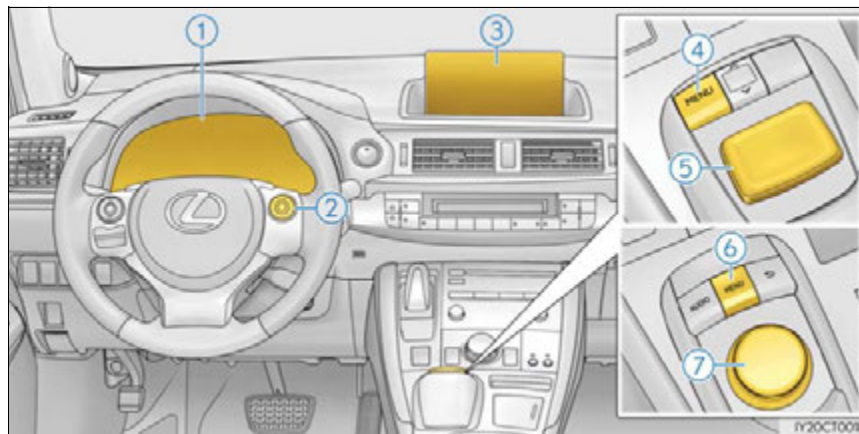

- ① Multi-information display
- ② "DISP" switch
- ③ Navigation system screen/Lexus Display Audio screen (if equipped)
 - ▶ Vehicles with a navigation system
- ④ "MENU" button
- ⑤ Remote Touch knob*
 - ▶ Vehicles with a Lexus Display Audio system
- ⑥ "MENU" button
- ⑦ Lexus Display Audio controller (→P. 322)

*: For use of the Remote Touch, refer to "NAVIGATION SYSTEM OWNER'S MANUAL".

Energy monitor

- ▶ Navigation system screen

Press the "MENU" button on the Remote Touch, then select "Info" on the "Menu" screen, and then select "Fuel Consumption".

If the "Trip Information" or "Past Record" screen is displayed, select "Energy".



- ▶ Lexus Display Audio screen

Press the "MENU" button on the Lexus Display Audio controller, then select "Info" on the "Menu" screen, and then select "Fuel Consumption".









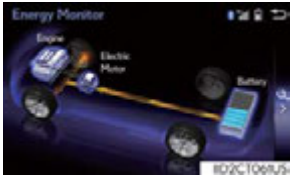

If the "Energy Monitor" screen does not appear, move the controller to the right and select "Energy".

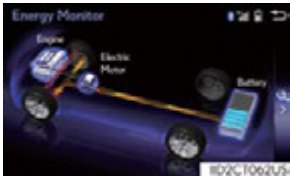

- ▶ Multi-information display

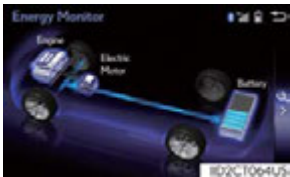
Press the "DISP" switch on the steering wheel several times to select the energy monitor display.

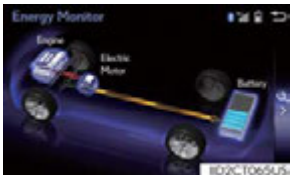
■ Navigation system screen/Lexus Display Audio screen

| | Navigation system screen | Lexus Display Audio screen |
|---|---|--|
| When the vehicle is powered by the electric motor (traction motor) |  |  |
| When the vehicle is powered by both the gasoline engine and the electric motor (traction motor) |  |  |
| When the vehicle is powered by the gasoline engine |  |  |
| When the vehicle is charging the hybrid battery (traction battery) |  |  |
| |  |  |
| When there is no energy flow |  |  |





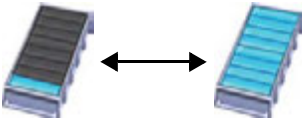
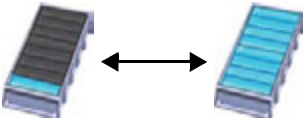

2

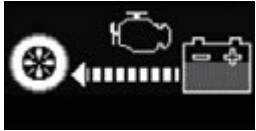

Instrument cluster

| | Navigation system screen | | Lexus Display Audio screen | |
|--|---|------|--|------|
| | Low | Full | Low | Full |
| Hybrid battery (traction battery) status |  | |  | |

These images are examples only, and may vary slightly from actual conditions.

■ Multi-information display screen

| | Multi-information display |
|---|--|
| When the vehicle is powered by the electric motor (traction motor) |  |
| When the vehicle is powered by both the gasoline engine and the electric motor (traction motor) |  |
| When the vehicle is powered by the gasoline engine |  |
| When the vehicle is charging the hybrid battery (traction battery) |  |
| |  |
| When there is no energy flow |  |

| | Multi-information display | |
|--|---|---|
| | Low | Full |
| Hybrid battery (traction battery) status |  |  |

These images are examples only, and may vary slightly from actual conditions.

Fuel consumption (vehicles with a navigation system or Lexus Display Audio system)

2

Instrument cluster

■ Trip information

- ▶ Navigation system screen

Press the "MENU" button on the Remote Touch, then select "Info" on the "Menu" screen, and then select "Fuel Consumption".

If the "Energy Monitor" or "Past Record" screen is displayed, select "Trip Information".

- ① Resetting the consumption data
- ② Fuel consumption in the past 15 minutes
- ③ Current fuel consumption
- ④ Regenerated energy in the past 15 minutes

One symbol indicates 30 Wh.
Up to 5 symbols are shown.

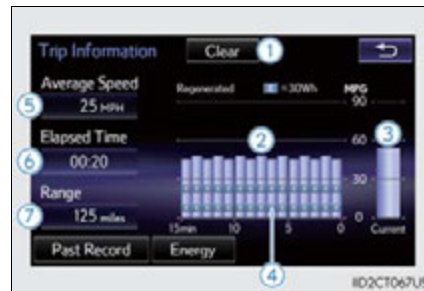

- ⑤ Average vehicle speed since the hybrid system was started.
- ⑥ Elapsed time since the hybrid system was started.
- ⑦ Cruising range (→P. 97)

▶ Lexus Display Audio screen

Press the “MENU” button on the Lexus Display Audio controller, then select “Info” on the “Menu” screen, and then select “Fuel Consumption”.

If the “Trip Information” screen does not appear, move the controller to the right and select “Trip Information”.

- ① Fuel consumption in the past 15 minutes
- ② Current fuel consumption
- ③ Regenerated energy in the past 15 minutes
- One symbol indicates 30 Wh. Up to 5 symbols are shown.
- ④ Average vehicle speed since the hybrid system was started.
- ⑤ Elapsed time since the hybrid system was started.
- ⑥ Cruising range (→P. 97)



Average fuel consumption for the past 15 minutes is divided by color into past averages and averages attained since the power switch was last turned to ON mode. Use the displayed average fuel consumption as a reference.

The image is an example only.

■ Past record

▶ Navigation system screen

Press the “MENU” button on the Remote Touch, then select “Info” on the “Menu” screen, and then select “Fuel Consumption”.

If the “Energy Monitor” or “Trip Information” screen is displayed, select “Past Record”.

- ① Resetting the past record data
- ② Best recorded fuel consumption
- ③ Average fuel consumption
- ④ Previous fuel consumption record
- ⑤ Updating the average fuel consumption data

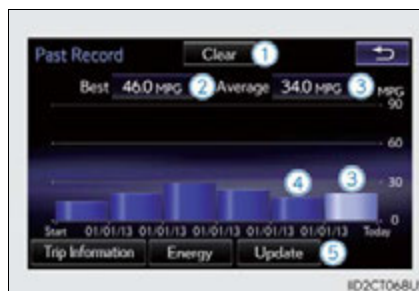

- ▶ Lexus Display Audio screen

Press the “MENU” button on the Lexus Display Audio controller, then select “Info” on the “Menu” screen, and then select “Fuel Consumption”.

If the “Past Record” screen does not appear, move the controller to the right and select “Past Record”.

- ① Previous fuel consumption record
- ② Current fuel consumption
- ③ Best recorded fuel consumption



The average fuel consumption history is divided by color into past averages and the average fuel consumption since the last updated. Use the displayed average fuel consumption as a reference.

The image is an example only.

■ Updating the past record data

- ▶ Vehicles with a navigation system

Update the average fuel consumption by selecting “Update” to measure the current fuel consumption again.

- ▶ Vehicles with a Lexus Display Audio system

Update the average fuel consumption by moving the controller to the left and select “Update” to measure the current fuel consumption again.

■ Resetting the data

- ▶ Vehicles with a navigation system

The fuel consumption data can be deleted by selecting “Clear”.

- ▶ Vehicles with a Lexus Display Audio system

The fuel consumption data can be deleted by moving the controller to the left and select “Clear”.

■ Cruising range

Displays the estimated maximum distance that can be driven with the quantity of fuel remaining.

This distance is computed based on your average fuel consumption.

As a result, the actual distance that can be driven may differ from that displayed.

| | |
|--|-----|
| 3-1. Key information | |
| Keys | 100 |
| 3-2. Opening, closing and locking the doors | |
| Side doors..... | 105 |
| Back door..... | 110 |
| Smart access system with push-button start..... | 114 |
| 3-3. Adjusting the seats | |
| Front seats..... | 120 |
| Rear seats..... | 122 |
| Driving position memory..... | 124 |
| Head restraints | 127 |
| 3-4. Adjusting the steering wheel and mirrors | |
| Steering wheel | 130 |
| Inside rear view mirror..... | 132 |
| Outside rear view mirrors..... | 135 |
| 3-5. Opening, closing the windows and moon roof | |
| Power windows | 137 |
| Moon roof..... | 140 |

Keys

The keys

The following keys are provided with the vehicle.

- ① Electronic keys
 - Operating the smart access system with push-button start (→P. 114)
 - Operating the wireless remote control function
- ② Mechanical keys
- ③ Key number plate
- ④ Card key (electronic key) (if equipped)
 - Operating the smart access system with push-button start (→P. 114)

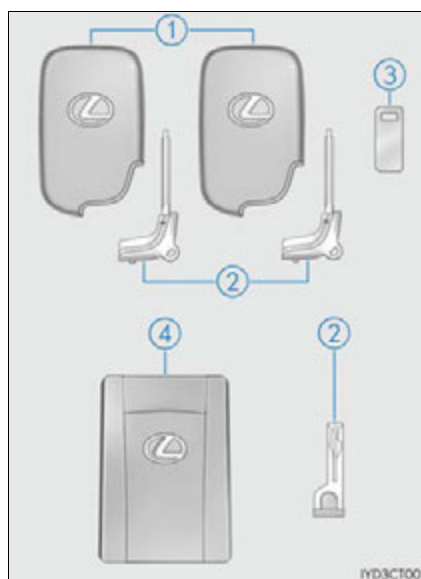

Wireless remote control

- ① Locks all the doors (→P. 105)
 - ② Unlocks all the doors (→P. 105)
 - ③ Opens the windows* (→P. 105)
 - ④ Sounds the alarm (→P. 101)
- *: This setting must be customized at your Lexus dealer.

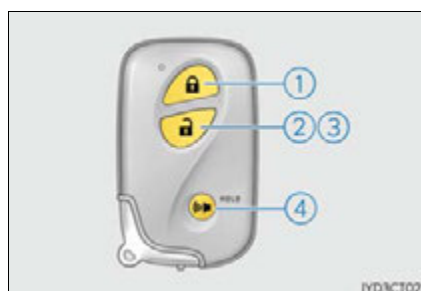

Using the mechanical key

To take out the mechanical key:

Electronic keys: Slide the release lever and take the key out.

Card key: Press the lock release button and take the key out.

The mechanical key can only be inserted in one direction, as the key only has grooves on one side. If the key cannot be inserted in a lock cylinder, turn it over and re-attempt to insert it.

After using the mechanical key, store it in the electronic key. Carry the mechanical key together with the electronic key. If the electronic key battery is depleted or the entry function does not operate properly, you will need the mechanical key. (→P.560)

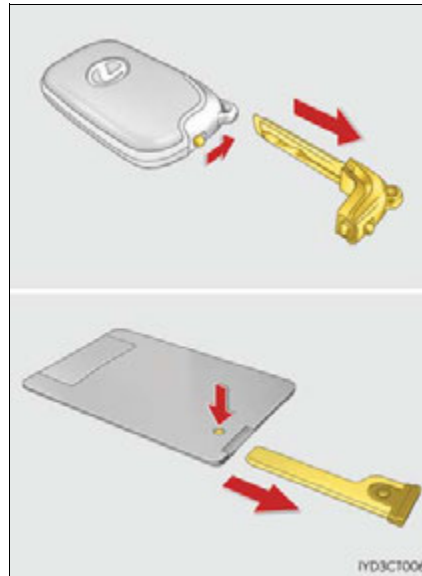

■ Panic mode

When  is pressed for longer than about one second, an alarm will sound intermittently and the vehicle lights will flash to deter any person from trying to break into or damage your vehicle.

To stop the alarm, press any button on the electronic key.



■ **Card key (if equipped)**

- The card key is not waterproof.
- The mechanical key that is stored inside the card key should be used only if a problem arises, such as when the card key does not operate properly.
- If it is difficult to take out the mechanical key, push down the lock release button using a pen tip etc. If it is still difficult to pull it out, use a coin etc.
- To store the mechanical key in the card key, insert it while pressing the lock release button.

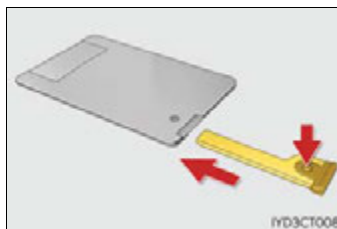

- If the battery cover is not installed and the battery falls out or if the battery was removed because the key got wet, reinstall the battery with the positive terminal facing the Lexus emblem.

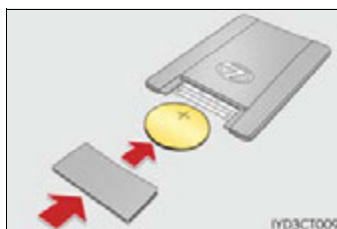

■ **When required to leave the vehicle's key with a parking attendant**

Lock the glove box as circumstances demand. (→P. 430)
Remove the mechanical key for your own use and provide the attendant with the electronic key only.

■ **If you lose your mechanical keys**

New genuine mechanical keys can be made by your Lexus dealer using another mechanical key and the key number stamped on your key number plate. Keep the plate in a safe place such as your wallet, not in the vehicle.

■ **When riding in an aircraft**

When bringing an electronic key onto an aircraft, make sure you do not press any buttons on the electronic key while inside the aircraft cabin. If you are carrying an electronic key in your bag etc., ensure that the buttons are not likely to be pressed accidentally. Pressing a button may cause the electronic key to emit radio waves that could interfere with the operation of the aircraft.

■ Electronic key battery depletion

- The standard battery life is 1 to 2 years. (The card key battery life is about a year and a half.)
- If the battery becomes low, an alarm will sound in the cabin when the hybrid system stops. (→P. 548)
- As the electronic key always receives radio waves, the battery will become depleted even if the electronic key is not used. The following symptoms indicate that the electronic key battery may be depleted. Replace the battery when necessary. (→P. 504)
 - The smart access system with push-button start or the wireless remote control does not operate.
 - The detection area becomes smaller.
 - The LED indicator on the key surface does not turn on.
- To avoid serious deterioration, do not leave the electronic key within 3 ft. (1 m) of the following electrical appliances that produce a magnetic field:
 - TVs
 - Personal computers
 - Cellular phones, cordless phones and battery chargers
 - Recharging cellular phones or cordless phones
 - Induction cookers
 - Table lamps

■ Replacing the battery

→P. 504

■ Confirmation of the registered key number

The number of keys already registered to the vehicle can be confirmed. Ask your Lexus dealer for details.

■ If a wrong key is used

The key cylinder rotates freely to isolate inside mechanism.

 NOTICE**■ To prevent key damage**

- Do not drop the keys, subject them to strong shocks or bend them.
- Do not expose the keys to high temperatures for long periods of time.
- Do not get the keys wet or wash them in an ultrasonic washer etc.
- Do not attach metallic or magnetic materials to the keys or place the keys close to such materials.
- Do not disassemble the keys.
- Do not attach a sticker or anything else to the surface of the electronic key.
- Do not place the keys near objects that produce magnetic fields, such as TVs, audio systems and induction cookers, or medical electrical equipment, such as low-frequency therapy equipment.

■ Carrying the electronic key on your person

Carry the electronic key 3.9 in. (10 cm) or more away from electric appliances that are turned on. Radio waves emitted from electric appliances within 3.9 in. (10 cm) of the electronic key may interfere with the key, causing the key to not function properly.

■ In case of a smart access system with push-button start malfunction or other key-related problems

Take your vehicle with all the electronic keys provided with your vehicle, including the card key, to your Lexus dealer.

■ When an electronic key is lost

If the electronic key remains lost, the risk of vehicle theft increases significantly. Visit your Lexus dealer immediately with all remaining electronic keys and the card key that were provided with your vehicle.

■ Handling the card key (if equipped)

- Do not apply excess force when inserting the mechanical key into the card key. Doing so may damage the card key.
- If the battery or card key terminals get wet, the battery may corrode.
If the key is dropped into water, or if drinking water etc. is spilled on the key, immediately remove the battery cover and wipe the battery and terminals. (To remove the battery cover, lightly grasp and pull it.) If the battery is corroded, have your Lexus dealer replace the battery.
- Do not crush the battery cover or use a screwdriver to remove the battery cover. Forcibly removing the battery cover may bend or damage the key.
- If the battery cover is frequently removed, the battery cover may become loose.
- When installing the battery, make sure to check the direction of the battery.
Installing the battery in the wrong direction may cause the battery to deplete rapidly.
- The surface of the card key may be damaged, or its coating may peel off in the following situations:
 - The card key is carried together with hard objects, such as coins and keys.
 - The card key is scraped with a sharp object, such as the tip of a mechanical pencil.
 - The surface of the card key is wiped with thinner or benzene.

Side doors

The vehicle can be locked and unlocked using the entry function, wireless remote control or door lock switch.

Locking and unlocking the doors from the outside

◆ Smart access system with push-button start

Carry the electronic key to enable this function.

- ① Grip the driver's door handle to unlock the door. Grip the passenger's door handle to unlock all the doors.*

Make sure to touch the sensor on the back of the handle.

The doors cannot be unlocked for 3 seconds after the doors are locked.

*: The door unlock settings can be changed. (→P. 591)

- ② Touch the lock sensor (the indentation on the upper part of the front door handle) to lock the doors.

Check that the door is securely locked.

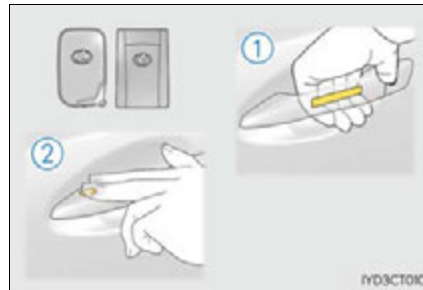

◆ Wireless remote control

- ① Locks all the doors

Check that the door is securely locked.

- ② Unlocks all the doors

Pressing the button unlocks the driver's door. Pressing the button again within 3 seconds unlocks the other doors.

Press and hold to open the windows*

*: This setting must be customized at your Lexus dealer.



3

Operation of each component

■ **Operation signals**

Doors:

A buzzer sounds and the emergency flashers flash to indicate that the doors have been locked/unlocked. (Locked: Once; Unlocked: Twice)

Windows:

A buzzer sounds to indicate that the windows are opening.

■ **Security feature**

If a door is not opened within approximately 60 seconds after the vehicle is unlocked, the security feature automatically locks the vehicle again.

■ **Welcome light illumination control**

The side marker, parking, tail and license plate lights automatically turn on at night when the doors are unlocked using the entry function or wireless remote control if the light switch is in the "AUTO" position.

■ **When the door cannot be locked by the lock sensor on the upper part of the door handle**

If the door will not lock even when the topside sensor area is touched, try touching both the topside and underside sensor areas at the same time.

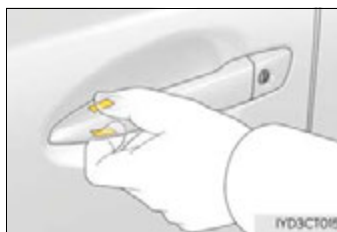

■ **Door lock buzzer**

If an attempt to lock the doors is made when a door is not fully closed, a buzzer sounds continuously for 5 seconds. Fully close the door to stop the buzzer, and lock the vehicle once more.

■ **Setting the alarm**

Locking the doors will set the alarm system. (→P. 76)

■ **If the smart access system with push-button start or the wireless remote control does not operate properly**

- Use the mechanical key to lock and unlock the doors. (→P. 560)
- Replace the key battery with a new one if it is depleted. (→P. 504)

Locking and unlocking the doors from the inside◆ **Door lock switch**

- ① Locks all the doors
- ② Unlocks all the doors

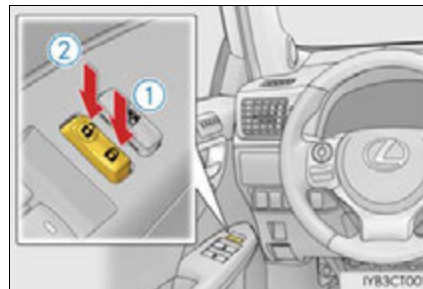
◆ **Inside lock buttons**

- ① Locks the door
- ② Unlocks the door

The front doors can be opened by pulling the inside handle even if the lock buttons are in the lock position.



3

Operation of each component

Locking the front doors from the outside without a key

- 1 Move the inside lock button to the lock position.
- 2 Close the door.

The door cannot be locked if the power switch is in ACCESSORY or ON mode, or the electronic key is left inside the vehicle.

The key may not be detected correctly and the door may be locked.

Rear door child-protector lock

The door cannot be opened from inside the vehicle when the lock is set.

- 1 Unlock
- 2 Lock

These locks can be set to prevent children from opening the rear doors. Push down on each rear door switch to lock both rear doors.



Automatic door locking and unlocking systems

The following functions can be set or canceled:

For instructions on customizing, refer to P. 591.

| Function | Operation |
|---|---|
| Shift position linked door locking function | Shifting the shift position to any positions other than P locks all the doors. |
| Shift position linked door unlocking function | Shifting the shift position to P unlocks all the doors. |
| Speed linked door locking function | All the doors are locked when the vehicle speed is approximately 12 mph (20 km/h) or higher. |
| Driver's door linked door unlocking function | All the doors are unlocked when the driver's door is opened within approximately 45 seconds after turning the power switch off. |

■ Impact detection door lock release system

In the event that the vehicle is subject to a strong impact, all the doors are unlocked. Depending on the force of the impact or the type of accident, however, the system may not operate.

■ Using the mechanical key

The doors can also be locked and unlocked with the mechanical key. (→P. 560)

■ If a wrong key is used

The key cylinder rotates freely to isolate inside mechanism.

■ Customization

Settings (e.g. unlocking function using a key) can be changed.
(Customizable features: →P. 591)

WARNING

■ To prevent an accident

Observe the following precautions while driving the vehicle. Failure to do so may result in a door opening and an occupant throwing out of the vehicle, resulting in death or serious injury.

- Ensure that all doors are properly closed and locked.
- Do not pull the inside handle of the doors while driving.
Be especially careful for the front doors, as the doors may be opened even if the inside lock buttons are in locked position.
- Set the rear door child-protector locks when children are seated in the rear seats.

■ When opening or closing a door

Check the surroundings of the vehicle such as whether the vehicle is on an incline, whether there is enough space for a door to open and whether a strong wind is blowing. When opening or closing the door, hold the door handle tightly to prepare for any unpredictable movement.

■ When using the wireless remote control and operating the power windows

Operate the power window after checking to make sure that there is no possibility of any passenger having any of their body parts caught in the window. Also, do not allow children to operate the wireless remote control. It is possible for children and other passengers to get caught in power window.

Back door

The back door can be locked/unlocked and opened by the following procedures.

Locking and unlocking the back door

◆ Smart access system with push-button start

Carry the electronic key to enable this function.

- ① Locks all the doors
Check that the door is securely locked.
- ② Unlocks all the doors
The doors cannot be unlocked for 3 seconds after the doors are locked.

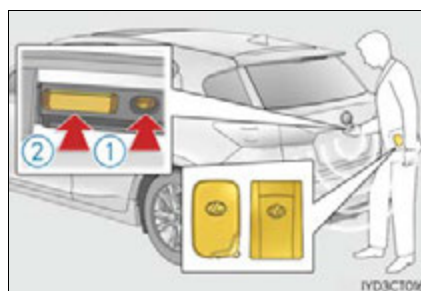

◆ Wireless remote control

→P.100

◆ Door lock switch

→P.107

Opening the back door from outside the vehicle

Raise the back door while pushing up the back door opener switch.



When closing the back door

Lower the back door using the back door handle, and make sure to push the back door down from the outside to close it.



3

Operation of each component

■ Luggage compartment light

The luggage compartment light turns on when the back door is opened with the luggage compartment light switch on.

- ① Off
- ② On

When the power switch is turned off, the light will go off automatically after 20 minutes.

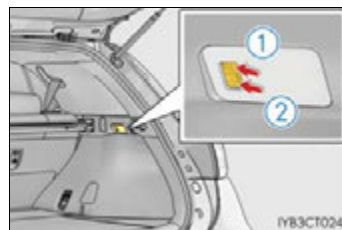

■ If the back door opener is inoperative

The back door can be unlocked from the inside.

Lift the center deck board and then push up the lever in the hole.

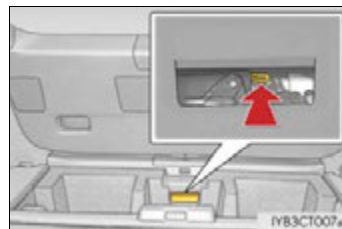

⚠ WARNING

Observe the following precautions.
Failure to do so may result in death or serious injury.

■ Before driving

- Make sure that the back door is fully closed. If the back door is not fully closed, it may open unexpectedly while driving and hit near-by objects or luggage in the luggage compartment may be thrown out, causing an accident.
- Do not allow children to play in the luggage compartment.
If a child is accidentally locked in the luggage compartment, they could have heat exhaustion or other injuries.
- Do not allow a child to open or close the back door.
Doing so may cause the back door to open unexpectedly, or cause the child's hands, head, or neck to be caught by the closing back door.

■ Important points while driving

- Keep the back door closed while driving.
If the back door is left open, it may hit near-by objects or luggage in the luggage compartment may be thrown out, causing an accident.
- Never let anyone sit in the luggage compartment. In the event of sudden braking, sudden swerving or a collision, they are susceptible to death or serious injury.

■ Operating the back door

- Observe the following precautions.
Failure to do so may cause parts of the body to be caught, resulting in death or serious injury.
- Remove any heavy loads, such as snow and ice, from the back door before opening it.
Failure to do so may cause the back door to suddenly shut again after it is opened.
 - When opening or closing the back door, thoroughly check to make sure the surrounding area is safe.
 - If anyone is in the vicinity, make sure they are safe and let them know that the back door is about to open or close.
 - Use caution when opening or closing the back door in windy weather as it may move abruptly in strong wind.
 - The back door may suddenly shut if it is not opened fully. It is more difficult to open or close the back door on an incline than on a level surface, so beware of the back door unexpectedly opening or closing by itself. Make sure that the back door is fully open and secure before using the luggage compartment.



⚠ WARNING

- When closing the back door, take extra care to prevent your fingers etc. from being caught.
- When closing the back door, make sure to press it lightly on its outer surface. If the back door handle is used to fully close the back door, it may result in hands or arms being caught.



- Do not pull on the back door damper stay to close the back door, and do not hang on the back door damper stay. Doing so may cause hands to be caught or the back door damper stay to break, causing an accident.
- If a bicycle carrier or similar heavy object is attached to the back door, it may suddenly shut closed again after being opened, causing someone's hands, head or neck to be caught and injured. When installing an accessory part to the back door, using a genuine Lexus part is recommended.

⚠ NOTICE**■ Back door damper stays**

The back door is equipped with damper stays that hold the back door in place.

Observe the following precautions.

Failure to do so may cause damage to the back door damper stay, resulting in malfunction.

- Do not attach any foreign objects, such as stickers, plastic sheets, or adhesives to the damper stay rod.
- Do not touch the damper stay rod with gloves or other fabric items.
- Do not attach any accessories other than genuine Lexus parts to the back door.
- Do not place your hand on the damper stay or apply lateral forces to it.

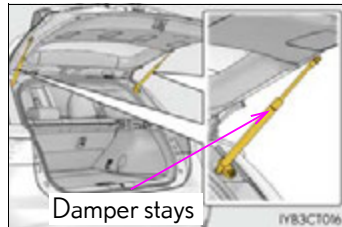

Smart access system with push-button start

The following operations can be performed simply by carrying the electronic key (including the card key) on your person, for example in your pocket. The driver should always carry the electronic key.

- Locks and unlocks the doors (→P. 105)
- Locks and unlocks the back door (→P. 110)
- Starts and stops the hybrid system (→P. 156)

■ Antenna location

- ① Antennas outside the cabin
- ② Antennas inside the cabin
- ③ Antenna inside the luggage compartment
- ④ Antenna outside the luggage compartment

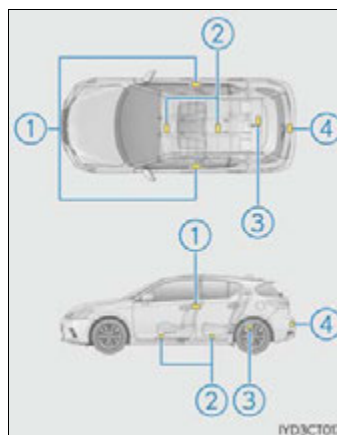

■ Effective range (areas within which the electronic key is detected)

- When locking or unlocking the doors
The system can be operated when the electronic key is within about 2.3 ft. (0.7 m) of either of the outside front door handles or back door opener switch. (Only the doors detecting the key can be operated.)

- When starting the hybrid system or changing power switch modes

The system can be operated when the electronic key is inside the vehicle.

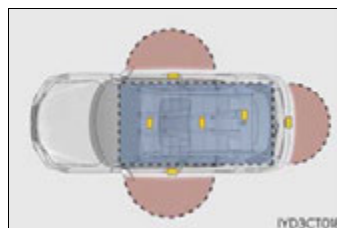

■ Alarms and warning messages

An alarm sounds and warning message displays shown on the multi-information display are used to protect against unexpected accidents or theft of the vehicle resulting from erroneous operation. When a warning message is displayed, take appropriate measures based on the displayed message. (→P. 536)

When only an alarm sounds, circumstances and correction procedures are as follows.

| Alarm | Situation | Correction procedure |
|--|--|--|
| Exterior alarm sounds once for 5 seconds | An attempt was made to lock the vehicle while a door was open. | Close all of the doors and lock the doors again. |
| Interior alarm pings repeatedly | The power switch was turned to ACCESSORY mode while the driver's door was open (The driver's door was opened when the power switch was in ACCESSORY mode). | Turn the power switch off and close the driver's door. |

■ Battery-saving function

The battery-saving function will be activated in order to prevent the electronic key battery and the 12-volt battery from being discharged while the vehicle is not in operation for a long time.

- In the following situations, the smart access system with push-button start may take some time to unlock the doors.
 - The electronic key has been left in an area of approximately 6 ft. (2 m) of the outside of the vehicle for 10 minutes or longer.
 - The smart access system with push-button start has not been used for 5 days or longer.
- If the smart access system with push-button start has not been used for 14 days or longer, the doors cannot be unlocked at any doors except the driver's door. In this case, take hold of the driver's door handle, or use the wireless remote control or the mechanical key, to unlock the doors.

■ Conditions affecting operation

The smart access system with push-button start, wireless remote control and immobilizer system use weak radio waves. In the following situations, the communication between the electronic key and the vehicle may be affected, preventing the smart access system with push-button start, wireless remote control and immobilizer system from operating properly. (Ways of coping: →P. 560)

- When the electronic key battery is depleted
- Near a TV tower, electric power plant, gas station, radio station, large display, airport or other facility that generates strong radio waves or electrical noise
- When carrying a portable radio, cellular phone, cordless phone or other wireless communication devices

- When the electronic key is in contact with, or is covered by the following metallic objects
 - Cards to which aluminum foil is attached
 - Cigarette boxes that have aluminum foil inside
 - Metallic wallets or bags
 - Coins
 - Hand warmers made of metal
 - Media such as CDs and DVDs
- When other wireless key (that emit radio waves) is being used nearby
- When carrying the electronic key together with the following devices that emit radio waves
 - Another vehicle's electronic key or a wireless key that emits radio waves
 - Personal computers or personal digital assistants (PDAs)
 - Digital audio players
 - Portable game systems
- If window tint with a metallic content or metallic objects are attached to the rear window

■ **Note for the entry function**

- Even when the electronic key is within the effective range (detection areas), the system may not operate properly in the following cases:
 - The electronic key is too close to the window or outside door handle, near the ground, or in a high place when the doors are locked or unlocked.
 - The electronic key is near the ground or in a high place, or too close to the rear bumper center when the back door is opened.
 - The electronic key is on the instrument panel, luggage room, floor, or in the door pockets or glove box when the hybrid system is started or power switch modes are changed.
- Do not leave the electronic key on top of the instrument panel or near the door pockets when exiting the vehicle. Depending on the radio wave reception conditions, it may be detected by the antenna outside the cabin and the door will become lockable from the outside, possibly trapping the electronic key inside the vehicle.
- As long as the electronic key is within the effective range, the doors may be locked or unlocked by anyone.
- Even if the electronic key is not inside the vehicle, it may be possible to start the hybrid system if the electronic key is near the window.
- The doors may unlock if a large amount of water splashes on the door handle, such as in the rain or in a car wash when the electronic key is within the effective range. (The door will automatically be locked after approximately 60 seconds if the doors are not opened and closed.)
- If the wireless remote control is used to lock the doors when the electronic key is near the vehicle, there is a possibility that the door may not be unlocked by the entry function. (Use the wireless remote control to unlock the doors.)
- Touching the door lock sensor while wearing gloves may delay or prevent lock operation. Remove the gloves and touch the lock sensor again.
- When the lock operation is performed using the lock sensor, recognition signals will be shown up to two consecutive times. After this, no recognition signals will be given.
- If the door handle becomes wet while the electronic key is within the effective range, the door may lock and unlock repeatedly. Place the key in a position 6 ft. (2 m) or more separate from the vehicle while the vehicle is being washed. (Take care to ensure that the key is not stolen.)

- If the electronic key is inside the vehicle and a door handle becomes wet during a car wash, a message may be shown on the multi-information display and a buzzer will sound outside the vehicle. To turn off the alarm, lock all the doors.
 - The lock sensor may not work properly if it comes into contact with ice, snow, mud, etc. Clean the lock sensor and attempt to operate it again, or use the lock sensor on the lower part of the door handle.
 - A sudden approach to the effective range of door handle may prevent the doors from being unlocked. In this case, return the door handle to the original position and check that the doors unlock before pulling the door handle again.
 - If there is another electronic key in the detection area, it may take slightly longer to unlock the doors after the door handle is gripped.
 - Fingernails may scrape against the door during operation of the door handle. Be careful not to injure fingernails or damage the surface of the door.
- **When the vehicle is not driven for extended periods**
- To prevent theft of the vehicle, do not leave the electronic key within 6 ft. (2 m) of the vehicle.
 - The smart access system with push-button start can be deactivated in advance. (→P. 591)
- **To operate the system properly**
- Make sure to carry the electronic key when operating the system. Do not get the electronic key too close to the vehicle when operating the system from the outside of the vehicle.
- Depending on the position and holding condition of the electronic key, the key may not be detected correctly and the system may not operate properly. (The alarm may go off accidentally, or the door lock prevention may not operate.)
- **If the smart access system with push-button start does not operate properly**
- Locking and unlocking the doors: Use the mechanical key. (→P. 560)
 - Starting the hybrid system: →P. 561
- **Customization**
- Settings (e.g. smart access system with push-button start) can be changed. (Customizable features: →P. 591)
- **If the smart access system with push-button start has been deactivated in a customized setting**
- Locking and unlocking the doors:
Use the wireless remote control or mechanical key. (→P. 105, 560)
 - Starting the hybrid system and changing power switch modes: →P. 561
 - Stopping the hybrid system: →P. 157

■ Certification for the smart access system with push-button start

- ▶ For vehicles sold in the U.S.A., Hawaii, Guam, Puerto Rico and NATO Germany

| |
|--|
| FCC ID: HYQ13CZD FCC ID: HYQ14ACX FCC ID: HYQ14AEB |
|--|

| |
|---|
| FCC ID: HYQ13CZE* FCC ID: HYQ14ADF* FCC ID: HYQ14AEF* |
|---|

*: For U.S. mainland and NATO Germany only

NOTE:

This device complies with part 15 of the FCC Rules. Operation is subject to the following two conditions: (1) This device may not cause harmful interference, and (2) this device must accept any interference received, including interference that may cause undesired operation.

FCC WARNING:

Changes or modifications not expressly approved by the party responsible for compliance could void the user's authority to operate the equipment.

FCC ID: NI4TMLF8-24

This device complies with part 15 of the FCC Rules. Operation is subject to the following two conditions: (1) This device may not cause harmful interference, and (2) this device must accept any interference received, including interference that may cause undesired operation.

Changes or modifications not expressly approved by the party responsible for compliance could void the user's authority to operate the equipment.

- ▶ For vehicles sold in Canada

NOTE:

This device complies with Industry Canada's licence-exempt RSSs.

Operation is subject to the following two conditions:

- (1) This device may not cause interference; and
- (2) This device must accept any interference, including interference that may cause undesired operation of the device.

NOTE:

Le présent appareil est conforme aux CNR d'Industrie Canada applicables aux appareils radio exempts de licence. L'exploitation est autorisée aux deux conditions suivantes:

- (1) l'appareil ne doit pas produire de brouillage;
- (2) l'utilisateur de l'appareil doit accepter tout brouillage radioélectrique subi, même si le brouillage est susceptible d'en compromettre le fonctionnement.

This device complies with Industry Canada licence-exempt RSS standard(s). Operation is subject to the following two conditions: (1) this device may not cause interference, and (2) this device must accept any interference, including interference that may cause undesired operation of the device.

Le présent appareil est conforme aux CNR d'Industrie Canada applicables aux appareils radio exempts de licence. L'exploitation est autorisée aux deux conditions suivantes : (1) l'appareil ne doit pas produire de brouillage, et (2) l'appareil doit accepter tout brouillage radioélectrique subi, même si le brouillage est susceptible d'en compromettre le fonctionnement.

 **WARNING**

■ **Caution regarding interference with electronic devices**

- People with implantable cardiac pacemakers, cardiac resynchronization therapy-pacemakers or implantable cardioverter defibrillators should keep away from the smart access system antennas. (→P. 114)

The radio waves may affect the operation of such devices. If necessary, the entry function can be disabled. Ask your Lexus dealer for details, such as the frequency of radio waves and timing of the emitted radio waves. Then, consult your doctor to see if you should disable the entry function.

- Users of any electrical medical device other than implantable cardiac pacemakers, cardiac resynchronization therapy-pacemakers or implantable cardioverter defibrillators should consult the manufacturer of the device for information about its operation under the influence of radio waves.

Radio waves could have unexpected effects on the operation of such medical devices.

Ask your Lexus dealer for details on disabling the entry function.

Front seats

Adjustment procedure

► Power seat

- ① Seat position adjustment switch
- ② Seat cushion (front) angle adjustment switch (for driver's side)
- ③ Vertical height adjustment switch (for driver's side)
- ④ Seatback angle adjustment switch
- ⑤ Lumbar support adjustment switch (for driver's side)

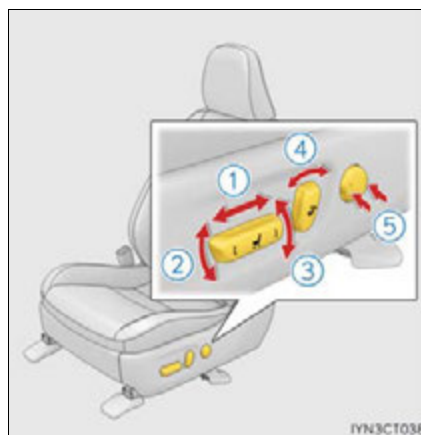

► Manual seat

- ① Seat position adjustment lever
- ② Seatback angle adjustment lever



 **WARNING****■ When adjusting the seat position**

- Take care when adjusting the seat position to ensure that other passengers are not injured by the moving seat.
- Do not put your hands under the seat or near the moving parts to avoid injury. Fingers or hands may become jammed in the seat mechanism.

■ Seat adjustment

- To reduce the risk of sliding under the lap belt during a collision, do not recline the seat more than necessary.
If the seat is too reclined, the lap belt may slide past the hips and apply restraint forces directly to the abdomen, or your neck may contact the shoulder belt, increasing the risk of death or serious injury in the event of an accident.
Adjustments should not be made while driving as the seat may unexpectedly move and cause the driver to lose control of the vehicle.
- After adjusting the seat, make sure that the seat is locked in position. (manual seat)

Rear seats

The seatbacks of the rear seats can be folded down.

Folding down the rear seatbacks

Pull up the seatback lock release lever until the lock is released, and fold the seatback down.



Returning the rear seatbacks

To avoid trapping the seat belt between the seat and the inside of the vehicle, pass the seat belt inside the seat belt guide and then return the seatback securely to the locked position.

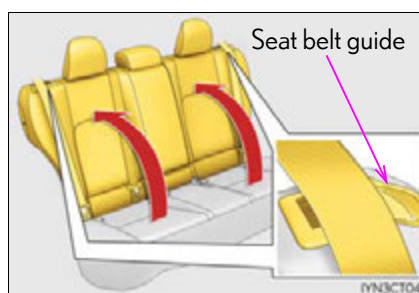

⚠ WARNING**■ When folding the rear seatbacks down**

Observe the following precautions. Failure to do so may result in death or serious injury.

- Do not fold the seatbacks down while driving.
- Stop the vehicle on level ground, set the parking brake and shift the shift position to P.
- Do not allow anyone to sit on a folded seatback or in the luggage compartment while driving.
- Do not allow children to enter the luggage compartment.

■ When returning the rear seatback to the upright position

Do not put your hand on the seat belt guide.

Doing so may cause you to trap your hand between the guide and the pillar, causing an injury.

■ After returning the rear seatback to the upright position

Observe the following precautions. Failure to do so may result in death or serious injury.

- Make sure that the seatback is securely locked in position by lightly pushing it back and forth.
If the seatback is not securely locked, the red marking will be visible behind the seatback lock release lever. Make sure that the red marking is not visible.

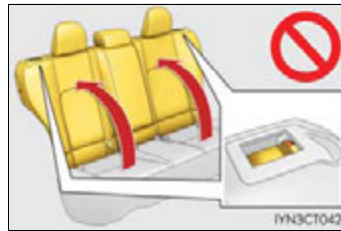

- Check that the seat belts are not twisted or caught in the seatback.

Driving position memory*

This feature automatically adjusts the driver's seat and outside rear view mirrors to suit your preferences.

Driving position memory

Your preferred driving position (the position of the driver's seat and outside rear view mirrors) can be recorded and recalled by pressing a button.

Three different driving positions can be recorded into memory.

■ Recording procedure

- 1 Turn the power switch to ON mode.
- 2 Check that the shift position is in P.
- 3 Adjust the driver's seat and outside rear view mirrors to the desired positions.
- 4 While pressing the "SET" button, or within 3 seconds after the "SET" button is pressed, press button "1", "2" or "3" until the buzzer sounds.

If the selected button has already been preset, the previously recorded position will be overwritten.

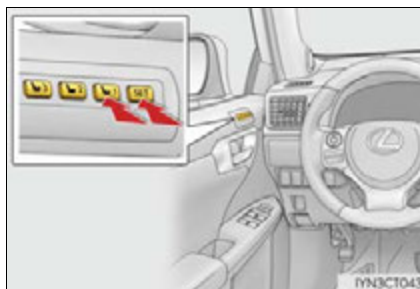

■ Recall procedure

- 1 Turn the power switch to ON mode.
- 2 Check that the shift position is in P.
- 3 Press one of the buttons for the driving position you want to recall until the buzzer sounds.

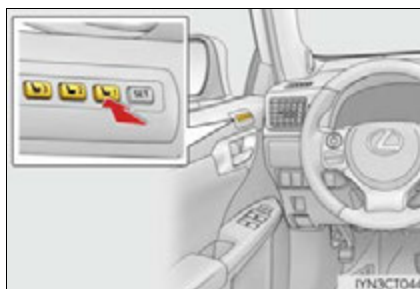

*: If equipped

■ To stop the position recall operation part-way through

Perform any of the following:

- Press the "SET" button.
- Press button "1", "2" or "3".
- Operate any of the seat adjustment switches (only cancels seat position recall).

■ Seat positions that can be memorized (→P. 120)

The adjusted positions other than the position adjusted by lumbar support switch can be recorded.

■ Operating the driving position memory after turning the power switch off

Recorded seat positions can be activated up to 180 seconds after the driver's door is opened and another 60 seconds after it is closed again.

■ In order to correctly use the driving position memory function

If a seat position is already in the furthest possible position and the seat is operated in the same direction, the recorded position may be slightly different when it is recalled.

Memory recall function

Each electronic key (including a card key) can be registered to recall your preferred driving position.

■ Registering procedure

Record your driving position to button "1", "2" or "3" before performing the following:

Carry only the key you want to register, and then close the driver's door.

If 2 or more keys are in the vehicle, the driving position cannot be recorded properly.

- 1 Turn the power switch to ON mode.
- 2 Check that the shift position is in P.
- 3 Recall the driving position that you want to record.
- 4 While pressing the recalled button, press and hold the door lock switch (either lock or unlock) until the buzzer sounds.

If the button could not be registered, the buzzer sounds continuously for approximately 3 seconds.

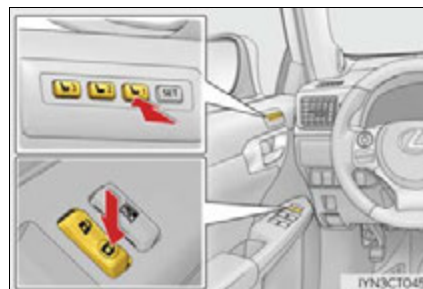

■ **Recall procedure**

Carry the electronic key that has been registered to the driving position, and then unlock and open the driver's door using the smart access system with push-button start or wireless remote control.

The driving position will move to the recorded position.

If the driving position is in a position that has already been recorded, the seat and outside rear view mirrors will not move.

■ **Cancellation procedure**

Carry only the key you want to cancel and then close the driver's door.

If 2 or more keys are in the vehicle, the driving position cannot be canceled properly.

- 1 Turn the power switch to ON mode.
- 2 While pressing the "SET" button, press and hold the door lock switch (either lock or unlock) until the buzzer sounds twice.

If the button could not be canceled, the buzzer sounds continuously for approximately 3 seconds.

■ **Recalling the driving position using the memory recall function**

- Different driving positions can be registered for each electronic key. Therefore, the driving position that is recalled may be different depending on the key being carried.
- If a door other than the driver's door is unlocked with the smart access system with push-button start, the driving position cannot be recalled. In this case, press the driving position button which has been set.

 **WARNING**

■ **Seat adjustment caution**

Take care during seat adjustment so that the seat does not strike the rear passenger or squeeze your body against the steering wheel.

Head restraints

Head restraints are provided for all seats.

Front seats

- ① Up
Pull the head restraints up.
- ② Down
Push the head restraint down while pressing the lock release button.



Center rear seat

- ① Up
Pull the head restraints up.
- ② Down
Push the head restraint down while pressing the lock release button.

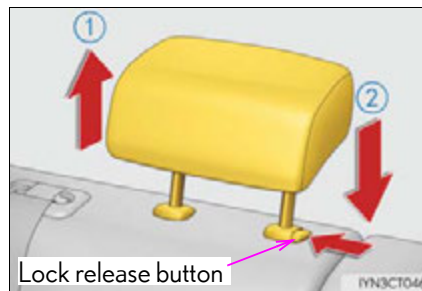

Outboard rear seats

- ① To fold
Pull up the head restraint while pressing the lock release button.
- ② To use
Lift up and push down the head restraint to the lowest lock position.

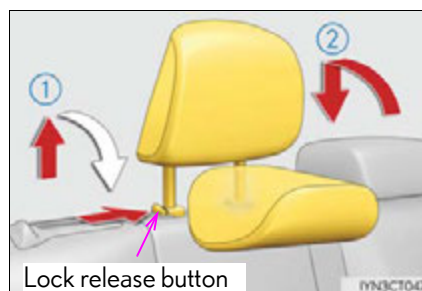

3

Operation of each component

■ Removing the head restraints

- ▶ Front and center rear seats

Pull the head restraint up while pressing the lock release button.

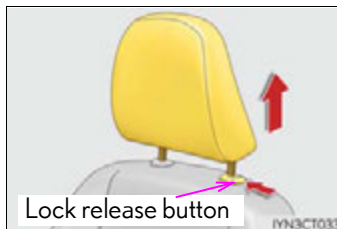

- ▶ Outboard rear seats

Pull the head restraint up while pressing the lock release buttons.

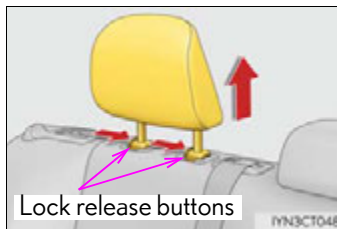

■ Installing the head restraints

- ▶ Front and center rear seats

Align the head restraint with the installation holes and push it down to the lock position.

Press and hold the lock release button when lowering the head restraint.

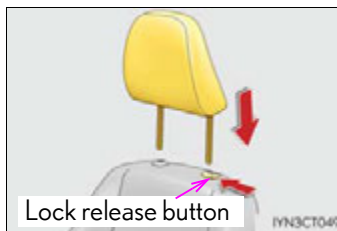

- ▶ Outboard rear seats

Align the head restraint with the installation holes and push it down to the lowest lock position.

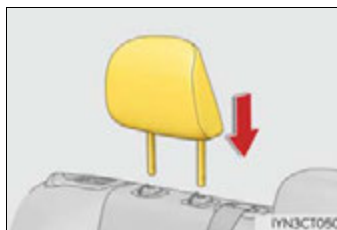

■ Adjusting the height of the head restraints (front seats)

Make sure that the head restraints are adjusted so that the center of the head restraint is closest to the top of your ears.

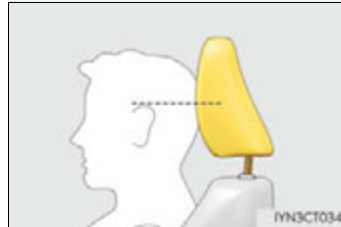
**■ Adjusting the center rear seat head restraint**

Always raise the head restraint one level from the stowed position when using.

⚠ WARNING**■ Head restraint precautions**

Observe the following precautions regarding the head restraints. Failure to do so may result in death or serious injury.

- Use the head restraints designed for each respective seat.
- Adjust the head restraints to the correct position at all times.
- After adjusting the head restraints, push down on them and make sure they are locked in position.
- Do not drive with the head restraints removed.

Steering wheel

Adjustment procedure

- 1 Hold the steering wheel and push the lever down.



- 2 Adjust to the ideal position by moving the steering wheel horizontally and vertically.
After adjustment, pull the lever up to secure the steering wheel.



Horn

To sound the horn, press on or close to the  mark.

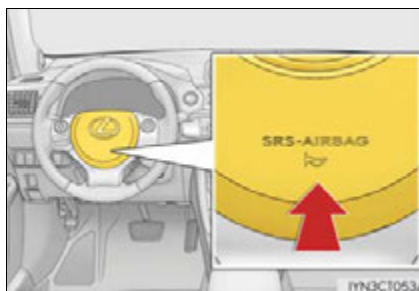

■ After adjusting the steering wheel

Make sure that the steering wheel is securely locked.
The horn may not sound if the steering wheel is not securely locked.

 **WARNING****■ While driving**

Do not adjust the steering wheel while driving. Doing so may cause the driver to mishandle the vehicle and cause an accident, resulting in death or serious injury.

■ After adjusting the steering wheel

Make sure that the steering wheel is securely locked. Otherwise, the steering wheel may move suddenly, possibly causing an accident, and resulting in death or serious injury.

Inside rear view mirror

The rear view mirror's position can be adjusted to enable sufficient confirmation of the rear view.

Adjusting the height of rear view mirror

The height of the rear view mirror can be adjusted to suit your driving posture.

Adjust the height of the rear view mirror by moving it up and down.

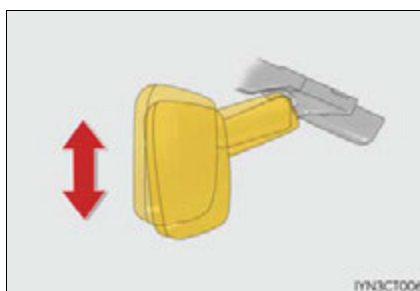

Anti-glare function

- ▶ Manual anti-glare inside rear view mirror

Reflected light from the headlights of vehicles behind can be reduced by operating the lever.

- ① Normal position
- ② Anti-glare position

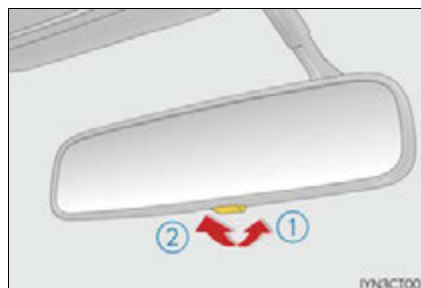

▶ Auto anti-glare inside rear view mirror (type A)

Responding to the level of brightness of the headlights of vehicles behind, the reflected light is automatically reduced.

Changing automatic anti-glare function mode

On/off

When the automatic anti-glare function is in ON mode, the indicator illuminates. The function will set to ON mode each time the power switch is turned to ON mode.

Pressing the button turns the function to OFF mode. (The indicator also turns off.)

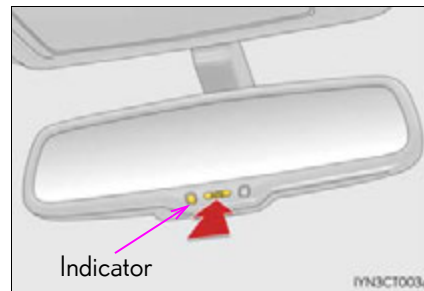

▶ Auto anti-glare inside rear view mirror (type B)

Responding to the level of brightness of the headlights of vehicles behind, the reflected light is automatically reduced.

Changing automatic anti-glare function mode

On/off

When the automatic anti-glare function is in ON mode, the indicator illuminates. The function will set to ON mode each time the power switch is turned to ON mode.

Pressing the button turns the function to OFF mode. (The indicator also turns off.)

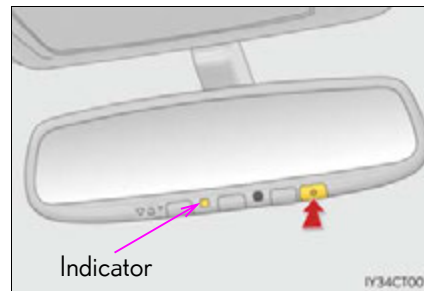

■ To prevent sensor error (vehicles with auto anti-glare inside rear view mirror)

To ensure that the sensors operate properly, do not touch or cover them.

▶ Type A



▶ Type B

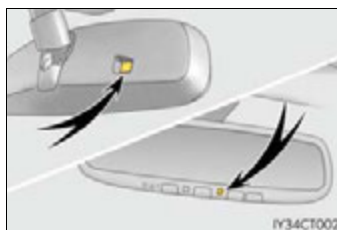

⚠ WARNING

Do not adjust the position of the mirror while driving. Doing so may lead to mishandling of the vehicle and cause an accident, resulting in death or serious injury.

Outside rear view mirrors

Adjustment procedure

1 To select a mirror to adjust, press the switch.

- ① Left
- ② Right



2 To adjust the mirror, press the switch.

- ① Up
- ② Right
- ③ Down
- ④ Left

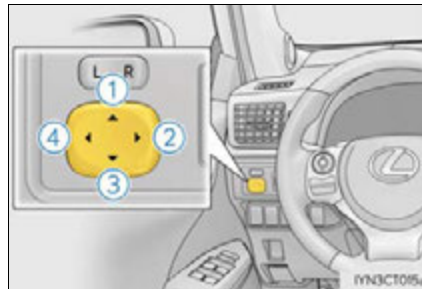

Folding the mirrors

Push the mirror back in the direction of the vehicle's rear.

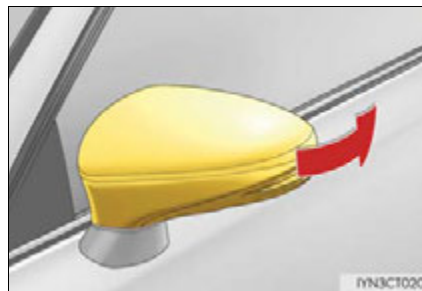

Linked mirror function when reversing (vehicles with driving position memory)

When the mirror select switch is in the "L" or "R" position, the outside rear view mirrors will automatically angle downwards when the vehicle is reversing in order to give a better view of the ground.

To disable this function, move the mirror select switch to the neutral position (between "L" and "R").

3

Operation of each component

■ **Mirror angle can be adjusted when**

The power switch is in ACCESSORY or ON mode.

■ **When the mirrors are fogged up**

The outside rear view mirrors can be cleared using the mirror defoggers. Turn on the rear window defogger to turn on the outside rear view mirror defoggers. (→P. 414, 420)

■ **Automatic adjustment of the mirror angle (vehicles with driving position memory)**

A desired mirror face angle can be entered to memory and recalled automatically by the driving position memory. (→P. 124)

■ **Auto anti-glare function (if equipped)**

When the anti-glare inside rear view mirror is set to automatic mode, the outside rear view mirrors will activate in conjunction with the anti-glare inside rear view mirror to reduce reflected light. (→P. 132)



WARNING

■ **Important points while driving**

Observe the following precautions while driving. Failing to do so may result in loss of control of the vehicle and cause an accident, resulting in death or serious injury.

- Do not adjust the mirrors while driving.
- Do not drive with the mirrors folded.
- Both the driver and passenger side mirrors must be extended and properly adjusted before driving.

■ **When a mirror is moving**

To avoid personal injury and mirror malfunction, be careful not to get your hand caught by the moving mirror.

■ **When the mirror defoggers are operating**

Do not touch the rear view mirror surfaces, as they can become very hot and burn you.

Power windows

Opening and closing procedures

The power windows can be opened and closed using the switches.

Operating the switch moves the windows as follows:

- ① Closing
- ② One-touch closing*
- ③ Opening
- ④ One-touch opening*

*: To stop the window partway, operate the switch in the opposite direction.

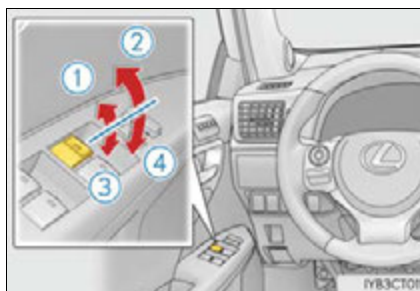

Window lock switch

Press the switch down to lock the passenger window.

Use this switch to prevent children from accidentally opening or closing a passenger window.

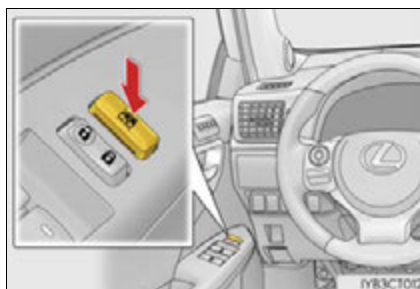

3

Operation of each component

■ The power windows can be operated when

The power switch is in ON mode.

■ Operating the power windows after turning the hybrid system off

The power windows can be operated for approximately 45 seconds even after the power switch is turned to ACCESSORY mode or turned off. They cannot, however, be operated once either front door is opened.

■ Up jam protection function

If an object becomes caught between the window and the window frame, window travel is stopped and the window is opened slightly.

■ Down jam protection function

When the side window is opening, if a foreign object malfunction within the door causes it to be clamped, the operation stops.

■ When opening and closing the window cannot be done

When the up or down jam protection function operates unusually or the door window can not be fully opened and closed, perform the following operations with the power window switch of that door.

- Stop the vehicle, with the power switch in ON mode, continually operate the power window switch in the one-touch closing position within 4 seconds after the up jam or down jam protection function was activated. Otherwise, by continually operating the power window switch in the one-touch opening position, the door window can be opened and closed.

- If the door window cannot be opened and closed even when performing the above operations, implement the following procedure for function initialization.

- 1 Turn the power switch to ON mode.
- 2 Pull and hold the power window switch in the one-touch closing position and completely close the door window.
- 3 Release the power window switch for a moment and then resume pulling and holding the switch in the one-touch closing position for approximately 4 seconds.
- 4 Press and hold the power window switch in the one-touch opening position and after the door window is completely opened, continue holding the switch for a further 1 second or more.
- 5 Pull and hold the power window switch in the one-touch closing position, once more, and after the door window is completely closed, continue holding the switch for a further 1 second or more.

If you release the switch while the window is moving, start again from the beginning.

If the window reverses and can not be closed or completely open, have the vehicle inspected by your Lexus dealer.

■ Door lock linked window operation

- The power windows can be opened and closed using the mechanical key.* (→P. 560)
- The power windows can be opened using the wireless remote control.* (→P. 105)

*: These settings must be customized at your Lexus dealer.

■ Customization

Setting (e.g. linked door lock operation) can be changed.
(Customizable features: →P. 591)

 **WARNING**

Observe the following precautions.
Failing to do so may result in death or serious injury.

■ Closing the windows

- The driver is responsible for all the power window operations, including the operation for the passengers. In order to prevent accidental operation, especially by a child, do not let a child operate the power windows. It is possible for children and other passengers to have body parts caught in the power window. Also, when riding with a child, it is recommended to use the window lock switch. (→P. 137)
- Check to make sure that all passengers do not have any part of their body in a position where it could be caught when a window is being operated.
- When using the wireless remote control or mechanical key and operating the power windows, operate the power window after checking to make sure that there is no possibility of any passenger having any of their body parts caught in the window. Also do not let a child operate window by the wireless remote control or mechanical key. It is possible for children and other passengers to get caught in the power window.
- When exiting the vehicle, turn the power switch off, and take the key with you. Do not leave children unattended in the vehicle. There may be accidental operation, due to mischief, etc., that may possibly lead to an accident.

■ Up jam protection function

- Never use any part of your body to intentionally activate the up jam protection function.
- The up jam protection function may not work if something gets caught just before the window fully closes.

■ Down jam protection function

- Never allow passengers to use hands, arms, cloths, etc., to intentionally activate the down jam protection function.
- The down jam protection function may not work if a foreign object gets caught just before the side window completely opens. Be careful not to get hands, arms, clothes, etc., caught in the window.

Moon roof*

Use the overhead switches to open and close the moon roof and tilt it up and down.

Opening and closing

- ① Opens the moon roof*
Push and hold "OPEN" for more than 1 second. The moon roof tilts up and then opens automatically.
- ② Closes the moon roof*
Push and hold "CLOSE" for more than 1 second. The moon roof closes automatically and stops slightly before the tilt up position.
Push and hold "CLOSE" again to fully close the moon roof.



*: Lightly press either end of the moon roof switch to stop the moon roof partway.

Tilting up and down

- ① Tilts the moon roof up*
 - ② Tilts the moon roof down*
- *: Lightly press either end of the moon roof switch to stop the moon roof partway.

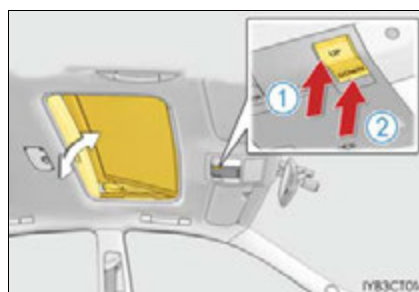

■ The moon roof can be operated when

The power switch is in ON mode.

■ Operating the moon roof after turning the hybrid system off

The moon roof can be operated for approximately 45 seconds even after the power switch is turned to ACCESSORY mode or turned off. It cannot, however, be operated once either front door is opened.

*: If equipped

■ Jam protection function

If an object is detected between the moon roof and the frame while the moon roof is closing or tilting down, travel is stopped and the moon roof opens slightly.

■ Sunshade

The sunshade can be opened and closed manually. However, the sunshade will open automatically to slightly before the fully open position when the moon roof is opened.

■ When the moon roof does not close normally

Perform the following procedure:

- If the moon roof closes but then re-opens slightly

- 1 Stop the vehicle.
- 2 Press and hold the "CLOSE" switch.*1
The moon roof will close, reopen and pause for approximately 10 seconds.*2 Then it will close again and tilt down. Finally it will be adjusted slightly and then stop.
- 3 Check to make sure that the moon roof completely stops and then release the switch.

- If the moon roof tilts down but then tilts back up

- 1 Stop the vehicle.
- 2 Press and hold the "DOWN" switch.*1
The moon roof will close, reopen and pause for approximately 10 seconds in the tilt up position.*2 Then it will close again and tilt down. Finally it will be adjusted slightly and then stop.
- 3 Check to make sure that the moon roof has completely stopped and then release the switch.

*1: If the switch is released at the incorrect time, the procedure will have to be performed again from the beginning.

*2: If the switch is released after the above mentioned 10 second pause, automatic operation will be disabled. In that case, press and hold the "CLOSE" or "DOWN" switch, and the moon roof will close, be adjusted slightly and then stop. Check to make sure that the moon roof has completely stopped and then release the switch.

If the moon roof does not fully close even after performing the above procedure correctly, have the vehicle inspected by your Lexus dealer.

■ Moon roof open warning buzzer

The buzzer sounds and a message is shown on the multi-information display in the instrument cluster when the power switch is turned off and the driver's door is opened with the moon roof open.

 **WARNING**

Observe the following precautions.
Failing to do so may cause death or serious injury.

■ Opening the moon roof

- Do not allow any passengers to put their hands or heads outside the vehicle while it is moving.
- Do not sit on top of the moon roof.

■ Closing the moon roof

- The driver is responsible for moon roof opening and closing operations. In order to prevent accidental operation, especially by a child, do not let a child operate the moon roof. It is possible for children and other passengers to have body parts caught in the moon roof.
- Check to make sure that all passengers do not have any part of their body in a position where it could be caught when the moon roof is being operated.
- When exiting the vehicle, turn the power switch off, carry the key and exit the vehicle along with the child. There may be accidental operation, due to mischief, etc., that may possibly lead to an accident.

■ Jam protection function

- Never use any part of your body to intentionally activate the jam protection function.
- The jam protection function may not work if something gets caught just before the moon roof fully closes.

| | |
|---|-----|
| 4-1. Before driving | |
| Driving the vehicle..... | 144 |
| Cargo and luggage..... | 150 |
| Vehicle load limits | 153 |
| Trailer towing..... | 154 |
| Dinghy towing..... | 155 |
| 4-2. Driving procedures | |
| Power (ignition) switch..... | 156 |
| EV drive mode | 160 |
| Hybrid transmission | 162 |
| Turn signal lever | 167 |
| Parking brake..... | 168 |
| 4-3. Operating the lights and wipers | |
| Headlight switch..... | 169 |
| Fog light switch | 172 |
| Windshield wipers and washer | 174 |
| Rear window wiper and washer | 180 |
| Headlight cleaner switch..... | 182 |
| 4-4. Refueling | |
| Opening the fuel tank cap | 183 |
| 4-5. Using the driving support systems | |
| Cruise control | 186 |
| Dynamic radar cruise control | 189 |
| Intuitive parking assist | 202 |
| Rear view monitor system | 209 |
| Lexus parking assist monitor | 219 |
| Driving mode select switch | 234 |
| Driving assist systems..... | 235 |
| PCS (Pre-Collision System)..... | 239 |
| 4-6. Driving tips | |
| Hybrid vehicle driving tips | 244 |
| Winter driving tips | 246 |

Driving the vehicle

The following procedures should be observed to ensure safe driving:

Starting the hybrid system

→P. 156

Driving

- 1 With the brake pedal depressed, shift the shift position to D. (→P. 162)
Check that the shift position indicator shows D.
- 2 Release the parking brake. (→P. 168)
- 3 Gradually release the brake pedal and gently depress the accelerator pedal to accelerate the vehicle.

Stopping

- 1 With the shift position in D, depress the brake pedal.
- 2 If necessary, set the parking brake.
If the vehicle is to be stopped for an extended period of time, shift the shift position to P. (→P. 163)

Parking the vehicle

- 1 Stop the vehicle completely.
- 2 Set the parking brake. (→P. 168)
- 3 Shift the shift position to P. (→P. 163)
Check that the shift position indicator shows P.
- 4 Press the power switch to stop the hybrid system.
- 5 Slowly release the brake pedal.
- 6 Lock the door, making sure that you have the electronic key on your person.
If parking on a hill, block the wheels as needed.

Starting off on a uphill

- 1 Firmly set the parking brake with the brake pedal depressed, and then shift the shift position to D.
- 2 Release the brake pedal and gently depress the accelerator pedal.
- 3 Release the parking brake.

■ When starting off on a uphill

The hill-start assist control is available. (→P. 235)

■ For fuel-efficient driving

Keep in mind that hybrid vehicles are similar to conventional vehicles, and it is necessary to refrain from activities such as sudden acceleration, etc. Refer to "Hybrid vehicle driving tips". (→P. 244)

■ Driving in the rain or adverse weather conditions

- Drive carefully, because visibility may be reduced, the windows may become fogged-up, and the road will be slippery.
- Drive carefully when it starts to rain, because the road surface will be especially slippery.
- Slow down when water is present on the roadway, because there may be a layer of water between the tires and the road surface, preventing the steering and brakes from operating properly.

■ Breaking in your new Lexus

To extend the life of the vehicle, observing the following precautions is recommended:

- For the first 200 miles (300 km):
Avoid sudden stops.
- For the first 1000 miles (1600 km):
 - Do not drive at extremely high speeds.
 - Avoid sudden acceleration.
 - Do not drive at a constant speed for extended periods.

■ Operating your vehicle in a foreign country

Comply with the relevant vehicle registration laws and confirm the availability of the correct fuel. (→P. 573)

WARNING

Observe the following precautions.
Failure to do so may result in death or serious injury.

■ When starting the vehicle

Always keep your foot on the brake pedal while stopped with the "READY" indicator is illuminated. This prevents the vehicle from creeping.

■ When driving the vehicle

- Do not drive if you are unfamiliar with the location of the brake and accelerator pedals to avoid depressing the wrong pedal.
 - Accidentally depressing the accelerator pedal instead of the brake pedal will result in sudden acceleration that may lead to an accident.
 - When backing up, you may twist your body around, leading to a difficulty in operating the pedals. Make sure to operate the pedals properly.
 - Make sure to keep a correct driving posture even when moving the vehicle only slightly. This allows you to depress the brake and accelerator pedals properly.
 - Depress the brake pedal using your right foot. Depressing the brake pedal using your left foot may delay response in an emergency, resulting in an accident.

 **WARNING**

Observe the following precautions.
Failure to do so may result in death or serious injury.

■ When driving the vehicle

- The driver should pay extra attention to pedestrians when the vehicle is powered only by the electric motor (traction motor). As there is no engine noise, the pedestrians may misjudge the vehicle's movement.
- Do not drive the vehicle over or stop the vehicle near flammable materials.
The exhaust system and exhaust gases can be extremely hot. These hot parts may cause a fire if there is any flammable material nearby.
- During normal driving, do not turn off the hybrid system. Turning the hybrid system off while driving will not cause loss of steering or braking control, however, power assist to the steering will be lost. This will make it more difficult to steer smoothly, so you should pull over and stop the vehicle as soon as it is safe to do so.
In the event of an emergency, such as if it becomes impossible to stop the vehicle in the normal way: →P. 523
- Use engine braking (shift position B instead of shift position D) to maintain a safe speed when driving down a steep hill.
Using the brakes continuously may cause the brakes to overheat and lose effectiveness. (→P. 163)
- Do not adjust the positions of the steering wheel, the seat, or the inside or outside rear view mirrors while driving.
Doing so may result in a loss of vehicle control.
- Always check that all passengers' arms, heads or other parts of their body are not outside the vehicle.
- Do not drive in excess of the speed limit. Even if the legal speed limit permits it, do not drive over 85 mph (140 km/h) unless your vehicle has high-speed capability tires. Driving over 85 mph (140 km/h) may result in tire failure, loss of control and possible injury. Be sure to consult a tire dealer to determine whether the tires on your vehicle are high-speed capability tires or not before driving at such speeds.

■ When driving on slippery road surfaces

- Sudden braking, acceleration and steering may cause tire slippage and reduce your ability to control the vehicle.
- Sudden acceleration, engine braking due to shifting, or changes in engine speed could cause the vehicle to skid.
- After driving through a puddle, lightly depress the brake pedal to make sure that the brakes are functioning properly. Wet brake pads may prevent the brakes from functioning properly. If the brakes on only one side are wet and not functioning properly, steering control may be affected.

⚠ WARNING

Observe the following precautions.
Failure to do so may result in death or serious injury.

■ **When shifting the shift position**

- Do not let the vehicle roll backward while a forward driving position is selected, or roll forward while the shift position is in R.
Doing so may result in an accident or damage to the vehicle.
- Do not shift the shift position to P while the vehicle is moving.
Doing so can damage the transmission and may result in a loss of vehicle control.
- Do not shift the shift position to R while the vehicle is moving forward.
Doing so can damage the transmission and may result in a loss of vehicle control.
- Do not shift the shift position to a driving position while the vehicle is moving backward.
Doing so can damage the transmission and may result in a loss of vehicle control.
- Moving the shift position to N while the vehicle is moving will disengage the hybrid system. Engine braking is not available with the hybrid system disengaged.
- Be careful not to change the shift position with the accelerator pedal depressed.
Changing the shift position to any positions other than P or N may lead to unexpected rapid acceleration of the vehicle that may cause an accident and result in death or serious injury.
After changing the shift position, make sure to confirm the current shift position displayed on the shift position indicator inside the meter.

■ **If you hear a squealing or scraping noise (brake pad wear limit indicators)**

Have the brake pads checked and replaced by your Lexus dealer as soon as possible.
Rotor damage may result if the pads are not replaced when needed.
It is dangerous to drive the vehicle when the wear limits of the brake pads and/or those of the brake discs are exceeded.

■ **When the vehicle is stopped**

- Do not depress the accelerator pedal unnecessarily.
If the shift position is any position other than P or N, the vehicle may accelerate suddenly and unexpectedly, causing an accident.
- In order to prevent accidents due to the vehicle rolling away, always keep depressing the brake pedal while stopped with the "READY" indicator is illuminated, and apply the parking brake as necessary.
- If the vehicle is stopped on an incline, in order to prevent accidents caused by the vehicle rolling forward or backward, always depress the brake pedal and securely apply the parking brake as needed.
- Avoid revving or racing the engine.
Running the engine at high speed while the vehicle is stopped may cause the exhaust system to overheat, which could result in a fire if combustible material is nearby.

⚠ WARNING

Observe the following precautions.
Failure to do so may result in death or serious injury.

■ When the vehicle is parked

- Do not leave glasses, cigarette lighters, spray cans, or soft drink cans in the vehicle when it is in the sun.
Doing so may result in the following:
 - Gas may leak from a cigarette lighter or spray can, and may lead to a fire.
 - The temperature inside the vehicle may cause the plastic lenses and plastic material of glasses to deform or crack.
 - Soft drink cans may fracture, causing the contents to spray over the interior of the vehicle, and may also cause a short circuit in the vehicle's electrical components.
- Do not leave cigarette lighters in the vehicle. If a cigarette lighter is in a place such as the glove box or on the floor, it may be lit accidentally when luggage is loaded or the seat is adjusted, causing a fire.
- Do not attach adhesive discs to the windshield or windows. Do not place containers such as air fresheners on the instrument panel or dashboard. Adhesive discs or containers may act as lenses, causing a fire in the vehicle.
- Do not leave a door or window open if the curved glass is coated with a metallized film such as a silver-colored one. Reflected sunlight may cause the glass to act as a lens, causing a fire.
- Always apply the parking brake, shift the shift position to P, stop the hybrid system and lock the vehicle.
Do not leave the vehicle unattended while the "READY" indicator is illuminated.
- Do not touch the exhaust pipe while the "READY" indicator is illuminated or immediately after turning the hybrid system off.
Doing so may cause burns.

■ When taking a nap in the vehicle

Always turn the hybrid system off. Otherwise, if you accidentally move the shift lever or depress the accelerator pedal, this could cause an accident or fire due to hybrid system overheating. Additionally, if the vehicle is parked in a poorly ventilated area, exhaust gases may collect and enter the vehicle, leading to death or a serious health hazard.

■ When braking

- When the brakes are wet, drive more cautiously.
Braking distance increases when the brakes are wet, and this may cause one side of the vehicle to brake differently than the other side. Also, the parking brake may not securely hold the vehicle.
- If the electronically controlled assist function does not operate, do not follow other vehicles closely and avoid downhill or sharp turns that require braking.
In this case, braking is still possible, but the brake pedal should be depressed more firmly than usual. Also, the braking distance will increase. Have your brakes fixed immediately.
- The brake system consists of 2 or more individual hydraulic systems; if one of the systems fails, the other(s) will still operate. In this case, the brake pedal should be depressed more firmly than usual and the braking distance will increase. Have your brakes fixed immediately.

 NOTICE

■ When driving the vehicle

- Do not depress the accelerator and brake pedals at the same time during driving, as this may restrain driving torque.
- Do not use the accelerator pedal or depress the accelerator and brake pedals at the same time to hold the vehicle on a hill.

■ When parking the vehicle

Always shift the shift position to P. Failure to do so may cause the vehicle to move or the vehicle may accelerate suddenly if the accelerator pedal is accidentally depressed.

■ Avoiding damage to vehicle parts

- Do not turn the steering wheel fully in either direction and hold it there for an extended period of time.
Doing so may damage the power steering motor.
- When driving over bumps in the road, drive as slowly as possible to avoid damaging the wheels, underside of the vehicle, etc.

■ If you get a flat tire while driving

A flat or damaged tire may cause the following situations. Hold the steering wheel firmly and gradually depress the brake pedal to slow down the vehicle.

- It may be difficult to control your vehicle.
- The vehicle will make abnormal sounds or vibrations.
- The vehicle will lean abnormally.

Information on what to do in case of a flat tire (→P. 549)

■ When encountering flooded roads

Do not drive on a road that has flooded after heavy rain etc. Doing so may cause the following serious damage to the vehicle:

- Engine stalling
- Short in electrical components
- Engine damage caused by water immersion

In the event that you drive on a flooded road and the vehicle is flooded, be sure to have your Lexus dealer check the following:

- Brake function
- Changes in quantity and quality of oil and fluid used for the engine, transmission, etc.
- Lubricant condition for the bearings and suspension joints (where possible), and the function of all joints, bearings, etc.

If the shift control system is damaged by flooding, it may not be possible to shift the shift position to P, or from P to other positions. When the shift position cannot be changed from P to any other position, the front wheels will lock, and you will be unable to tow the vehicle with the front wheels on the ground, as the front wheels may be locked. In this case, transport the vehicle with both front wheels or all four wheels lifted.

Cargo and luggage

Take notice of the following information about storage precautions, cargo capacity and load.

Capacity and distribution

Cargo capacity depends on the total weight of the occupants.

(Cargo capacity) = (Total load capacity) – (Total weight of occupants)

Steps for Determining Correct Load Limit—

- (1) Locate the statement “The combined weight of occupants and cargo should never exceed XXX kg or XXX lbs.” on your vehicle’s placard.
- (2) Determine the combined weight of the driver and passengers that will be riding in your vehicle.
- (3) Subtract the combined weight of the driver and passengers from XXX kg or XXX lbs.
- (4) The resulting figure equals the available amount of cargo and luggage load capacity.
For example, if the “XXX” amount equals 1400 lbs. and there will be five 150 lb passengers in your vehicle, the amount of available cargo and luggage load capacity is 650 lbs. $(1400 - 750 (5 \times 150) = 650 \text{ lbs.})$
- (5) Determine the combined weight of luggage and cargo being loaded on the vehicle. That weight may not safely exceed the available cargo and luggage load capacity calculated in Step 4.
- (6) If your vehicle will be towing a trailer, load from your trailer will be transferred to your vehicle. Consult this manual to determine how this reduces the available cargo and luggage load capacity of your vehicle. (→P. 153)

Lexus does not recommend towing a trailer with your vehicle. Your vehicle is not designed for trailer towing.

Calculation formula for your vehicle

- ① Cargo capacity
- ② Total load capacity (vehicle capacity weight) (→P. 572)

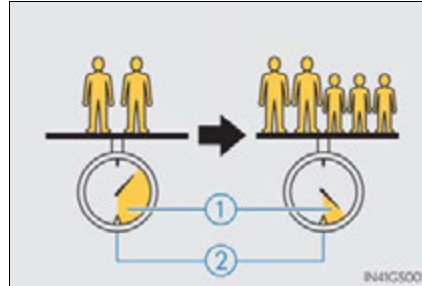

When 2 people with the combined weight of A lb. (kg) are riding in your vehicle, which has a total load capacity (vehicle capacity weight) of B lb. (kg), the available amount of cargo and luggage load capacity will be C lb. (kg) as follows:

$$B^{*2} \text{ lb. (kg)} - A^{*1} \text{ lb. (kg)} = C^{*3} \text{ lb. (kg)}$$

*1: A = Weight of people

*2: B = Total load capacity

*3: C = Available cargo and luggage load

In this condition, if 3 more passengers with the combined weight of D lb. (kg) get on, the available cargo and luggage load will be reduced E lb. (kg) as follows:

$$C \text{ lb. (kg)} - D^{*4} \text{ lb. (kg)} = E^{*5} \text{ lb. (kg)}$$

*4: D = Additional weight of people

*5: E = Available cargo and luggage load

As shown in the example above, if the number of occupants increases, the cargo and luggage load will be reduced by an amount that equals the increased weight due to the additional occupants. In other words, if an increase in the number of occupants causes an excess of the total load capacity (combined weight of occupants plus cargo and luggage load), you must reduce the cargo and luggage on your vehicle.

 **WARNING****■ Things that must not be carried in the luggage compartment**

The following things may cause a fire if loaded in the luggage compartment:

- Receptacles containing gasoline
- Aerosol cans

■ Storage precautions

Observe the following precautions.

Failure to do so may prevent the pedals from being depressed properly, may block the driver's vision, or may result in items hitting the driver or passengers, possibly causing an accident.

- Stow cargo and luggage in the luggage compartment whenever possible.
- Do not stack cargo and luggage in the luggage compartment higher than the seat-backs.
- When you fold down the rear seats, long items should not be placed directly behind the front seats.
- Never allow anyone to ride in the luggage compartment. It is not designed for passengers. They should ride in their seats with their seat belts properly fastened.
- Do not place cargo or luggage in or on the following locations.
 - At the feet of the driver
 - On the front passenger or rear seats (when stacking items)
 - On the luggage cover
 - On the instrument panel
 - On the dashboard
- Secure all items in the occupant compartment.

■ Capacity and distribution

- Do not exceed the maximum axle weight rating or the total vehicle weight rating.
- Even if the total load of occupant's weight and the cargo load is less than the total load capacity, do not apply the load unevenly. Improper loading may cause deterioration of steering or braking control which may cause death or serious injury.

Vehicle load limits

Vehicle load limits include total load capacity, seating capacity, towing capacity and cargo capacity.

◆ Total load capacity (vehicle capacity weight): →P. 572

Total load capacity means the combined weight of occupants, cargo and luggage.

◆ Seating capacity: 5 occupants (Front 2, Rear 3)

Seating capacity means the maximum number of occupants whose estimated average weight is 150 lb. (68 kg) per person.

◆ Towing capacity

Lexus does not recommend towing a trailer with your vehicle.

◆ Cargo capacity

Cargo capacity may increase or decrease depending on the weight and the number of occupants.

■ Total load capacity and seating capacity

These details are also described on the tire and loading information label. (→P. 497)

WARNING

■ Overloading the vehicle

Do not overload the vehicle.

It may not only cause damage to the tires, but also degrade steering and braking ability, resulting in an accident.

Trailer towing

Lexus does not recommend towing a trailer with your vehicle. Lexus also does not recommend the installation of a tow hitch or the use of a tow hitch carrier for a wheelchair, scooter, bicycle, etc. Your vehicle is not designed for trailer towing or for the use of tow hitch mounted carriers.



Dinghy towing

Your vehicle is not designed to be dinghy towed (with 4 wheels on the ground) behind a motor home.



NOTICE

- **To avoid serious damage to your vehicle**
Do not tow your vehicle with the four wheels on the ground.

4

Driving

Power (ignition) switch

Performing the following operations when carrying the electronic key on your person starts the hybrid system or changes power switch modes.

Starting the hybrid system

- 1 Check that the parking brake is set.
- 2 Firmly depress the brake pedal.

Check that the power switch indicator turns green. If the indicator does not turn green, the hybrid system cannot be started.

When the shift position is N, the hybrid system cannot start. Shift the shift position to P when starting the hybrid system. (→P. 163)

- 3 Press the power switch.

Continue depressing the brake pedal until the hybrid system is completely started.

The hybrid system can be started from any power switch mode.



- 4 Check that the "READY" indicator is illuminated.

If the "READY" indicator changes from a flashing light to a solid light and the buzzer sounds, the hybrid system is starting normally.

The vehicle will not move when the "READY" indicator is off.

The vehicle can move when the "READY" indicator is on even if the engine is stopped. (The gasoline engine starts or stops automatically in accordance with the state of the vehicle.)

Stopping the hybrid system

- 1 Stop the vehicle completely.
- 2 Set the parking brake. (→P. 168)
- 3 Shift the shift position to P.
(→P. 163)
Check that the shift position indicator shows P. (→P. 162)

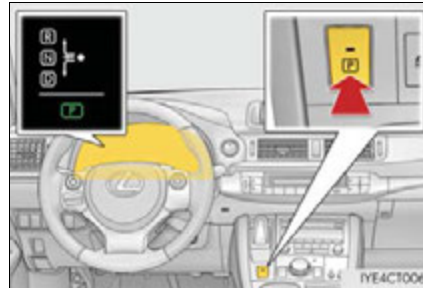

- 4 Press the power switch.
The hybrid system will stop, and the meter display will be extinguished (the shift position indicator will be extinguished a few seconds after the meter display).
- 5 Slowly release the brake pedal and check that the indicator on the power switch is off.

Changing power switch modes

Modes can be changed by pressing the power switch with the brake pedal released. (The mode changes each time the switch is pressed.)

- ① Off
The emergency flashers can be used.
- ② ACCESSORY mode
Some electrical components such as the audio system can be used.
The power switch indicator turns amber.
- ③ ON mode
All electrical components can be used.
The power switch indicator turns amber.

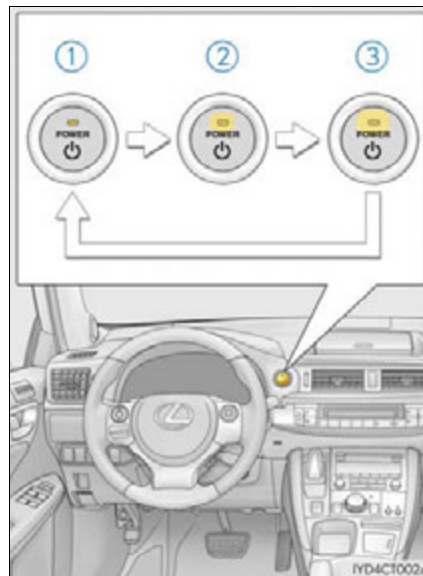

■ **Auto power off function**

If the vehicle is left in ACCESSORY mode for more than 20 minutes or ON mode (the hybrid system is not operating) for more than an hour with the shift position in P, the power switch will automatically turn off. However, this function cannot entirely prevent the 12-volt battery discharge. Do not leave the vehicle with the power switch in ACCESSORY or ON mode for long periods of time when the hybrid system is not operating.

■ **Sounds and vibrations specific to a hybrid vehicle**

→P. 68

■ **Electronic key battery depletion**

→P. 103

■ **When the ambient temperature is low, such as during winter driving conditions**

When starting the hybrid system, the flashing time of the "READY" indicator may be long. Leave the vehicle as it is until the "READY" indicator is steady on, as steady means the vehicle is able to move.

■ **Conditions affecting operation**

→P. 115

■ **Note for the entry function**

→P. 116

■ **If the hybrid system does not start**

The immobilizer system may not have been deactivated. (→P. 74)
Contact your Lexus dealer.

■ **When the power switch indicator flashes in amber**

The system may be malfunctioning. Have the vehicle inspected by your Lexus dealer immediately.

■ **If the "READY" indicator does not come on**

In the event that the "READY" indicator does not come on even after performing the proper procedures for starting the vehicle, contact your Lexus dealer immediately.

■ **If the hybrid system is malfunctioning**

→P. 539

■ **If the electronic key battery is depleted**

→P. 504

■ **Operation of the power switch**

- When operating the power switch, one short, firm press is enough. If the switch is pressed improperly, the hybrid system may not start or the power switch mode may not change. It is not necessary to press and hold the switch.
- If attempting to restart the hybrid system immediately after turning the power switch off, the hybrid system may not start in some cases. After turning the power switch off, please wait a few seconds before restarting the hybrid system.

■ **Automatically P position selection function**

→P. 165

■ **When the shift control system malfunctions**

The power switch will not be able to be turned off. In such a case, the switch can be turned off after applying the parking brake.
Have the vehicle inspected by your Lexus dealer immediately.

⚠ WARNING**■ When starting the hybrid system**

Always start the hybrid system while sitting in the driver's seat. Do not depress the accelerator pedal while starting the hybrid system under any circumstances. Doing so may cause an accident resulting in death or serious injury.

■ Stopping the hybrid system in an emergency

If you want to stop the hybrid system in an emergency while driving the vehicle, press and hold the power switch for more than 2 seconds, or press it briefly 3 times or more in succession. (→P. 523)

However, do not touch the power switch while driving except in an emergency. Turning the hybrid system off while driving will not cause loss of steering or braking control, however, power assist to the steering will be lost. This will make it more difficult to steer smoothly, so you should pull over and stop the vehicle as soon as it is safe to do so.

⚠ NOTICE**■ To prevent 12-volt battery discharge**

- Do not leave the power switch in ACCESSORY or ON mode for long periods of time without the hybrid system on.
- If the hybrid system is off, but the indicator on the power switch is illuminated, this indicates that the power switch is still turned on. When exiting the vehicle, always check that the power switch is off.

■ When starting the hybrid system

If the hybrid system becomes difficult to start, have your vehicle checked by your Lexus dealer immediately.

■ Symptoms indicating a malfunction with the power switch

If the power switch seems to be operating somewhat differently than usual, such as the switch sticking slightly, there may be a malfunction. Contact your Lexus dealer immediately.

EV drive mode

In EV drive mode, the electric motor (traction motor), powered by the hybrid battery (traction battery), is used to drive the vehicle.

This mode allows you to drive in residential areas late at night, or in indoor parking lots etc. without concern for noises and exhaust gas emissions.

Turns EV drive mode on/off

When EV drive mode is turned on, the EV drive mode indicator will come on. Pressing the switch when in EV drive mode will return the vehicle to normal driving (using the gasoline engine and electric motor [traction motor]).

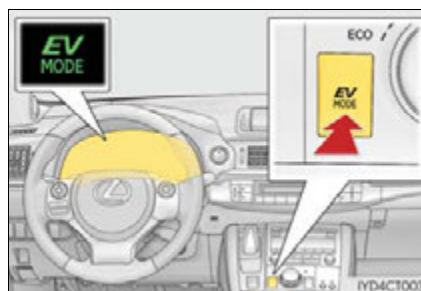

■ Situations in which EV drive mode cannot be turned on

It may not be possible to turn EV drive mode on in the following situations. If it cannot be turned on, a buzzer will sound and a message will be shown on the multi-information display.

- The temperature of the hybrid system is high.
The vehicle has been left in the sun, driven on a hill, driven at high speeds, etc.
- The temperature of the hybrid system is low.
The vehicle has been left in temperatures lower than about 68 °F (20 °C) for a long period of time etc.
- The gasoline engine is warming up.
- The hybrid battery (traction battery) is low.
The remaining battery level indicated in the "Energy Monitor" display is low. (→P. 92)
- Vehicle speed is high.
- The accelerator pedal is depressed firmly or the vehicle is on a hill etc.
- The windshield defogger is in use.

■ **Switching to EV drive mode when the gasoline engine is cold**

If the hybrid system is started while the gasoline engine is cold, the gasoline engine will start automatically after a short period of time in order to warm up. In this case, you will become unable to switch to EV drive mode.

After the hybrid system has started and the “READY” indicator has illuminated, press the EV drive mode switch before the gasoline engine starts to switch to EV drive mode.

■ **Automatic cancellation of EV drive mode**

When driving in EV drive mode, the gasoline engine may automatically restart in the following situations. When EV drive mode is canceled, a buzzer will sound and the EV drive mode indicator will flash and go off.

- The hybrid battery (traction battery) becomes low.
The remaining battery level indicated in the “Energy Monitor” display is low. (→P. 92)
- Vehicle speed becomes high.
- The accelerator pedal is depressed firmly or the vehicle is on a hill etc.

When it is possible to inform the driver of automatic cancellation in advance, a prior notice screen will appear on the multi-information display.

■ **Possible driving distance when driving in EV drive mode**

EV drive mode’s possible driving distance ranges from a few hundred meters to approximately 0.6 mile (1 km). However, depending on vehicle conditions, there are situations when EV drive mode cannot be used. (The distance that is possible depends on the hybrid battery [traction battery] level and driving conditions.)

■ **Fuel economy**

Your Lexus is designed to achieve the best possible fuel economy during normal driving (using the gasoline engine and electric motor [traction motor]). Driving in EV drive mode more than necessary may lower fuel economy.

 **WARNING**

■ **Caution while driving**

When driving in EV drive mode, pay special attention to the area around the vehicle. Because there is no engine noise, pedestrians, people riding bicycles or other people and vehicles in the area may not be aware of the vehicle starting off or approaching them, so take extra care while driving.

Hybrid transmission

Shifting the shift lever

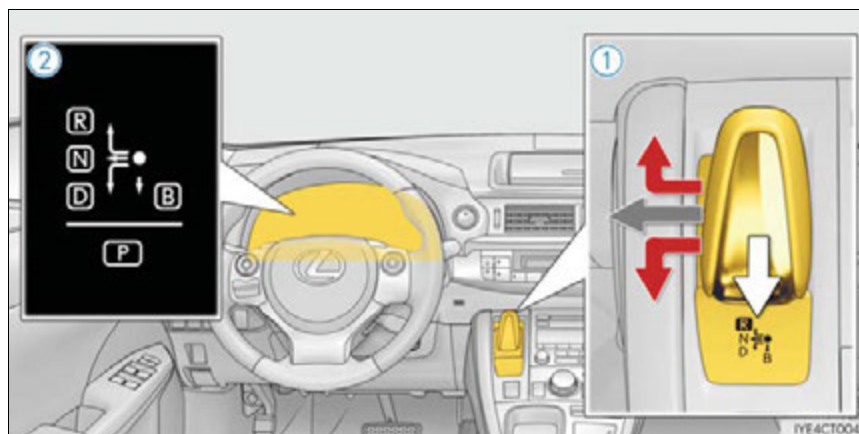

① Shift lever

Operate the shift lever gently and ensure correct shifting operation.

Release the shift lever after each shifting operation to allow it to return to the ● position.



When shifting to the D or R, move the shift lever along the shift gate.



To shift to the N, slide the shift lever to the left and hold it. The shift position will change to N.



To shift to the B, pull the shift lever down.
Shifting to B is only possible when shift position D is selected.

When shifting from P to N, D or R, from D to R, or from R to D, ensure that the brake pedal is being depressed and the vehicle is stationary.

② Shift position indicator

The current shift position is illuminated.

When any shift position other than D or B is selected, the arrow toward B and B position indicator disappear from the shift position indicator.

When selecting the shift position, make sure that the shift position has been changed to the desired position by checking the shift position indicator provided on the instrument cluster.

Shift position purpose

| Shift position | Objective or function |
|----------------|--|
| P | Parking the vehicle/starting the hybrid system |
| R | Reversing |
| N | Neutral (Condition in which the power is not transmitted) |
| D | Normal driving [*] |
| B | Applying engine braking or strong braking when the accelerator pedal has been released on steep downward slopes etc. |

^{*}: For good fuel economy and noise reduction, the D position should usually be used.

Selecting a driving mode

→P. 234

P position switch

■ When shifting the shift position to P

Fully stop the vehicle and set the parking brake, and then press the P position switch.

When the shift position is changed to P, the switch indicator comes on.

Check that the P position is illuminated on the shift position indicator.

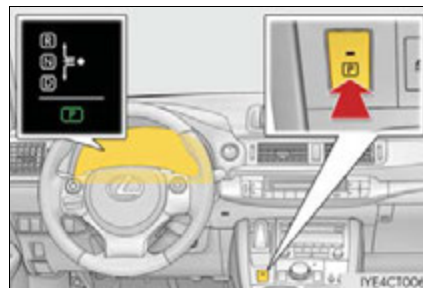

■ Shifting the shift position from P to other positions

- While depressing the brake pedal firmly, operate the shift lever. If the shift lever is operated without depressing the brake pedal, the buzzer will sound and the shifting operation will be disabled.
- When selecting the shift position, make sure that the shift position has been changed to the desired position by checking the shift position indicator provided on the instrument cluster.
- The shift position cannot be changed from P to B directly.

■ For the shift positions

- When the power switch is off, the shift position cannot be changed.
- When the power switch is in ON mode (the hybrid system is not operating), the shift position can only be changed to N. The shift position will be changed to N even if the shift lever is shifted to D or R and held in that position.
- When the “READY” indicator is on, the shift position can be changed from P to D, N or R.
- When the “READY” indicator is flashing, the shift position cannot be changed from P to another position even if the shift lever is operated. Wait until the “READY” indicator changes from a flashing to a solid light, and then operate the shift lever again.
- The shift position can only be changed to B directly from D.

In addition, if an attempt is made to change the shift position by moving the shift lever or by pressing the P position switch in any of the following situations, the buzzer will sound and the shifting operation will be disabled or the shift position will automatically change to N. When this happens, select an appropriate shift position.

- Situations where the shifting operation will be disabled:
 - When an attempt is made to change the shift position from P to another position by moving the shift lever without depressing the brake pedal.
 - When an attempt is made to change the shift position from P or N to B by moving the shift lever.
- Situations where the shift position will automatically change to N:
 - When the P position switch is pressed while the vehicle is running. ^{*1}
 - When an attempt is made to select the R position by moving the shift lever when the vehicle is moving forward. ^{*2}
 - When an attempt is made to select the D position by moving the shift lever when the vehicle is moving in reverse. ^{*3}
 - When an attempt is made to change the shift position from R to B by moving the shift lever.

^{*1}: Shift position may be changed to P when driving at extremely low speeds.

^{*2}: Shift position may be changed to R when driving at low speeds.

^{*3}: Shift position may be changed to D when driving at low speeds.

■ Reverse warning buzzer

When shifting into R, a buzzer will sound to inform the driver that the shift position is in R.

■ About engine braking

When shift position B is selected, releasing the accelerator pedal will apply engine braking.

- When the vehicle is driven at high speeds, compared to ordinary gasoline-fueled vehicles, the engine braking deceleration is felt less than that of other vehicles.
- The vehicle can be accelerated even when shift position B is selected.

If the vehicle is driven continuously in the B position, fuel efficiency will become low. Usually, select the D position.

■ When driving with cruise control or dynamic radar cruise control activated

Even if switching the driving mode to sport mode with the intent of enabling engine braking, engine braking will not activate because cruise control or dynamic radar cruise control will not be canceled.

■ Automatically P position selection function

When the shift position is in a position other than P, pressing the power switch with the vehicle stopped completely will cause the shift position to change to P automatically, and then the power switch will turn off.

■ If the shift position cannot be shifted from P

There is a possibility that the 12-volt battery is discharged. Check the 12-volt battery in this situation. (→P. 562)

■ After recharging/reconnecting the 12-volt battery

→P. 488

■ Customization

Settings (e.g. Reverse warning buzzer) can be changed.
(Customizable features: →P. 591)

⚠ WARNING**■ When driving on slippery road surfaces**

Do not accelerate or shift the shift position suddenly.
Sudden changes in engine braking may cause the vehicle to spin or skid, resulting in an accident.

■ For the shift lever

Do not remove the shift lever knob or use anything but a genuine Lexus shift lever knob. Also, do not hang anything on the shift lever.
Doing so could prevent the shift lever from returning to position, causing unexpected accidents to occur when the vehicle is in motion.

■ P position switch

Do not press the P position switch while the vehicle is moving.
If the P position switch is pressed when driving at very low speeds (for example, directly before stopping the vehicle), the vehicle may stop suddenly when the shift position switches to P, which could lead to an accident.

 NOTICE**■ Hybrid battery (traction battery) charge**

If the shift position is in N, the hybrid battery (traction battery) will not be charged. To help prevent the battery from discharging, avoid leaving the N position selected for an extended period of time.

■ Situations where shift control system malfunctions are possible

If any of the following situations occurs, shift control system malfunctions are possible. Immediately stop the vehicle in a safe place on level ground, apply the parking brake, and then contact your Lexus dealer.

- When the warning message indicating the shift control system appears on the multi-information display. (→P. 539)
- When the shift position indicator remains off.

■ Notes regarding shift lever and P position switch operation

Avoid repeatedly operating the shift lever and P position switch in quick succession. The system protection function may activate and it will not be temporarily possible to shift the shift position other than P. If this happens, please wait for a while before attempting to change the shift position again.

Turn signal lever

Operating instructions

- ① Right turn
- ② Lane change to the right (move the lever partway and release it)
The right hand signals will flash 3 times.
- ③ Lane change to the left (move the lever partway and release it)
The left hand signals will flash 3 times.
- ④ Left turn

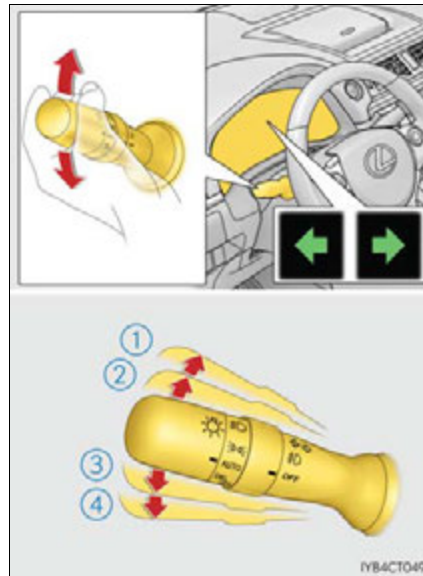

4

Driving

- **Turn signals can be operated when**
The power switch is in ON mode.
- **If the indicator flashes faster than usual**
Check that a light bulb in the front or rear turn signal lights has not burned out.
- **If the turn signals stop flashing before a lane change has been performed**
Operate the lever again.
- **Customization**
The number of times the turn signals flash during a lane change can be changed.
(Customizable features: →P. 591)

Parking brake

Operating instructions

To set the parking brake, fully depress the parking brake pedal with your left foot while depressing the brake pedal with your right foot.
(Depressing the pedal again releases the parking brake.)

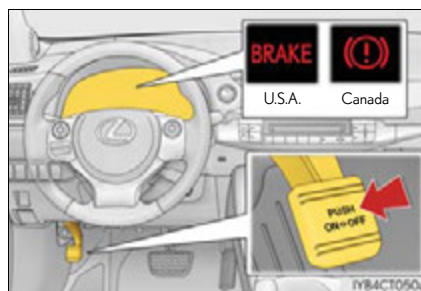

■ Parking brake engaged warning buzzer

The buzzer sounds to indicate that parking brake is still engaged (with the vehicle having reached a speed of 3 mph [5 km/h]). (→P. 539)

■ Usage in winter time

→P. 246

⚠ NOTICE

■ Before driving

Fully release the parking brake.
Driving the vehicle with the parking brake set will lead to brake components overheating, which may affect braking performance and increase brake wear.



Headlight switch

The headlights can be operated manually or automatically.

Operating instructions

Turning the end of the lever turns on the lights as follows:

► Type A

- ① AUTO The headlights, side marker, parking lights, daytime running lights (→P. 170) and so on turn on and off automatically (when the power switch is in ON mode).
- ②  The side marker, parking, tail, license plate, daytime running lights (→P. 170) and instrument panel lights turn on.
- ③  The headlights and all the lights listed above (except daytime running lights) turn on.
- ④  The daytime running lights turn off

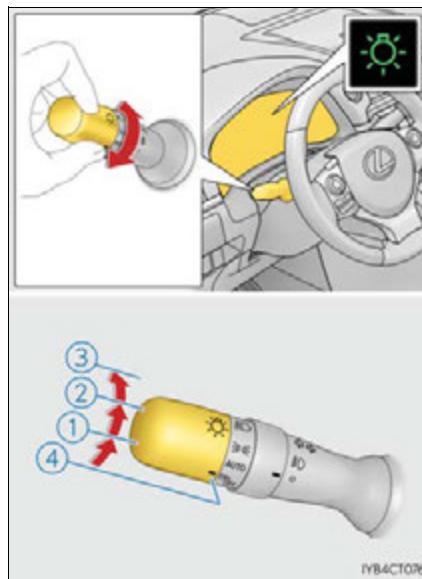

► Type B

- ① ○ The daytime running lights turn on. (→P. 170)
- ② ≡☼ The side marker, parking, tail, license plate, daytime running lights (→P. 170) and instrument panel lights turn on.
- ③ ≡☼ The headlights and all the lights listed above (except daytime running lights) turn on.
- ④ **AUTO** The headlights, side marker, parking lights, daytime running lights (→P. 170) and so on turn on and off automatically (when the power switch is in ON mode).

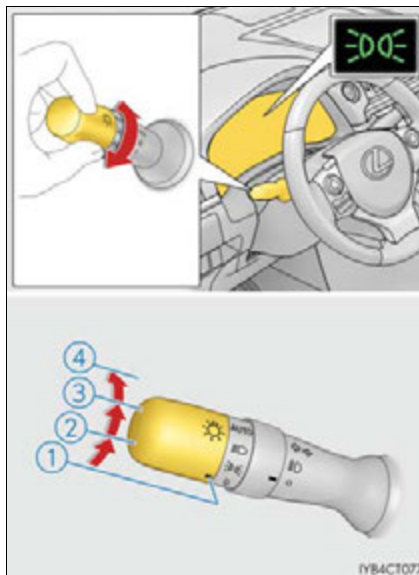

Turning on the high beam headlights

- ① With the headlights on, push the lever away from you to turn on the high beams.
Pull the lever toward you to the center position to turn the high beams off.
- ② Pull the lever toward you and release it to flash the high beams once.
You can flash the high beams with the headlights on or off.

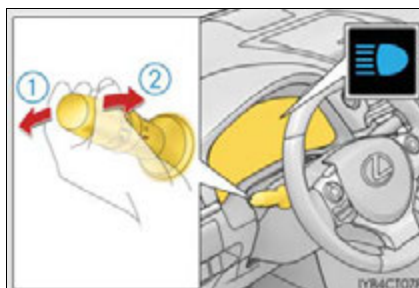

■ **Daytime running light system**



To make your vehicle more visible to other drivers during daytime driving, the daytime running lights turn on automatically whenever the hybrid system is started and the parking brake is released with the headlight switch off or in the "AUTO" position. (Illuminate brighter than the parking lights.) Daytime running lights are not designed for use at night. For the U.S.A.: Daytime running lights can be turned off by operating the switch.

■ Headlight control sensor

The sensor may not function properly if an object is placed on the sensor, or anything that blocks the sensor is affixed to the windshield. Doing so interferes with the sensor detecting the level of ambient light and may cause the automatic headlight system to malfunction.



■ Automatic light off system

- When the headlights come on: The headlights and tail lights turn off 30 seconds after a door is opened and closed if the power switch is turned to ACCESSORY mode or turned off. (The lights turn off immediately if  on the key is pressed after all the doors are locked.)
- When only the tail lights come on: The tail lights turn off automatically if the power switch is turned to ACCESSORY mode or turned off and the driver's door is opened. To turn the lights on again, turn the power switch to ON mode, or turn the light switch off once and then back to  or .

■ Automatic headlight leveling system (if equipped)

The level of the headlights is automatically adjusted according to the number of passengers and the loading condition of the vehicle to ensure that the headlights do not interfere with other road users.

■ 12-volt battery-saving function

In order to prevent the vehicle 12-volt battery from discharging, if the headlights and/or tail lights are on when the power switch is turned off the 12-volt battery saving function will operate and automatically turn off all the lights after approximately 20 minutes. When the power switch is turned to ON mode, the 12-volt battery-saving function will be disabled.

When any of the following are performed, the 12-volt battery-saving function is canceled once and then reactivated. All the lights will turn off automatically 20 minutes after the 12-volt battery-saving function has been reactivated:

- When the headlight switch is operated
- When a door is opened or closed

■ Customization

Settings (e.g. light sensor sensitivity) can be changed. (Customizable features: →P. 591)

NOTICE

■ To prevent 12-volt battery discharge

Do not leave the lights on longer than necessary when the hybrid system is off.

Fog light switch

The fog lights secure excellent visibility in difficult driving conditions, such as in rain and fog.

Operating instructions

► Type A

- ① ○ Turns the fog lights off
- ②  Turns the fog lights on

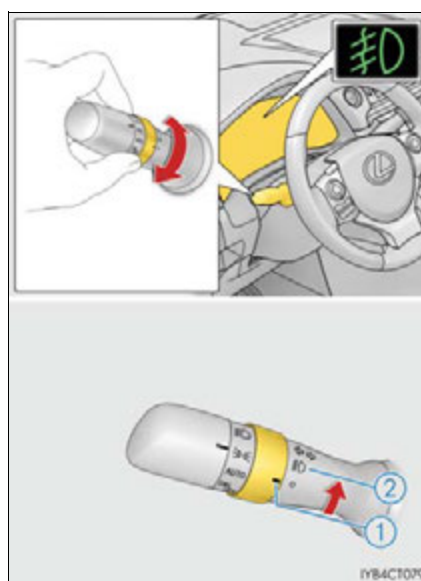

▶ Type B

- ① OFF Turns the fog lights off
- ②  Turns the fog lights on

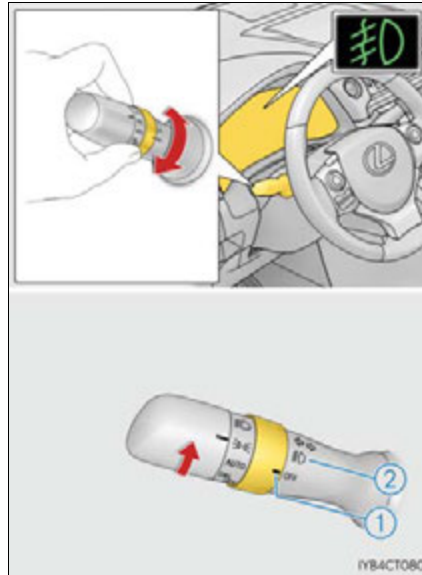

4

Driving

■ Fog lights can be used when

The headlights are on in low beam.

 NOTICE

■ To prevent 12-volt battery discharge

Do not leave the lights on longer than necessary when the hybrid system is off.

Windshield wipers and washer

Operating the wiper lever

The wiper operation is selected by moving the lever as follows.

■ Intermittent windshield wipers with interval adjuster (if equipped)

▶ Type A

- ① Intermittent operation
- ② Low speed operation
- ③ High speed operation
- ④ Temporary operation

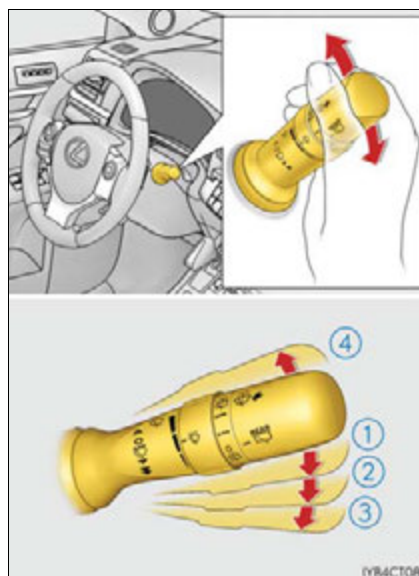

Wiper intervals can be adjusted when intermittent operation is selected.

- ⑤ Increases the intermittent windshield wiper frequency
- ⑥ Decreases the intermittent windshield wiper frequency

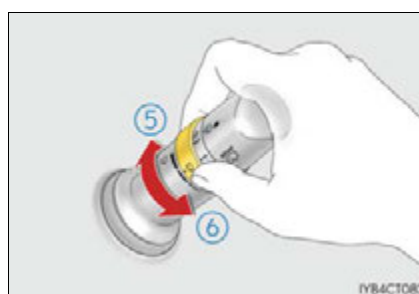

⑦ Washer/wiper dual operation

The wipers will automatically operate a couple of times after the washer squirts.

Vehicles with headlight cleaners: If the headlights are on, the headlight cleaners will operate once.



► Type B

- ① Intermittent operation
- ② Low speed operation
- ③ High speed operation
- ④ Temporary operation

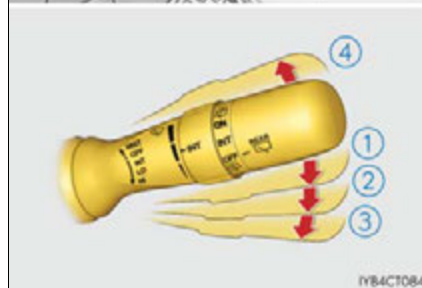
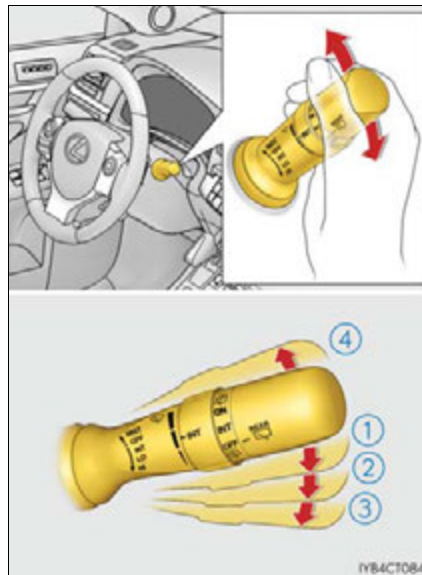

Wiper intervals can be adjusted when intermittent operation is selected.

- ⑤ Increases the intermittent windshield wiper frequency
- ⑥ Decreases the intermittent windshield wiper frequency

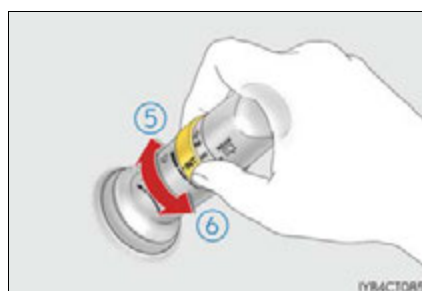

⑦ Washer/wiper dual operation

The wipers will automatically operate a couple of times after the washer squirts.
Vehicles with headlight cleaners: If the headlights are on, the headlight cleaners will operate once.



■ Rain-sensing windshield wipers (if equipped)

▶ Type A

- ① Rain-sensing operation
- ② Low speed operation
- ③ High speed operation
- ④ Temporary operation

When "AUTO" is selected, the wipers will operate automatically when the sensor detects falling rain. The system automatically adjusts wiper timing in accordance with rain volume and vehicle speed.

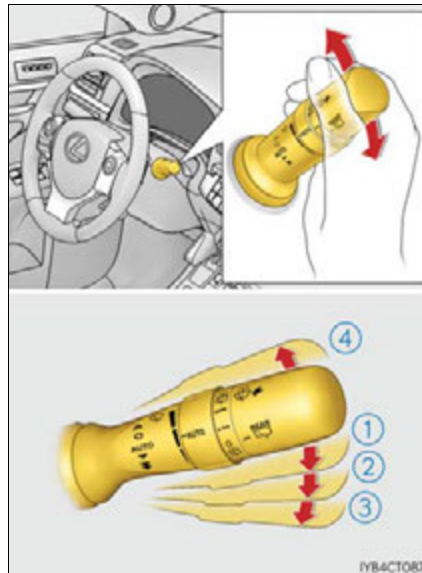

The sensor sensitivity can be adjusted when "AUTO" is selected.

- ⑤ Increases the sensitivity
- ⑥ Decreases the sensitivity

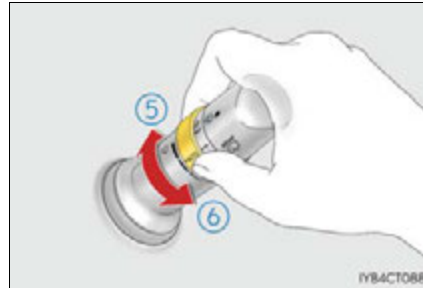

- ⑦ Washer/wiper dual operation

The wipers will automatically operate a couple of times after the washer squirts.

Vehicles with headlight cleaners: If the headlights are on, the headlight cleaners will operate once.



► Type B

- ① Rain-sensing operation
- ② Low speed operation
- ③ High speed operation
- ④ Temporary operation

When "AUTO" is selected, the wipers will operate automatically when the sensor detects falling rain. The system automatically adjusts wiper timing in accordance with rain volume and vehicle speed.

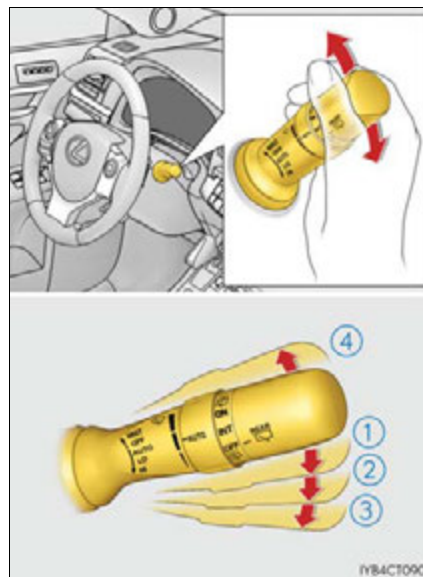

The sensor sensitivity can be adjusted when "AUTO" is selected.

- ⑤ Increases the sensitivity
- ⑥ Decreases the sensitivity

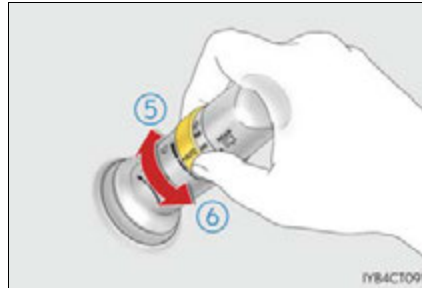

- ⑦ Washer/wiper dual operation
The wipers will automatically operate a couple of times after the washer squirts.
Vehicles with headlight cleaners: If the headlights are on, the headlight cleaners will operate once.



■ The windshield wipers and washer can be operated when

The power switch is in ON mode.

■ Raindrop sensor (vehicles with rain-sensing windshield wipers)

- The raindrop sensor judges the amount of raindrops.

An optical sensor is adopted. It may not operate properly when sunlight from the rising or setting of the sun intermittently strikes the windshield, or if bugs etc. are present on the windshield.



- If the wiper switch is turned to the "AUTO" position while the power switch is in ON mode, the wipers will operate once to show that AUTO mode is activated.
- If the temperature of the raindrop sensor is 194°F (90°C) or higher, or 5°F (-15°C) or lower, automatic operation may not occur. In this case, operate the wipers in any mode other than "AUTO".

■ If no windshield washer fluid sprays

Check that the washer nozzles are not blocked if there is washer fluid in the washer fluid tank.

 **WARNING****■ Caution regarding the use of windshield wipers in "AUTO" mode (vehicles with rain-sensing windshield wipers)**

The windshield wipers may operate unexpectedly if the sensor is touched or the windshield is subject to vibration in "AUTO" mode. Take care that your fingers etc. do not become caught in the windshield wipers.

■ Caution regarding the use of washer fluid

When it is cold, do not use the washer fluid until the windshield becomes warm. The fluid may freeze on the windshield and cause low visibility. This may lead to an accident, resulting in death or serious injury.

 **NOTICE****■ When the windshield is dry**

Do not use the wipers, as they may damage the windshield.

■ When the washer fluid tank is empty

Do not operate the switch continually as the washer fluid pump may overheat.

■ When a nozzle becomes blocked

In this case, contact your Lexus dealer.

Do not try to clear it with a pin or other object. The nozzle will be damaged.

■ To prevent 12-volt battery discharge



Do not leave the wipers on longer than necessary when the hybrid system is off.

Rear window wiper and washer

Operating the wiper lever



Turning the end of the lever turns on the rear window wiper and washer.

► Type A

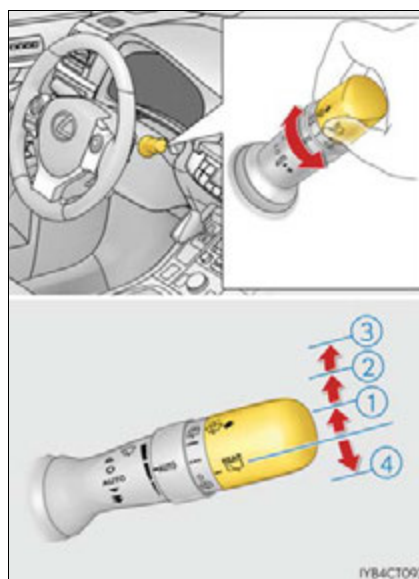
- ① - - - Intermittent operation
- ② — Normal operation
- ③  Washer/wiper dual operation
- ④  Washer/wiper dual operation



▶ Type B

- ① **INT** Intermittent operation
- ② **ON** Normal operation
- ③  Washer/wiper dual operation
- ④  Washer/wiper dual operation

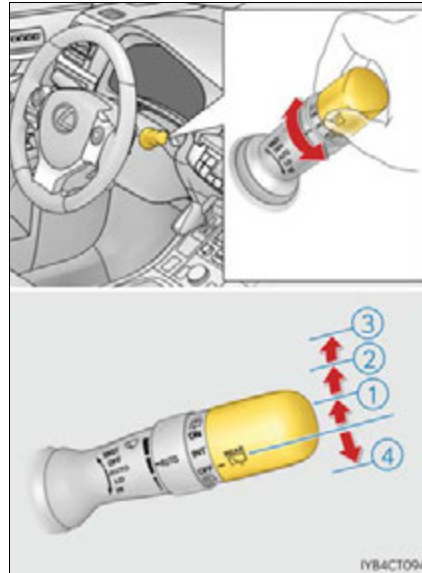

- **The rear window wiper and washer can be operated when**
The power switch is in ON mode.

 **NOTICE**

- **When the rear window is dry**
Do not use the wiper, as it may damage the rear window.
- **When the washer fluid tank is empty**
Do not operate the switch continually as the washer fluid pump may overheat.

Headlight cleaner switch *

Washer fluid can be sprayed on the headlights.

Press the switch to clean the headlights.



■ **The headlight cleaners can be operated when**

The power switch is in ON mode and the headlight switch is turned on.

■ **Windshield washer linked operation**

Only for the first time when the windshield washer is operated with the power switch in ON mode and the headlights on, the headlight cleaners will operate once. (→P. 174)

 **NOTICE**

■ **When the washer fluid tank is empty**

Do not press the switch continually as the washer fluid pump may overheat.

*: If equipped

Opening the fuel tank cap

Perform the following steps to open the fuel tank cap.

Before refueling the vehicle

- Close all the doors and windows, and turn the power switch off.
- Confirm the type of fuel.

■ Fuel types

→P. 580

■ Fuel tank opening for unleaded gasoline

To help prevent incorrect fueling, your vehicle has a fuel tank opening that only accommodates the special nozzle on unleaded fuel pumps.

WARNING

■ When refueling the vehicle

Observe the following precautions while refueling the vehicle. Failure to do so may result in death or serious injury.

- After exiting the vehicle and before opening the fuel door, touch an unpainted metal surface to discharge any static electricity. It is important to discharge static electricity before refueling because sparks resulting from static electricity can cause fuel vapors to ignite while refueling.
- Always hold the grips on the fuel tank cap and turn it slowly to remove it. A whooshing sound may be heard when the fuel tank cap is loosened. Wait until the sound cannot be heard before fully removing the cap. In hot weather, pressurized fuel may spray out of the filler neck and cause injury.
- Do not allow anyone that has not discharged static electricity from their body to come close to an open fuel tank.
- Do not inhale vaporized fuel. Fuel contains substances that are harmful if inhaled.
- Do not smoke while refueling the vehicle. Doing so may cause the fuel to ignite and cause a fire.
- Do not return to the vehicle or touch any person or object that is statically charged. This may cause static electricity to build up, resulting in a possible ignition hazard.

4

Driving

⚠ WARNING

■ **When refueling**

Observe the following precautions to prevent fuel overflowing from the fuel tank:

- Securely insert the fuel nozzle into the fuel filler neck.
- Stop filling the tank after the fuel nozzle automatically clicks off.
- Do not top off the fuel tank.

⚠ NOTICE

■ **Refueling**

Do not spill fuel during refueling.

Doing so may damage the vehicle, such as causing the emission control system to operate abnormally or damaging fuel system components or the vehicle's painted surface.

Opening the fuel tank cap

- 1** Press the opener to open the fuel filler door.



- 2** Turn the fuel tank cap slowly to open and hang it on the back of the fuel filler door.

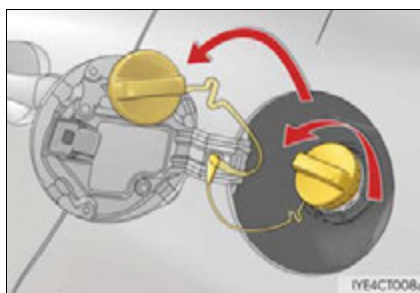

■ **When the fuel filler door cannot be opened by pressing the inside switch**

Remove the cover inside the luggage compartment and pull the lever.



Closing the fuel tank cap

After refueling, turn the fuel tank cap until you hear a click. Once the cap is released, it will turn slightly in the opposite direction.

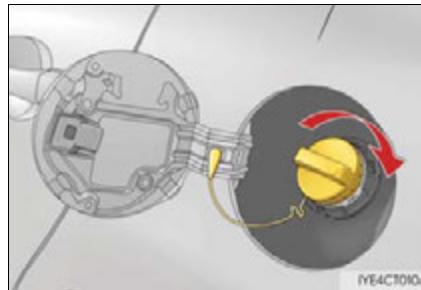

⚠ WARNING

■ **When replacing the fuel cap**

Do not use anything but a genuine Lexus fuel tank cap designed for your vehicle. Doing so may cause a fire or other incident which may result in death or serious injury.

Cruise control*

Summary of functions

Use the cruise control to maintain a set speed without depressing the accelerator pedal.

- ① Indicator
- ② Display
- ③ Cruise control switch



Setting the vehicle speed

- ① Press the “ON-OFF” button to activate the cruise control.

Cruise control indicator will come on.
Press the button again to deactivate the cruise control.

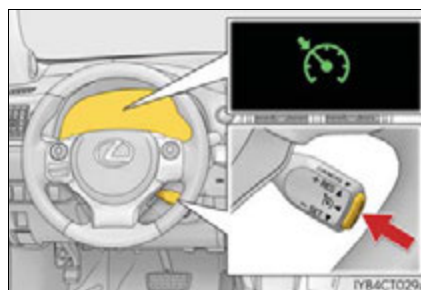

- ② Accelerate or decelerate the vehicle to the desired speed, and push the lever down to set the speed.

“SET” will be displayed.
The vehicle speed at the moment the lever is released becomes the set speed.

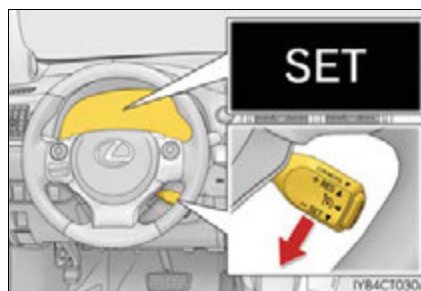

*: If equipped

Adjusting the set speed

To change the set speed, operate the lever until the desired set speed is obtained.

- ① Increases the speed
- ② Decreases the speed

Fine adjustment: Momentarily move the lever in the desired direction.

Large adjustment: Hold the lever in the desired direction.



The set speed will be increased or decreased as follows:

Fine adjustment: By approximately 1 mph (1.6 km/h) each time the lever is operated.

Large adjustment: The set speed can be increased or decreased continually until the lever is released.

Canceling and resuming the constant speed control

- ① Pulling the lever toward you cancels the constant speed control.
The speed setting is also canceled when the brakes are applied.
- ② Pushing the lever up resumes the constant speed control.

Resuming is available when the vehicle speed is more than approximately 25 mph (40 km/h).



■ **Cruise control can be set when**

- The shift position is in D.
- Vehicle speed is above approximately 25 mph (40 km/h).

■ **Accelerating after setting the vehicle speed**

- The vehicle can be accelerated normally. After acceleration, the set speed resumes.
- Even without canceling the cruise control, the set speed can be increased by first accelerating the vehicle to the desired speed and then pushing the lever down to set the new speed.

■ **Automatic cruise control cancelation**

Cruise control will stop maintaining the vehicle speed in any of the following situations.

- Actual vehicle speed falls more than approximately 10 mph (16 km/h) below the preset vehicle speed.
At this time, the memorized set speed is not retained.
- Actual vehicle speed is below approximately 25 mph (40km/h).
- Enhanced VSC is activated.

■ **If the warning message for the cruise control is shown on the multi-information display**

Press the "ON-OFF" button once to deactivate the system, and then press the button again to reactivate the system.

If the cruise control speed cannot be set or if the cruise control cancels immediately after being activated, there may be a malfunction in the cruise control system. Have the vehicle inspected by your Lexus dealer.



WARNING

■ **To avoid operating the cruise control by mistake**

Switch the cruise control off using the "ON-OFF" button when not in use.

■ **Situations unsuitable for cruise control**

Do not use cruise control in any of the following situations.

Doing so may result in loss of control and could cause an accident resulting in death or serious injury.

- In heavy traffic
- On roads with sharp bends
- On winding roads
- On slippery roads, such as those covered with rain, ice or snow
- On steep hills
Vehicle speed may exceed the set speed when driving down a steep hill.
- During emergency towing

Dynamic radar cruise control*

Summary of functions

Dynamic radar cruise control supplements conventional cruise control with a vehicle-to-vehicle distance control. In vehicle-to-vehicle distance control mode, the vehicle automatically accelerates or decelerates in order to maintain a set following distance from vehicles ahead.

- ① Indicators
- ② Display
- ③ Set speed
- ④ Vehicle-to-vehicle distance button
- ⑤ Cruise control switch

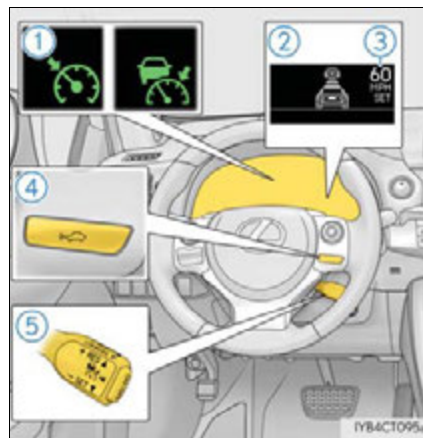

4

Driving

Setting the vehicle speed (vehicle-to-vehicle distance control mode)

- ① Press the "ON-OFF" button to activate the Dynamic radar cruise control.
Radar cruise control indicator will come on.
Press the button again to deactivate the cruise control.

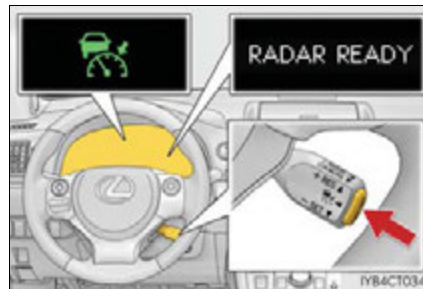

*: If equipped

- ② Accelerate or decelerate the vehicle to the desired speed, and push the lever down to set the speed.
 “SET” and set speed will be displayed.
 The vehicle speed at the moment the lever is released becomes the set speed.

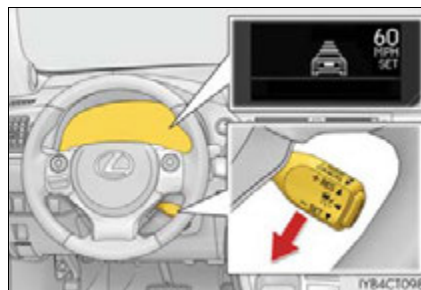

Adjusting the set speed

To change the set speed, operate the lever until the desired set speed is displayed.

- ① Increases the speed
- ② Decreases the speed

Fine adjustment: Momentarily move the lever in the desired direction.

Large adjustment: Hold the lever in the desired direction.

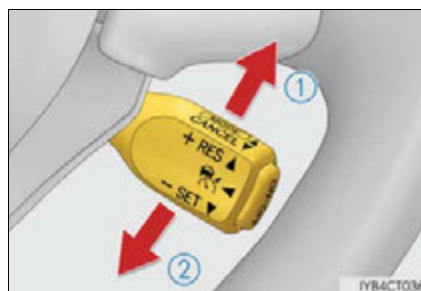

In the vehicle-to-vehicle distance control mode, the set speed will be increased or decreased as follows:

- ▶ When the set speed is shown in “MPH”

Fine adjustment: By approximately 1 mph (1.6 km/h) each time the lever is operated

Large adjustment: By approximately 5 mph (8 km/h) for each 0.75 seconds the lever is held

- ▶ When the set speed is shown in “km/h”

Fine adjustment: By approximately 0.6 mph (1 km/h) each time the lever is operated

Large adjustment: By approximately 3.1 mph (5 km/h) for each 0.75 seconds the lever is held

In the constant speed control mode (→P. 193), the set speed will be increased or decreased as follows:

Fine adjustment: By approximately 1 mph (1.6 km/h) each time the lever is operated

Large adjustment: The set speed can be increased or decreased continually until the lever is released.

Changing the vehicle-to-vehicle distance

Pressing the button changes the vehicle-to-vehicle distance as follows:

- ① Long
- ② Medium
- ③ Short

The vehicle-to-vehicle distance is set automatically to long mode when the power switch is turned to ON mode.

If a vehicle is running ahead of you, the preceding vehicle mark will also be displayed.

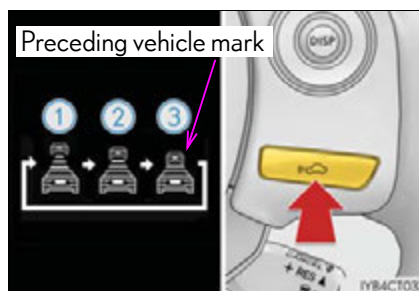

Vehicle-to-vehicle distance settings

Select a distance from the table below. Note that the distances shown correspond to a vehicle speed of 50 mph (80 km/h). Vehicle-to-vehicle distance increases/decreases in accordance with vehicle speed.

| Distance options | Vehicle-to-vehicle distance |
|------------------|------------------------------|
| Long | Approximately 160 ft. (50 m) |
| Medium | Approximately 130 ft. (40 m) |
| Short | Approximately 100 ft. (30 m) |

Canceling and resuming the speed control

- ① Pulling the lever toward you cancels the Dynamic radar cruise control.
The speed setting is also canceled when the brakes are applied.
- ② Pushing the lever up resumes the Dynamic radar cruise control and returns vehicle speed to the set speed.

Resuming is available when the vehicle speed is more than approximately 25 mph (40 km/h).

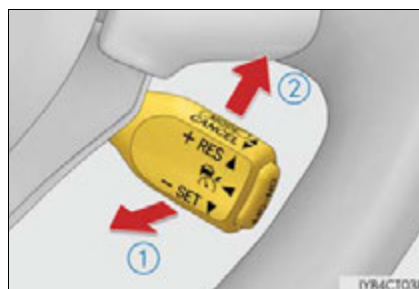

Driving in vehicle-to-vehicle distance control mode

This mode employs a radar sensor to detect the presence of vehicles up to approximately 400 ft. (120 m) ahead, determines the current vehicle-to-vehicle following distance, and operates to maintain a suitable following distance from the vehicle ahead.

Note that vehicle-to-vehicle distance will close in when traveling on long downhill slopes.

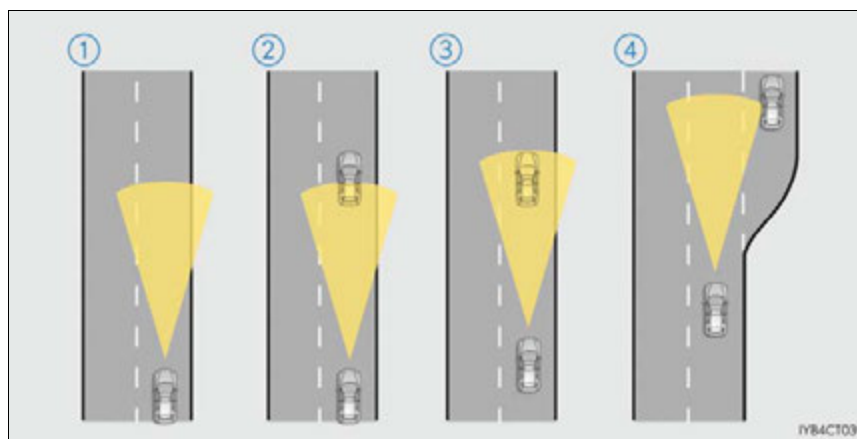

- ① Example of constant speed cruising
When there are no vehicles ahead
The vehicle travels at the speed set by the driver. The desired vehicle-to-vehicle distance can also be set by operating the vehicle-to-vehicle distance control.
- ② Example of deceleration cruising
When the vehicle ahead is driving slower than the set speed
When a vehicle is detected running ahead of you, the system automatically decelerates your vehicle. When a greater reduction in vehicle speed is necessary, the system applies the brakes. A warning tone warns you when the system cannot decelerate sufficiently to prevent your vehicle from closing in on the vehicle ahead.
- ③ Example of follow-up cruising
When following a vehicle driving slower than the set speed
The system continues follow-up cruising while adjusting for changes in the speed of the vehicle ahead in order to maintain the vehicle-to-vehicle distance set by the driver.
- ④ Example of acceleration
When there are no longer any vehicles ahead driving slower than the set speed
The system accelerates until the set speed is reached. The system then returns to constant speed cruising.

Approach warning

When your vehicle is too close to a vehicle ahead, and sufficient automatic deceleration via the Dynamic radar cruise control is not possible, the display will flash and the buzzer will sound to alert the driver. An example of this would be if another driver cuts in front of you while you are following a vehicle. Apply the brakes to ensure an appropriate vehicle-to-vehicle distance.

■ Warnings may not occur when

In the following instances, there is a possibility that the warnings will not occur:

- When the speed of the vehicle ahead matches or exceeds your vehicle speed
- When the vehicle ahead is traveling at an extremely slow speed
- Immediately after the cruise control speed was set
- At the instant the accelerator is applied

Selecting conventional constant speed control mode

Constant speed control mode differs from vehicle-to-vehicle distance control mode. When constant speed control mode is selected, your vehicle will maintain a set speed regardless of whether or not there are other vehicles in the lane ahead.

- ① Press the "ON-OFF" button to activate the cruise control.

Press the button again to deactivate the cruise control.

- ② Switch to constant speed control mode.

(Push the lever forward and hold for approximately one second.)

Cruise control indicator will come on.

When in constant speed control mode, to return to vehicle-to-vehicle distance control mode, push the lever forward again and hold for approximately 1 second.

After the desired speed has been set, it is not possible to return to vehicle-to-vehicle distance control mode.

If the power switch is turned off and then turned to ON mode again, the vehicle will automatically return to vehicle-to-vehicle distance control mode.

Adjusting the speed setting: →P. 190

Canceling and resuming the speed setting: →P. 191

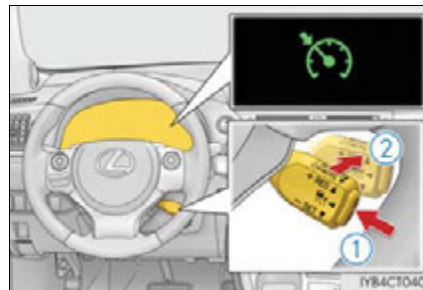

■ **Dynamic radar cruise control can be set when**

- The shift position is in D.
- Vehicle speed is above approximately 30 mph (50 km/h).

■ **Accelerating after setting the vehicle speed**

The vehicle can accelerate normally. After acceleration, the set speed resumes. However, during vehicle-to-vehicle distance control mode, the vehicle speed may decrease below the set speed in order to maintain the distance to the vehicle ahead.

■ **Set speed**

The set speed may be unsustainable depending on driving circumstances.

■ **Automatic cancelation of vehicle-to-vehicle distance control**

Vehicle-to-vehicle distance control driving is automatically canceled in the following situations:

- Actual vehicle speed falls below approximately 25 mph (40 km/h).
- Enhanced VSC is activated.
- The sensor cannot operate correctly because it is covered in some way.
- The windshield wipers are operating at high speed. (when the wiper switch is set to the "AUTO" mode or the high speed wiper operation position).

If vehicle-to-vehicle distance control driving is automatically canceled for any other reason, there may be a malfunction in the system. Contact your Lexus dealer.

■ **Automatic cancelation of constant speed control**

The cruise control will stop maintaining the vehicle speed in the following situations:

- Actual vehicle speed is more than approximately 10 mph (16 km/h) below the set vehicle speed.
At this time, the memorized set speed is not retained.
- Vehicle speed falls below approximately 25 mph (40 km/h).
- Enhanced VSC is activated.

■ **Radar sensor and grille cover**

Always keep the sensor and grille cover clean to ensure that the vehicle-to-vehicle distance control operates properly. (Some obstructions, such as snow, ice and plastic objects, cannot be detected by the obstruction sensor.)

Dynamic radar cruise control is canceled if an obstruction is detected.

- ① Grille cover
- ② Radar sensor

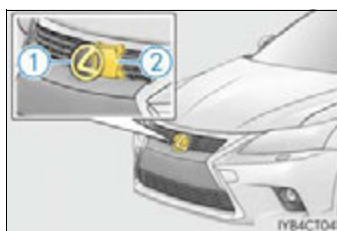

■ **Warning messages and buzzers for dynamic radar cruise control**

Warning messages and buzzers are used to indicate a system malfunction or to inform the driver of the need for caution while driving. (→P. 536)

■ Certification

- ▶ For vehicles sold in the U.S.A.

FCC ID: HYQDNMWR004

This device complies with part 15 of the FCC Rules. Operation is subject to the following two conditions: (1) This device may not cause harmful interference, and (2) this device must accept any interference received, including interference that may cause undesired operation.

FCC WARNING

Changes or modifications not expressly approved by the party responsible for compliance could void the user's authority to operate the equipment.

Radiofrequency radiation exposure Information:

This equipment complies with FCC radiation exposure limits set forth for an uncontrolled environment.

This equipment should be installed and operated with minimum distance of 20 cm between the radiator (antenna) and your body.

This transmitter must not be co-located or operating in conjunction with any other antenna or transmitter.

- ▶ For vehicles sold in Canada

This device complies with Industry Canada licence-exempt RSS standard(s).

Operation is subject to the following two conditions: (1) this device may not cause interference, and (2) this device must accept any interference, including interference that may cause undesired operation of the device.

 **WARNING****■ Before using dynamic radar cruise control**

Do not overly rely on vehicle-to-vehicle distance control.

Be aware of the set speed. If automatic deceleration/acceleration is not appropriate, adjust the vehicle speed, as well as the distance between your vehicle and vehicles ahead by applying the brakes etc.

■ Cautions regarding the driving assist systems

Observe the following precautions.

Failure to do so may cause an accident resulting in death or serious injury.

● Assisting the driver to measure following distance

The dynamic radar cruise control is only intended to help the driver in determining the following distance between the driver's own vehicle and a designated vehicle traveling ahead. It is not a mechanism that allows careless or inattentive driving, and it is not a system that can assist the driver in low-visibility conditions. It is still necessary for driver to pay close attention to the vehicle's surroundings.

● Assisting the driver to judge proper following distance

The dynamic radar cruise control determines whether the following distance between the driver's own vehicle and a designated vehicle traveling ahead is appropriate or not. It is not capable of making any other type of judgement. Therefore, it is absolutely necessary for the driver to remain vigilant and to determine whether or not there is a possibility of danger in any given situation.

● Assisting the driver to operate the vehicle

The dynamic radar cruise control has no capability to prevent or avoid a collision with a vehicle traveling ahead. Therefore, if there is ever any danger, the driver must take immediate and direct control of the vehicle and act appropriately in order to ensure the safety of all involved.

 **WARNING****■ To avoid inadvertent cruise control activation**

Switch the cruise control off using the "ON-OFF" button when not in use.

■ Situations unsuitable for dynamic radar cruise control

Do not use dynamic radar cruise control in any of the following situations. Doing so may result in inappropriate speed control and could cause an accident resulting in death or serious injury.

- Roads where there are pedestrians, cyclers, etc.
- In heavy traffic
- On roads with sharp bends
- On winding roads
- On slippery roads, such as those covered with rain, ice or snow
- On steep downhills, or where there are sudden changes between sharp up and down gradients
Vehicle speed may exceed the set speed when driving down a steep hill.
- At entrances to expressways
- When weather conditions are bad enough that they may prevent the sensors from detecting correctly (fog, snow, sandstorm, heavy rain, etc.)
- When an approach warning buzzer is heard often
- During emergency towing

⚠ WARNING**■ When the sensor may not be correctly detecting the vehicle ahead**

In the case of the following and depending on the conditions, operate the brake pedal when deceleration of the system is insufficient or operate the accelerator pedal when acceleration is required.

As the sensor may not be able to correctly detect these types of vehicles, the approach warning (→P. 193) will not be activated, which may lead to an accident resulting in death or serious injury.

- Vehicles that cut in suddenly

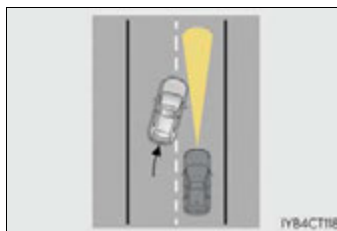

- Vehicles traveling at low speeds
- Vehicles that are not moving in the same lane



- Vehicles with small rear ends (trailers with no load on board etc.)

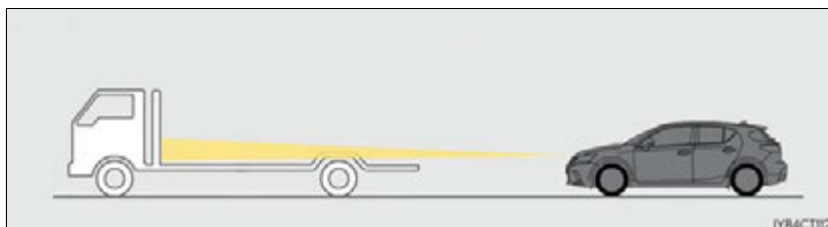

⚠ WARNING

- Motorcycles traveling in the same lane

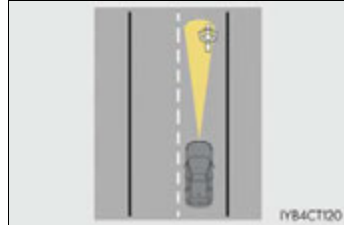

- When water or snow thrown up by the surrounding vehicles hinders the detecting of the sensor
- When your vehicle is pointing upwards (caused by a heavy load in the luggage compartment etc.)

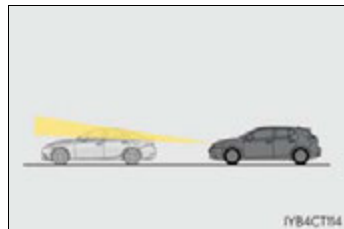

⚠ WARNING

■ **Conditions under which the vehicle-to-vehicle distance control may not function correctly**

Operate the brake pedal (or accelerator pedal operation depending on the situation) as necessary in the following conditions as the radar sensor may not be able to correctly detect vehicles ahead, which may lead to an accident resulting in death or serious injury.

- When the road curves or when the lanes are narrow

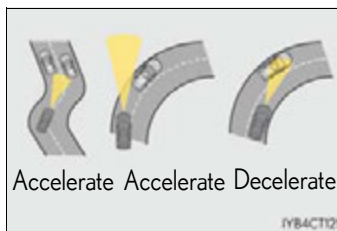

- When steering wheel operation or your position in the lane is unstable

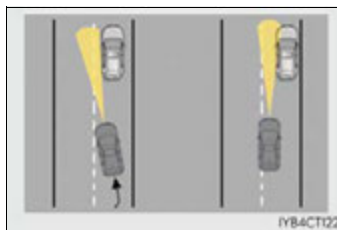

- When the vehicle ahead of you decelerates suddenly



 **WARNING****■ Handling the radar sensor**

Observe the following to ensure the cruise control system can function effectively. Otherwise, the system may not detect correctly and could result in an accident.

- Keep the sensor and grille cover clean at all times.
Clean the sensor and grille cover with a soft cloth so you do not mark or damage them.
- Do not subject the sensor or surrounding area to a strong impact.
If the sensor moves even slightly off position, the system may not work normally or malfunction. If the sensor or surrounding area is subject to a strong impact, always have the area inspected and adjusted by a Lexus dealer.
- Do not disassemble the sensor.
- Do not attach accessories or stickers to the sensor, grille cover or surrounding area.
- Do not modify or paint the sensor and grille cover.
- If the sensor needs to be replaced, contact your Lexus dealer.

Intuitive parking assist*

The distance from your vehicle to nearby obstacles when parallel parking or maneuvering into a garage is measured by the sensors and communicated via the displays and a buzzer. Always check the surrounding area when using this system.

Types of sensors

- ① Front corner sensors
- ② Rear corner sensors
- ③ Rear center sensors

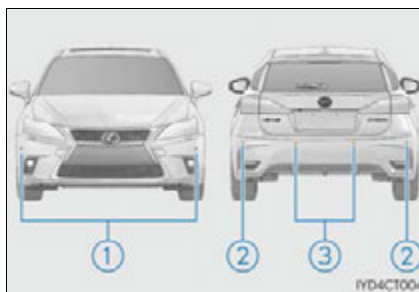

Intuitive parking assist switch

Turns the intuitive parking assist on/off

When on, the indicator light comes on to inform the driver that the system is operational.

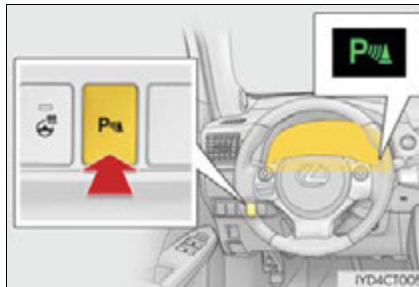

*: If equipped

Display

When the sensors detect an obstacle, the following displays inform the driver of the position and distance to the obstacle.

■ **Multi-information display**

- ① Front corner sensor operation
- ② Rear corner sensor operation
- ③ Rear center sensor operation

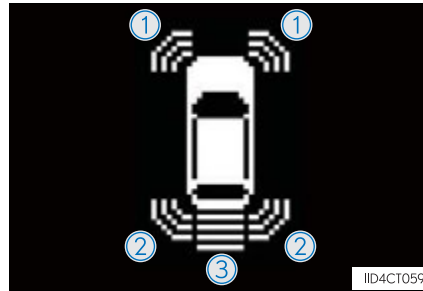

■ **Lexus Display Audio or navigation system screen (if equipped)**



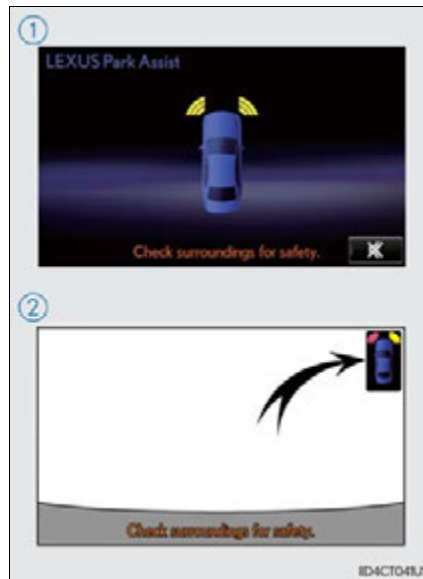





- ① Intuitive parking assist display
 When the Lexus parking assist monitor* is not displayed.
 A graphic is automatically displayed when an obstacle is detected. The screen can be set so that the graphic is not displayed. (→P. 206)
: Select to mute the buzzer sounds.
- ② Insert display
 When the Lexus parking assist monitor* is displayed.
 A simplified image is displayed on the right upper corner of the navigation system screen when an obstacle is detected.
 *: if equipped



Sensor detection display, obstacle distance

■ **Distance display**

Sensors that detect an obstacle will illuminate continuously or blink.

| Display *1 | Insert display | Approximate distance to obstacle | |
|---|---|---|-------------------------------------|
| | | Front and rear corner sensor | Rear center sensor |
|  (continuous) |  (blinking slowly) | — | 4.9 ft. (150 cm) to 2.0 ft. (60 cm) |
|  (continuous) |  (blinking) | Front corner sensor: 1.6 ft. (50 cm) to 1.3 ft. (40 cm) Rear corner sensor: 2.0 ft. (60 cm) to 1.5 ft. (45 cm) | 2.0 ft. (60 cm) to 1.5 ft. (45 cm) |
|  (continuous) |  (blinking rapidly) | Front corner sensor: 1.3 ft. (40 cm) to 1.0 ft. (30 cm) Rear corner sensor: 1.5 ft. (45 cm) to 1.0 ft. (30 cm) | 1.5 ft. (45 cm) to 1.2 ft. (35 cm) |
|  (blinking *2 or continuous *3) |  (continuous) | Less than 1.0 ft. (30 cm) | Less than 1.2 ft. (35 cm) |

*1: The images may differ from that shown in the illustrations. (→P. 203)

*2: Multi-information display

*3: Lexus Display Audio or navigation system screen

■ Buzzer operation and distance to an obstacle

A buzzer sounds when the sensors are operating.

- The buzzer sounds faster as the vehicle approaches an obstacle.

When the vehicle comes within the following distance of the obstacle, the buzzer sounds continuously.

- Front corner sensors: Approximately 1.0 ft. (30 cm)
- Rear corner sensors: Approximately 1.0 ft. (30 cm)
- Rear center sensors: Approximately 1.2 ft. (35 cm)
- When 2 or more obstacles are detected simultaneously, the buzzer system responds to the nearest obstacle. If one or both come within the above distances, the beep will repeat a long tone, followed by fast beeps.

Detection range of the sensors

- ① Approximately 1.6 ft. (50 cm)
- ② Approximately 2.0 ft. (60 cm)
- ③ Approximately 4.9 ft. (150 cm)

The diagram shows the detection range of the sensors. Note that the sensors cannot detect obstacles that are extremely close to the vehicle.

The range of the sensors may change depending on the shape of the object etc.

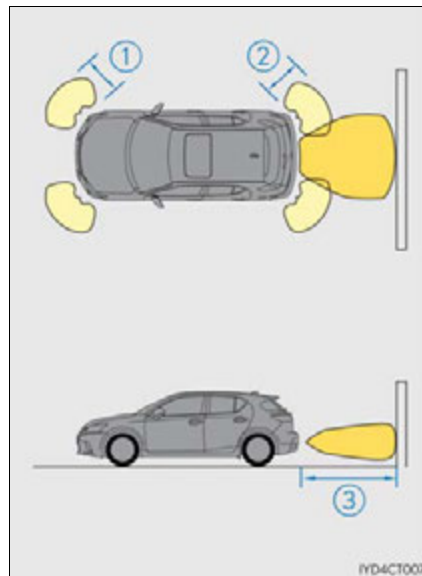

Setting up intuitive parking assist (vehicles with a Lexus Display Audio or navigation system)

You can change the buzzer sounds volume and the screen operating conditions.

▶ Lexus Display Audio system

- 1 Press the "MENU" button on the Lexus Display Audio controller, and then select "Setup" on the screen.
- 2 Select "Vehicle", and then select "LEXUS Park Assist" on the screen.
- 3 Select the desired item.

▶ Navigation system

- 1 Press the "MENU" button on the Remote Touch, and then select "Setup" on the screen.
- 2 Select "Vehicle", and then select "LEXUS Park Assist Settings" on the screen.
- 3 Select the desired item.

▶ Lexus Display Audio screen

▶ Navigation system screen

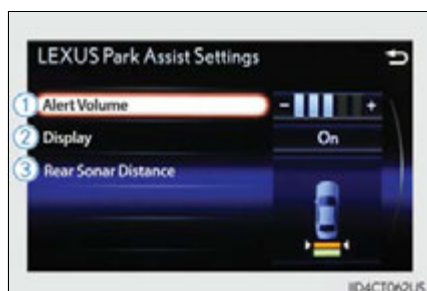

- 1 The buzzer sounds volume can be adjusted.
- 2 On or off can be selected for intuitive parking assist display.
- 3 Rear center sensor display and tone indication can be set.

■ **The intuitive parking assist can be operated when**

- Front corner sensors:
 - The power switch is in ON mode.
 - The shift position is in other than P.
 - The vehicle speed is less than about 6 mph (10 km/h).
(At any speed when the shift position is in R)
- Rear corner and rear center sensors:
 - The power switch is in ON mode.
 - The shift position is in R.

■ Intuitive parking assist display

When an obstacle is detected while the Lexus parking assist monitor is in use, the warning indicator will appear in the upper corner of the screen even if the display setting has been set to off.

■ Sensor detection information

- The sensor's detection areas are limited to the areas around the vehicle's bumper.
- Certain vehicle conditions and the surrounding environment may affect the ability of a sensor to correctly detect an obstacle. Particular instances where this may occur are listed below.
 - There is dirt, snow or ice on the sensor. (Wiping the sensors will resolve this problem.)
 - The sensor is frozen. (Thawing the area will resolve this problem.)
In especially cold weather, if a sensor is frozen the screen may show an abnormal display, or obstacles may not be detected.
 - The sensor is covered in any way.
 - The vehicle is leaning considerably to one side.
 - On an extremely bumpy road, on an incline, on gravel, or on grass.
 - The vicinity of the vehicle is noisy due to vehicle horns, motorcycle engines, air brakes of large vehicles, or other loud noises producing ultrasonic waves.
 - There is another vehicle equipped with parking assist sensors in the vicinity.
 - The sensor is coated with a sheet of spray or heavy rain.
 - The vehicle is equipped with a fender pole or wireless antenna.
 - Towing eyelets are installed.
 - The bumper or sensor receives a strong impact.
 - The vehicle is approaching a tall or curved curb.
 - In harsh sunlight or intense cold weather.
 - The area directly under the bumpers is not detected.
 - If obstacles draw too close to the sensor.
 - A non-genuine Lexus suspension (lowered suspension etc.) is installed.
 - People may not be detected if they are wearing certain types of clothing.

In addition to the examples above, there are instances in which, because of their shape, signs and other objects may be judged by a sensor to be closer than they are.
- The shape of the obstacle may prevent a sensor from detecting it. Pay particular attention to the following obstacles:
 - Wires, fences, ropes, etc.
 - Cotton, snow and other materials that absorb sound waves
 - Sharply-angled objects
 - Low obstacles
 - Tall obstacles with upper sections projecting outwards in the direction of your vehicle
- The following situations may occur during use.
 - Depending on the shape of the obstacle and other factors, the detection distance may shorten, or detection may be impossible.
 - Obstacles may not be detected if they are too close to the sensor.
 - There will be a short delay between obstacle detection and display. Even at slow speeds, there is a possibility that the obstacle will come within the sensor's detection areas before the display is shown and the buzzer sounds.
 - Thin posts or objects lower than the sensor may not be detected when approached, even if they have been detected once.
 - It might be difficult to hear beeps due to the volume of audio system or air flow noise of the air conditioning system.

■ **If a message is displayed on the multi-information display**

→P. 536

■ **Certification**

▶ For vehicles sold in the U.S.A.

This device complies with Part 15 of the FCC Rules. Operation is subject to the following two conditions; (1) This device may not cause harmful interference, and (2) this device must accept any interference received, including interference that may cause undesired operation.

▶ For vehicles sold in Canada

This ISM device complies with Canadian ICES-001.

Cet appareil ISM est conforme à la norme NMB-001 du Canada.

■ **Customization**

Settings (e.g. buzzer sounds volume) can be changed.

(Customizable features: →P. 591)

 **WARNING**

■ **When using the intuitive parking assist**

Observe the following precautions.

Failing to do so may result in the vehicle being unable to be driven safely and possibly cause an accident.

- Do not use the sensor at speeds in excess of 6 mph (10 km/h).
- The sensors' detection areas and reaction times are limited. When moving forward or reversing, check the areas surrounding the vehicle (especially the sides of the vehicle) for safety, and drive slowly, using the brake to control the vehicle's speed.
- Do not install accessories within the sensors' detection areas.

 **NOTICE**

■ **When using intuitive parking assist**

In the following situations, the system may not function correctly due to a sensor malfunction etc. Have the vehicle checked by your Lexus dealer.

- The intuitive parking assist operation display flashes, and a buzzer sounds when no obstacles are detected.
- If the area around a sensor collides with something, or is subjected to strong impact.
- If the bumper collides with something.
- If the display shows continuously without beeping, except when the buzzer mute switch has been turned on.
- If a display error occurs, first check the sensor.
If the error occurs even if there is no ice, snow or mud on the sensor, it is likely that the sensor is malfunctioning.

■ **Notes when washing the vehicle**

Do not apply intensive bursts of water or steam to the sensor area.

Doing so may result in the sensor malfunctioning.

Rear view monitor system*

The rear view monitor system assists the driver by displaying an image of the view behind the vehicle while reversing. The image is displayed in reverse on the screen. This allows the image to appear in the same manner as that of the rear view mirror.

The rear view image is displayed when the shift position is in R and the power switch is in ON mode.

This reversed image is a similar image to the one on the inside rear view mirror.

If you shift the shift position to any positions other than R, the screen is turned off.

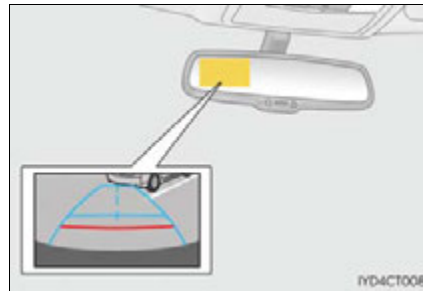

Switching the screen

- To temporarily turn off the monitor when it is on.
Push the "AUTO" button. The indicator should turn orange.
The monitor will automatically turn on again after the power switch is turned off and ON mode.
- To manually turn on the monitor when it is turned off.
Push the "AUTO" button. The indicator should turn green.

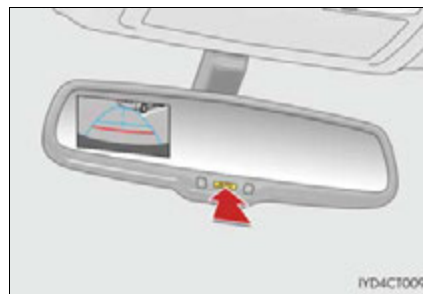

4

Driving

*: If equipped

■ **When using the rear view monitor system**

The anti-glare function of the inside rear view mirror will be canceled.

■ **Automatic shut off**

The display will be turned off automatically after 5 minutes.

■ **Display mode**

The rear view monitor display mode can be adjusted when the power switch is in ON mode and the shift position is in R.

- To select a display language (English, French or Spanish).

1 Push and hold the "AUTO" button for 6 to 12 seconds.

The monitor should turn on and the indicator should turn green.

2 Push the "AUTO" button.

3 Each time the "AUTO" button is pushed and released, the language will change.

The warning message should flash 5 seconds after the button is released, indicating that the change has been completed.

- To permanently disable the monitor.

Push and hold the "AUTO" button for 12 to 15 seconds.

The monitor will turn off and on after 6 seconds. Continue holding the button down until the display turns back off.

The indicator should flash orange.

The monitor will not automatically turn on again after the power switch is turned off and ON mode.

- To manually turn on the monitor when it is turned off.

Push the "AUTO" button.

The indicator should turn green.

Using the rear view monitor system

■ Screen description

The rear view monitor system screen will be displayed if the shift position is shifted to R while the power switch is in ON mode.

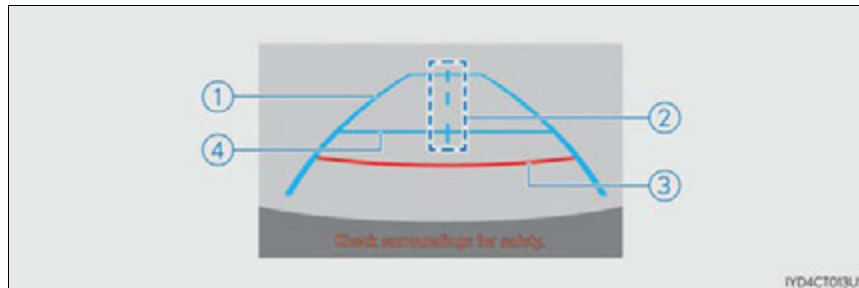

① Vehicle width guide line

The line indicates a guide path when the vehicle is being backed straight up. The displayed width is wider than the actual vehicle width.

② Vehicle center guide line

These lines indicate the estimated vehicle center on the ground.

③ Distance guide line (red)

The line shows distance behind the vehicle, a point approximately 1.5 ft. (0.5 m) from the edge of the bumper.

④ Distance guide line (blue)

The line shows distance behind the vehicle, a point approximately 3 ft. (1 m) from the edge of the bumper.

Rear view monitor system precautions

■ Area displayed on screen

The rear view monitor system displays an image of the view from the bumper of the rear area of the vehicle.

- The area displayed on the screen may vary according to vehicle orientation conditions.
- Objects which are close to either corner of the bumper or under the bumper cannot be displayed.
- The camera uses a special lens. The distance of the image that appears on the screen differs from the actual distance.
- Items which are located higher than the camera may not be displayed on the monitor.
- If your vehicle is equipped with a backlit license plate, it may interfere with the display.

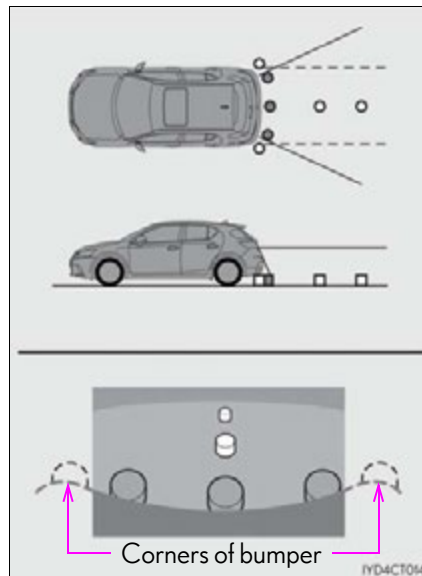

■ Rear view monitor system camera

The camera for the rear view monitor system is located above the license plate.

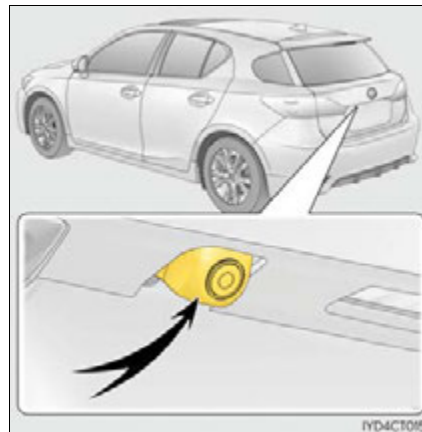

● Using the camera

If the camera lens becomes dirty, it cannot transmit a clear image. If water droplets, snow or mud adhere to the lens, rinse with water and wipe with a soft cloth. If the lens is extremely dirty, wash it with a mild cleanser and rinse.

■ Differences between the screen and the actual road

The distance guide lines and the vehicle width guide lines may not actually be parallel with the dividing lines of the parking space, even when they appear to be so. Be sure to check visually.

The distances between the vehicle width guide lines and the left and right dividing lines of the parking space may not be equal, even when they appear to be so. Be sure to check visually.

The distance guide lines give a distance guide for flat road surfaces. In any of the following situations, there is a margin of error between the fixation guide lines on the screen and the actual distance/course on the road.

● When the ground behind the vehicle slopes up sharply

The distance guide lines will appear to be closer to the vehicle than the actual distance. Because of this, objects will appear to be farther away than they actually are. In the same way, there will be a margin of error between the guide lines and the actual distance/course on the road.

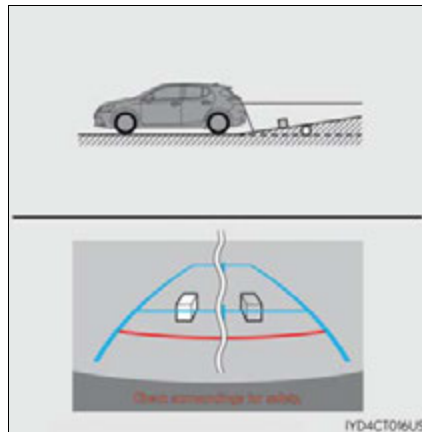

● When the ground behind the vehicle slopes down sharply

The distance guide lines will appear to be further from the vehicle than the actual distance. Because of this, objects will appear to be closer than they actually are. In the same way, there will be a margin of error between the guide lines and the actual distance/course on the road.

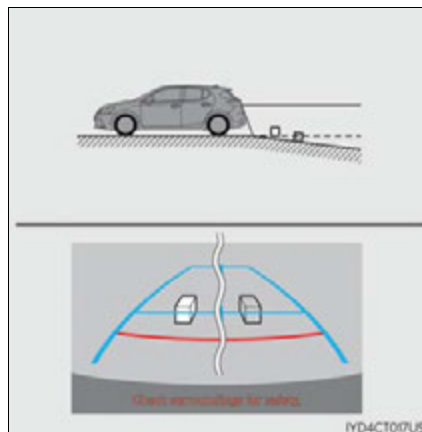

- When any part of the vehicle sags

When any part of the vehicle sags due to the number of passengers or the distribution of the load, there is a margin of error between the fixation guide lines on the screen and the actual distance/course on the road.

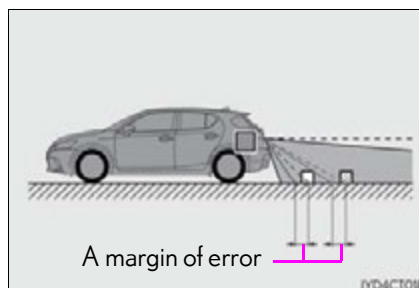

■ When approaching three-dimensional objects

The distance guide lines are displayed according to flat surfaced objects (such as the road). It is not possible to determine the position of three-dimensional objects (such as vehicles) using the distance guide lines. When approaching a three-dimensional object that extends outward (such as the flatbed of a truck), be careful of the following.

- Vehicle width guide lines

Visually check the surroundings and the area behind the vehicle. In the case shown in the illustration, the truck appears to be outside of the vehicle width guide lines and the vehicle does not look as if it hits the truck. However, the rear body of the truck may actually cross over the vehicle width guide lines. In reality if you back up as guided by the vehicle width guide lines, the vehicle may hit the truck.

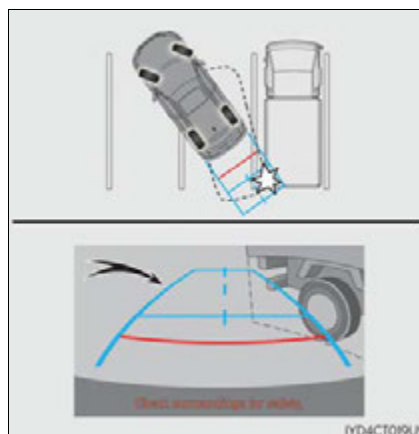

- Distance guide lines

Visually check the surroundings and the area behind the vehicle. On the screen, it appears that a truck is parking at point ②. However, in reality if you back up to point ①, you will hit the truck. On the screen, it appears that ① is closest and ③ is farthest away. However, in reality, the distance to ① and ③ is the same, and ② is farther than ① and ③.

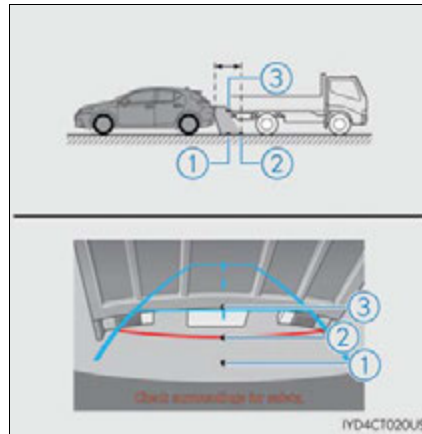

Things you should know

■ **If you notice any symptoms**

If you notice any of the following symptoms, refer to the likely cause and the solution, and re-check.

If the symptom is not resolved by the solution, have the vehicle inspected by your Lexus dealer.

| Likely cause | Solution |
|--|---|
| ❑ The image is difficult to see | |
| <ul style="list-style-type: none"> • The vehicle is in a dark area • The temperature around the lens is either high or low • The outside temperature is low • There are water droplets on the camera • It is raining or humid • Foreign matter (mud etc.) is adhering to the camera • There are scratches on the camera • Sunlight or headlights are shining directly into the camera • The vehicle is under fluorescent lights, sodium lights, mercury lights etc. | <p>If this happens due to these causes, it does not indicate a malfunction. Back up while visually checking the vehicle's surroundings. (Use the monitor again once conditions have been improved.)</p> |
| ❑ The image is blurry | |
| Dirt or foreign matter (such as water droplets, snow, mud etc.) is adhering to the camera. | Rinse the camera lens with water and wipe it clean with a soft cloth. Wash with a mild soap if the dirt is stubborn. |
| ❑ The image is out of alignment | |
| The camera or surrounding area has received a strong impact. | Have the vehicle inspected by your Lexus dealer. |
| ❑ The fixed guide lines are very far out of alignment | |
| The camera position is out of alignment. | Have the vehicle inspected by your Lexus dealer. |
| <ul style="list-style-type: none"> • The vehicle is tilted (there is a heavy load on the vehicle, tire pressure is low due to a tire puncture, etc.) • The vehicle is used on an incline. | <p>If this happens due to these causes, it does not indicate a malfunction. Back up while visually checking the vehicle's surroundings.</p> |

⚠ WARNING**■ When using the rear view monitor system**

The rear view monitor system is a supplemental device intended to assist the driver when backing up. When backing up, be sure to check visually behind and all around the vehicle before proceeding.

Observe the following precautions to avoid an accident that could result in death or serious injuries.

- Never depend on the rear view monitor system entirely when backing up. The image and the position of the guide lines displayed on the screen may differ from the actual state.
Use caution, just as you would when backing up any vehicle.
- Be sure to back up slowly, depressing the brake pedal to control vehicle speed.
- The instructions given are only guide lines.
When and how much to turn the steering wheel will vary according to traffic conditions, road surface conditions, vehicle condition, etc. when parking. It is necessary to be fully aware of this before using the rear view monitor system.
- When parking, be sure to check that the parking space will accommodate your vehicle before maneuvering into it.
- Do not use the rear view monitor system in the following cases:
 - On icy or slick road surfaces, or in snow
 - When using tire chains or emergency tires
 - When the back door is not closed completely
 - On roads that are not flat or straight, such as curves or slopes.
- In low temperatures, the screen may darken or the image may become faint. The image could distort when the vehicle is moving, or you may become unable to see the image on the screen. Be sure to check direct visually and with the mirrors all around the vehicle before proceeding.
- If the tire sizes are changed, the position of the fixed guide lines displayed on the screen may change.
- The camera uses a special lens. The distances between objects and pedestrians that appear in the image displayed on the screen will differ from the actual distances. (→P. 213)

 NOTICE

■ **How to use the camera**

- The rear view monitor system may not operate properly in the following cases.
 - If the back of the vehicle is hit, the position and mounting angle of the camera may change.
 - As the camera has a water proof construction, do not detach, disassemble or modify it. This may cause incorrect operation.
 - Do not strongly rub the camera lens. If the camera lens is scratched, it cannot transmit a clear image.
 - Do not allow organic solvent, car wax, window cleaner or glass coat to adhere to the camera. If this happens, wipe it off as soon as possible.
 - If the temperature changes rapidly, such as when hot water is poured on the vehicle in cold weather, the system may not operate normally.
 - When washing the vehicle, do not apply intensive bursts of water to the camera or camera area. Doing so may result in the camera malfunctioning.
 - When the camera is used under fluorescent lights, sodium light or mercury light etc., the lights and the illuminated areas may appear to flicker.
- Do not expose the camera to strong impact as this could cause a malfunction. If this happens, have the vehicle inspected by your Lexus dealer as soon as possible.

Lexus parking assist monitor*

The parking assist monitor assists the driver by displaying an image of the view behind the vehicle while backing up, for example while parking.

Owners of models equipped with a navigation system should refer to the "NAVIGATION SYSTEM OWNER'S MANUAL".

The screen illustrations used in this text are intended as examples, and may differ from the image that is actually displayed on the screen.

The rear view image is displayed when the shift position is in R and the power switch is in ON mode.

The parking assist monitor system will be deactivated when the shift position is in any position other than R.

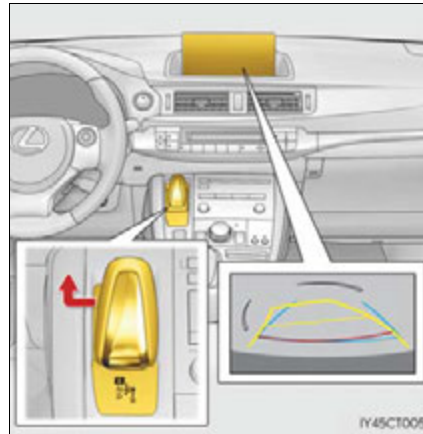

4

Driving

*: If equipped

Using the Lexus parking assist monitor

■ Screen display

The parking assist monitor screen will be displayed if the shift position is shifted to R while the power switch is in ON mode.

- Ⓐ Intuitive parking assist display (if equipped)

If an obstacle is detected while the intuitive parking assist is on, a display is shown in the top right corner of the screen.

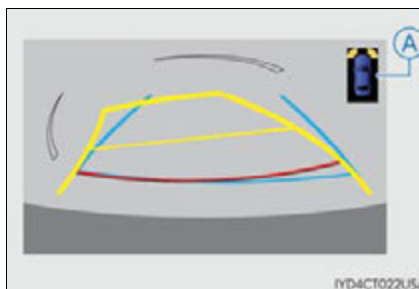

■ Using the system

Use any of the following modes.



- Estimated course line display mode (→P. 222)

Estimated course lines are displayed which move in accordance with the operation of the steering wheel.

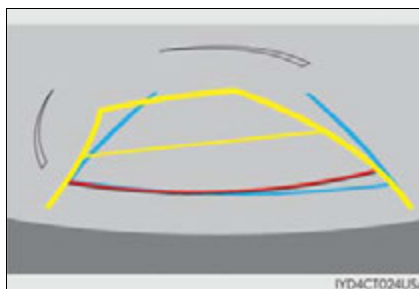

- Parking assist guide line display mode (→P. 224)

The steering wheel return points (parking assist guide lines) are displayed.

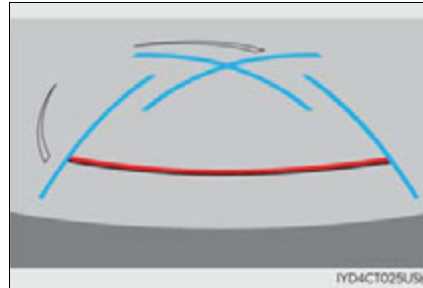

- Distance guide line display mode

Distance guide lines only are displayed.

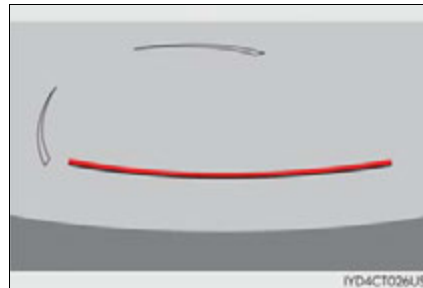

Switching the display mode

When the shift position is in any position other than R, the display mode can be changed in the following procedure.

- 1 Press the "MENU" button on the Lexus Display Audio controller, and then select "Setup" on the screen.
- 2 Select "Vehicle", and then select "Back Camera Guide Line Setting" on the screen.
- 3 Select the desired display mode.
 - ① Estimated course line display mode (→P. 222)
 - ② Parking assist guide line display mode (→P. 224)
 - ③ Distance guide line display mode
Distance guide lines only are displayed.

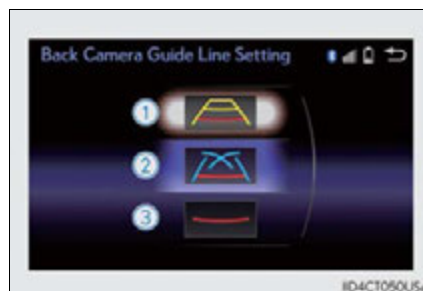

Estimated course line display mode

■ Screen description

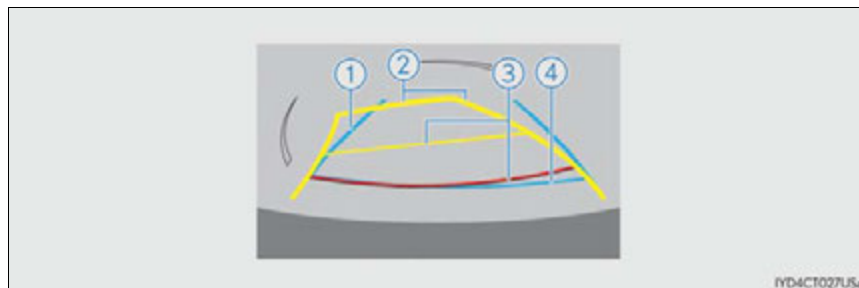

- ① Vehicle width guide line
The line indicates a guide path when the vehicle is being backed straight up. The displayed width is wider than the actual vehicle width. The line aligns with the estimated course lines when the steering wheel is straight.
- ② Estimated course lines
The lines show an estimated course when the steering wheel is turned.
- ③ Distance guide line
The line moves, together with the estimated course lines, in sync with the steering wheel. The line shows points approximately 1.5 ft. (0.5 m) (red) and approximately 3 ft. (1 m) (yellow) from the center of the edge of the bumper.
- ④ Distance guide line
The line shows distance behind the vehicle, a point approximately 1.5 ft. (0.5 m) (blue) from the edge of the bumper.

■ Parking operation

When parking in a space which is in the reverse direction to the space described in the procedure below, the steering directions will be reversed.

1 Shift the shift position to R position.

2 Turn the steering wheel so that the estimated course lines are within the parking space, and back up slowly.

① Parking space

② Estimated course lines

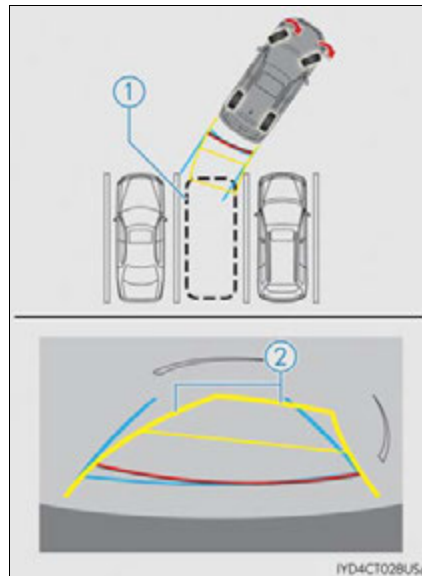

3 When the rear position of the vehicle has entered the parking space, turn the steering wheel so that the vehicle width guide lines are within the left and right dividing lines of the parking space.

③ Vehicle width guide line

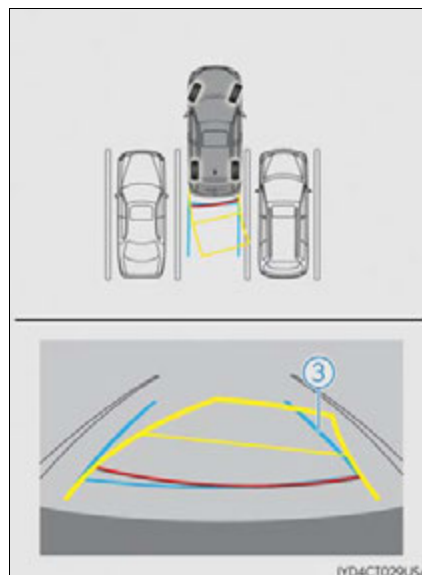

- 4 Once the vehicle width guide lines and the parking space lines are parallel, straighten the steering wheel and back up slowly until the vehicle has completely entered the parking space.
- 5 Stop the vehicle in an appropriate place, and finish parking.

Parking assist guide line display mode

■ Screen description

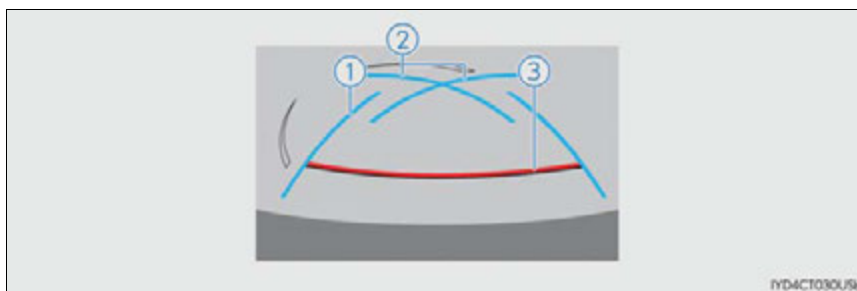

- ① Vehicle width guide lines
These lines indicate a guide path when the vehicle is being backed straight up. The displayed width is wider than the actual vehicle width.
- ② Parking assist guide lines
These lines indicate the path of the smallest turn possible behind the vehicle.
These lines also indicate the approximate position of the steering wheel when parking.
- ③ Distance guide line
This line (red) indicates points approximately 1.5 ft. (0.5 m) behind the rear bumper of your vehicle.

■ Parking operation

When parking in a space which is in the reverse direction to the space described in the procedure below, the steering directions will be reversed.

- 1 Shift the shift position to R position.
- 2 Back up until the parking assist guide line meets the edge of the left-hand dividing line of the parking space.
 - ① Parking assist guide line
 - ② Parking space dividing line

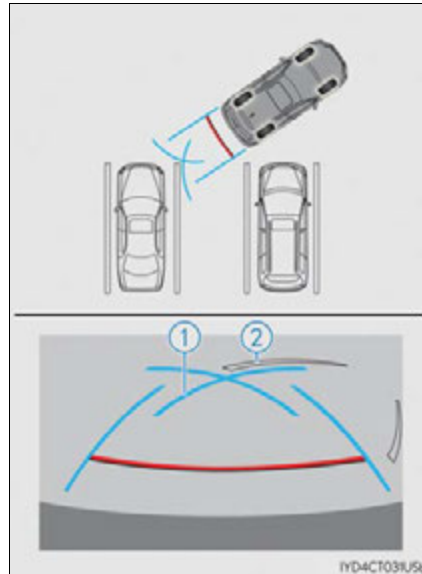

- 3 Turn the steering wheel all the way to the right, and back up slowly.
- 4 Once the vehicle is parallel with the parking space, straighten the steering wheel and back up slowly until the vehicle has completely entered the parking space.
- 5 Stop the vehicle in an appropriate place, and finish parking.

Lexus parking assist monitor precautions

■ Area displayed on screen

The parking assist monitor displays an image of the view from the bumper of the rear area of the vehicle.

The image on the rear view monitor system screen can be adjusted.

(→P. 333)

- The area displayed on the screen may vary according to vehicle orientation conditions.
- Objects which are close to either corner of the bumper or under the bumper cannot be seen on the screen.
- The camera uses a special lens. The distance of the image that appears on the screen differs from the actual distance.
- Items which are located higher than the camera may not be displayed on the monitor.
- If your vehicle is equipped with a backlit license plate, it may interfere with the display.

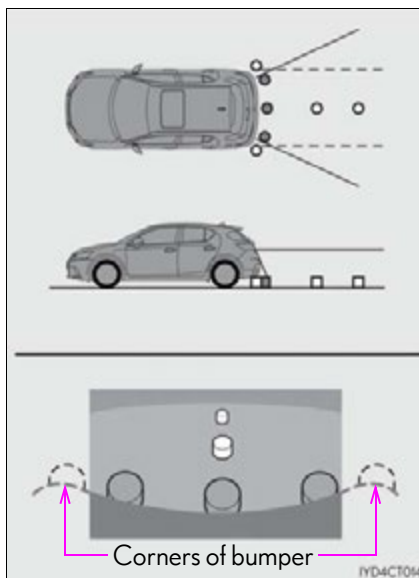

■ Lexus parking assist monitor camera

The camera for the parking assist monitor is located above the license plate.

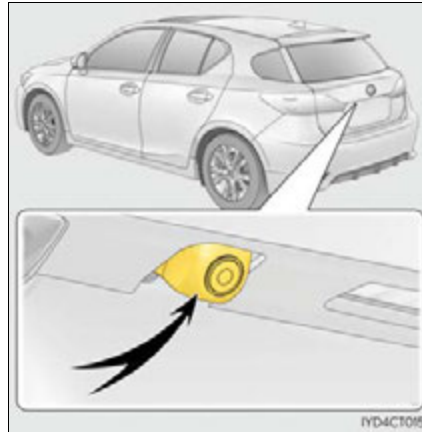
**● Using the camera**

If the camera lens becomes dirty, it cannot transmit a clear image. If water droplets, snow or mud adhere to the lens, rinse with water and wipe with a soft cloth. If the lens is extremely dirty, wash it with a mild cleanser and rinse.

■ Differences between the screen and the actual road

The distance guide lines and the vehicle width guide lines may not actually be parallel with the dividing lines of the parking space, even when they appear to be so. Be sure to check visually.

The distances between the vehicle width guide lines and the left and right dividing lines of the parking space may not be equal, even when they appear to be so. Be sure to check visually.

The distance guide lines give a distance guide for flat road surfaces. In any of the following situations, there is a margin of error between the guide lines on the screen and the actual distance/course on the road.

- When the ground behind the vehicle slopes up sharply

The distance guide lines will appear to be closer to the vehicle than the actual distance. Because of this, objects will appear to be farther away than they actually are. In the same way, there will be a margin of error between the guidelines and the actual distance/course on the road.

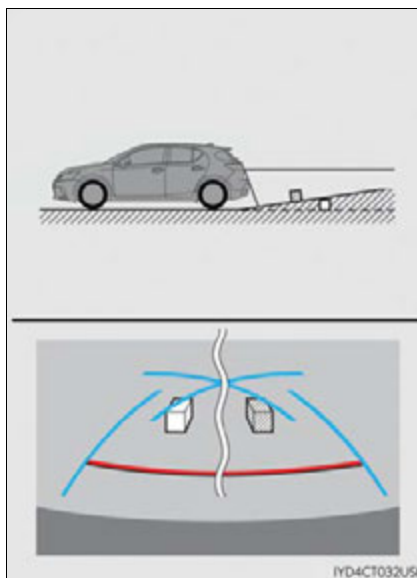

- When the ground behind the vehicle slopes down sharply

The distance guide lines will appear to be further from the vehicle than the actual distance. Because of this, objects will appear to be closer than they actually are. In the same way, there will be a margin of error between the guidelines and the actual distance/course on the road.

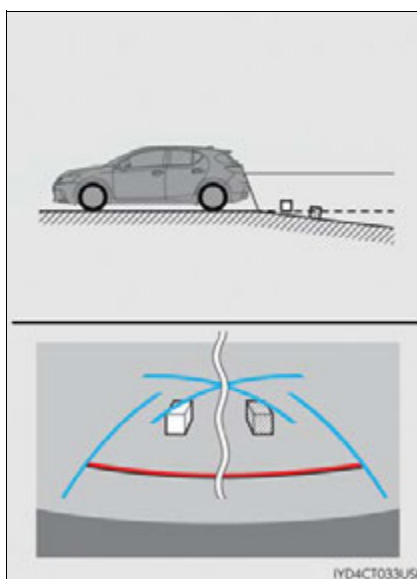

- When any part of the vehicle sags

When any part of the vehicle sags due to the number of passengers or the distribution of the load, there is a margin of error between the guide lines on the screen and the actual distance/course on the road.

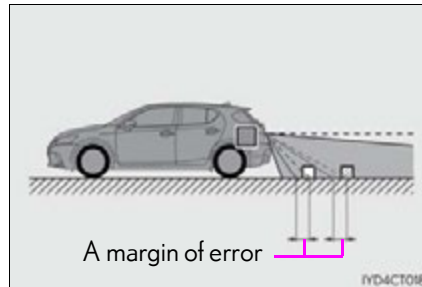

- When approaching three-dimensional objects

The estimated course lines target a flat surfaced objects (such as the road). It is not possible to determine the position of three-dimensional objects (such as vehicles) using the estimated course lines and distance guide lines. When approaching a three-dimensional object that extends outward (such as the flatbed of a truck), be careful of the following.

- Estimated course lines

Visually check the surroundings and the area behind the vehicle. In the case shown in the illustration, the truck appears to be outside of the estimated course lines and the vehicle does not look as if it will hit the truck. However, the rear body of the truck may actually cross over the estimated course lines. In reality if you back up as guided by the estimated course lines, the vehicle may hit the truck.

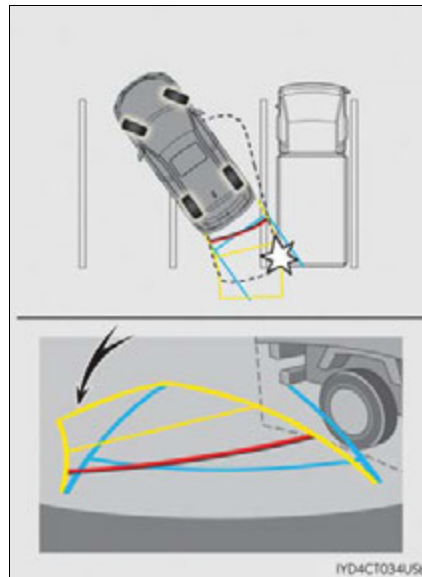

● Distance guidelines

Visually check the surroundings and the area behind the vehicle. On the screen, it appears that a truck is parking at point ②. However, in reality if you back up to point ①, you will hit the truck. On the screen, it appears that ① is closest and ③ is farthest away. However, in reality, the distance to ① and ③ is the same and ② is farther than ① and ③.

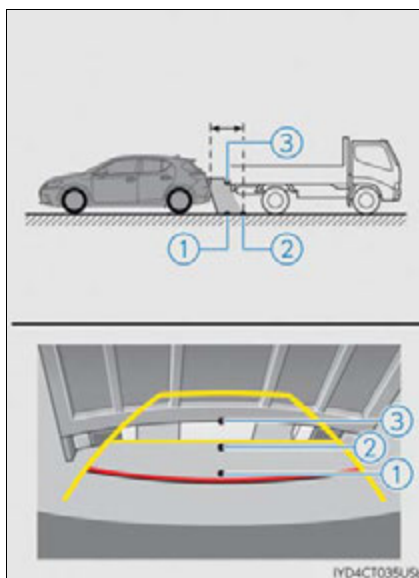

Things you should know

■ If you notice any symptoms

If you notice any of the following symptoms, refer to the likely cause and the solution, and re-check.

If the symptom is not resolved by the solution, have the vehicle inspected by your Lexus dealer.

| Likely cause | Solution |
|--|--|
| <p><input type="checkbox"/> The image is difficult to see</p> | |
| <ul style="list-style-type: none"> • The vehicle is in a dark area • The temperature around the lens is either high or low • The outside temperature is low • There are water droplets on the camera • It is raining or humid • Foreign matter (mud etc.) is adhering to the camera • There are scratches on the camera • Sunlight or headlights are shining directly into the camera • The vehicle is under fluorescent lights, sodium lights, mercury lights etc. | <p>If this happens due to these causes, it does not indicate a malfunction. Back up while visually checking the vehicle's surroundings. (Use the monitor again once conditions have been improved.) The image on the Lexus parking assist monitor system screen can be adjusted. (→P. 333)</p> |

| Likely cause | Solution |
|--|---|
| ❑ The image is blurry | |
| Dirt or foreign matter (such as water droplets, snow, mud etc.) is adhering to the camera. | Rinse the camera lens with water and wipe it clean with a soft cloth. Wash with a mild soap if the dirt is stubborn. |
| ❑ The image is out of alignment | |
| The camera or surrounding area has received a strong impact. | Have the vehicle inspected by your Lexus dealer. |
| ❑ The guide lines are very far out of alignment | |
| The camera position is out of alignment. | Have the vehicle inspected by your Lexus dealer. |
| <ul style="list-style-type: none"> • The vehicle is tilted (there is a heavy load on the vehicle, tire pressure is low due to a tire puncture, etc.) • The vehicle is used on an incline. | If this happens due to these causes, it does not indicate a malfunction. Back up while visually checking the vehicle's surroundings. |
| ❑ The estimated course lines move even though the steering wheel is straight | |
| There is a malfunction in the signals being output by the steering sensor. | Have the vehicle inspected by your Lexus dealer. |
| ❑ Guide lines are not displayed | |
| The back door is open. | Close the back door. If this does not resolve the symptom, have the vehicle inspected by your Lexus dealer. |
| ❑ The estimated course lines are not displayed | |
| <ul style="list-style-type: none"> • Battery power is low. • The steering sensor has been reinstalled. • There is a malfunction in the signals being output by the steering sensor. | Stop the vehicle, and turn the steering wheel as far as it will go to the left and right. If this does not resolve the symptom, have the vehicle inspected by your Lexus dealer. |

 **WARNING****■ When using the Lexus parking assist monitor system**

The parking assist monitor is a supplemental device intended to assist the driver when backing up. When backing up, be sure to check visually behind and all around the vehicle before proceeding.

Observe the following precautions to avoid an accident that could result in death or serious injuries.

- Never depend on the parking assist monitor entirely when backing up. The image and the position of the guide lines displayed on the screen may differ from the actual state.

Use caution, just as you would when backing up any vehicle.

- Be sure to back up slowly, depressing the brake pedal to control vehicle speed.
- If you seem likely to hit nearby vehicles, obstacles, people or mount the shoulder, depress the brake pedal to stop the vehicle.

- The instructions given are only guidelines.

When and how much to turn the steering wheel will vary according to traffic conditions, road surface conditions, vehicle condition, etc. when parking. It is necessary to be fully aware of this before using the parking assist system.

- When parking, be sure to check that the parking space will accommodate your vehicle before maneuvering into it.

- Do not use the parking assist monitor in the following cases:

- On icy or slick road surfaces, or in snow
- When using tire chains or emergency tires
- When the back door is not closed completely
- On roads that are not flat or straight, such as curves or slopes.

- In low temperatures, the screen may darken or the image may become faint. The image could distort when the vehicle is moving, or you may become unable to see the image on the screen. Be sure to check direct visually and with the mirrors all around the vehicle before proceeding.

- If the tire sizes are changed, the position of the guide lines displayed on the screen may change.

- The camera uses a special lens. The distances between objects and pedestrians that appear in the image displayed on the screen will differ from the actual distances. (→P. 227)

- Estimated course line display mode: If the steering wheel is straight and the vehicle width guide lines and the estimated course lines are not in alignment, have the vehicle inspected by your Lexus dealer.

 NOTICE■ **How to use the camera**

- The parking assist monitor may not operate properly in the following cases.
 - If the back of the vehicle is hit, the position and mounting angle of the camera may change.
 - As the camera has a water proof construction, do not detach, disassemble or modify it. This may cause incorrect operation.
 - Do not strongly rub the camera lens. If the camera lens is scratched, it cannot transmit a clear image.
 - Do not allow organic solvent, car wax, window cleaner or glass coat to adhere to the camera. If this happens, wipe it off as soon as possible.
 - If the temperature changes rapidly, such as when hot water is poured on the vehicle in cold weather, the system may not operate normally.
 - When washing the vehicle, do not apply intensive bursts of water to the camera or camera area. Doing so may result in the camera malfunctioning.
 - When the camera is used under fluorescent lights, sodium light or mercury light etc., the lights and the illuminated areas may appear to flicker.
- Do not expose the camera to strong impact as this could cause a malfunction. If this happens, have the vehicle inspected by your Lexus dealer as soon as possible.

Driving mode select switch

The driving modes can be selected to suit driving conditions.

- ① Normal mode
- ② Eco drive mode

Suitable for improving the fuel economy, because the torque corresponding to the accelerator pedal depression amount can be generated more smoothly than it is in normal conditions and the operation of the air conditioning system (heating/cooling) will be minimized.

When the driving mode select switch is turned left, the "ECO MODE" indicator comes on in the instrument cluster.

Press the switch to change the driving mode to normal mode.

- ③ Sport mode

Use when high levels of response and feeling are desirable, such as when driving in mountainous regions or when overtaking.

When the driving mode select switch is turned right, the "SPORT MODE" indicator comes on in the instrument cluster.

Press the switch to change the driving mode to normal mode.

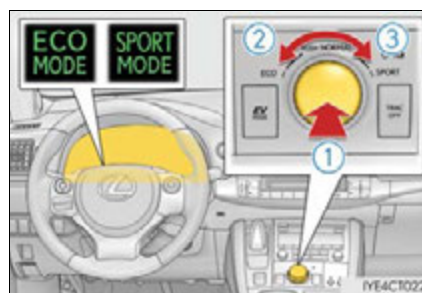

■ Operation of the air conditioning system in Eco drive mode

Eco drive mode controls the heating/cooling operations and fan speed of the air conditioning system to enhance fuel efficiency (→P. 416, 423). To improve air conditioning performance, adjust the fan speed or turn off Eco drive mode.

■ Sport mode automatic deactivation

Sport mode is automatically deactivated if the power switch is turned off after driving in sport mode.

Driving assist systems

To help enhance driving safety and performance, the following systems operate automatically in response to various driving situations. Be aware, however, that these systems are supplementary and should not be relied upon too heavily when operating the vehicle.

◆ ABS (Anti-lock Brake System)

Helps to prevent wheel lock when the brakes are applied suddenly, or if the brakes are applied while driving on a slippery road surface

◆ Brake assist

Generates an increased level of braking force after the brake pedal is depressed when the system detects a panic stop situation

◆ VSC (Vehicle Stability Control)

Helps the driver to control skidding when swerving suddenly or turning on slippery road surfaces

◆ TRAC (Traction Control)

Helps to maintain drive power and prevent the drive wheels from spinning when starting the vehicle or accelerating on slippery roads

◆ EPS (Electric Power Steering)

Employs an electric motor to reduce the amount of effort needed to turn the steering wheel

◆ Enhanced VSC (Enhanced Vehicle Stability Control)

Provides cooperative control of the ABS, TRAC, VSC and EPS.
Helps to maintain directional stability when swerving on slippery road surfaces by controlling steering performance.

◆ Hill-start assist control

Helps to prevent the vehicle from rolling backward when starting on an incline

◆ PCS (Pre-Collision System) (if equipped)

→P. 239

When the VSC/TRAC/ABS systems are operating

The slip indicator light will flash while the VSC/TRAC/ABS systems are operating.

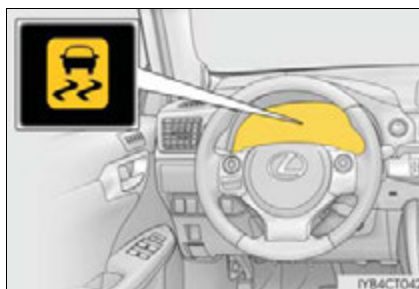

Disabling the TRAC system

If the vehicle gets stuck in mud, dirt or snow, the TRAC system may reduce power from the hybrid system to the wheels. Pressing  to turn the system off may make it easier for you to rock the vehicle in order to free it.

To turn the TRAC system off, quickly press and release .

The "TRAC OFF" indicator light will come on.

Press  again to turn the system back on.

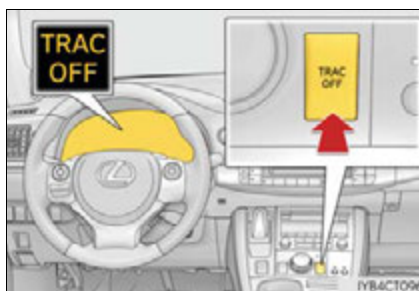

■ **When the "TRAC OFF" indicator comes on even if the TRAC OFF switch has not been pressed**

TRAC and hill-start assist control cannot be operated. Contact your Lexus dealer.

■ **Sounds and vibrations caused by the ABS, brake assist, VSC, TRAC and hill-start assist control systems**

- A sound may be heard from the engine compartment when the hybrid system is started, just after the vehicle begins to move, if the brake pedal is depressed forcefully or repeatedly, or 1-2 minutes after the hybrid system is stopped. This sound does not indicate that a malfunction has occurred in any of these systems.
- Any of the following conditions may occur when the above systems are operating. None of these indicates that a malfunction has occurred.
 - Vibrations may be felt through the vehicle body and steering.
 - A motor sound may be heard after the vehicle comes to a stop.
 - The brake pedal may pulsate slightly after the ABS is activated.
 - The brake pedal may move down slightly after the ABS is activated.

■ EPS operation sound

When the steering wheel is operated, a motor sound (whirring sound) may be heard. This does not indicate a malfunction.

■ Reduced effectiveness of the EPS system

The effectiveness of the EPS system is reduced to prevent the system from overheating when there is frequent steering input over an extended period of time. The steering wheel may feel heavy as a result. Should this occur, refrain from excessive steering input or stop the vehicle and turn the hybrid system off. The EPS system should return to normal within 10 minutes.

■ Operating conditions of hill-start assist control

When the following four conditions are met, the hill-start assist control will operate:

- The shift position is in a position other than P or N (when starting off forward/backward on an upward incline).
- The vehicle is stopped.
- The accelerator pedal is not depressed.
- The parking brake is not engaged.

■ Automatic system cancelation of hill-start assist control

The hill-start assist control will turn off in any of the following situations:

- Shift the shift position to P or N
- The accelerator pedal is depressed
- The parking brake is engaged.
- Approximately 2 seconds elapse after the brake pedal is released.

■ Automatic reactivation of TRAC system

After turning the TRAC system off, the system will be automatically re-enabled in the following situations:

- When the power switch is turned off
- The TRAC will turn on when vehicle speed increases

 **WARNING****■ The ABS does not operate effectively when**

- The limits of tire gripping performance have been exceeded (such as excessively worn tires on a snow covered road).
- The vehicle hydroplanes while driving at high speed on wet or slick road.

■ Stopping distance when the ABS is operating may exceed that of normal conditions

The ABS is not designed to shorten the vehicle's stopping distance. Always maintain a safe distance from the vehicle in front of you, especially in the following situations:

- When driving on dirt, gravel or snow-covered roads
- When driving with tire chains
- When driving over bumps in the road
- When driving over roads with potholes or uneven surfaces

■ TRAC may not operate effectively when

Directional control and power may not be achievable while driving on slippery road surfaces, even if the TRAC system is operating.

Drive the vehicle carefully in conditions where stability and power may be lost.

■ When the VSC is activated

The slip indicator light flashes. Always drive carefully. Reckless driving may cause an accident. Exercise particular care when the indicator light flashes.

■ Hill-start assist control does not operate effectively when

- Do not overly rely on the hill-start assist control. The hill-start assist control may not operate effectively on steep inclines and roads covered with ice.
- Unlike the parking brake, hill-start assist control is not intended to hold the vehicle stationary for an extended period of time. Do not attempt to use hill-start assist control to hold the vehicle on an incline, as doing so may lead to an accident.

■ When the TRAC system is turned off

Be especially careful and drive at a speed appropriate to the road conditions. As this is the system to help ensure vehicle stability and driving force, do not turn the TRAC system off unless necessary.

■ Replacing tires

Make sure that all tires are of the specified size and of the same brand, tread pattern and total load capacity. In addition, make sure that the tires are inflated to the recommended tire inflation pressure level.

The ABS, VSC and TRAC systems will not function correctly if different tires are installed on the vehicle.

Contact your Lexus dealer for further information when replacing tires or wheels.

■ Handling of tires and the suspension

Using tires with any kind of problem or modifying the suspension will affect the driving assist systems, and may cause a system to malfunction.

PCS (Pre-Collision System)*

When the radar sensor detects possibility of a frontal collision, the pre-collision system such as the brakes and seat belts are automatically engaged to lessen impact as well as vehicle damage.

◆ Pre-collision seat belts (front seat belts only)

If the pre-collision sensor detects that a collision is unavoidable, the pre-collision system will retract the seat belt before the collision occurs.

The same will happen if the driver makes an emergency braking or loses control of the vehicle. (→P. 33)

However, when the VSC system is disabled, the system will not operate in the event of skidding.

◆ Pre-collision brake assist

When there is a high possibility of a frontal collision, the system applies greater braking force in relation to how strongly the brake pedal is depressed.

◆ Pre-collision braking

When there is a high possibility of a frontal collision, the system warns the driver using a warning light, warning display and buzzer. If the system determines that a collision is unavoidable, the brakes are automatically applied to reduce the collision speed. Pre-collision braking can be disabled using the pre-collision braking off switch.

Disabling pre-collision braking

- ① Pre-collision braking disabled
- ② Pre-collision braking enabled

The “PCS” warning light will turn on when pre-collision braking is disabled.

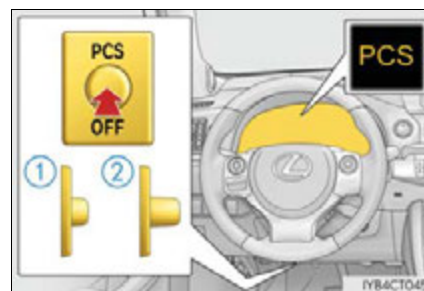

*: If equipped

Radar sensor

The radar sensor detects vehicles or other obstacles on or near the road ahead and determines whether a collision is imminent based on the position, speed, and heading of the obstacles.

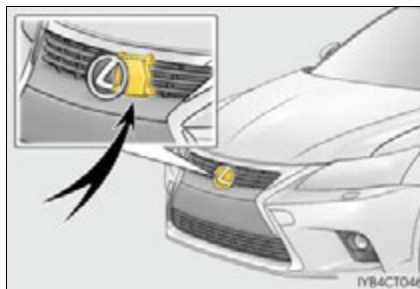

■ The pre-collision system is operational when

- Pre-collision seat belts (type A)
 - Vehicle speed is greater than about 19 mph (30 km/h).
 - The system detects sudden braking or skidding.
 - The front occupants are wearing a seat belt.
- Pre-collision seat belts (type B)
 - Vehicle speed is greater than about 4 mph (5 km/h).
 - The speed at which your vehicle is approaching the obstacle or the vehicle running ahead of you is greater than about 19 mph (30 km/h).
 - The front occupants are wearing a seat belt.
- Pre-collision brake assist:
 - Vehicle speed is greater than about 19 mph (30 km/h).
 - The speed at which your vehicle is approaching the obstacle or the vehicle running ahead of you is greater than about 19 mph (30 km/h).
 - The brake pedal is depressed.
- Pre-collision braking:
 - The pre-collision braking off switch is not pressed.
 - Vehicle speed is greater than about 10 mph (15 km/h).
 - The speed at which your vehicle is approaching the obstacle or the vehicle running ahead of you is greater than about 10 mph (15 km/h).

■ Conditions that may trigger the system even if there is no possibility of a collision

In any of the following situations where the frontal area of the radar sensor is interrupted, the radar sensor may detect possibility of a frontal collision and the system may be activated.

- When passing by an oncoming vehicle in a curve or a turn to the right or the left
- When rapidly approaching an obstacle ahead (e.g. preceding vehicle, toll gate barrier, etc.)
- When there is a structural object (billboard, low ceiling, fluorescent light, etc.) above the uphill road ahead
- When driving on a narrow road or through under a low overhead structure (bridge, tunnel, fly-under, etc.)
- When driving on an uneven road surface
- When there is a metal object, bump, or protrusion on the road surface
- When vehicle's front part is raised or lowered depending on loading conditions
- When the direction of radar sensor is misaligned by strong impact applied on an area around the radar sensor, etc.
- When there is an obstacle (guard rail, etc.) by the roadside at the entrance to a curve
- When the front of your vehicle is pointing upwards (caused by putting a heavy load in the luggage compartment etc.)

When the system is activated in the situations described above, there is also a possibility that the seat belts will retract quickly and the brakes may be applied with a force greater than normal. When the seat belt is locked in the retracted position, stop the vehicle in a safe place, release the seat belt and refasten it.

■ Obstacles not detected

The sensor cannot detect plastic obstacles such as traffic cones. There may also be occasions when the sensor cannot detect pedestrians, animals, bicycles, motorcycles, trees, or snowdrifts.

■ Situations in which the pre-collision system does not function properly

The system may not function effectively in situations such as the following:

- On roads with sharp bends or uneven surfaces
- If a vehicle suddenly moves in front of vehicle, such as at an intersection
- If a vehicle suddenly cuts in front of vehicle, such as when overtaking
- In inclement weather such as heavy rain, fog, snow or sand storms
- When your vehicle is skidding with the VSC system off
- When an extreme change in vehicle height occurs
- When the axis of the radar is out of adjustment
- Due to greatly turning the steering wheel when an obstacle suddenly appears ahead

■ **Automatic cancelation of the pre-collision system**

When a malfunction occurs due to sensor contamination, etc. that results in the sensors being unable to detect obstacles, the pre-collision system will be automatically disabled. In this case, the system will not activate even if there is a collision possibility.

■ **When there is a malfunction in the system, or if the system is temporarily unusable**

Warning lights and/or warning messages will turn on or flash. (→P. 529, 536)

■ **Certification**

▶ For vehicles sold in the U.S.A.

FCC ID: HYQDNMWR004

This device complies with part 15 of the FCC Rules. Operation is subject to the following two conditions: (1) This device may not cause harmful interference, and (2) this device must accept any interference received, including interference that may cause undesired operation.

FCC WARNING

Changes or modifications not expressly approved by the party responsible for compliance could void the user's authority to operate the equipment.

Radiofrequency radiation exposure Information:

This equipment complies with FCC radiation exposure limits set forth for an uncontrolled environment.

This equipment should be installed and operated with minimum distance of 20 cm between the radiator (antenna) and your body.

This transmitter must not be co-located or operating in conjunction with any other antenna or transmitter.

▶ For vehicles sold in Canada

This device complies with Industry Canada licence-exempt RSS standard(s).

Operation is subject to the following two conditions: (1) this device may not cause interference, and (2) this device must accept any interference, including interference that may cause undesired operation of the device.

 **WARNING**

■ **Limitations of the pre-collision system**

The driver is solely responsible for safe driving. Always drive safely, taking care to observe your surroundings.

Do not use the pre-collisions system instead of normal braking operations under any circumstances. This system will not prevent collisions or lessen damage or injuries in all cases. Do not overly rely on this system. Failure to do so may cause an accident, resulting in death or serious injury.

This system has been designed to help avoid and reduce the impact of collisions. However, the system operates differently depending on the situation (→P. 240, 241). As a result, the same level of performance may not be expected in all cases. Also, the pre-collision's brakes may not operate if the driver is depressing the brake pedal or turning the steering wheel, as the system will determine such conditions as collision avoidance operations.

⚠ WARNING**■ Cautions regarding the assist contents of the system**

By means of alarms and brake control, the pre-collision system is intended to assist the driver in avoiding collisions through the process of LOOK-JUDGE-ACT. There are limits to the degree of assistance the system can provide, so please keep in mind the following important points.

- **Assisting the driver in watching the road**
The pre-collision system is only able to detect obstacles directly in front of the vehicle, and only within a limited range. It is not a mechanism that allows careless or inattentive driving, and it is not a system that can assist the driver in low-visibility conditions. It is still necessary for the driver to pay close attention to the vehicle's surroundings.
- **Assisting the driver in making correct judgement**
When attempting to estimate the possibility of a collision, the only data available to the pre-collision system is that from obstacles it has detected directly in front of the vehicle. Therefore, it is absolutely necessary for the driver to remain vigilant and to determine whether or not there is a possibility of collision in any given situation.
- **Assisting the driver in taking action**
The pre-collision system's braking assist feature is designed to help reduce the severity of a collision, and so only acts when the system has judged that a collision is unavoidable. This system is not capable of automatically avoiding a collision or bringing the vehicle to a stop safely without appropriate operations performed by the driver. For this reason, when encountering a dangerous situation the driver must take direct and immediate action in order to ensure the safety of all involved.

■ When the sensor may not be correctly detecting the vehicle ahead

Apply the brakes as necessary in any of the following situations.

- When water or snow thrown up by the surrounding vehicles hinders the functioning of the sensor
- When your vehicle is pointing upwards (caused by a heavy load in the luggage compartment etc.)
- Vehicles that cut in suddenly
- Vehicles with small rear ends (trailers with no load on board etc.)
- Motorcycles traveling in the same lane

■ Handling the radar sensor

Observe the following to ensure the pre-collision system can function effectively:

- **Keep the sensor and front grille cover clean at all times.**
Clean the sensor and front grille cover with a soft cloth so you do not mark or damage them.
- **Do not subject the sensor or surrounding area to a strong impact.**
If the sensor moves even slightly off position, the system may become inaccurate or malfunction. If the sensor or surrounding area is subject to a strong impact, always have the area inspected and adjusted by your Lexus dealer.
- **Do not disassemble the sensor.**
- **Do not attach accessories or stickers to the sensor, grille cover or surrounding area.**
- **Do not modify or paint the sensor and grille cover.**
- **If the sensor needs to be replaced, contact your Lexus dealer.**

Hybrid vehicle driving tips

For economical and ecological driving, pay attention to the following points:

◆ Using Eco drive mode

When using Eco drive mode, the torque corresponding to the accelerator pedal depression amount can be generated more smoothly than it is in normal conditions. In addition, the operation of the air conditioning system (heating/cooling) will be minimized, improving the fuel economy. (→P. 234)

◆ Use of Hybrid System Indicator

The Eco-friendly driving is possible by keeping the indicator needle of Hybrid System Indicator within Eco area. (→P. 86)

◆ Shift lever operation

Shift the shift position to D when stopped at a traffic light, or driving in heavy traffic etc. Shift the shift position to P when parking. When using the N position, there is no positive effect on fuel consumption. In the N position, the gasoline engine operates but electricity cannot be generated. Also, when using the air conditioning system, etc., the hybrid battery (traction battery) power is consumed.

◆ Accelerator pedal/brake pedal operation

- Drive your vehicle smoothly. Avoid abrupt acceleration and deceleration. Gradual acceleration and deceleration will make more effective use of the electric motor (traction motor) without having to use gasoline engine power.
- Avoid repeated acceleration. Repeated acceleration consumes hybrid battery (traction battery) power, resulting in poor fuel consumption. Battery power can be restored by driving with the accelerator pedal slightly released.

◆ When braking

Make sure to operate the brakes gently and in a timely manner. A greater amount of electrical energy can be retained when slowing down.

◆ Delays

Repeated acceleration and deceleration, as well as long waits at traffic lights, will lead to bad fuel economy. Check traffic reports before leaving and avoid delays as much as possible. When driving in a traffic jam, gently release the brake pedal to allow the vehicle to move forward slightly while avoiding overuse of the accelerator pedal. Doing so can help control excessive gasoline consumption.

◆ Highway driving

Control and maintain the vehicle at a constant speed. Before stopping at a toll booth or similar, allow plenty of time to release the accelerator and gently apply the brakes. A greater amount of electrical energy can be regenerated when slowing down.

◆ Air conditioning

Use the air conditioning only when necessary. Doing so can help reduce excessive gasoline consumption.

In summer: When the ambient temperature is high, use the recirculated air mode. Doing so will help to reduce the burden on the air conditioning system and reduce fuel consumption as well.

In winter: Because the gasoline engine will not automatically cut out until it and the interior of the vehicle are warm, it will consume fuel. Fuel consumption can be improved by avoiding overuse of the heater.

◆ Checking tire inflation pressure

Make sure to check the tire inflation pressure frequently. Improper tire inflation pressure can cause poor fuel economy.

Also, as snow tires can cause large amounts of friction, their use on dry roads can lead to poor fuel economy. Use tires that are appropriate for the season.

◆ Luggage

Carrying heavy luggage will lead to poor fuel economy. Avoid carrying unnecessary luggage. Installing a large roof rack will also cause poor fuel economy.

◆ Warming up before driving

Since the gasoline engine starts up and cuts out automatically when cold, warming up the engine is unnecessary. Moreover, frequently driving short distances will cause the engine to repeatedly warm up, which can lead to excess fuel consumption.

Winter driving tips

Carry out the necessary preparations and inspections before driving the vehicle in winter. Always drive the vehicle in a manner appropriate to the prevailing weather conditions.

Preparation for winter

- Use fluids that are appropriate to the prevailing outside temperatures.
 - Engine oil
 - Engine/power control unit coolant
 - Washer fluid
- Have a service technician inspect the condition of the 12-volt battery.
- Have the vehicle fitted with four snow tires or purchase a set of tire chains for the front tires.

Ensure that all tires are the same size and brand, and that chains match the size of the tires.

Before driving the vehicle

Perform the following according to the driving conditions:

- Do not try to forcibly open a window or move a wiper that is frozen. Pour warm water over the frozen area to melt the ice. Wipe away the water immediately to prevent it from freezing.
- To ensure proper operation of the climate control system fan, remove any snow that has accumulated on the air inlet vents in front of the windshield.
- Check for and remove any excess ice or snow that may have accumulated on the exterior lights, vehicle's roof, chassis, around the tires or on the brakes.
- Remove any snow or mud from the bottom of your shoes before getting in the vehicle.

When driving the vehicle

Accelerate the vehicle slowly, keep a safe distance between you and the vehicle ahead, and drive at a reduced speed suitable to road conditions.

When parking the vehicle

Park the vehicle and shift the shift position to P and block the wheel under the vehicle without setting the parking brake. The parking brake may freeze up, preventing it from being released.

Selecting tire chains

Use the correct tire chain size when mounting the tire chains. Chain size is regulated for each tire size.

- ① Side chain:
0.12 in. (3 mm) in diameter
- ② Cross chain:
0.16 in. (4 mm) in diameter

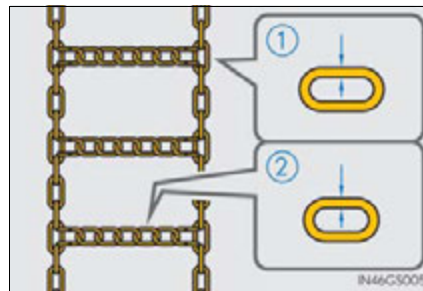

4

Driving

Regulations on the use of tire chains

Regulations regarding the use of tire chains vary depending on location and type of road. Always check local regulations before installing chains.

■ Tire chain installation

Observe the following precautions when installing and removing chains:

- Install and remove tire chains in a safe location.
- Install tire chains on the front tires only. Do not install tire chains on the rear tires.
- Install tire chains on front tires as tightly as possible. Retighten chains after driving 1/4 - 1/2 mile (0.5 - 1.0 km).
- Install tire chains following the instructions provided with the tire chains.

 **WARNING****■ Driving with snow tires**

Observe the following precautions to reduce the risk of accidents. Failure to do so may result in a loss of vehicle control and cause death or serious injury.

- Use tires of the specified size.
- Maintain the recommended level of air pressure.
- Do not drive in excess of 75 mph (120 km/h), regardless of the type of snow tires being used.
- Use snow tires on all, not just some wheels.

■ Driving with tire chains

Observe the following precautions to reduce the risk of accidents. Failure to do so may result in the vehicle being unable to be driven safely, and may cause death or serious injury.

- Do not drive in excess of the speed limit specified for the tire chains being used, or 30 mph (50 km/h), whichever is lower.
- Avoid driving on bumpy road surfaces or over potholes.
- Avoid sudden acceleration, abrupt steering, sudden braking and shifting operations that cause sudden engine braking.
- Slow down sufficiently before entering a curve to ensure that vehicle control is maintained.

■ When parking the vehicle

When parking the vehicle without applying the parking brake, make sure to chock the wheels. If you do not chock the wheels, the vehicle may move unexpectedly, possibly resulting in an accident.

 **NOTICE****■ Repairing or replacing snow tires**

Request repairs or replacement of snow tires from Lexus dealers or legitimate tire retailers.

This is because the removal and attachment of snow tires affects the operation of the tire pressure warning valves and transmitters.

■ Fitting tire chains

The tire pressure warning valves and transmitters may not function correctly when tire chains are fitted.

| | |
|---|-----|
| 5-1. Basic Operations | |
| Audio system types | 252 |
| Using the steering wheel audio switches | 254 |
| AUX port/USB port..... | 255 |
| 5-2. Using the audio system | |
| Optimal use of the audio system | 257 |
| 5-3. Using the radio | |
| Radio operation | 259 |
| 5-4. Playing audio CDs and MP3/WMA discs | |
| CD player operation..... | 265 |
| 5-5. Using an external device | |
| Listening to an iPod | 272 |
| Listening to a USB memory device..... | 278 |
| Using the AUX port..... | 283 |

- 5-6. **Using Bluetooth® devices**
 - Bluetooth® audio/phone284
 - Using the steering wheel switches 291
 - Registering a Bluetooth® audio system for the first time292
 - Registering a Bluetooth® phone for the first time293
- 5-7. **Setup menu**
 - Setting up a Bluetooth® enabled portable player294
 - Bluetooth® audio system setup 298
 - Setting a cellular phone299
 - Security and system setup 302
 - Using the phone book 305
- 5-8. **Bluetooth® Audio**
 - Operating a Bluetooth® enabled portable player310
- 5-9. **Bluetooth® Phone**
 - Making a phone call 312
 - Receiving a phone call 314
 - Speaking on the phone315
- 5-10. **Bluetooth®**
 - Bluetooth® 316
- 5-11. **Basic Operations (Lexus Display Audio System)**
 - Lexus Display Audio System.....320
 - Steering wheel audio switches.....325
 - USB/AUX ports 326
- 5-12. **Setup (Lexus Display Audio System)**
 - Setup menu.....328
 - General settings 329
 - Voice settings.....332
 - Display settings333
- 5-13. **Using the audio system (Lexus Display Audio System)**
 - Selecting the audio source334
 - Optimal use of the audio system335
 - Audio settings.....336
 - Audio menu screen operation338
- 5-14. **Using the radio (Lexus Display Audio System)**
 - Radio operation 341
- 5-15. **Playing an audio CD and MP3/WMA/AAC discs (Lexus Display Audio System)**
 - CD player operation..... 347

- 5-16. Using an external device (Lexus Display Audio System)**
 Listening to an iPod.....353
 Using USB memory device356
 Using the AUX port..... 360
- 5-17. Connecting Bluetooth® (Lexus Display Audio System)**
 Steps for using Bluetooth® devices 361
 Registering a Bluetooth® device363
 Selecting a Bluetooth® device364
 Connecting a Bluetooth® audio player365
 Connecting a Bluetooth® phone.....366
 Displaying a Bluetooth® device details..... 367
 Detailed Bluetooth® settings..... 368
- 5-18. Bluetooth® Audio (Lexus Display Audio System)**
 Listening to Bluetooth® Audio369
- 5-19. Bluetooth® Phone (Lexus Display Audio System)**
 Using a Bluetooth® Phone371
 Making a call 373
 Receiving a call 375
 Speaking on the phone.....376
 Using a Bluetooth® phone message..... 378
 Using the steering wheel switches..... 380
 Bluetooth® phone settings 381
- 5-20. Phonebook (Lexus Display Audio System)**
 Contact settings383
 Messaging setting.....386
- 5-21. Bluetooth® (Lexus Display Audio System)**
 What to do if.. (Troubleshooting)..... 387
 Bluetooth®390
- 5-22. Other function (Lexus Display Audio System)**
 "Information" screen395
 USB photo 397
 Weather information.....399
 Voice command system 400
 Mobile Assistant.....404
 LEXUS Enform Remote.....406

Audio system types

- ▶ Vehicles without a Lexus Display Audio System or navigation system



- ▶ Vehicles with a Lexus Display Audio System

→P. 320

- ▶ Vehicles with a navigation system

Owners of models equipped with a navigation system should refer to the "NAVIGATION SYSTEM OWNER'S MANUAL".

■ Using cellular phones

Interference may be heard through the audio system's speakers if a cellular phone is being used inside or close to the vehicle while the audio system is operating.

 **WARNING****■ Certification**

- Part 15 of the FCC Rules

FCC Warning:

Any unauthorized changes or modifications to this equipment would void the user's authority to operate this device.

- Laser products

CAUTION:

THIS PRODUCT IS A CLASS I LASER PRODUCT. USE OF CONTROLS OR ADJUSTMENTS OR PERFORMANCE OF PROCEDURES OTHER THAN THOSE SPECIFIED HEREIN MAY RESULT IN HAZARDOUS RADIATION EXPOSURE. DO NOT OPEN COVERS AND DO NOT REPAIR BY YOURSELF. REFER SERVICING TO QUALIFIED PERSONNEL.

 **NOTICE****■ To prevent 12-volt battery discharge**

Do not leave the audio system on longer than necessary with the hybrid system is not operating.

■ To avoid damaging the audio system

Take care not to spill drinks or other fluids over the audio system.

Using the steering wheel audio switches

Some audio features can be controlled using the switches on the steering wheel.

Operation may differ depending on the type of audio system or navigation system. For details, refer to the manual provided with the audio system or navigation system.

- ① Volume switch:
 - Press: Increases/decreases volume
 - Press and hold: Continuously increases/decreases volume
- ② Radio mode:
 - Press: Selects a radio station
 - Press and hold: Seeks up/down
 CD, MP3/WMA disc, Bluetooth[®], iPod or USB mode:
 - Press: Selects a track/file/song
 - Press and hold: Selects a folder or album (MP3/WMA disc, Bluetooth[®], iPod or USB)
- ③ "MODE" switch:
 - Press: Turns the power on, selects an audio source
 - Press and hold: Turns the power off

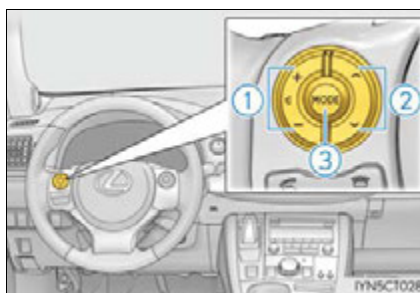

■ Canceling automatic selection of a radio station

Press the "∧" or "∨" button again.

⚠ WARNING

■ To reduce the risk of an accident

Exercise care when operating the audio switches on the steering wheel.

AUX port/USB port

Connect an iPod, USB memory device or portable audio player to the AUX port/USB port as indicated below. Press the “CD•AUX” button to select “iPod”, “USB” or “AUX”.

Connecting using the AUX port/USB port

■ iPod

- 1 Press down and release the lid.

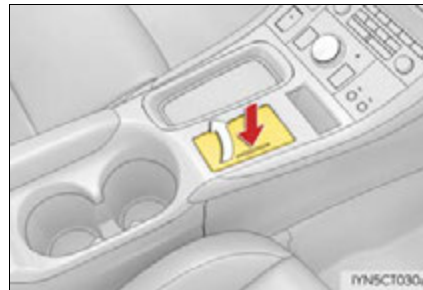

- 2 Open the cover and connect an iPod using an iPod cable.
Turn on the power of the iPod if it is not turned on.

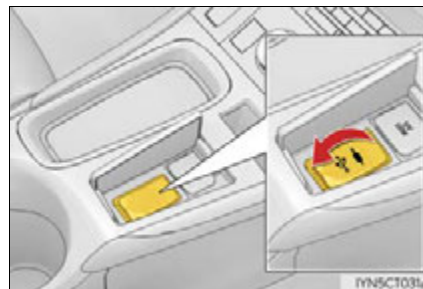

■ USB memory

- 1 Press down and release the lid.
- 2 Open the cover and connect the USB memory device.
Turn on the power of the USB memory device if it is not turned on.

■ Portable audio player

- 1 Press down and release the lid.
- 2 Open the cover and connect the portable audio player.
Turn on the power of the portable audio player if it is not turned on.

 **WARNING**

■ **While driving**

Do not connect a device or operate the device controls.

Optimal use of the audio system

The sound quality, volume balance and ASL settings can be adjusted.

- ① Displays the current mode
- ② Changes the following settings:
 - Sound quality and volume balance
→P. 257
 - The sound quality and balance setting can be changed to produce the best sound.
 - Automatic Sound Levelizer on/off
→P. 258

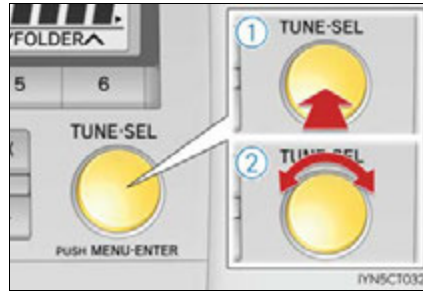

Adjusting sound quality and volume balance

■ **Changing sound quality modes**

Press the “TUNE•SEL” knob.
Pressing the knob changes sound modes in the following order:
“BAS” → “MID” → “TRE” → “FAD” → “BAL” → “ASL”

■ **Adjusting sound quality**

Turning the “TUNE•SEL” knob adjusts the level.

| Mode displayed | Sound quality mode | Level | Turn counter-clockwise | Turn clockwise |
|----------------|---------------------------|----------|------------------------|-----------------|
| “BAS” | Bass* | -5 to 5 | Low | High |
| “MID” | Mid-range* | -5 to 5 | | |
| “TRE” | Treble* | -5 to 5 | | |
| “FAD” | Front/rear volume balance | F7 to R7 | Shifts to rear | Shifts to front |
| “BAL” | Left/right volume balance | L7 to R7 | Shifts to left | Shifts to right |

*: The sound quality level is adjusted individually in each audio mode.

Turning the Automatic Sound Levelizer (ASL) on/off

Turning the "TUNE•SEL" knob clockwise turns on the ASL, and turning the "TUNE•SEL" knob counterclockwise turns off the ASL.

ASL automatically adjusts the volume and tone quality according to the noise level as you drive your vehicle.

Radio operation

Press the “AM•SAT”, “FM1” or “FM2” button to begin listening to the radio.

Control panel

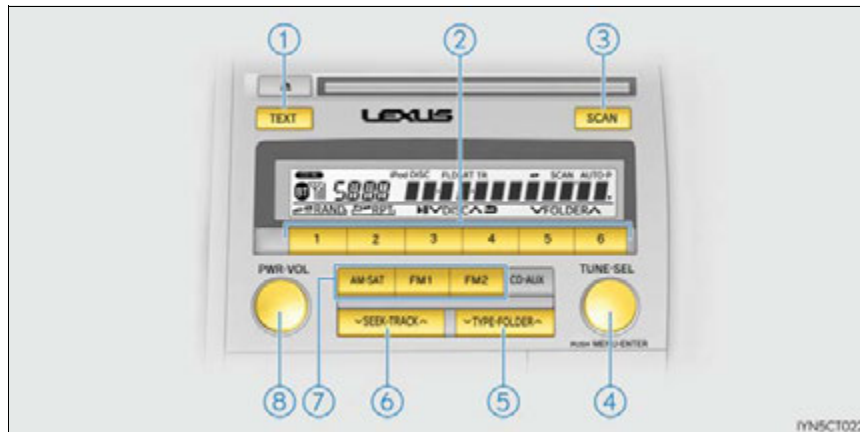

- ① Displaying text message
- ② Station selector
- ③ Scanning for receivable stations
- ④ “TUNE•SEL” knob
Adjusting the frequency
- ⑤ Changing the program type
- ⑥ Seeking the frequency
- ⑦ AM•SAT/FM mode buttons
Press: Turning the audio system on or off
Turn: Adjusting the volume
- ⑧ Power/volume knob

5

Audio system

Setting station presets (excluding XM[®] Satellite Radio)

- 1 Search for the desired stations by turning the “TUNE•SEL” knob or pressing “^” or “v” on the “SEEK•TRACK” button.
- 2 Press and hold the button (from the “1” button to the “6” button) the station is to be set to until you hear a beep.

Scanning radio stations (excluding XM[®] Satellite Radio)

■ Scanning the preset radio stations

- 1 Press and hold the "SCAN" button until you hear a beep.
- 2 When the desired station is reached, press the button again.

■ Scanning all the radio stations within range

- 1 Press the "SCAN" button.
All the stations with reception will be played for 5 seconds each.
- 2 When the desired station is reached, press the button again.

RDS (Radio Data System)

This feature allows your radio to receive station identification information and program information (classical, jazz, etc.) from radio stations which broadcast this information.

■ Receiving RDS broadcasts

- 1 Press "∧" or "∨" on the "TYPE•FOLDER" button during FM reception.

The type of program changes each time the button is pressed.

- "ROCK"
- "EASYLIS" (Easy listening)
- "CLS/JAZZ" (Classical music and Jazz)
- "R & B" (Rhythm and Blues)
- "INFORM" (Information)
- "RELIGION"
- "MISC" (Miscellaneous)
- "ALERT" (Emergency messages)

If the system receives no RDS stations, "NO PTY" appears on the display.

- 2 Press the "SCAN" button, or "∧" or "∨" on the "SEEK•TRACK" button.

The radio seeks or scans for stations of the relevant program type.

■ Displaying radio station names

Press the "TEXT" button.

■ Displaying radio text messages

Press the "TEXT" button twice.

A text message is displayed when "MSG" is shown on the screen.

If the text continues past the end of the display, ► is displayed. Press and hold the button until you hear a beep.

XM[®] Satellite Radio

■ Receiving XM[®] Satellite Radio

- 1 Press the "AM•SAT" button.

The display changes as follows each time the button is pressed.

"AM" → "SAT1" → "SAT2" → "SAT3"

- 2 Turn the "TUNE•SEL" knob to select the desired channel in all the categories or press "∧" or "∨" on the "SEEK•TRACK" button to select the desired channel in the current category.

■ Setting XM[®] Satellite Radio channel presets

Select the desired channel. Press and hold the button (from the "1" button to the "6" button) the channel is to be set to until you hear a beep.

■ Changing the channel category

Press "∧" or "∨" on the "TYPE•FOLDER" button.

■ Scanning the XM[®] Satellite Radio channels

- Scanning the channels in the current category

- 1 Press the "SCAN" button.

- 2 When the desired channel is reached, press the button again.

- Scanning the preset channels

- 1 Press and hold the "SCAN" button until you hear a beep.

- 2 When the desired channel is reached, press the button again.

■ Displaying text information

Press the "TEXT" button.

The display will show up to 10 characters.

The display changes as follows each time the button is pressed:

- CH NAME
- TITLE (SONG/PROGRAM TITLE)
- NAME (ARTIST NAME/FEATURE)
- CH NUMBER

■ When the 12-volt battery is disconnected

All preset stations are erased.

■ Reception sensitivity

- Cargo loaded on the roof luggage carrier, especially metal objects, may adversely affect the reception of XM[®] Satellite Radio.
- Maintaining perfect radio reception at all times is difficult due to the continually changing position of the antenna, differences in signal strength and surrounding objects, such as trains, transmitters, etc.
- When the "SCAN" button is used, automatic station selection may not be possible.
- The radio antenna is mounted inside the rear window. To maintain clear radio reception, do not attach metallic window tinting or other metallic objects to the antenna wire mounted inside the rear window.

■ Receiving XM[®] Satellite Radio

An XM[®] Satellite Radio is a tuner designed exclusively to receive broadcasts provided under a separate subscription. Availability is limited to the 48 contiguous states and 10 Canadian provinces.

- XM[®] subscriptions
For detailed information about XM[®] Satellite Radio or to subscribe:
U.S.A. —
Visit on the web at www.xmradio.com or call 1-877-515-3987.
Canada —
Visit on the web at www.xmradio.ca or call 1-877-438-9677.
- Radio ID
You will need the radio ID when activating XM[®] service or reporting a problem. Select "CH000" using the "TUNE•SEL" knob, and the receiver's 8-character ID number will appear.
- Satellite tuner
The tuner supports only Audio Services (Music and Talk) and the accompanying Text Information of XM[®] Satellite Radio.
- Infotainment and Data services
XM offers a variety of advanced Infotainment and data services.

■ **If the satellite radio does not operate normally**

If a problem occurs with the XM[®] tuner, a message will appear on the display. Refer to the table below to identify the problem, and take the suggested corrective action.

| | |
|-----------|--|
| ANTENNA | The XM [®] antenna is not connected. Check whether the XM [®] antenna cable is attached securely. |
| | There is a short-circuit in the antenna or the surrounding antenna cable. See a Lexus certified dealer. |
| UNAUTH | You have not subscribed to the XM [®] Satellite Radio. The radio is being updated with the latest encryption code. Contact the XM [®] Satellite Radio for subscription information. When a contract is canceled, you can choose the "CH000" and all the free-to-air channels. |
| | The premium channel you selected is not authorized. Wait for about 2 seconds until the radio returns to the previous channel or "CH001". If it does not change automatically, select another channel. If you want to listen to the premium channel, contact the XM [®] Satellite Radio. |
| NO SIGNAL | The XM [®] signal is too weak at the current location. Wait until your vehicle reaches a location with a stronger signal. |
| LOADING | The unit is acquiring audio or program information. Wait until the unit has received the information. |
| OFF AIR | The channel you selected is not broadcasting any programming. Select another channel. |
| ----- | There is no song/program title or artist name/feature associated with the channel at that time. No action needed. |
| CH UNAVL | The channel you selected is no longer available. Wait for about 2 seconds until the radio returns to the previous channel or "CH001". If it does not change automatically, select another channel. |

Contact the XM[®] Listener Care Center at 1-877-515-3987 (U.S.A.) or 1-877-438-9677 (Canada).

■ Certifications for the radio tuner

This equipment has been tested and found to comply with the limits for a class B digital device, pursuant to Part 15 of the FCC Rules. These limits are designed to provide reasonable protection against harmful interference in a residential installation. This equipment generates, uses and can radiate radio frequency energy and, if not installed and used in accordance with the instructions, may cause harmful interference to radio communications. However, there is no guarantee that interference will not occur in a particular installation.

If this equipment does cause harmful interference to radio or television reception, which can be determined by turning the equipment off and on, the user is encouraged to try to correct the interference by trying one or more of the following:

- Reorienting or relocate the receiving antenna.
- Increasing the separation between the equipment and receiver.
- Connecting the equipment into an outlet on a circuit different from that to which the receiver is connected.
- Consulting the dealer or an experienced radio/TV technician for help.

CD player operation

Insert a disc or press the “CD•AUX” button to begin listening to a disc.

Control panel

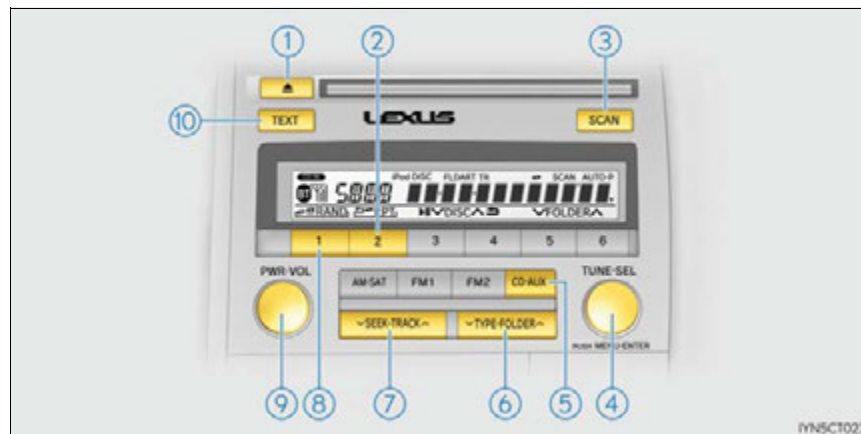

- | | |
|----------------------|---|
| ① CD eject | ⑦ Track/file selection |
| ② Repeat play | ⑧ Random play |
| ③ Search play | ⑨ Power/volume knob |
| ④ “TUNE•SEL” knob | Press: Turning the audio system on or off |
| Track/file selection | Turn: Adjusting the volume |
| ⑤ Playback | ⑩ Displaying text message |
| ⑥ Folder selection | |

Loading CDs or MP3 and WMA discs

Insert a CD.

Ejecting CDs or MP3 and WMA discs

Press  and remove the CD.

Using the CD player

■ Selecting a track

Press “^” to move up or “v” to move down using the “SEEK•TRACK” button until the desired track number appears on the displayed.

■ Fast-forwarding and reversing tracks

To fast-forward or reverse, press and hold “^” or “v” on the “SEEK•TRACK” button until you hear a beep.

■ Scanning tracks

- 1 Press the “SCAN” button.

The first 10 seconds of each track will be played.

To cancel, press the button again.

- 2 Press the button again when the desired track is reached.

■ Random play

Press the “1” button.

Songs are played in random order.

To cancel, press the button again.

■ Repeat play

Press the “2” button.

To cancel, press the button again.

■ Switching the display

Press the “TEXT” button.

Each time the button is pressed, the display changes in the following order:

Elapsed time → CD title → Track title

Playing back MP3 and WMA discs

■ Selecting a folder one at a time

Press “^” or “v” on the “TYPE•FOLDER” button to select the desired folder.

■ Returning to the first folder

Press and hold “v” on the “TYPE•FOLDER” button until you hear a beep.

■ Scanning the first file of all the folders

- 1 Press and hold the “SCAN” button until you hear a beep.

The first 10 seconds of the first file in each folder will be played.

- 2 When the desired folder is reached, press the button again.

■ Fast-forwarding and reversing files

To fast-forward or reverse, press and hold “^” or “v” on the “SEEK•TRACK” button until you hear a beep.

■ Selecting file

Turn the “TUNE•SEL” knob or press “^” or “v” on the “SEEK•TRACK” button to select the desired file.

■ Scanning the files in a folder

Press the “SCAN” button.

The first 10 seconds of each file will be played.

To cancel, press the button again.

When the desired file is reached, press the button again.

■ Random play

- ▶ Playing files from a folder in random order

Press the “1” button.

To cancel, press the button again.

- ▶ Playing all the files from a disc in random order

Press and hold the “1” button until you hear a beep.

To cancel, press the button again.

■ Repeat play

- ▶ Repeating a file

Press the “2” button.

To cancel, press the button again.

- ▶ Repeating all the files in a folder

Press and hold the “2” button until you hear a beep.

To cancel, press the button again.

■ Switching the display

Press the “TEXT” button.

Each time the button is pressed, the display changes in the following order: Folder no./File no./Elapsed time → Folder name → File name → Album title (MP3 only) → Track title → Artist name

■ **CD player protection feature**

To protect the internal components, playback is automatically stopped when a problem is detected.

■ **Display**

Up to 12 characters can be displayed at a time.
 If there are 13 or more characters, pressing and holding the "TEXT" button for 1 second or more enables to display the remaining characters.
 A maximum of 24 characters can be displayed.
 If the button is pressed for more than 1 second again or has not been operated for more than 6 seconds, the display will return to the first 12 characters.
 Depending on the contents recorded, the characters may not be displayed properly or may not be displayed at all.

■ **When "ERROR", "WAIT" or "NO MUSIC" is shown on the display**

"ERROR":
 This indicates a trouble either in the CD or inside the player. The CD may be dirty, damaged, or inserted up-side down.

"WAIT":
 This indicates that operation is stopped due to a high temperature inside the player. Wait for a while and then press the "CD•AUX" button. If the CD still cannot be played back, contact your Lexus dealer.

"NO MUSIC":
 This indicates that an MP3/WMA file is not included in the CD.

■ **Discs that can be used**

Discs with the marks shown below can be used.
 Playback may not be possible depending on recording format or disc features, or due to scratches, dirt or deterioration.



CDs with copy-protection features may not be used.

■ **Lens cleaners**

Do not use lens cleaners. Doing so may damage the CD player.

■ **If discs are left inside the CD player or in the ejected position for extended periods of time**

The discs may be damaged and may not play properly.

■ MP3 and WMA files

MP3 (MPEG Audio LAYER 3) is a standard audio compression format.

Files can be compressed to approximately 1/10 of their original size by using MP3 compression.

WMA (Windows Media Audio) is a Microsoft audio compression format.

This format compresses audio data to a size smaller than that of the MP3 format.

There is a limit to the MP3 and WMA file standards that can be used and to the media/formats on which the files are recorded.

● MP3 file compatibility

- Compatible standards
MP3 (MPEG1 LAYER3, MPEG2 LSF LAYER3)
- Compatible sampling frequencies
MPEG1 LAYER3: 32, 44.1, 48 (kHz)
MPEG2 LSF LAYER3: 16, 22.05, 24 (kHz)
- Compatible bit rates (compatible with VBR)
MPEG1 LAYER3: 64, 80, 96, 112, 128, 160, 192, 224, 256, 320 (kbps)
MPEG2 LSF LAYER3: 64, 80, 96, 112, 128, 144, 160 (kbps)
- Compatible channel modes: stereo, joint stereo, dual channel and monaural

● WMA file compatibility

- Compatible standards
WMA Ver. 7, 8, 9
- Compatible sampling frequencies
32, 44.1, 48 (kHz)
- Compatible bit rates (only compatible with 2-channel playback)
Ver. 7, 8: CBR 48, 64, 80, 96, 128, 160, 192 (kbps)
Ver. 9: CBR 48, 64, 80, 96, 128, 160, 192, 256, 320 (kbps)

● Compatible media

Media that can be used for MP3 and WMA playback are CD-Rs and CD-RWs.

Playback in some instances may not be possible if the CD-R or CD-RW is not finalized. Playback may not be possible or the audio may jump if the disc is scratched or marked with fingerprints.

● Compatible disc formats

The following disc formats can be used:

- Disc formats: CD-ROM Mode 1 and Mode 2
CD-ROM XA Mode 2, Form 1 and Form 2
- File formats: ISO9660 Level 1, Level 2, (Romeo, Joliet)
MP3 and WMA files written in any format other than those listed above may not play correctly, and their file names and folder names may not be displayed correctly.

Items related to standards and limitations are as follows:

- Maximum directory hierarchy: 8 levels (including the root)
- Maximum length of folder names/file names: 32 characters
- Maximum number of folders: 192 (including the root)
- Maximum number of files per disc: 255

- **File names**

The only files that can be recognized as MP3/WMA and played are those with the extension .mp3 or .wma.
- **Discs containing multi-session recordings**

As the audio system is compatible with multi-sessions, it is possible to play discs that contain MP3 and WMA files. However, only the first session can be played.
- **ID3 and WMA tags**

ID3 tags can be added to MP3 files, making it possible to record the track title, artist name, etc.

The system is compatible with ID3 Ver. 1.0, 1.1, and Ver. 2.2, 2.3 ID3 tags. (The number of characters is based on ID3 Ver. 1.0 and 1.1.)

WMA tags can be added to WMA files, making it possible to record the track title and artist name in the same way as with ID3 tags.
- **MP3 and WMA playback**

When a disc containing MP3 or WMA files is inserted, all files on the disc are first checked. Once the file check is finished, the first MP3 or WMA file is played. To make the file check finish more quickly, we recommend you do not write in any files other than MP3 or WMA files or create any unnecessary folders.

Discs that contain a mixture of music data and MP3 or WMA format data cannot be played.
- **Extensions**

If the file extensions .mp3 and .wma are used for files other than MP3 and WMA files, they will be mistakenly recognized and played as MP3 and WMA files. This may result in large amounts of interference and damage to the speakers.
- **Playback**
 - To play MP3 files with steady sound quality, we recommend a fixed bit rate of at least 128 kbps and a sampling frequency of 44.1 kHz.
 - CD-R or CD-RW playback may not be possible in some instances, depending on the characteristics of the disc.
 - There is a wide variety of freeware and other encoding software for MP3 and WMA files on the market, and depending on the status of the encoding and the file format, poor sound quality or noise at the start of playback may result. In some cases, playback may not be possible at all.
 - When files other than MP3 or WMA files are recorded on a disc, it may take more time to recognize the disc and in some cases, playback may not be possible at all.
 - Microsoft, Windows, and Windows Media are the registered trademarks of Microsoft Corporation in the U.S.A. and other countries.

 NOTICE**■ CDs and adapters that cannot be used**

Do not use the following types of CDs.

Also, do not use 3 in. (8 cm) CD adapters, DualDiscs or printable discs.

Doing so may damage the CD player and/or the CD load/eject function.

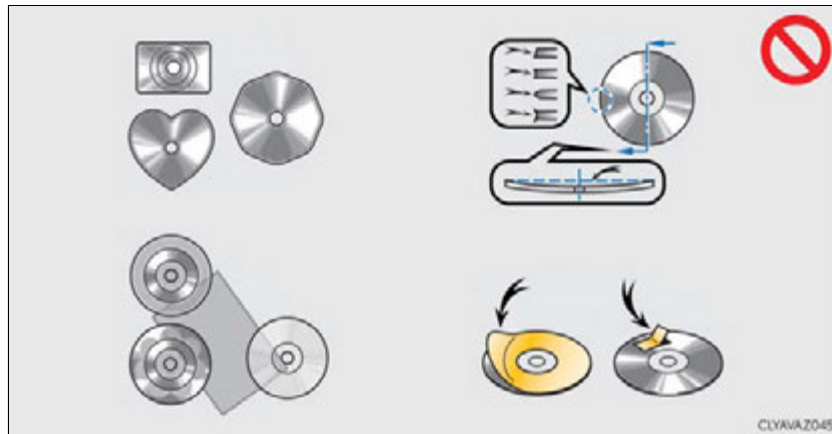

- Discs that have a diameter that is not 4.7 in. (12 cm).
- Low-quality or deformed discs.
- Discs with a transparent or translucent recording area.
- Discs that have tape, stickers or CD-R labels attached to them, or that have had the label peeled off.

■ CD player precautions

Failure to follow the precautions below may result in serious damage to the CDs or the player itself.

- Do not insert anything other than CDs into the CD slot.
- Do not apply oil to the CD player.
- Store CDs away from direct sunlight.
- Never try to disassemble any part of the CD player.

Listening to an iPod

Connecting an iPod enables you to enjoy music from the vehicle speakers. Press the “CD•AUX” button to select “iPod”.

Connecting an iPod

→P. 255

Control panel

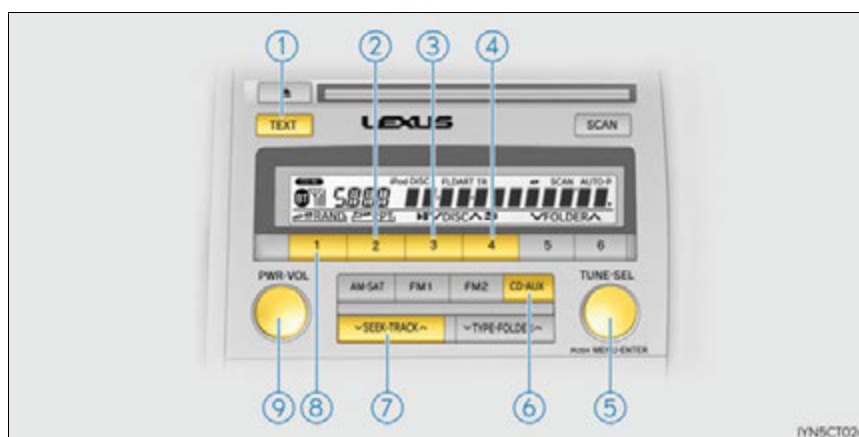

- | | |
|---|---|
| ① Displaying text message | ⑥ Playback |
| ② Repeat play | ⑦ Song selection |
| ③ Playback/pause | ⑧ Shuffle playback |
| ④ Go back | ⑨ Power/volume knob |
| ⑤ “TUNE•SEL” knob iPod menu/Song selection | Press: Turning the audio system on or off Turn: Adjusting the volume |

Selecting a play mode

- 1** Press the “TUNE•SEL” knob to select iPod menu mode.
- 2** Turning the knob changes the play mode in the following order:
 “PLAYLISTS” → “ARTISTS” → “ALBUMS” → “SONGS” →
 “PODCASTS” → “GENRES” → “COMPOSERS” →
 “AUDIOBOOKS”
- 3** Press the knob to select the desired play mode.

■ **Play mode list**

| Play mode | First selection | Second selection | Third selection | Fourth selection |
|--------------|------------------|------------------|-----------------|------------------|
| “PLAYLISTS” | Playlists select | Songs select | - | - |
| “ARTISTS” | Artists select | Albums select | Songs select | - |
| “ALBUMS” | Albums select | Songs select | - | - |
| “SONGS” | Songs select | - | - | - |
| “PODCASTS” | Albums select | Songs select | - | - |
| “GENRES” | Genre select | Artists select | Albums select | Songs select |
| “COMPOSERS” | Composers select | Albums select | Songs select | - |
| “AUDIOBOOKS” | Songs select | - | - | - |

■ **Selecting a list**

- 1** Turn the “TUNE•SEL” knob to display the first selection list.
- 2** Press the knob to select the desired item.
 Pressing the knob changes to the second selection list.
- 3** Repeat the same procedure to select the desired song name.
 To return to the previous selection list, select “GO BACK” or press the “4” button.

Selecting songs

Turn the "TUNE•SEL" knob or press "∧" or "∨" on the "SEEK•TRACK" button to select the desired song.

Playing and pausing songs

To play or pause a song, press the "3" button.

Fast-forwarding and rewinding songs

To fast-forward or rewind, press and hold "∧" or "∨" on the "SEEK•TRACK" button until you hear a beep.

Shuffle playback

■ Playing songs from one playlist or album in random order

Press the "1" button.

To cancel, press the button again.

■ Playing songs from all the playlists or albums in random order

Press and hold the "1" button until you hear a beep.

To cancel, press the button again.

Repeat play

Press the "2" button.

To cancel, press the button again.

Switching the display

Press the "TEXT" button.

Each time the button is pressed, the display changes in the following order: Elapsed time → Album title → Track title → Artist name

Adjusting sound quality and volume balance

- 1 Press the "TUNE•SEL" knob to enter iPod menu mode.
- 2 Pressing the knob changes sound modes. (→P. 257)

■ About iPod

- Apple is not responsible for the operation of this device or its compliance with safety and regulatory standards.
- iPod is a trademark of Apple, Inc., registered in the U.S. and other countries.

■ iPod functions

- When an iPod is connected and the audio source is changed to iPod mode, the iPod will resume play from the same point in which it was last used.
- Depending on the iPod that is connected to the system, certain functions may not be available. Disconnecting the device and reconnecting it once again may resolve some malfunctions.

■ iPod problems

To resolve most problems encountered when using your iPod, disconnect your iPod from the vehicle iPod connection and reset it.

For instructions on how to reset your iPod, refer to your iPod Owner's Manual.

■ Display

→P. 268

■ Error messages

"ERROR":

This indicates a problem in the iPod or its connection.

"NO MUSIC":

This indicates that there is no music data in the iPod.

"EMPTY":

This indicates that an empty playlist is selected.

"UPDATE":

This indicates that the version of the iPod is not compatible. Upgrade your iPod software to the latest version.

■ Compatible models

| Model | Generation | Software version [*] |
|--------------|------------------|-------------------------------|
| iPod | 5G | Ver. 1.3.0 or higher |
| iPod nano | 1G | Ver. 1.3.1 or higher |
| | 2G | Ver. 1.1.3 or higher |
| | 3G | Ver. 1.1.3 or higher |
| | 4G | Ver. 1.0.4 or higher |
| | 5G | Ver. 1.0.2 or higher |
| iPod touch | 1G | Ver. 2.1.0 or higher |
| | 2G | Ver. 3.1.3 or higher |
| | 3G | Ver. 3.1.3 or higher |
| iPod classic | 1G (80GB, 160GB) | Ver. 1.1.2 or higher |
| | 2G (120GB) | Ver. 2.0.1 or higher |
| | 2009 160GB | Ver. 2.0.4 or higher |
| iPhone | iPhone | Ver. 2.2.1 or higher |
| | iPhone 3G | Ver. 3.1.3 or higher |
| | iPhone 3GS | Ver. 3.1.3 or higher |
| | iPhone 4 | Ver. 4.0.0 or higher |

Depending on differences between models or software version etc., some models listed above might be incompatible with this system.

iPod 4G and earlier models are not compatible with this system.

iPod mini, iPod shuffle and iPod photo are not compatible with this system.

*: It is recommended to update your iPod/iPhone to the newest software version.

Items related to standards and limitations are as follows:

- Maximum number of lists in device: 9999
- Maximum number of songs in device: 65535
- Maximum number of songs per list: 65535

 **WARNING**

■ **Caution while driving**
Do not connect iPod or operate the controls.

 **NOTICE**

■ **To prevent damage to iPod**

- Do not leave iPod in the vehicle. The temperature inside the vehicle may become high, resulting in damage to the player.
- Do not push down on or apply unnecessary pressure to the iPod while it is connected as this may damage the iPod or its terminal.
- Do not insert foreign objects into the port as this may damage the iPod or its terminal.

Listening to a USB memory device

Connecting a USB memory enables you to enjoy music from the vehicle speakers. Press the “CD•AUX” button to select “USB”.

Connecting a USB memory

→P.255

Control panel

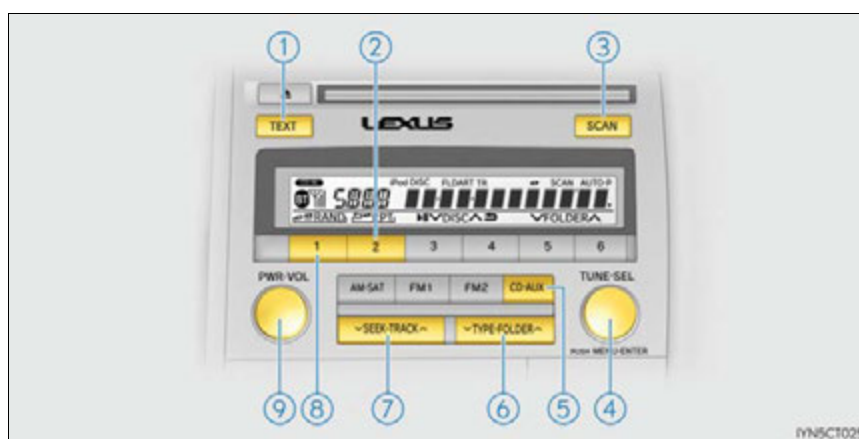

- | | |
|---------------------------|---|
| ① Displaying text message | ⑥ Folder selection |
| ② Repeat play | ⑦ File selection |
| ③ Search play | ⑧ Random play |
| ④ “TUNE•SEL” knob | ⑨ Power/volume knob |
| File selection | Press: Turning the audio system on or off |
| ⑤ Playback | Turn: Adjusting the volume |

Selecting and scanning a folder

■ Selecting folders one at a time

Press “^” or “v” on the “SEEK•TRACK” button to select the desired folder.

■ Returning to the first folder

Press and hold “v” on the “SEEK•TRACK” button until you hear a beep.

■ Scanning the first file of all the folders

- 1 Press and hold the “SCAN” button until you hear a beep.

The first ten seconds of the first file in each folder will be played.

- 2 When the desired folder is reached, press the button again.

Selecting and scanning files

■ Selecting a file

Turn the “TUNE•SEL” knob or press “^” or “v” on the “SEEK•TRACK” button to select the desired file.

■ Scanning the files in a folder

Press the “SCAN” button.

The first ten seconds of each file will be played.

To cancel, press the button again.

When the desired file is reached, press the button again.

Fast-forwarding and rewinding files

To fast-forward or rewind, press and hold “^” or “v” on the “SEEK•TRACK” button until you hear a beep.

Random play

■ Playing files from a folder in random order

Press the “1” button.

To cancel, press the button again.

■ Playing all the files from a USB memory in random order

Press and hold the “1” button until you hear a beep.

To cancel, press the button again.

Repeat play

■ Repeating a file

Press the "2" button.

To cancel, press the button again.

■ Repeating all the files in a folder

Press and hold the "2" button until you hear a beep.

To cancel, press the button again.

Switching the display

Press the "TEXT" button.

Each time the button is pressed, the display changes in the following order: Elapsed time → Folder name → File name → Album title → Track title → Artist name

■ USB memory functions

Depending on the USB memory that is connected to the system, certain functions may not be available. Disconnecting the device and reconnecting it once again may resolve some malfunctions.

■ Display

→P. 268

■ Error messages

"ERROR":

This indicates a problem in the USB memory or its connection.

"NO MUSIC":

This indicates that no MP3/WMA files are included in the USB memory.

■ USB memory

● Compatible devices

USB memory that can be used for MP3 and WMA playback

● Compatible device formats

The following device formats can be used:

- USB communication formats: USB2.0 FS (12mbps)
- File formats: FAT16/32 (Windows)
- Correspondence class: Mass storage class

MP3 and WMA files written in any format other than those listed above may not play correctly, and their file names and folder names may not be displayed correctly.

Items related to standards and limitations are as follows:

- Maximum directory hierarchy: 8 levels
- Maximum number of folders in a device: 999 (including the root)
- Maximum number of files in a device: 65025
- Maximum number of files per folder: 255

- **MP3 and WMA files**

MP3 (MPEG Audio LAYER 3) is a standard audio compression format. Files can be compressed to approximately 1/10 of their original size using MP3 compression.

WMA (Windows Media Audio) is a Microsoft audio compression format. This format compresses audio data to a size smaller than that of the MP3 format. There is a limit to the MP3 and WMA file standards that can be used and to the media/formats on which the files are recorded.
- **MP3 file compatibility**
 - Compatible standards
MP3 (MPEG1 AUDIO LAYERII, III, MPEG2 AUDIO LAYERII, III, MPEG2.5)
 - Compatible sampling frequencies
MPEG1 AUDIO LAYERII, III: 32, 44.1, 48 (kHz)
MPEG2 AUDIO LAYERII, III: 16, 22.05, 24 (kHz)
MPEG2.5: 8, 11.025, 12 (kHz)
 - Compatible bit rates (compatible with VBR)
MPEG1 AUDIO LAYERII, III: 32-320 (kbps)
MPEG2 AUDIO LAYERII, III: 32-160 (kbps)
MPEG2.5: 32-160 (kbps)
 - Compatible channel modes: stereo, joint stereo, dual channel and monaural
- **WMA file compatibility**
 - Compatible standards
WMA Ver. 9
 - Compatible sampling frequencies
HIGH PROFILE 32, 44.1, 48 (kHz)
 - Compatible bit rates
HIGH PROFILE 32-320 (kbps, VBR)
- **File names**

The only files that can be recognized as MP3/WMA and played are those with the extension .mp3 or .wma.
- **ID3 and WMA tags**

ID3 tags can be added to MP3 files, making it possible to record the track title, artist name, etc.

The system is compatible with ID3 Ver. 1.0, 1.1, and Ver. 2.2, 2.3, 2.4 ID3 tags. (The number of characters is based on ID3 Ver. 1.0 and 1.1.)

WMA tags can be added to WMA files, making it possible to record the track title and artist name in the same way as with ID3 tags.
- **MP3 and WMA playback**
 - When a device containing MP3 or WMA files is connected, all files in the USB memory device are checked. Once the file check is finished, the first MP3 or WMA file is played. To make the file check finish more quickly, we recommend that you do not include any files other than MP3 or WMA files or create any unnecessary folders.
 - When the USB device is connected and the audio source is changed to USB memory mode, the USB device will start playing the first file in the first folder. If the same device is removed and reinserted (and the contents have not been changed), the USB device will resume play from the same point in which it was last used.

● Extensions

If the file extensions .mp3 and .wma are used for files other than MP3 and WMA files, they will be mistakenly recognized and played as MP3 and WMA files. This may result in large amounts of interference and damage to the speakers.

● Playback

- To play MP3 files with steady sound quality, we recommend a fixed bit rate of at least 128 kbps and a sampling frequency of 44.1 kHz.
- There is a wide variety of freeware and other encoding software for MP3 and WMA files on the market, and depending on the status of the encoding and the file format, poor sound quality or noise at the start of playback may result. In some cases, playback may not be possible at all.
- Microsoft, Windows, and Windows Media are registered trademarks of Microsoft Corporation in the U.S.A. and other countries.

 **WARNING**

■ **Caution while driving**

Do not connect USB memory or operate the controls.

 **NOTICE**

■ **To prevent damage to USB memory**

- Do not leave USB memory in the vehicle. The temperature inside the vehicle may become high, resulting in damage to the player.
- Do not push down on or apply unnecessary pressure to the USB memory while it is connected as this may damage the USB memory or its terminal.
- Do not insert foreign objects into the port as this may damage the USB memory or its terminal.

Using the AUX port

This port can be used to connect a portable audio device and listen to it through the vehicle's speakers. Press the "CD•AUX" button to select "AUX".

Connecting a portable player

→P. 255

- **Operating portable audio devices connected to the audio system**
The volume can be adjusted using the vehicle's audio controls. All other adjustments must be made on the portable audio device itself.
- **When using a portable audio device connected to the power outlet**
Noise may occur during playback. Use the power source of the portable audio device.

NOTICE

- **To prevent damage to portable audio device**
 - Do not leave portable audio devices in the vehicle. The temperature inside the vehicle may become high, resulting in damage to the device.
 - Do not push down on or apply unnecessary pressure to the portable audio device while it is connected as this may damage the portable audio device or its terminal.
 - Do not insert foreign objects into the port as this may damage the portable audio device or its terminal.

Bluetooth® audio/phone

The following can be performed using Bluetooth® wireless communication:

■ **Bluetooth® audio**

The Bluetooth® audio system enables you to enjoy music played on a portable digital audio player (portable player) from the vehicle speakers via wireless communication.

This audio system supports Bluetooth®, a wireless data system capable of playing portable audio music without cables. If your portable player does not support Bluetooth®, the Bluetooth® audio system will not function.

■ **Bluetooth® phone (hands-free phone system)**

This system supports Bluetooth®, which allows you to make or receive calls without using cables to connect a cellular phone and the system, and without operating the cellular phone.

Device registration/connection flow

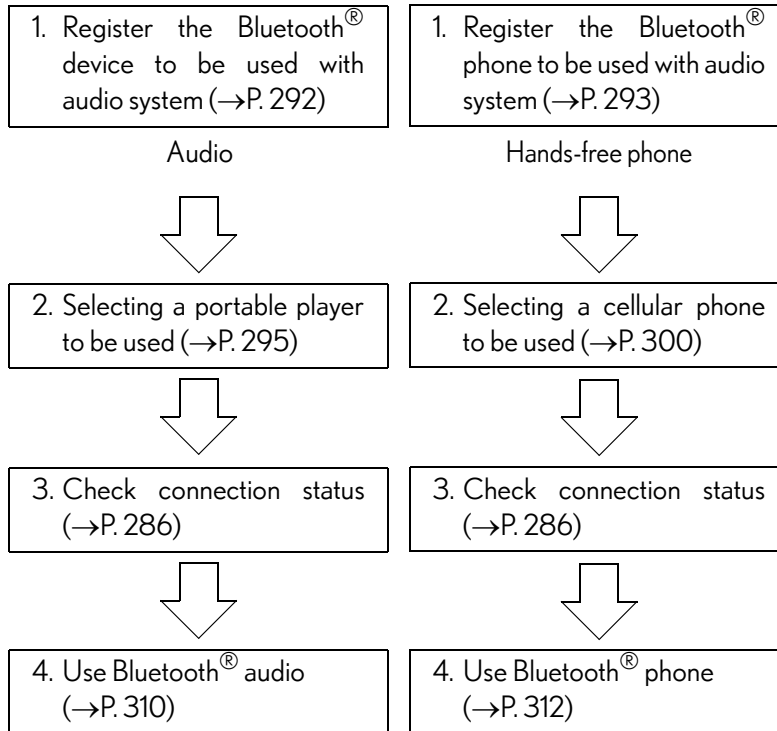

Audio unit

① Display

A message, name, number, etc. is displayed.

Lower-case characters and special characters may not be displayed.

② Press and hold: Displays information that is too long to be displayed at one time on the display

③ Selects speed dials (Bluetooth® phone operation)

④ “TUNE•SEL” knob

Displays set up menu or selects items such as menu and number

Turn: Selects an item

Press: Displays set up menu or inputs the selected item

⑤ Bluetooth® connection condition

If “BT” is not displayed, the Bluetooth® audio/phone cannot be used.

⑥ Reception level

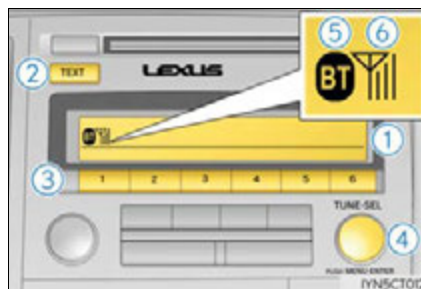

Microphone

The vehicle’s built-in microphone is used when talking on the phone.

The person you are speaking to can be heard from the front speakers.



To use the hands-free system, you must register your Bluetooth® phone in the system. (→P. 293)

Operating the system using voice commands

By following voice guidance instructions output from the speaker, voice commands enable the operation of the Bluetooth® audio system without the need to check the display or operate the “TUNE•SEL” knob.

■ Operation procedure when using voice commands

Press the talk switch and follow voice guidance instructions.

■ Auxiliary commands when using voice commands

The following auxiliary commands can be used when operating the system using a voice command:

“Cancel”: Exits the Bluetooth® audio system and the hands-free phone system

“Repeat”: Repeats the previous voice guidance instruction

“Go back”: Returns to the previous procedure

“Help”: Reads aloud the function summary if a help comment is registered for the selected function

Menu list of the Bluetooth® audio/phone

■ Normal operation

▶ Audio (→P. 294)

| First menu | Second menu | Third menu | Operation detail |
|------------|-------------|----------------|---|
| "BTA MENU" | "BTA Setup" | "Pair Audio" | Registering a portable player |
| | | "Connect" | Selecting a portable player to be used |
| | | "Change Name" | Changing the registered name of a portable player |
| | | "List Audios" | Listing the registered portable players |
| | | "Set Passkey" | Changing the passkey |
| | | "Delete Audio" | Deleting a registered portable player |

▶ Phone

| First menu | Second menu | Third menu | Operation detail |
|-----------------------|----------------|------------|---|
| "Callback" | - | - | Dialing a number stored in the incoming call history memory |
| "Redial" | - | - | Dialing a number stored in the outgoing call history memory |
| "Phonebook" (→P. 305) | "Add Entry" | - | Adding a new phone number |
| | "Change Name" | - | Changing the registered name in the phone book |
| | "Delete Entry" | - | Deleting the registered data |
| | "Del Spd Dial" | - | Deleting speed dials |
| | "List Names" | - | Listing the registered data |
| | "Speed Dial" | - | Setting speed dials |

| First menu | Second menu | Third menu | Operation detail |
|--------------|-----------------------------|-------------------------|---|
| "Setup" | "Security" (→P. 302) | "Set PIN" | Setting a PIN code |
| | | "Phbk Lock" | Locking the phone book |
| | | "Phbk Unlock" | Unlocking the phone book |
| | "Phone Setup" (→P. 299) | "Pair Phone" | Registering the cellular phone to be used |
| | | "Connect" | Selecting a cellular phone to be used |
| | | "Change Name" | Changing a registered name of a cellular phone |
| | | "List Phones" | Listing the registered cellular phones |
| | | "Set Passkey" | Changing the passkey |
| | | "Delete Phone" | Deleting a registered cellular phone |
| | "System Setup" (→P. 302) | "Guidance Vol" | Setting voice guidance volume |
| | | "Device Name" | Displaying the Bluetooth® device address and name |
| "Initialize" | | Initializing the system | |

■ Using a short cut key

| First menu | Second menu | Operation detail |
|--------------------------------|--------------------|--|
| "Dial XXX (name)" | - | Dialing a name registered in the phone book |
| "Phone book add Entry" | - | Adding a new phone number |
| "Phone book Change name" | - | Changing a registered name in the phone book |
| "Phone book Delete Entry" | - | Deleting the registered data |
| "Phone book List names" | - | Listing the registered data |
| "Phone book Set Speed Dial" | - | Setting speed dials |
| "Phone book Delete Speed Dial" | - | Deleting speed dials |
| "Dial XXX (number)" | - | Dialing by inputting a number |
| "Phonebook" | "Phonebook Unlock" | Unlocking the phone book |
| | "Phonebook Lock" | Locking the phone book |

■ Automatic volume adjustment

When vehicle speed reaches 50 mph (80 km/h) or more, the volume automatically increases. The volume returns to the previous volume setting when vehicle speed drops to 43 mph (70 km/h) or less.

■ When using a voice command

For numbers, say a combination of single digits from zero to nine, # (pound), * (star), and + (plus).

Say the command correctly and clearly.

■ Situations that the system may not recognize your voice

- When driving on rough roads
- When driving at high speeds
- When air is blowing out of the vents onto the microphone
- When the air conditioning fan emits a loud noise

■ Operations that cannot be performed while driving

- Operating the system with the "TUNE•SEL" knob.
- Registering a portable player or cellular phone to the system

Using the steering wheel switches

The steering wheel switches can be used to operate a connected cellular phone, or portable digital audio player (portable player) (→P. 254).

Operating Bluetooth® device using the steering wheel switches

- ① Volume
The voice guidance volume cannot be adjusted using this button.
- ② Off-hook switch
Turns the hands-free system on/
starts a call
- ③ On-hook switch
Turns the hands-free system off/ends
a call/refuses a call
- ④ Talk switch
Turns the voice command system on (press)/turns the voice command system
off (press and hold)

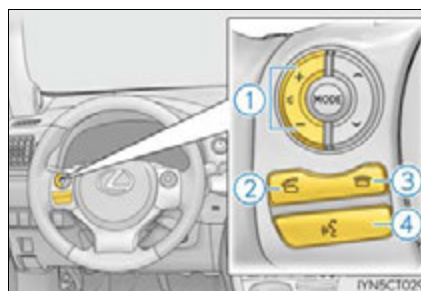

Registering a Bluetooth® audio system for the first time

Before using the Bluetooth® audio system, it is necessary to register a Bluetooth® enabled portable player in the system. Follow the procedure below to register (pair) a portable player:

1 Press the “CD•AUX” button and select “BTA MENU” using the “TUNE•SEL” knob.

2 Press the talk switch or select “BTA Setup” using the knob.

The introductory guidance and portable player name registration instructions are heard.

3 Select “Pair Audio Player (Pair Audio)” using a voice command or the knob.

4 Register a portable player name by either of the following methods:

- a. Select “Record Name” using the knob, and say the name to be registered.
- b. Press the talk switch and say the name to be registered.

A voice guidance instruction to confirm the input is heard.

5 Select “Confirm” using a voice command or the knob.

A passkey is displayed and heard, and a voice guidance instruction for inputting the passkey into the portable player is heard.

6 Input the passkey into the portable player.

Refer to the manual that comes with the portable player for the operation of the portable player.

Guidance for registration completion is heard.

If the portable player has a Bluetooth® phone, the phone can be registered at the same time. A voice guidance instruction to register a Bluetooth® phone is heard.

7 Select “Yes” or “No” using a voice command or the knob.
(Bluetooth® phone →P. 317)

■ Changing the passkey

→P. 297

Registering a Bluetooth® phone for the first time

Before using the hands-free phone system, it is necessary to register a cellular phone in the system. The system will enter phone registration mode automatically when starting the system with no cellular phone registered. Follow the procedure below to register (pair) a cellular phone:

- 1** Press the off-hook switch or the talk switch.
The introductory guidance and phone name registration instructions are heard.
- 2** Select “Pair Phone” using a voice command or the “TUNE•SEL” knob.
- 3** Register a phone name by either of the following methods:
 - a. Select “Record Name” using the knob, and say the name to be registered.
 - b. Press the talk switch and say the name to be registered.A voice guidance instruction to confirm the input is heard.
- 4** Select “Confirm” using a voice command or the knob.
A passkey is displayed and heard, and a voice guidance instruction for inputting the passkey into the cellular phone is heard.
- 5** Input the passkey into the cellular phone.
Refer to the manual that comes with the cellular phone for the operation of the phone. Guidance for registration completion is heard.
If the cellular phone has a Bluetooth® audio player, the audio player can be registered at the same time. A voice guidance instruction to register a Bluetooth® audio player is heard.
- 6** Select “Yes” or “No” using a voice command or the knob.
(Bluetooth® audio player →P. 317)

-
- **Changing the passkey**
→P. 301

Setting up a Bluetooth[®] enabled portable player

Registering a portable player in the Bluetooth[®] audio system allows the system to function. The following functions can be used for registered portable players:

Functions and operation procedures

▶ Pattern A

To enter the menu for each function, follow the steps below using a voice command or the "TUNE•SEL" knob:

- Registering a portable player
 1. "Setup" → 2. "Bluetooth Audio Setup (BTA Setup)" → 3. "Pair Audio Player (Pair Audio)"
- Selecting a portable player to be used
 1. "Setup" → 2. "Bluetooth Audio Setup (BTA Setup)" → 3. "Connect Audio Player (Connect)"
- Changing the registered name of a portable player
 1. "Setup" → 2. "Bluetooth Audio Setup (BTA Setup)" → 3. "Change Name"
- Listing the registered portable players
 1. "Setup" → 2. "Bluetooth Audio Setup (BTA Setup)" → 3. "List Audio Players (List Audios)"
- Changing the passkey
 1. "Setup" → 2. "Bluetooth Audio Setup (BTA Setup)" → 3. "Set Passkey"
- Deleting a registered portable player
 1. "Setup" → 2. "Bluetooth Audio Setup (BTA Setup)" → 3. "Delete Audio Player (Delete Audio)"

- ▶ Pattern B
- 1** Press the “CD•AUX” button and select “BTA MENU” using the “TUNE•SEL” knob.
- 2** Press the talk switch or select “BTA Setup” using the knob.
- 3** Select one of the following functions using a voice command or the knob.
 - Registering a portable player
“Pair Audio Player (Pair Audio)”
 - Selecting a portable player to be used
“Connect Audio Player (Connect)”
 - Changing the registered name
“Change Name”
 - Listing the registered portable players
“List Audio Players (List Audios)”
 - Changing the passkey
“Set Passkey”
 - Deleting a registered portable player
“Delete Audio Player (Delete Audio)”

Registering a portable player

Select “Pair Audio Player (Pair Audio)” using a voice command or the “TUNE•SEL” knob, and perform the procedure for registering a portable player. (→P. 292)

Selecting a portable player to be used

- 1** Select “Connect Audio Player (Connect)” using a voice command or the “TUNE•SEL” knob.
 - ▶ Pattern A
 - 2** Select the portable player to be used by either of the following methods, and select “Confirm” by using a voice command or the knob:
 - a. Press the talk switch and say the name of the desired portable player.
 - b. Press the talk switch and say “List Audio Players”. When the name of the desired portable player is read aloud, press the talk switch.
 - ▶ Pattern B
- 2** Select the portable player to be used using the knob.

- ▶ Pattern A
- 3 Press the talk switch and say “From Car” or “From Audio player”, and select “Confirm” by using a voice command or the knob.
- ▶ Pattern B
- 3 Select “From Car” or “From Audio”, using the knob.
If “From Car” is selected, the portable player will be automatically connected whenever the power switch is in either ACCESSORY or ON mode.

Changing the registered name of a portable player

- 1 Select “Change Name” using a voice command or the “TUNE•SEL” knob.
 - ▶ Pattern A
 - 2 Select the name of the portable player to be changed by either of the following methods, and select “Confirm” using a voice command or the knob:
 - a. Press the talk switch and say the name of desired portable player.
 - b. Press the talk switch and say “List Audio Players”. When the name of the desired portable player is read aloud, press the talk switch.
 - ▶ Pattern B
 - 2 Select the desired portable player name to be changed using the knob.
 - 3 Press the talk switch or select “Record Name” using the knob, and say the new name.
 - 4 Select “Confirm” using a voice command or the knob.

Listing the registered portable players

Select “List Audio Players (List Audios)” using a voice command or the “TUNE•SEL” knob. The list of registered portable players will be read aloud. When listing is complete, the system returns to “BTA Setup”.

Pressing the talk switch while the name of a portable player is being read aloud selects the portable player, and the following functions will become available:

- Selecting a portable player: “Connect Audio Player (Connect)”
- Changing a registered name: “Change Name”
- Deleting a portable player: “Delete Audio Player (Delete Audio)”

Changing the passkey

- 1 Select "Set Passkey" using a voice command or the "TUNE•SEL" knob.
 - ▶ Pattern A
- 2 Press the talk switch, say a 4 to 8-digit number, and select "Confirm" using a voice command or the knob.

The number should be input 1 digit at a time.

 - ▶ Pattern B
- 2 Select a 4 to 8-digit number using the knob.

The number should be input 1 digit at a time.
- 3 When the entire number to be registered as a passkey has been input, press the knob again.

If the number to be registered has 8 digits, pressing of the knob is not necessary.

Deleting a registered portable player

- 1 Select "Delete Audio Player (Delete Audio)" using a voice command or the "TUNE•SEL" knob.
 - ▶ Pattern A
- 2 Select the portable player to be deleted by either of the following methods and select "Confirm" using a voice command or the knob:
 - a. Press the talk switch and say the name of the desired portable player.
 - b. Press the talk switch and say "List Audio Players". When the name of the desired portable player is read aloud, press the talk switch.
 - ▶ Pattern B
- 2 Select the desired portable player to be deleted using the knob.

If the portable player to be deleted is paired as a Bluetooth[®] phone, the registration of the cellular phone can be deleted at the same time. A voice guidance instruction to delete a cellular phone is heard.
- 3 Select "Yes" or "No" using a voice command or the knob.

(Bluetooth[®] phone →P. 317)

■ The number of portable players that can be registered

Up to 2 portable players can be registered in the system.

Bluetooth® audio system setup

System setup items and operation procedures

To enter the menu for each function, follow the steps below using a voice command or the "TUNE•SEL" knob:

(→P. 302)

- Setting voice guidance volume
"Guidance Vol" (→P. 303)
- Displaying the Bluetooth® device address and name
"Device Name" (→P. 303)
- Initializing the system
"Initialize" (→P. 303)

Setting a cellular phone

Registering a cellular phone in the hands-free phone system allows the system to function. The following functions can be used for registered cellular phones:

Functions and operation procedures

To enter the menu for each function, follow the steps below using a voice command or the "TUNE•SEL" knob:

- Registering a cellular phone
 1. "Setup" → 2. "Phone Setup" → 3. "Pair Phone"
- Selecting a cellular phone to be used
 1. "Setup" → 2. "Phone Setup" → 3. "Connect Phone (Connect)"
- Changing the registered name of a cellular phone
 1. "Setup" → 2. "Phone Setup" → 3. "Change Name"
- Listing the registered cellular phones
 1. "Setup" → 2. "Phone Setup" → 3. "List Phones"
- Changing the passkey
 1. "Setup" → 2. "Phone Setup" → 3. "Set Passkey"
- Deleting a registered cellular phone
 1. "Setup" → 2. "Phone Setup" → 3. "Delete Phone"

Registering a cellular phone

Select "Pair Phone" using a voice command or the "TUNE•SEL" knob, and perform the procedure for registering a cellular phone. (→P. 293)

Selecting a cellular phone to be used

- 1 Select "Connect Phone (Connect)" using a voice command or the "TUNE•SEL" knob.
 - ▶ Pattern A
- 2 Select the cellular phone to be used by either of the following methods, and select "Confirm" by using a voice command or the knob:
 - a. Press the talk switch and say the name of the desired cellular phone.
 - b. Press the talk switch and say "List Phones". When the name of the desired cellular phone is read aloud, press the talk switch.
 - ▶ Pattern B
- 2 Select the cellular phone to be used using the knob.

Changing the registered name of a cellular phone

- 1 Select "Change Name" using a voice command or the "TUNE•SEL" knob.
 - ▶ Pattern A
- 2 Select the name of the cellular phone to be changed by either of the following methods, and select "Confirm" using a voice command or the knob:
 - a. Press the talk switch and say the name of the desired cellular phone.
 - b. Press the talk switch and say "List Phones". When the name of the desired cellular phone is read aloud, press the talk switch.
 - ▶ Pattern B
- 2 Select the desired cellular phone name to be changed using the knob.
- 3 Press the talk switch or select "Record Name" using the knob, and say the new name.
- 4 Select "Confirm" using a voice command or the knob.

Listing the registered cellular phones

Select "List Phones" using a voice command or the "TUNE•SEL" knob. The list of registered cellular phones will be read aloud.

When listing is complete, the system returns to "Phone Setup".

Pressing the talk switch while the name of a cellular phone is being read aloud selects the cellular phone, and the following functions will become available:

- Selecting a cellular phone: "Connect Phone (Connect)"
- Changing a registered name: "Change Name"
- Deleting a cellular phone: "Delete Phone"

Changing the passkey

- 1 Select "Set Passkey" using a voice command or the "TUNE•SEL" knob.
 - ▶ Pattern A
- 2 Press the talk switch, say a 4 to 8-digit number, and select "Confirm" using a voice command or the knob.
 - ▶ Pattern B
- 2 Select a 4 to 8-digit number using the knob.

The number should be input 1 digit at a time.
- 3 When the entire number to be registered as a passkey has been input, press the knob again.

If the number to be registered has 8 digits, pressing of the knob is not necessary.

Deleting a registered cellular phone

- 1 Select "Delete Phone" using a voice command or the "TUNE•SEL" knob.
 - ▶ Pattern A
- 2 Select the cellular phone to be deleted by either of the following methods and select "Confirm" using a voice command or the knob:
 - a. Press the talk switch and say the name of the desired cellular phone.
 - b. Press the talk switch and say "List Phones". When the name of the desired cellular phone is read aloud, press the talk switch.
 - ▶ Pattern B
- 2 Select the desired cellular phone to be deleted using the knob.

If the cellular phone to be deleted is paired as a Bluetooth[®] audio player, the registration of the audio player can be deleted at the same time. A voice guidance instruction to delete a Bluetooth[®] audio player is heard.
- 3 Select "Yes" or "No" using a voice command or the knob.

(Bluetooth[®] audio player →P. 317)

■ The number of cellular phones that can be registered

Up to 6 cellular phones can be registered in the system.

Security and system setup

Security setting items and operation procedures

To enter the menu for each function, follow the steps below using a voice command or the "TUNE•SEL" knob:

- Setting or changing the PIN (Personal Identification Number)
 1. "Setup" → 2. "Security" → 3. "Set PIN"
- Locking the phone book
 1. "Setup" → 2. "Security" → 3. "Phonebook Lock (Phbk Lock)"
- Unlocking the phone book
 1. "Setup" → 2. "Security" → 3. "Phonebook Unlock (Phbk Unlock)"

System setup items and operation procedures

To enter the menu for each function, follow the steps below using the "TUNE•SEL" knob:

- Setting voice guidance volume
 1. "Setup" → 2. "System Setup" → 3. "Guidance Vol"
- Displaying the Bluetooth® device address and name
 1. "Setup" → 2. "System Setup" → 3. "Device Name"
- Initializing the system
 1. "Setup" → 2. "System Setup" → 3. "Initialize"

Setting or changing the PIN

■ Setting a PIN

- 1 Select "Set PIN" using a voice command or the "TUNE•SEL" knob.
- 2 Enter a PIN using a voice command or the knob.
When using the "TUNE•SEL" knob, input the code 1 digit at a time.

■ Changing the PIN

- 1 Select "Set PIN" using a voice command or the "TUNE•SEL" knob.
- 2 Enter the registered PIN using a voice command or the knob.
- 3 Enter a new PIN using a voice command or the knob.
When using the knob, input the code 1 digit at a time.

Locking or unlocking the phone book

- 1 Select "Phonebook Lock (Phbk Lock)" or "Phonebook Unlock (Phbk Unlock)" using a voice command or the "TUNE•SEL" knob.
- 2 Input the PIN by either of the following methods and select "Confirm" using a voice command or the knob:
 - a. Press the talk switch and say the registered PIN.
 - b. Input a new PIN using the knob.

Setting voice guidance volume

- 1 Select "Guidance Vol" using the "TUNE•SEL" knob.
- 2 Change the voice guidance volume.
 - To decrease the volume: Turn the knob counterclockwise.
 - To increase the volume: Turn the knob clockwise.

Displaying the Bluetooth® device address and name

- 1 Select "Device Name" using the "TUNE•SEL" knob.
- 2 Turn the knob to display the Bluetooth® device address and name.
- 3 Select "Go Back" using the knob to return to "System Setup".

Initializing the system

- 1 Select "Initialize" and then "Confirm" using the "TUNE•SEL" knob.
- 2 Select "Confirm" again using the knob.

■ **Initialization**

● The following data in the system can be initialized:

- Phone book
- Outgoing and incoming call history
- Speed dials
- Registered cellular phone data
- Security code
- Registered Bluetooth[®] enabled portable player data
- Passkey for the cellular phones
- Passkey for the Bluetooth[®] audio players
- Guidance volume
- Receiver volume
- Ring tone volume

● Once the initialization has been completed, the data cannot be restored to its original state.

■ **When the phone book is locked**

The following functions cannot be used:

- Dialing by inputting a name
- Speed dialing
- Dialing a number stored in the call history memory
- Using the phone book

Using the phone book

To enter the menu for each function, follow the steps below using a voice command or the "TUNE•SEL" knob:

- Adding a new phone number
 1. "Phonebook" → 2. "Add Entry"
- Changing the registered name in the phone book
 1. "Phonebook" → 2. "Change Name"
- Listing the registered data
 1. "Phonebook" → 2. "List Names"
- Setting speed dials
 1. "Phonebook" → 2. "Set Speed Dial (Speed Dial)"
- Deleting the registered data
 1. "Phonebook" → 2. "Delete Entry"
- Deleting speed dials
 1. "Phonebook" → 2. "Delete Speed Dial (Del Spd Dial)"

Adding a new phone number

The following methods can be used to add a new phone number:

- Inputting a phone number using a voice command
- Transferring data from the cellular phone
- Inputting a phone number using the "TUNE•SEL" knob
- Selecting a phone number from outgoing or incoming call history

■ **Adding procedure**

- 1 Select "Add Entry" using a voice command or the "TUNE•SEL" knob.
- 2 Use one of the following methods to input a telephone number:

Inputting a telephone number using a voice command:

STEP2-1 Select "By Voice" using a voice command or the knob.

STEP2-2 Press the talk switch, say the desired number, and select "Confirm" using a voice command.

Transferring data from the cellular phone:

STEP2-1 Select "By Phone" and then "Confirm" using a voice command or the knob.

STEP2-2 Transfer the data from the cellular phone.

Refer to the manual that comes with the cellular phone for the details of transferring data.

STEP2-3 Select the data to be registered by either of the following methods:

- a. Say "Previous" or "Next" until the desired data is displayed, and select "Confirm" using a voice command.
- b. Select the desired data using the knob.

Inputting a phone number using the knob:

STEP2-1 Select "Manual Input" using the knob.

STEP2-2 Input a phone number using the knob, and press the knob again. Input the phone number 1 digit at a time.

Selecting a phone number from outgoing or incoming call history:

STEP2-1 Select "Call History" using a voice command or the knob.

STEP2-2 Select "Outgoing" or "Incoming" using a voice command or the knob.

STEP2-3 Select the data to be registered by either of the following methods:

- a. Say "Previous" or "Go back" until the desired data is displayed, and select "Confirm" using a voice command.
- b. Select the desired data using the knob.

- 3 Select the name to be registered by either of the following methods, and select “Confirm” using a voice command or the knob:
 - a. Press the talk switch and say the desired name.
 - b. Select “Record Name” using the knob, and say the desired name.
- 4 Select “Confirm” using a voice command or the knob.

In step 4, selecting “Set Speed Dial (Speed Dial)” instead of “Confirm” registers the newly added phone number as a speed dial.

Changing the registered name in the phone book

- 1 Select “Change Name” using a voice command or the “TUNE•SEL” knob.
 - ▶ Pattern A
- 2 Select the name to be changed by either of the following methods, and select “Confirm” using a voice command or the knob:
 - a. Press the talk switch, say the desired name.
 - b. Press the talk switch, and say “List Names”. When the desired name is read aloud, press the talk switch.
 - ▶ Pattern B
- 2 Select the desired name to be changed using the knob.
- 3 Press the talk switch or select “Record Name” using the knob, and say the new name.
- 4 Select “Confirm” using a voice command or the knob.

Listing the registered data

Select “List Names” using a voice command or the “TUNE•SEL” knob. The list of the registered data will be read aloud.

When listing is complete, the system returns to the “Phonebook”.

Pressing the talk switch while the desired data is being read aloud selects the data, and the following function will become available:

- Dialing: “Dial”
- Changing a registered name: “Change Name”
- Deleting an entry: “Delete Entry”
- Setting a speed dial: “Set Speed Dial (Speed Dial)”

Setting speed dials

- 1** Select “Set Speed Dial (Speed Dial)” using a voice command or the “TUNE•SEL” knob.
 - ▶ Pattern A
- 2** Select the data to be registered as a speed dial by either of the following methods, and select “Confirm” using a voice command or the knob:
 - a. Press the talk switch, say the desired name.
 - b. Press the talk switch, and say “List Names”. When the desired name is read aloud, press the talk switch.
 - ▶ Pattern B
- 2** Select the desired data using the knob.
- 3** Select the desired preset button, and register the data into speed dial by either of the following methods:
 - a. Press the desired preset button, and select “Confirm” by using a voice command or the knob.
 - b. Press and hold the desired preset button.

Deleting the registered data

- 1** Select “Delete Entry” using a voice command or the “TUNE•SEL” knob.
 - ▶ Pattern A
- 2** Select the data to be deleted by either of the following methods, and select “Confirm” using a voice command or the knob:
 - a. Press the talk switch, and say the name of the desired phone number.
 - b. Press the talk switch, say “List Names”. When the name of the desired phone number is read aloud, press the talk switch.
 - ▶ Pattern B
- 2** Select the desired data to be deleted using the knob.

Deleting speed dials

- 1 Select "Delete Speed Dial (Del Spd Dial)" using a voice command or the "TUNE•SEL" knob.
- 2 Press the preset button to which the desired speed dial is registered, and select "Confirm" using a voice command or the knob.

■ Limitation of number of digits

A phone number that exceeds 24 digits cannot be registered.

Operating a Bluetooth® enabled portable player

Control panel

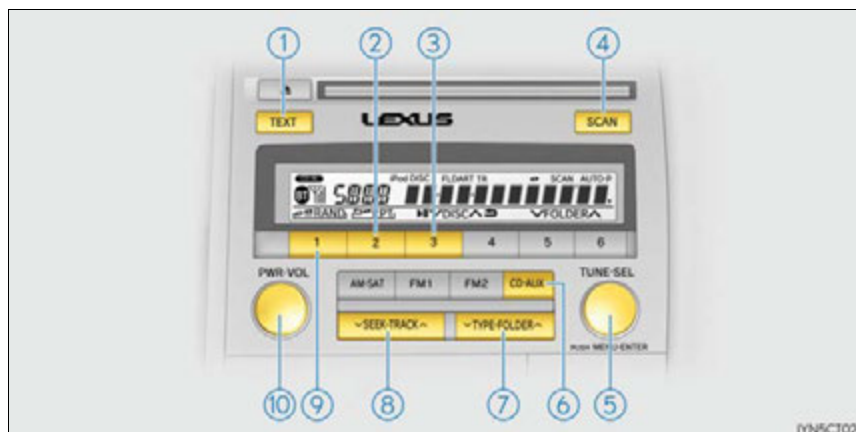

- | | |
|---------------------------|---|
| ① Displaying text message | ⑦ Album selection |
| ② Repeat play | ⑧ Track selection |
| ③ Playback/pause | ⑨ Random play |
| ④ Search play | ⑩ Power/volume knob |
| ⑤ "TUNE•SEL" knob | Press: Turning the audio system on or off |
| BT•A menu | Turn: Adjusting the volume |
| ⑥ Playback | |

Selecting an album

Press “^” or “v” on the “TYPE•FOLDER” button to select the desired album.

Selecting tracks

Press “^” or “v” on the “SEEK•TRACK” button to select the desired track.

Playing and pausing tracks

To play or pause a track, press the “3” button.

Fast-forwarding and rewinding tracks

To fast-forward or rewind, press and hold “^” or “v” on the “SEEK•TRACK” button until you hear a beep.

Random play

Press the “1” button.

To cancel, press the button again.

Repeat play

Press the “2” button.

To cancel, press the button again.

Scanning tracks

Press the “SCAN” button.

To cancel, press the button again.

Switching the display

Press the “TEXT” button.

Each time the button is pressed, the display changes in the following order: Elapsed time → Album title → Track title → Artist name

■ Bluetooth® audio system functions

Depending on the portable player that is connected to the system, certain functions may not be available.

■ Display

→P. 268

■ Error messages

“Memory Error”: This indicates a problem in the system.

Making a phone call

■ Making a phone call

- Dialing by inputting a number
“Dial by number”
- Dialing by inputting a name
“Dial by name”
- Speed dialing
- Dialing a number stored in the outgoing history memory
“Redial”
- Dialing a number stored in the incoming history memory
“Call back”

■ Using the call history memory

- Dialing
- Storing data in the phone book
- Deleting

Dialing by inputting a number

- 1 Press the talk switch and say “Dial by number”.
- 2 Press the talk switch and say the phone number.
- 3 Dial by one of the following methods:
 - a. Press the off-hook switch.
 - b. Press the talk switch and say “Dial”.
 - c. Select “Dial” using the “TUNE•SEL” knob.

Dialing by inputting a name

- 1 Press the talk switch and say “Dial by name”.
- 2 Select a registered name to be input by either of the following methods:
 - a. Press the talk switch and say a registered name.
 - b. Press the talk switch and say “List Names”. Press the talk switch when the desired name is read aloud.
- 3 Dial by one of the following methods:
 - a. Press the off-hook switch.
 - b. Press the talk switch and say “Dial”.
 - c. Select “Dial” using the “TUNE•SEL” knob.

Speed dialing

- 1 Press the off-hook switch.
- 2 Press the preset button in which the desired number is registered.
- 3 Press the off-hook switch.

Using the call history memory

Follow the procedure below to use a number stored in the call history memory:

- 1 Press the talk switch and say “Redial” (when using a number stored in the outgoing call history memory) or “Call back” (when using a number stored in the incoming call history memory).
- 2 Select the number by either of the following methods:
 - a. Say “Previous” or “Go back” until the desired number is displayed.
 - b. Select the desired number using the “TUNE•SEL” knob.
- 3 The following operations can be performed:

Dialing: Press the off-hook switch or select “Dial” using a voice command or the “TUNE•SEL” knob.

Storing the number in the phone book: Select “Store” and then “Confirm” using a voice command or the knob.

Deleting: Select “Delete” and then “Confirm” using a voice command or the knob.

■ Call history

Up to 5 numbers can be stored in each of the outgoing and incoming call history memories.

Receiving a phone call

Answering the phone

Press the off-hook switch.

Refusing the call

Press the on-hook switch.

Call waiting

When a call is interrupted by an incoming call from a third party, the following options will become available:

- Answer the incoming call: Press the off-hook switch. (Press the off-hook switch again as necessary to switch back and forth between calls.)
- Refuse the incoming call: Press the on-hook switch.

■ Call waiting

- If your phone does not support HFP Ver. 1.5, this function cannot be used.
- Call waiting operation may differ depending on your cellular phone and service provider.

Speaking on the phone

Transferring a call

A call can be transferred between the cellular phone and system while dialing, receiving a call, or during a call. Use one of the following methods:

- a. Operate the cellular phone.
Refer to the manual that comes with the cellular phone for the operation of the phone.
- b. Press the off-hook switch^{*1}.
- c. Press the talk switch and say "Call Transfer"^{*2}.

^{*1}: This operation can be performed only when transferring a call from the cellular phone to the system during a call.

^{*2}: While the vehicle is in motion, calls cannot be transferred from the system to the cellular phone.

■ When talking on the phone

- Do not talk simultaneously with the other party.
- Keep the volume of the received voice down. Otherwise, voice echo will increase.

Bluetooth®

■ Conditions under which the system will not operate

- If using a cellular phone that does not support Bluetooth®
- If the cellular phone is switched off
- If you are outside service range
- If the cellular phone is not connected
- If the cellular phone's battery is low
- If the cellular phone is behind the seat or in the glove box or console box
- If metal is covering or touching the portable player/phone

■ Signal status

This display may not correspond exactly with the cellular phone itself.

■ When using the hands-free system

- The audio system and voice guidance are muted when making a call.
- If both parties speak at the same time, it may be difficult to hear.
- If the incoming call volume is overly loud, an echo may be heard.
- Try to face toward the microphone as much as possible when speaking.
- In the following circumstances, it may be difficult to hear the other party:
 - When driving on unpaved roads
 - When driving at high speeds
 - When a window is open
 - When the air conditioning is blowing directly on the microphone
 - When the air conditioning is set to high

■ When transferring ownership of the vehicle

Be sure to initialize the system to prevent personal data from being improperly accessed.
(→P. 303)

■ For detailed information about Handsfree Phone System

For assistance with pairing and operating your cell phone, go to the website
www.lexus.letstalk.com.

■ About Bluetooth®

Bluetooth is a registered trademark of Bluetooth SIG, Inc.



■ Compatible models

Portable players must correspond to the following specifications:

- Bluetooth® specifications:
Ver. 1.2, or higher (Recommended: Ver. 2.0+EDR or higher)
- Following Profiles:
 - A2DP (Advanced Audio Distribution Profile) Ver. 1.0 or higher
 - AVRCP (Audio/Video Remote Control Profile) Ver. 1.0 or higher (Ver. 1.3 or higher recommended)

However, please note that some functions may be limited depending on the type of portable player.

This system supports the following service.

Compatible with HFP (Hands Free Profile) Ver. 1.5 and OPP (Object Push Profile) Ver.1.1.

If your cellular phone does not support HFP, you cannot enter the Bluetooth® phone. If your cellular phone supports OPP alone, you cannot use the Bluetooth® phone.

Please go to <http://www.lexus.com/MobileLink> to find approved Bluetooth® portable players/phones for this system.

■ Certification

FCC ID: ACJ932C5ZZ035

NOTE:

<§15.19(a)(3)> This device complies with part 15 of the FCC Rules. Operation is subject to the following two conditions: (1) This device may not cause harmful interference, and (2) this device must accept any interference received, including interference that may cause undesired operation.

FCC WARNING:

<§15.21> Changes or modifications not expressly approved by the party responsible for compliance could void the user's authority to operate the equipment.

CAUTION:

<§2.1091> Radio frequency radiation exposure information:

This equipment complies with FCC radiation exposure limits set forth for an uncontrolled environment.

This equipment should be installed and operated with minimum distance of 20cm between the radiator and your body.

This transmitter must not be co-located or operated in conjunction with any other antenna or transmitter.

NOTE:

This device complies with Industry Canada licence-exempt RSS standard(s). Operation is subject to the following two conditions: (1) this device may not cause interference, and (2) this device must accept any interference, including interference that may cause undesired operation of the device.

Le présent appareil est conforme aux CNR d'Industrie Canada applicables aux appareils radio exempts de licence. L'exploitation est autorisée aux deux conditions suivantes: (1) l'appareil ne doit pas produire de brouillage, et (2) l'utilisateur de l'appareil doit accepter tout brouillage radioélectrique subi, même si le brouillage est susceptible d'en compromettre le fonctionnement.

NOTE:

This radio transmitter (identify the device by certification number, or model number if Category II) has been approved by Industry Canada to operate with the antenna types listed below with the maximum permissible gain and required antenna impedance for each antenna type indicated. Antenna types not included in this list, having a gain greater than the maximum gain indicated for that type, are strictly prohibited for use with this device.

Le présent émetteur radio (identifier le dispositif par son numéro de certification ou son numéro de modèle s'il fait partie du matériel de catégorie II) a été approuvé par Industrie Canada pour fonctionner avec les types d'antenne énumérés ci-dessous et ayant un gain admissible maximal et l'impédance requise pour chaque type d'antenne. Les types d'antenne non inclus dans cette liste, ou dont le gain est supérieur au gain maximal indiqué, sont strictement interdits pour l'exploitation de l'émetteur.

 **WARNING****■ While driving**

Do not operate the portable audio player, cellular phone or connect a device to the Bluetooth® system.

■ Caution regarding interference with electronic devices

- Your audio unit is fitted with Bluetooth® antennas. People with implantable cardiac pacemakers, cardiac resynchronization therapy-pacemakers or implantable cardioverter defibrillators should maintain a reasonable distance between themselves and the Bluetooth® antennas. The radio waves may affect the operation of such devices.
- Before using Bluetooth® devices, users of any electrical medical device other than implantable cardiac pacemakers, cardiac resynchronization therapy-pacemakers or implantable cardioverter defibrillators should consult the manufacturer of the device for information about its operation under the influence of radio waves. Radio waves could have unexpected effects on the operation of such medical devices.

 **NOTICE****■ When leaving the vehicle**

Do not leave your portable audio player or cellular phone in the vehicle. The inside of the vehicle may become hot, causing damage to the portable audio player or cellular phone.

Lexus Display Audio System *

Use the following buttons to start listening to the audio system.

Lexus Display Audio operation buttons

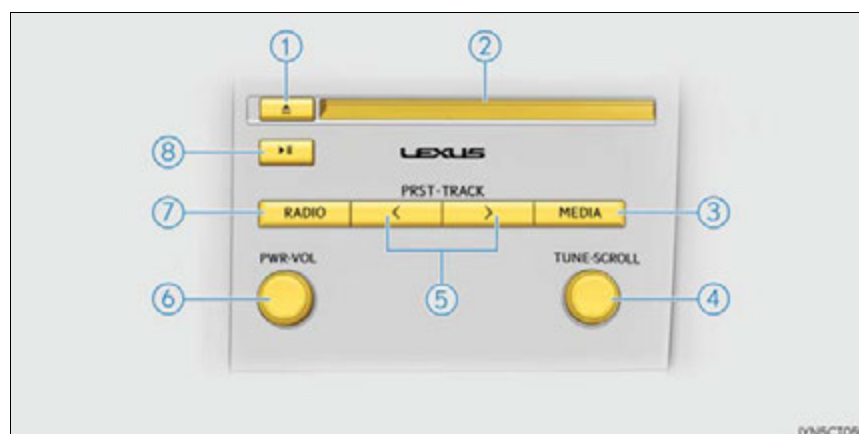

- ① Eject a disc.
- ② Disc slot
- ③ Display the media top screen.
- ④ "TUNE•SCROLL" knob
Select a radio station band, track or file.
- ⑤ Seek up or down for a radio station, or to access a desired track or file.
- ⑥ "PWR•VOL" knob
Press to turn the audio system on/off, and turn to adjust the volume.
- ⑦ Display the radio top screen.
- ⑧ Except radio and A/V mode: Pause or resume playing a track.
Radio and A/V mode: Turn mute on/off

*: If equipped

■ “Menu” screen

To display the “Menu” screen, press the “MENU” button on the controller unit.

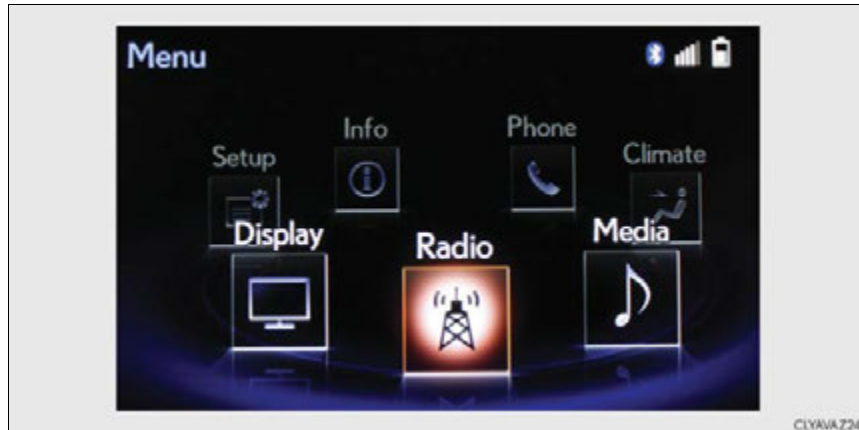

| Button | Function |
|-----------|--|
| “Radio” | Display the radio top screen (→P. 341) |
| “Media” | Display the media top screen (→P. 347, 353, 356, 360, 369) |
| “Climate” | Automatic air conditioning system (→P. 410) |
| “Phone” | Display the phone top screen (→P. 371) |
| “Info” | Display the “Information” screen (→P. 395) |
| “Setup” | Setup menu (→P. 328) |
| “Display” | Display settings (→P. 333) |

Lexus Display Audio controller

By using the Lexus Display Audio controller, you can control the audio system, hands-free system, etc.

- ① Display the “Source” screen or audio top screen (→P. 334)
- ② Display the “Menu” screen (→P. 321)
- ③ Back button
Display the previous screen
- ④ Turn or move the controller to select a function and number.



Move the controller to display the left or right side of the screen.

Push the controller to enter the selected function and number.

■ Using the Lexus Display Audio controller

- ① Select: Turn or move the controller.
- ② Enter: Push the controller.

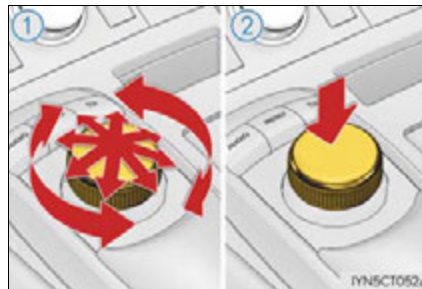

■ Basic screen operation

When a list is displayed, use the appropriate button to scroll through the list.

- ① Indicator turns on when you can select the list by turning the controller.
- ② Indicator turns on when you can return to the previous screen by pressing the back button.
- ③ Indicator turns on when you can move the controller left to view additional screen text.
- ④ Indicator turns on when you can move the controller right to view additional screen text.



Inputting letters and numbers

■ Input mode

Letters and numbers are inputted via the screen.

- ① Turn the controller to select the desired character and press the controller to input the character.
- ② When this indicator is shown, you can change input fields by moving the controller forward.
- ③ When this indicator is shown, you can change character types by moving the controller to the right and then selecting the desired character type.
- ④ Select to erase characters one by one. Select and hold to erase all characters.
- ⑤ Select to complete data input.

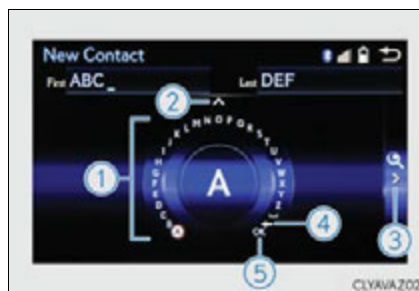

■ Input field mode

When in the input field you can move the cursor to the desired position.

- ① Turn the controller to move the cursor left or right.
- ② When this indicator is shown, you can move the cursor to the right input field by moving the controller to the right.
- ③ When this indicator is shown, you can move the cursor to the left input field by moving the controller to the left.
- ④ When this indicator is shown, you can change to input mode by moving the controller backward.

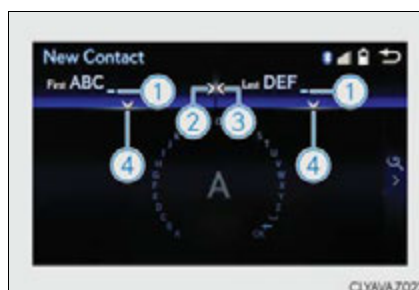

■ When using the screen

- Under extremely cold conditions, the Lexus Display Audio controller may react slowly.
- If the screen is cold, the display may be dark, or the system may seem to be operating slightly slower than normal.
- The screen may seem dark and hard to see when viewed through sunglasses. Change your angle of viewing, adjust the display on the "Display" screen (→P. 333) or remove your sunglasses.

■ Using cellular phones

Interference may be heard through the audio system's speakers if a cellular phone is being used inside or close to the vehicle while the audio system is operating.

**WARNING****■ Using the Lexus Display Audio controller**

Be careful when touching the Lexus Display Audio controller in extreme temperatures as it may become very hot or cold due to the temperature inside the vehicle.

■ Laser product

- CAUTION
USE OF CONTROL OR ADJUSTMENT OR PERFORMANCE OF PROCEDURES OTHER THAN THOSE SPECIFIED HEREIN MAY RESULT IN HAZARDOUS RADIATION EXPOSURE.
- CAUTION
THE USE OF OPTICAL INSTRUMENTS WITH THIS PRODUCT WILL INCREASE EYE HAZARD.

**NOTICE****■ To prevent Lexus Display Audio controller malfunction**

- Do not allow the Lexus Display Audio controller to come into contact with food, liquid, stickers or lit cigarettes as doing so may cause it to change color, emit a strange odor or stop functioning.
- Do not subject the Lexus Display Audio controller to excessive pressure or strong impact as the controller may bend or break off.

■ To prevent 12-volt battery discharge

Do not leave the audio system on longer than necessary when the hybrid system is off.

■ To avoid damaging the audio system

Take care not to spill drinks or other fluids on the audio system.

Steering wheel audio switches

Some audio features can be controlled using the switches on the steering wheel.

Operation may differ depending on the type of audio system or navigation system. For details, refer to the manual provided with the audio system or navigation system.

Operating the audio system using the steering wheel switches

- ① Volume switch
 - Increases/decreases volume
 - Press and hold: Continuously increases/decreases volume
- ② Radio mode:
 - Press: Select a radio station
 - Press and hold: Seek up/down CD, MP3/WMA/AAC disc, Bluetooth[®], iPod or USB mode:
 - Press: Select a track/file/video
 - Press and hold: Fast up/down tracks/files/videos (MP3/WMA/AAC disc, iPod or USB)
- ③ "MODE" switch
 - Turns the power on, selects audio source
 - Press and hold this switch to mute or pause the current operation. To cancel the mute or pause, press and hold.

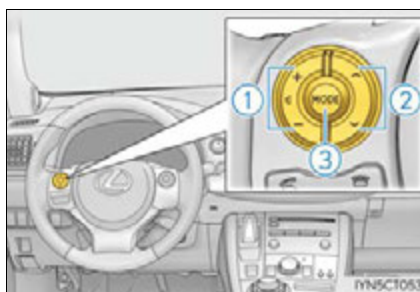

5

Audio system

WARNING

To reduce the risk of an accident

Exercise care when operating the audio switches on the steering wheel.

USB/AUX ports

Connect an iPod, USB memory device or portable audio player to the USB/AUX port as indicated below. Select "iPod", "USB", "AUX" or "A/V" on the audio source selection screen and the device can be operated via Lexus Display Audio system.

Connecting using the USB/AUX port

- 1 Press down and release the lid.



- 2 Open the cover.

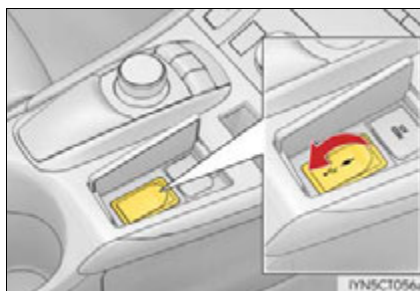

■ iPod

Open the cover and connect an iPod using an iPod cable.

Turn on the power of the iPod if it is not turned on.

■ USB memory

Open the cover and connect the USB memory device.

Turn on the power of the USB memory device if it is not turned on.

■ Portable audio player

Open the cover and connect the portable audio player.

Turn on the power of the portable audio player if it is not turned on.

**WARNING****■ While driving**

Do not connect a device or operate the device controls.

Setup menu

The Lexus Display Audio system can be adjusted to the desired settings.

Display “Setup” screen

“Setup” screen: “MENU” button → “Setup”

- ① Change the settings for operation sounds, screen animation, etc. (→P. 329)
- ② Adjust the settings for voice guidance volume and voice recognition prompts. (→P. 332)
- ③ Change the settings for registering, removing, connecting and disconnecting Bluetooth® devices. (→P. 362)
- ④ Change the settings for FM radio, iPod, etc. (→P. 336)
- ⑤ Change the settings for vehicle customization. (→P. 591)
- ⑥ Change the settings for phone sound, phonebook, etc. (→P. 381)

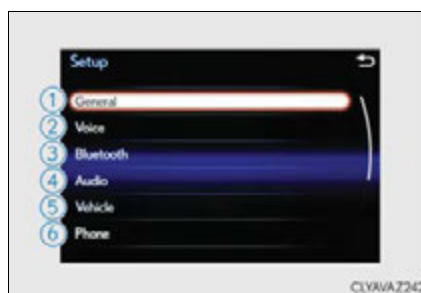

General settings

Settings are available for adjusting the operation sounds, screen animation, etc.

Screen for general settings

“General Settings” screen: “MENU” button → “Setup” → “General”

- ① Change language.
The selectable languages may differ depending on the model or region.
- ② Set the beep sound on/off.
- ③ Change the button color.
- ④ Change the startup image and screen off image. (→P. 330)
- ⑤ Set the animation effect on/off.
- ⑥ Delete personal data (→P. 331)
- ⑦ Update program versions.
For details, contact your Lexus dealer.
- ⑧ Update gracenote database versions.
For details, contact your Lexus dealer.
- ⑨ Display the open source license.



5

Audio system

Customizing images

- 1 Go to “Customize Images”: “MENU” button → “Setup” → “General” → “Customize Images”
- 2 Select “Set Images” and then select the desired image.
 - 1 Set as startup image.
 - 2 Set as screen off image.
 - 3 Set as startup image and screen off image.

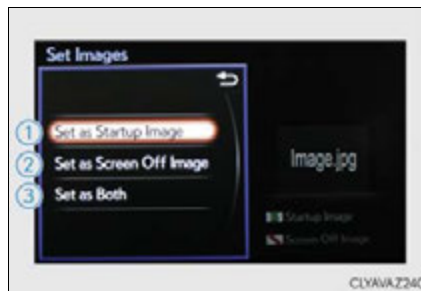

■ Adding an image

- 1 Connect a USB memory device. (→P. 326)
- 2 Select “Copy from USB” on the “Customize Images” screen and then select the desired image.
- 3 Move the controller to the left and then select “Copy”.
Up to 10 images can be downloaded.

■ Deleting images

Select “Delete Images” on the “Customize Images” screen and then select the desired images.

■ USB memory

When saving the images to a USB memory device, name the folder that the images are saved to “Image”.

● Compatible device formats

The following device format can be used:

- USB communication format: USB2.0 FS (480 Mbps)
- File system format: FAT16/32 (Windows)
- Correspondence class: Mass storage class

The following types of files can be used:

- The image’s file format must be JPEG.
- The file name may only contain ASCII characters.

● JPEG file compatibility

Compatible image size: Maximum 5MB

 NOTICE

- To prevent damage to the USB memory device or its terminals
→P. 359

Deleting personal data

- 1 "MENU" button → "Setup" → "General" → "Delete Personal Data"
- 2 Select "Delete".

Check carefully beforehand, as data cannot be retrieved once deleted.

The following personal data will be deleted or changed to its default settings.

- Phonebook data
- Call history data
- Favorite data
- Bluetooth[®] devices data
- Phone sound settings
- Detailed Bluetooth[®] settings
- Audio/video setting
- Preset switch data
- Last used radio station
- Customized image data
- FM info setting
- iPod tagging information
- Software update history
- Software update detail information
- Phone display setting
- Contact/call history setting
- Messaging setting
- Traffic information map
- Weather information
- Phonebook data for voice recognition
- Music data for voice recognition

Voice settings

You can adjust the guidance volume setting.

Go to "Voice Settings": "MENU" button → "Setup" → "Voice"

- ① Adjust the voice guidance volume setting.
- ② Set the voice recognition prompts on/off.

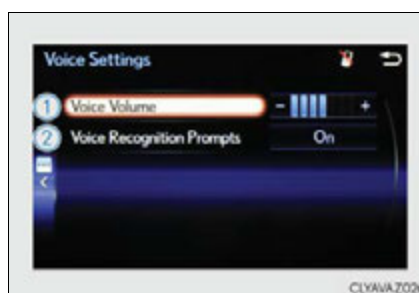

■ Return to the default settings

Move the controller to the left and select "Default".

Display settings

Settings are available for adjusting the contrast and brightness of the screen. The display can also be turned off.

Screen for display settings

Go to "Display": "MENU" button → "Display"

- ① Turn off screen.
- ② Adjust screen quality.
- ③ Adjust screen quality of the rear view monitor camera.
- ④ Change to day mode.

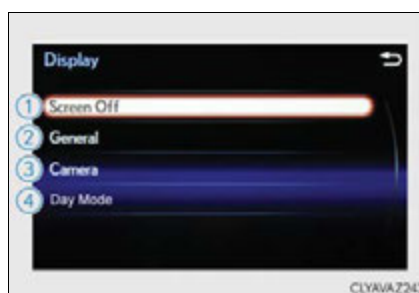

Screen off

This setting turns the screen off. To turn it on, press any button such as the "AUDIO" button or "MENU" button.

If a screen off image has been set, the set image will be displayed.

Day mode

When the headlights are turned on, the screen dims.

However, the screen can be switched to day mode by selecting "Day Mode".

The screen will stay in day mode when the headlights are turned on until "Day Mode" is selected again.

Adjusting the screen quality

- 1 Select "General" or "Camera" on the "Display" screen or select "Display" on each audio menu screen. (→P. 338)
- 2 Adjust the display as desired by turning the controller clockwise (+) or counterclockwise (-).
To select "Contrast", "Brightness", "Color" or "Tone", move the controller to the left. ("Colour" and "Tone" are available when "Display" on the audio settings screen for each audio source is selected.)

■ Changing the sample image (when "General" is selected)

Move the controller to the right and select the desired sample image.

Selecting the audio source

Switching between audio sources such as radio and CD are explained in this section.

Changing audio source

- 1 Press the "AUDIO" button to display the "Source" screen.
If the "Source" screen is not displayed, press the button again.
- 2 Select the desired audio source.
The audio source can be selected by pressing the "RADIO" or "MEDIA" button.

Using the steering wheel switches to change audio sources

Press the "MODE" switch when the audio system is turned on. The audio source changes each time the "MODE" switch is pressed.

■ Rearranging the list

The listing order of the source list can be rearranged.

- 1 Move the controller to the left while on the "Source" screen.
- 2 Select "Audio Source Select".
- 3 Select an item you wish to move and then select where to move the item to.

Optimal use of the audio system

On the “Sound Settings” screen, sound quality (Treble/Mid/Bass), volume balance and DSP settings can be adjusted.

How to adjust the sound settings and sound quality

1 Audio menu screen. (→P. 338)

2 Select “Sound Settings”.

To change between the sound setting screen and DSP setting screen, move the controller to the right then select the desired screen.

▶ “Sound Settings”

1 2 3 Adjust the treble, mid or bass.

4 Adjust the front/rear audio balance.

5 Adjust the left/right audio balance.



▶ “DSP”

1 Set the automatic sound levelizer (ASL) on/off

2 Set the surround function on/off

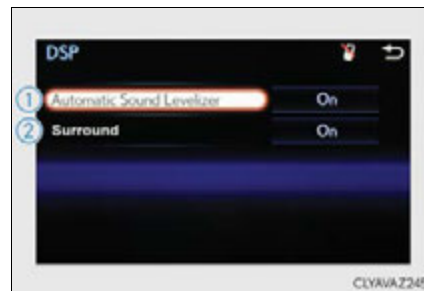

■ The sound quality level is adjusted individually

The treble, mid and bass levels can be adjusted for each audio mode separately.

■ About Automatic Sound Levelizer (ASL)

ASL automatically adjusts the volume and tone quality according to the vehicle speed.

Audio settings

Screen for audio settings

Go to "Audio Settings": "MENU" button → "Setup" → "Audio"

- ① Change radio settings (→P. 336)
- ② Change iPod settings (→P. 336)
- ③ Change A/V settings (→P. 337)
- ④ Change the cover art settings (→P. 337)
- ⑤ Change USB settings (→P. 337)

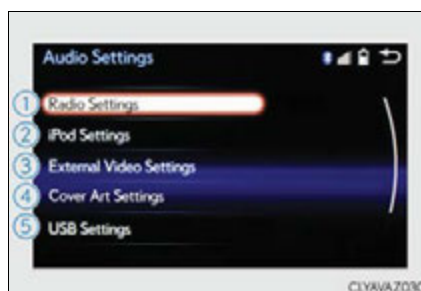

Changing radio settings

To change radio settings, select "Radio Settings" on the "Audio Settings" screen or radio menu screen. (→P. 338)

- ① Set the displaying RBDS text message on/off
- ② Change the number of radio presets

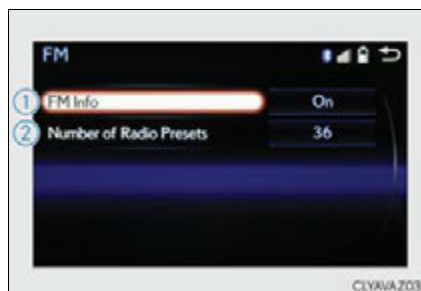

Changing iPod settings

To change iPod settings, select "iPod Settings" on the "Audio Settings" screen or iPod menu screen. (→P. 338)

- ① Change the screen size (video mode)
- ② Change the cover art settings (→P. 337)
- ③ Adjust the screen quality (video mode) (→P. 333)
- ④ Change video sound input port

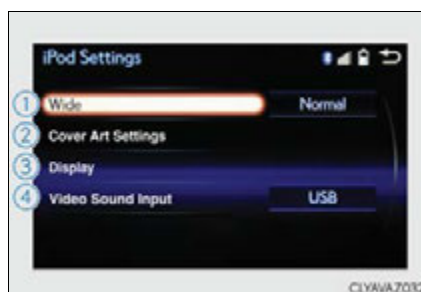

Changing A/V settings

To change A/V settings, select “External Video Settings” on the “Audio Settings” screen or A/V menu screen. (→P. 338)

- ① Change the screen size
- ② Change the video signal
- ③ Adjust the screen quality (video mode) (→P. 333)

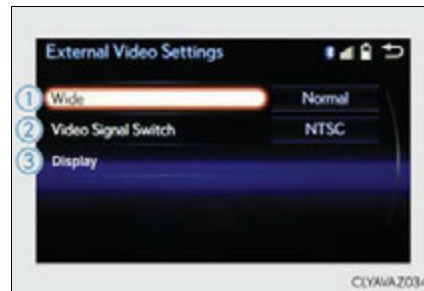

Changing the cover art settings

To change the cover art settings, select “Cover Art Settings” on the “Audio Settings” screen, CD or MP3/WMA/AAC disc menu screen. (→P. 338)

- ① Select to set the cover art display of the DISC mode on/off.
- ② Select to set the cover art display of the USB mode on/off.
- ③ Change the priority of the Gracenote database of the USB mode.
- ④ Select to set the cover art display of the iPod mode on/off.
- ⑤ Change the priority of the Gracenote database of the iPod mode.



5

Audio system

Changing USB settings

To change USB settings, select “USB Settings” on the “Audio Settings” screen or USB menu screen. (→P. 338)

- ① Change the cover art settings (→P. 337)

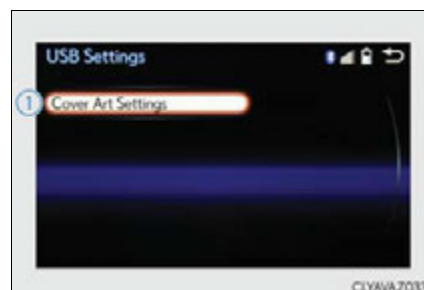

Audio menu screen operation

You can change the settings and control functions for each audio source.

Audio menu screen

To display the audio menu screen, move the controller to the left while on an audio top screen.

▶ AM, FM radio or XM Satellite Radio

- ① Scan for receivable stations (AM, FM radio)
- ② Seek a station of the nearest frequency (stops when a station is found) (AM, FM radio)
- ③ Captures the song title and artist name information for potential purchase (when the "HD" indicator on the selected station is appears) (FM radio)
- ④ Changes the channel of HD Radio (HD2, HD3, HD4 where applicable) (FM radio)
- ⑤ Seek a station of the traffic announcement (FM radio)
- ⑥ Select to set the station list shows of HD radio on/off (AM, FM radio)
- ⑦ Change radio settings (→P. 336)
- ⑧ Change sound settings (→P. 335)





▶ CD, MP3/WMA/AAC disc, iPod, USB or Bluetooth®

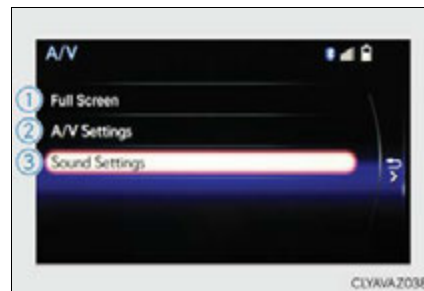
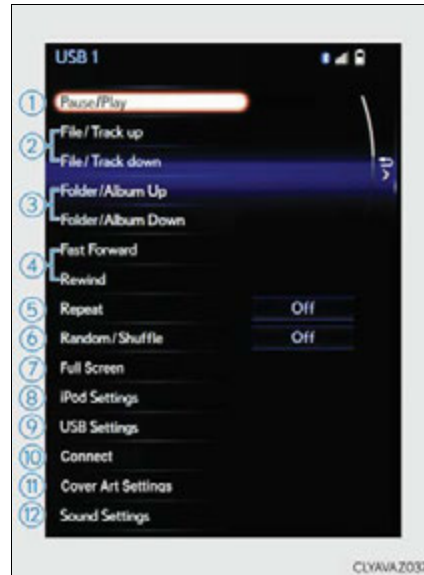

- ① Play or pause a track/file
- ② Select a track/file
- ③ Select a folder/album (MP3/WMA/AAC disc or USB)
- ④ Select and hold: Fast-forward or rewind a track/file
- ⑤ Select a repeat mode. (→P. 340)
- ⑥ Select a random/shuffle play mode. (→P. 340)
- ⑦ Select a full screen mode (iPod video mode)
- ⑧ Change iPod settings (iPod) (→P. 336)
- ⑨ Change USB settings (USB) (→P. 337)
- ⑩ Connect a Bluetooth device (Bluetooth®) (→P. 364)
- ⑪ Change the cover art settings (CD or MP3/WMA/AAC disc) (→P. 337)
- ⑫ Change sound settings (→P. 335)
 - ▶ A/V
 - ① Select full screen mode
 - ② Change A/V settings (→P. 337)
 - ③ Change sound settings (→P. 335)



Repeat play

| Mode | Action | Target audio source |
|---|-------------------|-----------------------|
|  | File/track repeat | All media |
|  | Folder repeat | MP3/WMA/AAC disc, USB |
|  | Album repeat | USB, Bluetooth® |

Random/shuffle playback

| Mode | Action | Target audio source |
|--|--|-----------------------|
|  | Random/shuffle play of the disc/ folder/album | All media |
|  | Random play of all folders | MP3/WMA/AAC disc, USB |
|  | Random/shuffle play of all albums | iPod, USB, Bluetooth® |

Radio operation

Select “AM”, “FM” or “SAT” on the audio source selection screen to begin listening to the radio.

Radio top screen

Pressing the “RADIO” button displays the radio top screen from any screen of the selected source.

- **Menu screen**

→P. 338

Selecting a station (AM or FM radio)

Tune in to the desired station using one of the following methods.

- **Seek tuning**

Press and hold then release “<” or “>”.

Seek tuning can also be operated on the menu screen. (→P. 338)

The radio will begin seeking up or down for a station of the nearest frequency and will stop when a station is found.

- **Manual tuning**

Turn the “TUNE•SCROLL” knob.

- **Preset stations**

Select the desired preset station by pressing “<” or “>” or controller.

- **Station list**

- 1 Move the controller to the right and selecting “Station List”.

- 2 AM radio: Selecting a desired station.

FM radio: Selecting a desired type of station and selecting a desired station.

To refreshing the station list, select “Refresh”. Select “Source” on the refresh screen, can be change to the other audio source while refreshing.

Selecting an HD Radio channel

When "HD Radio" is set to "On", available stations with HD Radio channels are marked with "HD".

- 1 In AM or FM mode, select a station marked with "HD".
- 2 Turn the "TUNE•SCROLL" knob to select an HD Radio channel.
HD Radio channels can also be selected by selecting "Multicast" on the menu screen. (→P. 338)

Selecting a channel (XM Satellite Radio)

Select in to the desired channel using one of the following methods.

■ Turning up/down the channel

Press and hold "<" or ">" or turn the "TUNE•SCROLL" knob.

■ Preset channels

Select the desired preset channel by pressing "<" or ">" or controller.

■ Channel list

- 1 Move the controller to the right and selecting "Select a SAT Category".
- 2 Selecting a desired category of channel and selecting a desired channel.

Setting presets

- 1 Search for desired stations or channel.
- 2 Select and hold one of the preset until you hear a beep.

Display the text message

■ Display the song information

Move the controller to the right and selecting "Text".

■ Display the Additional information (AM, FM radio)

Move the controller to the right and selecting "Additional Information".

HD Radio™ Technology

HD Radio™ Technology is the digital evolution of analog AM/FM radio. Your radio product has a special receiver which allows it to receive digital broadcasts (where available) in addition to the analog broadcasts it already receives.

Digital broadcasts have better sound quality than analog broadcasts as digital broadcasts provide free, crystal clear audio with no static or distortion. For more information, and a guide to available radio stations and programming, refer to www.hdradio.com.

“HD Radio features included in Lexus radios:

Digital Sound - HD Radio broadcasts deliver crystal-clear, digital audio quality to listeners.

HD2/HD3 Channels - FM stations can provide additional digital only audio programming with expanded content and format choices on HD2/HD3 channels.

PSD - Program Service Data (PSD) gives you on-screen information such as artist name and song title.

iTunes Tagging - Listeners can tag (store) songs they like for later review and purchase through iTunes.

Artist Experience - Images related to the broadcast are displayed on the radio screen, such as album cover art and station logos.”



HD Radio Technology manufactured under license from iBiquity Digital Corporation. U.S. and Foreign Patents. HD Radio™ and the HD, HD Radio, and “Arc” logos are proprietary trademarks of iBiquity Digital Corp.

■ HD Radio™ Technology troubleshooting guide

| Experience | Cause | Action |
|---|---|---|
| Mismatch of time alignment- a user may hear a short period of programming replayed or an echo, stutter or skip. | The radio stations analog and digital volume are not properly aligned or the station is in ballgame mode. | None, radio broadcast issue. A user can contact the radio station. |
| Sound fades, blending in and out. | Radio is shifting between analog and digital audio. | Reception issue, may clear-up as the vehicle continues to be driven. Set “HD Radio” to off, can force radio in an analog audio. |

| Experience | Cause | Action |
|--|---|---|
| Audio mute condition when an HD2/HD3 multicast channel had been playing. | The radio does not have access to digital signals at the moment. | This is normal behavior, wait until the digital signal returns. If out of the coverage area, seek a new station. |
| Audio mute delay when selecting an HD2/HD3 multicast channel preset. | The digital multicast content is not available until HD Radio™ broadcast can be decoded and make the audio available. This takes up to 7 seconds. | This is normal behavior, wait for the audio to become available. |
| Text information does not match the present song audio. | Data service issue at the radio broadcaster. | Broadcaster should be notified. Complete the form: www.ibiquity.com/automotive/report_radio_station_experiences . |
| No text information shown for the present selected frequency. | Data service issue by the radio broadcaster. | Broadcaster should be notified. Complete the form: www.ibiquity.com/automotive/report_radio_station_experiences . |

■ **Reception sensitivity**

- Maintaining perfect radio reception at all times is difficult due to the continually changing position of the antenna, differences in signal strength and surrounding objects, such as trains, transmitters, etc.
- The radio antenna is mounted inside the rear window. To maintain clear radio reception, do not attach metallic window tinting or other metallic objects to the antenna wire mounted inside the rear window.

■ **XM Radio Services – Descriptions**

- **Radio and Entertainment**
 XM offers more than 170 satellite radio channels of commercial-free music and premier sports, news, talk, and entertainment. XM is broadcast via satellites to millions of listeners across the continental United States. XM subscribers listen to XM on satellite radio receivers for the car, home, and portable use. More information about XM is available online at www.siriusxm.com (U.S.A.) or www.xmradio.ca (Canada).
- **Satellite tuner**
 The tuner supports only Audio Services (Music and Talk) and the accompanying Text Information of XM® Satellite Radio.

■ XM Radio Services – Subscription Instructions

For XM Services requiring a subscription (such as XM Radio), the following paragraph shall be included.

Required XM Radio monthly subscriptions sold separately after trial period. Subscription fee is consumer only. All fees and programming subject to change. Subscriptions are subject to the Customer Agreement available at www.siriusxm.com (U.S.A.) or www.xmradio.ca (Canada). XM service only available in the 48 contiguous United States and 10 Canadian provinces. © 2011 Sirius XM Radio Inc. Sirius, XM and all related marks and logos are trademarks of Sirius XM Radio Inc. All other marks, channel names and logos are the property of their respective owners.

For more information, program schedules, and to subscribe or extend subscription after complimentary trial period; more information is available at:

► U.S.A. Customers:

Visit www.siriusxm.com or call 1-877-515-3987

► Canadian Customers:

Visit www.xmradio.ca or call 1-877-438-9677

● Radio ID

You will need the radio ID when activating XM service or reporting a problem. If “Ch000” is selected using the “TUNE•SCROLL” knob, the ID code, which is 8 alphanumeric characters, will be displayed. If another channel is selected, the ID code will no longer be displayed. The channel (000) alternates between displaying the radio ID and the specific radio code.

■ XM Radio Services – Legal Disclaimers and Warnings

● Fees and Taxes – Subscription fee, taxes, one time activation fee, and other fees may apply. Subscription fee is consumer only. All fees and programming subject to change. Subscriptions subject to Customer Agreement available at www.siriusxm.com (U.S.A.) or www.xmradio.ca (Canada). XM service only available in the 48 contiguous United States and Canada*.

*: Canada – some deterioration of service may occur in extreme northern latitudes.

This is beyond the control of XM Satellite Radio.

Explicit Language Notice – Channels with frequent explicit language are indicated with an “XL” preceding the channel name. Channel blocking is available for XM Satellite Radio receivers by notifying XM at;

► U.S.A. Customers:

Visit www.siriusxm.com or calling 1-877-515-3987

► Canadian Customers:

Visit www.xmradio.ca or calling 1-877-438-9677

It is prohibited to copy, decompile, disassemble, reverse engineer, hack, manipulate, or otherwise make available any technology or software incorporated in receivers compatible with the XM Satellite Radio System or that support the XM website, the Online Service or any of its content. Furthermore, the AMBE[®] voice compression software included in this product is protected by intellectual property rights including patent rights, copyrights, and trade secrets of Digital Voice Systems, Inc.

Note: this applies to XM receivers only and not XM Ready devices.

■ **If the satellite radio does not operate normally**

If a problem occurs with the XM tuner, a message will appear on the screen. Refer to the table below to identify the problem, and take the suggested corrective action.

| | |
|----------------------|---|
| SAT Check Antenna | The XM antenna is not connected. Check whether the XM antenna cable is attached securely. |
| | There is a short-circuit in the antenna or the surrounding antenna cable. See a Lexus certified dealer. |
| SAT Ch Unauthorized | You have not subscribed to XM Satellite Radio. The radio is being updated with the latest encryption code. Contact XM Satellite Radio for subscription information. When a contract is canceled, you can choose "Ch000" and all free-to-air channels. |
| | The premium channel you selected is not authorized. Wait for about 2 seconds until the radio returns to the previous channel or "Ch001". If it does not change automatically, select another channel. To listen to the premium channel, contact XM Satellite Radio. |
| SAT No Signal | The XM signal is too weak at the current location. Wait until your vehicle reaches a location with a stronger signal. |
| SAT Loading | The unit is acquiring audio or program information. Wait until the unit has received the information. |
| SAT Channel Off Air | The channel you selected is not broadcasting any programming. Select another channel. |
| ----- | There is no song/program title or artist name/feature associated with the channel at that time. No action is required. |
| SAT Chan Unavailable | The channel you selected is no longer available. Wait for about 2 seconds until the radio returns to the previous channel or "Ch001". If it does not change automatically, select another channel. |

Contact the XM Listener Care Center at 1-877-515-3987 (U.S.A.) or 1-877-438-9677 (Canada).

CD player operation

Insert a disc, press the "MEDIA" button or select "DISC" on the "Source" screen with a disc inserted to begin listening to a CD.

CD top screen

Pressing the "MEDIA" button displays the CD top screen from any screen of the selected source.

■ Menu screen

→P. 338

■ Selecting a track/file

Press the "<" or ">" button or turn the "TUNE•SCROLL" knob to select the desired track/file number.

To fast-forward or rewind, press and hold the "<" or ">" button.

■ Selecting the track by the list (CD)

Move the controller to the right and then select the desired track.

■ Selecting a folder (MP3/WMA/AAC disc)

- 1 Move the controller to the right and then select "Folders".
- 2 Select the desired folder. Then select a file to begin using the selected folder.

■ Selecting a file by the selected folder (MP3/WMA/AAC disc)

- 1 Move the controller to the right and then select "Files".
- 2 Select the desired file.

■ Error messages

If the following error messages appear on the screen, refer to the table and take the appropriate measures. If the problem is not rectified, take the vehicle to your Lexus dealer.

| Message | Cause | Correction procedures |
|-------------------------|---|--|
| "Check disc" | <ul style="list-style-type: none"> • The disc is dirty or damaged. • The disc is inserted upside down. • The disc is not playable with the player. | <ul style="list-style-type: none"> • Clean the disc. • Insert the disc correctly. • Confirm the disc is playable with the player. |
| "DISC Error" | There is a malfunction within the system. | Eject the disc. |
| "No music files found." | No playable data is included on the disc. | Eject the disc. |

■ Discs that can be used

Discs with the marks shown below can be used.

Playback may not be possible depending on recording format or disc features, or due to scratches, dirt or deterioration.



CDs with copy-protection features may not play correctly.

■ CD player protection feature

To protect the internal components, playback is automatically stopped when a problem is detected.

■ If a disc is left inside the CD player or in the ejected position for extended periods

Disc may be damaged and may not play properly.

■ Lens cleaners

Do not use lens cleaners. Doing so may damage the CD player.

■ MP3, WMA and AAC files

MP3 (MPEG Audio LAYER3) is a standard audio compression format.

Files can be compressed to approximately 1/10 of their original size by using MP3 compression.

WMA (Windows Media Audio) is a Microsoft audio compression format.

This format compresses audio data to a size smaller than that of the MP3 format.

AAC is short for Advanced Audio Coding and refers to an audio compression technology standard used with MPEG2 and MPEG4.

MP3, WMA and AAC file and media/formats compatibility are limited.

- MP3 file compatibility
 - Compatible standards
MP3 (MPEG1 LAYER3, MPEG2 LSF LAYER3)
 - Compatible sampling frequencies
MPEG1 LAYER3: 32, 44.1, 48 (kHz)
MPEG2 LSF LAYER3: 16, 22.05, 24 (kHz)
 - Compatible bit rates (compatible with VBR)
MPEG1 LAYER3: 32-320 (kbps)
MPEG2 LSF LAYER3: 8-160 (kbps)
 - Compatible channel modes: stereo, joint stereo, dual channel and monaural
- WMA file compatibility
 - Compatible standards
WMA Ver. 7, 8, 9 (only compatible with Window Media Audio Standard)
 - Compatible sampling frequencies
32, 44.1, 48 (kHz)
 - Compatible bit rates (only compatible with 2-channel playback)
Ver. 7, 8: CBR 48-192 (kbps)
Ver. 9: CBR 48-320 (kbps)
- AAC file compatibility
 - Compatible standards
MPEG4/AAC-LC
 - Compatible sampling frequencies
11.025/12/16/22.05/24/32/44.1/48 (kHz)
 - Compatible bit rates
16-320 (kbps)
 - Compatible channel modes: 1 ch and 2 ch
- Compatible media
Media that can be used for MP3, WMA and AAC playback are CD-Rs and CD-RWs. Playback in some instances may not be possible if the CD-R or CD-RW is not finalized. Playback may not be possible or the audio may jump if the disc is scratched or marked with fingerprints.
- Compatible disc formats
The following disc formats can be used.
 - Disc formats: CD-ROM Mode 1 and Mode 2
CD-ROM XA Mode 2, Form 1 and Form 2
 - File formats: ISO9660 Level 1, Level 2, (Romeo, Joliet)
UDF (2.01 or lower)
 MP3, WMA and AAC files written in any format other than those listed above may not play correctly, and their file names and folder names may not be displayed correctly.

Items related to standards and limitations are as follows.

 - Maximum directory hierarchy: 8 levels (including the root)
 - Maximum length of folder names/file names: 32 characters
 - Maximum number of folders: 192 (including the root)
 - Maximum number of files per disc: 255

- File names
The only files that can be recognized as MP3/WMA/AAC and played are those with the extension .mp3, .wma or .m4a.
- Discs containing multi-session recordings
As the audio system is compatible with multi session discs, it is possible to play discs that contain MP3, WMA and AAC files. However, only the first session can be played.
- ID3, WMA and AAC tags
ID3 tags can be added to MP3 files, making it possible to record the track title, artist name, etc.
The system is compatible with ID3 Ver. 1.0, 1.1, and Ver. 2.2, 2.3 ID3 tags. (The number of characters is based on ID3 Ver. 1.0 and 1.1.)
WMA tags can be added to WMA files, making it possible to record the track title and artist name in the same way as with ID3 tags.
AAC tags can be added to AAC files, making it possible to record the track title and artist name in the same way as with ID3 tags.
- MP3, WMA and AAC playback
When a disc containing MP3, WMA or AAC files is inserted, all files on the disc are first checked. Once the file check is finished, the first MP3, WMA or AAC file is played. To make the file check finish more quickly, we recommend you do not write any files to the disc other than MP3, WMA or AAC files or create any unnecessary folders.
Discs that contain a mixture of music data and MP3, WMA or AAC format data cannot be played.
- Extensions
If the file extensions .mp3, .wma and .m4a are used for files other than MP3, WMA and AAC files, they may be mistakenly recognized and played as MP3, WMA and AAC files. This may result in large amounts of interference and damage to the speakers.
- Playback
 - To play MP3 files with steady sound quality, we recommend a fixed bit rate of at least 128 kbps and a sampling frequency of 44.1 kHz.
 - CD-R or CD-RW playback may not be possible in some instances, depending on the characteristics of the disc.
 - There is a wide variety of freeware and other encoding software for MP3, WMA and AAC files on the market, and depending on the status of the encoding and the file format, poor sound quality or noise at the start of playback may result. In some cases, playback may not be possible at all.
 - When files other than MP3, WMA or AAC files are recorded on a disc, it may take more time to recognize the disc and in some cases, playback may not be possible at all.
 - Microsoft, Windows, and Windows Media are the registered trademarks of Microsoft Corporation in the U.S.A. and other countries.

■ The Gracenote® media database

- Gracenote, the Gracenote logo and logotype, “Powered by Gracenote” and Gracenote MusicID are either registered trademarks or trademarks of Gracenote, Inc. in the United States and/or other countries.



Gracenote® End User License Agreement - Music

This application or device contains software from Gracenote, Inc. of Emeryville, California (“Gracenote”). The software from Gracenote (the “Gracenote Software”) enables this application to perform disc and/or file identification and obtain music-related information, including name, artist, track, and title information (“Gracenote Data”) from online servers or embedded databases (collectively, “Gracenote Servers”) and to perform other functions. You may use Gracenote Data only by means of the intended End-User functions of this application or device.

This application or device may contain content belonging to Gracenote’s providers. If so, all of the restrictions set forth herein with respect to Gracenote Data shall also apply to such content and such content providers shall be entitled to all of the benefits and protections set forth herein that are available to Gracenote.

You agree that you will use Gracenote Data, the Gracenote Software, and Gracenote Servers for your own personal non-commercial use only. You agree not to assign, copy, transfer or transmit the Gracenote Software or any Gracenote Data to any third party. **YOU AGREE NOT TO USE OR EXPLOIT GRACENOTE DATA, THE GRACENOTE SOFTWARE, OR GRACENOTE SERVERS, EXCEPT AS EXPRESSLY PERMITTED HEREIN.**

You agree that your non-exclusive license to use the Gracenote Data, the Gracenote Software, and Gracenote Servers will terminate if you violate these restrictions. If your license terminates, you agree to cease any and all use of the Gracenote Data, the Gracenote Software, and Gracenote Servers. Gracenote reserves all rights in Gracenote Data, the Gracenote Software, and the Gracenote Servers, including all ownership rights. Under no circumstances will Gracenote become liable for any payment to you for any information that you provide. You agree that Gracenote, Inc. may enforce its rights under this Agreement against you directly in its own name.

The Gracenote service uses a unique identifier to track queries for statistical purposes. The purpose of a randomly assigned numeric identifier is to allow the Gracenote service to count queries without knowing anything about who you are. For more information, see the web page for the Gracenote Privacy Policy for the Gracenote service.

The Gracenote Software and each item of Gracenote Data are licensed to you “AS IS.” Gracenote makes no representations or warranties, express or implied, regarding the accuracy of any Gracenote Data from the Gracenote Servers. Gracenote reserves the right to delete data from the Gracenote Servers or to change data categories for any cause that Gracenote deems sufficient. No warranty is made that the Gracenote Software or Gracenote Servers are error-free or that functioning of Gracenote Software or Gracenote Servers will be uninterrupted. Gracenote is not obligated to provide you with new enhanced or additional data types or categories that Gracenote may provide in the future and is free to discontinue its services at any time.

GRACENOTE DISCLAIMS ALL WARRANTIES EXPRESS OR IMPLIED, INCLUDING, BUT NOT LIMITED TO, IMPLIED WARRANTIES OF MERCHANTABILITY, FITNESS FOR A PARTICULAR PURPOSE, TITLE, AND NON-INFRINGEMENT. GRACENOTE DOES NOT WARRANT THE RESULTS THAT WILL BE OBTAINED BY YOUR USE OF THE GRACENOTE SOFTWARE OR ANY GRACENOTE SERVER. IN NO CASE WILL GRACENOTE BE LIABLE FOR ANY CONSEQUENTIAL OR INCIDENTAL DAMAGES OR FOR ANY LOST PROFITS OR LOST REVENUES.

© 2012 Gracenote, Inc. All rights reserved.

 NOTICE**■ Discs and adapters that cannot be used**

Do not use the following types of discs.

Also, do not use 3 in. (8 cm) disc adapters, DualDiscs or printable discs.

Doing so may damage the player and/or disc insert/eject function.

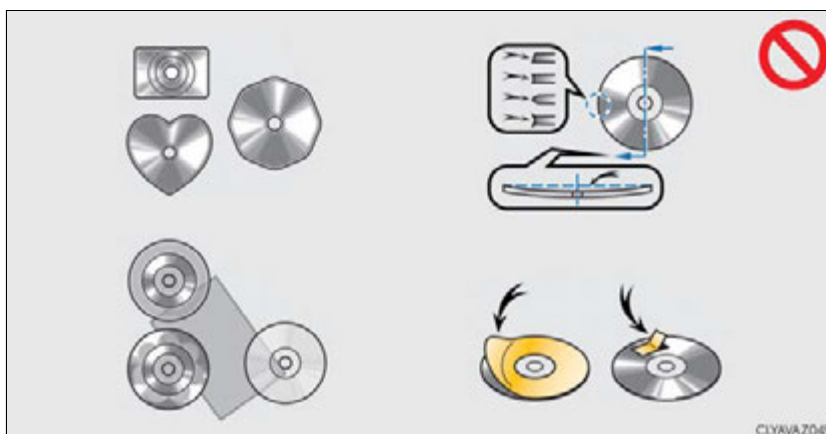

- Discs that have a diameter that is not 4.7 in. (12 cm).
- Low-quality or deformed discs.
- Discs with a transparent or translucent recording area.
- Discs that have tape, stickers or CD-R labels attached to them, or that have had the label peeled off.

■ Player precautions

Failure to follow the precautions below may result in damage to the discs or the player itself.

- Do not insert anything other than discs into the disc slot.
- Do not apply oil to the player.
- Store discs away from direct sunlight.
- Never try to disassemble any part of the player.

Listening to an iPod

Connecting an iPod enables you to enjoy music from the vehicle speakers. Press the “MEDIA” button or select “iPod” on the audio source selection screen.

Connecting an iPod

→P. 326

iPod top screen

Pressing the “MEDIA” button displays the iPod top screen from any screen of the selected source.

■ Menu screen

→P. 338

■ Selecting a song

Press the “<” or “>” button or turn the “TUNE•SCROLL” knob to select the desired song number.

To fast-forward or rewind, press and hold the “<” or “>” button.

■ Selecting a play mode

- 1 Move the controller to the right and then select “Browse”.
- 2 Select the desired play mode, and then select a song to begin using the selected play mode.

■ Displaying the now playing list

Move the controller to the right and then select “Now Playing List”.

■ About iPod



- “Made for iPod” and “Made for iPhone” mean that an electronic accessory has been designed to connect specifically to an iPod, or iPhone, respectively, and has been certified by the developer to meet Apple performance standards.
- Apple is not responsible for the operation of this device or its compliance with safety and regulatory standards. Please note that the use of this accessory with iPod or iPhone may affect wireless performance.
- iPhone, iPod, iPod classic, iPod nano and iPod touch are trademarks of Apple Inc., registered in the U.S. and other countries.

■ **iPod cover art**

- Depending on the iPod and songs in the iPod, iPod cover art may be displayed.
- This function can be changed to on/off. (→P. 337)
- It may take time to display iPod cover art, and the iPod may not be operated while the cover art display is in process.

■ **iPod functions**

- When an iPod is connected and the audio source is changed to iPod mode, the iPod will resume play from the same point in which it was last used.
- Depending on the iPod that is connected to the system, certain functions may not be available. If a function is unavailable due to a malfunction (as opposed to a system specification), disconnecting the device and reconnecting it may resolve the problem.
- Depending on the iPod, while connected to the system, the iPod cannot be operated with its own controls. It is necessary to use the controls of the vehicle’s audio system instead.
- When the battery level of an iPod is very low, the iPod may not operate. If so, charge the iPod before use.
- Compatible models (→P. 355)

■ **iPod problems**

To resolve most problems encountered when using your iPod, disconnect your iPod from the vehicle iPod connection and reset it. For instructions on how to reset your iPod, refer to your iPod Owner’s Manual.

■ **Error messages**

If the following error messages appear on the screen, refer to the table and take the appropriate measures. If the problem is not rectified, take the vehicle to your Lexus dealer.

| Message | Cause/Correction procedures |
|--|---|
| “Connection error.” | This indicates a problem in the iPod or its connection. |
| “There are no songs available for playback.” | This indicates that there is no music data in the iPod. |
| “No items available.” | This indicates that songs are not found in a selected playlist. |
| “Please check the iPod firmware version.” | This indicates that the software version is not compatible. Please check the compatible models. (→P. 355) |
| “iPod authorization failed.” | This indicates that the Lexus Display Audio system failed to authorize the iPod. Please check your iPod. |

Compatible models

The following iPod®, iPod nano®, iPod classic®, iPod touch® and iPhone® devices can be used with this system.

- Made for
 - iPod touch (5th generation)
 - iPod touch (4th generation)
 - iPod touch (3rd generation)
 - iPod touch (2nd generation)
 - iPod touch (1st generation)
 - iPod classic
 - iPod with video
 - iPod nano (7th generation)
 - iPod nano (6th generation)
 - iPod nano (5th generation)
 - iPod nano (4th generation)
 - iPod nano (3rd generation)
 - iPod nano (2nd generation)
 - iPod nano (1st generation)
 - iPhone 5
 - iPhone 4S
 - iPhone 4
 - iPhone 3GS
 - iPhone 3G
 - iPhone

Depending on differences between models or software versions etc., some models might be incompatible with this system.

 **NOTICE****To prevent damage to the iPod or its terminals**

- Do not leave the iPod in the vehicle. The temperature inside the vehicle may become high.
- Do not push down on or apply unnecessary pressure to the iPod while it is connected.
- Do not insert foreign objects into the port.

Using USB memory device

Connecting a USB memory device enables you to enjoy music from the vehicle speakers.

Select "USB1" or "USB2" on the audio source selection screen.

Connecting a USB memory device

→P. 326

USB top screen

Pressing the "MEDIA" button displays the USB top screen from any screen of the selected source.

- **Menu screen**

→P. 338

- **Selecting a file**

Press the "<" or ">" button or turn the "TUNE•SCROLL" knob to select the desired file number.

To fast-forward or rewind, press and hold the "<" or ">" button.

- **Selecting a play mode**

- 1 Move the controller to the right and select "Browse".
- 2 Select the desired play mode, then select a file to begin the selected play mode.

- **Displaying the now playing list**

Move the controller to the right and select "Now Playing List".

■ USB memory functions

- Depending on the USB memory device that is connected to the system, the device itself may not be operable and certain functions may not be available. If the device is inoperable or a function is unavailable due to a malfunction (as opposed to a system specification), disconnecting the device and reconnecting it may resolve the problem.
- If the USB memory device still does not begin operation after being disconnected and reconnected, format the device.

■ Error messages for USB memory

If the following error messages appear on the screen, refer to the table and take the appropriate measures. If the problem is not rectified, take the vehicle to your Lexus dealer.

| Message | Cause/Correction procedures |
|--|---|
| "Connection error." | This indicates a problem with the USB memory device or its connection. |
| "There are no files available for playback." | This indicates that no MP3/WMA/AAC files are included on the USB memory device. |

■ USB memory

- Compatible devices
USB memory devices that can be used for MP3, WMA and AAC playback.
- Compatible device formats
The following device format can be used:
 - USB communication format: USB2.0 FS (480 Mbps)
 - File system format: FAT16/32 (Windows)
 - Correspondence class: Mass storage class
 MP3, WMA and AAC files written to a device with any format other than those listed above may not play correctly, and their file names and folder names may not be displayed correctly.
Items related to standards and limitations are as follows:
 - Maximum directory hierarchy: 8 levels
 - Maximum number of folders in a device: 3000 (including the root)
 - Maximum number of files in a device: 9999
 - Maximum number of files per folder: 255

- MP3, WMA and AAC files

MP3 (MPEG Audio LAYER 3) is a standard audio compression format. Files can be compressed to approximately 1/10 of their original size using MP3 compression.

WMA (Windows Media Audio) is a Microsoft audio compression format. This format compresses audio data to a size smaller than that of the MP3 format.

AAC is short for Advanced Audio Coding and refers to an audio compression technology standard used with MPEG2 and MPEG4.

MP3, WMA and AAC file and media/formats compatibility are limited.
- MP3 file compatibility
 - Compatible standards
MP3 (MPEG1 AUDIO LAYERIII, MPEG2 AUDIO LAYERIII)
 - Compatible sampling frequencies
MPEG1 AUDIO LAYERIII: 32, 44.1, 48 (kHz)
MPEG2 AUDIO LAYERIII: 16, 22.05, 24 (kHz)
 - Compatible bit rates (compatible with VBR)
MPEG1 AUDIO LAYERIII: 32-320 (kbps)
MPEG2 AUDIO LAYERIII: 8-160 (kbps)
 - Compatible channel modes: stereo, joint stereo, dual channel and monaural
- WMA file compatibility
 - Compatible standards
WMA Ver. 7, 8, 9 (only compatible with Window Media Audio Standard)
 - Compatible sampling frequencies
32, 44.1, 48 (kHz)
 - Compatible bit rates (only compatible with 2-channel playback)
Ver. 7, 8: CBR 48-192 (kbps)
Ver. 9: CBR 48-320 (kbps)
- AAC file compatibility
 - Compatible standards
MPEG4/AAC-LC
 - Compatible sampling frequencies
11.025/12/16/22.05/24/32/44.1/48 (kHz)
 - Compatible bit rates
16-320 (kbps)
 - Compatible channel modes: 1 ch and 2 ch
- File names

The only files that can be recognized as MP3/WMA/AAC and played are those with the extension .mp3, .wma or .m4a.
- ID3, WMA and AAC tags

ID3 tags can be added to MP3 files, making it possible to record the track title, artist name, etc.

The system is compatible with ID3 Ver. 1.0, 1.1, and Ver. 2.2, 2.3 ID3 tags. (The number of characters is based on ID3 Ver. 1.0 and 1.1.)

WMA tags can be added to WMA files, making it possible to record the track title and artist name in the same way as with ID3 tags.

AAC tags can be added to AAC files, making it possible to record the track title and artist name in the same way as with ID3 tags.

- MP3, WMA and AAC playback
 - When a device containing MP3, WMA or AAC files is connected, all files in the USB memory device are checked. Once the file check is finished, the first MP3, WMA or AAC file is played. To make the file check finish more quickly, we recommend that you do not include any files other than MP3, WMA or AAC files or create any unnecessary folders.
 - When a USB memory device is connected and the audio source is changed to USB memory mode, the USB memory device will start playing the first file in the first folder. If the same device is removed and reconnected (and the contents have not been changed), the USB memory device will resume play from the same point in which it was last used.
- Extensions

If the file extensions .mp3, .wma and .m4a are used for files other than MP3, WMA and AAC files, they will be skipped (not played).
- Playback
 - To play MP3 files with steady sound quality, we recommend a fixed bit rate of at least 128 kbps and a sampling frequency of 44.1 kHz.
 - There is a wide variety of freeware and other encoding software for MP3, WMA and AAC files on the market, and depending on the status of the encoding and the file format, poor sound quality or noise at the start of playback may result. In some cases, playback may not be possible at all.
 - Microsoft, Windows, and Windows Media are the registered trademarks of Microsoft Corporation in the U.S.A. and other countries.

**NOTICE****■ To prevent damage to the USB memory device or its terminals**

- Do not leave the USB memory device in the vehicle. The temperature inside the vehicle may become high.
- Do not push down on or apply unnecessary pressure to the USB memory device while it is connected.
- Do not insert foreign objects into the port.

Using the AUX port

To use the AUX port, connect a portable player, press the “MEDIA” button or select “AUX” or “A/V” on the “Source” screen.

Connecting a portable player

→P. 326

Top screen

Pressing the “MEDIA” button displays the top screen from any screen of the selected source.

■ Menu screen

→P. 338

■ Operating portable players connected to the audio system

Volume can be adjusted using the vehicle’s audio controls. All other adjustments must be made on the portable player itself.

■ When using a portable player connected to the power outlet

Noise may occur during playback. Use the power source of the portable player.



NOTICE

■ To prevent damage to the portable player or its terminal

- Do not leave portable player in the vehicle. The temperature inside the vehicle may become high.
- Do not push down on or apply unnecessary pressure to the portable player while it is connected.
- Do not insert foreign objects into the port.

Steps for using Bluetooth® devices

The following can be performed using Bluetooth® wireless communication:

- A portable audio player can be operated and listened to via the Lexus Display Audio system
- Hands-free phone calls can be made via a cellular phone

In order to use wireless communication, register and connect a Bluetooth® device by performing the following procedures.

Device registration/connection flow

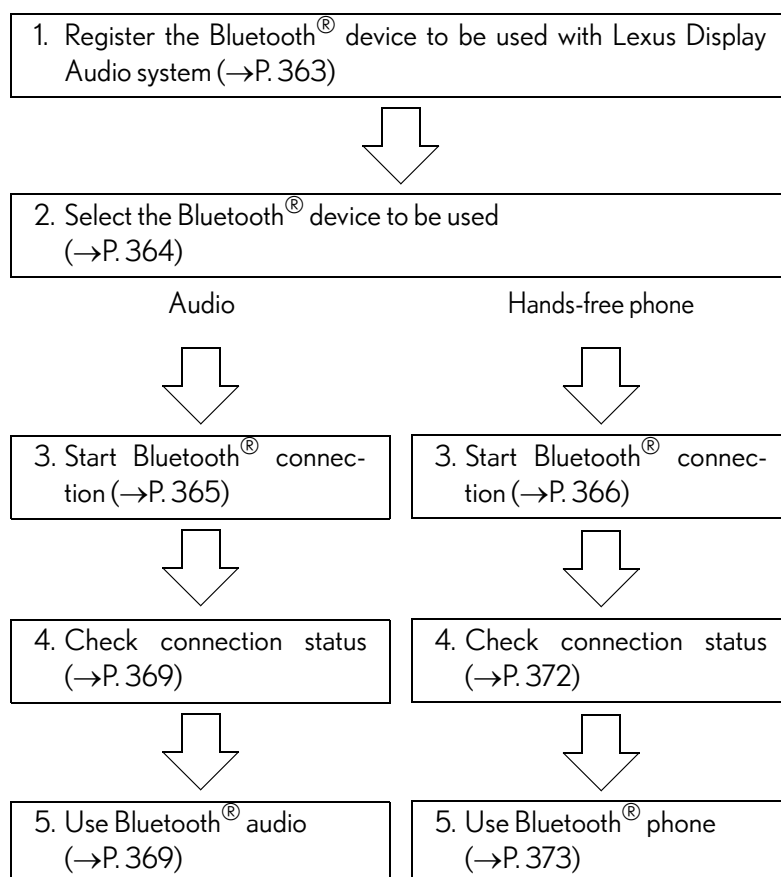

“Bluetooth* Setup” screen

Go to “Bluetooth* Setup”: “MENU” button → “Setup” → “Bluetooth*”

*: Bluetooth is a registered trademark of Bluetooth SIG, Inc.

■ **When displaying “Bluetooth* Setup” screen from the “Bluetooth* Audio” screen**

1 Display the “Bluetooth* Audio” screen. (→P. 369)

2 Move the controller to the left and select “Connect”.

■ **When displaying “Bluetooth* Setup” screen from the phone top screen**

1 Display the phone top screen. (→P. 371)

2 Move the controller to the left and select “Connect Phone”.

*: Bluetooth is a registered trademark of Bluetooth SIG, Inc.

Registering a Bluetooth® device

Bluetooth® compatible phones (HFP) and portable audio players (AVP) can be registered simultaneously. You can register up to 5 Bluetooth® devices.

How to register a Bluetooth® device

- 1 Turn the Bluetooth® connection setting of your device set to on.
- 2 Go to “Bluetooth* Setup”: “MENU” button → “Setup” → “Bluetooth*”
- 3 Move the controller to the left and then select “Add Device”

- 4 When this screen is displayed, input the passcode displayed on the screen into your Bluetooth® device.

For operation of the Bluetooth® device, see the manual that comes with your Bluetooth® device.

- 5 Register the Bluetooth® device using your Bluetooth® device.

A PIN code are not required for SSP (Secure Simple Pairing) compatible Bluetooth® devices. Depending on the device, you may need to select Yes to register, or No to cancel on the device.

If an error message is displayed, follow the guidance on the screen to try again.

*: Bluetooth is a registered trademark of Bluetooth SIG, Inc.

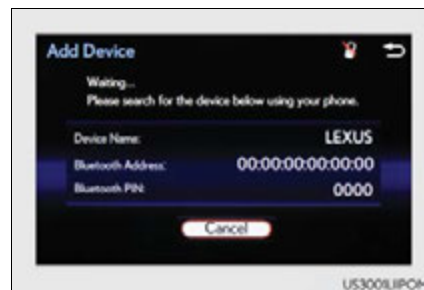

5

Audio system

Removing a Bluetooth® device

- 1 Go to “Bluetooth* Setup”: “MENU” button → “Setup” → “Bluetooth*”
- 2 Move the controller to the left and then select “Remove Device”.
- 3 Select the device to remove.

*: Bluetooth is a registered trademark of Bluetooth SIG, Inc.

Selecting a Bluetooth® device

If multiple Bluetooth® devices are registered, follow the procedure below to select the Bluetooth® device to be used. You may only use one device at a time.

How to select a Bluetooth® device

- 1 Go to "Bluetooth* Setup": "MENU" button → "Setup" → "Bluetooth*"
- 2 Select the device to connect.
- 3 Select "Connect All", "Connect as a Phone" or "Connect as an Audio Player".

If the desired Bluetooth® device is not displayed, register the device.
(→P. 363)

*: Bluetooth is a registered trademark of Bluetooth SIG, Inc.

Connecting a Bluetooth® audio player

There are 2 portable audio player connection settings available: connecting from the vehicle and connecting from the portable player.

Connecting method is set to “Vehicle”

When the portable audio player is in standby for a connection, it will be automatically connected whenever the power switch is in either ACCESSORY or ON mode.

Connecting method is set to “Device”

Operate the portable player and connect it to the Bluetooth® audio system.

- 1 Go to “Bluetooth* Setup”: “MENU” button → “Setup” → “Bluetooth*”
- 2 Select the device to connect.
- 3 Select “Connect All” or “Connect as an Audio player”.

If the desired Bluetooth® device is not displayed, register the device. (→P. 363)

*: Bluetooth is a registered trademark of Bluetooth SIG, Inc.

Connecting a Bluetooth® phone

There are two connecting methods available: automatic and manual.

Auto connection

When you register a phone, auto connection will be activated. Always set it to this mode and leave the Bluetooth® phone in a place where a connection can be established.

When the power switch is turned to ACCESSORY or ON mode, the system will search for a nearby cellular phone you have registered.

Next, the system automatically connects with the most recent phone that was connected. The connected result is displayed.

Manual connection

When auto connection has failed or “Bluetooth* Power” is turned off, you must connect the Bluetooth® device manually.

- 1 Go to “Bluetooth* Setup”: “MENU” button → “Setup” → “Bluetooth*”
- 2 Select the device to connect.
- 3 Select “Connect All”, “Connect as a Phone” or “Connect as an Audio player”.

If the desired Bluetooth® device is not displayed, register the device.
(→P. 363)

*: Bluetooth is a registered trademark of Bluetooth SIG, Inc.

■ Reconnecting a Bluetooth® phone

If the system cannot connect due to poor signal strength with the power switch in ACCESSORY or ON mode, the system will automatically attempt to reconnect.

If the phone is turned off, the system will not attempt to reconnect. In this case, the connection must be made manually, or the phone must be reselected.

■ Connecting a phone while Bluetooth® audio is playing

- Bluetooth® audio will stop temporarily.
- It may take time to connect.

Displaying a Bluetooth® device details

You can confirm and change the registered device details.

Bluetooth® device registration status

- 1 Go to "Bluetooth* Setup": "MENU" button → "Setup" → "Bluetooth*"
- 2 Select the desired device and then select "Device Info".

- ① Change the name of the device
- ② Change the connection method
 - "Vehicle": Connect the audio system to the portable audio player.
 - "Device": Connect the portable audio player to the audio system
- ③ Device address
- ④ Device telephone number

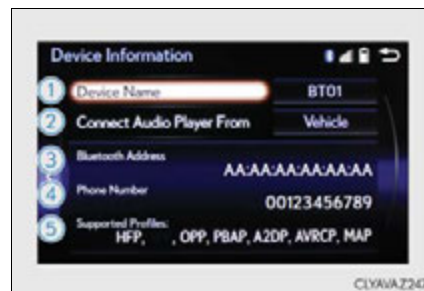

- ⑤ Device telephone number
 - Depending on the model of phone, the number may not be displayed.
- ⑤ Compatibility profile of the device

*: Bluetooth is a registered trademark of Bluetooth SIG, Inc.

Restoring the default settings

Move the controller to the left and select "Default" on the "Device Information" screen.

Detailed Bluetooth® settings

You can confirm and change the detailed Bluetooth® settings.

How to check and change detailed Bluetooth® settings

- 1 Go to “Bluetooth* Setup”: “MENU” button → “Setup” → “Bluetooth*”
- 2 Move the controller to the left and then select “System Settings”.

① Select to set the Bluetooth® function on/off.

② Change the name of the device.

③ Change the PIN-code.

You can change the PIN-code that is used to register your Bluetooth® devices in the system.

④ Device address

⑤ Select to set the display of the telephone status on/off

You can set the system to show the status confirmation display when connecting a telephone.

⑥ Select to set the display of the audio player status on/off

You can set the system to show the status confirmation display when connecting an audio player.

⑦ Compatibility profile of the system

*: Bluetooth is a registered trademark of Bluetooth SIG, Inc.

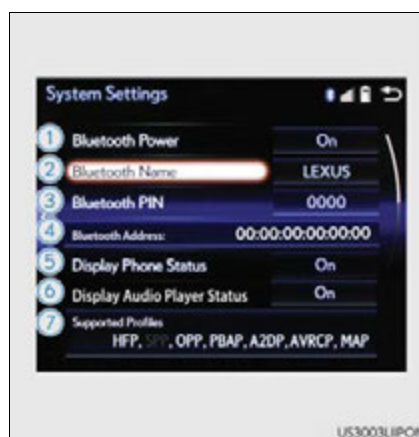

Restoring the default settings

Move the controller to the left and select “Default” on the “System Settings” screen.

Listening to Bluetooth® Audio

The Bluetooth® audio system enables the user to enjoy music played on a portable player from the vehicle speakers via wireless communication.

When a Bluetooth® device cannot be connected, check the connection status on the “Bluetooth* Audio” screen. If the device is not connected, either register or reconnect the device. (→P. 363, 365)

*: Bluetooth is a registered trademark of Bluetooth SIG, Inc.

Status display







You can check indicators, such as signal strength and battery charge on the screen.

- ① Connection status
- ② Battery charge

Depending on the type of portable audio player used, some titles may not be displayed.



5
Audio system

| Indicators | Conditions |
|-------------------|--|
| Connection status | Good ←————→ Not connected    |
| Battery charge | Full ←————→ Empty    |

Bluetooth® audio top screen

Pressing the "MEDIA" button displays the Bluetooth® audio top screen from any screen of the selected source.

■ **Menu screen**

→P. 338

■ **Selecting a song**

Press the "<" or ">" button or turn the "TUNE•SCROLL" knob to select the desired song number.

To fast-forward or reverse, press and hold the "<" or ">" button.

■ **Selecting a play mode**

- 1 Move the controller to the right and then select "Browse".
- 2 Select the desired play mode, and then select a song to begin using the selected play mode.

■ **Displaying the now playing list**

Move the controller to the right and then select "Now Playing List".

Using a Bluetooth® Phone

The hands-free system is a function that allows you to use your cellular phone without touching it.

This system supports Bluetooth®. Bluetooth® is a wireless data system that allows the cellular phone to wirelessly connect to the hands-free system and make/receive calls.

Before making a phone call, check the connection status, battery charge, call area and signal strength. (→P. 372)

If a Bluetooth® device cannot be connected, check the connection status. If the device is not connected, either register or reconnect it. (→P. 363, 366)

Phone top screen

To display the screen shown below, press the off-hook switch on the steering wheel or select "Phone" on the "Menu" screen.

- ① Phone name
- ② Bluetooth® connection status (→P. 372)
- ③ Display the call history screen (→P. 374)
- ④ Display the favorites screen (→P. 374)
- ⑤ Display the contacts screen (→P. 373)
- ⑥ Display the dial pad screen (→P. 373)
- ⑦ Display the message inbox screen (→P. 378)

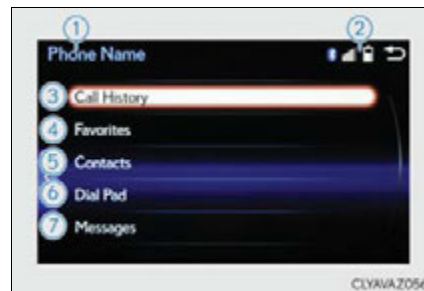

5

Audio system

◆ Telephone switch (→P. 380)

◆ Microphone

The vehicle's built-in microphone is used when talking on the phone.

The person you are speaking to can be heard from the front speakers.









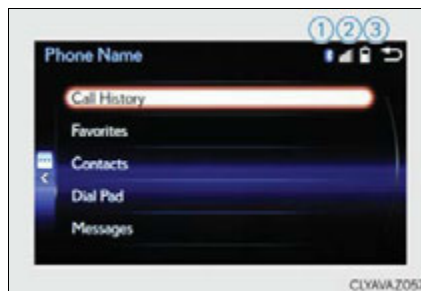

To use the hands-free system, you must register your Bluetooth® phone in the system. (→P. 363)

Status display

You can check indicators such as signal strength and battery charge on any screen.

- ① Connection status
- ② Signal strength
- ③ Battery charge



| Indicators | Conditions | | |
|-------------------|---|---|---|
| | Good | Poor | Not connected |
| Connection status |  |  |  |
| Battery charge |  |  | |
| Signal strength |  |  | |

Making a call

Once a Bluetooth® phone is registered, you can make a call using the following procedure:

Dialing

- 1 Go to “Dial Pad”: “MENU” button → “Phone” → “Dial Pad”
- 2 Input a phone number. (→P. 323)
- 3 Press the off-hook switch on the steering wheel or select .

Dialing from the phonebook

You can dial a number from the phonebook data imported from your cellular phone. The system has one phonebook for each registered telephone. Up to 2500 contacts may be stored in each phonebook. (→P. 373)

- 1 Go to “Contacts”: “MENU” button → “Phone” → “Contacts”
- 2 Choose the desired contact to call from the list.
- 3 Choose the number and then press the off-hook switch on the steering wheel or press the controller.

When the phonebook is empty

You can transfer the phone numbers in a Bluetooth® phone to the system. Operation methods differ between PBAP (Phone Book Access Profile) compatible and PBAP incompatible Bluetooth® phones. If the cellular phone does not support either PBAP or OPP (Object Push Profile) service, you cannot transfer contacts.

- 1 Press the off-hook switch on the steering wheel.
 - If the phonebook is empty, a message will be displayed.
 - ▶ For a PBAP compatible Bluetooth® phone and “Automatic Transfer” is off
- 2 To transfer new contacts from a cellular phone, select “Always” and then enable “Automatic Transfer”. (→P. 383)
Select “Once” if you want to transfer new contacts from a cellular phone.

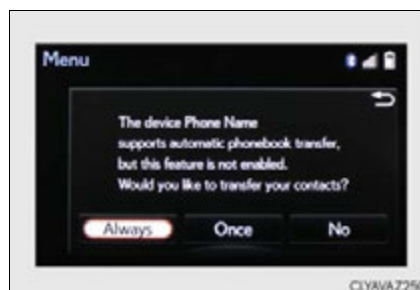

- ▶ For a PBAP incompatible and OPP compatible Bluetooth® phone

- 2 Select "Transfer" and operate your cellular phone to transfer new contacts from a cellular phone.

Select "Add" if you want to add a new contact manually.

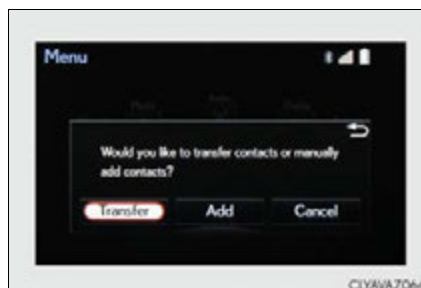

Dialing from favorites

You can make a call using numbers registered in the favorites.

- 1 Go to "Favorites": "MENU" button → "Phone" → "Favorites"
- 2 Choose the desired contact to call from the list.
- 3 Choose the number and then press the off-hook switch on the steering wheel or press the controller.

Dialing from history

You can make a call using the call history.

- 1 Go to "Call History": "MENU" button → "Phone" → "Call History"
- 2 Select the desired entry from the list.
- 3 Press the off-hook switch on the steering wheel or select .

■ Call history list

- If you make a call to or receive a call from a number registered in the phonebook, the name is displayed in the call history.
- If you make multiple calls to the same number, only the last call made is displayed in the call history.

■ International calls

Depending on the mobile phone in use, you may not be able to make international calls.

■ Calling by using the latest call history entry

- 1 Press the off-hook switch on the steering wheel to display the phone top screen.
- 2 Press the switch again to display the "Call History" screen.
- 3 Press the switch again to select the latest call history entry.

Receiving a call

When a call is received, the following screen is displayed together with a sound.

To answer the phone

Press the off-hook switch on the steering wheel or select .

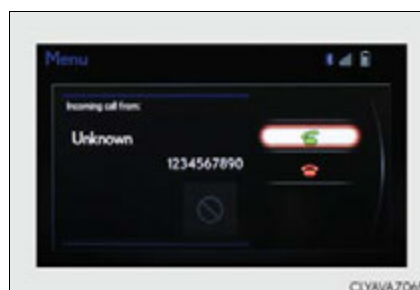

To refuse a call

Press the on-hook switch on the steering wheel or select .

■ International calls

Depending on the cellular phone in use, received international calls may not be displayed correctly.

Speaking on the phone

The following screen is displayed when speaking on the phone.

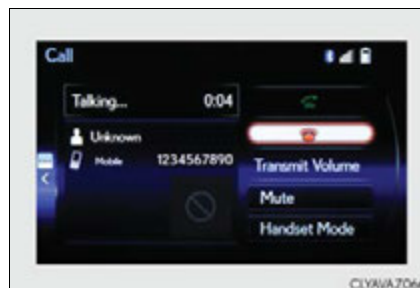

To adjust the transmit volume

Select "Transmit Volume". To restore default volume, move the controller to the left on the "Transmit Volume" screen and then select "Default".

To adjust in call volume

Move the controller to the left and then select "In-call Volume". You can also adjust the volume using the "PWR•VOL" knob or the steering switches.

To prevent the other party from hearing your voice

Select "Mute".

Inputting tones

When using phone services such as an answering service or a bank, you can store phone numbers and code numbers in the contacts using "p" or "w" symbols (eg. 056133 w 0123p#1).

- ▶ Contact including a phone number only

1 Move the controller to the left and then select "0-9".

2 Input the number.

- ▶ Phone number containing a "p" symbol

When the "p" symbol is dialed in an outgoing call, there will be a pause for 2 seconds before the following digits are dialed automatically.

- ▶ Phone number containing a “w” symbol

When the “w” symbol is dialed in an outgoing call, you need to go to the “Release Tones” screen to dial the following digits. Move the controller to the left and then select “Release Tones”.

To transfer a call

Select “Handset Mode” to change from a hands-free call to a cellular phone call or vice versa.

To hang up

Press the on-hook switch on the steering wheel or select .

Call waiting

When a call is interrupted by a third party while talking, an incoming call message will be displayed.

To talk with the other party:

Press the off-hook switch on the steering wheel or select .

To refuse the call:

Press the on-hook switch on the steering wheel or select .

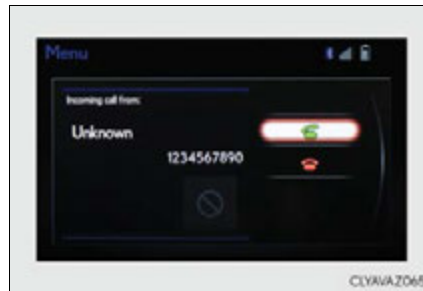

Every time you press the off-hook switch on the steering wheel or select  during call waiting, you will be switched to the other party.

■ **Transferring calls**

- It is not possible to transfer from hands-free to the cellular phone while driving.
- If you transfer from the cellular phone to hands-free, the hands-free screen will be displayed, and you can operate the system using the screen.
- Transfer method and operation may vary according to the cellular phone used.
- For operation of the cellular phone in use, see the phone’s manual.

■ **Call waiting operation**

Call waiting operation may differ depending on your phone company and cellular phone.

Using a Bluetooth® phone message

Once a MAP-profile compatible Bluetooth phone is registered, you can check the E-mail/SMS/MMS and reply to a message using the following procedures:

Checking messages

- 1 Go to message screen: "MENU" button → "Phone" → "Messages"
- 2 Select a message.

Moving the controller to the left while on the message list screen displays the setting screen. (→P. 386)

Move the controller to the right while on the message screen and then select an account to display a message list for the selected account.

Message screen

Selecting "Next" or "Previous" displays the next or previous message.
If a message is too long, select "Read More" to display the full text.

■ Option menu

Move the controller to the left while on the message screen.

- 1 Select a prepared message and send a reply message.
- 2 Call a sender.

If more than one phone number is registered for a sender, a phone number selection screen will be displayed.

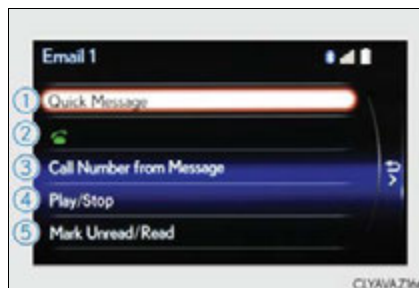

- 3 Call a phone number written in a message.
- 4 Select "Play" to have a message read out loud.
Select "Stop" to stop this function.
- 5 Select "Mark Unread" to mark mail that has been read as unread. Select "Mark Read" to mark mail that has not been read as read.

Replying to a message

- 1 Move the controller to the left while on the message screen.
- 2 Select "Quick Message" to display the "Quick Message" screen.
- 3 Select the desired message and then select "Send".

■ Editing a quick message

- 1 Move the controller to the left while on the message screen.
- 2 Select "Quick Message" and move the cursor to the desired message.
- 3 Move the controller to the left and select "Edit".

To return to the default message after editing, select "Default".

Receiving a message popup function

This function is available when the "E-mail Notification Popup" or "SMS/MMS Notification Popup" are set to on. (→P. 386)

- ▶ "Incoming E-mail Display" or "Incoming SMS/MMS Display" are set to "Drop-Down"

When E-mail/ SMS/MMS are received, the incoming message is displayed on the upper side of the screen with a sound.

- ▶ "Incoming E-mail Display" or "Incoming SMS/MMS Display" are set to "Full Screen"

When E-mail/ SMS/MMS are received, the incoming message screen is displayed with a sound and it can be operated on the screen.

- 1 Check the message.
- 2 Refuse to check the message.
- 3 Call to receive the message sender's phone number.

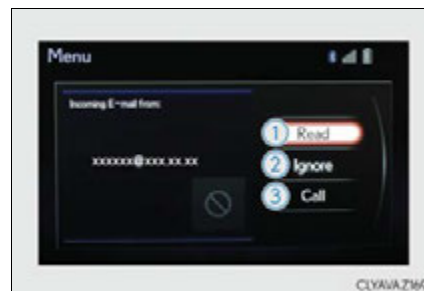

Using the steering wheel switches

The steering wheel switches can be used to operate a connected cellular phone.

Operating a telephone using the steering wheel switches

① Volume switch

During an incoming call: Adjusts the ring tone volume

During speaking on the phone: Adjusts in call volume

The voice guidance volume cannot be adjusted using this button.

② Off-hook switch

- Start call
- Receiving
- Phone top screen display

③ On-hook switch

- End call
- Refuse call

④ Talk switch

Press: Turns the voice command system on

Press and hold: Turns the voice command system off

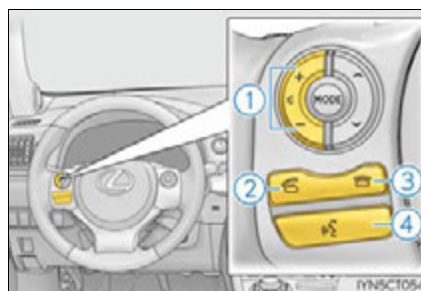

Bluetooth® phone settings

You can adjust the hands-free system to your desired settings.

“Phone/Message Settings” screen

Go to “Phone/Message Settings”: “MENU” button → “Setup” → “Phone”

- ① Register and connect a Bluetooth® device. (→P. 362)
- ② Adjust the call volume and message readout volume. (→P. 381)
- ③ Change the contact/call history settings. (→P. 383)
- ④ Change messaging settings. (→P. 386)
- ⑤ Change phone display settings. (→P. 382)

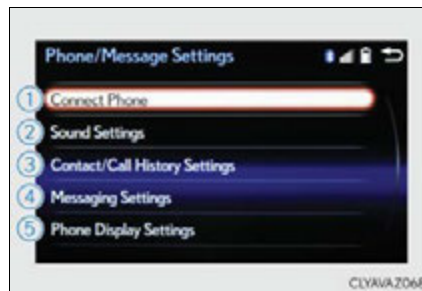

Sound settings

Go to “Sound Settings”: “MENU” button → “Setup” → “Phone” → “Sound Settings”

- ① Change the ring tone type
- ② Adjust the ring tone volume
- ③ Adjust the message readout volume
- ④ Change the incoming SMS/MMS tone type
- ⑤ Adjust the incoming SMS/MMS tone volume
- ⑥ Change the incoming e-mail tone type
- ⑦ Adjust the incoming e-mail tone volume
- ⑧ Adjust in call tone volume

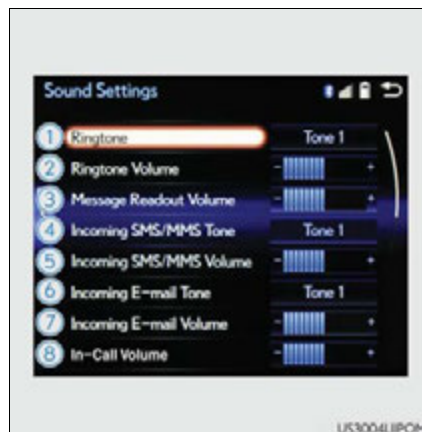

Phone display settings

Go to “Phone Display Settings”: “MENU” button → “Setup” → “Phone” → “Phone Display Settings”

- ① Change the incoming call display
- ② Set the phonebook/history transfer status notification display on/off

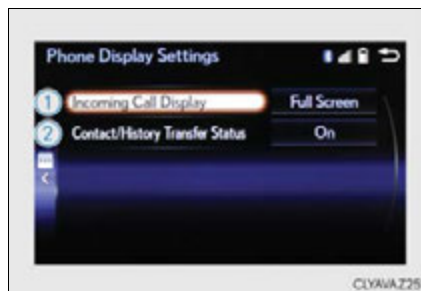

■ To return to the default volume settings

Move the controller to the left and then select “Default”.

Contact settings

Individual phonebooks can be registered for a maximum of 5 phones in total. The data for 2500 contacts (up to 4 numbers per contact) can be registered in each phonebook.

“Contact/Call History Settings” screen

Go to “Contact/Call History Settings”: “MENU” button → “Setup” → “Phone” → “Contact/Call History Settings”

- ① Select to set the automatic phonebook download on/off
With this setting on, phonebook data will be automatically transferred.
Depending on the cellular phone, call history will be also transferred.
- ② Update contacts
- ③ Change the sort contacts mode
- ④ Add a favorite (→P. 384)
- ⑤ Delete a favorite (→P. 384)
- ⑥ Select to set the display of contact images on/off
- ⑦ Delete call history. (PBAP incompatible Bluetooth[®] phones, or compatible phones with “Automatic Transfer” off)
- ⑧ Add a new contact (PBAP incompatible Bluetooth[®] phones, or compatible phones with “Automatic Transfer” off)
Input the name, phone number and phone number type to add a new contact.
- ⑨ Edit a contact (PBAP incompatible Bluetooth[®] phones, or compatible phones with “Automatic Transfer” off)
Select the desired contact to edit.
- ⑩ Delete contacts (→P. 385) (PBAP incompatible Bluetooth[®] phones, or compatible phones with “Automatic Transfer” off)

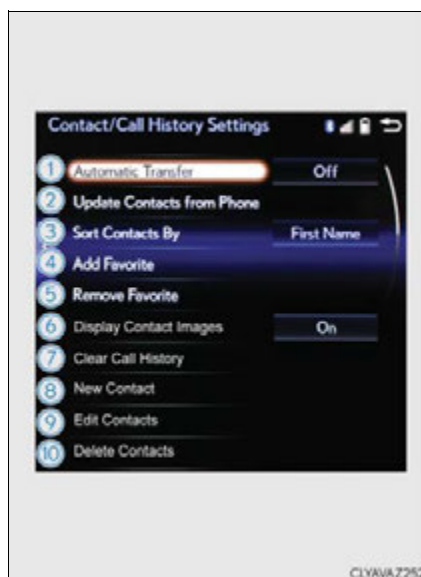

5

Audio system

■ Return to the default settings

Move the controller to the left and select “Default”.

Transferring a phone number

You can transfer the phone numbers in your Bluetooth® phone to the system. Operation methods differ between PBAP compatible and PBAP incompatible Bluetooth® phones. If your cellular phone does not support either PBAP or OPP services, you cannot transfer contacts.

Go to “Transfer Contacts”: “MENU” button → “Setup” → “Phone” → “Contact/Call History Settings” → “Update Contacts from Phone”

- ▶ For PBAP compatible Bluetooth® phones when “Automatic Transfer” is set to on

Start the update automatically.

- ▶ For PBAP compatible Bluetooth® phones when “Automatic Transfer” is set to off and PBAP incompatible Bluetooth® phones

- ① Select to transfer the contact from the connected cellular phone and replace the current one.
- ② Select to transfer the desired contact data from the connected cellular phone to add to the current one.

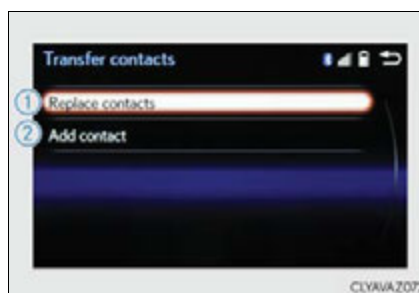

Registering favorites

You can register the desired contact from the phonebook. Up to 15 contacts per phone can be registered.

- 1 Go to “Add Favorite”: “MENU” button → “Setup” → “Phone” → “Contact/Call History Settings” → “Add Favorite”
- 2 Choose the contact to register.

Removing favorites

- 1 Go to “Remove Favorite”: “MENU” button → “Setup” → “Phone” → “Contact/Call History Settings” → “Remove Favorite”
- 2 Select the desired contacts.
 - You can select all contacts by selecting “Select All”.
- 3 Move the controller to the left and select “Remove”.

Deleting the contacts data

- 1 Go to "Delete Contacts": "MENU" button → "Setup" → "Phone" → "Contact/Call History Settings" → "Delete Contacts"
- 2 Select the desired contacts.
You can select all contacts by selecting "Select All".
- 3 Move the controller to the left and select "Delete".

■ Phonebook data

Phonebook data is managed separately for every registered phone. When another phone is connected, you cannot read the registered data.

■ When transferring contacts

Transfer contacts while the hybrid system is operating.

If the cellular phone is OPP or PBAP compatible, you may need to input "1234" on the cellular phone for OBEX certification.

■ When you have selected "Replace contacts" or "Add contact" to transfer contacts

If the cellular phone does not support OPP service, you cannot use these functions. You can transfer the phonebook data only by operating your phone.

■ Transferring contacts while Bluetooth® audio is playing

Bluetooth® audio will disconnect. It will reconnect automatically when data transfer finishes. It may not reconnect depending on the phone which is connected.

Messaging setting

Go to "Messaging Settings": "MENU" button → "Setup" → "Phone" → "Messaging Settings"

- ① Set the message forwarding from cellular phones on/off
- ② Set the automatic message read out function on/off
- ③ Set the new SMS/MMS notification display on/off
- ④ Set the new e-mail notification display on/off
- ⑤ Set the signature function on/off
- ⑥ Set the cellular phone's message read and unread status update function on/off.
- ⑦ Change the incoming SMS/MMS display.
- ⑧ Change the incoming e-mail display.
- ⑨ Change the account name to "Service name" (names from the connected device) or "Fixed name" (pre-defined names).



■ Restoring the default settings

Move the controller to the left then select "Default" on the "Messaging Settings" screen.

What to do if... (Troubleshooting)

If there is a problem with the hands-free system or a Bluetooth® device, first check the table below.

- ▶ When using the hands-free system with a Bluetooth® device

| |
|--|
| The hands-free system or Bluetooth® device does not work. |
| The connected device may not be a compatible Bluetooth® cellular phone. → For a list of specific devices which operation has been confirmed on this system, check with your Lexus dealer or the following website: http://www.lexus.com/MobileLink |
| The Bluetooth® version of the connected cellular phone may be older than the specified version. → Use a cellular phone with Bluetooth® version 2.0 or higher (recommended: Ver. 3.0 with EDR or higher). (→P. 392) |

- ▶ When registering/connecting a cellular phone

| |
|--|
| A cellular phone cannot be registered. |
| An incorrect passcode was entered on the cellular phone. → Enter the correct passcode on the cellular phone. |
| The registration operation has not been completed on the cellular phone side. → Complete the registration operation on the cellular phone (approve registration on the phone). |
| Old registration information remains on either this system or the cellular phone. → Delete the existing registration information from both this system and the cellular phone, then register the cellular phone you wish to connect to this system. (→P. 363) |
| A Bluetooth® connection cannot be made. |
| Another Bluetooth® device is already connected. → Manually connect the cellular phone you wish to use to this system. (→P. 366) |
| Bluetooth® function is not enabled on the cellular phone. → Enable the Bluetooth® function on the cellular phone. |

- ▶ When making/receiving a call

| |
|---|
| A call cannot be made/received. |
| Your vehicle is in a "No Service" area. → Move to where "No Service" no longer appears on the display. |

▶ When using the phonebook

| |
|---|
| Phonebook data cannot be transferred manually/automatically. |
| The profile version of the connected cellular phone may not be compatible with transferring phonebook data. → For a list of specific devices which operation has been confirmed on this system, check with your Lexus dealer or the following website: http://www.lexus.com/MobileLink |
| Automatic phonebook transfer function on this system is set to off. → Set automatic phonebook transfer function on this system to on. (→P. 383) |
| Passcode has not been entered on the cellular phone. → Enter the passcode on the cellular phone if requested (default passcode: 1234). |
| Transfer operation on the cellular phone has not completed. → Complete transfer operation on the cellular phone (approve transfer operation on the phone). |
| Phonebook data cannot be edited. |
| Automatic phonebook transfer function on this system is set to on. → Set automatic phonebook transfer function on this system to off. (→P. 383) |

▶ When using the Bluetooth® message function

| |
|---|
| Messages cannot be viewed. |
| Message transfer is not enabled on the cellular phone. → Enable message transfer on the cellular phone (approve message transfer on the phone). |
| Automatic transfer function on this system is set to off. → Set automatic transfer function on this system to on. (→P. 386) |
| New message notifications are not displayed. |
| Notification of SMS/MMS/E-mail reception on this system is set to off. → Set notification of SMS/MMS/E-mail reception on this system to on. (→P. 386) |
| Automatic message transfer function is not enabled on the cellular phone. → Enable automatic transfer function on the cellular phone. |

▶ In other situations

Even though all conceivable measures have been taken, the symptom status does not change.

The cellular phone is not close enough to this system.
→ **Bring the cellular phone closer to this system.**

The cellular phone is the most likely cause of the symptom.
→ **Turn the cellular phone off, remove and reinstall the battery pack, and then restart the cellular phone.**
→ **Enable the cellular phone's Bluetooth® connection.**
→ **Stop the cellular phone's security software and close all applications.**
→ **Before using an application installed on the cellular phone, carefully check its source and how its operation might affect this system.**

Bluetooth®

■ When using the Bluetooth® audio system

- In the following situations, the system may not function.
 - If the portable audio player is turned off
 - If the portable audio player is not connected
 - If the portable audio player's battery is low
- There may be a delay if a cellular phone connection is made during Bluetooth® audio play.
- Depending on the type of portable audio player that is connected to the system, operation may differ slightly and certain functions may not be available.

■ When using the hands-free system

- The audio system is muted when making a call.
- If both parties speak at the same time, it may be difficult to hear.
- If the received call volume is overly loud, an echo may be heard.
If the Bluetooth® phone is too close to the system, quality of the sound may deteriorate and connection status may deteriorate.
- In the following situations, it may be difficult to hear the other party:
 - When driving on unpaved roads
 - When driving at high speeds
 - If a window is open
 - If the air conditioning is blowing directly on the microphone
 - If there is interference from the network of the cellular phone
- Depending on the type phone, certain functions may not be available.

■ Conditions under which the system will not operate

- If using a cellular phone that does not support Bluetooth®
- If the cellular phone is turned off
- If you are outside of cellular phone service coverage
- If the cellular phone is not connected
- If the cellular phone's battery is low
- When outgoing calls are controlled, due to heavy traffic on telephone lines, etc.
- When the cellular phone itself cannot be used
- When transferring phonebook data from the cellular phone

■ Bluetooth® antenna

The antenna is built into the display.

If the portable audio player or cellular phone is behind the seat or in the glove box or console box, or is touching or covered by metal objects, the connection status may deteriorate.

■ Battery charge/signal status

- This display may not correspond exactly with the portable audio player or cellular phone itself.
- This system does not have a charging function.
- The portable audio player or cellular phone battery will be depleted quickly when the device is connected to Bluetooth®.

■ When using the Bluetooth® audio and hands-free system at the same time

The following problems may occur.

- The Bluetooth® audio connection may be interrupted.
- Noise may be heard during Bluetooth® audio playback.

■ About the contact in this system

The following data is stored for every registered cellular phone. When another phone is connecting, you cannot read the registered data.

- Contact data
- Call history
- Favorite
- Message

When removing a Bluetooth® phone from the system, the above-mentioned data is also deleted.

■ About Bluetooth®

The Bluetooth® word mark and logos are registered trademarks owned by Bluetooth SIG, Inc. and any use of such marks by PIONEER CORPORATION is under license. Other trademarks and trade names are those of their respective owners.



Compatible models

The Bluetooth® audio system supports portable audio players with the following specifications

- Bluetooth® specifications:
Ver. 2.0 or higher (Recommended: Ver. 3.0 +EDR or higher)
- Profiles:
 - A2DP (Advanced Audio Distribution Profile) Ver. 1.0, or higher
(Recommended: Ver. 1.2 or higher)
This is a profile to transmit stereo audio or high quality sound to the audio system.
 - AVRCP (Audio/Video Remote Control Profile) Ver. 1.0 or higher
(Recommended: Ver. 1.4 or higher)
This is a profile to allow remote control the A/V equipment.

However, please note that some functions may be limited depending on the type of portable audio player connected.

The hands-free system supports cellular phones with the following specifications.

- Bluetooth® specification:
Ver. 2.0 or higher (Recommended: Ver. 3.0 +EDR or higher)
- Profiles:
 - HFP (Hands Free Profile) Ver. 1.0 or higher (Recommended: Ver. 1.6 or higher)
This is a profile to allow hands-free phone calls using a cellular phone or head set. It has outgoing and incoming call functions.
 - OPP (Object Push Profile) Ver. 1.1 or higher (Recommended: Ver. 1.2)
This is a profile to transfer phonebook data. When a Bluetooth® compatible cellular phone has both PBAP and OPP, OPP cannot be used.
 - PBAP (Phone Book Access Profile) Ver. 1.0 or higher (Recommended: Ver. 1.1)
This is a profile to transfer phonebook data.
 - MAP (Message Access Profile) Ver.1.0 or higher
This is a profile to using phone message.

If the cellular phone does not support HFP, you cannot register it with the hands-free system. OPP, PBAP or MAP services must be selected individually.

Reconnecting the portable audio player

If the portable audio player is disconnected due to poor reception when the power switch is in ACCESSORY or ON mode, the system automatically reconnects the portable audio player.

If you have switched off the portable audio player yourself, follow the instructions below to reconnect:

- Select the portable audio player again
- Enter the portable audio player

When you sell your car

Be sure to delete your personal data. (→P. 331)

■ Certification

FCC ID:AJDK074

IC:775E-K074

NOTE:

This device complies with Part 15 of FCC Rules and Industry Canada licence-exempt RSS standard(s). Operation is subject to the following two conditions: (1) this device may not cause interference, and (2) this device must accept any interference, including interference that may cause undesired operation of this device.

Le présent appareil est conforme aux la partie 15 des règles de la FCC et CNR d'Industrie Canada applicables aux appareils radio exempts de licence. L'exploitation est autorisée aux deux conditions suivantes : (1) l'appareil ne doit pas produire de brouillage, et (2) l'utilisateur de l'appareil doit accepter tout brouillage radioélectrique subi, même si le brouillage est susceptible d'en compromettre le fonctionnement.

FCC WARNING:

Changes or modifications not expressly approved by the party responsible for compliance could void the user's authority to operate the equipment.

CAUTION:

This equipment complies with FCC/IC radiation exposure limits set forth for an uncontrolled environment and meets the FCC radio frequency (RF) Exposure Guidelines and RSS-102 of the IC radio frequency (RF) Exposure rules. This equipment should be installed and operated keeping the radiator at least 20cm or more away from person's body.

Cet équipement est conforme aux limites d'exposition aux rayonnements énoncées pour un environnement non contrôlé et respecte les règles les radioélectriques (RF) de la FCC lignes directrices d'exposition et d'exposition aux fréquences radioélectriques (RF) CNR-102 de l'IC. Cet équipement doit être installé et utilisé en gardant une distance de 20 cm ou plus entre le dispositif rayonnant et le corps.

Co-Location:

This transmitter must not be co-located or operated in conjunction with any other antenna or transmitter.

Under Industry Canada regulations, this radio transmitter may only operate using an antenna of a type and maximum (or lesser) gain approved for the transmitter by Industry Canada. To reduce potential radio interference to other users, the antenna type and its gain should be so chosen that the equivalent isotropically radiated power (e.i.r.p.) is not more than that necessary for successful communication.

Conformément à la réglementation d'Industrie Canada, le présent émetteur radio peut fonctionner avec une antenne d'un type et d'un gain maximal (ou inférieur) approuvé pour l'émetteur par Industrie Canada. Dans le but de réduire les risques de brouillage radioélectrique à l'intention des autres utilisateurs, il faut choisir le type d'antenne et son gain de sorte que la puissance isotrope rayonnée équivalente (p.i.r.e.) ne dépasse pas l'intensité nécessaire à l'établissement d'une communication satisfaisante.

 **WARNING**

■ **While driving**

Do not operate the portable audio player, cellular phone or connect a device to the Bluetooth® system.

■ **Caution regarding interference with electronic devices**

- Your audio unit is fitted with Bluetooth® antennas. People with implantable cardiac pacemakers, cardiac resynchronization therapy-pacemakers or implantable cardioverter defibrillators should maintain a reasonable distance between themselves and the Bluetooth® antennas. The radio waves may affect the operation of such devices.
- Before using Bluetooth® devices, users of any electrical medical device other than implantable cardiac pacemakers, cardiac resynchronization therapy-pacemakers or implantable cardioverter defibrillators should consult the manufacturer of the device for information about its operation under the influence of radio waves. Radio waves could have unexpected effects on the operation of such medical devices.

 **NOTICE**

■ **When leaving the vehicle**

Do not leave your portable audio player or cellular phone in the vehicle. The inside of the vehicle may become hot, causing damage to the portable audio player or cellular phone.

“Information” screen

Display “Information” screen

Go to “Information”: “MENU” button → “Info”

- ① Display the fuel consumption.
(→P. 95)
- ② Display the “USB Photo” screen.
(→P. 397)
- ③ Display the weather information.
(→P. 399)
- ④ Display the Traffic Map picture.

Available when in a traffic supported
HD Radio coverage area



Traffic information map

Go to “Traffic Map”: “MENU” button → “Info” → “Traffic Incidents”

- ① Current position of your car
- ② Traffic information line

The line color means the following:

Red: Heavy congestion

Yellow: Moderate traffic

Green: Free flowing traffic



■ Certification for U.S. owners

I. Clear Channel Disclaimers

"Total Traffic Network, a division of Clear Channel Broadcasting, Inc., owns or holds the rights to the traffic, news, sports, weather, stocks and other data (the "TOTAL TRAFFIC-HD+ Data") and TOTAL TRAFFIC-HD+ network through which it is delivered, together the "TTN Service". Use of the TTN Service is subject to the terms of these Device End User Terms.

"The TTN Service is informational only. User assumes all risk of use. Total Traffic Network and its suppliers and licensors make no representations about the accuracy or timeliness of any of the TOTAL TRAFFIC-HD+ Data, including traffic and road conditions, route usability, or speed."

"TOTAL TRAFFIC-HD+ NETWORK DATA IS PROVIDED "AS IS," AND "WHERE IS". TOTAL TRAFFIC NETWORK AND ITS SUPPLIERS AND LICENSORS EXPRESSLY DISCLAIM ALL WARRANTIES WITH RESPECT TO THE DATA (INCLUDING, WITHOUT LIMITATION, THAT THE DATA WILL BE ERROR-FREE, WILL OPERATE WITHOUT INTERRUPTION OR THAT THE DATA WILL BE ACCURATE), EXPRESS, IMPLIED OR STATUTORY, INCLUDING, WITHOUT LIMITATION, THE IMPLIED WARRANTIES OF MERCHANTABILITY, NON-INFRINGEMENT, FITNESS FOR A PARTICULAR PURPOSE, OR THOSE ARISING FROM A COURSE OF DEALING OR USAGE OF TRADE."

"TOTAL TRAFFIC NETWORK AND ITS SUPPLIERS AND LICENSORS WILL NOT BE LIABLE TO YOU FOR ANY INDIRECT, SPECIAL, CONSEQUENTIAL, EXEMPLARY, OR INCIDENTAL DAMAGES (INCLUDING, WITHOUT LIMITATION, LOST REVENUES, ANTICIPATED REVENUES, OR PROFITS RELATING TO THE SAME) ARISING FROM ANY CLAIM RELATING DIRECTLY OR INDIRECTLY TO USE OF THE DATA, WHETHER A CLAIM FOR SUCH DAMAGES IS BASED ON WARRANTY, CONTRACT, TORT (INCLUDING, WITHOUT LIMITATION, NEGLIGENCE OR STRICT LIABILITY) OR ANY OTHER LEGAL THEORY."

II. The Weather Channel's (TWC's) Disclaimers

THE FOLLOWING TERMS APPLY TO THE USE OF ANY MATERIAL, DATA OR INFORMATION PROVIDED BY THE WEATHER CHANNEL, LLC ("THE WEATHER CHANNEL"), INCLUDING WEATHER-RELATED INFORMATION AND REPORTS, OBTAINED BY YOU OR OTHERS THROUGH THE TTN SERVICE ("THE WC DATA").

DISCLAIMER OF WARRANTIES.

YOUR USE OF THE WC DATA IS AT YOUR SOLE RISK. THE WC DATA IS PROVIDED ON AN "AS IS" AND "AS AVAILABLE" BASIS. THE WEATHER CHANNEL EXPRESSLY DISCLAIMS ALL WARRANTIES OF ANY KIND, WHETHER EXPRESS OR IMPLIED, INCLUDING, BUT NOT LIMITED TO THE IMPLIED WARRANTIES OF MERCHANTABILITY, FITNESS FOR A PARTICULAR PURPOSE AND NON-INFRINGEMENT. THE WEATHER CHANNEL MAKES NO REPRESENTATION OR WARRANTY THAT (i) THE WC DATA WILL MEET YOUR REQUIREMENTS, (ii) THE WC DATA WILL BE UNINTERRUPTED, TIMELY, SECURE, OR ERROR-FREE, (iii) THE RESULTS THAT MAY BE OBTAINED FROM THE USE OF THE WC DATA WILL BE ACCURATE OR RELIABLE, OR (iv) ANY ERRORS OR BUGS IN THE WC DATA WILL BE CORRECTED. ACCORDINGLY, THE WEATHER CHANNEL SHALL NOT BE RESPONSIBLE OR LIABLE FOR THE ACCURACY, USEFULNESS OR AVAILABILITY OF THE WC DATA.

LIMITATION OF LIABILITY.

YOU EXPRESSLY UNDERSTAND AND AGREE THAT THE WEATHER CHANNEL, ITS SUPPLIERS, ITS LICENSORS AND ITS AFFILIATE COMPANIES SHALL NOT BE LIABLE, UNDER ANY LEGAL THEORY, INCLUDING CONTRACT, TORT, NEGLIGENCE OR STRICT LIABILITY, FOR ANY DIRECT, INDIRECT, INCIDENTAL, SPECIAL, PUNITIVE, CONSEQUENTIAL OR EXEMPLARY DAMAGES, INCLUDING BUT NOT LIMITED TO, DAMAGES FOR LOSS OF PROFITS, GOODWILL, USE, DATA OR OTHER INTANGIBLE LOSSES (EVEN IF THE WEATHER CHANNEL HAS BEEN ADVISED OF THE POSSIBILITY OF SUCH DAMAGES), RESULTING FROM OR ARISING OUT OF YOUR USE OF, OR YOUR INABILITY TO USE, THE WC DATA, THIS AGREEMENT, OR ANY OTHER MATTER RELATING TO THE WC DATA. YOUR SOLE AND EXCLUSIVE REMEDY FOR ANY DISPUTE WITH THE WEATHER CHANNEL RELATED TO THE WC DATA OR CONTENT SHALL BE CANCELLATION OF RECEIPT OF THE WC DATA. SOME JURISDICTIONS DO NOT ALLOW THE EXCLUSION OF CERTAIN WARRANTIES OR THE LIMITATION OR EXCLUSION OF LIABILITY FOR INCIDENTAL OR CONSEQUENTIAL DAMAGES. ACCORDINGLY, SOME OF THE ABOVE LIMITATIONS MAY NOT APPLY TO YOU.

USB photo

Connecting a USB memory device enables you to enjoy photos on the Lexus Display Audio display.

USB photo screen

Go to “USB Photo”: “MENU” button → “Info” → “USB1 Photo” or “USB2 Photo”

Connecting a USB memory device

→P.326

Menu screen

Move the controller to the left to display the menu screen.

- ① Change the full screen mode.
- ② Select to set the slide show display on/off.
Start the slide show at a selected folder.
- ③ Change the play speed.
- ④ Change the play mode.

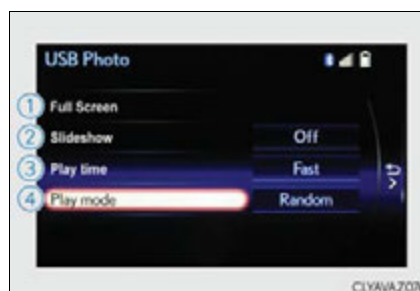

5

Audio system

Selecting a folder and a file

- 1 Move the controller to the right and select “Browse”.
- 2 Select the desired folder, and then select a desired file to begin using the selected folder.

■ **USB memory functions**

→P. 357

■ **USB memory**

● **Compatible devices**

USB memory device that can be used for JPEG display.

● **Compatible device formats**

The following device format can be used:

- USB communication format: USB2.0 FS (480 Mbps)
- File system format: FAT16/32 (Windows)
- Correspondence class: Mass storage class

● **JPEG file compatibility**

- Compatible image size: Maximum 10MB
- Compatible pixel size: Maximum 10,000,000 pixels



NOTICE

■ **To prevent damage to the USB memory device or its terminals**

→P. 359

Weather information

Weather information for the selected city is displayed.

Available when in weather supported HD Radio coverage area

How to check the weather information

1 Go to "Weather": "MENU" button → "Info" → "Weather"

2 Select the desired city/location.

- ① Current location of your car
- ② Select of the recently checked location list

Select the desired location on the recently checked location list.

- ③ Select of the National City list.

Select the region on the region list and then select the city on the National City list.

- ④ Select of the local location list

Select the location on the local location list.

3 Select the time

- ① Display the current weather information.

- ② Display the 3 days weather information.

You can display detail of a week, move the controller right and then select the desired week.

- ③ Display the 6/12 hour weather information.

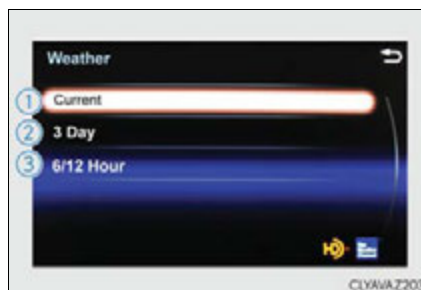
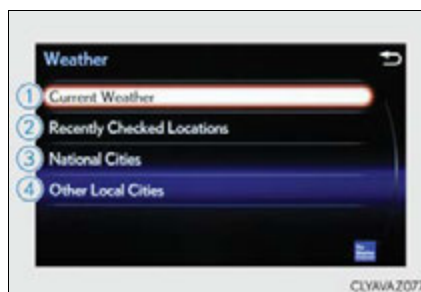

5

Audio system

Voice command system

The voice command system enables the audio and hands-free systems to be operated using voice commands.

Operations of the voice command system can be performed by selecting the menu corresponding to each function on the right part of the screen. Even if any menu is selected, commands displayed on all menus can be operated.

Using the voice command system

- 1 Press the talk switch.
To cancel the voice command system, press and hold the talk switch.
- 2 After a beep sounds, say the desired command.
On the list screen, you can select the desired command.

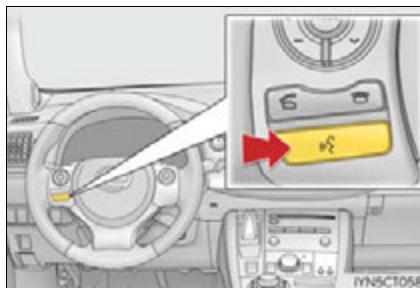

■ Menu screen

To display the menu screen, move the controller to the left.

- ① Offer examples of commands and operation methods
- ② Adjust the settings for voice guidance volume and voice recognition prompts. ("Hints" screen) (→P. 332)
- ③ Start over voice recognition (except "Hints" screen)
- ④ Cancel voice recognition

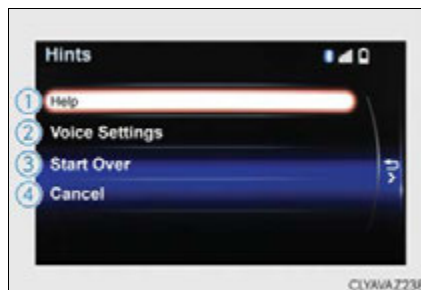

■ Microphone

→P. 372

■ When using the microphone

- It is unnecessary to speak directly into the microphone when giving a command.
- Wait for the confirmation beep before speaking a command.

- Voice commands may not be recognized if:
 - Spoken too quickly.
 - Spoken at a low or high volume.
 - The roof or windows are open.
 - Passengers are talking while voice commands are spoken.
 - The air conditioning speed is set high.
 - The air conditioning vents are turned towards the microphone.
- In the following conditions, the system may not recognize the command properly and using voice commands may not be possible:
 - The command is incorrect or unclear. Note that certain words, accents or speech patterns may be difficult for the system to recognize.
 - There is excessive background noise, such as wind noise.
- **When searching for a track**
 - A USB memory or iPod must be connected to enable track searching and playback. (→P. 326)
 - When a USB memory or iPod is connected, recognition data is created so tracks can be searched using voice commands.
 - Recognition data is updated under the following conditions:
 - When the USB memory or iPod data has changed.
 - When the voice recognition language is changed. (→P. 329)
 - While the recognition data is being created or being updated, a track search cannot be performed using a voice command.
- **The Gracenote® media database**
→P. 351

Casual speech recognition

Due to natural language speech recognition technology, this system enables recognition of a command when spoken naturally. However, the system cannot recognize every variation of each command.

In some situations, it is possible to omit the command for the procedure and directly state the desired operation.

This function is available in English, Spanish and French.

■ Expression examples for each function

| Command | Expression examples |
|----------------------|---|
| "Call <name> <type>" | Get me <Robert Brown>. I need to call <Robert Brown> at <Work> right away. |
| "Dial <number>" | Please dial the number <3334445555>. Ring <3334445555>. |
| "Play Artist <name>" | Play the artist <XXXXX>. I'd like to hear the band <XXXXX>.* |
| "Play Album <name>" | Play album <XXXXX>. Music from album <XXXXX>.* |

*: Say the desired artist name or album name in the place of the "<>".

Command list

Some recognizable voice commands and their actions are shown below as examples.

► Basic

| Command | Action |
|---------------|---|
| "Help" | Prompts voice guidance to offer examples of commands or operation methods |
| "Go Back" | Returns to the previous screen |
| "Go to <tab>" | Displays the command list of the selected tab |

► Phone

| Command | Action |
|---------------------------------|--|
| "Redial" | Places a call to the phone number of the latest outgoing call |
| "Call Back" | Places a call to the phone number of latest incoming call |
| "Show Recent Calls" | Displays the call history screen |
| "Dial <phone number>" | Places a call to the said phone number |
| "Call <contacts> <phone types>" | Place a call to the said phone type of the contact from the phone book |

▶ Audio

| Command | Action |
|-----------------------------|---|
| "Play Playlist <playlists>" | Plays tracks from the selected playlist |
| "Play Artist <artist>" | Plays tracks from the selected artist |
| "Play Song <songs>" | Plays the selected track |
| "Play Album <albums>" | Plays tracks from the selected album |
| "Turn Music On/Off" | Turns the audio system on/off |
| "Play the <audio sources>" | Selects audio source |

▶ Info

| Command | Action |
|-----------------|------------------------------|
| "Show Forecast" | Displays weather information |
| "Show Traffic" | Displays traffic information |

Mobile Assistant

The Mobile Assistant feature on this system allows the activation of Apple's Siri® Eyes Free mode via the steering wheel switches. To operate the Mobile Assistant, a compatible cellular phone must be registered and connected to this system via Bluetooth®. (→P. 361)

- 1 Press and hold the off hook switch until you hear the beeps that indicate the system is listening.

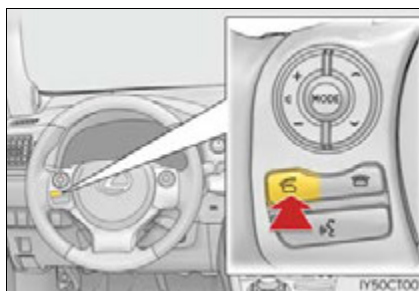

- 2 The Mobile Assistant can be used only when the neighboring screen is displayed.

To cancel the Mobile Assistant, select "Cancel", or press and hold the off hook switch.

To restart the Mobile Assistant for additional commands, press the off hook switch. Mobile Assistant can only be restarted after the system responds to a voice command. After some phone and music commands, the Mobile Assistant feature will automatically end to complete the requested action.

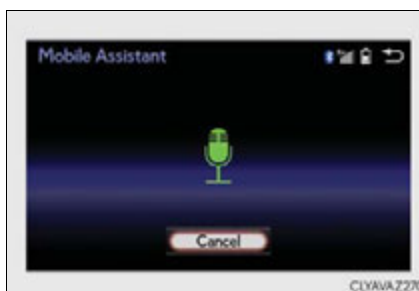

■ Adjusting the volume

The volume of the Mobile Assistant can be adjusted using the "PWR•VOL" knob or steering wheel volume switches. The Mobile Assistant and phone call volumes are synchronized.

■ Microphone

It is not necessary to speak directly into the microphone when using the Mobile Assistant.



- Wait for the listening beeps before using the Mobile Assistant.
- The Mobile Assistant may not recognize commands in the following situations:
 - When spoken too quickly.
 - When spoken at a low or high volume.
 - When the roof or windows are open.
 - When passengers are talking while the Mobile Assistant is being used.
 - When the air conditioning system's fan speed is set high.
 - When the air conditioning vents are turned toward the microphone.

■ Mobile Assistant precautions

- The available features and functions may vary based on the iOS version installed on the connected device.
- Some Siri features are limited in Eyes Free mode. If you attempt to use an unavailable function, Siri will inform you that the function is not available.
- If Siri is not enabled on the cellular phone connected via Bluetooth[®], an error message will be displayed on the screen.
- While a phone call is active, the Mobile Assistant cannot be used.
- If using the navigation feature of the cellular phone, ensure the active audio source is Bluetooth[®] audio or iPod in order to hear turn by turn direction prompts.

LEXUS Enform Remote*

Lexus Enform Remote is a cellular phone application that lets you view and remotely control certain aspects of your vehicle.

For details about the functions and services of this application, refer to <http://www.lexus.com/enform/>.

Function of the Lexus Enform Remote is achieved by using an embedded cellular device in the vehicle (DCM: Data Communication Module).

Subscription

After you sign the Telematics Subscription Service Agreement, download the Lexus Enform Remote app from your cellular phone's app store, and register within the app (or enroll and complete registration at the dealer), you can begin using these services. (→P. 455)

A variety of subscription terms are available. Contact your Lexus dealer, or call 1-800-25-LEXUS (1-800-255-3987) for further subscription details.

*: If equipped

■ Availability of service

Lexus Enform Remote is available in the contiguous United States, Washington D.C. and Alaska.

■ Lexus Enform Remote Information

- Lexus Enform Remote should only be used by authorized users.
- Laws in some communities may require that the vehicle be within view of the user when operating Lexus Enform Remote.
In some states, use of Lexus Enform Remote may violate state or local laws. Before using Lexus Enform Remote, check your state and local laws.
- Any malfunction of the Lexus should be repaired by your Lexus dealer.
- Lexus Enform Remote is designed to work at temperatures above -22°F (-30°C). This specification is related to the Lexus Enform Remote operation, but is dependent on the vehicle's operating temperature range which may be different.
- Content is subject to change without notice.
- Some features of the Lexus Enform Remote may not be available on some models.
- Additional information can be found at www.lexus.com/enform/.
- Availability of functions of the Lexus Enform service is dependent on network reception level.

■ Safety information for Lexus Enform Remote

→P. 458

Interior features

6

- 6-1. Using the air conditioning system and defogger**
- Automatic air conditioning system (Vehicles with a navigation system or Lexus Display Audio System)..... 410
 - Automatic air conditioning system (Vehicles without a navigation system or Lexus Display Audio System)..... 418
 - Heated steering wheel/ seat heaters.....425
 - Heated steering wheel..... 426
 - Seat heaters..... 426
- 6-2. Using the interior lights**
- Interior lights list427
 - Personal/interior light main switch427
 - Front personal/interior lights 428
 - Rear interior light 428
- 6-3. Using the storage features**
- List of storage features 429
 - Glove box430
 - Console box.....430
 - Cup holders/ bottle holders/ door pockets.....430
 - Auxiliary boxes 432
 - Luggage compartment features.....434
- 6-4. Using the other interior features**
- Other interior features 439
 - Sun visors439
 - Vanity mirrors439
 - Clock440
 - Power outlet440
 - Assist grips..... 442
 - Garage door opener..... 443
 - Compass 449
 - LEXUS Enform Safety Connect..... 455

Automatic air conditioning system (Vehicles with a navigation system or Lexus Display Audio System)

Air outlets and fan speed are automatically adjusted according to the temperature setting.

Vehicles with a Lexus Display Audio System: Press the "MENU" button on the Lexus Display Audio controller, then select "Climate" to display the air conditioning operation screen.

For details on the Lexus Display Audio controller, refer to "Lexus Display Audio controller" on P. 322.



Vehicles with a navigation system: Press the "MENU" button on the Remote Touch, then select "Climate" to display the air conditioning control screen.

For details on the Remote Touch, refer to the "NAVIGATION SYSTEM OWNER'S MANUAL".



Control panel



■ Adjusting the temperature setting

Press  to increase the temperature and  to decrease the temperature.

■ Adjusting the fan speed setting

Press  to increase the fan speed and  to decrease the fan speed.

Press the "OFF" button to turn the fan off.

■ Change the airflow mode

To change the air outlets, press



The air outlets used are switched each time the button is pressed.

- ① Air flows to the upper body.
- ② Air flows to the upper body and feet.
- ③ Air flows to the feet.
- ④ Air flows to the feet and the windshield defogger operates.



Control screen

▶ Vehicles with a Lexus Display Audio System

- ① Adjust the left-hand side temperature setting
- ② Adjust the fan speed setting
- ③ "AUTO": Select to set automatic mode on/off
"OFF": Turn the fan off
- ***: Display the option control screen (→P. 413)



- ④ Select the air flow mode
- ⑤ Adjust the right-hand side temperature setting
- 1 Move the Lexus Display Audio controller left/right to select the desired item (① to ⑤).
- 2 When ①, ② or ⑤ is selected:
Move the controller forward/backward or turn it left/right for adjusting.
When ③ or ④ is selected:
Move the controller forward/backward or turn it left/right to select a screen button, then press the controller.

▶ Vehicles with a navigation system

- ① Adjust the left-hand side temperature setting
- ② Adjust the fan speed setting
- ③ Select the air flow mode
- ④ Adjust the right-hand side temperature setting
- ⑤ Display the option control screen (→P. 413)
- ⑥ Turn the fan off
- ⑦ Select to set automatic mode on/off



To adjust or select settings, move the Remote Touch knob to select the screen button, and then press the Remote Touch knob to enter the selected function.

■ Option control screen

Select ******* on the climate screen to display the option control screen. The functions can be switched on and off.

- ▶ Vehicles with a Lexus Display Audio System
- ▶ Vehicles with a navigation system



- ① Select to set cooling and dehumidification function on/off
- ② Adjust the temperature for driver and passenger seats separately ("DUAL" mode) (→P. 413)
- ③ Prevent ice from building up on the windshield and wiper blades (if equipped) (→P. 415)
- ④ Remove pollen from the air (Micro dust and pollen filter) (→P. 414)

Air conditioning controls

■ Using the automatic mode

- 1 Press the "AUTO" button.
- 2 Adjust the temperature setting.
- 3 To stop the operation, press the "OFF" button.

■ Automatic mode indicator

If the fan speed setting or air flow modes are operated, the automatic mode indicator goes off. However, automatic mode for functions other than that operated is maintained.

■ Adjusting the temperature for driver and passenger seats separately ("DUAL" mode)

To turn on the "DUAL" mode, perform any of the following procedures:



- Press the "DUAL" button.
- Select "DUAL" on the option control screen.
- Adjust the passenger's side temperature setting.

The indicator comes on when the "DUAL" mode is on.

Other functions

■ Switching between outside air and recirculated air modes

Press  .

The mode switches between  (recirculated air mode) and  (outside air mode) modes each time the button is pressed.

■ Defogging the windshield

Defoggers are used to defog the windshield and front side windows.

Press  .

Set  to outside air mode if the recirculated air mode is used. (It may switch automatically.)

To defog the windshield and the side windows early, turn the air flow and temperature up.

To return to the previous mode, press  again when the windshield is defogged.

■ Defogging the rear window and outside rear view mirrors

Defoggers are used to defog the rear window and to remove raindrops, dew and frost from the outside rear view mirrors.

Press  .

The defoggers will automatically turn off after a period of time.

■ Micro dust and pollen filter

Pollen is removed from the air and the air flows to the upper part of the body.

Press  or select  on the operation screen.

When the micro dust and pollen filter is on,  is displayed on the air conditioning control screen.

In order to prevent the windshield from fogging up when the outside air is cold, the dehumidification function may operate.

The pollens are filtered out even if the micro dust and pollen filter is turned off.

■ Windshield wiper de-icer (if equipped)

This feature is used to prevent ice from building up on the windshield and wiper blades.

Select  on the option control screen.

When the windshield wiper de-icer is on,  is displayed on the air conditioning control screen.

The windshield wiper de-icer will automatically turn off after a period of time.

Air outlets

■ Location of air outlets

The air outlets and air volume changes according to the selected air flow mode.



■ Adjusting the position of and opening and closing the air outlets

- ① Direct air flow to the left or right, up or down.
- ② Turn the knob to open or close the vent.

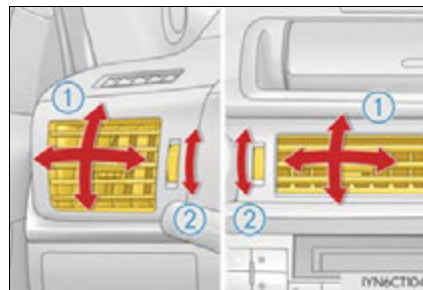

■ Registering air conditioning settings to electronic keys

- Unlocking the vehicle using an electronic key and turning the power switch to ON mode will recall that key's registered air conditioning settings.
- When the power switch is turned off, the current air conditioning settings will automatically be registered to the electronic key that was used to unlock the vehicle.

The system may not operate correctly if more than one electronic key is in the vicinity or if the smart access system is used to unlock a passenger door.

Settings for the electronic key and the corresponding door can be changed.

Contact your Lexus dealer.

■ **Using automatic mode**

Fan speed is adjusted automatically according to the temperature setting and the ambient conditions.

Therefore, the fan may stop for a while until warm or cool air is ready to flow immediately after the "AUTO" button is pressed or "AUTO" is selected.

■ **When the outside temperature exceeds 75°F (24°C) and the air conditioning system is on**

- In order to reduce the air conditioning power consumption, the air conditioning system may switch to recirculated air mode automatically. This may also reduce fuel consumption.
- Recirculated air mode is selected as a default mode when the power switch is turned ON mode.

- It is possible to switch to outside air mode at any time by pressing  .

■ **Fogging up of the windows**

- The windows will easily fog up when the humidity in the vehicle is high. Pressing "A/C" button or selecting "A/C" will dehumidify the air from the outlets and defog the windshield effectively.
- If you turn "A/C" off, the windows may fog up more easily.
- The windows may fog up if the recirculated air mode is used.

■ **Outside/recirculated air mode**

- When driving on dusty roads such as tunnels or in heavy traffic, set  to the recirculated air mode. This is effective in preventing outside air from entering the vehicle interior. During cooling operation, setting the recirculated air mode will also cool the vehicle interior effectively.
- Outside/recirculated air mode may automatically switch depending on the temperature setting or the inside temperature.

■ **When the outside temperature is low**

The dehumidification function may not operate even when "A/C" is pressed or "A/C" is selected.

■ **Operation of the air conditioning system in Eco drive mode**

- In the Eco drive mode, the air conditioning system is controlled as follows to prioritize fuel efficiency
 - Engine speed and compressor operation controlled to restrict heating/cooling capacity
 - Fan speed restricted when automatic mode is selected
- To improve air conditioning performance, perform the following operations
 - Adjust the fan speed
 - Turn off Eco drive mode
 - Customize the air conditioning control of Eco drive mode. (→P. 596)

■ Ventilation and air conditioning odors

- To let fresh air in, set the air conditioning system to the outside air mode.
- During use, various odors from inside and outside the vehicle may enter into and accumulate in the air conditioning system. This may then cause odor to be emitted from the vents.
- To reduce potential odors from occurring:
 - It is recommended that the air conditioning system be set to outside air mode prior to turning the vehicle off.
 - The start timing of the blower may be delayed for a short period of time immediately after the air conditioning system is started in automatic mode.

■ Air conditioning filter

→P. 502

■ Customization

Settings (e.g. A/C automatic mode switch operation) can be changed.
(Customizable features: →P. 591)

⚠ WARNING

■ To prevent the windshield from fogging up

- Do not use  during cool air operation in extremely humid weather. The difference between the temperature of the outside air and that of the windshield can cause the outer surface of the windshield to fog up, blocking your vision.
- Do not place anything on the instrument panel which may cover the air outlets. Otherwise, air flow may be obstructed, preventing the windshield defoggers from defogging.



■ To prevent burns

- Do not touch the rear view mirror surfaces when the outside rear view mirror defoggers are on.
- Do not touch the glass at lower part of the windshield or to the side of the front pillars when the windshield wiper de-icer is on. (vehicles with windshield wiper de-icer)

⚠ NOTICE

■ To prevent 12-volt battery discharge

Do not leave the air conditioning system on longer than necessary when the hybrid system is off.



Automatic air conditioning system (Vehicles without a navigation system or Lexus Display Audio System)

Air outlets and fan speed are automatically adjusted according to the temperature setting.

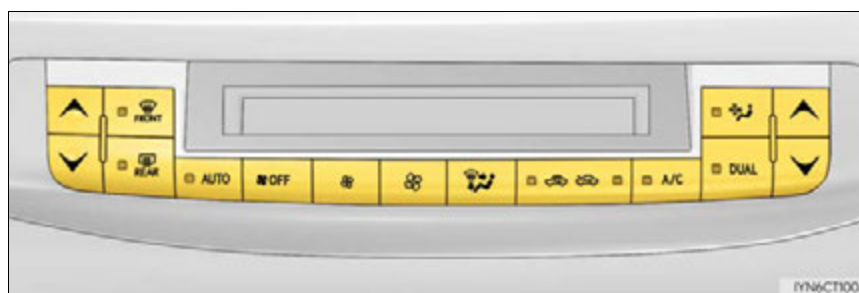

Control panel



■ Adjusting the temperature setting

Press  to increase the temperature and  to decrease the temperature.

■ Adjusting the fan speed setting

Press  to increase the fan speed and  to decrease the fan speed.

Press the "OFF" button to turn the fan off.

■ Change the airflow mode

To change the air outlets, press



The air outlets used are switched each time the button is pressed.

- ① Air flows to the upper body.
- ② Air flows to the upper body and feet.
- ③ Air flows to the feet.
- ④ Air flows to the feet and the windshield defogger operates.



Air conditioning controls

■ Using the automatic mode

- ① Press the "AUTO" button.
- ② Adjust the temperature setting.
- ③ To stop the operation, press the "OFF" button.

■ Automatic mode indicator

If the fan speed setting or air flow modes are operated, the automatic mode indicator goes off. However, automatic mode for functions other than that operated are maintained.

■ Adjusting the temperature for driver and passenger seats separately ("DUAL" mode)

To turn on the "DUAL" mode, perform any of the following procedures:



- Press the "DUAL" button.
- Adjust the passenger's side temperature setting.

The indicator comes on when the "DUAL" mode is on.

Other functions

■ Switching between outside air and recirculated air modes

Press .

The mode switches between  (recirculated air mode) and  (outside air mode) modes each time the button is pressed.

■ Defogging the windshield

Defoggers are used to defog the windshield and front side windows.

Press .

Set  to outside air mode if the recirculated air mode is used. (It may switch automatically.)

To defog the windshield and the side windows early, turn the air flow and temperature up.

To return to the previous mode, press  again when the windshield is defogged.

■ Defogging the rear window and outside rear view mirrors

Defoggers are used to defog the rear window and to remove raindrops, dew and frost from the outside rear view mirrors.

Press .

The defoggers will automatically turn off after a period of time.

■ Micro dust and pollen filter

Pollen is removed from the air and the air flows to the upper part of the body.

Press .

In order to prevent the windshield from fogging up when the outside air is cold, the dehumidification function may operate.

The pollens are filtered out even if the micro dust and pollen filter is turned off.

■ Windshield wiper de-icer (if equipped)

This feature is used to prevent ice from building up on the windshield and wiper blades.

Turns on/off.

The indicator comes on when the windshield wiper de-icer is on.

The windshield wiper de-icer will automatically turn off after a period of time.

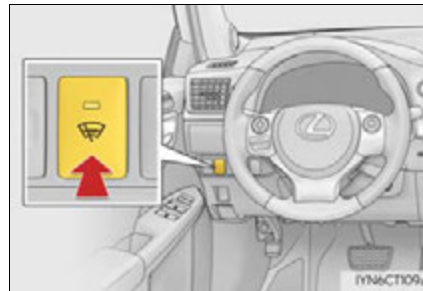

Air outlets

■ Location of air outlets

The air outlets and air volume changes according to the selected air flow mode.

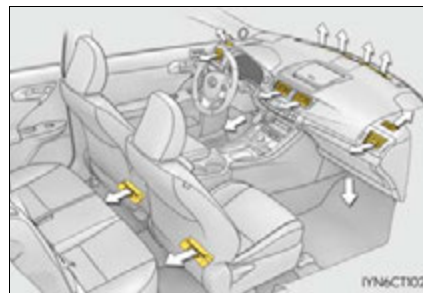

■ Adjusting the position of and opening and closing the air outlets

- ① Direct air flow to the left or right, up or down.
- ② Turn the knob to open or close the vent.

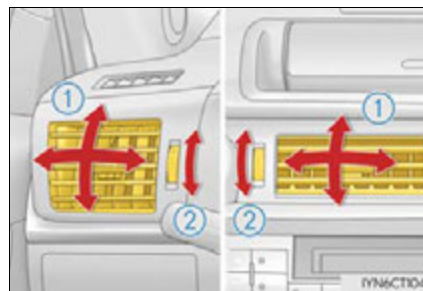

■ **Registering air conditioning settings to electronic keys**

- Unlocking the vehicle using an electronic key and turning the power switch to ON mode will recall that key's registered air conditioning settings.
- When the power switch is turned off, the current air conditioning settings will automatically be registered to the electronic key that was used to unlock the vehicle.

The system may not operate correctly if more than one electronic key is in the vicinity or if the smart access system is used to unlock a passenger door.

■ **Using automatic mode**

Fan speed is adjusted automatically according to the temperature setting and the ambient conditions.

Therefore, the fan may stop for a while until warm or cool air is ready to flow immediately after the "AUTO" button is pressed.

■ **When the outside temperature exceeds 75°F (24°C) and the air conditioning system is on**

- In order to reduce the air conditioning power consumption, the air conditioning system may switch to recirculated air mode automatically. This may also reduce fuel consumption.
- Recirculated air mode is selected as a default mode when the power switch is turned to ON mode.

- It is possible to switch to outside air mode at any time by pressing  .

■ **Fogging up of the windows**

- The windows will easily fog up when the humidity in the vehicle is high. Pressing "A/C" button on will dehumidify the air from the outlets and defog the windshield effectively.
- If you turn "A/C" off, the windows may fog up more easily.
- The windows may fog up if the recirculated air mode is used.

■ **Outside/recirculated air mode**

- When driving on dusty roads such as tunnels or in heavy traffic, set  to the recirculated air mode. This is effective in preventing outside air from entering the vehicle interior. During cooling operation, setting the recirculated air mode will also cool the vehicle interior effectively.
- Outside/recirculated air mode may automatically switch depending on the temperature setting or the inside temperature.

■ When the outside temperature is low

The dehumidification function may not operate even when "A/C" is pressed.

■ Operation of the air conditioning system in Eco drive mode

- In the Eco drive mode, the air conditioning system is controlled as follows to prioritize fuel efficiency
 - Engine speed and compressor operation controlled to restrict heating/cooling capacity
 - Fan speed restricted when automatic mode is selected
- To improve air conditioning performance, perform the following operations
 - Adjust the fan speed
 - Turn off Eco drive mode
 - Customize the air conditioning control of Eco drive mode. (→P. 596)

■ Ventilation and air conditioning odors

- To let fresh air in, set the air conditioning system to the outside air mode.
- During use, various odors from inside and outside the vehicle may enter into and accumulate in the air conditioning system. This may then cause odor to be emitted from the vents.
- To reduce potential odors from occurring:
 - It is recommended that the air conditioning system be set to outside air mode prior to turning the vehicle off.
 - The start timing of the blower may be delayed for a short period of time immediately after the air conditioning system is started in automatic mode.

■ Air conditioning filter

→P. 502

■ Customization

Settings (e.g. A/C automatic mode switch operation) can be changed.
(Customizable features: →P. 591)

⚠ WARNING**■ To prevent the windshield from fogging up**

- Do not use  during cool air operation in extremely humid weather. The difference between the temperature of the outside air and that of the windshield can cause the outer surface of the windshield to fog up, blocking your vision.
- Do not place anything on the instrument panel which may cover the air outlets. Otherwise, air flow may be obstructed, preventing the windshield defoggers from defogging.

**■ To prevent burns**

- Do not touch the rear view mirror surfaces when the outside rear view mirror defoggers are on.
- Do not touch the glass at lower part of the windshield or to the side of the front pillars when the windshield wiper de-icer is on. (vehicles with windshield wiper de-icer)

⚠ NOTICE**■ To prevent 12-volt battery discharge**

Do not leave the air conditioning system on longer than necessary when the hybrid system is off.

Heated steering wheel*/seat heaters*

Heated steering wheel and seat heaters heat the side grips of the steering wheel and seats, respectively.

WARNING

- Care should be taken to prevent injury if anyone in the following categories comes in contact with the steering wheel and seats when the heater is on:
 - Babies, small children, the elderly, the sick and the physically challenged
 - Persons with sensitive skin
 - Persons who are fatigued
 - Persons who have taken alcohol or drugs that induce sleep (sleeping drugs, cold remedies, etc.)
- Observe the following precautions to prevent minor burns or overheating:
 - Do not cover the seat with a blanket or cushion when using the seat heater.
 - Do not use seat heater more than necessary.

NOTICE

- Do not put heavy objects that have an uneven surface on the seat and do not stick sharp objects (needles, nails, etc.) into the seat.
- To prevent 12-volt battery discharge, do not use the functions when the hybrid system is off.

*: If equipped

Heated steering wheel

Turns the heated steering wheel on/off

The indicator light comes on when the heated steering wheel is operating.



- The heated steering wheel can be used when the power switch is in ON mode.
- The heated steering wheel will automatically turn off after about 30 minutes.

Seat heaters

① Pops the knob out

② Turns the seat heater on

The indicator light comes on.

③ Adjusts the seat temperature

The further you turn the knob clockwise, the warmer the seat becomes.

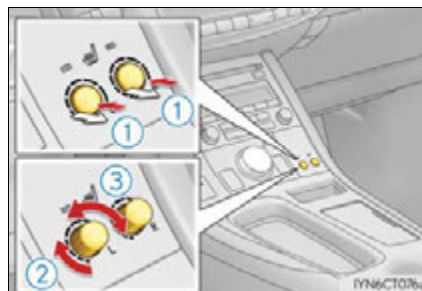

- The seat heaters can be used when the power switch is in ON mode.
- When not in use, turn the knob fully counterclockwise. The indicator light goes off. Press the knob into the recessed position.

Interior lights list

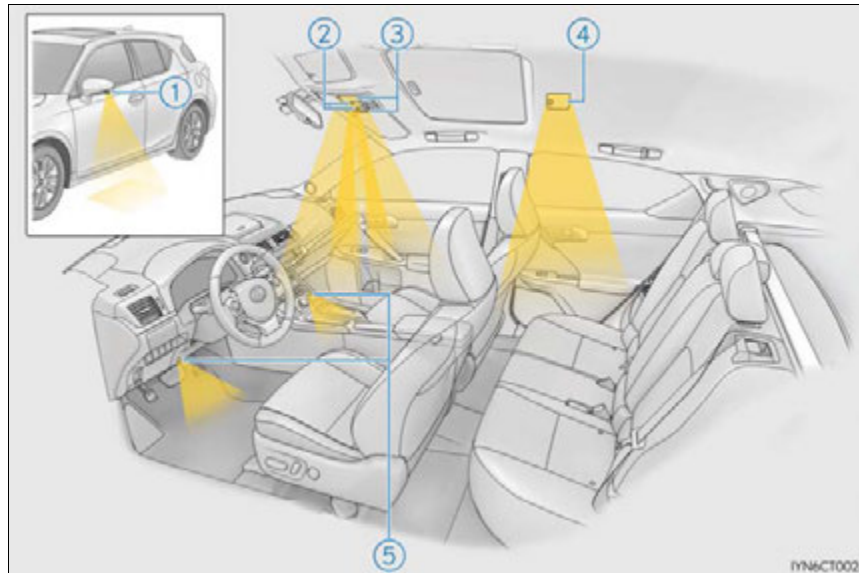

- ① Outer foot lights
- ② Cup holder light (when the power switch is in ACCESSORY or ON mode)
- ③ Front personal/interior lights (→P. 428)
- ④ Rear interior light (→P. 428)
- ⑤ Footwell lights

When the instrument panel light control dial is turned fully down, the cup holder light and the footwell lights will turn off. (→P. 85)

Personal/interior light main switch

- ① Turns the lights off
- ② Turns the door position on
- ③ Turns the lights on



Front personal/interior lights

Turns the lights on/off

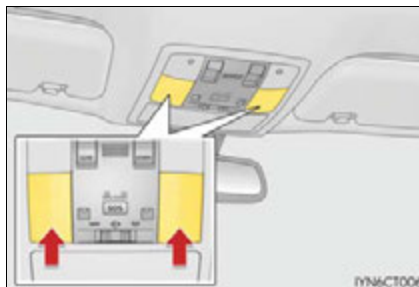

Rear interior light

- ① Turns the light on
- ② Turns the door position on*

*: When the personal/interior light main switch is in the off position, the rear interior light will not turn on even if the door is opened with the rear interior light switch in door position.

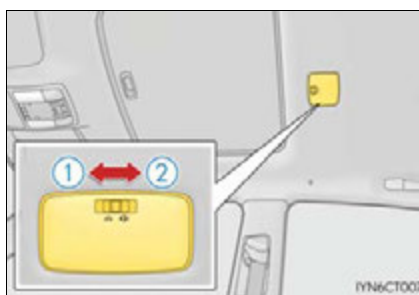

- Illuminated entry system: The lights automatically turn on/off according to power switch mode, the presence of the electronic key, whether the doors are locked/unlocked, and whether the doors are opened/closed.
- If the interior lights remain on when the power switch is turned off, the lights will go off automatically after 20 minutes.
- Settings (e.g. the time elapsed before the lights turn off) can be changed. (Customizable features: →P. 591)

NOTICE

To prevent 12-volt battery discharge, do not leave the lights on longer than necessary when the hybrid system is off.

List of storage features

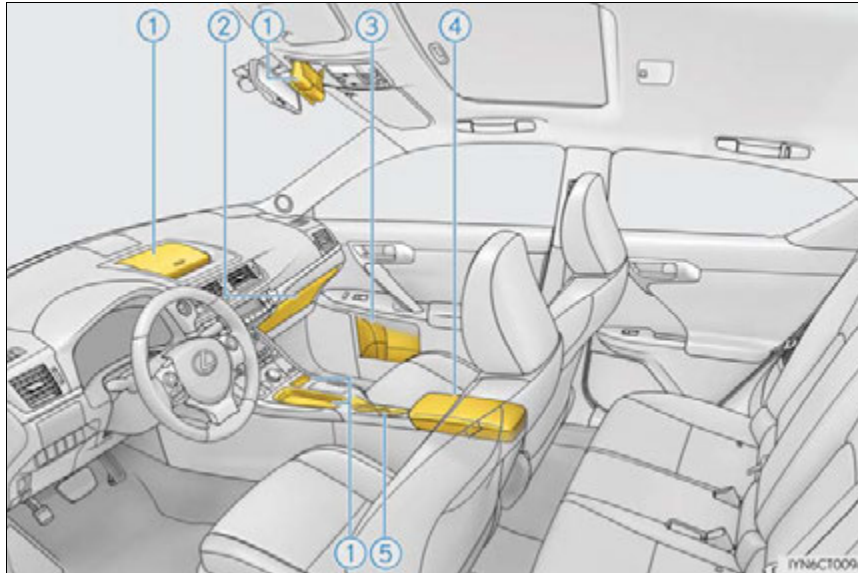

- ① Auxiliary boxes (→P. 432)
- ② Glove box (→P. 430)
- ③ Bottle holders/door pockets (→P. 431)
- ④ Console box (→P. 430)
- ⑤ Cup holders (→P. 430)

⚠ WARNING

- Do not leave glasses, lighters or spray cans in the storage spaces, as this may cause the following when cabin temperature becomes high:
 - Glasses may be deformed by heat or cracked if they come into contact with other stored items.
 - Lighters or spray cans may explode. If they come into contact with other stored items, the lighter may catch fire or the spray can may release gas, causing a fire hazard.
- When driving or when the storage compartments are not in use, keep the lids closed. In the event of sudden braking or sudden swerving, an accident may occur due to an occupant being struck by an open lid or the items stored inside.

Glove box

- ① Open (press the button)
- ② Lock with the mechanical key
- ③ Unlock with the mechanical key

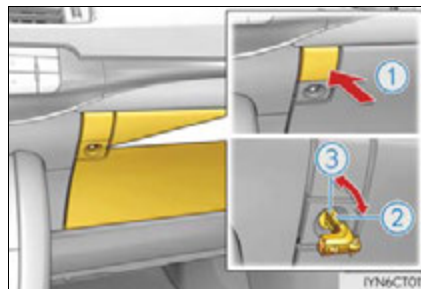

Console box

Lift the lid while pushing the knob to release the lock.

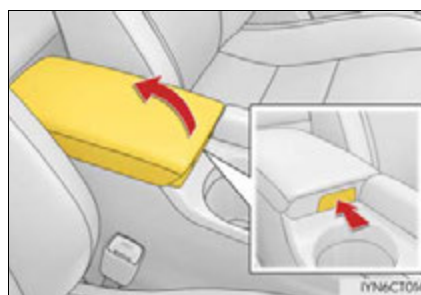

The tray slides forward/backward and can be removed.

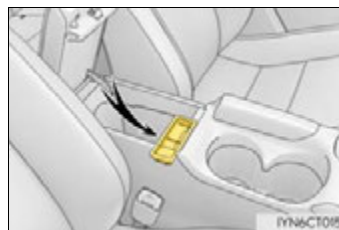

Cup holders/bottle holders/door pockets

■ Cup holders



■ Bottle holders/door pockets

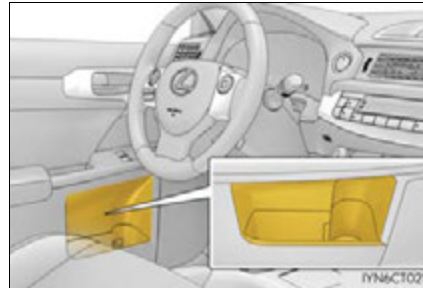

- The partition in the cup holder can also be used to store a small cup or can.

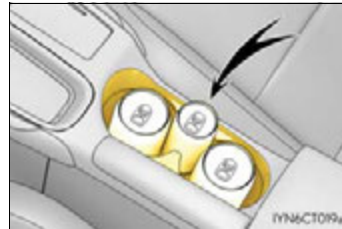

- When storing a bottle, close the cap.
- The bottle may not be stored depending on its size or shape.

⚠ WARNING

Do not place anything other than cups or aluminum cans in the cup holders. Other items may be thrown out of the holders in the event of an accident or sudden braking, causing injury. If possible, cover hot drinks to prevent burns.

⚠ NOTICE

Put the cap on before stowing a bottle. Do not place open bottles or glass and paper cups containing liquid in the bottle holders. The contents may spill and glasses may break.

Auxiliary boxes

▶ Type A

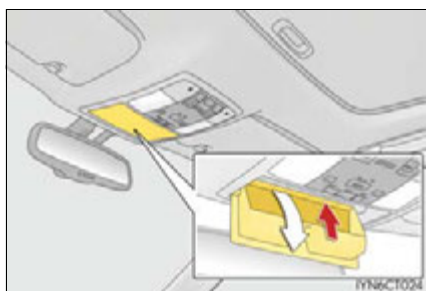

▶ Type B



Press in the lid.

This box is useful for temporarily storing sunglasses and similar small items.

▶ Type C (if equipped)



▶ Type D (if equipped)



■ Auxiliary box (type D) (if equipped)

If an object has fallen down the back of the lid, the fallen object can be retrieved by removing the cover inside the auxiliary box.

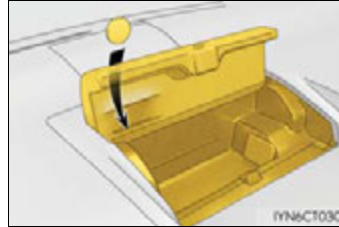

- 1 Remove the mat.

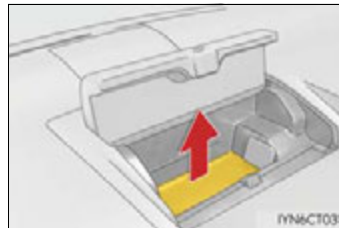

- 2 Remove the cover using a flathead screwdriver protected with tape etc.

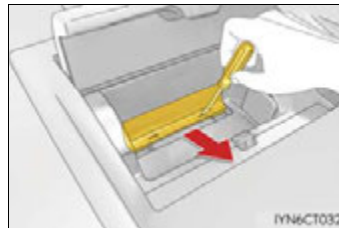

⚠ WARNING

Do not store items heavier than 0.44 lb. (200 g).
Doing so may cause the auxiliary box to open and the items inside may fall out, resulting in an accident. (type A)

⚠ NOTICE

Do not leave items in the auxiliary box or on the dashboard for long periods of time when the vehicle is in the sun.
The inside of the auxiliary box and the dashboard will become extremely hot compared to other parts of the vehicle, and the items could be deformed or damaged. (type D)

Luggage compartment features

Cargo hooks

Raise the hook to use.

The cargo hooks are provided for securing loose items.



First-aid kit storage belt (if equipped)

Secure the first-aid kit.

- ① To loosen
- ② To tighten

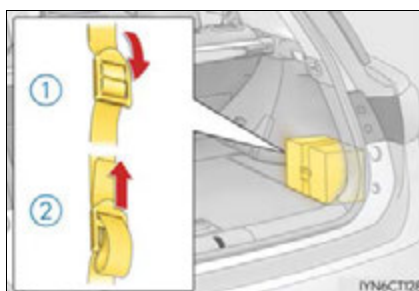

Auxiliary boxes

- ▶ Center

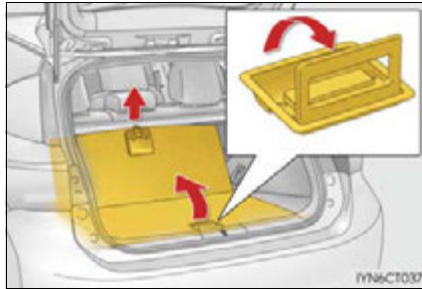

Lift the center deck board.

- ▶ Right side

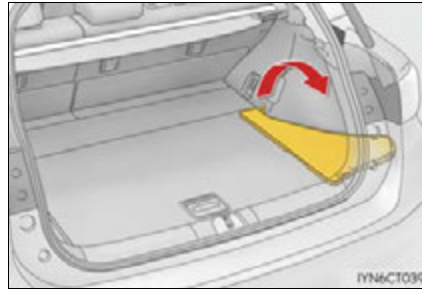

Lift the right side deck board.

- ▶ Left side (if equipped)

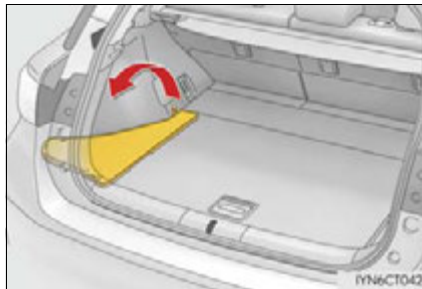

Lift the left side deck board.

Luggage cover

■ Using the luggage cover

Pull out the luggage cover and secure it to the hook brackets.

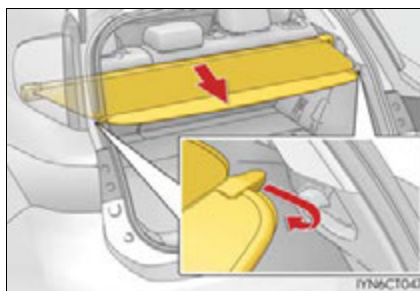

■ Removing the luggage cover

Retract the cover and release both ends, then lift it out.

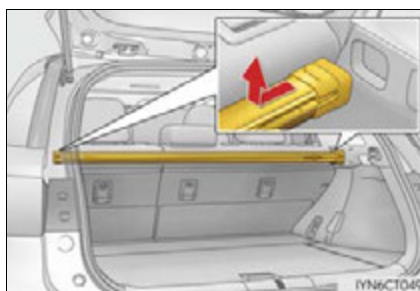

■ Stowing the luggage cover

- 1** Remove the side deck boards and open the center auxiliary box.

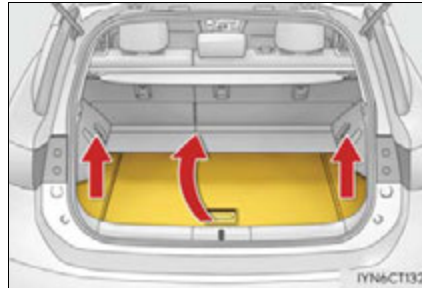

- 2** Adjust the cover so that the information label is facing up.



- 3** Fold the rear edge of the cover over, replace the side deck boards and close the center auxiliary box.

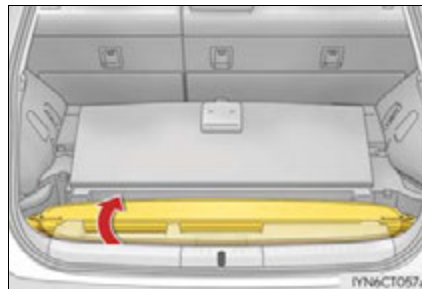

A part of the center auxiliary box can be used as an Owner's Manual holder.

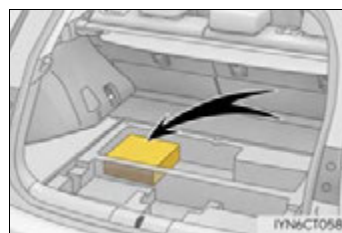

**WARNING**

- To avoid injury, always return the cargo hooks to their stowed positions when not in use.
- If the deck boards are removed, return them to their original positions before driving. In the event of sudden braking, an accident may occur due to an occupant being struck by the deck boards or the items stored in the auxiliary box.
- Do not allow children to climb on the luggage cover. Climbing on the luggage cover could result in damage to the luggage cover, possibly causing death or serious injury to the child.

Other interior features

Sun visors

- ① To set the visor in the forward position, flip it down.
- ② To set the visor in the side position, flip down, unhook, and swing it to the side.
- ③ To use the side extender, place the visor in the side position, then slide it backward.

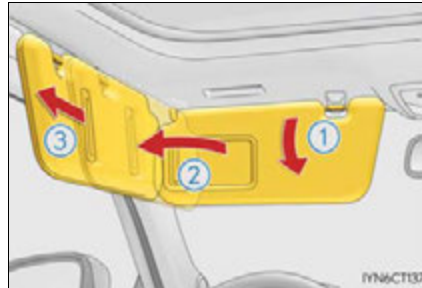

Vanity mirrors

Slide the cover to open.

The light turns on when the cover is opened.



If the vanity light remain on when the power switch is turned off, the light will go off automatically after 20 minutes.

NOTICE

To prevent 12-volt battery discharge, do not leave the vanity lights on for extended periods while the hybrid system is off.

Clock

- ▶ Vehicles with a navigation system

Refer to the "NAVIGATION SYSTEM OWNER'S MANUAL".

- ▶ Vehicles without navigation system

The clock can be adjusted by pressing the buttons.

- ① Adjusts the hours
- ② Adjusts the minutes
- ③ Rounds to the nearest hour*

*: e.g. 1:00 to 1:29 → 1:00
1:30 to 1:59 → 2:00

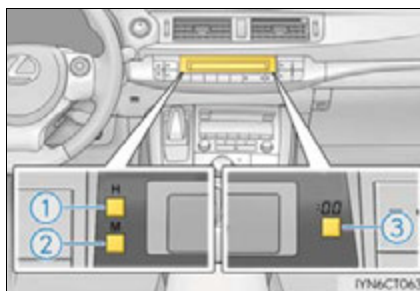

The clock is displayed when the power switch is in ACCESSORY or ON mode.

Power outlet

Please use a power supply for electronic goods that use less than 12 VDC /10 A (power consumption of 120 W).

When using electronic goods, make sure that the power consumption of all the connected power outlets is less than 120 W.

- ▶ Center console

- 1 Press down and release the lid.

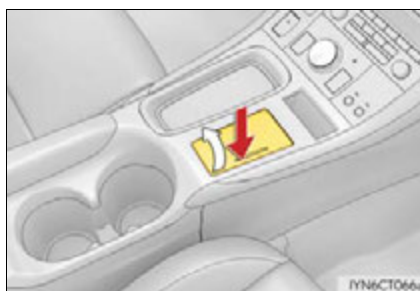

- 2 Open the cover.

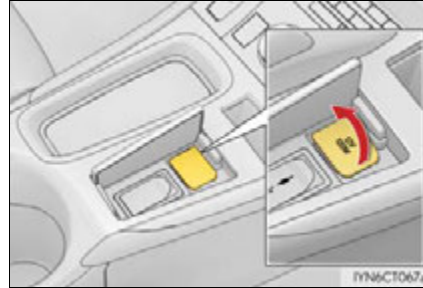

- ▶ Auxiliary box (if equipped)

- 1 Press the button.

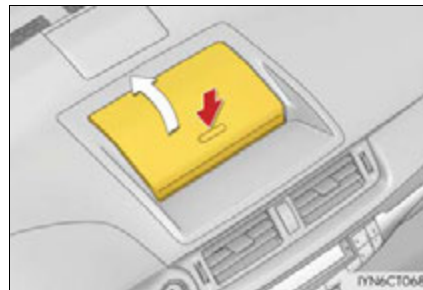

- 2 Open the cover.

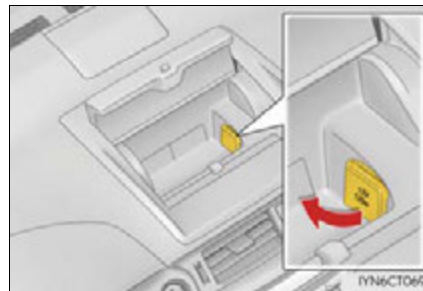

- The power outlet can be used when the power switch is in ACCESSORY or ON mode.
- The gap in the lid allows power cables to be passed through even when the lid is closed. (auxiliary box)

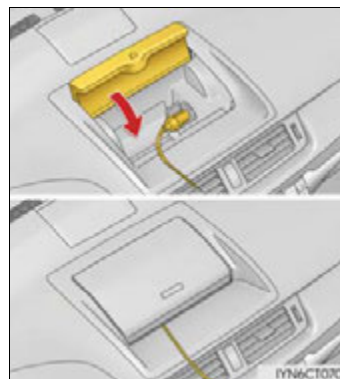

 NOTICE

- To avoid damaging the power outlet, close the power outlet lid when the power outlet is not in use.
Foreign objects or liquids that enter the power outlet may cause a short circuit.
- To prevent 12-volt battery discharge, do not use the power outlet longer than necessary when the hybrid system is off.

Assist grips

An assist grip installed on the ceiling can be used to support your body while sitting on the seat.



 WARNING

Do not use the assist grip when getting in or out of the vehicle or rising from your seat.

 NOTICE

To prevent damage to the assist grip, do not hang any heavy object or put a heavy load on the assist grip.

Garage door opener*

The garage door opener can be programmed to operate garage doors, gates, entry doors, door locks, home lighting systems, security systems, and other devices.

The garage door opener (HomeLink® Universal Transceiver) is manufactured under license from HomeLink®.

Programming the HomeLink®

The HomeLink® compatible transceiver in your vehicle has 3 buttons which can be programmed to operate 3 different devices. Refer to the programming method below appropriate for the device.

- ① Garage door operation indicators
- ② HomeLink® indicator light
- ③ Buttons

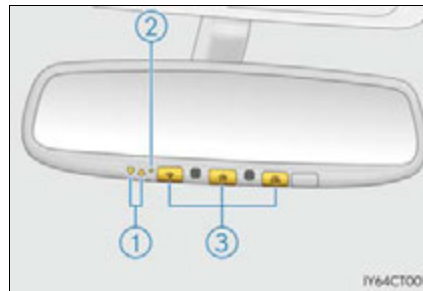

6

Interior features

*: If equipped

■ **Before programming HomeLink®**

- During programming, it is possible that garage doors, gates, or other devices may operate. For this reason, make sure that people and objects are clear of the garage door or other devices to prevent injury or other potential harm.
- It is recommended that a new battery be placed in the remote control transmitter for more accurate programming.
- Garage door openers manufactured after 1995 may be equipped with rolling code protection. If this is the case, you will need a stepladder or other sturdy, safe device to reach the “learn” or “smart” button on the garage door opener motor.
- In order to conserve electricity after the power switch is turned off and 20 minutes after the doors have been opened or closed, registration procedures may not be possible and the garage door opener may not operate. Perform the registration procedures with the power switch in ON mode.

■ **Programming HomeLink®**

- 1** Point the remote control transmitter for the device 1 to 3 in. (25 to 75 mm) from the HomeLink® buttons.

Keep the HomeLink® indicator light in view while programming.



► For U.S.A. owners

- 2** Press and hold the HomeLink® button you want to program and the remote control transmitter button simultaneously. When the HomeLink® indicator light changes from slowly flashing orange to rapidly flashing green (rolling code) or continuously lit green (fixed code), release both buttons.



- ▶ Programming an entry gate (for U.S.A. owners)/Programming a device in the Canadian market
- 2** With one hand, press and hold the HomeLink[®] button you want to program. With your other hand, press and release the remote control transmitter every 2 seconds and repeat this cycle until the HomeLink[®] indicator light starts to flash rapidly. Then, release the buttons.
- 3** Test the HomeLink[®] operation by pressing the newly programmed button and observing the indicator light:
 - If the indicator light is solid/continuous, programming has been completed and your device should activate when the HomeLink[®] button is pressed and released.
 - If the indicator light blinks rapidly for 2 seconds and then turns into a solid/continuous light, proceed to the heading “Programming a Rolling Code System”.
- 4** Repeat the steps above to program another device for any of the remaining HomeLink[®] buttons.

■ Programming a Rolling Code System

- 1** Locate the “learn” or “smart” button on the garage door opener motor in the garage.

This button can usually be found where the hanging antenna wire is attached to the unit. The name and color of the button may vary by manufacturer. Please refer to the Owner’s manual supplied with the garage door opener motor for details.

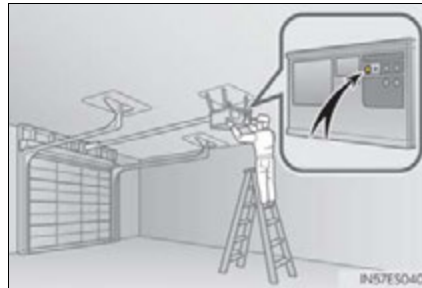

- 2** Press and release the “learn” or “smart” button.
Perform step **3** within 30 seconds after performing step **2**.

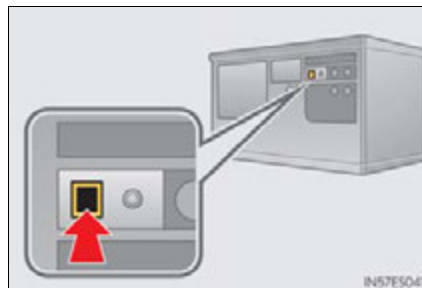

- 3 Press and hold the programmed HomeLink[®] button (located inside the vehicle) for 2 seconds and release it. Repeat this sequence (press/hold/release) up to 3 times to complete programming.

If the garage door opener motor activates when the HomeLink[®] button is pressed, the garage door opener motor recognizes the HomeLink[®] signal.



■ **Enabling 2-way communication with a garage door (only available for compatible devices)**

When enabled, 2-way communication allows you to check the status of the opening and closing of the garage door through indicators in your vehicle.

2-way communication is only available if the garage door opener motor used is a compatible device. (To check device compatibility, refer to the Owner's manual supplied with the garage door opener motor.)

- 1 Press a programmed HomeLink[®] button to operate a garage door.
- 2 Within 1 minute of pressing the HomeLink[®] button, after the garage door operation has stopped, press the "learn" or "smart" button on the garage door opener motor. Within 5 seconds of the establishment of 2-way communication with the garage door opener, both garage door operation indicators in the vehicle will flash rapidly (green).

■ **Reprogramming a single HomeLink[®] button**

When the following procedure is performed, buttons which already have devices registered to them can be overwritten:

- 1 With one hand, press and hold the desired HomeLink[®] button.
- 2 When the HomeLink[®] indicator starts flashing, continue to hold the HomeLink[®] button and perform "Programming HomeLink[®]" from step 1 (it takes 20 seconds for the HomeLink[®] indicator to start flashing).

Operating HomeLink®

Press the appropriate HomeLink® button. The HomeLink® indicator light should turn on.

Garage door operation indicators

The status of the opening and closing of a garage door is shown by the indicators.

- ① Opening
- ② Closing

This function is only available if the garage door opener motor used is a compatible device. (To check device compatibility, refer to the Owner's manual supplied with the garage door opener motor.)

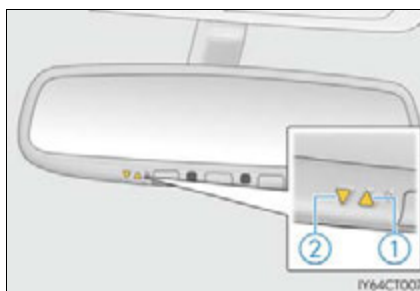

| Color | Status |
|-------------------|-------------------------------------|
| Orange (flashing) | Currently opening/closing |
| Green | Opening/closing has completed |
| Red (flashing) | Feedback signals cannot be received |

The indicators can operate within approximately 820 ft. (250 m) of the garage door. However, if there are obstacles between the garage door and the vehicle, such as houses and trees, feedback signals from the garage door may not be received.

To recall the previous door operation status, press and release either HomeLink® buttons "1" and "2" or "2" and "3" simultaneously for 2 seconds. The last recorded status will be displayed for 5 seconds.

Erasing the entire HomeLink® memory (all three programs)

Press and hold the 2 outside buttons for 10 seconds until the HomeLink® indicator light changes from continuously lit (orange) to rapidly flashing (green).

If you sell your vehicle, be sure to erase the programs stored in the HomeLink® memory.

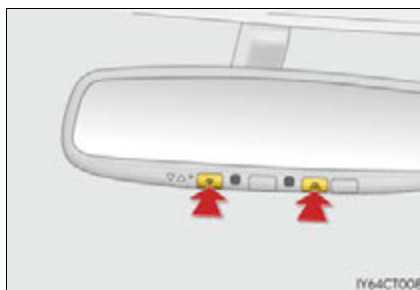

■ Programs stored in the HomeLink® memory

- The registered codes are not erased even if the 12-volt battery cable is disconnected.
- If learning failed when registering a different code to a HomeLink® button that already has a code registered to it, the already registered code is not erased.

■ Certification for the garage door opener

- ▶ For vehicles sold in the U.S.A.

This device complies with part 15 of the FCC Rules. Operation is subject to the following two conditions: (1) This device may not cause harmful interference, and (2) this device must accept any interference received, including interference that may cause undesired operation.

changes or modifications not expressly approved by the party responsible for compliance could void the user's authority to operate the equipment.

- ▶ For vehicles sold in Canada

This device complies with Industry Canada licence-exempt RSS standard(s). Operation is subject to the following two conditions: (1) this device may not cause interference, and (2) this device must accept any interference, including interference that may cause undesired operation of the device.

Le présent appareil est conforme aux CNR d'Industrie Canada applicables aux appareils radio exempts de licence. L'exploitation est autorisée aux deux conditions suivantes : (1) l'appareil ne doit pas produire de brouillage, et (2) l'utilisateur de l'appareil doit accepter tout brouillage radioélectrique subi, même si le brouillage est susceptible d'en compromettre le fonctionnement.

■ For additional programming assistance with your HomeLink® Universal Transceiver

Visit on the web at www.homelink.com or call 1-800-355-3515.

⚠ WARNING

- **When programming a garage door or other remote control device**
The garage door or other device may operate, so ensure people and objects are out of danger to prevent potential harm.
- **Conforming to federal safety standards**
Do not use the HomeLink® compatible transceiver with any garage door opener or device that lacks safety stop and reverse features as required by federal safety standards.
This includes any garage door that cannot detect an interfering object. A door or device without these features increases the risk of death or serious injury.
- **When operating or programming HomeLink®**
Never allow a child to operate or play with the HomeLink® buttons.

Compass*

The compass on the inside rear view mirror indicates the direction in which the vehicle is heading.

Operation

- ▶ Vehicles without garage door opener

Type A:

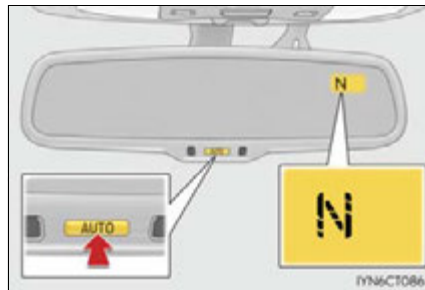

To turn the compass on or off, press the "AUTO" button for more than 3 seconds.

- ▶ Vehicles with garage door opener

To turn the compass on or off, press the button.

Type B:

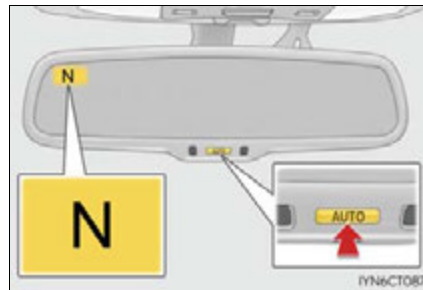

To turn the compass on or off, press the "AUTO" button for more than 3 seconds.

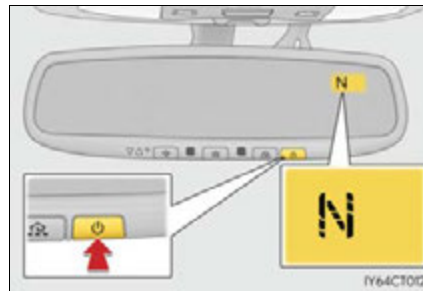

6

Interior features

*: If equipped

Displays and directions

| Display | Direction |
|---------|-----------|
| "N" | North |
| "NE" | Northeast |
| "E" | East |
| "SE" | Southeast |
| "S" | South |
| "SW" | Southwest |
| "W" | West |
| "NW" | Northwest |

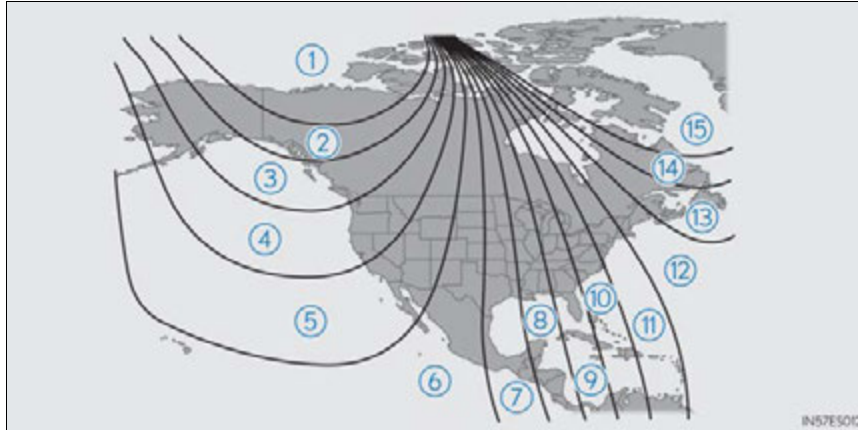
Calibrating the compass

The direction display deviates from the true direction determined by the earth's magnetic field. The amount of deviation varies depending on the geographic position of the vehicle.

If you cross over one of the map boundaries shown in illustration, the compass will deviate.

To obtain higher precision or perfect calibration, refer to "Deviation calibration".

■ **Deviation calibration**

▶ Vehicles without garage door opener

- 1 Stop the vehicle.
- 2 Press and hold the “AUTO” button for 6 seconds. A number (1 to 15) appears on the compass display.

Type A:

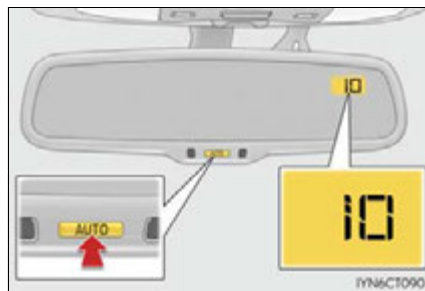

Type B:

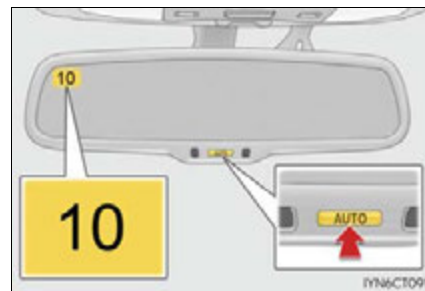

- 3 Referring to the map above, press the “AUTO” button to select the number of the zone you are in.

If the direction is displayed several seconds after adjustment, the calibration is complete.

▶ Vehicles with garage door opener

- 1 Stop the vehicle.
- 2 Press and hold the button for 3 seconds. A number (1 to 15) appears on the compass display.

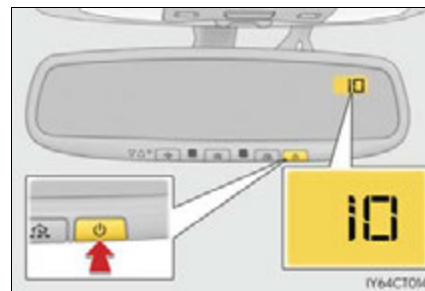

- 3 Referring to the map above, press the button to select the number of the zone you are in.

If the direction is displayed several seconds after adjustment, the calibration is complete.

■ Circling calibration

- ▶ Vehicles without garage door opener

- 1 Stop the vehicle in a place where it is safe to drive in a circle.
- 2 Press and hold the "AUTO" button for 9 seconds.
"C" appears on the compass display.

Type A:

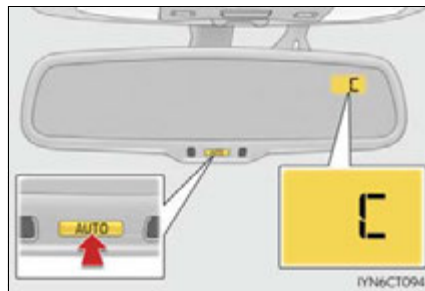

Type B:

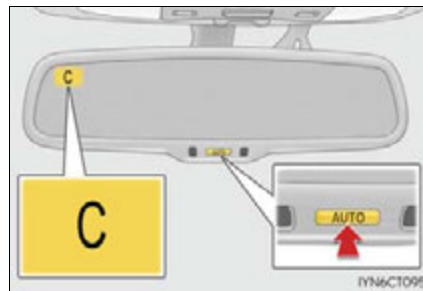

- 3 Drive the vehicle at 5 mph (8 km/h) or less in a circle until a direction is displayed.

If there is not enough space to drive in a circle, drive around the block until a direction is displayed.



- ▶ Vehicles with garage door opener

- 1 Stop the vehicle in a place where it is safe to drive in a circle.
- 2 Press and hold the button for 6 seconds.
"C" appears on the compass display.

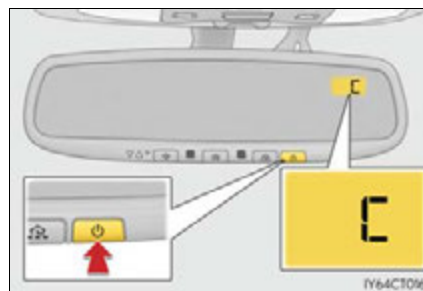

- 3 Drive the vehicle at 5 mph (8 km/h) or less in a circle until a direction is displayed.

If there is not enough space to drive in a circle, drive around the block until a direction is displayed.



■ Conditions unfavorable to correct operation

The compass may not show the correct direction in the following conditions:

- The vehicle is stopped immediately after turning.
- The vehicle is on an inclined surface.
- The vehicle is in a place where the earth's magnetic field is subject to interference by artificial magnetic fields (underground car park/parking lot, under a steel tower, between buildings, roof car park/parking lot, near an intersection, near a large vehicle, etc.).
- The vehicle has become magnetized. (There is a magnet or metal object near the inside rear view mirror.)
- The 12-volt battery has been disconnected.
- A door is open.

⚠ WARNING

- **While driving the vehicle**
Do not adjust the display. Adjust the display only when the vehicle is stopped.
- **When doing the circling calibration**
Secure a wide space, and watch out for people and vehicles in the vicinity. Do not violate any local traffic rules while performing circling calibration.

⚠ NOTICE

- **To avoid compass malfunctions**
Do not place magnets or any metal objects near the inside rear view mirror. Doing this may cause the compass sensor to malfunction.
- **To ensure normal operation of the compass**
 - Do not perform a circling calibration of the compass in a place where the earth's magnetic field is subject to interference by artificial magnetic fields.
 - During calibration, do not operate electric systems (moon roof, power windows, etc.) as they may interfere with the calibration.

LEXUS Enform Safety Connect*

Safety Connect is a subscription-based telematics service that uses Global Positioning System (GPS) data and embedded cellular technology to provide safety and security features to subscribers. Safety Connect is supported by Lexus' designated response center, which operates 24 hours per day, 7 days per week.

Safety Connect service is available by subscription on select, telematics hardware-equipped vehicles.

By using the Safety Connect service, you are agreeing to be bound by the Telematics Subscription Service Agreement and its Terms and Conditions, as in effect and amended from time to time, a current copy of which is available at Lexus.com. All use of the Safety Connect service is subject to such then-applicable Terms and Conditions.

System components

- ① Microphone
- ② LED light indicators
- ③ "SOS" button

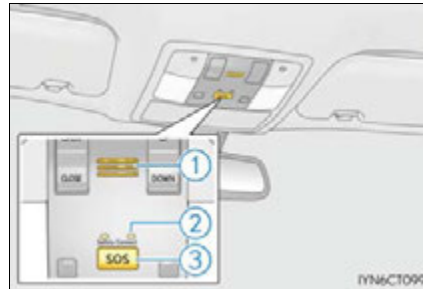

6

Interior features

*: If equipped

Services

Subscribers have the following Safety Connect services available:

- Automatic Collision Notification*
Helps drivers receive necessary response from emergency service providers.
(→P. 457)
- *: U.S. Patent No. 7,508,298 B2
- Stolen Vehicle Location
Helps drivers in the event of vehicle theft. (→P. 457)
- Emergency Assistance Button (SOS)
Connects drivers to response-center support. (→P. 457)
- Enhanced Roadside Assistance
Provides drivers various on-road assistance. (→P. 458)

Subscription

After you have signed the Telematics Subscription Service Agreement and are enrolled, you can begin receiving services.

A variety of subscription terms is available for purchase. Contact your Lexus dealer, call 1-800-25-LEXUS (1-800-255-3987) or push the “SOS” button in your vehicle for further subscription details.

■ Safety Connect Services Information

- Phone calls using the vehicles Bluetooth® technology will not be possible during Safety Connect.
- Contact with the Safety Connect response center is dependent upon the telematics device being in operative condition, cellular connection availability, and GPS satellite signal reception, which can limit the ability to reach the response center or receive emergency service support. Enrollment and Telematics Subscription Service Agreement required. A variety of subscription terms is available; charges vary by subscription term selected.
- Automatic Collision Notification, Emergency Assistance and Stolen Vehicle Location will function in the United States, including Hawaii and Alaska, and in Canada, and Enhanced Roadside Assistance will function in the United States (except Hawaii) and in Canada. No Safety Connect services will function outside of the United States in countries other than Canada.
- Safety Connect services are not subject to section 255 of the Telecommunications Act and the device is not TTY compatible.

■ Languages

The Safety Connect response center will offer support in multiple languages. The Safety Connect system will offer voice prompts in English and Spanish. Please indicate your language of choice when enrolling.

■ When contacting the response center

You may be unable to contact the response center if the network is busy.

Safety Connect LED light Indicators

When the power switch is turned to ON mode, the red indicator light comes on for 2 seconds then turns off. Afterward, the green indicator light comes on, indicating that the service is active.

The following indicator light patterns indicate specific system usage conditions:

- Green indicator light on = Active service
- Green indicator light flashing = Safety Connect call in process
- Red indicator light (except at vehicle start-up) = System malfunction (contact your Lexus dealer)
- No indicator light (off) = Safety Connect service not active

Safety Connect services

■ Automatic Collision Notification

In case of either airbag deployment or severe rear-end collision, the system is designed to automatically call the response center. The responding agent receives the vehicle's location and attempts to speak with the vehicle occupants to assess the level of emergency. If the occupants are unable to communicate, the agent automatically treats the call as an emergency, contacts the nearest emergency services provider to describe the situation, and requests that assistance be sent to the location.

■ Stolen Vehicle Location

If your vehicle is stolen, Safety Connect can work with local authorities to assist them in locating and recovering the vehicle. After filing a police report, call the Safety Connect response center at 1-800-25-LEXUS (1-800-255-3987) and follow the prompts for Safety Connect to initiate this service.

In addition to assisting law enforcement with recovery of a stolen vehicle, Safety-Connect-equipped vehicle location data may, under certain circumstances, be shared with third parties to locate your vehicle. Further information is available at Lexus.com.

■ Emergency Assistance Button ("SOS")

In the event of an emergency on the road, push the "SOS" button to reach the Safety Connect response center. The answering agent will determine your vehicle's location, assess the emergency, and dispatch the necessary assistance required.

If you accidentally press the "SOS" button, tell the response-center agent that you are not experiencing an emergency.

■ **Enhanced Roadside Assistance**

Enhanced Roadside Assistance adds GPS data to the already included warranty-based Lexus roadside service.

Subscribers can press the “SOS” button to reach a Safety Connect response-center agent, who can help with a wide range of needs, such as: towing, flat tire, fuel delivery, etc. For a description of the Roadside Assistance services and their limitations, please see the Safety Connect Terms and Conditions, which are available at Lexus.com.

Safety information for Safety Connect

Important! Read this information before using Safety Connect.

■ **Exposure to radio frequency signals**

The Safety Connect system installed in your vehicle is a low-power radio transmitter and receiver. It receives and also sends out radio frequency (RF) signals.

In August 1996, the Federal Communications Commission (FCC) adopted RF exposure guidelines with safety levels for mobile wireless phones. Those guidelines are consistent with the safety standards previously set by the following U.S. and international standards bodies.

- ANSI (American National Standards Institute) C95.1 [1992]
- NCRP (National Council on Radiation Protection and Measurement) Report 86 [1986]
- ICNIRP (International Commission on Non-Ionizing Radiation Protection) [1996]

Those standards were based on comprehensive and periodic evaluations of the relevant scientific literature. Over 120 scientists, engineers, and physicians from universities, and government health agencies and industries reviewed the available body of research to develop the ANSI Standard (C95.1).

The design of Safety Connect complies with the FCC guidelines in addition to those standards.

■ Certification for Lexus Enform with Safety Connect

FCC ID: O6Y-CDMRF101

FCC ID: XOECDMRF101B

FCC ID: N7NGTM2

FCC WARNING:

This equipment complies with FCC radiation exposure limits set forth for an uncontrolled environment and meets the FCC radio frequency (RF) Exposure Guidelines in Supplement C to OET65. This equipment should be installed and operated keeping the radiator at least 20cm or more away from person's body (excluding extremities: hands, wrists, feet and ankles).

7-1. Maintenance and care

Cleaning and protecting the
vehicle exterior 462

Cleaning and protecting the
vehicle interior 465

7-2. Maintenance

Maintenance
requirements..... 467

General maintenance..... 469

Emission inspection and
maintenance (I/M)
programs472

7-3. Do-it-yourself maintenance

Do-it-yourself service
precautions.....473

Hood 475

Positioning a floor jack.....477

Engine compartment 478

12-volt battery.....486

Tires.....490

Tire inflation pressure497

Wheels 500

Air conditioning filter502

Electronic key battery504

Checking and replacing
fuses.....506

Light bulbs.....509

Cleaning and protecting the vehicle exterior

Perform the following to protect the vehicle and maintain it in prime condition:

- Working from top to bottom, liberally apply water to the vehicle body, wheel wells and underside of the vehicle to remove any dirt and dust.
- Wash the vehicle body using a sponge or soft cloth, such as a chamois.
- For hard-to-remove marks, use car wash soap and rinse thoroughly with water.
- Wipe away any water.
- Wax the vehicle when the waterproof coating deteriorates.

If water does not bead on a clean surface, apply wax when the vehicle body is cool.

■ Self-restoring coat

The vehicle body has a self-restoring coating that is resistant to small surface scratches caused in a car wash etc.

- The coating lasts for 5 to 8 years from when the vehicle is delivered from the plant.
- The restoration time differs depending on the depth of the scratch and outside temperature. The restoration time may become shorter when the coating is warmed by applying warm water.
- Deep scratches caused by keys, coins, etc. cannot be restored.
- Do not use wax that contain abrasives.

■ Automatic car washes

- Fold the mirrors before washing the vehicle. Start washing from the front of the vehicle. Make sure to extend the mirrors before driving.
- Brushes used in automatic car washes may scratch the vehicle surface and harm your vehicle's paint.
- Rear spoiler may not be washable in some automatic car washes. There may also be an increased risk of damage to vehicle.

■ High pressure car washes

- Do not allow the nozzles of the car wash to come within close proximity of the windows.
- Before using the car wash, check that the fuel filler door on your vehicle is closed properly.

■ Note for a smart access system with push-button start

If the door handle becomes wet while the electronic key is within the effective range, the door may lock and unlock repeatedly. Place the key in a position 6 ft. (2 m) or more separate from the vehicle while the vehicle is being washed. (Take care to ensure that the key is not stolen.)

■ **Aluminum wheels**

- Remove any dirt immediately by using a neutral detergent. Do not use hard brushes or abrasive cleaners. Do not use strong or harsh chemical cleaners. Use the same mild detergent and wax as used on the paint.
- Do not use detergent on the wheels when they are hot, for example after driving for long distance in the hot weather.
- Wash detergent from the wheels immediately after use.

■ **Bumpers**

Do not scrub with abrasive cleaners.

■ **Front side windows water-repellent coating**

- The following precautions can extend the effectiveness of the water-repellent coating.
 - Remove any dirt, etc. from the front side windows regularly.
 - Do not allow dirt and dust to accumulate on the windows for a long period. Clean the windows with a soft, damp cloth as soon as possible.
 - Do not use wax or glass cleaners that contain abrasives when cleaning the windows.
 - Do not use any metallic objects to remove condensation build up.
- When the water-repellent performance has become insufficient, the coating can be repaired. Contact your Lexus dealer.

⚠ WARNING

■ **When washing the vehicle**

Do not apply water to the inside of the engine compartment. Doing so may cause the electrical components etc. to catch fire.

■ **When cleaning the windshield (vehicles with rain-sensing windshield wipers)**

Set the wiper switch to off. If the switch is in "AUTO", the wipers may operate unexpectedly in the following situations, and may result in hands being caught or other serious injuries and cause damage to the wiper blades.

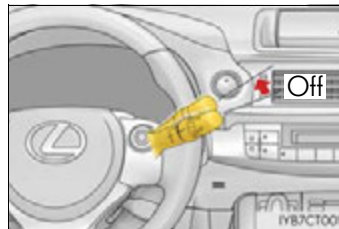

- When the upper part of the windshield where the raindrop sensor is located is touched by hand
- When a wet rag or similar is held close to the raindrop sensor
- If something bumps against the windshield
- If you directly touch the raindrop sensor body or if something bumps into the raindrop sensor

■ **Precautions regarding the exhaust pipe**

Exhaust gasses cause the exhaust pipe to become quite hot. When washing the vehicle, be careful not to touch the pipe until it has cooled sufficiently, as touching a hot exhaust pipe can cause burns.

 NOTICE**■ To prevent paint deterioration and corrosion on the body and components (aluminum wheels etc.)**

- Wash the vehicle immediately in the following cases:
 - After driving near the sea coast
 - After driving on salted roads
 - If coal tar or tree sap is present on the paint surface
 - If dead insects, insect droppings or bird droppings are present on the paint surface
 - After driving in an area contaminated with soot, oily smoke, mine dust, iron powder or chemical substances
 - If the vehicle becomes heavily soiled with dust or mud
 - If liquids such as benzene and gasoline are spilled on the paint surface
- If the paint is chipped or scratched, have it repaired immediately.
- To prevent the wheels from corroding, remove any dirt and store in a place with low humidity when storing the wheels.

■ Cleaning the exterior lights

- Wash carefully. Do not use organic substances or scrub with a hard brush. This may damage the surfaces of the lights.
- Do not apply wax to the surfaces of the lights. Wax may cause damage to the lenses.

■ When using an automatic car wash (vehicles with rain-sensing windshield wipers)

Set the wiper switch to the off position.
If the wiper switch is in "AUTO", the wipers may operate and the wiper blades may be damaged.

■ When using a high pressure car wash

- When washing the vehicle, do not let water from the high-pressure washer directly hit the camera or the area around the camera. Due to the shock from high-pressure water, it is possible that the device may not operate normally.
- Do not bring the nozzle tip close to boots (rubber or resin manufactured cover), connectors or the following parts. The parts may be damaged if they come into contact with high-pressure water.
 - Traction related parts
 - Steering parts
 - Suspension parts
 - Brake parts

Cleaning and protecting the vehicle interior

The following procedures will help protect your vehicle's interior and keep it in top condition:

Protecting the vehicle interior

Remove dirt and dust using a vacuum cleaner. Wipe dirty surfaces with a cloth dampened with lukewarm water.

Cleaning the leather areas

- Remove dirt and dust using a vacuum cleaner.
- Wipe off any excess dirt and dust with a soft cloth dampened with diluted detergent.
Use a diluted water solution of approximately 5% neutral wool detergent.
- Wring out any excess water from the cloth and thoroughly wipe off all remaining traces of detergent.
- Wipe the surface with a dry, soft cloth to remove any remaining moisture. Allow the leather to dry in a shaded and ventilated area.

Cleaning the synthetic leather areas

- Remove loose dirt using a vacuum cleaner.
- Apply a mild soap solution to the synthetic leather using a sponge or soft cloth.
- Allow the solution to soak in for a few minutes. Remove the dirt and wipe off the solution with a clean, damp cloth.

■ Caring for leather areas

Lexus recommends cleaning the interior of the vehicle at least twice a year to maintain the quality of the vehicle's interior.

■ Shampooing the carpets

There are several commercial foaming-type cleaners available. Use a sponge or brush to apply the foam. Rub in overlapping circles. Do not use water. Wipe dirty surfaces and let them dry. Excellent results are obtained by keeping the carpet as dry as possible.

■ Seat belts

Clean with mild soap and lukewarm water using a cloth or sponge. Also check the belts periodically for excessive wear, fraying or cuts.

 **WARNING****■ Water in the vehicle**

- Do not splash or spill liquid in the vehicle, such as on the floor, in the hybrid battery (traction battery) air vents, and in the luggage compartment. Doing so may cause the hybrid battery, electrical components, etc. to malfunction or catch fire.
- Do not get any of the SRS components or wiring in the vehicle interior wet. (→P. 39)
An electrical malfunction may cause the airbags to deploy or not function properly, resulting in death or serious injury.

■ Cleaning the interior (especially instrument panel)

Do not use polish wax or polish cleaner. The instrument panel may reflect off the windshield, obstructing the driver's view and leading to an accident, resulting in death or serious injury.

 **NOTICE****■ Cleaning detergents**

- Do not use the following types of detergent, as they may discolor the vehicle interior or cause streaks or damage to painted surfaces:
 - Non-seat portions: Organic substances such as benzene or gasoline, alkaline or acidic solutions, dye, and bleach
 - Seats: Alkaline or acidic solutions, such as thinner, benzene, and alcohol
- Do not use polish wax or polish cleaner. The instrument panel's or other interior part's painted surface may be damaged.

■ Preventing damage to leather surfaces

Observe the following precautions to avoid damage to and deterioration of leather surfaces:

- Remove any dust or dirt from leather surfaces immediately.
- Do not expose the vehicle to direct sunlight for extended periods of time. Park the vehicle in the shade, especially during summer.
- Do not place items made of vinyl, plastic, or containing wax on the upholstery, as they may stick to the leather surface if the vehicle interior heats up significantly.

■ Water on the floor

Do not wash the vehicle floor with water. Vehicle systems such as the audio system may be damaged if water comes into contact with electrical components such as the audio system above or under the floor of the vehicle. Water may also cause the body to rust.

■ Cleaning the inside of the rear window

- Do not use glass cleaner to clean the rear window, as this may cause damage to the rear window defogger heater wires or antenna. Use a cloth dampened with lukewarm water to gently wipe the window clean. Wipe the window in strokes running parallel to the heater wires or antenna.
- Be careful not to scratch or damage the heater wires or antenna.

Maintenance requirements

To ensure safe and economical driving, day-to-day care and regular maintenance are essential. It is the owner's responsibility to perform regular checks. Lexus recommends the following maintenance:

General maintenance

General maintenance should be performed on a daily basis. This can be done by yourself or by a Lexus dealer.

Scheduled maintenance

Scheduled maintenance should be performed at specified intervals according to the maintenance schedule.

For details about maintenance items and schedules, refer to the "Warranty and Service Guide", "Owner's Manual Supplement" or "Scheduled Maintenance".

Do-it-yourself maintenance

You can perform some maintenance procedures by yourself.

Please be aware that do-it-yourself maintenance may affect warranty coverage.

The use of Lexus repair manuals is recommended.

For details about warranty coverage, refer to the separate "Owner's Guide", "Warranty and Service Guide", "Owner's Manual Supplement" or "Warranty Booklet".

■ Repair and replacement

It is recommended that genuine Lexus parts be used for repairs to ensure performance of each system. If non-Lexus parts are used in replacement or if a repair shop other than a Lexus dealer performs repairs, confirm the warranty coverage.

■ Resetting the message indicating maintenance is required (U.S.A. only)

After the required maintenance is performed according to the maintenance schedule, please reset the message.

To reset the message, follow the procedures described below:

- 1 Switch the display to the trip meter "A" (→P. 84) when the hybrid system is operating.
- 2 Turn the power switch off.
- 3 While pressing the odometer/trip meter display change button (→P. 84), turn the power switch to ON mode (do not start the hybrid system because otherwise the reset mode will be canceled). Continue to press and hold the button until the trip meter displays "000000" and the multi-information display indicates that the reset is complete.

■ Allow inspection and repairs to be performed by a Lexus dealer

- Lexus technicians are well-trained specialists and are kept up to date with the latest service information. They are well informed about the operation of all systems on your vehicle.
- Keep a copy of the repair order. It proves that the maintenance that has been performed is under warranty coverage. If any problem should arise while your vehicle is under warranty, your Lexus dealer will promptly take care of it.

WARNING

■ If your vehicle is not properly maintained

Improper maintenance could result in serious damage to the vehicle and possible serious injury or death.

■ Handling of the 12-volt battery

- Engine exhaust, some of its constituents, and a wide variety of automobile components contain or emit chemicals known to the State of California to cause cancer and birth defects and other reproductive harm. Work in a well ventilated area.
- Oils, fuels and fluids contained in vehicles as well as waste produced by component wear contain or emit chemicals known to the State of California to cause cancer and birth defects or other reproductive harm. Avoid exposure and wash any affected area immediately.
- 12-volt battery posts, terminals and related accessories contain lead and lead compounds which are known to cause brain damage. Wash your hands after handling. (→P. 486)

General maintenance

Listed below are the general maintenance items that should be performed at the intervals specified in the “Warranty and Service Guide” or “Owner’s Manual Supplement”. It is recommended that any problem you notice should be brought to the attention of your Lexus dealer or qualified service shop for advice.

Engine compartment

| Items | Check points |
|-----------------------------------|---|
| Brake fluid | Is the brake fluid at the correct level? (→P. 484) |
| Engine/power control unit coolant | Is the engine/power control unit coolant at the correct level? (→P. 482) |
| Engine oil | Is the engine oil at the correct level? (→P. 479) |
| Exhaust system | There should not be any fumes or strange sounds. |
| Radiator/condenser | The radiator and condenser should be free from foreign objects. (→P. 484) |
| Washer fluid | Is there sufficient washer fluid? (→P. 485) |

Luggage compartment

| Items | Check points |
|-----------------|----------------------------------|
| 12-volt battery | Check the connections. (→P. 486) |

Vehicle interior

| Items | Check points |
|--------------------------------------|--|
| Accelerator pedal | <ul style="list-style-type: none"> The accelerator pedal should move smoothly (without uneven pedal effort or catching). |
| Hybrid transmission "Park" mechanism | <ul style="list-style-type: none"> When parked on a slope and the shift position is in P, is the vehicle securely stopped? |
| Brake pedal | <ul style="list-style-type: none"> Does the brake pedal move smoothly? Does the brake pedal have appropriate clearance from the floor? (→P. 577) Does the brake pedal have the correct amount of free play? (→P. 577) |
| Brakes | <ul style="list-style-type: none"> The vehicle should not pull to one side when the brakes are applied. The brakes should work effectively. The brake pedal should not feel spongy. The brake pedal should not get too close to the floor when the brakes are applied. |
| Head restraints | <ul style="list-style-type: none"> Do the head restraints move smoothly and lock securely? |
| Indicators/buzzers | <ul style="list-style-type: none"> Do the indicators and buzzers function properly? |
| Lights | <ul style="list-style-type: none"> Do all the lights come on? |
| Parking brake | <ul style="list-style-type: none"> Does the parking brake pedal move smoothly? When parked on a slope and the parking brake is on, is the vehicle securely stopped? |
| Seat belts | <ul style="list-style-type: none"> Do the seat belts operate smoothly? The seat belts should not be damaged. |
| Seats | <ul style="list-style-type: none"> Do the seat controls operate properly? |
| Steering wheel | <ul style="list-style-type: none"> Does the steering wheel rotate smoothly? Does the steering wheel have the correct amount of free play? There should not be any strange sounds coming from the steering wheel. |

Vehicle exterior

| Items | Check points |
|---|--|
| Doors | <ul style="list-style-type: none"> Do the doors operate smoothly? |
| Engine hood | <ul style="list-style-type: none"> Does the engine hood lock system work properly? |
| Fluid leaks | <ul style="list-style-type: none"> There should not be any signs of fluid leakage after the vehicle has been parked. |
| Tires | <ul style="list-style-type: none"> Is the tire inflation pressure correct? The tires should not be damaged or excessively worn. Have the tires been rotated according to the maintenance schedule? The wheel nuts should not be loose. |
| Windshield wipers/ rear window wiper | <ul style="list-style-type: none"> The wiper blades should not show any signs of cracking, splitting, wear, contamination or deformation. The wiper blades should clear the windshield/rear window without streaking or skipping. |

⚠ WARNING

■ If the hybrid system is operating

Turn the hybrid system off and ensure that there is adequate ventilation before performing maintenance checks.

Emission inspection and maintenance (I/M) programs

Some states have vehicle emission inspection programs which include OBD (On Board Diagnostics) checks. The OBD system monitors the operation of the emission control system.

If the malfunction indicator lamp comes on

The OBD system determines that a problem exists somewhere in the emission control system. Your vehicle may not pass the I/M test and may need to be repaired. Contact your Lexus dealer to service the vehicle.

Your vehicle may not pass the I/M test in the following situations:

- When the 12-volt battery is disconnected or discharged
Readiness codes that are set during ordinary driving are erased. Also, depending on your driving habits, the readiness codes may not be completely set.
- When the fuel tank cap is loose
The malfunction indicator lamp comes on indicating a temporary malfunction and your vehicle may not pass the I/M test.

When the malfunction indicator lamp still remains on after several driving trips

The error code in the OBD system will not be cleared unless the vehicle is driven 40 or more times.

If your vehicle does not pass the I/M test

Contact your Lexus dealer to prepare the vehicle for re-testing.

Do-it-yourself service precautions

If you perform maintenance by yourself, be sure to follow the correct procedure as given in these sections.

| Items | Parts and tools |
|---|---|
| 12-volt battery condition (→P. 486) | <ul style="list-style-type: none"> • Grease • Conventional wrench (for terminal clamp bolts) |
| Brake fluid level (→P. 484) | <ul style="list-style-type: none"> • FMVSS No.116 DOT 3 or SAE J1703 brake fluid • Rag or paper towel • Funnel (used only for adding brake fluid) |
| Engine/power control unit coolant level (→P. 482) | <ul style="list-style-type: none"> • "Toyota Super Long Life Coolant" or a similar high quality ethylene glycol-based non-silicate, non-amine, non-nitrite and non-borate coolant with long-life hybrid organic acid technology For the U.S.A.: "Toyota Super Long Life Coolant" is pre-mixed with 50% coolant and 50% deionized water. For Canada: "Toyota Super Long Life Coolant" is pre-mixed with 55% coolant and 45% deionized water. • Funnel (used only for adding coolant) |
| Engine oil level (→P. 479) | <ul style="list-style-type: none"> • "Toyota Genuine Motor Oil" or equivalent • Rag or paper towel • Funnel (used only for adding engine oil) |
| Fuses (→P. 506) | <ul style="list-style-type: none"> • Fuse with same amperage rating as original |
| Light bulbs (→P. 509) | <ul style="list-style-type: none"> • Bulb with same number and wattage rating as original • Phillips-head screwdriver • Flathead screwdriver • Wrench |
| Radiator and condenser (→P. 484) | — |
| Tire inflation pressure (→P. 497) | <ul style="list-style-type: none"> • Tire pressure gauge • Compressed air source |
| Washer fluid (→P. 485) | <ul style="list-style-type: none"> • Water or washer fluid containing antifreeze (for winter use) • Funnel (used only for adding water or washer fluid) |

 **WARNING**

The engine compartment contains many mechanisms and fluids that may move suddenly, become hot, or become electrically energized. To avoid death or serious injury, observe the following precautions.

■ When working on the engine compartment

- Make sure that the indicator on the power switch and the "READY" indicator are both off.
- Keep hands, clothing and tools away from the moving fan.
- Be careful not to touch the engine, power control unit, radiator, exhaust manifold, etc. right after driving as they may be hot. Oil and other fluids may also be hot.
- Do not leave anything that may burn easily, such as paper and rags, in the engine compartment.
- Do not smoke, cause sparks or expose an open flame to fuel. Fuel fumes are flammable.

■ When working near the electric cooling fans or radiator grille

Be sure the power switch is off.

With the power switch in ON mode, the electric cooling fans may automatically start to run if the air conditioning is on and/or the coolant temperature is high. (→P. 484)

■ Safety glasses

Wear safety glasses to prevent flying or falling material, fluid spray, etc. from getting in your eyes.

 **NOTICE****■ If you remove the air cleaner filter**

Driving with the air cleaner filter removed may cause excessive engine wear due to dirt in the air.

Hood

Release the lock from the inside of the vehicle to open the hood.

- 1** Pull the hood lock release lever.
The hood will pop up slightly.



- 2** Pull up the auxiliary catch lever and lift the hood.

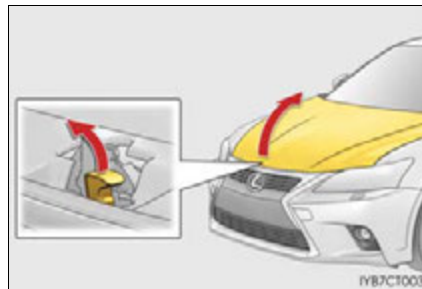

- 3** Hold the hood open by inserting the supporting rod into the slot.

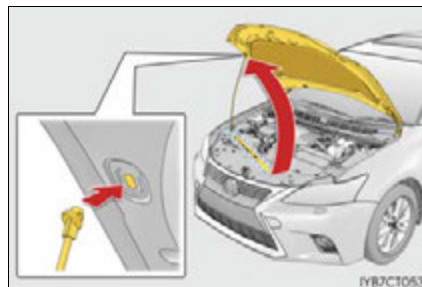

 **WARNING**

■ **Pre-driving check**

Check that the hood is fully closed and locked.

If the hood is not locked properly, it may open while the vehicle is in motion and cause an accident, which may result in death or serious injury.

■ **After installing the support rod into the slot**

Make sure the rod supports the hood securely from falling down on to your head or body.

 **NOTICE**

■ **When closing the hood**

Be sure to return the support rod to its clip before closing the hood. Closing the hood without returning the support rod properly could cause the hood to bend.

Positioning a floor jack

When using a floor jack, follow the instructions in the manual provided with the jack and perform the operation safely.

When raising your vehicle with a floor jack, position the jack correctly. Improper placement may damage your vehicle or cause injury.

◆ Front

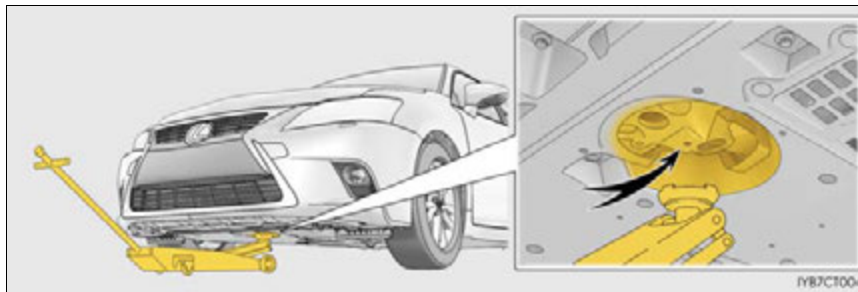

◆ Rear

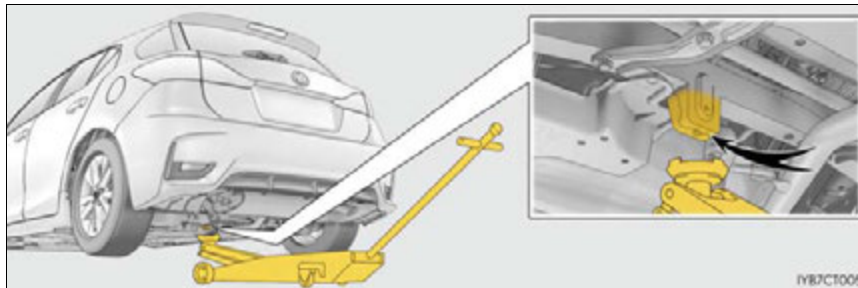

Engine compartment

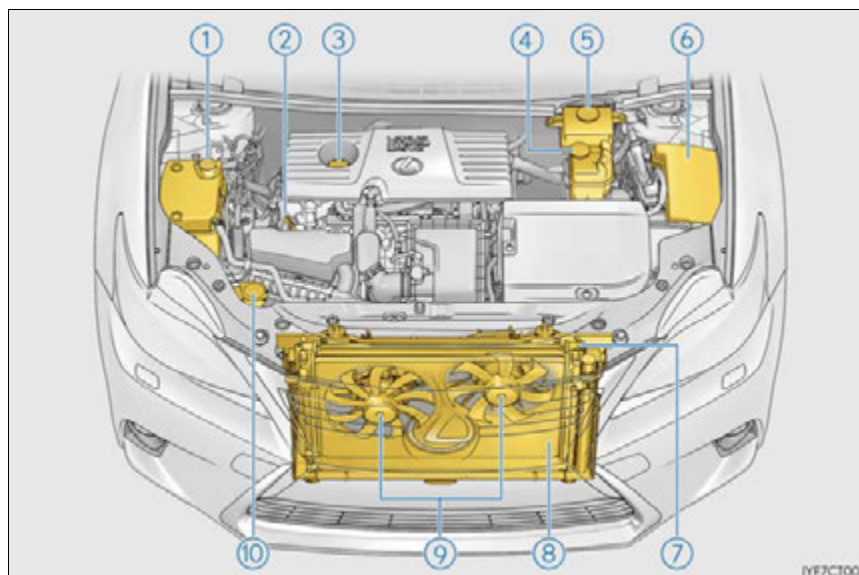

- | | |
|---|-----------------------------------|
| ① Engine coolant reservoir (→P. 482) | ⑤ Brake fluid reservoir (→P. 484) |
| ② Engine oil level dipstick (→P. 479) | ⑥ Fuse box (→P. 506) |
| ③ Engine oil filler cap (→P. 479) | ⑦ Radiator (→P. 484) |
| ④ Power control unit coolant reservoir (→P. 482) | ⑧ Condenser (→P. 484) |
| | ⑨ Electric cooling fans |
| | ⑩ Washer fluid tank (→P. 485) |

■ 12-volt battery
→P. 486

Engine compartment cover

■ Removing the engine compartment cover

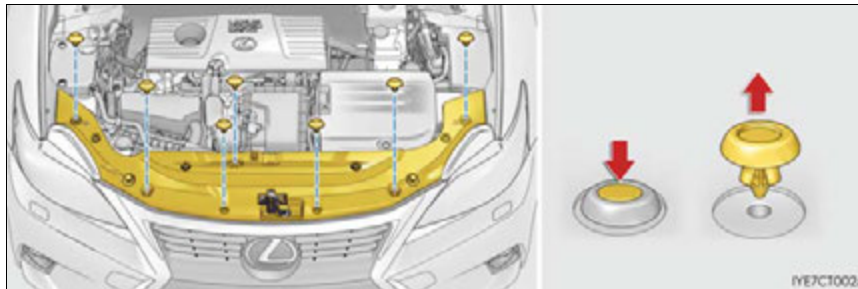

■ Installing the clips

- ① Push up center portion
- ② Insert
- ③ Press



⚠ NOTICE

■ After installing an engine compartment cover

Make sure that the cover is securely installed in its original position.

Engine oil

With the engine at operating temperature and turned off, check the oil level on the dipstick.

■ Checking the engine oil

- ① Park the vehicle on level ground. After warming up the engine and turning off the hybrid system, wait more than 5 minutes for the oil to drain back into the bottom of the engine.

- 2** Holding a rag under the end, pull the dipstick out.

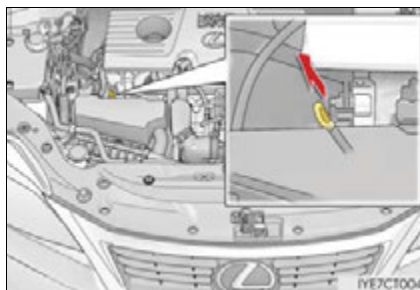

- 3** Wipe the dipstick clean.
- 4** Flat dipstick: Reinsert the dipstick fully.

Non-flat dipstick: Reinsert the dipstick fully with its protruding areas (① in the illustration) pointing towards engine.

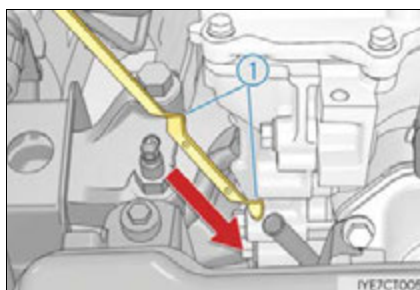

- 5** Holding a rag under the end, pull the dipstick out and check the oil level.

- ① Low
- ② Normal
- ③ Excessive

► Flat dipstick

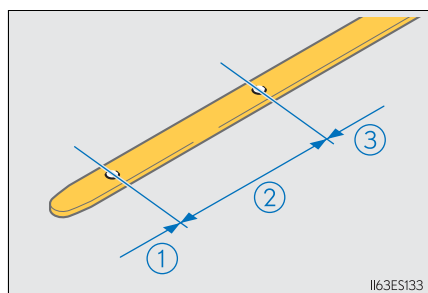

► Non-flat dipstick

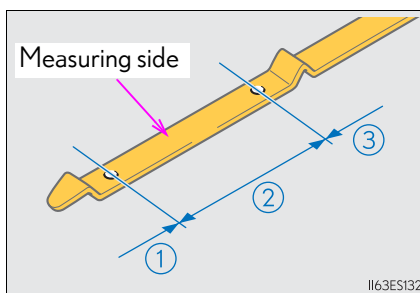

The shape of the dipstick may differ depending on the type of vehicle or engine.

- 6** Wipe the dipstick and reinsert it fully.

■ Adding engine oil

If the oil level is below or near the low level mark, add engine oil of the same type as that already in the engine.



Make sure to check the oil type and prepare the items needed before adding oil.

| | |
|---------------------------|------------------------------|
| Engine oil selection | →P. 574 |
| Oil quantity (Low → Full) | 1.6 qt. (1.5 L, 1.3 Imp.qt.) |
| Items | Clean funnel |

- 1 Remove the oil filler cap by turning it counterclockwise.
- 2 Add engine oil slowly, checking the dipstick.
- 3 Install the oil filler cap by turning it clockwise.

■ Engine oil consumption

A certain amount of engine oil will be consumed while driving. In the following situations, oil consumption may increase, and engine oil may need to be refilled in between oil maintenance intervals.

- When the engine is new, for example directly after purchasing the vehicle or after replacing the engine
- If low quality oil or oil of an inappropriate viscosity is used
- When driving at high engine speeds or with a heavy load, or when driving while accelerating or decelerating frequently
- When leaving the engine idling for a long time, or when driving frequently through heavy traffic

⚠ WARNING

■ **Used engine oil**

- Used engine oil contains potentially harmful contaminants which may cause skin disorders such as inflammation and skin cancer, so care should be taken to avoid prolonged and repeated contact. To remove used engine oil from your skin, wash thoroughly with soap and water.
- Dispose of used oil and filters only in a safe and acceptable manner. Do not dispose of used oil and filters in household trash, in sewers or onto the ground. Call your Lexus dealer, service station or auto parts store for information concerning recycling or disposal.
- Do not leave used engine oil within the reach of children.

⚠ NOTICE

■ **To prevent serious engine damage**

Check the oil level on a regular basis.

■ **When replacing the engine oil**

- Be careful not to spill engine oil on the vehicle components.
- Avoid overfilling, or the engine could be damaged.
- Check the oil level on the dipstick every time you refill the vehicle.
- Be sure the engine oil filler cap is properly tightened.

Coolant

The coolant level is satisfactory if it is between the “FULL” and “LOW” lines on the reservoir when the hybrid system is cold.

■ **Engine coolant reservoir**

- ① Reservoir cap
- ② “FULL” line
- ③ “LOW” line

If the level is on or below the “LOW” line, add coolant up to the “FULL” line. (→P. 566)



■ Power control unit coolant reservoir

- ① Reservoir cap
- ② "FULL" line
- ③ "LOW" line

If the level is on or below the "LOW" line, add coolant up to the "FULL" line. (→P. 566)



■ Coolant selection

Only use "Toyota Super Long Life Coolant" or a similar high quality ethylene glycol based non-silicate, non-amine, non-nitrite, and non-borate coolant with long-life hybrid organic acid technology.

U.S.A.:

"Toyota Super Long Life Coolant" is a mixture of 50% coolant and 50% deionized water. (Minimum temperature: -31°F [-35°C])

Canada:

"Toyota Super Long Life Coolant" is a mixture of 55% coolant and 45% deionized water. (Minimum temperature: -44°F [-42°C])

For more details about coolant, contact your Lexus dealer.

■ If the coolant level drops within a short time of replenishing

Visually check the radiator, hoses, engine/power control unit coolant reservoir caps, drain cock and water pump.

If you cannot find a leak, have your Lexus dealer test the cap and check for leaks in the cooling system.

⚠ WARNING

■ When the hybrid system is hot

Do not remove the engine/power control unit coolant reservoir caps. The cooling system may be under pressure and may spray hot coolant if the cap is removed, causing serious injuries, such as burns.

⚠ NOTICE

■ When adding coolant

Coolant is neither plain water nor straight antifreeze. The correct mixture of water and antifreeze must be used to provide proper lubrication, corrosion protection and cooling. Be sure to read the antifreeze or coolant label.

■ If you spill coolant

Be sure to wash it off with water to prevent it from damaging parts or paint.

Radiator and condenser

Check the radiator and condenser and clear away any foreign objects. If either of the above parts is extremely dirty or you are not sure of their condition, have your vehicle inspected by your Lexus dealer.

WARNING

■ **When the hybrid system is hot**

Do not touch the radiator or condenser as they may be hot and cause serious injuries, such as burns.

■ **When the electric cooling fans are operating**

Do not touch the engine compartment.

The electric cooling fans may keep rotating for about 3 minutes even after the power switch is off.

With the power switch in ON mode, the electric cooling fans may automatically start to run if the air conditioning is on and/or the coolant temperature is high. Be sure the power switch is off when working near the electric cooling fans or radiator grille.

Brake fluid

■ **Checking fluid level**

The brake fluid level should be between the "MAX" and "MIN" lines on the tank.

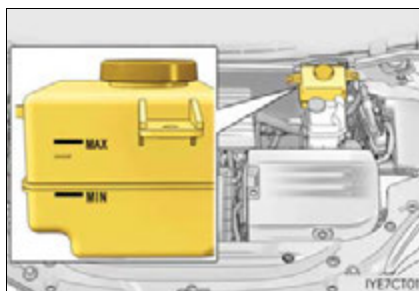

■ **Adding fluid**

Make sure to check the fluid type and prepare the necessary item.

| | |
|------------|---|
| Fluid type | FMVSS No.116 DOT 3 or SAE J1703 brake fluid |
| Items | Clean funnel |

■ **Brake fluid can absorb moisture from the air**

Excess moisture in the brake fluid can cause a dangerous loss of braking efficiency. Use only newly opened brake fluid.

⚠ WARNING**■ When filling the reservoir**

Take care as brake fluid can harm your hands and eyes and damage painted surfaces. If fluid gets on your hands or in your eyes, flush the affected area with clean water immediately.

If you still experience discomfort, see a doctor.

⚠ NOTICE**■ If the brake fluid level is low or high**

It is normal for the brake fluid level to go down slightly as the brake pads wear out or when the fluid level in the accumulator is high.

If the reservoir needs frequent refilling, there may be a serious problem.

Washer fluid

If any washer does not work or the warning message appears on the multi-information display, the washer tank may be empty. Add washer fluid.

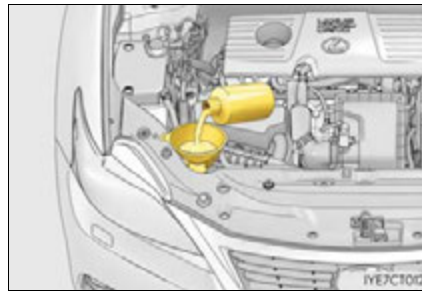
**⚠ WARNING****■ When adding washer fluid**

Do not add washer fluid when the hybrid system is hot or operating as washer fluid contains alcohol and may catch fire if spilled on the engine etc.

⚠ NOTICE**■ Do not use any fluid other than washer fluid**

Do not use soapy water or engine antifreeze instead of washer fluid. Doing so may cause streaking on the vehicle's painted surfaces.

■ Diluting washer fluid

Dilute washer fluid with water as necessary.

Refer to the freezing temperatures listed on the label of the washer fluid bottle.

12-volt battery

Location

The 12-volt battery is located in the right-hand side of luggage compartment.



Removing the 12-volt battery maintenance cover

- 1 Open the center and right side deck boards. (→P. 435)
- 2 Remove the center auxiliary box. (→P. 551)
- 3 Remove the right side auxiliary box.

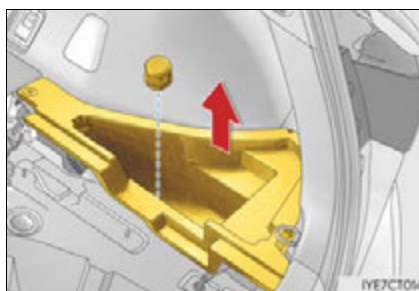

- 4 Remove the 12-volt battery maintenance cover.

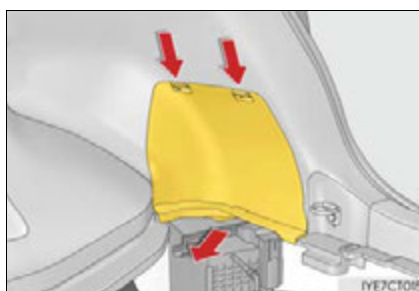

Exterior

Make sure that the 12-volt battery terminals are not corroded and that there are no loose connections, cracks, or loose clamps.

- ① Terminals
- ② Hold-down clamp

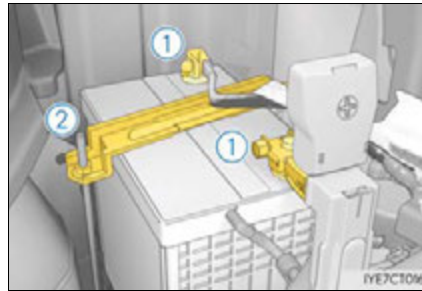

Installing the 12-volt battery maintenance cover

- ① Insert the 2 tabs on the far side of the cover into the holes.

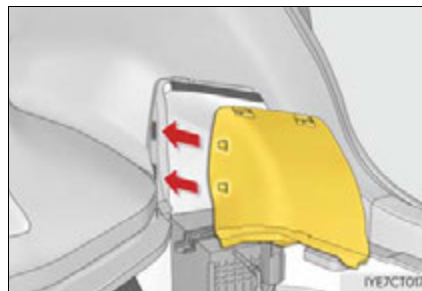

- ② Hook on the 2 tabs on the near side of the cover.

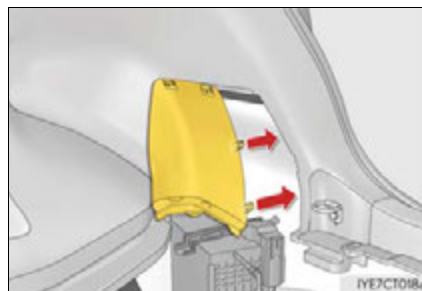

- ③ Hook on the 2 tabs on the upper side of the cover.



■ Before recharging

When recharging, the 12-volt battery produces hydrogen gas which is flammable and explosive. Therefore, observe the following precautions before recharging:

- If recharging with the 12-volt battery installed on the vehicle, be sure to disconnect the ground cable.
- Make sure the power switch on the charger is off when connecting and disconnecting the charger cables to the 12-volt battery.

■ After recharging/reconnecting the 12-volt battery

- Unlocking the doors using the smart access system with push-button start may not be possible immediately after reconnecting the 12-volt battery. If this happens, use the wireless remote control or the mechanical key to lock/unlock the doors.
- Start the hybrid system with the power switch in ACCESSORY mode. The hybrid system may not start with the power switch turned off. However, the hybrid system will operate normally from the second attempt.
- The power switch mode is recorded by the vehicle. If the 12-volt battery is reconnected, the vehicle will return the power switch mode to the status it was in before the 12-volt battery was disconnected. Make sure to turn off the power before disconnect the 12-volt battery. Take extra care when connecting the 12-volt battery if the power switch mode prior to discharge is unknown.
- Restart the hybrid system, depress the brake pedal, and confirm that it is possible to shift into each shift position.

If the system will not start even after multiple attempts at all methods above, contact your Lexus dealer.

**WARNING****■ Chemicals in the 12-volt battery**

The 12-volt battery contains poisonous and corrosive sulfuric acid and may produce hydrogen gas which is flammable and explosive. To reduce the risk of death or serious injury, take the following precautions while working on or near the 12-volt battery:

- Do not cause sparks by touching the 12-volt battery terminals with tools.
- Do not smoke or light a match near the 12-volt battery.
- Avoid contact with eyes, skin and clothes.
- Never inhale or swallow electrolyte.
- Wear protective safety glasses when working near the 12-volt battery.
- Keep children away from the 12-volt battery.

■ Where to safely charge the 12-volt battery

Always charge the 12-volt battery in an open area. Do not charge the 12-volt battery in a garage or closed room where there is insufficient ventilation.

■ How to recharge the 12-volt battery

Only perform a slow charge (4.2 A or less). The 12-volt battery may explode if charged at a quicker rate.

⚠ WARNING**■ Emergency measures regarding electrolyte**

- If electrolyte gets in your eyes
Flush your eyes with clean water for at least 15 minutes and get immediate medical attention. If possible, continue to apply water with a sponge or cloth while traveling to the nearest medical facility.
- If electrolyte gets on your skin
Wash the affected area thoroughly. If you feel pain or burning, get medical attention immediately.
- If electrolyte gets on your clothes
It can soak through clothing on to your skin. Immediately take off the clothing and follow the procedure above if necessary.
- If you accidentally swallow electrolyte
Drink a large quantity of water or milk. Get emergency medical attention immediately.

■ When replacing the 12-volt battery

Use a 12-volt battery designed for this vehicle. Failure to do so may cause gas (hydrogen) to enter the passenger compartment, causing a fire or explosion.

For replacement of the 12-volt battery, contact your Lexus dealer.

■ When disconnecting the 12-volt battery

Do not disconnect the negative (-) terminal on the body side as shown. The disconnected negative (-) terminal may touch the positive (+) terminal, which may cause a short and result in death or serious injury.

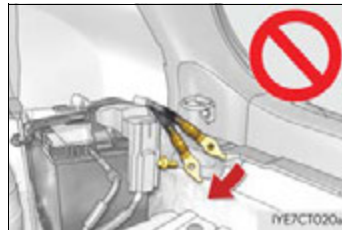
**⚠ NOTICE****■ When recharging the 12-volt battery**

Never recharge the 12-volt battery while the hybrid system is operating. Also, be sure all accessories are turned off.

Tires

Replace or rotate tires in accordance with maintenance schedules and treadwear.

Checking tires

Check if the treadwear indicators are showing on the tires. Also check the tires for uneven wear, such as excessive wear on one side of the tread.

Check the spare tire condition and pressure if not rotated.

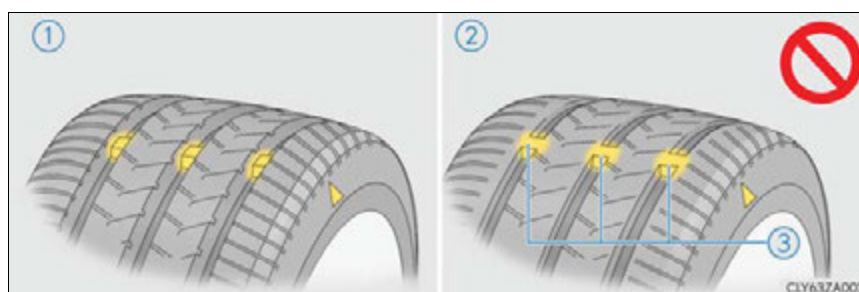

- ① New tread
- ② Worn tread
- ③ Treadwear indicator

The location of treadwear indicators is shown by the "TWI" or "Δ" mark, etc., molded into the sidewall of each tire.

Replace the tires if the treadwear indicators are showing on a tire.

Tire rotation

Rotate the tires in the order shown.

To equalize tire wear and extend tire life, Lexus recommends that tire rotation is carried out at the same interval as tire inspection.

Do not fail to initialize the tire pressure warning system after tire rotation.

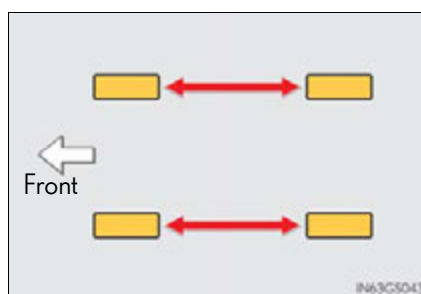

Tire pressure warning system

Your vehicle is equipped with a tire pressure warning system that uses tire pressure warning valves and transmitters to detect low tire inflation pressure before serious problems arise.

If the tire pressure drops below a predetermined level, the driver is warned by a warning light. (→P. 531)

◆ Installing tire pressure warning valves and transmitters

When replacing tires or wheels, tire pressure warning valves and transmitters must also be installed.

When new tire pressure warning valves and transmitters are installed, new ID codes must be registered in the tire pressure warning computer and the tire pressure warning system must be initialized. Have tire pressure warning valve and transmitter ID codes registered by your Lexus dealer. (→P. 492)

◆ Initializing the tire pressure warning system

■ The tire pressure warning system must be initialized in the following circumstances:

- Vehicles with 17 inch tires: When rotating front and rear tires which have different tire inflation pressures
- When changing the tire size

When the tire pressure warning system is initialized, the current tire inflation pressure is set as the benchmark pressure.

■ How to initialize the tire pressure warning system

- 1 Park the vehicle in a safe place and turn the power switch off.
Initialization cannot be performed while the vehicle is moving.
- 2 Adjust the tire inflation pressure to the specified cold tire inflation pressure level. (→P. 577)
Make sure to adjust the tire pressure to the specified cold tire inflation pressure level. The tire pressure warning system will operate based on this pressure level.
- 3 Turn the power switch to ON mode.

- 4 Press and hold the tire pressure warning reset switch until the tire pressure warning light blinks slowly 3 times.



- 5 Wait for a few minutes with the power switch in ON mode and then turn the power switch off.

◆ Registering ID codes

The tire pressure warning valve and transmitter is equipped with a unique ID code. When replacing a tire pressure warning valve and transmitter, it is necessary to register the ID code. Have the ID code registered by your Lexus dealer.

■ When to replace your vehicle's tires

Tires should be replaced if:

- The treadwear indicators are showing on a tire.
- You have tire damage such as cuts, splits, cracks deep enough to expose the fabric, and bulges indicating internal damage.
- A tire goes flat repeatedly or cannot be properly repaired due to the size or location of a cut or other damage.

If you are not sure, consult with your Lexus dealer.

■ Replacing tires and wheels

If the ID code of the tire pressure warning valve and transmitter is not registered, the tire pressure warning system will not work properly. After driving for about 20 minutes, the tire pressure warning light blinks for 1 minute and stays on to indicate a system malfunction.

■ Tire life

Any tire over 6 years old must be checked by a qualified technician even if it has seldom or never been used or damage is not obvious.

■ Routine tire inflation pressure checks

The tire pressure warning system does not replace routine tire inflation pressure checks. Make sure to check tire inflation pressure as part of your routine of daily vehicle checks.

■ Low profile tires (vehicles with 17 inch tires)

Generally, low profile tires will wear more rapidly and tire grip performance will be reduced on snowy and/or icy roads when compared to standard tires. Be sure to use snow tires or tire chains on snowy and/or icy roads and drive carefully at a speed appropriate for road and weather conditions.

■ Maximum load of tire

Check that the maximum load of the replacement tire is greater than 1/2 of the Gross Axle Weight Ratings (GAWR) of either the front axle or the rear axle, whichever is greater.

For the GAWR, see the Certification Label. For the maximum load of the tire, see the load limit at maximum cold tire inflation pressure mentioned on the sidewall of the tire. (→P. 582)

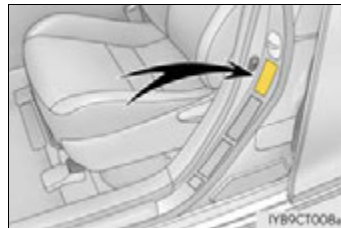

■ Tire types

● Summer tires

Summer tires are high-speed performance tires best suited to highway driving under dry conditions. Since summer tires do not have the same traction performance as snow tires, summer tires are inadequate for driving on snow-covered or icy roads. For driving on snow-covered roads or icy roads, the use of snow tires is recommended. When installing snow tires, be sure to replace all four tires.

● All season tires

All season tires are designed to provide better traction in snow and to be adequate for driving in most winter conditions as well as for use year-round. All season tires, however, do not have adequate traction performance compared with snow tires in heavy or loose snow. Also, all season tires fall short in acceleration and handling performance compared with summer tires in highway driving.

● Snow tires

For driving on snow-covered roads or icy roads, we recommend using snow tires. If you need snow tires, select tires of the same size, construction and load capacity as the originally installed tires. Since your vehicle has radial tires as original equipment, make sure your snow tires also have radial construction. Do not install studded tires without first checking local regulations for possible restrictions. Snow tires should be installed on all wheels. (→P. 246)

■ If the tread on snow tires wears down below 0.16 in. (4 mm)

The effectiveness of the tires as snow tires is lost.

■ Situations in which the tire pressure warning system may not operate properly

- In the following cases, the tire pressure warning system may not operate properly.
 - If non-genuine Lexus wheels are used.
 - A tire has been replaced with a tire that is not an OE (Original Equipment) tire.
 - A tire has been replaced with a tire that is not of the specified size.
 - Tire chains etc. are equipped.
 - Lock nuts are equipped.
 - An auxiliary-supported run-flat tire is equipped.
 - If a window tint that affects the radio wave signals is installed.
 - If there is a lot of snow or ice on the vehicle, particularly around the wheels or wheel housings.
 - If the tire inflation pressure is extremely higher than the specified level.
 - If wheel without the tire pressure warning valve and transmitter is used.
 - If the ID code on the tire pressure warning valves and transmitters is not registered in the tire pressure warning computer.
- Performance may be affected in the following situations.
 - Near a TV tower, electric power plant, gas station, radio station, large display, airport or other facility that generates strong radio waves or electrical noise
 - When carrying a portable radio, cellular phone, cordless phone or other wireless communication device
- When the vehicle is parked, the time taken for the warning to start or go off could be extended.
- When tire inflation pressure declines rapidly for example when a tire has burst, the warning may not function.

■ The initialization operation

- Make sure to carry out initialization after adjusting the tire inflation pressure. Also, make sure the tires are cold before carrying out initialization or tire inflation pressure adjustment.
- If you have accidentally turned the power switch off during initialization, it is not necessary to press the reset switch again as initialization will restart automatically when the power switch has been turned to ON mode for the next time.
- If you accidentally press the reset switch when initialization is not necessary, adjust the tire inflation pressure to the specified level when the tires are cold, and conduct initialization again.

■ When initialization of the tire pressure warning system has failed

Initialization can be completed in a few minutes. However, in the following cases, the settings have not been recorded and the system will not operate properly. If repeated attempts to record tire inflation pressure settings are unsuccessful, have the vehicle inspected by your Lexus dealer.

- When operating the tire pressure warning reset switch, the tire pressure warning light does not blink 3 times.
- After carrying out the initialization procedure, the tire pressure warning light blinks for 1 minute then stays on after driving for 20 minutes.

■ **Certification for tire pressure warning system**

- ▶ For vehicles sold in the U.S.A., Guam, Puerto Rico and NATO Germany
FCC ID: PAXPMV107J

NOTE

This device complies with part 15 of the FCC Rules. Operation is subject to the following two conditions: (1) This device may not cause harmful interference, and (2) this device must accept any interference received, including interference that may cause undesired operation.

FCC WARNING

Changes or modifications not expressly approved by the party responsible for compliance could void the user's authority to operate the equipment.

FCC ID: HYQ13BDE

NOTE:

This device complies with part 15 of the FCC Rules. Operation is subject to the following two conditions: (1) This device may not cause harmful interference, and (2) this device must accept any interference received, including interference that may cause undesired operation.

FCC WARNING:

Changes or modifications not expressly approved by the party responsible for compliance could void the user's authority to operate the equipment.

- ▶ For vehicles sold in Canada

NOTE

Operation is subject to the following two conditions: (1) this device may not cause interference, and (2) this device must accept any interference, including interference that may cause undesired operation of the device.

 **WARNING**

■ **When inspecting or replacing tires**
Observe the following precautions to prevent accidents. Failure to do so may cause damage to parts of the drive train as well as dangerous handling characteristics, which may lead to an accident resulting in death or serious injury.

- Make sure to install four tires that are of the specified size, and that all four tires are of the same size, same brand, and same tread pattern.
- Do not use tire sizes other than those recommended by Lexus.
- Do not mix differently constructed tires (radial, bias-belted or bias-ply tires).
- If only two tires are replaced, the new tires should be placed on the rear of the vehicle.
- Do not mix summer, all season and snow tires.
- Do not use tires that have been used on another vehicle.
Do not use tires if you do not know how they were used previously.

■ **When initializing the tire pressure warning system**
Do not operate the tire pressure warning reset switch without first adjusting the tire inflation pressure to the specified level. Otherwise, the tire pressure warning light may not come on even if the tire inflation pressure is low, or it may come on when the tire inflation pressure is actually normal.

 NOTICE**■ Repairing or replacing tires, wheels, tire pressure warning valves, transmitters and tire valve caps**

- When removing or fitting the wheels, tires or the tire pressure warning valves and transmitters, contact your Lexus dealer as the tire pressure warning valves and transmitters may be damaged if not handled correctly.
- Make sure to install the tire valve caps. If the tire valve caps are not installed, water could enter the tire pressure warning valves and the tire pressure warning valves could be bound.
- When replacing tire valve caps, do not use tire valve caps other than those specified. The cap may become stuck.

■ To avoid damage to the tire pressure warning valves and transmitters

When a tire is repaired with liquid sealants, the tire pressure warning valve and transmitter may not operate properly. If a liquid sealant is used, contact your Lexus dealer or other qualified service shop as soon as possible. After use of liquid sealant, make sure to replace the tire pressure warning valve and transmitter when repairing or replacing the tire. (→P. 491)

■ Driving on rough roads

Take particular care when driving on roads with loose surfaces or potholes. These conditions may cause losses in tire inflation pressure, reducing the cushioning ability of the tires. In addition, driving on rough roads may cause damage to the tires themselves, as well as the vehicle's wheels and body.

■ Low profile tires (vehicles with 17 inch tires)

Low profile tires may cause greater damage than usual to the tire wheel when sustaining impact from the road surface. Therefore, pay attention to the following:

- Be sure to use proper tire inflation pressure. If tires are under-inflated, they may be damaged more severely.
- Avoid potholes, uneven pavement, curbs and other road hazards. Failure to do so may lead to severe tire and wheel damage.

■ If tire inflation pressure of each tire becomes low while driving

Do not continue driving, or your tires and/or wheels may be ruined.

Tire inflation pressure

Tire inflation pressure

The recommended cold tire inflation pressure and tire size are displayed on the tire and loading information label. (→P.577)

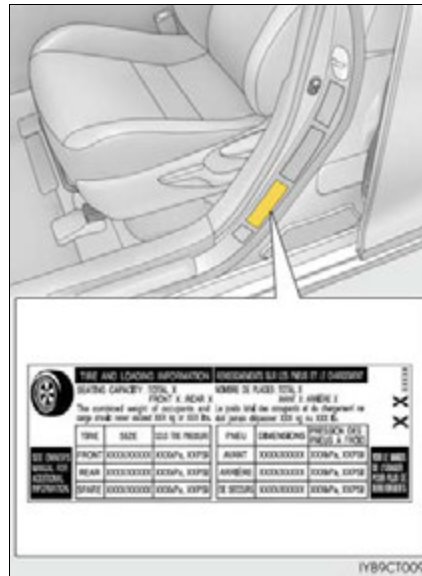

Inspection and adjustment procedure

- ① Tire valve
- ② Tire pressure gauge



- 1 Remove the tire valve cap.
- 2 Press the tip of the tire pressure gauge onto the tire valve.
- 3 Read the pressure using the gauge gradations.
- 4 If the tire inflation pressure is not at the recommended level, adjust the pressure.
If you add too much air, press the center of the valve to deflate.
- 5 After completing the tire inflation pressure measurement and adjustment, apply soapy water to the valve and check for leakage.
- 6 Put the tire valve cap back on.

■ Tire inflation pressure check interval

You should check tire inflation pressure every two weeks, or at least once a month. Do not forget to check the spare.

■ Effects of incorrect tire inflation pressure

Driving with incorrect tire inflation pressure may result in the following:

- Reduced fuel economy
- Reduced driving comfort and poor handling
- Reduced tire life due to wear
- Reduced safety
- Damage to the drive train

If a tire needs frequent inflating, have it checked by your Lexus dealer.

■ Instructions for checking tire inflation pressure

When checking tire inflation pressure, observe the following:

- Check only when the tires are cold.
If your vehicle has been parked for at least 3 hours or has not been driven for more than 1 mile or 1.5 km, you will get an accurate cold tire inflation pressure reading.
- Always use a tire pressure gauge.
It is difficult to judge if a tire is properly inflated based only on its appearance.
- It is normal for the tire inflation pressure to be higher after driving as heat is generated in the tire. Do not reduce tire inflation pressure after driving.
- Never exceed the vehicle capacity weight.
Passengers and luggage weight should be placed so that the vehicle is balanced.

WARNING

■ Proper inflation is critical to save tire performance

Keep your tires properly inflated.

If the tires are not properly inflated, the following conditions may occur which could lead to an accident resulting in death or serious injury:

- Excessive wear
- Uneven wear
- Poor handling
- Possibility of blowouts resulting from overheated tires
- Air leaking from between tire and wheel
- Wheel deformation and/or tire damage
- Greater possibility of tire damage while driving (due to road hazards, expansion joints, sharp edges in the road, etc.)

NOTICE

■ When inspecting and adjusting tire inflation pressure

Be sure to put the tire valve caps back on.

If a valve cap is not installed, dirt or moisture may get into the valve and cause an air leak, resulting in decreased tire inflation pressure.

Wheels

If a wheel is bent, cracked or heavily corroded, it should be replaced. Otherwise, the tire may separate from the wheel or cause a loss of handling control.

Wheel selection

When replacing wheels, care should be taken to ensure that they are equivalent to those removed in load capacity, diameter, rim width and inset*.

Replacement wheels are available at your Lexus dealer.

*: Conventionally referred to as "offset".

Lexus does not recommend using the following:

- Wheels of different sizes or types
- Used wheels
- Bent wheels that have been straightened

Aluminum wheel precautions

- Use only Lexus wheel nuts and wrenches designed for use with your aluminum wheels.
- When rotating, repairing or changing your tires, check that the wheel nuts are still tight after driving 1000 miles (1600 km).
- Be careful not to damage the aluminum wheels when using tire chains.
- Use only Lexus genuine balance weights or equivalent and a plastic or rubber hammer when balancing your wheels.

■ When replacing wheels

The wheels of your vehicle are equipped with tire pressure warning valves and transmitters that allow the tire pressure warning system to provide advance warning in the event of a loss in tire inflation pressure. Whenever wheels are replaced, tire pressure warning valves and transmitters must be installed. (→P. 491)

 **WARNING****■ When replacing wheels**

- Do not use wheels that are a different size from those recommended in the Owner's Manual, as this may result in a loss of handling control.
- Never use an inner tube in a leaking wheel which is designed for a tubeless tire. Doing so may result in an accident, causing death or serious injury.

■ Use of defective wheels prohibited

Do not use cracked or deformed wheels.
Doing so could cause the tire to leak air during driving, possibly causing an accident.

 **NOTICE****■ Replacing tire pressure warning valves and transmitters**

- Because tire repair or replacement may affect the tire pressure warning valves and transmitters, make sure to have tires serviced by your Lexus dealer or other qualified service shop. In addition, make sure to purchase your tire pressure warning valves and transmitters at your Lexus dealer.
- Ensure that only genuine Lexus wheels are used on your vehicle.
Tire pressure warning valves and transmitters may not work properly with non-genuine wheels.

Air conditioning filter

The air conditioning filter must be changed regularly to maintain air conditioning efficiency.

Removal method

- 1 Turn the power switch off.
- 2 Open the glove box. Lift and remove the partition.

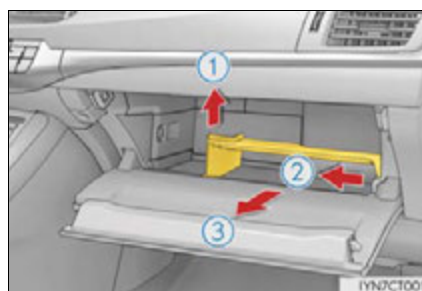

- 3 Remove the glove box cover.

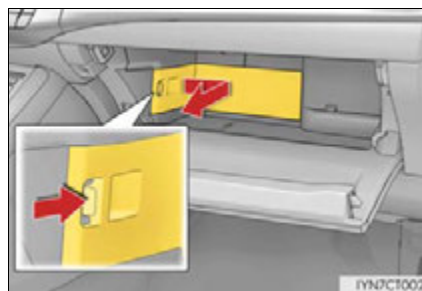

- 4 Remove the filter cover.

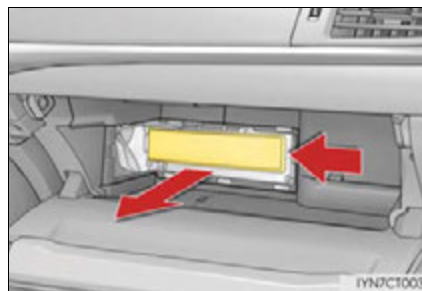

- 5 Slide and pull out the filter. Replace it with a new one.
The “↑UP” marks shown on the filter should be pointing up.

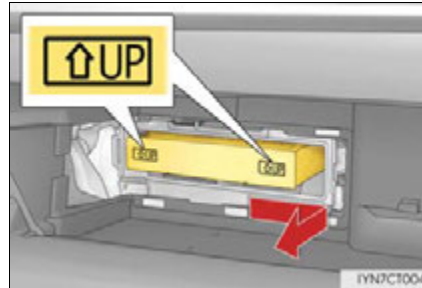

■ Checking interval

Inspect and replace the air conditioning filter according to the maintenance schedule. In dusty areas or areas with heavy traffic flow, early replacement may be required. (For scheduled maintenance information, please refer to the “Owner’s Manual Supplement” or “Scheduled Maintenance”.)

■ If air flow from the vents decreases dramatically

The filter may be clogged. Check the filter and replace if necessary.

⚠ NOTICE

■ When using the air conditioning system

Make sure that a filter is always installed.
Using the air conditioning system without a filter may cause damage to the system.

Electronic key battery

Replace the battery with a new one if it is depleted.

You will need the following items:

- Flathead screwdriver
- Lithium battery CR1632

Replacing the battery

- 1** Take out the mechanical key.



- 2** Remove the cover.
To prevent damage to the key, cover the tip of the screwdriver with a rag.

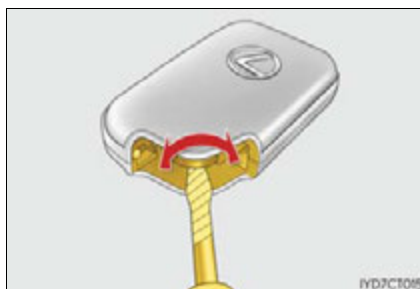

- 3** Remove the depleted battery.
Insert a new battery with the "+" terminal facing up.

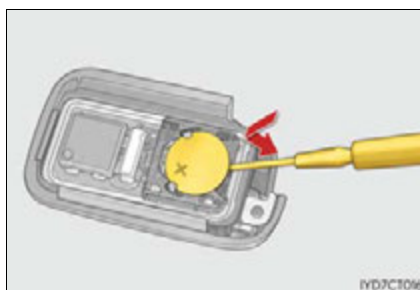

■ **Use a CR1632 lithium battery**

- Batteries can be purchased at your Lexus dealer, local electrical appliance shops or camera stores.
- Replace only with the same or equivalent type recommended by the manufacturer.
- Dispose of used batteries according to the local laws.

■ **When the card key battery needs to be replaced (if equipped)**

The battery for the card key is available only at Lexus dealers. Your Lexus dealer can replace the battery for you.

■ **If the electronic key battery is depleted**

The following symptoms may occur:

- The smart access system with push-button start and wireless remote control will not function properly.
- The operational range will be reduced.

 **WARNING**

■ **Removed battery and other parts**

These parts are small and if swallowed by a child, they can cause choking. Keep away from children. Failure to do so could result in death or serious injury.

 **NOTICE**

■ **For normal operation after replacing the battery**

Observe the following precautions to prevent accidents:

- Always work with dry hands.
Moisture may cause the battery to rust.
- Do not touch or move any other component inside the remote control.
- Do not bend either of the battery terminals.

Checking and replacing fuses

If any of the electrical components do not operate, a fuse may have blown. If this happens, check and replace the fuses as necessary.

- 1 Turn the power switch off.
- 2 Open the fuse box cover.
 - ▶ Engine compartment
Push the tab in and lift the lid off.

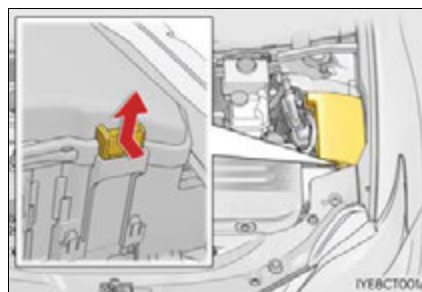

- ▶ Left side instrument panel
Remove the lid.



3 Remove the fuse.

Only type A fuse can be removed using the pullout tool.

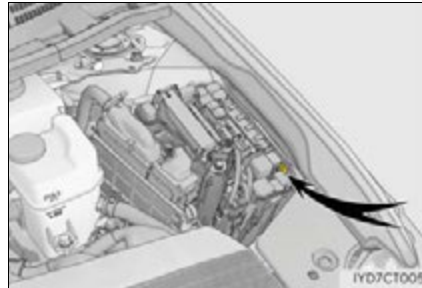

4 Check if the fuse is blown.

- ① Normal fuse
- ② Blown fuse

Replace the blown fuse with a new fuse of an appropriate amperage rating. The amperage rating can be found on the fuse box lid.

▶ Type A

▶ Type B

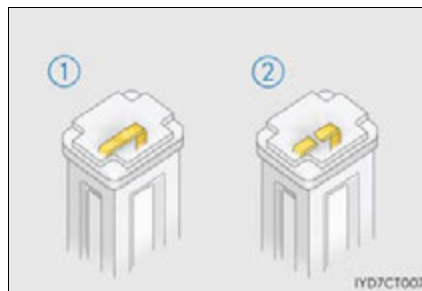
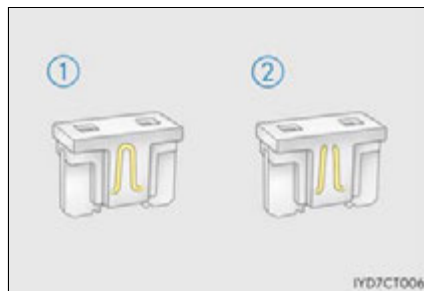

▶ Type C

▶ Type D

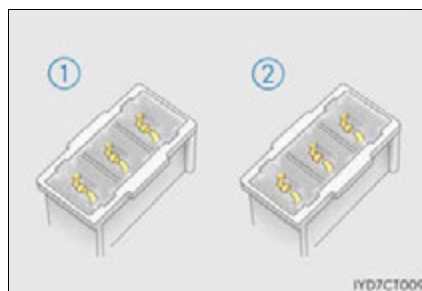
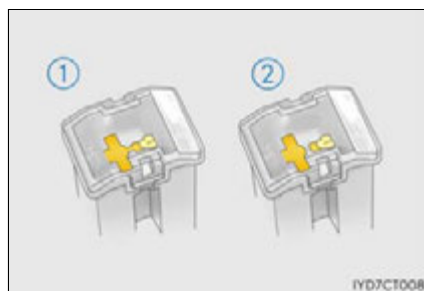

■ **After a fuse is replaced**

- If the lights do not turn on even after the fuse has been replaced, a bulb may need replacement. (→P. 509)
- If the replaced fuse blows again, have the vehicle inspected by your Lexus dealer.

■ **If there is an overload in a circuit**

The fuses are designed to blow, protecting the wiring harness from damage.

■ **When replacing light bulbs**

Lexus recommends that you use genuine Lexus products designed for this vehicle. Because certain bulbs are connected to circuits designed to prevent overload, nongenuine parts or parts not designed for this vehicle may be unusable.

| |
|---|
|  WARNING |
| <p>■ To prevent system breakdowns and vehicle fire</p> <p>Observe the following precautions. Failure to do so may cause damage to the vehicle, and possibly a fire or injury.</p> <ul style="list-style-type: none"> ● Never use a fuse of a higher amperage rating than that indicated, or use any other object in place of a fuse. ● Always use a genuine Lexus fuse or equivalent. Never replace a fuse with a wire, even as a temporary fix. ● Do not modify the fuses or fuse boxes. <p>■ Fuse box near the power control unit</p> <p>Never check or replace the fuses as there are high voltage parts and wiring near the fuse box. Doing so may cause electric shock, resulting in death or serious injury.</p> |

| |
|---|
|  NOTICE |
| <p>■ Before replacing fuses</p> <p>Have the cause of electrical overload determined and repaired by your Lexus dealer as soon as possible.</p> |

Light bulbs

You may replace the following bulbs by yourself. The difficulty level of replacement varies depending on the bulb. If necessary bulb replacement seems difficult to perform, contact your Lexus dealer.

For more information about replacing other light bulbs, contact your Lexus dealer.

Preparing for light bulb replacement

Check the wattage of the light bulb to be replaced. (→P. 579)

Removing the engine compartment cover

→P. 479

Bulb locations

■ Front

- ▶ Vehicles with halogen headlights

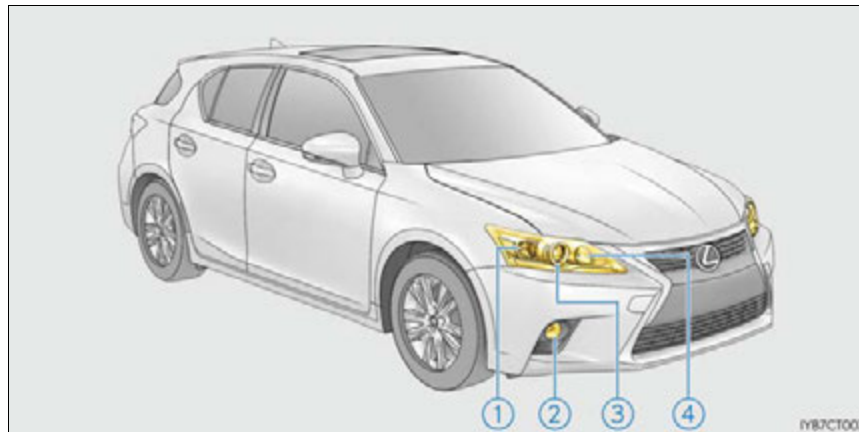

- | | |
|-----------------------------------|-----------------------|
| ① Front turn signal light | ③ Headlight low beam |
| ② Halogen fog light (if equipped) | ④ Headlight high beam |

▶ Vehicles with LED headlights

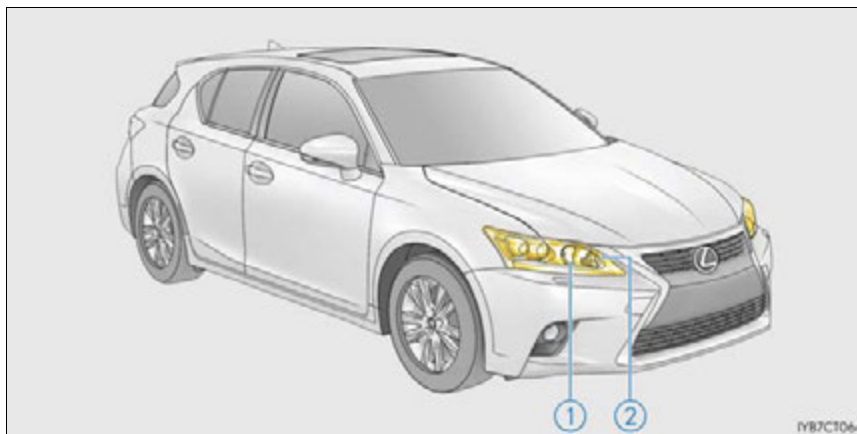

- ① Headlight high beam
- ② Front turn signal light

■ Rear

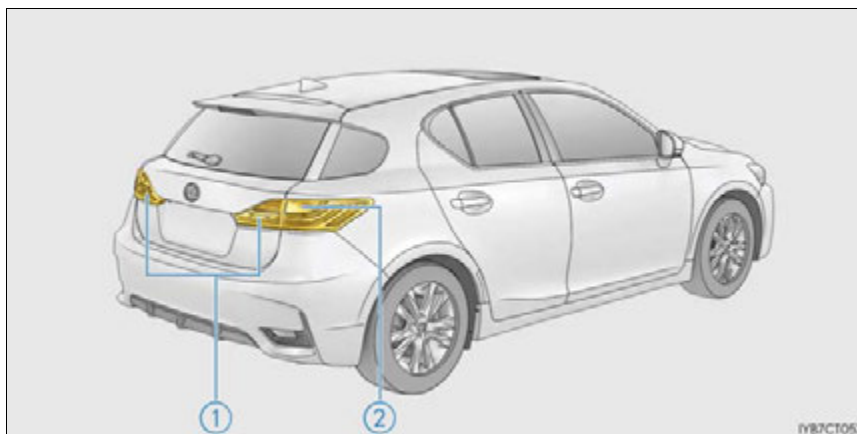

- ① Back-up light
- ② Rear turn signal light

Replacing light bulbs

■ Headlight low beams (halogen headlights)

- 1 Unplug the connector while pressing the lock release.

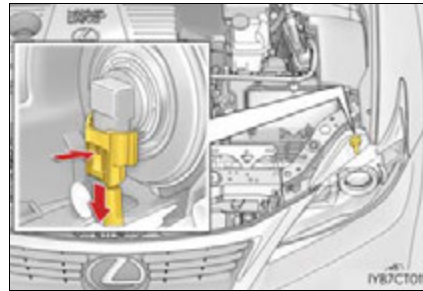

- 2 Turn the bulb base counterclockwise.

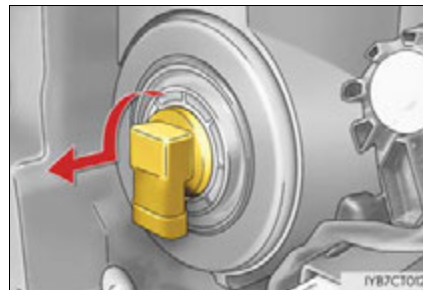

- 3 Set the new light bulb.
Align the 3 tabs on the light bulb with the mounting, and insert. Turn it clockwise to set.

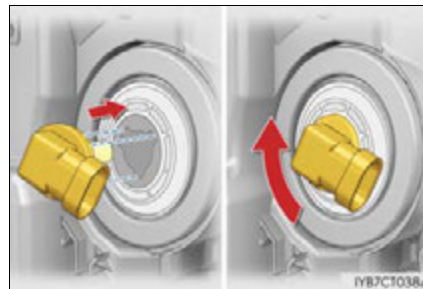

- 4 Set the connector.
After installing the connector, shake the bulb base gently to check that it is not loose, turn the headlight low beams on once and visually confirm that no light is leaking through the mounting.



■ Headlight high beams (halogen headlights)

- 1 For the right side only: Move the washer fluid filler opening.

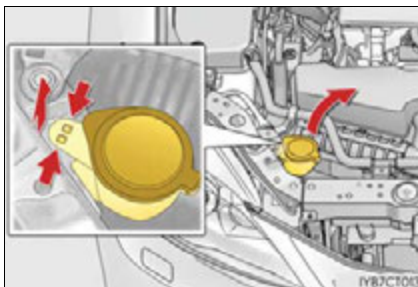

- 2 Unplug the connector while pressing the lock release.

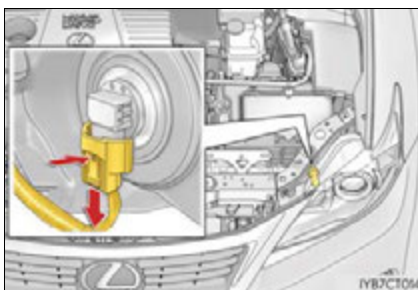

- 3 Turn the bulb base counterclockwise.

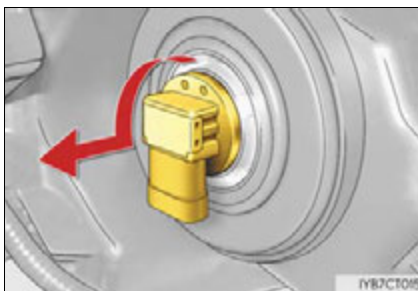

- 4 Set the new light bulb.
Align the 3 tabs on the light bulb with the mounting, and insert. Turn it clockwise to set.

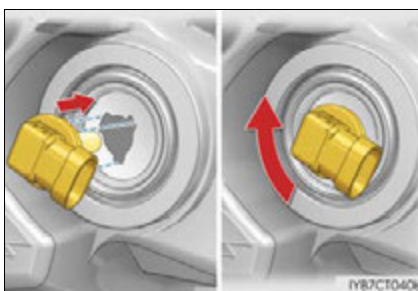

5 Set the connector.

After installing the connector, shake the bulb base gently to check that it is not loose, turn the headlight high beams on once and visually confirm that no light is leaking through the mounting.

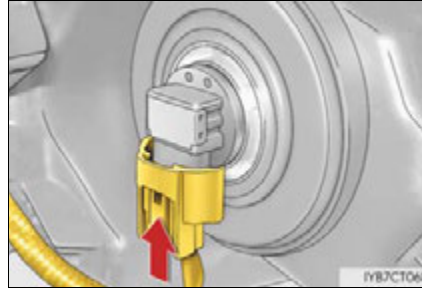
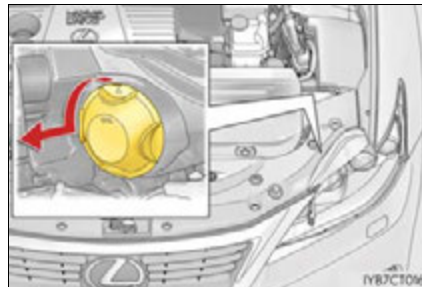
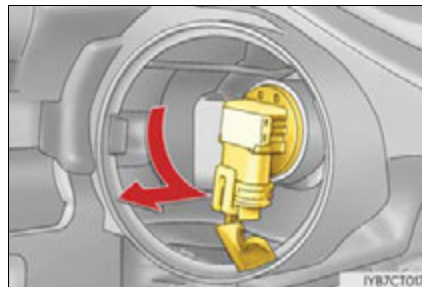
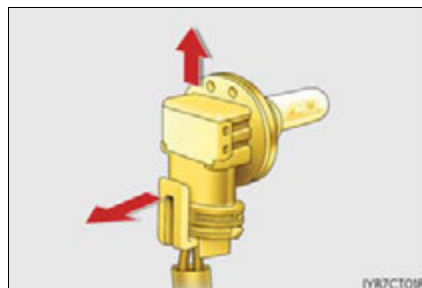
**6** For the right side only: Reinstall the washer fluid filler opening.**Headlight high beams (LED headlights)****1** Turn the cover counterclockwise and remove it.**2** Turn the bulb base counterclockwise.**3** Unplug the connector while pulling the lock release.

- 4** Replace the light bulb, and install the bulb base.

Align the 3 tabs on the light bulb with the mounting, and insert.



- 5** Turn and secure the bulb base.

Shake the bulb base gently to check that it is not loose, turn the headlight high beams on once and visually confirm that no light is leaking through the mounting.

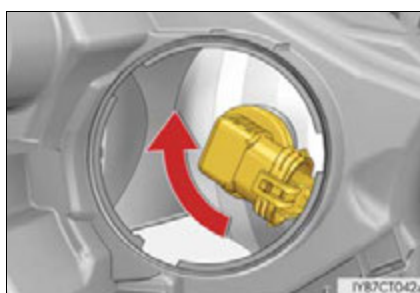

- 6** When installing the cover, conduct step **1** in reverse.

■ **Halogen fog light (if equipped)**

- 1** Remove 2 screws, a bolt and clip, and pull down the fender liner.

Pull the fender liner down slowly, being careful not to dislodge any fixed components.

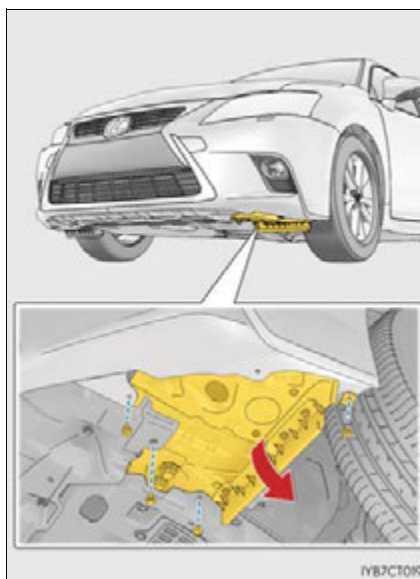

- 2** Unplug the connector while pressing the lock release.

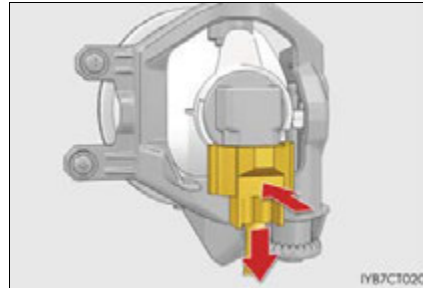

- 3** Turn the bulb base counterclockwise.

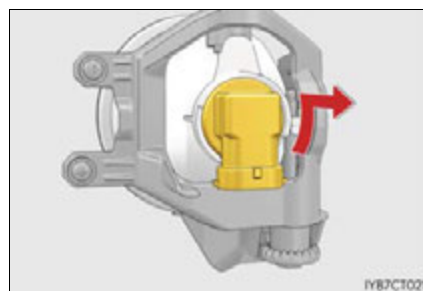

- 4** Set the new light bulb.
Align the 3 tabs on the light bulb with the mounting, and insert. Turn it clockwise to set.

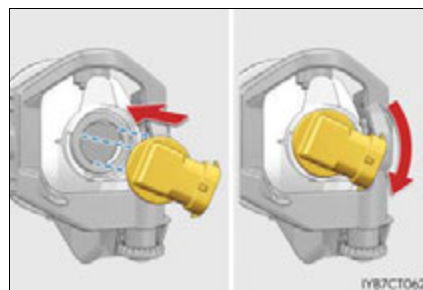

- 5** Set the connector.
After installing the connector, shake the bulb base gently to check that it is not loose, turn the fog lights on once and visually confirm that no light is leaking through the mounting.

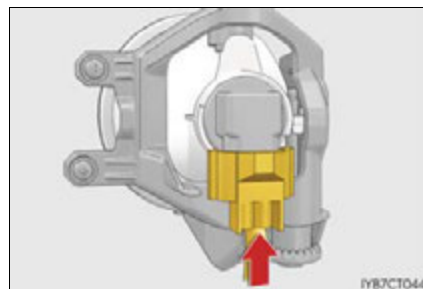

- 6 Reinstall the fender liner with 2 screws, a bolt and clip.



■ Front turn signal lights (halogen headlights)

- 1 Turn the bulb base counterclockwise.



- 2 Remove the light bulb.

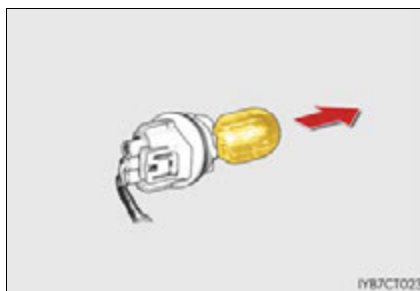

■ Front turn signal lights (LED headlights)

- ▶ Left side

- 1 Remove the power control unit cover.

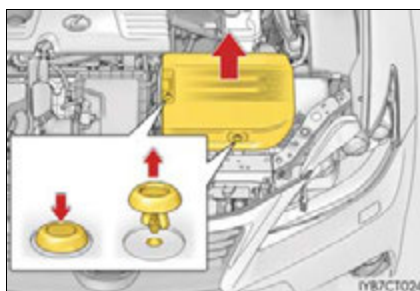

- 2** Turn the bulb base counterclockwise.

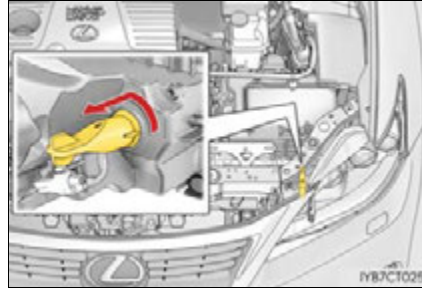

- 3** Remove the light bulb.

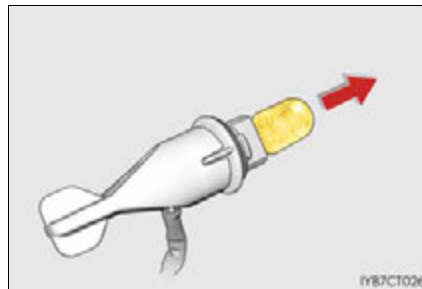

► Right side

- 1** Move the washer fluid filler opening. (→P. 512)
- 2** Turn the bulb base counterclockwise.

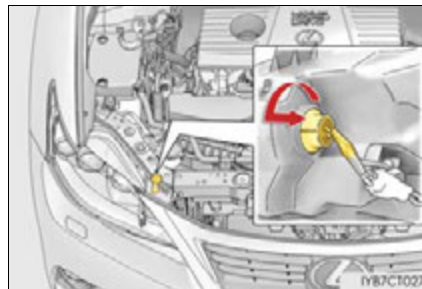

- 3** Remove the light bulb.

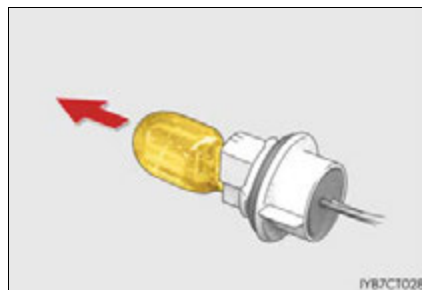

■ Rear turn signal lights

- 1 Open the back door and remove the covers and bolts, and remove the lamp assembly by pulling it directly backward from the rear of the vehicle.

Use a flathead screwdriver wrapped in a cloth.

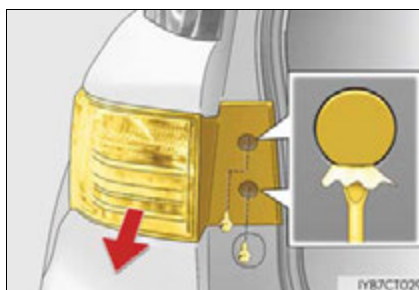

- 2 Turn the bulb base counterclockwise.

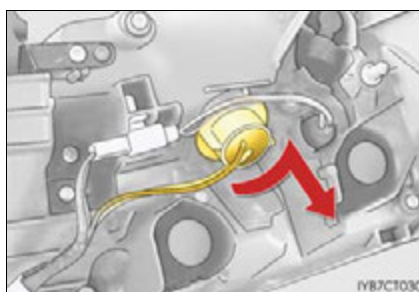

- 3 Remove the light bulb.

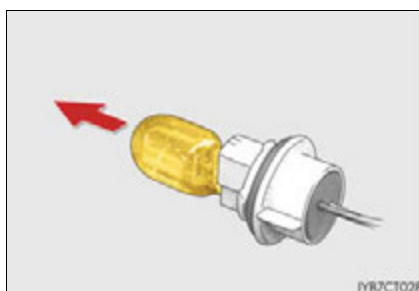

■ Back-up lights

- 1 Open the back door and remove the cover.

Use a flathead screwdriver wrapped in a cloth.

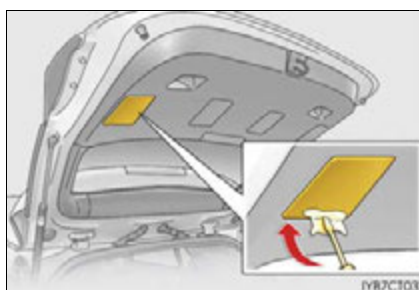

- 2 Turn the bulb base counterclockwise.



- 3 Remove the light bulb.

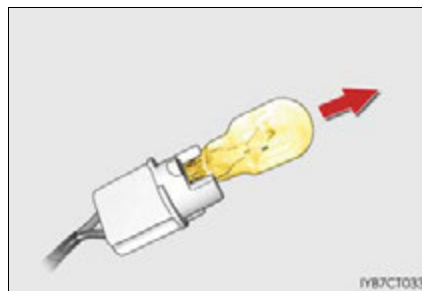

■ Replacing the following bulbs

If any of the lights listed below has burnt out, have it replaced by your Lexus dealer.

- Headlight low beams (LED type)
- Parking lights and daytime running lights
- LED fog lights (if equipped)
- Front side marker lights
- Side turn signal lights
- Stop/tail lights
- Rear side marker lights
- High mounted stoplight
- License plate lights
- Outer foot lights

■ After replacing the bulbs

After removing the power control unit cover, return the cover to original position with the clips.

- ① Push up center portion
- ② Insert
- ③ Press



■ LED lights

The headlight low beams (LED type), parking lights, front side marker lights, daytime running lights, LED fog lights (if equipped), side turn signal lights, rear side marker lights, stop/tail lights, high mounted stoplight and license plate lights consist of a number of LEDs. If any of the LEDs burn out, take your vehicle to your Lexus dealer to have the light replaced.

■ Condensation build-up on the inside of the lens

Temporary condensation build-up on the inside of the headlight lens does not indicate a malfunction. Contact your Lexus dealer for more information in the following situations:

- Large drops of water have built up on the inside of the lens.
- Water has built up inside the headlight.

■ When replacing light bulbs

→P.508

 **WARNING**

■ Replacing light bulbs

- Be sure to stop the hybrid system and turn off the lights. Do not attempt to replace the bulb immediately after turning off the lights.
The bulbs become very hot and may cause burns.
- Do not touch the glass portion of the light bulb with bare hands. When it is unavoidable to hold the glass portion, use and hold with a clean dry cloth to avoid getting moisture and oils on the bulb.
Also, if the bulb is scratched or dropped, it may blow out or crack.
- Fully install light bulbs and any parts used to secure them. Failure to do so may result in heat damage, fire, or water entering the headlight unit. This may damage the headlights or cause condensation to build up on the lens.
- Do not attempt to repair or disassemble light bulbs, connectors, electric circuits or component parts.
Doing so may result in death or serious injury due to electric shock.

■ To prevent damage or fire

- Make sure bulbs are fully seated and locked.
- Check the wattage of the bulb before installing to prevent heat damage.

8-1. Essential information

Emergency flashers 522

If your vehicle has to be
stopped in an emergency.... 523**8-2. Steps to take in an emergency**If your vehicle needs to
be towed 524If you think something is
wrong 528If a warning light turns on
or a warning buzzer
sounds..... 529If a warning message is
displayed..... 536

If you have a flat tire..... 549

If the hybrid system will not
start558If the electronic key does not
operate properly560If the 12-volt battery is
discharged 562

If your vehicle overheats 566

If the vehicle becomes
stuck 570

Emergency flashers

The emergency flashers are used to warn other drivers when the vehicle has to be stopped in the road due to a breakdown, etc.

Press the switch.

All the turn signal lights will flash. To turn them off, press the switch once again.

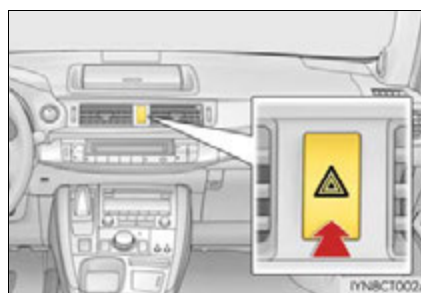

■ Emergency flashers

If the emergency flashers are used for a long time while the hybrid system is not operating (while the "READY" indicator is not illuminated), the 12-volt battery may discharge.

If your vehicle has to be stopped in an emergency

Only in an emergency, such as if it becomes impossible to stop the vehicle in the normal way, stop the vehicle using the following procedure:

- 1 Steadily step on the brake pedal with both feet and firmly depress it.
Do not pump the brake pedal repeatedly as this will increase the effort required to slow the vehicle.
- 2 Shift the shift position to N.
 - ▶ If the shift position is shifted to N
- 3 After slowing down, stop the vehicle in a safe place by the road.
- 4 Stop the hybrid system.
 - ▶ If the shift position cannot be shifted to N
- 3 Keep depressing the brake pedal with both feet to reduce vehicle speed as much as possible.
- 4 To stop the hybrid system, press and hold the power switch for 2 consecutive seconds or more, or press it briefly 3 times or more in succession.

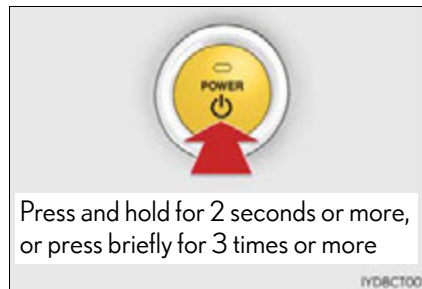

- 5 Stop the vehicle in a safe place by the road.

WARNING

■ If the hybrid system has to be turned off while driving

Power assist for the steering wheel will be lost, making the steering wheel heavier to turn. Decelerate as much as possible before turning off the hybrid system.

If your vehicle needs to be towed

If towing is necessary, we recommend having your vehicle towed by your Lexus dealer or commercial towing service, using a wheel-lift type truck or flatbed truck.

Use a safety chain system for all towing, and abide by all state/provincial and local laws.

Situations when it is not possible to be towed by another vehicle

In the following situations, it is not possible to be towed by another vehicle using cables or chains, as the front wheels may be locked due to the parking lock. Contact your Lexus dealer or commercial towing service.

- There is a malfunction in the shift control system. (→P. 539)
- There is a malfunction in the immobilizer system. (→P. 74)
- There is a malfunction in the smart access system with push-button start. (→P. 560)
- The 12-volt battery is discharged. (→P. 562)

Situations when it is necessary to contact dealers before towing

The following may indicate a problem with your hybrid transmission. Contact your Lexus dealer or commercial towing service before towing.

- The hybrid system warning message shows on the multi-information display and the vehicle does not move.
- The vehicle makes an abnormal sound.

Towing with a sling-type truck

Do not tow with a sling-type truck to prevent body damage.



Towing with a wheel-lift type truck

► From the front

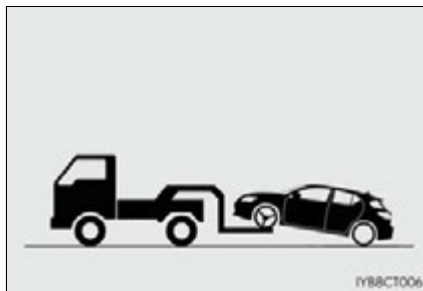

Release the parking brake.

► From the rear

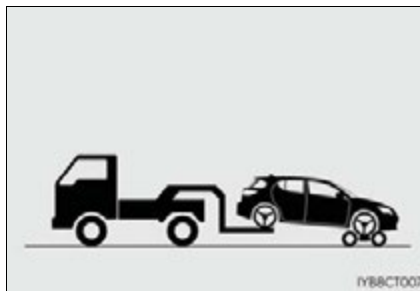

Use a towing dolly under the front wheels.

Using a flat bed truck

If your vehicle is transported by a flat-bed truck, it should be tied down at the locations shown in the illustration.

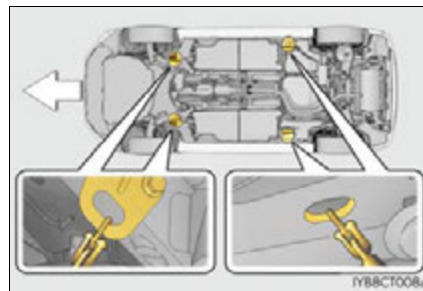

If you use chains or cables to tie down your vehicle, the angles shaded in black must be 45°.

Do not overly tighten the tie downs or the vehicle may be damaged.

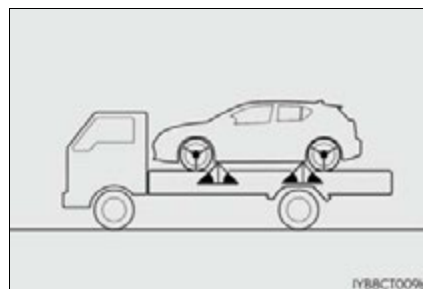

Emergency towing

If a tow truck is not available in an emergency, your vehicle may be temporarily towed using cables or chains secured to the emergency towing eyelets. This should only be attempted on hard surfaced roads for at most short distance at under 3 mph (5 km/h).

A driver must be in the vehicle to steer and operate the brakes. The vehicle's wheels, drive train, axles, steering and brakes must be in good condition.

Emergency towing procedure

- 1 Take out the towing eyelet. (→P. 550)

- 2 Remove the eyelet cover using a flat-head screwdriver.

To protect the bodywork, place a rag between the screwdriver and the vehicle body as shown in the illustration.

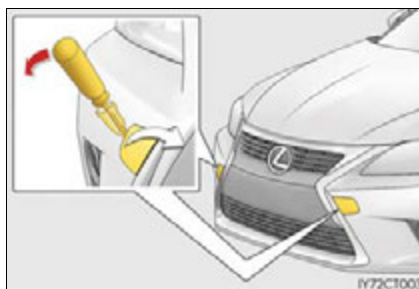

- 3 Insert the towing eyelet into the hole and tighten partially by hand.

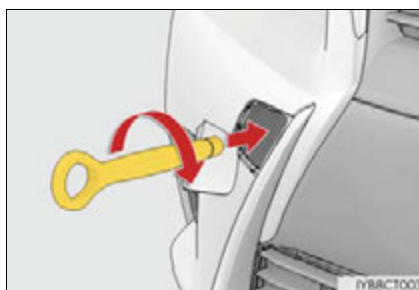

- 4 Tighten down the towing eyelet securely using a wheel nut wrench or hard metal bar.

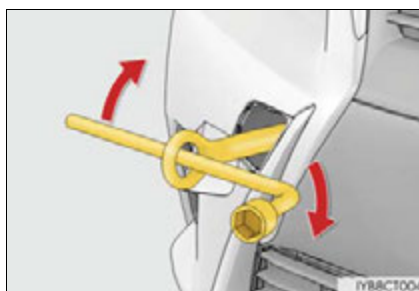

- 5 Securely attach cables or chains to the towing eyelet.

Take care not to damage the vehicle body.

- 6 Enter the vehicle being towed and start the hybrid system.

If the hybrid system does not start, turn the power switch to ON mode.

- 7 Shift the shift position to N and release the parking brake.

■ While towing

If the hybrid system is off, the power assist for the brakes and steering will not function, making steering and braking more difficult.

■ Wheel nut wrench

Wheel nut wrench is installed in luggage compartment. (→P. 550)

⚠ WARNING

Observe the following precautions.
Failure to do so may result in death or serious injury.

■ When towing the vehicle

Be sure to transport the vehicle with the front wheels raised or with all four wheels raised off the ground. If the vehicle is towed with the front wheels contacting the ground, the drivetrain and related parts may be damaged or electricity generated by the operation of the motor may cause a fire to occur depending on the nature of the damage or malfunction.

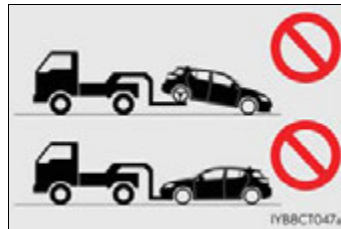

■ While towing

- When towing using cables or chains, avoid sudden starts, etc. which place excessive stress on the towing eyelets, cables or chains. The towing eyelets, cables or chains may become damaged, broken debris may hit people and cause serious damage.
- Do not turn the power switch off.
This may lead to an accident as the front wheels will be locked by the parking lock.

■ Installing towing eyelet to the vehicle

Make sure that towing eyelet is installed securely.
If not securely installed, towing eyelet may come loose during towing.

⚠ NOTICE

■ To prevent damage to the vehicle when towing using a wheel-lift type truck

When raising the vehicle, ensure adequate ground clearance for towing at the opposite end of the raised vehicle. Without adequate clearance, the vehicle could be damaged while being towed.

■ To prevent damage to the vehicle when towing with a sling-type truck

Do not tow with a sling-type truck, either from the front or rear.

■ To prevent damage to the vehicle during emergency towing

Do not secure cables or chains to the suspension components.

If you think something is wrong

If you notice any of the following symptoms, your vehicle probably needs adjustment or repair. Contact your Lexus dealer as soon as possible.

Visible symptoms

- Fluid leaks under the vehicle
(Water dripping from the air conditioning after use is normal.)
- Flat-looking tires or uneven tire wear
- High coolant temperature warning light flashes or comes on

Audible symptoms

- Changes in exhaust sound
- Excessive tire squeal when cornering
- Strange noises related to the suspension system
- Pinging or other noises related to the hybrid system





Operational symptoms









- Engine missing, stumbling or running roughly
- Appreciable loss of power
- Vehicle pulls heavily to one side when braking
- Vehicle pulls heavily to one side when driving on a level road
- Loss of brake effectiveness, spongy feeling, pedal almost touches the floor





If a warning light turns on or a warning buzzer sounds

Calmly perform the following actions if any of the warning lights comes on or flashes. If a light comes on or flashes, but then goes off, this does not necessarily indicate a malfunction in the system. However, if this continues to occur, have the vehicle inspected by your Lexus dealer.

Warning light and warning buzzer list

| Warning light | Warning light/Details/Actions |
|--|--|
|  <p>(U.S.A.) (Canada)</p> | <p>Brake system warning light and warning buzzer (red indicator)*¹ Indicates that:</p> <ul style="list-style-type: none"> • The brake fluid level is low; or • The brake system is malfunctioning <p>This light also comes on when the parking brake is not released. If the light turns off after the parking brake is fully released, the system is operating normally. → Immediately stop the vehicle in a safe place and contact your Lexus dealer. Continuing to drive the vehicle may be dangerous.</p> |
|  | <p>Brake system warning light (yellow indicator) Indicates a malfunction in:</p> <ul style="list-style-type: none"> • The regenerative brake system; or • The electronically controlled brake system <p>→ Have the vehicle inspected by your Lexus dealer immediately.</p> |
|  | <p>Charging system warning light Indicates a malfunction in the vehicle's charging system → Immediately stop the vehicle in a safe place and contact your Lexus dealer.</p> |
|  | <p>Low engine oil pressure warning light Indicates that the engine oil pressure is too low → Immediately stop the vehicle in a safe place and contact your Lexus dealer.</p> |
|  <p>(U.S.A.) (Canada)</p> | <p>Malfunction indicator lamp Indicates a malfunction in:</p> <ul style="list-style-type: none"> • The hybrid system; • The electronic engine control system; or • The electronic throttle control system <p>→ Have the vehicle inspected by your Lexus dealer immediately.</p> |

| Warning light | Warning light/Details/Actions |
|--|--|
|  | <p>SRS warning light Indicates a malfunction in:</p> <ul style="list-style-type: none"> • The SRS airbag system; • The front passenger occupant classification system; or • The seat belt pretensioner system <p>→ Have the vehicle inspected by your Lexus dealer immediately.</p> |
|  (U.S.A.)  (Canada) | <p>ABS warning light Indicates a malfunction in:</p> <ul style="list-style-type: none"> • The ABS; or • The brake assist system <p>→ Have the vehicle inspected by your Lexus dealer immediately.</p> |
|  | <p>Electric power steering system warning light (warning buzzer) Indicates a malfunction in the EPS system → Have the vehicle inspected by your Lexus dealer immediately.</p> |
|  (Flashes) (If equipped) | <p>“PCS” warning light Indicates a malfunction in the pre-collision system The warning light will operate as follows, even when the system is not malfunctioning:</p> <ul style="list-style-type: none"> • The light will flash quickly when the system is operating. (→P. 239) • The light will turn on when the pre-collision braking is disabled. (→P. 239) • The light will turn on when the system cannot temporarily be used. (→P. 543) <p>→ Have the vehicle inspected by your Lexus dealer immediately.</p> |
|  | <p>Slip indicator light Indicates a malfunction in:</p> <ul style="list-style-type: none"> • The VSC system; • The TRAC system; or • The hill-start assist control system <p>→ Have the vehicle inspected by your Lexus dealer immediately. The light will flash when the VSC, TRAC and/or ABS systems are operating.</p> |
|  (If equipped) | <p>Automatic headlight leveling system warning light Indicates a malfunction in the automatic headlight leveling system → Have the vehicle inspected by your Lexus dealer immediately.</p> |
|  | <p>High coolant temperature warning light Changes from a flashing to a solid light when the engine coolant temperature increases → Stop and check. (→P. 566)</p> |
|  | <p>Open door warning light (warning buzzer)*2 Indicates that a door is not fully closed → Check that all the doors are closed.</p> |

| Warning light | Warning light/Details/Actions |
|---|---|
|  | <p>Low fuel level warning light Indicates that remaining fuel is approximately 1.8 gal. (6.8 L, 1.5 Imp.gal.) or less → Refuel the vehicle.</p> |
|  | <p>Seat belt reminder light (warning buzzer)*3 Warns the driver and/or front passenger to fasten their seat belts → Fasten the seat belt. If the front passenger's seat is occupied, the front passenger's seat belt also needs to be fastened to make the warning light (warning buzzer) turn off.</p> |
|  | <p>Master warning light A buzzer sounds and the warning light comes on and flashes to indicate that the master warning system has detected a malfunction. → P. 536</p> |
|  | <p>Tire pressure warning light When the light comes on: Low tire inflation pressure such as • Natural causes (→P. 533) • Flat tire (→P. 549) → Adjust the tire inflation pressure to the specified level. The light will turn off after a few minutes. In case the light does not turn off even if the tire inflation pressure is adjusted, have the system checked by your Lexus dealer.</p> <p>When the light comes on after blinking for 1 minute: Malfunction in the tire pressure warning system (→P. 533) → Have the system checked by your Lexus dealer.</p> |

***1:** Brake system warning buzzer:

When there is a possible problem that could affect braking performance, the warning light will come on and a warning buzzer will sound.

Parking brake engaged warning buzzer:

→P. 539

***2:** Open door warning buzzer:

→P. 537

***3:** Driver's seat belt buzzer:

The driver's seat belt buzzer sounds to alert the driver that his or her seat belt is not fastened. Once the power switch is turned to ON mode, the buzzer sounds for 6 seconds. If the vehicle reaches a speed of 12 mph (20 km/h), the buzzer sounds once. If the seat belt is still unfastened after 30 seconds, the buzzer will sound intermittently for 10 seconds. Then, if the seat belt is still unfastened, the buzzer will sound in a different tone for 20 more seconds.

Front passenger's seat belt buzzer:

The front passenger's seat belt buzzer sounds to alert the front passenger that his or her seat belt is not fastened. The buzzer sounds once if the vehicle reaches a speed of 12 mph (20 km/h). If the seat belt is still unfastened after 30 seconds, the buzzer will sound intermittently for 10 seconds. Then, if the seat belt is still unfastened, the buzzer will sound in a different tone for 20 more seconds.

■ SRS warning light

This warning light system monitors the airbag sensor assembly, front impact sensors, side impact sensors (front door), side impact sensors (front), side impact sensors (rear), driver's seat position sensor, driver's seat belt buckle switch, front passenger occupant classification system (ECU and sensors), "AIR BAG ON" indicator light, "AIR BAG OFF" indicator light, front passenger's seat belt buckle switch, seat belt pretensioners, airbags, interconnecting wiring and power sources. (→P. 38)

■ Front passenger detection sensor, seat belt reminder and warning buzzer

- If luggage is placed on the front passenger seat, the front passenger detection sensor may cause the warning light to flash and the warning buzzer to sound even if a passenger is not sitting in the seat.
- If a cushion is placed on the seat, the sensor may not detect a passenger, and the warning light may not operate properly.

■ Electric power steering system warning light (warning buzzer)

When the 12-volt battery charge becomes insufficient or the voltage temporarily drops, the electric power steering system warning light may come on and the warning buzzer may sound.

■ If the malfunction indicator lamp comes on while driving

First check the following:

- Is the fuel tank empty?
If it is, fill the fuel tank immediately.
- Is the fuel tank cap loose?
If it is, tighten it securely.

The malfunction indicator lamp will go off after several driving trips.

If the malfunction indicator lamp does not go off even after several trips, contact your Lexus dealer as soon as possible.

■ When the tire pressure warning light comes on

Check the tire inflation pressure and adjust to the appropriate level. Pushing the tire pressure warning reset switch will not turn off the tire pressure warning light.

■ The tire pressure warning light may come on due to natural causes

The tire pressure warning light may come on due to natural causes such as natural air leaks and tire inflation pressure changes caused by temperature. In this case, adjusting the tire inflation pressure will turn off the warning light (after a few minutes).

■ When a tire is replaced with a spare tire

The compact spare tire is not equipped with a tire pressure warning valve and transmitter. If a tire goes flat, the tire pressure warning light will not turn off even though the flat tire has been replaced with the spare tire. Replace the spare tire with the repaired tire and adjust the tire inflation pressure. The tire pressure warning light will go off after a few minutes.

■ If the tire pressure warning system is not functioning

→P. 494

■ If the tire pressure warning light frequently comes on after blinking for 1 minute

If the tire pressure warning light frequently comes on after blinking for 1 minute when the power switch is turned to ON mode, have it checked by your Lexus dealer.

■ Warning buzzer

In some cases, the buzzer may not be heard due to being in a noisy location or audio sound.

■ Customization that can be configured at Lexus dealer

The vehicle speed linked seat belt reminder buzzer can be disabled.
(Customizable features: →P. 591)

However, Lexus recommends that the seat belt reminder buzzer be operational to alert the driver and front passenger when seat belts are not fastened.

 **WARNING****■ If both the ABS and the brake system warning lights remain on**

Stop your vehicle in a safe place immediately and contact your Lexus dealer. The vehicle will become extremely unstable during braking, and the ABS system may fail, which could cause an accident resulting in death or serious injury.

■ When the electric power steering system warning light comes on

The steering wheel may become extremely heavy.
If the steering wheel becomes heavier than usual when operating, hold firmly and operate using more force than usual.

■ If the tire pressure warning light comes on

Be sure to observe the following precautions. Failure to do so could cause a loss of vehicle control and result in death or serious injury.

- Stop your vehicle in a safe place as soon as possible. Adjust the tire inflation pressure immediately.
- If the tire pressure warning light comes on even after tire inflation pressure adjustment, it is probable that you have a flat tire. Check the tires. If a tire is flat, change it with the spare tire and have the flat tire repaired by the nearest Lexus dealer.
- Avoid abrupt maneuvering and braking. If the vehicle tires deteriorate, you could lose control of the steering wheel or the brakes.

■ If a blowout or sudden air leakage should occur

The tire pressure warning system may not activate immediately.

 **WARNING****■ Maintenance of the tires**

Each tire, including the spare (if provided), should be checked monthly when cold and inflated to the inflation pressure recommended by the vehicle manufacturer on the vehicle placard or tire inflation pressure label (tire and load information label). (If your vehicle has tires of a different size than the size indicated on the vehicle placard or tire inflation pressure label [tire and load information label], you should determine the proper tire inflation pressure for those tires.)

As an added safety feature, your vehicle has been equipped with a tire pressure monitoring system (TPMS-tire pressure warning system) that illuminates a low tire pressure telltale (tire pressure warning light) when one or more of your tires is significantly under-inflated. Accordingly, when the low tire pressure telltale (tire pressure warning light) illuminates, you should stop and check your tires as soon as possible, and inflate them to the proper pressure. Driving on a significantly under-inflated tire causes the tire to overheat and can lead to tire failure. Under-inflation also reduces fuel efficiency and tire tread life, and may affect the vehicle's handling and stopping ability.

Please note that the TPMS (tire pressure warning system) is not a substitute for proper tire maintenance, and it is the driver's responsibility to maintain correct tire pressure, even if under-inflation has not reached the level to trigger illumination of the TPMS low tire pressure telltale (tire pressure warning light).

Your vehicle has also been equipped with a TPMS (tire pressure warning system) malfunction indicator to indicate when the system is not operating properly. The TPMS (tire pressure warning system) malfunction indicator is combined with the low tire pressure telltale (tire pressure warning light). When the system detects a malfunction, the telltale will flash for approximately one minute and then remain continuously illuminated. This sequence will continue upon subsequent vehicle start-ups as long as the malfunction exists. When the malfunction indicator is illuminated, the system may not be able to detect or signal low tire pressure as intended.

TPMS (tire pressure warning system) malfunctions may occur for a variety of reasons, including the installation of replacement or alternate tires or wheels on the vehicle that prevent the TPMS (tire pressure warning system) from functioning properly. Always check the TPMS (tire pressure warning system) malfunction telltale after replacing one or more tires or wheels on your vehicle to ensure that the replacement or alternate tires and wheels allow the TPMS (tire pressure warning system) to continue to function properly.

 **NOTICE****■ To ensure the tire pressure warning system operates properly**

Do not install tires with different specifications or makers, as the tire pressure warning system may not operate properly.

If a warning message is displayed





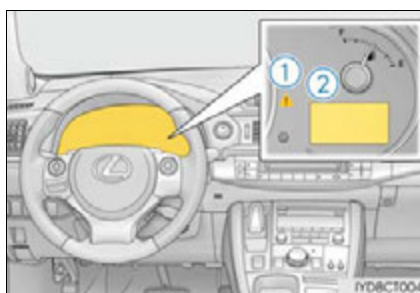





If a warning is shown on the multi-information display, stay calm and perform the following actions:





- ① Master warning light
The master warning light also comes on or flashes in order to indicate that a message is currently being displayed on the multi-information display.
- ② Multi-information display













If any of the warning lights come on again after the following actions have been performed, contact your Lexus dealer.







Warning message and warning buzzer list









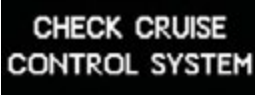

| Warning message | Details/Actions |
|--|---|
|   (Flashes rapidly) (If equipped) | Indicates that: <ul style="list-style-type: none"> • There is a high possibility of a frontal collision; or • The pre-collision braking function is operating A buzzer also sounds. → Slow the vehicle by applying the brakes. |
|  (Flashes) (If equipped) | Indicates that your vehicle is nearing the vehicle ahead (in vehicle-to-vehicle distance control mode) A buzzer also sounds. → Slow the vehicle by applying the brakes. |
|   (Flashes) | Indicates that the driver's door was opened with the shift position in any position other than P A buzzer also sounds. → Shift the shift position to P. |
|   | Indicates that one or more of the doors is not fully closed The system also indicates which doors are not fully closed. If the vehicle reaches a speed of 3 mph (5 km/h), a buzzer sounds to indicate that the door(s) are not yet fully closed. → Make sure that all the doors are closed. |
|  | Indicates that the hood is not fully closed → Close the hood. |
|   | Indicates that the back door is not fully closed If the vehicle reaches a speed of 3 mph (5 km/h), a buzzer sounds to indicate that the back door is not yet fully closed. → Close the back door. |

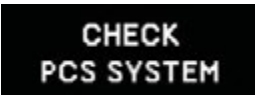





| Warning message | Details/Actions |
|---|---|
|   (If equipped) | Indicates a malfunction in the intuitive parking assist All the sensor lights flash. A buzzer also sounds. → Have the vehicle inspected by your Lexus dealer. |
|   (If equipped) | Indicates that an intuitive parking assist sensor is dirty or covered with ice All the sensor lights flash. A buzzer also sounds. → Clean the sensor. |
|   (Flashes) | Indicates that the accelerator pedal is depressed while the shift position is in N A buzzer also sounds. → Release the accelerator pedal and shift the shift position to D or R. |
|   (Flashes) | Indicates that the accelerator pedal is depressed to stop the vehicle on an upward slope etc. A buzzer also sounds. If this continues, the hybrid system may overheat. → Release the accelerator pedal and depress the brake pedal. |
|   (Flashes) | Indicates that the traction battery power has dropped because a long period of time has elapsed after shifting the shift position to N A buzzer also sounds. → Restart the hybrid system when starting the vehicle. |

| Warning message | Details/Actions |
|---|---|
|  | <p>Indicates a malfunction in the hybrid system A buzzer also sounds. → Immediately stop the vehicle in a safe place and contact your Lexus dealer.</p> |
|  <p>(Flashes)</p> | <p>Indicates that the traction battery is low A buzzer also sounds. → When stopping the vehicle for a long period of time, shift the shift position to P. The battery cannot be charged with the shift position in N.</p> |
|  <p>(U.S.A.) (Canada) (Flashes)</p> | <p>Indicates that the vehicle is being driven at 3 mph (5 km/h) or more with the parking brake still engaged. A buzzer also sounds. → Release the parking brake.</p> |
|  | <p>Indicates a malfunction in the shift control system A buzzer also sounds. → Have the vehicle inspected at your Lexus dealer immediately.</p> <ul style="list-style-type: none"> • The hybrid system may not be able to start. • The parking lock mechanism may not operate. Also, shifting the shift position to P may not be possible. When parking, choose a level place and apply the parking brake securely. • The automatically P position selection function (→P.165) may not operate. Before turning the power switch off, securely press the P position switch, and be sure to check that the shift position is in P by verifying the shift position indicator or P position switch indicator. • The power switch may not be able to be turned off. In this case, the power switch can be turned off by applying the parking brake. • The 12-volt battery may not be charged sufficiently. In this case, charge or replace the 12-volt battery. After charging the 12-volt battery, the message may continue to be displayed until the shift position is shifted from P. |

| Warning message | Details/Actions |
|--|--|
| <p>SHIFT MALFUNCTION. SEE OWNER'S MANUAL.</p>  | <p>Indicates a malfunction in the shift control system A buzzer also sounds. → Have the vehicle inspected at your Lexus dealer immediately. If not inspected, vehicle systems may not operate properly.</p> |
| <p>AUX BATTERY LOW . SHIFTING UNAVAILABLE . SEE OWNER'S MANUAL .</p>  | <p>An attempt was made to change the shift position when the 12-volt battery voltage was low. A buzzer also sounds. → Recharge or replace the 12-volt battery.</p> |
| <p>SHIFTING BRIEFLY UNAVAILABLE . WAIT A MOMENT AND TRY AGAIN .</p>  | <p>Indicates that the shift lever and P position switch were repeatedly operated in quick succession. A buzzer also sounds. → Wait approximately 20 seconds and change the shift position.</p> |
| <p>CANNOT SHIFT TO B . SHIFT TO D ONCE TO SHIFT TO B .</p>  | <p>An attempt was made to shift the shift position from P or N to B. A buzzer also sounds. → Shift the shift position to D, and then shift the shift position to B.</p> |
| <p>CANNOT SHIFT TO D OR R . START HYBRID SYSTEM AND TRY AGAIN .</p>  <p>(Flashes)</p> | <p>An attempt was made to shift the shift position to R, D or B with the power switch on (READY indicator turned off). A buzzer also sounds. → After starting the hybrid system, shift the shift position to R, D or B*. *: When shifting the shift position to B, first shift the shift position to D, and then shift the shift position to B.</p> |
| <p>SHIFTING UNAVAILABLE . DEPRESS BRAKE BEFORE SHIFTING .</p>  <p>(Flashes)</p> | <p>An attempt was made to shift the shift position from P with the brake pedal released. A buzzer also sounds. → When shifting the shift position from P, depress the brake pedal.</p> |

| Warning message | Details/Actions |
|--|---|
| <p data-bbox="395 477 651 566">SWITCHED TO N . SHIFT TO D ONCE TO SHIFT TO B .</p>  <p data-bbox="408 645 467 667">(Flashes)</p> | <p data-bbox="675 488 1233 544">An attempt was made to shift the shift position from R to B.</p> <p data-bbox="699 544 914 566">A buzzer also sounds.</p> <p data-bbox="699 566 1153 589">The shift position automatically changed to N.</p> <p data-bbox="675 589 1233 645">→ Shift the shift position to D, and then shift the shift position to B.</p> |
| <p data-bbox="395 701 651 790">SWITCHED TO N . TO SHIFT TO D , STOP CAR FIRST .</p>  <p data-bbox="408 869 467 891">(Flashes)</p> | <p data-bbox="675 723 1233 779">An attempt was made to shift the shift position to D while the vehicle was moving in reverse.</p> <p data-bbox="699 779 914 801">A buzzer also sounds.</p> <p data-bbox="699 801 1153 824">The shift position automatically changed to N.</p> <p data-bbox="675 824 1233 857">→ Stop the vehicle, and then change the shift position.</p> |
| <p data-bbox="395 925 651 1014">SWITCHED TO N . TO SHIFT TO R , STOP CAR FIRST .</p>  <p data-bbox="408 1093 467 1115">(Flashes)</p> | <p data-bbox="675 947 1233 1003">An attempt was made to shift the shift position to R while the vehicle was moving forward.</p> <p data-bbox="699 1003 914 1025">A buzzer also sounds.</p> <p data-bbox="699 1025 1153 1048">The shift position automatically changed to N.</p> <p data-bbox="675 1048 1233 1081">→ Stop the vehicle, and then change the shift position.</p> |
| <p data-bbox="395 1149 651 1238">SWITCHED TO N . TO ENGAGE P , STOP CAR THEN PRESS P SWITCH.</p>  <p data-bbox="408 1317 467 1339">(Flashes)</p> | <p data-bbox="675 1149 1233 1205">Indicates that the P position switch is pressed while the vehicle is running.</p> <p data-bbox="699 1205 914 1227">A buzzer also sounds.</p> <p data-bbox="699 1227 1153 1249">The shift position automatically changed to N.</p> <p data-bbox="675 1249 1233 1305">→ To shift the shift position to P, stop the vehicle completely and press the P position switch.</p> <p data-bbox="675 1305 1233 1328">→ To continue driving, shift the shift position to D or R.</p> |
| <p data-bbox="403 1384 643 1462">CLEAN RADAR SENSOR</p>  <p data-bbox="483 1552 563 1574">(If equipped)</p> | <p data-bbox="675 1406 1233 1462">Indicates that the radar cruise control sensor is dirty or covered with ice</p> <p data-bbox="699 1462 914 1485">A buzzer also sounds.</p> <p data-bbox="675 1485 882 1518">→ Clean the sensor.</p> |
| <p data-bbox="403 1608 643 1686">CRUISE CONTROL NOT AVAILABLE</p>  <p data-bbox="483 1776 563 1798">(If equipped)</p> | <p data-bbox="675 1619 1233 1675">Indicates that the dynamic radar cruise control system is unable to judge vehicle-to-vehicle distance</p> <p data-bbox="699 1675 914 1697">A buzzer also sounds.</p> <p data-bbox="675 1697 1233 1753">→ If the windshield wipers are on, turn them off or set them to either intermittent or slow mode.</p> |

| Warning message | Details/Actions |
|--|---|
|   | <p>Indicates a malfunction in:</p> <ul style="list-style-type: none"> • The cruise control system; or • The dynamic radar cruise control system <p>Press the "ON-OFF" button once to deactivate the system, and then press the button again to reactivate the system. A buzzer also sounds. → Have the vehicle inspected by your Lexus dealer.</p> |
|   <small>(Flashes)</small> <small>(If equipped)</small> | <p>Indicates a malfunction in the pre-collision system A buzzer also sounds. → Have the vehicle inspected by your Lexus dealer.</p> |
|   <small>(Flashes)</small> <small>(If equipped)</small> | <p>Indicates that the moon roof is not fully closed (with the power switch off, and the driver's door open) A buzzer also sounds. → Close the moon roof.</p> |
|   | <p>Indicates that the hybrid system has overheated This message may be displayed when driving under severe operating conditions. (For example, when driving up a long steep hill.) A buzzer also sounds. → Stop and check. (→P. 566)</p> |
|   <small>(Flashes)</small> <small>(If equipped)</small> | <p>Indicates a malfunction in the LED headlight system A buzzer also sounds. → Have the vehicle inspected by your Lexus dealer.</p> |
|  | <p>Indicates that the washer fluid level is low → Add washer fluid.</p> |

| Warning message | Details/Actions |
|---|---|
|  <p>(U.S.A. only)</p> | <p>Indicates that all maintenance according to the driven distance on the maintenance schedule ^{*1} should be performed soon. Comes on approximately 4500 miles (7200 km) after the message has been reset. → If necessary, perform maintenance.</p> |
|  <p>(U.S.A. only)</p> | <p>Indicates that all maintenance is required to correspond to the driven distance on the maintenance schedule ^{*1}. Comes on approximately 5000 miles (8000 km) after the message has been reset. (The indicator will not work properly unless the message has been reset.) → Perform the necessary maintenance. Please reset the message after the maintenance is performed (→P. 468)</p> |
|   <p>(If equipped)</p> | <p>Indicates that the pre-collision system is not currently functional because the grille cover or the sensor is dirty This message also appears when the pre-collision system is not functional due to overheating. → Check the grille cover and the sensor and clean them if they are dirty. In case of overheating, the system will become functional once the system cools down.</p> |
|  | <p>Indicates that the EV drive mode is not available ^{*2} The reason the EV drive mode is not available (the vehicle is idling, battery charge is low, speed is higher than the EV drive mode operating speed range, accelerator pedal is depressed too much) may be displayed. A buzzer also sounds. → Use the EV drive mode when it becomes available.</p> |
|   <p>(Flashes 3 times)</p> | <p>Indicates that the EV drive mode has been automatically canceled ^{*2} The reason the EV drive mode is not available (the battery charge is low, speed is higher than the EV drive mode operating speed range, accelerator pedal is depressed too much) may be displayed. A buzzer also sounds. → Drive the vehicle for a while.</p> |

*1: Refer to the separate "Scheduled Maintenance" or "Owner's Manual Supplement" for the maintenance interval applicable to your vehicle.

*2: For the EV drive mode operating conditions (→P. 160).

■ **Warning messages**

The warning message illustrations used are intended as examples, and may differ from the image that is actually displayed on the multi-information display.

■ **Warning message in radar cruise mode (if equipped)**

In the following situations, the warning message may not be displayed even if vehicle-to-vehicle distance decreases:

- When your vehicle and the vehicle ahead are traveling at the same speed or the vehicle ahead is traveling more quickly than your vehicle
- When the vehicle ahead is traveling at a very low speed
- Immediately after cruise control speed is set
- At the instant the accelerator pedal is depressed







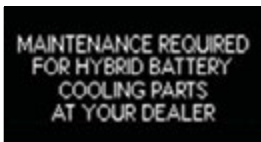

■ **Warning buzzer**







→P. 533

Other displayed message





Carrying out the corresponding action turns the message off.

| Displayed message | Details/Actions |
|---|---|
|  | <p>Maintenance of the hybrid battery (traction battery) cooling component is required The filter may be clogged, the air intake vent may be blocked or there may be a gap in the duct. → Have maintenance performed on the hybrid battery (traction battery) cooling component at your Lexus dealer.</p> |

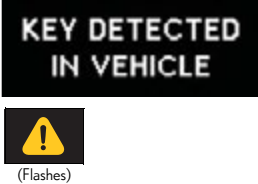
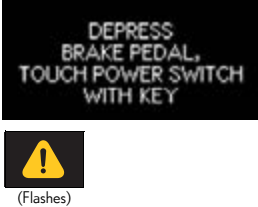
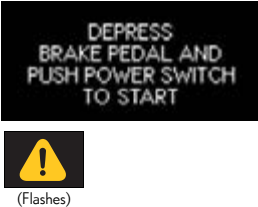
| Interior buzzer | Exterior buzzer | Warning message | Details/Actions |
|-----------------|-----------------|---|---|
| — | — |  | Power was turned off due to the automatic power off function. → Next time, start the hybrid system and keep it on for approximately 5 minutes or more to recharge the 12-volt battery. |
| Continuous | — |   (Flashes) | The driver's door was opened while any shift position other than P was selected without turning off the power switch. → Shift the shift position to P. |
| Continuous | Continuous |    (Flashes) | The electronic key was carried outside the vehicle and the driver's door was opened and closed while any shift position other than P was selected without turning off the power switch. → Shift the shift position to P. → Bring the electronic key back into the vehicle. |
| Once | — |   (Flashes) | An attempt was made to start the hybrid system without the electronic key being present, or the electronic key was not functioning normally. → Start the hybrid system with the electronic key present. An attempt was made to drive when the regular key was not inside the vehicle. → Confirm that the electronic key is inside the vehicle. |

| Interior buzzer | Exterior buzzer | Warning message | Details/Actions |
|-----------------|---------------------------|--|---|
| Once | 3 times |   (Flashes) | <p>The electronic key was carried outside the vehicle and a door other than the driver's door was opened and closed while the power switch was in a mode other than off. → Bring the electronic key back into the vehicle.</p> <p>The electronic key was carried outside the vehicle and the driver's door was opened and closed while the shift position P was selected without turning off the power switch. → Turn the power switch off. → Bring the electronic key back into the vehicle.</p> |
| Once | Sounds once for 5 seconds |   (Displayed alternately)  (Flashes) | <p>An attempt was made to exit the vehicle with the electronic key and lock the doors without first turning the power switch off. → Turn the power switch off and lock the doors again.</p> |
| Once | — |   (Flashes) | <p>An attempt was made to turn the power switch off when the shift position was not in P. → To turn off the hybrid system, first shift the shift position to P and then turn the power switch off.</p> |

| Interior buzzer | Exterior buzzer | Warning message | Details/Actions |
|-----------------|---------------------------|--|--|
| Once | Sounds once for 5 seconds |  <p>(Flashes)</p> | <ul style="list-style-type: none"> An attempt was made to lock the doors using the smart access system with push-button start while the electronic key was still inside the vehicle. An attempt was made to lock either front door by opening a door and putting the inside lock button into the lock position, then closing the door with the electronic key still inside the vehicle. <p>→ Retrieve the electronic key from the vehicle and lock the doors again.</p> |
| Once | — |  <p>(Flashes)</p> | <ul style="list-style-type: none"> When the doors were unlocked with the mechanical key and then the power switch was pressed, the electronic key could not be detected in the vehicle. The electronic key could not be detected in the vehicle even after the power switch was pressed two consecutive times. <p>→ Touch the electronic key to the power switch while depressing the brake pedal.</p> |
| Once | — |  <p>(Flashes)</p> | <p>The driver's door was opened and closed with the power switch turned off and then the power switch was put in ACCESSORY mode twice without the hybrid system being started.</p> <p>→ Press the power switch while depressing the brake pedal.</p> <p>During a hybrid system starting procedure in the event that the electronic key was not functioning properly (→P. 561), the power switch was touched with the electronic key.</p> <p>→ Press the power switch within 10 seconds of the buzzer sounding.</p> |

| Interior buzzer | Exterior buzzer | Warning message | Details/Actions |
|-----------------|-----------------|---|---|
| Once | — |   (Flashes) | An attempt was made to start the hybrid system with the shift position in N. → Shift the shift position to P and start the hybrid system. |
| Once | — |   | The electronic key has a low battery. → Replace the electronic key battery. (→P. 504) |

- **Warning messages**
→P. 544
- **Warning buzzer**
→P. 533

If you have a flat tire

Your vehicle is equipped with a spare tire. The flat tire can be replaced with the spare tire.

For details about tires: →P. 490

WARNING

■ If you have a flat tire

Do not continue driving with a flat tire.

Driving even a short distance with a flat tire can damage the tire and the wheel beyond repair, which could result in an accident.

Before jacking up the vehicle

- Stop the vehicle on a hard, flat surface.
- Set the parking brake.
- Shift the shift position to P.
- Stop the hybrid system.
- Turn on the emergency flashers. (→P. 522)

Location of the spare tire, jack and tools

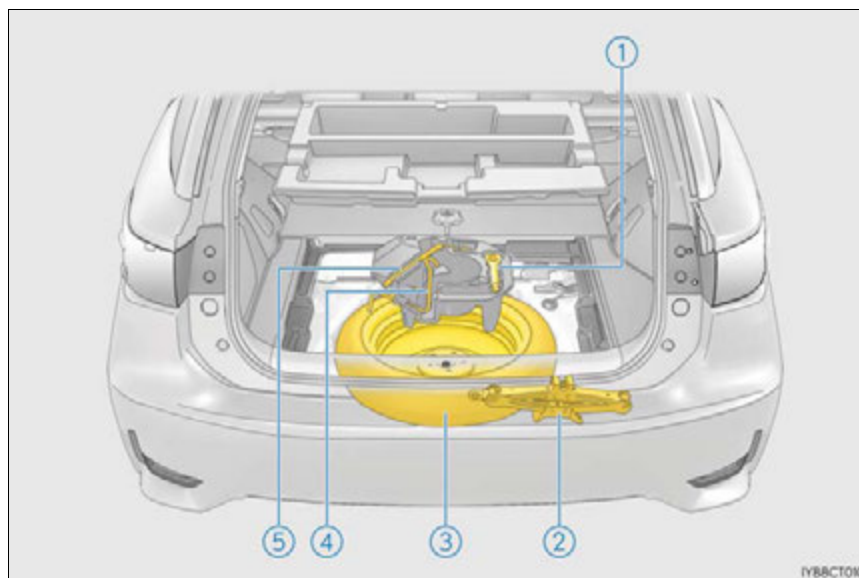

- ① Towing eyelet
- ② Jack
- ③ Spare tire
- ④ Jack handle
- ⑤ Wheel nut wrench

⚠ WARNING**■ Using the tire jack**

Observe the following precautions.

Improper use of the tire jack may cause the vehicle to suddenly fall off the jack, leading to death or serious injury.

- Do not use the tire jack for any purpose other than replacing tires or installing and removing tire chains.
- Only use the tire jack that comes with this vehicle for replacing a flat tire.
Do not use it on other vehicles, and do not use other tire jacks for replacing tires on this vehicle.
- Put the jack properly in its jack point.
- Do not put any part of your body under the vehicle while it is supported by the jack.
- Do not start the hybrid system or drive the vehicle while the vehicle is supported by the jack.
- Do not raise the vehicle while someone is inside.
- When raising the vehicle, do not put an object on or under the jack.
- Do not raise the vehicle to a height greater than that required to replace the tire.
- Use a jack stand if it is necessary to get under the vehicle.
- When lowering the vehicle, make sure that there is no-one near the vehicle. If there are people nearby, warn them vocally before lowering.

Taking out the jack

- 1 Remove the center deck board.

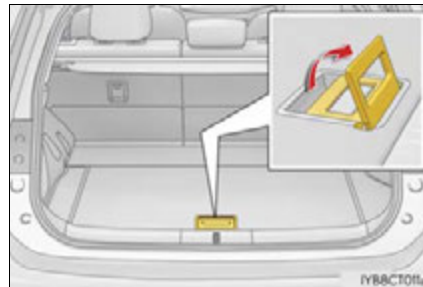

- 2 Remove the center auxiliary box.



- 3 Take out the jack.
 - ① For loosening
 - ② For tightening

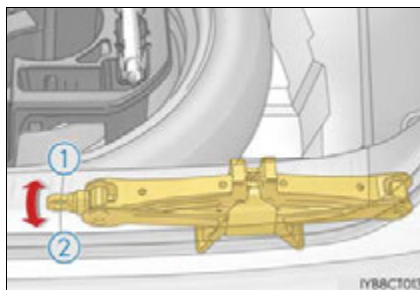

Taking out the spare tire

- 1 Remove the center deck board and center auxiliary box. (→P. 551)
- 2 Loosen the center fastener that secures the spare tire.

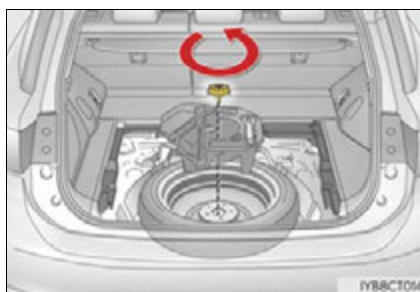

WARNING

■ When storing the spare tire

Be careful not to catch fingers or other body parts between the spare tire and the body of the vehicle.

Replacing a flat tire

- 1 Check the tires.



| Flat tire | | Wheel chock positions |
|-----------|-----------------|--|
| Front | Left-hand side | Behind the rear right-hand side tire |
| | Right-hand side | Behind the rear left-hand side tire |
| Rear | Left-hand side | In front of the front right-hand side tire |
| | Right-hand side | In front of the front left-hand side tire |

- 2 Slightly loosen the wheel nuts (one turn).

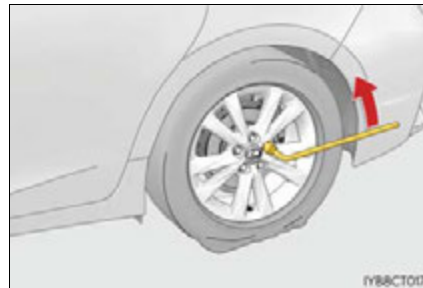

- 3 Turn the tire jack portion (A) by hand until the notch of the jack is in contact with the jack point.

The jack point guides are located under the rocker panel. They indicate the jack point positions.

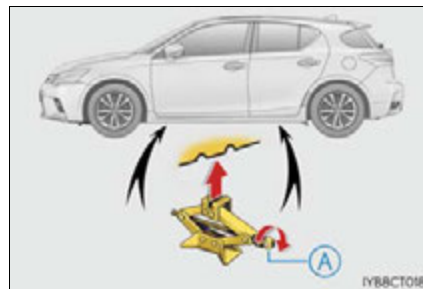

- 4 Raise the vehicle until the tire is slightly raised off the ground.

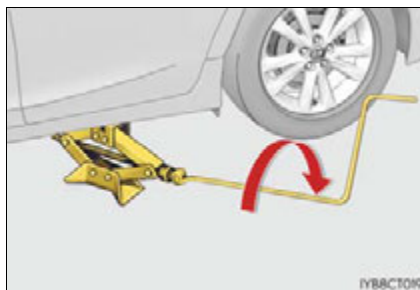

- 5 Remove all the wheel nuts and the tire.

When resting the tire on the ground, place the tire so that the wheel design faces up to avoid scratching the wheel surface.

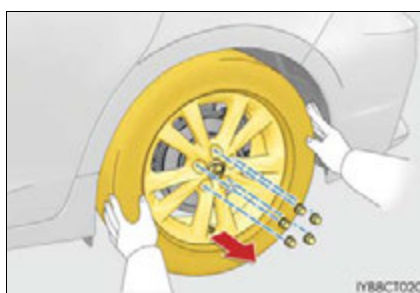

⚠ WARNING

■ **Replacing a flat tire**

- Do not touch the disc wheels or the area around the brakes immediately after the vehicle has been driven. After the vehicle has been driven the disc wheels and the area around the brakes will be extremely hot. Touching these areas with hands, feet or other body parts while changing a tire, etc. may result in burns.
- Failure to follow these precautions could cause the wheel nuts to loosen and the tire to fall off, resulting in death or serious injury.
 - Never use oil or grease on the wheel bolts or wheel nuts. Oil and grease may cause the wheel nuts to be excessively tightened, leading to bolt or disc wheel damage. In addition, the oil or grease can cause the wheel nuts to loosen and the wheel may fall off, causing a serious accident. Remove any oil or grease from the wheel bolts or wheel nuts.
 - Have the wheel nuts tightened with a torque wrench to 76 ft•lbf (103 N•m, 10.5 kgf•m) as soon as possible after changing wheels.
 - When installing a tire, only use wheel nuts that have been specifically designed for that wheel.
 - If there are any cracks or deformations in the bolt screws, nut threads or bolt holes of the wheel, have the vehicle inspected by your Lexus dealer.

Installing the spare tire

- 1 Remove any dirt or foreign matter from the wheel contact surface.

If foreign matter is on the wheel contact surface, the wheel nuts may loosen while the vehicle is in motion, causing the tire to come off.

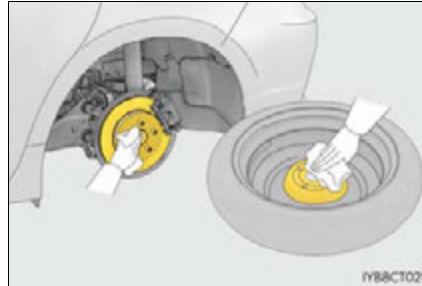

- 2 Install the spare tire and loosely tighten each wheel nut by hand by approximately the same amount.

Tighten the wheel nuts until the tapered portion comes into loose contact with the disc wheel seat.

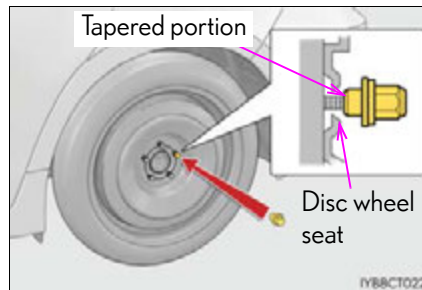

- 3 Lower the vehicle.

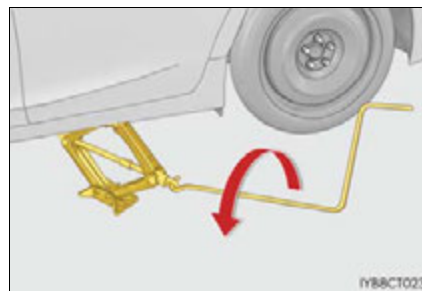

- 4 Firmly tighten each wheel nut two or three times in the order shown in the illustration.

Tightening torque:
76 ft•lbf (103 N•m, 10.5 kgf•m)

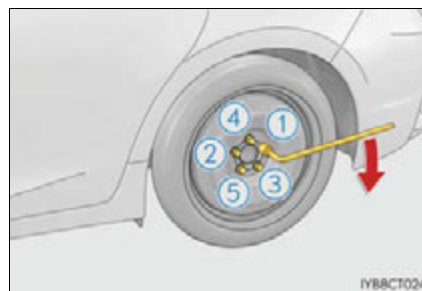

- 5 Stow the flat tire, tire jack and all tools.

■ **The compact spare tire**

- The compact spare tire is identified by the label “TEMPORARY USE ONLY” on the tire sidewall.
Use the compact spare tire temporarily, and only in an emergency.
- Make sure to check the tire inflation pressure of the compact spare tire. (→P. 577)

■ **After completing the tire change**

The tire pressure warning system must be reset. (→P. 491)

■ **When using the compact spare tire**

As the compact spare tire is not equipped with a tire pressure warning valve and transmitter, low inflation pressure of the spare tire will not be indicated by the tire pressure warning system. Also, if you replace the compact spare tire after the tire pressure warning light comes on, the light remains on.

■ **When the compact spare tire is equipped**

The vehicle becomes lower when driving with the compact spare tire compared to when driving with standard tires.

■ **If you have a flat front tire on a road covered with snow or ice**

Install the compact spare tire on one of the rear wheels of the vehicle. Perform the following steps and fit tire chains to the front tires:

- 1 Replace a rear tire with the compact spare tire.
- 2 Replace the flat front tire with the tire removed from the rear of the vehicle.
- 3 Fit tire chains to the front tires.

 **WARNING**

■ **When using the compact spare tire**

- Remember that the spare tire provided is specifically designed for use with your vehicle. Do not use your spare tire on another vehicle.
- Do not use more than one spare tire simultaneously.
- Replace the spare tire with a standard tire as soon as possible.
- Avoid sudden acceleration, abrupt steering, sudden braking and shifting operations that cause sudden engine braking.

■ **When the compact spare tire is attached**

The vehicle speed may not be correctly detected, and the following systems may not operate correctly:

- | | |
|--|--|
| • ABS & Brake assist | • Pre-collision system (if equipped) |
| • VSC | • EPS |
| • TRAC | • Rear view monitor system (if equipped) |
| • Cruise control (if equipped) | • Intuitive parking assist (if equipped) |
| • Dynamic radar cruise control (if equipped) | • Navigation system (if equipped) |

 **WARNING****■ Speed limit when using the compact spare tire**

Do not drive at speeds in excess of 50 mph (80 km/h) when a compact spare tire is installed on the vehicle.

The compact spare tire is not designed for driving at high speeds. Failure to observe this precaution may lead to an accident causing death or serious injury.

■ After using the tools and jack

Before driving, make sure all the tools and jack are securely in place in their storage location to reduce the possibility of personal injury during a collision or sudden braking.

 **NOTICE****■ Be careful when driving over bumps with the compact spare tire installed on the vehicle.**

The vehicle becomes lower when driving with the compact spare tire compared to when driving with standard tires. Be careful when driving over uneven road surfaces.

■ Driving with tire chains and the compact spare tire

Do not fit tire chains to the compact spare tire.

Tire chains may damage the vehicle body and adversely affect driving performance.

If the hybrid system will not start

Reasons for the hybrid system not starting vary depending on the situation. Check the following and perform the appropriate procedure:

The hybrid system will not start even though the correct starting procedure is being followed. (→P. 156)

One of the following may be the cause of the problem:

- The electronic key may not be functioning properly.* (→P. 560)
- There may not be sufficient fuel in the vehicle's tank.
Refuel the vehicle. (→P. 71)
- There may be a malfunction in the immobilizer system.* (→P. 74)
- There may be a malfunction in the shift control system.* (→P. 158, 539)
- The hybrid system may be malfunctioning due to an electrical problem such as electronic key battery depletion or a blown fuse. However, depending on the type of malfunction, an interim measure is available to start the hybrid system. (→P. 559)

*: It may not be possible to shift the shift position other than P.

The interior lights and headlights are dim, or the horn does not sound or sounds at a low volume.

One of the following may be the cause of the problem:

- The 12-volt battery may be discharged. (→P. 562)
- The 12-volt battery terminal connections may be loose or corroded. (→P. 486)

The interior lights and headlights do not turn on, or the horn does not sound.

One of the following may be the cause of the problem:

- The 12-volt battery may be discharged. (→P. 562)
- One or both of the 12-volt battery terminals may be disconnected. (→P. 486)

Contact your Lexus dealer if the problem cannot be repaired, or if repair procedures are unknown.

Emergency start function

When the hybrid system does not start, the following steps can be used as an interim measure to start the hybrid system if the power switch is functioning normally. Do not use this starting procedure except in cases of emergency.

- 1 Set the parking brake.
- 2 Turn the power switch to ACCESSORY mode.
- 3 Press and hold the power switch for about 15 seconds while depressing the brake pedal firmly.

Even if the hybrid system can be started using the above steps, the system may be malfunctioning. Have the vehicle inspected by your Lexus dealer.

If the electronic key does not operate properly

If communication between the electronic key and vehicle is interrupted (→P. 115) or the electronic key cannot be used because the battery is depleted, the smart access system with push-button start and wireless remote control cannot be used. In such cases, the doors can be opened and the hybrid system can be started by following the procedure below.

Locking and unlocking the doors and key linked functions

Use the mechanical key (→P. 101) in order to perform the following operations:

- ① Locks all the doors
- ② Closes the windows* (turn and hold)
- ③ Unlocks the door

Turning the key rearward unlocks the driver's door. Turning the key once again within 3 seconds unlocks the other doors.

- ④ Opens the windows* (turn and hold)

*: These settings must be customized at your Lexus dealer.

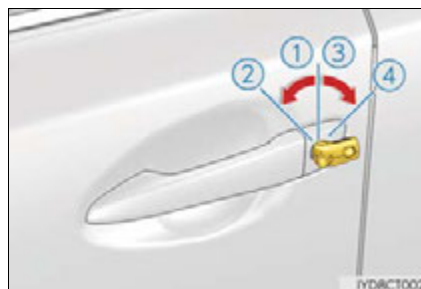

Starting the hybrid system

- 1 Depress the brake pedal.
- 2 Touch the Lexus emblem side of the electronic key to the power switch.

If any of the doors is opened or closed while the key is being touched to the switch, an alarm will sound to indicate that the start function cannot detect the electronic key.

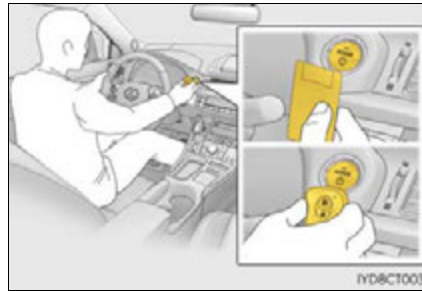

- 3 Press the power switch within 10 seconds of the buzzer sounding, keeping the brake pedal depressed.

In the event that the hybrid system still cannot be operated, contact your Lexus dealer.

■ Stopping the hybrid system

Set the parking brake, shift the shift position to P and press the power switch as you normally do when stopping the hybrid system.

■ Replacing the key battery

As the above procedure is a temporary measure, it is recommended that the electronic key battery be replaced immediately when the battery is depleted. (→P. 504)

■ Changing power switch modes

Within 10 seconds of the buzzer sounding, release the brake pedal and press the power switch.

The hybrid system does not start and modes will be changed each time the switch is pressed. (→P. 157)

⚠ WARNING

■ When using the mechanical key and operating the power windows

Operate the power window after checking to make sure that there is no possibility of any passenger having any of their body parts caught in the window.

Also, do not allow children to operate the mechanical key. It is possible for children and other passengers to get caught in the power window.

If the 12-volt battery is discharged

The following procedures may be used to start the hybrid system if the vehicle's 12-volt battery is discharged.

You can also call your Lexus dealer or a qualified repair shop.

If you have a set of jumper (or booster) cables and a second vehicle with a 12-volt battery, you can jump start your vehicle by following the steps below.

- 1 Confirm that the electronic key is being carried.

When connecting the jumper (or booster) cables, depending on the situation, the alarm may activate and doors locked. (→P. 77)



- 2 Open the hood (→P. 475) and fuse box cover.

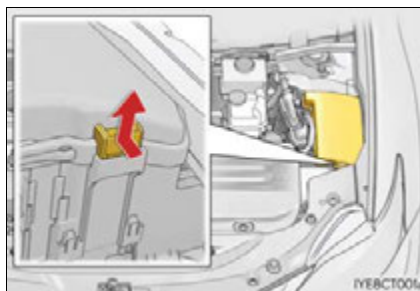

- 3 Open the exclusive jump starting terminal cover.

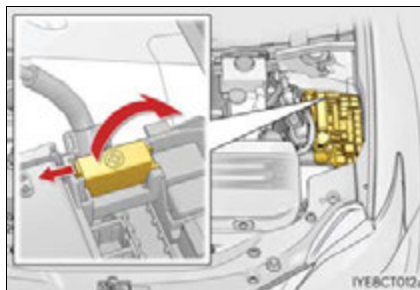

- 4 Connect the jumper cables according to the following procedure:

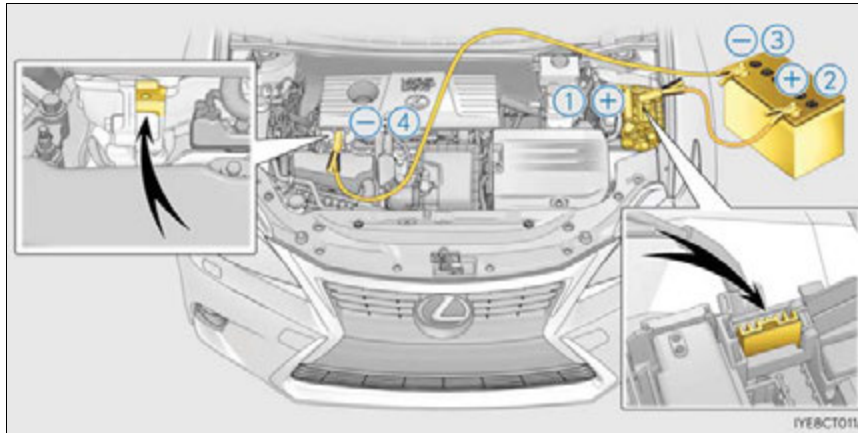

- ① Connect a positive jumper cable clamp to the exclusive jump starting terminal on your vehicle.
 - ② Connect the clamp on the other end of the positive cable to the positive (+) battery terminal on the second vehicle.
 - ③ Connect a negative cable clamp to the negative (-) battery terminal on the second vehicle.
 - ④ Connect the clamp at the other end of the negative cable to a solid, stationary, unpainted metallic point away from the exclusive jump starting terminal and any moving parts, as shown in the illustration.
- 5 Start the engine of the second vehicle. Increase the engine speed slightly and maintain at that level for approximately 5 minutes to recharge the 12-volt battery of your vehicle.
 - 6 Open and close any of the doors of your vehicle with the power switch off.
 - 7 Maintain the engine speed of the second vehicle and start the hybrid system of your vehicle by turning the power switch to ON mode.
 - 8 Make sure the "READY" indicator comes on. If the indicator light does not come on, contact your Lexus dealer.
 - 9 Once the hybrid system has started, remove the jumper cables in the exact reverse order from which they were connected.
 - 10 Close the exclusive jump starting terminal cover, and reinstall the fuse box cover to its original position.

Once the hybrid system starts, have the vehicle inspected at your Lexus dealer as soon as possible.

■ Starting the hybrid system when the 12-volt battery is discharged

The hybrid system cannot be started by push-starting.

■ To prevent 12-volt battery discharge

- Turn off the headlights and the audio system while the hybrid system is off.
- Turn off any unnecessary electrical components when the vehicle is running at a low speed for an extended period, such as in heavy traffic.

■ When the 12-volt battery is removed or discharged

- The hybrid system may not start. (→P. 488)
- If the 12-volt battery discharges while the shift position is in P, it may not be possible to shift the shift position to other positions. In this case, the vehicle cannot be towed without lifting both front wheels because the front wheels will be locked. (→P. 524)
- When the 12-volt battery is reconnected, start the hybrid system and confirm that the shift position can be changed to each position using the shift position indicator.

■ Charging the 12-volt battery

The electricity stored in the 12-volt battery will discharge gradually even when the vehicle is not in use, due to natural discharge and the draining effects of certain electrical appliances. If the vehicle is left for a long time, the 12-volt battery may discharge, and the hybrid system may be unable to start. (The 12-volt battery recharges automatically while the hybrid system is operating.)

⚠ WARNING**■ Avoiding 12-volt battery fires or explosions**

Observe the following precautions to prevent accidentally igniting the flammable gas that may be emitted from the 12-volt battery:

- Make sure each jumper cable is connected to the correct terminal and that it is not unintentionally in contact with any other than the intended terminal.
- Do not allow the other end of the jumper cable connected to the “+” terminal to come into contact with any other parts or metal surfaces in the area, such as brackets or unpainted metal.
- Do not allow the + and - clamps of the jumper cables to come into contact with each other.
- Do not smoke, use matches, cigarette lighters or allow open flame near the 12-volt battery.

 **WARNING****■ 12-volt battery precautions**

The 12-volt battery contains poisonous and corrosive acidic electrolyte, while related parts contain lead and lead compounds. Observe the following precautions when handling the 12-volt battery:

- When working with the 12-volt battery, always wear safety glasses and take care not to allow any battery fluids (acid) to come into contact with skin, clothing or the vehicle body.
- Do not lean over the 12-volt battery.
- In the event that battery fluid comes into contact with the skin or eyes, immediately wash the affected area with water and seek medical attention.
Place a wet sponge or cloth over the affected area until medical attention can be received.
- Always wash your hands after handling the 12-volt battery support, terminals, and other battery-related parts.
- Do not allow children near the 12-volt battery.

■ After recharging the 12-volt battery

Have the 12-volt battery inspected at your Lexus dealer as soon as possible. If the 12-volt battery is deteriorating, continued use may cause the 12-volt battery to emit a malodorous gas, which may be detrimental to the health of passengers.

■ When replacing the 12-volt battery

→P. 489

 **NOTICE****■ When handling jumper cables**

When connecting the jumper cables, ensure that they do not become entangled in the cooling fans or belt.

■ To prevent damaging the vehicle

The exclusive jump starting terminal is to be used when charging the 12-volt battery from another vehicle in an emergency. It cannot be used to jump start another vehicle.

If your vehicle overheats

The following may indicate that your vehicle is overheating.

- The high coolant temperature warning light (→P. 530) comes on or flashes, or a loss of hybrid system power is experienced. (For example, the vehicle speed does not increase.)
- The warning message indicating overheats is shown on the multi-information display. (→P. 542)
- Steam comes out from under the hood.

Correction procedures

■ If the high coolant temperature warning light comes on or flashes

- 1 Stop the vehicle in a safe place and turn off the air conditioning system, and then stop the hybrid system.
- 2 If you see steam:
Carefully lift the hood after the steam subsides.
If you do not see steam:
Carefully lift the hood.
- 3 After the hybrid system has cooled down sufficiently, inspect the hoses and radiator core (radiator) for any leaks.

① Radiator

② Cooling fans

If a large amount of coolant leaks, immediately contact your Lexus dealer.

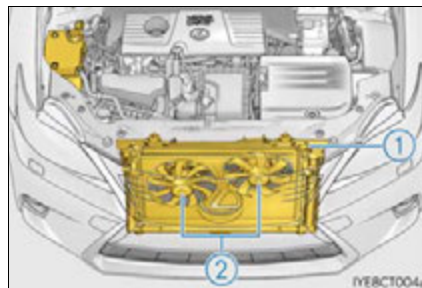

- 4** The coolant level is satisfactory if it is between the “FULL” and “LOW” lines on the reservoir.

- ① Reservoir
- ② “FULL” line
- ③ “LOW” line



- 5** Add coolant if necessary.

Water can be used in an emergency if coolant is unavailable.

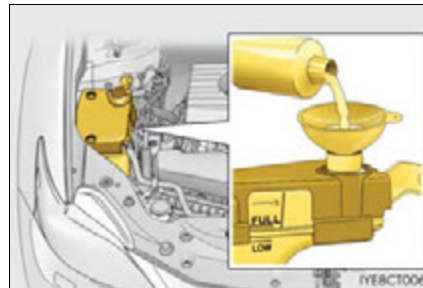

- 6** Start the hybrid system and turn the air conditioning system on to check that the radiator cooling fans operate and to check for coolant leaks from the radiator or hoses.

The fans operate when the air conditioning system is turned on immediately after a cold start. Confirm that the fans are operating by checking the fan sound and air flow. If it is difficult to check these, turn the air conditioning system on and off repeatedly. (The fans may not operate in freezing temperatures.)

- 7** If the fans are not operating:

Stop the hybrid system immediately and contact your Lexus dealer.

If the fans are operating:

Have the vehicle inspected at the nearest Lexus dealer.

■ If the warning message indicating overheats is shown on the multi-information display

- 1 Stop the vehicle in a safe place.
- 2 Stop the hybrid system and carefully lift the hood.
- 3 After the hybrid system has cooled down, inspect the hoses and radiator core (radiator) for any leaks.

- ① Radiator
- ② Cooling fans

If a large amount of coolant leaks, immediately contact your Lexus dealer.

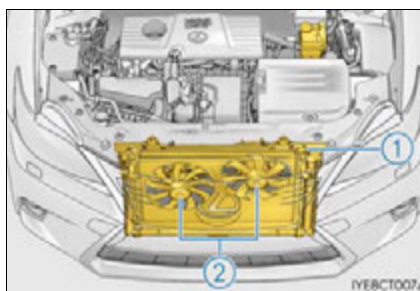

- 4 The coolant level is satisfactory if it is between the "FULL" and "LOW" lines on the reservoir.

- ① Reservoir
- ② "FULL" line
- ③ "LOW" line



- 5 Add coolant if necessary.
Water can be used in an emergency if coolant is unavailable.

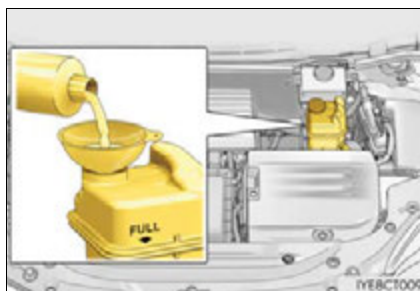

- 6 Start the hybrid system and check for the multi-information display.
- If the message does not disappear:
Stop the hybrid system and contact your Lexus dealer.
- If the message is not displayed:
Have the vehicle inspected at the nearest Lexus dealer.

 **WARNING**

■ **When inspecting under the hood of your vehicle**

Observe the following precautions.

Failure to do so may result in serious injury such as burns.

- If steam is seen coming from under the hood, do not open the hood until the steam has subsided. The engine compartment may be very hot.
- After the hybrid system has been turned off, check that the indicator on the power switch and the "READY" indicator are off.
When the hybrid system is operating, the gasoline engine may automatically start, or the cooling fan may suddenly operate even if the gasoline engine stops. Do not touch or approach rotating parts such as the fan, which may lead to fingers or clothing (especially a tie, a scarf or a muffler) getting caught, resulting in serious injury.
- Do not loosen the coolant reservoir cap while the hybrid system and radiator are hot. High temperature steam or coolant could spray out.

 **NOTICE**

■ **When adding engine/power control unit coolant**

Add coolant slowly after the hybrid system has cooled down sufficiently. Adding cool coolant to a hot hybrid system too quickly can cause damage to the hybrid system.

■ **To prevent damage to the cooling system**

Observe the following precautions:

- Avoid contaminating the coolant with foreign matter (such as sand or dust etc.).
- Do not use any coolant additive.

If the vehicle becomes stuck

Carry out the following procedures if the tires spin or the vehicle becomes stuck in mud, dirt or snow:

- 1 Set the parking brake and shift the shift position to P. Stop the hybrid system.
- 2 Remove the mud, snow or sand from around the stuck tire.
- 3 Place wood, stones or some other material under the tires to help provide traction.
- 4 Restart the hybrid system.
- 5 Shift the shift position to D or R, release the parking brake and carefully apply the accelerator to free the vehicle.

■ When it is difficult to free the vehicle

Press  to turn off TRAC. (→P. 236)

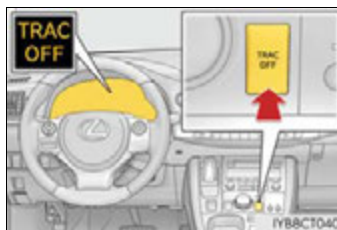

⚠ WARNING

■ When attempting to free a stuck vehicle

If you choose to push the vehicle back and forth to free it, make sure the surrounding area is clear to avoid striking other vehicles, objects or people. The vehicle may also lunge forward or lunge back suddenly as it becomes free. Use extreme caution.

■ When changing the shift position

Be careful not to change the shift position with the accelerator pedal depressed. Changing the shift position to any positions other than P or N may cause the vehicle to accelerate abruptly, causing an accident and resulting in death or serious injury.

⚠ NOTICE

■ To avoid damage to the hybrid transmission and other components

- Avoid spinning the wheels and depressing the accelerator pedal more than necessary.
- If the vehicle remains stuck even after these procedures are performed, the vehicle may require towing to be freed.

Vehicle specifications

9

571

9-1. Specifications

| | |
|--|-----|
| Maintenance data (fuel, oil level, etc.)..... | 572 |
| Fuel information..... | 580 |
| Tire information..... | 582 |

9-2. Customization

| | |
|-----------------------------|-----|
| Customizable features | 591 |
|-----------------------------|-----|

9-3. Initialization

| | |
|---------------------------|-----|
| Items to initialize | 599 |
|---------------------------|-----|

Maintenance data (fuel, oil level, etc.)

Dimensions and weight

| | | |
|---|---------------------|--------------------|
| Overall length | 171.3 in. (4350 mm) | |
| Overall width | 69.5 in. (1765 mm) | |
| Overall height* | 57.3 in. (1455 mm) | |
| Wheelbase | 102.4 in. (2600 mm) | |
| Tread | Front | 60.0 in. (1525 mm) |
| | Rear | 59.8 in. (1520 mm) |
| Vehicle capacity weight (Occupants + luggage) | 825 lb. (370 kg) | |

*: Unladen vehicle

Vehicle identification

■ Vehicle identification number

The vehicle identification number (VIN) is the legal identifier for your vehicle. This is the primary identification number for your Lexus. It is used in registering the ownership of your vehicle.

This number is stamped on the top left of the instrument panel.



This number is also on the Certification label.

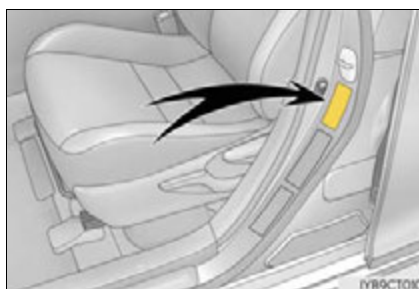

This number is also stamped under the right-hand front seat.

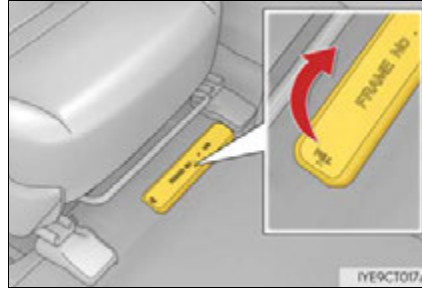

■ **Engine number**

The engine number is stamped on the engine block as shown.

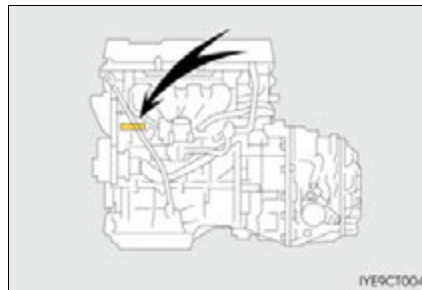

Engine

| | |
|-------------------------------|---------------------------------------|
| Model | 1.8 L 4-cylinder (2ZR-FXE) |
| Type | 4-cylinder in line, 4-cycle, gasoline |
| Bore and stroke | 3.17 × 3.48 in. (80.5 × 88.3 mm) |
| Displacement | 109.7 cu.in. (1798 cm ³) |
| Valve clearance (engine cold) | Automatic adjustment |

Fuel

| | |
|--------------------------------|--|
| Fuel type | Unleaded gasoline only |
| Octane Rating | 87 (Research Octane Number 91) or higher |
| Fuel tank capacity (Reference) | 11.9 gal. (45 L, 9.9 Imp.gal.) |

Electric motor (traction motor)

| | |
|----------------|----------------------------------|
| Type | Permanent magnet motor |
| Maximum output | 60 kW |
| Maximum torque | 153 ft•lbf (207 N•m, 21.1 kgf•m) |

Hybrid battery (traction battery)

| | |
|-----------------|------------------------------|
| Type | Nickel-Metal hydride battery |
| Voltage | 7.2 V/module |
| Capacity | 6.5 Ah (3HR) |
| Quantity | 28 modules |
| Overall voltage | 201.6 V |

Lubrication system

| | |
|--|------------------------------|
| Oil capacity (Drain and refill – reference *) | |
| With filter | 4.4 qt. (4.2 L, 3.7 Imp.qt.) |
| Without filter | 4.1 qt. (3.9 L, 3.4 Imp.qt.) |

*: The engine oil capacity is a reference quantity to be used when changing the engine oil. Warm up the engine and turn off the hybrid system, wait more than 5 minutes, and check the oil level on the dipstick.

■ Engine oil selection

“Toyota Genuine Motor Oil” is used in your Lexus vehicle. Use Lexus approved “Toyota Genuine Motor Oil” or equivalent to satisfy the following grade and viscosity.

Oil grade: ILSAC GF-5 multigrade engine oil

Recommended viscosity: SAE 0W-20

SAE 0W-20 is the best choice for good fuel economy and good starting in cold weather.

If SAE 0W-20 is not available, SAE 5W-20 oil may be used. However, it must be replaced with SAE 0W-20 at the next oil change.

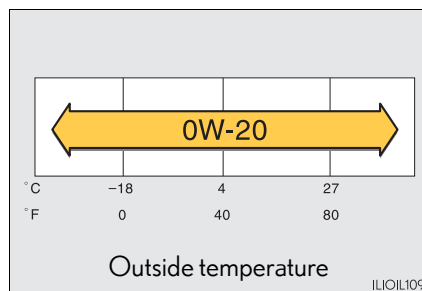

Oil viscosity (0W-20 is explained here as an example):

- The 0W in 0W-20 indicates the characteristic of the oil which allows cold startability. Oils with a lower value before the W allow for easier starting of the engine in cold weather.
- The 20 in 0W-20 indicates the viscosity characteristic of the oil when the oil is at high temperature. An oil with a higher viscosity (one with a higher value) may be better suited if the vehicle is operated at high speeds, or under extreme load conditions.

How to read oil container label:

The International Lubricant Specification Advisory Committee (ILSAC) Certification Mark is added to some oil containers to help you select the oil you should use.



Cooling system

| | | |
|--------------|--------------------|--|
| Capacity | Gasoline engine | <ul style="list-style-type: none"> ▶ Without exhaust heat recirculator system 6.9 qt. (6.5 L, 5.7 Imp.qt.) ▶ With an exhaust heat recirculator system 7.3 qt. (6.9 L, 6.1 Imp.qt.) |
| | Power control unit | 2.2 qt. (2.1 L, 1.8 Imp.qt.) |
| Coolant type | | Use either of the following: <ul style="list-style-type: none"> • "Toyota Super Long Life Coolant" • Similar high-quality ethylene glycol-based non-silicate, non-amine, non-nitrite, and non-borate coolant with long-life hybrid organic acid technology Do not use plain water alone. |

Ignition system (spark plug)

| | |
|------|--------------------------|
| Make | DENSO SC20HR11, SC16HR11 |
| Gap | 0.043 in. (1.1 mm) |

 NOTICE

■ **Iridium-tipped spark plugs**

Use only iridium-tipped spark plugs. Do not adjust the spark plug gap.

Electrical system

| | |
|------------------------------|--|
| 12-volt battery | |
| Open voltage at 68°F (20°C): | 12.0 V or higher If the voltage is lower than the standard value, charge the battery. (Voltage is checked 20 minutes after the hybrid system and all lights are turned off.) |
| Charging rates | 4.2 A max. |

Hybrid transmission

| | |
|-----------------|------------------------------|
| Fluid capacity* | 3.6 qt. (3.4 L, 3.0 Imp.qt.) |
| Fluid type | Toyota Genuine ATF WS |

*: The fluid capacity is the quantity of reference.
If replacement is necessary, contact your Lexus dealer.

 NOTICE

■ **Hybrid transmission fluid type**

Using transmission fluid other than “Toyota Genuine ATF WS” may cause deterioration in shift quality, locking up of your transmission accompanied by vibration, and ultimately damage the transmission of your vehicle.

Brakes

| | |
|--|--|
| Pedal clearance ^{*1} | <ul style="list-style-type: none"> ▶ Without an aluminum pedal 3.03 in. (77mm) Min. ▶ With an aluminum pedal 3.11 in. (79 mm) Min. |
| Pedal free play | 0.04 – 0.24 in. (1.0 – 6.0 mm) |
| Brake pad wear limit | 0.04 in. (1.0 mm) |
| Parking brake lining wear limit | 0.04 in. (1.0 mm) |
| Parking brake pedal travel ^{*2} | 8 – 11 clicks |
| Fluid type | FMVSS No. 116 DOT 3 or SAE J1703 |

*1: Minimum pedal clearance when depressed with a force of 44.1 lbf (196 N, 20.0 kgf) while the hybrid system is operating.

*2: Parking brake pedal travel when depressed with a force of 67.5 lbf (300 N, 30.6 kgf).

Steering

| | |
|-----------|---------------------------|
| Free play | Less than 1.2 in. (30 mm) |
|-----------|---------------------------|

Tires and wheels

▶ Type A

| | |
|--|---|
| Tire size | 205/55R16 91V |
| Tire inflation pressure (Recommended cold tire inflation pressure) | <ul style="list-style-type: none"> ▶ Front tire 32 psi (220 kPa, 2.2 kgf/cm² or bar) ▶ Rear tire 32 psi (220 kPa, 2.2 kgf/cm² or bar) |
| Wheel size | 16 × 6 J |
| Wheel nut torque | 76 ft•lbf (103 N•m, 10.5 kgf•m) |

▶ Type B

| | |
|---|---|
| Tire size | P205/55R16 89H |
| Tire inflation pressure (Recommended cold tire inflation pressure) | <ul style="list-style-type: none"> ▶ Front tire 32 psi (220 kPa, 2.2 kgf/cm² or bar) ▶ Rear tire 32 psi (220 kPa, 2.2 kgf/cm² or bar) |
| Wheel size | 16 × 6 J |
| Wheel nut torque | 76 ft•lbf (103 N•m, 10.5 kgf•m) |

▶ Type C

| | |
|---|---|
| Tire size | P215/45R17 87V |
| Tire inflation pressure (Recommended cold tire inflation pressure) | <ul style="list-style-type: none"> ▶ Front tire 33 psi (230 kPa, 2.3 kgf/cm² or bar) ▶ Rear tire 32 psi (220 kPa, 2.2 kgf/cm² or bar) |
| Wheel size | 17 × 7 J |
| Wheel nut torque | 76 ft•lbf (103 N•m, 10.5 kgf•m) |

▶ Compact spare tire

| | |
|---|--|
| Tire size | T125/70D17 98M |
| Spare tire inflation pressure (Recommended cold tire inflation pressure) | 60 psi (420 kPa, 4.2 kgf/cm ² or bar) |
| Wheel size | 17 × 4 T |
| Wheel nut torque | 76 ft•lbf (103 N•m, 10.5 kgf•m) |

Light bulbs

| | Light bulbs | Bulb No. | W | Type |
|----------|--|----------|----------|--------|
| Exterior | Headlights Low beam (halogen bulbs)* High beam | — — | 55 65 | A B |
| | Fog lights (halogen bulbs)* | — | 19 | C |
| | Front turn signal lights | 7444NA | 28/8 | D |
| | Rear turn signal lights | WY21W | 21 | D |
| | Back-up lights | W16W | 16 | E |
| | Outer foot lights | W5W | 5 | E |
| Interior | Personal/interior lights | — | 5 | E |
| | Rear interior lights | — | 8 | F |
| | Vanity lights | — | 8 | E |
| | Luggage compartment light | — | 5 | E |

A: H11 halogen bulbs

B: H9 halogen bulbs

C: H16 halogen bulbs

D: Wedge base bulbs (amber)

E: Wedge base bulbs (clear)

F: Double end bulbs

*: If equipped

Fuel information

You must only use unleaded gasoline in your vehicle.

Select octane rating 87 (Research Octane Number 91) or higher. Use of unleaded gasoline with an octane rating lower than 87 may result in engine knocking. Persistent knocking can lead to engine damage.

At minimum, the gasoline you use should meet the specifications of ASTM D4814 in the U.S.A..

■ Gasoline quality

In very few cases, driveability problems may be caused by the brand of gasoline you are using. If driveability problems persist, try changing the brand of gasoline. If this does not correct the problem, consult your Lexus dealer.

■ If your engine knocks

- Consult your Lexus dealer.
- You may occasionally notice light knocking for a short time while accelerating or driving uphill. This is normal and there is no need for concern.

■ Gasoline quality standards

- Automotive manufacturers in the U.S.A., Europe and Japan have developed a specification for fuel quality called the World-Wide Fuel Charter (WWFC), which is expected to be applied worldwide.
- The WWFC consists of four categories that are based on required emission levels. In the U.S., category 4 has been adopted.
- The WWFC improves air quality by lowering emissions in vehicle fleets, and improves customer satisfaction through better performance.

■ Recommendation of the use of gasoline containing detergent additives

- Lexus recommends the use of gasoline that contains detergent additives to avoid the build-up of engine deposits.
- All gasoline sold in the U.S.A. contains minimum detergent additives to clean and/or keep clean intake systems, per EPA's lowest additives concentration program.
- Lexus strongly recommends the use of Top Tier Detergent Gasoline. For more information on Top Tier Detergent Gasoline and a list of marketers, please go to the official website www.toptiergas.com.

■ Recommendation of the use of low emissions gasoline

Gasolines containing oxygenates such as ethers and ethanol, as well as reformulated gasolines, are available in some cities. These fuels are typically acceptable for use, providing they meet other fuel requirements.

Lexus recommends these fuels, since the formulations allow for reduced vehicle emissions.

■ **Non-recommendation of the use of blended gasoline**

- Use only gasoline containing up to 15% ethanol.
DO NOT use any flex-fuel or gasoline that could contain more than 15% ethanol, including from any pump labeled E30, E50, E85 (which are only some examples of fuel containing more than 15% ethanol).

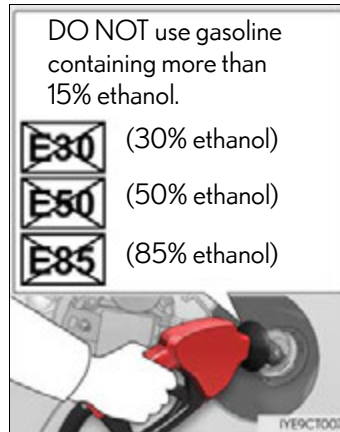

- If you use gasohol in your vehicle, be sure that it has an octane rating no lower than 87.
- Lexus does not recommend the use of gasoline containing methanol.

■ **Non-recommendation of the use of gasoline containing MMT**

Some gasoline contains an octane enhancing additive called MMT (Methylcyclopentadienyl Manganese Tricarbonyl).

Lexus does not recommend the use of gasoline that contains MMT. If fuel containing MMT is used, your emission control system may be adversely affected.

The malfunction indicator lamp on the instrument cluster may come on. If this happens, contact your Lexus dealer for service.

 **NOTICE**

■ **Notice on fuel quality**

- Do not use improper fuels. If improper fuels are used, the engine will be damaged.
- Do not use leaded gasoline.
Leaded gasoline can cause damage to your vehicle's three-way catalytic converters causing the emission control system to malfunction.
- Do not use gasohol other than the type previously stated.
Other gasohol may cause fuel system damage or vehicle performance problems.
- Using unleaded gasoline with an octane number or rating lower than the level previously stated will cause persistent heavy knocking.
At worst, this will lead to engine damage.

■ **Fuel-related poor driveability**

If poor driveability is encountered after using a different type of fuel (poor hot starting, vaporization, engine knocking, etc.), discontinue the use of that type of fuel.

■ **When refueling with gasohol**

Take care not to spill gasohol. It can damage your vehicle's paint.

Tire information

Typical tire symbols

► Full-size tire

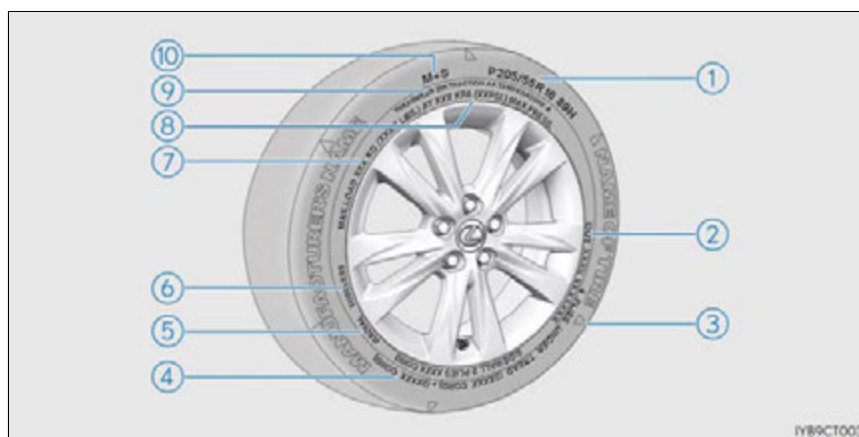

► Compact spare tire

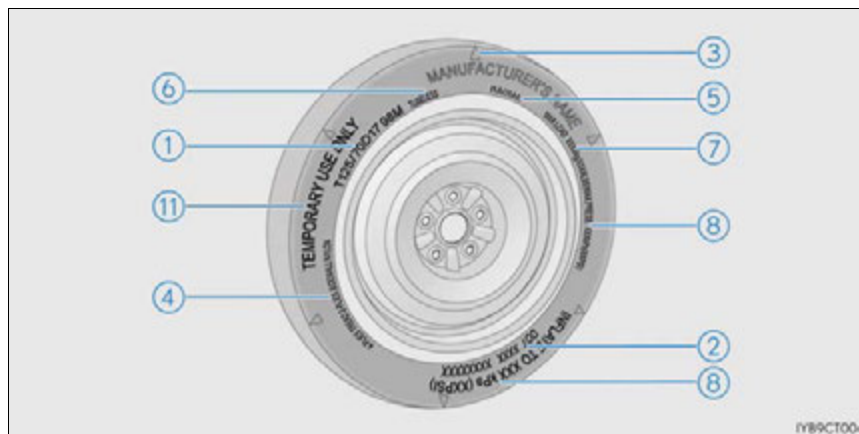

- ① Tire size (→P. 584)
- ② DOT and Tire Identification Number (TIN) (→P. 583)
- ③ Location of treadwear indicators (→P. 490)
- ④ Tire ply composition and materials
 Plies are layers of rubber-coated parallel cords. Cords are the strands which form the plies in a tire.
- ⑤ Radial tires or bias-ply tires
 A radial tire has "RADIAL" on the sidewall. A tire not marked "RADIAL" is a bias-ply tire.
- ⑥ TUBELESS or TUBE TYPE
 A tubeless tire does not have a tube and air is directly put into the tire. A tube type tire has a tube inside the tire and the tube maintains the air pressure.
- ⑦ Load limit at maximum cold tire inflation pressure (→P. 493)
- ⑧ Maximum cold tire inflation pressure (→P. 577)
 This means the pressure to which a tire may be inflated.
- ⑨ Uniform tire quality grading
 For details, see "Uniform Tire Quality Grading" that follows.
- ⑩ Summer tires or all season tires (→P. 493)
 An all season tire has "M+S" on the sidewall. A tire not marked "M+S" is a summer tire.
- ⑪ "TEMPORARY USE ONLY"
 A compact spare tire is identified by the phrase "TEMPORARY USE ONLY" molded on its sidewall. This tire is designed for temporary emergency use only.

Typical DOT and Tire Identification Number (TIN)

- ① DOT symbol*
- ② Tire Identification Number (TIN)
- ③ Tire manufacturer's identification mark
- ④ Tire size code
- ⑤ Manufacturer's optional tire type code (3 or 4 letters)
- ⑥ Manufacturing week
- ⑦ Manufacturing year

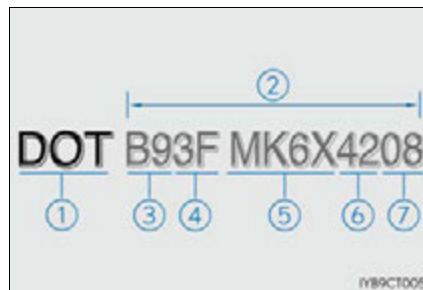

*: The DOT symbol certifies that the tire conforms to applicable Federal Motor Vehicle Safety Standards.

Tire size

■ Typical tire size information

The illustration indicates typical tire size.

- ① Tire use
(P = Passenger car,
T = Temporary use)
- ② Section width (millimeters)
- ③ Aspect ratio
(tire height to section width)
- ④ Tire construction code (R = Radial, D = Diagonal)
- ⑤ Wheel diameter (inches)
- ⑥ Load index (2 digits or 3 digits)
- ⑦ Speed symbol (alphabet with one letter)

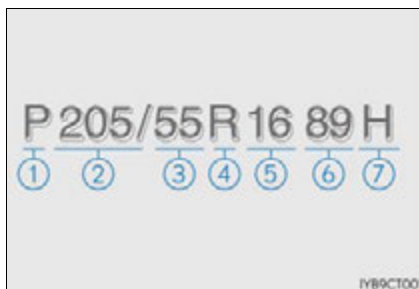

■ Tire dimensions

- ① Section width
- ② Tire height
- ③ Wheel diameter



Tire section names

- ① Bead
- ② Sidewall
- ③ Shoulder
- ④ Tread
- ⑤ Belt
- ⑥ Inner liner
- ⑦ Reinforcing rubber
- ⑧ Carcass
- ⑨ Rim lines
- ⑩ Bead wires
- ⑪ Chafer

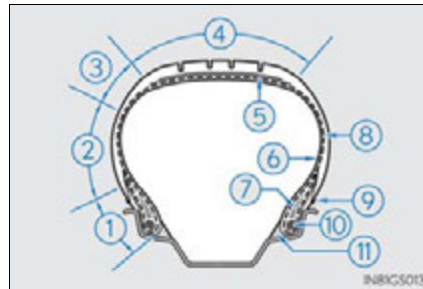

Uniform Tire Quality Grading

This information has been prepared in accordance with regulations issued by the National Highway Traffic Safety Administration of the U.S. Department of Transportation.

It provides the purchasers and/or prospective purchasers of Lexus vehicles with information on uniform tire quality grading.

Your Lexus dealer will help answer any questions you may have as you read this information.

■ DOT quality grades

All passenger vehicle tires must conform to Federal Safety Requirements in addition to these grades. Quality grades can be found where applicable on the tire sidewall between tread shoulder and maximum section width.

For example: Treadwear 200 Traction AA Temperature A

■ Treadwear

The treadwear grade is a comparative rating based on the wear rate of the tire when tested under controlled conditions on a specified government test course.

For example, a tire graded 150 would wear one and a half (1 - 1/2) times as well on the government course as a tire graded 100.

The relative performance of tires depends upon the actual conditions of their use. Performance may differ significantly from the norm due to variations in driving habits, service practices and differences in road characteristics and climate.

■ **Traction AA, A, B, C**

The traction grades, from highest to lowest, are AA, A, B and C, and they represent the tire's ability to stop on wet pavement as measured under controlled conditions on specified government test surfaces of asphalt and concrete.

A tire marked C may have poor traction performance.

Warning: The traction grade assigned to this tire is based on braking (straight ahead) traction tests and does not include cornering (turning) traction.

■ **Temperature A, B, C**

The temperature grades are A (the highest), B, and C, representing the tire's resistance to the generation of heat and its ability to dissipate heat when tested under controlled conditions on a specified indoor laboratory test wheel.

Sustained high temperature can cause the material of the tire to degenerate and reduce tire life, and excessive temperature can lead to sudden tire failure.

Grade C corresponds to a level of performance which all passenger car tires must meet under the Federal Motor Vehicle Safety Standard No. 109.

Grades B and A represent higher levels of performance on the laboratory test wheel than the minimum required by law.

Warning: The temperature grades of a tire assume that it is properly inflated and not overloaded.

Excessive speed, underinflation, or excessive loading, either separately or in combination, can cause heat buildup and possible tire failure.

Glossary of tire terminology

| Tire related term | Meaning |
|--------------------------------|---|
| Cold tire inflation pressure | Tire pressure when the vehicle has been parked for three hours or more, or has not been driven more than 1 mile or 1.5 km under that condition |
| Maximum inflation pressure | The maximum cold inflated pressure to which a tire may be inflated, shown on the sidewall of the tire |
| Recommended inflation pressure | Cold tire inflation pressure recommended by a manufacturer |
| Accessory weight | The combined weight (in excess of those standard items which may be replaced) of automatic transmission, power steering, power brakes, power windows, power seats, radio and heater, to the extent that these items are available as factory-installed equipment (whether installed or not) |

| Tire related term | Meaning |
|---|--|
| Curb weight | The weight of a motor vehicle with standard equipment, including the maximum capacity of fuel, oil and coolant, and if so equipped, air conditioning and additional weight optional engine |
| Maximum loaded vehicle weight | The sum of: (a) Curb weight (b) Accessory weight (c) Vehicle capacity weight (d) Production options weight |
| Normal occupant weight | 150 lb. (68 kg) times the number of occupants specified in the second column of Table 1* that follows |
| Occupant distribution | Distribution of occupants in a vehicle as specified in the third column of Table 1* below |
| Production options weight | The combined weight of installed regular production options weighing over 5 lb. (2.3 kg) in excess of the standard items which they replace, not previously considered in curb weight or accessory weight, including heavy duty brakes, ride levelers, roof rack, heavy duty 12-volt battery, and special trim |
| Rim | A metal support for a tire or a tire and tube assembly upon which the tire beads are seated |
| Rim diameter (Wheel diameter) | Nominal diameter of the bead seat |
| Rim size designation | Rim diameter and width |
| Rim type designation | The industry manufacturer's designation for a rim by style or code |
| Rim width | Nominal distance between rim flanges |
| Vehicle capacity weight (Total load capacity) | The rated cargo and luggage load plus 150 lb. (68 kg) times the vehicle's designated seating capacity |
| Vehicle maximum load on the tire | The load on an individual tire that is determined by distributing to each axle its share of the maximum loaded vehicle weight, and dividing by two |
| Vehicle normal load on the tire | The load on an individual tire that is determined by distributing to each axle its share of curb weight, accessory weight, and normal occupant weight (distributed in accordance with Table 1* below), and dividing by two |
| Weather side | The surface area of the rim not covered by the inflated tire |

| Tire related term | Meaning |
|----------------------------|---|
| Bead | The part of the tire that is made of steel wires, wrapped or reinforced by ply cords and that is shaped to fit the rim |
| Bead separation | A breakdown of the bond between components in the bead |
| Bias ply tire | A pneumatic tire in which the ply cords that extend to the beads are laid at alternate angles substantially less than 90 degrees to the centerline of the tread |
| Carcass | The tire structure, except tread and sidewall rubber which, when inflated, bears the load |
| Chunking | The breaking away of pieces of the tread or sidewall |
| Cord | The strands forming the plies in the tire |
| Cord separation | The parting of cords from adjacent rubber compounds |
| Cracking | Any parting within the tread, sidewall, or innerliner of the tire extending to cord material |
| CT | A pneumatic tire with an inverted flange tire and rim system in which the rim is designed with rim flanges pointed radially inward and the tire is designed to fit on the underside of the rim in a manner that encloses the rim flanges inside the air cavity of the tire |
| Extra load tire | A tire designed to operate at higher loads and at higher inflation pressures than the corresponding standard tire |
| Groove | The space between two adjacent tread ribs |
| Innerliner | The layer(s) forming the inside surface of a tubeless tire that contains the inflating medium within the tire |
| Innerliner separation | The parting of the innerliner from cord material in the carcass |
| Intended outboard sidewall | (a) The sidewall that contains a whitewall, bears white lettering, or bears manufacturer, brand, and/or model name molding that is higher or deeper than the same molding on the other sidewall of the tire, or (b) The outward facing sidewall of an asymmetrical tire that has a particular side that must always face outward when mounted on a vehicle |
| Light truck (LT) tire | A tire designated by its manufacturer as primarily intended for use on lightweight trucks or multipurpose passenger vehicles |
| Load rating | The maximum load that a tire is rated to carry for a given inflation pressure |

| Tire related term | Meaning |
|--|---|
| Maximum load rating | The load rating for a tire at the maximum permissible inflation pressure for that tire |
| Maximum permissible inflation pressure | The maximum cold inflation pressure to which a tire may be inflated |
| Measuring rim | The rim on which a tire is fitted for physical dimension requirements |
| Open splice | Any parting at any junction of tread, sidewall, or innerliner that extends to cord material |
| Outer diameter | The overall diameter of an inflated new tire |
| Overall width | The linear distance between the exteriors of the sidewalls of an inflated tire, including elevations due to labeling, decorations, or protective bands or ribs |
| Passenger car tire | A tire intended for use on passenger cars, multipurpose passenger vehicles, and trucks, that have a gross vehicle weight rating (GVWR) of 10,000 lb. or less. |
| Ply | A layer of rubber-coated parallel cords |
| Ply separation | A parting of rubber compound between adjacent plies |
| Pneumatic tire | A mechanical device made of rubber, chemicals, fabric and steel or other materials, that, when mounted on an automotive wheel, provides the traction and contains the gas or fluid that sustains the load |
| Radial ply tire | A pneumatic tire in which the ply cords that extend to the beads are laid at substantially 90 degrees to the centerline of the tread |
| Reinforced tire | A tire designed to operate at higher loads and at higher inflation pressures than the corresponding standard tire |
| Section width | The linear distance between the exteriors of the sidewalls of an inflated tire, excluding elevations due to labeling, decoration, or protective bands |
| Sidewall | That portion of a tire between the tread and bead |
| Sidewall separation | The parting of the rubber compound from the cord material in the sidewall |
| Snow tire | A tire that attains a traction index equal to or greater than 110, compared to the ASTM E-1136 Standard Reference Test Tire, when using the snow traction test as described in ASTM F-1805-00, Standard Test Method for Single Wheel Driving Traction in a Straight Line on Snow-and Ice-Covered Surfaces, and which is marked with an Alpine Symbol () on at least one sidewall |

| Tire related term | Meaning |
|----------------------------|---|
| Test rim | The rim on which a tire is fitted for testing, and may be any rim listed as appropriate for use with that tire |
| Tread | That portion of a tire that comes into contact with the road |
| Tread rib | A tread section running circumferentially around a tire |
| Tread separation | Pulling away of the tread from the tire carcass |
| Treadwear indicators (TWI) | The projections within the principal grooves designed to give a visual indication of the degrees of wear of the tread |
| Wheel-holding fixture | The fixture used to hold the wheel and tire assembly securely during testing |

*: Table 1— Occupant loading and distribution for vehicle normal load for various designated seating capacities

| Designated seating capacity, Number of occupants | Vehicle normal load, Number of occupants | Occupant distribution in a normally loaded vehicle |
|--|--|---|
| 2 through 4 | 2 | 2 in front |
| 5 through 10 | 3 | 2 in front, 1 in second seat |
| 11 through 15 | 5 | 2 in front, 1 in second seat, 1 in third seat, 1 in fourth seat |
| 16 through 20 | 7 | 2 in front, 2 in second seat, 2 in third seat, 1 in fourth seat |

Customizable features

Your vehicle includes a variety of electronic features that can be personalized to suit your preferences. The settings of these features can be changed using the “DISP” switch, the Remote Touch or Lexus Display Audio controller, or at your Lexus dealer.

Some function settings are changed simultaneously with other functions being customized. Contact your Lexus dealer for further details.

Customizing vehicle features

When customizing vehicle features, ensure that the vehicle is parked in a safe place with the shift position in P and the parking brake set.

■ Changing using the Remote Touch

- 1 Press the “MENU” button on the Remote Touch.
- 2 Select “Setup” on the “Menu” screen and select “Vehicle”.

Various setting can be changed. Refer to the list of settings that can be changed for details.

■ Changing using the Lexus Display Audio controller

- 1 Press the “MENU” button on the Lexus Display Audio controller.
- 2 Select “Setup” on the “Menu” screen and select “Vehicle”.

Various setting can be changed. Refer to the list of settings that can be changed for details.

■ Changing using the “DISP” switch

- 1 Press the “DISP” switch to display the “SETTINGS” screen while the vehicle is stopped, and then press and hold the “DISP” switch to display the customize mode screen.
- 2 Press the “DISP” switch and select the item, and then press and hold the “DISP” switch.
- 3 Press the “DISP” switch and select the desired setting, and then press and hold the “DISP” switch.

To go back to the previous screen or exit the customize mode, press the “DISP” switch to select the “EXIT”, and then press and hold the “DISP” switch.

Customizable Features

- ① Vehicles with a navigation system or Lexus Display Audio system: Settings that can be changed using the screen of the Remote Touch or Lexus Display Audio controller
- ② Vehicles with a navigation system or Lexus Display Audio system: Settings that can be changed using the “DISP” switch
- ③ Vehicles without a navigation system or Lexus Display Audio system: Settings that can be changed using the “DISP” switch
- ④ Settings that can be changed by your Lexus dealer

Definition of symbols: ○ = Available, - =Not available

■ **Door lock (→P.105, 560)**

| Function | Default setting | Customized setting | ① | ② | ③ | ④ |
|---|---|---|---|---|---|---|
| Unlocking on second key turn | On (Driver's door unlocked in first step, all doors unlocked in second step) | Off (All doors unlocked in first step) | - | - | - | ○ |
| Speed linked door locking function | Off | On | ○ | - | ○ | ○ |
| Shift position linked door locking function | On | Off | ○ | - | ○ | ○ |
| Shift position linked door unlocking function | On | Off | ○ | - | ○ | ○ |
| Driver's door linked door unlocking function | Off | On | ○ | - | ○ | ○ |

■ Smart access system with push-button start and wireless remote control (→P. 114, 100)

| Function | Default setting | Customized setting | ① | ② | ③ | ④ |
|--|-----------------|--------------------|-----------------------|---|-----------------------|-----------------------|
| Operation signal (buzzer) | 7 | Off | <input type="radio"/> | - | <input type="radio"/> | <input type="radio"/> |
| | | 1 to 6 | | | | |
| Operation signal (emergency flashers) | On | Off | <input type="radio"/> | - | <input type="radio"/> | <input type="radio"/> |
| Time elapsed before the automatic door lock function is activated if a door is not opened after being unlocked | 60 seconds | Off | | | | |
| | | 30 seconds | <input type="radio"/> | - | <input type="radio"/> | <input type="radio"/> |
| | | 120 seconds | | | | |
| Open door reminder buzzer (When locking the vehicle) | On | Off | - | - | - | <input type="radio"/> |

■ Smart access system with push-button start (→P. 114)

| Function | Default setting | Customized setting | ① | ② | ③ | ④ |
|--|-----------------|--------------------|-----------------------|---|-----------------------|-----------------------|
| Smart door unlocking | Driver's door | All the doors | <input type="radio"/> | - | <input type="radio"/> | <input type="radio"/> |
| Smart access system with push-button start | On | Off | <input type="radio"/> | - | <input type="radio"/> | <input type="radio"/> |
| Number of consecutive door lock operations | 2 times | As many as desired | - | - | - | <input type="radio"/> |

■ Wireless remote control (→P.100)

| Function | Default setting | Customized setting | ① | ② | ③ | ④ |
|-------------------------|---|----------------------------------|---|---|---|---|
| Wireless remote control | On | Off | - | - | - | ○ |
| Unlocking operation | Driver's door unlocked in first step, all doors unlocked in second step | All doors unlocked in first step | ○ | - | ○ | ○ |
| Panic function | On | Off | - | - | - | ○ |

■ Turn signal lever (→P.167)

| Function | Default setting | Customized setting | ① | ② | ③ | ④ |
|--|-----------------|--------------------|---|---|---|---|
| Times of flashing of the lane change signal flashers | 3 | 5 | ○ | - | - | ○ |
| | | 7 | | | | |
| | | 9 | | | | |
| | | 11 | | | | |
| | | Off | | | | |

■ Automatic light control system (→P.169)

| Function | Default setting | Customized setting | ① | ② | ③ | ④ |
|---|-----------------|--------------------|---|---|---|---|
| Time elapsed before the headlights turn off | 30 seconds | Off | ○ | - | ○ | ○ |
| | | 60 seconds | | | | |
| | | 90 seconds | | | | |
| Light sensor sensitivity | Standard | -2 to 2 | ○ | - | ○ | ○ |
| Daytime running lights* | On | Off | ○ | - | ○ | ○ |
| Welcome light illumination control | On | Off | - | - | - | ○ |

*: This function cannot be customized for vehicles sold in Canada.

■ Illumination (→P. 427)

| Function | Default setting | Customized setting | ① | ② | ③ | ④ |
|--|-----------------|--------------------|---|---|---|---|
| Time elapsed before the interior lights turn off | 15 seconds | Off | | | | |
| | | 7.5 seconds | ○ | - | ○ | ○ |
| | | 30 seconds | | | | |
| Time elapsed before the exterior lights turn off | 15 seconds | Off | | | | |
| | | 7.5 seconds | ○ | - | ○ | ○ |
| | | 30 seconds | | | | |
| Operation after the power switch is turned off | On | Off | - | - | - | ○ |
| Operation when the doors are unlocked with the smart access system with push-button start or the wireless remote control function or the mechanical key* | On | Off | - | - | - | ○ |
| Operation when you approach the vehicle with the electronic key on your person* | On | Off | - | - | - | ○ |
| Footwell lighting | On | Off | - | - | - | ○ |
| Cup holder light | On | Off | - | - | - | ○ |
| Enable/disable operation of the outer foot lights when the doors are unlocked with the power door lock switch | On | Off | - | - | - | ○ |

*: Interior or exterior illumination can be set separately.

■ Instrument cluster (→P. 84, 88)

| Function | Default setting | Customized setting | ① | ② | ③ | ④ |
|--|-------------------|----------------------------------|---|---|---|---|
| Display of the tachometer and Hybrid System Indicator | Auto | Hybrid system indicator (always) | - | ○ | ○ | ○ |
| | | Tachometer (always) | | | | |
| Eco lamp | Eco drive support | On (always) | - | ○ | ○ | ○ |
| | | Off | | | | |
| Sport lamp | On | Off | - | ○ | ○ | ○ |
| Brightness of Eco lamp and sport lamp | Standard | Bright | - | ○ | ○ | ○ |
| EV indicator | Auto | Off | - | ○ | ○ | ○ |
| Language | English | French | - | ○ | ○ | ○ |
| | | Spanish | | | | |
| Units (except for Canada) | miles (MPG) | km (km/L) | - | ○ | ○ | ○ |
| | | km (L/100km) | | | | |
| Units (For Canada) | km (L/100km) | km (km/L) | - | ○ | ○ | ○ |
| | | miles (MPG) | | | | |
| Sensitivity of the ambient light sensor used for dimming the meter light etc.* | Standard | -2 to 2 | - | - | - | ○ |
| Sensitivity of the ambient light sensor used for brightening the meter light etc.* | Standard | -2 to 2 | - | - | - | ○ |

*: If equipped

■ Automatic air conditioning system (→P. 410, 418)

| Function | Default setting | Customized setting | ① | ② | ③ | ④ |
|---|-----------------|--------------------|---|---|---|---|
| A/C Auto switch operation | Off | On | ○ | - | ○ | ○ |
| Heating/cooling operation minimized in Eco drive mode | On | Off | - | - | - | ○ |

■ Power windows (→P. 137)

| Function | Default setting | Customized setting | ① | ② | ③ | ④ |
|--|-----------------|--------------------|---|---|---|---|
| Mechanical key linked operation (close) | Off | On | - | - | - | ○ |
| Mechanical key linked operation (open) | Off | On | - | - | - | ○ |
| Wireless remote control linked operation (open) | Off | On (Open only) | - | - | - | ○ |
| Buzzer sounds if operated using wireless remote control* | On | Off | - | - | - | ○ |

*: This function cannot be customized unless power window operation using the wireless remote control is enabled.

■ Intuitive parking assist* (→P. 202)

| Function | Default setting | Customized setting | ① | ② | ③ | ④ |
|---|-----------------|--------------------|---|---|---|---|
| Alert Volume (Alert volume can be adjusted) | 3 | 1 to 5 | ○ | - | - | ○ |
| Display (Automatic display off the LEXUS Park Assist graphic can be enabled/disabled) | On | Off | ○ | - | - | ○ |
| Distance (Distance mode can be selected) | Long | Short | ○ | - | - | ○ |

*: If equipped

■ Seat belt reminder (→P. 531)

| Function | Default setting | Customized setting | ① | ② | ③ | ④ |
|--|-----------------|--------------------|---|---|---|---|
| Vehicle speed linked seat belt reminder buzzer | On | Off | - | - | - | ○ |

■ Reverse warning buzzer (→P. 164)

| Function | Default setting | Customized setting | ① | ② | ③ | ④ |
|---|-----------------|--------------------|---|---|---|---|
| Signal (buzzer) when the shift position is in R | Intermittent | Single | - | - | - | ○ |

■ Vehicle customization

- When the Speed linked door locking function and the Shift position linked door locking function are both on, the door lock operates as follows.
 - When shifting the shift position to any position other than P, all the doors will be locked.
 - If the vehicle is started with all the doors locked, the Speed linked door locking function would not operate.
 - If the vehicle is started with any door unlocked, the Speed linked door locking function will operate.
 - When the smart access system with push-button start is off, Smart door unlocking cannot be customized.
 - When the doors remain closed after unlocking the doors and the automatic door lock function is activated, the signals will be generated in accordance with the operation signal (buzzer) and the operation signal (emergency flashers) settings.
- In the following situations, customize mode in which the settings can be changed through the “DISP” switch will automatically be turned off.
- A warning message appears after the customize mode screen is displayed.
 - The power switch is turned off.
 - The vehicle begins to move while the customize mode screen is displayed.

⚠ WARNING

■ **Cautions during customization**

As the hybrid system needs to be operating during customization, ensure that the vehicle is parked in a place with adequate ventilation. In a closed area such as a garage, exhaust gases including harmful carbon monoxide (CO) may collect and enter the vehicle. This may lead to death or a serious health hazard.

⚠ NOTICE

■ **During customization**

To prevent 12-volt battery discharge, ensure that the hybrid system is operating while customizing features.

Items to initialize

The following items must be initialized for normal system operation after such cases as the 12-volt battery being reconnected, or maintenance being performed on the vehicle.

| Item | When to initialize | Reference |
|--|--|-----------|
| Message indicating maintenance is required | After the maintenance is performed | P. 468 |
| Tire pressure warning system | <ul style="list-style-type: none">• When rotating the tires on vehicles with differing front and rear tire inflation pressures• When changing the tire size | P. 491 |

For owners

10

601

Reporting safety defects for
U.S. owners.....602

Seat belt instructions for
Canadian owners (in French)603

SRS airbag instructions for
Canadian owners (in French)604

Reporting safety defects for U.S. owners

If you believe that your vehicle has a defect which could cause a crash or could cause injury or death, you should immediately inform the National Highway Traffic Safety Administration (NHTSA) in addition to notifying the Lexus Division of Toyota Motor Sales, U.S.A., Inc. (Toll-free: 1-800-25-LEXUS).

If NHTSA receives similar complaints, it may open an investigation, and if it finds that a safety defect exists in a group of vehicles, it may order a recall and remedy campaign. However, NHTSA cannot become involved in individual problems between you, your dealer, or Lexus Division of Toyota Motor Sales, U.S.A., Inc.

To contact NHTSA, you may call the Vehicle Safety Hotline toll-free at 1-888-327-4236 (TTY: 1-800-424-9153); go to <http://www.safercar.gov>; or write to: Administrator, NHTSA, 1200 New Jersey Ave, S.E., Washington, DC 20590. You can also obtain other information about motor vehicle safety from <http://www.safercar.gov>.

Seat belt instructions for Canadian owners (in French)

The following is a French explanation of seat belt instructions extracted from the seat belt section in this manual.

See the seat belt section for more detailed seat belt instructions in English.

Utilisation adéquate des ceintures de sécurité

- Tirez sur la ceinture épaulière jusqu'à ce qu'elle recouvre entièrement l'épaule; elle ne doit cependant pas toucher le cou ni glisser de l'épaule.
- Placez la ceinture abdominale le plus bas possible sur les hanches.
- Réglez la position du dossier. Tenez-vous assis bien au fond du siège, le dos droit.
- Ne vrillez pas la ceinture de sécurité.



Entretien et soin

■ Ceintures de sécurité

Avec un chiffon ou une éponge, nettoyez à l'aide d'un savon doux et de l'eau tiède. Vérifiez aussi les ceintures régulièrement pour vous assurer qu'elles ne présentent pas d'usure excessive, d'effilochage ou de coupures.

▲ AVERTISSEMENT

■ Dommages et usure de la ceinture de sécurité

Vérifiez périodiquement le système de ceintures de sécurité. Vérifiez qu'il n'y a pas de coupures, d'effilochures ni de pièces desserrées. N'utilisez pas une ceinture de sécurité endommagée avant qu'elle ne soit remplacée. Les ceintures de sécurité endommagées ne peuvent pas protéger les occupants contre les blessures graves, voire mortelles.

SRS airbag instructions for Canadian owners (in French)

The following is a French explanation of SRS airbag instructions extracted from the SRS airbag section in this manual.

See the SRS airbag section for more detailed SRS airbag instructions in English.

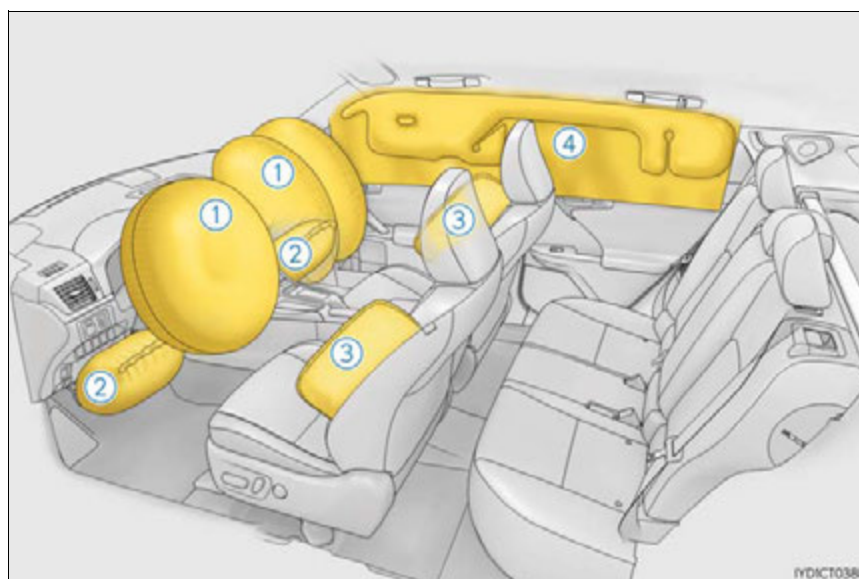

◆ Coussins gonflables SRS avant

- ① Coussin gonflable SRS du conducteur/coussin gonflable SRS du passager avant
Peuvent aider à protéger la tête et la poitrine du conducteur et du passager avant contre les impacts avec des composants intérieurs
- ② Coussins gonflables SRS de protection des genoux
Peuvent aider à protéger le conducteur et le passager avant

◆ Coussins gonflables SRS latéraux et en rideau

- ③ Coussins gonflables SRS latéraux
Peuvent aider à protéger le torse des occupants des sièges avant
- ④ Coussins gonflables SRS en rideau
Peuvent aider à protéger principalement la tête des occupants des sièges latéraux

Composants du système de coussins gonflables SRS

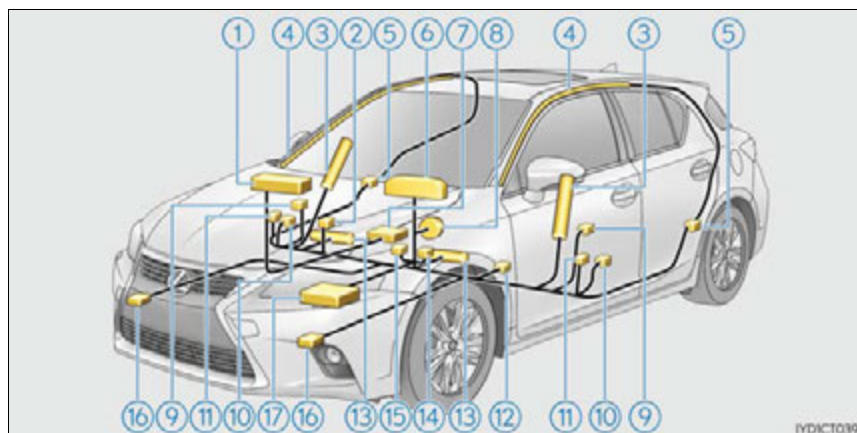

- | | |
|--|--|
| ① Coussin gonflable du passager avant | ⑩ Dispositifs de tension des ceintures de sécurité |
| ② Voyants "AIR BAG ON" et "AIR BAG OFF" | ⑪ Capteurs d'impact latéral (avant) |
| ③ Coussins gonflables latéraux | ⑫ Capteur de position du siège du conducteur |
| ④ Coussins gonflables en rideau | ⑬ Coussins gonflables de protection des genoux |
| ⑤ Capteurs d'impact latéral (arrière) | ⑭ Contacteur de boucle de ceinture de sécurité du conducteur |
| ⑥ Lampe témoin SRS | ⑮ Contacteur de boucle de ceinture de sécurité du passager avant |
| ⑦ Système de classification de l'occupant du siège du passager avant (ECU et capteurs) | ⑯ Capteurs d'impact avant |
| ⑧ Coussin gonflable du conducteur | ⑰ Module de capteur de coussin gonflable |
| ⑨ Capteurs d'impact latéral (avant) | |

Votre véhicule est doté de COUSSINS GONFLABLES ÉVOLUÉS dont la conception s'appuie sur les normes de sécurité des véhicules à moteur américains (FMVSS208). Le module de capteur de coussin gonflable (ECU) contrôle le déploiement des coussins gonflables en fonction des informations obtenues des capteurs et d'autres éléments affichés dans le diagramme des composants du système ci-dessus. Ces informations comprennent des données relatives à la gravité de l'accident et aux occupants. Au moment du déploiement des coussins gonflables, une réaction chimique se produit dans les gonfleurs de coussin gonflable et les coussins gonflables se remplissent rapidement d'un gaz non toxique pour aider à limiter le mouvement des occupants.

AVERTISSEMENT

■ Précautions relatives aux coussins gonflables SRS

Observez les précautions suivantes en ce qui concerne les coussins gonflables SRS. Les négliger pourrait occasionner des blessures graves, voire mortelles.

- Le conducteur et tous les passagers du véhicule doivent porter leur ceinture de sécurité de la manière appropriée.

Les coussins gonflables SRS sont des dispositifs supplémentaires qui doivent être utilisés avec les ceintures de sécurité.

- Le coussin gonflable SRS du conducteur se déploie avec une force considérable et peut occasionner des blessures graves, voire mortelles, notamment lorsque le conducteur se trouve très près du coussin gonflable. La National Highway Traffic Safety Administration (NHTSA), aux États-Unis, fait les recommandations suivantes :

La zone à risque du coussin gonflable du conducteur couvre 2 à 3 in. (50 à 75 mm) de la zone de déploiement du coussin gonflable. Pour assurer une marge de sécurité suffisante, restez à 10 in. (250 mm) du coussin gonflable. Cette distance est mesurée depuis le centre du volant jusqu'à votre sternum. Si maintenant vous vous tenez assis à moins de 10 in. (250 mm), vous pouvez changer votre position de conduite de plusieurs manières :

- Reculez votre siège à la position maximale vous permettant d'atteindre encore aisément les pédales.
- Inclinez légèrement le dossier du siège. Même si les véhicules sont conçus différemment, la plupart des conducteurs peuvent maintenir une distance de 10 in. (250 mm), même si leur siège se trouve complètement vers l'avant, simplement en inclinant un peu le dossier du siège vers l'arrière. Si la visibilité avant est moindre après avoir incliné le dossier de votre siège, utilisez un coussin ferme et non glissant pour être assis plus haut ou relevez le siège si cette option est disponible sur votre véhicule.
- Si votre volant est réglable en hauteur, inclinez-le vers le bas. Cela vous permet d'orienter le coussin gonflable vers votre buste plutôt que vers votre tête et vers votre cou.

Le siège doit être réglé de la manière recommandée ci-dessus par la NHTSA, tout en gardant le contrôle des pédales et du volant, ainsi que la vue sur les commandes du tableau de bord.

AVERTISSEMENT

■ Précautions relatives aux coussins gonflables SRS

- Si la rallonge de ceinture de sécurité a été reliée à la boucle des ceintures de sécurité des sièges avant sans avoir aussi été attachée à la plaque de blocage des ceintures de sécurité, les coussins gonflables SRS avant considéreront que le conducteur et le passager avant portent tout de même leur ceinture de sécurité même si les ceintures de sécurité ne sont pas attachées. Les coussins gonflables SRS avant peuvent alors ne pas s'activer correctement lors d'une collision, ce qui pourrait occasionner des blessures graves, voire mortelles, en cas de collision. Assurez-vous de toujours porter la ceinture de sécurité avec la rallonge de ceinture de sécurité.



- Le coussin gonflable SRS du passager avant se déploie également avec une force considérable et peut occasionner des blessures graves, voire mortelles, notamment lorsque le passager avant se trouve très près du coussin gonflable. Le siège du passager avant doit se trouver le plus loin possible du coussin gonflable et le dossier doit être réglé de manière à ce que le passager avant soit assis bien droit.
- Le déploiement d'un coussin gonflable risque d'infliger des blessures graves, voire mortelles, aux bébés et aux enfants mal assis et/ou mal attachés. Un bébé ou un enfant trop petit pour utiliser une ceinture de sécurité doit être correctement retenu à l'aide d'un dispositif de retenue pour enfants. Lexus recommande vivement de placer et d'attacher correctement tous les bébés et tous les enfants sur les sièges arrière du véhicule à l'aide de dispositifs de retenue adaptés. Les sièges arrière sont plus sécuritaires pour les bébés et les enfants que le siège du passager avant.
- N'installez jamais un dispositif de retenue pour enfants de type dos à la route sur le siège du passager avant, même si le voyant "AIR BAG OFF" est allumé. En cas d'accident, la force et la vitesse de déploiement du coussin gonflable du passager avant pourraient infliger à l'enfant des blessures graves, voire mortelles, si le dispositif de retenue pour enfants de type dos à la route était installé sur le siège du passager avant.

⚠ AVERTISSEMENT**■ Précautions relatives aux coussins gonflables SRS**

- Ne vous asseyez pas sur le bord du siège et ne vous appuyez pas sur la planche de bord.



- Ne laissez pas un enfant se tenir face au coussin gonflable SRS du passager avant ni s'asseoir sur les genoux d'un passager avant.

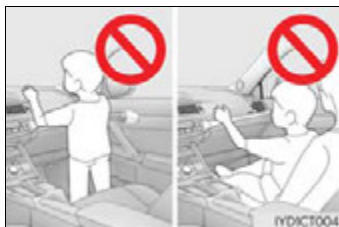

- Ne laissez pas les occupants des sièges avant tenir des objets sur leurs genoux.

- Ne vous appuyez pas sur la portière ou sur le brancard de pavillon, ni sur les montants avant, latéraux ou arrière.



- Ne laissez personne s'agenouiller face à la portière sur le siège du passager ni sortir la tête ou les mains à l'extérieur du véhicule.



AVERTISSEMENT

■ Précautions relatives aux coussins gonflables SRS

- Ne fixez et n'appuyez rien sur des zones telles que la planche de bord, le tampon de volant ou encore la partie inférieure du tableau de bord.

Ces objets peuvent se transformer en projectiles lorsque les coussins gonflables SRS du conducteur, du passager avant ou de protection des genoux se déploient.

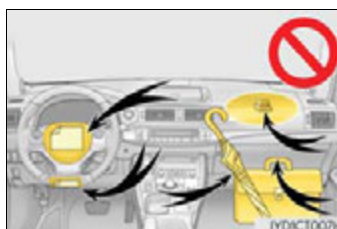

- Ne fixez rien sur des zones telles que les portières, le pare-brise, les glaces de portières, les montants avant ou arrière, le brancard de pavillon et la poignée de maintien.

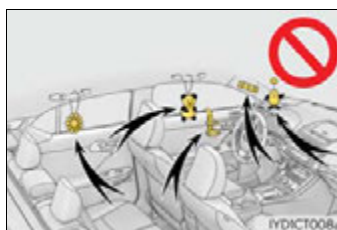

- N'accrochez pas de cintres ni d'autres objets rigides sur les crochets porte-vêtements. Tous ces objets pourraient se transformer en projectiles et vous occasionner des blessures graves, voire mortelles, en cas de déploiement des coussins gonflables SRS en rideau.
- Si un recouvrement de vinyle est placé sur la zone de déploiement du coussin gonflable SRS de protection des genoux, veillez à le retirer.
- N'utilisez pas d'accessoires recouvrant les parties du siège où les coussins gonflables SRS latéraux se déploient, car ces accessoires pourraient entraver le déploiement des coussins gonflables. De tels accessoires peuvent empêcher les coussins gonflables latéraux de se déployer correctement, rendre le système inopérant ou provoquer accidentellement le déploiement des coussins gonflables latéraux, occasionnant des blessures graves, voire mortelles.
- Ne frappez pas et n'appliquez pas une pression importante à l'emplacement des composants des coussins gonflables SRS. Cela peut provoquer un mauvais fonctionnement des coussins gonflables SRS.
- Ne touchez à aucun composant des coussins gonflables SRS immédiatement après leur déploiement (gonflage), car ils pourraient être chauds.

⚠ AVERTISSEMENT**■ Précautions relatives aux coussins gonflables SRS**

- Si vous avez de la difficulté à respirer après le déploiement des coussins gonflables SRS, ouvrez une portière ou une glace pour laisser entrer l'air, ou quittez le véhicule si vous pouvez le faire en toute sécurité. Dès que possible, nettoyez tous les résidus afin d'éviter les irritations cutanées.
- Si les emplacements de stockage des coussins gonflables SRS, tels que le tampon de volant et les garnitures des montants avant et arrière, sont endommagés ou fissurés, faites-les remplacer par votre concessionnaire Lexus.
- Ne placez aucun objet, par exemple un coussin, sur le siège du passager avant. Cela disperserait le poids du passager, ce qui empêcherait le capteur de le détecter correctement. Cela pourrait empêcher le déploiement des coussins gonflables SRS du passager avant en cas de collision.

■ Modification et mise au rebut des composants du système de coussins gonflables SRS

Ne mettez pas votre véhicule au rebut et n'effectuez aucune des modifications suivantes sans d'abord consulter votre concessionnaire Lexus. Les coussins gonflables SRS pourraient fonctionner de manière incorrecte ou se déployer (gonfler) accidentellement, ce qui serait susceptible d'occasionner des blessures graves, voire mortelles.

- Installation, retrait, démontage et réparation des coussins gonflables SRS
- Réparations, modifications, retrait ou remplacement du volant, du tableau de bord, de la planche de bord, des sièges ou du capitonnage des sièges, des montants avant, latéraux et arrière ou des brancards de pavillon
- Réparations ou modifications de l'aile avant, du pare-chocs avant ou du côté de l'habitacle
- Installation d'une protection de calandre (barre safari, barre kangourou, etc.), de lames de déneigement ou de treuils
- Modifications du système de suspension du véhicule
- Installation d'appareils électroniques tels qu'un émetteur-récepteur radio ou un lecteur de CD
- Modifications à votre véhicule pour une personne aux capacités physiques réduites

Index

611

| | |
|--|-----|
| What to do if... (Troubleshooting)..... | 612 |
| Alphabetical index..... | 616 |

For vehicles with a navigation system, refer to the "NAVIGATION SYSTEM OWNER'S MANUAL" for information regarding the equipment listed below.

- Navigation system
- Rear view monitor system
- Audio/visual system

What to do if... (Troubleshooting)

If you have a problem, check the following before contacting your Lexus dealer.

The doors cannot be locked, unlocked, opened or closed



You lose your keys

- If you lose your mechanical keys, new genuine mechanical keys can be made by your Lexus dealer. (→P. 102)
- If you lose your electronic keys, the risk of vehicle theft increases significantly. Contact your Lexus dealer immediately. (→P. 104)



The doors cannot be locked or unlocked

- Is the electronic key battery weak or depleted? (→P. 504)
- Is the power switch in ON mode?
When locking the doors, turn the power switch off. (→P. 157)
- Is the electronic key left inside the vehicle?
When locking the doors, make sure that you have the electronic key on your person.
- The function may not operate properly due to the condition of the radio wave. (→P. 115)



The rear door cannot be opened

- Is the child-protector lock set?
The rear door cannot be opened from inside the vehicle when the lock is set. Open the rear door from outside and then unlock the child-protector lock. (→P. 108)

If you think something is wrong**The hybrid system does not start**

- Did you press the power switch while firmly depressing the brake pedal? (→P. 156)
- Is the shift position in P? (→P. 156)
- Is the electronic key anywhere detectable inside the vehicle? (→P. 114)
- Is the electronic key battery weak or depleted?
In this case, the hybrid system can be started in a temporary way. (→P. 561)
- Is the 12-volt battery discharged? (→P. 562)

**The windows do not open or close by operating the power window switches**

- Is the window lock switch pressed?
The power window except for the one at the driver's seat cannot be operated if the window lock switch is pressed. (→P. 137)

**The power switch is turned off automatically**

- The auto power off function will be operated if the vehicle is left in ACCESSORY or ON mode (the hybrid system is not operating) for a period of time. (→P. 158)

 **A warning buzzer sounds during driving**

- The seat belt reminder light is flashing
Are the driver and the front passenger wearing the seat belts? (→P. 531)
 - The parking brake indicator is on
Is the parking brake released? (→P. 168)
- Depending on the situation, other types of warning buzzer may also sound.
(→P. 529, 536)

 **An alarm is activated and the horn sounds**

- Did anyone inside the vehicle open a door during setting the alarm?
The sensor detects it and the alarm sounds. (→P. 76)
- To stop the alarm, turn the power switch to ON mode or start the hybrid system.

 **A warning buzzer sounds when leaving the vehicle**

- Is the electronic key left inside the vehicle or the moon roof opened?
Check the message on the multi-information display. (→P. 536)

 **A warning light turns on or a warning message is displayed**

- When a warning light turns on or a warning message is displayed, refer to P. 529, 536.

When a problem has occurred**If you have a flat tire**

- Stop the vehicle in a safe place and replace the flat tire with the spare tire.
(→P. 549)

**The vehicle becomes stuck**

- Try the procedure for when the vehicle becomes stuck in mud, dirt, or snow.
(→P. 570)

Alphabetical index

A

- A/C..... 410, 418
 - Air conditioning filter..... 502
 - Automatic air conditioning
 - system 410, 418
 - Micro dust and pollen
 - filter 414, 420
- ABS (Anti-lock Brake System)..... 235
 - Function 235
 - Warning light 530
- Air conditioning filter..... 502
- Air conditioning system..... 410, 418
 - Air conditioning filter..... 502
 - Automatic air conditioning
 - system 410, 418
 - Micro dust and pollen
 - filter 414, 420
- Airbags 38
 - Airbag operating conditions..... 43
 - Airbag precautions for your
 - child 40
 - Airbag warning light..... 530
 - Correct driving posture 30
 - Curtain shield airbag
 - operating conditions..... 44
 - Curtain shield airbag
 - precautions..... 41
 - Front passenger occupant
 - classification system..... 47
 - General airbag precautions..... 40
 - Locations of airbags..... 38
 - Modification and disposal of
 - airbags..... 43
 - Side airbag operating
 - conditions 44
 - Side airbag precautions..... 41
 - Side and curtain shield airbags
 - operating conditions 44
 - Side and curtain shield airbags
 - precautions 41
 - SRS airbag instructions for
 - Canadian owners 604
 - SRS airbags 38
- Alarm 76
 - Alarm 76
 - Warning buzzer..... 529
- Anchor brackets..... 56
- Antenna
 - Radio..... 262, 344, 462
 - Smart access system
 - with push-button start..... 114
- Anti-lock brake system (ABS)..... 235
 - Function..... 235
 - Warning light..... 530
- Approach warning 193
- Assist grips..... 442
- Audio system
 - (with navigation system)*

Audio system (with Lexus Display Audio system) 320

- Antenna 344
- Audio input..... 326
- AUX port..... 326
- Bluetooth® audio 369
- CD player 347
- iPod..... 353
- MP3/WMA disc 347
- Optimal use 335
- Portable music player 360
- Radio 341
- Setup menu..... 328
- Steering wheel audio switches..... 325
- USB memory 356

Audio system (without Lexus Display Audio system) 252

- Antenna 262
- Audio input..... 255
- AUX port..... 255
- Bluetooth® audio 310
- CD player/changer 265
- iPod..... 272
- MP3/WMA disc 265
- Optimal use 257
- Portable music player 255
- Radio 259
- Steering wheel audio switches..... 254
- USB memory 278

Automatic air conditioning system

- Air conditioning filter 502
- Automatic air conditioning system..... 410, 418

Automatic headlight leveling system..... 171

Automatic light control system 171

AUX port 255, 326

Auxiliary boxes 435

B

Back door 110

Back-up lights

- Replacing light bulbs 518
- Wattage 579

Battery (12-volt battery)

- If the 12-volt battery is discharged..... 562
- Preparing and checking before winter..... 246
- Warning light..... 529

Battery (traction battery) 69

Bluetooth® 316, 390

- Audio system..... 310, 369
- Hands-free system (for cellular phone) 284, 371

Bottle holders 430

Brake

- Fluid 577
- Parking brake 168
- Regenerative braking 67
- Warning light..... 529

*: Refer to the "NAVIGATION SYSTEM OWNER'S MANUAL".

Brake assist 235
 Break-in tips..... 145
 Brightness control
 Instrument panel light
 control..... 85

C

Card key 100
 Care
 Aluminum wheels 463
 Exterior..... 462
 Interior 465
 Seat belts..... 465
 Cargo capacity..... 153
 Cargo hooks 434
 CD player 265, 347
 Chains 247
 Child restraint system..... 53
 Booster seats definition 54
 Booster seats installation..... 60
 Convertible seats definition..... 54
 Convertible seats
 installation..... 58, 59
 Front passenger occupant
 classification system 47
 Infant seats definition 54
 Infant seats installation 58
 Installing child restraint system
 with LATCH anchors 57
 Installing child restraint system
 with seat belts 58
 Installing child restraint system
 with top tether strap 61
 LATCH anchors 56

Child safety 52
 12-volt battery
 precautions 488, 565
 Airbag precautions..... 40
 Back door precautions..... 112
 Child restraint system..... 53
 How your child should
 wear the seat belt..... 33
 Installing child restraints 56
 Moon roof precautions 142
 Power window lock switch..... 137
 Power window precautions..... 139
 Rear door child-protectors..... 108
 Removed key battery
 precautions 505
 Seat belt extender
 precautions 36
 Seat belt precautions 36
 Seat heater precautions 425
 Child-protectors 108
 Cleaning 462, 465
 Aluminum wheels..... 463
 Exterior 462
 Interior 465
 Seat belts..... 465
 Clock..... 440
 Compass 449
 Condenser..... 484
 Console box..... 430
 Coolant
 Capacity 575
 Checking 482
 Preparing and checking
 before winter 246

| | |
|---------------------------------|-----|
| Cooling system | 482 |
| Hybrid system overheating | 566 |
| Consumption screen | 91 |
| Cruise control | |
| Cruise control | 186 |
| Dynamic radar cruise | |
| control | 189 |
| Cup holders | 430 |
| Curtain shield airbags | 38 |
| Customizable features | 591 |

D

| | |
|------------------------------------|----------|
| Daytime running light system | 170 |
| Defogger | |
| Outside rear view | |
| mirrors | 414, 420 |
| Rear window | 414, 420 |
| Windshield | 414, 420 |
| Dimension | 572 |
| Dinghy towing | 155 |
| Display | |
| Drive information | 88 |
| Dynamic radar cruise | |
| control | 189 |
| Energy monitor | 91 |
| Multi-information display | 88 |
| Warning messages | 536 |
| Do-it-yourself maintenance | 473 |

| | |
|-------------------------------------|-----|
| Doors | |
| Automatic door locking and | |
| unlocking system | 108 |
| Back door | 110 |
| Door glasses | 137 |
| Door lock | 105 |
| Open door warning buzzer | 530 |
| Open door warning light | 530 |
| Outside rear view mirrors | 135 |
| Rear door child-protectors | 108 |
| Side doors | 105 |
| Drive information | 88 |
| Driver's seat belt reminder | |
| light | 531 |
| Driver's seat position memory | 124 |
| Driving | |
| Break-in tips | 145 |
| Correct posture | 30 |
| Driving mode select switch | 234 |
| Hybrid vehicle driving tips | 244 |
| Procedures | 144 |
| Winter drive tips | 246 |
| Driving position memory | 124 |
| Memory recall function | 125 |
| Dynamic radar cruise control | |
| Function | 189 |
| Warning message | 541 |

E

| | |
|---|----------|
| ECO lamp..... | 86 |
| EDR (Event data recorder)..... | 12 |
| Electric motor | |
| Location..... | 65 |
| Specification..... | 573 |
| Electric Power Steering (EPS) | |
| Function..... | 235 |
| Warning light..... | 530 |
| Electronic key | |
| If the electronic key does not operate properly..... | 560 |
| Replacing the battery..... | 504 |
| Emergency flashers..... | 522 |
| Emergency, in case of | |
| If a warning buzzer sounds..... | 529 |
| If a warning light turns on..... | 529 |
| If a warning message is displayed..... | 536 |
| If the 12-volt battery is discharged..... | 562 |
| If the electronic key does not operate properly..... | 560 |
| If the hybrid system will not start..... | 558 |
| If you have a flat tire..... | 549 |
| If you lose your keys..... | 102, 104 |
| If you think something is wrong..... | 528 |
| If your vehicle becomes stuck..... | 570 |
| If your vehicle has to be stopped in an emergency..... | 523 |
| If your vehicle needs to be towed..... | 524 |
| If your vehicle overheats..... | 566 |

| | |
|---|-----|
| Energy monitor..... | 91 |
| Engine | |
| Accessory mode..... | 157 |
| Compartment..... | 478 |
| Engine switch..... | 156 |
| Hood..... | 475 |
| How to start the hybrid system..... | 156 |
| Identification number..... | 573 |
| If your vehicle has to be stopped in an emergency..... | 523 |
| Ignition switch (power switch)..... | 156 |
| Overheating..... | 566 |
| Power switch..... | 156 |
| Engine compartment cover..... | 479 |
| Engine coolant | |
| Capacity..... | 575 |
| Checking..... | 482 |
| Preparing and checking before winter..... | 246 |
| Engine oil | |
| Capacity..... | 574 |
| Checking..... | 479 |
| Oil pressure warning light..... | 529 |
| Engine oil maintenance data..... | 468 |
| Engine switch..... | 156 |
| Auto power off function..... | 158 |
| Changing the power switch modes..... | 157 |
| If your vehicle has to be stopped in an emergency..... | 523 |
| Starting the hybrid system..... | 156 |
| EPS (Electronic Power Steering) | |
| Function..... | 235 |
| Warning light..... | 530 |

EV indicator67
 EV drive mode..... 160
 Event data recorder (EDR)..... 12

F

First-aid kit storage belt 434
 Flat tire 549
 Floor mats 28
 Fluid
 Brake.....577
 Transmission.....576
 Washer 485
 Fog lights
 Replacing light bulbs.....514, 519
 Switch.....172
 Wattage.....579
 Front passenger occupant
 classification system.....47
 Front passenger's seat belt
 reminder light 531
 Front seats 120
 Adjustment..... 120
 Cleaning..... 465
 Correct driving posture30
 Driving position memory124
 Head restraints.....127
 Seat heaters425
 Seat position memory.....124
 Front side marker lights
 Light switch 169
 Replacing light bulbs..... 519
 Front turn signal lights
 Replacing light bulbs..... 516, 516
 Turn signal lever167
 Wattage.....579

Fuel
 Capacity..... 573
 Fuel gauge 84
 Gas station information.....632
 Information.....580
 Refueling 183
 Type.....573
 Fuel filler door.....183
 Refueling 183
 When the fuel filler door
 cannot be opened..... 185
 Fuses.....506

G

Gas station information632
 Gauges..... 84
 Glove box 430

H

Hands-free system
 (for cellular phone).....284, 371
 HD Radio® system 343
 Head restraints..... 127
 Headlight cleaner 182
 Headlights.....169
 Automatic headlight leveling.....171
 Light switch.....169
 Replacing light
 bulbs511, 512, 513, 519
 Wattage579
 Heated steering wheel425
 Heaters
 Automatic air conditioning
 system..... 410, 418
 Outside rear view
 mirrors 414, 420
 Seat heaters.....425

| | |
|-------------------------------------|----------|
| High mounted stoplight | |
| Replacing..... | 519 |
| Hill-start assist control..... | 235 |
| Hood..... | 475 |
| Warning message..... | 537 |
| Hooks | |
| Cargo hooks..... | 434 |
| Retaining hooks (floor mat)..... | 28 |
| Horn..... | 130 |
| Hybrid battery (traction battery) | |
| Location..... | 69 |
| Specification..... | 574 |
| Hybrid battery air vent..... | 70 |
| Hybrid system..... | 65 |
| Emergency shut off system..... | 70 |
| Energy monitor/ | |
| consumption screen..... | 91 |
| EV drive mode..... | 160 |
| High voltage components..... | 69 |
| Hybrid System Indicator..... | 86 |
| Hybrid system precautions..... | 69 |
| Hybrid vehicle driving tips..... | 244 |
| If the hybrid system will not | |
| start..... | 558 |
| Overheating..... | 566 |
| Power switch..... | 156 |
| Regenerative braking..... | 67 |
| Starting the hybrid system..... | 156 |
| Vehicle proximity notification | |
| system..... | 66 |
| Hybrid System Indicator..... | 86 |
| Hybrid transmission..... | 162 |
| | |
| | I |
| I/M test..... | 472 |
| Identification | |
| Engine..... | 573 |
| Vehicle..... | 572 |
| Ignition switch (Power switch)..... | 156 |
| Auto power off function..... | 158 |
| Changing the power switch | |
| modes..... | 157 |
| If your vehicle has to be | |
| stopped in an emergency..... | 523 |
| Starting the hybrid system..... | 156 |
| Illuminated entry system..... | 428 |
| Immobilizer system..... | 74 |
| Indicators..... | 80 |
| Initialization | |
| Engine oil maintenance data..... | 468 |
| Items to initialize..... | 599 |
| Tire pressure warning | |
| system..... | 491 |
| Inside rear view mirror..... | 132 |
| Instrument panel light control..... | 85 |
| Interior lights..... | 427 |
| Switch..... | 428 |
| Wattage..... | 579 |
| Intuitive parking assist | |
| Function..... | 202 |
| Warning message..... | 538 |

J

Jack
 Positioning a floor jack 477
 Vehicle-equipped jack 550
 Jack handle 550
 Jam protection function
 Moon roof 141
 Power windows 138

K

Keyless entry
 Smart access system with
 push-button start 114
 Wireless remote control 100
 Keys 100
 Electronic key 100
 Engine switch 156
 If the electronic key does not
 operate properly 560
 If you lose your keys 102, 104
 Key number plate 100
 Keyless entry 100
 Mechanical key 100
 Power switch 156
 Replacing the battery 504
 Warning buzzer 115
 Wireless remote control key 100
 Knee airbags 38

L

Language (multi-information
 display) 596
 LATCH anchors 56
 Lever
 Auxiliary catch lever 475
 Hood lock release lever 475
 Shift lever 162
 Turn signal lever 167
 Wiper lever 174
 Lexus Display
 Audio controller 91, 206, 412
 Lexus parking assist monitor
 Display 220
 Function 219
 Precautions 226
 License plate lights
 Light switch 169
 Replacing light bulbs 519
 Light
 Fog light switch 172
 Headlight switch 169
 Illuminated entry system 428
 Interior lights 428
 Interior light list 427
 Luggage compartment light 111
 Personal lights 427
 Replacing light bulbs 509
 Turn signal lever 167
 Vanity lights 439
 Wattage 579
 Light bulbs
 Replacing 509
 Wattage 579
 Luggage cover 436

M

| | |
|---|-----------------|
| Maintenance | |
| Do-it-yourself | |
| maintenance..... | 473 |
| General maintenance | 469 |
| Maintenance data..... | 572 |
| Maintenance requirements..... | 467 |
| Malfunction indicator lamp | 529 |
| Meter | |
| Indicators..... | 80 |
| Instrument panel light | |
| control..... | 85 |
| Meters..... | 84 |
| Multi-information display | 88 |
| Warning lights..... | 529 |
| Warning messages..... | 536 |
| Micro dust and pollen | |
| filter | 414, 420 |
| Microphone..... | 286, 372 |
| Mirrors | |
| Inside rear view mirror | 132 |
| Outside rear view mirror | |
| defoggers..... | 414, 420 |
| Outside rear view mirrors..... | 135 |
| Vanity mirrors..... | 439 |
| Moon roof | |
| Jam protection function..... | 141 |
| Operation..... | 140 |
| Warning message..... | 542 |
| MP3 disc..... | 265, 347 |

Multi-information display

| | |
|------------------------|-----|
| Drive information..... | 88 |
| Dynamic radar cruise | |
| control..... | 189 |
| Energy monitor..... | 91 |
| Language..... | 596 |
| Warning messages | 536 |

N

| | |
|--------------------------------------|-----------|
| Navigation system* | |
| Noise from under vehicle..... | 10 |

O

| | |
|---|------------|
| Odometer..... | 85 |
| Oil | |
| Engine oil..... | 574 |
| Opener | |
| Back door..... | 111 |
| Fuel filler door..... | 183 |
| Hood..... | 475 |
| Outside rear view mirrors..... | 135 |
| Adjusting and folding | 135 |
| Outside rear view mirror | |
| defoggers..... | 414 |
| Outside temperature display..... | 84 |
| Overhead console | 435 |
| Overheating..... | 566 |

P

P position switch163

Panic mode101

Parking brake

 Operation168

 Parking brake engaged

 warning buzzer/message.....529

Parking lights

 Light switch169

 Replacing light bulbs.....519

Parking lock.....163

PCS (Pre-Collision System).....239

 Function239

 Pre-collision braking off

 switch.....239

 Warning light530

 Warning

 message537, 542, 543

Personal lights.....427

 Switch.....428

 Wattage.....579

Power control unit coolant

 Capacity575

 Checking.....482

 Preparing and checking

 before winter246

 Radiator484

Power outlets440

Power steering (Electric Power

 Steering system).....235

 Warning light530

Power switch.....156

 Auto power off function.....158

 Changing the power switch

 modes.....157

 If your vehicle has to be

 stopped in an emergency.....523

 Starting the hybrid system.....156

Power windows

 Jam protection function.....138

 Operation.....137

 Window lock switch137

Pre-Collision System (PCS).....239

 Function.....239

 Pre-collision braking off

 switch239

 Warning light.....530

 Warning message.....537, 542, 543

R

Radar cruise control (dynamic

 radar cruise control).....189

Radiator.....484

Radio259

Radio data system.....260

RDS.....260

Rear seat

 Folding down the rear

 seatbacks122

Rear side marker lights

 Light switch.....169

 Replacing light bulbs519

*: Refer to the "NAVIGATION SYSTEM OWNER'S MANUAL".

| | |
|----------------------------------|--------------|
| Rear turn signal lights | |
| Replacing light bulbs..... | 518 |
| Turn signal lever..... | 167 |
| Wattage..... | 579 |
| Rear view mirror | |
| Inside rear view mirror..... | 132 |
| Outside rear view mirrors..... | 135 |
| Rear view monitor system..... | 209 |
| Rear window defogger..... | 414, 420 |
| Rear window wiper..... | 180 |
| Refueling..... | 183 |
| Capacity..... | 573 |
| Fuel types..... | 573 |
| Opening the fuel tank cap..... | 183 |
| When the fuel filler door | |
| cannot be opened..... | 185 |
| Regenerative braking..... | 67 |
| Remote Touch*..... | 91, 206, 412 |
| Replacing | |
| Electronic key battery..... | 504 |
| Fuses..... | 506 |
| Light bulbs..... | 509 |
| Tires..... | 549 |
| Reporting safety defects for | |
| U.S. owners..... | 602 |
| Resetting the message indicating | |
| maintenance is required..... | 468 |
| Road accident cautions..... | 72 |

S

| | |
|---------------------------------|-----|
| Seat belts..... | 32 |
| Adjusting the seat belt..... | 32 |
| Automatic Locking | |
| Retractor..... | 33 |
| Child restraint system | |
| installation..... | 58 |
| Cleaning and maintaining the | |
| seat belt..... | 465 |
| Emergency Locking | |
| Retractor..... | 33 |
| How to wear your seat belt..... | 30 |
| How your child should | |
| wear the seat belt..... | 33 |
| Pre-collision seat belts..... | 33 |
| Pregnant women, proper seat | |
| belt use..... | 35 |
| Reminder light and buzzer..... | 531 |
| Seat belt extender..... | 34 |
| Seat belt instructions for | |
| Canadian owners..... | 603 |
| Seat belt pretensioners..... | 33 |
| SRS warning light..... | 530 |
| Seat heaters..... | 425 |
| Seat position memory..... | 124 |
| Seating capacity..... | 153 |

| | |
|---|------------|
| Seats | |
| Adjustment..... | 120 |
| Adjustment precautions..... | 121 |
| Child seats/child restraint | |
| system installation..... | 53, 56 |
| Cleaning..... | 465 |
| Driving position memory..... | 124 |
| Folding down the rear | |
| seatbacks..... | 122 |
| Head restraint..... | 127 |
| Properly sitting in the seat..... | 30 |
| Seat heaters..... | 425 |
| Sensor | |
| Inside rear view mirror..... | 134 |
| Intuitive parking assist..... | 202 |
| Radar sensor..... | 194, 240 |
| Rain-sensing windshield | |
| wipers..... | 178 |
| Service reminder indicators..... | 80 |
| Shift lever..... | 162 |
| Side airbags..... | 38 |
| Side doors..... | 105 |
| Side marker lights | |
| Light switch..... | 169 |
| Replacing light bulbs..... | 519 |
| Side mirrors..... | 135 |
| Adjusting and folding..... | 135 |
| Heaters..... | 414, 420 |
| Side turn signal lights | |
| Replacing light bulbs..... | 519 |
| Turn signal lever..... | 167 |
| Smart access system with | |
| push-button start..... | 114 |
| Antenna location..... | 114 |
| Entry functions..... | 105, 110 |
| Starting the hybrid system..... | 156 |
| Warning message..... | 546 |
| Snow tires..... | 246 |
| Spare tire | |
| Inflation pressure..... | 577 |
| Storage location..... | 550 |
| Spark plug..... | 576 |
| Specifications..... | 572 |
| Speedometer..... | 84 |
| Sport mode..... | 234 |
| Steering wheel | |
| Adjustment..... | 130 |
| Audio switches..... | 254, 325 |
| "DISP" switch..... | 88 |
| Heated steering wheel..... | 425 |
| Telephone switches..... | 291 |
| Stop lights | |
| Replacing light bulbs..... | 519 |
| Storage feature..... | 429 |
| Storage precautions..... | 429 |
| Stuck | |
| If the vehicle becomes stuck..... | 570 |
| Sun visors..... | 439 |

*: Refer to the "NAVIGATION SYSTEM OWNER'S MANUAL".

Switch

| | |
|--------------------------------------|----------|
| Audio remote control | |
| switches..... | 254, 325 |
| Cruise control switch..... | 186, 189 |
| "DISP" switch | 88 |
| Door lock switch..... | 107 |
| Driving mode select switch | 234 |
| Driving position memory | |
| switches..... | 124 |
| Emergency flashers switch | 522 |
| EV drive mode switch..... | 160 |
| Fog light switch | 172 |
| Garage door opener | |
| switches..... | 443 |
| Headlight cleaner switch | 182 |
| Heated steering wheel..... | 425 |
| Ignition switch | 156 |
| Intuitive parking assist switch..... | 202 |
| Light switches | 169 |
| Moon roof switches..... | 140 |
| Outside rear view mirror | |
| switches..... | 135 |
| Pre-collision braking off | |
| switch..... | 239 |
| Power switch..... | 156 |
| Power window switch | 137 |
| Rear window wiper and | |
| washer switch..... | 180 |
| Rear window and outside | |
| rear view mirror | |
| defoggers switch..... | 414, 420 |

| | |
|-----------------------------|---------------|
| Seat heater switches..... | 425 |
| "SOS" button..... | 455 |
| Talk switch..... | 291, 380, 400 |
| Telephone switches..... | 291, 380 |
| Tire pressure warning reset | |
| switch | 491 |
| TRAC OFF switch..... | 236 |
| Vehicle-to-vehicle distance | |
| button..... | 189 |
| Window lock switch | 137 |
| Windshield wipers and | |
| washer switch | 174 |

T

| | |
|-------------------------------------|----------------------|
| Tachometer | 84 |
| Tail lights | |
| Light switch..... | 169 |
| Replacing light bulbs | 519 |
| Talk switch..... | 291, 380, 400 |
| Telephone switch..... | 291, 380 |
| Theft deterrent system | |
| Alarm..... | 76 |
| Immobilizer system..... | 74 |
| Tire inflation pressure | |
| Maintenance data..... | 577 |
| Warning light..... | 531 |
| Tire pressure warning system | |
| Function..... | 491 |
| Initializing | 491 |
| Installing tire pressure warning | |
| valves and transmitters..... | 491 |
| Registering ID codes | 492 |
| Tire pressure warning reset | |
| switch | 491 |
| Warning light..... | 531 |

Tire information.....582

Tires.....490

- Chains.....247
- Checking.....490
- Glossary.....586
- If you have a flat tire549
- Inflation pressure.....497
- Replacing.....549
- Rotating tires490
- Size.....577
- Snow tires246
- Spare tire.....549, 577
- Tire identification number.....583
- Tire pressure warning system.....491
- Uniform Tire Quality
 - Grading.....585
 - Warning light.....531

Tools.....550

Top tether strap.....61

Total load capacity.....572

Towing

- Dinghy towing.....155
- Emergency towing.....524
- Towing eyelet.....525
- Trailer towing.....154

TRAC (Traction Control)

- Function.....235
- TRAC OFF switch.....236

Traction control.....235

Trailer towing.....154

Transmission

- Hybrid transmission.....162
- P position switch.....163
- Selecting a driving mode.....234

Trip meters.....85

Turn signal lights

- Replacing light
 - bulbs.....516, 516, 518, 519
- Turn signal lever.....167
- Wattage.....579

U

USB memory.....278, 356

USB port.....255, 326

V

Vanity lights

- Vanity lights.....439
- Wattage.....579

Vanity mirrors.....439

- Vanity lights.....439

Vehicle data recordings.....11

Vehicle identification number.....572

Vehicle Stability Control (VSC).....235

Voice command system.....400

VSC (Vehicle Stability Control).....235

W

Warning buzzers

| | |
|-------------------------------|-----|
| Approach warning..... | 193 |
| Intuitive parking assist..... | 205 |
| Open door..... | 530 |
| Seat belt reminder..... | 531 |

Warning lights

| | |
|---|-----|
| ABS..... | 530 |
| Automatic headlight leveling system..... | 530 |
| Brake system..... | 529 |
| Charging system..... | 529 |
| Electric power steering..... | 530 |
| High coolant temperature..... | 530 |
| Low engine oil pressure..... | 529 |
| Low fuel level..... | 531 |
| Malfunction indicator lamp..... | 529 |
| Master warning light..... | 531 |
| Open door..... | 530 |
| "PCS"..... | 530 |
| Seat belt reminder light..... | 531 |
| Slip indicator..... | 530 |
| SRS..... | 530 |
| Tire pressure..... | 531 |

Warning messages.....536

Washer

| | |
|--|-----|
| Checking..... | 485 |
| Low washer fluid warning message..... | 542 |
| Preparing and checking before winter..... | 246 |
| Switch..... | 174 |

Washing and waxing.....462

Weights

| | |
|---------------------|-----|
| Cargo capacity..... | 153 |
| Load limits..... | 572 |

Wheels.....500

| | |
|-----------------------|-----|
| Replacing wheels..... | 549 |
| Size..... | 577 |

Window glasses.....137

Window lock switch.....137

Windows

| | |
|---------------------------|----------|
| Power windows..... | 137 |
| Rear window defogger..... | 414, 420 |
| Washer..... | 174 |

Windshield wiper de-icer.....415, 421

Windshield wipers

| | |
|--|-----|
| Intermittent windshield wipers..... | 174 |
| Rain-sensing windshield wipers..... | 176 |

Winter driving tips.....246

Wireless communication.....316, 390

Wireless remote control key.....100

| | |
|----------------------------|-----|
| Locking/Unlocking..... | 100 |
| Panic mode..... | 101 |
| Replacing the battery..... | 504 |

WMA disc.....265, 347

X

XM® Satellite Radio.....261, 342

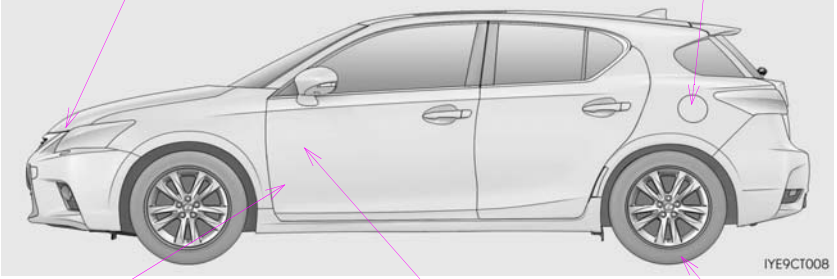

| GAS STATION INFORMATION | | |
|--|---|--|
| Auxiliary catch lever P. 475 | Fuel filler door P. 184 | |
|  | | |
| Hood lock release lever P. 475 | Fuel filler door opener P. 184 | Tire inflation pressure P. 577 |
| Fuel tank capacity (Reference) | 11.9 gal. (45 L, 9.9 Imp.gal.) | |
| Fuel type | Unleaded gasoline only | P. 573 |
| Cold tire inflation pressure | | P. 577 |
| Engine oil capacity (Drain and refill – reference) | With filter Without filter | 4.4 qt. (4.2 L, 3.7 Imp.qt.) 4.1 qt. (3.9 L, 3.4 Imp.qt.) |
| Engine oil type | "Toyota Genuine Motor Oil" or equivalent Oil grade: ILSAC GF-5 multigrade engine oil Recommended viscosity: SAE 0W-20 <div style="text-align: right;">P. 574</div> | |