

# TABLE OF CONTENTS

<b>1</b>	<b>Before driving</b>	Information on the hybrid system and adjusting and operating features such as door locks, mirrors, and steering column.
<b>2</b>	<b>When driving</b>	Driving, stopping and safe-driving information.
<b>3</b>	<b>Interior features</b>	Air conditioning and audio systems, as well as other interior features for a comfortable driving experience.
<b>4</b>	<b>Maintenance and care</b>	Cleaning and protecting your vehicle, performing do-it-yourself maintenance, and maintenance information.
<b>5</b>	<b>When trouble arises</b>	What to do if the vehicle needs to be towed, gets a flat tire, or is involved in an accident.
<b>6</b>	<b>Vehicle specifications</b>	Detailed vehicle information.
<b>7</b>	<b>For owners</b>	Reporting safety defects for U.S. owners, and seat belt, SRS airbag and headlight aim instructions for Canadian owners.
	<b>Index</b>	Alphabetical listing of information contained in this manual.

For vehicles with a navigation system, refer to the “Navigation System Owner’s Manual” for information regarding the equipment listed below.

- Navigation system
- Air conditioning controls
- Windshield wiper de-icer
- Rear view monitor system
- Intuitive parking assist
- Audio/video system
- Rear window and outside rear view mirror defogging

**1 Before driving**

**1-1. Hybrid system**

- Hybrid system..... 30
- Hybrid system precautions..... 34
- Energy monitor/consumption screen..... 39
- Hybrid vehicle driving tips..... 49

**1-2. Key information**

- Keys ..... 51

**1-3. Opening, closing and locking the doors**

- Smart access system with push-button start ..... 56
- Wireless remote control..... 69
- Side doors ..... 72
- Back door..... 75

**1-4. Adjustable components (seats, mirrors, steering wheel)**

- Front seats..... 86
- Rear seats..... 89
- Driving position memory ..... 93
- Head restraints..... 97
- Seat belts ..... 99
- Steering wheel..... 105
- Anti-glare inside rear view mirror ..... 107
- Outside rear view mirrors..... 109

**1-5. Opening and closing the windows and moon roof**

- Power windows..... 112
- Moon roof ..... 115

**1-6. Refueling**

- Opening the fuel tank cap..... 119

**1-7. Theft deterrent system**

- Immobilizer system ..... 124
- Alarm..... 126
- Theft prevention labels ..... 129

## 1-8. Safety information

Correct driving posture .....	130
SRS airbags .....	132
Front passenger occupant classification system.....	145
Child restraint systems .....	150
Installing child restraints .....	154

## 2 When driving

### 2-1. Driving procedures

Driving the vehicle.....	166
Power (ignition) switch.....	177
EV drive mode .....	183
Hybrid transmission .....	186
Turn signal lever .....	193
Parking brake .....	195
Horn.....	196

### 2-2. Instrument cluster

Gauges and meters .....	197
Indicators and warning lights.....	201
Multi-information display.....	206
Head-up display .....	212

### 2-3. Operating the lights and windshield wipers

Headlight switch.....	217
Fog light switch .....	221
Windshield wipers and washer.....	223

Rear window wiper and washer .....	229
Headlight cleaner switch .....	231

### 2-4. Using other driving systems

Cruise control .....	232
Dynamic radar cruise control.....	236
Intuitive parking assist .....	248
Rear view monitor system (rear view mirror-attached type).....	258
Rear view monitor system (vehicles with the Lexus Display Audio system).....	266
Driving assist systems.....	271
Hill-start assist control .....	276
Pre-Collision System.....	278
BSM (Blind Spot Monitor) .....	286

### 2-5. Driving information

Utility vehicle precautions.....	292
Cargo and luggage.....	296
Vehicle load limits.....	301
Winter driving tips .....	302
Trailer towing (AWD models with towing package).....	306
Trailer towing (without towing package).....	323
Dinghy towing .....	324

**3 Interior features**

**3-1. Lexus Display Audio system**

Lexus Display Audio system ..... 328  
 Display settings ..... 332  
 Setup menu..... 334  
 Mobile Assistant ..... 340

**3-2. Using the air conditioning system and defogger**

Automatic air conditioning system (with the Lexus Display Audio system) ..... 342  
 Automatic air conditioning system (without a navigation system or the Lexus Display Audio system)..... 350  
 Rear window defogger switch..... 358  
 Windshield wiper de-icer ..... 360

**3-3. Using the Lexus Display Audio system**

Audio system (with the Lexus Display Audio system) ..... 362  
 Using the radio..... 365  
 Using the CD player ..... 380  
 Playing an audio CD and MP3/WMA discs..... 381  
 Listening to an iPod..... 391  
 Listening to a USB memory ..... 399

Using the AUX port ..... 408  
 Listening to Bluetooth® audio ..... 410  
 Optimal use of the audio system ..... 424  
 Using the steering wheel audio switches ..... 426  
 Hands-free system (for mobile phone)..... 429  
 Using the Bluetooth® phone ..... 437  
 Setting the hands-free system ..... 454  
 Bluetooth® settings ..... 466

**3-4. Using the audio system**

Audio system (without a navigation system or the Lexus Display Audio system)..... 474  
 Using the radio..... 477  
 Using the CD player..... 485  
 Playing MP3 and WMA discs ..... 493  
 Operating an iPod..... 501  
 Operating a USB memory..... 510  
 Bluetooth® audio system ..... 519  
 Using the Bluetooth® audio system ..... 523  
 Operating a Bluetooth® enabled portable player ..... 528  
 Setting up a Bluetooth® enabled portable player ..... 531  
 Bluetooth® audio system setup ..... 538

Optimal use of the audio system .....	539
Using the AUX port .....	541
Using the steering wheel audio switches .....	543
Hands-free system for mobile phones .....	547
Using the hands-free system (for mobile phones).....	552
Making a phone call.....	560
Setting a mobile phone.....	565
Security and system setup.....	571
Using the phone book.....	575

### 3-5. Using the interior lights

Interior lights list.....	582
• Interior lights .....	583
• Personal lights .....	583

### 3-6. Using the storage features

List of storage features.....	585
• Glove box .....	586
• Bottle holders/door pockets .....	587
• Cup holders.....	588
• Console box.....	590
• Coin holder.....	592
• Auxiliary boxes.....	592
• Under tray.....	594

### 3-7. Other interior features

Sun visors.....	595
Vanity mirrors.....	596
Clock.....	597
Outside temperature display .....	598
Multi-display light control.....	600
Power outlets.....	601
Heated steering wheel .....	604
Seat heaters and ventilators.....	605
Armrest.....	607
Coat hooks .....	608
Assist grips.....	609
Floor mat.....	610
Luggage compartment features.....	612
Garage door opener.....	616
Compass .....	622
Safety Connect .....	626



**4 Maintenance and care**

**4-1. Maintenance and care**

- Cleaning and protecting the vehicle exterior..... 634
- Cleaning and protecting the vehicle interior ..... 637

**4-2. Maintenance**

- Maintenance requirements .... 640
- General maintenance ..... 643
- Emission inspection and maintenance (I/M) programs ..... 647

**4-3. Do-it-yourself maintenance**

- Do-it-yourself service precautions..... 648
- Hood..... 651
- Positioning a floor jack..... 652
- Engine compartment..... 654
- 12-volt battery..... 664
- Tires ..... 670
- Tire inflation pressure..... 679
- Wheels..... 683
- Air conditioning filter..... 685
- Electronic key battery ..... 687
- Checking and replacing fuses ..... 689
- Headlight aim..... 705
- Light bulbs..... 708

**5 When trouble arises**

**5-1. Essential information**

- Emergency flashers..... 724
- If your vehicle needs to be towed..... 725
- If you think something is wrong ..... 732

**5-2. Steps to take in an emergency**

- If a warning light turns on or a warning buzzer sounds... ..... 733
- If a warning message is displayed..... 743
- If you have a flat tire..... 764
- If the hybrid system will not start ..... 777
- If the shift lever cannot be shifted from P ..... 779
- If you lose your keys ..... 780
- If the electronic key does not operate properly ..... 781
- If the vehicle 12-volt battery is discharged ..... 784
- If your vehicle overheats ..... 788
- If the vehicle becomes stuck..... 793
- If your vehicle has to be stopped in an emergency ..... 795

## 6 Vehicle specifications

### 6-1. Specifications

Maintenance data (fuel, oil level, etc.).....	798
Fuel information.....	810
Tire information.....	813

### 6-2. Customization

Customizable features .....	825
-----------------------------	-----

### 6-3. Initialization

Items to initialize .....	837
---------------------------	-----

## 7 For owners

Reporting safety defects for U.S. owners.....	840
Seat belt instructions for Canadian owners (in French).....	841
SRS airbag instructions for Canadian owners (in French).....	843
Headlight aim instructions for Canadian owners (in French).....	852

## Index

Abbreviation list .....	858
Alphabetical index.....	860
What to do if... ..	874

1

2

3

4

5

6

7

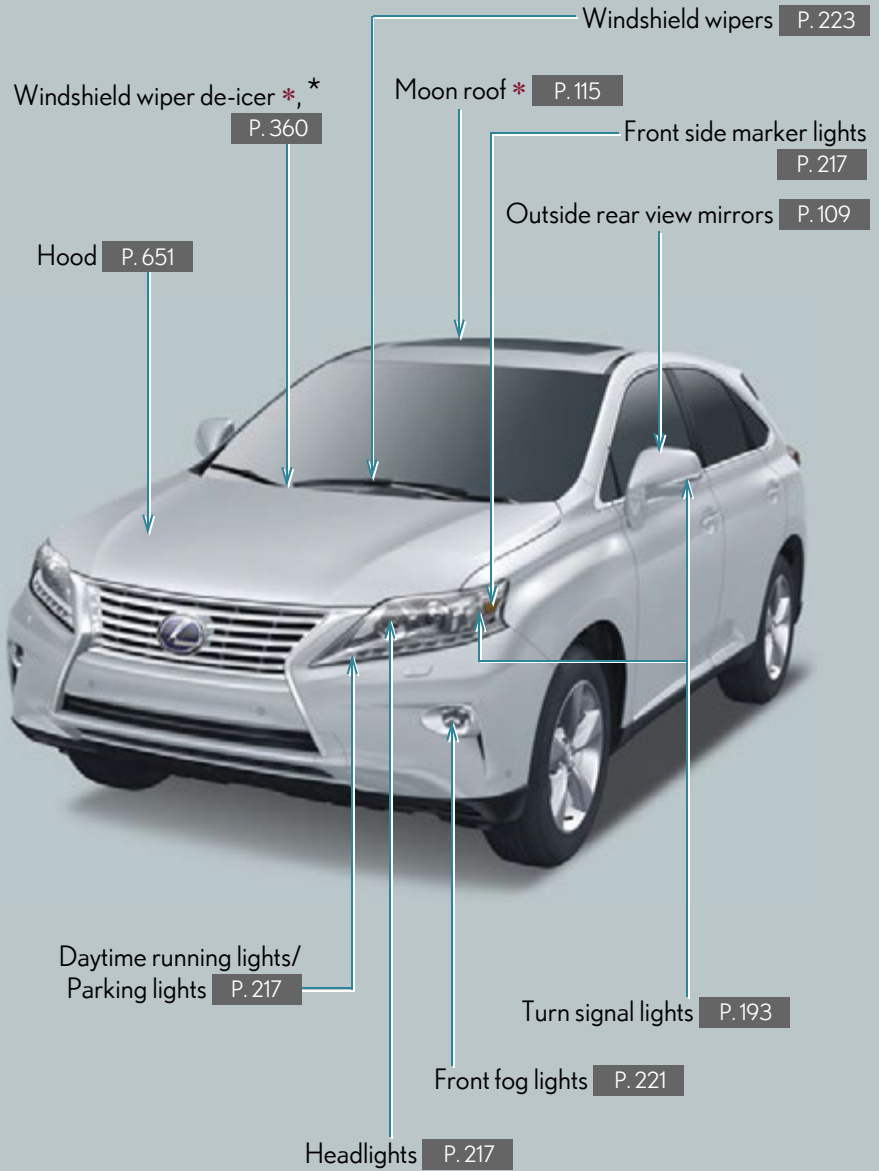



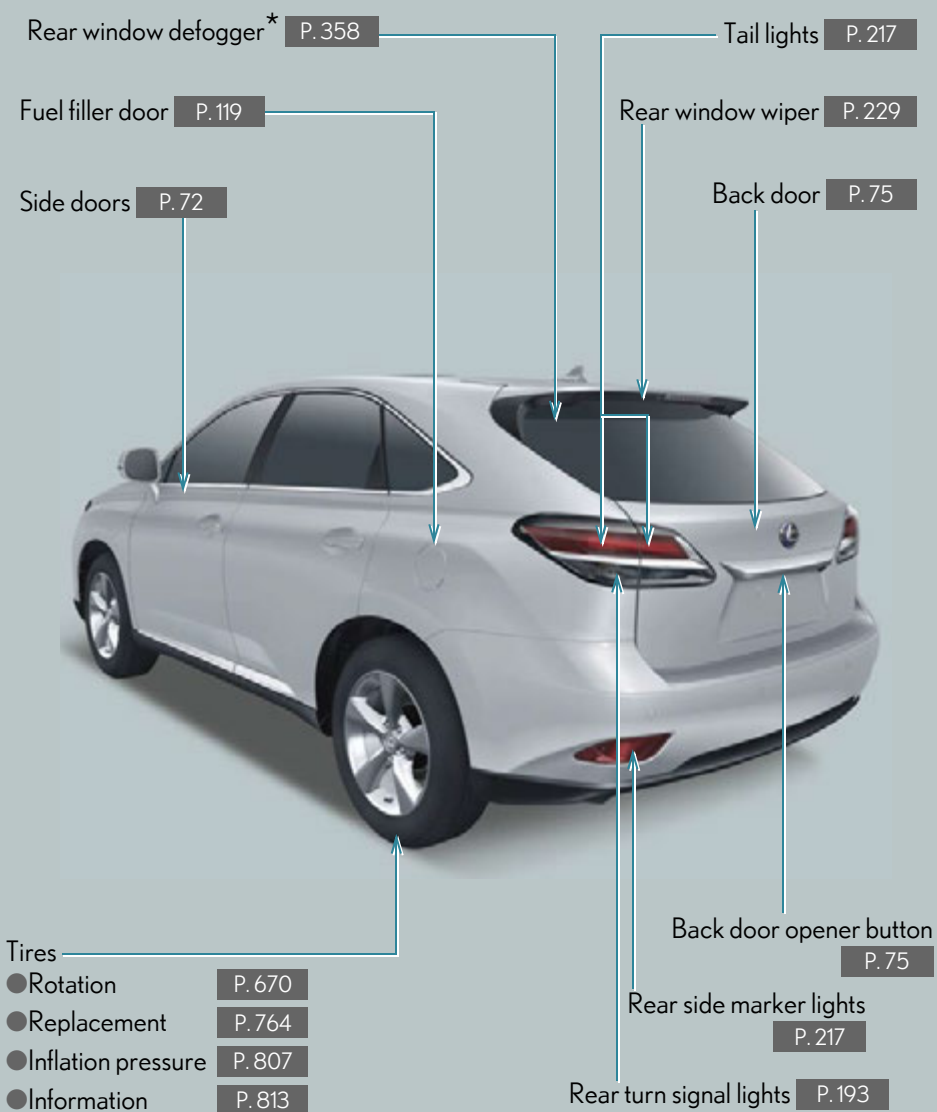

\*: If equipped

\*: For vehicles with a navigation system, refer to the "Navigation System Owner's Manual".

# Pictorial index

# Interior

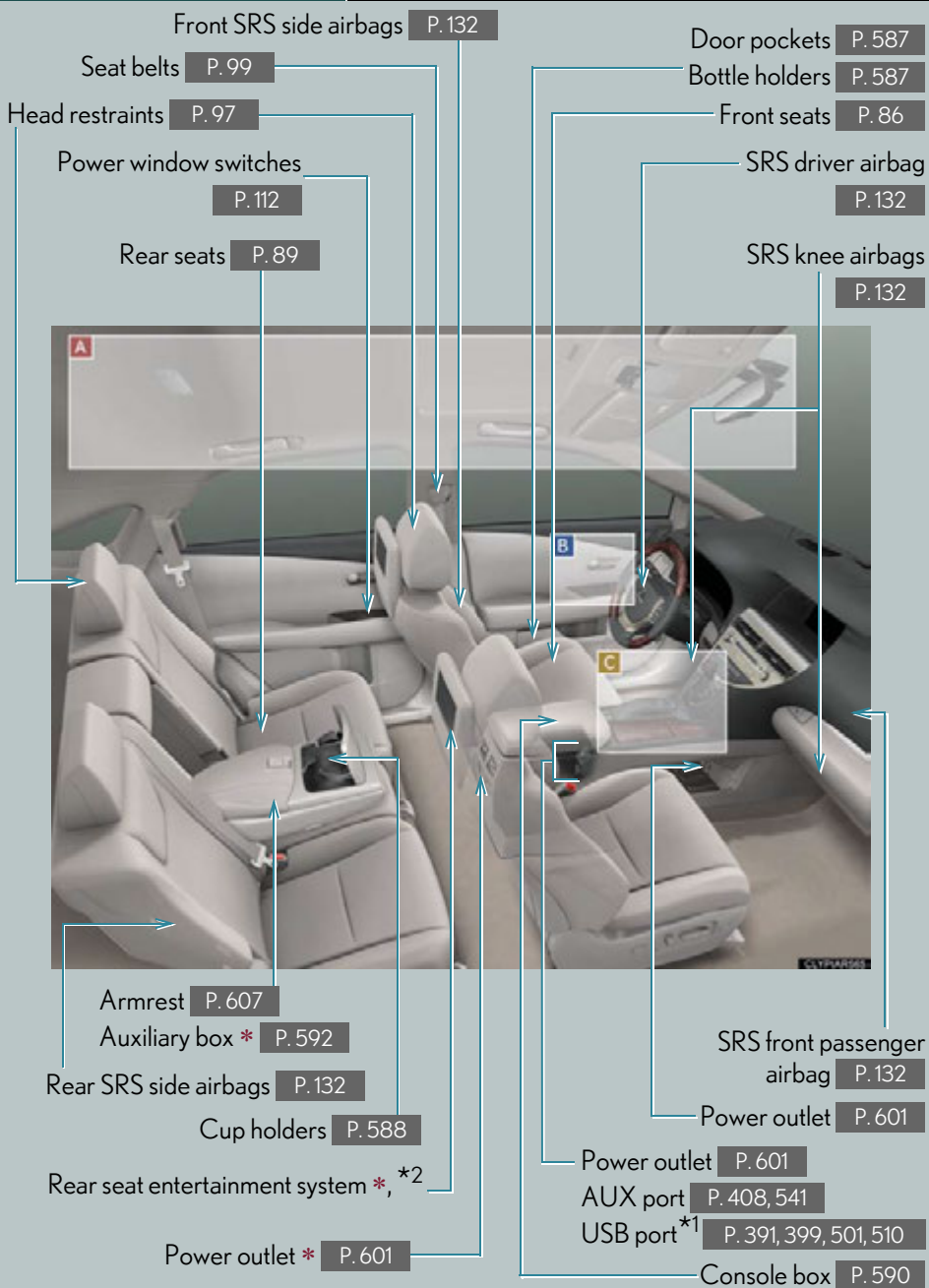

A

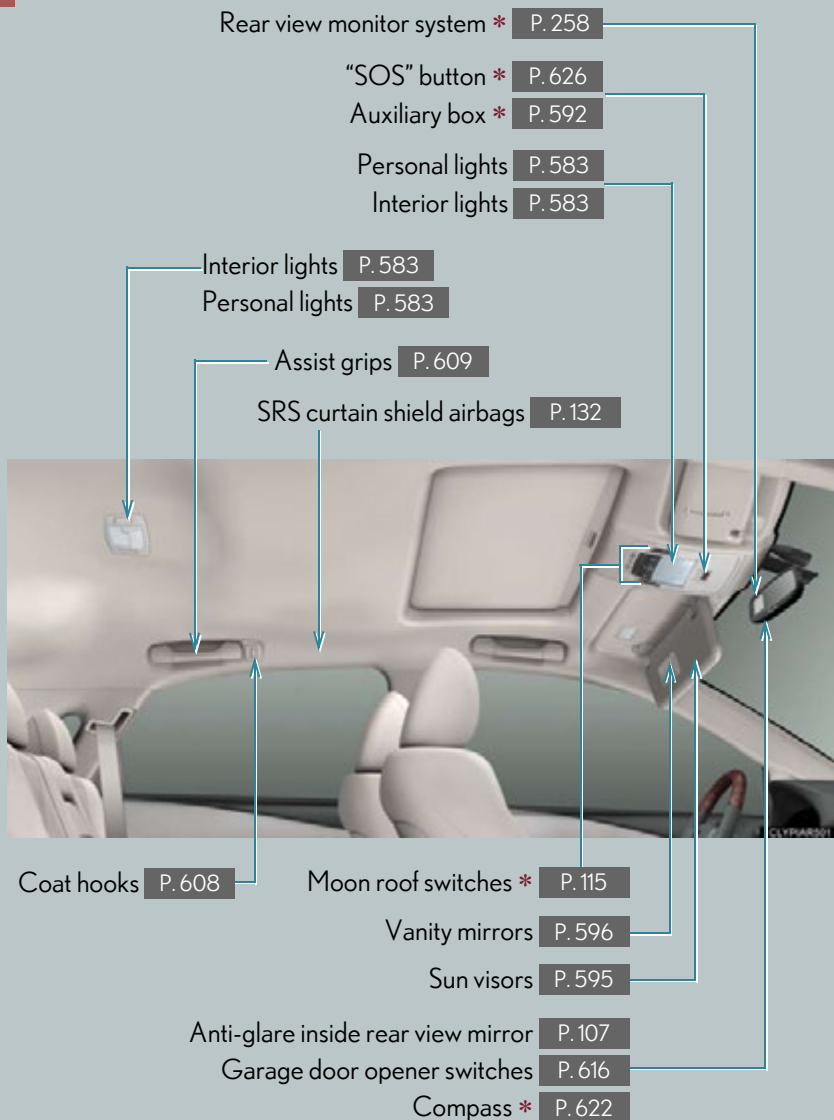

\*: If equipped

\*1: For vehicles with a navigation system, refer to the "Navigation System Owner's Manual".

\*2: Refer to the "Navigation System Owner's Manual".

**B**

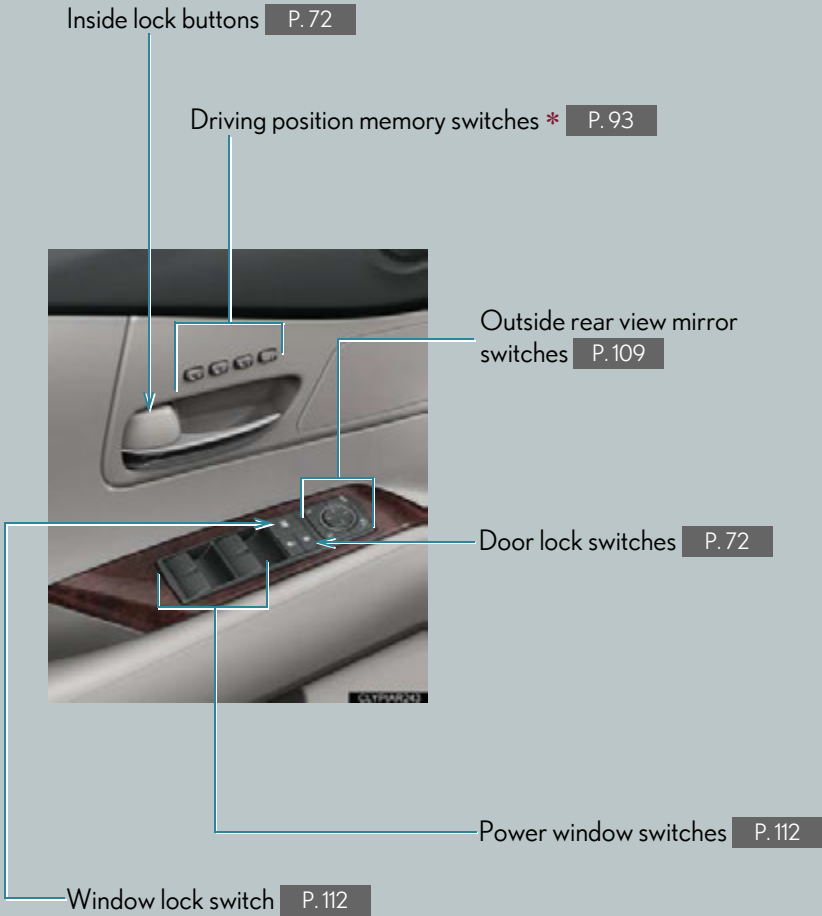

C

Hybrid transmission shift lever P. 186

Shift lock override button P. 779

Lexus Display Audio controller \* P. 328

Cup holders P. 588

Remote Touch \*, \*

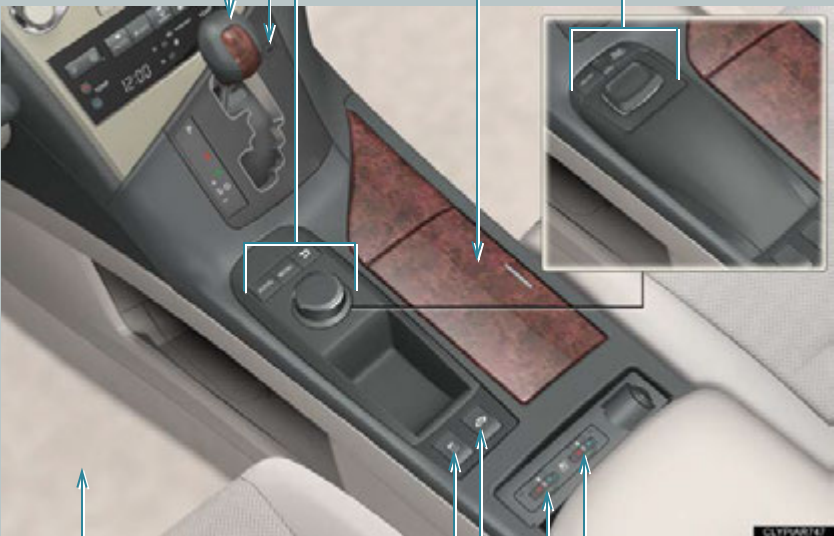

Floor mat P. 610

VSC off switch P. 271

EV drive mode switch P. 183

Seat heater and ventilator switches \* P. 605

\*: If equipped

\*: Refer to the "Navigation System Owner's Manual".

# Pictorial index

# Instrument panel

Headlight switch P. 217

Turn signal lever P.193

Fog light switch P. 221

Glove box P.586

Power back door main switch P.77

Gauges and meters P.197

Multi-information display P. 206

Horn P.196

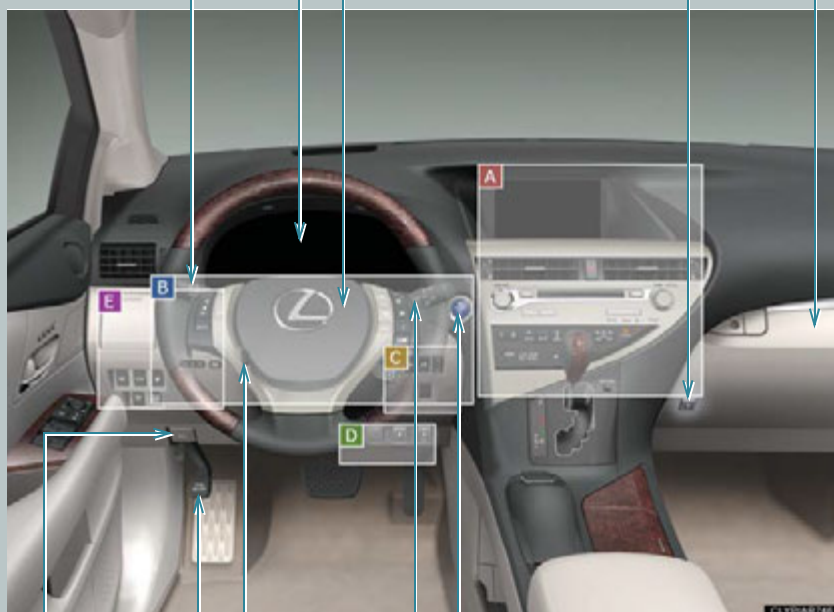

Hood lock release lever P. 651

Power (ignition) switch P.177

Windshield wipers and washer switch P. 223

Rear window wiper and washer switch P. 229

Tilt and telescopic steering control switch P. 105

Parking brake pedal P. 195

**A**

► Without a navigation system or the Lexus Display Audio system

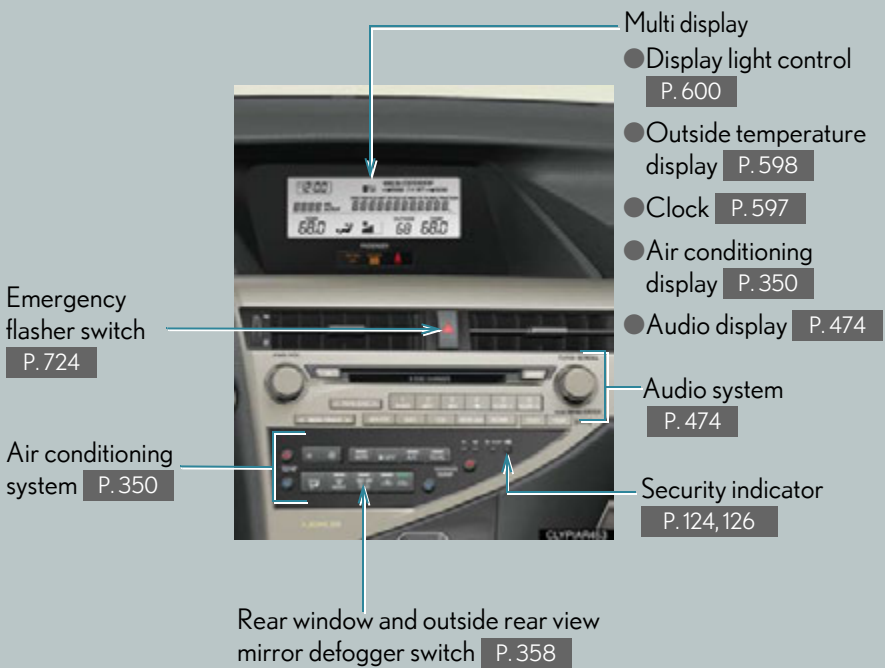

**A** ▶ With the Lexus Display Audio system

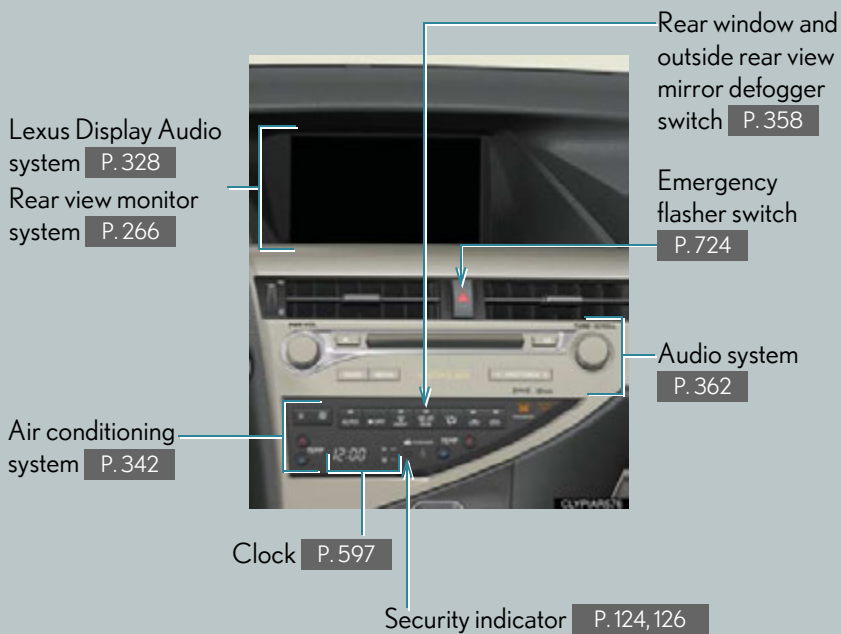



A

► With a navigation system

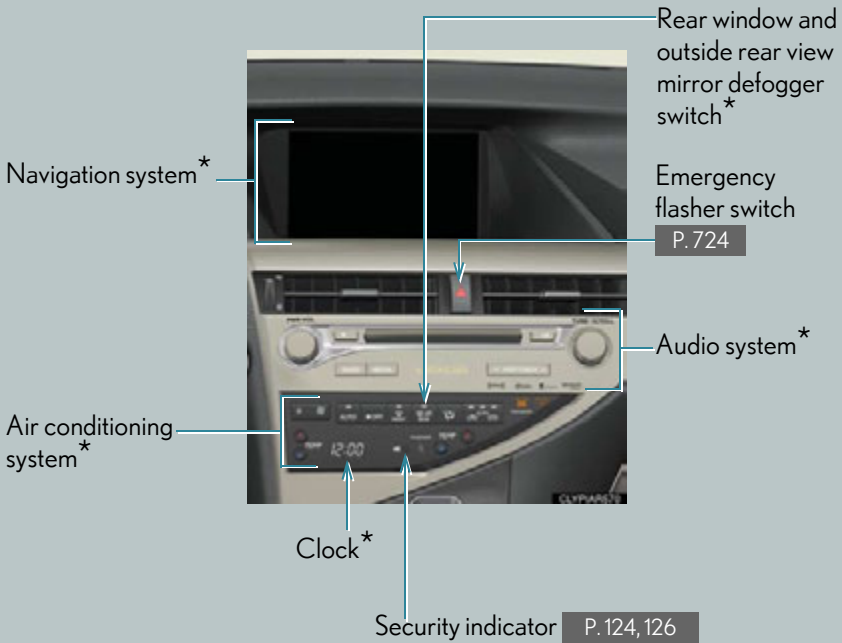

\*: Refer to the "Navigation System Owner's Manual".

## B

Steering wheel audio switches\*

P. 426, 543

Telephone switch\*

P. 429, 547



Multi-information switches

P. 206

Talk switch\*

P. 429, 547

Cruise control switch

P. 232, 236

Vehicle-to-vehicle distance button\*

P. 236

## C



Head-up display main switch\*

P. 212

Display contrast adjustment switch\*

P. 212

Display position adjustment switch\*

P. 212

Heated steering wheel switch\*

P. 604

D



Tire pressure warning reset switch P. 672

Pre-collision braking off switch \* P. 279

E

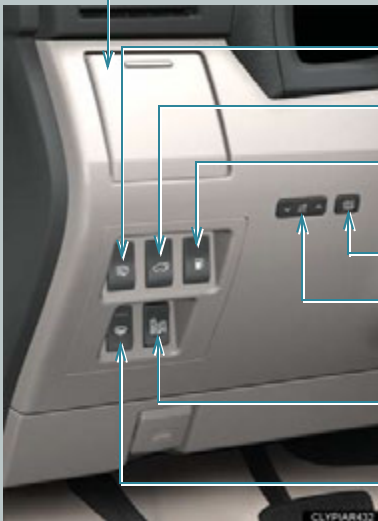

Cup holder P. 588

Headlight cleaner switch \* P. 231

Power back door switch P. 76

Fuel filler door opener P. 119

“ODO/TRIP” button P. 198

Instrument panel light control buttons P. 198

BSM main switch \* P. 286

Windshield wiper de-icer switch \*, \* P. 360

\*: If equipped

\*: For vehicles with a navigation system, refer to the “Navigation System Owner’s Manual”.



A

Luggage compartment lights P.77



Rear seatback lock release levers P. 89

\*: If equipped

## For your information

### Main Owner's Manual

Please note that this manual applies to all models and explains all equipment, including options. Therefore, you may find some explanations for equipment not installed on your vehicle.

All specifications provided in this manual are current at the time of printing. However, because of the Lexus policy of continual product improvement, we reserve the right to make changes at any time without notice.

Depending on specifications, the vehicle shown in the illustrations may differ from your vehicle in terms of color and equipment.

### Noise from under vehicle after turning off the hybrid system

Approximately five hours after the hybrid system is turned off, you may hear sound coming from under the vehicle for several minutes. This is the sound of a fuel evaporation leakage check and, it does not indicate a malfunction.

### Accessories, spare parts and modification of your Lexus

A wide variety of non-genuine spare parts and accessories for Lexus vehicles are currently available in the market. You should know that Toyota does not warrant these products and is not responsible for their performance, repair, or replacement, or for any damage they may cause to, or adverse effect they may have on, your Lexus vehicle.

This vehicle should not be modified with non-genuine Lexus products. Modification with non-genuine Lexus products could affect its performance, safety or durability, and may even violate governmental regulations. In addition, damage or performance problems resulting from the modification may not be covered under warranty.

## Installation of a mobile two-way radio system

The installation of a mobile two-way radio system in your vehicle could affect electronic systems such as:

- Hybrid system
- Multiport fuel injection system/sequential multiport fuel injection system
- Cruise control system
- Dynamic radar cruise control system
- Anti-lock brake system
- SRS airbag system
- Seat belt pretensioner system

Be sure to check with your Lexus dealer for precautionary measures or special instructions regarding installation of a mobile two-way radio system.

High voltage parts and cables on the hybrid vehicles emit approximately the same amount of electromagnetic waves as the conventional gasoline powered vehicles or home electronic appliances despite of their electromagnetic shielding.

Unwanted noise may occur in the reception of the mobile two-way radio.

## Vehicle data recordings

Your Lexus is equipped with several sophisticated computers that will record certain data, such as:

- Engine speed
- Motor speed
- Accelerator status
- Brake status
- Vehicle speed
- Shift position
- Hybrid battery (traction battery) status

The recorded data varies according to the vehicle grade level and options with which it is equipped. Furthermore, these computers do not record conversations, sounds or pictures.

## ● Data usage

Lexus may use the data recorded in these computers to diagnose malfunctions, conduct research and development, and improve quality.

Lexus will not disclose the recorded data to a third party except:

- With the consent of the vehicle owner or with the consent of the lessee if the vehicle is leased
  - In response to an official request by the police, a court of law or a government agency
  - For use by Lexus in a law suit
  - For research purposes where the data is not tied to a specific vehicle or vehicle owner
- Usage of data collected through Safety Connect /Lexus Enform (U.S. mainland only)

If your Lexus has Safety Connect or Lexus Enform and if you have subscribed to those services, please refer to the Safety Connect /Lexus Enform Telematics Subscription Service Agreement for information on data collected and its usage.



## Event data recorder

This vehicle is equipped with an event data recorder (EDR). The main purpose of an EDR is to record, in certain crash or near crash-like situations, such as an air bag deployment or hitting a road obstacle, data that will assist in understanding how a vehicle's systems performed. The EDR is designed to record data related to vehicle dynamics and safety systems for a short period of time, typically 30 seconds or less.

The EDR in this vehicle is designed to record such data as:

- How various systems in your vehicle were operating;
- Whether or not the driver and passenger safety belts were buckled/fastened;
- How far (if at all) the driver was depressing the accelerator and/or brake pedal; and,
- How fast the vehicle was traveling.

These data can help provide a better understanding of the circumstances in which crashes and injuries occur.

NOTE: EDR data are recorded by your vehicle only if a non-trivial crash situation occurs; no data are recorded by the EDR under normal driving conditions and no personal data (e.g., name, gender, age, and crash location) are recorded. However, other parties, such as law enforcement, could combine the EDR data with the type of personally identifying data routinely acquired during a crash investigation.

To read data recorded by an EDR, special equipment is required, and access to the vehicle or the EDR is needed. In addition to the vehicle manufacturer, other parties, such as law enforcement, that have the special equipment, can read the information if they have access to the vehicle or the EDR.

### ● Disclosure of the EDR data

Lexus will not disclose the data recorded in an EDR to a third party except when:

- An agreement from the vehicle's owner (or the lessee for a leased vehicle) is obtained
- In response to an official request by the police, a court of law or a government agency
- For use by Lexus in a law suit

However, if necessary, Lexus may:

- Use the data for research on vehicle safety performance
- Disclose the data to a third party for research purposes without disclosing information about the specific vehicle or vehicle owner

## Scrapping of your Lexus

The SRS airbag and seat belt pretensioner devices in your Lexus contain explosive chemicals. If the vehicle is scrapped with the airbags and seat belt pretensioners left as they are, this may cause an accident such as fire. Be sure to have the systems of the SRS airbag and seat belt pretensioner removed and disposed of by a qualified service shop or by your Lexus dealer before you scrap your vehicle.

## Perchlorate Material

Special handling may apply, See [www.dtsc.ca.gov/hazardouswaste/perchlorate](http://www.dtsc.ca.gov/hazardouswaste/perchlorate).

Your vehicle has components that may contain perchlorate. These components may include airbag, seat belt pretensioners, and wireless remote control batteries.

### CAUTION

#### ■ General precautions while driving

**Driving under the influence:** Never drive your vehicle when under the influence of alcohol or drugs that have impaired your ability to operate your vehicle. Alcohol and certain drugs delay reaction time, impair judgment and reduce coordination, which could lead to an accident that could result in death or serious injury.

**Defensive driving:** Always drive defensively. Anticipate mistakes that other drivers or pedestrians might make and be ready to avoid accidents.

**Driver distraction:** Always give your full attention to driving. Anything that distracts the driver, such as adjusting controls, talking on a cellular phone or reading can result in a collision with resulting death or serious injury to you, your occupants or others.

#### ■ General precaution regarding children's safety

Never leave children unattended in the vehicle, and never allow children to have or use the key.

Children may be able to start the vehicle or shift the vehicle into neutral. There is also a danger that children may injure themselves by playing with the windows, the moon roof, or other features of the vehicle. In addition, heat build-up or extremely cold temperatures inside the vehicle can be fatal to children.

 **CAUTION**

■ **Hybrid battery (traction battery)**

Never resell, hand over or modify the hybrid battery. To prevent accidents, hybrid batteries that have been removed from a disposed vehicle are collected through Lexus dealers. Do not dispose of the battery yourself.

Unless the battery is properly collected, the following may occur, resulting in death or serious injury:

- The hybrid battery may be illegally disposed of or dumped, and someone may touch a high voltage part, resulting in an electric shock.
- The hybrid battery is intended to be used exclusively with your hybrid vehicle. If the hybrid battery is used outside of your vehicle or modified in any way, accidents such as electric shock, heat generation, smoke generation, an explosion and electrolyte leakage may occur.

When reselling or handing over your vehicle, the possibility of an accident is extremely high because the person receiving the vehicle may not be aware of these dangers.

■ **Disposal of the hybrid battery (traction battery)**

If your vehicle is disposed of without the hybrid battery having been removed, there is a danger of serious electric shock if high voltage parts, cables and their connectors are touched. In the event that your vehicle must be disposed of, the hybrid battery must be disposed of by your Lexus dealer or a qualified service shop. If the hybrid battery is not disposed of properly, it may cause electric shock that can result in death or serious injury.

# Symbols used throughout this manual

## Cautions & Notices

**⚠ CAUTION**

This is a warning against something which, if ignored, may cause injury to people. You are informed about what you must or must not do in order to reduce the risk of injury to yourself and others.

**⚠ NOTICE**

This is a warning against something which, if ignored, may cause damage to the vehicle or its equipment. You are informed about what you must or must not do in order to avoid or reduce the risk of damage to your Lexus and its equipment.

## Symbols used in illustrations



### Safety symbol

The symbol of a circle with a slash through it means “Do not”, “Do not do this”, or “Do not let this happen”.



### Arrows indicating operations

**➡** Indicates the action (pushing, turning, etc.) used to operate switches and other devices.

**⇨** Indicates the outcome of an operation (e.g. a lid opens).

## 1-1. Hybrid system

Hybrid system .....	30
Hybrid system precautions .....	34
Energy monitor/ consumption screen .....	39
Hybrid vehicle driving tips .....	49

## 1-2. Key information

Keys .....	51
------------	----

## 1-3. Opening, closing and locking the doors

Smart access system with push-button start .....	56
Wireless remote control .....	69
Side doors .....	72
Back door .....	75

## 1-4. Adjustable components (seats, mirrors, steering wheel)

Front seats .....	86
Rear seats .....	89
Driving position memory .....	93
Head restraints .....	97
Seat belts .....	99
Steering wheel .....	105

Anti-glare inside rear view mirror .....	107
Outside rear view mirrors .....	109

## 1-5. Opening and closing the windows and moon roof

Power windows .....	112
Moon roof .....	115

## 1-6. Refueling

Opening the fuel tank cap .....	119
------------------------------------	-----

## 1-7. Theft deterrent system

Immobilizer system .....	124
Alarm .....	126
Theft prevention labels .....	129

## 1-8. Safety information

Correct driving posture .....	130
SRS airbags .....	132
Front passenger occupant classification system .....	145
Child restraint systems .....	150
Installing child restraints .....	154

## 1-1. Hybrid system

# Hybrid system

Your vehicle is a hybrid vehicle. It has characteristics different from conventional vehicles. Be sure you are closely familiar with the characteristics of your vehicle, and operate with care.

The hybrid system combines the use of a gasoline engine and an electric motor (traction motor) according to driving conditions, improving fuel efficiency and reducing exhaust emissions.

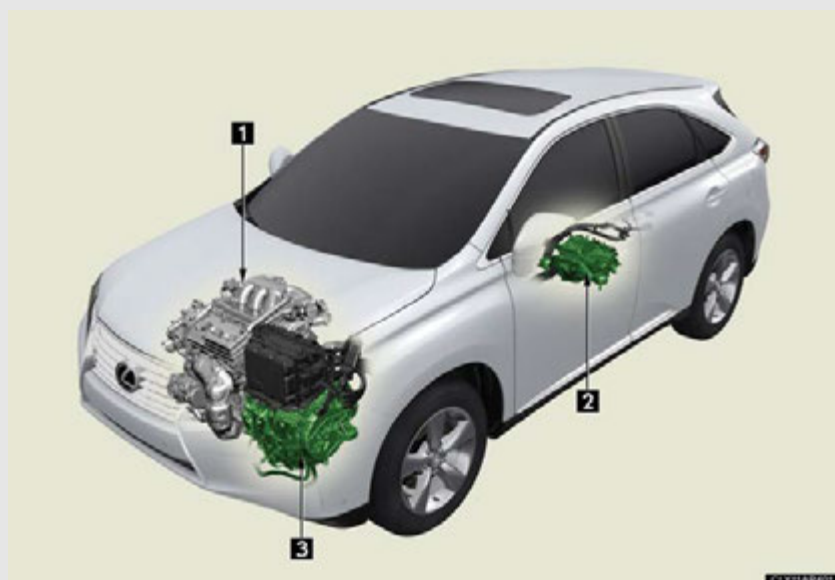

- 1 Gasoline engine
  - 2 Rear electric motor (Traction motor)\*
  - 3 Front electric motor (Traction motor)
- \*: AWD models only

**■ When stopped/during start-off**

The gasoline engine stops when the vehicle is stopped. During start-off, the electric motor (traction motor) drives the vehicle. At slow speeds or when traveling down a gentle slope, the engine is stopped and the motor is used.

**■ During normal driving**

The gasoline engine is predominantly used. The electric motor (traction motor) charges the hybrid battery as necessary.

**■ When accelerating sharply**

The power of the hybrid battery (traction battery) is added to that of the gasoline engine via the electric motor (traction motor).

**■ When braking (regenerative braking)**

The electric motor (traction motor) charges the hybrid battery (traction battery).

**Vehicle Proximity Notification System**

When the gasoline engine is off while driving, a sound is produced to warn pedestrians, people riding bicycles or other people and vehicles in the surrounding area that the vehicle is approaching. The pitch of the sound adjusts according to vehicle speed. When vehicle speed is approximately 12 mph (20 km/h) or more, the warning system turns off.

### ■ Regenerative braking

In the following situations, kinetic energy is converted to electric energy and deceleration force can be obtained in conjunction with the recharging of the hybrid battery (traction battery).

- The accelerator pedal is released.
- The brake pedal is depressed with the shift lever in D or S.

### ■ Conditions in which the gasoline engine may not stop

The gasoline engine starts and stops automatically. However, it may not stop automatically in the following conditions:

- During gasoline engine warm-up
- During hybrid battery (traction battery) charging
- When the temperature of the hybrid battery (traction battery) is high or low
- When the heater is switched on

### ■ Charging the hybrid battery (traction battery)

- As the gasoline engine charges the hybrid battery (traction battery), the battery does not need to be charged from an outside source. However, if the vehicle is left parked for a long time the hybrid battery will slowly discharge. For this reason, be sure to drive the vehicle at least once every few months for at least 30 minutes. If the hybrid battery becomes fully discharged and you are unable to jump-start the vehicle with the 12-volt battery, contact your Lexus dealer.
- If the shift lever is in N, the hybrid battery (traction battery) will not be charged. Always put the shift lever in P when the vehicle is stopped. When driving in heavy traffic, operate the vehicle with the shift lever in D or S to avoid discharging the battery.

### ■ After the 12-volt battery has discharged or has been changed or removed

The gasoline engine may not stop even if the vehicle is running on the hybrid battery (traction battery). If this continues for a few days, contact your Lexus dealer.



## ■ Sounds and vibrations specific to a hybrid vehicle

There may be no engine sounds or vibration even though the vehicle is able to move. Always shift the shift lever to P when parked.

The following sounds or vibrations may occur when the hybrid system is operating, and are not a malfunction:

- Motor sounds may be heard from the engine compartment.
- Sounds may be heard from the hybrid battery (traction battery) under the rear seat when the hybrid system starts or stops.
- Sounds from the hybrid system may be heard when the back door is open.
- Sounds may be heard from the hybrid transmission when the engine is started or stopped, or while the engine is idling.
- Engine sounds may be heard when accelerating sharply.
- Sounds may be heard due to regenerative braking when the brake pedal is depressed and accelerator is loosened.
- Vibration may be felt when the gasoline engine starts or stops.
- Cooling fan sounds may be heard from the air intake vents under the rear seat.

## ■ Vehicle Proximity Notification System

In the following cases, the Vehicle Proximity Notification System sound may be difficult for pedestrians, people riding bicycles or other people and vehicles in the surrounding area to hear:

- When there is a lot of noise in the vicinity
- When it is raining or during strong winds
- When in the area surrounding the rear of the vehicle, rather than in front of the vehicle

## ■ Maintenance, repair, recycling, and disposal

Contact your Lexus dealer regarding maintenance, repair, recycling and disposal. Do not dispose of the vehicle yourself.

## 1-1. Hybrid system

# Hybrid system precautions

Take care when handling the hybrid system, as it contains a high voltage system (about 650 V at maximum) as well as parts that become extremely hot when the hybrid system is operating. Obey the caution labels attached to the vehicle.

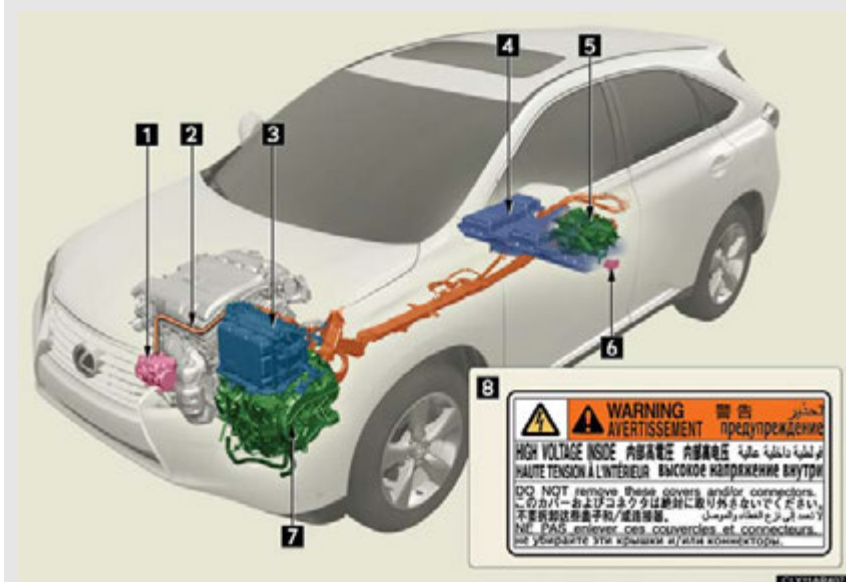

- 1 Air conditioning compressor
- 2 High voltage cables (orange)
- 3 Power control unit with DC/DC converter
- 4 Hybrid battery (traction battery)
- 5 Rear electric motor (traction motor)\*
- 6 Service plug
- 7 Front electric motor (traction motor)
- 8 Caution label

\*: AWD models only

## Hybrid battery air vents



There are air intake vents under the rear seats for the purpose of cooling the hybrid battery (traction battery). If the vents become blocked, the hybrid battery may overheat, leading to a reduction in hybrid battery output.

1

Before driving

## Emergency shut off system

When a certain level of impact is detected by the impact sensor, the emergency shut off system blocks off the high voltage current and stops the fuel pump to minimize the risk of electrocution and fuel leakage. If the emergency shut off system activates, your vehicle will not restart. To restart the hybrid system, contact your Lexus dealer.

## Hybrid warning message

A message is automatically displayed when a malfunction occurs in the hybrid system or an improper operation is attempted.



If a warning message is shown on the multi-information display, read the message and follow the instructions. (→P. 743)

### ■ If a warning light comes on or a warning message is displayed, or the 12-volt battery is disconnected

The hybrid system may not start. In that case, try to start the system again. If the "READY" indicator does not come on, contact your Lexus dealer.

### ■ When refueling, the fuel filler door may take a few moments to open

As part of emission system operation, it may take up to 10 seconds for the fuel filler door to automatically release after the opener switch is pressed. Before refueling is possible, a message will be shown on the multi-information display. (→P. 119, 755)

### ■ Electromagnetic waves

- High voltage parts and cables on the hybrid vehicles incorporate electromagnetic shielding, and therefore emit approximately the same amount of electromagnetic waves as conventional gasoline powered vehicles or home electronic appliances.
- Your vehicle may cause sound interference in some third party-produced radio parts.

### ■ Running out of fuel

When the vehicle has run out of fuel and the hybrid system cannot be started, refuel the vehicle with at least enough gasoline to make the low fuel level warning light (→P. 733) go off. If there is only a small amount of fuel, the hybrid system may not be able to start. (The minimum amount of fuel to add to make the low fuel level warning light go out is about 2.7 gal. [10.1 L, 2.2 Imp. gal.] when the vehicle is on a level surface. This value may vary when the vehicle is on a slope.)

### ■ Hybrid battery (traction battery)

The hybrid battery (traction battery) has a limited service life. The lifespan of the hybrid battery (traction battery) can change in accordance with driving style and driving conditions.

## ⚠ CAUTION

### ■ High voltage and high temperature precautions

The vehicle has high voltage DC and AC systems as well as a 12-volt system. DC and AC high voltage is very dangerous and can cause severe burns and electric shock that may result in death or serious injury.

- Never touch, disassemble, remove or replace the high voltage parts, cables and their connectors.
- The hybrid system will become hot after starting as the system uses high voltage. Be careful of both the high voltage and the high temperature, and always obey the caution labels attached to the vehicle.



- Never try to open the service plug access hole located under the rear seat. The service plug is used only when the vehicle is serviced and is subject to high voltage.

### ■ Road accident cautions

Observe the following precautions to reduce the risk of death or serious injury:

- Pull your vehicle off the road, shift the shift lever to P, apply the parking brake, and turn the hybrid system off.
- Do not touch the high voltage parts, cables and connectors.
- If electric wires are exposed inside or outside your vehicle, an electric shock may occur. Never touch exposed electric wires.
- If a fluid leak occurs, do not touch it as it may be strong alkaline electrolyte from the hybrid battery (traction battery). If it comes into contact with your skin or eyes, wash it off immediately with a large amount of water or, if possible, boric acid solution. Seek immediate medical attention.
- If a fire occurs in the hybrid vehicle, leave the vehicle as soon as possible. Never use a fire extinguisher that is not meant for electric fires. Using even a small amount of water may be dangerous.

### CAUTION

- If your vehicle needs to be towed, do so with all front wheels (for 2WD models) or four wheels (for AWD models) raised. If the wheels connected to the electric motor (traction motor) are on the ground when towing, the motor may continue to generate electricity. This may cause an electricity leakage leading to a fire. (→P.725)
- Carefully inspect the ground under the vehicle. If you find that liquid has leaked onto the ground, the fuel system may have been damaged. Leave the vehicle as soon as possible.

### ■ Nickel-metal hydride battery

Your vehicle contains a sealed nickel-metal hydride battery. If disposed of improperly, it is hazardous to the environment and there is a risk of severe burns and electrical shock that may result in death or serious injury.

### ■ Emergency shut off system

Carefully check to see if there are exposed high voltage parts or cables. Never touch the parts or cables. (→P.34)

### NOTICE

### ■ Hybrid battery air vents

- Do not put foreign objects over the air vents. The hybrid battery (traction battery) may overheat or lose power and be damaged.
- Clean the air vents regularly to prevent the hybrid battery (traction battery) from overheating.
- Do not wet or allow foreign substances to enter the air vents as this may cause a short circuit and damage the hybrid battery (traction battery).
- Do not carry large amounts of water such as an aquarium into the vehicle. If water spills onto the hybrid battery (traction battery), the battery may be damaged. Have the vehicle inspected by your Lexus dealer.

## Energy monitor/consumption screen

You can view the status of your hybrid system on the multi-information display and the navigation system screen or the Lexus Display Audio screen.



- 1 Navigation system screen or Lexus Display Audio screen (if equipped)
- 2 Multi-information display

► Vehicles with a navigation system



Remote Touch\*

- 1 "MENU" button
- 2 Remote Touch knob

\*: For use of the Remote Touch, refer to the "Navigation System Owner's Manual".

► Vehicles with the Lexus Display Audio system



Lexus Display Audio controller (→P. 328)

- 1 Displaying the "Menu" screen (→P. 329)
- 2 Turn or move the controller to select a function, number and screen button.

Push the controller to enter the selected function, number and screen button.

## Energy monitor

► Navigation system screen (if equipped)



Press the "MENU" button on the Remote Touch.

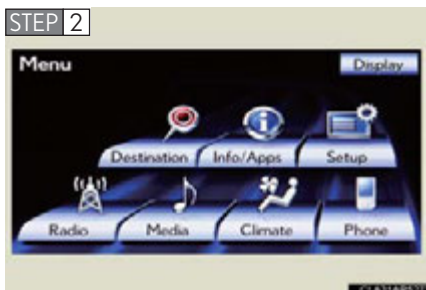

Select "Info/Apps".

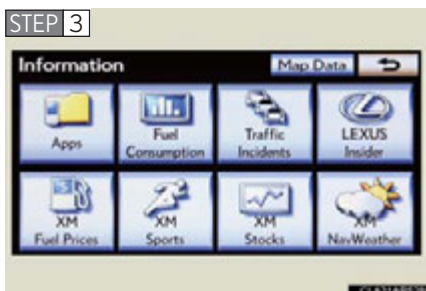

Select "Fuel Consumption".

If the "Trip Information" or "Past Record" screen is displayed, select the "Energy".



▶ Lexus Display Audio system screen (if equipped)



Press the "MENU" button on the Lexus Display Audio controller.



Select "Car".





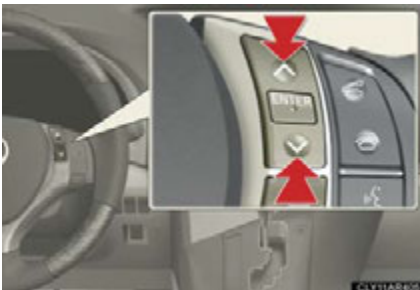

If the "Trip Information" or "History" screen is displayed, select the "Energy".



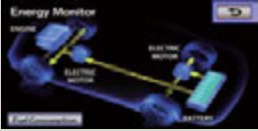

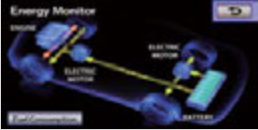
▶ Multi-information display

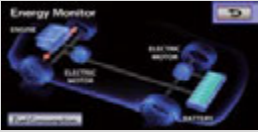



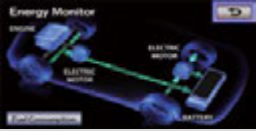

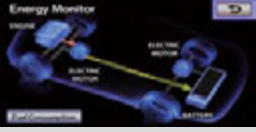
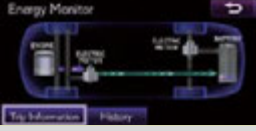
Press the "∧" or "∨" switch on the steering wheel through several items to select the energy monitor display.

# 1-1. Hybrid system

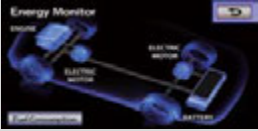
	Navigation system or Lexus Display Audio system	Multi-information display
When the vehicle is powered by the electric motor (traction motor)	<ul style="list-style-type: none"> <li>▶ Navigation system</li> </ul>  <ul style="list-style-type: none"> <li>▶ Lexus Display Audio system</li> </ul> 	
When the vehicle is powered by both the gasoline engine and the electric motor (traction motor)	<ul style="list-style-type: none"> <li>▶ Navigation system</li> </ul>  <ul style="list-style-type: none"> <li>▶ Lexus Display Audio system</li> </ul> 	
When the vehicle is powered by the gasoline engine	<ul style="list-style-type: none"> <li>▶ Navigation system</li> </ul>  <ul style="list-style-type: none"> <li>▶ Lexus Display Audio system</li> </ul> 	

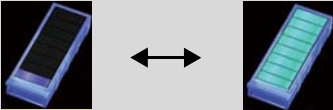
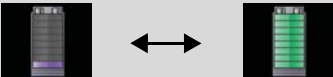
	Navigation system or Lexus Display Audio system	Multi-information display
<p>When the vehicle is charging the hybrid battery (traction battery)</p>	<ul style="list-style-type: none"> <li>▶ Navigation system</li> </ul>  <ul style="list-style-type: none"> <li>▶ Lexus Display Audio system</li> </ul> 	
	<ul style="list-style-type: none"> <li>▶ Navigation system</li> </ul>  <ul style="list-style-type: none"> <li>▶ Lexus Display Audio system</li> </ul> 	

	Navigation system or Lexus Display Audio system	Multi-information display
When there is no energy flow	<p>▶ Navigation system</p>  <p>▶ Lexus Display Audio system</p> 	
Hybrid battery (traction battery) status	<p>▶ Navigation system</p> <p>Low <span style="margin-left: 150px;">Full</span></p>  <p>▶ Lexus Display Audio system</p> <p>Low <span style="margin-left: 150px;">Full</span></p> 	<p>Low <span style="margin-left: 150px;">Full</span></p> 

These images are examples only, and may vary slightly from actual conditions.

## Consumption

### ■ Trip information

▶ Vehicles with a navigation system

**STEP 1** Press the “MENU” button on the Remote Touch and select “Info/Apps”.

**STEP 2** Select “Fuel Consumption”.

If the “Trip Information” screen does not appear, select “Fuel Consumption” on the “Energy Monitor” screen or “Trip Information” on the “Past Record” screen.

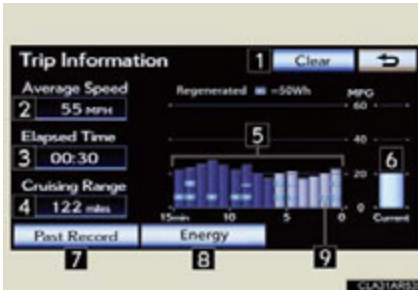

- 1** Reset the trip information data
  - 2** Average vehicle speed
  - 3** Elapsed time
  - 4** Cruising range
  - 5** Previous fuel consumption per minute
  - 6** Current fuel consumption
  - 7** “Past Record” screen appears
  - 8** “Energy Monitor” screen appears
  - 9** Regenerated energy
- E**: One symbol indicates 50 Wh.

The image is example only, and may vary slightly from actual conditions.

### ► Vehicles with the Lexus Display Audio system

**STEP 1** Press the “MENU” button on the Lexus Display Audio controller.

**STEP 2** Select “Car” on the “Menu” screen.

If the “Trip information” screen does not appear, select “Trip information”.

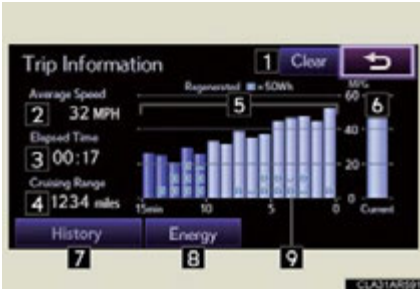

- 1** Reset the trip information data
- 2** Average vehicle speed
- 3** Elapsed time
- 4** Cruising range
- 5** Previous fuel consumption per minute
- 6** Current fuel consumption
- 7** “History” screen appears
- 8** “Energy Monitor” screen appears
- 9** Regenerated energy

**E**: One symbol indicates 50 Wh.

The image is example only, and may vary slightly from actual conditions.

## ■ Past record

### ▶ Vehicles with a navigation system

**STEP 1** Press the “MENU” button on the Remote Touch and select “Info/Apps”.

**STEP 2** Select “Fuel Consumption”.

If the “Past Record” screen does not appear, select “Fuel Consumption” on the “Energy Monitor” screen or “Past Record” on the “Trip Information” screen.

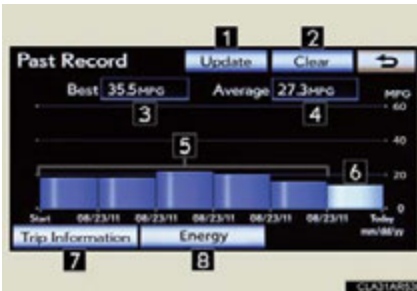

**1** Update the past record data

**2** Reset the past record data

**3** Best past fuel consumption

**4** Average fuel consumption

Use the displayed average fuel consumption as a reference.

**5** Previous fuel economy record

**6** Current fuel economy

**7** “Trip Information” screen appears

**8** “Energy Monitor” screen appears

The image is example only, and may vary slightly from actual conditions.

### ► Vehicles with the Lexus Display Audio system

**STEP 1** Press the “MENU” button on the Lexus Display Audio controller.

**STEP 2** Select “Car” on the “Menu” screen.

If the “History” screen does not appear, select “History”.

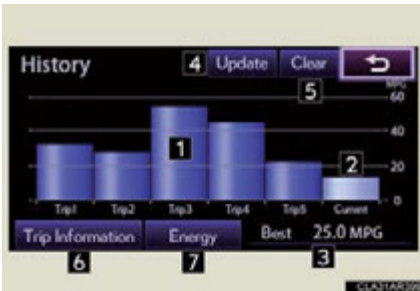

- 1 Previous fuel economy record
- 2 Current fuel economy
- 3 Best past fuel consumption
- 4 Update the past record data
- 5 Reset the past record data
- 6 “Trip information” screen appears
- 7 “Energy Monitor” screen appears

The image is example only, and may vary slightly from actual conditions.

### ■ Updating the past record data

Selecting “Update” on the “Past Record” or “History” screen will update the past record data.

Also, the average fuel consumption displayed in the multi-information display will be reset at the same time.



For economical and ecological driving, pay attention to the following points:

### ■ Use of Hybrid System Indicator

More Eco-friendly driving is possible by keeping the indicate of Hybrid System Indicator within Eco area.

### ■ When braking the vehicle

Make sure to operate the brakes gently and in good time. A greater amount of electrical energy can be retained when slowing down.

### ■ Delays

Repeated acceleration and deceleration, as well as long waits at traffic lights, will lead to bad fuel consumption. Check traffic reports before leaving and avoid delays as much as possible. When encountering a delay, gently release the brake pedal to allow the vehicle to move forward slightly while avoiding overuse of the accelerator pedal. Doing so can help control excessive gasoline consumption.

### ■ Highway driving

Control your speed and keep at a constant speed. Also, before stopping at a toll booth or similar, allow plenty of time to release the accelerator and gently apply the brakes. A greater amount of electrical energy can be retained when slowing down.

### ■ Air conditioning

Use the air conditioning only when necessary. Doing so can help control excessive gasoline consumption.

In summer: In high temperatures, use the recirculated air mode. Doing so will help to reduce the burden on the air conditioning and reduce fuel consumption as well.

In winter: Because the gasoline engine will not automatically cut out until the gasoline engine and the interior of the vehicle are warm, it will consume fuel. Also, fuel consumption can be improved by avoiding overuse of the heater.

### ■ **Checking tire inflation pressure**

Make sure to check the tire inflation pressure frequently. Improper tire inflation pressure can cause poor fuel consumption. Also, as snow tires can cause large amounts of friction, their use on dry roads can lead to poor fuel consumption. Use a tire that is appropriate for the season.

### ■ **Luggage**

Carrying heavy luggage can lead to poor fuel consumption. Avoid carrying unnecessary luggage. Installing a large roof rack can also cause poor fuel consumption.

### ■ **Warming up before driving**

Since the gasoline engine starts up and cuts out automatically when cold, warming up the engine is unnecessary. Moreover, frequently driving short distances will cause the engine to repeatedly warm up, which can lead to poor fuel consumption.

# Keys

The following keys are provided with the vehicle.



**1** Electronic keys

- Operating the smart access system with push-button start (→P. 56)
- Operating the wireless remote control function (→P. 69)

**2** Mechanical keys

**3** Key number plate

**4** Card key (electronic key)  
(if equipped)

Operating the smart access system with push-button start (→P. 56)

## Using the mechanical key



To take out the mechanical key:

Electronic keys: Slide the release lever and take the key out.

Card key: Press the lock release button and take the key out.

If the key cannot be inserted in a lock cylinder, turn it over and re-attempt to insert it. The mechanical key with grooves on one side can be inserted in one direction only.

After using the mechanical key, store it in the electronic key. Carry the mechanical key together with the electronic key. If the electronic key battery is depleted or the entry function does not operate properly, you will need the mechanical key. (→P. 781)

### ■ Card key (if equipped)

- The mechanical key that is stored inside the card key should be used only if a problem arises, such as when the key does not operate properly.
- If it is difficult to take out the mechanical key, press down the lock release button using a pen tip etc. If it is still difficult to pull it out, use a coin etc.



- To store the mechanical key in the card key, insert it while pressing the lock release button.



- If the battery cover is not installed and the battery falls out or if the battery was removed because the key got wet, reinstall the battery with the positive terminal facing the Lexus emblem.

- The card key is not waterproof.

#### ■ When required to leave the vehicle's key with a parking attendant

Lock the glove box as circumstances demand. (→P. 586)

Remove the mechanical key for your own use and provide the attendant with the electronic key only.

#### ■ Key number plate

Keep the plate in a safe place such as your wallet, not in the vehicle. In the event that a mechanical key is lost, a new key can be made at your Lexus dealer using the key number plate. (→P. 780)

#### ■ When riding in an aircraft

When bringing an electronic key onto an aircraft, make sure you do not press any buttons on the electronic key while inside the aircraft cabin. If you are carrying an electronic key in your bag etc., ensure that the buttons are not likely to be pressed accidentally. Pressing a button may cause the electronic key to emit radio waves that could interfere with the operation of the aircraft.

### NOTICE

#### ■ To prevent key damage

Observe the following:

- Do not drop the keys, subject them to strong shocks or bend them.
- Do not expose the keys to high temperatures for a long period of time.
- Do not get the keys wet or wash them in an ultrasonic washer etc.
- Do not attach metallic or magnetic materials to the keys or place the keys close to such materials.
- Do not disassemble the keys.
- Do not attach a sticker or anything else to the surface of the electronic key.
- Do not place the keys near objects that produce magnetic fields, such as TVs, audio systems, induction cookers, or medical electrical equipment, such as low-frequency therapy equipment.

#### ■ Carrying the electronic key on your person

Carry the electronic key 3.9 in. (10 cm) or more away from electric appliances that are turned on. Radio waves emitted from electric appliances within 3.9 in. (10 cm) of the electronic key may interfere with the key, causing the key to not function properly.

#### ■ In case of a smart access system with push-button start malfunction or other key-related problems

Take your vehicle with all the electronic keys provided with your vehicle, including the card key, to your Lexus dealer.

#### ■ When a vehicle key is lost

If the key remains lost, the risk of vehicle theft increases significantly. Visit your Lexus dealer immediately with all remaining electronic keys and the card key that was provided with your vehicle.

 NOTICE**■ Precautions for handling the card key**

- Do not apply excess force when inserting the mechanical key into the card key. Doing so may damage the card key.
- If the battery or card key terminals get wet, the battery may corrode and the card key may stop working.  
If the key is dropped into water, or if drinking water etc. is spilled on the key, immediately remove the battery cover and wipe the battery and terminals. (To remove the battery cover, lightly grasp and pull it.) If the battery is corroded, have your Lexus dealer replace the battery.
- Do not crush the battery cover or use a screwdriver to remove the battery cover. Forcibly removing the battery cover may bend or damage the key.
- If the battery cover is frequently removed, the battery cover may become loose.
- When installing the battery, make sure to check the direction of the battery. Installing the battery in the wrong direction may cause the battery to deplete rapidly.
- The surface of the card key may be damaged, or its coating may peel off in the following situations:
  - The card key is carried together with hard objects, such as coins and keys.
  - The card key is scraped with a sharp object, such as the tip of a mechanical pencil.
  - The surface of the card key is wiped with thinner or benzene.

### 1-3. Opening, closing and locking the doors

## Smart access system with push-button start

The following operations can be performed simply by carrying the electronic key (including the card key) on your person, for example in your pocket.

(The driver should always carry the electronic key.)

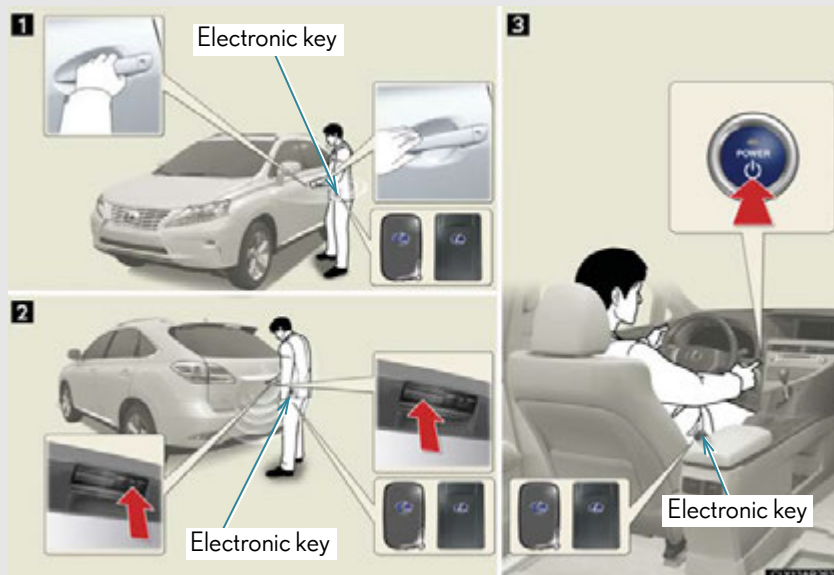

**1** Locks and unlocks the side doors (→P. 57)

**2** Locks and unlocks the back door (→P. 57)

**3** Starts the hybrid system (→P. 177)



### Unlocking and locking the side doors (front door handles only)

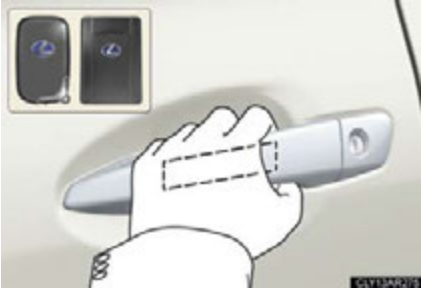

Grip the driver's door handle to unlock the door. Grip the passenger's door handle to unlock all the doors.\*

Make sure to touch the sensor on the back of the handle.

The doors cannot be unlocked for 3 seconds after the doors are locked.

\*: The door unlock settings can be changed. (→P. 825)



Touch the lock sensor (the indentation on the upper part of the door handle) to lock the doors.

### Locking the back door



Press the button to lock the door.

1

Before driving

### Opening the back door



Press the button to open the door.

The door automatically opens fully.

The door cannot be opened for 3 seconds after the door is locked.

### Antenna location and effective range

#### ■ Antenna location

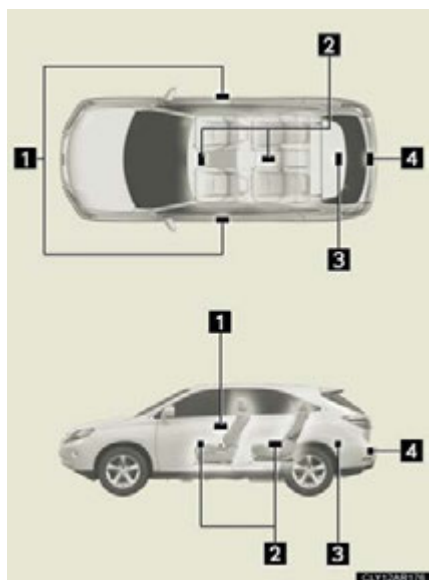

1 Antennas outside the cabin

2 Antennas inside the cabin

3 Antenna inside the luggage compartment

4 Antenna outside the luggage compartment

### ■ Effective range (areas within which the electronic key is detected)

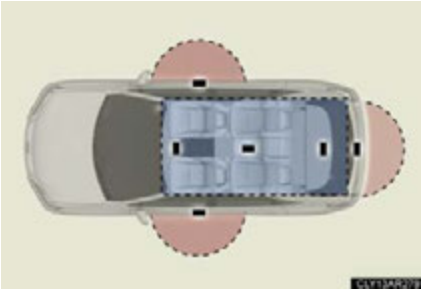

- When locking or unlocking the doors

The system can be operated when the electronic key is within about 2.3 ft. (0.7 m) of an outside door handle. (Only the doors detecting the key can be operated.)

- When starting the hybrid system or changing "POWER" switch modes

The system can be operated when the electronic key is inside the vehicle.

1

Before driving

### ■ Operation signals

A buzzer sounds and the emergency flashers flash to indicate that the doors have been locked/unlocked. (Locked: Once; Unlocked: Twice)

### ■ When the door cannot be locked by the lock sensor on the upper part of the door handle



Touch both lock sensors on the upper and lower part of the door handle simultaneously.

### ■ Alarms and warning indicators

A combination of exterior and interior alarms as well as warning messages shown on the multi-information display is used to prevent theft of the vehicle and accidents resulting from erroneous operation. Take appropriate measures in response to any warning message on the multi-information display. (→P. 743)

The following table describes circumstances and correction procedures when only alarms are sounded.

Alarm	Situation	Correction procedure
Exterior alarm sounds once for 5 seconds.	An attempt was made to lock the vehicle while a door was open.	Close all of the doors and lock the doors again.
Interior alarm pings repeatedly	The "POWER" switch was turned to ACCESSORY mode while the driver's door is open. (The driver's door was opened when the "POWER" switch is in ACCESSORY mode.)	Close the driver's door.
	The "POWER" switch was turned off while the driver's door is open.	Close the driver's door.

### ■ Security feature

If a door is not opened within approximately 60 seconds after the vehicle is unlocked, the security feature automatically locks the vehicle again.

### ■ Battery-saving function

If the vehicle is parked for a long period of time, the battery-saving function is activated in order to prevent the vehicle 12-volt battery from being discharged and the electronic key battery from being depleted.

- In the following circumstances, unlocking the vehicle using the entry function may take longer than usual:
  - When the entry function has not been used for 5 days or more
  - When the electronic key has been left within approximately 6 ft. (2 m) of the vehicle for 10 minutes or more
- If the entry function has not been used for 14 days or more, the vehicle cannot be unlocked by a door other than the driver's door. To unlock the vehicle, grip the driver's door handle or use the wireless remote control or the mechanical key.

The system will resume operation when:

- The vehicle is locked using the lock sensor.
- The vehicle is locked/unlocked using the wireless remote control function. (→P. 69)
- The vehicle is locked/unlocked using the mechanical key. (→P. 781)

### ■ Conditions affecting operation

The smart access system with push-button start uses weak radio waves. In the following situations, the communication between the electronic key and the vehicle may be affected, preventing the smart access system with push-button start, wireless remote control and immobilizer system from operating properly.

(Ways of coping: →P. 781)

- When the electronic key battery is depleted
- Near a TV tower, electric power plant, gas station, radio station, large display, airport or other facility that generates strong radio waves or electrical noise
- When carrying a portable radio, cellular phone, cordless phone or other wireless communication devices
- When the electronic key is in contact with, or is covered by the following metallic objects
  - Cards to which aluminum foil is attached
  - Cigarette boxes that have aluminum foil inside
  - Metallic wallets or bags
  - Coins
  - Hand warmers made of metal
  - Media such as CDs and DVDs
- When multiple electronic keys are in the vicinity
- When another wireless key (that emits radio waves) is being used nearby
- When carrying the electronic key together with the following devices that emit radio waves
  - Another vehicle's electronic key or a wireless key that emits radio waves
  - Personal computers or personal digital assistants (PDAs)
  - Digital audio players
  - Portable game systems
- If window tint with a metallic content or metallic objects are attached to the rear window

**■ Note for the entry function**

- Even when the electronic key is within the effective range (detection areas), the system may not operate properly in the following cases:
  - The electronic key is too close to the window or outside door handle, near the ground, or in a high place when the doors are locked or unlocked.
  - The electronic key is on the instrument panel, luggage cover or floor or in the glove box.
- Do not leave the electronic key on top of the instrument panel or near the door pockets when exiting the vehicle. Depending on the radio wave reception conditions, it may be detected by the antenna outside the cabin and the door will become lockable from the outside, possibly trapping the electronic key inside the vehicle.
- As long as the electronic key is within the effective range, the doors may be locked or unlocked by anyone. However, only the doors detecting the electronic key can be used to unlock the vehicle.
- The doors may lock or unlock if the electronic key is within the effective range and a large amount of water splashes on the door handle, such as in the rain or in a car wash. The doors will automatically be locked after approximately 60 seconds if a door is not opened and closed.
- If the wireless remote control is used to lock the doors when the electronic key is near the vehicle, there is a possibility that the door may not be unlocked by the entry function. (Use the wireless remote control to unlock the doors.)

### ■ Notes for locking the doors

- Touching the door lock sensor while wearing gloves may delay or prevent lock operation. Remove the gloves and touch the lock sensor again.
- When the lock operation is performed using the lock sensor, recognition signals will be shown up to two consecutive times. After this, no recognition signals will be given.
- If the door handle becomes wet while the electronic key is within the effective range, the door may lock and unlock repeatedly. Place the key in a position 6 ft. (2 m) or more separate from the vehicle while the vehicle is being washed. (Take care to ensure that the key is not stolen.)
- If the electronic key is inside the vehicle and a door handle becomes wet during a car wash, a message may be shown on the multi-information display and a buzzer will sound outside the vehicle. To turn off the alarm, lock all the doors.
- The lock sensor may not work properly if it comes into contact with ice, snow, mud, etc. Clean the lock sensor and attempt to operate it again, or use the lock sensor on the lower part of the door handle.
- Fingernails may scrape against the door during operation of the door handle. Be careful not to injure fingernails or damage the surface of the door.

### ■ Notes for the unlocking function

- Gripping the door handle when wearing a glove may not unlock the door.
- A sudden approach to the effective range or door handle may prevent the doors from being unlocked. In this case, return the door handle to the original position and check that the doors unlock before pulling the door handle again.
- If there is another electronic key in the detection area, it may take slightly longer to unlock the doors after the door handle is gripped.

### ■ When the vehicle is not driven for extended periods

- To prevent theft of the vehicle, do not leave the electronic key within 6 ft. (2 m) of the vehicle.
- The smart access system with push-button start can be deactivated in advance. (→P. 825)



### ■ To operate the system properly

Make sure to carry the electronic key when operating the system. Do not get the electronic key too close to the vehicle when operating the system from the outside of the vehicle.

Depending on the position and holding condition of the electronic key, the key may not be detected correctly and the system may not operate properly. (The alarm may go off accidentally, or the door lock prevention function may not operate.)

### ■ If the smart access system with push-button start does not operate properly

- Locking and unlocking the doors: Use the mechanical key. (→P. 781)
- Starting the hybrid system: →P. 782

### ■ Electronic key battery depletion

- The standard battery life is 1 to 2 years. (The card key battery life is about a year and a half.)
- If the battery becomes low, an alarm will sound in the cabin when the hybrid system stops. (→P. 756)
- As the electronic key always receives radio waves, the battery will become depleted even if the electronic key is not used. The following symptoms indicate that the electronic key battery may be depleted. Replace the battery when necessary. (→P. 687)
  - The smart access system with push-button start or the wireless remote control does not operate.
  - The detection area becomes smaller.
  - The LED indicator on the key surface does not turn on.
- To avoid serious deterioration, do not leave the electronic key within 3 ft. (1 m) of the following electrical appliances that produce a magnetic field:
  - TVs
  - Personal computers
  - Cellular phones, cordless phones and battery chargers
  - Recharging cellular phones or cordless phones
  - Induction cookers
  - Table lamps

### ■ When the electronic key battery is fully depleted

→P. 687

### ■ Customization

Settings (e.g. smart access system with push-button start) can be changed.  
(Customizable features →P. 825)

### ■ Certification for the smart access system with push-button start

This system meets the certification requirements of Radio Law.

► For vehicles sold in Hawaii, Guam, Saipan and Puerto Rico

FCC ID: NI4TMLF8-6

FCC ID: HYQ14ACX

FCC ID: HYQ14AEB

FCC ID: HYQ13CZF

NOTE:

This device complies with part 15 of the FCC Rules. Operation is subject to the following two conditions: (1) This device may not cause harmful interference, and (2) this device must accept any interference received, including interference that may cause undesired operation.

FCC WARNING:

Changes or modifications not expressly approved by the party responsible for compliance could void the user's authority to operate the equipment.

► For vehicles sold in the mainland U.S.A.

FCC ID: NI4TMLF8-6

FCC ID: HYQ14ACX

FCC ID: HYQ14AEB

FCC ID: HYQ13CZF

FCC ID: HYQ14ADF

FCC ID: HYQ14AEF

FCC ID: HYQ13CZG

NOTE:

This device complies with part 15 of the FCC Rules. Operation is subject to the following two conditions: (1) This device may not cause harmful interference, and (2) this device must accept any interference received, including interference that may cause undesired operation.

FCC WARNING:

Changes or modifications not expressly approved by the party responsible for compliance could void the user's authority to operate the equipment.

► For vehicles sold in Canada

NOTE:

This device complies with Industry Canada licence-exempt RSS standard(s). Operation is subject to the following two conditions: (1) this device may not cause interference, and (2) this device must accept any interference, including interference that may cause undesired operation of the device.

### CAUTION

#### ■ Caution regarding interference with electronic devices

- People with implantable cardiac pacemakers, cardiac resynchronization therapy-pacemakers or implantable cardioverter defibrillators should keep away from the smart access system antennas. (→P. 59)

The radio waves may affect the operation of such devices. If necessary, the entry function can be disabled. Ask your Lexus dealer for details, such as the frequency of radio waves and timing of the emitted radio waves. Then, consult your doctor to see if you should disable the entry function.

- User of any electrical medical device other than implantable cardiac pacemakers, cardiac resynchronization therapy-pacemakers or implantable cardioverter defibrillators should consult the manufacturer of the device for information about its operation under the influence of radio waves.

Radio waves could have unexpected effects on the operation of such medical devices.

Ask your Lexus dealer for disabling the entry function.

# Wireless remote control

The wireless remote control can be used to lock and unlock the vehicle. It also opens and closes the back door.



- 1 Locks all the doors
  - 2 Unlocks all the doors
- Pressing the button unlocks the driver's door. Pressing the button again within 3 seconds unlocks the other doors.
- 3 Opens the windows and moon roof (press and hold)
  - 4 Opens and closes the back door (press and hold)
  - 5 Sounds the alarm (press and hold) (→P. 70)

### ■ Operation signals

Doors:

A buzzer sounds and the emergency flashers flash to indicate that the doors have been locked/unlocked. (Locked: Once; Unlocked: Twice)

Back door:

A buzzer sounds and the emergency flashers flash twice to indicate that the back door is opening/closing.

Windows and moon roof:

A buzzer sounds to indicate that the windows and moon roof are opening.

### ■ Door lock buzzer

If an attempt to lock the doors is made when a door is not fully closed, a buzzer sounds continuously. Fully close the door to stop the buzzer, and lock the vehicle once more.

### ■ Security feature

→P. 61

### ■ Panic mode



When  is pressed for longer than about one second, an alarm will sound intermittently and the vehicle lights will flash to deter any person from trying to break into or damage your vehicle.

To stop the alarm, press any button on the electronic key.

### ■ Back door operation

The back door can be opened even if it is locked. Lock the back door again when you leave the vehicle. The back door will not be locked automatically after it has been opened and then closed.

### ■ Alarm

Using the wireless remote control to lock the doors will set the alarm system. (→P. 126)

**■ Reversing the operation of the power back door**

Pressing the wireless remote control switch again while the power back door is operating will cause the operation to reverse.

**■ Wireless remote control operation while the power back door is closing**

If the wireless remote control is used to lock the doors while the power back door is closing, the doors will lock after the power back door has completely closed. To prevent locking the keys inside the vehicle, do not place the electric key inside the vehicle while the power back door is closing.

**■ Conditions affecting operation**

→P. 62

**■ If the wireless remote control does not operate properly**

Locking and unlocking the doors: Use the mechanical key. (→P. 781)

**■ Electronic key battery depletion**

→P. 65

**■ When the electronic key battery is fully depleted**

→P. 687

**■ Customization**

Settings (e.g. door unlocking function) can be changed.  
(Customizable features →P. 825)

## 1-3. Opening, closing and locking the doors

### Side doors

The vehicle can be locked and unlocked using the entry function, wireless remote control or door lock switches.

#### ■ Entry function

→P. 57

#### ■ Wireless remote control

→P. 69

#### ■ Door lock switches



- 1 Locks all the doors
- 2 Unlocks all the doors

#### ■ Inside lock buttons

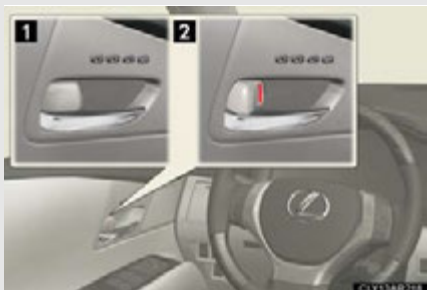

- 1 Locks the door
- 2 Unlocks the door

The front doors can be opened by pulling the inside handle even if the lock buttons are in the lock position.



### Locking the front doors from the outside without a key

**STEP 1** Move the inside lock button to the lock position.

**STEP 2** Close the door.

The door cannot be locked if the “POWER” switch is in ACCESSORY or ON mode, or the electronic key is left inside the vehicle.

The key may not be detected correctly and the door may be locked.

### Rear door child-protector lock



The door cannot be opened from inside the vehicle when the lock is set.

- 1** Unlock
- 2** Lock

These locks can be set to prevent children from opening the rear doors. Push down on each rear door switch to lock both rear doors.

### ■ Impact detection door lock release system

In the event that the vehicle is subject to a strong impact, all the doors are unlocked. Depending on the force of the impact or the type of accident, however, the system may not operate.

### ■ Using the mechanical key

The doors can also be locked and unlocked with the mechanical key. (→P. 781)

### ■ If a wrong key is used

The key cylinder rotates freely to protect the inside mechanism.

### ■ Customization

Settings (e.g. unlocking function using a key) can be changed.  
(Customizable features →P. 825)

## CAUTION

### ■ To prevent an accident

Observe the following precautions while driving the vehicle.

Failure to do so may result in a door opening and an occupant falling out, resulting in death or serious injury.

● Always use a seat belt.

● Always lock all the doors.

● Ensure that all the doors are properly closed.

● Do not pull the inside handle of the doors while driving.

The doors may be opened and the passengers are thrown out of the vehicle and it may result in serious injury or death.

Be especially careful with the front doors, as the doors may be opened even if the inside lock buttons are in the locked position.

● Set the rear door child-protector locks when children are seated in the rear seats.

### ■ When opening or closing a door

Check the surroundings of the vehicle such as whether the vehicle is on an incline, whether there is enough space for a door to open and whether a strong wind is blowing. When opening or closing the door, hold the door handle tightly to prepare for any unpredictable movement.

### Back door

The back door can be locked/unlocked and opened/closed by the following procedures:

#### ■ Locking and unlocking the back door

- ▶ Door lock switches  
→P. 72
- ▶ Entry function  
→P. 57
- ▶ Wireless remote control  
→P. 69

#### ■ Opening the back door from outside the vehicle automatically

- ▶ Using the back door opener button



Press the back door opener button.

- ▶ Using the wireless remote control  
→P. 69

#### ■ Opening the back door from outside the vehicle manually\*



Raise the back door while pushing up the back door opener button.

\*: This setting must be customized at your Lexus dealer.

### ■ Opening the back door from inside the vehicle



Press and hold the switch to open/close the back door.

Pressing the switch again while the power back door is operating will cause the operation to reverse.

### Power back door switch



Press the switch to close the back door.

Pressing the switch again while the power back door is closing will cause it to open again.

However, the reverse operation cannot be performed for the first second after automatic operation starts even if the switch is pressed again.

### When closing the back door



Lower the back door using the back door handle, and make sure to push the back door down from the outside to close it.

## Canceling the power back door system

Turn off the main switch in the glove box to disable the power back door system.



- 1 On
- 2 Off

The back door cannot be operated even with the wireless remote control or power back door switch.

1

Before driving

### ■ The power back door can be operated when

- The back door is unlocked. (Except for using the back door opener button or wireless remote control, when the power back door can be operated even if it is locked.)
- The power back door main switch is on.
- To open the power back door when the "POWER" switch is in ON mode, the power back door main switch must be on, the vehicle speed must be lower than 1 mph (3 km/h) and the shift lever must be in P. (When using the back door opener button only)
- The "POWER" switch is turned off. (When using the wireless remote control only)

### ■ Luggage compartment lights



The luggage compartment lights turn on when the back door is opened with the luggage compartment light switch on.

When the "POWER" switch is turned off, the lights will go off automatically after 20 minutes.

### ■ Back door closer

In the event that the back door is left slightly open, the back door closer will automatically close it to the fully closed position.

- The back door closer will operate regardless of “POWER” switch mode.
- The back door can be opened while the back door closer is operating by pressing the back door opener button.

### ■ Power back door operation

- A buzzer sounds and the emergency flashers flash twice to indicate that the back door is opening/closing.
- The back door can still be opened and closed manually, even when the power back door main switch is off.
- Pressing the back door opener button while the power back door system is operating will cause the back door to switch to manual operation.
- If anything obstructs the power back door while it is closing/opening, a buzzer will sound and the back door will automatically operate in the opposite direction.
- If two or more successive attempts are made to close the back door, a buzzer will sound and the back door will switch to manual operation.

### ■ Jam protection function



Sensors are attached to the left and right sides of the power back door. If these sensors detect an obstruction while the power back door is closing, the jam protection function will return the door to the fully open position.

### ■ After the back door has been opened and then closed

Lock the back door as the back door will not lock automatically.

### ■ If the back door opener is inoperative

The back door can be opened from the inside.

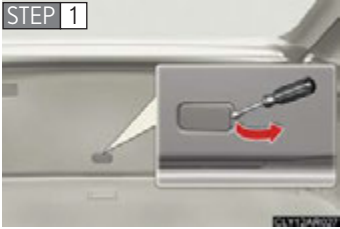

Remove the cover.

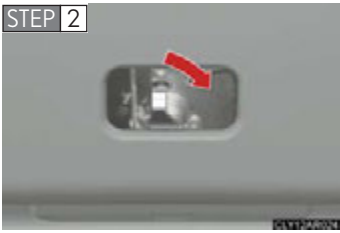

Move the lever.

### ■ When reconnecting the 12-volt battery or changing a fuse while the back door is open:

To enable the power back door to operate properly, initialize the system by completely closing the back door manually. If the 12-volt battery is reconnected or a fuse is changed while the back door is closed, initializing the system is not necessary.

### CAUTION

#### ■ Caution while driving

- Keep the back door closed while driving.

If the back door is left open, it may hit near-by objects while driving or luggage may be unexpectedly thrown out, causing an accident.

In addition, exhaust gases may enter the vehicle, causing death or a serious health hazard. Make sure to close the back door before driving.

- Before driving the vehicle, make sure that the back door is fully closed. If the back door is not fully closed, it may open unexpectedly while driving, causing an accident.
- Never let anyone sit in the luggage compartment. In the event of sudden braking or a collision, they are susceptible to death or serious injury.

#### ■ When children are in the vehicle

Observe the following precautions.

Failure to do so may result in death or serious injury.

- Do not allow children to play in the luggage compartment.

If a child is accidentally locked in the luggage compartment, they could have heat exhaustion or other injuries.

- Do not allow a child to open or close the back door.

Doing so may cause the back door to move unexpectedly, or cause the child's hands, head, or neck to be caught by the closing back door, which may result in death or serious injury of the child.

#### ■ Operating the back door

Observe the following precautions.

Failure to do so may cause parts of the body to be caught, resulting in death or serious injury.

- Remove any heavy loads, such as snow and ice, from the back door before opening it. Failure to do so may cause the back door to suddenly shut again after it is opened.
- When opening or closing the back door, thoroughly check to make sure the surrounding area is safe.
- If anyone is in the vicinity, make sure they are safe and let them know that the back door is about to open or close.



## ! CAUTION

- Use caution when opening or closing the back door in windy weather as it may move abruptly in strong wind.



- The back door may suddenly shut if it is not opened fully. It is more difficult to open or close the back door on an incline than on a level surface, so beware of the back door unexpectedly opening or closing by itself. Make sure that the back door is fully open and secure before using the luggage compartment.
- When closing the back door, take extra care to prevent your fingers etc. from being caught.
- When closing the back door, make sure to press it lightly on its outer surface. If the back door handle is used to fully close the back door, it may result in hands or arms being caught.
- Do not pull on the back door damper stay to close the back door, and do not hang on the back door damper stay. Doing so may cause hands to be caught or the back door damper stay to break, causing an accident.
- If a bicycle carrier or similar heavy object is attached to the back door, it may suddenly shut again after being opened, causing someone's hands, head or neck to be caught and injured. When installing an accessory part to the back door, using a genuine Lexus part is recommended.

### CAUTION

#### ■ Back door closer



- In the event that the back door is left slightly open, the back door closer will automatically close it to the fully closed position. It takes several seconds before the back door closer begins to operate. Be careful not to catch fingers or anything else in the back door, as this may cause bone fractures or other serious injuries.

- Use caution when using the back door closer as it still operates when the power back door system is cancelled.

#### ■ Power back door

Observe the following precautions when operating the power back door. Failure to do so may cause death or serious injury.

- Check the safety of the surrounding area to make sure there are no obstacles or anything that could cause any of your belongings to get caught.
- If anyone is in the vicinity, make sure they are safe and let them know that the back door is about to open or close.
- If the power back door system is turned off with the main switch while the back door is operating automatically, the automatic operation is stopped. The back door then has to be operated manually. Take extra care when on an incline, as the back door may open or close unexpectedly.
- If the operating conditions of the power back door are no longer met, a buzzer may sound and the back door may stop opening or closing. The back door then has to be operated manually. Take extra care when on an incline, as the back door may open or close abruptly.
- On an incline, the back door may suddenly shut after it opens. Make sure the back door is fully open and secure.

 **CAUTION**

- In the following situations, the power back door may detect an abnormality and automatic operation may be stopped. In this case, the back door has to be operated manually. Take extra care when on an incline, as the back door may open or close abruptly.
  - When the back door contacts an obstacle
  - When the 12-volt battery voltage suddenly drops, such as when the “POWER” switch is turned to ON mode or the hybrid system is started during automatic operation
- If a bicycle carrier or similar heavy object is attached to the back door, the power back door may not operate, causing itself to malfunction, or the back door may suddenly shut again after being opened, causing someone’s hands, head or neck to be caught and injured. When installing an accessory part to the back door, using a genuine Lexus part is recommended.

**■ Jam protection function**

Observe the following precautions.

Failure to do so may cause death or serious injury.

- Be careful while the jam protection function is operating. Being hit by the back door may result in an injury.
- Although the back door stops closing when the jam protection function detects an object, take extra care as you may still be injured if part of your body is already caught.
- If anything obstructs the power back door while it is closing, the jam protection function will cause the back door to automatically operate in the opposite direction. However, be careful not to jam body parts in the doorframe, as an injury may result.
- Never use any part of your body to intentionally activate the jam protection function.
- The jam protection function may not work if something gets caught just before the back door fully closes. Be careful not to catch fingers or anything else.

### CAUTION

- The jam protection function may not work depending on the shape of the object that is caught. Be careful not to catch fingers or anything else.
- The sensors located on the right and left sides of the power back door detect obstructions and prevent them from becoming jammed in the door. Some objects may not be detected depending on their shape or how they are jammed. Be careful not to get fingers or other body parts caught in the back door while it is operating as this may result in a serious injury.

### NOTICE

#### ■ Back door damper stays

The back door is equipped with damper stays that hold the back door in place.

Observe the following precautions.

Failure to do so may cause damage to the back door damper stay, resulting in malfunction.



- Do not attach any foreign objects, such as stickers, plastic sheets, or adhesives to the damper stay rod.
- Do not touch the damper stay rod with gloves or other fabric items.
- Do not attach any accessories other than genuine Lexus parts to the back door.
- Do not place your hand on the damper stay or apply lateral forces to it.

#### ■ To prevent back door closer malfunction

- Do not apply excessive force to the back door while the back door closer is operating.
- If the back door is opened and closed repeatedly in a short amount of time, the back door closer may stop operating. In this case, manually open the back door once and wait for a while before attempting to close it again.

 NOTICE**■ To prevent damage to the power back door**

- Make sure that there is no ice between the back door and frame that would prevent movement of the back door. Operating the power back door when excessive load is present on the back door may cause a malfunction.
- Do not apply excessive force to the back door while the power back door is operating.
- Take care not to damage the sensors (installed on the right and left edges of the power back door) with a knife or other sharp object. If the sensor is disconnected, the power back door will not operate in automatic operation.
- When manually closing the back door immediately after the power back door has been automatically opened fully, some resistance may be felt.

## 1-4. Adjustable components (seats, mirrors, steering wheel)

### Front seats

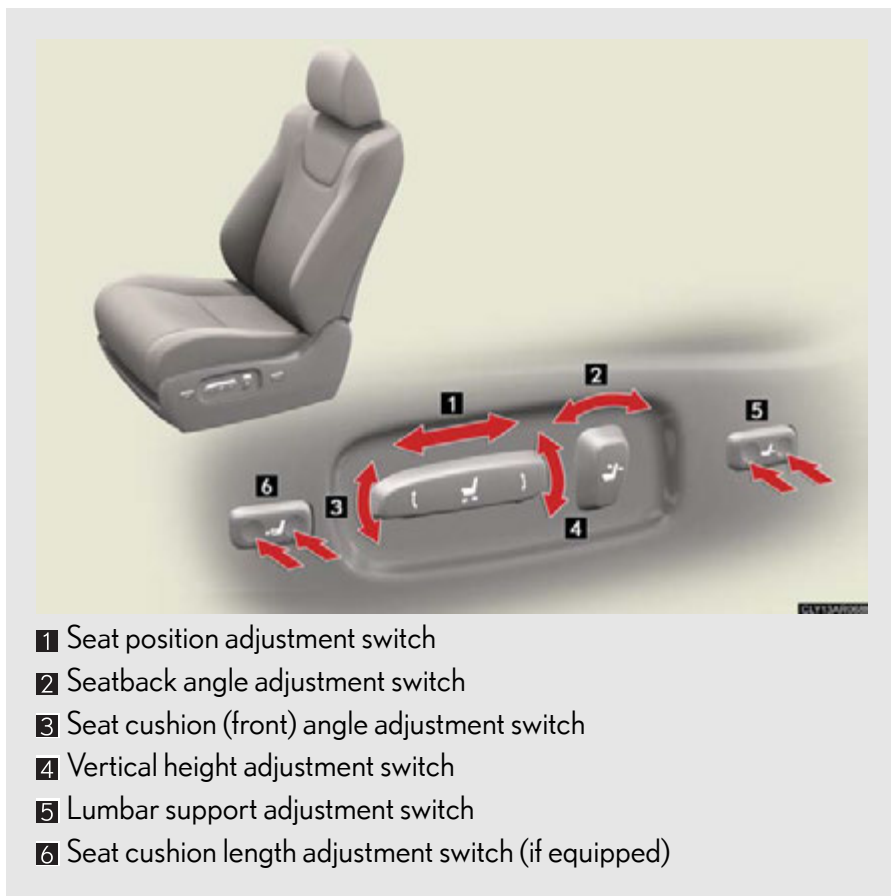

## Flattening the front seatbacks

### ■ Before flattening the front seatbacks

Slide the rear seats as far back as possible. (→P. 89)

### ■ Flattening the front seatbacks

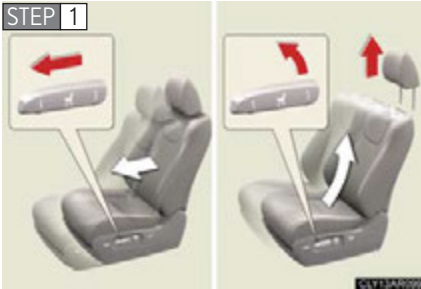

Move the front seat forward, raise the seat, and remove the head restraint. (→P. 97)

After returning the seat to its original position, make sure to replace the head restraint.



Move the seatback angle adjustment switch backward to flatten the seatback.

## Active head restraints



When the occupant's lower back presses against the seatback during a rear-end collision, the head restraint moves slightly forward and upward to help reduce the risk of whiplash to the seat occupant.

### ■ Active head restraints

Even small forces applied to the seatback may cause the head restraint to move. Pushing up a locked head restraint forcibly may appear the head restraint inner structure. These do not indicate problems.

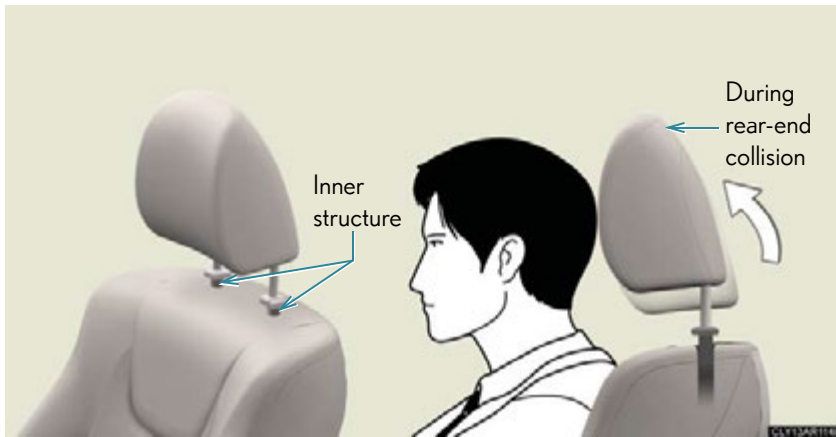

### ⚠ CAUTION

#### ■ Seat adjustment

- To reduce the risk of sliding under the lap belt during a collision, do not recline the seat more than necessary. If the seat is too reclined, the lap belt may slide past the hips and apply restraint forces directly to the abdomen, or your neck may contact the shoulder belt, increasing the risk of death or serious injury in the event of an accident.
- Adjustments should not be made while driving as the seat may unexpectedly move and cause the driver to lose control of the vehicle.

#### ■ While driving

Do not allow passengers to ride on the flattened seat.



## 1-4. Adjustable components (seats, mirrors, steering wheel)

### Rear seats

1

Before driving



- 1 Seat position adjustment lever
- 2 Seatback angle adjustment lever

### Folding down the rear seatbacks

#### ■ Before folding down the rear seatbacks

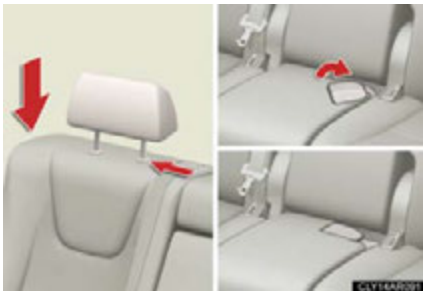

Stow all the head restraints and the rear center seat belt buckle.

### ■ Folding down the rear seatbacks

#### ► From inside



Pull the seatback angle adjustment lever.

To return the rear seatbacks to their original positions, lift them up until they lock.

#### ► From outside



Pull the levers.

Left side lever: Folds down the left side rear seat

Right side lever: Folds down the right side and center rear seats

To return the rear seatbacks to their original positions, lift them up until they lock.

### ■ Folding down the rear center seatback



Pull the center seatback angle lever behind the seatback and fold the seatback down.

To return the rear center seatback to its original position, lift it up until it locks.

**⚠ CAUTION****■ When folding the rear seatbacks down**

Observe the following precautions. Failure to do so may result in death or serious injury.

- Do not fold the seatbacks down while driving.
- Do not fold seatbacks down while passengers are seated or luggage is placed on the seats.
- Stop the vehicle on level ground, set the parking brake and shift the shift lever to P.
- After folding the seatback, lightly move the seat back and forth to lock it in place.
- Do not allow anyone to sit on a folded seatback or in the luggage compartment while driving.
- Do not allow children to enter the luggage compartment.

**■ Seat adjustment**

- To reduce the risk of sliding under the lap belt during a collision, do not recline the seat more than necessary.

If the seat is too reclined, the lap belt may slide past the hips and apply restraint forces directly to the abdomen, or your neck may contact the shoulder belt, increasing the risk of death or serious injury in the event of an accident.

- Adjustments should not be made while driving as the seat may unexpectedly move and cause the driver to lose control of the vehicle.

**■ After returning the rear seatback to the upright position**

Observe the following precautions. Failure to do so may result in death or serious injury.

- Make sure the seatback is securely locked by pushing it forward and rearward on the top.
- Check that the seat belts are not twisted or caught in the seatback.

 NOTICE

■ **Stowing the center seat belt buckle**

Before folding down the rear seatbacks, stow the center seat belt buckle to prevent it from becoming caught in the seatbacks.

### Driving position memory\*

Your preferred driving position (the position of the driver's seat, steering wheel and outside rear view mirrors) can be memorized and recalled with the touch of a button. It is also possible to set this function to activate automatically when the doors are unlocked.

Three different driving positions can be entered into memory.

#### ■ Entering a position to memory

**STEP 1** Turn the "POWER" switch to ON mode.

**STEP 2** Adjust the driver's seat, steering wheel and outside rear view mirrors to the desired positions.

**STEP 3**



Press the "SET" button, then within 3 seconds press button "1", "2" or "3" until the signal beeps.

If the selected button has already been preset, the previously recorded position will be overwritten.

#### ■ Recalling the memorized position

**STEP 1** Check that the shift lever is set in P.

**STEP 2** Turn the "POWER" switch to ON mode.

**STEP 3**



Press button "1", "2" or "3" until the signal beeps to recall the desired position.

### Linking driving position memory with door unlock operation

Record your driving position to button “1”, “2” or “3” before performing the following:

Carry only the key (including the card key) to which you want to link the driving position. If 2 or more keys are in the vehicle, the driving position cannot be linked properly.

**STEP 1** Shift the shift lever to P and close the driver's door. Turn the “POWER” switch to ON mode.

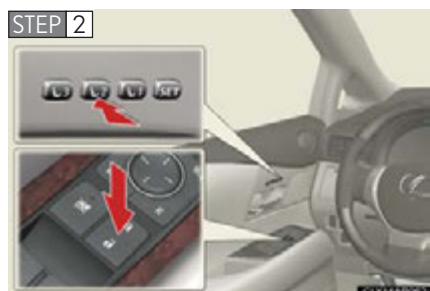

Press the desired button (“1”, “2” or “3”) to recall the position. Then, while keep pressing the button, press the driver's door lock switches (either lock or unlock) until the signal beeps.

The driving position is recalled when the driver's door is unlocked using the entry function or wireless remote control and the driver's door is opened.

## Power easy access system

When the driver enters and exits the vehicle, the driver's seat and steering wheel will automatically perform the following operations:



Exiting the vehicle: When all of the following actions have been performed, the steering wheel will move up and back to the point farthest away from the driver and the seat will move backward (auto away function):

- The shift lever has been shifted to P
- The “POWER” switch has been turned off
- The driver’s seat belt has been unfastened

Entering the vehicle: When either of the following actions has been performed, the steering wheel will move toward the driver and seat will move forward (auto return function):

- The “POWER” switch has been turned to ACCESSORY mode
- The driver’s seat belt has been fastened

### ■ When driving position memory is linked with door unlock operation

If the driver’s door is opened, the driver’s seat will move toward the memorized position but stop slightly beforehand to allow easy access to the vehicle.

Turning the “POWER” switch to ACCESSORY mode or fastening the driver’s seat belt moves the seat fully into the memorized position.

### ■ Canceling the linked door unlock operation

**STEP 1** Turn the “POWER” switch to ON mode and close the driver's door.

**STEP 2** While pressing the “SET” button, press the driver's door lock switches (either lock or unlock) until the signal beeps.

### ■ Operating the driving position memory after turning the “POWER” switch off

Memorized positions (except for the steering wheel position) can be activated up to 180 seconds after the driver's door is opened and another 60 seconds after it is closed again, even after turning the “POWER” switch off.

### ■ Stopping seat position operation part-way through

Perform any of the following operations:

- Press the “SET” button.
- Press button “1”, “2” or “3”.
- Adjust the seat using the switches (only cancels seat position recall).
- Adjust the steering wheel using the tilt and telescopic steering control switch (only cancels steering wheel position recall).

### ■ Correct seat position

When the seat is in the most forward or most backward position, and the seat is being moved in those directions, the system may not correctly recognize the current position and the memorized position will not be correctly recalled.

### ■ The auto away function for exiting the driver seat

If the seat is already close to the rearmost position, the auto away function may not operate when the driver exits the vehicle.

### ■ Customization

The distance that the driver's seat moves backward during the auto away function can be changed. (Customizable features →P. 825)

## CAUTION

### ■ Seat adjustment caution

Take care during seat adjustment so that the seat does not strike the rear passenger or squeeze your body against the steering wheel.



## Head restraints

Head restraints are provided for all seats.

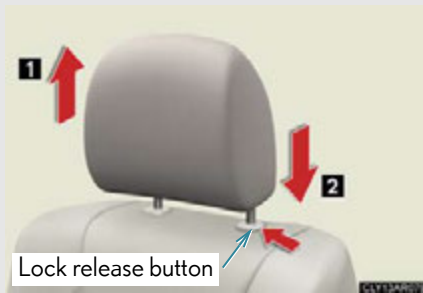

**1** Up

Pull the head restraints up.

**2** Down

Push the head restraint down while pressing the lock release button.

1

Before driving

### ■ Removing the head restraints



Pull the head restraint up while pressing the lock release button.

### ■ Installing the head restraints

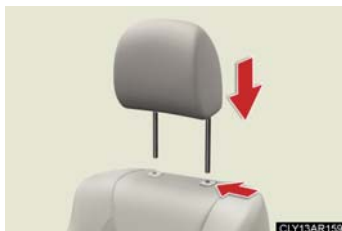

Align the head restraint with the installation holes and push it down to the lock position.

Press and hold the lock release button when lowering the head restraint.

### ■ Adjusting the height of the head restraints (front seats)



Make sure that the head restraints are adjusted so that the center of the head restraint is closest to the top of your ears.

### ■ Adjusting the rear seat head restraints

Always raise the head restraints to the uppermost lock position during use.

#### CAUTION

#### ■ Head restraint precautions

Observe the following precautions regarding the head restraints. Failure to do so may result in death or serious injury.

- Use the head restraints designed for each respective seat.
- Adjust the head restraints to the correct position at all times.
- After adjusting the head restraints, push down on them and make sure they are locked in position.
- Do not drive with the head restraints removed.

## Seat belts

Make sure that all occupants are wearing their seat belts before driving the vehicle.

### ■ Correct use of the seat belts



- Extend the shoulder belt so that it comes fully over the shoulder, but does not come into contact with the neck or slide off the shoulder.
- Position the lap belt as low as possible over the hips.
- Adjust the position of the seatback. Sit up straight and well back in the seat.
- Do not twist the seat belt.

### ■ Fastening and releasing the seat belt

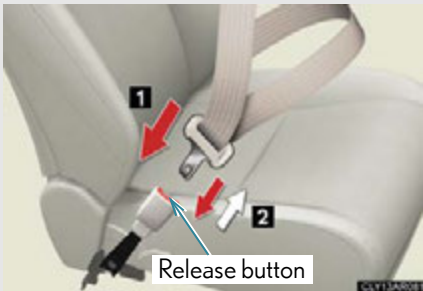

- 1 To fasten the seat belt, push the plate into the buckle until a click sound is heard.
- 2 To release the seat belt, press the release button.

### ■ Adjusting the seat belt shoulder anchor height (front seats)



1 Push the seat belt shoulder anchor down while pressing the release button.

2 Push the seat belt shoulder anchor up.

Move the height adjuster up and down as needed until you hear a click.

### ■ Seat belt pretensioners (front and outside rear seats)



The pretensioner helps the seat belt to quickly restrain the occupant by retracting the seat belt when the vehicle is subjected to certain types of severe frontal collision or a vehicle rollover.

The pretensioner may not activate in the event of a minor frontal impact, a side impact or a rear impact.

### ■ Pre-collision seat belts (front seats of vehicles with a pre-collision system)

If the system determines that a collision is unavoidable, the front seat belts will retract before the collision. (→P. 278)

### ■ Emergency locking retractor (ELR)

The retractor will lock the belt during a sudden stop or on impact. It may also lock if you lean forward too quickly. To allow the belt to extend, retract the belt and then pull it slowly.

### ■ Automatic locking retractor (ALR)

When a passenger's shoulder belt is completely extended and then retracted even slightly, the belt is locked in that position and cannot be extended. This feature is used to hold the child restraint system (CRS) firmly. To free the belt again, fully retract the belt and then pull the belt out once more. (→P. 154)

### ■ Child seat belt usage

The seat belts of your vehicle were principally designed for persons of adult size.

- Use a child restraint system appropriate for the child, until the child becomes large enough to properly wear the vehicle's seat belt. (→P. 150)
- When the child becomes large enough to properly wear the vehicle's seat belt, follow the instructions on P. 99 regarding seat belt usage.

### ■ Replacing the belt after the pretensioner has been activated

If the vehicle is involved in multiple collisions, the pretensioner will activate for the first collision, but will not activate for the second or subsequent collisions.

### ■ Seat belt extender



If your seat belts cannot be fastened securely because they are not long enough, a personalized seat belt extender is available from your Lexus dealer free of charge.

### CAUTION

Observe the following precautions to reduce the risk of injury in the event of sudden braking, sudden swerving or an accident.

Failing to do so may cause death or serious injury.

#### ■ Wearing a seat belt

- Ensure that all passengers wear a seat belt.
- Always wear a seat belt properly.
- Each seat belt should be used by one person only. Do not use a seat belt for more than one person at once, including children.
- Lexus recommends that children be seated in the rear seat and always use a seat belt and/or an appropriate child restraint system.
- To achieve a proper seating position, do not recline the seat more than necessary. The seat belt is most effective when the occupants are sitting up straight and well back in the seats.
- Do not wear the shoulder belt under your arm.
- Always wear your seat belt low and snug across your hips.

#### ■ Pregnant women

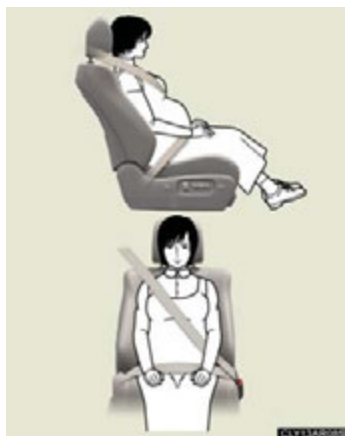

Obtain medical advice and wear the seat belt in the proper way. (→P. 99)

Women who are pregnant should position the lap belt as low as possible over the hips in the same manner as other occupants. Extend the shoulder belt completely over the shoulder and position the belt across the chest. Avoid belt contact over the round part of the abdominal area.

If the seat belt is not worn properly, not only the pregnant woman, but also the fetus could suffer death or serious injury as a result of sudden braking or a collision.

 **CAUTION****■ People suffering illness**

Obtain medical advice and wear the seat belt in the proper way.

**■ When children are in the vehicle**

Do not allow children to play with the seat belt. If the seat belt becomes twisted around a child's neck, it may lead to choking or other serious injuries that could result in death.

If this occurs and the buckle cannot be unfastened, scissors should be used to cut the belt.

**■ Seat belt pretensioners**

● Do not place anything, such as a cushion, on the front passenger's seat. Doing so will disperse the passenger's weight, which prevents the sensor from detecting the passenger's weight properly. As a result, the seat belt pretensioner for the front passenger's seat may not activate in the event of a collision.

● If the pretensioner has activated, the SRS warning light will come on. In that case, the seat belt cannot be used again and must be replaced at your Lexus dealer.

**■ Adjustable shoulder anchor**

Always make sure the shoulder belt is positioned across the center of your shoulder. The belt should be kept away from your neck, but not falling off your shoulder. Failure to do so could reduce the amount of protection in an accident and cause death or serious injuries in the event of a sudden stop, sudden swerve or accident. (→P.100)

### CAUTION

#### ■ Seat belt damage and wear

- Do not damage the seat belts by allowing the belt, plate, or buckle to be jammed in the door.
- Inspect the seat belt system periodically. Check for cuts, fraying, and loose parts. Do not use a damaged seat belt until it is replaced. Damaged seat belts cannot protect an occupant from death or serious injury.
- Ensure that the belt and tab are locked and the belt is not twisted. If the seat belt does not function correctly, immediately contact your Lexus dealer.
- Replace the seat assembly, including the belts, if your vehicle has been involved in a serious accident, even if there is no obvious damage.
- Do not attempt to install, remove, modify, disassemble or dispose of the seat belts. Have any necessary repairs carried out by your Lexus dealer. Inappropriate handling of the pretensioner may prevent it from operating properly, resulting in death or serious injury.

#### ■ Using a seat belt extender

- Do not wear the seat belt extender if you can fasten the seat belt without the extender.
- Do not use the seat belt extender when installing a child restraint system because the belt will not securely hold the child restraint system, increasing the risk of death or serious injury in the event of an accident.
- The personalized extender may not be safe on another vehicle, when used by another person, or at a different seating position other than the one originally intended.

### NOTICE

#### ■ When using a seat belt extender

When releasing the seat belt, press on the buckle release button on the extender, not on the seat belt.

This helps prevent damage to the vehicle interior and the extender itself.



## 1-4. Adjustable components (seats, mirrors, steering wheel)

### Steering wheel

The steering wheel can be adjusted to a comfortable position.

Operating the switch moves the steering wheel in the following directions:

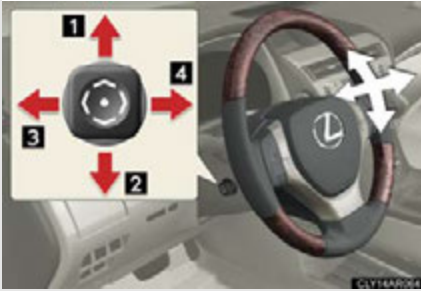

- 1 Up
- 2 Down
- 3 Away from the driver
- 4 Toward the driver

### Auto tilt away



When the “POWER” switch is turned off, the steering wheel returns to its stowed position by moving up and away to enable easier driver entry and exit.

Turning the “POWER” switch to ACCESSORY or ON mode will return the steering wheel to the original position.

### ■ The steering wheel can be adjusted when

The "POWER" switch is in ACCESSORY or ON mode\*.

\*: Vehicles with driving position memory: If the driver's seat belt is fastened, the steering wheel can be adjusted regardless of "POWER" switch mode.

### ■ Automatic adjustment of the steering position (vehicles with driving position memory)

A desired steering position can be entered to memory and recalled automatically by the driving position memory. (→P. 93)

### ■ Notes for the auto tilt away function (vehicles with driving position memory)

The auto tilt away function can only operate when the "POWER" switch has been turned off, the driver seat belt has been unfastened and the driver's seat movement (→P. 825) is in a setting other than off.

When the driver fastens the seat belt again, the steering wheel will return to the original position. (→P. 95)

### CAUTION

#### ■ Caution while driving

Do not adjust the steering wheel while driving.

Doing so may cause the driver to mishandle the vehicle and cause an accident, resulting in death or serious injury.

## 1-4. Adjustable components (seats, mirrors, steering wheel)

### Anti-glare inside rear view mirror

The rear view mirror's position can be adjusted to enable sufficient confirmation of the rear view in accordance with the driver's seating posture.

#### Adjusting the height of rear view mirror

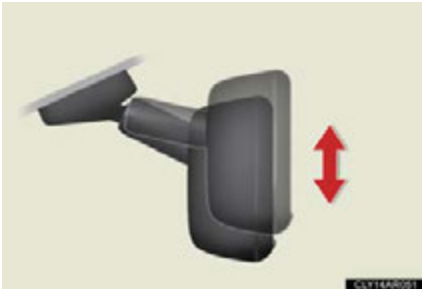

Adjust the height of the rear view mirror by moving it up and down.

#### Automatic anti-glare function

Responding to the level of brightness of the headlights of vehicles behind, the reflected light is automatically reduced.

##### ► Type A

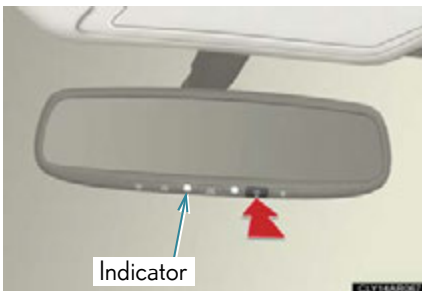

Changing automatic anti-glare function mode  
ON/OFF

When the automatic anti-glare function is in ON mode, the indicator illuminates.

The function will set to ON mode each time the "POWER" switch is turned to ON mode.

Pressing the button turns the function to OFF mode. (The indicator also turns off.)

► Type B



Changing automatic anti-glare function mode  
ON/OFF

When the automatic anti-glare function is in ON mode, the indicator illuminates.

The function will set to ON mode each time the "POWER" switch is turned to ON mode.

Pressing  turns the function to OFF mode. (The indicator also turns off.)

Pressing  turns the function to ON mode. (The indicator also turns on.)

■ To prevent sensor error



To ensure that the sensors operate properly, do not touch or cover them.

 CAUTION

■ Caution while driving

Do not adjust the position of the mirror while driving.

Doing so may lead to mishandling of the vehicle and cause an accident, resulting in death or serious injury.

## Outside rear view mirrors

Mirror angle can be adjusted using the switch.



To select a mirror to adjust, press the switch.

- 1 Left
- 2 Right

Pressing the same switch again will put the switch in neutral.

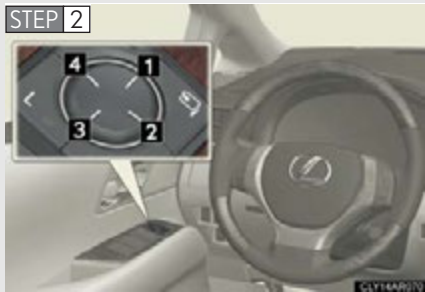

To adjust the mirror, press the switch.

- 1 Up
- 2 Right
- 3 Down
- 4 Left

### Folding the mirrors (manual type)



Push the mirror back in the direction of the vehicle's rear.

## Automatically folding and extending the mirrors (power type)

### ■ Using the switch



Press the switch to fold the mirrors.

Press it again to return them.

### ■ Setting automatic mode



Automatic mode allows the folding or extending of the mirrors to be linked to locking/unlocking of the doors.

Press the "AUTO" switch to set automatic mode.

The indicator will come on.

---

### ■ Mirror angle can be adjusted when

The "POWER" switch is in ACCESSORY or ON mode.

### ■ Linked mirror function when reversing

When the mirror select switch is in the "L" or "R" position, the outside rear view mirrors will automatically angle downwards when the vehicle is reversing in order to give a better view of the ground. To disable this function, move the mirror select switch to the neutral position (between "L" and "R").

### ■ When the mirrors are fogged up

The outside rear view mirrors can be cleared using the mirror defoggers. Turn on the rear window defogger to turn on the outside rear view mirror defoggers. (→P. 358)

### ■ Automatic adjustment of the mirror angle (vehicles with driving position memory)

A desired mirror face angle can be entered to memory and recalled automatically by the driving position memory. (→P. 93)

### ■ Auto anti-glare function

When the anti-glare inside rear view mirror is set to automatic mode, the outside rear view mirrors will activate in conjunction with the anti-glare inside rear view mirror to reduce reflected light. (→P. 107)

## CAUTION

### ■ When driving the vehicle

Observe the following precautions while driving.

Failing to do so may result in loss of control of the vehicle and cause an accident, resulting in death or serious injury.

- Do not adjust the mirrors while driving.
- Do not drive with the mirrors folded.
- Both the driver and passenger side mirrors must be extended and properly adjusted before driving.

### ■ When a mirror is moving

To avoid personal injury and mirror malfunction, be careful not to get your hand caught by the moving mirror.

### ■ When the mirror defoggers are operating

Do not touch the rear view mirror surfaces, as they can become very hot and burn you.

## 1-5. Opening and closing the windows and moon roof

### Power windows

The power windows can be opened and closed using the switches.

Operating the switch moves the windows as follows:

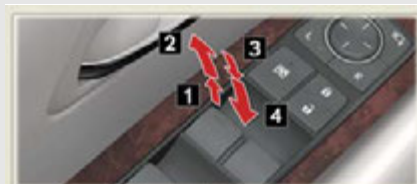

- 1 Closing
- 2 One-touch closing\*
- 3 Opening
- 4 One-touch opening\*

\*: To stop the window partway, operate the switch in the opposite direction.



### Window lock switch



Press the switch to lock the passenger window switches.

The indicator will come on.

Use this switch to prevent children from accidentally opening or closing a passenger window.

The passenger windows can still be opened and closed using the power window switches on the driver's side even if the lock switch is on.



### ■ The power windows can be operated when

The "POWER" switch is in ON mode.

### ■ Operating the power windows after turning the hybrid system off

The power windows can be operated for approximately 45 seconds even after the "POWER" switch is turned to ACCESSORY mode or turned off. They cannot, however, be operated once either front door is opened.

### ■ Jam protection function

If an object becomes caught between the window and the window frame, window travel is stopped and the window is opened slightly.

### ■ When the power window does not close normally

If the jam protection function is operating abnormally and a window cannot be closed, perform the following operations using the power window switch on the relevant door.

- After stopping the vehicle, the window can be closed by holding the power window switch in the one-touch closing position while the "POWER" switch is turned to ON mode.
- If the window still cannot be closed even by carrying out the operation explained above, initialize the function by performing the following procedure.

**STEP 1** Hold the power window switch in the one-touch closing position. Continue holding the switch for a further 6 seconds after the window has closed.

**STEP 2** Hold the power window switch in the one-touch opening position. Continue holding the switch for a further 2 seconds after the window has opened completely.

**STEP 3** Hold the power window switch in the one-touch closing position once again. Continue holding the switch for a further 2 seconds after the window has closed.

If you release the switch while the window is moving, start again from the beginning. If the window continues to close but then re-open slightly even after performing the above procedure correctly, have the vehicle inspected by your Lexus dealer.

### ■ Door lock linked window operation

- The power windows can be opened and closed using the mechanical key.  
(→P. 781)
- The power windows can be opened using the wireless remote control.  
(→P. 69)

### ■ When the 12-volt battery is disconnected

The window lock switch is disabled. If necessary, press the window lock switch after reconnecting the battery.

### ■ Customization

Settings (e.g. linked door lock operation) can be changed.  
(Customizable features →P. 825)

## CAUTION

### ■ Closing the windows

Observe the following precautions.

Failing to do so may result in death or serious injury.

- Check to make sure that all passengers do not have any part of their body in a position where it could be caught when a window is being operated.
- Do not allow children to operate the power windows.  
Closing a power window on someone can cause death or serious injury.  
The driver is responsible for instructing children not to operate the power windows.

### ■ Jam protection function

- Never use any part of your body to intentionally activate the jam protection function.
- The jam protection function may not work if something gets caught just before the window fully closes. Also, the jam protection does not operate when the power window switch is pulled up continually to close the windows.

## 1-5. Opening and closing the windows and moon roof

### Moon roof\*

Use the overhead switches to open and close the moon roof and tilt it up and down.

#### ■ Opening and closing

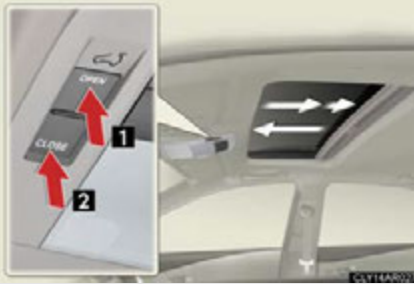

#### 1 Opens the moon roof\*

The moon roof stops slightly before the fully open position to reduce wind noise.

Press the switch again to fully open the moon roof.

#### 2 Closes the moon roof\*

\*: Lightly press either of the moon roof switches to stop the moon roof partway.

#### ■ Tilting up and down

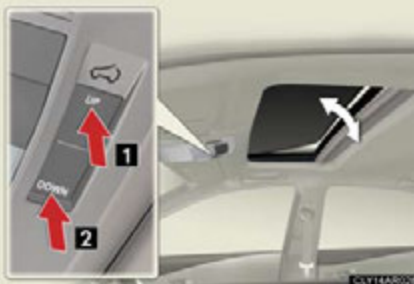

#### 1 Tilts the moon roof up\*

#### 2 Tilts the moon roof down\*

\*: Lightly press either of the moon roof switches to stop the moon roof partway.

### ■ The moon roof can be operated when

The "POWER" switch is in ON mode.

### ■ Operating the moon roof after turning the hybrid system off

The moon roof can be operated for approximately 45 seconds even after the "POWER" switch is turned to ACCESSORY mode or turned off. It cannot, however, be operated once either front door is opened.

### ■ Jam protection function

If an object is detected between the moon roof and the frame while the moon roof is closing or tilting down, travel is stopped and the moon roof opens slightly.

### ■ Sunshade

The sunshade can be opened and closed manually. However, the sunshade will open automatically when the moon roof is opened.

### ■ Door lock linked moon roof operation

- The moon roof can be opened and closed using the mechanical key. (→P. 781)
- The moon roof can be opened using the wireless remote control. (→P. 69)

### ■ When the moon roof does not close normally

Perform the following procedure:

- If the moon roof closes but then re-opens slightly

**STEP 1** Stop the vehicle.

**STEP 2** Press and hold the “CLOSE” switch.\*<sup>1</sup>

The moon roof will close, reopen and pause for approximately 10 seconds.\*<sup>2</sup> Then it will close again, tilt up and pause for approximately 1 second. Finally, it will tilt down, open and close.

**STEP 3** Check to make sure that the moon roof is completely closed and then release the switch.

- If the moon roof tilts down but then tilts back up

**STEP 1** Stop the vehicle.

**STEP 2** Press and hold the “UP” switch\*<sup>1</sup> until the moon roof moves into the tilt up position and stops.

**STEP 3** Release the “UP” switch once and then press and hold the “UP” switch again.\*<sup>1</sup>

The moon roof will pause for approximately 10 seconds in the tilt up position.\*<sup>2</sup> Then it will adjust slightly and pause for approximately 1 second. Finally, it will tilt down, open and close.

**STEP 4** Check to make sure that the moon roof is completely closed and then release the switch.

\*<sup>1</sup>: If the switch is released at the incorrect time, the procedure will have to be performed again from the beginning.

\*<sup>2</sup>: If the switch is released after the above mentioned 10 second pause, automatic operation will be disabled. In that case, press and hold the “CLOSE” or “UP” switch, and the moon roof will tilt up and pause for approximately 1 second. Then it will tilt down, open and close. Check to make sure that the moon roof is completely closed and then release the switch.

If the moon roof does not fully close even after performing the above procedure correctly, have the vehicle inspected by your Lexus dealer.

### ■ Customization

Settings (e.g. linked door lock operation) can be changed.  
(Customizable features →P. 825)

### CAUTION

#### ■ Opening the moon roof

Observe the following precautions.

Failing to do so may cause death or serious injury.

- Do not allow any passengers to put their hands or heads outside the vehicle while it is moving.
- Do not sit on top of the moon roof.

#### ■ Closing the moon roof

Observe the following precautions.

Failing to do so may result in death or serious injury.

- Check to make sure that all passengers do not have any part of their body in a position where it could be caught when the moon roof is being operated.
- Do not allow children to operate the moon roof.  
Closing the moon roof on someone can cause death or serious injury. The driver is responsible for instructing children not to operate the moon roof.

#### ■ Jam protection function

Observe the following precautions.

Failing to do so may result in death or serious injury.

- Never use any part of your body to intentionally activate the jam protection function.
- The jam protection function may not work if something gets caught just before the moon roof fully closes. Be careful not to catch fingers or anything else.

## 1-6. Refueling

### Opening the fuel tank cap

The fuel tank of your vehicle has a special structure, which requires a reduction in fuel tank pressure before refueling. After the opener switch has been pressed, it will take several seconds until the vehicle is ready for refueling.

#### ■ Before refueling the vehicle

- Turn the “POWER” switch off and close all the doors and windows.
- Confirm the type of fuel. (→P. 121)

#### ■ Opening the fuel tank cap



Press the opener to open the fuel filler door.

The fuel filler door will open within about 10 seconds of the switch being pressed. Before refueling is possible, a message will be shown on the multi-information display in the instrument cluster to indicate the progress of the fuel filler door opener. (→P. 755)

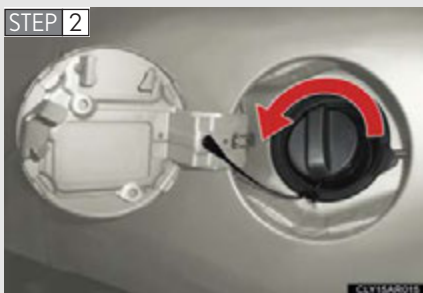

Turn the fuel tank cap slowly to open.

STEP 3



Hang the fuel tank cap on the back of the fuel filler door.

### Closing the fuel tank cap

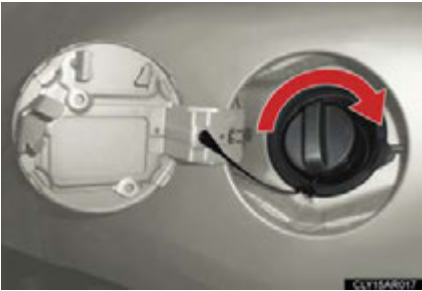

After refueling, turn the fuel tank cap until you hear a click.



■ **When the fuel filler door cannot be opened by pressing the inside switch**

**STEP 1** Open the back door and lift the deck board up. (→P. 664)

**STEP 2** With a compact spare tire only:  
Remove the spare tire cover. (→P. 664)

**STEP 3** Remove the 12-volt battery cover. (→P. 664)



If the fuel filler door opener switch cannot be operated, contact your Lexus dealer to service the vehicle. In case where refueling is urgently necessary, the fuel filler door can be opened using the lever in the luggage compartment.

**STEP 5** Install the 12-volt battery cover using the clips. (→P. 667)

Using the lever to open the fuel filler door may not allow for an adequate reduction in fuel tank pressure before refueling. To prevent fuel from spilling out, turn the cap slowly when removing it.

During refueling, fuel may spill out from the filler opening due to air being discharged from inside the fuel tank. Therefore, fill the fuel tank carefully and slowly.

■ **Fuel types**

Unleaded gasoline (Octane rating 91 [Research Octane Number 96] or higher)

### CAUTION

#### ■ When refueling the vehicle

Observe the following precautions while refueling the vehicle. Failure to do so may result in death or serious injury.

- After exiting the vehicle and before opening the fuel door, touch an unpainted metal surface to discharge any static electricity. It is important to discharge static electricity before refueling because sparks resulting from static electricity can cause fuel vapors to ignite while refueling.
- Always hold the grips on the fuel tank cap and turn it slowly to remove it. A whooshing sound may be heard when the fuel tank cap is loosened. Wait until the sound cannot be heard before fully removing the cap. In hot weather, pressurized fuel may spray out of the filler neck and cause injury.
- Do not allow anyone that has not discharged static electricity from their body to come close to an open fuel tank.
- Do not inhale vaporized fuel.  
Fuel contains substances that are harmful if inhaled.
- Do not smoke while refueling the vehicle.  
Doing so may cause the fuel to ignite and cause a fire.
- Do not return to the vehicle or touch any person or object that is statically charged.  
This may cause static electricity to build up, resulting in a possible ignition hazard.

#### ■ When refueling

Observe the following precautions to prevent fuel overflowing from the fuel tank:

- Securely insert the fuel nozzle into the fuel filler neck
- Stop filling the tank after the fuel nozzle automatically clicks off
- Do not top off the fuel tank

#### ■ When replacing the fuel cap

Do not use anything but a genuine Lexus fuel tank cap designed for your vehicle. Doing so may cause a fire or other incident which may result in death or serious injury.

 NOTICE**■ Refueling**

- Finish refueling within 30 minutes. If more than 30 minutes passes, the internal valve closes. In this condition, fuel may overflow during the refueling process. Press the fuel filler door opener switch again.
- Do not spill fuel during refueling.  
Doing so may damage the vehicle, such as causing the emission control system to operate abnormally or damaging fuel system components or the vehicle's painted surface.

## 1-7. Theft deterrent system Immobilizer system

The vehicle's keys have built-in transponder chips that prevent the hybrid system from starting if the key has not been previously registered in the vehicle's on-board computer.

Never leave the keys inside the vehicle when you leave the vehicle.

This system is designed to help prevent vehicle theft but does not guarantee absolute security against all vehicle thefts.

- ▶ Vehicles with a navigation system or the Lexus Display Audio system



The indicator light flashes after the "POWER" switch has been turned off to indicate that the system is operating.

The indicator light stops flashing after the "POWER" switch has been turned to ACCESSORY or ON mode to indicate that the system has been canceled.

- ▶ Vehicles without a navigation system or the Lexus Display Audio system



The indicator light flashes after the "POWER" switch has been turned off to indicate that the system is operating.

The indicator light stops flashing after the "POWER" switch has been turned to ACCESSORY or ON mode to indicate that the system has been canceled.

**■ System maintenance**

The vehicle has a maintenance-free type immobilizer system.

**■ Conditions affecting operation**

Depending on surrounding environment and conditions, the immobilizer system may not operate properly. This may prevent the hybrid system from starting.  
(→P. 62)

**■ Certifications for the immobilizer system**

This system meets the certification requirements of Radio Law.

▶ For vehicles sold in the U.S.A.

FCC ID: NI4TMIMB-1

This device complies with part 15 of the FCC Rules. Operation is subject to the following two conditions: (1) This device may not cause harmful interference, and (2) this device must accept any interference received, including interference that may cause undesired operation.

▶ For vehicles sold in Canada

This device complies with Industry Canada licence-exempt RSS standard(s). Operation is subject to the following two conditions: (1) this device may not cause interference, and (2) this device must accept any interference, including interference that may cause undesired operation of the device.

**⚠ CAUTION****■ Certifications for the immobilizer system**

Changes or modifications not expressly approved by the party responsible for compliance could void the user's authority to operate the equipment.

**⚠ NOTICE****■ To ensure the system operates correctly**

Do not modify or remove the system. If modified or removed, the proper operation of the system cannot be guaranteed.

# Alarm

The system sounds the alarm and flashes the lights when forcible entry is detected.

### ■ Triggering of the alarm

The alarm is triggered in the following situations when the alarm is set:

- A locked door is unlocked or opened in any way other than using the entry function, wireless remote control or mechanical key. (The doors will lock again automatically.)
- The hood is opened.

### ■ Setting the alarm system

- ▶ Vehicles with a navigation system or the Lexus Display Audio system



Close the doors and hood, and lock all the doors. The system will be set automatically after 30 seconds.

The indicator light changes from being on to flashing when the system is set.

- ▶ Vehicles without a navigation system or the Lexus Display Audio system



Close the doors and hood, and lock all the doors. The system will be set automatically after 30 seconds.

The indicator light changes from being on to flashing when the system is set.

### ■ Deactivating or stopping the alarm

Do one of the following to deactivate or stop the alarms:

- Unlock the doors.
- Turn the “POWER” switch to ACCESSORY or ON mode, or start the hybrid system. (The alarm will be deactivated or stopped after a few seconds.)

---

### ■ System maintenance

The vehicle has a maintenance-free type alarm system.

### ■ Items to check before locking the vehicle

To prevent unexpected triggering of the alarm and vehicle theft, make sure of the following:

- Nobody is in the vehicle.
- The windows and moon roof are closed before the alarm is set.
- No valuables or other personal items are left in the vehicle.

### ■ Triggering of the alarm

The alarm may be triggered in the following situations:  
(Stopping the alarm deactivates the alarm system.)



- A person inside the vehicle opens a door or the hood.



- The 12-volt battery is recharged or replaced when the vehicle is locked.

### ■ Alarm-operated door lock

- When the alarm is operating, the doors are locked automatically to prevent intruders.
- Do not leave the key inside the vehicle when the alarm is operating, and make sure the key is not inside the vehicle when recharging or replacing the 12-volt battery.

#### NOTICE

#### ■ To ensure the system operates correctly

Do not modify or remove the system. If modified or removed, the proper operation of the system cannot be guaranteed.



## 1-7. Theft deterrent system

### Theft prevention labels (for U.S.A.)



These labels are attached to the vehicle to reduce vehicle theft by facilitating the tracing and recovery of parts from stolen vehicles. Do not remove under penalty of law.

1

Before driving

## Correct driving posture

Drive in a good posture as follows:



- 1 Sit upright and well back in the seat. (→P. 86)
- 2 Adjust the position of the seat forward or backward to ensure the pedals can be reached and easily depressed to the extent required. (→P. 86)
- 3 Adjust the seatback so that the controls are easily operable. (→P. 86)
- 4 Adjust the tilt and telescopic positions of the steering wheel downward so the air-bag is facing your chest. (→P. 105)
- 5 Lock the head restraint in place with the center of the head restraint closest to the top of your ears. (→P. 97)
- 6 Wear the seat belt correctly. (→P. 99)

 **CAUTION****■ While driving**

- Do not adjust the position of the driver's seat.  
Doing so could cause the driver to lose control of the vehicle.
- Do not place a cushion between the driver or passenger and the seatback.  
A cushion may prevent correct posture from being achieved, and reduce the effectiveness of the seat belt and head restraint, increasing the risk of death or serious injury to the driver or passenger.
- Do not place anything under the front seats.  
Objects placed under the front seats may become jammed in the seat tracks and stop the seat from locking in place. This may lead to an accident, resulting in death or serious injury. The adjustment mechanism may also be damaged.

**■ Adjusting the seat position**

- Take care when adjusting the seat position to ensure that other passengers are not injured by the moving seat.
- Do not put your hands under the seat or near the moving parts to avoid injury.  
Fingers or hands may become jammed in the seat mechanism.

## 1-8. Safety information

### SRS airbags

The SRS airbags inflate when the vehicle is subjected to certain types of severe impacts that may cause significant injury to the occupants. They work together with the seat belts to help reduce the risk of death or serious injury.

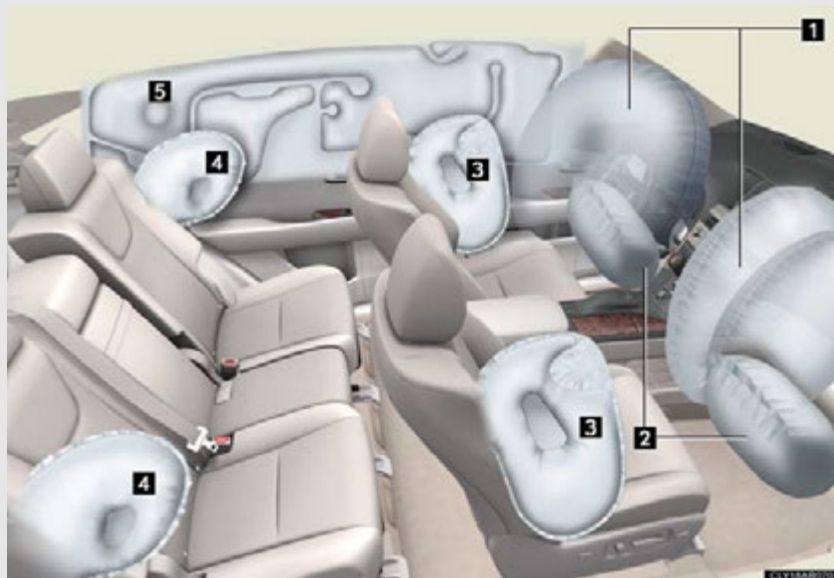

► SRS front airbags

**1** SRS driver airbag/front passenger airbag

Can help protect the head and chest of the driver and front passenger from impact with interior components

**2** SRS knee airbags

Can help provide driver and front passenger protection

- ▶ SRS side and curtain shield airbags
- 3 Front SRS side airbags
  - Can help protect the torso of the front seat occupants
- 4 Rear SRS side airbags
  - Can help protect the torso of occupants in the rear outer seats
- 5 SRS curtain shield airbags
  - Can help protect primarily the head of occupants in the outer seats
  - Can help prevent the occupants from being thrown from the vehicle in the event of vehicle rollover

## SRS airbag system components

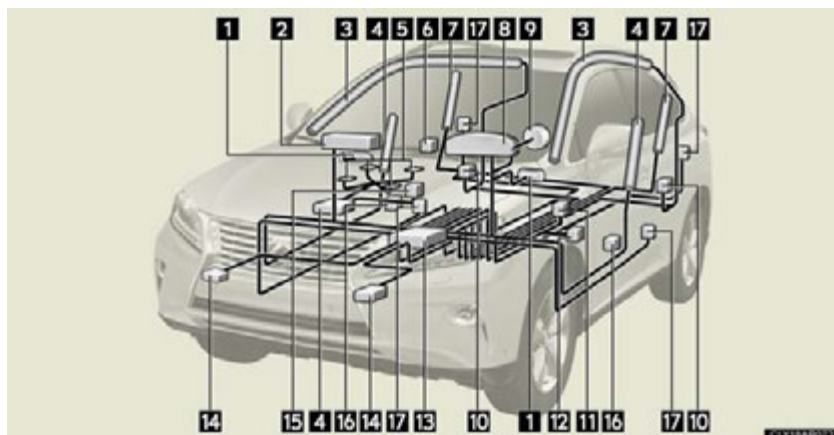

- |   |   |
|---|---|
| <b>1</b> Knee airbags   | <b>10</b> Curtain shield and rear side airbag sensors |
| <b>2</b> Front passenger airbag   | <b>11</b> Driver's seat belt buckle switch            |
| <b>3</b> Curtain shield airbags   | <b>12</b> Driver's seat position sensor               |
| <b>4</b> Front side airbags   | <b>13</b> Airbag sensor assembly                      |
| <b>5</b> Front passenger occupant classification system (ECU and sensors) | <b>14</b> Front airbag sensors                        |
| <b>6</b> "AIR BAG ON" and "AIR BAG OFF" indicator lights                  | <b>15</b> Front passenger's seat belt buckle switch   |
| <b>7</b> Rear side airbags  | <b>16</b> Door sensors                                |
| <b>8</b> SRS warning light  | <b>17</b> Seat belt pretensioners and force limiters  |
| <b>9</b> Driver airbag  |   |

Your vehicle is equipped with ADVANCED AIRBAGS designed based on the US motor vehicle safety standards (FMVSS208). The airbag sensor assembly (ECU) controls airbag deployment based on information obtained from the sensors etc. shown in the system components diagram above. This information includes crash severity and occupant information. As the airbags deploy, a chemical reaction in the inflators quickly fills the airbags with non-toxic gas to help restrain the motion of the occupants.

#### ■ If the SRS airbags deploy (inflate)

- Bruising and slight abrasions may result from contact with a deploying (inflating) SRS airbag.
- A loud noise and white powder will be emitted.
- Parts of the airbag module (steering wheel hub, airbag cover and inflator) as well as the seats, parts of the front and rear pillars, and roof side rails, may be hot for several minutes. The airbag itself may also be hot.
- The windshield may crack.
- For Safety Connect subscribers, if the SRS airbags deploy or in the event of a severe rear-end collision, the system is designed to send an emergency call to the response center, notifying them of the vehicle's location (without needing to push the "SOS" button) and an agent will attempt to speak with the occupants to ascertain the level of emergency and assistance required. If the occupants are unable to communicate, the agent automatically treats the call as an emergency and helps to dispatch the necessary emergency services. (→P. 626)

#### ■ SRS airbag deployment conditions (SRS front airbags)

- The SRS front airbags will deploy in the event of an impact that exceeds the set threshold level (the level of force corresponding to an approximately 12 - 18 mph [20 - 30 km/h] frontal collision with a fixed wall that does not move or deform).

However, this threshold velocity will be considerably higher in the following situations:

- If the vehicle strikes an object, such as a parked vehicle or sign pole, which can move or deform on impact
- If the vehicle is involved in an underride collision, such as a collision in which the front of the vehicle "underrides", or goes under, the bed of a truck

- Depending on the type of collision, it is possible that only the seat belt pretensioners will activate.
- The SRS front airbags for the front passenger will not activate if there is no passenger sitting in the front passenger seat. However, the SRS front airbags for the front passenger may deploy if luggage is put in the seat, even if the seat is unoccupied. (→P. 145)

### ■ SRS airbag deployment conditions (SRS side airbags and curtain shield airbags)

The SRS side airbags and SRS curtain shield airbags will deploy in the event of an impact that exceeds the set threshold level (the level of force corresponding to the impact force produced by an approximately 3300 lb. [1500 kg] vehicle colliding with the vehicle cabin from a direction perpendicular to the vehicle orientation at an approximate speed of 12 - 18 mph [20 - 30 km/h]).

The SRS curtain shield airbags will deploy in the event of vehicle rollover.

### ■ Conditions under which the SRS airbags may deploy (inflate), other than a collision (SRS front airbags)

The SRS front airbags may also deploy if a serious impact occurs to the underside of your vehicle. Some examples are shown in the illustration.

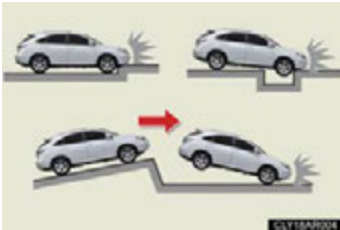

- Hitting a curb, edge of pavement or hard surface
- Falling into or jumping over a deep hole
- Landing hard or vehicle falling

The SRS curtain shield airbags may also deploy under the situations shown in the illustration.



- The angle of vehicle tip-up is marginal.
- The vehicle skids and hits a curb stone.



### ■ Types of collisions that may not deploy the SRS airbags (SRS front airbags)

The SRS front airbags are generally not designed to inflate if the vehicle is involved in a side or rear collision, if it rolls over, or if it is involved in a low-speed frontal collision. But, whenever a collision of any type causes sufficient forward deceleration of the vehicle, deployment of the SRS front airbags may occur.



- Collision from the side
- Collision from the rear
- Vehicle rollover

### ■ Types of collisions that may not deploy the SRS airbags (SRS side airbags and curtain shield airbags)

The SRS side airbag and curtain shield airbag system may not activate if the vehicle is subjected to a collision from the side at certain angles, or a collision to the side of the vehicle body other than the passenger compartment.



- Collision from the side to the vehicle body other than the passenger compartment
- Collision from the side at an angle

The SRS side airbags are not generally designed to inflate if the vehicle is involved in a frontal or rear collision, if it rolls over, or if it is involved in a low-speed side collision.



- Collision from the front
- Collision from the rear
- Vehicle rollover

The SRS curtain shield airbags are not generally designed to inflate if the vehicle is involved in a frontal or rear collision, if it pitches end over end, or if it is involved in a low-speed side collision.

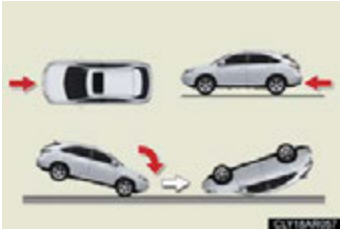

- Collision from the front
- Collision from the rear
- Pitching end over end

### ■ When to contact your Lexus dealer

In the following cases, the vehicle will require inspection and/or repair. Contact your Lexus dealer as soon as possible.

- Any of the SRS airbags has been inflated.

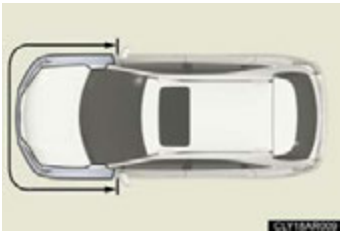

- The front of the vehicle is damaged or deformed, or was involved in an accident that was not severe enough to cause the SRS airbags to inflate.



- A portion of the doors is damaged or deformed, or the vehicle was involved in an accident that was not severe enough to cause the SRS side airbags and curtain shield airbags to inflate.



- The pad section of the steering wheel, dashboard near the front passenger airbag or lower portion of the instrument panel is scratched, cracked, or otherwise damaged.



- The surface of the seats with the side air-bag is scratched, cracked, or otherwise damaged.



- The portion of the front pillars, rear pillars or roof side rail garnishes (padding) containing the curtain shield airbags inside is scratched, cracked, or otherwise damaged.

### CAUTION

#### ■ SRS airbag precautions

Observe the following precautions regarding the SRS airbags. Failure to do so may cause death or serious injury.

- The driver and all passengers in the vehicle must wear their seat belts properly. The SRS airbags are supplemental devices to be used with the seat belts.
- The SRS driver airbag deploys with considerable force, and can cause death or serious injury especially if the driver is very close to the airbag. The National Highway Traffic Safety Administration (“NHTSA”) advises:

Since the risk zone for driver’s airbag is the first 2 - 3 in. (50 - 75 mm) of inflation, placing yourself 10 in. (250 mm) from your driver airbag provides you with a clear margin of safety. This distance is measured from the center of the steering wheel to your breastbone. If you sit less than 10 in. (250 mm) away now, you can change your driving position in several ways:

- Move your seat to the rear as far as you can while still reaching the pedals comfortably.
- Slightly recline the back of the seat.  
Although vehicle designs vary, many drivers can achieve the 10 in. (250 mm) distance, even with the driver seat all the way forward, simply by reclining the back of the seat somewhat. If reclining the back of your seat makes it hard to see the road, raise yourself by using a firm, non-slippery cushion, or raise the seat if your vehicle has that feature.
- If your steering wheel is adjustable, tilt it downward. This points the airbag toward your chest instead of your head and neck.

The seat should be adjusted as recommended by NHTSA above, while still maintaining control of the foot pedals, steering wheel, and your view of the instrument panel controls.

**! CAUTION****■ SRS airbag precautions**

- If the seat belt extender has been connected to the front seat belt buckles but the seat belt extender has not also been fastened to the latch plate of the seat belt, the SRS front airbags will judge that the driver and front passenger are wearing the seat belt even though the seat belt has not been connected. In this case, the SRS front airbags may not activate correctly in a collision, resulting in death or serious injury in the event of a collision. Be sure to wear the seat belt with the seat belt extender.
- The SRS front passenger airbag also deploys with considerable force, and can cause death or serious injury especially if the front passenger is very close to the airbag. The front passenger seat should be as far from the airbag as possible with the seatback adjusted, so the front passenger sits upright.
- Improperly seated and/or restrained infants and children can be killed or seriously injured by a deploying airbag. An infant or child who is too small to use a seat belt should be properly secured using a child restraint system. Lexus strongly recommends that all infants and children be placed in the rear seats of the vehicle and properly restrained. The rear seats are safer for infants and children than the front passenger seat. (→P. 150)

**CAUTION**

**SRS airbag precautions**



- Do not sit on the edge of the seat or lean against the dashboard.



- Do not allow a child to stand in front of the SRS front passenger airbag unit or sit on the knees of a front passenger.
- Do not allow the front seat occupants to hold items on their knees.



- Do not lean against the door, the roof side rail or the front, side and rear pillars.



- Do not allow anyone to kneel on the passenger seats toward the door or put their head or hands outside the vehicle.

 CAUTION

 SRS airbag precautions

- Do not attach anything to or lean anything against areas such as the dashboard, steering wheel pad or lower portion of the instrument panel.  
These items can become projectiles when SRS driver, front passenger and knee airbags deploy.
- Do not attach anything to areas such as the door, windshield glass, side door glass, front and rear pillars, roof side rail or assist grip.
- Do not hang coat hangers or other hard objects on the coat hooks. All of these items could become projectiles and may cause death or serious injury, should the SRS curtain shield airbags deploy.
- If a vinyl cover is put on the area where the SRS knee airbags will deploy, be sure to remove it.
- Do not use seat accessories which cover the parts where the SRS side airbags inflate as they may interfere with inflation of the airbags. Such accessories may prevent the side airbags from activating correctly, disable the system or cause the side airbags to inflate accidentally, resulting in death or serious injury.
- Do not strike or apply significant levels of force to the area of the SRS airbag components.  
Doing so can cause the SRS airbags to malfunction.
- Do not touch any of the component parts immediately after the SRS airbags have deployed (inflated) as they may be hot.
- If breathing becomes difficult after the SRS airbags have deployed, open a door or window to allow fresh air in, or leave the vehicle if it is safe to do so. Wash off any residue as soon as possible to prevent skin irritation.
- If the areas where the SRS airbags are stored, such as the steering wheel pad and front and rear pillar garnishes, are damaged or cracked, have them replaced by your Lexus dealer.

### CAUTION

#### ■ SRS airbag precautions

- Do not place anything, such as a cushion, on the front passenger's seat. Doing so will disperse the passenger's weight, which prevents the sensor from detecting the passenger's weight properly. As a result, the SRS front passenger airbag may not deploy in the event of a collision.

#### ■ Modification and disposal of SRS airbag system components

Do not dispose of your vehicle or perform any of the following modifications without consulting your Lexus dealer.

The SRS airbags may malfunction or deploy (inflate) accidentally, causing death or serious injury.

- Installation, removal, disassembly and repair of the SRS airbags
- Repairs, modifications, removal or replacement of the steering wheel, instrument panel, dashboard, seats or seat upholstery, front, side and rear pillars or roof side rails
- Repairs or modifications of the front fender, front bumper, or side of the occupant compartment
- Installation of a grille guard (bull bars, kangaroo bar, etc.), snow plows or winches
- Modifications to the vehicle's suspension system
- Installation of electronic devices such as mobile two-way radios or CD players
- Modifications to your vehicle for a person with a physical disability



## 1-8. Safety information

# Front passenger occupant classification system

Your vehicle is equipped with a front passenger occupant classification system. This system detects the condition of the front passenger seat and activates or deactivates the devices for the front passenger.



- 1 SRS warning light
- 2 "AIR BAG OFF" indicator light
- 3 "AIR BAG ON" indicator light
- 4 Front passenger's seat belt reminder light

### Condition and operation in the front passenger occupant classification system

#### ■ Adult<sup>\*1</sup>

Indicator/ warning light	"AIR BAG ON" and "AIR BAG OFF" indicator lights	"AIR BAG ON"
	SRS warning light	Off
	Front passenger's seat belt reminder light	Flashing <sup>*2</sup>
Devices	Front passenger airbag	Activated
	Side airbag on the front passenger seats	
	Curtain shield airbag in the front passenger side	
	Front passenger knee airbag	
	Front passenger's seat belt pretensioner	

#### ■ Child<sup>\*3</sup> or child restraint system<sup>\*4</sup>

Indicator/ warning light	"AIR BAG ON" and "AIR BAG OFF" indicator lights	"AIR BAG OFF" <sup>*5</sup>
	SRS warning light	Off
	Front passenger's seat belt reminder light	Flashing <sup>*2</sup>
Devices	Front passenger airbag	Deactivated
	Side airbag on the front passenger seats	Activated
	Curtain shield airbag in the front passenger side	
	Front passenger knee airbag	Deactivated
	Front passenger's seat belt pretensioner	Activated

## ■ Unoccupied

Indicator/ warning light	“AIR BAG ON” and “AIR BAG OFF” indicator lights	Not illuminated
	SRS warning light	Off
	Front passenger’s seat belt reminder light	
Devices	Front passenger airbag	Deactivated
	Side airbag on the front passenger seats	Activated
	Curtain shield airbag in the front passenger side	
	Front passenger knee airbag	Deactivated
	Front passenger’s seat belt pretensioner	Deactivated or activated*6

1

Before driving

## ■ There is a malfunction in the system

Indicator/ warning light	“AIR BAG ON” and “AIR BAG OFF” indicator lights	“AIR BAG OFF”
	SRS warning light	On
	Front passenger’s seat belt reminder light	Flashing
Devices	Front passenger airbag	Deactivated
	Side airbag on the front passenger seats	Activated
	Curtain shield airbag in the front passenger side	
	Front passenger knee airbag	Deactivated
	Front passenger’s seat belt pretensioner	Activated

- \*1: The system judges a person of adult size as an adult. When a smaller adult sits in the front passenger seat, the system may recognize him/her as a child depending on his/her physique and posture.
- \*2: In the event the front passenger does not wear a seat belt.

- \*3: When a larger child who has outgrown a child restraint system sits in the front passenger seat, the system may recognize him/her as an adult depending on his/her physique or posture.
- \*4: Never install a rear-facing child restraint system on the front passenger seat. A forward-facing child restraint system should only be installed on the front passenger seat when it is unavoidable. (→P. 150)
- \*5: If the indicator light is not illuminated, consult this manual on how to install the child restraint system properly. (→P. 154)
- \*6: Activated only in cases of side impact

### CAUTION

#### ■ Front passenger occupant classification system precautions

Observe the following precautions regarding the front passenger occupant classification system.

Failure to do so may cause death or serious injury.

- Wear the seat belt properly.
- Make sure the front passenger's seat belt tab has not been left inserted into the buckle before someone sits in the front passenger seat.
- Make sure the "AIR BAG OFF" indicator light is not illuminated when using the seat belt extender for the front passenger seat. If the "AIR BAG OFF" indicator light is illuminated, disconnect the extender tongue from the seat belt buckle, then reconnect the seat belt. Reconnect the seat belt extender after making sure the "AIR BAG ON" indicator light is illuminated. If you use the seat belt extender while the "AIR BAG OFF" indicator light is illuminated, the SRS airbags for the passenger may not activate correctly, which could cause death or serious injury in the event of collision.
- Do not apply a heavy load to the front passenger seat or equipment.
- Do not put weight on the front passenger seat by putting your hands or feet on the front passenger seat seatback from the rear passenger seat.
- Do not let a rear passenger lift the front passenger seat with their feet or press on the seatback with their legs.
- Do not put objects under the front passenger seat.

 CAUTION**■ Front passenger occupant classification system precautions**

- Do not recline the front passenger seatback so far that it touches a rear seat. This may cause the "AIR BAG OFF" indicator light to be illuminated, which indicates that the passenger's airbags will not deploy in the event of a severe accident. If the seatback touches the rear seat, return the seatback to a position where it does not touch the rear seat. Keep the front passenger seatback as upright as possible when the vehicle is moving. Reclining the seatback excessively may lessen the effectiveness of the seat belt system.
- If an adult sits in the front passenger seat, the "AIR BAG ON" indicator light is illuminated. If the "AIR BAG OFF" indicator is illuminated, ask the passenger to sit up straight, well back in the seat, feet on the floor, and with the seat belt worn correctly. If the "AIR BAG OFF" indicator still remains illuminated, either ask the passenger to move to the rear seat, or if that is not possible, move the front passenger seat fully rearward.
- When it is unavoidable to install the forward-facing child restraint system on the front passenger seat, install the child restraint system on the front passenger seat in the proper order. (→P. 154)
- Do not modify or remove the front seats.
- Do not kick the front passenger seat or subject it to severe impact. Otherwise, the SRS warning light may come on to indicate a malfunction of the detection system. In this case, contact your Lexus dealer immediately.
- Child restraint systems installed on the rear seat should not contact the front seatbacks.
- Do not use a seat accessory, such as a cushion or seat cover, that covers the seat cushion surface.
- Do not modify or replace the upholstery of the front seat.

## 1-8. Safety information

# Child restraint systems

A child restraint system for a small child or baby must itself be properly restrained on the seat with the lap portion of the lap/shoulder belt.

The laws of all 50 states of the U.S.A. and Canada now require the use of child restraint systems.

### Points to remember

Studies have shown that installing a child restraint on a rear seat is much safer than installing one to the front passenger seat.

- Choose a child restraint system that suits your vehicle and is appropriate to the age and size of the child.
- For installation details, follow the instructions provided with the child restraint system.  
General installation instructions are provided in this manual. (→P.154)

### Types of child restraints

Child restraint systems are classified into the following 3 types according to the age and size of the child.

- ▶ Rear facing — Infant seat/convertible seat



▶ Forward facing — Convertible seat



▶ Booster seat



■ Selecting an appropriate child restraint system

- Use a child restraint system appropriate for the child until the child becomes large enough to properly wear the vehicle's seat belt.
- If the child is too large for a child restraint system, sit the child on a rear seat and use the vehicle's seat belt. (→P. 99)

### CAUTION

#### ■ Child restraint precautions

- For effective protection in automobile accidents and sudden stops, a child must be properly restrained, using a seat belt or child restraint system depending on the age and size of the child. Holding a child in your arms is not a substitute for a child restraint system. In an accident, the child can be crushed against the windshield, or between you and the vehicle's interior. This may cause death or serious injury to the child in the event of a sudden stop or an accident.
- Lexus strongly urges the use of a proper child restraint system that conforms to the size of the child, installed on the rear seat. According to accident statistics, the child is safer when properly restrained in the rear seat than in the front seat.
- Never install a rear-facing child restraint system on the front passenger seat even if the "AIR BAG OFF" indicator light is illuminated. In the event of an accident, the force of the rapid inflation of the front passenger airbag can cause death or serious injury to the child if a rear-facing child restraint system is installed on the front passenger seat.
- A forward-facing child restraint system may be installed on the front passenger seat only when it is unavoidable. A child restraint system that requires a top tether strap should not be used in the front passenger seat since there is no top tether strap anchor for the front passenger seat. Adjust the seatback as upright as possible and always move the seat as far back as possible even if the "AIR BAG OFF" indicator light is illuminated, because the front passenger airbag could inflate with considerable speed and force. Otherwise, the child may be killed or seriously injured.
- Do not use the seat belt extender when installing a child restraint system on the front or rear passenger seat. If installing a child restraint system with the seat belt extender connected to the seat belt, the seat belt will not securely hold the child restraint system, which could cause death or serious injury to the child or other passengers in the event of a sudden stop, sudden swerve or accident.
- Do not allow the child to lean his/her head or any part of his/her body against the door or the area of the seat, front and rear pillars or roof side rails from which the SRS side airbags or SRS curtain shield airbags deploy even if the child is seated in the child restraint system. It is dangerous if the side airbags and curtain shield airbags inflate, and the impact could cause death or serious injury to the child.



 **CAUTION****■ Child restraint precautions**

Make sure you have complied with all installation instructions provided by the child restraint manufacturer and that the system is properly secured. If it is not secured properly, it may cause death or serious injury to the child in the event of a sudden stop, sudden swerve or an accident.

**■ When children are in the vehicle**

Do not allow children to play with the seat belt. If the seat belt becomes twisted around a child's neck, it may lead to choking or other serious injuries that could result in death.

If this occurs and the buckle cannot be unfastened, scissors should be used to cut the belt.

**■ When the child restraint system is not in use**

- Keep the child restraint system properly secured on the seat even if it is not in use. Do not store the child restraint system unsecured in the passenger compartment.
- If it is necessary to detach the child restraint system, remove it from the vehicle or store it securely in the luggage compartment. This will prevent it from injuring passengers in the event of a sudden stop, sudden swerve or accident.

## 1-8. Safety information

### Installing child restraints

Follow the child restraint system manufacturer's instructions. Firmly secure child restraints to the seats using the LATCH anchors or a seat belt. Attach the top tether strap when installing a child restraint.

The lap/shoulder belt can be used if your child restraint system is not compatible with the LATCH (Lower Anchors and Tethers for Children) system.



Child restraint LATCH anchors  
LATCH anchors are provided for the outer rear seats. (Buttons displaying the location of the anchors are attached to the seats.)



Seat belts equipped with a child restraint locking mechanism (ALR/ELR belts except driver's seat belt) (→P. 99)



Anchor brackets (for top tether strap)  
An anchor bracket is provided for each rear seat.

## Installation with LATCH system

### STEP 1

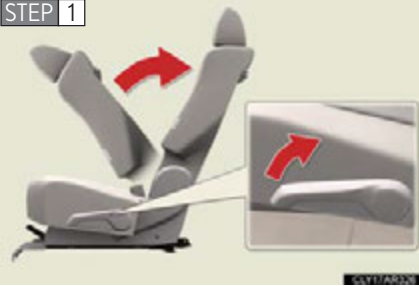

Fold the seatback while pulling the seatback angle adjustment lever. Return the seatback and secure it at the first lock position. (→P. 89)

**STEP 2** Widen the gap between the seat cushion and seatback slightly.

► Type A

### STEP 3

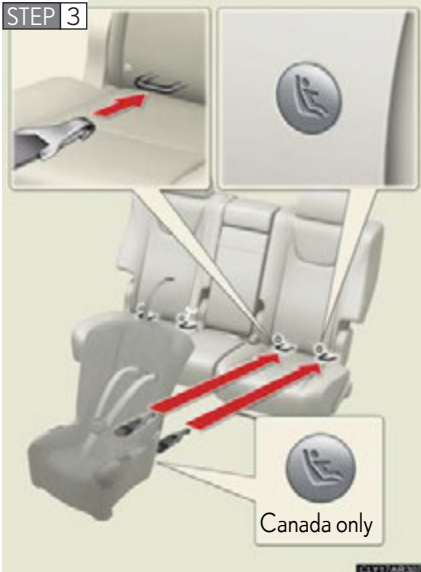

Latch the hooks of the lower straps onto the LATCH anchors. If the child restraint has a top tether strap, the top tether strap should be latched onto the top tether strap anchor bracket.

For owners in Canada:  
The symbol on a child restraint system indicates the presence of a lower connector system.

► Type B

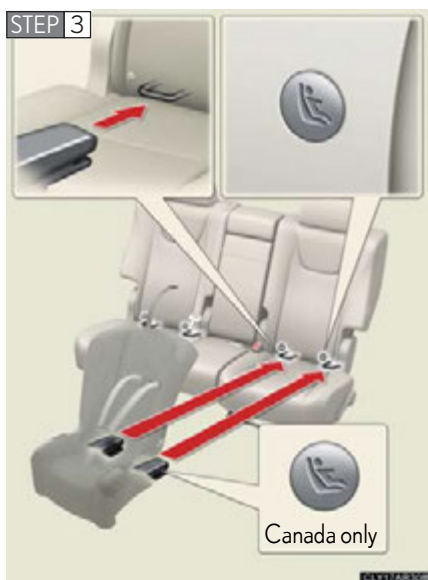

Latch the buckles onto the LATCH anchors. If the child restraint has a top tether strap, the top tether strap should be latched onto the top tether strap anchor bracket.

For owners in Canada:  
The symbol on a child restraint system indicates the presence of a lower connector system.

**STEP 4** If the child restraint has a top tether strap, the top tether strap should be latched onto the top tether strap anchor. (→P. 161)

## Installing child restraints using a seat belt (child restraint lock function belt)

### ■ Rear-facing — Infant seat/convertible seat

STEP 1

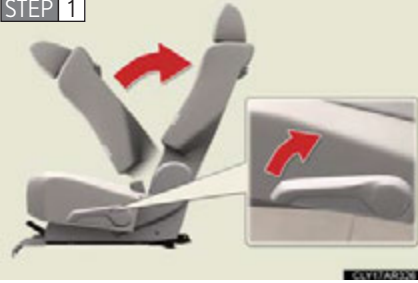

Fold the seatback while pulling the seatback angle adjustment lever. Return the seatback and secure it at the first lock position. (→P. 89)

STEP 2



Place the child restraint system on the rear seat facing the rear of the vehicle.

STEP 3



Run the seat belt through the child restraint system and insert the plate into the buckle. Make sure that the belt is not twisted.

1

Before driving

STEP 4



Fully extend the shoulder belt and allow it to retract to put it in lock mode. In lock mode, the belt cannot be extended.

STEP 5



While pushing the child restraint system down into the rear seat, allow the shoulder belt to retract until the child restraint system is securely in place.

After the shoulder belt has retracted to a point where there is no slack in the belt, pull the belt to check that it cannot be extended.

### ■ Forward-facing — Convertible seat

STEP 1

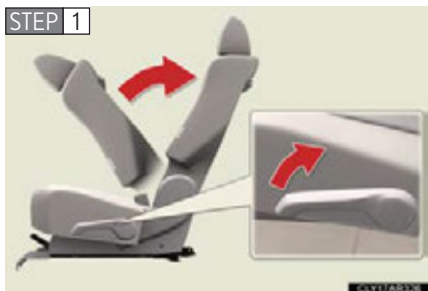

Fold the seatback while pulling the seatback angle adjustment lever. Return the seatback and secure it at the first lock position. (→P. 89)

STEP 2



Place the child restraint system on the seat facing the front of the vehicle.

## STEP 3



Run the seat belt through the child restraint system and insert the plate into the buckle. Make sure that the belt is not twisted.

## STEP 4



Fully extend the shoulder belt and allow it to retract to put it in lock mode. In lock mode, the belt cannot be extended.

## STEP 5



While pushing the child restraint system into the rear seat, allow the shoulder belt to retract until the child restraint system is securely in place.

After the shoulder belt has retracted to a point where there is no slack in the belt, pull the belt to check that it cannot be extended.

## STEP 6

If the child restraint has a top tether strap, the top tether strap should be latched onto the top tether strap anchor. (→P. 161)

## ■ Booster seat

STEP 1

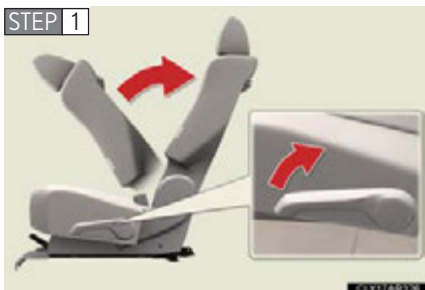

Fold the seatback while pulling the seatback angle adjustment lever. Return the seatback and secure it at the first lock position. (→P. 89)

STEP 2



Place the child restraint system on the seat facing the front of the vehicle.

STEP 3

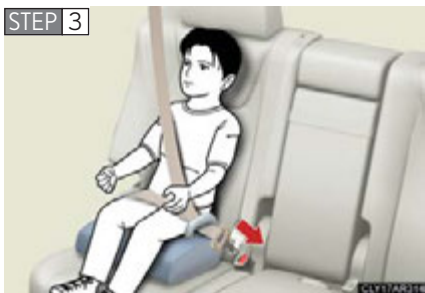

Sit the child in the child restraint system. Fit the seat belt to the child restraint system according to the manufacturer's instructions and insert the plate into the buckle. Make sure that the belt is not twisted.

Check that the shoulder belt is correctly positioned over the child's shoulder, and that the lap belt is as low as possible. (→P. 99)



**Removing a child restraint installed with a seat belt**



Press the buckle release button and fully retract the seat belt.

**Child restraint systems with a top tether strap**



Secure the child restraint system using a seat belt or the LATCH anchors, and remove the head restraint.



Open the anchor bracket cover, latch the hook onto the anchor bracket and tighten the top tether strap.

Make sure the top tether strap is securely latched.

STEP 3



Replace the head restraint and lift it up to the uppermost lock position.

### ■ Laws and regulations pertaining to anchors

The LATCH system conforms to FMVSS225 or CMVSS210.2.

Child restraint systems conforming to FMVSS213 or CMVSS213 specifications can be used.

This vehicle is designed to conform to the SAE J1819.

### ⚠ CAUTION

#### ■ When installing a booster seat

To prevent the belt from going into ALR lock mode, do not fully extend the shoulder belt. ALR mode causes the belt to tighten only. This could cause injury or discomfort to the child. (→P.101)

**! CAUTION****■ When installing a child restraint system**

Follow the directions given in the child restraint system installation manual and fix the child restraint system securely in place.

If the child restraint system is not correctly fixed in place, the child or other passengers may be injured or even killed in the event of sudden braking, sudden swerving or an accident.



- If the driver's seat interferes with the child restraint system and prevents it from being attached correctly, attach the child restraint system to the right-hand rear seat.
- Adjust the front passenger seat so that it does not interfere with the child restraint system.
- Only put a forward-facing child restraint system on the front seat when unavoidable. When installing a forward-facing child restraint system on the front passenger seat, move the seat as far back as possible even if the "AIR BAG OFF" indicator light is illuminated. Failure to do so may result in death or serious injury if the airbags deploy (inflate).
- When installing a child restraint system in the rear center seat, adjust both seat cushions to the same position and align both seatbacks at the same angle. The seatbacks must be adjusted to the same angle. Otherwise, the child restraint system cannot be securely restrained and this may cause death or serious injuries in the event of sudden braking, sudden swerving or an accident.
- When using the LATCH system, move the seat as far back as possible and adjust the seatback as upright as possible.
- When a booster seat is installed, always ensure that the shoulder belt is positioned across the center of the child's shoulder. The belt should be kept away from the child's neck, but not so that it could fall off the child's shoulder. Failing to do so may result in death or serious injury in the event of sudden braking, sudden swerving or an accident.

### CAUTION

#### ■ When installing a child restraint system

- Ensure that the belt and tab are securely locked and the seat belt is not twisted.
- Shake the child restraint system left and right, and forward and backward to ensure that it has been securely installed.
- After securing a child restraint system, never adjust the seat.
- Follow all installation instructions provided by the child restraint system manufacturer.

#### ■ Do not use a seat belt extender

If a seat belt extender is used when installing a child restraint system, the seat belt will not securely hold the child restraint system, which could cause death or serious injury to the child or other passengers in the event of sudden braking, sudden swerving or an accident.

#### ■ To correctly attach a child restraint system to the anchors

When using the LATCH anchors, be sure that there are no foreign objects around the anchors and that the seat belt is not caught behind the child restraint system. Make sure the child restraint system is securely attached, or it may cause death or serious injury to the child or other passengers in the event of a sudden stop, sudden swerve or accident.

**2-1. Driving procedures**

Driving the vehicle.....	166
Power (ignition) switch .....	177
EV drive mode.....	183
Hybrid transmission .....	186
Turn signal lever .....	193
Parking brake .....	195
Horn .....	196

**2-2. Instrument cluster**

Gauges and meters .....	197
Indicators and warning lights .....	201
Multi-information display ....	206
Head-up display .....	212

**2-3. Operating the lights and windshield wipers**

Headlight switch.....	217
Fog light switch .....	221
Windshield wipers and washer .....	223
Rear window wiper and washer .....	229
Headlight cleaner switch.....	231

**2-4. Using other driving systems**

Cruise control.....	232
Dynamic radar cruise control .....	236
Intuitive parking assist.....	248
Rear view monitor system (rear view mirror-attached type) .....	258
Rear view monitor system (vehicles with the Lexus Display Audio system) .....	266
Driving assist systems .....	271
Hill-start assist control .....	276
Pre-Collision System.....	278
BSM (Blind Spot Monitor) .....	286

**2-5. Driving information**

Utility vehicle precautions.....	292
Cargo and luggage .....	296
Vehicle load limits.....	301
Winter driving tips .....	302
Trailer towing (AWD models with towing package).....	306
Trailer towing (without towing package).....	323
Dinghy towing.....	324

## 2-1. Driving procedures

# Driving the vehicle

The following procedures should be observed to ensure safe driving.

### ■ Starting the hybrid system

→P.177

### ■ Driving

**STEP 1** With the brake pedal depressed, shift the shift lever to D.  
(→P.186)

**STEP 2** Release the parking brake. (→P.195)

**STEP 3** Gradually release the brake pedal and gently depress the accelerator pedal to accelerate the vehicle.

### ■ Stopping

**STEP 1** With the shift lever in D, depress the brake pedal.

**STEP 2** If necessary, set the parking brake.

If the vehicle is to be stopped for an extended period of time, shift the shift lever to P. (→P.186)

### ■ Parking the vehicle

**STEP 1** With the shift lever in D, depress the brake pedal.

**STEP 2** Set the parking brake. (→P.195)

**STEP 3** Shift the shift lever to P. (→P.186)

If parking on a hill, block the wheels as needed.

**STEP 4** Press the “POWER” switch to stop the hybrid system.

**STEP 5** Lock the door, making sure that you have the electronic key on your person.

### Starting off on a steep uphill

**STEP 1** Make sure that the parking brake is set and shift the shift lever to D.

**STEP 2** Gently depress the accelerator pedal.

**STEP 3** Release the parking brake.

### ■ When starting off on an uphill

The hill-start assist control is available. (→P. 276)

### ■ Driving in the rain

- Drive carefully when it is raining, because visibility will be reduced, the windows may become fogged-up, and the road will be slippery.
- Drive carefully when it starts to rain, because the road surface will be especially slippery.
- Refrain from high speeds when driving on an expressway in the rain, because there may be a layer of water between the tires and the road surface, preventing the steering and brakes from operating properly.

### ■ Engine speed while driving

In the following conditions, the engine speed may become high while driving. This is due to automatic up-shifting control or down-shifting implementation to meet driving conditions. It does not indicate sudden acceleration.

- The vehicle is judged to be driving uphill or downhill
- When the accelerator pedal is released
- When the brake pedal is depressed while sport mode is selected

### ■ Breaking in your new Lexus

To extend the life of the vehicle, observing the following precautions is recommended:

- For the first 200 miles (300 km):  
Avoid sudden stops.
- For the first 500 miles (800 km):  
Do not tow a trailer.
- For the first 1000 miles (1600 km):
  - Do not drive at extremely high speeds.
  - Avoid sudden acceleration.
  - Do not drive continuously in low gears.
  - Do not drive at a constant speed for extended periods.

### ■ Drum-in-disc type parking brake system

Your vehicle has a drum-in-disc type parking brake system. This type of brake system needs bedding-down of the brake shoes periodically or whenever the parking brake shoes and/or drum are replaced. Have your Lexus dealer perform the bedding down operation.

### ■ Operating your vehicle in a foreign country

Comply with the relevant vehicle registration laws and confirm the availability of the correct fuel. (→P. 800)

### ■ For efficient use

- Shift the shift lever to D when driving.

In the N position, the gasoline engine operates but electricity cannot be generated. The hybrid battery (traction battery) will discharge, requiring unnecessary engine power to recharge.

- Drive your vehicle smoothly.

Avoid abrupt acceleration and deceleration. Gradual acceleration and deceleration will make more effective use of the electric motor (traction motor) without having to use gasoline engine power.

- Avoid repeated acceleration.

Repeated acceleration consumes hybrid battery (traction battery) power, resulting in poor acceleration. Battery power can be restored by driving with the accelerator pedal slightly released.

- Shift the shift lever to P when parking.

In the N position, the hybrid battery (traction battery) does not recharge. Leaving the shift lever in the N position for an extended period of time may discharge the hybrid battery. The vehicle cannot run if the hybrid battery is discharged.

### ■ Eco-friendly driving

→P.199

### CAUTION

#### ■ When starting the vehicle

Always keep your foot on the brake pedal while stopped with the hybrid system operating. This prevents the vehicle from creeping.



 **CAUTION**
**■ When driving the vehicle**

- Do not drive if you are unfamiliar with the location of the brake and accelerator pedals to avoid depressing the wrong pedal.
  - Accidentally depressing the accelerator pedal instead of the brake pedal will result in sudden acceleration that may lead to an accident that could result in death or serious injury.
  - When backing up, you may twist your body around, leading to a difficulty in operating the pedals. Make sure to operate the pedals properly.
  - Make sure to keep a correct driving posture even when moving the vehicle only slightly. This allows you to depress the brake and accelerator pedals properly.
  - Depress the brake pedal using your right foot. Depressing the brake pedal using your left foot may delay response in an emergency, resulting in an accident.
- When the hybrid vehicle is driven using the electric motor only, no engine noise is made. As such, pedestrians, people riding bicycles or other people and vehicles in the surrounding area may not realize that the vehicle is approaching. Even with the Vehicle Proximity Notification System active, people may not realize the vehicle is approaching when the surrounding area is noisy and so forth. Therefore, take extra care while driving.
- Do not drive the vehicle over or stop the vehicle near flammable materials. The exhaust system and exhaust gases can be extremely hot. These hot parts may cause a fire if there is any flammable material nearby.
- Do not let the vehicle roll backward while the shift lever is in a driving position, or roll forward while the shift lever is in R. Doing so may result in an accident or damage to the vehicle.
- If the smell of exhaust is noticed inside the vehicle, open the windows and check that the back door is closed. Large amounts of exhaust in the vehicle can cause driver drowsiness and an accident, resulting in death or a serious health hazard. Have the vehicle inspected by your Lexus dealer immediately.
- Do not shift the shift lever to P while the vehicle is moving. Doing so can damage the transmission and may result in a loss of vehicle control.

### CAUTION

- Do not shift the shift lever to R while the vehicle is moving forward.  
Doing so can damage the transmission and may result in a loss of vehicle control.
- Do not shift the shift lever to D while the vehicle is moving backward.  
Doing so can damage the transmission and may result in a loss of vehicle control.
- Moving the shift lever to N while the vehicle is moving will disengage the hybrid system. Engine braking is not available with the hybrid system disengaged.
- During normal driving, do not turn off the hybrid system. Turning the hybrid system off while driving will not cause loss of steering or braking control, however, power assist to the steering will be lost. This will make it more difficult to steer smoothly, so you should pull over and stop the vehicle as soon as it is safe to do so. In the event of an emergency, such as if it becomes impossible to stop the vehicle in the normal way: →P. 795
- Use engine braking (downshift) to maintain a safe speed when driving down a steep hill.  
Using the brakes continuously may cause the brakes to overheat and lose effectiveness. (→P. 186)
- When stopped on an incline, use the brake pedal and parking brake to prevent the vehicle from rolling backward or forward, causing an accident.
- Do not adjust the position of the steering wheel, the seat, or the inside or outside rear view mirrors while driving.  
Doing so may result in a loss of vehicle control that can cause accidents, resulting in death or serious injury.
- Always check that all passengers' arms, heads or other parts of their body are not outside the vehicle, as this may result in death or serious injury.
- Do not drive in excess of the speed limit. Even if the legal speed limit permits it, do not drive over 85 mph (140 km/h) unless your vehicle has high-speed capability tires. Driving over 85 mph (140 km/h) may result in tire failure, loss of control and possible injury. Be sure to consult a tire dealer to determine whether the tires on your vehicle are high-speed capability tires or not before driving at such speeds.

 **CAUTION****■ When driving on slippery road surfaces**

- Sudden braking, acceleration and steering may cause tire slippage and reduce your ability to control the vehicle, resulting in an accident.
- Sudden acceleration, engine braking due to shift changing, or changes in engine speed could cause the vehicle to skid, resulting in an accident.
- After driving through a puddle, lightly depress the brake pedal to make sure that the brakes are functioning properly. Wet brake pads may prevent the brakes from functioning properly. If the brakes on only one side are wet and not functioning properly, steering control may be affected, resulting in an accident.

**■ When shifting the shift lever**

Be careful not to shift the shift lever with the accelerator pedal depressed. This may lead to unexpected rapid acceleration of the vehicle that may cause an accident and result in death or serious injury.

**■ If you hear a squealing or scraping noise (brake pad wear limit indicators)**

Have your Lexus dealer check and replace the brake pads as soon as possible. Rotor damage can result if the pads are not replaced when needed.

It is dangerous to drive the vehicle when the wear limits of the brake pads and/or those of the brake discs are exceeded.

### CAUTION

#### ■ When the vehicle is stopped

- Do not depress the accelerator pedal unnecessarily.  
If the vehicle is in any gear other than P or N, the vehicle may accelerate suddenly and unexpectedly, causing an accident.
- Do not leave the vehicle with the hybrid system on for a long time.  
If such a situation cannot be avoided, park the vehicle in an open space and check that exhaust fumes do not enter the vehicle interior.
- In order to prevent accidents due to the vehicle rolling away, always keep depressing the brake pedal while the "READY" indicator is on. Apply the parking brake as necessary.
- If the vehicle is stopped on an incline, in order to prevent accidents caused by the vehicle rolling forward or backward, always depress the brake pedal and securely apply the parking brake as needed.
- Avoid revving or racing the engine.  
Running the engine at high speed while the vehicle is stopped may cause the exhaust system to overheat, which could result in a fire if combustible material is nearby.

 **CAUTION**
**■ When the vehicle is parked**

- Do not leave glasses, cigarette lighters, spray cans, or soft drink cans in the vehicle when it is in the sun.  
Doing so may result in the following:
  - Gas may leak from a cigarette lighter or spray can, and may lead to a fire.
  - The temperature inside the vehicle may cause the plastic lenses and plastic material of glasses to deform or crack.
  - Soft drink cans may fracture, causing the contents to spray over the interior of the vehicle, and may also cause a short circuit in the vehicle's electrical components.
- Do not leave cigarette lighters in the vehicle. If a cigarette lighter is in a place such as the glove box or on the floor, it may be lit accidentally when luggage is loaded or the seat is adjusted, causing a fire.
- Do not attach adhesive discs to the windshield or windows. Do not place containers such as air fresheners on the instrument panel or dashboard. Adhesive discs or containers may act as lenses, causing a fire in the vehicle.
- Do not leave a door or window open if the curved glass is coated with a metalized film such as a silver-colored one. Reflected sunlight may cause the glass to act as a lens, causing a fire.
- Always apply the parking brake, shift the shift lever to P, stop the hybrid system and lock the vehicle.  
Do not leave the vehicle unattended while the hybrid system is operating.
- Do not touch the exhaust pipes while the hybrid system is operating or immediately after turning the hybrid system off.  
Doing so may cause burns.
- Do not leave the hybrid system operating in an area with snow build-up, or where it is snowing. If snowbanks build up around the vehicle while the hybrid system is operating, exhaust gases may collect and enter the vehicle. This may lead to death or a serious health hazard.

### CAUTION

#### ■ Exhaust gases

Exhaust gases include harmful carbon monoxide (CO) that is colorless and odorless. Inhaling exhaust gases may lead to death or a serious health hazard.

- If the vehicle is in a poorly ventilated area, stop the hybrid system. In a closed area, such as a garage, exhaust gases may collect and enter the vehicle. This may lead to death or a serious health hazard.
- The exhaust system should be checked occasionally. If there is a hole or crack caused by corrosion, damage to a joint or abnormal exhaust noise, be sure to have the vehicle inspected and repaired by your Lexus dealer. Failure to do so may allow exhaust gases to enter the vehicle, resulting in death or a serious health hazard.

#### ■ When taking a nap in the vehicle

Always turn the hybrid system off. Otherwise, if you accidentally move the shift lever or depress the accelerator pedal, this could cause an accident or fire due to hybrid system overheating. Additionally, if the vehicle is parked in a poorly ventilated area, exhaust gases may collect and enter the vehicle, leading to death or a serious health hazard.

#### ■ When braking the vehicle

- When the brakes are wet, drive more cautiously.  
Braking distance increases when the brakes are wet, and this may cause one side of the vehicle to brake differently than the other side. Also, the parking brake may not securely hold the vehicle.
- If the electronically controlled brake system does not operate, do not follow other vehicles closely and avoid hills or sharp turns that require braking.  
In this case, braking is still possible, but the brake pedal should be depressed more firmly than usual. Also, the braking distance will increase. Have your brakes fixed immediately.
- The brake system consists of 2 or more individual hydraulic systems; if one of the systems fails, the other(s) will still operate. In this case, the brake pedal should be depressed more firmly than usual and the braking distance will increase. Have your brakes fixed immediately.

**⚠ CAUTION****■ If the vehicle becomes stuck**

Do not spin the wheels excessively when any of the tires is up in the air, or the vehicle is stuck in sand, mud, etc. This may damage the driveline components or propel the vehicle forward or backward, causing an accident.

**⚠ NOTICE****■ When driving the vehicle**

- Do not depress the accelerator and brake pedals at the same time during driving, as this may restrain driving torque.
- Do not use the accelerator pedal or depress the accelerator and brake pedals at the same time to hold the vehicle on a hill.

**■ When parking the vehicle**

Always shift the shift lever to P. Failure to do so may cause the vehicle to move or the vehicle may accelerate suddenly if the accelerator pedal is accidentally depressed.

**■ Avoiding damage to vehicle parts**

- Do not turn the steering wheel fully in either direction and hold it there for an extended period of time.  
Doing so may damage the power steering motor.
- When driving over bumps in the road, drive as slowly as possible to avoid damaging the wheels, underside of the vehicle, etc.

**■ If you get a flat tire while driving**

A flat or damaged tire may cause the following situations. Hold the steering wheel firmly and gradually depress the brake pedal to slow down the vehicle.

- It may be difficult to control your vehicle.
- The vehicle will make abnormal sounds.
- The vehicle will behave abnormally.

Information on what to do in case of a flat tire (→P. 764)

### NOTICE

#### ■ When encountering flooded roads

Do not drive on a road that has flooded after heavy rain etc. Doing so may cause the following serious damage to the vehicle:

- Engine stalling
- Short in electrical components
- Engine damage caused by water immersion

In the event that you drive on a flooded road and the vehicle is flooded, be sure to have your Lexus dealer check the following:

- Brake function
- Changes in quantity and quality of oil and fluid used for the engine, hybrid transmission, etc., and, for AWD models, the rear electric motor (traction motor).
- Lubricant condition for the bearings, suspension joints (where possible) and the function of all joints, bearings, etc.



# Power (ignition) switch

Performing the following operations when carrying the electronic key on your person starts the hybrid system or changes “POWER” switch modes.

### ■ Starting the hybrid system

**STEP 1** Check that the parking brake is set.

**STEP 2** Check that the shift lever is set in P.

**STEP 3** Firmly depress the brake pedal.

The “POWER” switch indicator will turn green. If the indicator does not turn green, the hybrid system cannot be started.



Press the “POWER” switch.

After a while, the “READY” indicator comes on with a beep sound.

The vehicle can move when the “READY” indicator is on even if the engine is stopped.

Continue depressing the brake pedal until the hybrid system is completely started.

The hybrid system can be started from any “POWER” switch mode.

**STEP 5** Check that the “READY” indicator is on.

The vehicle will not move when the “READY” indicator is off.

### ■ Stopping the hybrid system

**STEP 1** Stop the vehicle.

**STEP 2** Shift the shift lever to P.

**STEP 3** Set the parking brake. (→P. 195)

**STEP 4** Press the “POWER” switch.

**STEP 5** Release the brake pedal and check that the indicator on the “POWER” switch is off.

### ■ Changing “POWER” switch modes

Modes can be changed by pressing the “POWER” switch with the brake pedal released. (The mode changes each time the switch is pressed.)



#### 1 Off\*

The emergency flashers can be used.

#### 2 ACCESSORY mode

Some electrical components such as the audio system can be used.

The “POWER” switch indicator turns amber.

#### 3 ON mode

All electrical components can be used.

The “POWER” switch indicator turns blue.

\*: If the shift lever is in a position other than P when turning off the hybrid system, the “POWER” switch will be turned to ACCESSORY mode, not to off.

## When stopping the hybrid system with the shift lever in a position other than P

If the hybrid system is stopped with the shift lever in a position other than P, the “POWER” switch will not be turned off but instead be turned to ACCESSORY mode. Perform the following procedure to turn the switch off:

**STEP 1** Check that the parking brake is set.

**STEP 2** Shift the shift lever to P.

**STEP 3** Check that the indicator on the “POWER” switch is illuminated in amber and then press the “POWER” switch once.

**STEP 4** Check that the indicator on the “POWER” switch is off.

### ■ Auto power off function

When the shift lever is in P, if the vehicle is left in ACCESSORY or ON mode with the hybrid system not operating for more than 20 minutes (ACCESSORY mode) or one hour (ON mode), the “POWER” switch will automatically turn off. However, this function cannot entirely prevent 12-volt battery discharge. Do not leave the vehicle with the “POWER” switch in ACCESSORY or ON mode for long periods of time when the hybrid system is not operating.

### ■ Operation of the “POWER” switch

When operating the “POWER” switch, one short, firm press is enough. If the switch is pressed improperly, the hybrid system may not start or the “POWER” switch mode may not change. It is not necessary to press and hold the switch.

### ■ Sounds and vibrations specific to a hybrid vehicle

→P. 33

### ■ Electronic key battery depletion

→P. 65

### ■ When the ambient temperature is low, such as during winter driving conditions

It may take time until the “READY” indicator comes on.

### ■ Conditions affecting operation

→P. 62

### ■ Note for the entry function

→P. 63

### ■ If the hybrid system does not start

The immobilizer system may not have been deactivated. (→P. 124)  
Contact your Lexus dealer.

### ■ Steering lock

After turning the “POWER” switch off and opening and closing the doors, the steering wheel will be locked due to the steering lock function. Operating the “POWER” switch again automatically cancels the steering lock.

### ■ When the steering lock cannot be released



The green indicator light on the “POWER” switch will flash and a message will be shown on the multi-information display. Press the “POWER” switch again while turning the steering wheel left and right.

### ■ Steering lock motor overheating prevention

To prevent the steering lock motor from overheating, the motor may be suspended if the hybrid system is turned on and off repeatedly in a short period of time. In this case, refrain from operating the hybrid system. After about 2 seconds, the steering lock motor will resume functioning.

### ■ When the “POWER” switch indicator flashes in amber

The system may be malfunctioning. Have the vehicle inspected by your Lexus dealer immediately.

### ■ If the “READY” indicator does not come on

If the “READY” indicator does not come on when you press the “POWER” switch with the shift lever in P and the brake pedal depressed, contact your Lexus dealer immediately.

### ■ If the hybrid system is malfunctioning

→P. 744

### ■ If the electronic key battery is depleted

→P. 687

 **CAUTION****■ When starting the hybrid system**

Always start the hybrid system while sitting in the driver's seat. Do not depress the accelerator pedal while starting the hybrid system under any circumstances. Doing so may cause an accident resulting in death or serious injury.

**■ Caution while driving**

If a hybrid system failure occurs while the vehicle is moving, do not lock or open the doors until the vehicle reaches a safe and complete stop. Activation of the steering lock in this circumstance may lead to an accident, resulting in death or serious injury.

**■ Stopping the hybrid system in an emergency**

If you want to stop the hybrid system in an emergency while driving the vehicle, press and hold the "POWER" switch for more than 2 seconds, or press it briefly 3 times or more in succession. (→P. 795)

However, do not touch the "POWER" switch while driving except in an emergency. Turning the hybrid system off while driving will not cause loss of steering or braking control, however, power assist to the steering will be lost. This will make it more difficult to steer smoothly, so you should pull over and stop the vehicle as soon as it is safe to do so.

### NOTICE

#### ■ To prevent 12-volt battery discharge

- Do not leave the “POWER” switch in ACCESSORY or ON mode for long periods of time without the hybrid system on.
- If the indicator on the “POWER” switch is illuminated, the “POWER” switch is not off. When exiting the vehicle, always check that the “POWER” switch is off.
- Do not stop the hybrid system when the shift lever is in a position other than P. If the hybrid system is stopped in another shift lever position, the “POWER” switch will not be turned off but instead be turned to ACCESSORY mode. If the vehicle is left in ACCESSORY mode, 12-volt battery discharge may occur.

#### ■ When starting the hybrid system

- Do not depress the accelerator pedal unnecessarily.
- If the hybrid system becomes difficult to start, have your vehicle checked by your Lexus dealer immediately.

#### ■ Symptoms indicating a malfunction with the “POWER” switch

If the “POWER” switch seems to be operating somewhat differently than usual, such as the switch sticking slightly, there may be a malfunction. Contact your Lexus dealer immediately.

## 2-1. Driving procedures

### EV drive mode

In EV drive mode, the electric motor (traction motor), powered by the hybrid battery (traction battery), is used to drive the vehicle.

This mode allows you to drive in residential areas early in the morning and late at night, or in indoor parking lots etc. without concern for noises and exhaust gas emissions.

However, when the Vehicle Proximity Notification System is active, the vehicle may produce sound.



Turns EV drive mode on/off

When EV drive mode is turned on, the EV drive mode indicator will come on. Pressing the switch when in EV drive mode will return the vehicle to normal driving (using the gasoline engine and electric motor [traction motor]).

2

When driving

#### ■ Switching to EV drive mode when the gasoline engine is cold

If the hybrid system is started while the gasoline engine is cold, the gasoline engine will start automatically after a short period of time in order to warm up. In this case, you will become unable to switch to EV drive mode.

After the hybrid system has started and the "READY" indicator has illuminated, press the EV drive mode switch before the gasoline engine starts to switch to EV drive mode.

### ■ Situations in which EV drive mode cannot be turned on

It may not be possible to turn EV drive mode on in the following situations. If it cannot be turned on, a buzzer will sound and a message will be shown on the multi-information display.

- The temperature of the hybrid system is high.  
The vehicle has been left in the sun, driven on a hill, driven at high speeds, etc.
- The temperature of the hybrid system is low.  
The vehicle has been left in extremely low temperatures for a long period of time etc.
- The gasoline engine is warming up.
- The hybrid battery (traction battery) is low.
- Vehicle speed is about 25 mph (40 km/h) or more.
- The accelerator pedal is depressed firmly or the vehicle is on a hill etc.
- The windshield defogger is in use.

### ■ Automatic cancelation of EV drive mode

When driving in EV drive mode, the gasoline engine may automatically restart in the following situations. When EV drive mode is canceled, a buzzer will sound and the EV drive mode indicator will flash and go off.

- The hybrid battery (traction battery) becomes low.
- Vehicle speed becomes more than about 25 mph (40 km/h).  
If engine coolant temperature is low, EV drive mode may be canceled when vehicle speed is below 25 mph (40 km/h).
- The accelerator pedal is depressed firmly or the vehicle is on a hill etc.

When it is possible to inform the driver of automatic cancelation in advance, a prior notice screen will appear on the multi-information display.

### ■ Possible driving distance when driving in EV drive mode

In EV drive mode, it is possible to drive up about 1/2 mile (1 km) if driving at a speed of about 25 mph (40 km/h) or less.

(The distance that is possible depends on the hybrid battery [traction battery] level and driving conditions.)

### ■ Fuel economy

RX450h is designed to achieve the best possible fuel economy during normal driving (using the gasoline engine and electric motor [traction motor]). Driving in EV drive mode more than necessary may lower fuel economy.



 **CAUTION****■ Caution while driving**

When driving in EV drive mode no engine noise is made. As such, pedestrians, people riding bicycles or other people and vehicles in the surrounding area may not be aware of the vehicle starting off or approaching them. Therefore, take extra care while driving even if the Vehicle Proximity Notification System is active.

## 2-1. Driving procedures

# Hybrid transmission

Select a shift position appropriate for the driving conditions.

### ■ Shifting the shift lever



While the “POWER” switch is in ON mode, depress the brake pedal and move the shift lever.

When shifting the shift lever between P and D, make sure that the vehicle is completely stopped.

### ■ Shift position purpose

Shift position	Function
P	Parking the vehicle/starting the hybrid system
R	Reversing
N	Neutral
D	Normal driving <sup>*1</sup>
S	S mode driving <sup>*2</sup> (→P. 190)

\*1: Shifting to the D position allows the system to select a gear suitable for the driving conditions. Setting the shift lever to the D position is recommended for normal driving.

\*2: Selecting shift ranges using S mode controls engine braking forces.

## ■ Selecting Eco drive mode

When the vehicle is driven in Eco drive mode, vehicle driving force and operation of the air conditioning system (heating/cooling) is controlled to improve fuel efficiency.



- 1 Press the menu switch.

The multi-information display will change modes to electronic features control mode.

- 2 Press the “^” or “v” switch until “ECO MODE” appears.



Press the “ENTER” switch to change to “ON”. The “ECO MODE” indicator will be displayed.

Each pressing of the switch turns Eco drive mode on and off.

Press the menu switch to change to the normal display.

### ■ Selecting snow mode

Use snow mode for accelerating and driving on slippery road surfaces such as snow.

STEP 1



1 Press the menu switch.

The multi-information display will change modes to electronic features control mode.

2 Press the “^” or “v” switch until “HYBRID SNOW” appears.

STEP 2



Press the “ENTER” switch to change to “ON”.

The “Hybrid SNOW” indicator will be displayed.

Each pressing of the switch turns snow mode on and off.

Press the menu switch to change to the normal display.

## ■ Selecting sport mode

Use when high levels of response and feeling are desirable, such as when driving in mountainous regions or when overtaking.



- 1 Press the menu switch.

The multi-information display will change modes to electronic features control mode.

- 2 Press the “^” or “v” switch until “SPORT MODE” appears.



Press the “ENTER” switch to change to “ON”. The “SPORT MODE” indicator will be displayed.

Each pressing of the switch turns sport mode on and off.

Press the menu switch to change to the normal display.

### Changing shift ranges in S mode

When the shift lever is in the S position, the shift lever can be operated as follows:



- 1 Upshifting
- 2 Downshifting

The initial shift range in S mode is set automatically to “5” or “4” according to vehicle speed.

#### ■ Shift ranges and their functions

- You can choose from 6 levels of engine braking force.
- A lower shift range will provide greater engine braking force than a higher shift range, and the engine speed will also increase.

---

#### ■ Operation of the air conditioning system in Eco drive mode

Eco drive mode controls the heating/cooling operations and fan speed of the air conditioning system to enhance fuel efficiency. (→P. 342, 350) To improve air conditioning performance, adjust the fan speed or turn off Eco drive mode.

#### ■ Automatic return to normal driving mode

If snow mode or sport mode is selected, the driving mode will automatically return to normal mode when the hybrid system is turned off.

#### ■ S mode

- When the shift range is “5” or lower, holding the shift lever toward “+” sets the shift range to “6”.
- To prevent the engine from over-revving, upshifting may automatically occur.

## ■ AI-SHIFT

AI-SHIFT automatically selects the suitable gear according to driver performance and driving conditions.

AI-SHIFT automatically operates when the shift lever is in the D position. (Shifting the shift lever to the S position cancels the function.)

## ■ When driving with cruise control or radar cruise control activated

Even when performing the following actions with the intent of enabling engine braking, engine braking will not activate because cruise control or radar cruise control will not be canceled.

- While driving in D or S mode, downshifting to 5 or 4. (→P. 232, 236)
- When switching the driving mode to sport mode while driving in D position. (→P. 189)

## ■ If the shift lever cannot be shifted from P

→P. 779

## ■ If S does not come on even after shifting the shift lever to S

This may indicate a malfunction in the hybrid transmission system. Have the vehicle inspected by your Lexus dealer immediately.

(In this situation, the hybrid transmission will operate in the same as manner as when the shift lever is in D.)

## ■ Downshift restriction warning buzzer (S mode)

To help ensure safety and driving performance, downshifting operation may sometimes be restricted. In some circumstances, downshifting may not be possible even when the shift lever is operated. (The buzzer will sound twice.)

### CAUTION

#### ■ When driving on slippery road surfaces

Do not accelerate or shift gears suddenly.

Sudden changes in engine braking may cause the vehicle to spin or skid, resulting in an accident.

### NOTICE

#### ■ Hybrid battery (traction battery) charge precaution

If the shift lever is in N, the hybrid battery (traction battery) will not be charged even when the engine is running. Therefore, if the vehicle is left with the shift lever in N for a long period of time, the hybrid battery (traction battery) will discharge, and this may result in the vehicle not being able to start.



## 2-1. Driving procedures

# Turn signal lever

The turn signal lever can be used to show the following intention of the driver:

### ► Type A

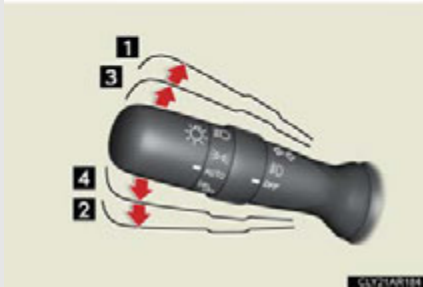

- 1 Right turn
- 2 Left turn
- 3 Lane change to the right (move the lever partway and release it)

The right hand signals will flash 3 times.

- 4 Lane change to the left (move the lever partway and release it)

The left hand signals will flash 3 times.

### ▶ Type B

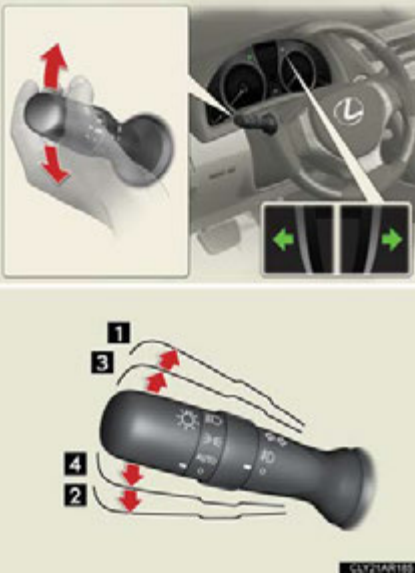

- 1 Right turn
- 2 Left turn
- 3 Lane change to the right (move the lever partway and release it)

The right hand signals will flash 3 times.

- 4 Lane change to the left (move the lever partway and release it)

The left hand signals will flash 3 times.

#### ■ Turn signals can be operated when

The "POWER" switch is in ON mode.

#### ■ If the indicators flash faster than usual

Check that a light bulb in the front or rear turn signal lights has not burned out.

#### ■ If the turn signals stop flashing before a lane change has been performed

Operate the lever again.

#### ■ To discontinue flashing of the turn signals during a lane change

Operate the lever in the opposite direction.

#### ■ Customization

The number of times the turn signals flash during a lane change can be changed. (Customizable features →P. 825)

## 2-1. Driving procedures

# Parking brake



To set the parking brake, fully depress the parking brake pedal with your left foot while depressing the brake pedal with your right foot.

(Depressing the pedal again releases the parking brake.)

2

When driving

### ■ Usage in winter time

→P. 302

### ⚠ NOTICE

#### ■ Before driving

Fully release the parking brake.

Driving the vehicle with the parking brake set will lead to brake components overheating, which may affect braking performance and increase brake wear.

## 2-1. Driving procedures

### Horn



To sound the horn, press on or close to the  mark.

## 2-2. Instrument cluster

# Gauges and meters



- 1** Hybrid System Indicator  
Displays hybrid system power output and regenerative charging level
- 2** ECO lamp and SPORT lamp  
Changes colors according to driving mode
- 3** Speedometer  
Displays the vehicle speed
- 4** Fuel gauge  
Displays the quantity of fuel remaining in the tank
- 5** Multi-information display  
Presents the driver with a variety of driving-related data (→P. 206)
- 6** Odometer and trip meter  
Odometer: Displays the total distance the vehicle has been driven  
Trip meter: Displays the distance the vehicle has been driven since the meter was last reset. Trip meters “A” and “B” can be used to record and display different distances independently.
- 7** Shift position and shift range display  
Displays the selected shift position or selected shift range (→P. 186)
- 8** Engine coolant temperature gauge  
Displays the engine coolant temperature

### Changing the display



Switches between odometer and trip meter displays. When the trip meter is displayed, pressing and holding the button will reset the trip meter.

### Instrument panel light control

The brightness of the instrument panel lights can be adjusted.



- 1 Darker
- 2 Brighter

### ■ The meters and display illuminate when

The "POWER" switch is in ON mode.

## ■ Hybrid System Indicator

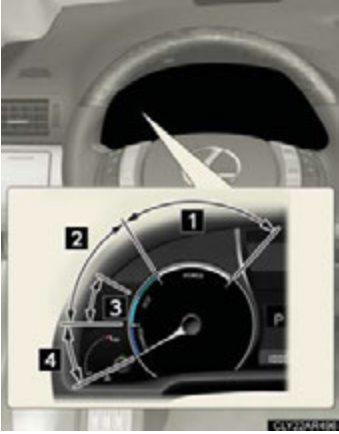

- 1** Power area  
Shows that an Eco-friendly driving range is being exceeded (during full power driving etc.)
- 2** Eco area  
Shows that the vehicle is being driven in an Eco-friendly manner.
- 3** Hybrid Eco area  
Shows that gasoline engine power is not being used very often.  
The gasoline engine will automatically stop and restart under various conditions.
- 4** Charge area  
Shows that energy is being recovered via regenerative braking.

- By keeping the indicator within Eco area, more Eco-friendly driving can be achieved.
- Charge area indicates regeneration\* status. Regenerated energy will be used to charge the hybrid battery (traction battery).

\*: When used in this manual, “regeneration” refers to the conversion of energy created by the movement of the vehicle into electrical energy.

## ■ ECO lamp and SPORT lamp

- When sport mode is selected, the SPORT lamp (red) will illuminate.
- When all of the following conditions are satisfied and the Eco-friendly driving, the ECO lamp (blue) will illuminate:
  - When driving with the shift lever in D
  - When either normal mode or Eco mode are selected, and EV drive mode and snow mode are not in use
  - The vehicle speed is approximately 80 mph (130 km/h) or below.

## ■ Customization

Settings (e.g. on/off operation of the ECO lamp) can be changed.  
(Customizable features →P. 825)

### NOTICE

#### ■ To prevent damage to the engine and its components

The engine may be overheating if the engine coolant temperature gauge is in the red zone (H). In this case, immediately stop the vehicle in a safe place, and check the engine after it has cooled completely. (→P. 788)



## 2-2. Instrument cluster

# Indicators and warning lights

The indicator and warning lights on the instrument cluster, center panel and outside rear view mirrors inform the driver of the status of the vehicle's various systems.

For the purpose of explanation, the following illustration displays all indicators and warning lights illuminated.

### ■ Instrument cluster



### ■ Center panel

▶ With a navigation system



▶ With the Lexus Display Audio system



▶ Without a navigation system or the Lexus Display Audio system



■ Outside rear view mirrors (if equipped)



## ■ Indicators

The indicators inform the driver of the operating state of the vehicle's various systems.



Turn signal indicator  
(→P. 193)



Headlight high beam indicator (→P. 219)



(U.S.A.)

Headlight indicator  
(→P. 217)



(Canada)

Tail light indicator  
(→P. 217)



Front fog light indicator  
(→P. 221)



Cruise control indicator  
(→P. 232, 236)



(if equipped)

Radar cruise control indicator (→P. 236)



(if equipped)

Intuitive parking assist indicator  
(→P. 248)



\*1,2

Slip indicator  
(→P. 272, 276)



\*1

VSC off indicator  
(→P. 272)



\*1,3

(if equipped)

Pre-collision system warning light (→P. 278)



\*1

(if equipped)

BSM indicator  
(→P. 286)



\*4

(if equipped)

BSM outside rear view mirror indicators  
(→P. 286)



"READY" indicator  
(→P. 177)



EV drive mode indicator  
(→P. 183)



"ECO MODE" indicator  
(→P. 187)



"SPORT MODE" indicator (→P. 189)



"Hybrid SNOW" indicator (→P. 188)



\*<sub>1</sub> SRS airbag on-off indicator (→P. 145)

(if equipped)



\*<sub>1</sub> SRS airbag on-off indicator (→P. 145)

(if equipped)

- \*<sub>1</sub>: These lights turn on when the “POWER” switch is turned to ON mode to indicate that a system check is being performed. They will turn off after the hybrid system is on, or after a few seconds. There may be a malfunction in a system if a light does not come on, or if the lights do not turn off. Have the vehicle inspected by your Lexus dealer.
- \*<sub>2</sub>: The light flashes to indicate that the system is operating.
- \*<sub>3</sub>: The light comes on when the system is turned off. The light flashes faster than usual to indicate that the system is operating.
- \*<sub>4</sub>: In order to confirm operation, the BSM outside rear view mirror indicators illuminate in the following situations:
  - When the “POWER” switch is turned to ON mode while the BSM main switch is set to ON.
  - When the BSM main switch is set to ON while the “POWER” switch is in ON mode.

If the system is functioning correctly, the BSM outside rear view mirror indicators will turn off after a few seconds.

If the BSM outside rear view mirror indicators do not illuminate or do not turn off, there may be a malfunction with the system.

If this occurs, have the vehicle inspected by your Lexus dealer.

## ■ Warning lights

Warning lights inform the driver of malfunctions in any of the vehicle's systems. (→P. 733)

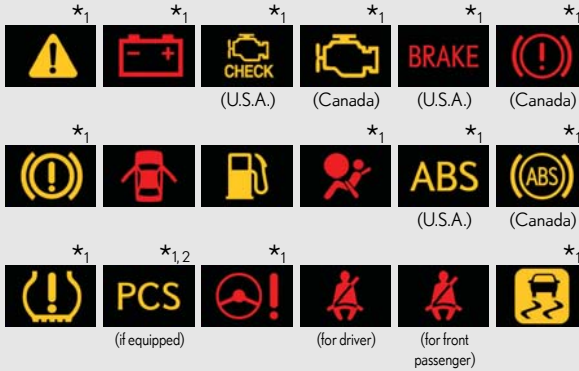

\*1: These lights turn on when the “POWER” switch is turned to ON mode to indicate that a system check is being performed. They will turn off after the hybrid system is on, or after a few seconds. There may be a malfunction in a system if a light does not come on, or if the lights do not turn off. Have the vehicle inspected by your Lexus dealer.

\*2: The light flashes to indicate a malfunction.

### ⚠ CAUTION

#### ■ If a safety system warning light does not come on

Should a safety system light such as the ABS and SRS warning light not come on when you start the hybrid system, this could mean that these systems are not available to help protect you in an accident, which could result in death or serious injury. Have the vehicle inspected by your Lexus dealer immediately if this occurs.

# Multi-information display

The multi-information display presents the driver with a variety of driving-related data including the current outside air temperature.

### ■ Multi-information switches



#### 1 "∧" "∨" switch

Changes items.

#### 2 "ENTER" switch

Turns on/off electronic features controls and changes customization settings.

#### 3 Menu switch

Changes mode from normal display to electronic features, customization or back to normal display.

## ■ Display contents

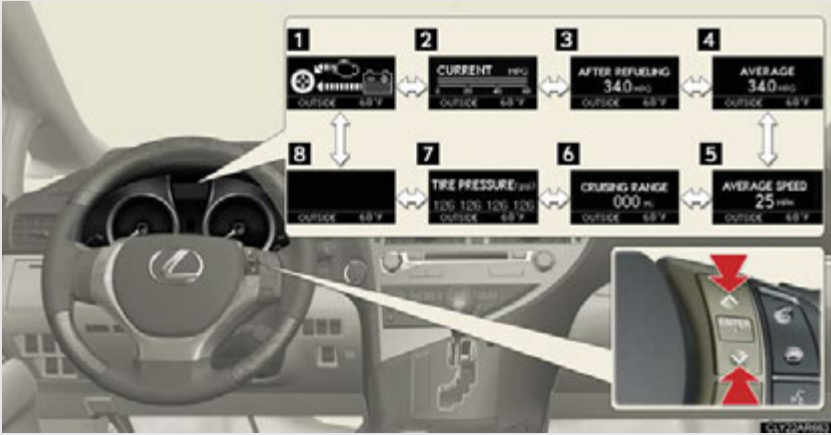

Trip information contents	Switching display items
1 Energy monitor	Press the “∧” or “∨” switch.
2 Current fuel consumption	
3 Average fuel consumption after refueling	
4 Average fuel consumption	
5 Average vehicle speed	
6 Cruising range	
7 Tire inflation pressure	
8 Multi-information display off	

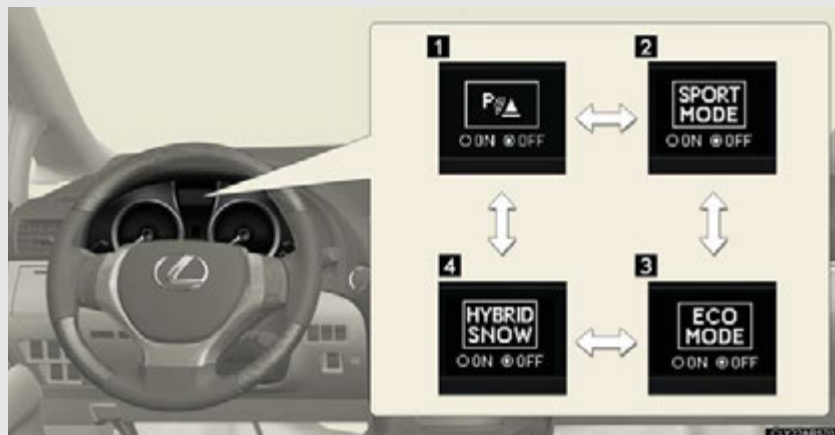

Electronic features control contents	Setting electronic features controls
<b>1</b> Intuitive parking assist (if equipped)	→P. 248
<b>2</b> Sport mode	→P. 189
<b>3</b> Eco drive mode	→P. 187
<b>4</b> Snow mode	→P. 188

Display order may vary depending on vehicle condition.



Other contents	Details
Outside temperature	Displays the outside temperature
Dynamic radar cruise control display (if equipped) (→P. 236)	Automatically displayed when using dynamic radar cruise control
Customization (→P. 825)	Settings of functions such as the door lock and light illumination time can be changed
Warning message (→P. 743)	Automatically displayed when a malfunction occurs in one of the vehicle's systems

### Trip information

#### ■ Energy monitor

Displays the status of the hybrid system (→P. 40)

#### ■ Current fuel consumption

Displays the current rate of fuel consumption

#### ■ Average fuel consumption after refueling

Displays the average fuel consumption since the vehicle was last refueled

Use the displayed average fuel consumption as a reference.

#### ■ Average fuel consumption

Displays the average fuel consumption since the function was reset

- The function can be reset by pushing the “ENTER” switch for longer than one second when the average fuel consumption is displayed.
- Use the displayed average fuel consumption as a reference.

### ■ Average vehicle speed

Displays the average vehicle speed since the function was reset

The function can be reset by pushing the “ENTER” switch for longer than one second when the average vehicle speed is displayed.

### ■ Cruising range

Displays the estimated maximum distance that can be driven with the quantity of fuel remaining

- This distance is computed based on your average fuel consumption. As a result, the actual distance that can be driven may differ from that displayed.
- When only a small amount of fuel is added to the tank, the display may not be updated.  
When refueling, turn the “POWER” switch off. If the vehicle is refueled without turning the “POWER” switch off, the display may not be updated.

### ■ Tire inflation pressure

Displays inflation pressure of each tire. There is no correlation between the order of the displayed values and the tire positions.

If the inflation pressure of any tire drops a certain amount below the tire inflation pressure value currently memorized in the system, the displayed values will be highlighted.

It may take a few minutes to display the tire inflation pressure after the “POWER” switch is turned to ON mode. It may also take a few minutes to display the tire inflation pressure after inflation pressure has been adjusted.

If the tire pressure warning light is on or flashing, a message describing the situation will be displayed.

### ■ Electronic features control can be turned on/off when

The "POWER" switch is in ON mode.

### ■ Conditions for ending electronic features control

In the following situations, the electronic features control will end:

- The menu switch is pressed.
- The dynamic radar cruise control is operated (if equipped).
- Intuitive parking assist starts operating (if equipped).
- No action is performed for some time after the electronic features control screen is displayed.
- A warning message appears after the electronic features control screen is displayed.

### ■ Outside temperature display

In the following situations, the correct outside temperature may not be displayed, or the display may take longer than normal to change.

- When stopped, or driving at low speeds (less than 16 mph [25 km/h])
- When the outside temperature has changed suddenly (at the entrance/exit of a garage, tunnel, etc.)

### ■ The multi-information display at low temperatures

Allow the interior of the vehicle to warm up before using the liquid crystal information display. At extremely low temperatures, the information display monitor may respond slowly, and display changes may be delayed.

### ■ Customization

Settings (e.g. available languages) can be changed.  
(Customizable features →P. 825)

## CAUTION

### ■ Caution while driving

When operating the electronic features control while driving, take extra notice of the vehicle's surrounding area.

## 2-2. Instrument cluster Head-up display\*

The head-up display can be used to project vehicle speed and other information onto the windshield.



### 1 Head-up display

Display brightness will change automatically according to the brightness of the surrounding area.

### 2 Head-up display main switch

### 3 Display contrast adjustment switch

Display brightness can be adjusted to the desired level.

### 4 Display position adjustment switch

## ■ Head-up display contents

In addition to vehicle speed, the following information will be displayed:



### 1 Audio display

Displays audio information for approximately 3 seconds when the audio system is operated

### 2 Shift position and shift range display

Displays the selected shift position or selected shift range (→P. 186)

### 3 Dynamic radar cruise control display (if equipped)

Displays the approach warning message (→P. 748)

### 4 Pre-collision system display (if equipped)

Displays the brake warning (→P. 748)

### 5 Turn-by-turn navigation display\*

Displays a notification of upcoming intersections during navigation system route guidance

### 6 Vehicle speed display

\*: Refer to the "Navigation System Owner's Manual".

## Head-up display main switch



Pressing the switch turns the head-up display on/off and changes the vehicle speed display units as follows:

- ▶ Vehicles sold in the U.S.A.  
OFF → ON (mph) → ON (km/h) → OFF
- ▶ Except vehicles sold in the U.S.A.  
OFF → ON (km/h) → ON (mph) → OFF

## Display adjustment

- ▶ Adjusting display contrast



- 1 Brighter
- 2 Darker

- ▶ Adjusting display position



- 1 Higher
- 2 Lower

## Display customization

The audio mode display and/or the shift position and shift range display can be shown or hidden.



Press and hold the head-up display main switch changes the display to the display on/off mode.

Press the head-up display main switch to select the desired setting item. Press and hold the head-up display main switch to turn the display on/off.

Customization can be performed when the head-up display is on and the vehicle is traveling at less than 5 mph (8 km/h).

2

When driving

### ■ Brightness of the head-up display

The headlight control sensor detects the brightness of the area surrounding the head-up display and adjusts the brightness accordingly. (→P. 219)

### ■ Head-up display

The head-up display may seem dark and hard to see when viewed through sunglasses, especially polarized sunglasses.

Adjust the brightness of the head-up display or remove your sunglasses.

## ⚠ CAUTION

### ■ Before using the head-up display

Check that the position and brightness of the head-up display image does not interfere with safe driving. Incorrect adjustment of the image's position or brightness may obstruct the driver's view and lead to an accident, resulting in death or serious injury.

 NOTICE

■ **To prevent damage to components**

- Do not place anything on the head-up display opening.



- If an object falls into the opening of the head-up display, remove it immediately. Also, avoid spilling water or other liquids near the head-up display opening as this may cause mechanical damage.







## 2-3. Operating the lights and windshield wipers

### Headlight switch

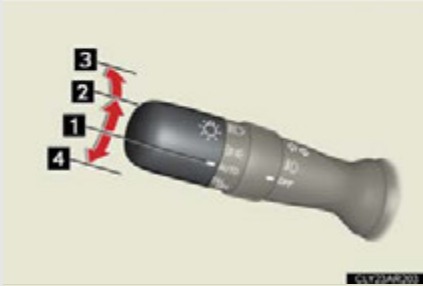
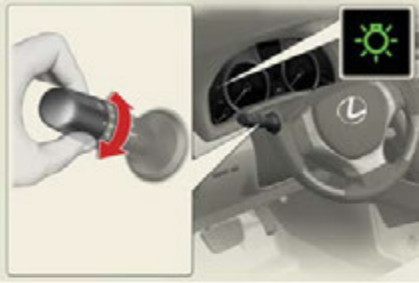
The headlights can be operated manually or automatically.



#### ► Type A

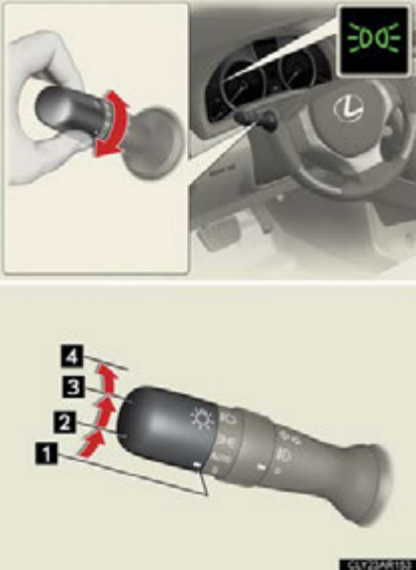

- 1 AUTO** The headlights and side marker, parking, tail, license plate, daytime running lights and instrument panel lights turn on and off automatically. (When the “POWER” switch is in ON mode)
- 2 ** The side marker, parking, tail, license plate, daytime running lights and instrument panel lights turn on.
- 3 ** The headlights and all the lights listed above (except daytime running lights) turn on.
- 4 ** The daytime running lights turn off.

► Type B



- 1  The daytime running lights turn on.
- 2 **AUTO** The headlights and side marker, parking, tail, license plate, daytime running lights and instrument panel lights turn on and off automatically. (When the "POWER" switch is in ON mode)
- 3  The side marker, parking, tail, license plate, daytime running lights and instrument panel lights turn on.
- 4  The headlights and all the lights listed above (except daytime running lights) turn on.

## Turning on the high beam headlights

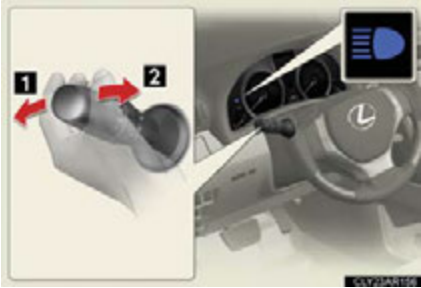

**1** With the headlights on, push the lever away from you to turn on the high beams.

Pull the lever toward you to the center position to turn the high beams off.

**2** Pull the lever toward you to turn on the high beams.

Release the lever to turn them off. You can flash the high beams with the headlights on or off.

2

When driving

### ■ Daytime running light system

- To make your vehicle more visible to other drivers, the daytime running lights turn on automatically whenever the hybrid system is started and the parking brake is released. Daytime running lights are not designed for use at night.  
Type A: Daytime running lights can be turned off by operating the switch.
- Compared to turning on the headlights, the daytime running light system offers greater durability and consumes less electricity, so it can help improve fuel economy.

### ■ Headlight control sensor



The sensor may not function properly if an object is placed on the sensor, or anything that blocks the sensor is affixed to the windshield.

Doing so interferes with the sensor detecting the level of ambient light and may cause the automatic headlight system to malfunction.

### ■ Automatic light off system

- When the headlights are on: The headlights and tail lights turn off 30 seconds after a door is opened and closed if the “POWER” switch is turned to ACCESSORY mode or turned off. (The lights turn off immediately if  on the key is pressed after all the doors are locked.)
- When only the tail lights are on: The tail lights turn off automatically if the “POWER” switch is turned to ACCESSORY mode or turned off and the driver’s door is opened.

To turn the lights on again, turn the “POWER” switch to ON mode, or turn the light switch off once and then back to  or .

If any of the doors is kept open, the lights automatically turn off after 20 minutes.

### ■ Automatic headlight leveling system (if equipped)

The level of the headlights is automatically adjusted according to the number of passengers and the loading condition of the vehicle to ensure that the headlights do not interfere with other road users.

### ■ Light reminder buzzer (headlights)

A buzzer sounds when the “POWER” switch is turned off or turned to ACCESSORY mode and the driver’s door is opened while the headlights are turned on.

### ■ Illuminated entry system

If the wireless remote control switch is used to unlock the vehicle when the light switch is in  and the surrounding area is dark, the parking light turns on.

### ■ Customization

Settings (e.g. light sensor sensitivity) can be changed.  
(Customizable features →P. 825)

#### NOTICE

#### ■ To prevent 12-volt battery discharge

Do not leave the lights on longer than necessary when the hybrid system is off.

## 2-3. Operating the lights and windshield wipers

### Fog light switch

The fog lights improve visibility in difficult driving conditions, such as in rain and fog.

► Type A

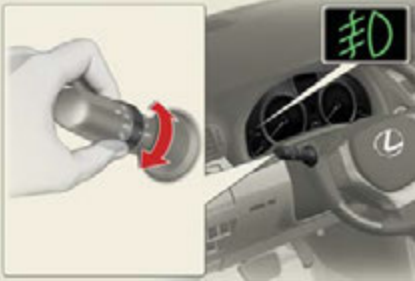

1 **OFF** Turns the front fog lights off

2 **☞** Turns the front fog lights on

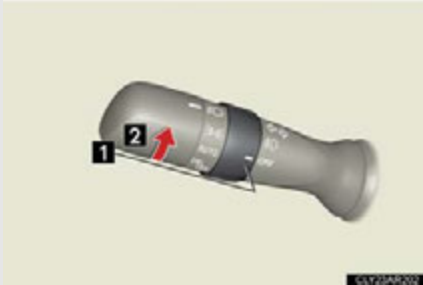

► Type B

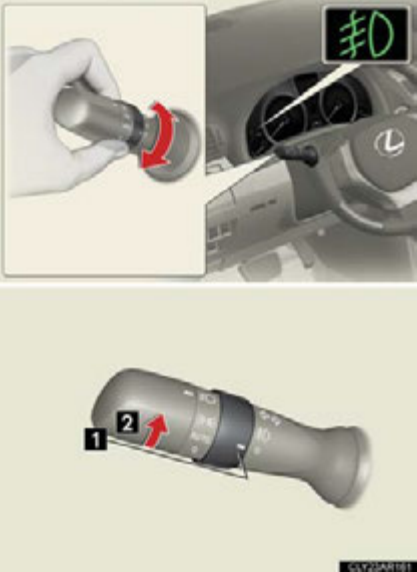

- 1 **0** Turns the front fog lights off
- 2 **F** Turns the front fog lights on

- Fog lights can be used when  
The headlights are on in low beam.

## 2-3. Operating the lights and windshield wipers

### Windshield wipers and washer

#### ■ Intermittent windshield wipers with interval adjuster

The wiper operation is selected by moving the lever as follows. When intermittent windshield wiper operation is selected, the wiper intervals can be also adjusted.



- 1 OFF** Off
- 2 INT** Intermittent windshield wiper operation
- 3 LO** Low speed windshield wiper operation
- 4 HI** High speed windshield wiper operation
- 5 MIST** Temporary operation



- 6** Increases the intermittent windshield wiper frequency
- 7** Decreases the intermittent windshield wiper frequency

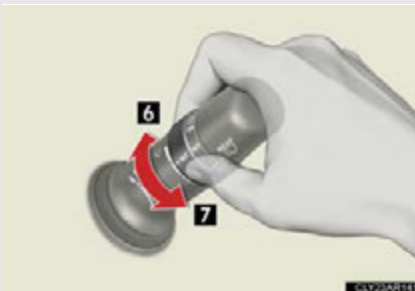



**8** Washer/wiper dual operation

The wipers will automatically operate a couple of times after the washer squirts.

If the headlights are on, the headlight cleaners will operate once.

**■** Rain-sensing windshield wipers

When **AUTO** is selected, the wipers will operate automatically when the sensor detects falling rain. The system automatically adjusts wiper timing in accordance with rain volume and vehicle speed.

When **AUTO** is selected, the sensor sensitivity can be adjusted as follows by turning the switch ring:

► Type A



- 1 OFF** Off
- 2 AUTO** Rain-sensing wiper operation
- 3 LO** Low speed wiper operation
- 4 HI** High speed wiper operation
- 5 MIST** Temporary operation





► Type B

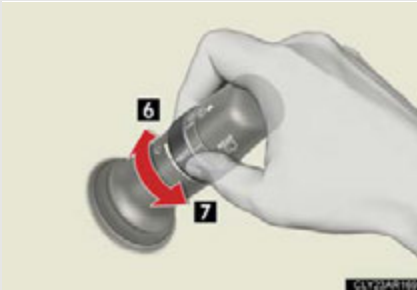

- 1 Off
- 2 **AUTO** Rain-sensing wiper operation
- 3 Low speed wiper operation
- 4 High speed wiper operation
- 5 Temporary operation

- 6 Sensor sensitivity (high)
- 7 Sensor sensitivity (low)

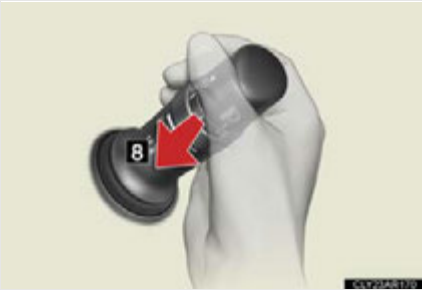

### 8 Washer/wiper dual operation

The wipers will automatically operate a couple of times after the washer squirts. (After operating several times, the wipers operate one more time after a short delay to prevent dripping.)

If the headlights are on, the headlight cleaners will operate once.

### ■ The windshield wipers and washer can be operated when

The "POWER" switch is in ON mode.

### ■ Effects of vehicle speed on wiper operation

Vehicle speed affects the following even when the wipers are not in AUTO mode:

- Intermittent wiper interval
- Wiper operation when the washer is being used (delay until drip prevention wiper sweep occurs)

When low speed wiper operation is selected, wiper operation will be switched from low speed to intermittent wiper operation only when the vehicle is stationary. (However, when the sensor sensitivity is adjusted to the highest level, the mode cannot be switched.)

### ■ Raindrop sensor (vehicles with rain-sensing windshield wipers)



- The raindrop sensor judges the amount of raindrops.

An optical sensor is adopted. It may not operate properly when sunlight from the rising or setting of the sun intermittently strikes the windshield, or if bugs etc. are present on the windshield.

- If the wiper switch is turned to the **AUTO** position while the “POWER” switch is in ON mode, the wipers will operate once to show that AUTO mode is activated.
- When the sensor sensitivity ring is turned toward high while in AUTO mode, the wipers will operate once to indicate that the sensor sensitivity is enhanced.
- If the temperature of the raindrop sensor is 194°F (90°C) or higher, or 5°F (-15°C) or lower, automatic operation may not occur.  
In this case, operate the wipers in any mode other than AUTO.

### ■ If no windshield washer fluid sprays

Check that the washer nozzles are not blocked if there is washer fluid in the windshield washer fluid reservoir.

#### ⚠ CAUTION

#### ■ Caution regarding the use of windshield wipers in AUTO mode (vehicles with rain-sensing windshield wipers)

The windshield wipers may operate unexpectedly if the sensor is touched or the windshield is subject to vibration in AUTO mode. Take care that your fingers or anything else do not become caught in the windshield wipers.

#### ■ Caution regarding the use of washer fluid

When it is cold, do not use the washer fluid until the windshield becomes warm. The fluid may freeze on the windshield and cause low visibility. This may lead to an accident, resulting in death or serious injury.

### NOTICE

#### ■ **When the windshield is dry**

Do not use the wipers, as they may damage the windshield.

#### ■ **When the washer fluid tank is empty**

Damage to the washer fluid pump may be caused if the lever is pulled toward you and held continually.

#### ■ **When a nozzle becomes blocked**

In this case, contact your Lexus dealer.

Do not try to clear it with a pin or other object. The nozzle will be damaged.



## 2-3. Operating the lights and windshield wipers

### Rear window wiper and washer

The wiper operation is selected by moving the lever as follows:

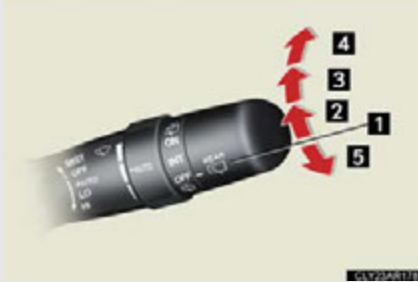
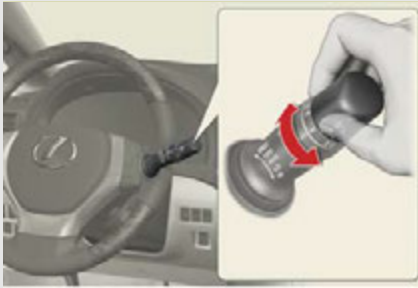



► Type A

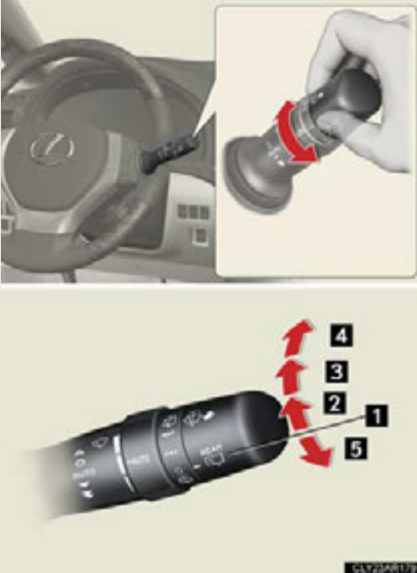

- 1 **OFF** Off
- 2 **INT** Intermittent window wiper operation
- 3 **ON** Normal window wiper operation
- 4  Washer/wiper dual operation
- 5  Washer/wiper dual operation

► Type B



- 1  Off
- 2  Intermittent window wiper operation
- 3  Normal window wiper operation
- 4  Washer/wiper dual operation
- 5  Washer/wiper dual operation

■ The rear window wiper and washer can be operated when the “POWER” switch is in ON mode.

 NOTICE

■ **When the rear window is dry**

Do not use the wipers, as they may damage the rear window.

■ **When the washer fluid tank is empty**

Damage to the washer fluid pump may be caused if the lever is operated continually.

■ **When a nozzle becomes blocked**

In this case, contact your Lexus dealer.

Do not try to clear it with a pin or other object. The nozzle will be damaged.

### Headlight cleaner switch\*

Washer fluid can be sprayed on the headlights.



Press the switch to clean the headlights.

#### ■ The headlight cleaner can be operated when

The "POWER" switch is in ON mode and the headlight switch is turned on.

#### ■ Windshield washer linked operation

When the windshield washer is operated with the "POWER" switch in ON mode and the headlights on, the headlight cleaner will operate once. (→P. 223)

#### NOTICE

#### ■ When the washer fluid tank is empty

Do not press the switch continually as the washer fluid pump may overheat.

## 2-4. Using other driving systems

### Cruise control\*

Use the cruise control to maintain a set speed without depressing the accelerator pedal.



- 1 Indicator
- 2 Display
- 3 Cruise control switch

#### ■ Setting the vehicle speed



Press the “ON-OFF” button to activate the cruise control.

Cruise control indicator will come on.

Press the button again to deactivate the cruise control.



STEP 2



Accelerate or decelerate the vehicle to the desired speed, and push the lever down to set the speed.

“SET” will be displayed.

The vehicle speed at the moment the lever is released becomes the set speed.

### ■ Adjusting the set speed

To change the set speed, operate the lever until the desired set speed is obtained.

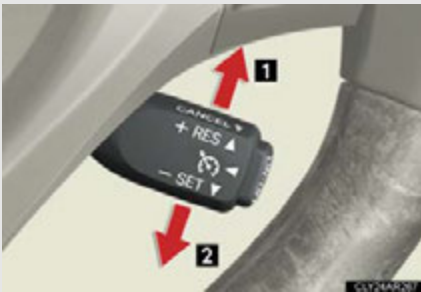

**1** Increases the speed

**2** Decreases the speed

Fine adjustment: Momentarily move the lever in the desired direction.

Large adjustment: Hold the lever in the desired direction.

The set speed will be increased or decreased as follows:

Fine adjustment: By approximately 1 mph (1.6 km/h) each time the lever is operated.

Large adjustment: The set speed can be increased or decreased continually until the lever is released.

### ■ Canceling and resuming the constant speed control

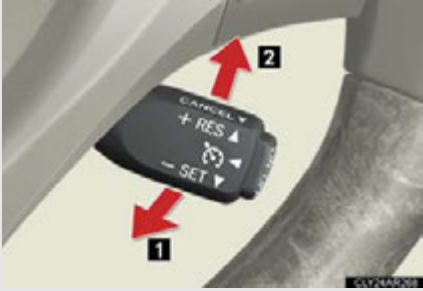

**1** Pulling the lever toward you cancels the constant speed control.

The speed setting is also canceled when the brakes are applied.

**2** Pushing the lever up resumes the constant speed control.

Resuming is available when the vehicle speed is more than approximately 25 mph (40 km/h).

---

### ■ Cruise control can be set when

- The shift lever is in D or range 4 or higher of S has been selected.
- Vehicle speed is above 25 mph (40 km/h).

### ■ Accelerating after setting the vehicle speed

- The vehicle can be accelerated normally. After acceleration, the set speed resumes.
- Even without canceling the cruise control, the set speed can be increased by first accelerating the vehicle to the desired speed and then pushing the lever down to set the new speed.

### ■ Automatic cruise control cancellation

Cruise control will stop maintaining the vehicle speed in any of the following situations.

- Actual vehicle speed falls more than approximately 10 mph (16 km/h) below the preset vehicle speed.  
At this time, the memorized set speed is not retained.
- Actual vehicle speed is below approximately 25 mph (40 km/h).
- VSC is activated.

■ **If a warning message is shown on the multi-information display**

Press the “ON-OFF” button once to deactivate the system, and then press the button again to reactivate the system.

If the cruise control speed cannot be set or if the cruise control cancels immediately after being activated, there may be a malfunction in the cruise control system. Have the vehicle inspected by your Lexus dealer.

 **CAUTION**

■ **To avoid operating the cruise control by mistake**

Switch the cruise control off using the “ON-OFF” button when not in use.

■ **Situations unsuitable for cruise control**

Do not use cruise control in any of the following situations.

Doing so may result in loss of control and could cause an accident resulting in death or serious injury.

- In heavy traffic
- On roads with sharp bends
- On winding roads
- On slippery roads, such as those covered with rain, ice or snow
- On steep hills  
Vehicle speed may exceed the set speed when driving down a steep hill.
- When your vehicle is towing a trailer or during emergency towing

## 2-4. Using other driving systems

### Dynamic radar cruise control\*

Dynamic radar cruise control supplements conventional cruise control with a vehicle-to-vehicle distance control. In vehicle-to-vehicle distance control mode, the vehicle automatically accelerates or decelerates in order to maintain a set following distance from vehicles ahead.

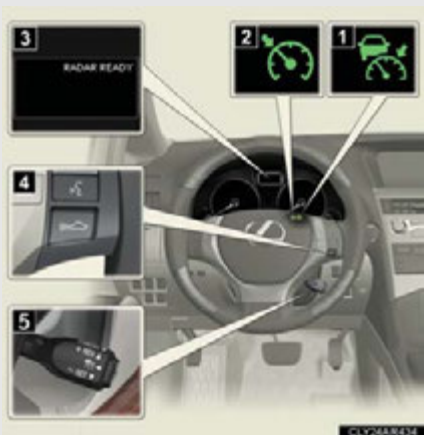

- 1 Indicator (vehicle-to-vehicle distance control mode)
- 2 Indicator (constant speed control mode)
- 3 Display
- 4 Vehicle-to-vehicle distance button
- 5 Cruise control switch

#### ■ Setting the vehicle speed (vehicle-to-vehicle distance control mode)



STEP 1 Press the "ON-OFF" button to activate the cruise control.

Radar cruise control indicator will come on.

Press the button again to deactivate the cruise control.

STEP 2



Accelerate or decelerate the vehicle to the desired speed, and push the lever down to set the speed.

“SET” will be displayed.

The vehicle speed at the moment the lever is released becomes the set speed.

### ■ Adjusting the set speed

To change the set speed, operate the lever until the desired set speed is displayed.

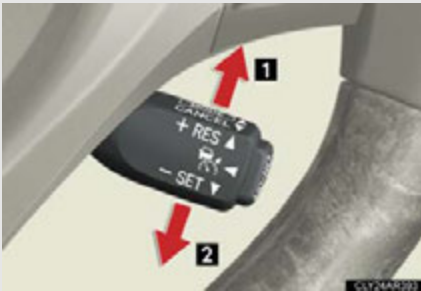

- 1 Increases the speed
- 2 Decreases the speed

Fine adjustment: Momentarily move the lever in the desired direction.

Large adjustment: Hold the lever in the desired direction.

In the vehicle-to-vehicle distance control mode, the set speed will be increased or decreased as follows:

#### ► When the set speed is shown in “MPH”

Fine adjustment: By approximately 1 mph (1.6 km/h) each time the lever is operated

Large adjustment: By approximately 5 mph (8 km/h) for each 0.75 seconds the lever is held

### ► When the set speed is shown in “km/h”

Fine adjustment: By approximately 0.6 mph (1 km/h) each time the lever is operated

Large adjustment: By approximately 3.1 mph (5 km/h) for each 0.75 seconds the lever is held

In the constant speed control mode (→P. 242), the set speed will be increased or decreased as follows:

Fine adjustment: By approximately 1 mph (1.6 km/h) each time the lever is operated

Large adjustment: The set speed can be increased or decreased continually until the lever is released.

### ■ Changing the vehicle-to-vehicle distance

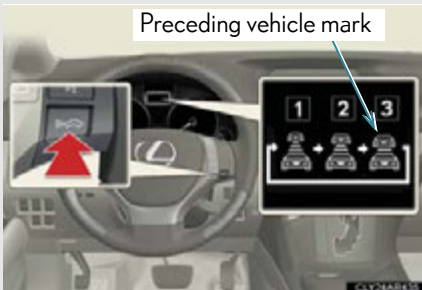

Pressing the button changes the vehicle-to-vehicle distance as follows:

- 1 Long
- 2 Medium
- 3 Short

The vehicle-to-vehicle distance is set automatically to long mode when the “POWER” switch is turned to ON mode.

If a vehicle is running ahead of you, the preceding vehicle mark will also be displayed.

### ■ Vehicle-to-vehicle distance settings

Select a distance from the table below. Note that the distances shown correspond to a vehicle speed of 50 mph (80 km/h). Vehicle-to-vehicle distance increases/decreases in accordance with vehicle speed.

Distance options	Vehicle-to-vehicle distance
Long	Approximately 164 ft. (50 m)
Medium	Approximately 132 ft. (40 m)
Short	Approximately 82 ft. (25 m)

### ■ Canceling and resuming the speed control

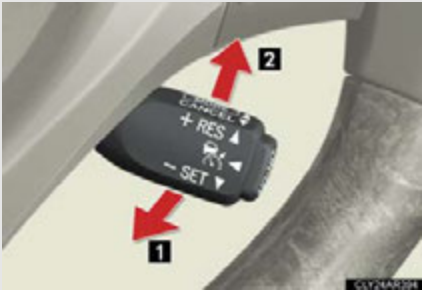

- 1** Pulling the lever toward you cancels the cruise control.

The speed setting is also canceled when the brakes are applied.

- 2** Pushing the lever up resumes the cruise control and returns vehicle speed to the set speed.

Resuming is available when the vehicle speed is more than approximately 25 mph (40 km/h).

### Driving in vehicle-to-vehicle distance control mode

This mode employs a radar sensor to detect the presence of vehicles up to approximately 400 ft. (120 m) ahead, determines the current vehicle-to-vehicle following distance, and operates to maintain a suitable following distance from the vehicle ahead.

Note that vehicle-to-vehicle distance will close in when traveling on long downhill slopes.

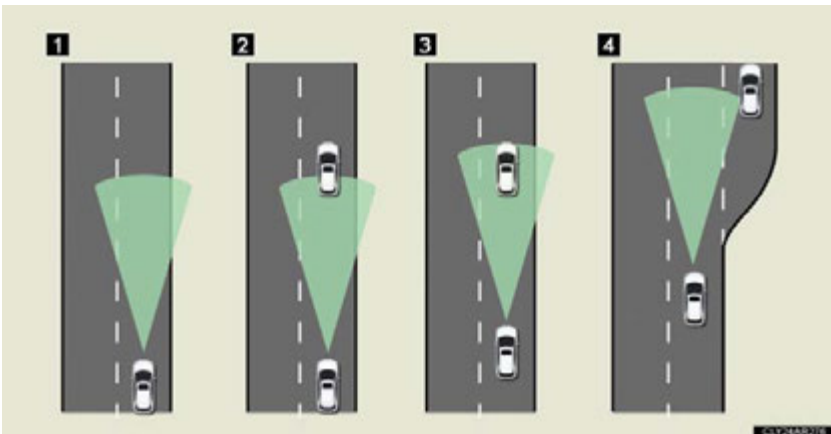

- 1** Example of constant speed cruising  
When there are no vehicles ahead

The vehicle travels at the speed set by the driver. The desired vehicle-to-vehicle distance can also be set by operating the vehicle-to-vehicle distance control.

- 2** Example of deceleration cruising  
When the vehicle ahead is driving slower than the set speed

When a vehicle is detected running ahead of you, the system automatically decelerates your vehicle. When a greater reduction in vehicle speed is necessary, the system applies the brakes. A warning tone warns you when the system cannot decelerate sufficiently to prevent your vehicle from closing in on the vehicle ahead.



### 3 Example of follow-up cruising

When following a vehicle driving slower than the set speed

The system continues follow-up cruising while adjusting for changes in the speed of the vehicle ahead in order to maintain the vehicle-to-vehicle distance set by the driver.

### 4 Example of acceleration

When there are no longer any vehicles ahead driving slower than the set speed

The system accelerates until the set speed is reached. The system then returns to constant speed cruising.

## Approach warning

When your vehicle is too close to a vehicle ahead, and sufficient automatic deceleration via the cruise control is not possible, the display will flash and the buzzer will sound to alert the driver. An example of this would be if another driver cuts in front of you while you are following a vehicle. Apply the brakes to ensure an appropriate vehicle-to-vehicle distance.

### ■ Warnings may not occur when

In the following instances, there is a possibility that the warnings will not occur:

- When the speed of the vehicle ahead matches or exceeds your vehicle speed
- When the vehicle ahead is traveling at an extremely slow speed
- Immediately after the cruise control speed was set
- At the instant the accelerator is applied

## Selecting conventional constant speed control mode

Constant speed control mode differs from vehicle-to-vehicle distance control mode. When constant speed control mode is selected, your vehicle will maintain a set speed regardless of whether or not there are other vehicles in the lane ahead.

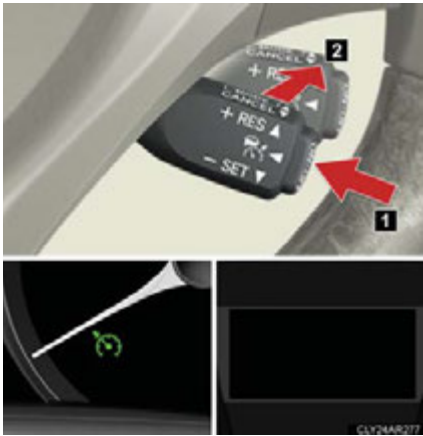

- 1 Press the “ON-OFF” button to activate the cruise control.

Press the button again to deactivate the cruise control.

- 2 Switch to constant speed control mode.

(Push the lever forward and hold for approximately one second.)

Constant speed control mode indicator will come on.

When in constant speed control mode, to return to vehicle-to-vehicle distance control mode, push the lever forward again and hold for approximately 1 second.

After the desired speed has been set, it is not possible to return to vehicle-to-vehicle distance control mode.

If the “POWER” switch is turned off and then turned to ON mode again, the vehicle will automatically return to vehicle-to-vehicle distance control mode.

Adjusting the speed setting:  
→P. 237

Canceling and resuming the speed setting: →P. 239

**■ Dynamic radar cruise control can be set when**

- The shift lever is in D or range 4 or higher of S has been selected.
- Vehicle speed is above approximately 30 mph (50 km/h).

**■ Accelerating after setting the vehicle speed**

The vehicle can accelerate normally. After acceleration, the set speed resumes. However, during vehicle-to-vehicle distance control mode, the vehicle speed may decrease below the set speed in order to maintain the distance to the vehicle ahead.

**■ Automatic cancelation of vehicle-to-vehicle distance control**

Vehicle-to-vehicle distance control driving is automatically canceled in the following situations:

- Actual vehicle speed falls below approximately 25 mph (40 km/h).
- VSC is activated.
- The sensor cannot operate correctly because it is covered in some way.
- The windshield wipers are operating at high speed (when the wiper switch is set to the AUTO mode or the high speed wiper operation position).
- When the snow mode is set.

If vehicle-to-vehicle distance control driving is automatically canceled for any other reason, there may be a malfunction in the system. Contact your Lexus dealer.

**■ Automatic cancelation of constant speed control**

The cruise control will stop maintaining the vehicle speed in the following situations:

- Actual vehicle speed is more than approximately 10 mph (16 km/h) below the set vehicle speed.  
At this time, the memorized set speed is not retained.
- Actual vehicle speed falls below approximately 25 mph (40 km/h).
- VSC is activated.

### ■ Radar sensor and grille cover

Always keep the sensor and grille cover clean to ensure that the vehicle-to-vehicle distance control operates properly. (Some obstructions, such as snow, ice and plastic objects, cannot be detected by the obstruction sensor.)

Dynamic radar cruise control is canceled if an obstruction is detected.



- 1 Grille cover
- 2 Radar sensor

### ■ Warning lights, messages and buzzers for dynamic radar cruise control

Warning lights, messages and buzzers are used to indicate a system malfunction or to inform the driver of the need for caution while driving. (→P. 748)

### ■ Certification

► For vehicles sold in the U.S.A.

FCC ID: HYQDNMWR004

This device complies with part 15 of the FCC Rules. Operation is subject to the following two conditions: (1) This device may not cause harmful interference, and (2) this device must accept any interference received, including interference that may cause undesired operation.

#### FCC WARNING

Changes or modifications not expressly approved by the party responsible for compliance could void the user's authority to operate the equipment.

Radiofrequency radiation exposure Information:

This equipment complies with FCC radiation exposure limits set forth for an uncontrolled environment.

This equipment should be installed and operated with minimum distance of 20 cm between the radiator (antenna) and your body.

This transmitter must not be co-located or operating in conjunction with any other antenna or transmitter.

► For vehicles sold in Canada

Operation is subject to the following two conditions: (1) this device may not cause interference, and (2) this device must accept any interference, including interference that may cause undesired operation of the device.

### CAUTION

#### ■ Before using dynamic radar cruise control

Do not overly rely on vehicle-to-vehicle distance control.

Be aware of the set speed. If automatic deceleration/acceleration is not appropriate, adjust the vehicle speed, as well as the distance between your vehicle and vehicles ahead by applying the brakes etc.

#### ■ Cautions regarding the driving assist systems

Observe the following precautions.

Failure to do so may cause an accident resulting in death or serious injury.

##### ● Assisting the driver to measure following distance

The dynamic radar cruise control is only intended to help the driver in determining the following distance between the driver's own vehicle and a designated vehicle traveling ahead. It is not a mechanism that allows careless or inattentive driving, and it is not a system that can assist the driver in low-visibility conditions. It is still necessary for driver to pay close attention to the vehicle's surroundings.

##### ● Assisting the driver to judge proper following distance

The dynamic radar cruise control determines whether the following distance between the driver's own vehicle and a designated vehicle traveling ahead is appropriate or not. It is not capable of making any other type of judgement. Therefore, it is absolutely necessary for the driver to remain vigilant and to determine whether or not there is a possibility of danger in any given situation.

##### ● Assisting the driver to operate the vehicle

The dynamic radar cruise control has no capability to prevent or avoid a collision with a vehicle traveling ahead. Therefore, if there is ever any danger, the driver must take immediate and direct control of the vehicle and act appropriately in order to ensure the safety of all involved.

#### ■ To avoid inadvertent cruise control activation

Switch the cruise control off using the "ON-OFF" button when not in use.

### CAUTION

#### ■ Situations unsuitable for dynamic radar cruise control

Do not use dynamic radar cruise control in any of the following situations. Doing so may result in inappropriate speed control and could cause an accident resulting in death or serious injury.

- In heavy traffic
- On roads with sharp bends
- On winding roads
- On slippery roads, such as those covered with rain, ice or snow
- On steep downhills, or where there are sudden changes between sharp up and down gradients  
Vehicle speed may exceed the set speed when driving down a steep hill.
- At entrances to expressways
- When weather conditions are bad enough that they may prevent the sensors from functioning correctly (fog, snow, sandstorm, heavy rain, etc.)
- When an approach warning buzzer is heard often
- When your vehicle is towing a trailer or during emergency towing

#### ■ When the sensor may not be correctly detecting the vehicle ahead

Apply the brakes as necessary when any of the following types of vehicles are in front of you.

As the sensor may not be able to correctly detect these types of vehicles, the approach warning (→P. 241) will not be activated, and a fatal or serious accident may result.

- Vehicles that cut in suddenly
- Vehicles traveling at low speeds
- Vehicles that are not moving
- Vehicles with small rear ends (trailers with no load on board etc.)
- Motorcycles traveling in the same lane

 **CAUTION****■ Conditions under which the vehicle-to-vehicle distance control may not function correctly**

Apply the brakes as necessary in the following conditions as the radar sensor may not be able to correctly detect vehicles ahead, and a fatal or serious accident may result:

- When water or snow thrown up by the surrounding vehicles hinders the functioning of the sensor
- When your vehicle is pointing upwards (caused by a heavy load in the luggage compartment etc.)
- When the road curves or when the lanes are narrow
- When steering wheel operation or your position in the lane is unstable
- When the vehicle ahead of you decelerates suddenly

**■ Handling the radar sensor**

Observe the following to ensure the cruise control system can function effectively. Otherwise, the system may not function correctly and could result in an accident.

- Keep the sensor and grille cover clean at all times.  
Clean the sensor and grille cover with a soft cloth so you do not mark or damage them.
- Do not subject the sensor or surrounding area to a strong impact.  
If the sensor moves even slightly off position, the system may malfunction. If the sensor or surrounding area is subject to a strong impact, always have the area inspected and adjusted by your Lexus dealer.
- Do not disassemble the sensor.
- Do not attach accessories or stickers to the sensor, grille cover or surrounding area.
- Do not modify or paint the sensor and grille cover.
- Do not replace them with non-genuine parts.

## 2-4. Using other driving systems

### Intuitive parking assist\*

The distance to obstacles measured by the sensors is communicated via the multi-information display, screen (vehicles with the Lexus Display Audio system) and a buzzer when parallel parking or maneuvering into a garage is conducted. Always check the surrounding area when using this system.

#### ■ Types of sensors

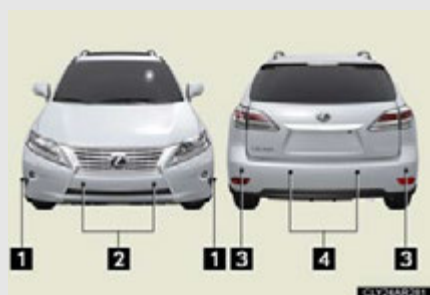

- 1 Front corner sensors
- 2 Front center sensors
- 3 Rear corner sensors
- 4 Rear center sensors

#### ■ Setting the intuitive parking assist mode



- 1 Press the menu switch.  
The multi-information display will change modes to electronic features control mode.
- 2 Press the “^” or “v” switch until the intuitive parking assist mark appears in the multi-information display.



## STEP 2



Press the “ENTER” switch to change to “ON”.

The intuitive parking assist indicator will be displayed.

Each pressing of the switch turns the intuitive parking assist on and off.

When on, the buzzer sounds to inform the driver that the system is operational.

Press the menu switch to change to the normal display.

## Display

When the sensors detect an obstacle, a graphic is shown on the multi-information display and screen (vehicles with the Lexus Display Audio system) depending on the position and distance to the obstacle.

### ■ Multi-information display



- 1 Front corner sensor operation
- 2 Front center sensor operation
- 3 Rear corner sensor operation
- 4 Rear center sensor operation

■ Screen (vehicles with the Lexus Display Audio system)

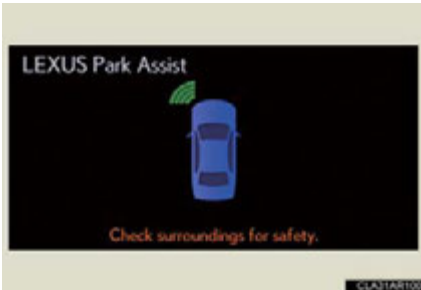

When the vehicle is moving forward

The graphic is automatically displayed when an obstacle is detected. The screen can be set so that the graphic is not displayed. (→P. 255)



When the vehicle is moving backward



A simplified image is displayed on the right upper corner of the screen when an obstacle is detected.

## The distance display and buzzer





When a sensor detects an obstacle, the direction of and the approximate distance to the obstacle are displayed and the buzzer sounds.

The site of the obstacle will flash (detection level 4 only).



### ■ Front corner sensors

Detection level	Multi-information display	Approximate distance to obstacle	Buzzer
2		1.6 to 1.2 ft. (50 to 37.5 cm)	Medium
3		1.2 to 0.8 ft. (37.5 to 25 cm)	Fast
4		0.8 ft. (25 cm) or less	Continuous





■ Front center sensors

Detection level	Multi-information display	Approximate distance to obstacle	Buzzer
1		3.3 to 1.6 ft. (100 to 50 cm)	Slow
2		1.6 to 1.3 ft. (50 to 40 cm)	Medium
3		1.3 to 1.0 ft. (40 to 30 cm)	Fast
4		1.0 ft. (30 cm) or less	Continuous

■ Rear corner sensors

Detection level	Multi-information display	Approximate distance to obstacle	Buzzer
2		1.6 to 1.2 ft. (50 to 37.5 cm)	Medium
3		1.2 to 0.8 ft. (37.5 to 25 cm)	Fast
4		0.8 ft. (25 cm) or less	Continuous

### ■ Rear center sensors

Detection level	Multi-information display	Approximate distance to obstacle	Buzzer
1		4.9 to 2.0 ft. (150 to 60 cm)	Slow
2		2.0 to 1.5 ft. (60 to 45 cm)	Medium
3		1.5 to 1.2 ft. (45 to 35 cm)	Fast
4		1.2 ft. (35 cm) or less	Continuous

### Detection range of the sensors

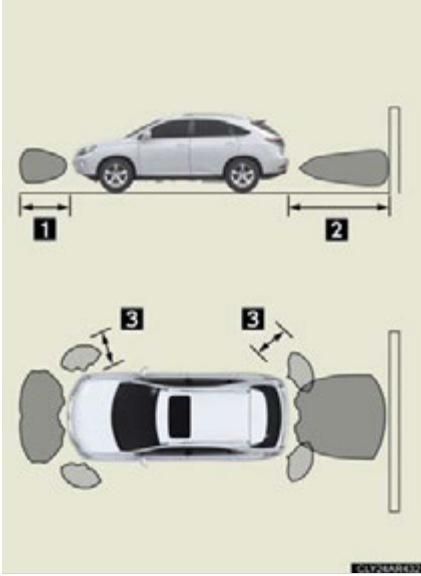

- 1 Approximately 3.3 ft. (100 cm)
- 2 Approximately 4.9 ft. (150 cm)
- 3 Approximately 1.6 ft. (50 cm)

The diagram shows the detection range of the sensors. Note that the sensors cannot detect obstacles that are extremely close to the vehicle.

The range of the sensors may change depending on the shape of the object etc.

## Customization of the intuitive parking assist (vehicle with the Lexus Display Audio system)

The buzzer volume, display and buzzer timing and display of the graphic on the screen can be customized.

**STEP 1** Press the “MENU” button on the Lexus Display Audio controller.

**STEP 2** Select “Setup” on the “Menu” screen.

**STEP 3** Select “Vehicle” on the “Setup” screen.

**STEP 4** Select “LEXUS Park Assist” on the “Vehicle Settings” screen.

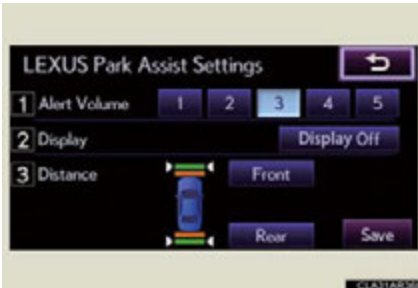

- 1 Alert volume setting
- 2 Display on/off
- 3 Alert distance setting

**STEP 5** When you complete settings, select “Save”.

### ■ The intuitive parking assist can be operated when

- Front corner sensors:
  - The “POWER” switch is in ON mode.
  - The shift lever is in a position other than P.
  - The vehicle speed is less than about 6 mph (10 km/h).
- Front center sensors:
  - The “POWER” switch is in ON mode.
  - The shift lever is in a position other than P or R.
  - The vehicle speed is less than about 6 mph (10 km/h).
- Rear corner and center sensors:
  - The “POWER” switch is in ON mode.
  - The shift lever is in R.

### ■ Sensor detection information

- Certain vehicle conditions and the surrounding environment may affect the ability of a sensor to correctly detect an obstacle. Particular instances where this may occur are listed below.
  - There is dirt, snow or ice on a sensor.
  - A sensor is frozen.
  - A sensor is covered in any way.
  - The vehicle is leaning considerably to one side.
  - On an extremely bumpy road, on an incline, on gravel, or on grass
  - The vicinity of the vehicle is noisy due to vehicle horns, motorcycle engines, air brakes of large vehicles, or other loud noises producing ultrasonic waves.
  - There is another vehicle equipped with parking assist sensors in the vicinity.
  - A sensor is coated with a sheet of spray or heavy rain.
  - The vehicle is equipped with a fender pole or radio antenna.
  - Towing eyelets are installed.
  - A bumper or sensor receives a strong impact.
  - The vehicle is approaching a tall or right-angled curb.
  - In harsh sunlight or intense cold weather.
  - A non-genuine Lexus suspension (lowered suspension, etc.) is installed.

In addition to the examples above, there are instances in which, because of their shapes, signs and other objects may be judged by a sensor to be closer than they are.

- The shape of the obstacle may prevent a sensor from detecting it. Pay particular attention to the following obstacles:
  - Wires, fences, ropes, etc.
  - Cotton, snow and other materials that absorb sound waves
  - Sharply-angled objects
  - Low obstacles
  - Tall obstacles with upper sections projecting outwards in the direction of your vehicle

### ■ If a message is displayed

→P. 743



### ■ Certification (Canada only)

This ISM device complies with Canadian ICES-001.

### ■ Customization

Settings (e.g. buzzer volume) can be changed.  
(Customizable features →P. 825)

## CAUTION

### ■ Caution when using the intuitive parking assist

Observe the following precautions.

Failing to do so may result in the vehicle being unable to be driven safely and possibly cause an accident.

- Do not use the sensor at speeds in excess of 6 mph (10 km/h).
- Do not attach any accessories within the sensor range.

## NOTICE

### ■ Notes when washing the vehicle

Do not apply intensive bursts of water or steam to the sensor area.  
Doing so may result in the sensor malfunctioning.

### ■ Conditions possibly indicating system malfunctions

If any of the following occurs, the system may be malfunctioning due to a sensor failure etc. Have the vehicle inspected by your Lexus dealer.

- The buzzer does not sound when the intuitive parking assist mode is set.
- The sensor operation display flashes and the buzzer sounds even when no obstacle is detected.
- An area of the sensors is hit or subjected to a strong impact.
- Either bumper is hit.
- The sensor operation display remains on even though no buzzer sounds.

## 2-4. Using other driving systems

### Rear view monitor system (rear view mirror-attached type)\*

The rear view monitor system assists the driver by displaying an image of the view behind the vehicle while reversing. The image is displayed in reverse on the screen. This allows the image to appear in the same manner as that of the rear view mirror.



The rear view image is displayed when the shift lever is in the R position.

The screen turns off in the following situations:

- The shift lever is shifted out of R.
- The screen remains on for approximately 5 minutes.

#### ■ The rear view monitor system can be operated when

The shift lever is in R, the "POWER" switch is in ON mode.

\*: If equipped

### ■ Changing display modes

The rear view monitor display mode can be changed while the screen is on.

- To temporarily disable the rear view monitor system

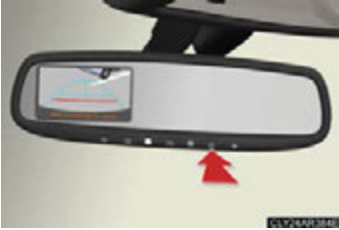



Press .

The indicator will turn amber.

The system will be re-enabled once the "POWER" switch is turned off and then turned to ON mode.

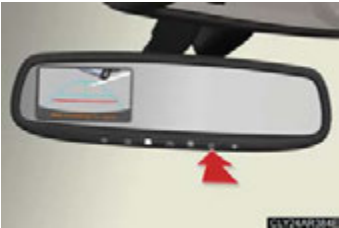
- To constantly disable the rear view monitor system



Press and hold  for 12 to 15 seconds. The screen will turn off and on after 6 seconds. Keep pressing the button until the screen turns back off. The indicator will flash amber.

The system will not automatically turn on again after the "POWER" switch is off and then turned to ON mode.

- To re-enable the rear view monitor system

Press . The indicator will turn green.

### ■ Selecting a language (English, French or Spanish)

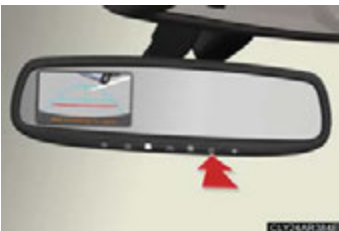

**STEP 1** Press and hold  for 6 to 12 seconds.

The screen will turn on and the indicator will turn green.

**STEP 2** Press .

Each time  is pressed and released, the language changes. A message will flash in the mirror for 5 seconds after the button is released, indicating that the change has been completed.

### ■ Rear view monitor guide lines

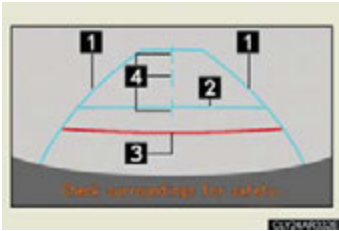

Guide lines are displayed on the screen.

Guidelines shown differ from those shown on the actual screen.

- 1 Vehicle width extension guide lines (blue)

These lines indicate the estimated vehicle width extension.

- 2 Distance guide line (blue)

This line indicates a position on the ground about 3 ft. (1 m) behind on the ground of the rear bumper of your vehicle.

- 3 Distance guide line (red)

This line indicates a position on the ground about 1.5ft. (0.5 m) behind on the ground of the rear bumper of your vehicle.

- 4 Vehicle center guide lines (blue)

These lines indicate the estimated vehicle center on the ground.

### ■ Displayed area

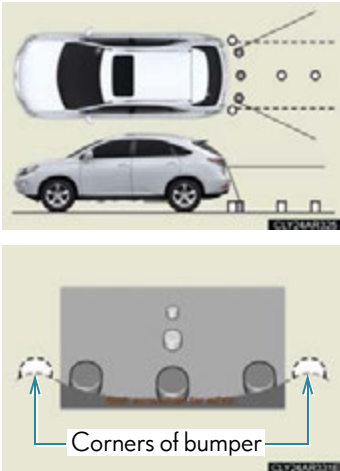

### ■ Driving precautions

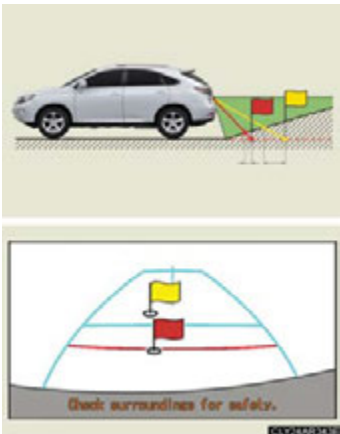

The area detected by the camera is limited. Object which are close to either corner of the bumper or under the bumper cannot be seen on the screen.

The area displayed on the screen may vary according to vehicle orientation or road conditions.

The camera uses a special lens.

The distance of the image that appears on the screen differs from the actual distance.

When the grade behind the vehicle slopes up sharply, objects appear to be farther away than they actually are.

## 2-4. Using other driving systems

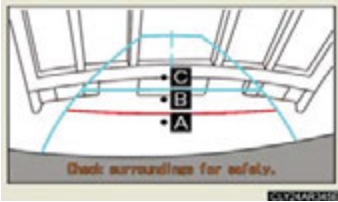
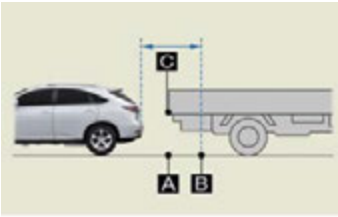
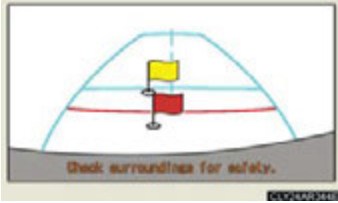
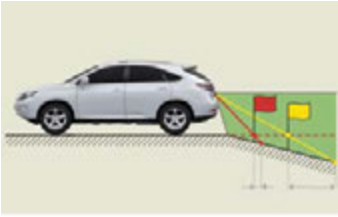

When the grade behind the vehicle slopes down sharply, objects appear to be closer than they actually are.

The distance that appears on the screen between three-dimensional objects (such as vehicles) and flat surfaces (such as the road) and the actual distance differ as follows.

In reality,  $C = A < B$  (C and A are equally far away; B is farther than C and A). However, on the screen, the situation appears to be  $A < B < C$ .

On the screen, it appears that a truck is parking about 1.5 ft (0.5 m) away. However, in reality if you back up to point A, you will hit the track.

### ■ Rear view monitor system camera



The rear view monitor system camera is located on the back door as shown in the illustration.

In the following cases, it may become difficult to see the images on the screen, even when the system is functioning correctly.

- The vehicle is in a dark area, such as at night.
- The temperature near the lens is extremely high or low.
- Water droplets are on the camera lens or humidity is high, such as when it rains.
- Foreign matter, such as snow or mud, adheres to the camera lens.
- The sun or headlights are shining directly into the camera lens.
- A bright object such as a white wall is reflected in the mirror surface over the monitor.
- The camera has scratches or dirt on it.

### ■ Smear effect

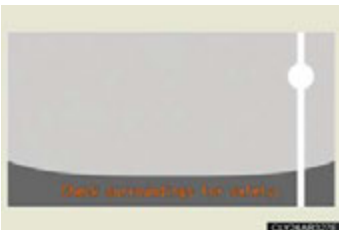

If a bright light, such as sunlight reflected off the vehicle body, is picked up by the camera, a smear effect\* characteristic to the camera may occur.

\*: Smear effect — A phenomenon that occurs when a bright light is picked up by the camera; when transmitted by the camera, the light source appears to have a vertical streak above and below it.

### ■ Flicker effect

When the camera is used under fluorescent light, sodium lights, or mercury lights etc., the lights and the illuminated areas may appear to flicker.

### CAUTION

- **When using the rear view monitor system, observe the following precautions to avoid an accident that could result in death or serious injuries:**
  - Never depend solely on the monitor system when reversing.
  - Always check visually and with the mirrors to confirm your intended path is clear.
  - Use your own eyes to confirm the vehicle's surroundings, as the displayed image may become faint or dark, and moving images will be distorted, or not entirely visible when the outside temperature is low. When backing up, be sure to check behind and all around the vehicle visually and with the mirrors before proceeding.
  - Always check the vehicle surrounding area, because the guide lines are ancillary lines.
  - The guide lines are ancillary lines and do not change even if the steering wheel is turned.
  - Depicted distances between objects and flat surfaces differ from actual distances.
  - Do not use the system if the back door is open.



 NOTICE**■ Conditions which may affect the rear view monitor system**

- If the back of the vehicle has been hit, the camera's position and mounting angle may have changed. Have the vehicle inspected by your Lexus dealer.
- Rapid temperature changes, such as when hot water is poured on the vehicle in cold weather, may cause the system to function abnormally.
- If the camera lens is dirty, it cannot transmit a clear image. Rinse with water and wipe with a soft cloth. If extremely dirty, wash with a mild cleanser and rinse.
- The displayed image may be darker and moving images may be slightly distorted when the system is cold.

**■ Camera precautions**

- As the camera has a water proof construction, do not detach, disassemble or modify it. This may cause incorrect operation.
- Do not subject the camera to a strong impact.
- If the camera lens becomes dirty, it cannot transmit a clear image. If water droplets, snow, or mud adhere to the lens, rinse with water and wipe with a soft cloth. If the lens is extremely dirty, wash it with a mild cleanser and rinse. Do not rub hard.
- Do not allow organic solvent, car wax, window cleaner or glass coat to adhere to the camera. If this happens, wipe it off as soon as possible.
- Do not strongly rub the camera lens. If the camera lens is scratched, it cannot transmit a clear image.
- When washing the vehicle, do not apply intensive bursts of water to the camera or camera area. Doing so may result in the camera malfunctioning.
- When replacing tires, please consult your Lexus dealer. If you replace the tires, the area displayed on the screen may change.

## 2-4. Using other driving systems

### Rear view monitor system (vehicles with the Lexus Display Audio system)\*

The rear view monitor system assists the driver by displaying an image of the view behind the vehicle while reversing. The image is displayed in reverse on the screen. This allows the image to appear in the same manner as that of the rear view mirror.



The rear view image is displayed when the shift lever is in the R position.

If the shift lever is shifted out of R, the screen returns to the previous one.

\*: If equipped

## ■ Displayed area

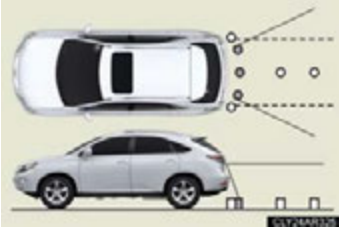

The area detected by the camera is limited. Object which are close to either corner of the bumper or under the bumper cannot be seen on the screen.

The area displayed on the screen may vary according to vehicle orientation or road conditions.

The camera uses a special lens.

The distance of the image that appears on the screen differs from the actual distance.

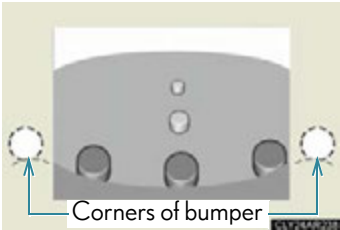

### ■ Rear view monitor system camera



The rear view monitor system camera is located on the back door as shown in the illustration.

In the following cases, it may become difficult to see the images on the screen, even when the system is functioning correctly:

- The vehicle is in a dark area, such as at night.
- The temperature near the lens is extremely high or low.
- Water droplets are on the camera lens or humidity is high, such as when it rains.
- Foreign matter, such as snow or mud, adheres to the camera lens.
- The sun or headlights are shining directly into the camera lens.
- A bright object such as a white wall is reflected in the mirror surface over the monitor.
- The camera has scratches or dirt on it.

### ■ Smear effect

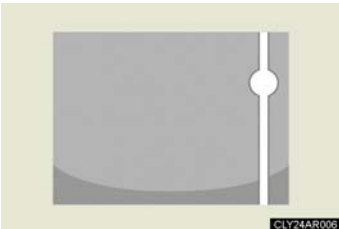

If a bright light, such as sunlight reflected off the vehicle body, is picked up by the camera, a smear effect\* characteristic to the camera may occur.

\*: Smear effect — A phenomenon that occurs when a bright light is picked up by the camera; when transmitted by the camera, the light source appears to have a vertical streak above and below it.

### ■ Flicker effect

When the camera is used under fluorescent lights, sodium lights, mercury lights etc., the lights and the illuminated areas may appear to flicker.

### CAUTION

#### ■ When using the rear view monitor system, observe the following precautions to avoid an accident that could result in death or serious injuries:

- Never depend solely on the monitor system when reversing.
- Always check visually and with the mirrors to confirm your intended path is clear.
- Use your own eyes to confirm the vehicle's surroundings, as the displayed image may become faint or dark, and moving images will be distorted, or not entirely visible when the outside temperature is low. When backing up, be sure to check behind and all around the vehicle visually and with the mirrors before proceeding.
- Depicted distances between objects and flat surfaces differ from actual distances.
- Do not use the system if the back door is open.

### NOTICE

#### ■ Conditions which may affect the rear view monitor system

- If the back of the vehicle has been hit, the camera's position and mounting angle may have changed. Have the vehicle inspected by your Lexus dealer.
- Rapid temperature changes, such as when hot water is poured on the vehicle in cold weather, may cause the system to function abnormally.
- If the camera lens is dirty, it cannot transmit a clear image. Rinse with water and wipe with a soft cloth. If extremely dirty, wash with a mild cleanser and rinse.
- The displayed image may be darker and moving images may be slightly distorted when the system is cold.

#### ■ Camera precautions

- As the camera has a water proof construction, do not detach, disassemble or modify it. This may cause incorrect operation.
- Do not subject the camera to a strong impact.
- If the camera lens becomes dirty, it cannot transmit a clear image. If water droplets, snow, or mud adhere to the lens, rinse with water and wipe with a soft cloth. If the lens is extremely dirty, wash it with a mild cleanser and rinse. Do not rub hard.
- Do not allow organic solvent, car wax, window cleaner or glass coat to adhere to the camera. If this happens, wipe it off as soon as possible.
- Do not strongly rub the camera lens. If the camera lens is scratched, it cannot transmit a clear image.
- When washing the vehicle, do not apply intensive bursts of water to the camera or camera area. Doing so may result in the camera malfunctioning.
- When replacing tires, please consult your Lexus dealer. If you replace the tires, the area displayed on the screen may change.

# Driving assist systems

To help enhance driving safety and performance, the following systems operate automatically in response to various driving situations. Be aware, however, that these systems are supplementary and should not be relied upon too heavily when operating the vehicle.

### ■ ABS (Anti-lock Brake System)

Helps to prevent wheel lock when the brakes are applied suddenly, or if the brakes are applied while driving on a slippery road surface

### ■ Brake assist

Generates an increased level of braking force after the brake pedal is depressed, when the system detects a panic stop situation

### ■ VSC (Vehicle Stability Control)

Helps the driver to control skidding when swerving suddenly or turning on slippery road surfaces

### ■ TRAC (Traction Control)

Helps to maintain drive power and prevent the drive wheels from spinning when starting the vehicle or accelerating on slippery roads

### ■ Hill-start assist control

→P. 276

### ■ EPS (Electric Power Steering)

Employs an electric motor to reduce the amount of effort needed to turn the steering wheel

### ■ VDIM (Vehicle Dynamics Integrated Management)

Provides integrated control of the ABS, brake assist, TRAC, VSC, hill-start assist control, and EPS systems.

Helps to maintain vehicle stability when swerving on slippery road surfaces by controlling the brakes and hybrid system output.

### ■ PCS (Pre-Collision System) (if equipped)

→P. 278

### ■ BSM (Blind Spot Monitor) (if equipped)

→P. 286

### When the VSC/TRAC systems are operating



If the vehicle is in danger of slipping or if any of the drive wheels spins, the slip indicator light flashes to indicate that the VSC/TRAC systems are operating.

### Disabling TRAC and/or VSC systems

If the vehicle gets stuck in fresh snow or mud, the TRAC/VSC systems may reduce power from the hybrid system to the wheels. You may need to turn the system off to enable you to rock the vehicle in order to free it.

#### ■ Turning off the TRAC system only



To turn the TRAC system off, quickly press and release the switch.

A message will be shown on the multi-information display.

Press the switch again to turn the system back on.



### ■ Turning off both TRAC and VSC systems



To turn the TRAC and VSC systems off, press and hold the switch for 3 seconds or more while the vehicle is stopped.

A message will be shown on the multi-information display and VSC off indicator light will come on.

Press the switch again to turn the systems back on.

2

When driving

### ■ When the message is displayed on the multi-information display showing that TRAC has been disabled even if the VSC off switch has not been pressed

TRAC and hill-start assist control cannot be operated. Contact your Lexus dealer.

### ■ Sounds and vibrations caused by the ABS, VSC, TRAC and brake assist

- A sound may be heard from the engine compartment when the hybrid system is started or just after the vehicle begins to move. This sound does not indicate that a malfunction has occurred in any of these systems.
- Any of the following conditions may occur when the above systems are operating. None of these indicates that a malfunction has occurred.
  - Vibrations may be felt through the vehicle body and steering.
  - A motor sound may be heard after the vehicle comes to a stop.
  - The brake pedal may pulsate slightly after the ABS is activated.
  - The brake pedal may move down slightly after the ABS is activated.

### ■ EPS operation sound

When the steering wheel is operated, a motor sound (whirring sound) may be heard. This does not indicate a malfunction.

### ■ Reactivation of the TRAC /VSC systems

Turning off the hybrid system after turning off the TRAC/VSC systems will automatically reactivate them.

### ■ **Reactivation of the TRAC system linked to vehicle speed**

When only the TRAC system is turned off, the TRAC system will turn on when vehicle speed increases. However, when both TRAC and VSC systems are turned off, the systems will not turn on even when vehicle speed increases.

### ■ **Reduced effectiveness of the EPS system**

The effectiveness of the EPS system is reduced to prevent the system from overheating when there is frequent steering input over an extended period of time. The steering wheel may feel heavy as a result. Should this occur, refrain from excessive steering input or stop the vehicle and turn the hybrid system off. The EPS system should return to normal within 10 minutes.

### **CAUTION**

#### ■ **The ABS does not operate effectively when**

- The limits of tire gripping performance have been exceeded (such as excessively worn tires on a snow covered road).
- The vehicle hydroplanes while driving at high speed on a wet or slick road.

#### ■ **Stopping distance when the ABS is operating may exceed that of normal conditions**

The ABS is not designed to shorten the vehicle's stopping distance. Always maintain a safe distance from the vehicle in front of you, especially in the following situations:

- When driving on dirt, gravel or snow-covered roads
- When driving with tire chains
- When driving over bumps in the road
- When driving over roads with potholes or roads with uneven surfaces

#### ■ **TRAC may not operate effectively when**

Directional control and power may not be achievable while driving on slippery road surfaces, even if the TRAC system is operating.

Drive the vehicle carefully in conditions where stability and power may be lost.

 **CAUTION****■ When the VSC is activated**

The slip indicator light flashes. Always drive carefully. Reckless driving may cause an accident, resulting in death or serious injury. Exercise particular care when the indicator light flashes.

**■ When the TRAC/VSC systems are turned off**

Be especially careful and drive at a speed appropriate to the road conditions. As these are the systems to help ensure vehicle stability and driving force, do not turn the TRAC/VSC systems off unless necessary.

**■ Replacing tires**

Make sure that all tires are of the same size, brand, tread pattern and total load capacity. In addition, make sure that the tires are inflated to the recommended tire inflation pressure level.

The ABS and VSC systems will not function correctly if different tires are installed on the vehicle.

Contact your Lexus dealer for further information when replacing tires or wheels.

**■ Handling of tires and suspension**

Using tires with any kind of problem or modifying the suspension will affect the driving assist systems, and may cause a system malfunction.

## 2-4. Using other driving systems

### Hill-start assist control

Hill-start assist control helps to prevent the vehicle from rolling backwards when starting on an incline or slippery slope.



To engage hill-start assist control, further depress the brake pedal when the vehicle is stopped completely.

A buzzer will sound once to indicate the system is activated. The slip indicator will also start flashing.

#### ■ Hill-start assist control can be operated when

- The shift lever is in a position other than P.
- The parking brake is not applied.
- The accelerator pedal is not depressed.

#### ■ Hill-start assist control

- While hill-start assist control is operating, the brakes remain automatically applied after the driver releases the brake pedal. The stop lights and the high mounted stoplight turn on.
- Hill-start assist control operates for about 2 seconds after the brake pedal is released.
- If the slip indicator does not flash and the buzzer does not sound when the brake pedal is further depressed, slightly reduce the pressure on the brake pedal (do not allow the vehicle to roll backward) and then firmly depress it again. If the system still does not operate, check if the operating conditions explained above have been met.

### ■ Hill-start assist control buzzer

- When hill-start assist control is activated, the buzzer will sound once.
- In the following situations, hill-start assist control will be canceled and the buzzer will sound twice.
  - No attempt is made to drive the vehicle within approximately 2 seconds of releasing the brake pedal.
  - The shift lever is moved to P.
  - The parking brake is applied.
  - The brake pedal is depressed again.
  - The brake pedal has been depressed for more than approximately 3 minutes.
- If a buzzer other than the hill-start assist control buzzer is sounding, the hill-start assist control buzzer may not sound when the system is activated or canceled.

### ■ If the slip indicator comes on

It may indicate a malfunction in the system. Contact your Lexus dealer.

## CAUTION

### ■ Hill-start assist control

- Do not overly rely on hill-start assist control. Hill-start assist control may not operate effectively on extremely steep inclines or roads covered in ice.
- Unlike the parking brake, hill-start assist control is not intended to hold the vehicle stationary for an extended period of time. Do not attempt to use hill-start assist control to hold the vehicle on an incline for an extended period of time, as doing so may lead to an accident.

### Pre-Collision System \*

When the radar sensor detects the possibility of a frontal collision, the pre-collision system such as the brakes and seat belts are automatically engaged to lessen impact as well as vehicle damage.

#### ■ Pre-collision seat belts (front seat belts only)

If the pre-collision sensor detects that a collision is unavoidable, the pre-collision system will retract the seat belt before the collision occurs.

The same will happen if the driver makes an emergency braking or loses control of the vehicle. (→P.100)

However, the system will not operate in the event of skidding when the VSC system is disabled.

#### ■ Pre-collision brake assist

When there is a high possibility of a frontal collision, the system applies greater braking force in relation to how strongly the brake pedal is depressed. The system may not warn the driver using a warning light, warning display and buzzer when the system detects and judges braking operations.

#### ■ Pre-collision braking

When there is a high possibility of a frontal collision, the system warns the driver using a warning light, warning display and buzzer. If the system determines that a collision is unavoidable, the brakes are automatically applied to reduce the collision speed. Pre-collision braking can be disabled using the pre-collision braking off switch.

\*: If equipped

## Disabling pre-collision braking



- 1 Pre-collision braking disabled
- 2 Pre-collision braking enabled

The pre-collision system warning light turn on when pre-collision braking is disabled.

2

When driving

## Radar sensor



The radar sensor detects vehicles or other obstacles on or near the road ahead and determines whether a collision is imminent based on the position, speed, and heading of the obstacles.

### ■ The pre-collision system is operational when

- Pre-collision seat belts (type A):
  - Vehicle speed is greater than about 4 mph (5 km/h).
  - The speed at which your vehicle is approaching the obstacle or the vehicle running ahead of you is greater than about 19 mph (30 km/h).
  - The front occupants are wearing a seat belt.
- Pre-collision seat belts (type B):
  - Vehicle speed is greater than about 19 mph (30 km/h).
  - The system detects sudden braking or skidding.
  - The front occupants are wearing a seat belt.
- Pre-collision brake assist:
  - Vehicle speed is greater than about 19 mph (30 km/h).
  - The speed at which your vehicle is approaching the obstacle or the vehicle running ahead of you is greater than about 19 mph (30 km/h).
  - The brake pedal is depressed.
- Pre-collision braking:
  - The pre-collision braking off switch is not pressed.
  - Vehicle speed is greater than about 10 mph (15 km/h).
  - The speed at which your vehicle is approaching the obstacle or the vehicle running ahead of you is greater than about 10 mph (15 km/h).



**■ Conditions that may trigger the system even if there is no possibility of collision**

- When there is an object by the roadside at the entrance to a curve
- When passing an oncoming vehicle on a curve
- When driving over a narrow iron bridge
- When there is a metal object on the road surface
- When driving on an uneven road surface
- When passing an oncoming vehicle on a left-turn
- When your vehicle rapidly closes on the vehicle in front
- When a grade separation/interchange, sign, billboard, or other structure appears to be directly in the vehicle's line of travel
- When climbing a steep hill causes an overhead billboard or other metallic structure to appear directly in the vehicle's line of travel
- When an extreme change in vehicle height occurs
- When the axis of the radar is out of adjustment
- When passing through certain toll gates
- When driving on a bridge
- When passing through a tunnel

When the system is activated in the situations described above, there is also a possibility that the seat belts will retract quickly and the brakes will be applied with a force greater than normal. When the seat belt is locked in the retracted position, stop the vehicle in a safe place, release the seat belt and refasten it.

**■ Obstacles not detected**

The sensor cannot detect plastic obstacles such as traffic cones. There may also be occasions when the sensor cannot detect pedestrians, animals, bicycles, motorcycles, trees, or snowdrifts.

### ■ Situations in which the pre-collision system does not function properly

The system may not function effectively in situations such as the following:

- On roads with sharp bends or uneven surfaces
- If a vehicle suddenly moves in front of your vehicle, such as at an intersection
- If a vehicle suddenly cuts in front of your vehicle, such as when overtaking
- In inclement weather such as heavy rain, fog, snow or sand storms
- When your vehicle is skidding with the VSC system off
- When an extreme change in vehicle height occurs
- When the axis of the radar is out of adjustment

### ■ Automatic cancelation of the pre-collision system

When a malfunction occurs due to sensor contamination, etc. that results in the sensors being unable to detect obstacles, the pre-collision system will be automatically disabled. In this case, the system will not activate even if there is a collision possibility.

### ■ When there is a malfunction in the system, or if the system is temporarily unusable

Warning lights and/or warning messages will turn on or flash. (→P. 733, 743)

## ■ Certification

- ▶ For vehicles sold in the U.S.A.

FCC ID: HYQDNMWR004

This device complies with part 15 of the FCC Rules. Operation is subject to the following two conditions: (1) This device may not cause harmful interference, and (2) this device must accept any interference received, including interference that may cause undesired operation.

### FCC WARNING

Changes or modifications not expressly approved by the party responsible for compliance could void the user's authority to operate the equipment.

Radiofrequency radiation exposure Information:

This equipment complies with FCC radiation exposure limits set forth for an uncontrolled environment.

This equipment should be installed and operated with minimum distance of 20 cm between the radiator (antenna) and your body.

This transmitter must not be co-located or operating in conjunction with any other antenna or transmitter.

- ▶ For vehicles sold in Canada

Operation is subject to the following two conditions: (1) this device may not cause interference, and (2) this device must accept any interference, including interference that may cause undesired operation of the device.

### CAUTION

#### ■ Limitations of the pre-collision system

Do not overly rely on the pre-collision system. Always drive safely, taking care to observe your surroundings and checking for any obstacles or other road hazards.

Failure to do so may cause an accident resulting in death or serious injury.

#### ■ Cautions regarding the assist contents of the system

By means of alarms and brake control, the pre-collision system is intended to assist the driver in avoiding collisions through the process of LOOK-JUDGE-ACT. There are limits to the degree of assistance the system can provide, so please keep in mind the following important points.

##### ● Assisting the driver in watching the road

The pre-collision system is only able to detect obstacles directly in front of the vehicle, and only within a limited range. It is not a mechanism that allows careless or inattentive driving, and it is not a system that can assist the driver in low-visibility conditions. It is still necessary for the driver to pay close attention to the vehicle's surroundings.

##### ● Assisting the driver in making correct judgment

When attempting to estimate the possibility of a collision, the only data available to the pre-collision system is that from obstacles it has detected directly in front of the vehicle. Therefore, it is absolutely necessary for the driver to remain vigilant and to determine whether or not there is a possibility of collision in any given situation.

##### ● Assisting the driver in taking action

The pre-collision system's braking assist feature is designed to help reduce the severity of a collision, and so only acts when the system has judged that a collision is unavoidable. This system by itself is not capable of automatically avoiding a collision or bringing the vehicle to a stop safely. For this reason, when encountering a dangerous situation the driver must take direct and immediate action in order to ensure the safety of all involved.

 **CAUTION****■ When the sensor may not be correctly detecting the vehicle ahead**

Apply the brakes as necessary in any of the following situations:

- When water or snow thrown up by the surrounding vehicles hinders the functioning of the sensor
- When your vehicle is pointing upwards (caused by a heavy load in the luggage compartment etc.)
- Vehicles that cut in suddenly
- Vehicles with small rear ends (trailers with no load on board etc.)
- Motorcycles traveling in the same lane

**■ Handling the radar sensor**

Observe the following to ensure the pre-collision system can function effectively:

- Keep the sensor and front grille clean at all times.  
Clean the sensor and front grille with a soft cloth so you do not mark or damage them.
- Do not subject the sensor or surrounding area to a strong impact.  
If the sensor moves even slightly off position, the system may become inaccurate or malfunction. If the sensor or surrounding area is subject to a strong impact, always have the area inspected and adjusted by your Lexus dealer.
- Do not disassemble the sensor.
- Do not attach accessories or stickers to the sensor, grille or surrounding area.
- Do not modify or paint the sensor and grille cover.

## 2-4. Using other driving systems

### BSM (Blind Spot Monitor)\*

The Blind Spot Monitor is a system that assists the driver in making the decision to change lanes.

The system uses radar sensors to detect vehicles that are traveling in an adjacent lane in the area that is not reflected in the outside rear view mirror (the blind spot), and advises the driver of the vehicles existence via the outside rear view mirror indicator.

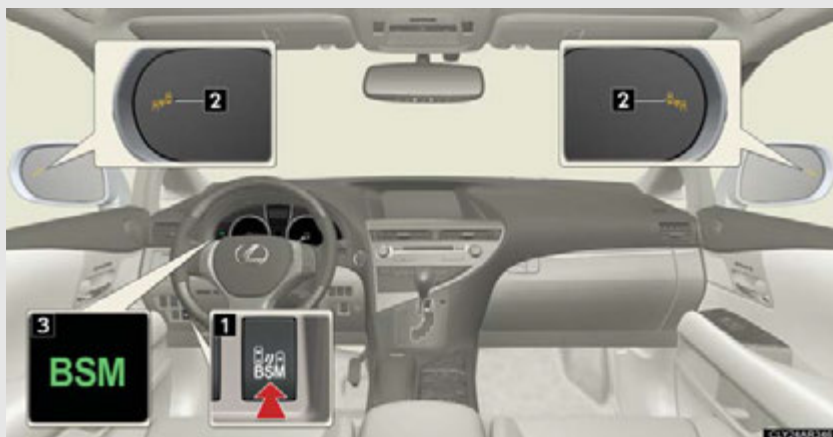

#### 1 BSM main switch

Pressing the switch turns the system on or off.

#### 2 Outside rear view mirror indicator

When a vehicle is detected in the blind spot, the outside rear view mirror indicator on that side illuminates. If the turn signal lever is operated when a vehicle is in the blind spot, the outside rear view mirror indicator flashes.

#### 3 BSM indicator

When the system is on, the indicator will come on.

\*: If equipped

## The Blind Spot Monitor detection areas

The blind spot that vehicles can be detected in are outlined below.

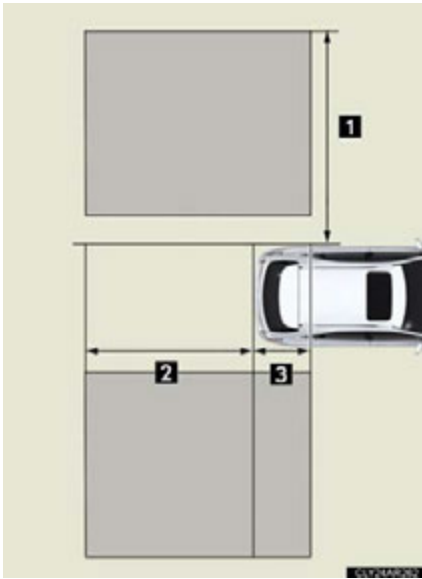

The range of the detection area extends to:

- 1 Approximately 11.5 ft. (3.5 m) from the side of the vehicle

The first 1.6 ft. (0.5 m) from the side of the vehicle is not in the detection area

- 2 Approximately 9.8 ft. (3 m) from the rear bumper
- 3 Approximately 3.3 ft. (1 m) forward of the rear bumper

2

When driving

### ■ The Blind Spot Monitor is operational when

The BSM main switch is set to on and vehicle speed is greater than about 10 mph (16 km/h)

### ■ The Blind Spot Monitor will detect a vehicle when

- A vehicle in an adjacent lane overtakes your vehicle
- Another vehicle enters the vehicles detection area when it changes lanes.

### ■ Conditions under which the Blind Spot Monitor will not detect a vehicle

The Blind Spot Monitor is not designed to detect the following types of vehicles and/or objects:

- Vehicles traveling from the opposite direction
- Small motorcycles, bicycles, pedestrians etc.\*
- Guardrails, walls, signs, parked vehicles and similar stationary objects\*
- Following vehicles that are in the same lane\*
- Vehicles driving 2 lanes across from your vehicle\*

\*: Depending on conditions, detection of a vehicle and/or object may occur

### ■ Conditions under which the Blind Spot Monitor may not function correctly

- The Blind Spot Monitor may not detect vehicles correctly in the following conditions:
  - During bad weather such as heavy rain, fog, snow etc.
  - When ice, mud etc. is attached to the rear bumper
  - When driving on a road surface that is wet due to rain, standing water etc.
  - When there is a significant difference in speed between your vehicle and the vehicle that enters the detection area
  - When a vehicle is in the detection area from a stop and remains in the detection area as your vehicle accelerates
  - When driving up or down consecutive steep inclines, such as hills, a dip in the road etc.
  - When multiple vehicles approach with only a small gap between each vehicle
  - When vehicle lanes are wide, and the vehicle in the next lane is too far away from your vehicle
  - When the vehicle that enters the detection area is traveling at about the same speed as your vehicle
  - When there is a significant difference in height between your vehicle and the vehicle that enters the detection area.
  - Directly after the BSM switch is set to on.
  - When towing a trailer
  - When items such as a bicycle carrier are installed on the rear of the vehicle



- Instances of the Blind Spot Monitor unnecessarily detecting a vehicle and/or object may increase under the following conditions:
  - When there is only a short distance between your vehicle and a guardrail, wall etc.
  - When there is only a short distance between your vehicle and a following vehicle.
  - When vehicle lanes are narrow and a vehicle driving 2 lanes across from your vehicle enters the detection area

### ■ The outside rear view mirror indicators visibility

When under strong sunlight, the outside rear view mirror indicator may be difficult to see.

### ■ When there is a malfunction in the system

If a system malfunction is detected due to any of the following reasons, warning message is displayed: (→P. 743)

- There is a malfunction with the sensors
- The sensors have become dirty
- The outside temperature is extremely high or low
- The sensor voltage has become abnormal

### ■ Certification for the Blind Spot Monitor

► For vehicles sold in the U.S.A.

FCC ID: OAYSRR2A

This device complies with part 15 of the FCC Rules. Operation is subject to the following two conditions: (1) This device may not cause harmful interference, and (2) this device must accept any interference received, including interference that may cause undesired operation.

#### FCC WARNING

Changes or modifications not expressly approved by the party responsible for compliance could void the user's authority to operate the equipment.

► For vehicles sold in Canada

Applicable law : Canada 310

This device complies with Industry Canada licence-exempt RSS standard(s). Operation is subject to the following two conditions: (1) this device may not cause interference, and (2) this device must accept any interference, including interference that may cause undesired operation of the device.

Frequency bands : 24.05 - 24.25GHz

Output power : less than 20 milliwatts

### CAUTION

#### ■ Cautions regarding the use of the system

The driver is solely responsible for safe driving. Always drive safely, taking care to observe your surroundings.

The Blind Spot Monitor is a supplementary system which alerts the driver that a vehicle is present in the blind spot. Do not overly rely on the Blind Spot Monitor. The system cannot judge if it is safe to change lanes, therefore over reliance could cause an accident resulting in death or serious injury. According to conditions, the system may not function correctly. Therefore the driver's own visual confirmation of safety is necessary.

**⚠ CAUTION****■ Handling the radar sensor**

One Blind Spot Monitor is installed inside the left and right side of the vehicle rear bumper respectively. Observe the following to ensure the Blind Spot Monitor can function correctly.



- Keep the sensor and its surrounding area on the bumper clean at all times.

- Do not subject the sensor or surrounding area on the bumper to a strong impact. If the sensor moves even slightly off position, the system may malfunction and vehicles that enter the detection area may not be detected. If the sensor or surrounding area is subject to a strong impact, always have the area inspected by your Lexus dealer.
- Do not disassemble the sensor.
- Do not attach accessories or stickers to the sensor or surrounding area on the bumper.
- Do not modify the sensor or surrounding area on the bumper.
- Do not paint the sensor or surrounding area on the bumper.

## 2-5. Driving information

# Utility vehicle precautions

This vehicle belongs to the utility vehicle class, which has higher ground clearance and narrower tread in relation to the height of its center of gravity.

### Utility vehicle feature

- Specific design characteristics give it a higher center of gravity than ordinary passenger cars. This vehicle design feature causes this type of vehicle to be more likely to rollover. And, utility vehicles have a significantly higher rollover rate than other types of vehicles.
- It is not designed for cornering at the same speeds as ordinary passenger cars any more than low-slung sports cars designed to perform satisfactorily under off-road conditions. Therefore, sharp turns at excessive speeds may cause rollover.

### CAUTION

#### ■ Utility vehicle precautions

Always observe the following precautions to minimize the risk of death or serious injury or damage to your vehicle:

- In a rollover crash, an unbelted person is significantly more likely to die than a person wearing a seat belt. Therefore, the driver and all passengers should fasten their seat belts whenever the vehicle is moving.
- Avoid sharp turns or abrupt maneuvers, if at all possible.  
Failure to operate this vehicle correctly may result in loss of control or vehicle rollover causing death or serious injury.
- Loading cargo on the roof luggage carrier will make the center of the vehicle gravity higher. Avoid high speeds, sudden starts, sharp turns, sudden braking or abrupt maneuvers, otherwise it may result in loss of control or vehicle rollover due to failure to operate this vehicle correctly.

**⚠ CAUTION**

- Always slow down in gusty crosswinds. Because of its profile and higher center of gravity, your vehicle is more sensitive to side winds than an ordinary passenger car. Slowing down will allow you to have better control.
- Do not drive horizontally across steep slopes. Driving straight up or straight down is preferred. Your vehicle (or any similar off-road vehicle) can tip over sideways much more easily than forward or backward.

**Off-road driving**

Your vehicle is not designed to be driven off-road. However, in the event that off-road driving cannot be avoided, please observe the following precautions to help avoid the areas prohibited to vehicles.

- Drive your vehicle only in areas where off-road vehicles are permitted to travel.
- Respect private property. Get owner's permission before entering private property.
- Do not enter areas that are closed. Honor gates, barriers and signs that restrict travel.
- Stay on established roads. When conditions are wet, driving techniques should be changed or travel delayed to prevent damage to roads.
- Avoid driving on very steep, slippery roads and other surfaces, such as sand, where the tires are liable to lose traction. Your vehicle may not perform as well as conventional AWD on-road vehicles on these surfaces.

### ■ Additional information for off-road driving

► For owners in U.S. mainland, Hawaii and Puerto Rico:

To obtain additional information pertaining to driving your vehicle off-road, consult the following organizations.

- State and Local Parks and Recreation Departments
- State Motor Vehicle Bureau
- Recreational Vehicle Clubs
- U.S. Forest Service and Bureau of Land Management

### CAUTION

#### ■ Off-road driving precautions

Always observe the following precautions to minimize the risk of death or serious injury or damage to your vehicle:

- Drive carefully when off the road. Do not take unnecessary risks by driving in dangerous places.
- Do not grip the steering wheel spokes when driving off-road. A bad bump could jerk the wheel and injure your hands. Keep both hands and especially your thumbs on the outside of the rim.
- Always check your brakes for effectiveness immediately after driving in sand, mud, water or snow.
- After driving through tall grass, mud, rock, sand, water, etc., check that there is no grass, bush, paper, rags, stone, sand, etc. adhering or trapped to the underbody. Clear off any such matter from the underbody. If the vehicle is used with these materials trapped or adhering to the underbody, a breakdown or fire could occur.
- When driving off-road or in rugged terrain, do not drive at excessive speeds, jump, make sharp turns, strike objects, etc. This may cause loss of control or vehicle rollover causing death or serious injury. You are also risking expensive damage to your vehicle's suspension and chassis.

 NOTICE**■ To prevent water damage**

Take all necessary safety measures to ensure that water damage to the hybrid battery, hybrid system or other components does not occur.

- Water entering the engine compartment may cause severe damage to the hybrid system. Water entering the interior may cause the hybrid battery stowed under the rear seats to short circuit.
- Water entering the hybrid transmission will cause deterioration in transmission quality. The malfunction indicator may come on, and the vehicle may not be drivable.
- Water can wash the grease from wheel bearings, causing rusting and premature failure, and may also enter the hybrid transmission case, reducing the gear oil's lubricating qualities.

**■ When you drive through water**

If driving through water, such as when crossing shallow streams, first check the depth of the water and the bottom of the riverbed for firmness. Drive slowly and avoid deep water.

**■ Inspection after off-road driving**

- Sand and mud that has accumulated around brake discs may affect braking efficiency and may damage brake system components.
- Always perform a maintenance inspection after each day of off-road driving that has taken you through rough terrain, sand, mud, or water. For scheduled maintenance information, refer to the "Warranty and Services Guide/Owner's Manual Supplement/Scheduled Maintenance".

## 2-5. Driving information

# Cargo and luggage

Take notice of the following information about storage precautions, cargo capacity and load.

- Stow cargo and luggage in the luggage compartment whenever possible.
- Be sure all items are secured in place.
- Be careful to keep the vehicle level. Placing the weight as far forward as possible helps maintain vehicle balance.
- For better fuel economy, do not carry unnecessary weight.

### Capacity and distribution

Cargo capacity depends on the total weight of the occupants.

(Cargo capacity) = (Total load capacity) – (Total weight of occupants)

#### Steps for Determining Correct Load Limit—

- (1) Locate the statement “The combined weight of occupants and cargo should never exceed XXX kg or XXX lbs.” on your vehicle’s placard.
- (2) Determine the combined weight of the driver and passengers that will be riding in your vehicle.
- (3) Subtract the combined weight of the driver and passengers from XXX kg or XXX lbs.
- (4) The resulting figure equals the available amount of cargo and luggage load capacity.  
For example, if the “XXX” amount equals 1400 lbs. and there will be five 150 lb passengers in your vehicle, the amount of available cargo and luggage load capacity is 650 lbs. (1400 – 750 (5 × 150) = 650 lbs.)
- (5) Determine the combined weight of luggage and cargo being loaded on the vehicle. That weight may not safely exceed the available cargo and luggage load capacity calculated in Step 4.



(6) If your vehicle will be towing a trailer, load from your trailer will be transferred to your vehicle. Consult this manual to determine how this reduces the available cargo and luggage load capacity of your vehicle.

(→P.798)

### Calculation formula for your vehicle

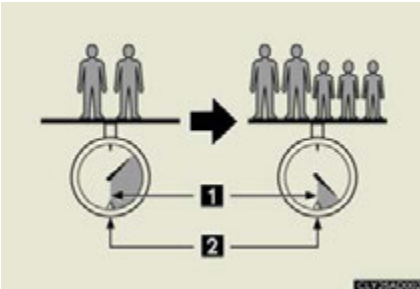

1 Cargo capacity

2 Total load capacity (vehicle capacity weight) (→P.798)

2

When driving

When 2 people with the combined weight of A lb. (kg) are riding in your vehicle, which has a total load capacity (vehicle capacity weight) of B lb. (kg), the available amount of cargo and luggage load capacity will be C lb. (kg) as follows:

$$B^{*2} \text{ lb. (kg)} - A^{*1} \text{ lb. (kg)} = C^{*3} \text{ lb. (kg)}$$

\*1: A = Weight of people

\*2: B = Total load capacity

\*3: C = Available cargo and luggage load

In this condition, if 3 more passengers with the combined weight of D lb. (kg) get on, the available cargo and luggage load will be reduced E lb. (kg) as follows:

$$C \text{ lb. (kg)} - D^{*4} \text{ lb. (kg)} = E^{*5} \text{ lb. (kg)}$$

\*4: D = Additional weight of people

\*5: E = Available cargo and luggage load

As shown in the example above, if the number of occupants increases, the cargo and luggage load will be reduced by an amount that equals the increased weight due to the additional occupants. In other words, if an increase in the number of occupants causes an excess of the total load capacity (combined weight of occupants plus cargo and luggage load), you must reduce the cargo and luggage on your vehicle.

### CAUTION

#### ■ Things that must not be carried in the luggage compartment

The following things may cause a fire if loaded in the luggage compartment:

- Receptacles containing gasoline
- Aerosol cans

#### ■ Storage precautions

Observe the following precautions.

Failure to do so may result in death or serious injury.

- Stow cargo and luggage in the luggage compartment whenever possible.
- Do not stack cargo and luggage in the luggage compartment higher than the seatbacks.  
Such items may be thrown about and possibly injure people in the vehicle in the event of sudden braking or in an accident.
- Do not place cargo or luggage in or on the following locations as the items may get under the brake or accelerator pedal and prevent the pedals from being depressed properly, block the driver's vision, or hit the driver or passengers, causing an accident:
  - At the feet of the driver
  - On the front passenger or rear seats (when stacking items)
  - On the luggage cover
  - On the instrument panel
  - On the dashboard
- Secure all items in the occupant compartment, as they may shift and injure someone in the event of sudden braking, sudden swerving or an accident.

**! CAUTION**

- Never allow anyone to ride in the luggage compartment. It is not designed for passengers. They should ride in their seats with their seat belts properly fastened. Otherwise, they are much more likely to suffer death or serious bodily injury, in the event of sudden braking, sudden swerving or an accident.

**■ Capacity and distribution**

- Do not exceed the maximum axle weight rating or the total vehicle weight rating.
- Even if the total load of occupant's weight and the cargo load is less than the total load capacity, do not apply the load unevenly. Improper loading may cause deterioration of steering or braking control which may cause death or serious injury.

**■ Roof luggage carrier precautions (if equipped)**

To use the roof rails as a roof luggage carrier, you must fit the roof rails with two or more genuine Lexus cross rails or their equivalent.

When you load cargo on the roof luggage carrier, observe the following:

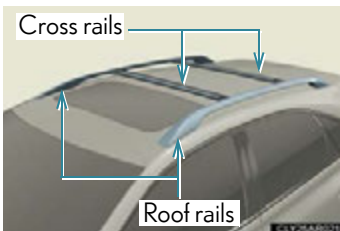

- Place the cargo so that its weight is distributed evenly between the front and rear axles.
- If loading long or wide cargo, never exceed the vehicle's overall length or width. (→P. 798)
- Before driving, make sure the cargo is securely fastened on the roof luggage carrier.
- Loading cargo on the roof luggage carrier will make the center of gravity of the vehicle higher. Avoid high speeds, sudden starts, sharp turns, sudden braking or abrupt maneuvers, otherwise the result may be a loss of control or vehicle roll-over due to failure to operate this vehicle correctly and result in death or serious injury.
- If driving for long distances, on rough roads, or at high speeds, stop the vehicle now and then during the trip to make sure the cargo remains in its place.
- Do not exceed 165 lb. (75 kg) cargo weight on the roof luggage carrier.
- To reduce wind noise when there is no luggage loaded on the roof luggage carrier, move the front cross rail to the front-most position and the rear cross rail to the rearmost position.

 NOTICE

■ **When loading cargo**

Be careful not to scratch the surface of the moon roof.

# Vehicle load limits

Vehicle load limits include total load capacity, seating capacity, TWR (Trailer Weight Rating) and cargo capacity.

### ■ Total load capacity (vehicle capacity weight): (→P. 798)

Total load capacity means the combined weight of occupants, cargo and luggage.

### ■ Seating capacity: 5 occupants (Front 2, Rear 3)

Seating capacity means the maximum number of occupants whose estimated average weight is 150 lb. (68 kg) per person.

### ■ TWR (Trailer Weight Rating) (AWD models with towing package): (→P. 310, 798)

TWR means the maximum gross trailer weight (trailer weight plus its cargo weight) that your vehicle is able to tow.

### ■ TWR (Trailer Weight Rating) (2WD models and AWD models without towing package)

Lexus does not recommend towing a trailer with your vehicle.

### ■ Cargo capacity

Cargo capacity may increase or decrease depending on the weight and the number of occupants.

### ■ Total load capacity and seating capacity

These details are also described on the tire and loading information label. (→P. 679)

## CAUTION

### ■ Overloading the vehicle

Do not overload the vehicle.

It may not only cause damage to the tires, but also degrade steering and braking ability, resulting in an accident.

# Winter driving tips

Carry out the necessary preparations and inspections before driving the vehicle in winter. Always drive the vehicle in a manner appropriate to the prevailing weather conditions.

### ■ Pre-winter preparations

- Use fluids that are appropriate to the prevailing outside temperatures.
  - Engine oil
  - Engine coolant
  - Power control unit coolant
  - Washer fluid
- Have a service technician inspect the condition of the 12-volt battery.
- Have the vehicle fitted with four snow tires or purchase a set of tire chains for the front tires.

Ensure that all tires are the same size and brand, and that chains match the size of the tires.

### ■ Before driving the vehicle

Perform the following according to the driving conditions:

- Do not try to forcibly open a window or move a wiper that is frozen. Pour warm water over the frozen area to melt the ice. Wipe away the water immediately to prevent it from freezing.
- To ensure proper operation of the climate control system fan, remove any snow that has accumulated on the air inlet vents in front of the windshield.
- Check for and remove any excess ice or snow that may have accumulated on the exterior lights, vehicle's roof, chassis, around the tires or on the brakes.
- Remove any snow or mud from the bottom of your shoes before getting in the vehicle.

### ■ When driving the vehicle

Accelerate the vehicle slowly, keep a safe distance between you and the vehicle ahead, and drive at a reduced speed suitable to road conditions.

### ■ When parking the vehicle

Park the vehicle and move the shift lever to P without setting the parking brake. The parking brake may freeze up, preventing it from being released. If necessary, block the wheels to prevent inadvertent sliding or creeping.

2

When driving

## Selecting tire chains

Use the correct tire chain size when mounting the tire chains. Chain size is regulated for each tire size.

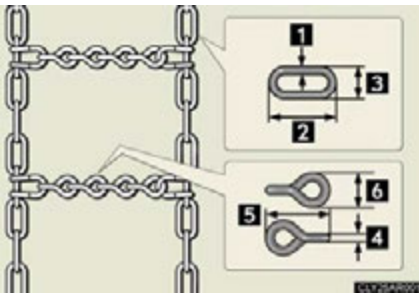

Side chain:

- 1 0.12 in. (3 mm) in diameter
- 2 0.98 in. (25 mm) in length
- 3 0.43 in. (10.8 mm) in width

Cross chain:

- 4 0.15 in. (3.9 mm) in diameter
- 5 1.00 in. (25.3 mm) in length
- 6 0.54 in. (13.8 mm) in width

## Regulations on the use of tire chains

Regulations regarding the use of tire chains vary depending on location and type of road. Always check local regulations before installing chains.

### ■ Tire chain installation

Observe the following precautions when installing and removing chains:

- Install and remove tire chains in a safe location.
- Install tire chains on the front tires only. Do not install tire chains on the rear tires.
- Install the tire chains on front tires as tightly as possible. Retighten chains after driving 1/4 — 1/2 mile (0.5 — 1.0 km).
- Install tire chains following the instructions provided with the tire chains.

### CAUTION

#### ■ Driving with snow tires

Observe the following precautions to reduce the risk of accidents.

Failure to do so may result in a loss of vehicle control and cause death or serious injury.

- Use tires of the size specified for your vehicle.
- Maintain the recommended level of air pressure.
- Do not drive in excess of 75 mph (120 km/h), regardless of the type of snow tires being used.
- Use snow tires on all, not just some wheels.

#### ■ Driving with tire chains

Observe the following precautions to reduce the risk of accidents.

Failure to do so may result in the vehicle being unable to be driven safely, and may cause death or serious injury.

- Do not drive in excess of the speed limit specified for the tire chains being used, or 30 mph (50 km/h), whichever is lower.
- Avoid driving on bumpy road surfaces or over potholes.
- Avoid sudden acceleration, abrupt steering, sudden braking and shifting operations that cause sudden engine braking.
- Slow down sufficiently before entering a curve to ensure that vehicle control is maintained.



 NOTICE**■ Repairing or replacing snow tires**

Request repairs or replacement of snow tires from Lexus dealers or legitimate tire retailers.

This is because the removal and attachment of snow tires affects the operation of the tire pressure warning valves and transmitters.

**■ Fitting tire chains**

The tire pressure warning valves and transmitters may not function correctly when tire chains are fitted.

## 2-5. Driving information

### Trailer towing (AWD models with towing package)

Your vehicle is designed primarily as a passenger-and-load-carrying vehicle. Towing a trailer can have an adverse impact on handling, performance, braking, durability, and fuel consumption. For your safety and the safety of others, you must not overload your vehicle or trailer. You must also ensure that you are using appropriate towing equipment, that the towing equipment has been installed correctly and used properly, and that you employ the requisite driving habits.

Vehicle-trailer stability and braking performance are affected by trailer stability, brake performance and setting, trailer brakes, the hitch and hitch systems (if equipped).

To tow a trailer safely, use extreme care and drive the vehicle in accordance with your trailer's characteristics and operating conditions.

Lexus warranties do not apply to damage or malfunction caused by towing a trailer for commercial purposes.

Contact your Lexus dealer for further information about additional requirements such as towing kits, etc.

#### Towing related terms

##### ■ GCWR (Gross Combination Weight Rating)

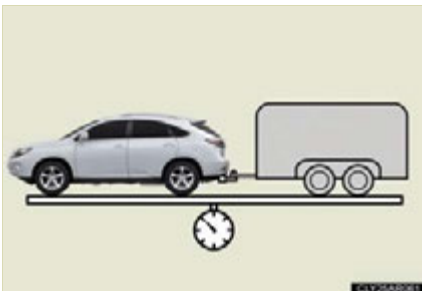

The maximum allowable gross combination weight. The gross combination weight is the sum of the total vehicle weight (including the occupants, cargo and any optional equipment installed on the vehicle) and the weight of the trailer being towed (including the cargo in the trailer).

### ■ GVWR (Gross Vehicle Weight Rating)

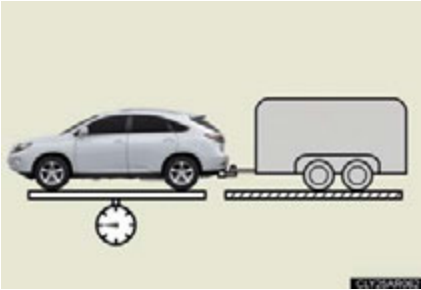

The maximum allowable gross vehicle weight. The gross vehicle weight is the total weight of the vehicle. When towing a trailer, it is the sum of the vehicle weight (including the occupants, cargo and any optional equipment installed on the vehicle) and the tongue weight.

### ■ GAWR (Gross Axle Weight Rating)

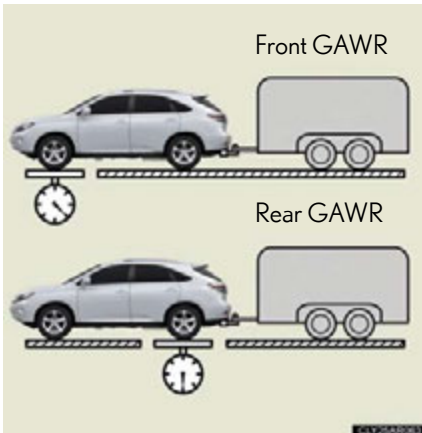

The maximum allowable gross axle weight. The gross axle weight is the load placed on each axle (front and rear).

### ■ TWR (Trailer Weight Rating)

(With brakes)

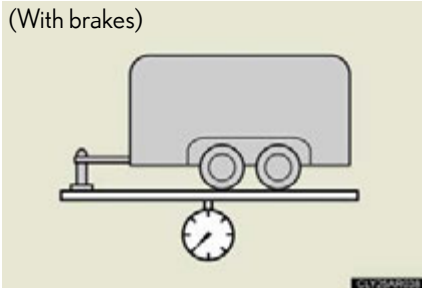

The maximum allowable gross trailer weight. The gross trailer weight is the sum of the trailer weight and the weight of the cargo in the trailer.

TWR is calculated assuming base vehicle with one driver, one front passenger, towing package (if available), hitch and hitch systems (if required).

Additional optional equipment, passengers and cargo in the vehicle will reduce the trailer weight rating so as not to exceed GCWR, GVWR and GAWR.

If the gross trailer weight exceeds 3000 lb. (1360 kg), it is recommended to use a trailer with 2 or more axles.

### ■ Unbraked TWR (Unbraked Trailer Weight Rating)

(Without brakes)

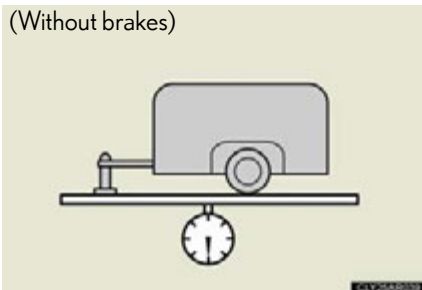

The trailer weight rating for towing a trailer without a trailer service brake system.

## ■ Tongue Weight

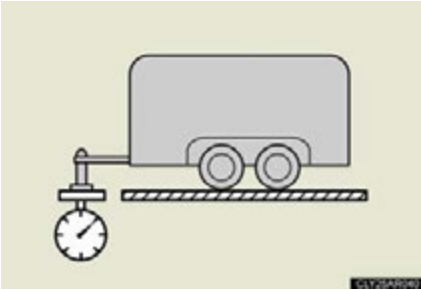

The load placed on the trailer hitch ball. (→P. 311)

## Weight limits

- The gross trailer weight must never exceed the TWR described in the table. (→P. 310)
- The gross combination weight must never exceed the GCWR described in the table. (→P. 310)



- The gross vehicle weight must never exceed the GVWR indicated on the Certification Label.
- The gross axle weight on each axle must never exceed the GAWR indicated on the Certification Label.
- If the gross trailer weight is over the unbraked TWR, trailer service brakes are required.
- If the gross trailer weight is over 2000 lb. (907 kg), a sway control device with sufficient capacity is required.

**GCWR, TWR, Unbraked TWR, Fifth wheel and Gooseneck towing TWR**

Confirm that the gross trailer weight, gross combination weight, gross vehicle weight, gross axle weight and tongue weight are all within the limits.

**■ GCWR\* and TWR\***

Towing type	Driving system	GCWR	TWR
With towing package	AWD	9480 lb. (4297 kg)	3500 lb. (1588 kg)

**■ Unbraked TWR\***

1000 lb. (453 kg)

\*: These models meet the tow-vehicle trailering requirement of SAE International per SAE J2807.

## Trailer Tongue Weight

- A recommended tongue weight varies in accordance with the types of trailers or towing as described below.
- To ensure the recommended values shown below, the trailer must be loaded by referring to the following instructions.

- Tongue Weight

The gross trailer weight should be distributed so that the tongue weight is 9% to 11%. (Tongue weight /Gross trailer weight x 100 = 9% to 11%)

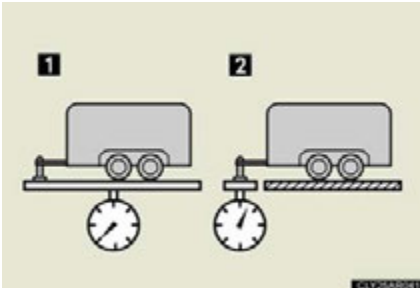

1 Gross trailer weight

2 Tongue weight

If using a weight distributing hitch when towing, return the front axle to the same weight as before the trailer connection.

If front axle weight cannot be measured directly, measure the front fender height above the front axle before connection. Adjust weight distributing hitch torque until front fender is returned to the same height as before connection.

The gross trailer weight, gross axle weight and tongue weight can be measured with platform scales found at a highway weighing station, building supply company, trucking company, junk yard, etc.

### Hitch

Trailer hitch assemblies have different weight capacities. Lexus recommends the use of Lexus hitch/bracket for your vehicle. For details, contact your Lexus dealer.

- If you wish to install a trailer hitch, contact your Lexus dealer.
- Use only a hitch that conforms to the gross trailer weight requirement of your vehicle.
- Follow the directions supplied by the hitch manufacturer.
- Lubricate the hitch ball with a light coating of grease.
- Remove the trailer hitch whenever you are not towing a trailer. After removing the hitch, seal any mounting hole in the vehicle body to prevent entry of any substances into the vehicle.



## Selecting trailer ball

Use the correct trailer ball for your application.

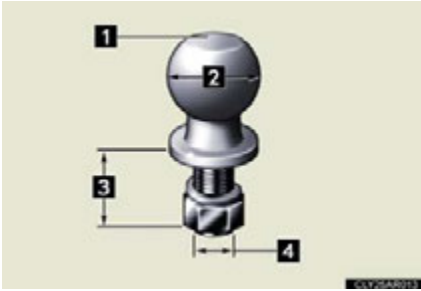

### 1 Trailer ball load rating

Matches or exceeds the gross trailer weight rating of the trailer.

### 2 Ball diameter

Matches the size of the trailer coupler. Most couplers are stamped with the required trailer ball size.

Trailer class	Typical trailer ball size
IV	2 5/16 in.
II and III	2 in.
I	1 7/8 in.

### 3 Shank length

Protrudes beyond the bottom of the lock washer and nut by at least 2 threads.

### 4 Shank diameter

Matches the ball mount hole diameter size.

### Positions for towing hitch receiver and hitch ball

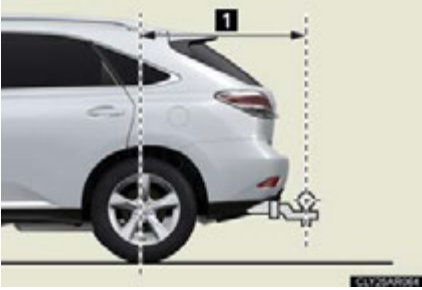

**1** Weight carrying ball position:  
45.1 in. (1145 mm)

### Connecting trailer lights



Use the wire harness stored in the rear end under body.

### ■ Auto current cut-off function

In case of over current, the auto cut-off function stops the power flowing to the trailer lights to prevent damage to the vehicle's electrical system.

This function is activated when the rated current of any of the following trailer light circuit components is exceeded:

- Tail lights: maximum 7.8 A
- Stop/turn signal light (right): maximum 4.5 A
- Stop/turn signal light (left): maximum 4.5 A

### ■ When the auto current cut function is activated

If a trailer light does not come on due to the activation of the auto current cut function, the light system will need to be reset.

Follow the reset procedure shown below.

- If a tail light does not come on, turn off the headlight switch.
- If the right-side stop/turn signal light does not come on, put the turn signal in the off position or remove foot from the brake pedal.
- If the left-side stop/turn signal light does not come on, put the turn signal in the off position or remove foot from the brake pedal.

If the emergency flashers do not operate, press the emergency flasher switch to turn them off.

After the light system is reset, operate the light switches again to see if the lights operate normally.

If the lights do not operate normally, have the vehicle inspected by your Lexus dealer.

### Trailer towing tips

Your vehicle will handle differently when towing a trailer. Help to avoid an accident, death or serious injury, keep the following in mind when towing:

- Speed limits for towing a trailer vary by state or province. Do not exceed the posted towing speed limit.
- Lexus recommends that the vehicle-trailer speed limit is 65 mph (104 km/h) on a flat, straight, dry road. Do not exceed this limit, the posted towing speed limit or the speed limit for your trailer as set forth in your trailer owner's manual, whichever is lowest. Instability of the towing vehicle-trailer combination (trailer sway) increases as speed increases. Exceeding speed limits may cause loss of control.
- Before starting out, check the trailer lights, tires and the vehicle-trailer connections. Recheck after driving a short distance.
- Practice turning, stopping and reversing with the trailer attached in an area away from traffic until you become accustomed to the feel of the vehicle-trailer combination.
- Reversing with a trailer attached is difficult and requires practice. Grip the bottom of the steering wheel and move your hand to the left to move the trailer to the left. Move your hand to the right to move the trailer to the right. (This is generally opposite to reversing without a trailer attached.) Avoid sharp or prolonged turning. Have someone guide you when reversing to reduce the risk of an accident.
- As stopping distance is increased when towing a trailer, vehicle-to-vehicle distance should be increased. For each 10 mph (16 km/h) of speed, allow at least one vehicle and trailer length.
- Avoid sudden braking as you may skid, resulting in the trailer jackknifing and a loss of vehicle control. This is especially true on wet or slippery surfaces.
- Avoid jerky starts or sudden acceleration.

- Avoid jerky steering and sharp turns, and slow down before making a turn.
- Note that when making a turn, the trailer wheels will be closer than the vehicle wheels to the inside of the turn. Compensate by making a wider than normal turning radius.
- Slow down before making a turn, in cross winds, on wet or slippery surfaces, etc.  
Increasing vehicle speed can destabilize the trailer.
- Take care when passing other vehicles. Passing requires considerable distance. After passing a vehicle, do not forget the length of your trailer, and be sure you have plenty of room before changing lanes.
- To maintain engine braking efficiency and charging system performance when using engine braking, do not put the transmission in D.
- Instability happens more frequently when descending steep or long downhill grades. Before descending, slow down and downshift. Do not make sudden downshifts while descending steep or long downhill grades.
- Avoid holding the brake pedal down too long or applying the brakes too frequently. This could cause the brakes to overheat and result in reduced braking efficiency.
- Due to the added load of the trailer, your vehicle's engine may overheat on hot days (at temperatures over 85°F [30°C]) when driving up a long or steep grade. If the engine coolant temperature gauge indicates overheating, immediately turn off the air conditioning (if in use), pull your vehicle off the road and stop in a safe spot. (→P. 788)

- Always place wheel blocks under both the vehicle's and the trailer's wheels when parking. Apply the parking brake firmly, and put the transmission in P. Avoid parking on a slope, but if unavoidable, do so only after performing the following:

**STEP 1** Apply the brakes and keep them applied.

**STEP 2** Have someone place wheel blocks under both the vehicle's and trailer's wheels.

**STEP 3** When the wheel blocks are in place, release the brakes slowly until the blocks absorb the load.

**STEP 4** Apply the parking brake firmly.

**STEP 5** Shift into P and turn off the hybrid system.

- When restarting after parking on a slope:

**STEP 1** With the transmission in P, start the hybrid system. Be sure to keep the brake pedal depressed.

**STEP 2** Shift into a forward gear. If reversing, shift into R.

**STEP 3** Release the parking brake and brake pedal, and slowly pull or back away from the wheel blocks. Stop and apply the brakes.

**STEP 4** Have someone retrieve the blocks.

## ■ Matching trailer ball height to trailer coupler height



No matter which class of tow hitch applies, for a more safe trailer hookup, the trailer ball setup must be the proper height for the coupler on the trailer.

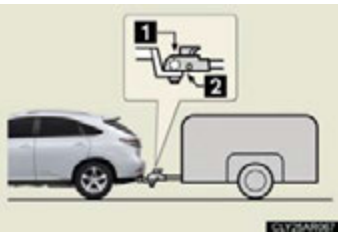

- 1 Coupler
- 2 Trailer ball

## ■ Before towing

Check that the following conditions are met:

- Ensure that your vehicle's tires are properly inflated. (→P. 807)
- Trailer tires are inflated according to the trailer manufacturer's recommendation.
- All trailer lights work as required by law.
- All lights work each time you connect them.
- The trailer ball is set at the proper height for the coupler on the trailer.
- The trailer is level when it is hitched.  
Do not drive if the trailer is not level, and check for improper tongue weight, overloading, worn suspension, or other possible causes.
- The trailer cargo is securely loaded.
- The rear view mirrors conform to all applicable federal, state/provincial or local regulations. If they do not, install rear view mirrors appropriate for towing purposes.

### ■ Break-in schedule

If your vehicle is new or equipped with any new power train components (such as an engine, transmission, differential or wheel bearing), Lexus recommends that you do not tow a trailer until the vehicle has been driven for over 500 miles (800 km).

After the vehicle has been driven for over 500 miles (800 km), you can start towing. However, for the next 500 miles (800 km), drive the vehicle at a speed of less than 50 mph (80 km/h) when towing a trailer, and avoid full throttle acceleration.

### ■ Maintenance

- If you tow a trailer, your vehicle will require more frequent maintenance due to the additional load. (See “Warranty and Services Guide”, “Owner’s Manual Supplement” or “Scheduled Maintenance”.)
- Retighten the fixing bolts of the towing ball and bracket after approximately 600 miles (1000 km) of trailer towing.

### ■ If trailer sway occurs

One or more factors (crosswinds, passing vehicles, rough roads, etc.) can adversely affect handling of your vehicle and trailer, causing instability.

- If trailer swaying occurs:
  - Firmly grip the steering wheel. Steer straight ahead.  
Do not try to control trailer swaying by turning the steering wheel.
  - Begin releasing the accelerator pedal immediately but very gradually to reduce speed.  
Do not increase speed. Do not apply vehicle brakes.

If you make no extreme correction with the steering or brakes, your vehicle and trailer should stabilize.

- After the trailer swaying has stopped:
  - Stop in a safe place. Get all occupants out of the vehicle.
  - Check the tires of the vehicle and the trailer.
  - Check the load in the trailer.  
Make sure the load has not shifted.  
Make sure the tongue weight is appropriate, if possible.
  - Check the load in the vehicle.  
Make sure the vehicle is not overloaded after occupants get in.

If you cannot find any problems, the speed at which trailer swaying occurred is beyond the limit of your particular vehicle-trailer combination.

Drive at a lower speed to prevent instability. Remember that swaying of the towing vehicle-trailer increases as speed increases.



 **CAUTION****■ Trailer towing precautions**

To tow a trailer safely, use extreme care and drive the vehicle in accordance with the trailer's characteristics and operating conditions. Failure to do so could cause an accident resulting in death or serious injury. Vehicle stability and braking performance are affected by trailer stability, brake setting and performance, and the hitch. Your vehicle will handle differently when towing a trailer.

**■ To avoid accident or injury**

- Do not exceed the TWR, unbraked TWR, GCWR, GVWR or GAWR.
- If the gross trailer weight is over 2000 lb. (907 kg), a sway control device with sufficient capacity is required.
- Adjust the tongue weight within the appropriate range. Place heavier loads as close to the trailer axle as possible.
- Do not exceed 65 mph (104 km/h), the posted towing speed limit or the speed limit for your trailer as set forth in your trailer owner's manual, whichever is lowest. Slow down sufficiently before making a turn, in cross winds, on wet or slippery surface, etc. to help avoid an accident. If you experience a vehicle-trailer instability from reducing a certain speed, slow down and make sure you keep your vehicle speed under the speed of which you experience the instability.
- Do not make jerky, abrupt or sharp turns.
- Do not apply the brakes suddenly as you may skid, resulting in jackknifing and loss of vehicle control. This is especially true on wet or slippery surfaces.
- Do not exceed the trailer hitch assembly weight, gross vehicle weight, gross axle weight and trailer tongue weight capacities.
- Do not use cruise control when towing.
- Slow down and downshift before descending steep or long downhill grades. Do not make sudden downshifts while descending steep or long downhill grades.
- Vehicle-trailer instability is more likely on steep long downhills. Before descending steep or long downhill grades, slow down and downshift. Do not make sudden downshifts when descending steep or long downhill grades. Avoid holding the brake pedal down too long or applying the brakes too frequently. This could cause the brakes to overheat and result in reduced braking efficiency.
- Do not tow a trailer when the compact spare tire is installed on your vehicle.

### CAUTION

#### ■ Hitch

Trailer hitch assemblies have different weight capacities established by the hitch manufacturer. Even though the vehicle may be physically capable of towing a higher weight, the operator must determine the maximum weight rating of the particular hitch assembly and never exceed the maximum weight rating specified for the trailer-hitch. Exceeding the maximum weight rating set by the trailer-hitch manufacturer can cause an accident resulting in death or serious personal injuries.

#### ■ When towing a trailer

Lexus recommends trailers with brakes that conform to any applicable federal and state/provincial regulations.

- If the gross trailer weight exceeds unbraked TWR, trailer brakes are required. Lexus recommends trailers with brakes that conform to all applicable federal and state/provincial regulations.
- Never tap into your vehicle's hydraulic system, as this will lower the vehicle's braking effectiveness.
- Never tow a trailer without using a safety chain securely attached to both the trailer and the vehicle. If damage occurs to the coupling unit or hitch ball, there is danger of the trailer wandering into another lane.

### NOTICE

#### ■ When installing a trailer hitch

Use only the position recommended by your Lexus dealer. Do not install the trailer hitch on the bumper; this may cause body damage.

#### ■ Do not directly splice trailer lights

Do not directly splice trailer lights. Directly splicing trailer lights may damage your vehicle's electrical system and cause a malfunction.

## 2-5. Driving information

### Trailer towing (without towing package)

Lexus does not recommend towing a trailer with your vehicle. Lexus also does not recommend the installation of a tow hitch or the use of a tow hitch carrier for a wheelchair, scooter, bicycle, etc. Your vehicle is not designed for trailer towing or for the use of tow hitch mounted carriers.



## 2-5. Driving information

# Dinghy towing

Your vehicle is not designed to be dinghy towed (with 4 wheels on the ground) behind a motor home.



### NOTICE

#### To avoid serious damage to your vehicle

Do not tow your vehicle with 4 wheels on the ground.

#### To prevent causing serious damage to the hybrid transmission and AWD system (AWD models)



2WD models: Never tow this vehicle from the rear with the front wheels on the ground. This may cause serious damage to the hybrid transmission.



AWD models: Never tow this vehicle with any of the wheels on the ground. This may cause serious damage to the hybrid transmission and AWD system.

**3-1. Lexus Display Audio system**

Lexus Display Audio system.....	328
Display settings .....	332
Setup menu .....	334
Mobile Assistant .....	340

**3-2. Using the air conditioning system and defogger**

Automatic air conditioning system (with the Lexus Display Audio system) .....	342
Automatic air conditioning system (without a navigation system or the Lexus Display Audio system) .....	350
Rear window defogger switch.....	358
Windshield wiper de-icer.....	360

---

### **3-3. Using the Lexus Display Audio system**

Audio system (with the Lexus Display Audio system).....	362
Using the radio.....	365
Using the CD player .....	380
Playing an audio CD and MP3/WMA discs.....	381
Listening to an iPod.....	391
Listening to a USB memory .....	399
Using the AUX port .....	408
Listening to Bluetooth <sup>®</sup> audio.....	410
Optimal use of the audio system .....	424
Using the steering wheel audio switches.....	426
Hands-free system (for mobile phone).....	429
Using the Bluetooth <sup>®</sup> phone .....	437
Setting the hands-free system .....	454
Bluetooth <sup>®</sup> settings .....	466

### **3-4. Using the audio system**

Audio system (without a navigation system or the Lexus Display Audio system) .....	474
Using the radio .....	477
Using the CD player .....	485
Playing MP3 and WMA discs.....	493
Operating an iPod.....	501
Operating a USB memory.....	510
Bluetooth <sup>®</sup> audio system .....	519
Using the Bluetooth <sup>®</sup> audio system.....	523
Operating a Bluetooth <sup>®</sup> enabled portable player .....	528
Setting up a Bluetooth <sup>®</sup> enabled portable player .....	531
Bluetooth <sup>®</sup> audio system setup .....	538
Optimal use of the audio system.....	539
Using the AUX port.....	541
Using the steering wheel audio switches.....	543

Hands-free system for mobile phones .....	547
Using the hands-free system (for mobile phones).....	552
Making a phone call .....	560
Setting a mobile phone.....	565
Security and system setup .....	571
Using the phone book.....	575

### 3-5. Using the interior lights

Interior lights list.....	582
• Interior lights .....	583
• Personal lights.....	583

### 3-6. Using the storage features

List of storage features .....	585
• Glove box .....	586
• Bottle holders/ door pockets.....	587
• Cup holders .....	588
• Console box .....	590
• Coin holder .....	592
• Auxiliary boxes .....	592
• Under tray .....	594

### 3-7. Other interior features

Sun visors .....	595
Vanity mirrors .....	596
Clock.....	597
Outside temperature display.....	598
Multi-display light control .....	600
Power outlets .....	601
Heated steering wheel .....	604
Seat heaters and ventilators .....	605
Armrest .....	607
Coat hooks .....	608
Assist grips.....	609
Floor mat .....	610
Luggage compartment features.....	612
Garage door opener .....	616
Compass .....	622
Safety Connect .....	626

## 3-1. Lexus Display Audio system

# Lexus Display Audio system\*

By using the Lexus Display Audio controller, you can control the audio system and hands-free system, etc.

### ■ Lexus Display Audio controller



- 1 Displaying the audio control screen (→P. 362)
- 2 Displaying the “Menu” screen (→P. 329)
- 3 Displaying the previous screen
- 4 Turn or move the controller to select a function, number and screen button.

Push the controller to enter the selected function, number and screen button.

\*: If equipped



### ■ “Menu” screen

To display the “Menu” screen, press the “MENU” button on the Lexus Display Audio controller.



Button	Function
“Climate”	Automatic air conditioning system (→P. 342)
“Phone”	Hands-free system (→P. 429)
“Car”	Energy monitor/consumption screen (→P. 39)
“Setup”	Setup menu (→P. 334)
“Display”	Display settings (→P. 332)

## Lexus Display Audio system operation

### ■ Using the Lexus Display Audio controller

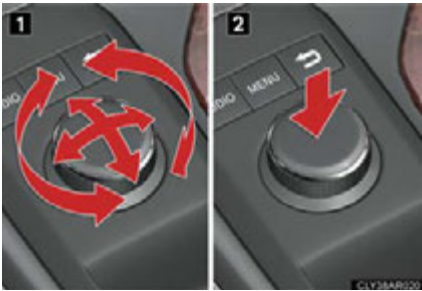

1 Select: Turn or move the controller.



2 Enter: Push the controller.

### ■ Basic screen operation

When a list is displayed, use the appropriate button to scroll through the list.



: This indicator will turn on when the list box is selected.

 : To scroll to the next or previous page.

: To return to the previous screen.

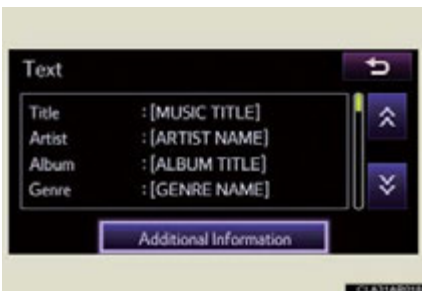

### ■ When using the screen

- Under extremely cold conditions, the Lexus Display Audio controller may react slowly.
- If the screen is cold, the display may be dark, or the system may seem to be operating slightly slower than normal.
- The screen may seem dark and hard to see when viewed through sunglasses. Change your angle of viewing, adjust the display on the “Display Settings” screen (→P. 332) or remove your sunglasses.

### CAUTION

#### ■ Using the Lexus Display Audio controller

- Do not allow fingers, fingernails or hair to become caught in the Lexus Display Audio controller as this may cause an injury.
- Be careful when touching the Lexus Display Audio controller in extreme temperatures as it may become very hot or cold due to the temperature inside the vehicle.

### NOTICE

#### ■ To prevent the Lexus Display Audio controller malfunction

- Do not allow the Lexus Display Audio controller to come into contact with food, liquid, stickers or lit cigarettes as doing so may cause it to change color, emit a strange odor or stop functioning.
- Do not subject the Lexus Display Audio controller to excessive pressure or strong impact as the controller may bend or break off.
- Do not allow coins, contact lenses or other such items to become caught in the Lexus Display Audio controller as this may cause it to stop functioning.
- Items of clothing may rip if they become caught on the Lexus Display Audio controller.
- If your hand or any object is on the Lexus Display Audio controller when the “POWER” switch is turned to ACCESSORY mode, the Lexus Display Audio controller may not operate properly.

## 3-1. Lexus Display Audio system

### Display settings

You can adjust the contrast and brightness of the screen and also turn the display off.

To display the “Display Settings” screen, press the “MENU” button on the Lexus Display Audio controller and then select “Display” on the “Menu” screen.



#### 1 Turn off screen

The screen is turned off. To turn it on, press the “AUDIO” or “MENU” button on the Lexus Display Audio controller.

#### 2 Changes to day mode. (→P. 332)

#### 3 Adjust screen contrast/brightness (→P. 333)

#### 4 Adjust screen contrast/brightness of rear view monitor camera (→P. 333)

### Changing between day mode and night mode

When the headlights are turned on, the screen dims.

However, the screen can be switched to day mode by selecting “Day Mode”.

If the screen is set in day mode with the headlight switch turned on, this condition is memorized even with the “POWER” switch is turned off.

## Adjusting the screen contrast/brightness

**STEP 1** Select “General” or “Camera” on the “Display Settings” screen.

**STEP 2**



Adjust the display as desired using “+” or “-”.

Select “Contrast” or “Brightness” using the “<<” or “>>”.

	“-”	“+”
“Contrast”	Weaker	Stronger
“Brightness”	Darker	Brighter

**STEP 3** Select “OK”.

## 3-1. Lexus Display Audio system

### Setup menu

You can change the Lexus Display Audio system to your desired setting. To display the “Setup” screen, press the “MENU” button on the Lexus Display Audio controller and then select “Setup” on the “Menu” screen.

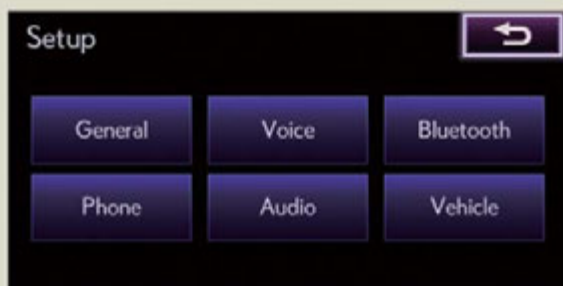

Button	Page
“General”	P. 335
“Voice”	P. 339
“Bluetooth <sup>*</sup> ”	P. 466
“Phone”	P. 454
“Audio”	P. 338
“Vehicle”	P. 337

\*: Bluetooth is a registered trademark of Bluetooth SIG, Inc.

## General settings

This screen is used for various settings.

**STEP 1** Display the “Setup” screen. (→P. 334)

**STEP 2** Select “General” on the “Setup” screen.

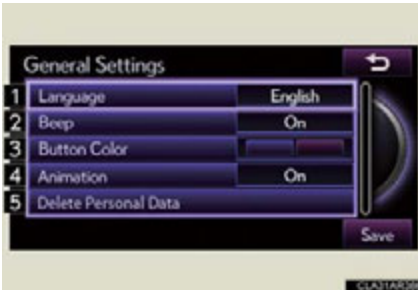

**1** Select language (→P. 335)

**2** Beep on/off

**3** Select button color

**4** Animation on/off

The animation effect for audio source selection screen, screen transitions, etc. can be set to “On” or “Off”.

**5** Personal data can be deleted.  
(→P. 336)

**STEP 3** When you complete settings, select “Save”.

### Selecting a language

**STEP 1** Select “Language” on the “General Settings” screen.

**STEP 2**

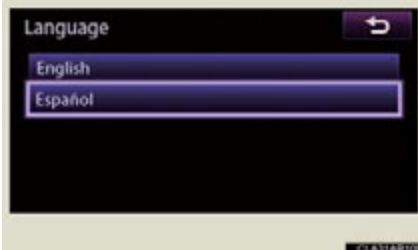

Select the desired language.

The selectable languages may differ depending on the model or region.

### ■ Delete personal data

**STEP 1** Select “Delete Personal Data” on the “General Settings” screen.

**STEP 2**

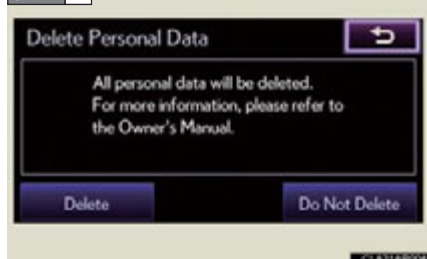

Select “Delete”.

Check carefully beforehand, as data cannot be retrieved once deleted.

**STEP 3** A confirmation screen will be displayed. Select “Yes”.

The following personal data can be deleted or turned to their default settings.

- Phonebook data
- Call history data
- Speed dial data
- Bluetooth® devices data
- Phone sound settings
- Detailed Bluetooth® settings
- Sound settings
- Preset switch data
- Last used radio station



## Vehicle settings

This screen is used for various vehicle settings.

**STEP 1** Display the “Setup” screen. (→P. 334)

**STEP 2** Select “Vehicle” on the “Setup” screen.

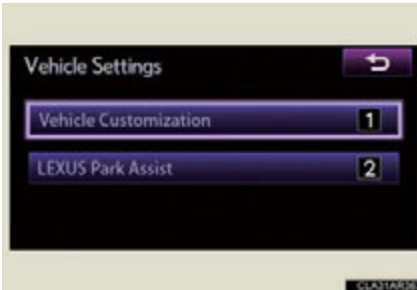

**1** Vehicle customization settings (→P. 337)

**2** Intuitive parking assist settings\* (→P. 255)

### ■ Vehicle customization settings

Various setting can be changed.

**STEP 1** Select “Vehicle Customization” on the “Vehicle Settings” screen.

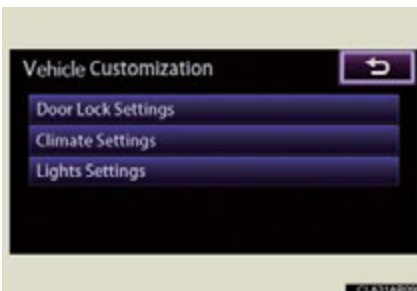

Refer to the list of settings that can be changed for details. (→P. 825)

**STEP 2** When you complete settings, select “Save”.

\*: If equipped

## Audio settings

This screen is used for various audio settings.

**STEP 1** Display the “Setup” screen. (→P. 334)

**STEP 2** Select “Audio” on the “Setup” screen.

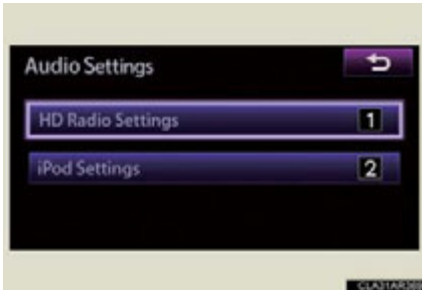

**1** HD Radio™ technology settings (→P. 371)

**2** iPod setting (→P. 338)

### ■ iPod setting

This screen is used for iPod setting.

**STEP 1** Select “iPod Settings” on the “Audio Settings” screen. (→P. 338)

**STEP 2**

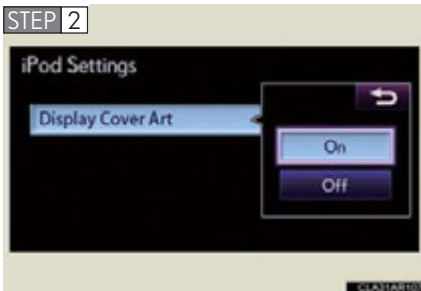

Select “Display Cover Art”.

“On” or “Off” can be selected to display captured image/iPod cover art in the screen.

**STEP 3** When you complete settings, select “OK”.

## Voice settings

This screen is used for guidance for Bluetooth<sup>®</sup> hands-free systems setting.

**STEP 1** Display the “Setup” screen. (→P. 334)

**STEP 2** Select “Voice” on the “Setup” screen.

**STEP 3**

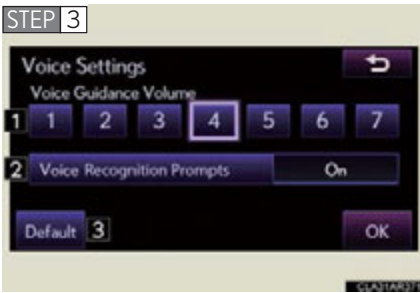

- 1** Voice guidance volume setting
- 2** Voice recognition prompts on/off
- 3** Restore default settings

**STEP 4** When you complete settings, select “OK”.

## 3-1. Lexus Display Audio system

### Mobile Assistant

The Mobile Assistant feature will activate Apple's Siri® Eyes Free mode via the steering wheel switches. To operate the Mobile Assistant, a compatible cellular phone must be registered and connected to this system via Bluetooth®. (→P. 437)



Press and hold the off hook switch until you hear the beeps that indicate the system is listening.



The Mobile Assistant can be used only when the neighboring screen is displayed.

To cancel the Mobile Assistant, select "Cancel", or press and hold the off hook switch.

To restart the Mobile Assistant for additional commands, press the off hook switch. Mobile Assistant can only be restarted after the system responds to a voice command. After some phone and music commands, the Mobile Assistant feature will automatically end to complete the requested action.

### ■ Adjusting the volume

The volume of the Mobile Assistant can be adjusted using the “PWR·VOL” knob or steering wheel volume switches. The Mobile Assistant and phone call volumes are synchronized.

### ■ Microphone



It is not necessary to speak directly into the microphone when using the Mobile Assistant.

- Wait for the listening beeps before using the Mobile Assistant.
- The Mobile Assistant may not recognize commands in the following situations:
  - When spoken too quickly.
  - When spoken at a low or high volume.
  - When the roof or windows are open.
  - When passengers are talking while the Mobile Assistant is being used.
  - When the air conditioning system's fan speed is set high.
  - When the air conditioning vents are turned toward the microphone.

### ■ Mobile Assistant precautions

- The available features and functions may vary based on the iOS version installed on the connected device.
- Some Siri features are limited in Eyes Free mode. If you attempt to use an unavailable function, Siri will inform you that the function is not available.
- If Siri is not enabled on the cellular phone connected via Bluetooth<sup>®</sup>, an error message will be displayed on the screen.
- While a phone call is active, the Mobile Assistant cannot be used.
- If using the navigation feature of the cellular phone, ensure the active audio source is Bluetooth<sup>®</sup> audio or iPod in order to hear turn by turn direction prompts.

## 3-2. Using the air conditioning system and defogger

### Automatic air conditioning system (with the Lexus Display Audio system)

Air outlets and fan speed are automatically adjusted according to the temperature setting.

To display the air conditioning operation screen, press the “MENU” button on the Lexus Display Audio controller and then select “Climate”.

#### ■ Control panel

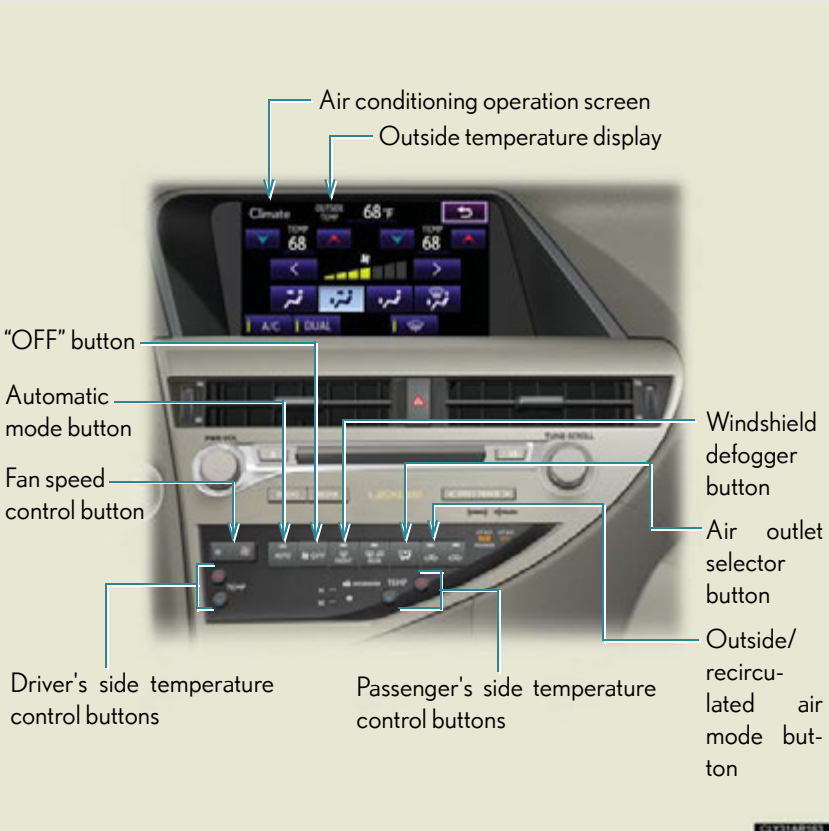

### ■ Automatic air conditioning system control screen







- 1 Adjusting driver's side temperature setting
- 2 Adjusting passenger's side temperature setting
- 3 Adjusting the fan speed
- 4 Selecting air outlet mode
- 5 Cooling and dehumidification function on/off
- 6 Dual mode on/off
- 7 Windshield wiper de-icer on/off

### Using the automatic air conditioning system

**STEP 1** Press .

The air conditioning system begins to operate. Air outlets and fan speed are automatically adjusted according to the temperature setting.

**STEP 2** Press  or select  of the "TEMP" to increase the temperature and  or  to decrease the temperature.





When **DUAL** is selected (the indicator on **DUAL** is on) or the passenger's side temperature control button is pressed, the temperature for the driver and passenger seats can be adjusted separately.

### ■ Automatic mode indicator





If fan speed setting or air flow modes are operated, the automatic mode indicator goes off. However, automatic mode for functions other than that operated are maintained.

## Adjusting the settings manually

### Basic setting

**STEP 1** To turn on the air conditioning system and adjust the fan speed, press  on  to increase the fan speed and  to decrease the fan speed or select ">" of  to increase the fan speed and "<" to decrease the fan speed.

Press  to turn the fan off.

**STEP 2** To adjust the temperature setting, press  or select  of the "TEMP" to increase the temperature and  or  to decrease the temperature.

When **DUAL** is selected (the indicator on  is on) or the passenger's side temperature control button is pressed, the temperature for the driver and passenger seats can be adjusted separately.



To change the air outlets, press  or select an air outlet switch on the operation screen.

The air outlets used are switched each time  is pressed. The air flow shown on the display indicates the following:



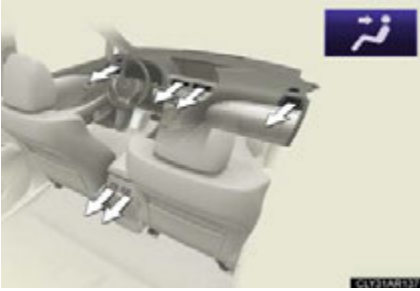

Air flows to the upper body.

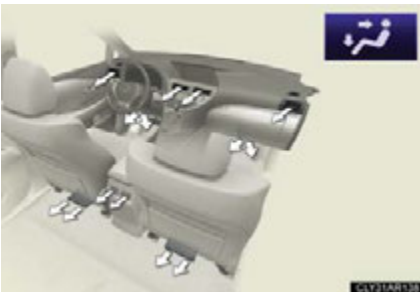

Air flows to the upper body and feet.

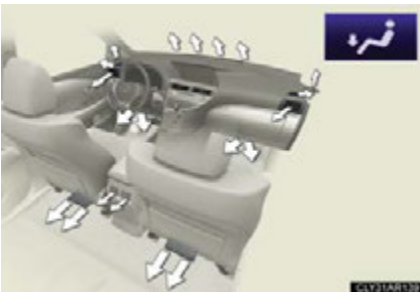

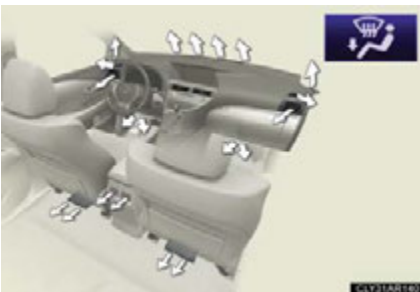

Air flows to the feet.



Air flows to the feet and the windshield defogger operates.

### ■ Switching between outside air and recirculated air modes

Press .

The mode switches between  (recirculated air mode) and  (outside air mode) modes each time the button is pressed.

### Defogging the windshield



#### Defogging

The air conditioning system operates automatically.

Recirculated air mode will automatically switch to outside air mode. It is not possible to return to recirculated air mode when the switch is on.

### Adjusting the position of and opening and closing the air outlets

#### ► Front center outlets

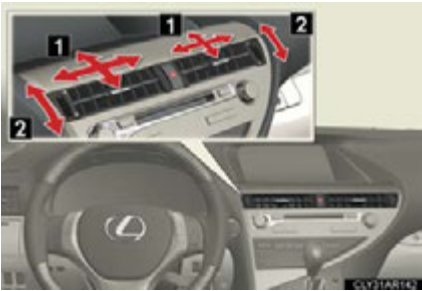

- 1 Direct air flow to the left or right, up or down.
- 2 Turn the knob to open or close the vent.

► Front side outlets

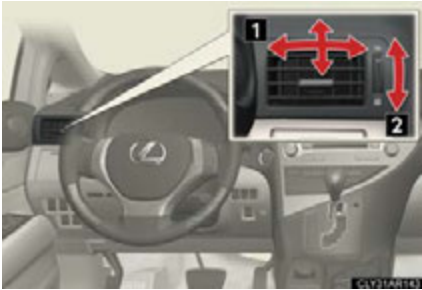

- 1 Direct air flow to the left or right, up or down.
- 2 Turn the knob to open or close the vent.

► Rear outlets

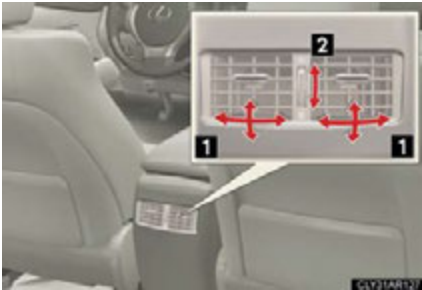

- 1 Direct air flow to the left or right, up or down.
- 2 Turn the knob to open or close the vent.

■ Operation of the air conditioning system in Eco drive mode

In Eco drive mode, the air conditioning system is controlled as follows to prioritize fuel efficiency:

- Engine speed and compressor operation controlled to restrict heating/cooling capacity
- Fan speed restricted when automatic mode is selected

To improve air conditioning performance, perform the following operations:

- Adjust the fan speed
- Turn off Eco drive mode

■ Customization

The air conditioning control of Eco drive mode can be changed to the same setting as that used in normal drive mode.  
(Customizable features →P. 825)

## 3-2. Using the air conditioning system and defogger

### ■ Air conditioning system settings

- When the “POWER” switch is turned on, the air conditioning system settings will be set to those that were in use the last time the “POWER” switch was turned off.
- Air conditioning system settings are memorized individually on each electronic key, so the settings reproduced will be specific to the key that is used.
- This feature is customizable at your Lexus dealer.

### ■ Using automatic mode

Fan speed is adjusted automatically according to the temperature setting and ambient conditions. As a result, the following may occur:

Immediately after the button is pressed, the fan may stop for a while until warm or cool air is ready to flow.

### ■ Using the system in recirculated air mode

The windows will fog up more easily if recirculated air mode is used for an extended period.

### ■ Switching between outside air and recirculated air modes

Recirculated air mode or outside air mode may be automatically switched in accordance with the temperature setting and the inside temperature.

### ■ When the outside temperature exceeds 75°F (24°C) and the air conditioning system is on

- In order to reduce the air conditioning power consumption, the air conditioning system may switch to recirculated air mode automatically. This may also reduce fuel consumption.
- Recirculated air mode is selected as a default mode when the “POWER” switch is turned to ON mode.
- It is possible to switch to outside air mode at any time by pressing .

### ■ Window defogger feature

Recirculated air mode may automatically switch to outside air mode in situations where the windows need to be defogged.

### ■ When outside air temperature is below 32°F (0°C)

The cooling and dehumidification function may not operate even when  is on.

### ■ Ventilation and air conditioning odors

- To let fresh air in, set the air conditioning system to the outside air mode.
- During use, various odors from inside and outside the vehicle may enter into and accumulate in the air conditioning system. This may then cause odor to be emitted from the vents.
- To reduce potential odors from occurring:
  - It is recommended that the air conditioning system be set to outside air mode prior to turning the vehicle off.
  - The start timing of the blower may be delayed for a short period of time immediately after the air conditioning system is started in automatic mode.

### CAUTION

#### ■ To prevent the windshield from fogging up

Do not use  during cool air operation in extremely humid weather. The difference between the temperature of the outside air and that of the windshield can cause the outer surface of the windshield to fog up, blocking your vision.

### NOTICE

#### ■ To prevent 12-volt battery discharge

Do not leave the air conditioning system on longer than necessary when the hybrid system is off.

### 3-2. Using the air conditioning system and defogger

#### Automatic air conditioning system (without a navigation system or the Lexus Display Audio system)

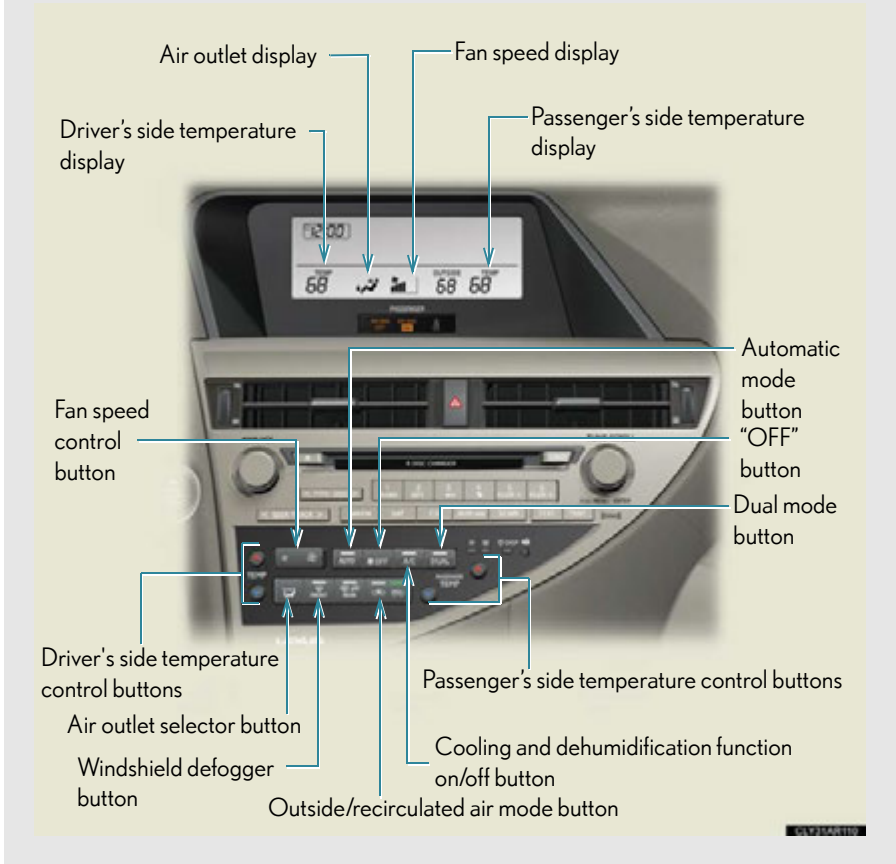

Air outlets and fan speed are automatically adjusted according to the temperature setting.





## Using the automatic air conditioning system

**STEP 1** Press .

The air conditioning system begins to operate. Air outlets and fan speed are automatically adjusted according to the temperature setting.

**STEP 2** Press  on  to increase the temperature and  to decrease the temperature.



When  is pressed (the indicator on  is on) or the passenger's side temperature control button is pressed, the temperature for the driver and passenger seats can be adjusted separately.

### ■ Automatic mode indicator



If fan speed setting or air flow modes are operated, the automatic mode indicator goes off. However, automatic mode for functions other than that operated are maintained.



## Adjusting the settings manually

### ■ Basic setting

**STEP 1** To turn on the air conditioning system and adjust the fan speed, press  on  to increase the fan speed and  to decrease the fan speed.

To turn the fan off, press .

**STEP 2** To adjust the temperature setting, press  on  to increase the temperature and  to decrease the temperature.

When  is pressed (the indicator on  is on) or the passenger's side temperature control button is pressed, the temperature for the driver and passenger seats can be adjusted separately.

### 3-2. Using the air conditioning system and defogger

**STEP 3** To change the air outlets, press  .

The air outlets used are switched each time the button is pressed. The air flow shown on the display indicates the following:

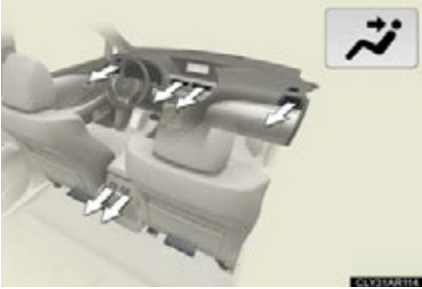

Air flows to the upper body.



Air flows to the upper body and feet.

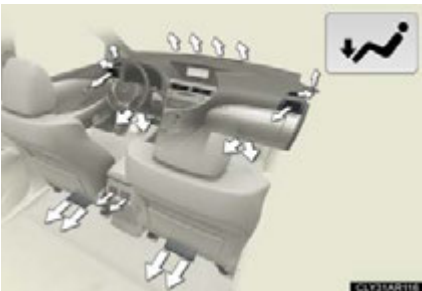

Air flows to the feet.



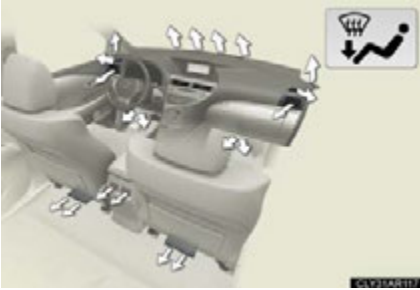



Air flows to the feet and the windshield defogger operates.

### ■ Switching between outside air and recirculated air modes

Press  .

The mode switches between  (recirculated air mode) and  (outside air mode) modes each time the button is pressed.

### Defogging the windshield



### Defogging

The air conditioning system operates automatically.

Recirculated air mode will automatically switch to outside air mode. It is not possible to return to recirculated air mode when the switch is on.

## Adjusting the position of and opening and closing the air outlets

### ► Front center outlets

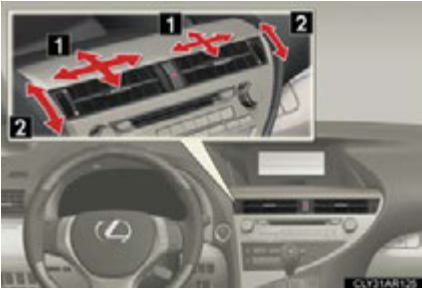

1 Direct air flow to the left or right, up or down.

2 Turn the knob to open or close the vent.

### ► Front side outlets



1 Direct air flow to the left or right, up or down.

2 Turn the knob to open or close the vent.

### ► Rear outlets

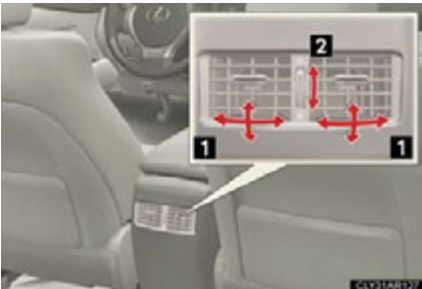

1 Direct air flow to the left or right, up or down.

2 Turn the knob to open or close the vent.

### ■ Operation of the air conditioning system in Eco drive mode

In Eco drive mode, the air conditioning system is controlled as follows to prioritize fuel efficiency:

- Engine speed and compressor operation controlled to restrict heating/cooling capacity
- Fan speed restricted when automatic mode is selected

To improve air conditioning performance, perform the following operations:

- Adjust the fan speed
- Turn off Eco drive mode

### ■ Customization

The air conditioning control of Eco drive mode can be changed to the same setting as that used in normal drive mode.

(Customizable features →P. 825)

### ■ Air conditioning system settings

- When the “POWER” switch is turned on, the air conditioning system settings will be set to those that were in use the last time the “POWER” switch was turned off.
- Air conditioning system settings are memorized individually on each electronic key, so the settings reproduced will be specific to the key that is used.
- This feature is customizable at your Lexus dealer.

### ■ Using automatic mode

Fan speed is adjusted automatically according to the temperature setting and ambient conditions. As a result, the following may occur:

Immediately after the button is pressed, the fan may stop for a while until warm or cool air is ready to flow.

### ■ Using the system in recirculated air mode

The windows will fog up more easily if recirculated air mode is used for an extended period.

### ■ Switching between outside air and recirculated air modes

Recirculated air mode or outside air mode may be automatically switched in accordance with the temperature setting and the inside temperature.

### ■ When the outside temperature exceeds 75°F (24°C) and the air conditioning system is on

- In order to reduce the air conditioning power consumption, the air conditioning system may switch to recirculated air mode automatically. This may also reduce fuel consumption.
- Recirculated air mode is selected as a default mode when the "POWER" switch is turned to ON mode.
- It is possible to switch to outside air mode at any time by pressing .

### ■ Window defogger feature

Recirculated air mode may automatically switch to outside air mode in situations where the windows need to be defogged.

### ■ When outside air temperature is below 32°F (0°C)

The cooling and dehumidification function may not operate even when  is pressed.

### ■ When the indicator light on goes off

Press  to turn on the cooling and dehumidification function again. There may be a problem in the air conditioning system if the indicator light goes off again shortly after the button is pressed. Have it inspected by your Lexus dealer.

### ■ Ventilation and air conditioning odors

- To let fresh air in, set the air conditioning system to the outside air mode.
- During use, various odors from inside and outside the vehicle may enter into and accumulate in the air conditioning system. This may then cause odor to be emitted from the vents.
- To reduce potential odors from occurring:
  - It is recommended that the air conditioning system be set to outside air mode prior to turning the vehicle off.
  - The start timing of the blower may be delayed for a short period of time immediately after the air conditioning system is started in automatic mode.

 CAUTION

■ To prevent the windshield from fogging up

Do not use  during cool air operation in extremely humid weather. The difference between the temperature of the outside air and that of the windshield can cause the outer surface of the windshield to fog up, blocking your vision.

 NOTICE

■ To prevent 12-volt battery discharge

Do not leave the air conditioning system on longer than necessary when the hybrid system is off.

## 3-2. Using the air conditioning system and defogger

### Rear window defogger switch

Defoggers are used to defog the rear window, and to remove raindrops, dew and frost from the outside rear view mirrors.

▶ Vehicles with a navigation system

Owners of models equipped with a navigation system should refer to the “Navigation System Owner’s Manual”.

▶ Vehicles with the Lexus Display Audio system



Turns the rear window and outside rear view mirror defoggers on/off

The defoggers will automatically turn off after 15 to 60 minutes. The operation time changes according to the ambient temperature and vehicle speed.

▶ Vehicles without a navigation system or the Lexus Display Audio system



Turns the rear window and outside rear view mirror defoggers on/off

The defoggers will automatically turn off after 15 to 60 minutes. The operation time changes according to the ambient temperature and vehicle speed.

---

■ **Operating conditions**

The "POWER" switch is in ON mode.

■ **The outside rear view mirror defoggers**

Turning the rear window defogger on will turn the outside rear view mirror defoggers on.

 **CAUTION**

■ **When the outside rear view mirror defoggers are on**

Do not touch the outside surface of the rear view mirrors, as they can become very hot and burn you.

## 3-2. Using the air conditioning system and defogger

### Windshield wiper de-icer\*

This feature is used to prevent ice from building up on the windshield and wiper blades.

- ▶ Vehicles with a navigation system

Owners of models equipped with a navigation system should refer to the "Navigation System Owner's Manual".

- ▶ Vehicles with the Lexus Display Audio system

**STEP 1** Display the air conditioning operation screen. (→P. 342)

**STEP 2**



Select  to the windshield wiper de-icer on/off

The windshield wiper de-icer will automatically turn off after approximately 15 minutes.

- ▶ Vehicles without a navigation system or the Lexus Display Audio system



Turns the windshield wiper de-icer on/off

The windshield wiper de-icer will automatically turn off after approximately 15 minutes.

\*: If equipped



---

■ **Operating conditions**

The "POWER" switch is in ON mode.

 **CAUTION**

■ **When the windshield wiper de-icer is on**

Do not touch the lower part of the windshield or the side of the front pillars, as the surfaces can become very hot and burn you.

### 3-3. Using the Lexus Display Audio system Audio system (with the Lexus Display Audio system)

To display the audio control screen, press the “MEDIA” button, “RADIO” button or the “AUDIO” button on the Lexus Display Audio controller.



LEXUS

Title	Page
Using the radio	P. 365
Using the CD player	P. 380
Playing an audio CD and MP3/WMA discs	P. 381
Listening to an iPod	P. 391
Listening to a USB memory	P. 399
Using the AUX port	P. 408
Listening to Bluetooth <sup>®</sup> audio	P. 410
Optimal use of the audio system	P. 424
Using the steering wheel audio switches	P. 426

## Switching the audio source

**STEP 1** Press the “MEDIA” button, “RADIO” button or the “AUDIO” button on the Lexus Display Audio controller to display the audio control screen.

**STEP 2**

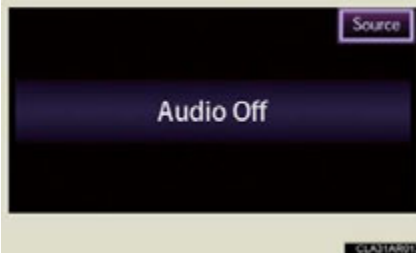

Select “Source” or press the “AUDIO” button on the Lexus Display Audio controller to display the audio source selection screen.

Each time the “MEDIA” button is pressed, an audio source other than radio is changed to.

Each time the “RADIO” button is pressed, radio mode is changed.

**STEP 3**

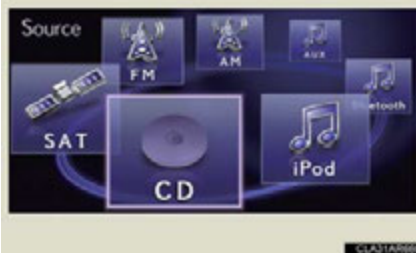

Select the desired audio source.

#### ■ Using mobile phones

Interference may be heard through the audio system's speakers if a mobile phone is being used inside or close to the vehicle while the audio system is operating.

#### CAUTION

##### ■ Certification

Part 15 of the FCC Rules

FCC Warning:

Any unauthorized changes or modifications to this equipment will void the user's authority to operate this device.

#### NOTICE

##### ■ To prevent 12-volt battery discharge

Do not leave the audio system on longer than necessary when the hybrid system is off.

##### ■ To avoid damaging the audio system

Take care not to spill drinks or other fluids on the audio system.

### 3-3. Using the Lexus Display Audio system

## Using the radio

Press the “RADIO” button or “AUDIO” button on the Lexus Display Audio controller and then select “AM”, “FM” or “SAT”.

#### ■ Control panel

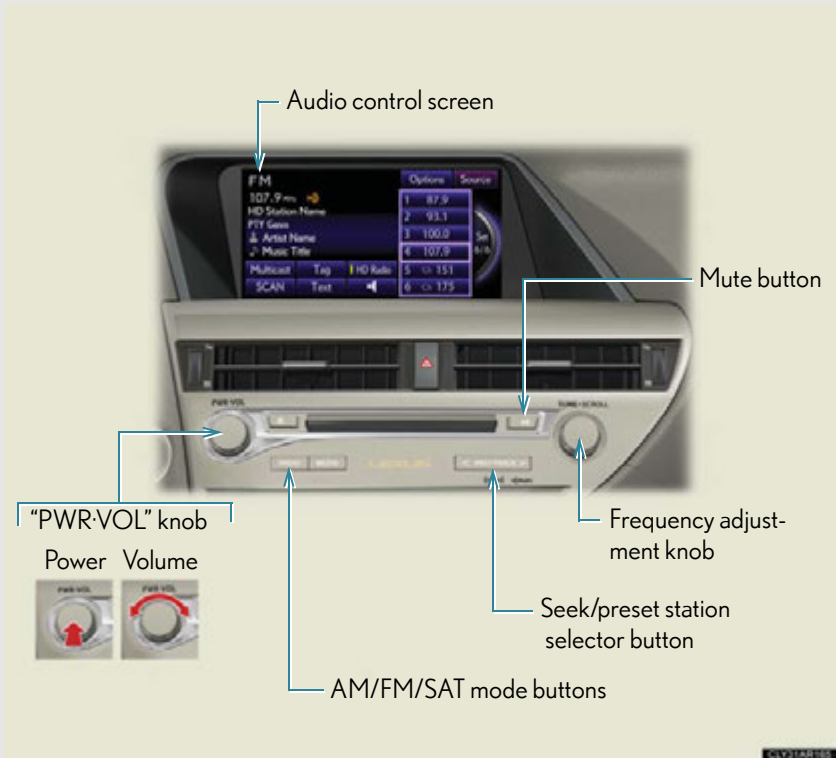

### ■ Audio control screen

Pressing the “RADIO” button or “AUDIO” button on the Lexus Display Audio controller displays the audio control screen from any screens of the selected source.

#### ▶ “Presets” screen



#### ▶ “Options” screen



- 1 “Options” screen appears
- 2 Audio source selection screen appears
- 3 Changing the Multicast Ch
- 4 Information in the music under broadcasting is memorized
- 5 Selecting HD Radio™ technology
- 6 Setting the sound (→P. 424)
- 7 Displaying text messages
- 8 Scanning for receivable station
- 9 Preset stations
- 10 “Presets” screen appears
- 11 Selecting program type or channel category
- 12 RBDS message display on/off
- 13 Displaying traffic messages

## Selecting a station

### ■ Seek tuning

Press and hold “<” or “>” on the “PRST•TRACK” button.

### ■ Manual tuning

Turn the “TUNE•SCROLL” knob.

### ■ Preset stations

Press “<” or “>” on the “PRST•TRACK” button or select desired preset stations.

## Setting station presets (excluding XM® Satellite Radio)

Radio mode has a mix preset function, which can store up to 36 stations (6 station per page × 6 page) from any of the AM, FM or SAT bands.

**STEP 1** Search for desired stations by turning the “TUNE•SCROLL” knob or pressing and holding “<” or “>” on the “PRST•TRACK” button.

**STEP 2** Select and hold one of the preset stations (1-6 every page).

## Scanning radio stations (excluding XM® Satellite Radio)

**STEP 1** Select “SCAN” on the screen.

“SCAN” appears on the screen. The radio will find the next station and stay there for 10 seconds if “All” or “HD Only” is selected, or 5 seconds if “Analog” is selected (→P. 371), and then scan again.

**STEP 2** Select “SCAN” once again when the desired station is reached.

## RBDS (Radio Broadcast Data System)

This feature allows your radio to receive station identification information and program information (classical, jazz, etc.) from radio stations which broadcast this information. RBDS features are available only when listening to an FM station that broadcasts RBDS information and the “FM Info” indicator is on.

### ■ Selecting a desired type

STEP 1

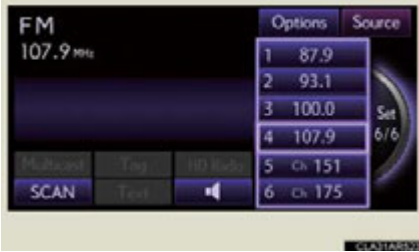

Select “Options”.

STEP 2

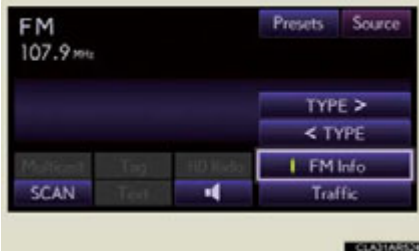

Select “FM Info” to turn the indicator on.



**STEP 3** Select “TYPE >” or “<TYPE” to select program types.

The type of program changes each time the button is selected.

- Classical
- Country
- EasyLis (Easy Listening)
- Inform (Information)
- Jazz
- News
- Oldies
- Other
- Pop Music
- Religion
- Rock
- R&B (Rhythm and Blues)
- Sports
- Talk
- Traffic (Not available when “HD Radio Settings” are set to analog)
- Alert (Emergency Alert)

When a program is set, “TYPE SEEK” appears.

**STEP 4**

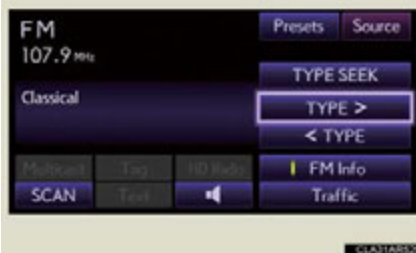

Select “TYPE SEEK”.

The radio seeks or scans for stations by the relevant program type.

If no relevant program can be found, “no type” will appear on the screen.

### ■ Traffic announcement

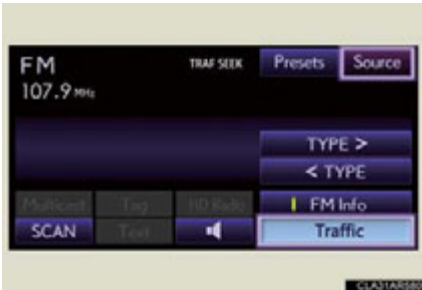

Select “Traffic” on the “Options” screen.

“TRAF SEEK” appears on the screen, and the radio will start seeking any station broadcasting traffic program information.

If no traffic program station is found, “No Traffic” appears on the screen.

### HD Radio™ technology information

HD Radio™ Technology is the digital evolution of analog AM/FM radio. Your radio product has a special receiver which allows it to receive digital broadcasts (where available) in addition to the analog broadcasts it already receives. Digital broadcasts have better sound quality than analog broadcasts as digital broadcasts provide free, crystal clear audio with no static or distortion. For more information, and a guide to available radio stations and programming, refer to [www.hdradio.com](http://www.hdradio.com).



HD Radio Technology manufactured under license from iBiquity Digital Corporation. U.S. and Foreign Patents. HD Radio™ and the HD, HD Radio, and “Arc” logos are proprietary trademarks of iBiquity Digital Corp.

### ■ HD Radio™ technology settings

**STEP 1** Display the “Setup” screen. (→P. 334)

**STEP 2** Select “Audio” on the “Setup” screen.

**STEP 3**

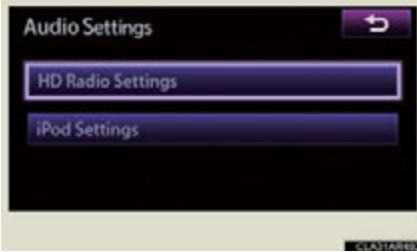

Select “HD Radio Settings”.

**STEP 4**

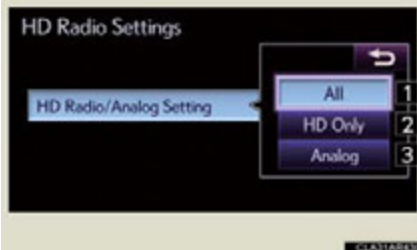

Select “HD Radio/Analog Settings”.

- 1 Receiving both analog and digital broadcasts
- 2 Receiving only digital broadcasts
- 3 Receiving only analog broadcasts

**STEP 5** When you complete settings, select “Save”.

### ■ Using HD Radio™ technology

**STEP 1**

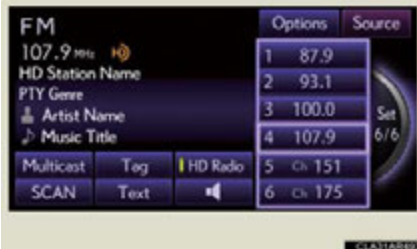

Select “HD Radio” portion to turn the indicator on.

The radio receiver will automatically tune from an analog signal to a digital signal within 5 seconds.

An orange “HD”) logo indicator will be displayed when in digital.

**STEP 2** Search for desired stations by turning the “TUNE•SCROLL” knob or pressing and holding “<” or “>” on the “PRST•TRACK” button.

### ■ Selecting a desired type

**STEP 1** Select "Options".

**STEP 2** Select "TYPE >" or "< TYPE" to select program types.

The type of program changes each time the button is selected.  
(→P. 368)

When a program is set, "TYPE SEEK" appears.

**STEP 3** Select "TYPE SEEK".

The radio seeks or scans for stations by the relevant program type.

If no relevant program can be found, "no type" will appear on the screen.

### ■ Displaying text information

Information such as the artist name, song title, album title and music genre being listened to are displayed on the text screen.

**STEP 1**



Select "Text".

**STEP 2**

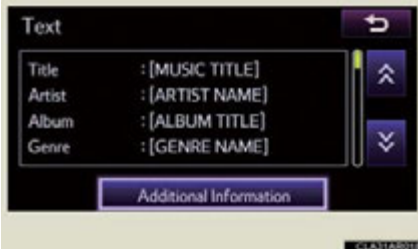

Select "Additional Information" to display messages from the station.

### ■ Changing the multiple or supplemental programs

On the FM radio frequency most digital stations have multiple or supplemental programs on one FM station.

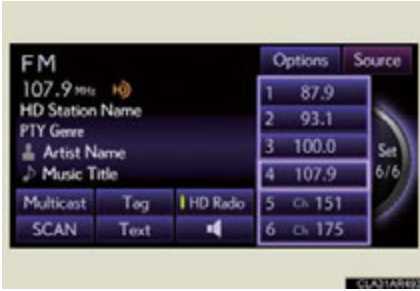

Select "Multicast".

Each time "Multicast" is selected, the supplemental program changes.

If "Multicast" is selected when tuned to the last of the supplemental programs, the main program will be returned to.

### ■ Preserving tag information

Tag information in the music broadcasting is preserved in the system and transmits to an iPod.



Select "Tag" to bookmark the music information.

**STEP 2** Connect iPod using an iPod cable.  
(→P. 391)

The music tag moves from the system into the iPod.

If tagging the music information fails, error message will be displayed on the screen. If this occurs, tag the information again.

Turn on the power of the iPod if it is not turned on.

When the iPod is connected to iTunes, the "tagged" information of the songs which were tagged while listening to the radio can be viewed. Then a user may decide to purchase the song or CD/Album.

■ HD Radio™ technology troubleshooting guide

Experience	Cause	Action
Mismatch of time alignment- a user may hear a short period of programming replayed or an echo, stutter or skip.	The radio stations analog and digital volume is not properly aligned or the station is in ball-game mode.	None, radio broadcast issue. A user can contact the radio station.
Sound fades, blending in and out.	Radio is shifting between analog and digital audio.	Reception issue, may clear-up as the vehicle continues to be driven. Selecting "Analog" can force radio in an analog audio.
Audio mute condition when an HD2/ HD3 multicast channel had been playing.	The radio does not have access to digital signals at the moment.	This is normal behavior, wait until the digital signal returns. If out of the coverage area, seek a new station.
Audio mute delay when selecting an HD2/HD3 multicast channel preset.	The digital multicast content is not available until HD Radio™ broadcast can be decoded and make the audio available. This takes up to 7 seconds.	This is normal behavior, wait for the audio to become available.
Text information does not match the present song audio.	Data service issue by the radio broadcaster.	Broadcaster should be notified. Complete the form; <a href="http://www.ibiquity.com/automotive/report_radio_station_experiences">www.ibiquity.com/automotive/report_radio_station_experiences</a> .

Experience	Cause	Action
No text information shown for the present selected frequency.	Data service issue by the radio broadcaster.	Broadcaster should be notified. Complete the form; <a href="http://www.ibiquity.com/automotive/report_radio_station_experiences">www.ibiquity.com/automotive/report_radio_station_experiences</a> .

## XM<sup>®</sup> Satellite Radio

### ■ Receiving XM<sup>®</sup> Satellite Radio

**STEP 1** Press the “RADIO” button or select “SAT” on the audio source selection.

**STEP 2** Turn the “TUNE•SCROLL” knob to select the desired channel in the all categories or press and hold “<” or “>” on the “PRST•TRACK” button to select the desired channel in the current category.

### ■ Setting XM<sup>®</sup> Satellite Radio channel presets

Select the desired channel. Select and hold one of the preset stations (1-6 every page).

### ■ Changing the channel category

STEP 1

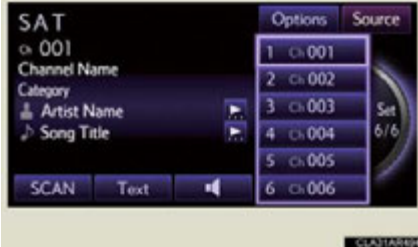

Select "Options".

STEP 2



Select "TYPE >" or "<TYPE".

### ■ Scanning XM<sup>®</sup> Satellite Radio channels

Scanning channels in the current category

STEP 1 Select "SCAN" on the screen.

"SCAN" appears on the screen.

STEP 2 Select "SCAN" once again when the desired channel is reached.

### ■ Displaying the title and artist name

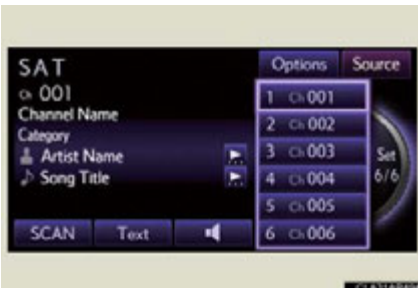

Select "Text".

The screen will show up to 64 characters.



### ■ When the 12-volt battery is disconnected

All preset stations are erased.

### ■ Reception sensitivity

- Cargo loaded on the roof luggage carrier, especially metal objects, may adversely affect the reception of XM<sup>®</sup> Satellite Radio.
- It is difficult to maintain perfect radio reception at all times due to the continually changing position of the antenna, differences in signal strength and surrounding objects, such as trains and transmitters.
- The radio antenna is mounted inside the rear spoiler and the rear window. To maintain clear radio reception, do not attach metallic window tinting or other metallic objects to the antenna wire mounted inside the rear window.

### ■ XM<sup>®</sup> Satellite Radio

An XM<sup>®</sup> Satellite Radio is a tuner designed exclusively to receive broadcasts provided under a separate subscription. Availability is limited to the 48 contiguous states and 10 Canadian provinces.

#### ● XM<sup>®</sup> subscriptions

For detailed information about XM<sup>®</sup> Satellite Radio or to subscribe:

U.S.A. —

Visit on the web at [www.siriusxm.com](http://www.siriusxm.com) or call 1-877-515-3987.

Canada —

Visit on the web at [www.xmradio.ca](http://www.xmradio.ca) or call 1-877-438-9677.

#### ● Radio ID

You will need the radio ID when activating XM<sup>®</sup> service or reporting a problem. Select “CH000” using the “TUNE•SCROLL” knob, and the receiver's 8-character ID number will appear.

#### ● Satellite tuner

The tuner supports only Audio Services (Music and Talk) and the accompanying Text Information of XM<sup>®</sup> Satellite Radio.

■ **If the satellite radio does not operate normally**

If a problem occurs with the XM<sup>®</sup> tuner, a message will appear on the display. Refer to the table below to identify the problem, and take the suggested corrective action.

Message	Explanation
SAT Check Antenna	The XM antenna is not connected. Check whether the XM antenna cable is attached securely.
	A short circuit occurs in the antenna or the surrounding antenna cable. See a Lexus certified dealer for assistance.
SAT Ch Unauthorized	You have not subscribed to XM Satellite Radio. The radio is being updated with the latest encryption code. Contact XM Satellite Radio for subscription information. When a contract is canceled, you can choose "CH 000" and all free-to-air channels.
	The premium channel you selected is not authorized. Wait for about 2 seconds until the radio returns to the previous channel or "CH001". If it does not change automatically, select another channel. To listen to the premium channel, contact XM Satellite Radio.
SAT No Signal	The XM signal is too weak at the current location. Wait until your vehicle reaches a location with a stronger signal.
Loading	The unit is acquiring audio or program information. Wait until the unit has received the information.
SAT Channel Off Air	The channel you selected is not broadcasting any programming. Select another channel.

Message	Explanation
-----	There is no song/program title or artist name/feature associated with the channel at that time. No action is required.
SAT Chan Unavailable	The channel you selected is no longer available. Wait for about 2 seconds until the radio returns to the previous channel or "CH 001". If it does not change automatically, select another channel.

Contact the XM<sup>®</sup> Listener Care Center at 1-877-515-3987 (U.S.A.) or 1-877-438-9677 (Canada).

#### ■ Certifications for XM<sup>®</sup> Satellite Radio

This device complies with RSS-310 of Industry Canada. Operation is subject to the condition that this device does not cause harmful interference.

Cet appareil est conforme au CNR-310 d'Industrie Canada. Son exploitation est autorisée sous réserve que l'appareil ne cause pas de brouillage préjudiciable.

### 3-3. Using the Lexus Display Audio system

## Using the CD player

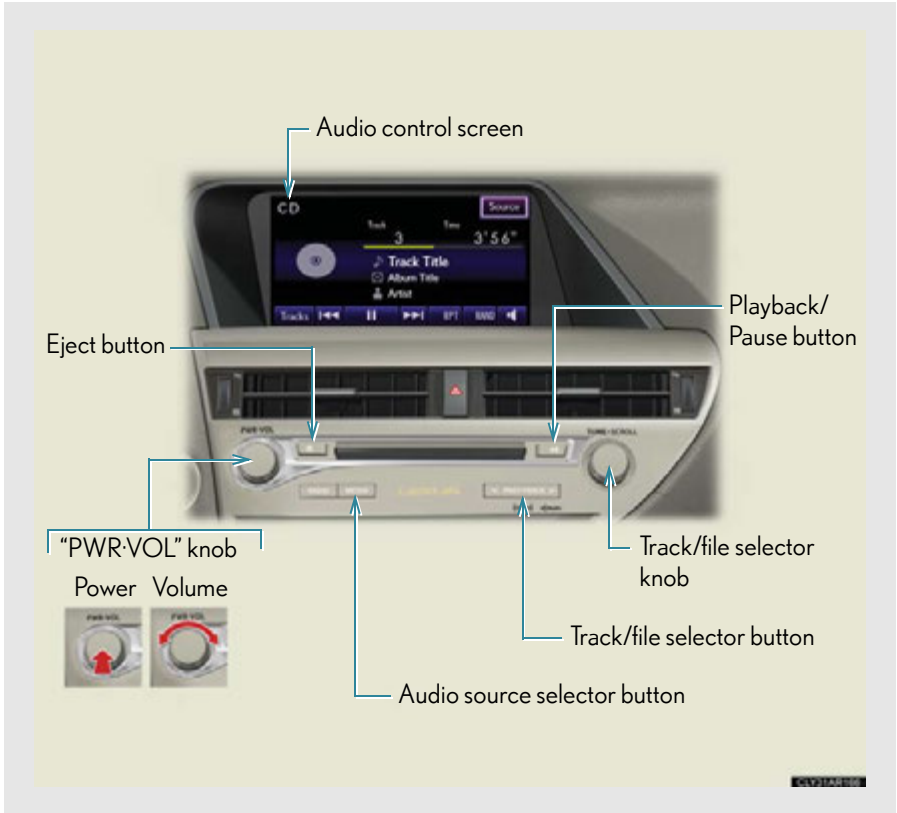

#### Loading a disc

Insert a disc into the disc slot.

#### Ejecting a disc

Press  and remove the disc.

### 3-3. Using the Lexus Display Audio system

## Playing an audio CD and MP3/WMA discs

Insert a disc or press the “MEDIA” button or the “AUDIO” button on the Lexus Display Audio controller and then select “CD” with a disc inserted.

#### ■ Audio control screen

Pressing the “MEDIA” button or the “AUDIO” button on the Lexus Display Audio controller displays the audio control screen from any screens of the selected source.

#### ▶ Audio CD

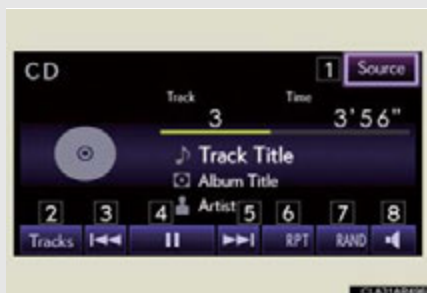

#### ▶ MP3/WMA disc



- 1 Audio source selection screen appears
- 2 Displaying the track/file list
- 3 Select: Playing the previous track/file  
Select and hold: Reversing a track/file
- 4 Pause  
Select  to play
- 5 Select: Playing the next track/file  
Select and hold: Fast-forwarding a track/file
- 6 Repeat play
- 7 Random playback
- 8 Setting the sound (→P. 424)
- 9 Displaying the folder list

## Selecting, fast-forwarding and reversing tracks (Audio CD)



### ■ Selecting a track

Press “<” or “>” on the “PRST•TRACK” button or turn the “TUNE•SCROLL” knob to select the desired track number.

To fast-forward or reverse, press and hold “>” or “<” on the “PRST•TRACK” button until you hear a beep.

### ■ Selecting a track from audio control screen

Select  or .

To fast-forward or reverse, select and hold  or  until you hear a beep.

### ■ Selecting a track from the track list

**STEP 1** Select “Tracks” on the screen.

**STEP 2**



Select the desired track number.

## Selecting, fast-forwarding and reversing files (MP3/WMA disc)



### ■ Selecting a file

Press “<” or “>” on the “PRST•TRACK” button or turn the “TUNE•SCROLL” knob to select the desired file number.

To fast-forward or reverse, press and hold “>” or “<” on the “PRST•TRACK” button until you hear a beep.

### ■ Selecting a file from audio control screen

Select  or .

To fast-forward or reverse, select and hold  or  until you hear a beep.

### ■ Selecting a file from the file list

**STEP 1** Select "Files" on the screen.

**STEP 2**



Select the desired file number.

### Selecting a folder (MP3/WMA disc)

**STEP 1** Select "Folders" on the screen.

**STEP 2**



Select the desired folder number.

**STEP 3**

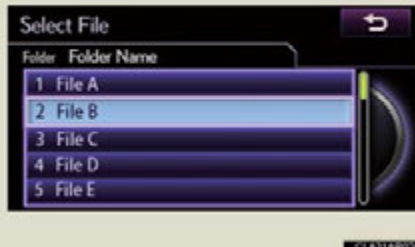

Select the desired file number.

## Random playback

Each time **RAND** is selected, the mode changes in the following order:

### ▶ Audio CD

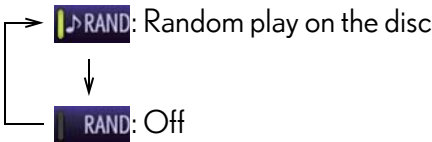

### ▶ MP3/WMA disc

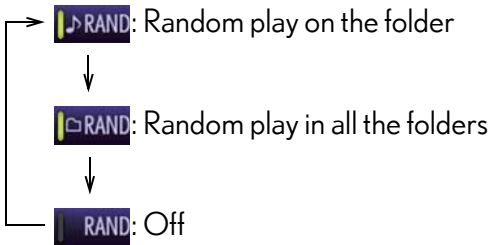

## Repeat play

Each time **RPT** is selected, the mode changes in the following order:

### ▶ Audio CD



### ▶ MP3/WMA disc

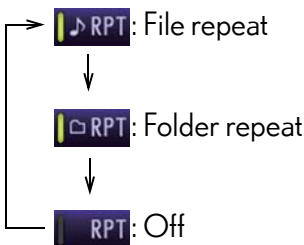



### ■ Displaying the title and artist name

If a CD-TEXT disc is inserted, the title of the disc and track will be displayed.

### ■ Error messages

If the following error messages appear on the screen, refer to the table and take the appropriate measures. If the problem is not rectified, take the vehicle to your Lexus dealer.

Message	Cause	Correction procedures
Check DISC	<ul style="list-style-type: none"> <li>• The disc is dirty or damaged.</li> <li>• The disc is inserted upside down.</li> <li>• The disc is not playable with the player.</li> </ul>	<ul style="list-style-type: none"> <li>• Clean the disc.</li> <li>• Insert the disc correctly.</li> <li>• Confirm the disc is playable with the player.</li> </ul>
DISC Error	There is a malfunction within the system.	Eject the disc.
No music files found.	This indicates that no playable data is included in the disc.	Eject the disc.

### ■ Discs that can be used

Discs with the marks shown below can be used.

Playback may not be possible depending on recording format or disc features, or due to scratches, dirt or deterioration.



CDs with copy-protection features may not play correctly.

### ■ CD player protection feature

To protect the internal components, playback is automatically stopped when a problem is detected.

### ■ If disc is left inside the CD player or in the ejected position for extended periods

Disc may be damaged and may not play properly.

#### ■ Lens cleaners

Do not use lens cleaners. Doing so may damage the CD player.

#### ■ MP3 and WMA files

MP3 (MPEG Audio LAYER 3) is a standard audio compression format.

Files can be compressed to approximately 1/10 of their original size by using MP3 compression.

WMA (Windows Media Audio) is a Microsoft audio compression format.

This format compresses audio data to a size smaller than that of the MP3 format.

There is a limit to the MP3 and WMA file standards that can be used and to the media/formats on which the files are recorded.

#### ● MP3 file compatibility

- Compatible standards  
MP3 (MPEG1 LAYER3, MPEG2 LSF LAYER3)
- Compatible sampling frequencies  
MPEG1 LAYER3: 32, 44.1, 48 (kHz)  
MPEG2 LSF LAYER3: 16, 22.05, 24 (kHz)
- Compatible bit rates (compatible with VBR)  
MPEG1 LAYER3: 32–320 (kbps)  
MPEG2 LSF LAYER3: 8–160 (kbps)
- Compatible channel modes: stereo, joint stereo, dual channel and monaural

#### ● WMA file compatibility

- Compatible standards  
WMA Ver. 7, 8, 9
- Compatible sampling frequencies  
32, 44.1, 48 (kHz)

Compatible bit rates (only compatible with 2-channel playback)

Ver. 7, 8: CBR 48–192 (kbps)

Ver. 9: CBR 48–320 (kbps)

#### ● Compatible media

Media that can be used for MP3 and WMA playback are CD-Rs and CD-RWs.

Playback in some instances may not be possible if the CD-R or CD-RW is not finalized. Playback may not be possible or the audio may jump if the disc is scratched or marked with fingerprints.

### ● Compatible disc formats

The following disc formats can be used.

- Disc formats: CD-ROM Mode 1 and Mode 2  
CD-ROM XA Mode 2, Form 1 and Form 2
- File formats: ISO9660 Level 1, Level 2, (Romeo, Joliet)  
UDF (2.01 or lower)

MP3 and WMA files written in any format other than those listed above may not play correctly, and their file names and folder names may not be displayed correctly.

Items related to standards and limitations are as follows.

- Maximum directory hierarchy: 8 levels (including the root)
- Maximum length of folder names/file names: 32 characters
- Maximum number of folders: 192 (including the root)
- Maximum number of files per disc: 255

### ● File names

The only files that can be recognized as MP3/WMA and played are those with the extension .mp3 or .wma.

### ● Discs containing multi-session recordings

As the audio system is compatible with multi-sessions, it is possible to play discs that contain MP3 and WMA files. However, only the first session can be played.

### ● ID3 and WMA tags

ID3 tags can be added to MP3 files, making it possible to record the track title, artist name, etc.

The system is compatible with ID3 Ver. 1.0, 1.1, and Ver. 2.2, 2.3 ID3 tags. (The number of characters is based on ID3 Ver. 1.0 and 1.1.)

WMA tags can be added to WMA files, making it possible to record the track title and artist name in the same way as with ID3 tags.

#### ● MP3 and WMA playback

When a disc containing MP3 or WMA files is inserted, all files on the disc are first checked. Once the file check is finished, the first MP3 or WMA file is played. To make the file check finish more quickly, we recommend you do not write in any files other than MP3 or WMA files or create any unnecessary folders.

Discs that contain a mixture of music data and MP3 or WMA format data cannot be played.

#### ● Extensions

If the file extensions .mp3 and .wma are used for files other than MP3 and WMA files, they may be mistakenly recognized and played as MP3 and WMA files. This may result in large amounts of interference and damage to the speakers.

#### ● Playback

- To play MP3 files with steady sound quality, we recommend a fixed bit rate of at least 128 kbps and a sampling frequency of 44.1 kHz.
- CD-R or CD-RW playback may not be possible in some instances, depending on the characteristics of the disc.
- There is a wide variety of freeware and other encoding software for MP3 and WMA files on the market, and depending on the status of the encoding and the file format, poor sound quality or noise at the start of playback may result. In some cases, playback may not be possible at all.
- When files other than MP3 or WMA files are recorded on a disc, it may take more time to recognize the disc and in some cases, playback may not be possible at all.
- Microsoft, Windows, and Windows Media are the registered trademarks of Microsoft Corporation in the U.S.A. and other countries.

 NOTICE

**■ CDs and adapters that cannot be used**

Do not use the following types of CDs.

Also, do not use 3 in. (8 cm) CD adapters, DualDiscs or printable discs.

Doing so may damage the CD player and/or the CD load/eject function.



- CDs that have a diameter that is not 4.7 in. (12 cm)

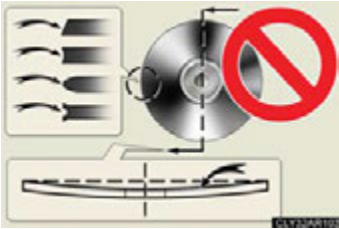

- Low-quality and deformed CDs



- CDs with a transparent or translucent recording area



- CDs that have had tape, stickers or CD-R labels attached to them, or that have had the label peeled off

#### NOTICE

##### ■ CD player precautions

Failure to follow the precautions below may result in serious damage to the CDs or the player itself.

- Do not insert anything other than CDs into the CD slot.
- Do not apply oil to the CD player.
- Store CDs away from direct sunlight.
- Never try to disassemble any part of the CD player.

## 3-3. Using the Lexus Display Audio system

### Listening to an iPod

Connecting an iPod enables you to enjoy music from the vehicle speakers. Press the “MEDIA” button or the “AUDIO” button on the Lexus Display Audio controller and then select “iPod” with an iPod connected.

#### ■ Connecting an iPod

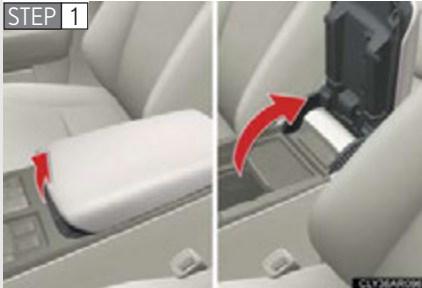

Pull up the lever to release the lock, and lift the armrest.



Open the cover and connect an iPod using an iPod cable.

Turn on the power of the iPod if it is not turned on.

■ Control panel

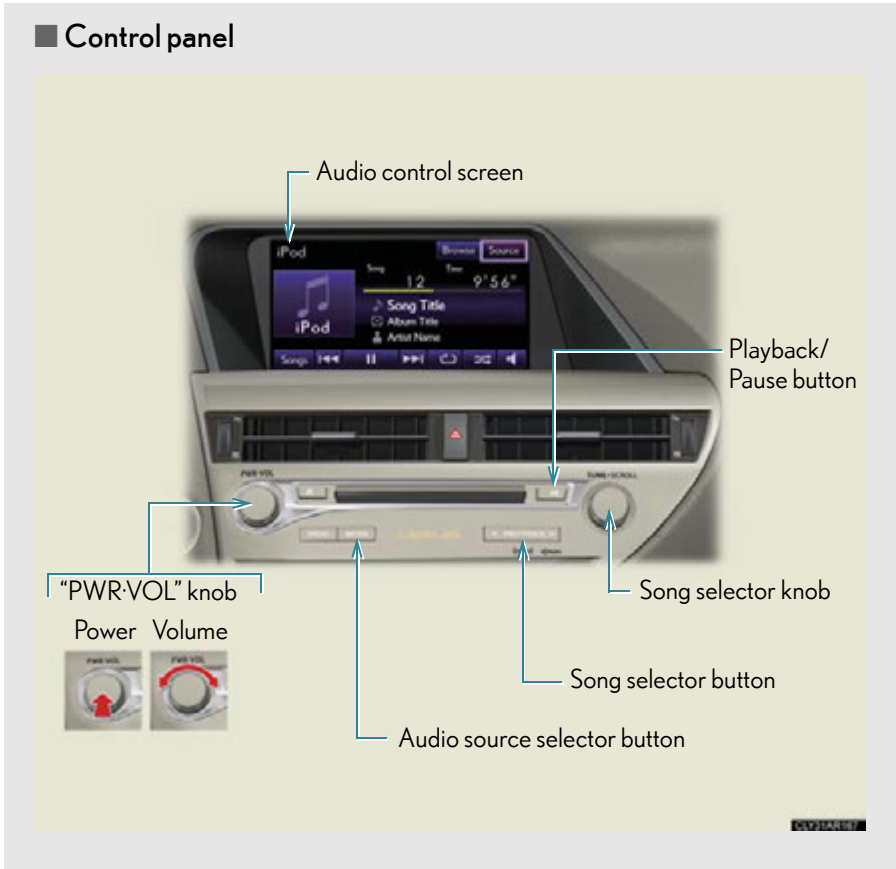



### ■ Audio control screen

Pressing the “MEDIA” button or the “AUDIO” button on the Lexus Display Audio controller displays the audio control screen from any screens of the selected source.

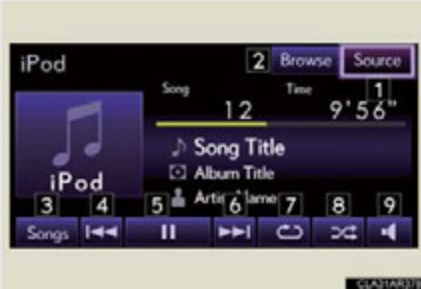

- 1 Audio source selection screen appears
- 2 Selecting the play mode
- 3 Displaying the song list
- 4 Select: Playing the previous song  
Select and hold: Reversing a song
- 5 Pause  
Select  to playback
- 6 Select: Playing the next song  
Select and hold: Fast-forwarding a song
- 7 Repeat play
- 8 Shuffle play
- 9 Setting the sound (→P. 424)

## Selecting a play mode

**STEP 1** Select “Browse” on the screen.

**STEP 2**

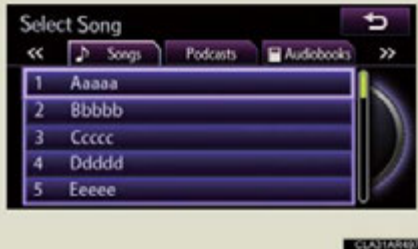

Select the desired play mode by selecting the “Playlists”, “Artists”, “Albums”, “Songs”, “Podcasts”, “Audio books”, “Genres” or “Composers” tabs.

## Selecting, fast-forwarding and reversing songs



### ■ Selecting one song at a time

Press “<” or “>” on the “PRST•TRACK” button or turn the “TUNE•SCROLL” knob to select the desired song.

To fast-forward or reverse, press and hold “>” or “<” on the “PRST•TRACK” button until you hear a beep.

### ■ Selecting a song from audio control screen

Select  or .

To fast-forward or reverse, select and hold  or  until you hear a beep.

### ■ Selecting a song from the list

**STEP 1** Select “Songs” on the screen.

**STEP 2**



Select the desired song.

## Shuffle play

Each time  is selected, the mode changes in the following order:

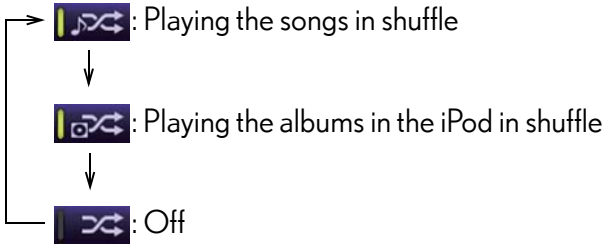

When a large number of songs is stored in an iPod, shuffle selection may take time.

## Repeat play

Each time  is selected, the mode changes in the following order:



### ■ About iPod

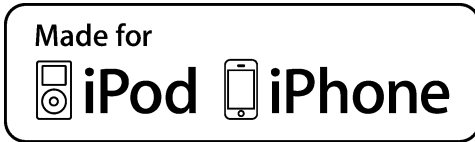

- “Made for iPod” and “Made for iPhone” mean that an electronic accessory has been designed to connect specifically to iPod, or iPhone, respectively, and has been certified by the developer to meet Apple performance standards.
- Apple is not responsible for the operation of this device or its compliance with safety and regulatory standards. Please note that the use of this accessory with iPod or iPhone may affect wireless performance.
- iPhone, iPod, iPod classic, iPod nano and iPod touch are trademarks of Apple Inc., registered in the U.S. and other countries.

### ■ iPod cover art

- Depending on the iPod and songs in the iPod, iPod cover art may be displayed.
- This function can be changed to “On” or “Off”. (→P. 338)
- It may take time to display iPod cover art, and the iPod may not be operated while the cover art display is in process.
- Only iPod cover art that is saved in a JPEG format can be displayed.

### ■ iPod functions

- When an iPod is connected and the audio source is changed to iPod mode, the iPod will resume play from the same point in which it was last used.
- Depending on the iPod that is connected to the system, certain functions may not be available. If a function is unavailable due to a malfunction (as opposed to a system specification), disconnecting the device and reconnecting it once again may resolve the problem.
- While connected to the system, the iPod cannot be operated with its own controls. It is necessary to use the controls of the vehicle’s audio system instead.
- When the battery level of an iPod is very low, the iPod may not operate. If so, charge the iPod before use.
- Supported models (→P. 397)

### ■ iPod problems

To resolve most problems encountered when using your iPod, disconnect your iPod from the vehicle iPod connection and reset it. For instructions on how to reset your iPod, refer to your iPod Owner's Manual.

### ■ Error messages

"Connection error. Please consult your Owner's Manual for instructions on how to connect the iPod.":

This indicates a problem in the iPod or its connection.

"There are no songs available for playback. Please load compatible media to your iPod.":

This indicates that there is no music data in the iPod.

### ■ Compatible models

The following iPod<sup>®</sup>, iPod nano<sup>®</sup>, iPod classic<sup>®</sup>, iPod touch<sup>®</sup> and iPhone<sup>®</sup> devices can be used with this system.

#### ● Made for

- iPod touch (4th generation)
- iPod touch (3rd generation)
- iPod touch (2nd generation)
- iPod touch (1st generation)
- iPod classic
- iPod with video
- iPod nano (6th generation)
- iPod nano (5th generation)
- iPod nano (4th generation)
- iPod nano (3rd generation)
- iPod nano (2nd generation)
- iPod nano (1st generation)
- iPhone 4
- iPhone 3GS
- iPhone 3G
- iPhone

Depending on differences between models or software versions etc., some models might be incompatible with this system.

#### CAUTION

##### ■ Caution while driving

Do not connect iPod or operate the controls.

#### NOTICE

##### ■ If the armrest cannot be fully closed

Depending on the size and shape of the iPod that is connected to the system, the armrest may not close fully. In this case, do not forcibly close the armrest as this may damage the iPod or the terminal, etc.

##### ■ To prevent damage to iPod

- Do not leave iPod in the vehicle. The temperature inside the vehicle may become high, resulting in damage to the player.
- Do not push down on or apply unnecessary pressure to the iPod while it is connected as this may damage the iPod or its terminal.
- Do not insert foreign objects into the port as this may damage the iPod or its terminal.

### 3-3. Using the Lexus Display Audio system

## Listening to a USB memory

Connecting a USB memory enables you to enjoy music from the vehicle speakers.

Press the “MEDIA” button or the “AUDIO” button on the Lexus Display Audio controller and then select “USB” with a USB memory connected.

#### ■ Connecting a USB memory



Pull up the lever to release the lock, and lift the armrest.

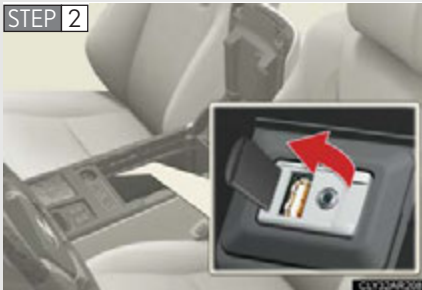

Open the cover and connect a USB memory.

Turn on the power of the USB memory if it is not turned on.

### ■ Control panel

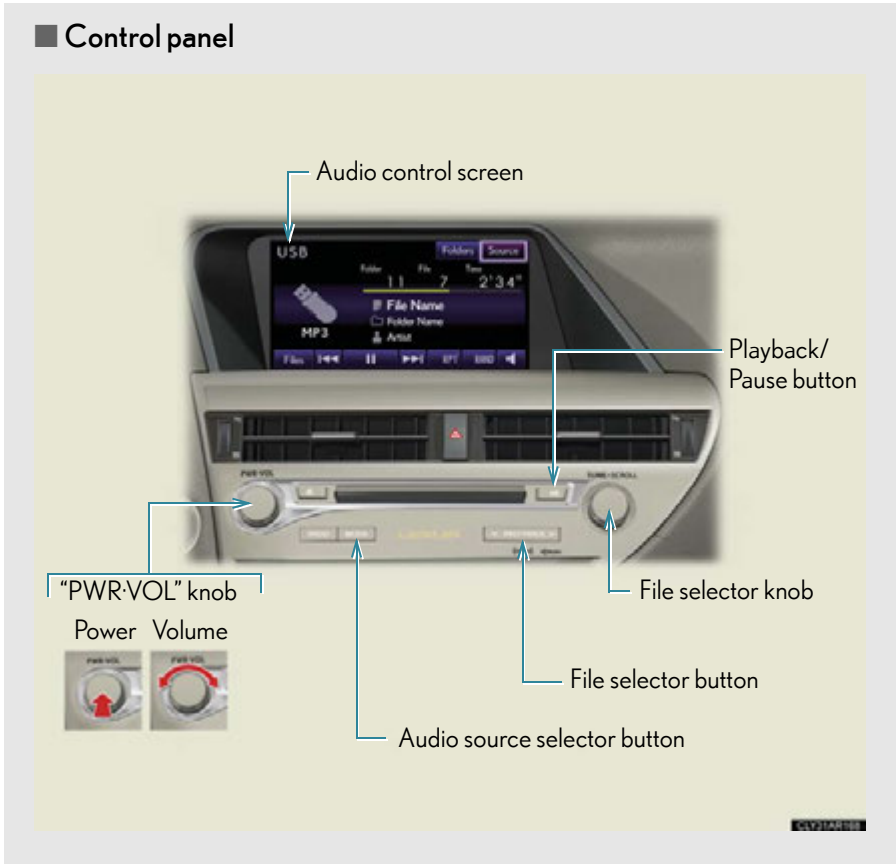



### ■ Audio control screen

Pressing the “MEDIA” button or the “AUDIO” button on the Lexus Display Audio controller displays the audio control screen from any screens of the selected source.



- 1 Audio source selection screen appears
- 2 Displaying the folder list
- 3 Displaying the file list
- 4 Select: Playing the previous file  
Select and hold: Reversing a file
- 5 Pause  
Select  to playback
- 6 Select: Playing the next file  
Select and hold: Fast-forwarding a file
- 7 Repeat play
- 8 Random playback
- 9 Setting the sound (→P. 424)

## Selecting, fast-forwarding and reversing files



### ■ Selecting one file at time

Press “<” or “>” on the “PRST•TRACK” button or turn the “TUNE•SCROLL” knob to select the desired file.

To fast-forward or reverse, press and hold “>” or “<” on the “PRST•TRACK” button until you hear a beep.

### ■ Selecting a file from audio control screen

Select  or .

To fast-forward or reverse, select and hold  or  until you hear a beep.

### ■ Selecting a file from the list

**STEP 1** Select “Files” on the screen.

**STEP 2**

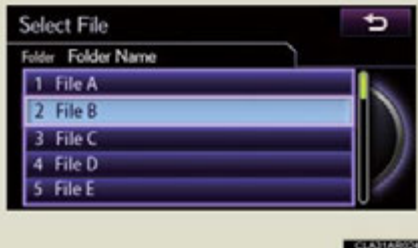

Select the desired file number.

## Selecting a folder

**STEP 1** Select "Folders" on the screen.

**STEP 2**



Select the desired folder number.

**STEP 3**

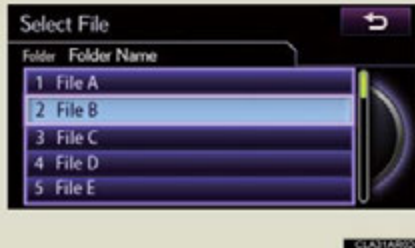

Select the desired file number.

3

Interior features

## Random playback

Each time **RAND** is selected, the mode changes in the following order:

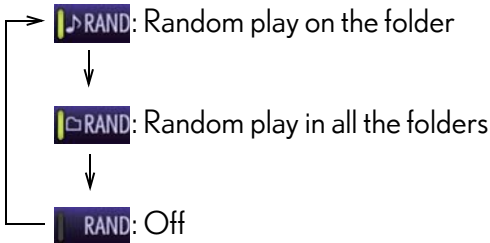

## Repeat play

Each time **RPT** is selected, the mode changes in the following order:

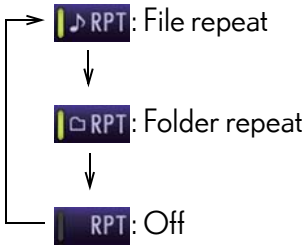

### ■ USB memory functions

- Depending on the USB memory that is connected to the system, the device itself may not be operable and certain functions may not be available. If the device is inoperable or a function is unavailable due to a malfunction (as opposed to a system specification), disconnecting the device and reconnecting it once again may resolve the problem.
- If the USB memory still does not begin operation after being disconnected and reconnected, format the memory.

### ■ Error messages for USB memory

“Connection error. Please consult your Owner’s Manual for instructions on how to connect the USB device.”:

This indicates a problem in the USB memory or its connection.

“No compatible audio files found. Please add compatible files to your USB device.”:

This indicates that no MP3/WMA files are included in the USB memory.

## ■ USB memory

### ● Compatible devices

USB memory that can be used for MP3 and WMA playback.

### ● Compatible device formats

The following device formats can be used:

- USB communication formats: USB2.0 HS (480Mbps)
  - File formats: FAT16/32 (Windows)
  - Correspondence class: Mass storage class
- MP3 and WMA files written in any format other than those listed above may not play correctly, and their file names and folder names may not be displayed correctly.

Items related to standards and limitations are as follows:

- Maximum directory hierarchy: 8 levels
- Maximum number of folders in a device: 3000 (including the root)
- Maximum number of files in a device: 9999
- Maximum number of files per folder: 255

### ● MP3 and WMA files

MP3 (MPEG Audio LAYER 3) is a standard audio compression format.

Files can be compressed to approximately 1/10 of their original size using MP3 compression.

WMA (Windows Media Audio) is a Microsoft audio compression format. This format compresses audio data to a size smaller than that of the MP3 format.

There is a limit to the MP3 and WMA file standards that can be used and to the media/formats on which the files are recorded.

### ● MP3 file compatibility

- Compatible standards  
MP3 (MPEG1 AUDIO LAYERII, III, MPEG2 AUDIO LAYERII, III, MPEG2.5)
- Compatible sampling frequencies  
MPEG1 AUDIO LAYERII, III: 32, 44.1, 48 (kHz)  
MPEG2 AUDIO LAYERII, III: 16, 22.05, 24 (kHz)
- Compatible bit rates (compatible with VBR)  
MPEG1 AUDIO LAYERII, III: 32-320 (kbps)  
MPEG2 AUDIO LAYERII, III: 8-160 (kbps)
- Compatible channel modes: stereo, joint stereo, dual channel and monaural

- WMA file compatibility

- Compatible standards  
WMA Ver. 7, 8, 9
- Compatible sampling frequencies  
HIGH PROFILE 32, 44.1, 48 (kHz)
- Compatible bit rates  
HIGH PROFILE 48-320 (kbps, VBR)

- File names

The only files that can be recognized as MP3/WMA and played are those with the extension .mp3 or .wma.

- ID3 and WMA tags

ID3 tags can be added to MP3 files, making it possible to record the track title, artist name, etc.

The system is compatible with ID3 Ver. 1.0, 1.1, and Ver. 2.2, 2.3, 2.4 ID3 tags. (The number of characters is based on ID3 Ver. 1.0 and 1.1.)

WMA tags can be added to WMA files, making it possible to record the track title and artist name in the same way as with ID3 tags.

- MP3 and WMA playback



- When a device containing MP3 or WMA files is connected, all files in the USB memory device are checked. Once the file check is finished, the first MP3 or WMA file is played. To make the file check finish more quickly, we recommend that you do not include any files other than MP3 or WMA files or create any unnecessary folders.
- When the USB device is connected and the audio source is changed to USB memory mode, the USB device will start playing the first file in the first folder. If the same device is removed and reinserted (and the contents have not been changed), the USB device will resume play from the same point in which it was last used.

- Extensions

If the file extensions .mp3 and .wma are used for files other than MP3 and WMA files, they will be skipped (not played).

- Playback

- To play MP3 files with steady sound quality, we recommend a fixed bit rate of at least 128 kbps and a sampling frequency of 44.1 kHz.
- There is a wide variety of freeware and other encoding software for MP3 and WMA files on the market, and depending on the status of the encoding and the file format, poor sound quality or noise at the start of playback may result. In some cases, playback may not be possible at all.
- Microsoft, Windows, and Windows Media are the registered trademarks of Microsoft Corporation in the U.S.A. and other countries.

 **CAUTION**
 **Caution while driving**

Do not connect USB memories or operate the controls.

 **NOTICE**
 **If the armrest cannot be fully closed**

Depending on the size and shape of the USB memory that is connected to the system, the armrest may not close fully. In this case, do not forcibly close the armrest as this may damage the USB memory or the terminal, etc.

 **To prevent damage to USB memories**

- Do not leave USB memories in the vehicle. The temperature inside the vehicle may become high, resulting in damage to the player.
- Do not push down on or apply unnecessary pressure to the USB memory while it is connected as this may damage the USB memory or its terminal.
- Do not insert foreign objects into the port as this may damage the USB memory or its terminal.

### 3-3. Using the Lexus Display Audio system

## Using the AUX port

This port can be used to connect a portable audio device and listen to it through the vehicle's speakers.

STEP 1

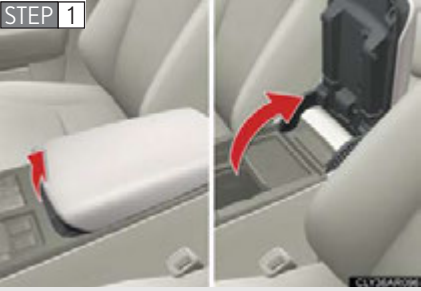

Pull up the lever to release the lock, and lift the armrest.

STEP 2



Open the cover and connect the portable audio device.

STEP 3

Press the "MEDIA" button or the "AUDIO" button on the Lexus Display Audio controller and then select "AUX".

#### ■ Operating portable audio devices connected to the audio system

The volume can be adjusted using the vehicle's audio controls. All other adjustments must be made on the portable audio device itself.

#### ■ When using a portable audio device connected to the power outlet

Noise may occur during playback. Use the power source of the portable audio device.



 **CAUTION****■ Caution while driving**

Do not connect portable audio device or operate the controls.

 **NOTICE****■ If the armrest cannot be fully closed**

Depending on the size and shape of the portable audio device that is connected to the system, the armrest may not close fully. In this case, do not forcibly close the armrest as this may damage the portable audio device or the terminal, etc.

**■ To prevent damage to portable audio device**

- Do not leave portable audio device in the vehicle. The temperature inside the vehicle may become high, resulting in damage to the player.
- Do not push down on or apply unnecessary pressure to the portable audio device while it is connected as this may damage the portable audio device or its terminal.
- Do not insert foreign objects into the port as this may damage the portable audio device or its terminal.

### 3-3. Using the Lexus Display Audio system Listening to Bluetooth® audio

The Bluetooth® audio system enables users to enjoy music played on a portable player from the vehicle speaker via wireless communication. This audio system supports Bluetooth®, a wireless data system capable of playing portable audio music without cables. If your portable player does not support Bluetooth®, the Bluetooth® audio system will not function.

Press the “MEDIA” button or the “AUDIO” button on the Lexus Display Audio controller and then select “Bluetooth\*”.

\*: Bluetooth is a registered trademark of Bluetooth SIG, Inc.

#### ■ Control panel

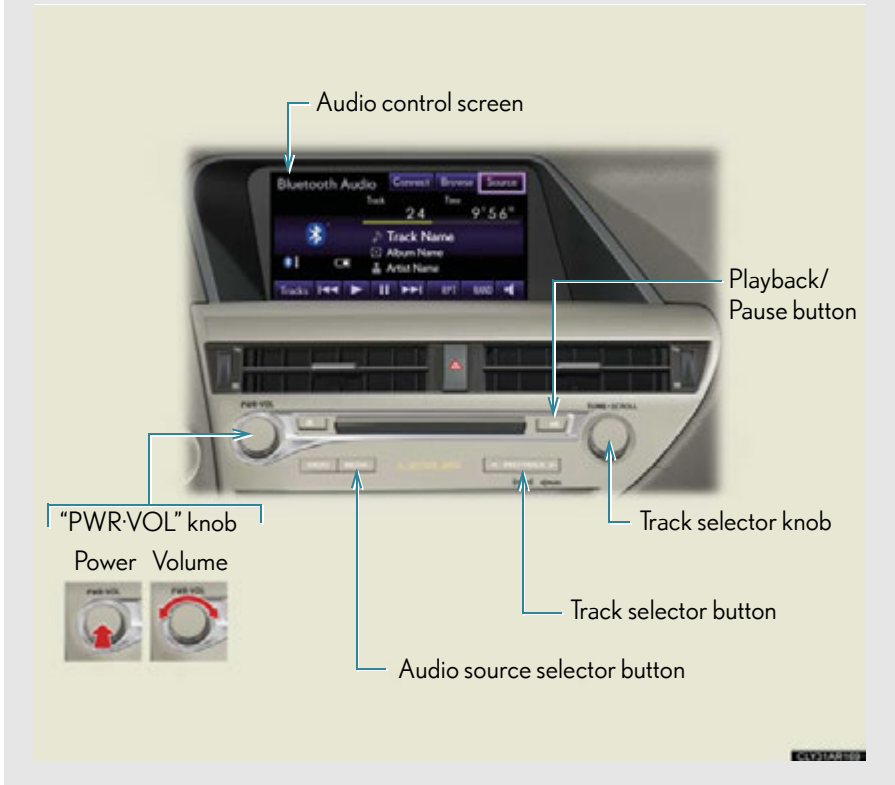

### ■ Audio control screen

Pressing the “MEDIA” button or the “AUDIO” button on the Lexus Display Audio controller displays the audio control screen from any screens of the selected source.



- 1 Audio source selection screen appears
- 2 Displaying the list
- 3 Connecting a Bluetooth<sup>®</sup> audio player
- 4 Displaying the track list
- 5 Select: Playing the previous track  
Select and hold: Reversing a track
- 6 Playback
- 7 Pause
- 8 Select: Playing the next track  
Select and hold: Fast-forwarding a track
- 9 Repeat play
- 10 Random playback
- 11 Setting the sound (→P. 424)

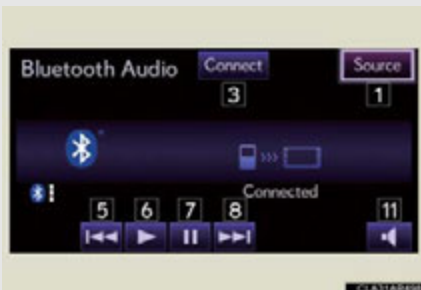







Some titles and controls may not be displayed depending on the type of portable audio player.

## Status display

You can check such indicators as signal strength and battery charge on the screen.



- 1 Connection status
- 2 Battery charge

Indicators	Conditions
Connection status	Good ←————→ Not connected   
Battery charge	Full ←————→ Empty   

## Registering a Bluetooth® audio player

To use the Bluetooth® audio system, you need to register your portable audio player into the system. Once registered, you can enjoy your music on the vehicle's audio system.

You can register up to 5 devices in the system.

**STEP 1** Display the "Bluetooth\* Audio" screen.

**STEP 2**

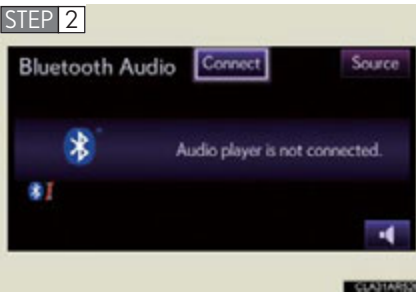

Select "Connect".

**STEP 3**

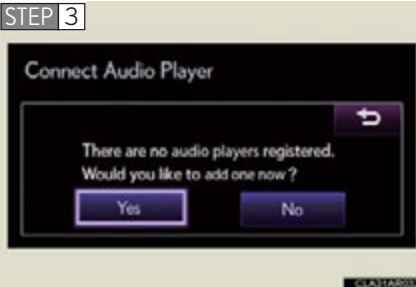

Select "Yes".

\*: Bluetooth is a registered trademark of Bluetooth SIG. Inc.

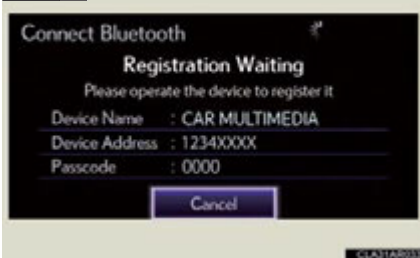
**STEP 4**

Input the passcode displayed on the screen into your portable audio player.

For the operation of the portable audio player, see the manual that comes with your portable audio player.

Passcodes are not required for SSP (Secure Simple Pairing) compatible Bluetooth<sup>®</sup> devices. Depending on the device, you may need to select "Yes" to register, or "No" to cancel on your Bluetooth<sup>®</sup> device.

If you want to cancel it, select "Cancel".

If a completion message is displayed, registration is complete.

If an error message is displayed, follow the guidance on the screen to try again.

## Selecting the Bluetooth® audio player

If multiple Bluetooth® devices are registered, follow the procedure below to select the Bluetooth® device to be used. You may only use one device at a time.

**STEP 1** Display the “Bluetooth\* Audio” screen.

**STEP 2**

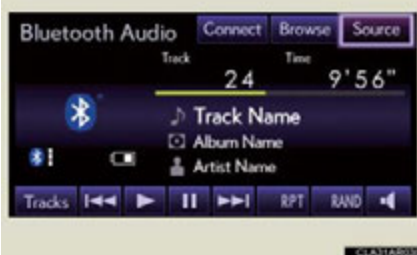

Select “Connect”.

**STEP 3**

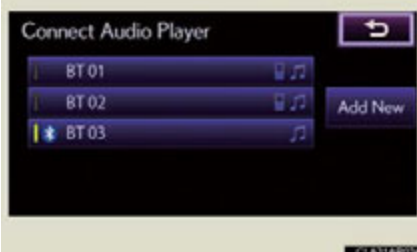

Select the device to connect.

“Add New”: Registering a Bluetooth® device. (→P. 467)

The selection indicator is displayed on left side of the selected device name.

The Bluetooth® mark is displayed when you connected the device.

\*: Bluetooth is a registered trademark of Bluetooth SIG, Inc.

## Connecting the Bluetooth® audio player

There are two connection methods available.

### ■ When the connection method is set to “From Vehicle”

When the portable audio player is on standby for the connection, it will be automatically connected whenever the “POWER” switch is in either ACCESSORY or ON mode.

### ■ When the connection method is set to “From Audio Player”

Operate the portable player and connect it to the Bluetooth® audio system.

**STEP 1** Display the “Bluetooth\* Audio” screen.

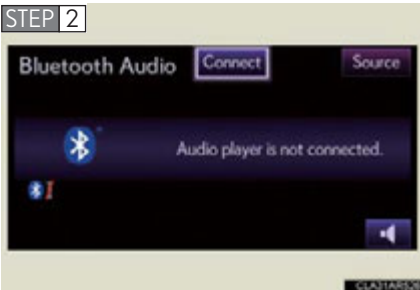

Select “Connect”.

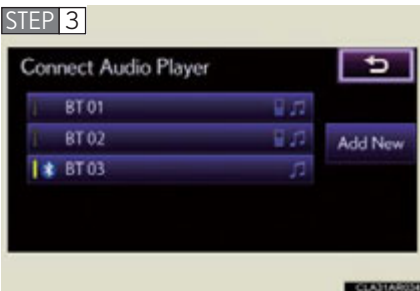

Select the device to connect.

A message is shown if connection has been successful.

If connection fails, a message will be displayed and connection will be re-attempted.

\*: Bluetooth is a registered trademark of Bluetooth SIG, Inc.



## Selecting, fast-forwarding and reversing tracks



### ■ Selecting a track

Press “<” or “>” on the “PRST•TRACK” button or turn the “TUNE•SCROLL” knob to select the desired track number.

To fast-forward or reverse, press and hold “>” or “<” on the “PRST•TRACK” button until you hear a beep.

### ■ Selecting a track from audio control screen

Select  or .

To fast-forward or reverse, select and hold  or  until you hear a beep.

### ■ Selecting a track from the list

#### ► From “Tracks”

**STEP 1** Select “Tracks” on the screen.

**STEP 2**



Select the desired track.

► From “Browse”

**STEP 1** Select “Browse” on the screen.

**STEP 2**

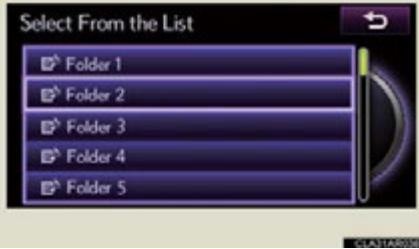

Select the desired item.

Continue to select the applicable screen button until its track list is displayed.

**STEP 3**



Select the desired track.

### Random playback

Each time **RAND** is selected, the mode changes in the following order:

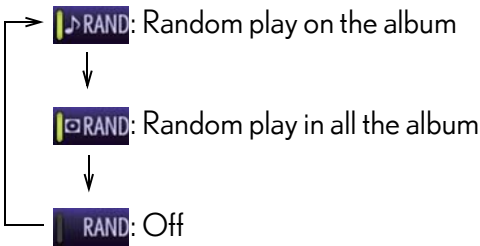

## Repeat play

Each time **RPT** is selected, the mode changes in the following order:

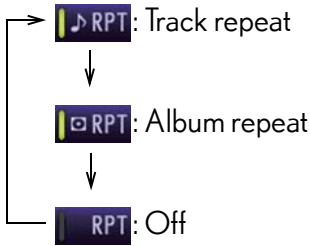

### ■ When using the Bluetooth® audio system

- In the following conditions, the system may not function.
  - If the portable audio player is turned off
  - If the portable audio player is not connected
  - If the portable audio player's battery is low
  - If the portable player is behind the seat or in the glove box or console box
  - If metal is covering or touching the portable player
- There may be a delay if phone connection is carried out during Bluetooth® audio play.
- Depending on the type of portable audio player that is connected to the system, operation may differ slightly and certain functions may not be available.

### ■ Bluetooth® antenna

The antenna is built into the display. If the portable audio player is behind the seat or in the glove box or console box, or is touching or covered by metal objects, connection status may deteriorate.

### ■ Battery charge/signal status

This display may not correspond exactly with the portable audio player, and this system does not have a charging function.

#### ■ About Bluetooth®



Bluetooth is a registered trademark of Bluetooth SIG, Inc.

#### ■ Compatible models

Portable audio players must correspond to the specifications.

- Bluetooth® specifications:

Ver. 1.1, or higher (Recommended: Ver. 2.1 + EDR or higher)

- Profiles:

- A2DP (Advanced Audio Distribution Profile) Ver. 1.0, or higher (Recommended: Ver. 1.2 or higher)

This is a profile to transmit stereo audio or high quality sounds to the head-phone.

- AVRCP (Audio/Video Remote Control Profile) Ver. 1.0 or higher (Recommended: Ver. 1.4 or higher)

This is a profile to remote control the A/V equipment.

However, please note that some functions may be limited depending on the type of portable audio player.

### ■ Certification for the Bluetooth® audio system

FCC ID: AJDK046

IC ID: 775E-K046

This device complies with Part 15 of FCC Rules and Industry Canada licence-exempt RSS standard(s). Operation is subject to the following two conditions: (1) this device may not cause interference, and (2) this device must accept any interference, including interference that may cause undesired operation of this device.

Le présent appareil est conforme aux la partie 15 des règles de la FCC et CNR d'Industrie Canada applicables aux appareils radio exempts de licence. L'exploitation est autorisée aux deux conditions suivantes : (1) l'appareil ne doit pas produire de brouillage, et (2) l'utilisateur de l'appareil doit accepter tout brouillage radioélectrique subi, même si le brouillage est susceptible d'en compromettre le fonctionnement.

### ■ Reconnecting the portable audio player

If the portable audio player is disconnected with a poor reception when the "POWER" switch is in ACCESSORY or ON mode, the system automatically reconnects the portable audio player.

If you have switched off the portable audio player yourself, follow the instructions below to reconnect:

- Select the portable audio player again
- Enter the portable audio player

### ■ When you release your car

Be sure to initialize your data. (→P. 336)

#### CAUTION

##### ■ FCC WARNING

Changes or modifications not expressly approved by the party responsible for compliance could void the user's authority to operate the equipment.

This equipment complies with FCC/IC radiation exposure limits set forth for an uncontrolled environment and meets the FCC radio frequency (RF) Exposure Guidelines in Supplement C to OET65 and RSS-102 of the IC radio frequency (RF) Exposure rules. This equipment has very low levels of RF energy that it deemed to comply without maximum permissive exposure evaluation (MPE). But it is desirable that it should be installed and operated keeping the radiator at least 20 cm or more away from person's body (excluding extremities: hands, wrists, feet and ankles).

Cet équipement est conforme aux limites d'exposition aux rayonnements énoncées pour un environnement non contrôlé et respecte les règles des radioélectriques (RF) de la FCC lignes directrices d'exposition dans le Supplément C à OET65 et d'exposition aux fréquences radioélectriques (RF) CNR-102 de l'IC. Cet équipement émet une énergie RF très faible qui est considérée conforme sans évaluation de l'exposition maximale autorisée.

Cependant, cet équipement doit être installé et utilisé en gardant une distance de 20 cm ou plus entre le dispositif rayonnant et le corps (à l'exception des extrémités : mains, poignets, pieds et chevilles).

This transmitter must not be co-located or operated in conjunction with any other antenna or transmitter.

Under Industry Canada regulations, this radio transmitter may only operate using an antenna of a type and maximum (or lesser) gain approved for the transmitter by Industry Canada. To reduce potential radio interference to other users, the antenna type and its gain should be so chosen that the equivalent isotropically radiated power (e.i.r.p.) is not more than that necessary for successful communication.

Conformément à la réglementation d'Industrie Canada, le présent émetteur radio peut fonctionner avec une antenne d'un type et d'un gain maximal (ou inférieur) approuvé pour l'émetteur par Industrie Canada. Dans le but de réduire les risques de brouillage radioélectrique à l'intention des autres utilisateurs, il faut choisir le type d'antenne et son gain de sorte que la puissance isotrope rayonnée équivalente (p.i.r.e.) ne dépasse pas l'intensité nécessaire à l'établissement d'une communication satisfaisante.

 CAUTION**■ Caution while driving**

Do not connect portable players or operate the controls.

**■ Caution regarding interference with electronic devices**

- Your audio unit is fitted with Bluetooth<sup>®</sup> antennas. People with implantable cardiac pacemakers, cardiac resynchronization therapy-pacemakers or implantable cardioverter defibrillators should maintain a reasonable distance between themselves and the Bluetooth<sup>®</sup> antennas. The radio waves may affect the operation of such devices.
- Before using Bluetooth<sup>®</sup> devices, users of any electrical medical device other than implantable cardiac pacemakers, cardiac resynchronization therapy-pacemakers or implantable cardioverter defibrillators should consult the manufacturer of the device for information about its operation under the influence of radio waves. Radio waves could have unexpected effects on the operation of such medical devices.

 NOTICE**■ To prevent damage to portable players**

Do not leave portable players in the vehicle. The temperature inside the vehicle may become high, resulting in damage to the player.

### 3-3. Using the Lexus Display Audio system

## Optimal use of the audio system

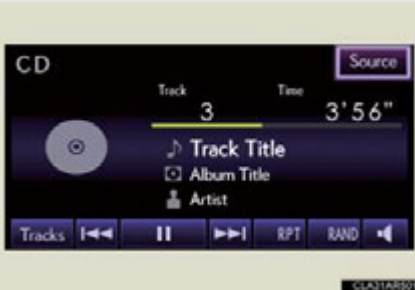

► “Sound” tab

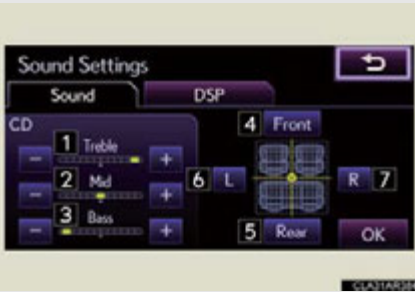

► “DSP” tab



Select  on the audio control screen to adjust the sound settings.

- 1 2 3 Select “-” or “+” to adjust the treble, mid or bass to a level between -5 to 5.
- 4 5 Select “Front” or “Rear” to adjust the front/rear audio balance to a level between Front 7 and Rear 7.
- 6 7 Select “L” or “R” to adjust the left/right audio balance to a level between L7 and R7.

- 1 Surround on/off
- 2 Automatic sound levelizer (ASL) on/off



---

- **The sound quality level is adjusted individually**

The treble, mid and bass levels can be adjusted for the each audio mode separately.

- **About Automatic Sound Leveliser (ASL)**

ASL automatically adjusts the volume and tone quality according to the vehicle speed.

### 3-3. Using the Lexus Display Audio system

## Using the steering wheel audio switches

Some audio features can be controlled using the switches on the steering wheel.



- 1** Press: Turns the power on, selects audio source  
Press and hold: Pause or mute
- 2** Increases/decreases volume
- 3** Radio mode:  
Selects radio stations
- CD mode:  
Selects tracks/files and folders (MP3/WMA)
- iPod mode: Selects songs
- USB memory mode:  
Selects files and folders
- Bluetooth<sup>®</sup> audio mode:  
Selects tracks and albums

### Turning the audio system on

To turn the audio system on, press the “MODE” switch.

## Changing the audio source

Press the “MODE” switch when the audio system is turned on. The audio source changes as follows each time the “MODE” switch is pressed. If no discs are inserted in the player, or if the external device is not connected, that mode will be skipped.

FM→SAT→CD player→iPod or USB memory→  
Bluetooth<sup>®</sup> audio→AUX→AM→FM

## Adjusting the volume

Press “+” to increase the volume and “-” to decrease the volume.

Hold the button in that position to continue increasing or decreasing the volume.

## Silencing a sound

Press and hold the “MODE” switch.

To cancel, press and hold the “MODE” switch.

## Selecting a radio station

**STEP 1** Press the “MODE” switch to select the radio mode.

**STEP 2** Press “^” or “v” on  to select a radio station.

To seek stations, press and hold “^” or “v” on  until you hear a beep.

### Selecting a track/file or song

**STEP 1** Press the “MODE” switch to select the CD, Bluetooth<sup>®</sup> audio, iPod or USB memory mode.

**STEP 2** Press “^” or “v” on  to select the desired track/file or song.

### Selecting a folder or album

**STEP 1** Press the “MODE” switch to select the CD (only when MP3/WMA disc is in use), Bluetooth<sup>®</sup> audio or USB memory mode.

**STEP 2** Press and hold “^” or “v” on  until you hear a beep.

### CAUTION

#### To reduce the risk of an accident

Exercise care when operating the audio switches on the steering wheel.

### 3-3. Using the Lexus Display Audio system

## Hands-free system (for mobile phone)

The hands-free system is a function that allows you to use your mobile phone without touching it.

This system supports Bluetooth®. Bluetooth® is a wireless data system that allows the mobile phone to wirelessly connect to the hands-free system and make/receive calls.

#### ■ Telephone switch

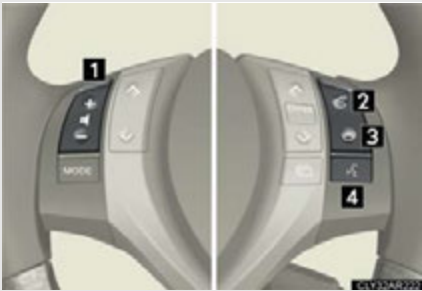

#### 1 Volume switch

During an incoming call:  
Adjusts the ring tone volume

During an ongoing call:  
Adjusts the receiver volume

The voice guidance volume cannot be adjusted using this button.

#### 2 Off hook switch

- Sending
- Receiving
- “Phone” screen display

#### 3 On hook switch

- End call
- Refuse call

#### 4 Talk switch

Press: Turns the voice command system on

Press and hold: Turns the voice command system off

#### ■ Microphone



You can use the microphone when talking on the phone.

The person you are speaking to can be heard from the front speakers.

To use the hands-free system, you must register your Bluetooth<sup>®</sup> phone in the system. (→P. 438)

## Status display

You can check indicators such as signal strength and battery charge on the “Phone” screen.

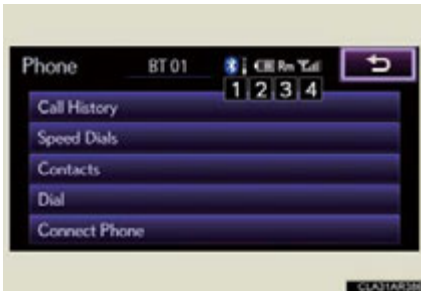

- 1 Connection status
- 2 Battery charge
- 3 Call area
- 4 Signal strength

Indicators	Conditions	
Connection status	Good 	Not connected 
Battery charge	Full 	Empty 
Call area	“Rm”: Roaming area	
Signal strength	Excellent 	Poor 

### ■ When using the hands-free system

- The audio system is muted when making a call.
- If both parties speak at the same time, it may be difficult to hear.
- If the received call volume is overly loud, an echo may be heard.  
If the Bluetooth<sup>®</sup> phone is too close to the system, quality of the sound may deteriorate and connecting condition may go down.

- In the following circumstances, it may be difficult to hear the other party:
  - When driving on unpaved roads
  - When driving at high speeds
  - If a window is open
  - If the air conditioning is blowing directly on the microphone
  - There is an effect from the network of the mobile phone

#### ■ Conditions under which the system will not operate

- If using a mobile phone that does not support Bluetooth<sup>®</sup>
- If the mobile phone is turned off
- If you are outside service range
- If the mobile phone is not connected
- If the mobile phone's battery is low
- When outgoing is controlled, due to heavy traffic on telephone lines, etc.
- When the mobile phone itself cannot be used
- When transferring the phonebook data from the mobile phone

#### ■ Bluetooth<sup>®</sup> antenna

The antenna is built into the display. If the mobile phone is behind the seat or in the console box, or touching or covered by metal objects, connection status may deteriorate.

#### ■ Battery charge/Signal status

- This display may not correspond exactly with the mobile phone itself.
- This system does not have a charging function.
- The Bluetooth<sup>®</sup> phone battery will burn quickly when it is connected to Bluetooth<sup>®</sup>.
- When the mobile phone is not connected, "No Connect" is displayed.
- When you are out of service area or in a place inaccessible by radio waves, "No service" is displayed.

#### ■ When using Bluetooth<sup>®</sup> audio and hands-free system at the same time

The following problems may occur.

- The Bluetooth<sup>®</sup> connection may be cut.
- Noise may be heard on the Bluetooth<sup>®</sup> audio playback.



### ■ About the phonebook in this system

The following data is stored for every registered phone. When another phone is connecting, you cannot read the registered data.

- Phonebook data
- Call history date
- Speed dial

When you delete the phone, the above-mentioned data is also deleted.

### ■ When you release your car

Be sure to initialize your data. (→P. 336)

### ■ About Bluetooth®



Bluetooth is a registered trademark of Bluetooth SIG, Inc.

### ■ Compatible models

This system supports the following service.

- Bluetooth® Specification:  
Ver. 1.1 or higher (Recommended: Ver. 2.1+EDR or higher)
- Profiles:
  - HFP (Hands Free Profile) Ver. 1.0 or higher (Recommended: Ver. 1.5 or higher)  
This is a profile to allow hands-free phone calls using the mobile phone or head sets. It has an outgoing and incoming call function.
  - OPP (Object Push Profile) Ver. 1.1 or higher  
This is a profile to exchange phonebook data. When the Bluetooth® phone has PBAP and OPP, OPP cannot be used.
  - PBAP (Phone Book Access Profile) Ver. 1.0 or higher  
This is a profile to transfer phonebook data.

If your mobile phone does not support HFP, you cannot enter the Bluetooth® phone. You need to take OPP or PBAP service individually.

#### ■ Certification for the hands-free system

FCC ID: AJDK046

IC ID: 775E-K046

This device complies with Part 15 of FCC Rules and Industry Canada licence-exempt RSS standard(s). Operation is subject to the following two conditions: (1) this device may not cause interference, and (2) this device must accept any interference, including interference that may cause undesired operation of this device.

Le présent appareil est conforme aux la partie 15 des règles de la FCC et CNR d'Industrie Canada applicables aux appareils radio exempts de licence. L'exploitation est autorisée aux deux conditions suivantes : (1) l'appareil ne doit pas produire de brouillage, et (2) l'utilisateur de l'appareil doit accepter tout brouillage radioélectrique subi, même si le brouillage est susceptible d'en compromettre le fonctionnement.

 CAUTION

## ■ FCC WARNING

Changes or modifications not expressly approved by the party responsible for compliance could void the user's authority to operate the equipment.

This equipment complies with FCC/IC radiation exposure limits set forth for an uncontrolled environment and meets the FCC radio frequency (RF) Exposure Guidelines in Supplement C to OET65 and RSS-102 of the IC radio frequency (RF) Exposure rules. This equipment has very low levels of RF energy that is deemed to comply without maximum permissive exposure evaluation (MPE). But it is desirable that it should be installed and operated keeping the radiator at least 20 cm or more away from person's body (excluding extremities: hands, wrists, feet and ankles).

Cet équipement est conforme aux limites d'exposition aux rayonnements énoncées pour un environnement non contrôlé et respecte les règles les radioélectriques (RF) de la FCC lignes directrices d'exposition dans le Supplément C à OET65 et d'exposition aux fréquences radioélectriques (RF) CNR-102 de l'IC. Cet équipement émet une énergie RF très faible qui est considérée conforme sans évaluation de l'exposition maximale autorisée.

Cependant, cet équipement doit être installé et utilisé en gardant une distance de 20 cm ou plus entre le dispositif rayonnant et le corps (à l'exception des extrémités : mains, poignets, pieds et chevilles).

This transmitter must not be co-located or operated in conjunction with any other antenna or transmitter.

Under Industry Canada regulations, this radio transmitter may only operate using an antenna of a type and maximum (or lesser) gain approved for the transmitter by Industry Canada. To reduce potential radio interference to other users, the antenna type and its gain should be so chosen that the equivalent isotropically radiated power (e.i.r.p.) is not more than that necessary for successful communication.

Conformément à la réglementation d'Industrie Canada, le présent émetteur radio peut fonctionner avec une antenne d'un type et d'un gain maximal (ou inférieur) approuvé pour l'émetteur par Industrie Canada. Dans le but de réduire les risques de brouillage radioélectrique à l'intention des autres utilisateurs, il faut choisir le type d'antenne et son gain de sorte que la puissance isotrope rayonnée équivalente (p.i.r.e.) ne dépasse pas l'intensité nécessaire à l'établissement d'une communication satisfaisante.

 CAUTION

■ **Caution while driving**

Do not use a mobile phone or connect the Bluetooth<sup>®</sup> phone.

■ **Caution regarding interference with electronic devices**

- Your audio unit is fitted with Bluetooth<sup>®</sup> antennas. People with implantable cardiac pacemakers, cardiac resynchronization therapy-pacemakers or implantable cardioverter defibrillators should maintain a reasonable distance between themselves and the Bluetooth<sup>®</sup> antennas. The radio waves may affect the operation of such devices.
- Before using Bluetooth<sup>®</sup> devices, users of any electrical medical device other than implantable cardiac pacemakers, cardiac resynchronization therapy-pacemakers or implantable cardioverter defibrillators should consult the manufacturer of the device for information about its operation under the influence of radio waves. Radio waves could have unexpected effects on the operation of such medical devices.

 NOTICE

■ **To prevent damage to mobile phones**

Do not leave mobile phones in the vehicle. The temperature inside the vehicle may become high, resulting in damage to the phone.

### 3-3. Using the Lexus Display Audio system Using the Bluetooth® phone

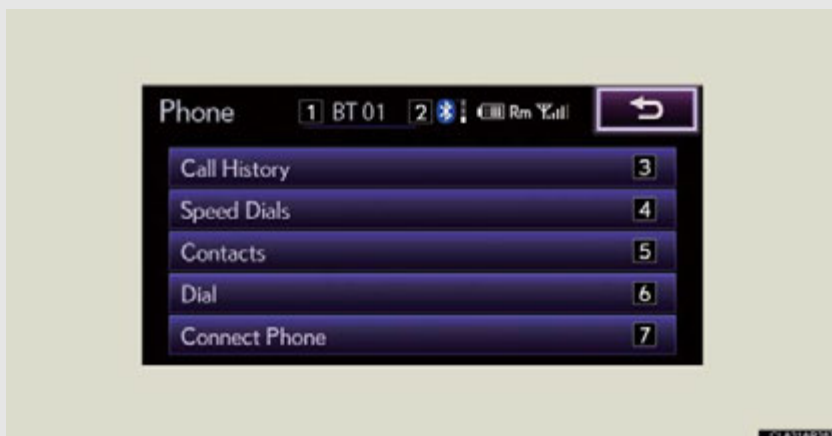

- 1 Device name
- 2 Bluetooth® connection status (→P. 431)
- 3 Dialing from history (→P. 445)
- 4 Speed dialing (→P. 445)
- 5 Dialing from the phonebook (→P. 443)
- 6 Dialing by inputting a number (→P. 442)
- 7 Connecting a Bluetooth® phone (→P. 440)

To display the screen shown above, press  on the steering wheel or press the “MENU” button on the Lexus Display Audio controller and then select “Phone” on the “Menu” screen.

#### Registering a Bluetooth® phone

To use the hands-free system, you must register a Bluetooth® phone in the system. You can register up to 5 phones in the system.

**STEP 1** Display the “Phone” screen. (→P. 437)

**STEP 2**

Select “Yes”.

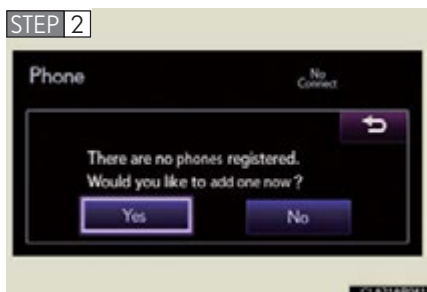



Input the passcode displayed on the screen into your phone.

For the operation of the phone, see the manual that comes with your mobile phone.

Depending on the type of phone, further phone operations may be required after inputting the passcode (for example to confirm if connection is to be received or not) when registering a phone.

Passcodes are not required for SSP (Secure Simple Pairing) compatible Bluetooth<sup>®</sup> devices. Depending on the phone, you may need to select “Yes” to register, or “No” to cancel on your mobile phone.

If you want to cancel it, select “Cancel”.

If a completion message is displayed, registration is complete.

If an error message is displayed, follow the guidance on the screen to try again.

## Selecting the Bluetooth® phone

If multiple Bluetooth® devices are registered, follow the procedure below to select the Bluetooth® device to be used. You may only use one device at a time.

**STEP 1** Display the “Phone” screen. (→P. 437)

**STEP 2**



Select “Connect Phone”.

**STEP 3**

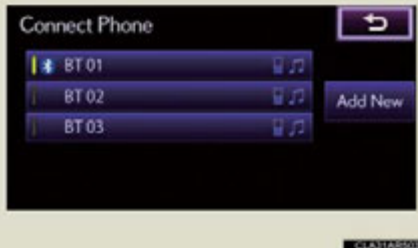

Select the device to connect.

“Add New”: Registering a Bluetooth® device. (→P. 467)

The selection indicator is displayed on left side of the selected device name.

The Bluetooth® mark is displayed when you connected the device.

When the system cannot get the device names, alternate names will be displayed such as “Device1”, “Device2”, etc.



## Connecting a Bluetooth® phone

There are two connecting methods available-automatic and manual.

### ► Automatic

When you register your phone, auto connection will be activated. Always set it to this mode and leave the Bluetooth® phone in a place where connection can be established.

When the “POWER” switch is turned to ACCESSORY or ON mode, the system will search for a nearby mobile phone you have registered.

The system automatically connects with the most recent phone that was connected. The connection result is displayed.

Depending on the type of phone, phone operations may be required (to confirm if connection is to be received or not) even when automatically connected.

### ► Manual

When the auto connection has failed or “Bluetooth\* Power” is turned off (→P. 472), you must connect Bluetooth® manually.

\*: Bluetooth is a registered trademark of Bluetooth SIG. Inc.

**STEP 1** Display the “Phone” screen. (→P. 437)

**STEP 2**

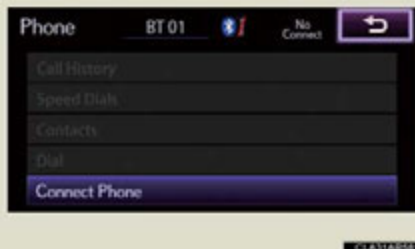

Select “Connect Phone”.

**STEP 3**



Select the device to connect.

A message is shown if connection has been successful.

If connection fails, a message will be displayed and connection will be re-attempted.

■ **Reconnecting to the Bluetooth® phone**

If the system cannot connect due to poor signal strength with the “POWER” switch in ACCESSORY or ON mode, the system will automatically attempt to reconnect.

If the phone is turned off, the system will not attempt to reconnect. In this case, connection must be made manually, or the phone must be re-selected.

■ **Connecting the phone while Bluetooth® audio is playing**

- Bluetooth® audio will stop temporarily.
- It may take time to connect.

**Making a call**

Once the Bluetooth® phone is registered, you can make a call using the following procedure:

■ **Dialing**

**STEP 1** Display the “Phone” screen. (→P. 437)

**STEP 2** Select “Dial” on the “Phone” screen.



**STEP 3**



Input the phone number.

To delete the inputted phone number, select .

For the first digit, you can enter “+” by selecting “\*” for a while.

**STEP 4** Press  on the steering wheel or select .

Depending on the type of phone, when internet communication functions such as skype are available, phone operations (selecting between normal phone communication or internet communication) may be necessary after dialing operations are performed.

### ■ Dialing from the phonebook

You can dial a number from the phonebook data imported from your mobile phone. The system has one phonebook for each telephone. Up to 1000 entries may be stored in each phonebook.

(→P. 456)

**STEP 1** Display the “Phone” screen. (→P. 437)

**STEP 2** Select “Contacts” on the “Phone” screen.

**STEP 3**





Choose the desired data to call from the list.

If the phonebook is empty, a message will be displayed. (→P. 444)

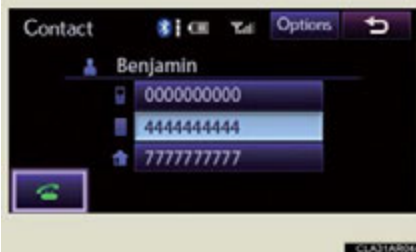
**STEP 4**



Choose the number and then press  on the steering wheel or select .

● When the phonebook is empty

You can transfer the phone numbers in your Bluetooth® phone to the system.

Operation methods differ between PBAP compatible and PBAP incompatible Bluetooth® phones. If your mobile phone does not support either PBAP or OPP service, you cannot transfer contacts.

**STEP 1** Select “Contacts” on the “Phone” screen.

**STEP 2**

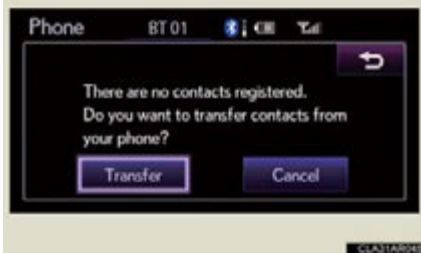

If the phonebook is empty, a message will be displayed.

▶ For PBAP compatible Bluetooth® phone

**STEP 3** Select “Yes” if you want to transfer new contacts from a mobile phone.

Select “No” if you want to cancel transferring the contacts.

Depending on the type of phone, phone operations may be necessary when transferring contacts by PBAP.

▶ For PBAP incompatible and OPP compatible Bluetooth® phone

**STEP 3** Select “Transfer” if you want to transfer new contacts from a mobile phone.

Select “Cancel” if you want to cancel transferring the contacts.

You need to operate your phone to transfer new contacts.

### ■ Calling using speed dial

You can make a call using numbers registered from the phonebook.

**STEP 1** Display the “Phone” screen. (→P. 437)

**STEP 2** Select “Speed Dials” on the “Phone” screen.

**STEP 3**



Select the desired tab and choose the desired number to make a call.

### ■ Dialing from history

You can call using the call history which has the 4 functions below.

“All”: all the calls below which were memorized

“Missed”: calls which you missed

“Incoming”: calls which you received

“Outgoing”: calls which you called

**STEP 1** Display the “Phone” screen. (→P. 437)



**STEP 2** Select “Call History” on the “Phone” screen.

**STEP 3**

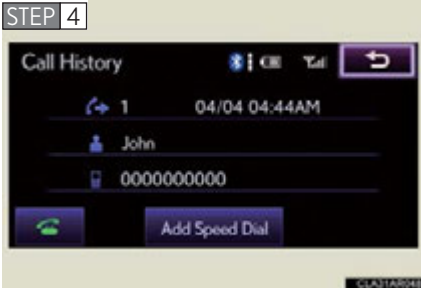

Select the desired tab and choose the desired data from the list.



Press  on the steering wheel or select .

### ■ Calling using voice recognition

Calls can be made by giving a voice command.

**STEP 1** Press the talk switch.

To cancel voice recognition press and hold the talk switch.

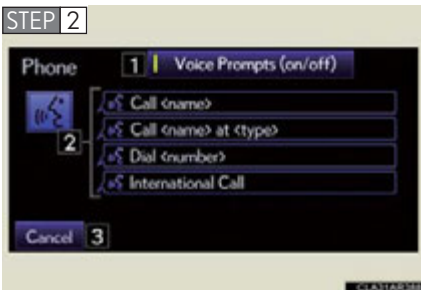

Following the system guidance, wait for the beep, and then say the desired voice commands.

**1** Voice prompts on/off

**2** Voice commands

Voice commands are marked with .

**3** Canceling voice recognition system

### ● Dial by name

The procedure below shows “Call <name>” or “Call <name> at <type>”. Follow similar procedures for the other operations.

**STEP 1** Press the talk switch.

**STEP 2** Say the name, or the name and type of phone, of a registered contact.

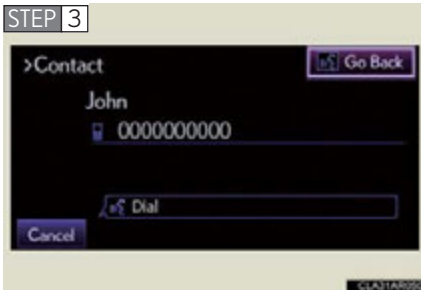

Say “Dial” or press  on the steering wheel.

Say or select “Go Back” to return to the previous screen.

### ■ Call history list

- If you make a call to or receive a call from a number registered in the phonebook, the name is displayed in the call history.
- If you make multiple calls to the same number, only the last call made is displayed in the call history.

### ■ When driving

The functions “Dialing”, “Dialing from the phonebook”, and “Dialing from history” (only the 6th page of “All” tab) are unavailable.

### ■ International calls



Depending on the mobile phone in use, you may not be able to make international calls.

### ■ Calling by using the latest call history item

**STEP 1** Press  on the steering wheel to display the “Phone” screen.

**STEP 2** Press  on the steering wheel to display the “Call History” screen.

**STEP 3** Press  on the steering wheel to select the latest history item.

**STEP 4** Press  on the steering wheel or select  to call the latest history item.

#### ■ Voice guidance function

- Voice guidance for the voice recognition system can be skipped by pressing the talk switch.
- When “Voice Prompts (on/off)” is selected, voice recognition will be temporarily suspended. Press the talk switch again.
- Voice guidance can be canceled by setting voice prompts to off. Use this setting when it is desirable to say a command immediately after pressing the talk switch.

#### ■ Using voice command

- Using voice command “Call <name>” or “Call <name> at <type>”
  - In the same manner as it is displayed on the screen, “Call <name>” or “Call <name> at <type>”, after saying “Call” say the name, or the name and type of phone, of a contact.  
For example: “Call”, “John Smith” or “Call”, “Mary Davis”, “at”, “Mobile”
  - There are 4 types of phones: Home, Mobile, Work and Other.
  - Short or abbreviated names in the phonebook may not be recognized. Change names in the phonebook to full names.
  - Sometimes a voice recognition result confirmation screen will be displayed. After confirming the result, say “Yes” or “No”.
  - When the system recognizes multiple names from the phonebook, a name candidate list will be displayed on the screen. If the desired name is not displayed on the top of the screen, say the number of the name from the candidate list (number 1 or number 2) to select a name from the candidate list.
  - When a contact has multiple phone numbers registered in the phonebook, a candidate list will be displayed. If the desired phone number is not displayed on the top of the screen, say the number of the desired phone number from the candidate list (number 1 or number 2) to select a phone number from the candidate list.



- Using voice command “Dial <number>”

- In the same manner as it is displayed on the screen, “Dial <number>”, after saying “Dial” say the phone number.
- Say the phone number one digit at a time.  
For example, if the phone number is 2345678:  
Say “two three four five six seven eight”  
Do not say “twenty three forty five sixty seven eight”
- The system can recognize the following types of the phone numbers:  
3 digit numbers (911, 411, 611)  
7 digit numbers (Local phone numbers)  
10 digit numbers (Area code + Local phone number)  
11 digit phone numbers (1 + Area code + Local phone number)
- As the system cannot recognize additional numbers, say the complete number without stopping.
- When the system recognizes multiple phone numbers, a phone number candidate list will be displayed on the screen. If the desired phone number is not displayed on the top of the screen, say the number of the desired phone number from the candidate list (number 1 or number 2) to select a phone number from the candidate list.

- Using voice command “International call”.

Up to 20 digits can be recognized when using the international call function. The number can also be divided into multiple groups and recognized.

- **When using voice recognition**



Speak clearly when using the voice recognition, otherwise the system may not correctly recognize your voice. Wind or other noises may also cause the system not to recognize your voice.

## Receiving a call

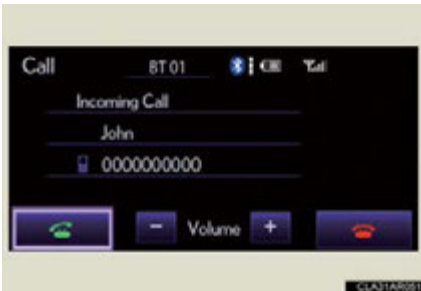
When a call is received, the following screen is displayed together with a sound.



To answer the phone:

- Press  on the steering wheel.
- Select .

### ■ To refuse a call

Press  on the steering wheel or select .

### ■ To adjust the incoming call volume

Select “-” or “+”. You can also adjust the volume using the steering switches or volume knob.

---

### ■ International calls

Depending on the cellular phone in use, received international calls may not be displayed correctly.

## Speaking on the phone

The following screen is displayed when speaking on the phone.



### ■ To adjust the receiver volume

Select “-” or “+”. You can also adjust the volume using the steering switches or the volume knob.

### ■ To prevent the other party from hearing your voice

Select “Mute”.

### ■ Inputting tones

When using phone services such as an answering service or a bank, you can store phone numbers and code numbers in the phonebook.

**STEP 1** Select “0-9”.

**STEP 2**



Input the number.

**STEP 3**



If repeated tone symbols\* are stored in the phone book, “Send” and “Exit” are displayed on the right side of the screen.

\*: Repeated tone symbols are symbols or numbers displayed as p or w, that come after the phone number. (e.g. 056133w0123p#1\*)

**STEP 4**

Confirm the number displayed on the screen, and select “Send”.  
If you select “Exit”, this function will end.

**■ To transfer a call**

Select “Handset Mode” to change from Hands-free call to mobile phone call.

Select “Handsfree Mode” to change from mobile phone call to Hands-free call.

**■ To hang up**



Press  on the steering wheel or select .

**■ Call waiting**

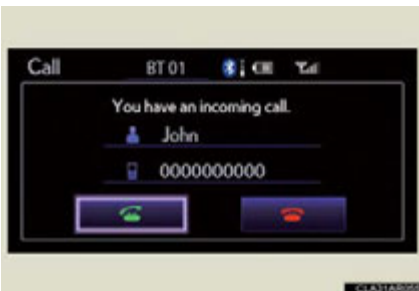

When a call is interrupted by a third party while talking, the incoming call message will be displayed.





To talk with the other party:

- Press  on the steering wheel.
- Select .

To refuse the call:

- Press  on the steering wheel.
- Select .

Every time you press  on the steering wheel or select  during call waiting, you will be switched to the other party.

---

### ■ Transferring calls

- It is not possible to transfer from hands-free to the mobile phone while driving.
- If you transfer from the mobile phone to hands-free, the hands-free screen will be displayed, and you can operate the system using the screen.
- Transfer method and operate may vary according to the mobile phone used.
- For operation of the mobile phone in use, see the phone's manual.

### ■ Call waiting operation

Call waiting operation may differ depending on your phone company and mobile phone.

### 3-3. Using the Lexus Display Audio system

## Setting the hands-free system

You can set the hands-free system to your desired settings.

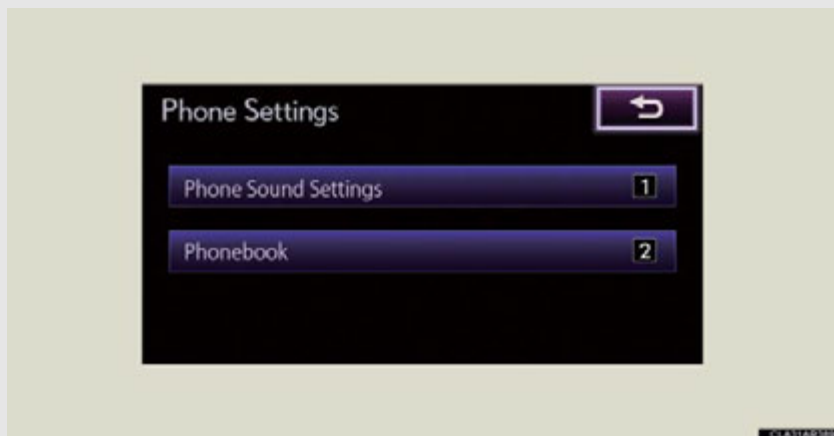

- 1 Setting the sound
- 2 Phonebook settings

To display the screen shown above, follow the steps below.

- STEP 1** Press the "MENU" button on the Lexus Display Audio controller.
- STEP 2** Select "Setup" on the "Menu" screen.
- STEP 3** Select "Phone" on the "Setup" screen.

### Setting the sound

- STEP 1** Display the "Phone Settings" screen. (→P. 454)
- STEP 2** Select "Phone Sound Settings" on the "Phone Settings" screen.

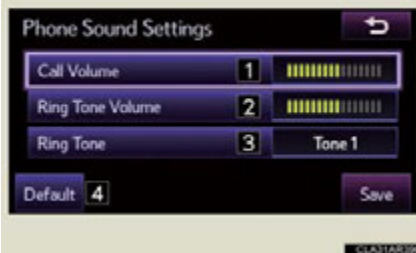
**STEP 3**

**1** Changes the speaker volume (→P. 455)

**2** Changes the ring tone volume (→P. 455)

**3** Changes the ring tone (→P. 455)

**4** Restore default settings

**STEP 4** When you complete settings, select “Save”.

### ■ Setting the volume

**STEP 1** Select “Call Volume” or “Ring Tone Volume” on the “Phone Sound Settings” screen.

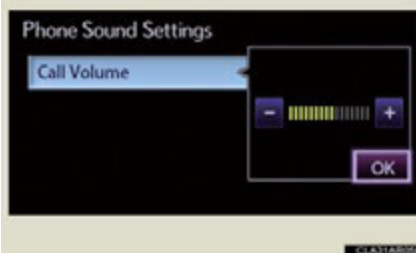
**STEP 2**

Select “-” or “+” to lower or raise the volume, and then “OK”.

### ■ Setting the ring tone

**STEP 1** Select “Ring Tone” on the “Phone Sound Settings” screen.

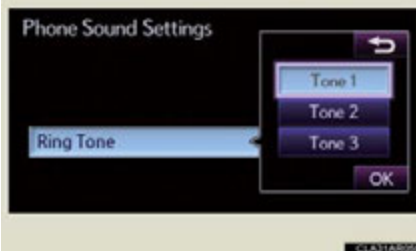
**STEP 2**

Select “Tone1”, “Tone2” or “Tone3” to change the ring tone, and then “OK”.

## Phonebook settings

The phonebook manages a maximum of 5 phones in total. The data for 1000 contacts (up to 3 numbers per contact) can be registered in each phonebook.

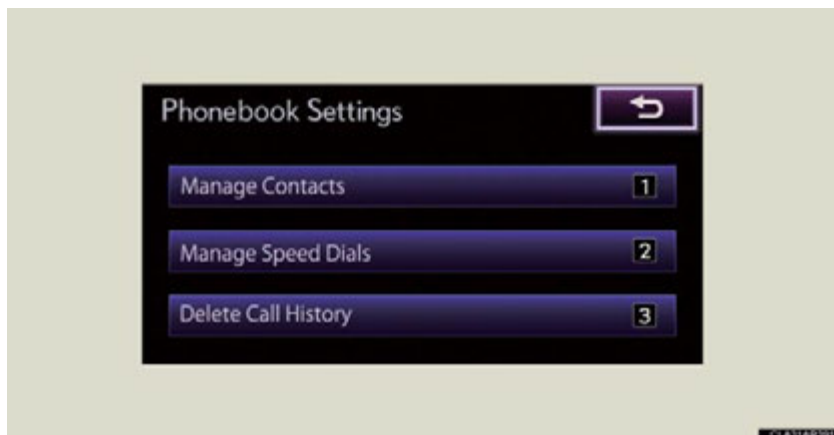

- 1 Managing the contacts
- 2 Managing the speed dials
- 3 Deleting the call history

To display the screen above, follow the steps below.

- STEP 1 Display the "Phone Settings" screen. (→P. 454)
- STEP 2 Select "Phonebook" on the "Phone Settings" screen.



## ■ Managing the contacts

### ● Transferring a phone number

You can transfer the phone numbers in your Bluetooth<sup>®</sup> phone to the system. Operation methods differ between PBAP compatible and PBAP incompatible Bluetooth<sup>®</sup> phones. If your mobile phone does not support either PBAP or OPP services, you cannot transfer contacts.

**STEP 1** Display the “Phonebook Settings” screen. (→P. 456)

**STEP 2** Select “Manage Contacts” on the “Phonebook Settings” screen.

**STEP 3**



Select “Transfer Contacts”.

► For PBAP compatible Bluetooth<sup>®</sup> phones

**STEP 4**



**1** Automatic phonebook download on/off

The phonebook data can be automatically transferred.

Depending on the mobile phone, call history will be also transferred.

**2** Update phonebook

The phonebook data can be updated.

**3** Restore default settings

► For PBAP incompatible Bluetooth® phones

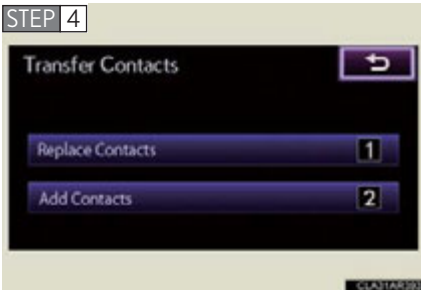

1 Replace contacts

The phonebook data can be replaced.

2 Add contacts

The phonebook can be added.

● Deleting the phonebook data

**STEP 1** Display the “Phonebook Settings” screen. (→P. 456)

**STEP 2** Select “Manage Contacts” on the “Phonebook Settings” screen.

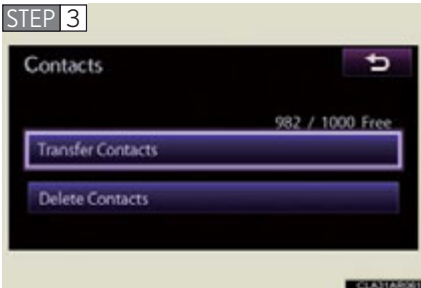

Select “Delete Contacts”.

If your phone supports PBAP service, “Automatically Download Contacts” setting needs to be set to “Off”. (→P. 457)



Choose the data to delete.

To delete all data, select “All Delete”.

**STEP 5** A confirmation message will be displayed. If everything is correct, select “Yes”.

### ■ Phonebook data

Phonebook data is managed for every registered phone. When another phone is connecting, you cannot read the registered data.

### ■ Setting the phonebook in a different way (To display the “Contacts” screen)

**STEP 1** Display the “Phone” screen. (→P. 437)

**STEP 2** Select “Contacts” on the “Phone” screen.

**STEP 3** Select “Options” on the “Contacts” screen.

**STEP 4** Select “Manage Contacts” on the “Contacts” screen.

### ■ When transferring a phone number

Transfer the phone number while engine is running.

If your mobile phone is OPP or PBAP compatible, you may need to input “1234” by your mobile phone for OBEX certification.

### ■ When you have selected “Update Contacts” to transfer the phone number

- If your mobile phone does not support PBAP service, you cannot use this function.

- If your phone supports PBAP service, you can transfer the phonebook data without operating your phone.

### ■ When you have selected “Replace Contacts” or “Add Contacts” to transfer the phone number

If your mobile phone does not support OPP service, you cannot use these functions. You can transfer the phonebook data only by operating your phone.

### ■ Transferring the phone number in a different way (To display the “Transfer Contacts” screen)

**STEP 1** Display the “Phone” screen. (→P. 437)

**STEP 2** Select “Contacts” on the “Phone” screen.

**STEP 3** Select “Transfer” on the “Contacts” screen.

### ■ Transferring the phone number while Bluetooth<sup>®</sup> audio is playing

Bluetooth<sup>®</sup> audio will disconnect. It will reconnect automatically when data transfer finishes. It will not be reconnected depending on the phone you are using.

#### ■ Deleting the phonebook data in a different way

**STEP 1** Display the “Phone” screen. (→P. 437)

**STEP 2** Select “Contacts” on the “Phone” screen.

**STEP 3** Choose the desired data from the list.

**STEP 4** Select “Options” on the “Contact” screen.

**STEP 5** Select “Delete” on the “Contact” screen.

**STEP 6** A confirmation message will be displayed. If everything is correct, select “Yes”.

If your phone supports PBAP service, “Automatically Download Contacts” setting needs to be set to “Off”. (→P. 457)

When you delete a Bluetooth<sup>®</sup> phone, the phonebook data will be deleted at the same time.

#### ■ Managing the speed dials

##### ● Registering the speed dial from contacts

You can register the desired phone number from phonebook. Up to 18 numbers per phone can be registered.

**STEP 1** Display the “Phonebook Settings” screen. (→P. 456)

**STEP 2** Select “Manage Speed Dials” on the “Phonebook Settings” screen.

**STEP 3**

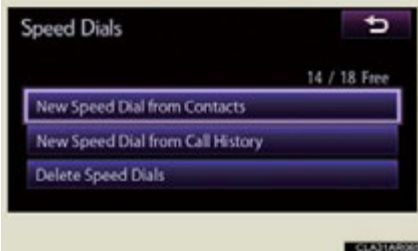

Select “New Speed Dial from Contacts”.

## STEP 4



Choose the data to register.

## STEP 5

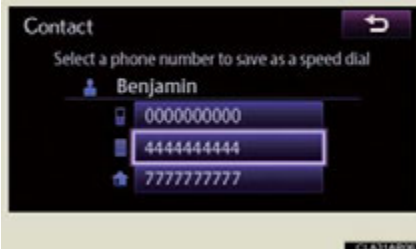

Select the desired phone number.

## STEP 6



Select the switch you want to register the number in.

STEP 7 If you select a switch you registered before, a confirmation message will be displayed. If you want to replace it, select "Yes".

● Registering the speed dial from call history

**STEP 1** Display the “Phonebook Settings” screen. (→P. 456)

**STEP 2** Select “Manage Speed Dials” on the “Phonebook Settings” screen.

**STEP 3** Select “New Speed Dial from Call History” on the “Speed Dials” screen.



Choose the data to register.



Select the switch you want to register the number in.

**STEP 6** If you select a switch you registered before, a confirmation message will be displayed. If you want to replace it, select “Yes”.

● Deleting the speed dial

**STEP 1** Display the “Phonebook Settings” screen. (→P. 456)

**STEP 2** Select “Manage Speed Dials” on the “Phonebook Settings” screen.

**STEP 3** Select “Delete Speed Dials” on the “Speed Dials” screen.

**STEP 4**



Choose the data to delete.

To delete all data, select “All Delete”.

**STEP 5** A confirmation message will be displayed. If everything is correct, select “Yes”.

■ **Setting the speed dials in a different way (From “Speed Dial” screen)**

**STEP 1** Display the “Phone” screen. (→P. 437)

**STEP 2** Select “Speed Dials” on the “Phone” screen.

**STEP 3** Select “Options” on the “Speed Dial” screen.

■ **Setting the speed dials in a different way (From “Contacts” screen)**

**STEP 1** Display the “Phone” screen. (→P. 437)

**STEP 2** Select “Contacts” on the “Phone” screen.

**STEP 3** Select “Options” on the “Contacts” screen.

**STEP 4** Select “Manage Speed Dials” on the “Contacts” screen.

#### ■ Registering the speed dial in a different way (From “Speed Dial” screen)

- STEP 1** Display the “Phone” screen. (→P. 437)
- STEP 2** Select “Speed Dials” on the “Phone” screen.
- STEP 3** Select “(add new)” on the “Speed Dial” screen.
- STEP 4** Select “Contacts” or “History” to set new speed dial.  
Select “Cancel” to cancel it.
- STEP 5** Choose the desired data from the list.
- STEP 6** Select the desired phone number.

#### ■ Registering the speed dial in a different way (From “Contact” screen)

- STEP 1** Display the “Phone” screen. (→P. 437)
- STEP 2** Select “Contacts” on the “Phone” screen.
- STEP 3** Choose the desired data from the list.
- STEP 4** Select “Options” on the “Contact” screen.
- STEP 5** Select “Set Speed Dial” on the “Contact” screen.
- STEP 6** Select the desired telephone number.
- STEP 7** Follow the steps “Registering the speed dial from contacts” from “STEP6” (→P. 460).

#### ■ Registering the speed dial in a different way (From “Call History” screen)

- STEP 1** Display the “Phone” screen. (→P. 437)
- STEP 2** Select “Call History” on the “Phone” screen.
- STEP 3** Choose the desired data from the list.
- STEP 4** Select “Add Speed Dial” on the “Call History” screen.
- STEP 5** Follow the steps “Registering the speed dial from call history” from “STEP5”. (→P. 462)



## ■ Deleting the call history

**STEP 1** Display the “Phonebook Settings” screen. (→P. 456)

**STEP 2** Select “Delete Call History” on the “Phonebook Settings” screen.

If your phone supports PBAP service, the “Automatically Download Contacts” setting needs to be set to “Off”. (→P. 457)

**STEP 3**



Choose the desired history to delete.

**STEP 4**



Choose the data to delete.  
To delete all data, select “All Delete”.

**STEP 5** A confirmation message will be displayed. If everything is correct, select “Yes”.

## ■ Deleting call history in a different way

**STEP 1** Display the “Phone” screen. (→P. 437)

**STEP 2** Select “Call History” on the “Phone” screen.

**STEP 3** Select “Delete” on the “Call History” screen.

**STEP 4** Follow the steps “Deleting the call history” from “STEP4”. (→P. 465)

### 3-3. Using the Lexus Display Audio system Bluetooth<sup>®</sup> settings

You can set the Bluetooth<sup>®</sup> system to your desired settings.

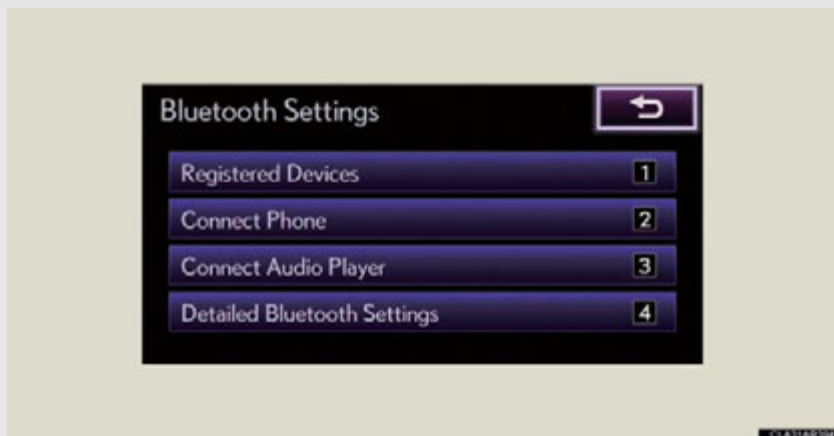

- 1 Registered devices settings
- 2 Connecting telephone
- 3 Connecting audio player
- 4 Detailed Bluetooth<sup>®</sup> settings

To display the screen shown above, follow the steps below.

**STEP 1** Press the "MENU" button on the Lexus Display Audio controller.

**STEP 2** Select "Setup" on the "Menu" screen.

**STEP 3** Select "Bluetooth\*" on the "Setup" screen.

\*: Bluetooth is a registered trademark of Bluetooth SIG, Inc.

## Registered devices settings

### ■ Registering a Bluetooth® device

Bluetooth® devices compatible with phones (HFP) and portable audio players (AVP) can be registered simultaneously. You can register up to 5 Bluetooth® devices.

**STEP 1** Display the “Bluetooth\* Settings” screen. (→P. 466)

**STEP 2** Select “Registered Devices” on the “Bluetooth\* Settings” screen.

**STEP 3**



Select “Add New”.

\*: Bluetooth is a registered trademark of Bluetooth SIG, Inc.

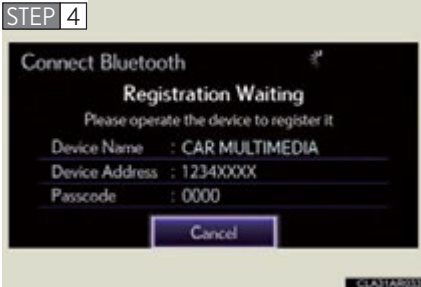

When this screen is displayed, input the passcode displayed on the screen into your Bluetooth® device.

For the operation of the Bluetooth® device, see the manual that comes with your Bluetooth® device.

Depending on the type of phone, further phone operations may be required after inputting the passcode (for example to confirm if connection is to be received or not) when registering a phone.

Passcodes are not required for SSP (Secure Simple Pairing) compatible Bluetooth® devices. Depending on the phone, you may need to select “Yes” to register, or “No” to cancel on your mobile phone.

If you want to cancel it, select “Cancel”.

If a completion message is displayed, registration is complete.

If an error message is displayed, follow the guidance on the screen to try again.

#### ■ Removing a Bluetooth® device

**STEP 1** Display the “Bluetooth\* Settings” screen. (→P. 466)

**STEP 2** Select “Registered Devices” on the “Bluetooth\* Settings” screen.

\*: Bluetooth is a registered trademark of Bluetooth SIG, Inc.

**STEP 3**

Select "Remove".

**STEP 4**

Select the device to remove.

**STEP 5**

A confirmation message will be displayed, select "Yes" to remove the device.

### ■ Displaying a Bluetooth® device details

You can confirm and change the device details.

**STEP 1** Display the "Bluetooth\* Settings" screen. (→P. 466)

**STEP 2** Select "Registered Devices" on the "Bluetooth\* Settings" screen.

**STEP 3**

Select "Details".

\*: Bluetooth is a registered trademark of Bluetooth SIG, Inc.

**STEP 4**



Select the device.

**STEP 5** Following screen is displayed:

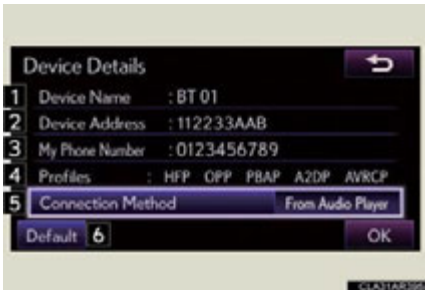

- 1 Display device name
- 2 Display device address
- 3 Display your telephone number  
Depending on the model of the phone, the number may not be displayed.
- 4 Display compatibility profile of the device
- 5 Change connection method (→P. 470)
- 6 Restore default settings

**STEP 6** When you complete settings, select “OK”.

● Changing connection method

**STEP 1** Select “Connection Method” on the “Device Details” screen.

**STEP 2**

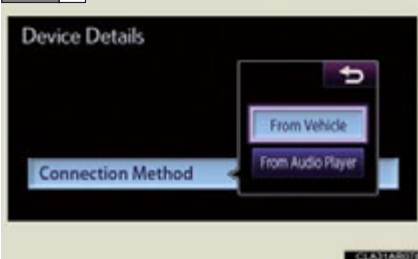

Select “From Vehicle” or “From Audio Player”.

“From Vehicle”: Connect the audio system to the portable audio player.

“From Audio Player”: Connect the portable audio player to the audio system.

### Selecting the Bluetooth® phone

If multiple Bluetooth® devices are registered, follow the procedure below to select the Bluetooth® device to be used. You may only use one device at a time.

**STEP 1** Display the “Bluetooth\* Settings” screen. (→P. 466)

**STEP 2** Select “Connect Phone” on the “Bluetooth\* Settings” screen.

**STEP 3**

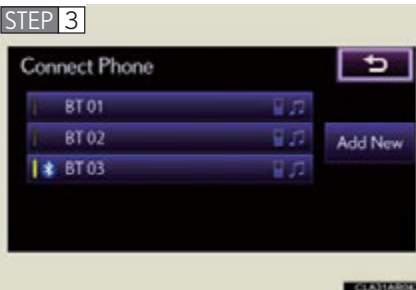

Select the device to connect.

“Add New”: Registering a Bluetooth® device. (→P. 467)

The selection indicator is displayed on left side of the selected device name.

The Bluetooth® mark is displayed when you connected the device.

\*: Bluetooth is a registered trademark of Bluetooth SIG. Inc.

### Selecting the audio player

If multiple Bluetooth® devices are registered, follow the procedure below to select the Bluetooth® device to be used. You may only use one device at a time.

**STEP 1** Display the “Bluetooth\* Settings” screen. (→P. 466)

**STEP 2** Select “Connect Audio Player” on the “Bluetooth\* Settings” screen.

**STEP 3**

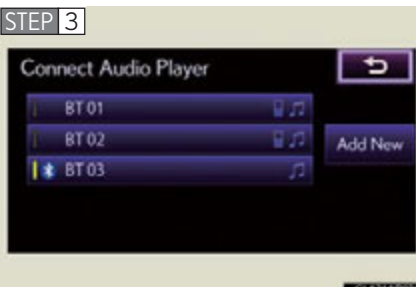

Select the device to connect.

“Add New”: Registering a Bluetooth® device. (→P. 467)

The selection indicator is displayed on left side of the selected device name.

The Bluetooth® mark is displayed when you connected the device.

\*: Bluetooth is a registered trademark of Bluetooth SIG. Inc.

## Detailed Bluetooth® settings

You can confirm and change the detailed Bluetooth® settings.

**STEP 1** Display the “Bluetooth\* Settings” screen. (→P. 466)

**STEP 2** Select “Detailed Bluetooth\* Settings” on the “Bluetooth\* Settings” screen.

**STEP 3** Following screen is displayed:

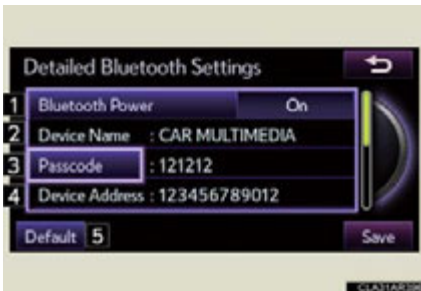

**1** Change Bluetooth® power on/off

You can change Bluetooth® function to “On” or “Off”

**2** Display device name

**3** Change passcode (→P. 473)

**4** Display device address

**5** Restore default settings

**6** Display compatibility profile of the system

**7** Change displaying telephone status on/off

You can set the system to show the status confirmation display when connecting telephone

**8** Change displaying audio player status on/off

You can set the system to show the status confirmation display when connecting audio player

**STEP 4** When you complete settings, select “Save”.

\*: Bluetooth is a registered trademark of Bluetooth SIG, Inc.



### ■ Editing the passcode

You can change the passcode that you use to register your Bluetooth® device in the system.

**STEP 1** Select “Passcode” on the “Detailed Bluetooth\* Settings” screen.

**STEP 2**



Input a passcode, and select “OK”.

To delete the inputted phone number, select .

\*: Bluetooth is a registered trademark of Bluetooth SIG, Inc.

### 3-4. Using the audio system

#### Audio system (without a navigation system or the Lexus Display Audio system)

- ▶ CD player with a changer and AM/FM radio (type A)



## ▶ CD player with a changer and AM/FM radio (type B)



Title	Page
Using the radio	P. 477
Using the CD player	P. 485
Playing MP3 and WMA discs	P. 493
Operating an iPod	P. 501
Operating a USB memory	P. 510
Bluetooth® audio system	P. 519
Optimal use of the audio system	P. 539
Using the AUX port	P. 541
Using the steering wheel audio switches	P. 543
Hands-free system for mobile phones	P. 547

■ Using mobile phones

Interference may be heard through the audio system's speakers if a mobile phone is being used inside or close to the vehicle while the audio system is operating.

 CAUTION

■ Certification

- Part 15 of the FCC Rules

FCC Warning:

Any unauthorized changes or modifications to this equipment will void the user's authority to operate this device.

- This product is a class 1 laser product classified under the Safety of laser products, IEC 60825-1:2007, and contains a class 1 M laser module. To ensure continued safety, do not remove any covers or attempt to gain access to the inside of the product. Refer all servicing to qualified personnel.

CLASS 1 LASER PRODUCT

CAUTION - CLASS 1 M INVISIBLE LASER RADIATION WHEN OPEN, DO NOT VIEW DIRECTLY WITH OPTICAL INSTRUMENTS.

 NOTICE

■ To prevent 12-volt battery discharge

Do not leave the audio system on longer than necessary when the hybrid system is off.

■ To avoid damaging the audio system

Take care not to spill drinks or other fluids over the audio system.

### 3-4. Using the audio system

## Using the radio

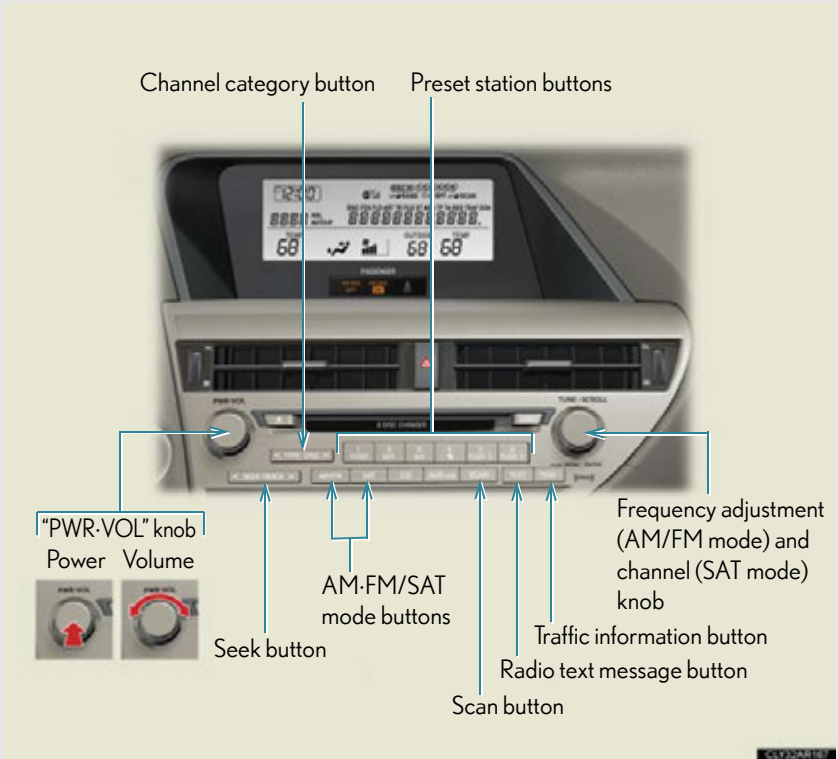

#### ► Type A



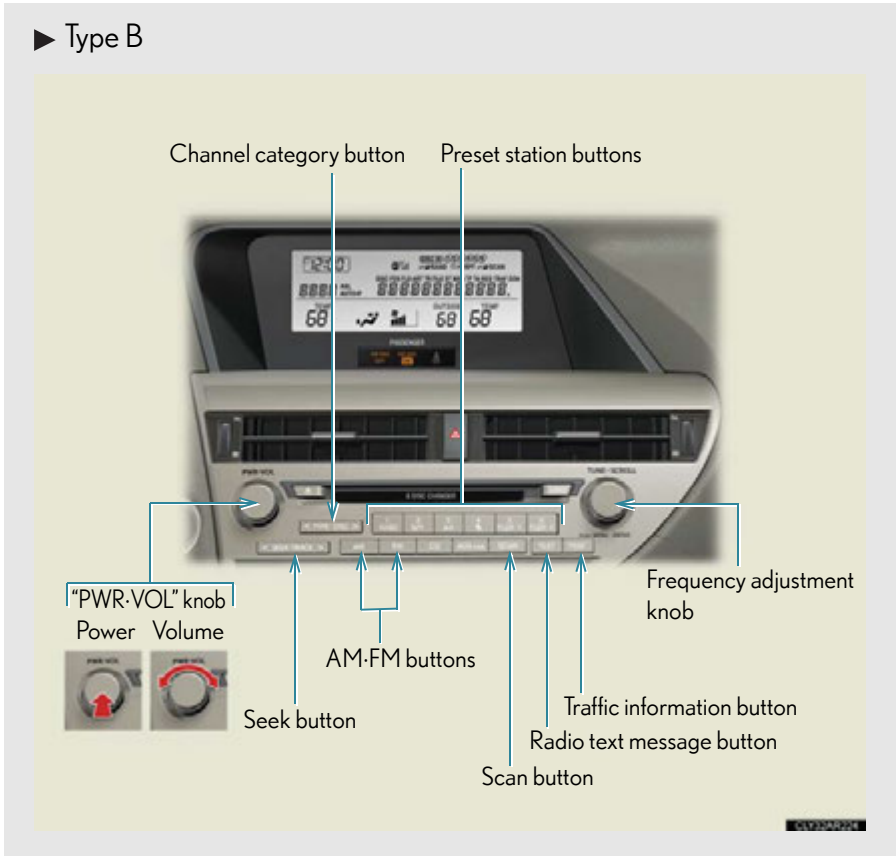

► Type B



**Setting station presets (excluding XM® Satellite Radio)**

**STEP 1** Search for the desired stations by turning  or pressing ">" or "<" on .

**STEP 2** Press and hold the button (from  to ) the station is to be set to until you hear a beep.

## Scanning radio stations (excluding XM<sup>®</sup> Satellite Radio)

### ■ Scanning the preset radio stations

**STEP 1** Press and hold **SCAN** until you hear a beep.

Preset stations will be played for 5 seconds each.

**STEP 2** When the desired station is reached, press the button again.

### ■ Scanning all the radio stations within range

**STEP 1** Press **SCAN**.

All the stations with reception will be played for 5 seconds each.

**STEP 2** When the desired station is reached, press the button again.

## RBDS (Radio Broadcast Data System)

This feature allows your radio to receive station identification information and program information (classical, jazz, etc.) from radio stations which broadcast this information.



### ■ Receiving RBDS broadcasts

**STEP 1** Press “>” or “<” on **<TYPE-DISC>** during FM reception.

The type of program changes each time the button is pressed.

- “ROCK”
- “EASYLIS” (Easy listening)
- “CLS/JAZZ” (Classical music and Jazz)
- “R & B” (Rhythm and Blues)
- “INFORM” (Information)
- “RELIGION”
- “MISC” (Miscellaneous)
- “ALERT” (Emergency messages)

If the system receives no RBDS stations, “NO PTY” appears on the display.

**STEP 2** Press , or “>” or “<” on .

The radio seeks or scans for stations of the relevant program type.



#### ■ Displaying radio station names

Press .

#### ■ Displaying radio text messages

Press  twice.

A text message is displayed when “MSG” is shown on the screen.



If the text continues past the end of the display,  is displayed. Press and hold  until you hear a beep.

## XM<sup>®</sup> Satellite Radio (type A)



#### ■ Receiving XM<sup>®</sup> Satellite Radio

**STEP 1** Press .

The display changes as follows each time the button is pressed:  
“SAT1” → “SAT2” → “SAT3”

**STEP 2** Turn  to select the desired channel in all the categories or press “>” or “<” on  to select the desired channel in the current category.

#### ■ Setting XM<sup>®</sup> Satellite Radio channel presets

Select the desired channel. Press and hold the button (from  to ) the channel is to be set to until you hear a beep.

#### ■ Changing the channel category

Press “>” or “<” on .



## ■ Scanning the XM<sup>®</sup> Satellite Radio channels

- Scanning the channels in the current category

**STEP 1** Press **SCAN** .

**STEP 2** When the desired channel is reached, press the button again.

- Scanning the preset channels

**STEP 1** Press and hold **SCAN** until you hear a beep.

**STEP 2** When the desired channel is reached, press the button again.

## ■ Displaying text information

Press **TEXT** .

The display will show up to 10 characters.

The display changes as follows each time the button is pressed:

- CH NAME
- TITLE (SONG/PROGRAM TITLE)
- NAME (ARTIST NAME/FEATURE)
- CH NUMBER

### ■ When the 12-volt battery is disconnected

All preset stations are erased.

### ■ Reception sensitivity

- Cargo loaded on the roof luggage carrier, especially metal objects, may adversely affect the reception of XM<sup>®</sup> Satellite Radio.
- It is difficult to maintain perfect radio reception at all times due to the continually changing position of the antenna, differences in signal strength and surrounding objects, such as trains and transmitters.
- The radio antenna is mounted inside the rear spoiler and the rear window. To maintain clear radio reception, do not attach metallic window tinting or other metallic objects to the antenna wire mounted inside the rear window.

### ■ Receiving XM<sup>®</sup> Satellite Radio

An XM<sup>®</sup> Satellite Radio is a tuner designed exclusively to receive broadcasts provided under a separate subscription. Availability is limited to the 48 contiguous states and 10 Canadian provinces.

#### ● XM<sup>®</sup> subscriptions

For detailed information about XM<sup>®</sup> Satellite Radio or to subscribe:  
U.S.A. —

Visit on the web at [www.siriusxm.com](http://www.siriusxm.com) or call 1-877-515-3987.

Canada —

Visit on the web at [www.xmradio.ca](http://www.xmradio.ca) or call 1-877-438-9677.

#### ● Radio ID

You will need the radio ID when activating XM<sup>®</sup> service or reporting a problem.



Select "CH000" using , and the receiver's 8-character ID number will appear.

#### ● Satellite tuner

The tuner supports only Audio Services (Music and Talk) and the accompanying Text Information of XM<sup>®</sup> Satellite Radio.

### ■ If the satellite radio does not operate normally

If a problem occurs with the XM<sup>®</sup> tuner, a message will appear on the display. Refer to the table below to identify the problem, and take the suggested corrective action.

"ANTENNA"	The XM <sup>®</sup> antenna is not connected. Check whether the XM <sup>®</sup> antenna cable is attached securely.
	There is a short-circuit in the antenna or the surrounding antenna cable. See a Lexus certified dealer.
"UNAUTH"	You have not subscribed to the XM <sup>®</sup> Satellite Radio. The radio is being updated with the latest encryption code. Contact the XM <sup>®</sup> Satellite Radio for subscription information. When a contract is canceled, you can choose the "CH000" and all the free-to-air channels.
	The premium channel you selected is not authorized. Wait for about 2 seconds until the radio returns to the previous channel or "CH001". If it does not change automatically, select another channel. If you want to listen to the premium channel, contact the XM <sup>®</sup> Satellite Radio.
"NO SIGNAL"	The XM <sup>®</sup> signal is too weak at the current location. Wait until your vehicle reaches a location with a stronger signal.
"LOADING"	The unit is acquiring audio or program information. Wait until the unit has received the information.
"OFF AIR"	The channel you selected is not broadcasting any programming. Select another channel.

“----”	There is no song/program title or artist name/feature associated with the channel at that time. No action needed.
“CH UNAVL”	The channel you selected is no longer available. Wait for about 2 seconds until the radio returns to the previous channel or “CH001”. If it does not change automatically, select another channel.

Contact the XM<sup>®</sup> Listener Care Center at 1-877-515-3987 (U.S.A.) or 1-877-438-9677 (Canada).

#### ■ Certifications for XM<sup>®</sup> Satellite Radio

This device complies with RSS-310 of Industry Canada. Operation is subject to the condition that this device does not cause harmful interference.

Cet appareil est conforme au CNR-310 d'Industrie Canada. Son exploitation est autorisée sous réserve que l'appareil ne cause pas de brouillage préjudiciable.

### 3-4. Using the audio system

## Using the CD player

#### ► Type A

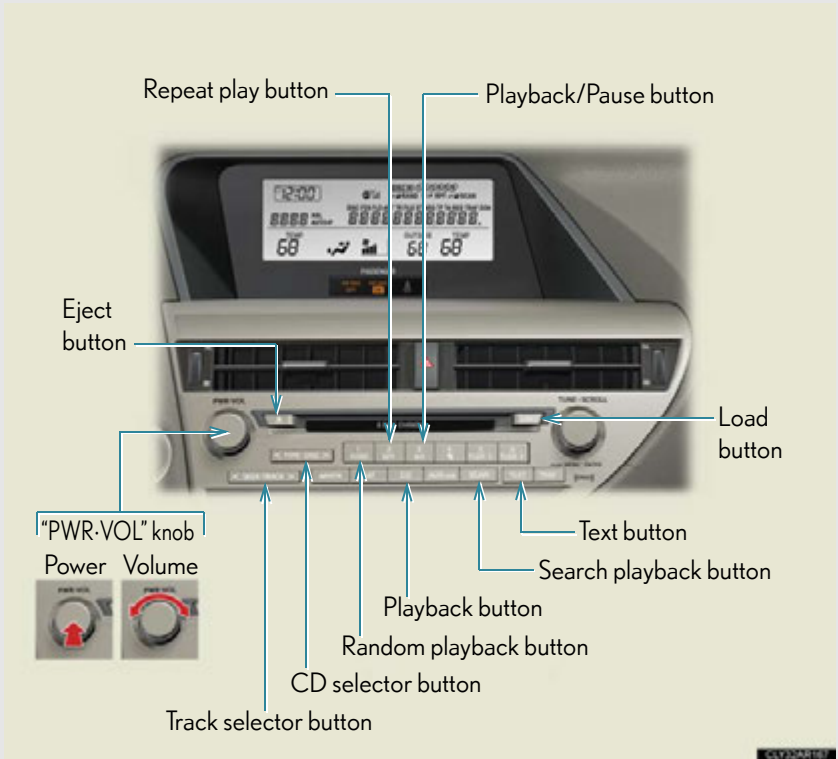

► Type B

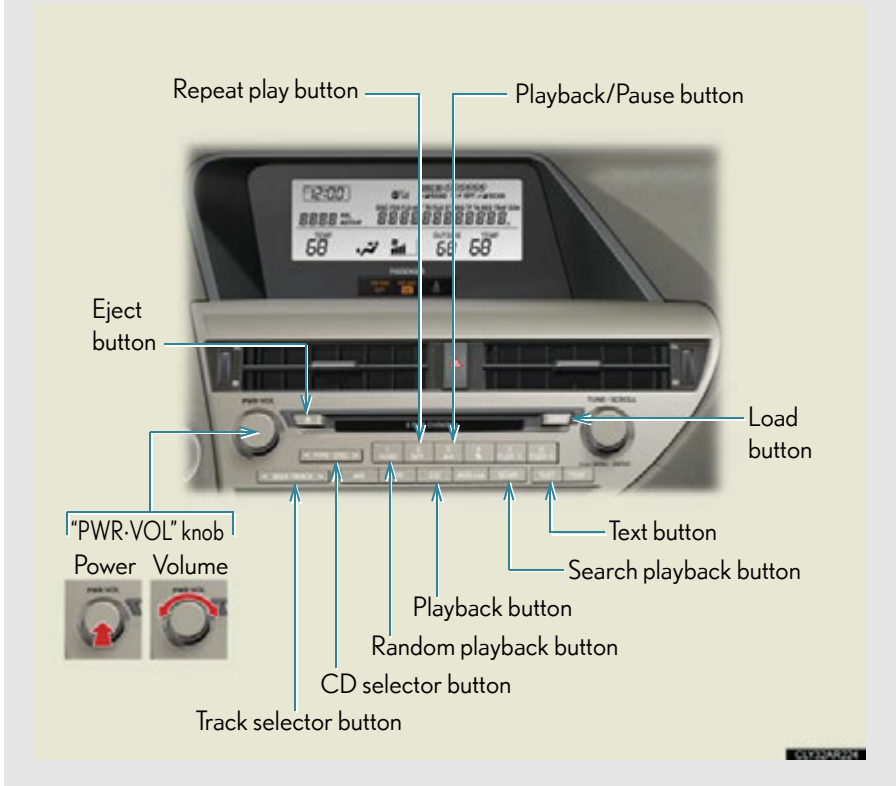

**Loading a CD**

■ Loading a CD

**STEP 1** Press .

“WAIT” is shown on the display.

**STEP 2** When the indicator on the slot turns from amber to green, insert a CD.

The display changes from “WAIT” to “LOAD”.

### ■ Loading multiple CDs

**STEP 1** Press and hold  until you hear a beep.  
“WAIT” is shown on the display.

**STEP 2** When the indicator on the slot turns from amber to green, insert a CD.

The display changes from “WAIT” to “LOAD”.

The indicator on the slot turns to amber when the CD is being inserted.

**STEP 3** When the indicator on the slot turns from amber to green, insert the next CD.

Repeat the procedure for the remaining CDs.

To cancel the operation, press . If you do not insert a disc within 15 seconds, loading will be canceled automatically.

## Ejecting CDs

### ■ Ejecting a CD



To select the CD to be ejected, press “>” or “<” on .

The selected disc number is shown on the display.

**STEP 2** Press  and remove the CD.

### ■ Ejecting all the CDs

Press and hold  until you hear a beep, and then remove the CDs.

## Selecting, fast-forwarding, reversing and scanning tracks

### ■ Selecting a track

Press “>” to move up or “<” to move down using  until the desired track number is displayed.

### ■ Fast-forwarding and reversing tracks

To fast-forward or reverse, press and hold “>” or “<” on  until you hear a beep.

### ■ Scanning tracks

**STEP 1** Press .

The first ten seconds of each track will be played.

To cancel, press  again.

**STEP 2** Press the button again when the desired track is reached.

## Selecting a CD

### ■ Selecting a CD to play

To select the desired CD, press “>” or “<” on .

### ■ Scanning loaded CDs

**STEP 1** Press and hold  until you hear a beep.

The first ten seconds of the first track on each CD will be played.

To cancel, press  again.

**STEP 2** Press the button again when the desired CD is reached.

## Playing and pausing tracks

To play or pause a track, press .



## Random playback

### ■ Current CD

Press .

Songs are played in random order.

To cancel, press  again.

### ■ All CDs

Press and hold  until you hear a beep.

Tracks on all loaded CDs are played in random order.

To cancel, press  again.

## Repeat play

### ■ Repeating a track

Press .

To cancel, press  again.

### ■ Repeating all of the tracks on a CD

Press and hold  until you hear a beep.

To cancel, press  again.

## Switching the display

Press .

Each time the button is pressed, the display changes in the following order:  
Elapsed time → CD title → Track title

### ■ CD player protection feature

To protect the internal components, playback is automatically stopped when a problem is detected.

### ■ Display

Up to 12 characters can be displayed at a time.

If there are 13 or more characters, pressing and holding **TEXT** until you hear a beep enables to display the remaining characters.

A maximum of 24 characters can be displayed.

If **TEXT** is pressed until you hear a beep again or has not been operated for more than 6 seconds, the display will return to the first 12 characters.

Depending on the contents recorded, the characters may not be displayed properly or may not be displayed at all.

### ■ When “ERROR” or “WAIT” is shown on the display

“ERROR”: This indicates a problem either in the CD or inside the player. The CD may be dirty, damaged, or inserted up-side down.

“WAIT”: This indicates that operation is stopped due to a high temperature inside the player. Wait for a while and then press **CD**. If the CD still cannot be played back, contact your Lexus dealer.

### ■ Discs that can be used

Discs with the marks shown below can be used.

Playback may not be possible depending on recording format or disc features, or due to scratches, dirt or deterioration.



CDs with copy-protection features may not be used.

### ■ Lens cleaners

Do not use lens cleaners. Doing so may damage the CD player.

### ■ If discs are left inside the CD player or in the ejected position for extended periods of time

The discs may be damaged and may not play properly.

 NOTICE

**■ CDs and adapters that cannot be used**

Do not use the following types of CDs.

Also, do not use 3 in. (8 cm) CD adapters, DualDiscs or printable discs.

Doing so may damage the CD player and/or the CD load/eject function.



- CDs that have a diameter that is not 4.7 in. (12 cm)

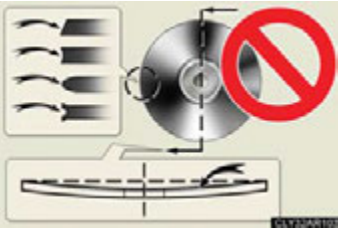

- Low-quality and deformed CDs



- CDs with a transparent or translucent recording area



- CDs that have had tape, stickers or CD-R labels attached to them, or that have had the label peeled off

 NOTICE

■ **CD player precautions**

Failure to follow the precautions below may result in serious damage to the CDs or the player itself.

- Do not insert anything other than CDs into the CD slot.
- Do not apply oil to the CD player.
- Store CDs away from direct sunlight.
- Never try to disassemble any part of the CD player.



- Do not insert more than one CD at a time.

### 3-4. Using the audio system

## Playing MP3 and WMA discs

#### ▶ Type A

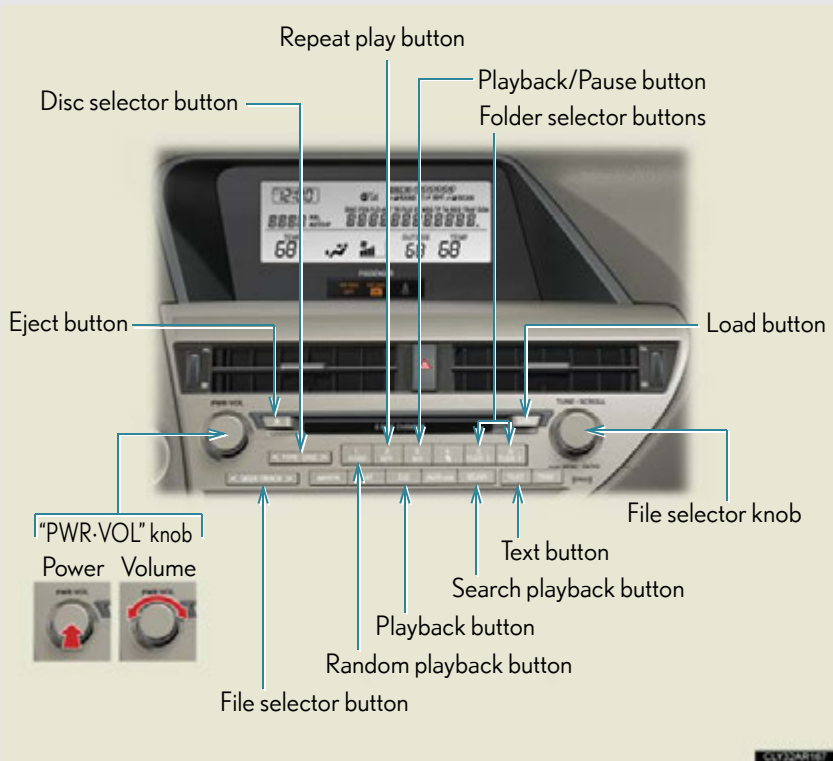

► Type B

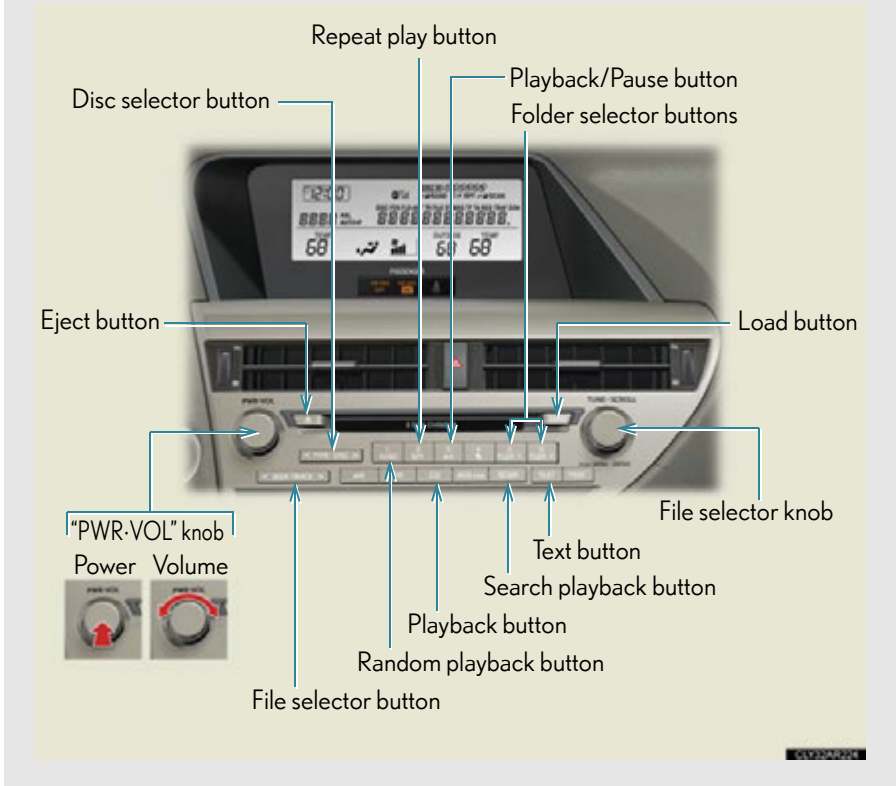

**Loading and ejecting MP3 and WMA discs**



→P. 486, 487

**Selecting MP3 and WMA discs**

→P. 488

## Selecting and scanning a folder

### ■ Selecting a folder one at a time

Press  or  to select the desired folder.

### ■ Returning to the first folder

Press and hold  until you hear a beep.

### ■ Scanning the first file of all the folders

**STEP 1** Press and hold  until you hear a beep.

The first ten seconds of the first file in each folder will be played.

**STEP 2** When the desired folder is reached, press  again.

## Fast-forwarding and reversing files

To fast-forward or reverse, press and hold “>” or “<” on  until you hear a beep.

## Selecting and scanning files

### ■ Selecting a file

Turn  or press “>” or “<” on  to select the desired file.

### ■ Scanning the files in a folder

Press .

The first ten seconds of each file will be played.

To cancel, press  again.

When the desired file is reached, press  again.

## Playing and pausing files

To play or pause a file, press .

## Random playback

### ■ Playing files from a folder in random order

Press .

To cancel, press  again.

### ■ Playing all the files from a disc in random order

Press and hold  until you hear a beep.

To cancel, press  again.

## Repeat play

### ■ Repeating a file

Press .

To cancel, press  again.

### ■ Repeating all the files in a folder

Press and hold  until you hear a beep.

To cancel, press  again.

## Switching the display

Press .

Each time the button is pressed, the display changes in the following order:  
Folder no./File no./Elapsed time → Folder name → File name → Album title  
(MP3 only) → Track title → Artist name



---

- **CD player protection feature**

→P. 490

- **Display**

→P. 490

- **When “ERROR”, “WAIT” or “NO MUSIC” is shown on the display**

“ERROR”: This indicates a problem either in the CD or inside the player. The CD may be dirty, damaged, or inserted up-side down.

“WAIT”: This indicates that operation is stopped due to a high temperature inside the player. Wait for a while and then press . If the CD still cannot be played back, contact your Lexus dealer.

“NO MUSIC”: This indicates that an MP3/WMA file is not included in the CD.

- **Discs that can be used**

→P. 490

- **Lens cleaners**

→P. 490

- **If discs are left inside the CD player or in the ejected position for extended periods of time**

→P. 490

### ■ MP3 and WMA files

MP3 (MPEG Audio LAYER 3) is a standard audio compression format.

Files can be compressed to approximately 1/10 of their original size by using MP3 compression.

WMA (Windows Media Audio) is a Microsoft audio compression format.

This format compresses audio data to a size smaller than that of the MP3 format.

There is a limit to the MP3 and WMA file standards that can be used and to the media/formats on which the files are recorded.

#### ● MP3 file compatibility

- Compatible standards  
MP3 (MPEG1 LAYER3, MPEG2 LSF LAYER3)
- Compatible sampling frequencies  
MPEG1 LAYER3: 32, 44.1, 48 (kHz)  
MPEG2 LSF LAYER3: 16, 22.05, 24 (kHz)
- Compatible bit rates (compatible with VBR)  
MPEG1 LAYER3: 64, 80, 96, 112, 128, 160, 192, 224, 256, 320 (kbps)  
MPEG2 LSF LAYER3: 64, 80, 96, 112, 128, 144, 160 (kbps)
- Compatible channel modes: stereo, joint stereo, dual channel and monaural

#### ● WMA file compatibility

- Compatible standards  
WMA Ver. 7, 8, 9
- Compatible sampling frequencies  
32, 44.1, 48 (kHz)
- Compatible bit rates (only compatible with 2-channel playback)  
Ver. 7, 8: CBR 48, 64, 80, 96, 128, 160, 192 (kbps)  
Ver. 9: CBR 48, 64, 80, 96, 128, 160, 192, 256, 320 (kbps)

#### ● Compatible media

Media that can be used for MP3 and WMA playback are CD-Rs and CD-RWs.

Playback in some instances may not be possible if the CD-R or CD-RW is not finalized. Playback may not be possible or the audio may jump if the disc is scratched or marked with fingerprints.

- Compatible disc formats

The following disc formats can be used:

- Disc formats: CD-ROM Mode 1 and Mode 2  
CD-ROM XA Mode 2, Form 1 and Form 2
- File formats: ISO9660 Level 1, Level 2, (Romeo, Joliet)  
MP3 and WMA files written in any format other than those listed above may not play correctly, and their file names and folder names may not be displayed correctly.

Items related to standards and limitations are as follows:

- Maximum directory hierarchy: 8 levels (including the root)
- Maximum length of folder names/file names: 32 characters
- Maximum number of folders: 192 (including the root)
- Maximum number of files per disc: 255

- File names

The only files that can be recognized as MP3/WMA and played are those with the extension .mp3 or .wma.

- Discs containing multi-session recordings

As the audio system is compatible with multi-sessions, it is possible to play discs that contain MP3 and WMA files. However, only the first session can be played.

- ID3 and WMA tags

ID3 tags can be added to MP3 files, making it possible to record the track title, artist name, etc.

The system is compatible with ID3 Ver. 1.0, 1.1, and Ver. 2.2, 2.3 ID3 tags. (The number of characters is based on ID3 Ver. 1.0 and 1.1.)

WMA tags can be added to WMA files, making it possible to record the track title and artist name in the same way as with ID3 tags.

### ● MP3 and WMA playback

When a disc containing MP3 or WMA files is inserted, all files on the disc are first checked. Once the file check is finished, the first MP3 or WMA file is played. To make the file check finish more quickly, we recommend you do not write in any files other than MP3 or WMA files or create any unnecessary folders.

Discs that contain a mixture of music data and MP3 or WMA format data cannot be played.

### ● Extensions

If the file extensions .mp3 and .wma are used for files other than MP3 and WMA files, they will be mistakenly recognized and played as MP3 and WMA files. This may result in large amounts of interference and damage to the speakers.

### ● Playback

- To play MP3 files with steady sound quality, we recommend a fixed bit rate of at least 128 kbps and a sampling frequency of 44.1 kHz.
- CD-R or CD-RW playback may not be possible in some instances, depending on the characteristics of the disc.
- There is a wide variety of freeware and other encoding software for MP3 and WMA files on the market, and depending on the status of the encoding and the file format, poor sound quality or noise at the start of playback may result. In some cases, playback may not be possible at all.
- When files other than MP3 or WMA files are recorded on a disc, it may take more time to recognize the disc and in some cases, playback may not be possible at all.
- Microsoft, Windows, and Windows Media are registered trademarks of Microsoft Corporation in the U.S.A. and other countries.

### NOTICE

#### ■ CDs and adapters that cannot be used

→P. 491

#### ■ CD player precautions

→P. 492

## 3-4. Using the audio system

# Operating an iPod

Connecting an iPod enables you to enjoy music from the vehicle speakers.

### ■ Connecting an iPod



Pull up the lever to release the lock, and lift the armrest.



Open the cover and connect an iPod using an iPod cable.

Turn on the power of the iPod if it is not turned on.

■ Control panel

► Type A

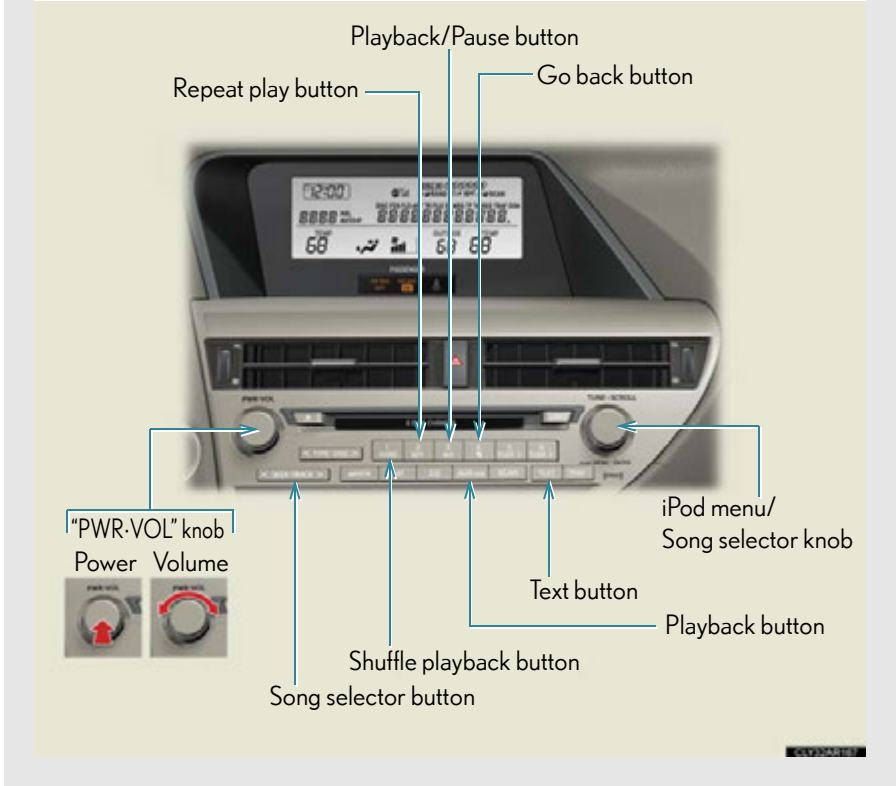

## ▶ Type B

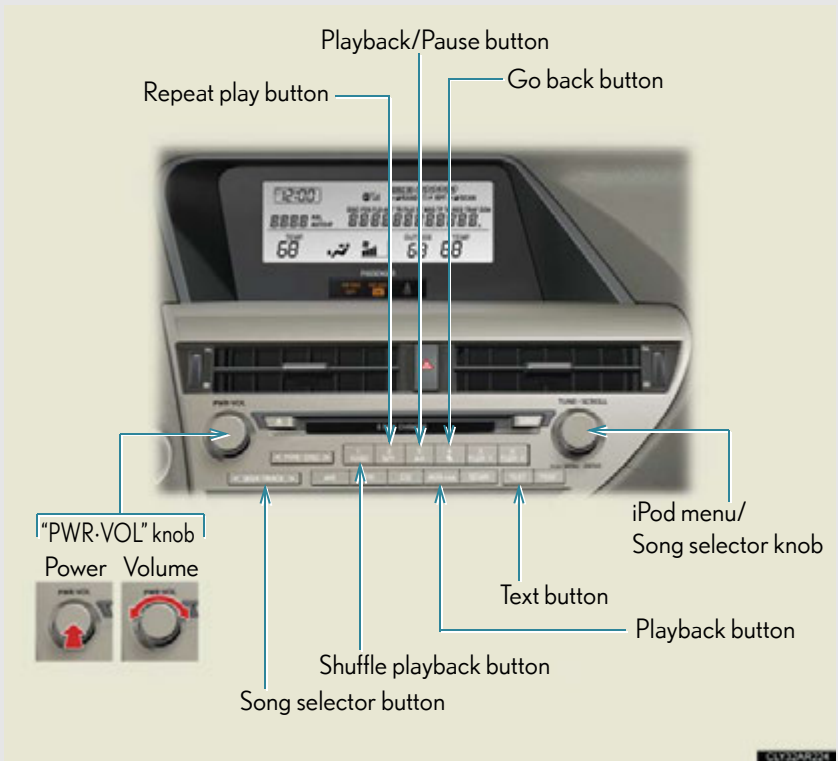

## Selecting a play mode

**STEP 1** Press  to select iPod menu mode.

**STEP 2** Turning  changes the play mode in the following order:

"PLAYLISTS" → "ARTISTS" → "ALBUMS" → "SONGS" →  
 "PODCASTS" → "GENRES" → "COMPOSERS" →  
 "AUDIOBOOKS"

**STEP 3** Press  to select the desired play mode.

### ■ Play mode list

Play mode	First selection	Second selection	Third selection	Fourth selection
"PLAYLISTS"	Playlists select	Songs select	-	-
"ARTISTS"	Artists select	Albums select	Songs select	-
"ALBUMS"	Albums select	Songs select	-	-
"SONGS"	Songs select	-	-	-
"PODCASTS"	Albums select	Songs select	-	-
"GENRES"	Genre select	Artists select	Albums select	Songs select
"COMPOSERS"	Composers select	Albums select	Songs select	-
"AUDIOBOOKS"	Songs select	-	-	-

### ■ Selecting a list

**STEP 1** Turn  to display the first selection list.

**STEP 2** Press  to select the desired item.

Pressing the knob changes to the second selection list.

**STEP 3** Repeat the same procedure to select the desired item.

To return to the previous selection list, select "GO BACK" or press







## Selecting songs

Turn  or press ">" or "<" on  to select the desired song.

## Playing and pausing songs

To play or pause a song, press .

## Fast-forwarding and reversing songs

To fast-forward or reverse, press and hold ">" or "<" on  until you hear a beep.

## Shuffle playback

### ■ Playing songs from one playlist or album in random order

Press .

To cancel, press  again.

### ■ Playing songs from all the playlists or albums in random order

Press and hold  until you hear a beep.

To cancel, press  again.

## Repeat play

Press .

To cancel, press  again.

## Switching the display

Press .

Each time the button is pressed, the display changes in the following order:  
Elapsed time → Album title → Track title → Artist name

## Adjusting sound quality and volume balance

**STEP 1** Press  to enter iPod menu mode.



**STEP 2** Pressing  changes sound modes. (→P. 539)



### ■ About iPod

Made for



iPod



iPhone

- “Made for iPod” and “Made for iPhone” mean that an electronic accessory has been designed to connect specifically to iPod, or iPhone, respectively, and has been certified by the developer to meet Apple performance standards.
- Apple is not responsible for the operation of this device or its compliance with safety and regulatory standards. Please note that the use of this accessory with iPod or iPhone may affect wireless performance.
- iPhone, iPod, iPod classic, iPod nano and iPod touch are trademarks of Apple Inc., registered in the U.S. and other countries.

### ■ iPod functions

- When an iPod is connected and the audio source is changed to iPod mode, the iPod will resume play from the same point in which it was last used.
- Depending on the iPod that is connected to the system, certain functions may not be available. If a function is unavailable due to a malfunction (as opposed to a system specification), disconnecting the device and reconnecting it once again may resolve the problem.
- While connected to the system, the iPod cannot be operated with its own controls. It is necessary to use the controls of the vehicle's audio system instead.
- When the battery level of an iPod is very low, the iPod may not operate. If so, charge the iPod before use.
- Supported models (→P. 508)

### ■ iPod problems

To resolve most problems encountered when using your iPod, disconnect your iPod from the vehicle iPod connection and reset it.

For instructions on how to reset your iPod, refer to your iPod Owner's Manual.

### ■ Display

→P. 490

### ■ Error messages

- “ERROR”: This indicates a problem in the iPod or its connection.
- “NO MUSIC”: This indicates that there is no music data in the iPod.
- “EMPTY”: This indicates that some available songs are not found in a selected playlist.
- “UPDATE”: This indicates that the version of the iPod is not compatible. Upgrade your iPod software to the latest version.

### ■ Compatible models

The following iPod<sup>®</sup>, iPod nano<sup>®</sup>, iPod classic<sup>®</sup>, iPod touch<sup>®</sup> and iPhone<sup>®</sup> devices can be used with this system.

#### ● Made for

- iPod touch (4th generation)
- iPod touch (3rd generation)
- iPod touch (2nd generation)
- iPod touch (1st generation)
- iPod classic
- iPod with video
- iPod nano (6th generation)
- iPod nano (5th generation)
- iPod nano (4th generation)
- iPod nano (3rd generation)
- iPod nano (2nd generation)
- iPod nano (1st generation)
- iPhone 4
- iPhone 3GS
- iPhone 3G
- iPhone

Depending on differences between models or software versions etc., some models might be incompatible with this system.

Items related to standards and limitations are as follows:

- Maximum number of lists in device: 9999
- Maximum number of songs in device: 65535
- Maximum number of songs per list: 65535

### CAUTION

#### ■ Caution while driving

Do not connect iPod or operate the controls.

 NOTICE**■ If the armrest cannot be fully closed**

Depending on the size and shape of the iPod that is connected to the system, the armrest may not close fully. In this case, do not forcibly close the armrest as this may damage the iPod or the terminal, etc.

**■ To prevent damage to iPod**

- Do not leave iPod in the vehicle. The temperature inside the vehicle may become high, resulting in damage to the player.
- Do not push down on or apply unnecessary pressure to the iPod while it is connected as this may damage the iPod or its terminal.
- Do not insert foreign objects into the port as this may damage the iPod or its terminal.

## 3-4. Using the audio system

### Operating a USB memory

Connecting a USB memory enables you to enjoy music from the vehicle speakers.

#### ■ Connecting a USB memory

STEP 1

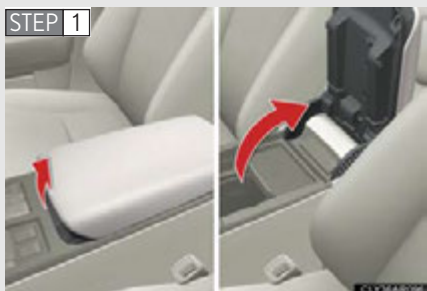

Pull up the lever to release the lock, and lift the armrest.

STEP 2



Open the cover and connect a USB memory.

Turn on the power of the USB memory if it is not turned on.

■ Control panel

► Type A

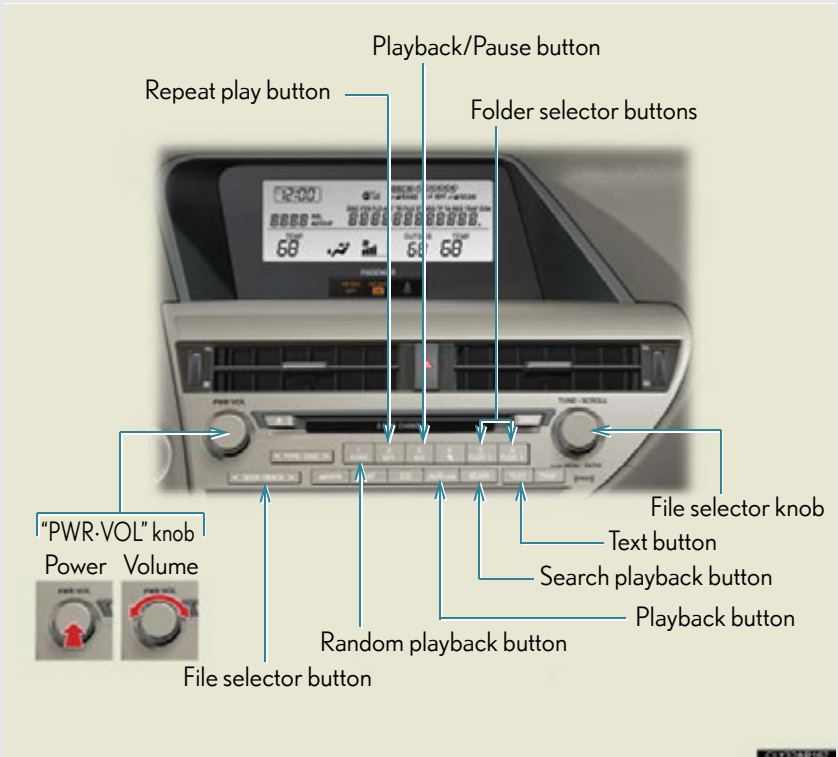

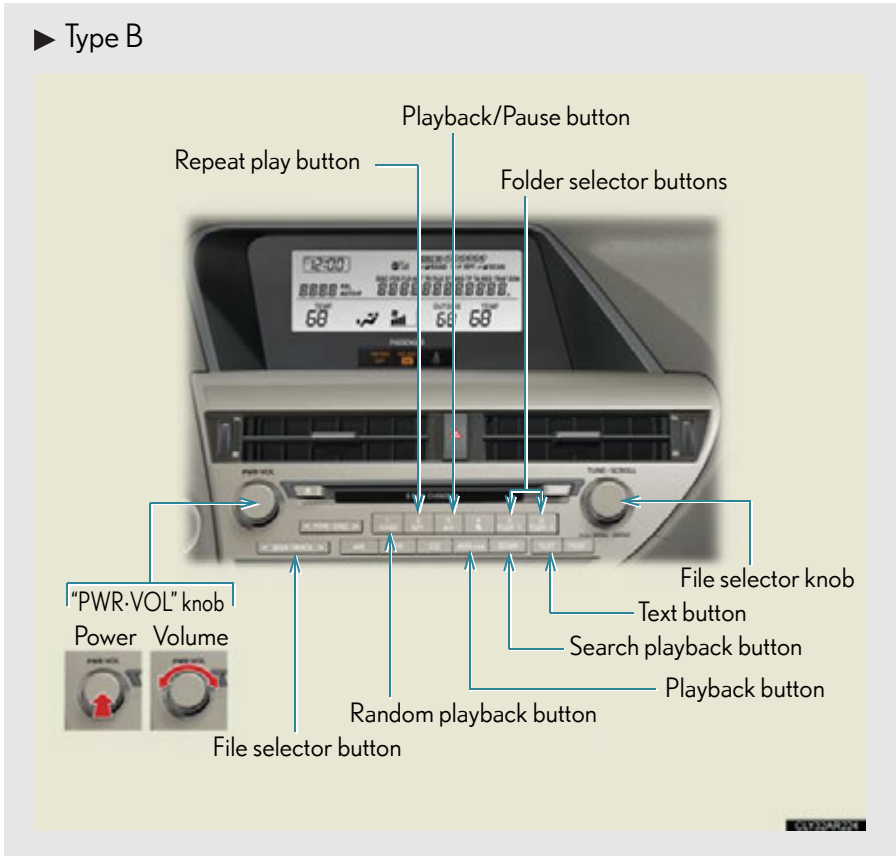

► Type B





## Selecting and scanning a folder

### ■ Selecting folders one at a time

Press  or  to select the desired folder.

### ■ Returning to the first folder

Press and hold  until you hear a beep.

### ■ Scanning the first file of all the folders

**STEP 1** Press and hold  until you hear a beep.

The first ten seconds of the first file in each folder will be played.

**STEP 2** When the desired folder is reached, press  again.

## Selecting and scanning files

### ■ Selecting a file

Turn  or press ">" or "<" on  to select the desired file.

### ■ Scanning the files in a folder

Press .

The first ten seconds of each file will be played.

To cancel, press  again.

When the desired file is reached, press  again.

## Playing and pausing files

To play or pause a file, press .

## Fast-forwarding and reversing files

To fast-forward or reverse, press and hold ">" or "<" on  until you hear a beep.

## Random playback

### ■ Playing files from a folder in random order

Press .

To cancel, press  again.

### ■ Playing all the files from a USB memory in random order

Press and hold  until you hear a beep.

To cancel, press  again.

## Repeat play

### ■ Repeating a file

Press .

To cancel, press  again.

### ■ Repeating all the files in a folder

Press and hold  until you hear a beep.

To cancel, press  again.

## Switching the display

Press .

Each time the button is pressed, the display changes in the following order:  
Elapsed time → Folder name → File name → Album title (MP3 only) →  
Track title → Artist name

### ■ USB memory functions

- Depending on the USB memory that is connected to the system, the device itself may not be operable and certain functions may not be available. If the device is inoperable or a function is unavailable due to a malfunction (as opposed to a system specification), disconnecting the device and reconnecting it once again may resolve the problem.
- If the USB memory still does not begin operation after being disconnected and reconnected, format the memory.

## ■ Display

→P. 490

## ■ Error messages

“ERROR”: This indicates a problem in the USB memory or its connection.

“NO MUSIC”: This indicates that no MP3/WMA files are included in the USB memory.

## ■ USB memory

### ● Compatible devices

USB memories that can be used for MP3 and WMA playback

### ● Compatible device formats

The following device formats can be used:

- USB communication formats: USB2.0 FS (12 Mbps)
- File formats: FAT16/32 (Windows)
- Correspondence class: Mass storage class

MP3 and WMA files written in any format other than those listed above may not play correctly, and their file names and folder names may not be displayed correctly.

Items related to standards and limitations are as follows:

- Maximum directory hierarchy: 8 levels
- Maximum number of folders in a device: 999 (including the root)
- Maximum number of files in a device: 65025
- Maximum number of files per folder: 255

### ● MP3 and WMA files

MP3 (MPEG Audio LAYER 3) is a standard audio compression format.

Files can be compressed to approximately 1/10 of their original size using MP3 compression.

WMA (Windows Media Audio) is a Microsoft audio compression format.

This format compresses audio data to a size smaller than that of the MP3 format.

There is a limit to the MP3 and WMA file standards that can be used and to the media/formats on which the files are recorded.

### ● MP3 file compatibility

- Compatible standards  
MP3 (MPEG1 AUDIO LAYERII, III, MPEG2 AUDIO LAYERII, III, MPEG2.5)
- Compatible sampling frequencies  
MPEG1 AUDIO LAYERII, III: 32, 44.1, 48 (kHz)  
MPEG2 AUDIO LAYERII, III: 16, 22.05, 24 (kHz)  
MPEG2.5: 8, 11.025, 12 (kHz)
- Compatible bit rates (compatible with VBR)  
MPEG1 AUDIO LAYERII, III: 32-320 (kbps)  
MPEG2 AUDIO LAYERII, III: 32-160 (kbps)  
MPEG2.5: 32-160 (kbps)
- Compatible channel modes: stereo, joint stereo, dual channel and monaural

### ● WMA file compatibility

- Compatible standards  
WMA Ver. 9
- Compatible sampling frequencies  
HIGH PROFILE 32, 44.1, 48 (kHz)
- Compatible bit rates  
HIGH PROFILE 32-320 (kbps, VBR)

### ● File names

The only files that can be recognized as MP3/WMA and played are those with the extension .mp3 or .wma.

### ● ID3 and WMA tags

ID3 tags can be added to MP3 files, making it possible to record the track title, artist name, etc.

The system is compatible with ID3 Ver. 1.0, 1.1, and Ver. 2.2, 2.3, 2.4 ID3 tags. (The number of characters is based on ID3 Ver. 1.0 and 1.1.)

WMA tags can be added to WMA files, making it possible to record the track title and artist name in the same way as with ID3 tags.

### ● MP3 and WMA playback

- When a device containing MP3 or WMA files is connected, all files in the USB memory device are checked. Once the file check is finished, the first MP3 or WMA file is played. To make the file check finish more quickly, we recommend that you do not include any files other than MP3 or WMA files or create any unnecessary folders.
- When the USB device is connected and the audio source is changed to USB memory mode, the USB device will start playing the first file in the first folder. If the same device is removed and reinserted (and the contents have not been changed), the USB device will resume play from the same point in which it was last used.

### ● Extensions

If the file extensions .mp3 and .wma are used for files other than MP3 and WMA files, they will be skipped (not played).

### ● Playback

- To play MP3 files with steady sound quality, we recommend a fixed bit rate of at least 128 kbps and a sampling frequency of 44.1 kHz.
- There is a wide variety of freeware and other encoding software for MP3 and WMA files on the market, and depending on the status of the encoding and the file format, poor sound quality or noise at the start of playback may result. In some cases, playback may not be possible at all.
- Microsoft, Windows, and Windows Media are registered trademarks of Microsoft Corporation in the U.S.A. and other countries.

## CAUTION

### ■ Caution while driving

Do not connect USB memories or operate the controls.

### NOTICE

#### ■ **If the armrest cannot be fully closed**

Depending on the size and shape of the USB memory that is connected to the system, the armrest may not close fully. In this case, do not forcibly close the armrest as this may damage the USB memory or the terminal, etc.

#### ■ **To prevent damage to USB memories**

- Do not leave USB memories in the vehicle. The temperature inside the vehicle may become high, resulting in damage to the player.
- Do not push down on or apply unnecessary pressure to the USB memory while it is connected as this may damage the USB memory or its terminal.
- Do not insert foreign objects into the port as this may damage the USB memory or its terminal.

## 3-4. Using the audio system

# Bluetooth<sup>®</sup> audio system

The Bluetooth<sup>®</sup> audio system enables you to enjoy music played on a portable digital audio player (portable player) from the vehicle speakers via wireless communication.

This audio system supports Bluetooth<sup>®</sup>, a wireless data system capable of playing portable audio music without cables. If your portable player does not support Bluetooth<sup>®</sup>, the Bluetooth<sup>®</sup> audio system will not function.

Title	Page
Using the Bluetooth <sup>®</sup> audio system	P. 523
Operating a Bluetooth <sup>®</sup> enabled portable player	P. 528
Setting up a Bluetooth <sup>®</sup> enabled portable player	P. 531
Bluetooth <sup>®</sup> audio system setup	P. 538

### ■ Conditions under which the system will not operate

- If using a portable player that does not support Bluetooth<sup>®</sup>
- If the portable player is switched off
- If the portable player is not connected
- If the portable player's battery is low
- If the portable player is behind the seat or in the glove box or console box
- If metal is covering or touching the portable player

### ■ When transferring ownership of the vehicle

Be sure to initialize the system to prevent personal data from being improperly accessed. (→P. 574)

### ■ About Bluetooth®



Bluetooth is a registered trademark of Bluetooth SIG, Inc.

### ■ Compatible models

- Bluetooth® specifications:  
Ver. 1.1, or higher (Recommended: Ver. 1.2 or higher)
- Following profiles:
  - A2DP (Advanced Audio Distribution Profile) Ver. 1.0, or higher (Conformed: Ver. 1.2)
  - AVRCP (Audio/Video Remote Control Profile) Ver. 1.0 or higher (Conformed: Ver. 1.3)

Portable players must correspond to the above specifications in order to be connected to the Bluetooth® audio system. However, please note that some functions may be limited depending on the type of portable player.

### ■ Certification for the Bluetooth® audio system

FCC ID: AJDK018

IC ID: 775E-K018

This device complies with Part 15 of FCC Rules and Industry Canada licence-exempt RSS standard(s). Operation is subject to the following two conditions: (1) this device may not cause interference, and (2) this device must accept any interference, including interference that may cause undesired operation of this device.

Le présent appareil est conforme aux la partie 15 des règles de la FCC et CNR d'Industrie Canada applicables aux appareils radio exempts de licence. L'exploitation est autorisée aux deux conditions suivantes : (1) l'appareil ne doit pas produire de brouillage, et (2) l'utilisateur de l'appareil doit accepter tout brouillage radioélectrique subi, même si le brouillage est susceptible d'en compromettre le fonctionnement.



 CAUTION

## ■ FCC WARNING

Changes or modifications not expressly approved by the party responsible for compliance could void the user's authority to operate the equipment.

This equipment complies with FCC/IC radiation exposure limits set forth for an uncontrolled environment and meets the FCC radio frequency (RF) Exposure Guidelines in Supplement C to OET65 and RSS-102 of the IC radio frequency (RF) Exposure rules. This equipment has very low levels of RF energy that is deemed to comply without maximum permissive exposure evaluation (MPE). But it is desirable that it should be installed and operated keeping the radiator at least 20 cm or more away from person's body (excluding extremities: hands, wrists, feet and ankles).

Cet équipement est conforme aux limites d'exposition aux rayonnements énoncées pour un environnement non contrôlé et respecte les règles les radioélectriques (RF) de la FCC lignes directrices d'exposition dans le Supplément C à OET65 et d'exposition aux fréquences radioélectriques (RF) CNR-102 de l'IC. Cet équipement émet une énergie RF très faible qui est considérée conforme sans évaluation de l'exposition maximale autorisée.

Cependant, cet équipement doit être installé et utilisé en gardant une distance de 20 cm ou plus entre le dispositif rayonnant et le corps (à l'exception des extrémités : mains, poignets, pieds et chevilles).

This transmitter must not be co-located or operated in conjunction with any other antenna or transmitter.

Under Industry Canada regulations, this radio transmitter may only operate using an antenna of a type and maximum (or lesser) gain approved for the transmitter by Industry Canada. To reduce potential radio interference to other users, the antenna type and its gain should be so chosen that the equivalent isotropically radiated power (e.i.r.p.) is not more than that necessary for successful communication.

Conformément à la réglementation d'Industrie Canada, le présent émetteur radio peut fonctionner avec une antenne d'un type et d'un gain maximal (ou inférieur) approuvé pour l'émetteur par Industrie Canada. Dans le but de réduire les risques de brouillage radioélectrique à l'intention des autres utilisateurs, il faut choisir le type d'antenne et son gain de sorte que la puissance isotrope rayonnée équivalente (p.i.r.e.) ne dépasse pas l'intensité nécessaire à l'établissement d'une communication satisfaisante.

 CAUTION

■ **Caution while driving**

Do not connect portable players or operate the controls.

■ **Caution regarding interference with electronic devices**

- Your audio unit is fitted with Bluetooth<sup>®</sup> antennas. People with implantable cardiac pacemakers, cardiac resynchronization therapy-pacemakers or implantable cardioverter defibrillators should maintain a reasonable distance between themselves and the Bluetooth<sup>®</sup> antennas. The radio waves may affect the operation of such devices.
- Before using Bluetooth<sup>®</sup> devices, users of any electrical medical device other than implantable cardiac pacemakers, cardiac resynchronization therapy-pacemakers or implantable cardioverter defibrillators should consult the manufacturer of the device for information about its operation under the influence of radio waves. Radio waves could have unexpected effects on the operation of such medical devices.

 NOTICE

■ **To prevent damage to portable players**

Do not leave portable players in the vehicle. The temperature inside the vehicle may become high, resulting in damage to the player.

## Using the Bluetooth® audio system

### ■ Audio unit

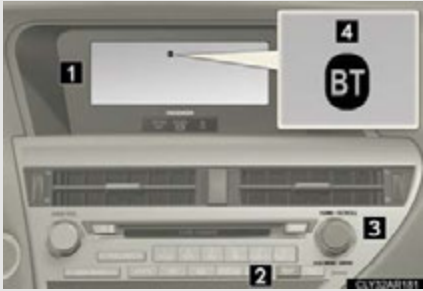

- 1** Display  
A message, name, number, etc. is displayed.

Lower-case characters and special characters cannot be displayed.

- 2** Displays information that is too long to be displayed at one time on the display (press and hold)

- 3** Selects items such as menu and number

Turn: Selects an item

Press: Inputs the selected item

- 4** Bluetooth® connection condition

If "BT" is not displayed, the Bluetooth® audio system cannot be used.

## Operating the system using voice commands

By following voice guidance instructions output from the speaker, voice commands enable the operation of the Bluetooth® audio system without the need to check the display or operate



### ■ Operation procedure when using voice commands

Press the talk switch and follow voice guidance instructions.

### ■ Auxiliary commands when using voice commands

The following auxiliary commands can be used when operating the system using a voice command:

“Cancel”: Exits the Bluetooth® audio system

“Repeat”: Repeats the previous voice guidance instruction

“Go back”: Returns to the previous procedure

“Help”: Reads aloud the function summary if a help comment is registered for the selected function

## Using the Bluetooth® audio system for the first time

Before using the Bluetooth® audio system, it is necessary to register a Bluetooth® enabled portable player in the system. Follow the procedure below to register (pair) a portable player:

**STEP 1**

Press  and select “BT•A MENU” using .

**STEP 2**

Press the talk switch or select “BT•A Setup” using .

The introductory guidance and portable player name registration instructions are heard.

**STEP 3**

Select “Pair Audio Player (Pair Audio)” using a voice command

or .

**STEP 4**

Register a portable player name by either of the following methods:

a. Select “Record Name” using , and say the name to be registered.

b. Press the talk switch and say the name to be registered.

A voice guidance instruction to confirm the input is heard.

**STEP 5**

Select “Confirm” using a voice command or .

A passkey is displayed and heard, and a voice guidance instruction for inputting the passkey into the portable player is heard.

**STEP 6**

Input the passkey into the portable player.

Refer to the manual that comes with the portable player for the operation of the portable player.

Guidance for registration completion is heard.

If the portable player has a Bluetooth<sup>®</sup> phone, the phone can be registered at the same time. A voice guidance instruction to register a Bluetooth<sup>®</sup> phone is heard.

**STEP 7** Select “Yes” or “No” using a voice command or (Bluetooth<sup>®</sup> phone →P. 549)



**Menu list of the Bluetooth<sup>®</sup> audio system**

First menu	Second menu	Third menu	Operation detail
“Setup”	“BT·A Setup”	“Pair Audio”	Registering a portable player
		“Connect”	Selecting a portable player to be used
		“Change Name”	Changing the registered name of a portable player
		“List Audios”	Listing the registered portable players
		“Set Passkey”	Changing the passkey
		“Delete Audio”	Deleting a registered portable player
	“System Setup”	“Guidance Vol”	Setting voice guidance volume
		“Device Name”	Displaying the Bluetooth <sup>®</sup> device address and name
		“Initialize”	Initializing the system

**■ When using a voice command**

For numbers, say a combination of single digits from zero to nine.

Say the command correctly and clearly.

**■ Situations in which the system may not recognize your voice**

- When driving on rough roads
- When driving at high speeds
- When air is blowing out of the vents onto the microphone
- When the air conditioning fan emits a loud noise

**■ Operations that cannot be performed while driving**

- Operating the system using 
- Registering a portable player to the system

**■ Changing the passkey**

→P. 536

### 3-4. Using the audio system

## Operating a Bluetooth® enabled portable player

#### ▶ Type A

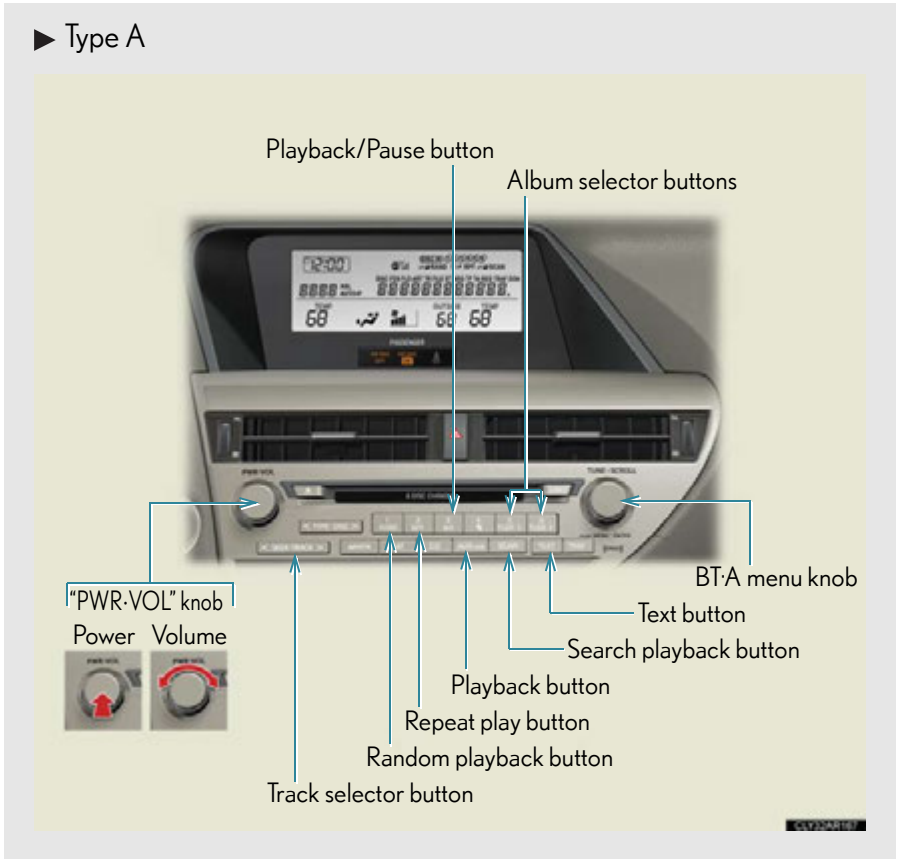

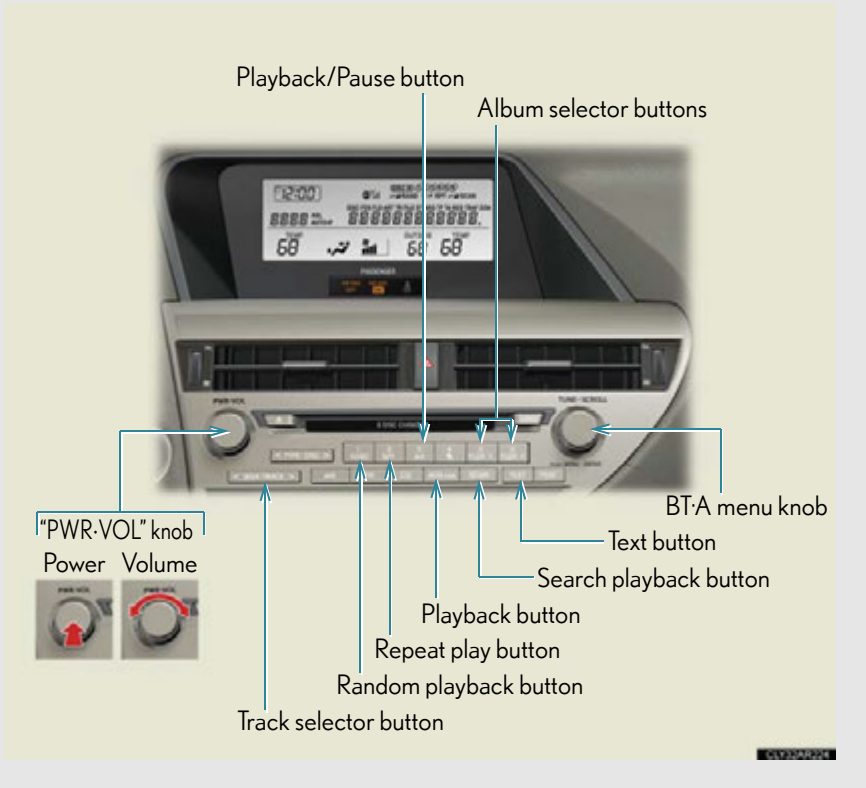

## ▶ Type B

**Selecting an album**

To select the desired album, press **5 FLDOR <** or **6 FLDOR >**.

**Selecting tracks**

Press ">" or "<" on **< SEEK-TRACK >** to select the desired track.

**Playing and pausing tracks**

To play or pause a track, press **3 ▶/⏸**.

#### Fast-forwarding and reversing tracks

To fast-forward or reverse, press and hold “>” or “<” on  until you hear a beep.

#### Random playback

Press .

To cancel, press  again.

#### Repeat play

Press .

To cancel, press  again.

#### Scanning tracks

Press .

To cancel, press  again.

#### Switching the display

Press .

Each time the button is pressed, the display changes in the following order:  
Elapsed time → Album title → Track title → Artist name

#### ■ Bluetooth® audio system functions

Depending on the portable player that is connected to the system, certain functions may not be available.

#### ■ Display

→P. 490

#### ■ Error messages

“Memory Error”: This indicates a problem in the system.

## Setting up a Bluetooth<sup>®</sup> enabled portable player

Registering a portable player in the Bluetooth<sup>®</sup> audio system allows the system to function. The following functions can be used for registered portable players:

### ■ Functions and operation procedures

#### ▶ Pattern A

To enter the menu for each function, follow the steps below using a

voice command or  :

- Registering a portable player
  1. "Setup" → 2. "Bluetooth Audio Setup (BT•A Setup)" → 3. "Pair Audio Player (Pair Audio)"
- Selecting a portable player to be used
  1. "Setup" → 2. "Bluetooth Audio Setup (BT•A Setup)" → 3. "Connect Audio Player (Connect)"
- Changing the registered name of a portable player
  1. "Setup" → 2. "Bluetooth Audio Setup (BT•A Setup)" → 3. "Change Name"
- Listing the registered portable players
  1. "Setup" → 2. "Bluetooth Audio Setup (BT•A Setup)" → 3. "List Audio Players (List Audios)"
- Changing the passkey
  1. "Setup" → 2. "Bluetooth Audio Setup (BT•A Setup)" → 3. "Set Passkey"
- Deleting a registered portable player
  1. "Setup" → 2. "Bluetooth Audio Setup (BT•A Setup)" → 3. "Delete Audio Player (Delete Audio)"

► Pattern B

**STEP 1** Press  to select "BT•A MENU".

**STEP 2** Press the talk switch or select "BT•A Setup" using .

**STEP 3** Select one of the following functions using a voice command

or .

- Registering a portable player  
"Pair Audio Player (Pair Audio)"
- Selecting a portable player to be used  
"Connect Audio Player (Connect)"
- Changing the registered name of a portable player  
"Change Name"
- Listing the registered portable players  
"List Audio Players (List Audios)"
- Changing the passkey  
"Set Passkey"
- Deleting a registered portable player  
"Delete Audio Player (Delete Audio)"

## Registering a portable player

Select “Pair Audio Player (Pair Audio)” using a voice command or , and perform the procedure for registering a portable player. (→P. 525)

## Selecting a portable player to be used

**STEP 1** Select “Connect Audio Player (Connect)” using a voice com-

mand or .

### ► Pattern A

**STEP 2** Select the portable player to be used by either of the following methods, and select “Confirm” by using a voice command or



- a. Press the talk switch and say the name of the desired portable player.
- b. Press the talk switch and say “List Audio Players”. When the name of the desired portable player is read aloud, press the talk switch.

### ► Pattern B

**STEP 2** Select the portable player to be used using .

► Pattern A

**STEP 3** Press the talk switch and say “From Car” or “From Audio player”, and select “Confirm” by using a voice command or .

► Pattern B

**STEP 3** Select “From Car” or “From Audio”, using .

If “From Car” is selected, the portable player will be automatically connected whenever the “POWER” switch is in either ACCESSORY or ON mode.

### Changing the registered name of a portable player

**STEP 1** Select “Change Name” using a voice command or .

► Pattern A

**STEP 2** Select the name of the portable player to be changed by either of the following methods, and select “Confirm” using a voice command or :

- a. Press the talk switch and say the name of the desired portable player.
- b. Press the talk switch and say “List Audio Players”. When the name of the desired portable player is read aloud, press the talk switch.

► Pattern B

**STEP 2** Select the desired portable player name to be changed using



**STEP 3** Press the talk switch or select “Record Name” using , and say the new name.

**STEP 4** Select “Confirm” using a voice command or



### Listing the registered portable players

Select “List Audio Players (List Audios)” using a voice command or



. The list of registered portable players will be read aloud.

When listing is complete, the system returns to “BT•A Setup”.

Pressing the talk switch while the name of a portable player is being read aloud selects the portable player, and the following functions will become available:

- Selecting a portable player: “Connect Audio Player (Connect)”
- Changing a registered name: “Change Name”
- Deleting a portable player: “Delete Audio Player (Delete Audio)”

## Changing the passkey

**STEP 1** Select “Set Passkey” using a voice command or



► Pattern A

**STEP 2** Press the talk switch, say a 4 to 8-digit number, and select “Confirm” using a voice command or



► Pattern B

**STEP 2** Select a 4 to 8-digit number using



The number should be input 1 digit at a time.

**STEP 3** When the entire number to be registered as a passkey has been input, press



again.

If the number to be registered has 8 digits, pressing of the knob is not necessary.



## Deleting a registered portable player

**STEP 1** Select “Delete Audio Player (Delete Audio)” using a voice command or  .

### ► Pattern A

**STEP 2** Select the portable player to be deleted by either of the following methods and select “Confirm” using a voice command or  :

- Press the talk switch and say the name of the desired portable player.
- Press the talk switch and say “List Audio Players”. When the name of the desired portable player is read aloud, press the talk switch.

### ► Pattern B

**STEP 2** Select the desired portable player to be deleted using  .

If the portable player to be deleted is paired as a Bluetooth<sup>®</sup> phone, the registration of the mobile phone can be deleted at the same time. A voice guidance instruction to delete a mobile phone is heard.

**STEP 3** Select “Yes” or “No” using a voice command or  .

(Bluetooth<sup>®</sup> phone →P. 549)

### ■ The number of portable players that can be registered

Up to 2 portable players can be registered in the system.

## 3-4. Using the audio system Bluetooth<sup>®</sup> audio system setup

### ■ System setup items and operation procedures

#### ▶ Pattern A

To enter the menu for each function, follow the steps below using a

voice command or  :

(→P. 571)

#### ▶ Pattern B

**STEP 1** Press  to select “BT•A MENU”.

**STEP 2** Select “System Setup” using .

**STEP 3** Select one of the following items using  :

- Setting voice guidance volume  
“Guidance Vol” (→P. 573)
- Displaying the Bluetooth<sup>®</sup> device address and name  
“Device Name” (→P. 573)
- Initializing the system  
“Initialize” (→P. 574)

## 3-4. Using the audio system

### Optimal use of the audio system



- 1 Displays the current mode
- 2 Changes the following settings:
  - Sound quality and volume balance  
→P.540The sound quality and balance setting can be changed to produce the best sound.
- Automatic Sound Levelizer on/off  
→P.540

#### Adjusting sound quality and volume balance

##### ■ Changing sound quality modes



Pressing the button changes sound modes in the following order:  
“BAS”→“MID”→“TRE”→“FAD”→“BAL”→“ASL”



### ■ Adjusting sound quality

Turning  adjusts the level.

Mode displayed	Sound quality mode	Level	Turn counter-clockwise	Turn clockwise
"BAS"	Bass*	-5 to 5	Low	High
"MID"	Mid-range*	-5 to 5		
"TRE"	Treble*	-5 to 5		
"FAD"	Front/rear volume balance	F7 to R7	Shifts to rear	Shifts to front
"BAL"	Left/right volume balance	L7 to R7	Shifts to left	Shifts to right

\*: The sound quality level is adjusted individually in each audio mode.

### Turning the Automatic Sound Levelizer (ASL) on/off

Turning  clockwise turns on the ASL, and turning  counter-clockwise turns off the ASL.

ASL automatically adjusts the volume and tone quality according to the noise level as you drive your vehicle.

## 3-4. Using the audio system

### Using the AUX port

This port can be used to connect a portable audio device and listen to it through the vehicle's speakers.

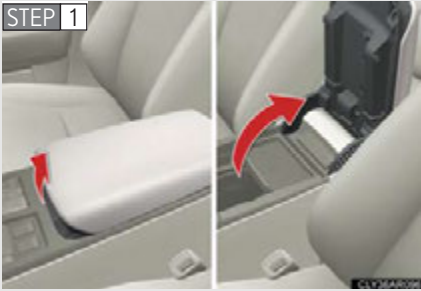

Pull up the lever to release the lock, and lift the armrest.

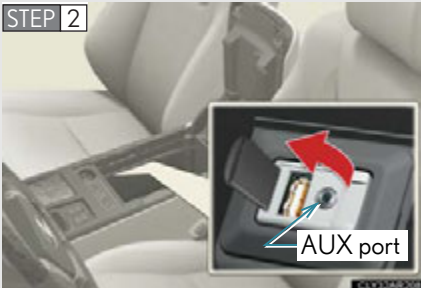

Open the cover and connect the portable audio device.

**STEP 3** Press **AUX-USB**.

#### ■ Operating portable audio devices connected to the audio system

The volume can be adjusted using the vehicle's audio controls. All other adjustments must be made on the portable audio device itself.

#### ■ When using a portable audio device connected to the power outlet

Noise may occur during playback. Use the power source of the portable audio device.

#### CAUTION

##### ■ Caution while driving

Do not connect portable audio device or operate the controls.

#### NOTICE

##### ■ If the armrest cannot be fully closed

Depending on the size and shape of the portable audio device that is connected to the system, the armrest may not close fully. In this case, do not forcibly close the armrest as this may damage the portable audio device or the terminal, etc.

##### ■ To prevent damage to portable audio device

- Do not leave portable audio device in the vehicle. The temperature inside the vehicle may become high, resulting in damage to the player.
- Do not push down on or apply unnecessary pressure to the portable audio device while it is connected as this may damage the portable audio device or its terminal.
- Do not insert foreign objects into the port as this may damage the portable audio device or its terminal.

## 3-4. Using the audio system

# Using the steering wheel audio switches

Some audio features can be controlled using the switches on the steering wheel.

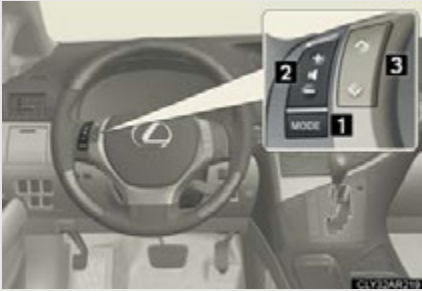

- 1 Turns the power on, selects an audio source
- 2 Increases/decreases volume
- 3 Radio mode: Selects a radio station  
CD mode: Selects a track, file (MP3 and WMA) and disc  
Bluetooth® audio mode: Selects a track and album  
iPod mode: Selects a song  
USB memory mode: Selects a file and folder

### Turning the power on

Press **MODE** when the audio system is turned off.

The audio system can be turned off by holding the switch down until you hear a beep.

## Changing the audio source

Press **MODE** when the audio system is turned on. The audio source changes as follows each time the button is pressed. If no discs are inserted in the player, that mode will be skipped.

Type A:

FM1→FM2→SAT1→SAT2→SAT3→CD player→  
Bluetooth® audio→AUX→iPod or USB memory→  
AM→FM1

Type B:

FM1→FM2→CD player→Bluetooth® audio→AUX→  
iPod or USB memory→AM→FM1

## Adjusting the volume

Press “+” on  to increase the volume and “-” to decrease the volume.

Hold down the button to continue increasing or decreasing the volume.

## Selecting a radio station

**STEP 1** Press **MODE** to select radio mode.

**STEP 2** Press “^” or “v” on  to select a radio station.

To scan for receivable stations, press and hold “^” or “v” on the button until you hear a beep.



### Selecting a track/file or song

**STEP 1** Press **MODE** to select CD, Bluetooth® audio, iPod or USB memory mode.

**STEP 2** Press “^” or “v” on  to select the desired track/file or song.

### Selecting an album

**STEP 1** Press **MODE** to select Bluetooth® audio mode.

**STEP 2** Press and hold “^” or “v” on  until you hear a beep.

### Selecting a folder

**STEP 1** Press **MODE** to select USB memory mode.

**STEP 2** Press and hold “^” or “v” on  until you hear a beep.

### Selecting a disc in the CD player

**STEP 1** Press **MODE** to select CD mode.

**STEP 2** Press and hold “^” or “v” on  until you hear a beep.

### ■ Canceling automatic selection of a radio station

Press  again.

 **CAUTION**

■ **To reduce the risk of an accident**

Exercise care when operating the audio switches on the steering wheel.

### 3-4. Using the audio system

## Hands-free system for mobile phones

The hands-free system is a function that allows you to use your mobile phone without touching it.

This system supports Bluetooth<sup>®</sup> mobile phones. Bluetooth<sup>®</sup> is a wireless data system that allows the mobile phone to wirelessly connect to the hands-free system and make/receive calls.

Title	Page
Using the hands-free system	P. 552
Making a phone call	P. 560
Setting a mobile phone	P. 565
Security and system setup	P. 571
Using the phone book	P. 575

### ■ Conditions under which the system will not operate

- If using a mobile phone that does not support Bluetooth®
- If the mobile phone is switched off
- If you are outside service range
- If the mobile phone is not connected
- If the mobile phone's battery is low
- If the mobile phone is behind the seat or in the glove box or console box
- If metal is covering or touching the phone

### ■ When using the hands-free system

- The audio system and voice guidance are muted when making a call.
- If both parties speak at the same time, it may be difficult to hear.
- If the incoming call volume is overly loud, an echo may be heard.
- Try to face toward the microphone as much as possible when speaking.
- In the following circumstances, it may be difficult to hear the other party:
  - When driving on unpaved roads
  - When driving at high speeds
  - When a window is open
  - When the air conditioning is blowing directly on the microphone
  - When the air conditioning is set to high

### ■ When transferring ownership of the vehicle

Be sure to initialize the system to prevent personal data from being improperly accessed. (→P. 574)

### ■ About Bluetooth®



Bluetooth is a registered trademark of Bluetooth SIG, Inc.

### ■ Compatible models

Compatible with HFP (Hands Free Profile) Ver. 1.0 or higher (Conformed: Ver. 1.5) and OPP (Object Push Profile) Ver. 1.1.

If your mobile phone does not support HFP, you cannot enter the Bluetooth<sup>®</sup> phone. If your mobile phone supports OPP alone, you cannot use the Bluetooth<sup>®</sup> phone.

### ■ Certification for the hands-free system

FCC ID: AJDK018

IC ID: 775E-K018

This device complies with Part 15 of FCC Rules and Industry Canada licence-exempt RSS standard(s). Operation is subject to the following two conditions: (1) this device may not cause interference, and (2) this device must accept any interference, including interference that may cause undesired operation of this device.

Le présent appareil est conforme aux la partie 15 des règles de la FCC et CNR d'Industrie Canada applicables aux appareils radio exempts de licence. L'exploitation est autorisée aux deux conditions suivantes : (1) l'appareil ne doit pas produire de brouillage, et (2) l'utilisateur de l'appareil doit accepter tout brouillage radioélectrique subi, même si le brouillage est susceptible d'en compromettre le fonctionnement.

#### CAUTION

##### ■ FCC WARNING

Changes or modifications not expressly approved by the party responsible for compliance could void the user's authority to operate the equipment.

This equipment complies with FCC/IC radiation exposure limits set forth for an uncontrolled environment and meets the FCC radio frequency (RF) Exposure Guidelines in Supplement C to OET65 and RSS-102 of the IC radio frequency (RF) Exposure rules. This equipment has very low levels of RF energy that it deemed to comply without maximum permissive exposure evaluation (MPE). But it is desirable that it should be installed and operated keeping the radiator at least 20 cm or more away from person's body (excluding extremities: hands, wrists, feet and ankles).

Cet équipement est conforme aux limites d'exposition aux rayonnements énoncées pour un environnement non contrôlé et respecte les règles les radioélectriques (RF) de la FCC lignes directrices d'exposition dans le Supplément C à OET65 et d'exposition aux fréquences radioélectriques (RF) CNR-102 de l'IC. Cet équipement émet une énergie RF très faible qui est considérée conforme sans évaluation de l'exposition maximale autorisée.

Cependant, cet équipement doit être installé et utilisé en gardant une distance de 20 cm ou plus entre le dispositif rayonnant et le corps (à l'exception des extrémités : mains, poignets, pieds et chevilles).

This transmitter must not be co-located or operated in conjunction with any other antenna or transmitter.

Under Industry Canada regulations, this radio transmitter may only operate using an antenna of a type and maximum (or lesser) gain approved for the transmitter by Industry Canada. To reduce potential radio interference to other users, the antenna type and its gain should be so chosen that the equivalent isotropically radiated power (e.i.r.p.) is not more than that necessary for successful communication.

Conformément à la réglementation d'Industrie Canada, le présent émetteur radio peut fonctionner avec une antenne d'un type et d'un gain maximal (ou inférieur) approuvé pour l'émetteur par Industrie Canada. Dans le but de réduire les risques de brouillage radioélectrique à l'intention des autres utilisateurs, il faut choisir le type d'antenne et son gain de sorte que la puissance isotrope rayonnée équivalente (p.i.r.e.) ne dépasse pas l'intensité nécessaire à l'établissement d'une communication satisfaisante.

 CAUTION**■ Caution while driving**

Do not use a mobile phone or connect the Bluetooth® phone.

**■ Caution regarding interference with electronic devices**

- Your audio unit is fitted with Bluetooth® antennas. People with implantable cardiac pacemakers, cardiac resynchronization therapy-pacemakers or implantable cardioverter defibrillators should maintain a reasonable distance between themselves and the Bluetooth® antennas. The radio waves may affect the operation of such devices.
- Before using Bluetooth® devices, users of any electrical medical device other than implantable cardiac pacemakers, cardiac resynchronization therapy-pacemakers or implantable cardioverter defibrillators should consult the manufacturer of the device for information about its operation under the influence of radio waves. Radio waves could have unexpected effects on the operation of such medical devices.

 NOTICE**■ To prevent damage to mobile phones**

Do not leave mobile phones in the vehicle. The temperature inside the vehicle may become high, resulting in damage to the phone.

## 3-4. Using the audio system

### Using the hands-free system (for mobile phones)

#### ■ Audio unit



- 1** Display  
A message, name, phone number, etc. is displayed.  
Lower-case characters and special characters cannot be displayed.
- 2** Displays information that is too long to be displayed at one time on the display (press and hold)
- 3** Selects speed dials
- 4** Selects items such as menu and number  
Turn: Selects an item  
Press: Inputs the selected item
- 5** Bluetooth<sup>®</sup> connection condition  
If "BT" is not displayed, the hands-free phone system cannot be used.
- 6** Reception level



## ■ Steering wheel switches

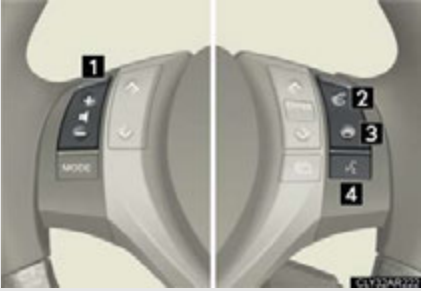

### 1 Volume

During an incoming call:  
Adjusts the ring tone volume

During an ongoing call:  
Adjusts the receiver volume

The voice guidance volume cannot be adjusted using this button.

### 2 Off-hook switch

Turns the hands-free system on/starts a call

### 3 On-hook switch

Turns the hands-free system off/ends a call/refuses a call

### 4 Talk switch

Turns the voice command system on (press)/turns the voice command system off (press and hold)

## ■ Microphone



## Operating the system using voice commands

By following voice guidance instructions output from the speaker, voice commands enable the operation of the hands-free phone system without

the need to check the display or operate



### ■ Operation procedure when using voice commands

Press the talk switch and follow voice guidance instructions.

### ■ Auxiliary commands when using voice commands

The following auxiliary commands can be used when operating the system using a voice command:

“Cancel”: Exits the hands-free phone system

“Repeat”: Repeats the previous voice guidance instruction

“Go back”: Returns to the previous procedure

“Help”: Reads aloud the function summary if a help comment is registered for the selected function

## Using the hands-free phone system for the first time

Before using the hands-free phone system, it is necessary to register a mobile phone in the system. The system will enter phone registration mode automatically when starting the system with no mobile phone registered. Follow the procedure below to register (pair) a mobile phone:

**STEP 1** Press the off-hook switch or the talk switch.

The introductory guidance and phone name registration instructions are heard.

**STEP 2** Select “Pair Phone” using a voice command or



**STEP 3** Register a phone name by either of the following methods:

- a. Select “Record Name” using , and say the name to be registered.
- b. Press the talk switch and say the name to be registered.

A voice guidance instruction to confirm the input is heard.

**STEP 4** Select “Confirm” using a voice command or



A passkey is displayed and heard, and a voice guidance instruction for inputting the passkey into the mobile phone is heard.

**STEP 5** Input the passkey into the mobile phone.

Refer to the manual that comes with the mobile phone for the operation of the phone.

Guidance for registration completion is heard.

If the mobile phone has a Bluetooth<sup>®</sup> audio player, the audio player can be registered at the same time. A voice guidance instruction to register a Bluetooth<sup>®</sup> audio player is heard.

**STEP 6** Select “Yes” or “No” using a voice command or



(Bluetooth® audio player →P. 520)

## Menu list of the hands-free phone system

### ■ Normal operation

First menu	Second menu	Third menu	Operation detail
“Callback”	-	-	Dialing a number stored in the incoming call history memory
“Redial”	-	-	Dialing a number stored in the outgoing call history memory
“Phonebook”	“Add Entry”	-	Adding a new phone number
	“Change Name”	-	Changing the registered name in the phone book
	“Delete Entry”	-	Deleting the registered data
	“Del Spd Dial”	-	Deleting speed dials
	“List Names”	-	Listing the registered data
	“Speed Dial”	-	Setting speed dials

First menu	Second menu	Third menu	Operation detail
"Setup"	"Security"	"Set PIN"	Setting a PIN code
		"Phbk Lock"	Locking the phone book
		"Phbk Unlock"	Unlocking the phone book
	"Phone Setup"	"Pair Phone"	Registering the mobile phone to be used
		"Connect"	Selecting a mobile phone to be used
		"Change Name"	Changing the registered name of a mobile phone
		"List Phones"	Listing the registered mobile phones
		"Set Passkey"	Changing the passkey
		"Delete Phone"	Deleting a registered mobile phone
	"System Setup"	"Guidance Vol"	Setting voice guidance volume
		"Device Name"	Displaying the Bluetooth <sup>®</sup> device address and name
		"Initialize"	Initializing the system

### ■ Short cut key operation

First menu	Second menu	Operation detail
"Dial XXX (name)"	-	Dialing a name registered in the phone book
"Phone book add Entry"	-	Adding a new phone number
"Phone book Change name"	-	Changing a registered name in the phone book
"Phone book Delete Entry"	-	Deleting the registered data
"Phone book List names"	-	Listing the registered data
"Phone book Set Speed Dial"	-	Setting speed dials
"Phone book Delete Speed Dial"	-	Deleting speed dials
"Dial XXX (number)"	-	Dialing by inputting a number
"Phonebook"	"Phonebook Unlock"	Unlocking the phone book
	"Phonebook Lock"	Locking the phone book

### ■ Automatic volume adjustment

When vehicle speed reaches 50 mph (80 km/h) or more, the volume automatically increases. The volume returns to the previous volume setting when vehicle speed drops to 43 mph (70 km/h) or less.

### ■ When using a voice command

For numbers, say a combination of single digits from zero to nine, # (pound), \* (star), and + (plus).

Say the command correctly and clearly.

### ■ Situations in which the system may not recognize your voice

- When driving on rough roads
- When driving at high speeds
- When air is blowing out of the vents onto the microphone
- When the air conditioning fan emits a loud noise

### ■ Operations that cannot be performed while driving

- Operating the system using 
- Registering a mobile phone to the system

### ■ Changing the passkey

→P. 568

# Making a phone call

### ■ Making a phone call

- Dialing by inputting a number  
“Dial by number”
- Dialing by inputting a name  
“Dial by name”
- Speed dialing
- Dialing a number stored in the outgoing history memory  
“Redial”
- Dialing a number stored in the incoming history memory  
“Call back”

### ■ Receiving a phone call

- Answering a phone call
- Refusing a phone call

### ■ Transferring a phone call

### ■ Call waiting

### ■ Using the call history memory

- Dialing
- Storing number in the phone book
- Deleting



### Dialing by inputting a number

- STEP 1** Press the talk switch and say “Dial by number”.
- STEP 2** Press the talk switch and say the phone number.
- STEP 3** Dial by one of the following methods:
  - a. Press the off-hook switch.
  - b. Press the talk switch and say “Dial”.
  - c. Select “Dial” using  .



### Dialing by inputting a name

- STEP 1** Press the talk switch and say “Dial by name”.
- STEP 2** Select a registered name to be input by either of the following methods:
  - a. Press the talk switch and say a registered name.
  - b. Press the talk switch and say “List Names”. Press the talk switch when the desired name is read aloud.
- STEP 3** Dial by one of the following methods:
  - a. Press the off-hook switch.
  - b. Press the talk switch and say “Dial”.
  - c. Select “Dial” using  .



### Speed dialing

- STEP 1** Press the off-hook switch.
- STEP 2** Press the preset button in which the desired number is registered.
- STEP 3** Press the off-hook switch.

### When receiving a phone call

#### ■ Answering a phone call

Press the off-hook switch.

#### ■ Refusing a phone call

Press the on-hook switch.

### Transferring a phone call

A call can be transferred between the mobile phone and system while dialing, receiving a call, or during a call. Use one of the following methods:

- a. Operate the mobile phone.

Refer to the manual that comes with the mobile phone for the operation of the phone.

- b. Press the off-hook switch<sup>\*1</sup>.

- c. Press the talk switch and say "Call Transfer"<sup>\*2</sup>.

<sup>\*1</sup>: This operation can be performed only when transferring a call from the mobile phone to the system during a call.

<sup>\*2</sup>: While the vehicle is in motion, calls cannot be transferred from the system to the mobile phone.

### Call waiting

When a call is interrupted by an incoming call from a third party, the following options will become available:

- Answer the incoming call: Press the off-hook switch. (Press the off-hook switch again as necessary to switch back and forth between calls.)
- Refuse the incoming call: Press the on-hook switch.

## Using the call history memory

Follow the procedure below to use a number stored in the call history memory:

**STEP 1** Press the talk switch and say “Redial” (when using a number stored in the outgoing call history memory) or “Call back” (when using a number stored in the incoming call history memory).

**STEP 2** Select the number by either of the following methods:

- Say “Previous” or “Go back” until the desired number is displayed.
- Select the desired number using .

**STEP 3** The following operations can be performed:

Dialing: Press the off-hook switch or select “Dial” using a voice command or .

Storing the number in the phone book: Select “Store” and then “Confirm” using a voice command or .

Deleting: Select “Delete” and then “Confirm” using a voice command or .

### ■ Call waiting

- If your phone does not support HFP Ver. 1.5, this function cannot be used.
- Call waiting operation may differ depending on your mobile phone and service provider.

### ■ Call history

Up to 5 numbers can be stored in each of the outgoing and incoming call history memories.

### ■ When talking on the phone

- Do not talk at the same time as the other party.
- Keep the volume of the incoming voice down. Otherwise, voice echo will increase.

# Setting a mobile phone

Registering a mobile phone in the hands-free phone system allows the system to function. The following functions can be used for registered mobile phones:

### ■ Functions and operation procedures

To enter the menu for each function, follow the steps below using a

voice command or



- Registering a mobile phone
  1. "Setup" → 2. "Phone Setup" → 3. "Pair Phone"
- Selecting a mobile phone to be used
  1. "Setup" → 2. "Phone Setup" → 3. "Connect Phone (Connect)"
- Changing the registered name of a mobile phone
  1. "Setup" → 2. "Phone Setup" → 3. "Change Name"
- Listing the registered mobile phones
  1. "Setup" → 2. "Phone Setup" → 3. "List Phones"
- Changing the passkey
  1. "Setup" → 2. "Phone Setup" → 3. "Set Passkey"
- Deleting a registered mobile phone
  1. "Setup" → 2. "Phone Setup" → 3. "Delete Phone"

## Registering a mobile phone

Select “Pair Phone” using a voice command or , and perform the procedure for registering a mobile phone. (→P. 555)

## Selecting a mobile phone to be used

**STEP 1** Select “Connect Phone (Connect)” using a voice command or



▶ Pattern A

**STEP 2** Select the mobile phone to be used by either of the following methods, and select “Confirm” by using a voice command or



- Press the talk switch and say the name of the desired mobile phone.
- Press the talk switch and say “List Phones”. When the name of the desired mobile phone is read aloud, press the talk switch.

▶ Pattern B

**STEP 2** Select the mobile phone to be used using



## Changing the registered name of a mobile phone

**STEP 1** Select “Change Name” using a voice command or  .

### ► Pattern A

**STEP 2** Select the name of the mobile phone to be changed by either of the following methods, and select “Confirm” using a voice com-

mand or  :

- Press the talk switch and say the name of the desired mobile phone.
- Press the talk switch and say “List Phones”. When the name of the desired mobile phone is read aloud, press the talk switch.

### ► Pattern B

**STEP 2** Select the desired mobile phone name to be changed using



**STEP 3** Press the talk switch or select “Record Name” using  , and say the new name.

**STEP 4** Select “Confirm” using a voice command or  .

## Listing the registered mobile phones

Select “List Phones” using a voice command or . The list of registered mobile phones will be read aloud.

When listing is complete, the system returns to “Phone Setup”.

Pressing the talk switch while the name of a mobile phone is being read aloud selects the mobile phone, and the following functions will become available:

- Selecting a mobile phone: “Connect Phone (Connect)”
- Changing a registered name: “Change Name”
- Deleting a mobile phone: “Delete Phone”

## Changing the passkey

**STEP 1** Select “Set Passkey” using a voice command or .

▶ Pattern A

**STEP 2** Press the talk switch, say a 4 to 8-digit number, and select “Con-

firm” using a voice command or .



## ▶ Pattern B

**STEP 2** Select a 4 to 8-digit number using .

The number should be input 1 digit at a time.

**STEP 3** When the entire number to be registered as a passkey has been

input, press  again.

If the number to be registered has 8 digits, pressing of the knob is not necessary.

## Deleting a registered mobile phone

**STEP 1** Select “Delete Phone” using a voice command or .

## ▶ Pattern A

**STEP 2** Select the mobile phone to be deleted by either of the following

methods and select “Confirm” using a voice command or  :

- a. Press the talk switch and say the name of the desired mobile phone.
- b. Press the talk switch and say “List Phones”. When the name of the desired mobile phone is read aloud, press the talk switch.

► Pattern B

**STEP 2** Select the desired mobile phone to be deleted using  .

If the mobile phone to be deleted is paired as a Bluetooth<sup>®</sup> audio player, the registration of the audio player can be deleted at the same time. A voice guidance instruction to delete a Bluetooth<sup>®</sup> audio player is heard.

**STEP 3** Select “Yes” or “No” using a voice command or  .

(Bluetooth<sup>®</sup> audio player →P. 520)

---

■ **The number of mobile phones that can be registered**

Up to 6 mobile phones can be registered in the system.

## Security and system setup

### ■ Security setting items and operation procedures

To enter the menu for each function, follow the steps below using a

voice command or



- Setting or changing the PIN (Personal Identification Number)
  1. "Setup" → 2. "Security" → 3. "Set PIN"
- Locking the phone book
  1. "Setup" → 2. "Security" → 3. "Phonebook Lock (Phbk Lock)"
- Unlocking the phone book
  1. "Setup" → 2. "Security" → 3. "Phonebook Unlock (Phbk Unlock)"

### ■ System setup items and operation procedures

To enter the menu for each function, follow the steps below using



- Setting voice guidance volume
  1. "Setup" → 2. "System Setup" → 3. "Guidance Vol"
- Displaying the Bluetooth<sup>®</sup> device address and name
  1. "Setup" → 2. "System Setup" → 3. "Device Name"
- Initializing the system
  1. "Setup" → 2. "System Setup" → 3. "Initialize"

## Setting or changing the PIN

### ■ Setting a PIN

**STEP 1** Select “Set PIN” using a voice command or



**STEP 2** Enter a PIN using a voice command or



When using  , input the code 1 digit at a time.

### ■ Changing the PIN

**STEP 1** Select “Set PIN” using a voice command or



**STEP 2** Enter the registered PIN using a voice command or



**STEP 3** Enter a new PIN using a voice command or



When using  , input the code 1 digit at a time.

## Locking or unlocking the phone book

**STEP 1** Select “Phonebook Lock (Phbk Lock)” or “Phonebook Unlock (Phbk Unlock)” using a voice command or



**STEP 2** Input the PIN by either of the following methods and select “Con-

firm” using a voice command or  :

a. Press the talk switch and say the registered PIN.

b. Input a new PIN using  .

### Setting voice guidance volume

**STEP 1** Select “Guidance Vol” using  .

**STEP 2** Change the voice guidance volume.

To decrease the volume: Turn  counterclockwise.

To increase the volume: Turn  clockwise.

### Displaying the Bluetooth® device address and name

**STEP 1** Select “Device Name” using  .

**STEP 2** Turn  to display the Bluetooth® device address and name.

**STEP 3** Select “Go Back” using  to return to “System Setup”.

## Initializing the system

**STEP 1** Select “Initialize” and then “Confirm” using



**STEP 2** Select “Confirm” again using



### Initialization

- The following data in the system can be initialized:
  - Phone book
  - Outgoing and incoming call history
  - Speed dials
  - Registered mobile phone data
  - Security code
  - Registered Bluetooth<sup>®</sup> enabled portable player data
  - Passkey for the mobile phones
  - Passkey for the Bluetooth<sup>®</sup> audio players
  - Guidance volume
  - Receiver volume
  - Ring tone volume
- Once the initialization has been completed, the data cannot be restored to its original state.

### When the phone book is locked

The following functions cannot be used:

- Dialing by inputting a name
- Speed dialing
- Dialing a number stored in the call history memory
- Using the phone book

## 3-4. Using the audio system

# Using the phone book

To enter the menu for each function, follow the steps below using a

voice command or



- Adding a new phone number
  1. "Phonebook" → 2. "Add Entry"
- Changing the registered name in the phone book
  1. "Phonebook" → 2. "Change Name"
- Listing the registered data
  1. "Phonebook" → 2. "List Names"
- Setting speed dials
  1. "Phonebook" → 2. "Set Speed Dial (Speed Dial)"
- Deleting the registered data
  1. "Phonebook" → 2. "Delete Entry"
- Deleting speed dials
  1. "Phonebook" → 2. "Delete Speed Dial (Del Spd Dial)"

### Adding a new phone number

The following methods can be used to add a new phone number:

- Inputting a phone number using a voice command
- Transferring data from the mobile phone
- Inputting a phone number using 
- Selecting a phone number from the outgoing or incoming call history

### ■ Adding procedure

**STEP 1** Select “Add Entry” using a voice command or  .

**STEP 2** Use one of the following methods to input a telephone number:  
Inputting a telephone number using a voice command:

STEP2-1 Select “By Voice” using a voice command or  .

STEP2-2 Press the talk switch, say the desired number, and select “Confirm” using a voice command.

Transferring data from the mobile phone:

STEP2-1 Select “By Phone” and then “Confirm” using a voice command or  .

STEP2-2 Transfer the data from the mobile phone.

Refer to the manual that comes with the mobile phone for details on transferring data.

STEP2-3 Select the data to be registered by either of the following methods:



a. Say “Previous” or “Next” until the desired data is displayed, and select “Confirm” using a voice command.

b. Select the desired data using  .



Inputting a phone number using  :

STEP2-1 Select “Manual Input” using  .

STEP2-2 Input a phone number using  , and press  again.

Input the phone number 1 digit at a time.

Selecting a phone number from the outgoing or incoming call history:

STEP2-1 Select “Call History” using a voice command or  .

STEP2-2 Select “Outgoing” or “Incoming” using a voice command or  .

STEP2-3 Select the data to be registered by either of the following methods:

- a. Say “Previous” or “Go back” until the desired data is displayed, and select “Confirm” using a voice command.
- b. Select the desired data using  .

**STEP 3** Select the name to be registered by either of the following meth-

ods, and select “Confirm” using a voice command or  :

a. Press the talk switch and say the desired name.

b. Select “Record Name” using  and say the desired name.

**STEP 4** Select “Confirm” using a voice command or  .

In **STEP 4** , selecting “Set Speed Dial (Speed Dial)” instead of “Confirm” registers the newly added phone number as a speed dial.

## Changing the registered name in the phone book

**STEP 1** Select “Change Name” using a voice command or  .

### ► Pattern A

**STEP 2** Select the name to be changed by either of the following meth-

ods, and select “Confirm” using a voice command or  :

a. Press the talk switch and say the desired name.

b. Press the talk switch and say “List Names”. When the desired name is read aloud, press the talk switch.

### ► Pattern B

**STEP 2** Select the desired name to be changed using  .

**STEP 3** Press the talk switch or select “Record Name” using  and say the new name.

**STEP 4** Select “Confirm” using a voice command or .

### Listing the registered data

Select “List Names” using a voice command or . The list of the registered data will be read aloud.

When listing is complete, the system returns to the “Phonebook”.

Pressing the talk switch while the desired data is being read aloud selects the data, and the following function will become available:

- Dialing: “Dial”
- Changing a registered name: “Change Name”
- Deleting an entry: “Delete Entry”
- Setting a speed dial: “Set Speed Dial (Speed Dial)”

## Setting speed dials

**STEP 1** Select “Set Speed Dial (Speed Dial)” using a voice command or



► Pattern A

**STEP 2** Select the data to be registered as a speed dial by either of the following methods and select “Confirm” using a voice command



or :

- a. Press the talk switch and say the desired name.
- b. Press the talk switch and say “List Names”. When the desired name is read aloud, press the talk switch.

► Pattern B

**STEP 2** Select the desired data using



**STEP 3** Select the desired preset button and register the data into speed dial by either of the following methods:

- a. Press the desired preset button and select “Confirm” by using a

voice command or



- b. Press and hold the desired preset button.

## Deleting the registered data

**STEP 1** Select “Delete Entry” using a voice command or



► Pattern A

**STEP 2** Select the data to be deleted by either of the following methods

and select “Confirm” using a voice command or



a. Press the talk switch and say the name of the desired phone number.

b. Press the talk switch and say “List Names”. When the name of the desired phone number is read aloud, press the talk switch.

► Pattern B

**STEP 2** Select the desired data to be deleted using



## Deleting speed dials

**STEP 1** Select “Delete Speed Dial (Del Spd Dial)” using a voice command or



**STEP 2** Press the preset button to which the desired speed dial is registered and select “Confirm” using a voice command or



### ■ Limitation of number of digits

A phone number that exceeds 24 digits cannot be registered.

### 3-5. Using the interior lights

## Interior lights list

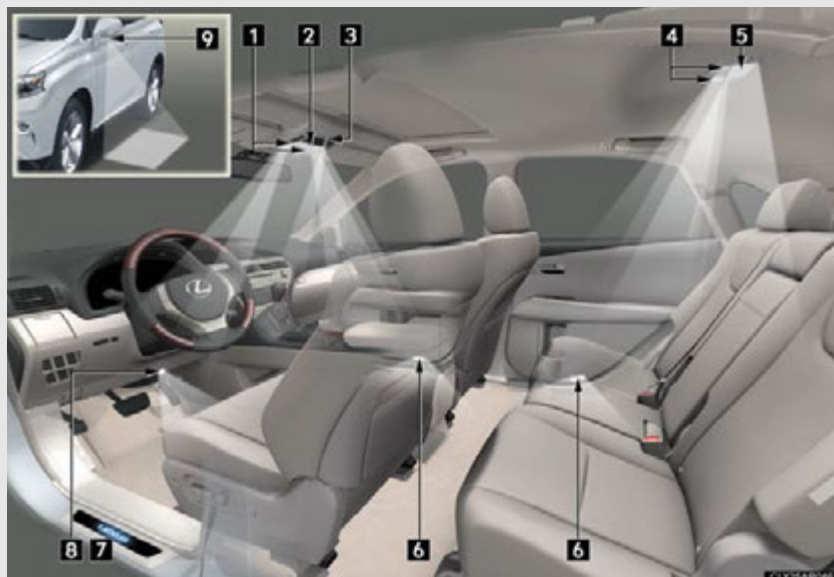

- 1 Front personal lights (→P. 583)
- 2 Front interior light (→P. 583)
- 3 Shift lever light (when the “POWER” switch is in ACCESSORY or ON mode)
- 4 Rear personal lights (→ P. 583)
- 5 Rear interior light
- 6 Door courtesy lights
- 7 Scuff lights (if equipped)
- 8 Footwell lights
- 9 Outer foot lights

## Interior lights

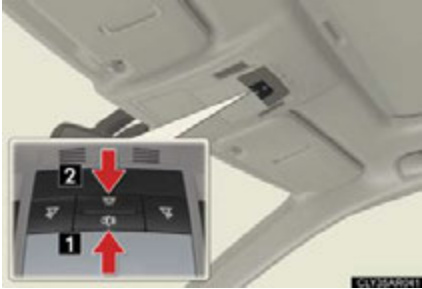

- 1 Turns the lights on/off linked to door positions.
- 2 Turns the lights on/off

## Personal lights

### ► Front

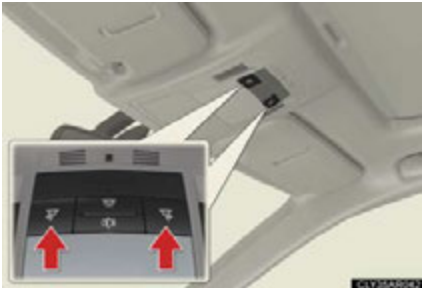

Turns the light on/off

### ► Rear



Turns the light on/off

---

**■ Illuminated entry system**

The lights automatically turn on/off according to “POWER” switch mode, the presence of the electronic key, whether the doors are locked/unlocked, and whether the doors are open/closed.

**■ To prevent 12-volt battery discharge**

When the “POWER” switch is turned off, the lights will go off automatically after 20 minutes.

- Personal lights
- Interior lights
- Door courtesy lights
- Scuff lights (if equipped)
- Footwell lights

**■ Customization**

Settings (e.g. the time elapsed before the lights turn off) can be changed. (Customizable features →P. 825)



## 3-6. Using the storage features

### List of storage features

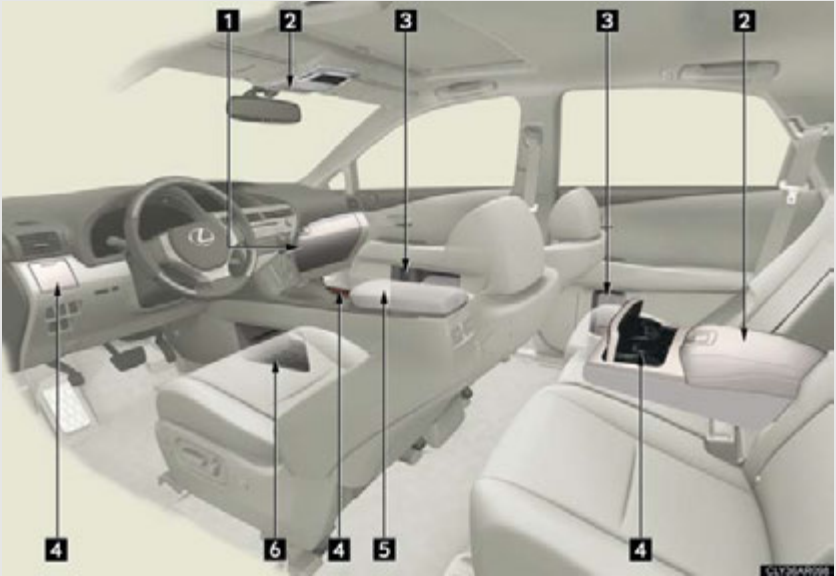



- 1 Glove box
- 2 Auxiliary boxes (if equipped)
- 3 Bottle holders/door pockets
- 4 Cup holders
- 5 Console box/coin holder
- 6 Under tray

#### CAUTION

##### Items that should not be left in the storage spaces

Do not leave glasses, lighters or spray cans in the storage spaces, as this may cause the following when cabin temperature becomes high:

-  Glasses may be deformed by heat or cracked if they come into contact with other stored items.
-  Lighters or spray cans may explode. If they come into contact with other stored items, the lighter may catch fire or the spray can may release gas, causing a fire hazard.

## Glove box

The glove box can be opened by pressing the lock release button and locked and unlocked using the mechanical key.

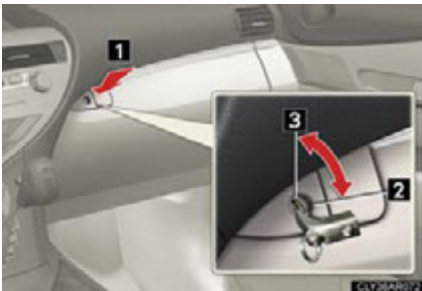

- 1 Opens
- 2 Locks
- 3 Unlocks

### ■ Power back door main switch

The power back door main switch is located in the glove box. (→P. 77)

## ⚠ CAUTION

### ■ Caution while driving

Keep the glove box closed. In the event of sudden braking or sudden swerving, an accident may occur due to an occupant being struck by the open glove box or the items stored inside.

## Bottle holders/door pockets

### ► Front



The front door pockets can be opened and closed.

### ► Rear



## ! CAUTION

### ■ Caution while driving (front door pockets)

Keep the door pockets closed.

Injuries may result in the event of an accident or sudden braking.

### ■ Items unsuitable for the bottle holders

Do not place anything other than bottles in the bottle holders.

Other items may be thrown out of the holders in the event of an accident or sudden braking and cause injury.

 NOTICE

■ **When stowing a bottle**

Put the cap on before stowing the bottle. Do not place open bottles in the bottle holders. The contents may spill.

**Cup holders**

▶ Front (Center console)



Press down the lid on the farthest side from the driver.

▶ Front (Instrument panel)



Press in and release the cup holder.

## ► Rear

STEP 1

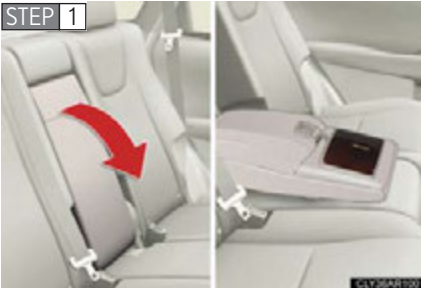

Pull down the armrest.

STEP 2

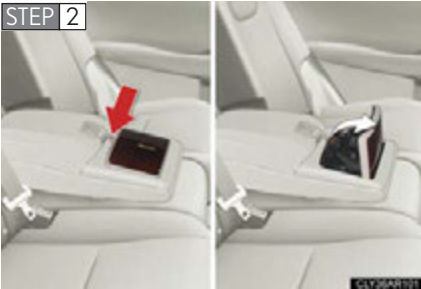

Press down the button on the armrest.

## ■ Cup holder insert



The cup holder insert may be removed for cleaning.

**! CAUTION****■ Items unsuitable for the cup holder**

Do not place anything other than cups or beverage cans in the cup holders. Even when the lid is closed, items must not be stored in the cup holders.

Other items may be thrown out of the holders in the event of an accident or sudden braking and cause injury. If possible, cover hot drinks to prevent burns.

**■ To prevent burns**

Put a lid on containers with hot liquids inside.

**■ When not in use**

Keep the cup holders closed.

Injuries may result in the event of an accident or sudden braking.

**Console box**

Pull up the lever to release the lock, and lift the armrest.

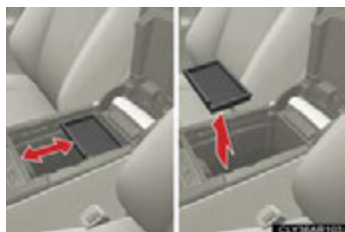
**■ Tray in the console box**

The tray slides forward/backward and can be removed.

### ■ Console box storage space

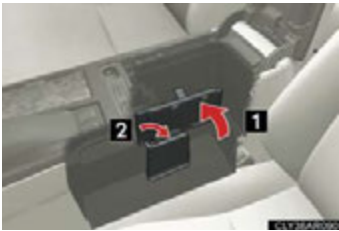
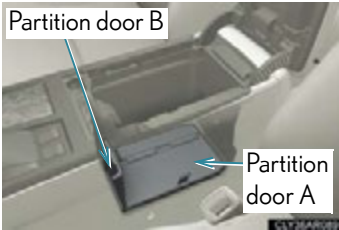

The console box comes with partition doors.  
Partition door A can be removed.

The storage space can be expanded by opening the partition doors.

- 1 Lift the tab
- 2 Pull partition door B as shown in the illustration

#### ⚠ CAUTION

##### ■ Caution while driving

Keep the console box closed.  
Injuries may result in the event of an accident or sudden braking.

#### ⚠ NOTICE

##### ■ Tray

Do not insert items exceeding the height of the tray. Doing so may prevent opening and closing of the lid.

### Coin holder



Pull up the lever to release the lock, and slide the armrest.

### Auxiliary boxes (if equipped)

► Overhead

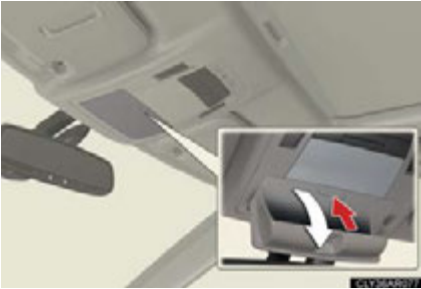

Press in the lid.

This box is useful for temporarily storing sunglasses and similar small items.



## ► Rear seat

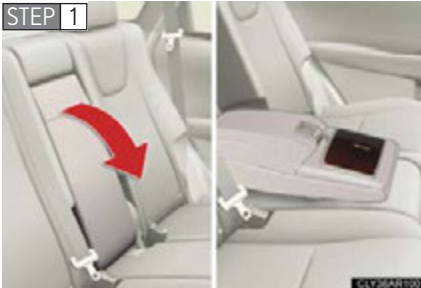

Pull down the armrest.



Pull up the lever to release the lock and lift the armrest.

**!** CAUTION

**■ Caution while driving**

Do not leave the auxiliary box open while driving. Items stored in the auxiliary box may fall out and cause death or serious injury in case of an accident or sudden stop.

**Under tray****⚠ CAUTION****■ Items unsuitable for the under tray**

Observe the following precautions when putting items in the under tray. Failure to do so may cause items to be thrown out of the tray in the event of sudden braking or steering. In these cases, the items may interfere with pedal operation or cause driver distraction, resulting in an accident.

- Do not store items in the tray that can easily shift or roll out.
- Do not stack items in the tray higher than the tray's edge.
- Do not put items in the tray that may protrude over the tray's edge.

### 3-7. Other interior features

## Sun visors

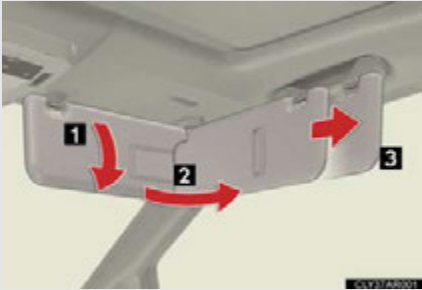

- 1 To set the visor in the forward position, flip it down.
- 2 To set the visor in the side position, flip down, unhook, and swing it to the side.
- 3 To use the side extender, place the visor in the side position, then slide it backward.

### 3-7. Other interior features

## Vanity mirrors



Slide the cover to open.

The light turns on when the cover is opened.

#### ■ To prevent 12-volt battery discharge

When the "POWER" switch is turned off, the lights will go off automatically after 20 minutes.

#### NOTICE

#### ■ When not in use

Keep the vanity mirror closed.

## 3-7. Other interior features

### Clock

The clock can be adjusted by pressing the buttons.

- ▶ With a navigation system  
Refer to the “Navigation System Owner’s Manual”.
- ▶ With the Lexus Display Audio system



- 1 Adjusts the hours
- 2 Adjusts the minutes

- ▶ Without a navigation system or the Lexus Display Audio system



- 1 Adjusts the hours
- 2 Adjusts the minutes

#### ■ The clock is displayed when

The clock is displayed when the “POWER” switch is in ACCESSORY or ON mode.

#### ■ When the 12-volt battery is disconnected

The time display will automatically be set to 1:00.

### 3-7. Other interior features

## Outside temperature display

The temperature display shows temperatures within the range of -40°F (-40°C) and 122°F (50°C).

- ▶ With a navigation system  
Refer to the “Navigation System Owner’s Manual”.
- ▶ With the Lexus Display Audio system



The outside temperature is displayed on the air conditioning operation screen. (→P. 342)

- ▶ Without a navigation system or the Lexus Display Audio system



---

**■ If the temperature does not appear (without the Lexus Display Audio system)**

The system may be malfunctioning. Take your vehicle to your Lexus dealer.

**■ When “-” or “E” is displayed (with the Lexus Display Audio system)**

The system may be malfunctioning. Take your vehicle to your Lexus dealer.

**■ Display**

In the following situations, the correct outside temperature may not be displayed, or the display may take longer than normal to change:

- When the vehicle is stopped, or moving at low speeds (less than 16 mph [25 km/h])
- When the outside temperature has changed suddenly (at the entrance/exit of a garage, tunnel, etc.)

## 3-7. Other interior features

### Multi-display light control\*

The brightness of the multi-display can be adjusted to four levels.



Press and release the “DISP” switch until the brightness of the display is adjusted to the desired level.

#### ■ Instrument panel linked brightness control

When the headlight switch is turned on, the brightness of the multi-display will be reduced in accordance with the brightness of the instrument panel. (→P. 198)

\*: If equipped



## 3-7. Other interior features

### Power outlets

The power outlets can be used for the following components.

12 V: Accessories that run on less than 10 A.

120 VAC: Accessories that use less than 100 W.

#### ► Inside the console (12 V)



Pull up the lever to release the lock, and lift the armrest.



Open the cover.

#### ► Under tray (12V)



Open the cover.

▶ Luggage compartment (12V)



Open the cover.

▶ On the back surface of the console (120 VAC)\*



Open the cover.

\*: If equipped

■ The power outlets can be used when

▶ 12 V

The "POWER" switch is in ACCESSORY or ON mode.

▶ 120 VAC

The "POWER" switch is in ON mode.

 NOTICE**■ To avoid damaging the power outlets**

Close the power outlet lid when the power outlet is not in use.

Foreign objects or liquids that enter the power outlet may cause a short circuit.

**■ To prevent the fuse from being blown**

Close the power outlet lid when the power outlet is not in use.

Foreign objects or liquids that enter the power outlet may cause a short circuit.

12 V: Do not use an accessory that uses more than 12 V 10 A.

120 VAC: Do not use a 120 VAC appliance that requires more than 100 W.

If a 120 VAC appliance that consumes more than 100 W is used, the protection circuit will cut the power supply.

**■ To prevent 12-volt battery discharge**

Do not use the power outlets longer than necessary when the hybrid system is off.

**■ Appliances that may not operate properly (120 VAC)**

The following 120 VAC appliances may not operate properly even if their power consumption is under 100 W:

- Appliances with high initial peak wattage
- Measuring devices that process precise data
- Other appliances that require an extremely stable power supply

### 3-7. Other interior features

## Heated steering wheel\*

The heated steering wheel heats the leather portions on the left and right of the steering wheel.



Turns the heater on/off

The indicator light comes on when the heater is operating.

#### ■ The heated steering wheel can be used when

The "POWER" switch is in ON mode.

#### ■ To prevent 12-volt battery discharge

The heated steering wheel will automatically turn off after about 30 minutes.

#### ■ If the indicator light does not come on

If the indicator light does not come on when the switch is pressed, a malfunction may have occurred in the system. Have the vehicle inspected by your Lexus dealer.

### ⚠ CAUTION

#### ■ Burns

Care should be taken to prevent injury if anyone in the following categories comes in contact with the steering wheel when the heated steering wheel is on:

- Babies, small children, the elderly, the sick and the physically challenged
- Persons with sensitive skin
- Persons who are fatigued
- Persons who have taken alcohol or drugs that induce sleep (sleeping drugs, cold remedies, etc.)

\*: If equipped

### 3-7. Other interior features

## Seat heaters and ventilators\*

The seat heaters and ventilators heat the seats and maintain good airflow by blowing air from the seats.



- 1** Turns the seat heater on  
The indicator light comes on.  
The higher the number is, the warmer the seat becomes.
- 2** Blows air from the seat  
The indicator light comes on.  
The higher the number is, the stronger the airflow becomes.

#### ■ Operating condition

The "POWER" switch is in ON mode.

#### ■ When not in use

Set the knob at "0". The indicator light turns off.

### ⚠ CAUTION

#### ■ Burns

- Use caution when seating the following persons in a seat with the seat heater on to avoid the possibility of burns:
  - Babies, small children, the elderly, the sick and the physically challenged
  - Persons with sensitive skin
  - Persons who are fatigued
  - Persons who have taken alcohol or drugs that induce sleep (sleeping drugs, cold remedies, etc.)
- Do not cover the seat with anything when using the seat heater.  
Using the seat heater with a blanket or cushion increases the temperature of the seat and may lead to overheating.

 NOTICE

■ **To prevent damage to the seat heaters/ventilators**

Do not put heavy objects that have an uneven surface on the seat and do not stick sharp objects (needles, nails, etc.) into the seat.

■ **To prevent 12-volt battery discharge**

Do not leave the system on longer than necessary when the hybrid system is off.

### 3-7. Other interior features

## Armrest



Pull the armrest down for use.

#### NOTICE

■ **To prevent damage to the armrest**

Do not place too much strain on the armrest.

### 3-7. Other interior features

## Coat hooks



To use the coat hook, push it in.

### CAUTION

#### Items that must not be hung on the hook

Do not hang a coat hanger or other hard or sharp object on the hook. If the SRS curtain shield airbags deploy, these items may become projectiles that cause death or serious injury.



## Assist grips

An assist grip installed on the ceiling can be used to support your body while sitting on the seat.



### CAUTION

#### ■ Assist grip

Do not use the assist grip when getting in or out of the vehicle or rising from your seat.

### NOTICE

#### ■ To prevent damage to the assist grip

Do not hang any heavy object or put a heavy load on the assist grip.

### 3-7. Other interior features

## Floor mat

Use only floor mats designed specifically for vehicles of the same model and model year as your vehicle. Fix them securely in place onto the carpet.

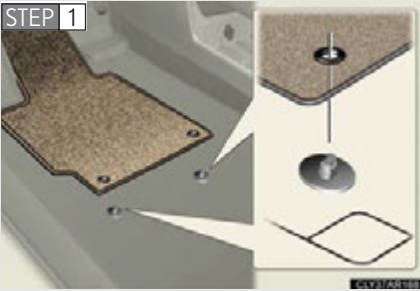

Insert the retaining hooks (clips) into the floor mat eyelets.

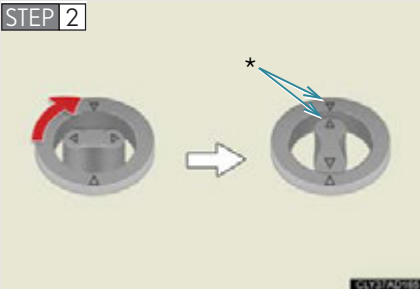

Turn the upper knob of each retaining hook (clip) to secure the floor mats in place.

\*: Always align the  $\Delta$  marks.

The shape of the retaining hooks (clips) may differ from that shown in the illustration.

**! CAUTION**

Observe the following precautions.

Failure to do so may cause the driver's floor mat to slip, possibly interfering with the pedals while driving. An unexpectedly high speed may result or it may become difficult to stop the vehicle, leading to a serious accident.

**■ When installing the driver's floor mat**

- Do not use floor mats designed for other models or different model year vehicles, even if they are Lexus Genuine floor mats.
- Only use floor mats designed for the driver's seat.
- Always install the floor mat securely using the retaining hooks (clips) provided.
- Do not use two or more floor mats on top of each other.
- Do not place the floor mat bottom-side up or upside-down.

**■ Before driving**

- Check that the floor mat is securely fixed in the correct place with all the provided retaining hooks (clips). Be especially careful to perform this check after cleaning the floor.
- With the hybrid system stopped and the shift lever in P, fully depress each pedal to the floor to make sure it does not interfere with the floor mat.

### 3-7. Other interior features

## Luggage compartment features

#### ■ Cargo hooks



Pull the hook to use.

The cargo hooks are provided for securing loose items.

#### ■ Auxiliary boxes

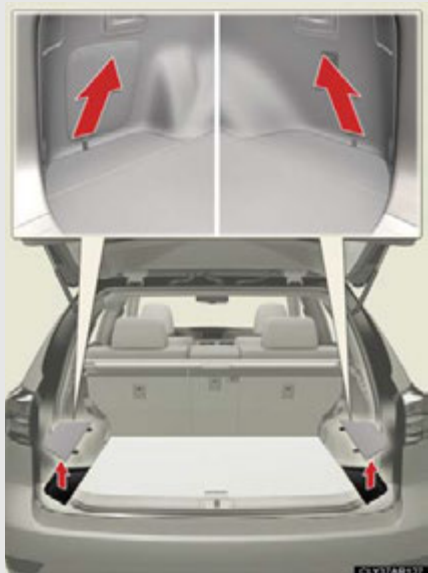

Pull the strap upwards when lifting the cover up.

### ■ Luggage cover (if equipped)

STEP 1

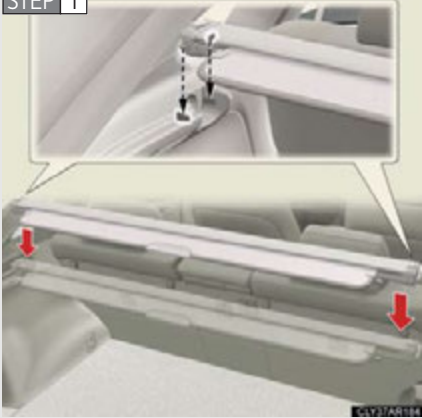

Push from above until the claws on both sides are securely locked in position.

STEP 2

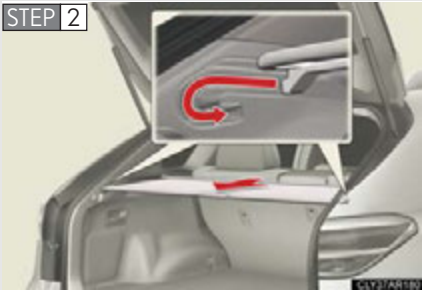

Pull out the luggage cover and hook it onto the anchors.

### Removing the luggage covers

#### ► Front luggage cover

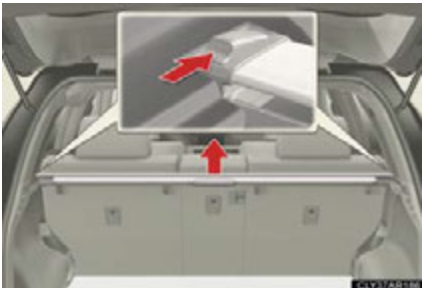

Press the buttons to remove the luggage cover.

► Rear luggage cover

STEP 1



Detach the outer clips of the rear luggage cover from the back door.

STEP 2

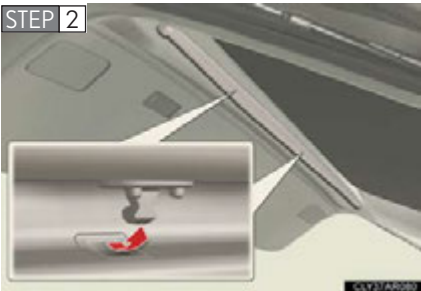

Detach the inner clips of the rear luggage cover from the back door.

---

■ Installing the rear luggage cover

- Ensure that the luggage cover is in the proper installation position. Push the clips of the rear luggage cover into the indentions on the back door until they are locked into place.
- Check that the rear luggage cover is securely attached.

 CAUTION

■ **When the cargo hooks are not in use**

To avoid injury, always return the cargo hooks to their stowed positions.

### 3-7. Other interior features

## Garage door opener

The garage door opener can be programmed to operate garage doors, gates, entry doors, door locks, home lighting systems, security systems, and other devices.

The garage door opener (HomeLink<sup>®</sup> Universal Transceiver) is manufactured under license from HomeLink<sup>®</sup>.

### Programming the HomeLink<sup>®</sup> (for U.S.A. owners)

The HomeLink<sup>®</sup> compatible transceiver in your vehicle has 3 buttons which can be programmed to operate 3 different devices. Refer to the programming method below appropriate for the device.

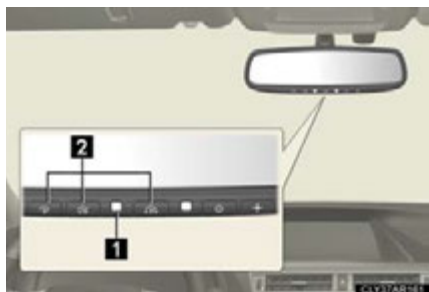

1 Indicator

2 Buttons

### ■ Programming the HomeLink<sup>®</sup>



Point the remote control transmitter for the device 1 to 3 in. (25 to 75 mm) from the HomeLink<sup>®</sup> control buttons.

Keep the HomeLink<sup>®</sup> indicator light in view while programming.



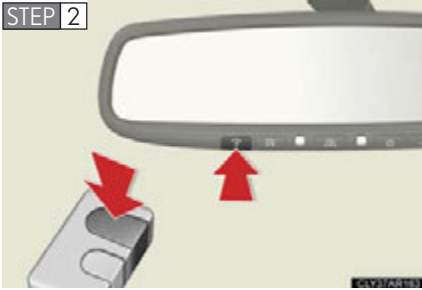

Press and hold one of the HomeLink<sup>®</sup> buttons and the transmitter button. When the HomeLink<sup>®</sup> indicator light changes from a slow to a rapid flash, you can release both buttons.

If the HomeLink<sup>®</sup> indicator light comes on but does not flash, or flashes rapidly for 2 seconds and remains lit, the HomeLink<sup>®</sup> button is already programmed. Use the other buttons or follow the "Reprogramming a HomeLink<sup>®</sup> button" instructions. (→P. 619)

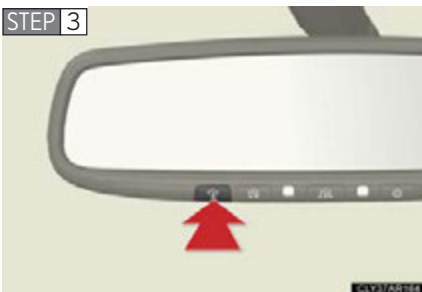

Test the HomeLink<sup>®</sup> operation by pressing the newly programmed button.

If a HomeLink<sup>®</sup> button has been programmed for a garage door, check to see if the garage door opens and closes. If the garage door does not operate, see if your remote control transmitter is of the rolling code type. Press and hold the programmed HomeLink<sup>®</sup> button. The remote control transmitter is of the rolling code type if the HomeLink<sup>®</sup> indicator light flashes rapidly for 2 seconds and then remains lit. If your transmitter is of the rolling code type, proceed to the heading "Programming a rolling code system".

**STEP 4** Repeat the steps above to program another device for each of the remaining HomeLink<sup>®</sup> buttons.

### ■ Programming a Rolling Code system (for U.S.A. owners)

If your device is Rolling Code equipped, follow the steps under the heading “Programming the HomeLink<sup>®</sup>” before proceeding with the steps listed below.

**STEP 1** Locate the learn button on the ceiling mounted garage door opener motor. The exact location and color of the button may vary by brand of garage door opener motor.

Refer to the operation manual supplied with the garage door opener for the location of the learn button.

**STEP 2** Press the learn button.

Following this step, you have 30 seconds in which to initiate step 3 below.

**STEP 3** Press and hold the vehicle’s programmed HomeLink<sup>®</sup> button for 2 seconds and release it. Repeat this step once again. The garage door may open.

If the garage door opens, the programming process is complete. If the door does not open, press and release the button a third time. This third press and release will complete the programming process by opening the garage door.

The ceiling mounted garage door opener motor should now recognize the HomeLink<sup>®</sup> signal and operate the garage door.

**STEP 4** Repeat the steps above to program another rolling code system for any of the remaining HomeLink<sup>®</sup> buttons.

### ■ Programming an entry gate (for U.S.A. owners)/Programming all devices in the Canadian market

**STEP 1** Place your transmitter 1 to 3 in. (25 to 75 mm) away from the surface of the HomeLink<sup>®</sup>.

Keep the HomeLink<sup>®</sup> indicator light in view while programming.

**STEP 2** Press and hold the selected HomeLink<sup>®</sup> button.

**STEP 3** Repeatedly press and release (cycle) the device’s remote control button for two seconds each until step 4 is completed.

**STEP 4** When the indicator light on the HomeLink<sup>®</sup> compatible transceiver starts to flash rapidly, release the buttons.

**STEP 5** Test the operation of the HomeLink<sup>®</sup> by pressing the newly programmed button. Check to see if the gate/device operates correctly.

**STEP 6** Repeat the steps above to program another device for each of the remaining HomeLink<sup>®</sup> buttons.

### ■ Programming other devices

To program other devices such as home security systems, home door locks or lighting, contact your authorized Lexus dealer for assistance.

### ■ Reprogramming a button

The individual HomeLink<sup>®</sup> buttons cannot be erased but can be reprogrammed. To reprogram a button, follow the “Reprogramming a HomeLink<sup>®</sup> button” instructions.

## Operating HomeLink<sup>®</sup>

Press the appropriate HomeLink<sup>®</sup> button. The HomeLink<sup>®</sup> indicator light should turn on.

The HomeLink<sup>®</sup> compatible transceiver in your vehicle continues to send a signal for up to 20 seconds as long as the button is pressed.

## Reprogramming a HomeLink<sup>®</sup> button

Press and hold the desired HomeLink<sup>®</sup> button. After 20 seconds, the HomeLink<sup>®</sup> indicator light will start flashing slowly. Next, while still pressing and holding the HomeLink<sup>®</sup> button, press and hold the button on the transmitter until the HomeLink<sup>®</sup> indicator light changes from a slow to a rapid flash.

### Erasing the entire HomeLink® memory (all three programs)

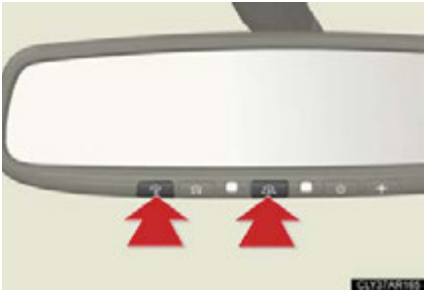

Press and hold the 2 outside buttons for 10 seconds until the indicator light flashes.

If you sell your vehicle, be sure to erase the programs stored in the HomeLink® memory.

#### ■ Before programming

- Install a new battery in the remote control transmitter.
- The battery side of the remote control transmitter must be pointed away from the HomeLink® button.

#### ■ When programming

Depending on radio wave conditions, the direction the remote control transmitter is pointed and the remaining charge of the transmitter's batteries, there are cases when programming may be difficult.

### ■ Certification for the garage door opener

► For vehicles sold in the U.S.A.

FCC ID: NZLGHSHL4

FCC ID: NZLOBIHL4

FCC ID: NZLWZLHL4

NOTE:

This device complies with Part 15 of the FCC Rules. Operation is subject to the following two conditions: (1) this device may not cause harmful interference, and (2) this device must accept any interference received, including interference that may cause undesired operation.

FCC WARNING:

Changes or modifications not expressly approved by the party responsible for compliance could void the user's authority to operate the equipment.

► For vehicles sold in Canada

NOTE:

Operation is subject to the following two conditions: (1) this device may not cause interference, and (2) this device must accept any interference, including interference that may cause undesired operation of the device.

### ■ When support is necessary

Visit on the web at [www.homelink.com](http://www.homelink.com) or call 1-800-355-3515.

## CAUTION

### ■ When programming a garage door or other remote control device

The garage door or other device may operate, so ensure people and objects are out of danger to prevent potential harm.

### ■ Conforming to federal safety standards

Do not use the HomeLink<sup>®</sup> compatible transceiver with any garage door opener or device that lacks safety stop and reverse features as required by federal safety standards.

This includes any garage door that cannot detect an obstruction object. A door or device without these features increases the risk of death or serious injury.

### 3-7. Other interior features

## Compass\*

The compass on the inside rear view mirror indicates the direction in which the vehicle is heading.

#### ■ Operation



To turn the compass on or off, press  for more than 3 seconds.

The location the compass is displayed differs according to the type of inner rear view mirror.

#### ■ Displays and directions

Display	Direction
"N"	North
"NE"	Northeast
"E"	East
"SE"	Southeast
"S"	South
"SW"	Southwest
"W"	West
"NW"	Northwest

\*: If equipped

## Calibrating the compass

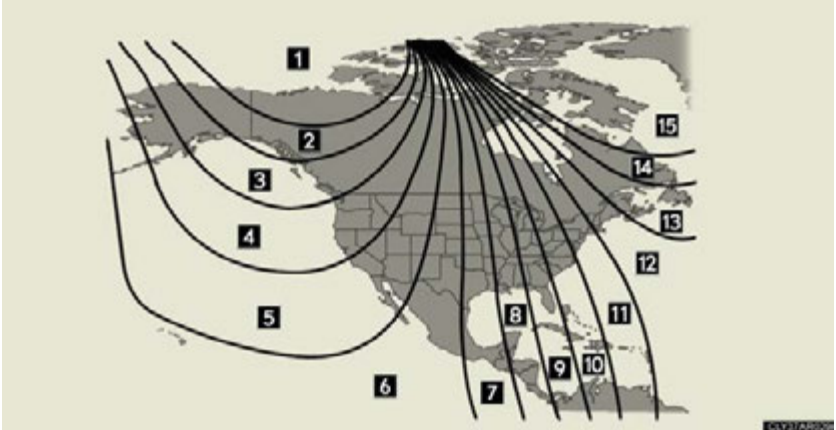

The direction display deviates from the true direction determined by the earth's magnetic field. The amount of deviation varies depending on the geographic position of the vehicle.

If you cross over one of the map boundaries shown in illustration, the compass will deviate.

To obtain higher precision or perfect calibration, refer to “Deviation calibration”.

### ■ Deviation calibration

**STEP 1** Stop the vehicle.

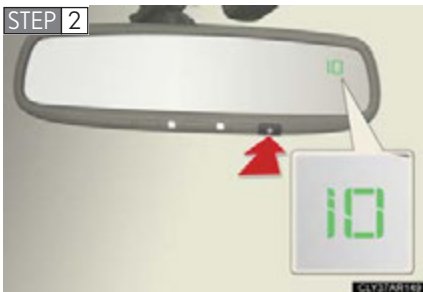

Press and hold .

A number (1 to 15) appears on the compass display.

The location the compass is displayed differs according to the type of inner rear view mirror.

**STEP 3** Referring to the map above, press  to select the number of the zone you are in.

If the direction is displayed for several seconds after adjustment, the calibration is complete.

### ■ Circling calibration



If “C” appears on the display, drive the vehicle at 5 mph (8 km/h) or less in a circle until a direction is displayed.

If there is not enough space to drive in a circle, drive around the block until a direction is displayed.

---

### ■ Conditions unfavorable to correct operation

The compass may not show the correct direction in the following conditions:

- The vehicle is stopped immediately after turning.
- The vehicle is on an inclined surface.
- The vehicle is in a place where the earth's magnetic field is subject to interference by artificial magnetic fields (underground car park/parking lot, under a steel tower, between buildings, roof car park/parking lot, near an intersection, near a large vehicle, etc.).
- The vehicle has become magnetized. (There is a magnet or metal object near the inside rear view mirror.)
- The 12-volt battery has been disconnected.
- A door is open.



 CAUTION**■ While driving the vehicle**

Do not adjust the display. Adjust the display only when the vehicle is stopped.

**■ When doing the circling calibration**

Secure a wide space, and watch out for people and vehicles in the vicinity. Do not violate any local traffic rules while performing circling calibration.

 NOTICE**■ To avoid compass malfunctions**

Do not place magnets or any metal objects near the inside rear view mirror. Doing this may cause the compass sensor to malfunction.

**■ To ensure normal operation of the compass**

- Do not perform a circling calibration of the compass in a place where the earth's magnetic field is subject to interference by artificial magnetic fields.
- During calibration, do not operate electric systems (moon roof, power windows, etc.) as they may interfere with the calibration.

### 3-7. Other interior features

## Safety Connect\*

Safety Connect is a subscription-based telematics service that uses Global Positioning System (GPS) data and embedded cellular technology to provide safety and security features to subscribers. Safety Connect is supported by Lexus' designated response center, which operates 24 hours per day, 7 days per week.

Safety Connect service is available by subscription on select, telematics hardware-equipped vehicles.

By using the Safety Connect service, you are agreeing to be bound by the Telematics Subscription Service Agreement and its Terms and Conditions, as in effect and amended from time to time, a current copy of which is available at Lexus.com. All use of the Safety Connect service is subject to such then-applicable Terms and Conditions.

#### ■ System components

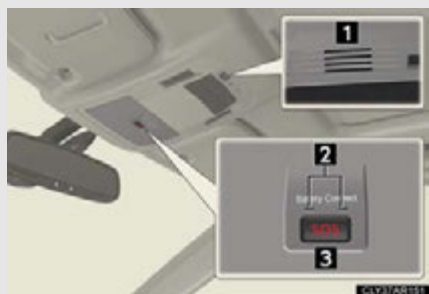

- 1 Microphone
- 2 LED light indicators
- 3 "SOS" button

## ■ Services

Subscribers have the following Safety Connect services available:

- Automatic Collision Notification\*

Helps drivers receive necessary response from emergency service providers. (→P. 629)

\*: U.S. Patent No. 7,508,298 B2

- Stolen Vehicle Location

Helps drivers in the event of vehicle theft. (→P. 630)

- Emergency Assistance Button (SOS)

Connects drivers to response-center support. (→P. 630)

- Enhanced Roadside Assistance

Provides drivers various on-road assistance. (→P. 630)

## ■ Subscription

After you have signed the Telematics Subscription Service Agreement and are enrolled, you can begin receiving services.

A variety of subscription terms is available for purchase. Contact your Lexus dealer, call 1-800-25-LEXUS (1-800-255-3987) or push the “SOS” button in your vehicle for further subscription details.

### ■ Safety Connect Services Information

- Phone calls using the vehicles Bluetooth® technology will not be possible during Safety Connect.
- Safety Connect is available beginning Fall 2009 on select Lexus models. Contact with the Safety Connect response center is dependent upon the telematics device being in operative condition, cellular connection availability, and GPS satellite signal reception, which can limit the ability to reach the response center or receive emergency service support. Enrollment and Telematics Subscription Service Agreement required. A variety of subscription terms is available; charges vary by subscription term selected.
- Automatic Collision Notification, Emergency Assistance and Stolen Vehicle Location will function in the United States, including Hawaii and Alaska, and in Canada, and Enhanced Roadside Assistance will function in the United States (except Hawaii) and in Canada. No Safety Connect services will function outside of the United States in countries other than Canada.
- Safety Connect services are not subject to section 255 of the Telecommunications Act and the device is not TTY compatible.

### ■ Languages

The Safety Connect response center will offer support in multiple languages. The Safety Connect system will offer voice prompts in English and Spanish. Please indicate your language of choice when enrolling.

### ■ When contacting the response center

You may be unable to contact the response center if the network is busy.

## Safety Connect LED light Indicators

- When the “POWER” switch is turned to ON mode, the red indicator light comes on for 2 seconds then turns off. Afterward, the green indicator light comes on, indicating that the service is active.
- The following indicator light patterns indicate specific system usage conditions:
  - Green indicator light on = Active service
  - Green indicator light flashing = Safety Connect call in process
  - Red indicator light (except at vehicle start-up) = System malfunction (contact your Lexus dealer)
  - No indicator light (off) = Safety Connect service not active

## Safety Connect services

### ■ Automatic Collision Notification

In case of either airbag deployment or severe rear-end collision, the system is designed to automatically call the response center. The responding agent receives the vehicle's location and attempts to speak with the vehicle occupants to assess the level of emergency. If the occupants are unable to communicate, the agent automatically treats the call as an emergency, contacts the nearest emergency services provider to describe the situation, and requests that assistance be sent to the location.

### ■ Stolen Vehicle Location

If your vehicle is stolen, Safety Connect can work with local authorities to assist them in locating and recovering the vehicle. After filing a police report, call the Safety Connect response center at 1-800-25-LEXUS (1-800-255-3987) and follow the prompts for Safety Connect to initiate this service.

In addition to assisting law enforcement with recovery of a stolen vehicle, Safety-Connect-equipped vehicle location data may, under certain circumstances, be shared with third parties to locate your vehicle. Further information is available at [Lexus.com](http://Lexus.com).

### ■ Emergency Assistance Button (“SOS”)

In the event of an emergency on the road, push the “SOS” button to reach the Safety Connect response center. The answering agent will determine your vehicle’s location, assess the emergency, and dispatch the necessary assistance required.

If you accidentally press the “SOS” button, tell the response-center agent that you are not experiencing an emergency.

### ■ Enhanced Roadside Assistance

Enhanced Roadside Assistance adds GPS data to the already included warranty-based Lexus roadside service.

Subscribers can press the “SOS” button to reach a Safety Connect response-center agent, who can help with a wide range of needs, such as: towing, flat tire, fuel delivery, etc. For a description of the Enhanced Roadside Assistance services and their limitations, please see the Safety Connect Terms and Conditions, which are available at [Lexus.com](http://Lexus.com).

## Safety information for Safety Connect

Important! Read this information before using Safety Connect.

### ■ Exposure to radio frequency signals

The Safety Connect system installed in your vehicle is a low-power radio transmitter and receiver. It receives and also sends out radio frequency (RF) signals.

In August 1996, the Federal Communications Commission (FCC) adopted RF exposure guidelines with safety levels for mobile wireless phones. Those guidelines are consistent with the safety standards previously set by the following U.S. and international standards bodies.

- ANSI (American National Standards Institute) C95.1 [1992]
- NCRP (National Council on Radiation Protection and Measurement) Report 86 [1986]
- ICNIRP (International Commission on Non-Ionizing Radiation Protection) [1996]

Those standards were based on comprehensive and periodic evaluations of the relevant scientific literature. Over 120 scientists, engineers, and physicians from universities, and government health agencies and industries reviewed the available body of research to develop the ANSI Standard (C95.1).

The design of Safety Connect complies with the FCC guidelines in addition to those standards.

### ■ Certification for Lexus Enform with Safety Connect

FCC ID: O6Y-CDMRF101

FCC ID: XOECDMRF101B

FCC ID: N7NGTM2

#### NOTE:

This device complies with Part 15 of the FCC Rules. Operation is subject to the following two conditions: (1) This device may not cause harmful interference, and (2) this device must accept any interference received, including interference that may cause undesired operation.

#### FCC WARNING:

Changes or modifications not expressly approved by the party responsible for compliance could void the user's authority to operate the equipment.



## 4-1. Maintenance and care

- Cleaning and protecting the vehicle exterior..... 634
- Cleaning and protecting the vehicle interior ..... 637

## 4-2. Maintenance

- Maintenance requirements ..... 640
- General maintenance ..... 643
- Emission inspection and maintenance (I/M) programs..... 647

## 4-3. Do-it-yourself maintenance

- Do-it-yourself service precautions..... 648
- Hood..... 651
- Positioning a floor jack ..... 652
- Engine compartment ..... 654
- 12-volt battery ..... 664
- Tires..... 670
- Tire inflation pressure..... 679
- Wheels..... 683
- Air conditioning filter ..... 685
- Electronic key battery..... 687
- Checking and replacing fuses ..... 689
- Headlight aim ..... 705
- Light bulbs..... 708

# Cleaning and protecting the vehicle exterior

Perform the following to protect the vehicle and maintain it in prime condition:

- Working from top to bottom, liberally apply water to the vehicle body, wheel wells and underside of the vehicle to remove any dirt and dust.
- Wash the vehicle body using a sponge or soft cloth, such as a chamois.
- For hard-to-remove marks, use car wash soap and rinse thoroughly with water.
- Wipe away any water.
- Wax the vehicle when the waterproof coating deteriorates.

If water does not bead on a clean surface, apply wax when the vehicle body is cool.

---

### ■ Automatic car washes

- Before washing the vehicle:
  - Fold the mirrors.
  - Turn off the power back door system.
- Brushes used in automatic car washes may scratch the vehicle surface and harm your vehicle's paint.
- In certain automatic car washes, the rear spoiler may interfere with machine operation. This may prevent the vehicle from being cleaned properly or result in damage to the rear spoiler.

### ■ High pressure car washes

- Do not allow the nozzles of the car wash to come within close proximity of the windows.
- Before using the car wash, check that the fuel filler door on your vehicle is closed properly.

### ■ Aluminum wheels

- Remove any dirt immediately by using a neutral detergent. Do not use hard brushes or abrasive cleaners. Do not use strong or harsh chemical cleaners. Use the same mild detergent and wax as used on the paint.
- Do not use detergent on the wheels when they are hot, for example after driving for long distance in the hot weather.
- Wash detergent from the wheels immediately after use.

### ■ Bumpers

Do not scrub with abrasive cleaners.

## ⚠ CAUTION

### ■ When cleaning the windshield (vehicles with rain-sensing windshield wipers)

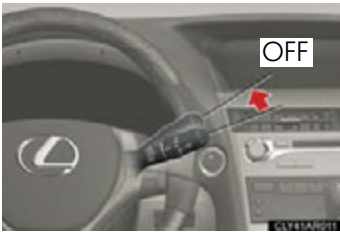

Set the wiper switch to off.

If the wiper switch is in **AUTO**, the wipers may operate unexpectedly in the following situations, and may result in hands being caught or other serious injuries and cause damage to the wiper blades.

- When the upper part of the windshield where the raindrop sensor is located is touched by hand
- When a wet rag or similar is held close to the raindrop sensor
- If something bumps against the windshield
- If you directly touch the raindrop sensor body or if something bumps into the raindrop sensor

### ■ Precautions regarding the exhaust pipe

Exhaust gasses cause the exhaust pipe to become quite hot.

When washing the vehicle, be careful not to touch the pipe until it has cooled sufficiently, as touching a hot exhaust pipe can cause burns.

### NOTICE

#### ■ To prevent paint deterioration and corrosion on the body and components (aluminum wheels etc.)

- Wash the vehicle immediately in the following cases:
  - After driving near the sea coast
  - After driving on salted roads
  - If you see coal tar or tree sap on the paint surface
  - If you see dead insects, insect droppings or bird droppings on the paint
  - After driving in an area contaminated with soot, oily smoke, mine dust, iron powder or chemical substances
  - If the vehicle becomes heavily soiled in dust or mud
  - If liquids such as benzene and gasoline are spilled on the paint surface
- If the paint is chipped or scratched, have it repaired immediately.
- To prevent the wheels from corroding, remove any dirt and store in a place with low humidity when storing the wheels.

#### ■ Cleaning the exterior lights

- Wash carefully. Do not use organic substances or scrub with a hard brush. This may damage the surfaces of the lights.
- Do not apply wax to the surfaces of the lights. Wax may cause damage to the lenses.

#### ■ To prevent damage to the windshield wiper arms

When lifting the wiper arms away from the windshield, pull the driver side wiper arm upward first, and repeat for the passenger side. When returning the wipers to their original position, do so from the passenger side first.

#### ■ When using an automatic car wash (vehicles with rain-sensing windshield wipers)

Set the wiper switch to the off position.

If the wiper switch is in **AUTO**, the wipers may operate and the wiper blades may be damaged.

# Cleaning and protecting the vehicle interior

The following procedures will help protect your vehicle's interior and keep it in top condition:

### ■ Protecting the vehicle interior

Remove dirt and dust using a vacuum cleaner. Wipe dirty surfaces with a cloth dampened with lukewarm water.

### ■ Cleaning the leather areas

- Remove dirt and dust using a vacuum cleaner.
- Wipe any excess dirt and dust with a soft cloth dampened with diluted detergent.

Use a diluted water solution of approximately 5% neutral wool detergent.

- Wring out any excess water from the cloth and thoroughly wipe off all remaining traces of detergent.
- Wipe the surface with a dry, soft cloth to remove any remaining moisture. Allow the leather to dry in a shaded and ventilated area.

### ■ Cleaning the synthetic leather areas

- Remove loose dirt using a vacuum cleaner.
- Apply a mild soap solution to the synthetic leather using a sponge or soft cloth.
- Allow the solution to soak in for a few minutes. Remove the dirt and wipe off the solution with a clean, damp cloth.

### ■ Caring for leather areas

Lexus recommends cleaning the interior of the vehicle at least twice a year to maintain the quality of the vehicle's interior.

### ■ Shampooing the carpets

There are several commercial foaming-type cleaners available. Use a sponge or brush to apply the foam. Rub in overlapping circles. Do not apply water. Excellent results are obtained by keeping the carpet as dry as possible.

### ■ Seat belts

Clean with mild soap and lukewarm water using a cloth or sponge. Also check the belts periodically for excessive wear, fraying or cuts.

### CAUTION

#### ■ Water in the vehicle

● Do not splash or spill liquid in the vehicle, such as on the floor and in the hybrid battery (traction battery) air vents or in the luggage compartment.

Doing so may cause the hybrid battery, electrical components, etc. to malfunction or catch fire.

● Do not get any of the SRS components or wiring in the vehicle interior wet. (→P. 134)

An electrical malfunction may cause the airbags to deploy or not function properly, resulting in death or severe injury.

#### ■ Cleaning the interior (especially instrument panel)

Do not use polish wax or polish cleaner. The instrument panel may reflect off the windshield, obstructing the driver's view and leading to an accident, resulting in death or serious injury.

 NOTICE**■ Cleaning detergents**

- Do not use the following types of detergent, as they may discolor the vehicle interior or cause streaks or damage to painted surfaces:
  - Non-seat portions: Organic substances such as benzene or gasoline, alkaline or acidic solutions, dye, or bleach
  - Seats: Acidic solutions, such as thinner, benzene, or alcohol
- Do not use polish wax or polish cleaner. The instrument panel's or other interior part's painted surface may be damaged.

**■ Preventing damage to leather surfaces**

Observe the following precautions to avoid damage to and deterioration of leather surfaces:

- Remove any dust or dirt from leather surfaces immediately.
- Do not expose the vehicle to direct sunlight for extended periods of time. Park the vehicle in the shade, especially during summer.
- Do not place items made of vinyl, plastic, or that contain wax on the upholstery, as they may stick to the leather surface if the vehicle interior heats up significantly.

**■ Water on the floor**

Do not wash the vehicle floor with water.

Vehicle systems such as the audio system may be damaged if water comes into contact with electrical components under the floor of vehicle. Water may also cause the body to rust.

**■ Cleaning the inside of the rear window**

- Do not use glass cleaner to clean the rear window, as this may cause damage to the rear window defogger heater wires or antenna. Use a cloth dampened with lukewarm water to gently wipe the window clean. Wipe the window in strokes running parallel to the heater wires or antenna.
- Be careful not to scratch or damage the heater wires or antenna.

# Maintenance requirements

To ensure safe and economical driving, day-to-day care and regular maintenance are essential. It is the owner's responsibility to perform regular checks. Lexus recommends the following maintenance:

### ■ General maintenance

General maintenance should be performed on a daily basis. This can be done by yourself or by a Lexus dealer.

### ■ Scheduled maintenance

Scheduled maintenance should be performed at specified intervals according to the maintenance schedule.

For details about maintenance items and schedules, refer to the "Warranty and Service Guide", "Owner's Manual Supplement" or "Scheduled Maintenance".

### ■ Do-it-yourself maintenance

You can perform some maintenance procedures yourself.

Please be aware that do-it-yourself maintenance may affect warranty coverage.

The use of Lexus Repair Manuals is recommended.

For details about warranty coverage, refer to the separate "Owner's Guide", "Warranty and Service Guide", "Owner's Manual Supplement" or "Warranty Booklet".

---

### ■ Repair and replacement

It is recommended that genuine Lexus parts be used for repair to ensure performance of each system. If non-Lexus parts are used in replacement or if a repair shop other than a Lexus dealer performs repairs, confirm the warranty coverage.



### ■ Reset the maintenance data (U.S.A. only)

After the required maintenance is performed according to the maintenance schedule, please reset the maintenance data.

To reset the data, follow the procedures described below:

**STEP 1** Display the trip meter “A” (→P. 198), then turn the “POWER” switch off.

**STEP 2** While pressing the “ODO/TRIP” button, turn the “POWER” switch to ON mode.

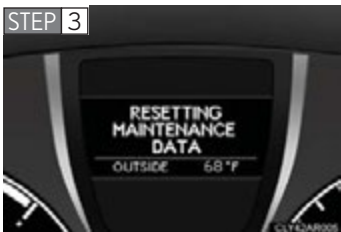

Keep the “ODO/TRIP” button pressed for about 5 seconds. The resetting procedure is complete when “000000” in the trip meter flashes once and the message in the multi-information display disappears.

### ■ Allow inspection and repairs to be performed by a Lexus dealer

- Lexus technicians are well-trained specialists and are kept up to date with the latest service information. They are well informed about the operations of all systems on your vehicle.
- Keep a copy of the repair order. It proves that the maintenance that has been performed is under warranty coverage. If any problem should arise while your vehicle is under warranty, your Lexus dealer will promptly take care of it.

 **CAUTION**

■ **If your vehicle is not properly maintained**

Improper maintenance could result in serious damage to the vehicle and possible serious injury or death.

■ **Handling of the 12-volt battery**

- Engine exhaust, some of its constituents, and a wide variety of automobile components contain or emit chemicals known to the State of California to cause cancer and birth defects and other reproductive harm. Work in a well ventilated area.
- Oils, fuels and fluids contained in vehicles as well as waste produced by component wear contain or emit chemicals known to the State of California to cause cancer and birth defects or other reproductive harm. Avoid exposure and wash any affected area immediately.
- 12-volt battery posts, terminals and related accessories contain lead and lead compounds which are known to cause brain damage. Wash your hands after handling. (→P. 664)

## 4-2. Maintenance

### General maintenance

Listed below are the general maintenance items that should be performed at the intervals specified in the “Warranty and Service Guide” or “Owner’s Manual Supplement”. It is recommended that any problem you notice should be brought to the attention of your Lexus dealer or qualified service shop for advice.

#### Engine compartment

Items	Check points
Brake fluid	Is the brake fluid at the correct level? (→P. 662)
Coolant	Is the coolant at the correct level? (→P. 659)
Engine oil	Is the engine oil at the correct level? (→P. 656)
Exhaust system	There should not be any fumes or strange sounds.
Radiator/condenser/hoses	The radiator and condenser should be free from foreign objects. (→P. 661)
Washer fluid	Is there sufficient washer fluid? (→P. 663)

## Vehicle interior

Items	Check points
12-volt battery	Check the connections. (→P. 664)
Accelerator pedal	<ul style="list-style-type: none"> <li>• The accelerator pedal should move smoothly (without uneven pedal effort or catching).</li> </ul>
Brake pedal	<ul style="list-style-type: none"> <li>• Does the brake pedal move smoothly?</li> <li>• Does the brake pedal have appropriate clearance from the floor? (→P. 806)</li> <li>• Does the brake pedal have the correct amount of free play? (→P. 806)</li> </ul>
Brakes	<ul style="list-style-type: none"> <li>• The vehicle should not pull to one side when the brakes are applied.</li> <li>• The brakes should work effectively.</li> <li>• The brake pedal should not feel spongy.</li> <li>• The brake pedal should not get too close to the floor when the brakes are applied.</li> </ul>
Head restraints	<ul style="list-style-type: none"> <li>• Do the head restraints move smoothly and lock securely?</li> </ul>
Hybrid transmission “Park” mechanism	<ul style="list-style-type: none"> <li>• When parked on a slope and the parking brake is on, is the vehicle securely stopped?</li> </ul>

Items	Check points
Indicators/buzzers	<ul style="list-style-type: none"> <li>• Do the indicators and buzzers function properly?</li> </ul>
Lights	<ul style="list-style-type: none"> <li>• Do all the lights come on?</li> <li>• Are the headlights aimed correctly? (→P. 705)</li> </ul>
Parking brake	<ul style="list-style-type: none"> <li>• Does the parking brake pedal move smoothly?</li> <li>• When parked on a slope and the parking brake is on, is the vehicle securely stopped?</li> </ul>
Seat belts	<ul style="list-style-type: none"> <li>• Do the seat belts operate smoothly?</li> <li>• The seat belts should not be damaged.</li> </ul>
Seats	<ul style="list-style-type: none"> <li>• Do the seat controls operate properly?</li> </ul>
Steering wheel	<ul style="list-style-type: none"> <li>• Does the steering wheel rotate smoothly?</li> <li>• Does the steering wheel have the correct amount of free play?</li> <li>• There should not be any strange sounds coming from the steering wheel.</li> </ul>

**Vehicle exterior**

Items	Check points
Doors	<ul style="list-style-type: none"> <li>• Do the doors operate smoothly?</li> </ul>
Engine hood	<ul style="list-style-type: none"> <li>• Does the engine hood lock system work properly?</li> </ul>
Fluid leaks	<ul style="list-style-type: none"> <li>• There should not be any signs of fluid leakage after the vehicle has been parked.</li> </ul>
Tires	<ul style="list-style-type: none"> <li>• Is the tire inflation pressure correct?</li> <li>• The tires should not be damaged or excessively worn.</li> <li>• Have the tires been rotated according to the maintenance schedule?</li> <li>• The wheel nuts should not be loose.</li> </ul>
Windshield wipers	<ul style="list-style-type: none"> <li>• The wiper blades should not show any signs of cracking, splitting, wear, contamination or deformation.</li> <li>• The wiper blades should clear the windshield without streaking or skipping.</li> </ul>

**⚠ CAUTION**

**■ If the hybrid system is operating**

Turn the hybrid system off and ensure that there is adequate ventilation before performing maintenance checks.

Some states have vehicle emission inspection programs which include OBD (On Board Diagnostics) checks. The OBD system monitors the operation of the emission control system.

### ■ If the malfunction indicator lamp comes on

The OBD system determines that a problem exists somewhere in the emission control system. Your vehicle may not pass the I/M test and may need to be repaired. Contact your Lexus dealer to service the vehicle.

### ■ Your vehicle may not pass the I/M test in the following situations:

- When the 12-volt battery is disconnected or discharged

Readiness codes that are set during ordinary driving are erased. Also, depending on your driving habits, the readiness codes may not be completely set.

- When the fuel tank cap is loose

The malfunction indicator lamp comes on indicating a temporary malfunction and your vehicle may not pass the I/M test.

### ■ When the malfunction indicator lamp still remains on after several driving trips

The error code in the OBD system will not be cleared unless the vehicle is driven 40 or more times.

### ■ If your vehicle does not pass the I/M test

Contact your Lexus dealer to prepare the vehicle for re-testing.

### 4-3. Do-it-yourself maintenance

## Do-it-yourself service precautions

If you perform maintenance by yourself, be sure to follow the correct procedures as given in these sections.

Items	Parts and tools
12-volt battery condition (→P. 664)	<ul style="list-style-type: none"><li>• Grease</li><li>• Conventional wrench (for terminal clamp bolts)</li></ul>
Brake fluid level (→P. 662)	<ul style="list-style-type: none"><li>• FMVSS No.116 DOT 3 or SAE J1703 brake fluid</li><li>• Rag or paper towel</li><li>• Funnel (used only for adding brake fluid)</li></ul>
Engine/power control unit coolant level (→P. 659)	<ul style="list-style-type: none"><li>• “Toyota Super Long Life Coolant” or a similar high quality ethylene glycol based non-silicate, non-amine, non-nitrite and non-borate coolant with long-life hybrid organic acid technology. For the U.S.A.: “Toyota Super Long Life Coolant” is pre-mixed with 50% coolant and 50% deionized water. For Canada: “Toyota Super Long Life Coolant” is pre-mixed with 55% coolant and 45% deionized water.</li><li>• Funnel (used only for adding coolant)</li></ul>



Items	Parts and tools
Engine oil level (→P. 656)	<ul style="list-style-type: none"> <li>• “Toyota Genuine Motor Oil” or equivalent</li> <li>• Rag or paper towel</li> <li>• Funnel (used only for adding engine oil)</li> </ul>
Fuses (→P. 689)	<ul style="list-style-type: none"> <li>• Fuse with same amperage rating as original</li> </ul>
Tire inflation pressure (→P. 679)	<ul style="list-style-type: none"> <li>• Tire pressure gauge</li> <li>• Compressed air source</li> </ul>
Headlight aim (→P. 705)	<ul style="list-style-type: none"> <li>• Phillips-head screwdriver</li> </ul>
Radiator and condenser (→P. 661)	—
Washer fluid (→P. 663)	<ul style="list-style-type: none"> <li>• Water or washer fluid containing antifreeze (for winter use)</li> <li>• Funnel (used only for adding water or washer fluid)</li> </ul>

 **CAUTION**

The engine compartment contains many mechanisms and fluids that may move suddenly, become hot, or become electrically energized. To avoid death or serious injury, observe the following precautions:

■ **When working on the engine compartment**

- Make sure that the indicator on the “POWER” switch and the “READY” indicator are both off.
- Keep hands, clothing and tools away from the moving fans and engine drive belt.
- Be careful not to touch the engine, power control unit, radiator, exhaust manifold, etc. right after driving as they may be hot. Oil and other fluids may also be hot.
- Do not leave anything that may burn easily, such as paper and rags, in the engine compartment.
- Do not smoke, cause sparks or expose an open flame to fuel. Fuel fumes are flammable.

■ **When working near the electric cooling fans or radiator grille**

Be sure the “POWER” switch is off.

With the “POWER” switch in ON mode, the electric cooling fans may automatically start to run if the air conditioning is on and/or the coolant temperature is high. (→P. 661)

■ **Safety glasses**

Wear safety glasses to prevent flying or falling material, fluid spray, etc. from getting in your eyes.

 **NOTICE**

■ **If you remove the air cleaner filter**

Driving with the air cleaner filter removed may cause excessive engine wear due to dirt in the air.

## 4-3. Do-it-yourself maintenance

# Hood

Release the lock from the inside of the vehicle to open the hood.

STEP 1



Pull the hood lock release lever.

The hood will pop up slightly.

STEP 2



Pull up the hood catch and lift the hood.

### CAUTION

#### ■ Pre-driving check

Check that the hood is fully closed and locked.

If the hood is not locked properly, it may open while the vehicle is in motion and cause an accident, which may result in death or serious injury.

## 4-3. Do-it-yourself maintenance

### Positioning a floor jack

When raising your vehicle with a floor jack, position the jack correctly. Improper placement may damage your vehicle or cause injury.

#### ■ Front



#### ■ Rear



## ⚠ CAUTION

### ■ When raising your vehicle

Make sure to observe the following precautions to reduce the possibility of death or serious injury:



- Lift up the vehicle using a floor jack such as the one shown in the illustration.

- When using a floor jack, follow the instructions of the manual provided with the jack.
- Do not use the jack that was supplied with your vehicle.
- Do not put any part of your body underneath the vehicle when it is supported only by the floor jack.
- Always use floor jack and/or automotive jack stands on a solid, flat, level surface.
- Do not start the hybrid system while the vehicle is supported by the floor jack.
- Stop the vehicle on level, firm ground, firmly set the parking brake and shift the shift lever to P.
- Make sure to set the floor jack properly at the jack point.  
Raising the vehicle with an improperly positioned floor jack will damage the vehicle and may cause the vehicle to fall off the floor jack.
- Do not raise the vehicle while someone is in the vehicle.
- When raising the vehicle, do not place any objects on top of or underneath the floor jack.

## 4-3. Do-it-yourself maintenance

### Engine compartment

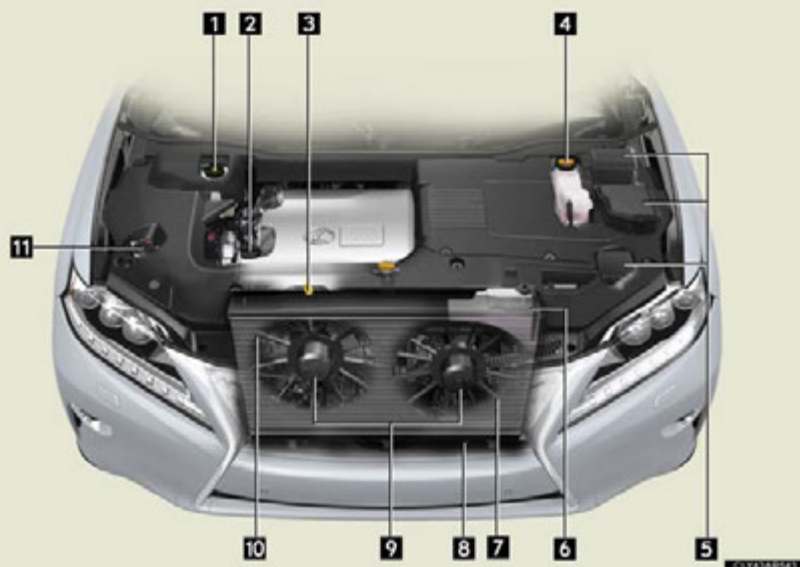

- |   |   |
|---|---|
| <b>1</b> Brake fluid reservoir<br>(→P. 662)                   | <b>6</b> Engine coolant reservoir<br>(→P. 659)                |
| <b>2</b> Engine oil filler cap<br>(→P. 657)                   | <b>7</b> Condenser<br>(→P. 661)                               |
| <b>3</b> Engine oil level dipstick<br>(→P. 656)               | <b>8</b> Radiator<br>(→P. 661)                                |
| <b>4</b> Power control unit coolant<br>reservoir<br>(→P. 659) | <b>9</b> Electric cooling fans                                |
| <b>5</b> Fuse boxes<br>(→P. 689)                              | <b>10</b> Power control unit coolant<br>radiator<br>(→P. 661) |
|   | <b>11</b> Washer fluid tank (→P. 663)                         |

## Engine compartment cover

### ■ Removing the engine compartment covers

#### ▶ Outside

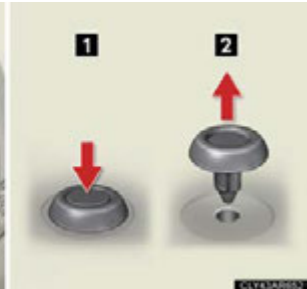

#### ▶ Front

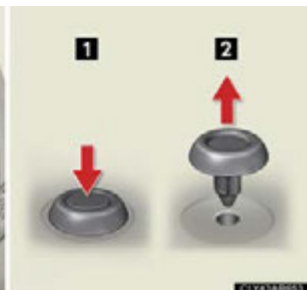

### ■ Installing the clips

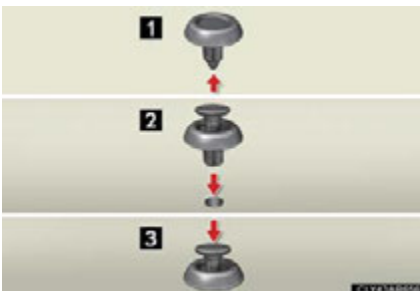

 NOTICE

■ **After installing an engine compartment cover**

Make sure that the cover is securely installed in its original position.

## Engine oil

With the engine at operating temperature and turned off, check the oil level on the dipstick.

### ■ Checking the engine oil

**STEP 1** Park the vehicle on level ground. After warming up the engine and turning off the hybrid system, wait more than 5 minutes for the oil to drain back into the bottom of the engine.

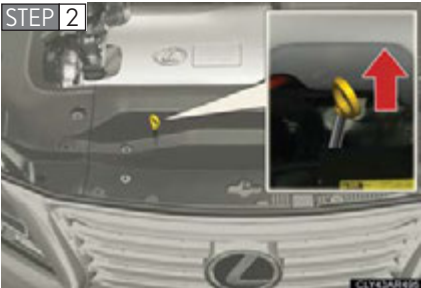

Holding a rag under the end, pull the dipstick out.

**STEP 3** Wipe the dipstick clean.

**STEP 4** Reinsert the dipstick fully.



**STEP 5** Holding a rag under the end, pull the dipstick out and check the oil level.

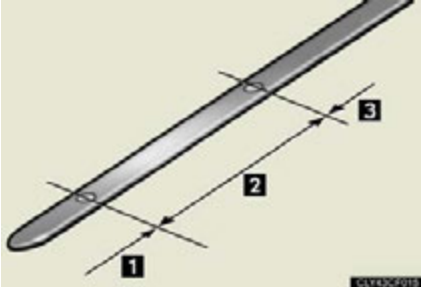

- 1** Low
- 2** Normal
- 3** Excessive

The shape of the dipstick may differ depending on the type of vehicle or engine.

**STEP 6** Wipe the dipstick and reinsert it fully.

### ■ Adding engine oil



If the oil level is below or near the low level mark, add engine oil of the same type as that already in the engine.

Make sure to check the oil type and prepare the items needed before adding oil.

Engine oil selection	→P. 802
Oil quantity (Low → Full)	1.6 qt. (1.5 L, 1.3 Imp. qt.)
Items	Clean funnel

**STEP 1** Remove the oil filler cap by turning it counterclockwise.

**STEP 2** Add engine oil slowly, checking the dipstick.

**STEP 3** Install the oil filler cap by turning it clockwise.

### ■ Engine oil consumption

A certain amount of engine oil will be consumed while driving. In the following situations, oil consumption may increase, and engine oil may need to be refilled in between oil maintenance intervals.

- When the engine is new, for example directly after purchasing the vehicle or after replacing the engine
- If low quality oil or oil of an inappropriate viscosity is used
- AWD models with towing package: When driving at high engine speeds or with a heavy load, when towing, or when driving while accelerating or decelerating frequently
- 2WD models and AWD models without towing package: When driving at high engine speeds or with a heavy load, or when driving while accelerating or decelerating frequently
- When leaving the engine idling for a long time, or when driving frequently through heavy traffic

### CAUTION

#### ■ Used engine oil

- Used engine oil contains potentially harmful contaminants which may cause skin disorders such as inflammation or skin cancer, so care should be taken to avoid prolonged and repeated contact. To remove used engine oil from your skin, wash thoroughly with soap and water.
- Dispose of used oil and filters only in a safe and acceptable manner. Do not dispose of used oil and filters in household trash, in sewers or onto the ground. Call your Lexus dealer, service station or auto parts store for information concerning recycling or disposal.
- Do not leave used engine oil within the reach of children.

 NOTICE

■ **To prevent serious engine damage**

Check the oil level on a regular basis.

■ **When replacing the engine oil**

- Be careful not to spill engine oil on the vehicle components.
- Avoid overfilling, or the engine could be damaged.
- Check the oil level on the dipstick every time you refill the vehicle.
- Be sure the engine oil filler cap is properly tightened.

## Coolant

The coolant level is satisfactory if it is between the “FULL” and “LOW” lines on the reservoir when the engine and hybrid system are cold.

► Engine coolant reservoir

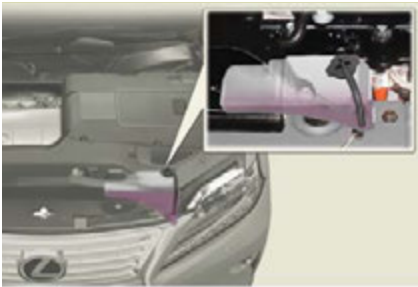

- 1 Reservoir cap
- 2 “FULL” line
- 3 “LOW” line

If the level is on or below the “LOW” line, add coolant up to the “FULL” line. (→P. 788)

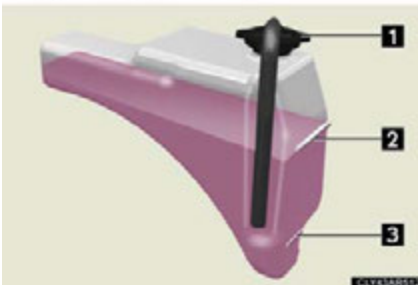

### ▶ Power control unit coolant reservoir



- 1 Reservoir cap
- 2 "FULL" line
- 3 "LOW" line

If the level is on or below the "LOW" line, add coolant up to the "FULL" line. (→P. 788)



### ■ Coolant selection

Only use "Toyota Super Long Life Coolant" or similar high quality ethylene glycol based non-silicate, non-amine, non-nitrite, and non-borate coolant with long-life hybrid organic acid technology.

U.S.A.: "Toyota Super Long Life Coolant" is a mixture of 50% coolant and 50% deionized water. (Minimum temperature: -31°F [-35°C])

Canada: "Toyota Super Long Life Coolant" is a mixture of 55% coolant and 45% deionized water. (Minimum temperature: -44°F [-42°C])

For more details about coolant, contact your Lexus dealer.

### ■ If the coolant level drops within a short time of replenishing

Visually check the radiators, hoses, engine/power control unit coolant reservoir caps, drain cock and water pump.

If you cannot find a leak, have your Lexus dealer test the cap and check for leaks in the cooling systems.

**⚠ CAUTION****■ When the engine and hybrid system are hot**

Do not remove the coolant reservoir cap.

The cooling system may be under pressure and may spray hot coolant if the cap is removed, causing serious injuries, such as burns.

**⚠ NOTICE****■ When adding coolant**

Coolant is neither plain water nor straight antifreeze. The correct mixture of water and antifreeze must be used to provide proper lubrication, corrosion protection and cooling. Be sure to read the antifreeze or coolant label.

**■ If you spill coolant**

Be sure to wash it off with water to prevent damaging to parts or paint.

**Radiator and condenser**

Check the radiator and condenser and clear away any foreign objects. If either of the above parts are extremely dirty or you are not sure of their condition, have your vehicle checked by your Lexus dealer.

**⚠ CAUTION****■ When the hybrid system is hot**

Do not touch the radiator or condenser as they may be hot and cause serious injuries, such as burns.

## Brake fluid

### ■ Checking fluid level



The brake fluid level should be between the “MAX” and “MIN” lines on the tank.

### ■ Adding fluid

Make sure to check the fluid type and prepare the necessary item.

Fluid type	FMVSS No.116 DOT 3 or SAE J1703
Items	Clean funnel

### ■ Brake fluid can absorb moisture from the air

Excess moisture in the brake fluid can cause a dangerous loss of braking efficiency. Use only newly opened brake fluid.

## ⚠ CAUTION

### ■ When filling the reservoir

Take care because brake fluid can harm your hands or eyes and damage painted surfaces.

If fluid gets on your hands or in your eyes, flush the affected area with clean water immediately.

If you still experience discomfort, see a doctor.

 NOTICE

■ **If the fluid level is low or high**

It is normal for the brake fluid level to go down slightly as the brake pads wear out or when the fluid level in the accumulator is high.

If the reservoir needs frequent refilling, may be a serious problem.

## Washer fluid



If any washer does not work or the warning message appears on the multi-information display, the washer tank may be empty. Add washer fluid.

 CAUTION

■ **When adding washer fluid**

Do not add washer fluid when the hybrid system is hot or operating as washer fluid contains alcohol and may catch fire if spilled on the hybrid system etc.

 NOTICE

■ **Do not use any fluid other than washer fluid**

Do not use soapy water or engine antifreeze instead of washer fluid. Doing so may cause streaking on the vehicle's painted surfaces.

■ **Diluting washer fluid**

Dilute washer fluid with water as necessary.

Refer to the freezing temperatures listed on the label of the washer fluid bottle.

## 4-3. Do-it-yourself maintenance

# 12-volt battery

### ■ Location



The 12-volt battery is located on the left-hand side of the luggage compartment.

### ■ Removing the 12-volt battery cover

► Vehicles with a compact spare tire

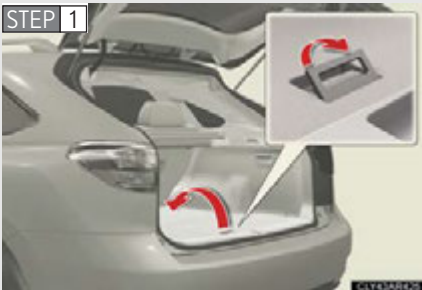

Pull the lever upward to fold back the front part of the deck board.



Pull the folded deck board upright.



STEP 3

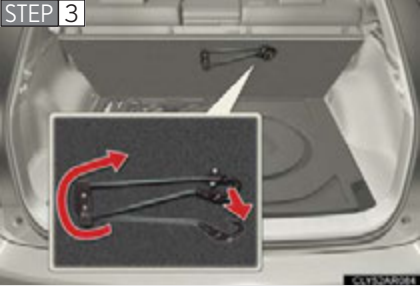

Pull on the attached hook to extend the string.

STEP 4



Use the hook to secure the deck board as shown in the illustration.

STEP 5



Remove the spare tire cover.

STEP 6

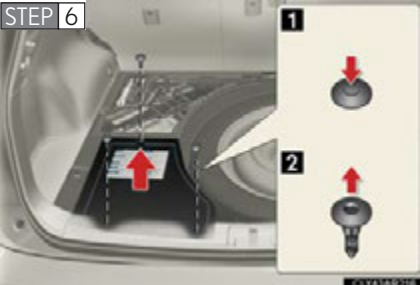

After removing the clips, remove the 12-volt battery cover.

► Vehicles with a full-size spare tire

STEP 1



Pull the lever upward to fold back the front part of the deck board.

STEP 2



Pull on the attached hook to extend the string.

STEP 3



Use the hook to secure the deck board as shown in the illustration.

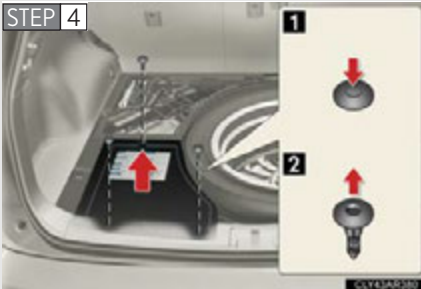

After removing the clips, remove the 12-volt battery cover.

### Exterior

Make sure that the 12-volt battery terminals are not corroded and that there are no loose connections, cracks or loose clamps.

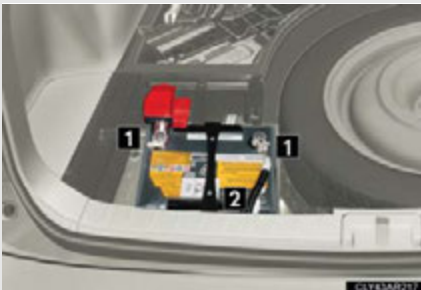

1 Terminals

2 Hold-down clamp

### Installing the 12-volt battery cover

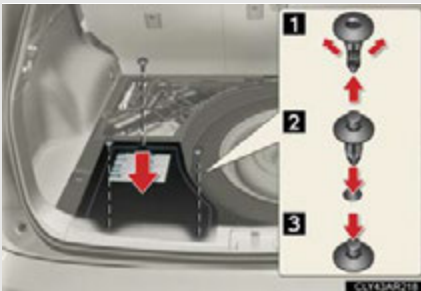

Install the 12-volt battery cover with the clips.

### ■ Before recharging

When recharging, the 12-volt battery produces hydrogen gas which is flammable and explosive. Therefore, observe the following precautions before recharging:

- If recharging with the 12-volt battery installed on the vehicle, be sure to disconnect the ground cable.
- Make sure the power switch on the charger is off when connecting and disconnecting the charger cables to the 12-volt battery.

### ■ After recharging/reconnecting the 12-volt battery

The hybrid system may not start. Follow one or both of the following procedures:

- After opening and closing the driver's door, wait 10 seconds and then attempt to start the hybrid system. (If the system does not start the first time, repeat the procedure.)
- With the shift lever in P and the "POWER" switch off, open and close any door and then attempt to start the hybrid system.

If the system will not start even after multiple attempts at both methods, contact your Lexus dealer.

### CAUTION

#### ■ Chemicals in the 12-volt battery

The 12-volt battery contain poisonous and corrosive sulfuric acid and may produce hydrogen gas which is flammable and explosive. To reduce the risk of death or serious injury, take the following precautions while working on or near the 12-volt battery:

- Do not cause sparks by touching the 12-volt battery terminals with tools.
- Do not smoke or light a match near the 12-volt battery.
- Avoid contact with eyes, skin and clothes.
- Never inhale or swallow electrolyte.
- Wear protective safety glasses when working near the 12-volt battery.
- Keep children away from the 12-volt battery.

 CAUTION**■ Where to safely charge the 12-volt battery**

Always charge the 12-volt battery in an open area. Do not charge the 12-volt battery in a garage or closed room where there is insufficient ventilation.

**■ How to recharge the 12-volt battery**

Only perform a slow charge (5 A or less). The 12-volt battery may explode if charged at a quicker rate.

**■ Emergency measures regarding electrolyte****● If electrolyte gets in your eyes**

Flush your eyes with clean water for at least 15 minutes and get immediate medical attention. If possible, continue to apply water with a sponge or cloth while traveling to the nearest medical facility.

**● If electrolyte gets on your skin**

Wash the affected area thoroughly. If you feel pain or burning, get medical attention immediately.

**● If electrolyte gets on your clothes**

It can soak through clothing on to your skin. Immediately take off the clothing and follow the procedure above if necessary.

**● If you accidentally swallow electrolyte**

Drink a large quantity of water or milk. Get emergency medical attention immediately.

**■ When replacing the 12-volt battery**

Use a 12-volt battery designed for the RX450h. Failure to do so may cause gas (hydrogen) to enter the passenger compartment, causing a fire or explosion.

For replacement of the 12-volt battery, contact your Lexus dealer.

 NOTICE**■ When recharging the 12-volt battery**

Never recharge the 12-volt battery while the hybrid system is operating. Also, be sure all accessories are turned off.

## 4-3. Do-it-yourself maintenance

# Tires

Replace or rotate tires in accordance with maintenance schedules and treadwear.

### ■ Checking tires



- 1 New tread
- 2 Treadwear indicator
- 3 Worn tread

The location of treadwear indicators is shown by the “TWI” or “Δ” marks, etc., molded on the sidewall of each tire.

Check spare tire condition and pressure if not rotated.

### ■ Tire rotation

#### ► Vehicles with a compact spare tire

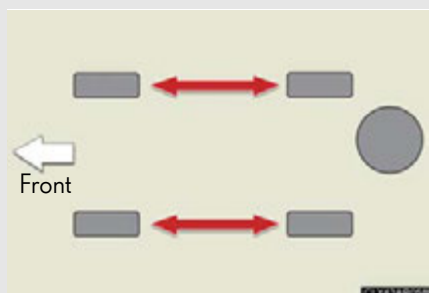

Rotate the tires in the order shown.

To equalize tire wear and extend tire life, Lexus recommends that tire rotation is carried out at the same interval as tire inspection.

#### ► Vehicles with a full-size spare tire

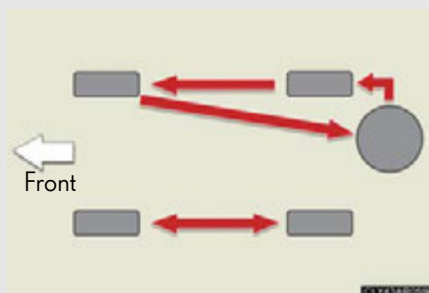

Rotate the tires in the order shown.

To equalize tire wear and extend tire life, Lexus recommends that tire rotation is carried out at the same interval as tire inspection.

### ■ The tire pressure warning system

Your Lexus is equipped with a tire pressure warning system that uses tire pressure warning valves and transmitters to detect low tire inflation pressure before serious problems arise. (→P. 736)

### Installing tire pressure warning valves and transmitters

When replacing tires or wheels, tire pressure warning valves and transmitters must also be installed.

When new tire pressure warning valves and transmitters are installed, new tire pressure warning valve and transmitter ID codes must be registered in the tire pressure warning computer and the tire pressure warning system must be initialized. Have tire pressure warning valve and transmitter ID codes registered by your Lexus dealer. (→P. 673)

### Initializing the tire pressure warning system

#### ■ The tire pressure warning system must be initialized in the following circumstances:

- When rotating the tires
- When the tire inflation pressure is changed such as when changing travelling speed or load weight
- When changing the tire size

When the tire pressure warning system is initialized, the current tire inflation pressure is set as the benchmark pressure.

### ■ How to initialize the tire pressure warning system

**STEP 1** Park the vehicle in a safe place and turn the “POWER” switch off. Initialization cannot be performed while the vehicle is moving.

**STEP 2** Adjust the tire inflation pressure to the specified cold tire inflation pressure level. (→P. 807)

Make sure to adjust the tire pressure to the specified cold tire inflation pressure level. The tire pressure warning system will operate based on this pressure level.

**STEP 3** Turn the “POWER” switch to ON mode.



Press and hold the tire pressure warning reset switch until the tire pressure warning light blinks slowly 3 times.

**STEP 5** Wait for a few minutes with the “POWER” switch on and then turn the “POWER” switch off.



## Registering ID codes

The tire pressure warning valve and transmitter is equipped with a unique ID code. When replacing a tire pressure warning valve and transmitter, it is necessary to register the ID code. Have the ID code registered by your Lexus dealer.

### ■ When to replace your vehicle's tires

Tires should be replaced if:

- You have tire damage such as cuts, splits, cracks deep enough to expose the fabric, and bulges indicating internal damage.
- A tire goes flat repeatedly or cannot be properly repaired due to the size or location of a cut or other damage.

If you are not sure, consult with your Lexus dealer.

### ■ Replacing tires and wheels

If the ID code of the tire pressure warning valve and transmitter is not registered, the tire pressure warning system will not work properly. After driving for about 20 minutes, the tire pressure warning light blinks for 1 minute and stays on to indicate a system malfunction.

### ■ Tire life

Any tire over 6 years old must be checked by a qualified technician even if it has seldom or never been used or damage is not obvious.

### ■ If the tread on snow tires wears down below 0.16 in. (4 mm)

The effectiveness of the tires as snow tires is lost.

### ■ Routine tire inflation pressure checks

The tire pressure warning system does not replace routine tire inflation pressure checks. Make sure to check tire inflation pressure as part of your routine of daily vehicle checks.

### ■ Maximum load of tire

Check that the number given by dividing the maximum load by 1.10 of the replacement tire is greater than 1/2 of the Gross Axle Weight Ratings (GAWR) of either the front axle or the rear axle, whichever is greater.



For the GAWR, see the Certification Label. For the maximum load of the tire, see the load limit at maximum cold tire inflation pressure mentioned on the sidewall of the tire. (→P. 813)

### ■ Tire types

#### 1 Summer tires

Summer tires are high-speed performance tires best suited to highway driving under dry conditions. Since summer tires do not have the same traction performance as snow tires, summer tires are inadequate for driving on snow-covered or icy roads. For driving on snow-covered roads or icy roads, the use of snow tires is recommended. When installing snow tires, be sure to replace all four tires.

#### 2 All season tires

All season tires are designed to provide better traction in snow and to be adequate for driving in most winter conditions, as well as for use year round. All season tires, however, do not have adequate traction performance compared with snow tires in heavy or loose snow. Also, all season tires fall short in acceleration and handling performance compared with summer tires in highway driving.

#### 3 Snow tires

For driving on snow-covered roads or icy roads, we recommend using snow tires. If you need snow tires, select tires of the same size, construction and load capacity as the originally installed tires. Since your vehicle has radial tires as original equipment, make sure your snow tires also have radial construction. Do not install studded tires without first checking local regulations for possible restrictions. Snow tires should be installed on all wheels. (→P. 302)

**■ The initialization operation**

- Make sure to carry out initialization after adjusting the tire inflation pressure. Also, make sure the tires are cold before carrying out initialization or tire inflation pressure adjustment.
- If you have accidentally turned the “POWER” switch off during initialization, it is not necessary to press the reset switch again as initialization will restart automatically when the “POWER” switch has been turned to ON mode for the next time.
- If you accidentally press the reset switch when initialization is not necessary, adjust the tire inflation pressure to the specified level when the tires are cold, and conduct initialization again.

**■ When the initialization of the tire pressure warning system has failed**

Initialization can be completed in a few minutes. However, in the following cases, the settings have not been recorded and the system will not operate properly. If repeated attempts to record tire inflation pressure settings are unsuccessful, have the vehicle inspected by your Lexus dealer.

- When operating the tire pressure warning reset switch, the tire pressure warning light does not blink 3 times.
- After carrying out the initialization procedure, the tire pressure warning light blinks for 1 minute then stays on after driving for 20 minutes.

### ■ Certification for tire pressure warning system

TPMS Transmitter FCC ID: PAXPMV107J

► For vehicles sold in the U.S.A.

NOTE:

This device complies with part 15 of the FCC Rules. Operation is subject to the following two conditions: (1) This device may not cause harmful interference, and (2) this device must accept any interference received, including interference that may cause undesired operation.

FCC WARNING:

Changes or modifications not expressly approved by the party responsible for compliance could void the user's authority to operate the equipment.

► For vehicles sold in Canada

NOTE:

Operation is subject to the following two conditions: (1) this device may not cause interference, and (2) this device must accept any interference, including interference that may cause undesired operation of the device.

L'utilisation de ce dispositif est autorisée seulement aux deux conditions suivantes: (1) il ne doit pas produire de brouillage, et (2) l'utilisateur du dispositif doit être prêt à accepter tout brouillage radioélectrique reçu, même si ce brouillage est susceptible de compromettre le fonctionnement du dispositif.

TPMS Receiver FCC ID: HYQ13BCX

NOTE:

This device complies with part 15 of the FCC Rules. Operation is subject to the following two conditions: (1) This device may not cause harmful interference, and (2) this device must accept any interference received, including interference that may cause undesired operation.

FCC WARNING:

Changes or modifications not expressly approved by the party responsible for compliance could void the user's authority to operate the equipment.

 **CAUTION****■ Tire pressure warning system operation**

The tire pressure warning system may not provide warning immediately if a tire bursts or if sudden air leakage occurs.

**■ When inspecting or replacing tires**

Observe the following precautions to prevent accidents. Failure to do so may cause damage to parts of the drive train, as well as dangerous handling characteristics, which may lead to an accident resulting in death or serious injury.

- Do not mix tires of different makes, models or tread patterns. Also, do not mix tires of remarkably different treadwear.
- Do not use tire sizes other than those recommended by Lexus.
- Do not mix differently constructed tires (radial, bias-belted or bias-ply tires).
- Do not mix summer, all season and snow tires.
- Do not use tires that have been used on another vehicle.  
Do not use tires if you do not know how they were used previously.
- Do not tow if your vehicle has a compact spare tire installed.

**■ When initializing the tire pressure warning system**

Do not push the tire pressure warning reset switch without first adjusting the tire inflation pressure to the specified level. Otherwise, the tire pressure warning light may not come on even if the tire inflation pressure is low, or it may come on when the tire inflation pressure is actually normal.

 NOTICE

■ **Repairing or replacing tires, wheels, tire pressure warning valves, transmitters and tire valve caps**

- When removing or fitting the wheels, tires or the tire pressure warning valves and transmitter, contact your Lexus dealer as the tire pressure warning valves and transmitters may be damaged if not handled correctly.
- When replacing tire valve caps, do not use tire valve caps other than those specified. The cap may become stuck.

■ **To avoid damage to the tire pressure warning valves and transmitters**

When a tire is repaired with liquid sealants, the tire pressure warning valve and transmitter may not operate properly. If a liquid sealant is used, contact your Lexus dealer or other qualified service shop as soon as possible. Make sure to replace the tire pressure warning valve and transmitter when replacing the tire. (→P. 671)

■ **Driving on rough roads**

Take particular care when driving on roads with loose surfaces or potholes. These conditions may cause losses in tire inflation pressure, reducing the cushioning ability of the tires. In addition, driving on rough roads may cause damage to the tires themselves, as well as the vehicle's wheels and body.

■ **If tire inflation pressure of each tire becomes low while driving**

Do not continue driving, or your tires and/or wheels may be ruined.

## 4-3. Do-it-yourself maintenance

### Tire inflation pressure

#### ■ Tire inflation pressure

The recommended cold tire inflation pressure and tire size is displayed on the tire and loading information label. (→P. 807)



### ■ Inspection and adjustment procedure



- 1 Tire valve
- 2 Tire pressure gauge

**STEP 1** Remove the tire valve cap.

**STEP 2** Press the tip of the tire pressure gauge onto the tire valve.

**STEP 3** Read the pressure using the gauge graduations.

**STEP 4** If the tire inflation pressure is not at the recommended level, adjust the pressure.

If you add too much air, press the center of the valve to deflate.

**STEP 5** After completing the tire inflation pressure measurement and adjustment, apply soapy water to the valve and check for leakage.

**STEP 6** Put the tire valve cap back on.

---

### ■ Tire inflation pressure check interval

You should check tire inflation pressure every two weeks, or at least once a month. Do not forget to check the spare.



**■ Effects of incorrect tire inflation pressure**

Driving with incorrect tire inflation pressure may result in the following:

- Reduced fuel efficiency
- Reduced driving comfort and tire life
- Reduced safety
- Damage to the drive train

If a tire needs frequent inflating, have it checked by your Lexus dealer.

**■ Instructions for checking tire pressure**

When checking tire inflation pressure, observe the following:

- Check only when the tires are cold.  
If your vehicle has been parked for at least 3 hours or has not been driven for more than 1 mile or 1.5 km, you will get an accurate cold tire inflation pressure reading.
- Always use a tire pressure gauge.  
The appearance of the tire can be misleading. In addition, tire inflation pressure that is even just a few pounds off can degrade ride and handling.
- Do not reduce tire inflation pressure after driving. It is normal for tire inflation pressure to be higher after driving.
- Never exceed the vehicle capacity weight.  
Passengers and luggage weight should be placed so that the vehicle is balanced.

### CAUTION

#### ■ Proper inflation is critical to save tire performance

Keep your tires properly inflated. Otherwise, the following conditions may occur and result in an accident causing death or serious injury:

- Excessive wear
- Uneven wear
- Poor handling
- Possibility of blowouts resulting from overheated tires
- Poor sealing of the tire bead
- Wheel deformation and/or tire separation
- A greater possibility of tire damage from road hazards

### NOTICE

#### ■ When inspecting and adjusting tire inflation pressure

Be sure to put the tire valve caps back on.

Without the valve caps, dirt or moisture could get into the valve and cause air leakage, which could result in an accident. If the caps are lost, replace them as soon as possible.

# Wheels

If a wheel is bent, cracked or heavily corroded, it should be replaced. Otherwise, the tire may separate from the wheel or cause a loss of handling control.

### ■ Wheel selection

When replacing wheels, care should be taken to ensure that they are equivalent to those removed in load capacity, diameter, rim width, and inset\*.

Replacement wheels are available at your Lexus dealer.

\*: Conventionally referred to as “offset”.

Lexus does not recommend using the following:

- Wheels of different sizes or types
- Used wheels
- Bent wheels that have been straightened

### ■ Aluminum wheel precautions

- Use only Lexus wheel nuts and wrenches designed for use with your aluminum wheels.
- When rotating, repairing or changing your tires, check that the wheel nuts are still tight after driving 1000 miles (1600 km).
- Be careful not to damage the aluminum wheels when using tire chains.
- Use only Lexus genuine balance weights or equivalent and a plastic or rubber hammer when balancing your wheels.

### ■ When replacing wheels

The wheels of your vehicle are equipped with tire pressure warning valves and transmitters that allow the tire pressure warning system to provide advanced warning in the event of a loss in tire inflation pressure. Whenever wheels are replaced, tire pressure warning valves and transmitters must be installed. (→P. 671)

### CAUTION

#### ■ When replacing wheels

- Do not use wheels that are a different size from those recommended in the Owner's Manual, as this may result in loss of handling control.
- Never use an inner tube in a leaking wheel which is designed for a tubeless tire. Doing so may result in an accident, causing death or serious injury.

### NOTICE

#### ■ Replacing tire pressure warning valves and transmitters

- Because tire repair or replacement may affect the tire pressure warning valves and transmitters, make sure to have tires serviced by your Lexus dealer or other qualified service shop. In addition, make sure to purchase your tire pressure warning valves and transmitters at your Lexus dealer.
- Ensure that only genuine Lexus wheels are used on your vehicle. Tire pressure warning valves and transmitters may not work properly with non-genuine wheels.

## 4-3. Do-it-yourself maintenance

### Air conditioning filter

The air conditioning filter must be changed regularly to maintain air conditioning efficiency.

#### ■ Removal method

**STEP 1** Turn the "POWER" switch off.

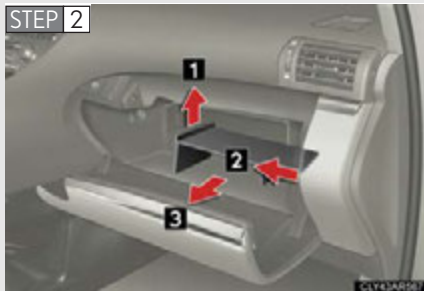

Open the glove box. Lift and remove the partition.

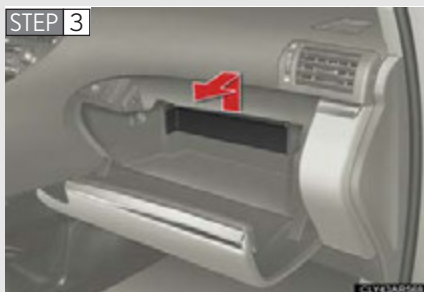

Remove the glove box cover.

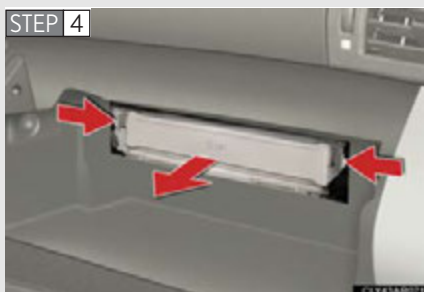

Remove the filter cover.

STEP 5

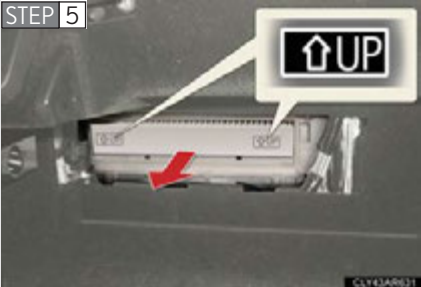

Remove the air conditioning filter and replace it with a new one.

The “↑UP” mark shown on the filter should be pointing up.

#### ■ Checking interval

Inspect and replace the air conditioning filter according to the maintenance schedule. In dusty areas or areas with heavy traffic flow, early replacement may be required. (For scheduled maintenance information, please refer to the “Owner’s Manual Supplement” or “Scheduled Maintenance”).

#### ■ If air flow from the vents decreases dramatically

The filter may be clogged. Check the filter and replace if necessary.

#### ⚠ NOTICE

#### ■ To prevent damage to the system

When using the air conditioning system, make sure that a filter is always installed.

## 4-3. Do-it-yourself maintenance

### Electronic key battery

Replace the battery with a new one if it is discharged.

■ You will need the following items:

- Flathead screwdriver
- Small Phillips-head screwdriver
- Lithium battery (CR1632)

■ Replacing the battery

STEP 1



Take out the mechanical key.

STEP 2



Remove the cover.

STEP 3

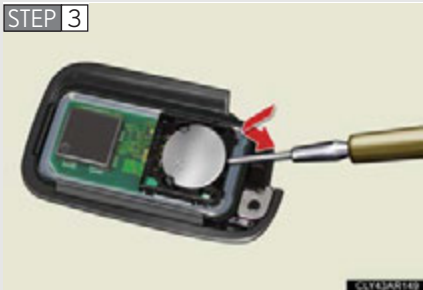

Remove the depleted battery.

Insert a new battery with the “+” terminal facing up.

### ■ Use a CR1632 lithium battery

- Batteries can be purchased at your Lexus dealer, local electrical appliance shops or camera stores.
- Replace only with the same or equivalent type recommended by the manufacturer.
- Dispose of used batteries according to the local laws.

### ■ If the electronic key battery is discharged

The following symptoms may occur:

- The smart access system with push-button start and wireless remote control will not function properly.
- The operational range is reduced.

### ■ When the card key battery needs to be replaced (if equipped)

The battery for the card key is available only at Lexus dealers. Your Lexus dealer can replace the battery for you.

### CAUTION

#### ■ Removed battery and other parts

These parts are small and if swallowed by a child, they can cause choking. Keep away from children. Failure to do so could result in death or serious injury.

### NOTICE

#### ■ For normal operation after replacing the battery

Observe the following precautions to prevent accidents:

- Always work with dry hands.  
Moisture may cause the battery to rust.
- Do not touch or move any other components inside the remote control.
- Do not bend either of the battery terminals.



## 4-3. Do-it-yourself maintenance

### Checking and replacing fuses

If any of the electrical components do not operate, a fuse may have blown. If this happens, check and replace the fuses as necessary.

**STEP 1** Turn the “POWER” switch off.

**STEP 2** After a system failure, see “Fuse layout and amperage ratings” for details about which fuse to check. (→P. 694)

**STEP 3** Engine compartment:

To gain access to the fuse box, remove the engine compartment cover. (→P. 655)

Luggage compartment:

To gain access to the fuse box, secure the deck board with the hook and then remove the spare tire cover and 12-volt battery cover. (→P. 664)

**STEP 4** Open the fuse box cover.

▶ Engine compartment (type A fuse box)

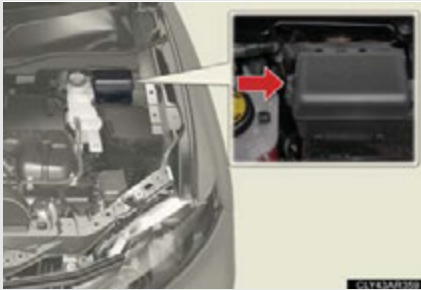

Push the tab in and lift the lid off.

▶ Engine compartment (type B fuse box)



Push the tab in and lift the lid off.

▶ Engine compartment (type C fuse box)



Push the tab in and lift the lid off.

▶ Driver's side instrument panel



Remove the lid.

▶ Luggage compartment (type A fuse box)



► Luggage compartment (type B fuse box)



Remove the terminal cover.



STEP 5

Remove the fuse with the pull-out tool.

STEP 6 Check if the fuse has blown.

► Type A

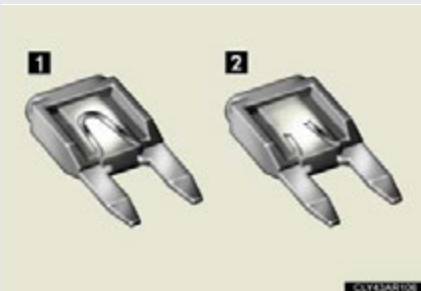

1 Normal fuse

2 Blown fuse

Replace the blown fuse with a new fuse of an appropriate amperage rating. The amperage rating can be found on the fuse box lid.

► Type B

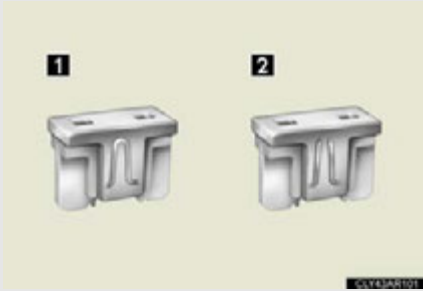

**1** Normal fuse

**2** Blown fuse

Replace the blown fuse with a new fuse of an appropriate amperage rating. The amperage rating can be found on the fuse box lid.

► Type C

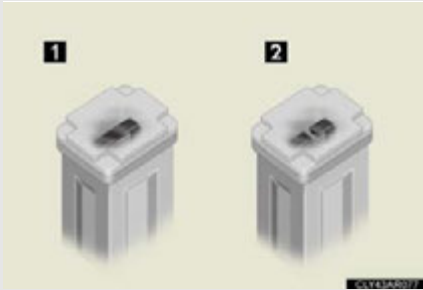

**1** Normal fuse

**2** Blown fuse

Replace the blown fuse with a new fuse of an appropriate amperage rating. The amperage rating can be found on the fuse box lid.

► Type D

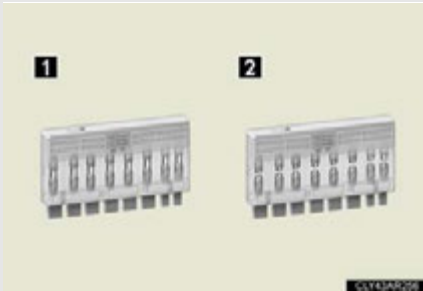

**1** Normal fuse

**2** Blown fuse

Replace the blown fuse with a new fuse of an appropriate amperage rating. The amperage rating can be found on the fuse box lid.

## ▶ Type E

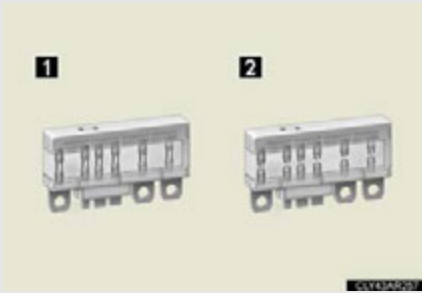

**1** Normal fuse

**2** Blown fuse

Replace the blown fuse with a new fuse of an appropriate amperage rating. The amperage rating can be found on the fuse box lid.

## ▶ Type F

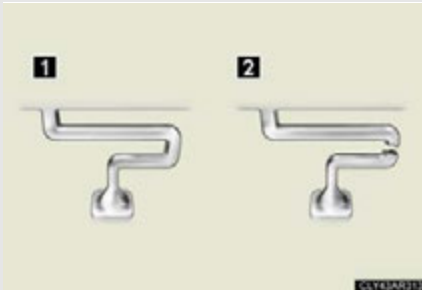

**1** Normal fuse

**2** Blown fuse

Contact your Lexus dealer.

## Fuse layout and amperage ratings

### ■ Engine compartment (type A fuse box)

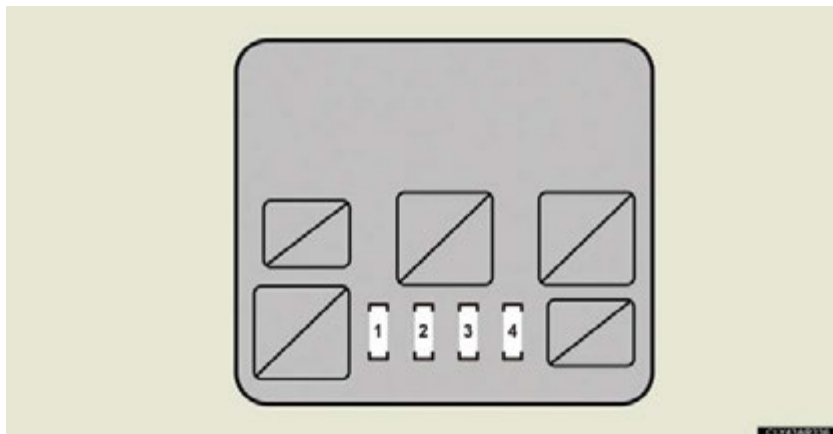

	Fuse	Ampere	Circuit
1	PCU	15 A	Hybrid system
2	IGCT NO. 2	10 A	Hybrid system
3	IGCT NO. 3	10 A	Hybrid system
4	INV W/P	10 A	Hybrid system

### ■ Engine compartment (type B fuse box)

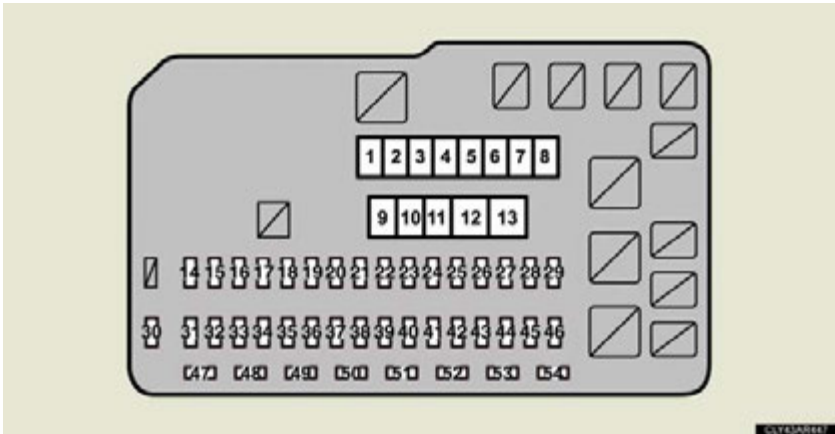

	Fuse	Ampere	Circuit
1	RR DEF	50 A	Rear window defogger
2	AIR SUS	50 A	—
3	HEATER	50 A	Air conditioning system
4	ABS NO. 1	50 A	Electronically controlled brake system
5	RDI FAN NO. 1	40 A	Electric cooling fans
6	RDI FAN NO. 2	40 A	Electric cooling fans
7	H-LP CLN	30 A	Headlight cleaner
8	PBD	30 A	Power back door
9	HV R/B NO. 1	30 A	PCU, IGCT NO. 2, IGCT NO. 3, INV W/P
10	PD	50 A	A/F, H-LP RH HI, H-LP LH LO, H-LP RH LO, H-LP LH HI, HORN, S-HORN
11	ABS NO. 2	50 A	Electronically controlled brake system
12	HV R/B NO. 2	80 A	ABS MAIN NO. 1, ABS MAIN NO. 2, A/C W/P, BATT FAN, OIL PMP

Fuse		Ampere	Circuit
13	DCDC	150 A	IG1 MAIN, TOWING BATT, DEICER, TOWING, STOP, RDI FAN NO. 1, ABS NO. 1, RR DEF, AIR SUS, HEATER, RDI FAN NO. 2, H-LP CLN, PBD, ECU-IG1 NO. 1, ECU-IG1 NO. 3, GAUGE NO. 1, ECU-IG1 NO. 2, EPS, FR WIP, RR WIP, FR WASH, RR WASH, RH S-HTR, LH S-HTR, TAIL, PANEL, D/L ALT B, FR FOG, FR DOOR, FL DOOR, RR DOOR, RL DOOR, PSB, P-SEAT LH, P-SEAT RH, TI&TE, FUEL OPN, DR LOCK, OBD, RR FOG, S/ROOF, 4WD, INVERTER, ECU-ACC, P/POINT, CIG, RADIO NO. 2
14	AMP1	30 A	Audio system
15	EFI MAIN	30 A	Multiport fuel injection system/ sequential multiport fuel injection system, EFI NO. 1, EFI NO. 2, F/PMP
16	AMP2	30 A	Audio system
17	IG2 MAIN	30 A	IGN, GAUGE NO. 2, ECU IG2
18	IP J/B	25 A	Power door lock system
19	STR LOCK	20 A	Starter system
20	RAD NO. 3	15 A	Meters and gauges, navigation system, audio system
21	HAZ	15 A	Emergency flashers
22	ETCS	10 A	Multiport fuel injection system/ sequential multiport fuel injection system
23	RAD NO. 1	10 A	Audio system, navigation system



	Fuse	Ampere	Circuit
24	AM2	7.5 A	Starter system
25	ECU-B NO. 2	7.5 A	Air conditioning system, front passenger occupant classification system, audio system, vehicle dynamics integrated management, power windows, electric power steering system
26	MAYDAY/TEL	7.5 A	MAYDAY/TEL
27	IMMOBI	7.5 A	IMMOBI
28	ABS MAIN NO. 3	15 A	Brake system
29	DRL	7.5 A	Daytime running light system
30	IGN	10 A	Multiport fuel injection system/ sequential multiport fuel injection system
31	DOME	10 A	Vanity mirror lights, luggage compartment lights, interior lights, personal lights, door courtesy lights, footwell lights, scuff lights
32	ECU-B NO. 1	10 A	Tilt and telescopic steering, multiplex communication system, meters and gauges, driving position memory, power seats, power back door, head-up display, starter system, outside rear view mirror, steering sensor, garage door opener
33	EFI NO. 1	10 A	Multiport fuel injection system/ sequential multiport fuel injection system
34	WIP-S	7.5 A	Cruise control

### 4-3. Do-it-yourself maintenance

Fuse		Ampere	Circuit
35	ECU-IG1 NO. 4	10 A	Air conditioning system, rear window defogger, electronically controlled brake system, electric cooling fans
36	BK/UP LP	7.5 A	Back-up lights
37	ECU-IG1 NO. 5	15 A	Air conditioning system
38	ECU-IG1 NO. 6	10 A	Head light cleaner, cruise control, air conditioning system, Blind Spot Monitor
39	EFI NO. 2	10 A	Multiport fuel injection system/ sequential multiport fuel injection system
40	F/PMP	15 A	Multiport fuel injection system/ sequential multiport fuel injection system
41	DEICER	25 A	Windshield wipers and washer
42	STOP	7.5 A	Vehicle Proximity Notification System, vehicle dynamics integrated management, stop lights, multiport fuel injection system/sequential multiport fuel injection system, shift lock control system, starter system, cruise control
43	TOWING BATT	20 A	——
44	TOWING	30 A	Trailer lights
45	FILTER	10 A	——
46	IG1 MAIN	30 A	ECU-IG1 NO. 6, BK/UP LP, ECU-IG1 NO. 5, ECU-IG1 NO. 4
47	H-LP RH HI	15 A	Right-hand headlight (high beam)
48	H-LP LH HI	15 A	Left-hand headlight (high beam)

	Fuse	Ampere	Circuit
49	BIXENON	10 A	—
50	H-LP RH LO	15 A	Right-hand headlight (low beam)
51	H-LP LH LO	15 A	Left-hand headlight (low beam)
52	HORN	10 A	Horn
53	A/F	20 A	Multiport fuel injection system/ sequential multiport fuel injection system
54	S-HORN	7.5 A	S-HORN

#### ■ Engine compartment (type C fuse box)

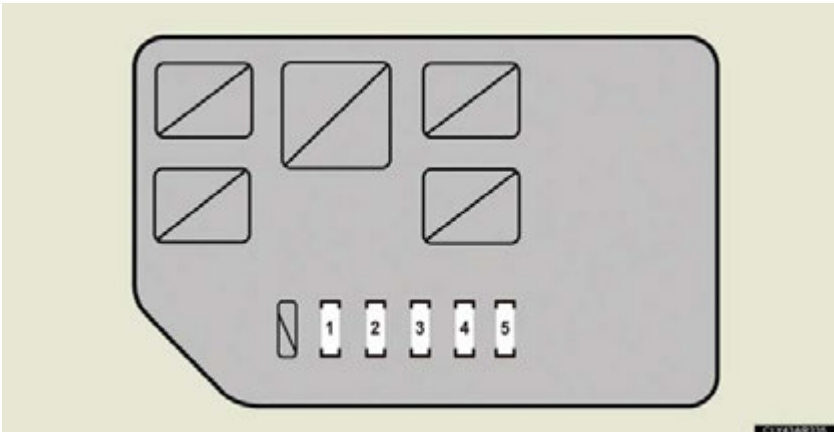

	Fuse	Ampere	Circuit
1	ABS MAIN NO.1	10 A	Brake system
2	ABS MAIN NO.2	10 A	Brake system
3	BATT FAN	15 A	Battery cooling fan
4	OIL PMP	10 A	Hybrid system
5	A/C W/P	10 A	Air conditioning system

■ Driver's side instrument panel

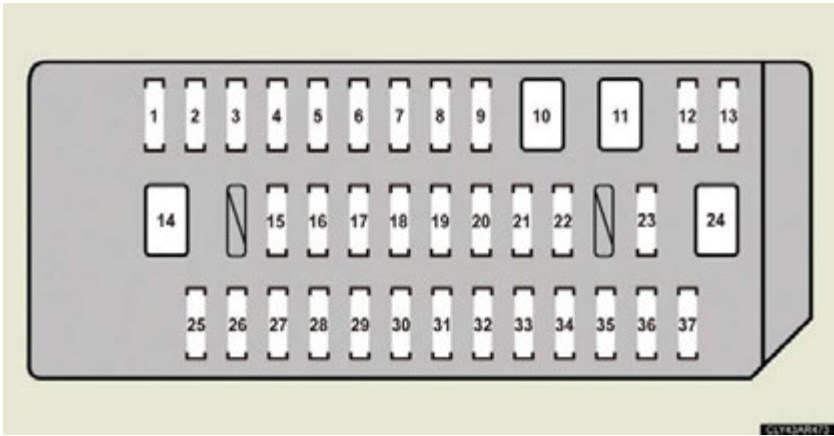

Fuse		Ampere	Circuit
1	P/POINT	15 A	Power outlet
2	ECU-ACC	10 A	Navigation system, air conditioning system, audio system, multiplex communication system, multi-information display, head-up display
3	CIG	15 A	Power outlet
4	RADIO NO.2	7.5 A	Audio system, navigation system
5	GAUGE NO.1	10 A	Emergency flashers, navigation system, head-up display, air conditioning system, Vehicle Proximity Notification System, audio system
6	ECU-IG1 NO.3	10 A	Outside rear view mirror, windshield wipers and washer, seat heaters, starter system, power outlet, moon roof, air conditioning system

Fuse		Ampere	Circuit
7	ECU-IG1NO.1	10 A	Multiplex communication system, steering sensor, shift lock control system, tilt and telescopic steering, power back door, pre-collision system, vehicle dynamics integrated management, tire pressure warning system
8	S/ROOF	30 A	Moon roof
9	FUEL OPN	7.5 A	Fuel filler door opener
10	PSB	30 A	Pre-collision seat belt
11	TI & TE	30 A	Tilt and telescopic steering system
12	DR LOCK	10 A	_____
13	FR FOG	7.5 A	Front fog lights
14	P-SEAT LH	30 A	Power seat (left-side)
15	4WD	7.5 A	AWD system
16	INVERTER	20 A	Power outlet
17	RR FOG	7.5 A	_____
18	D/L ALT B	25 A	Multiplex communication system, power door lock system, power back door
19	EPS	10 A	Electric power steering system
20	ECU-IG1NO.2	10 A	Intuitive parking assist, pre-collision seat belt, capacitor
21	PANEL	10 A	Switch illumination, navigation system, hybrid transmission system, audio system, multi-information display, air conditioning system, multiplex communication system

### 4-3. Do-it-yourself maintenance

Fuse		Ampere	Circuit
22	TAIL	10 A	Parking lights, front side marker lights, tail lights, license plate lights, front fog lights, towing converter
23	AIR SUS	20 A	_____
24	P-SEAT RH	30 A	Power seat (right-side)
25	OBD	7.5 A	On-board diagnosis
26	FR DOOR	25 A	Front power window (right-side), outside rear view mirror
27	RR DOOR	25 A	Rear power window (right-side)
28	FL DOOR	25 A	Front power window (left-side), outside rear view mirror
29	RL DOOR	25 A	Rear power window (left-side)
30	FR WASH	25 A	Windshield wipers and washer
31	RR WIP	15 A	Windshield wipers and washer
32	RR WASH	20 A	Windshield wipers and washer
33	FR WIP	30 A	Windshield wipers and washer
34	ECU IG2	10 A	Multiport fuel injection system/ sequential multiport fuel injection system, front passenger occupant classification system, SRS airbag system, stop lights, electronically controlled brake system, steering lock system, hybrid system
35	GAUGE NO. 2	7.5 A	Gauge and meters
36	RHS-HTR	15 A	Seat heater (right-side)
37	LHS-HTR	15 A	Seat heater (left-side)

### ■ Luggage compartment (type A fuse box)

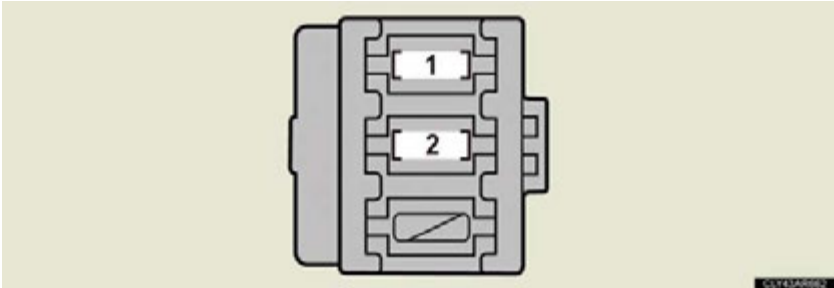

	Fuse	Ampere	Circuit
1	DCDC-S	7.5 A	Hybrid system
2	CAPACITOR	10 A	Capacitor

### ■ Luggage compartment (type B fuse box)



	Fuse	Ampere	Circuit
1	MAIN	180 A	All electrical components
2	RR-B	50 A	CAPACITOR, DCDC-S
3	EPS	80 A	Hybrid system

### ■ After a fuse is replaced

- If the lights do not turn on even after the fuse has been replaced, a bulb may need replacement. (→P. 708)
- If the replaced fuse blows again, have the vehicle inspected by your Lexus dealer.

### ■ If there is an overload in the circuit

The fuses are designed to blow, protecting the wiring harness from damage.

### CAUTION

#### ■ To prevent system breakdowns and vehicle fire

Observe the following precautions.

Failure to do so may cause damage to the vehicle, and possibly a fire or injury.

- Never use a fuse of a higher amperage rating than that indicated, or use any other object in place of a fuse.
- Always use a genuine Lexus fuse or equivalent.  
Never replace a fuse with a wire, even as a temporary fix.
- Do not modify the fuses or fuse boxes.

### NOTICE

#### ■ Before replacing fuses

Have the cause of electrical overload determined and repaired by your Lexus dealer as soon as possible.



## 4-3. Do-it-yourself maintenance

# Headlight aim (vehicles without LED headlights)

### ■ Removing the engine compartment cover

→P. 655

### ■ Vertical movement adjusting bolts

#### ▶ Vehicles with halogen headlights

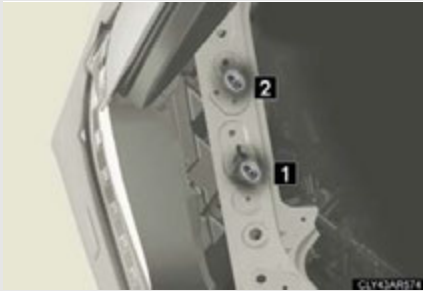

1 Adjustment bolt A

2 Adjustment bolt B

#### ▶ Vehicles with discharge headlights

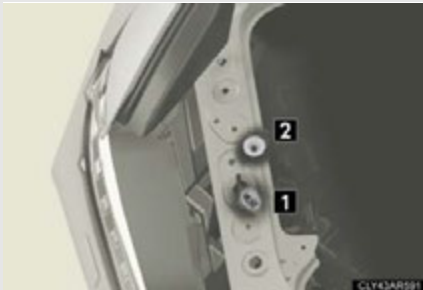

1 Adjustment bolt A

2 Adjustment bolt B

### ■ Before checking the headlight aim

**STEP 1** Make sure the vehicle has a full tank of gas and the area around the headlight is not deformed.

**STEP 2** Park the vehicle on level ground.

**STEP 3** Sit in the driver's seat.

**STEP 4** Bounce the vehicle several times.

## ■ Adjusting the headlight aim

### ► Vehicles with halogen headlights

STEP 1

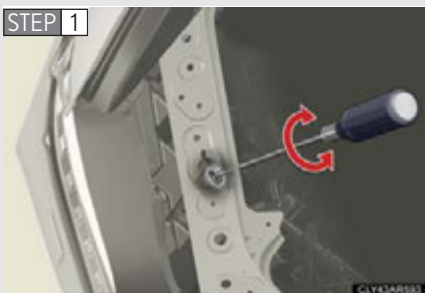

Turn bolt A in either direction using a Phillips-head screwdriver.

Remember the turning direction and the number of turns.

STEP 2

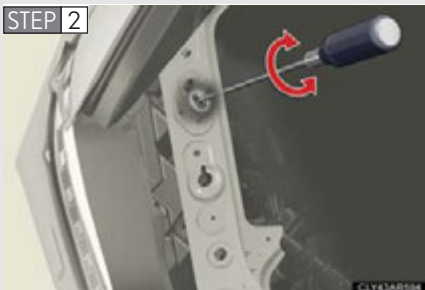

Turn bolt B the same number of turns and in the same direction as in step 1 using a Phillips-head screwdriver.

If the headlight cannot be adjusted using this procedure, take the vehicle to your Lexus dealer to adjust the headlight aim.

► Vehicles with discharge headlights

STEP 1

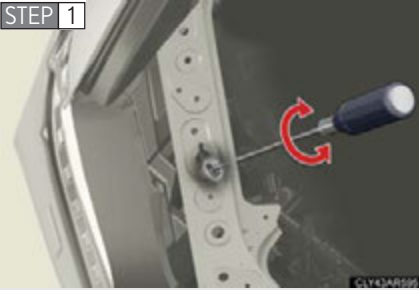

Turn bolt A in either direction using a Phillips-head screwdriver.

Remember the turning direction and the number of turns in mind.

STEP 2

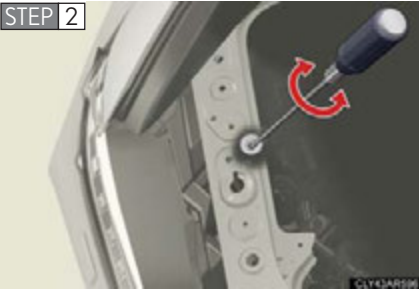

Turn bolt B the same number of turns and in the same direction as step 1 using a Phillips-head screwdriver.

If the headlight cannot be adjusted using this procedure, take the vehicle to your Lexus dealer to adjust the headlight aim.

## 4-3. Do-it-yourself maintenance

### Light bulbs

You may replace the following bulbs by yourself. The difficulty level of replacement varies depending on the bulb. If necessary bulb replacement seems difficult to perform, contact your Lexus dealer.

For more information about replacing other light bulbs, contact your Lexus dealer.

#### ■ Preparing for light bulb replacement

Check the wattage of the light bulb to be replaced. (→P. 809)

#### ■ Removing the engine compartment covers

→P. 655

#### ■ Turning off the power back door main switch

→P. 77

#### ■ Front bulb locations

##### ▶ Vehicles with halogen headlights

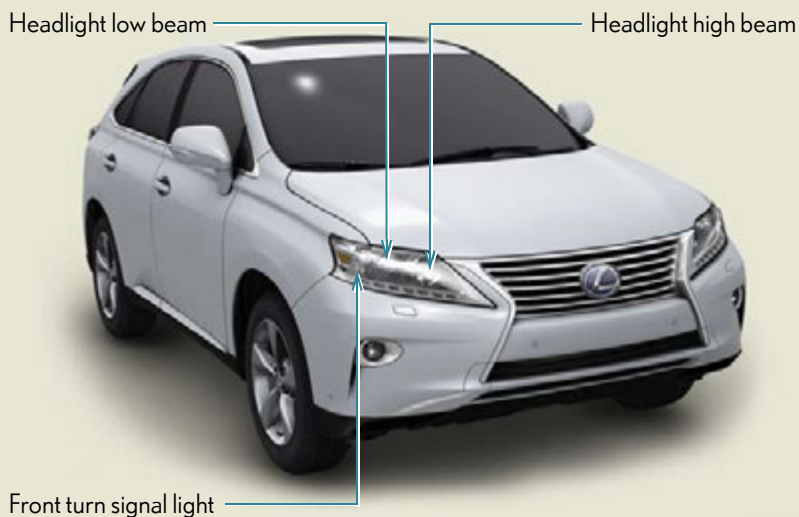

▶ Vehicles with discharge headlights



▶ Vehicles with LED headlights

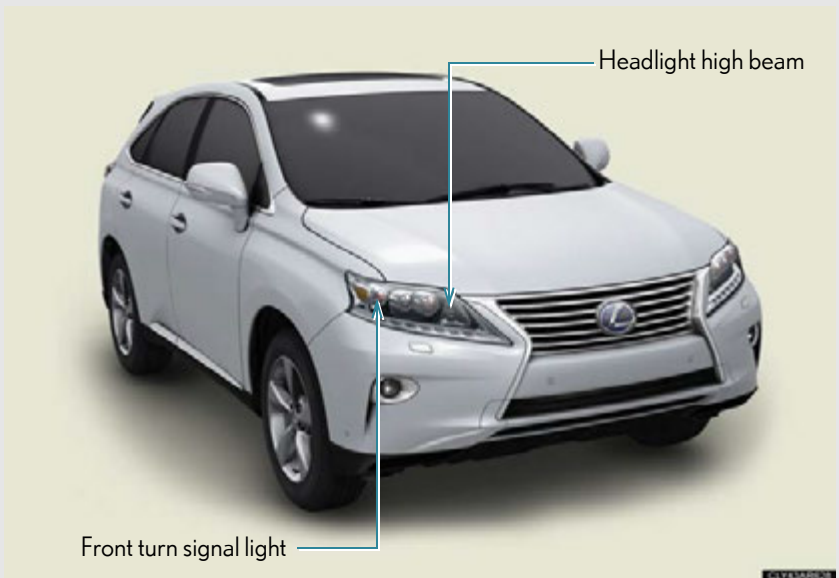

### Rear bulb locations



### Replacing light bulbs

#### Headlight high beams (except vehicles with LED headlights)

STEP 1

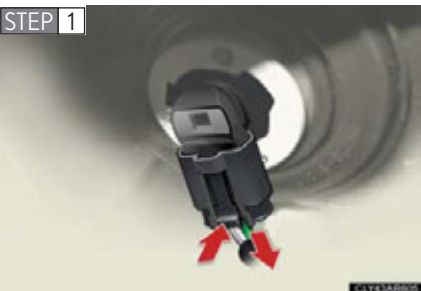

Unplug the connector while depressing the lock release.

STEP 2



Turn the bulb base counterclockwise.

STEP 3



Replace the light bulb, and install the bulb base.

Align the 3 tabs on the light bulb with the mounting, and insert.

STEP 4



- 1 Turn and secure the bulb base.
- 2 Connect the connector.

Shake the bulb base gently to check that it is not loose, turn the headlight high beams on once and visually confirm that no light is leaking through the mounting.

### ■ Headlight high beams (vehicles with LED headlights)

STEP 1



Turn the cover counterclockwise and remove it.

STEP 2



Unplug the connector while pulling the lock release.

STEP 3



Turn the bulb base counterclockwise.

STEP 4



Replace the light bulb, and install the bulb base.

Align the 3 tabs on the light bulb with the mounting, and insert.





- 1 Turn and secure the bulb base.
- 2 Connect the connector.

Shake the bulb base gently to check that it is not loose, turn the headlight high beams on once and visually confirm that no light is leaking through the mounting.

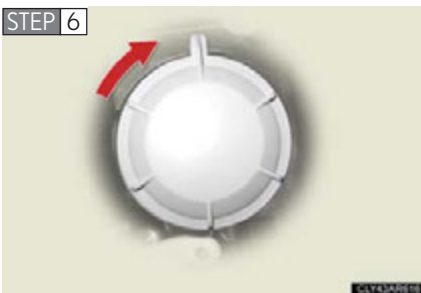

Turn the cover clockwise.

■ Halogen headlight low beams (if equipped)

STEP 1

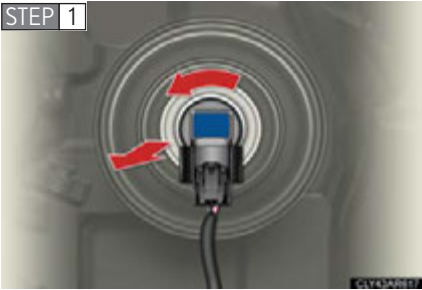

Turn the bulb base counterclockwise.

STEP 2

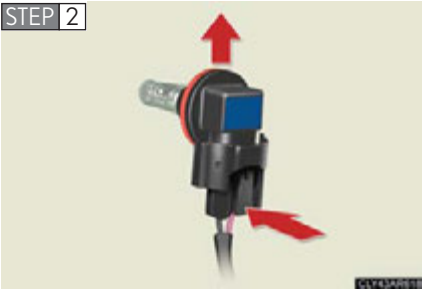

Unplug the connector while depressing the lock release.

STEP 3

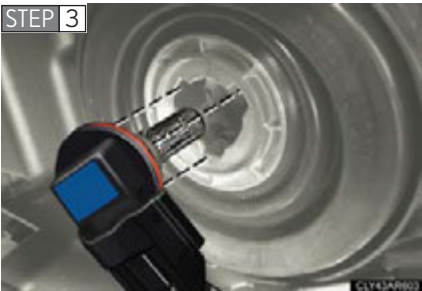

Replace the light bulb, and install the bulb base.

Align the 3 tabs on the light bulb with the mounting, and insert.

STEP 4



Turn and secure the bulb base.

Shake the bulb base gently to check that it is not loose, turn the headlight low beams on once and visually confirm that no light is leaking through the mounting.

## ■ Front turn signal light (left side)

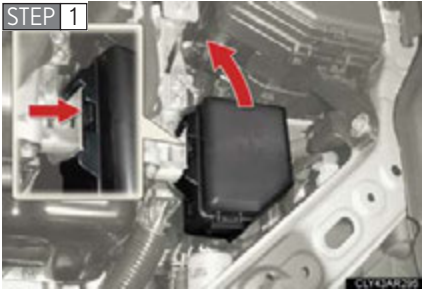

Move the fuse box.

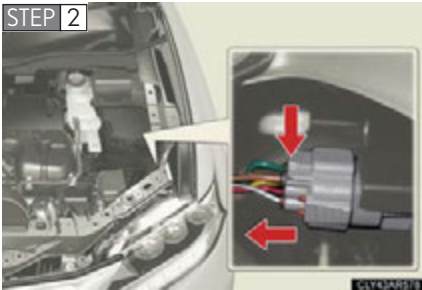

Vehicles with LED headlights:

Unplug the connector while depressing the lock release.



Turn the bulb base counterclockwise.

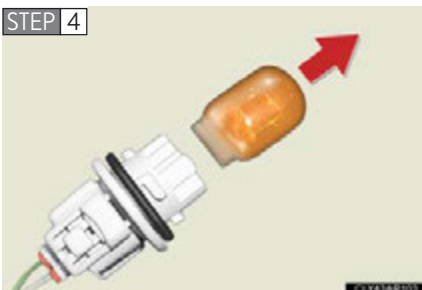

Remove the light bulb.

■ Front turn signal light (right side)



Move the washer fluid filler opening.

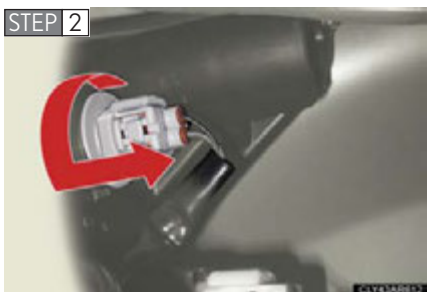

Turn the bulb base counterclockwise.

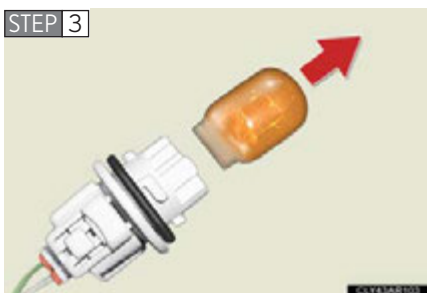

Remove the light bulb.

## ■ Rear turn signal and tail lights

STEP 1



Remove the access hole cover.

Use a flathead screwdriver wrapped in a cloth.

STEP 2

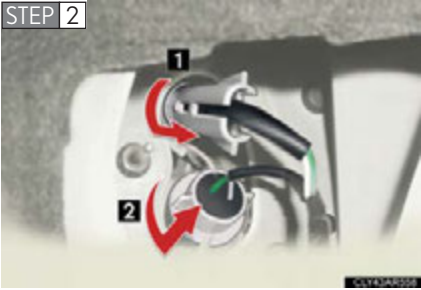

Turn the bulb base counterclockwise.

1 Tail light

2 Rear turn signal light

STEP 3

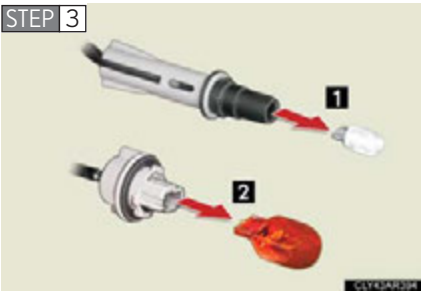

Remove the light bulb.

1 Tail light

2 Rear turn signal light

### ■ Tail and back-up lights

STEP 1

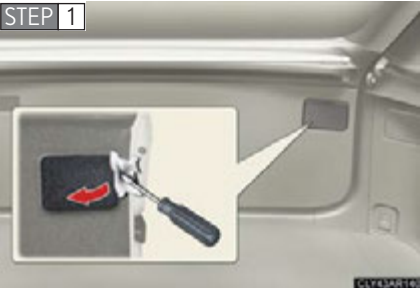

Remove the access hole cover.

Use a flathead screwdriver wrapped in a cloth.

STEP 2

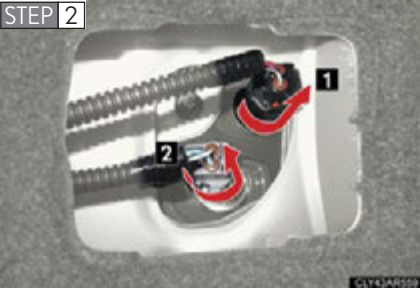

Turn the bulb base counterclockwise.

1 Tail light

2 Back-up light

STEP 3

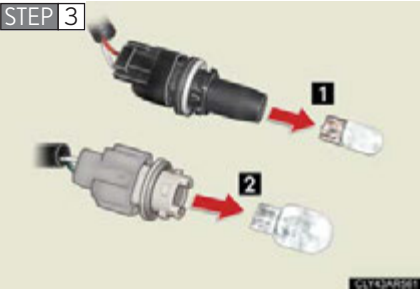

Remove the light bulb.

1 Tail light

2 Back-up light

### ■ Rear side marker light (right side)



Remove the bolts using a Phillips-head screwdriver and remove the clip.

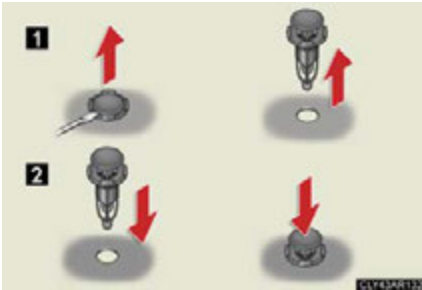

**1** Removing the clip  
**2** Installing the clip



Turn the bulb base counterclockwise.



Remove the light bulb.

### ■ Rear side marker light (left side)

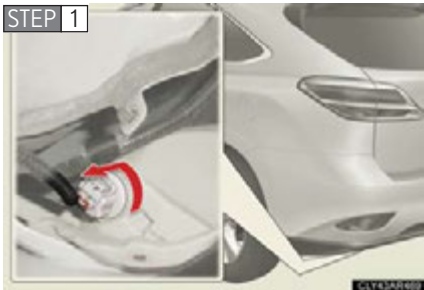

Turn the bulb base counterclockwise.



Remove the light bulb.

### ■ Lights other than the above

If any of the lights listed below has burnt out, have it replaced by your Lexus dealer.

- Discharge headlight low beams (if equipped)
- LED headlight low beams (if equipped)
- Daytime running lights
- Parking lights
- Front side marker lights
- Front fog lights
- Side turn signal lights
- Stop lights
- High mounted stoplight
- License plate lights



### ■ Discharge headlights (if equipped)

If voltage to the discharge bulbs is insufficient, the bulbs may not come on, or may go out temporarily. The discharge bulbs will come on when normal power is restored.

### ■ LED light bulbs

The LED headlight low beams (if equipped), daytime running lights, parking lights, front side marker lights, LED front fog lights (if equipped), side turn signal lights, stop lights, high mounted stoplight and licence plate lights consist of a number of LEDs. If any of the LEDs burn out, take your vehicle to your Lexus dealer to have the light replaced.

### ■ Condensation build-up on the inside of the lens

Temporary condensation build-up on the inside of the headlight lens does not indicate a malfunction. Contact your Lexus dealer for more information in the following situations:

- Large drops of water are built up on the inside of the lens.
- Water has built up inside the headlight.

### CAUTION

#### ■ Replacing light bulbs

- Turn off the lights. Do not attempt to replace the bulb immediately after turning off the lights.  
The bulbs become very hot and may cause burns.
- Do not touch the glass portion of the light bulb with bare hands. When it is unavoidable to hold the glass portion, use and hold with a clean dry cloth to avoid getting moisture and oils on the bulb.  
Also, if the bulb is scratched or dropped, it may blow out or crack.
- Fully install light bulbs and any parts used to secure them. Failure to do so may result in heat damage, fire, or water entering the headlight unit. This may damage the headlights or cause condensation to build up on the lens.

**! CAUTION**



● Vehicles with discharge headlights:

While the low beam headlights are turned on, and for a short time after they have been turned off, metal components at the rear of the headlight assembly will be extremely hot. To prevent burns, do not touch these metal components until you are certain they have cooled down.

■ **Discharge headlights (if equipped)**

- Contact your Lexus dealer before replacing discharge headlights (including light bulbs).
- Do not touch the discharge headlight's high voltage socket when the headlights are turned on.  
An extremely high voltage of 30000 V will be discharged and could result in serious injury or death by electric shock.
- Do not attempt to take apart or repair the low beam discharge headlight bulbs, connectors, power supply circuits, or related components.  
Doing so could result in electric shock and serious injury or death.

■ **To prevent damage or fire**

Make sure bulbs are fully seated and locked.



**5-1. Essential information**

Emergency flashers..... 724  
If your vehicle needs to be  
towed ..... 725  
If you think something is  
wrong ..... 732

**5-2. Steps to take in an  
emergency**

If a warning light turns on  
or a warning buzzer  
sounds... ..... 733  
If a warning message is  
displayed..... 743  
If you have a flat tire..... 764  
If the hybrid system will  
not start ..... 777  
If the shift lever cannot be  
shifted from P ..... 779  
If you lose your keys ..... 780  
If the electronic key does  
not operate properly..... 781  
If the vehicle 12-volt  
battery is discharged ..... 784  
If your vehicle overheats ..... 788  
If the vehicle becomes  
stuck..... 793  
If your vehicle has to  
be stopped in an  
emergency..... 795

## 5-1. Essential information

# Emergency flashers

The emergency flashers are used to warn other drivers when the vehicle has to be stopped in the road due to a breakdown, etc.

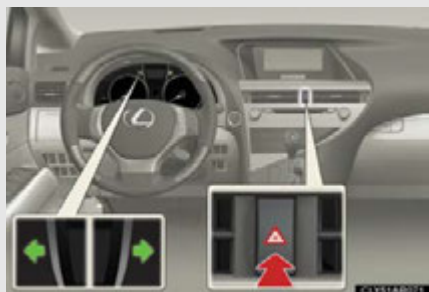

Press the switch.

All the turn signal lights will flash. To turn them off, press the switch once again.

### ■ Emergency flashers

If the emergency flashers are used for a long time while the hybrid system is not operating (while the "READY" indicator is not illuminated), the 12-volt battery may discharge.

## 5-1. Essential information

### If your vehicle needs to be towed

If towing is necessary, we recommend having your vehicle towed by your Lexus dealer or a commercial towing service, using a lift-type truck or a flatbed truck.

Use a safety chain system for all towing, and abide by all state/provincial and local laws.

2WD models: If towing your vehicle with a wheel-lift type truck from the front, the vehicle's rear wheels and axles must be in good conditions.

(→P. 726, 730)

If they are damaged, use a towing dolly or flatbed truck.

AWD models: If towing your vehicle with a wheel-lift type truck, use a towing dolly. (→P. 726, 730)

#### Situations needs to contact dealers before towing

The following may indicate a problem with your transmission. Contact your Lexus dealer before towing.

- A warning message for the hybrid system is shown on the multi-information display and the vehicle does not move.
- The vehicle makes an abnormal sound.

### Towing with a sling-type truck



Do not tow with a sling-type truck to prevent body damage.

### Towing with a wheel-lift type truck

- ▶ From the front (2WD models)

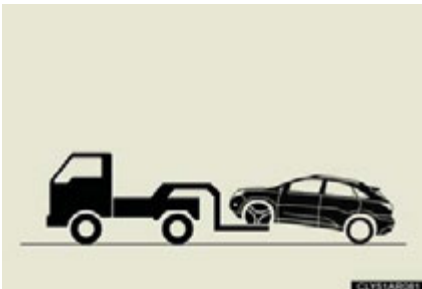

Release the parking brake.

- ▶ From the front (AWD models)

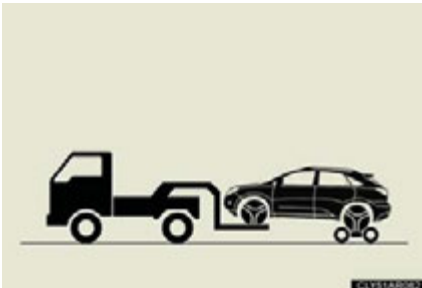

Use a towing dolly under the rear wheels.

► From the rear

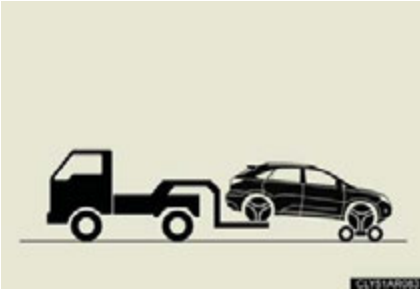

Use a towing dolly under the front wheels.

### Using a flatbed truck

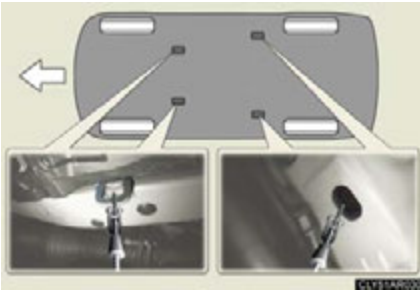

If your Lexus is transported by a flatbed truck, it should be tied down at the locations shown in the illustration.

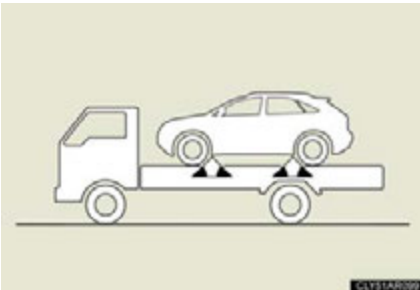

If you use chains or cables to tie down your vehicle, the angles shaded in black must be 45°.

Do not overly tighten the tie downs or the vehicle may be damaged.



## Emergency towing

If a tow truck is not available in an emergency, your vehicle may be temporarily towed using a cable or chain secured to the emergency towing eyelet. This should only be attempted on hard surfaced roads for short distance at under 18 mph (30 km/h).

A driver must be in the vehicle to steer and operate the brakes. The vehicle's wheels, drive train, axles, steering and brakes must be in good condition.

## Emergency towing procedure

**STEP 1** Take out the towing eyelet. (→P. 764)

► Type A

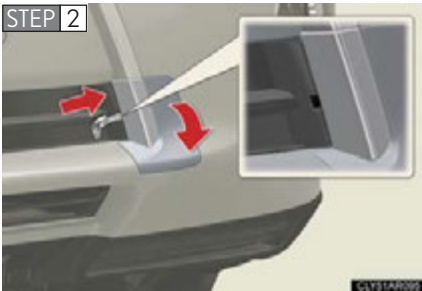

Insert the mechanical key (→P. 52) into the groove and release the claws. With the mechanical key inserted, remove the eyelet cover by pulling it towards you.

## ► Type B

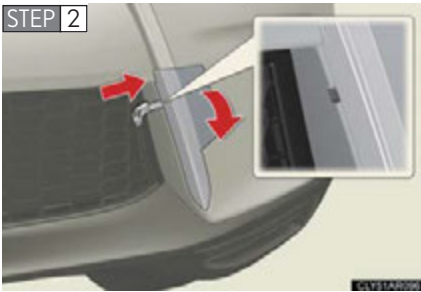

Insert the mechanical key (→P. 52) into the groove and release the claws. With the mechanical key inserted, remove the eyelet cover by pulling it towards you.

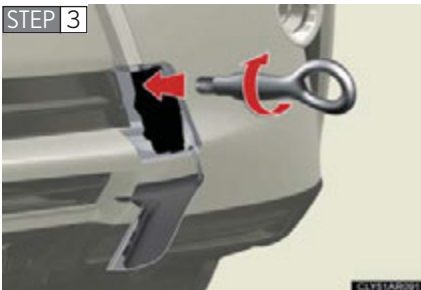

Insert the towing eyelet into the hole and tighten as much as possible by hand.

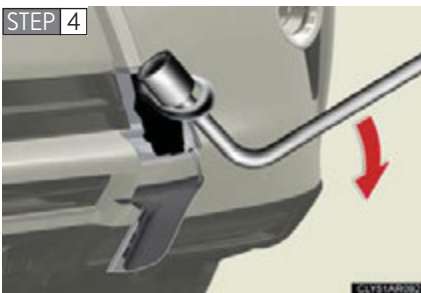

Using the tip of the wheel nut wrench, tighten down the towing eyelet securely without interfering with the bumper.

**STEP 5** Securely attach a cable or chain to the towing eyelet.  
Take care not to damage the vehicle body.

**STEP 6** Enter the vehicle being towed and start the hybrid system.  
If the hybrid system does not start, turn the "POWER" switch to ON mode.

**STEP 7** Shift the shift lever to N and release the parking brake.  
When the shift lever cannot be shifted: →P. 779

■ **While towing**

If the hybrid system is off, the power assist for the brakes and steering will not function, making steering and braking more difficult.

■ **Wheel nut wrench**

Wheel nut wrench is installed in the luggage compartment. (→P. 764)

**⚠ CAUTION**

Observe the following precautions.

Failure to do so may result in death or serious injury.

■ **When towing the vehicle**

▶ 2WD models



Be sure to transport the vehicle with the front wheels raised or with all four wheels raised off the ground. If the vehicle is towed with the front wheels contacting the ground, the drivetrain and related parts may be damaged or electricity generated by the operation of the motor may cause a fire to occur depending on the nature of the damage or malfunction.

▶ AWD models



Be sure to transport the vehicle with all four wheels raised off the ground. If the vehicle is towed with the tires contacting the ground, the drivetrain or related parts may be damaged, the vehicle may fly off the truck, or electricity generated by the operation of the motor may cause a fire to occur depending on the nature of the damage or malfunction.

## ⚠ CAUTION

### ■ While towing

- When towing using a rope, avoid sudden starts, etc. which place excessive stress on the towing hook and rope.  
The towing hook or rope may become damaged, broken debris may hit people and cause serious damage.
- Do not turn the "POWER" switch off.  
There is a possibility that the steering wheel is locked and can not be operated.

### ■ Installing towing eyelet to the vehicle

Make sure that towing eyelet is installed securely.  
If not securely installed, towing eyelet may come loose during towing.

## ⚠ NOTICE

### ■ To prevent damage to the vehicle when towing using a wheel-lift type truck

When raising the vehicle, ensure adequate ground clearance for towing at the opposite end of the raised vehicle. Without adequate clearance, the vehicle could be damaged while being towed.

### ■ To prevent body damage when towing with a sling-type truck

Do not tow with a sling-type truck, either from the front or rear.

### ■ Recreational towing (behind motor home, etc.)



Never dinghy tow your vehicle to prevent causing serious damage to the AWD system (AWD models) and transmission. (→P. 324)

## 5-1. Essential information

### If you think something is wrong

If you notice any of the following symptoms, your vehicle probably needs adjustment or repair. Contact your Lexus dealer as soon as possible.

#### ■ Visible symptoms

- Fluid leaks under the vehicle.  
(Water dripping from the air conditioning after use is normal.)
- Flat-looking tires or uneven tire wear
- Engine coolant temperature gauge needle continually points higher than normal.

#### ■ Audible symptoms

- Changes in exhaust sound
- Excessive tire squeal when cornering
- Strange noises related to the suspension system
- Pinging or other noises related to the hybrid system

#### ■ Operational symptoms

- Engine missing, stumbling or running rough
- Appreciable loss of power
- Vehicle pulls heavily to one side when braking.
- Vehicle pulls heavily to one side when driving on a level road.
- Loss of brake effectiveness, spongy feeling, pedal almost touches the floor



## 5-2. Steps to take in an emergency

### If a warning light turns on or a warning buzzer sounds...

Calmly perform the following actions if any of the warning lights comes on or flashes. If a light comes on or flashes, but then goes off, this does not necessarily indicate a malfunction in the system.

**Stop the vehicle immediately. Continuing to drive the vehicle may be dangerous.**

The following warning indicates a possible problem in the brake system. Immediately stop the vehicle in a safe place and contact your Lexus dealer.

Warning light	Warning light/Details
 (U.S.A.)  (Canada)	<b>Brake system warning light (warning buzzer)*</b> <ul style="list-style-type: none"><li>• Low brake fluid</li><li>• Malfunction in the brake system</li></ul> This light also comes on when the parking brake is not released. If the light turns off after the parking brake is fully released the system is operating normally.

\*: Parking brake engaged warning buzzer

→P. 748







**Stop the vehicle immediately.**



The following warning indicates the possibility of damage to the vehicle that may lead to an accident. Immediately stop the vehicle in a safe place and contact your Lexus dealer.

Warning light	Warning light/Details
	<b>Charging system warning light</b> Indicates a malfunction in the vehicle's charging system

**Have the vehicle inspected immediately.**

Failing to investigate the cause of the following warnings may lead to the system operating abnormally and possibly cause an accident. Have the vehicle inspected by your Lexus dealer immediately.

Warning light	Warning light/Details
 (U.S.A.)  (Canada)	<p><b>Malfunction indicator lamp</b></p> <p>Indicates a malfunction in:</p> <ul style="list-style-type: none"> <li>• The hybrid system;</li> <li>• The electronic engine control system;</li> <li>• The electronic throttle control system; or</li> <li>• The emission control system</li> </ul>
	<p><b>SRS warning light</b></p> <p>Indicates a malfunction in:</p> <ul style="list-style-type: none"> <li>• The SRS airbag system;</li> <li>• The front passenger occupant classification system; or</li> <li>• The seat belt pretensioner system</li> </ul>
 (U.S.A.)  (Canada)	<p><b>ABS warning light</b></p> <p>Indicates a malfunction in:</p> <ul style="list-style-type: none"> <li>• The ABS; or</li> <li>• The brake assist system</li> </ul>
	<p><b>Brake system warning light</b></p> <p>Indicates a malfunction in:</p> <ul style="list-style-type: none"> <li>• The regenerative brake system; or</li> <li>• The electronically controlled brake system</li> </ul>
	<p><b>Electric power steering system warning light (warning buzzer)</b></p> <p>Indicates a malfunction in the EPS (Electric Power Steering) system</p>

Warning light	Warning light/Details
 <p data-bbox="153 464 256 493">(Flashes)</p>	<p data-bbox="328 258 852 289"><b>Pre-collision system warning light (if equipped)</b></p> <p data-bbox="343 297 880 328">Indicates a malfunction in the pre-collision system</p> <p data-bbox="343 336 990 399">The warning light will operate as follows, even when the system is not malfunctioning:</p> <ul data-bbox="343 407 979 623" style="list-style-type: none"> <li data-bbox="343 407 958 470">• The light will flash quickly when the system is operating. (→P. 278)</li> <li data-bbox="343 479 979 542">• The light will turn on when the pre-collision braking is disabled. (→P. 279)</li> <li data-bbox="343 550 979 623">• The light will turn on when the system cannot temporarily be used. (→P. 748)</li> </ul>
	<p data-bbox="328 647 479 678"><b>Slip indicator</b></p> <p data-bbox="328 686 610 717">Indicates a malfunction in:</p> <ul data-bbox="328 725 706 821" style="list-style-type: none"> <li data-bbox="328 725 533 756">• The VSC system;</li> <li data-bbox="328 764 575 795">• The TRAC system; or</li> <li data-bbox="328 803 706 834">• The hill-start assist control system</li> </ul>



**Follow the correction procedures.**

After taking the specified steps to correct the suspected problem, check that the warning light goes off.

Warning light	Warning light/Details	Correction procedure
	<p><b>Open door warning light (warning buzzer)*<sup>1</sup></b>                      Indicates that one or more of the doors is not fully closed.</p>	<p>Check that all the doors are closed.</p>
	<p><b>Low fuel level warning light</b>                      Indicates remaining fuel is approximately 2.7 gal. (10.1 L, 2.2 Imp. gal.) or less</p>	<p>Refuel the vehicle.</p>
 <p>(On the instrument panel)</p>	<p><b>Driver's seat belt reminder light (warning buzzer)*<sup>2</sup></b>                      Warns the driver to fasten his/her seat belt.</p>	<p>Fasten the seat belt.</p>
 <p>(On the center panel)</p>	<p><b>Front passenger's seat belt reminder light (warning buzzer)*<sup>2</sup></b>                      Warns the front passenger to fasten his/her seat belt.</p>	<p>Fasten the seat belt.</p>
	<p><b>Master warning light</b>                      A buzzer sounds and the warning light comes on and flashes to indicate that the master warning system has detected a malfunction.</p>	<p>→P. 743</p>

Warning light	Warning light/Details	Correction procedure
	<b>Tire pressure warning light</b>	
	When the light comes on: Low tire inflation pressure such as <ul style="list-style-type: none"> <li>• Natural causes (→P. 739)</li> <li>• Flat tire (→P. 764)</li> </ul>	Adjust the tire inflation pressure (including the full-size spare tire) to the specified level.  The light will turn off after a few minutes. In case the light does not turn off even if the tire inflation pressure is adjusted, have the system checked by your Lexus dealer.
	When the light comes on after blinking for 1 minute: Malfunction in the tire pressure warning system (→P. 740)	Have the system checked by your Lexus dealer.

\*1: Open door warning buzzer:

The open door warning buzzer sounds to alert one or more of the doors is not fully closed (with the vehicle having reached a speed of 3 mph [5 km/h]). (→P. 748)

\*2: Driver's and front passenger's seat belt buzzer:

The driver's and front passenger's seat belt buzzer sounds to alert the driver and front passenger that his or her seat belt is not fastened. The buzzer sounds intermittently for 10 seconds after the vehicle reaches a speed of 12 mph (20 km/h). Then, if the seat belt is still unfastened, the buzzer will sound in a different tone for 20 more seconds.

### ■ If the malfunction indicator lamp comes on while driving

First check the following:

- Is the fuel tank empty?  
If it is, fill the fuel tank immediately.
- Is the fuel tank cap loose?  
If it is, tighten it securely.

The lamp will go off after several driving trips.

If the light does not go off even after several trips, contact your Lexus dealer as soon as possible.

### ■ SRS warning light

This warning light system monitors the airbag sensor assembly, front airbag sensors, side and curtain shield airbag sensors, curtain shield and rear side airbag sensors, door sensors, driver's seat position sensor, driver's seat belt buckle switch, front passenger occupant classification system (ECU and sensors), "AIR BAG ON" indicator light, "AIR BAG OFF" indicator light, front passenger's seat belt buckle switch, seat belt pretensioner assemblies, inflators, interconnecting wiring and power sources. (→P. 132)

### ■ Front passenger detection sensor, passenger seat belt reminder and warning buzzer

- If luggage is placed on the front passenger seat, the front passenger detection sensor may cause the warning light to flash and the warning buzzer to sound even if a passenger is not sitting in the seat.
- If a cushion is placed on the seat, the sensor may not detect a passenger, and the warning light may not operate properly.

### ■ Electric power steering system warning light (warning buzzer)

When the 12-volt battery charge becomes insufficient or the voltage temporarily drops, the electric power steering system warning light may come on and the warning buzzer may sound.

### ■ When the tire pressure warning light comes on

Check the tire inflation pressure and adjust to the appropriate level. Pushing the tire pressure warning reset switch will not turn off the tire pressure warning light.

### ■ The tire pressure warning light may come on due to natural causes

The tire pressure warning light may come on due to natural causes such as natural air leaks and tire inflation pressure changes caused by temperature. In this case, adjusting the tire inflation pressure will turn off the warning light (after a few minutes).

### ■ When a tire is replaced with a spare tire

#### ▶ Vehicles with a compact spare tire

The compact spare tire is not equipped with a tire pressure warning valve and transmitter. If a tire goes flat, the tire pressure warning light will not turn off even though the flat tire has been replaced with the spare tire. Replace the spare tire with the repaired tire and adjust the tire inflation pressure. The tire pressure warning light will go off after a few minutes.

#### ▶ Vehicles with a full-size spare tire

The spare tire is also equipped with the tire pressure warning valve and transmitter. The tire pressure warning light will turn on if the tire inflation pressure of the spare tire is low. If a tire goes flat, even though the flat tire is replaced with the spare tire, the tire pressure warning light does not turn off. Replace the spare tire with the repaired tire and adjust to the proper tire inflation pressure. The tire pressure warning light will turn off after a few minutes.

### ■ If the tire pressure warning system is not functioning

The tire pressure warning system will be disabled in the following conditions:  
(When the condition becomes normal, the system will work properly.)

- If tires not equipped with tire pressure warning valves and transmitters are used
- If the ID code on the tire pressure warning valves and transmitters is not registered in the tire pressure warning computer

- If the tire inflation pressure is 73 psi (500 kPa, 5.1 kgf/cm<sup>2</sup> or bar) or higher

The tire pressure warning system may be disabled in the following conditions:  
(When the condition becomes normal, the system will work properly.)

- If electronic devices or facilities using similar radio wave frequencies are nearby
- If a radio set at similar frequencies is in use in the vehicle
- If a window tint that affects the radio wave signals is installed
- If there is a lot of snow or ice on the vehicle, in particular around the wheels or wheel housings

## 5-2. Steps to take in an emergency

- If non-genuine Lexus wheels are used (Even if you use Lexus wheels, the tire pressure warning system may not work properly with some types of tires.)
- If tire chains are used
- Vehicles with a full-size spare tire: If the spare tire is in a location subject to poor radio wave signal reception
- Vehicles with a full-size spare tire: If a large metallic object which can interfere with signal reception is put in the luggage compartment

### ■ If the tire pressure warning light frequently comes on after blinking for 1 minute

If the tire pressure warning light frequently comes on after blinking for 1 minute when the "POWER" switch is turned to ON mode, have it checked by your Lexus dealer.

### ■ Customization

The vehicle speed linked seat belt reminder buzzer can be disabled.  
(Customizable features →P. 825)

## CAUTION

### ■ When the electric power steering system warning light comes on

The steering wheel may become extremely heavy.

If the steering wheel becomes heavier than usual when operating, hold firmly and operate using more force than usual.

### ■ If the tire pressure warning light comes on

Be sure to observe the following precautions. Failure to do so could cause loss of vehicle control and result in death or serious injury.

- Stop your vehicle in a safe place as soon as possible. Adjust the tire inflation pressure immediately.
- If the tire pressure warning light comes on even after tire inflation pressure adjustment, it is probable that you have a flat tire. Check the tires. If a tire is flat, change it with the spare tire and have the flat tire repaired by the nearest Lexus dealer.
- Avoid abrupt maneuvering and braking. If the vehicle tires deteriorate, you could lose control of the steering wheel or the brakes.

### ■ If a blowout or sudden air leakage should occur

The tire pressure warning system may not activate immediately.

 **CAUTION****■ Maintenance of the tires**

Each tire, including the spare (if provided), should be checked monthly when cold and inflated to the inflation pressure recommended by the vehicle manufacturer on the vehicle placard or tire inflation pressure label (tire and load information label). (If your vehicle has tires of a different size than the size indicated on the vehicle placard or tire inflation pressure label [tire and load information label], you should determine the proper tire inflation pressure for those tires.)

As an added safety feature, your vehicle has been equipped with a tire pressure monitoring system (TPMS-tire pressure warning system) that illuminates a low tire pressure telltale (tire pressure warning light) when one or more of your tires is significantly under-inflated. Accordingly, when the low tire pressure telltale (tire pressure warning light) illuminates, you should stop and check your tires as soon as possible, and inflate them to the proper pressure. Driving on a significantly under-inflated tire causes the tire to overheat and can lead to tire failure. Under-inflation also reduces fuel efficiency and tire tread life, and may affect the vehicle's handling and stopping ability.

Please note that the TPMS (tire pressure warning system) is not a substitute for proper tire maintenance, and it is the driver's responsibility to maintain correct tire pressure, even if under-inflation has not reached the level to trigger illumination of the TPMS low tire pressure telltale (tire pressure warning light).

Your vehicle has also been equipped with a TPMS (tire pressure warning system) malfunction indicator to indicate when the system is not operating properly. The TPMS (tire pressure warning system) malfunction indicator is combined with the low tire pressure telltale (tire pressure warning light). When the system detects a malfunction, the telltale will flash for approximately one minute and then remain continuously illuminated. This sequence will continue upon subsequent vehicle start-ups as long as the malfunction exists. When the malfunction indicator is illuminated, the system may not be able to detect or signal low tire pressure as intended.

TPMS (tire pressure warning system) malfunctions may occur for a variety of reasons, including the installation of replacement or alternate tires or wheels on the vehicle that prevent the TPMS (tire pressure warning system) from functioning properly. Always check the TPMS (tire pressure warning system) malfunction telltale after replacing one or more tires or wheels on your vehicle to ensure that the replacement or alternate tires and wheels allow the TPMS (tire pressure warning system) to continue to function properly.

 NOTICE

■ **To ensure the tire pressure warning system operates properly**

Do not install tires with different specifications or makers, as the tire pressure warning system may not operate properly.

## 5-2. Steps to take in an emergency

### If a warning message is displayed

If a warning is shown on the multi-information display, stay calm and perform the following actions:



#### 1 Master warning light





The master warning light also comes on or flashes in order to indicate that a message is currently being displayed on the multi-information display.

#### 2 Multi-information display

If any of the warning lights comes on again after the following actions have been performed, contact your Lexus dealer.

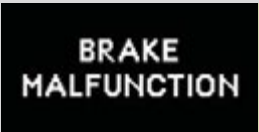
**Stop the vehicle immediately. Continuing to drive the vehicle may be dangerous.**

The following warning indicates a possible problem in the brake system. Immediately stop the vehicle in a safe place and contact your Lexus dealer.

Warning message	Details
  (U.S.A.)  (Canada)	<b>Indicates the following:</b> <ul style="list-style-type: none"><li>• The brake fluid level is low; or,</li><li>• The brake system is malfunctioning.</li></ul> A buzzer also sounds.
 	<b>Indicates a malfunction in:</b> <ul style="list-style-type: none"><li>• The regenerative brake system; or,</li><li>• The electronically controlled brake system</li></ul> A buzzer also sounds.











**Stop the vehicle immediately.**





A buzzer sounds and a warning message is shown on the multi-information display. The following warning indicates the possibility of damage to the vehicle that may lead to an accident. Immediately stop the vehicle in a safe place and contact your Lexus dealer.



Warning message	Details
<div data-bbox="79 516 338 646" data-label="Image"> </div> <div data-bbox="160 651 253 683" data-label="Text"> <p>(U.S.A.)</p> </div> <div data-bbox="79 699 338 829" data-label="Image"> </div> <div data-bbox="152 834 261 867" data-label="Text"> <p>(Canada)</p> </div> <div data-bbox="79 883 174 948" data-label="Image"> </div>	<p><b>Indicates abnormal engine oil pressure</b>                      The warning light may come on if the engine oil pressure is too low.</p>
<div data-bbox="79 976 338 1105" data-label="Image"> </div> <div data-bbox="79 1122 174 1187" data-label="Image"> </div>	<p><b>Indicates a malfunction in the hybrid system</b></p>

### Have the vehicle inspected by your Lexus dealer immediately.

A buzzer sounds and a warning message is shown on the multi-information display. Failure to investigate the cause of the following warnings may lead to the system operating abnormally and possibly cause an accident. Have the vehicle inspected by your Lexus dealer immediately.



Warning message	Details
  (AWD models)	Indicates a malfunction in the AWD system
 	Indicates a malfunction in the steering lock system
  (Flashes) (If equipped)	Indicates a malfunction in the LED headlight system
 	Indicates a malfunction in the brake lights system

Warning message	Details
<p><b>CHECK PCS SYSTEM</b></p> <p><b>PCS</b> (Flashes)</p>  <p>(If equipped)</p>	<p>Indicates a malfunction in the pre-collision system</p>
 <p><b>CHECK SONAR</b></p>  <p>(If equipped)</p>	<p>Indicates a malfunction in the intuitive parking assist The malfunctioning assist-sensor is flashing.</p>
<p><b>CHECK CRUISE CONTROL SYSTEM</b></p> 	<p>Indicates a malfunction in the cruise control system or the radar cruise control system (If equipped) Press the “ON-OFF” button once to deactivate the system, and then press the button again to reactivate the system.</p>
<p><b>CHECK HEADLIGHT LEVELING SYSTEM</b></p>  <p>(If equipped)</p>	<p>Indicates a malfunction in the automatic headlight leveling system</p>

Warning message	Details
<p><b>CHECK SRS SYSTEM AIRBAG</b></p> 	<p><b>Indicates a malfunction in:</b></p> <ul style="list-style-type: none"> <li>• The SRS airbag system;</li> <li>• The front passenger occupant classification system;</li> <li>or,</li> <li>• The seat belt pretensioner system</li> </ul>
<p><b>CHECK ABS</b></p>	<p><b>Indicates a malfunction in:</b></p> <ul style="list-style-type: none"> <li>• The ABS; or,</li> <li>• The brake assist system</li> </ul>
<p><b>CHECK POWER STEERING SYSTEM</b></p> 	<p>Indicates a malfunction in the EPS (Electric Power Steering) system</p>
<p><b>CHECK BSM SYSTEM</b></p>  <p>(If equipped)</p>	<p>Indicates a malfunction in the Blind Spot Monitor.</p>

**Follow the correction procedures.**

A buzzer sounds and a warning message is shown on the multi-information display. After taking the specified steps to correct the suspected problem, check that the warning message goes off.

Warning message	Details	Correction procedure
	<p><b>Indicates that one or more of the doors is not fully closed</b></p> <p>The system also indicates which doors are not fully closed.</p> <p>If the vehicle reaches a speed of 3 mph (5 km/h), a buzzer sounds to indicate that the door(s) are not yet fully closed.</p>	<p>Make sure that all the doors are closed.</p>
	<p><b>Indicates that the hood is not fully closed</b></p> <p>If the vehicle reaches a speed of 3 mph (5 km/h), a buzzer sounds to indicate that the hood is not yet fully closed.</p>	<p>Close the hood.</p>





Warning message	Details	Correction procedure
	<p><b>Indicates that the back door is not fully closed</b></p> <p>If the vehicle reaches a speed of 3 mph (5 km/h), a buzzer sounds to indicate that the back door is not yet fully closed.</p>	<p>Close the back door.</p>
<p><b>MOONROOF OPENED</b></p>  (Flashes) (If equipped)	<p><b>Indicates that the moon roof is not fully closed (with the "POWER" switch off, and the driver's door open)</b></p>	<p>Close the moon roof.</p>
<p><b>RELEASE PARKING BRAKE</b></p>	<p><b>Indicates that the parking brake is still engaged</b></p> <p>If the vehicle reaches a speed of 3 mph (5 km/h),  flashes and a buzzer sounds to indicate that the parking brake is still engaged.</p>	<p>Release the parking brake.</p>
<p><b>LOW WASHER FLUID</b></p>	<p><b>Indicates that the washer fluid level is low</b></p>	<p>Add washer fluid.</p>

Warning message	Details	Correction procedure
<p><b>MAINTENANCE REQUIRED SOON</b></p> <p>(U.S.A. only)</p>	<p>Indicates that all maintenance according to the driven distance on the maintenance schedule* should be performed soon.</p> <p>Comes on approximately 4500 miles (7200 km) after the maintenance data has been reset.</p>	<p>If necessary, perform maintenance.</p>
<p><b>MAINTENANCE REQUIRED</b></p> <p>(U.S.A. only)</p>	<p>Indicates that all maintenance is required to correspond to the driven distance on the maintenance schedule*.</p> <p>Comes on approximately 5000 miles (8000 km) after the maintenance data has been reset. (The indicator will not work properly unless the maintenance data has been reset.)</p>	<p>Perform the necessary maintenance. Please reset the maintenance data after the maintenance is performed. (→P. 641)</p>

Warning message	Details	Correction procedure
  (If equipped)	<p><b>Indicates that the pre-collision system is not currently functional because the grille or the sensor is dirty.</b></p> <p>This message also appears when the pre-collision system is not functional due to overheating.</p>	<ul style="list-style-type: none"> <li>• Check the grille and the sensor and clean them if they are dirty.</li> <li>• In case of overheating, the system will become functional once the system cools down.</li> </ul>
  (If equipped)	<p><b>Indicates that intuitive parking assist is dirty or covered with ice</b></p> <p>A buzzer also sounds. The site of the malfunction and the vehicle image are flashing.</p>	<p>Clean the sensor.</p>
  (If equipped)	<p><b>Indicates that the radar cruise control sensor is dirty or covered with ice</b></p> <p>A buzzer also sounds.</p>	<p>Clean the sensor.</p>
  (If equipped)	<p><b>Indicates that the radar cruise control system is unable to judge vehicle-to-vehicle distance</b></p> <p>A buzzer also sounds.</p>	<ul style="list-style-type: none"> <li>• Switch driving mode to normal.</li> <li>• If the windshield wipers are on, turn them off or set them to a mode other than AUTO (If equipped) or high speed wiper operation.</li> </ul>



Warning message	Details	Correction procedure
 <p><b>PCS</b> (Flashes) (If equipped)</p>	<p><b>Indicates that there is a high possibility of a frontal collision, or that the pre-collision braking function is operating</b> A buzzer also sounds. At the same time,  will appear on the head-up display (the image flashes).</p>	<p>Slow the vehicle by applying the brakes.</p>
 <p>(Flashes) (If equipped)</p>	<p><b>Indicates that your vehicle is nearing the vehicle ahead (in radar cruise mode)</b> A buzzer also sounds. At the same time,  will appear on the head-up display (the image flashes).</p>	<p>Slow the vehicle by applying the brakes.</p>
 	<p><b>Indicates that the engine has overheated</b> A buzzer also sounds.</p>	<p>Stop and check. (→P. 788)</p>

Warning message	Details	Correction procedure
 	<p><b>Indicates that the hybrid system has overheated</b></p> <p>A buzzer also sounds. This message may be displayed when driving under severe operating conditions. (For example, when driving up a long steep hill.)</p>	<p>Stop and check. (→P. 788)</p>
  (Flashes)	<p><b>Indicates that the hybrid battery (traction battery) is low.</b></p>	<ul style="list-style-type: none"> <li>• If a buzzer sounds intermittently, stop the vehicle in a safe place and shift the shift lever to P to charge the hybrid battery (traction battery).</li> <li>• If a buzzer sounds continuously, immediately stop the vehicle in a safe place. Turn the “POWER” switch off and then to ON mode to restart the hybrid system. Ensuring the shift lever is in P, charge the hybrid battery (traction battery).</li> </ul>
	<p><b>Indicates that remaining fuel is approximately 2.7 gal. (10.1 L, 2.2 Imp. gal.) or less</b></p>	<p>Refuel the vehicle.</p>





## 5-2. Steps to take in an emergency

Warning message	Details	Correction procedure
  (Flashes)	Indicates that the “POWER” switch is turned off or turned to ACCESSORY mode and the driver’s door is opened while the lights are turned on.	Turn the lights off.
  (Flashes)	Indicates that the driver’s door is opened when the hybrid transmission is out of P with the hybrid system on.	Shift the shift lever to P.
  (If equipped)	Indicates that the Blind Spot Monitor sensors or the surrounding area on the bumper is dirty or covered with ice.	Clean the sensor and its surrounding area on the bumper.
  (Flashes)	Indicates that the accelerator pedal is depressed while the shift lever is in N.	Release the accelerator pedal and shift the shift lever to D or R.

\*: Refer to the separate “Scheduled Maintenance” or “Owner’s Manual Supplement” for the maintenance interval applicable to your vehicle.





## Messages displayed when refueling



The following messages are displayed after the fuel filler door opener is pressed. If the messages do not change or are displayed continuously, have the vehicle checked by your Lexus dealer.

Message	Details
 <b>PLEASE WAIT NOW OPENING</b> 	<b>Preparing the vehicle for refueling.</b> Wait a moment.
 <b>REFUEL READY</b>	<b>You may commence refueling.</b> Finish refueling within 30 minutes.
<b>CLOSE FUEL LID</b>  	<b>Close the fuel filler door.</b>





**Have the malfunction repaired immediately**

After taking the specified steps to correct the suspected problem, check that the warning message and light go off.

Interior buzzer	Exterior buzzer	Warning message	Details	Correction procedure
Sounds once	—	  (Flashes)	The electronic key is not detected when an attempt is made to start the hybrid system.	Confirm the location of the electronic key.
Sounds once	Sounds 3 times	  (Flashes)	The electronic key was carried outside the vehicle and a door other than the driver's door was opened and closed while the "POWER" switch was in a mode other than off.	Bring the electronic key back into the vehicle.
			The driver's door was opened and closed while the electronic key was not in the vehicle, the shift lever was in P and the "POWER" switch was not turned off.	Turn the "POWER" switch off or bring the electronic key back into the vehicle.

Interior buzzer	Exterior buzzer	Warning message	Details	Correction procedure
Sounds once	Sounds once	<div data-bbox="285 305 543 435" style="background-color: black; color: white; text-align: center; padding: 5px;"><b>KEY NOT DETECTED</b></div> <div data-bbox="285 443 543 573" style="background-color: black; color: white; text-align: center; padding: 5px;"><b>TURN POWER OFF</b></div> <p data-bbox="285 573 543 613">(Displayed alternately)</p> <div data-bbox="285 621 380 686" style="background-color: black; color: yellow; text-align: center; padding: 5px;"></div> <p data-bbox="380 621 487 662">(Flashes)</p>	<p>An attempt was made to exit the vehicle with the electronic key and lock the doors without first turning the “POWER” switch off.</p>	<p>Turn the “POWER” switch off and lock the doors again.</p>
Sounds once	—	<div data-bbox="285 857 543 987" style="background-color: black; color: white; text-align: center; padding: 5px;"><b>KEY NOT DETECTED</b></div> <div data-bbox="285 995 380 1060" style="background-color: black; color: yellow; text-align: center; padding: 5px;"></div> <p data-bbox="380 995 487 1036">(Flashes)</p>	<p>An attempt was made to start the hybrid system without the electronic key being present, or the electronic key was not functioning normally.</p> <p>An attempt was made to drive when the regular key was not inside the vehicle.</p>	<p>Confirm that the electronic key is inside the vehicle.</p>

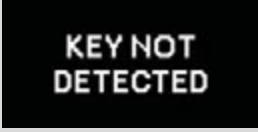



## 5-2. Steps to take in an emergency





Interior buzzer	Exterior buzzer	Warning message	Details	Correction procedure
Continuous	—	  (Flashes)	The driver's door was opened when the shift lever was not in P and the "POWER" switch was not turned off.	Shift the shift lever to P.
Continuous	Continuous	  (Displayed alternately)  (Flashes)	The driver's door was opened and closed while the electronic key was not in the vehicle, the shift lever was not in P and the "POWER" switch was not turned off.	<ul style="list-style-type: none"> <li>• Shift the shift lever to P.</li> <li>• Bring the electronic key back into the vehicle.</li> </ul>

Interior buzzer	Exterior buzzer	Warning message	Details	Correction procedure
Sounds once	Continuous	<div data-bbox="285 613 543 743" data-label="Image"> </div> <div data-bbox="285 753 378 816" data-label="Image"> </div> <div data-bbox="384 760 485 795" data-label="Text"> <p>(Flashes)</p> </div>	<p>An attempt was made to lock the doors using the smart access system with push-button start while the electronic key was still inside the vehicle.</p> <p>An attempt was made to lock either front door by opening a door and putting the inside lock button into the lock position, then closing the door by pulling on the outside door handle with the electronic key still inside the vehicle.</p>	<p>Retrieve the electronic key from the vehicle and lock the doors again.</p>



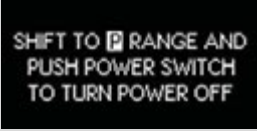



## 5-2. Steps to take in an emergency

Interior buzzer	Exterior buzzer	Warning message	Details	Correction procedure
Sounds once	—	  (Flashes)	<ul style="list-style-type: none"> <li>• When the doors were unlocked with the mechanical key and then the “POWER” switch was pressed, the electronic key could not be detected in the vehicle.</li> <li>• The electronic key could not be detected in the vehicle even after the “POWER” switch was pressed two consecutive times.</li> </ul>	Touch the electronic key to the “POWER” switch while depressing the brake pedal.
Sounds once	—	  (Flashes)	An attempt was made to start the hybrid system with the shift lever in an incorrect position.	Shift the shift lever to P and start the hybrid system.

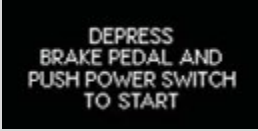
Interior buzzer	Exterior buzzer	Warning message	Details	Correction procedure
Sounds once	—	  (Flashes)	An attempt was made to turn the “POWER” switch off when the shift lever was not in P.	To turn off the hybrid system, first shift the shift lever to P and then turn the “POWER” switch off.
—	—		Power was turned off due to the automatic power off function.	Next time when starting the hybrid system, increase the hybrid system speed slightly and maintain that level for approximately 5 minutes to recharge the 12-volt battery.
Sounds once	—	 	The electronic key has a low battery.	Replace the electronic key battery. (→P. 687)

## 5-2. Steps to take in an emergency

Interior buzzer	Exterior buzzer	Warning message	Details	Correction procedure
Sounds once	—		The driver's door was opened and closed with the "POWER" switch turned off and then the "POWER" switch was put in ACCESSORY mode twice without the hybrid system being started.	Press the "POWER" switch while depressing the brake pedal.
		 (Flashes)	During an hybrid system starting procedure in the event that the electronic key was not functioning properly (→P. 782), the "POWER" switch was touched with the electronic key.	Press the "POWER" switch within 10 seconds of the buzzer sounding.
Sounds once	—	  (Flashes)	The steering lock could not be released within 3 seconds of the "POWER" switch being pressed.	Press the "POWER" switch while depressing the brake pedal and moving the steering wheel left and right.

---

**■ Warning message in radar cruise mode (if equipped)**

In the following cases, the warning message may not be displayed even if vehicle-to-vehicle distance decreases:

- When your vehicle and the vehicle ahead are traveling at the same speed or the vehicle ahead is traveling more quickly than your vehicle
- When the vehicle ahead is traveling at a very low speed
- Immediately after cruise control speed is set
- At the instant the accelerator pedal is depressed

## 5-2. Steps to take in an emergency

### If you have a flat tire

Your vehicle is equipped with a spare tire. The flat tire can be replaced with the spare tire.

#### ■ Before jacking up the vehicle

- Stop the vehicle on a hard, flat surface.
- Set the parking brake.
- Shift the shift lever to P.
- Stop the hybrid system.
- Turn on the emergency flashers.

■ Location of the spare tire, jack and tools

► Vehicles with a compact spare tire

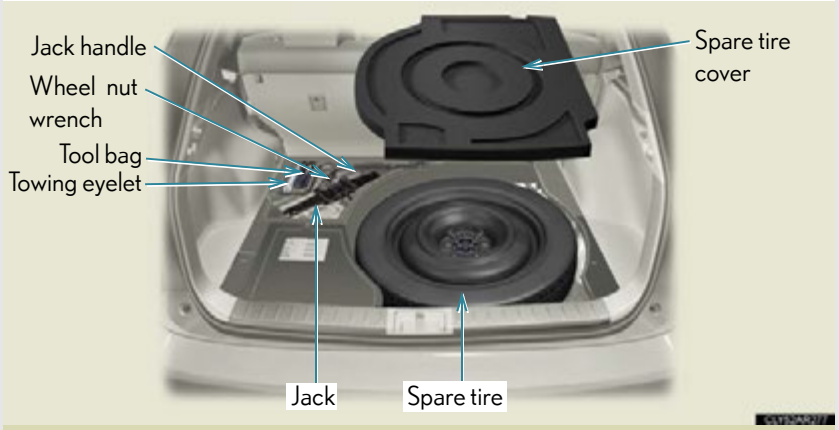

► Vehicles with a full-size spare tire

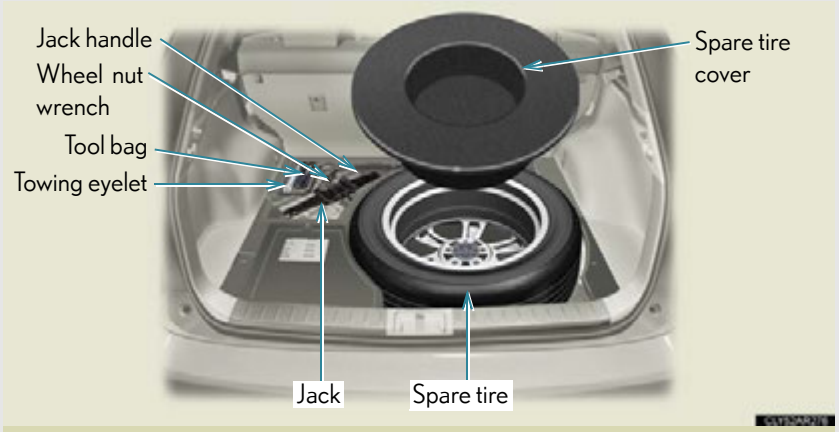

## Taking out the jack

► Vehicles with a compact spare tire



Pull the lever upward to fold back the front part of the deck board.



Pull the folded deck board upright.



Pull on the attached hook to extend the string.



Use the hook to secure the deck board as shown in the illustration.



Remove the jack after removing the hook.

► Vehicles with a full-size spare tire

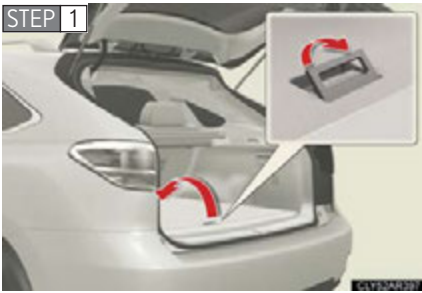

Pull the lever upward to fold back the front part of the deck board.

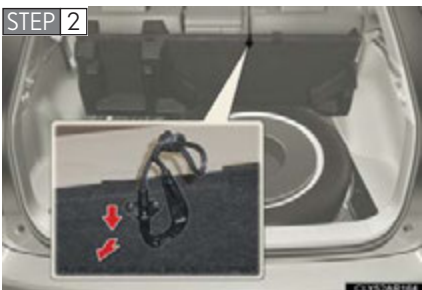

Pull on the attached hook to extend the string.



## 5-2. Steps to take in an emergency



Use the hook to secure the deck board as shown in the illustration.

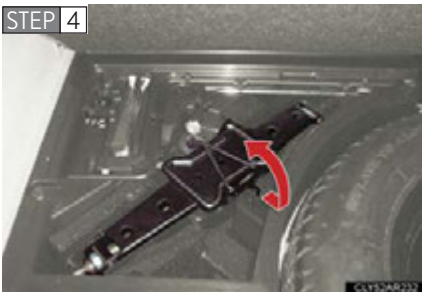

Remove the jack after removing the hook.

### Taking out the spare tire

**STEP 1** Lift up the deck board. (See “Taking out the jack” for details.)

**STEP 2** Remove the spare tire cover.

**STEP 3** Loosen the center fastener that secures the spare tire.

► Vehicles with a compact spare tire



► Vehicles with a full-size spare tire



## Replacing a flat tire

STEP 1



Chock the tires.

Flat tire		Wheel chock positions
Front	Left-hand side	Behind the rear right-hand side tire
	Right-hand side	Behind the rear left-hand side tire
Rear	Left-hand side	In front of the front right-hand side tire
	Right-hand side	In front of the front left-hand side tire

## 5-2. Steps to take in an emergency

STEP 2



Slightly loosen the wheel nuts (one turn).

STEP 3



Turn the tire jack portion "A" by hand until the notch of the jack is in contact with the jack point.

STEP 4

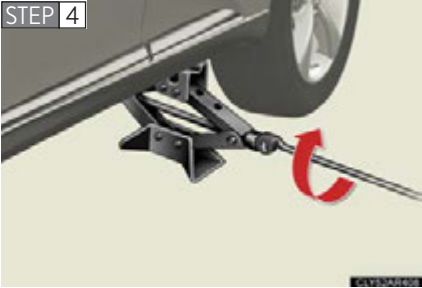

Raise the vehicle until the tire is slightly raised off the ground.

STEP 5



Remove all the wheel nuts and the tire.

When resting the tire on the ground, place the tire so that the wheel design faces up to avoid scratching the wheel surface.

## Installing the spare tire

### STEP 1

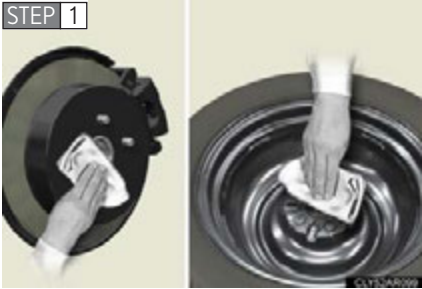

Remove any dirt or foreign matter from the wheel contact surface.

If foreign matter is on the wheel contact surface, the wheel nuts may loosen while the vehicle is in motion, causing the tire to come off.

**STEP 2** Install the spare tire and loosely tighten each wheel nut by hand by approximately the same amount.

#### ► Vehicles with a compact spare tire

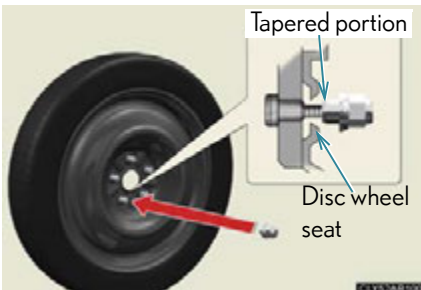

Tighten the nuts until the tapered portion comes into loose contact with the disc wheel seat.

#### ► Vehicles with a full-size spare tire

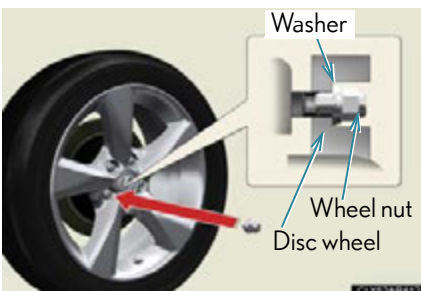

Turn the nuts until the washers come into contact with the wheel.

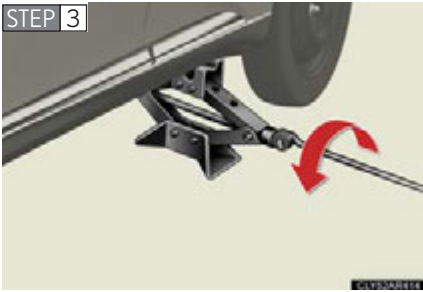

Lower the vehicle.

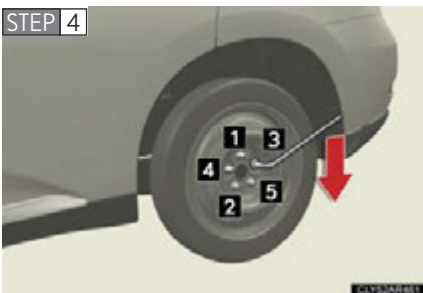

Firmly tighten each wheel nut two or three times in the order shown in the illustration.

**Tightening torque:**  
76 ft•lbf (103 N•m, 10.5 kgf•m)

STEP 5 Stow the flat tire, tire jack and all tools.

### ■ The compact spare tire

- The compact spare tire is identified by the label “TEMPORARY USE ONLY” on the tire sidewall.  
Use the compact spare tire temporarily, and only in an emergency.
- Make sure to check the tire inflation pressure of the compact spare tire.  
(→P. 807)

### ■ When using the compact spare tire

As the compact spare tire is not equipped with a tire pressure warning valve and transmitter, low inflation pressure of the spare tire will not be indicated by the tire pressure warning system. Also, if you replace the compact spare tire after the tire pressure warning light comes on, the light remains on.

■ **If you have a flat front tire on a road covered with snow or ice (vehicles with a compact spare tire)**

Install the compact spare tire on one of the rear wheels of the vehicle. Perform the following steps and fit tire chains to the front tires:

**STEP 1** Replace a rear tire with the compact spare tire.

**STEP 2** Replace the flat front tire with the tire removed from the rear of the vehicle.

**STEP 3** Fit tire chains to the front tires.

■ **After completing the tire change**

The tire pressure warning system must be reset. (→P. 671)

 **CAUTION**

■ **Using the tire jack**

Improper use of the tire jack may cause the vehicle to suddenly fall off the jack, leading to death or serious injury.

- Do not use the tire jack for any purpose other than replacing tires or installing and removing tire chains.
- Only use the tire jack that comes with this vehicle for replacing a flat tire. Do not use it on other vehicles, and do not use other tire jacks for replacing tires on this vehicle.
- Always check that the tire jack is securely set to the jack point.
- Do not put any part of your body under the vehicle while it is supported by the jack.
- Do not start or run the hybrid system while your vehicle is supported by the jack.
- Do not raise the vehicle while someone is inside.
- When raising the vehicle, do not put an object on or under the jack.
- Do not raise the vehicle to a height greater than that required to replace the tire.
- Use a jack stand if it is necessary to get under the vehicle.

Take particular care when lowering the vehicle to ensure that no one working on or near the vehicle may be injured.

 **CAUTION**

■ **Replacing a flat tire**

- Observe the following precautions.

Failure to do so may result in serious injury:

- Do not touch the disc wheels or the area around the brakes immediately after the vehicle has been driven.

After the vehicle has been driven the disc wheels and the area around the brakes will be extremely hot. Touching these areas with hands, feet or other body parts while changing a tire, etc. may result in burns.

- Do not attach a heavily damaged wheel ornament, as it may fly off the wheel while the vehicle is moving.
- Failure to follow these precautions could cause the wheel nuts to loosen and the tire to fall off, resulting in death or serious injury.
  - Never use oil or grease on the wheel bolts or wheel nuts.  
Oil and grease may cause the wheel nuts to be excessively tightened, leading to bolt or disc wheel damage. In addition, the oil or grease can cause the wheel nuts to loosen and the wheel may fall off, causing a serious accident. Remove any oil or grease from the wheel bolts or wheel nuts.
  - Have the wheel nuts tightened with a torque wrench to 76 ft•lbf (103 N•m, 10.5 kgf•m) as soon as possible after changing wheels.
  - When installing a tire, only use wheel nuts that have been specifically designed for that wheel.
  - If there are any cracks or deformations in the bolt screws, nut threads or bolt holes of the wheel, have the vehicle inspected by your Lexus dealer.

■ **Replacing a flat tire for vehicles with power back door**

In cases such as when replacing tires, make sure to turn off the power back door main switch (→P. 77). Failure to do so may cause the back door to operate unintentionally if the power back door switch is accidentally touched, resulting in hands and fingers being caught and injured.

 **CAUTION**
**■ When using the compact spare tire**

- Remember that the compact spare tire provided is specifically designed for use with your vehicle. Do not use your compact spare tire on another vehicle.
- Do not use more than one compact spare tire simultaneously.
- Replace the compact spare tire with a standard tire as soon as possible.
- Avoid sudden acceleration, abrupt steering, sudden braking and shifting operations that cause sudden engine braking.

**■ When the compact spare tire is attached**

The vehicle speed may not be correctly detected, and the following systems may not operate correctly:

- ABS & Brake assist
- VSC
- TRAC
- VDIM
- Intuitive parking assist (if equipped)
- Navigation system (if equipped)
- Cruise control (if equipped)
- Dynamic radar cruise control (if equipped)
- Pre-Collision System (if equipped)

Also, not only can the following system not be utilized fully, but it may even negatively affect the drive-train components:

- AWD system (if equipped)

**■ Speed limit when using the compact spare tire**

Do not drive at speeds in excess of 50 mph (80 km/h) when a compact spare tire is installed on the vehicle.

The compact spare tire is not designed for driving at high speeds. Failure to observe this precaution may lead to an accident causing death or serious injury.



 NOTICE

■ **Do not drive the vehicle with a flat tire**

Do not continue driving with a flat tire.

Driving even a short distance with a flat tire can damage the tire and the wheel beyond repair.

■ **Be careful when driving over bumps with the compact spare tire installed on the vehicle.**

The vehicle becomes lower when driving with the compact spare tire compared to when driving with standard tires. Be careful when driving over uneven road surfaces.

■ **Driving with tire chains and the compact spare tire**

Do not fit tire chains to the compact spare tire.

Tire chains may damage the vehicle body and adversely affect driving performance.

■ **When replacing the tires**

When removing or fitting the wheels, tires or the tire pressure warning valve and transmitter, contact your Lexus dealer as the tire pressure warning valve and transmitter may be damaged if not handled correctly.

■ **To avoid damage to the tire pressure warning valves and transmitters**

When a tire is repaired with liquid sealants, the tire pressure warning valve and transmitter may not operate properly. If a liquid sealant is used, contact your Lexus dealer or other qualified service shop as soon as possible. Make sure to replace the tire pressure warning valve and transmitter when replacing the tire. (→P. 671)

## 5-2. Steps to take in an emergency

### If the hybrid system will not start

Reasons for the hybrid system not starting vary depending on the situation. Check the following and perform the appropriate procedure:

■ **The hybrid system will not start even though the correct starting procedure is being followed. (→P. 177)**

One of the following may be the cause of the problem:

- The electronic key may not be functioning properly. (→P. 782)
- There may be a malfunction in the immobilizer system. (→P. 124)
- There may be a malfunction in the steering lock system.
- The hybrid system may be malfunctioning due to an electrical problem such as an open circuit or a blown fuse. However, depending on the type of malfunction, an interim measure is available to start the hybrid system. (→P. 778)

■ **The interior lights and headlights are dim, or the horn does not sound or sounds at a low volume.**

One of the following may be the cause of the problem:

- The 12-volt battery may be discharged. (→P. 784)
- The 12-volt battery terminal connections may be loose or corroded.

■ **The interior lights and headlights do not turn on, or the horn does not sound.**

One of the following may be the cause of the problem:

- One or both of the 12-volt battery terminals may be disconnected.
- The 12-volt battery may be discharged. (→P. 784)

Contact your Lexus dealer if the problem cannot be repaired, or if repair procedures are unknown.

## Emergency start function

When the hybrid system does not start, the following steps can be used as an interim measure to start the hybrid system if the "POWER" switch is functioning normally:

**STEP 1** Set the parking brake.

**STEP 2** Shift the shift lever to P.

**STEP 3** Turn the "POWER" switch to ACCESSORY mode.

**STEP 4** Press and hold the "POWER" switch for about 15 seconds while depressing the brake pedal firmly.

Even if the hybrid system can be started using the above steps, the system may be malfunctioning. Have the vehicle inspected by your Lexus dealer.

## 5-2. Steps to take in an emergency

### If the shift lever cannot be shifted from P

If the shift lever cannot be shifted with your foot on the brake pedal, there may be a problem with the shift lock system (a system to prevent accidental operation of the shift lever). Have the vehicle inspected by your Lexus dealer immediately.

The following steps may be used as an emergency measure to ensure that the shift lever can be shifted:

**STEP 1** Set the parking brake.

**STEP 2** Turn the "POWER" switch to ACCESSORY mode.

**STEP 3** Depress the brake pedal.

**STEP 4**

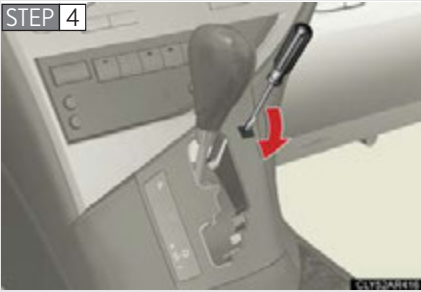

Pry the cover up with a flathead screwdriver or equivalent.

**STEP 5**



Press the shift lock override button.

The shift lever can be shifted while the button is pressed.

## 5-2. Steps to take in an emergency

### If you lose your keys

New genuine Lexus keys can be made by your Lexus dealer using the other keys and the key number stamped on your key number plate.

## 5-2. Steps to take in an emergency

### If the electronic key does not operate properly

If communication between the electronic key and vehicle is interrupted (→P. 62) or the electronic key cannot be used because the battery is depleted, the smart access system with push-button start and wireless remote control cannot be used. In such cases, the doors can be opened and the hybrid system can be started by following the procedure below.

#### Locking and unlocking the side doors and key linked functions

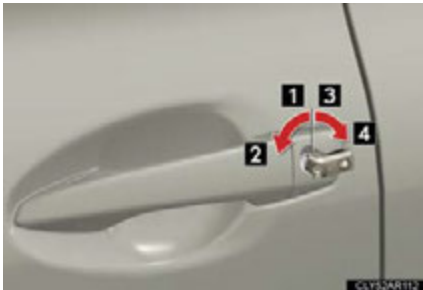

Use the mechanical key (→P. 52) in order to perform the following operations (driver's door only):

- 1 Locks all the doors
- 2 Closes the windows and moon roof (turn and hold)
- 3 Unlocks the door

Turning the key rearward unlocks the driver's door. Turning the key once again unlocks the other doors.

- 4 Opens the windows and moon roof (turn and hold)

## Starting the hybrid system

**STEP 1** Ensure that the shift lever is in P and depress the brake pedal.



Touch the Lexus emblem side of the electronic key to the "POWER" switch.

If any of the doors is opened or closed while the key is being touched to the switch, an alarm will sound to indicate that the start function cannot detect the electronic key.



**STEP 3** Press the "POWER" switch within 10 seconds of the buzzer sounding, keeping the brake pedal depressed.

In the event that the hybrid system still cannot be operated, contact your Lexus dealer.

---

**■ Stopping the hybrid system**

Shift the shift lever to P and press the "POWER" switch as you normally do when stopping the hybrid system.

**■ Replacing the key battery**

As the above procedure is a temporary measure, it is recommended that the electronic key battery be replaced immediately when the battery is depleted.

(→P. 687)

**■ Changing "POWER" switch modes**

Within 10 seconds of the buzzer sounding, release the brake pedal and press the "POWER" switch.

The hybrid system does not start and modes will be changed each time the switch is pressed. (→P. 178)



## 5-2. Steps to take in an emergency

### If the vehicle 12-volt battery is discharged

The following procedures may be used to start the hybrid system if the vehicle's 12-volt battery is discharged.

You can also call your Lexus dealer or a qualified repair shop.

If you have a set of jumper (or booster) cables and a second vehicle with a 12-volt battery, you can jump start your vehicle by following the steps below.

**STEP 1** Open the hood and remove the engine compartment covers. (→P. 655)

**STEP 2** Remove the fuse box cover and open the exclusive jump starting terminal cover.

**STEP 3**

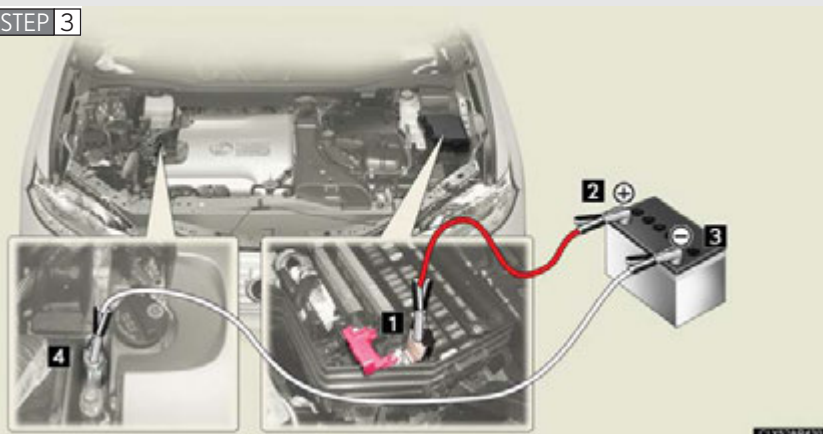

Connect the jumper cables according to the following procedure:

- 1** Connect a positive jumper cable clamp to the exclusive jump starting terminal on your vehicle
- 2** Connect a positive jumper cable clamp to the positive (+) battery terminal on the second vehicle
- 3** Connect a negative cable clamp to the negative (-) battery terminal on the second vehicle
- 4** Connect the clamp at the other end of the negative cable to a solid, stationary, unpainted metallic point away from the exclusive jump starting terminal and any moving parts, as shown in the illustration.

**STEP 4** Start the engine of the second vehicle. Increase the engine speed slightly and maintain that level for approximately 5 minutes to recharge the 12-volt battery of your vehicle.

**STEP 5** Open and close any of the doors of your vehicle with the “POWER” switch off.

**STEP 6** Maintain the engine speed of the second vehicle and start the hybrid system of your vehicle by turning the “POWER” switch to ON mode.

**STEP 7** Make sure the “READY” indicator comes on. If the indicator does not come on, contact your Lexus dealer.

**STEP 8** Once the hybrid system has started, remove the jumper cables in the exact reverse order from which they were connected.

Once the hybrid system starts, have the vehicle inspected at your Lexus dealer as soon as possible.

### ■ Starting the hybrid system when the 12-volt battery is discharged

The hybrid system cannot be started by push-starting.

### ■ To prevent 12-volt battery discharge

- Turn off the headlights and the audio system while the hybrid system is off.
- Turn off any unnecessary electrical components when the vehicle is running at a low speed for an extended period, such as in heavy traffic.

### ■ When the 12-volt battery is removed or discharged

- The power back door must be initialized. (→P. 837)
- The hybrid system may not start. (→P. 668)
- Make sure that the key is not inside the vehicle when recharging or replacing the 12-volt battery. The key may be locked in the vehicle if the alarm is activated. (→P. 128)

### ■ Charging the 12-volt battery

The electricity stored in the 12-volt battery will discharge gradually even when the vehicle is not in use, due to natural discharge and the draining effects of certain electrical appliances. If the vehicle is left for a long time, the 12-volt battery may discharge, and the hybrid system may be unable to start. (The 12-volt battery recharges automatically while the hybrid system is operating.)

### CAUTION

#### ■ Avoiding 12-volt battery fires or explosions

Observe the following precautions to prevent accidentally igniting the flammable gas that may be emitted from the 12-volt battery:

- Make sure each jumper cable is connected to the correct terminal and that it is not unintentionally in contact with any other than the intended terminal.
- Do not allow the other end of the jumper cable connected to the “+” terminal to come into contact with any other parts or metal surfaces in the area, such as brackets or unpainted metal.
- Do not allow the + and - clamps of the jumper cables to come into contact with each other.
- Do not smoke, use matches, cigarette lighters or allow open flame near the 12-volt battery.

#### ■ 12-volt battery precautions

The 12-volt battery contains poisonous and corrosive acidic electrolyte, while related parts contain lead and lead compounds. Observe the following precautions when handling the 12-volt battery:

- When working with the 12-volt battery, always wear safety glasses and take care not to allow any battery fluids (acid) to come into contact with skin, clothing or the vehicle body.
- Do not lean over the 12-volt battery.
- In the event that battery fluid comes into contact with the skin or eyes, immediately wash the affected area with water and seek medical attention.  
Place a wet sponge or cloth over the affected area until medical attention can be received.

**⚠ CAUTION**

- Always wash your hands after handling the battery support, terminals, and other battery-related parts.
- Do not allow children near the 12-volt battery.

**■ After recharging the 12-volt battery**

Have the 12-volt battery inspected at your Lexus dealer as soon as possible.

If the 12-volt battery is deteriorating, continued use may cause the 12-volt battery to emit a malodorous gas, which may be detrimental to the health of passengers.

**■ When replacing the 12-volt battery**

→P. 669

**⚠ NOTICE****■ When handling jumper cables**

When connecting the jumper cables, ensure that they do not become entangled in the cooling fans or belt.

**■ Avoiding accidental short-circuits**

When connecting jumper cables, observe the following precautions:

- Make sure each jumper cable is connected to the correct terminal.
- Do not allow the ends of the jumper cable used for the “+” terminals to come into contact with any other parts or metal surfaces in the area, such as brackets or unpainted metal.
- Do not allow the “+” and “-” terminals of the jumper cables to come into contact with each other.

**■ Exclusive jump starting terminal precaution**

The exclusive jump starting terminal is to be used when charging the 12-volt battery from another vehicle in an emergency. It cannot be used to jump start another vehicle.

## 5-2. Steps to take in an emergency If your vehicle overheats

The following may indicate that your vehicle is overheating.

- “ENGINE OVERHEAT” is shown on the multi-information display:  
The engine may be overheating.
- “HYBRID SYSTEM OVERHEAT” is shown on the multi-information display:  
A hybrid system component such as the power control unit or an electric motor (traction motor) may be overheating.
- Steam comes out from under the hood.

### Correction procedures

#### ■ If “ENGINE OVERHEAT” is shown on the multi-information display

**STEP 1** Stop the vehicle in a safe place and turn off the air conditioning system, and then stop the hybrid system.

**STEP 2** If you see steam:

Carefully lift the hood after the steam subsides.

If you do not see steam:

Carefully lift the hood.

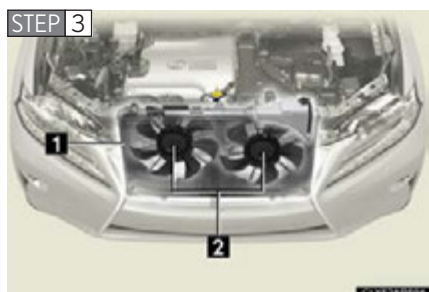

After the hybrid system has cooled down sufficiently, inspect the hoses and radiator core (radiator) for any leaks.

- 1** Radiator
- 2** Cooling fans

If a large amount of coolant leaks, immediately contact your Lexus dealer.

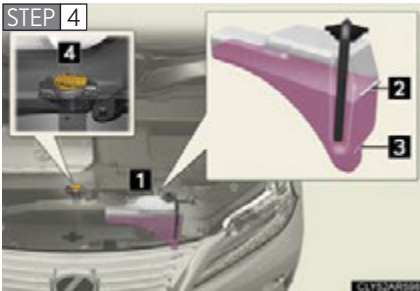

The coolant level is satisfactory if it is between the “FULL” and “LOW” lines on the reservoir.

- 1 Reservoir
- 2 “FULL” line
- 3 “LOW” line
- 4 Radiator cap



Add coolant if necessary.  
(→P. 655)

Water can be used in an emergency if coolant is unavailable.



**STEP 6** Start the hybrid system and turn the air conditioning system on to check that the radiator cooling fans operate and to check for coolant leaks from the radiator or hoses.

The fans operate when the air conditioning system is turned on immediately after a cold start. Confirm that the fans are operating by checking the fan sound and air flow. If it is difficult to check these, turn the air conditioning system on and off repeatedly.

(The fans may not operate in freezing temperatures.)

**STEP 7** If the fans are not operating:

Stop the hybrid system immediately and contact your Lexus dealer.

If the fans are operating:

Have the vehicle inspected at the nearest Lexus dealer.

■ If “HYBRID SYSTEM OVERHEAT” is shown on the multi-information display

**STEP 1**



Stop the vehicle in a safe place.

Ensure that the opening for the oil cooler is not blocked by dirt or any other foreign substance. If the opening is not blocked or if the message does not disappear after some time the opening has been cleaned, proceed to STEP 2.

**STEP 2** Stop the hybrid system and carefully lift the hood.

**STEP 3**



After the hybrid system has cooled down, inspect the hoses and radiator core (radiator) for any leaks.

- 1 Radiator
- 2 Cooling fans

If a large amount of coolant leaks, immediately contact your Lexus dealer.

**STEP 4**

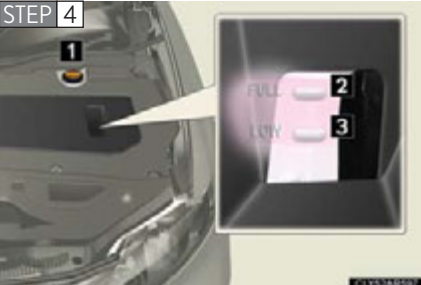

The coolant level is satisfactory if it is between the “FULL” and “LOW” lines on the reservoir.

- 1 Reservoir
- 2 “FULL” line
- 3 “LOW” line



Add coolant if necessary.

Water can be used in an emergency if coolant is unavailable.

**STEP 6** Start the hybrid system and check for the multi-information display.

If the message does not disappear:

Stop the hybrid system and contact your Lexus dealer.

If the message is not displayed:

Have the vehicle inspected at the nearest Lexus dealer.

### CAUTION

#### ■ To prevent an accident or injury when inspecting under the hood of your vehicle

- If steam is seen coming from under the hood, do not open the hood until the steam has subsided. The engine compartment may be very hot, causing serious injuries such as burns.
- After the hybrid system has been turned off, check that the indicator on the "POWER" switch and the "READY" indicator are off.  
When the hybrid system is operating, the gasoline engine may automatically start, or the cooling fans may suddenly operate even if the gasoline engine stops. Do not touch or approach rotating parts such as the fans, which may lead to fingers or clothing (especially a tie, a scarf or a muffler) getting caught, resulting in serious injury.
- Do not loosen the radiator cap while the hybrid system and radiator are hot. Serious injuries, such as burns, may result from hot coolant and steam released under pressure.



 NOTICE

■ **When adding engine/power control unit coolant**

Wait until the hybrid system has cooled down before adding engine/power control unit coolant.

When adding coolant, do so slowly. Adding cool coolant to a hot hybrid system too quickly can cause damage to the hybrid system.

■ **To prevent damage to the cooling system**

Observe the following precautions:

- Avoid contaminating the coolant with foreign matter (such as sand or dust etc.).
- Do not use any coolant additives.

## 5-2. Steps to take in an emergency If the vehicle becomes stuck

Carry out the following procedures if the tires spin or the vehicle becomes stuck in mud, dirt or snow:

- STEP 1** Stop the hybrid system. Set the parking brake and shift the shift lever to P.
- STEP 2** Remove the mud, snow or sand from around the front wheels.
- STEP 3** Place wood, stones or some other material under the front wheels to help provide traction.
- STEP 4** Restart the hybrid system.
- STEP 5** Shift the shift lever to the D or R position and release the parking brake. Then, while exercising caution, depress the accelerator pedal.

### ■ When it is difficult to free the vehicle



Press the VSC off switch to turn off TRAC.

 **CAUTION**

■ **When attempting to free a stuck vehicle**

If you choose to push the vehicle back and forth to free it, make sure the surrounding area is clear to avoid striking other vehicles, objects or people. The vehicle may also lunge forward or lunge back suddenly as it becomes free. Use extreme caution.

■ **When shifting the shift lever**

Be careful not to shift the shift lever with the accelerator pedal depressed. This may lead to unexpected rapid acceleration of the vehicle that may cause an accident resulting in death or serious injury.

 **NOTICE**

■ **To avoid damage to the hybrid transmission and other components**

- Avoid spinning the front wheels and depressing the accelerator pedal more than necessary.
- If the vehicle remains stuck even after these procedures are performed, the vehicle may require towing to be freed.

## 5-2. Steps to take in an emergency

### If your vehicle has to be stopped in an emergency

Only in an emergency, such as if it becomes impossible to stop the vehicle in the normal way, stop the vehicle using the following procedure:

**STEP 1** Steadily step on the brake pedal with both feet and firmly depress it.

Do not pump the brake pedal repeatedly as this will increase the effort required to slow the vehicle.

**STEP 2** Shift the shift lever to N.

▶ If the shift lever is shifted to N

**STEP 3** After slowing down, stop the vehicle in a safe place by the road.

**STEP 4** Stop the hybrid system.

▶ If the shift lever cannot be shifted to N

**STEP 3** Keep depressing the brake pedal with both feet to reduce vehicle speed as much as possible.

**STEP 4**



Press and hold for 2 seconds or more, or press briefly 3 times or more

To stop the hybrid system, press and hold the “POWER” switch for 2 consecutive seconds or more, or press it briefly 3 times or more in succession.

**STEP 5** Stop the vehicle in a safe place by the road.

#### CAUTION

##### ■ If the hybrid system has to be turned off while driving

Power assist for the steering wheel will be lost, making the steering wheel heavier to turn. Decelerate as much as possible before turning off the hybrid system.



**6-1. Specifications**

Maintenance data  
(fuel, oil level, etc.) ..... 798

Fuel information ..... 810

Tire information ..... 813

**6-2. Customization**

Customizable features ..... 825

**6-3. Initialization**

Items to initialize ..... 837

## 6-1. Specifications

### Maintenance data (fuel, oil level, etc.)

#### Dimensions and weight

Overall length	187.8 in. (4770 mm)	
Overall width	74.2 in. (1885 mm)	
Overall height* <sup>1</sup>	66.3 in. (1685 mm)* <sup>2</sup> 66.7 in. (1695 mm)* <sup>3</sup> 67.9 in. (1725 mm)* <sup>4</sup>	
Wheelbase	107.9 in. (2740 mm)	
Tread	Front	64.2 in. (1630 mm)
	Rear	64.0 in. (1625 mm)
Vehicle capacity weight (Occupants + luggage)	► 2WD 825 lb. (370 kg) ► AWD 885 lb. (400 kg)	
Trailer Weight Rating (trailer weight + cargo weight)* <sup>5</sup>	3500 lb. (1588 kg)	

\*1: Unladen vehicles

\*2: Vehicles without roof antenna and roof rails

\*3: Vehicles with roof antenna but without roof rails

\*4: Vehicles with roof rails

\*5: AWD models with towing package only

## Vehicle identification

### ■ Vehicle identification number

The vehicle identification number (VIN) is the legal identifier for your vehicle. This is the primary identification number for your Lexus. It is used in registering the ownership of your vehicle.

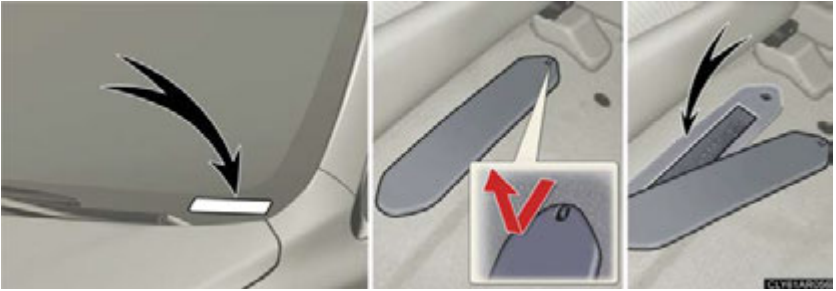

This number is stamped on the top left of the instrument panel. On some models, this number is also stamped under the front passenger seat.



This number is also on the Certification Label.



### ■ Engine number

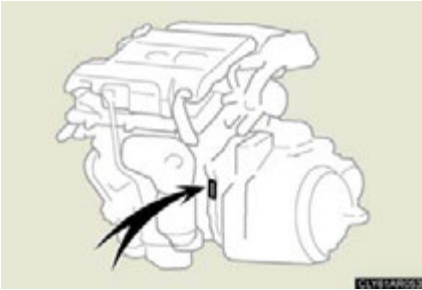

The engine number is stamped on the engine block as shown.

### Engine

Model	2GR-FXE
Type	6-cylinder V type, 4-cycle, gasoline
Bore and stroke	3.70 × 3.27 in. (94.0 × 83.0 mm)
Displacement	210.9 cu.in. (3456 cm <sup>3</sup> )
Drive belt tension	Automatic adjustment

### Fuel

Fuel type	Unleaded gasoline only
Octane rating	91 (Research octane number 96) or higher
Fuel tank capacity (Reference)	17.1 gal. (65 L, 14.2 Imp. gal.)

### Electric motor (Traction motor)

#### ▶ Front

Type	Permanent magnet synchronous motor
Maximum output	123 kW
Maximum torque	247 ft•lbf (335 N•m, 34.2 kgf•m)

#### ▶ Rear (AWD models)

Type	Permanent magnet synchronous motor
Maximum output	50 kW
Maximum torque	103 ft•lbf (139 N•m, 14.2 kgf•m)

### Hybrid battery (Traction battery)

Type	Nickel-metal hydride battery
Voltage	9.6 V/module
Capacity	6.5 Ah (3HR)
Quantity	30 modules
Overall voltage	288 V

## Lubrication system

Oil capacity  
(Drain and refill —  
reference\*)

With filter

6.4 qt. (6.1 L, 5.4 Imp. qt.)

Without filter

6.0 qt. (5.7 L, 5.0 Imp. qt.)

\*: The engine oil capacity is a reference quantity to be used when changing the engine oil. Warm up the engine and turn off the hybrid system, wait more than 5 minutes, and check the oil level on the dipstick.

### ■ Engine oil selection

“Toyota Genuine Motor Oil” is used in your Lexus vehicle. Use Lexus approved “Toyota Genuine Motor Oil” or equivalent to satisfy the following grade and viscosity.

Oil grade: ILSAC GF-5 multigrade engine oil

## Recommended viscosity: SAE 0W-20

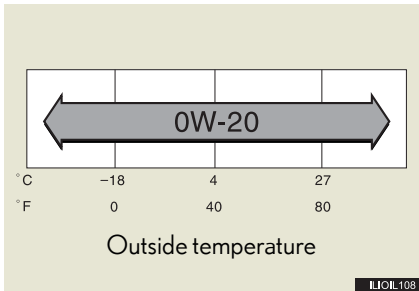

SAE 0W-20 is the best choice for good fuel economy and good starting in cold weather.

If SAE 0W-20 is not available, SAE 5W-20 oil may be used. However, it must be replaced with SAE 0W-20 at the next oil change.

Oil viscosity (0W-20 is explained here as an example):

- The 0W in 0W-20 indicates the characteristic of the oil which allows cold startability. Oils with a lower value before the W allow for easier starting of the engine in cold weather.
- The 20 in 0W-20 indicates the viscosity characteristic of the oil when the oil is at high temperature. An oil with a higher viscosity (one with a higher value) may be better suited if the vehicle is operated at high speeds, or under extreme load conditions.

How to read oil container label:

The International Lubricant Specification Advisory Committee (ILSAC) Certification Mark is added to some oil containers to help you select the oil you should use.



### Cooling system

Capacity	
Gasoline engine	12.0 qt. (11.4 L, 10.0 Imp. qt.) 12.4 qt. (11.7 L, 10.3 Imp. qt.)*
Power control unit	1.9 qt. (1.8 L, 1.6 Imp. qt.)
Coolant type	Use either of the following: <ul style="list-style-type: none"><li>• “Toyota Super Long Life Coolant”</li><li>• Similar high-quality ethylene glycol-based non-silicate, non-amine, non-nitrite, and non-borate coolant with long-life hybrid organic acid technology</li></ul> Do not use plain water alone.

\*: With towing package

### Ignition system

Spark plug	
Make	DENSO FK20HR11
Gap	0.043 in. (1.1 mm)

#### NOTICE

##### Iridium-tipped spark plugs

Use only iridium-tipped spark plugs. Do not adjust the spark plug gap.

## Electrical system

12-volt battery	
Open voltage* at 68°F (20°C):	12.6—12.8 V Fully charged 12.2—12.4 V Half charged 11.8—12.0 V Discharged (*: Voltage checked 20 minutes after the hybrid system and all the lights are turned off)
Charging rates	5 A max.

## Hybrid Transaxle

Fluid capacity*	<ul style="list-style-type: none"> <li>▶ Front 4.9 qt. (4.6 L, 4.0 Imp. qt.)</li> <li>▶ Rear (AWD models) 1.9 qt. (1.8 L, 1.6 Imp. qt.)</li> </ul>
Fluid type	Toyota Genuine ATF WS

\*: The fluid capacity is a reference quantity. If replacement is necessary, contact your Lexus dealer.

### NOTICE

#### ■ Hybrid transmission fluid type

Using transmission fluid other than “Toyota Genuine ATF WS” may ultimately damage the hybrid transmission of your vehicle.

## Brakes

Pedal clearance <sup>*1</sup>	4.1 in. (104 mm) Min.
Pedal free play	0.04 — 0.08 in. (1 — 2 mm)
Brake pad wear limit	0.04 in. (1.0 mm)
Parking brake lining wear limit	0.04 in. (1.0 mm)
Parking brake pedal travel <sup>*2</sup>	7 — 10 clicks
Fluid type	SAE J1703 or FMVSS No.116 DOT 3

\*1: Minimum pedal clearance when depressed with a force of 112 lbf (500 N, 51 kgf) while the hybrid system is operating

\*2: Parking brake pedal travel when depressed with a force of 67.5 lbf (300 N, 31 kgf)

## Steering

Free play	Less than 1.2 in. (30 mm)
-----------	---------------------------

## Tires and wheels

### ► Type A

Tire size	P235/60R18 102V, T165/90D18 107M (spare)
Tire inflation pressure (recommended cold tire inflation pressure)	Front: 33 psi (230 kPa, 2.3 kgf/cm <sup>2</sup> or bar) Rear: 33 psi (230 kPa, 2.3 kgf/cm <sup>2</sup> or bar) Spare: 60 psi (420 kPa, 4.2 kgf/cm <sup>2</sup> or bar)
Wheel size	18 × 7 1/2J, 18 × 4T (spare)
Wheel nut torque	76 ft•lbf (103 N•m, 10.5 kgf•m)

### ► Type B

Tire size	P235/60R18 102V
Tire inflation pressure (recommended cold tire inflation pressure)	Front: 33 psi (230 kPa, 2.3 kgf/cm <sup>2</sup> or bar) Rear: 33 psi (230 kPa, 2.3 kgf/cm <sup>2</sup> or bar) Spare: 33 psi (230 kPa, 2.3 kgf/cm <sup>2</sup> or bar)
Wheel size	18 × 7 1/2J
Wheel nut torque	76 ft•lbf (103 N•m, 10.5 kgf•m)



► Type C

Tire size	P235/55R19 101V, T165/90D18 107M (spare)
Tire inflation pressure (recommended cold tire inflation pressure)	<p>Driving under normal conditions</p> <p>Front: 33 psi (230 kPa, 2.3 kgf/cm<sup>2</sup> or bar)*</p> <p>Rear: 33 psi (230 kPa, 2.3 kgf/cm<sup>2</sup> or bar)*</p> <p>Spare: 60 psi (420 kPa, 4.2 kgf/cm<sup>2</sup> or bar)</p> <p>*: When driving at high speeds above 100 mph (160 km/h), in countries where such speeds are permitted by law, add 3 psi (20 kPa, 0.2 kgf/cm<sup>2</sup> or bar) to the tires. Never exceed the maximum cold tire inflation pressure indicated on the tire sidewall.</p>
Wheel size	19 × 7 1/2J, 18 × 4T (spare)
Wheel nut torque	76 ft•lbf (103 N•m, 10.5 kgf•m)

► Type D

Tire size	P235/55R19 101V
Tire inflation pressure (recommended cold tire inflation pressure)	<p>Driving under normal conditions</p> <p>Front: 33 psi (230 kPa, 2.3 kgf/cm<sup>2</sup> or bar)</p> <p>Rear: 33 psi (230 kPa, 2.3 kgf/cm<sup>2</sup> or bar)</p> <p>Spare: 33 psi (230 kPa, 2.3 kgf/cm<sup>2</sup> or bar)</p> <p>When driving at high speeds above 100 mph (160 km/h), in countries where such speeds are permitted by law, add 3 psi (20 kPa, 0.2 kgf/cm<sup>2</sup> or bar) to the front tires and rear tires. Never exceed the maximum cold tire inflation pressure indicated on the tire sidewall.</p>
Wheel size	19 × 7 1/2J
Wheel nut torque	76 ft•lbf (103 N•m, 10.5 kgf•m)

## Light bulbs

	Light bulbs	Bulb No.	W	Type
Exterior	Headlights			
	High beam <sup>*1</sup>	9005	60	A
	High beam <sup>*2</sup>	—	65	B
	Low beam (halogen bulbs) <sup>*3</sup>	—	55	C
	Low beam (discharge bulbs) <sup>*3</sup>	—	35	D
	Front turn signal lights	7444NA	28/8	E
	Tail lights	—	5	F
	Front fog lights (halogen bulbs) <sup>*3</sup>	—	19	G
	Rear side marker lights	—	5	F
	Rear turn signal lights	—	21	E
Interior	Back-up lights	921	16	F
	Outer foot lights	—	5	F
	Vanity lights	—	8	F
	Front interior lights	—	5	F
	Rear interior lights	—	8	F
	Luggage compartment lights	—	5	F
	Door courtesy lights	—	5	F
Footwell lights	—	3.8	F	

A: HB3 halogen bulbs

B: H9 halogen bulbs

C: H11 halogen bulbs

D: D4S discharge bulbs

E: Wedge base bulbs (amber)

F: Wedge base bulbs (clear)

G: H16 halogen bulbs

<sup>\*1</sup>: Vehicles with halogen or discharge headlights<sup>\*2</sup>: Vehicles with LED headlights<sup>\*3</sup>: If equipped

## 6-1. Specifications

### Fuel information

Your vehicle must use only unleaded gasoline.

Premium unleaded gasoline with an octane rating of 91 (Research Octane Number 96) or higher required for optimum engine performance. If 91 octane cannot be obtained, you may use unleaded gasoline with an octane rating as low as 87 (Research Octane Number 91). Use of unleaded gasoline with an octane rating lower than 91 may result in engine knocking. Persistent knocking can lead to engine damage and should be corrected by refueling with higher octane unleaded gasoline.

At minimum, the gasoline you use should meet the specifications of ASTM D4814 in the U.S.A. and CGSB3.5-M93 in Canada.

---

#### ■ Fuel tank opening for unleaded gasoline

To help prevent incorrect fueling, your Lexus has a fuel tank opening that only accommodates the special nozzle on unleaded fuel pumps.

#### ■ If your engine knocks

- Consult your Lexus dealer.
- You may occasionally notice light knocking for a short time while accelerating or driving uphill. This is normal and there is no need for concern.

#### ■ Gasoline quality

In very few cases, driveability problems may be caused by the brand of gasoline you are using. If driveability problems persist, try changing the brand of gasoline. If this does not correct the problem, consult your Lexus dealer.

#### ■ Gasoline quality standards

- Automotive manufacturers in the US, Europe and Japan have developed a specification for fuel quality called the World-Wide Fuel Charter (WWFC) that is expected to be applied worldwide.
- The WWFC consists of four categories that are based on required emission levels. In the US, category 4 has been adopted.
- The WWFC improves air quality by lowering emissions in vehicle fleets, and customer satisfaction through better performance.

### ■ Lexus recommends the use of gasoline containing detergent additives

- Lexus recommends the use of gasoline that contains detergent additives to avoid build-up of engine deposits.
- All gasoline sold in the U.S.A. contains minimum detergent additives to clean and/or keep clean intake systems, per EPA's lowest additives concentration program.
- Lexus strongly recommends the use of Top Tier Detergent Gasoline. For more information on Top Tier Detergent Gasoline and a list of marketers, please go to the official website [www.toptiergas.com](http://www.toptiergas.com).

### ■ Lexus recommends the use of cleaner burning gasoline

Cleaner burning gasoline, including reformulated gasoline that contains oxygenates such as ethanol or MTBE (Methyl Tertiary Butyl Ether) is available in many areas.

Lexus recommends the use of cleaner burning gasoline and appropriately blended reformulated gasoline. These types of gasoline provide excellent vehicle performance, reduce vehicle emissions and improve air quality.

### ■ Lexus does not recommend blended gasoline

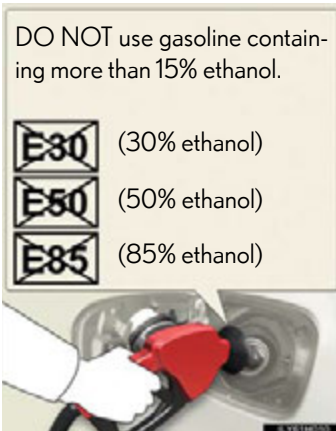

- Use only gasoline containing up to 15% ethanol.

DO NOT use any flex-fuel or gasoline that could contain more than 15% ethanol, including from any pump labeled E30, E50, E85 (which are only some examples of fuel containing more than 15% ethanol).

- If you use gasohol in your Lexus, be sure that it has an octane rating no lower than 87.
- Lexus DOES NOT recommend the use of gasoline containing methanol.

### ■ Lexus does not recommend gasoline containing MMT

Some gasoline contains octane enhancing additive called MMT (Methylcyclopentadienyl Manganese Tricarbonyl).

Lexus DOES NOT recommend the use of gasoline that contains MMT. If fuel containing MMT is used, your emission control system may be adversely affected.

The malfunction indicator lamp on the instrument cluster may come on. If this happens, contact your Lexus dealer for service.

### NOTICE

#### ■ Notice on fuel quality

- Do not use improper fuels. If improper fuels are used, the engine will be damaged.
- Do not use leaded gasoline.  
Leaded gasoline can cause damage to your vehicle's three-way catalytic converters causing the emission control system to malfunction.
- Do not use gasohol other than that stated here.  
Other gasohol may cause fuel system damage or vehicle performance problems.
- Using unleaded gasoline with an octane number or rating lower than that stated here will cause persistent heavy knocking.  
At worst, this will lead to engine damage.

#### ■ Fuel-related poor driveability

If after using a different type of fuel, poor driveability is encountered (poor hot starting, vaporization, engine knocking, etc.), discontinue the use of that type of fuel.

#### ■ When refueling with gasohol

Take care not to spill gasohol. It can damage your vehicle's paint.

## 6-1. Specifications

# Tire information

### Typical tire symbols

#### ► Standard tire



#### ► Compact spare tire

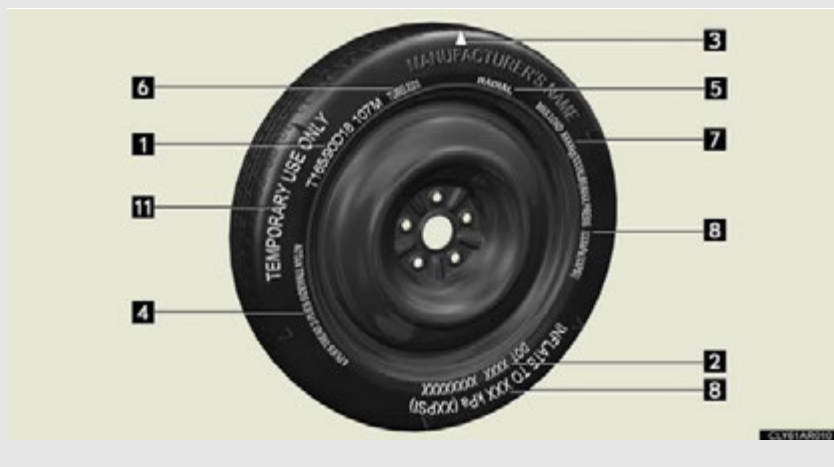

- 1** Tire size (→P. 815)
- 2** DOT and Tire Identification Number (TIN) (→P. 815)
- 3** Location of treadwear indicators (→P. 670)
- 4** Tire ply composition and materials  
Plies are layers of rubber-coated parallel cords. Cords are the strands which form the plies in a tire.
- 5** Radial tires or bias-ply tires  
A radial tire has “RADIAL” on the sidewall. A tire not marked “RADIAL” is a bias-ply tire.
- 6** TUBELESS or TUBE TYPE  
A tubeless tire does not have a tube and air is directly put into the tire. A tube type tire has a tube inside the tire and the tube maintains the air pressure.
- 7** Load limit at maximum cold tire inflation pressure (→P. 674)
- 8** Maximum cold tire inflation pressure (→P. 807)  
This means the pressure to which a tire may be inflated.
- 9** Uniform tire quality grading  
For details, see “Uniform tire quality grading” that follows.
- 10** Summer tire or all season tire (→P. 674)  
An all season tire has “M+S” on the sidewall. A tire not marked “M+S” is a summer tire.
- 11** “TEMPORARY USE ONLY” (→P. 772)  
A compact spare tire is identified by the phrase “TEMPORARY USE ONLY” molded on its sidewall. This tire is designed for temporary emergency use only.

## Typical DOT and tire identification number (TIN)

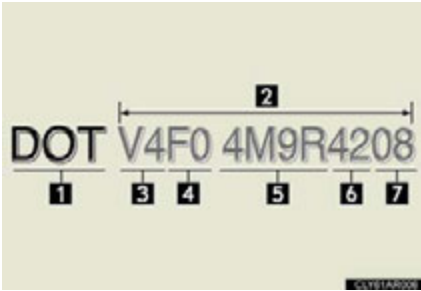

- 1 DOT symbol\*
- 2 Tire Identification Number (TIN)
- 3 Tire manufacturer's identification mark
- 4 Tire size code
- 5 Manufacturer's optional tire type code (3 or 4 letters)
- 6 Manufacturing week
- 7 Manufacturing year

\*:The DOT symbol certifies that the tire conforms to applicable Federal Motor Vehicle Safety Standards.

## Tire size

### Typical tire size information

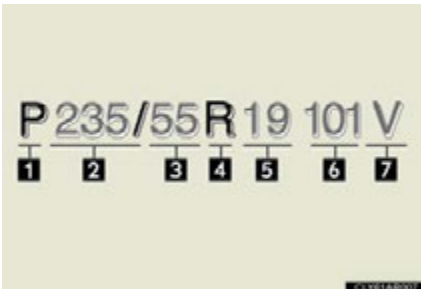

The illustration indicates typical tire size.

- 1 Tire use  
(P = Passenger car,  
T = Temporary use)
- 2 Section width (millimeters)
- 3 Aspect ratio  
(tire height to section width)
- 4 Tire construction code  
(R = Radial, D = Diagonal)
- 5 Wheel diameter (inches)
- 6 Load index (2 digits or 3 digits)
- 7 Speed symbol  
(alphabet with one letter)



■ Tire dimensions



- 1 Section width
- 2 Tire height
- 3 Wheel diameter

Tire section names

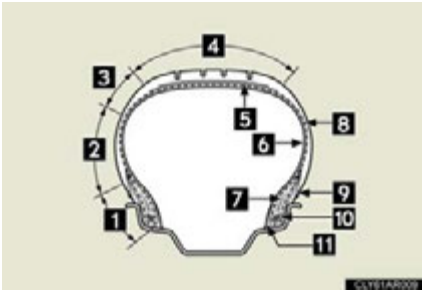

- 1 Bead
- 2 Sidewall
- 3 Shoulder
- 4 Tread
- 5 Belt
- 6 Inner liner
- 7 Reinforcing rubber
- 8 Carcass
- 9 Rim lines
- 10 Bead wires
- 11 Chafer

## Uniform Tire Quality Grading

This information has been prepared in accordance with regulations issued by the National Highway Traffic Safety Administration of the U.S. Department of Transportation.

It provides the purchasers and/or prospective purchasers of Lexus vehicles with information on uniform tire quality grading.

Your Lexus dealer will help answer any questions you may have as you read this information.

### ■ DOT quality grades

All passenger vehicle tires must conform to Federal Safety Requirements in addition to these grades. Quality grades can be found where applicable on the tire sidewall between tread shoulder and maximum section width.

For example: Treadwear 200 Traction AA Temperature A

### ■ Treadwear

The treadwear grade is a comparative rating based on the wear rate of the tire when tested under controlled conditions on a specified government test course.

For example, a tire graded 150 would wear one and a half (1 - 1/2) times as well on the government course as a tire graded 100.

The relative performance of tires depends upon the actual conditions of their use, however, and may depart significantly from the norm due to variations in driving habits, service practices and differences in road characteristics and climate.

### ■ Traction AA, A, B, C

The traction grades, from highest to lowest, are AA, A, B and C, and they represent the tire's ability to stop on wet pavement as measured under controlled conditions on specified government test surfaces of asphalt and concrete.

A tire marked C may have poor traction performance.

Warning: The traction grade assigned to this tire is based on braking (straight ahead) traction tests and does not include cornering (turning) traction.

### ■ Temperature A, B, C

The temperature grades are A (the highest), B, and C, representing the tire's resistance to the generation of heat and its ability to dissipate heat when tested under controlled conditions on a specified indoor laboratory test wheel.

Sustained high temperature can cause the material of the tire to degenerate and reduce tire life, and excessive temperature can lead to sudden tire failure.

The grade C corresponds to a level of performance which all passenger car tires must meet under the Federal Motor Vehicle Safety Standard No. 109.

Grades B and A represent higher levels of performance on the laboratory test wheel than the minimum required by law.

Warning: The temperature grades for this tire are established for a tire that is properly inflated and not overloaded.

Excessive speed, underinflation, or excessive loading, either separately or in combination, can cause heat buildup and possible tire failure.

## Glossary of tire terminology

Tire related term	Meaning
Cold tire inflation pressure	Tire pressure when the vehicle has been parked for three hours or more, or has not been driven more than 1 mile or 1.5 km under that condition
Maximum inflation pressure	The maximum cold inflated pressure to which a tire may be inflated, shown on the sidewall of the tire
Recommended inflation pressure	Cold tire inflation pressure recommended by a manufacturer
Accessory weight	The combined weight (in excess of those standard items which may be replaced) of hybrid transmission, power steering, power brakes, power windows, power seats, radio and heater, to the extent that these items are available as factory-installed equipment (whether installed or not)
Curb weight	The weight of a motor vehicle with standard equipment, including the maximum capacity of fuel, oil and coolant, and if so equipped, air conditioning and additional weight optional engine
Maximum loaded vehicle weight	The sum of: (a) Curb weight (b) Accessory weight (c) Vehicle capacity weight (d) Production options weight
Normal occupant weight	150 lb. (68 kg) times the number of occupants specified in the second column of Table 1* that follows

## 6-1. Specifications

Tire related term	Meaning
Occupant distribution	Distribution of occupants in a vehicle as specified in the third column of Table 1* below
Production options weight	The combined weight of installed regular production options weighing over 5 lb. (2.3 kg) in excess of the standard items which they replace, not previously considered in curb weight or accessory weight, including heavy duty brakes, ride levelers, roof rack, heavy duty 12-volt battery, and special trim
Rim	A metal support for a tire or a tire and tube assembly upon which the tire beads are seated
Rim diameter (Wheel diameter)	Nominal diameter of the bead seat
Rim size designation	Rim diameter and width
Rim type designation	The industry manufacturer's designation for a rim by style or code
Rim width	Nominal distance between rim flanges
Vehicle capacity weight (Total load capacity)	The rated cargo and luggage load plus 150 lb. (68 kg) times the vehicle's designated seating capacity
Vehicle maximum load on the tire	The load on an individual tire that is determined by distributing to each axle its share of the maximum loaded vehicle weight, and dividing by two
Vehicle normal load on the tire	The load on an individual tire that is determined by distributing to each axle its share of curb weight, accessory weight, and normal occupant weight (distributed in accordance with Table 1* below), and dividing by two
Weather side	The surface area of the rim not covered by the inflated tire

Tire related term	Meaning
Bead	The part of the tire that is made of steel wires, wrapped or reinforced by ply cords and that is shaped to fit the rim
Bead separation	A breakdown of the bond between components in the bead
Bias ply tire	A pneumatic tire in which the ply cords that extend to the beads are laid at alternate angles substantially less than 90 degrees to the centerline of the tread
Carcass	The tire structure, except tread and sidewall rubber which, when inflated, bears the load
Chunking	The breaking away of pieces of the tread or sidewall
Cord	The strands forming the plies in the tire
Cord separation	The parting of cords from adjacent rubber compounds
Cracking	Any parting within the tread, sidewall, or innerliner of the tire extending to cord material
CT	A pneumatic tire with an inverted flange tire and rim system in which the rim is designed with rim flanges pointed radially inward and the tire is designed to fit on the underside of the rim in a manner that encloses the rim flanges inside the air cavity of the tire
Extra load tire	A tire designed to operate at higher loads and at higher inflation pressures than the corresponding standard tire
Groove	The space between two adjacent tread ribs
Innerliner	The layer(s) forming the inside surface of a tubeless tire that contains the inflating medium within the tire
Innerliner separation	The parting of the innerliner from cord material in the carcass

Tire related term	Meaning
Intended outboard sidewall	(a) The sidewall that contains a whitewall, bears white lettering, or bears manufacturer, brand, and/or model name molding that is higher or deeper than the same molding on the other sidewall of the tire, or (b) The outward facing sidewall of an asymmetrical tire that has a particular side that must always face outward when mounted on a vehicle
Light truck (LT) tire	A tire designated by its manufacturer as primarily intended for use on lightweight trucks or multipurpose passenger vehicles
Load rating	The maximum load that a tire is rated to carry for a given inflation pressure
Maximum load rating	The load rating for a tire at the maximum permissible inflation pressure for that tire
Maximum permissible inflation pressure	The maximum cold inflation pressure to which a tire may be inflated
Measuring rim	The rim on which a tire is fitted for physical dimension requirements
Open splice	Any parting at any junction of tread, sidewall, or innerliner that extends to cord material
Outer diameter	The overall diameter of an inflated new tire
Overall width	The linear distance between the exteriors of the sidewalls of an inflated tire, including elevations due to labeling, decorations, or protective bands or ribs
Passenger car tire	A tire intended for use on passenger cars, multipurpose passenger vehicles, and trucks, that have a gross vehicle weight rating (GVWR) of 10,000 lb. or less.
Ply	A layer of rubber-coated parallel cords

Tire related term	Meaning
Ply separation	A parting of rubber compound between adjacent plies
Pneumatic tire	A mechanical device made of rubber, chemicals, fabric and steel or other materials, that, when mounted on an automotive wheel, provides the traction and contains the gas or fluid that sustains the load
Radial ply tire	A pneumatic tire in which the ply cords that extend to the beads are laid at substantially 90 degrees to the centerline of the tread
Reinforced tire	A tire designed to operate at higher loads and at higher inflation pressures than the corresponding standard tire
Section width	The linear distance between the exteriors of the sidewalls of an inflated tire, excluding elevations due to labeling, decoration, or protective bands
Sidewall	That portion of a tire between the tread and bead
Sidewall separation	The parting of the rubber compound from the cord material in the sidewall
Snow tire	A tire that attains a traction index equal to or greater than 110, compared to the ASTM E-1136 Standard Reference Test Tire, when using the snow traction test as described in ASTM F-1805-00, Standard Test Method for Single Wheel Driving Traction in a Straight Line on Snow- and Ice-Covered Surfaces, and which is marked with an Alpine Symbol (  ) on at least one sidewall
Test rim	The rim on which a tire is fitted for testing, and may be any rim listed as appropriate for use with that tire



Tire related term	Meaning
Tread	That portion of a tire that comes into contact with the road
Tread rib	A tread section running circumferentially around a tire
Tread separation	Pulling away of the tread from the tire carcass
Treadwear indicators (TWI)	The projections within the principal grooves designed to give a visual indication of the degrees of wear of the tread
Wheel-holding fixture	The fixture used to hold the wheel and tire assembly securely during testing

\*: Table 1— Occupant loading and distribution for vehicle normal load for various designated seating capacities

Designated seating capacity, Number of occupants	Vehicle normal load, Number of occupants	Occupant distribution in a normally loaded vehicle
2 through 4	2	2 in front
5 through 10	3	2 in front, 1 in second seat
11 through 15	5	2 in front, 1 in second seat, 1 in third seat, 1 in fourth seat
16 through 20	7	2 in front, 2 in second seat, 2 in third seat, 1 in fourth seat

# Customizable features

Your vehicle includes a variety of electronic features that can be personalized to suit your preferences. Programming of these preferences can be performed by your Lexus dealer.

It is also possible to customize certain vehicle features yourself using the multi-information switches, the navigation system screen or the Display Audio system screen.

Some function settings are changed simultaneously with other functions being customized. Contact your Lexus dealer for further details.

### Customizing vehicle features

It is possible to customize certain vehicle features using the multi-information switches.\*

\*: For instructions on customizing vehicle features using the navigation system screen, refer to the “Navigation System Owner’s Manual”.

For instructions on customizing vehicle features using the Display Audio system screen: →P. 337

When customizing vehicle features, ensure that the vehicle is parked in a safe place with the shift lever in P and the parking brake set.

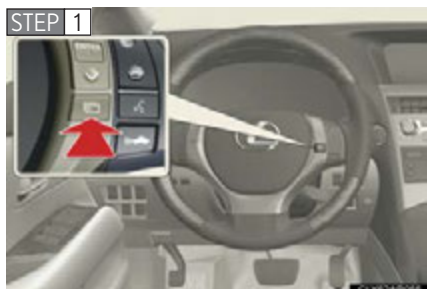

Press and hold the menu switch of the multi-information switches to display customize mode.



- 1 Press the “^” or “v” switch to select the item to be customized.
- 2 Press the “ENTER” switch to confirm.



- 1 Press the “^” or “v” switch to select the desired setting for the item being customized.
- 2 Press the “ENTER” switch to confirm.

When customization is completed, press the menu switch to clear the customization screen.

### Customizable Features

- 1 Vehicles with a Display Audio system: Settings that can be changed using the Display Audio system
  - 2 Vehicles with a Display Audio system: Settings that can be changed using the multi-information switches
  - 3 Vehicles with a navigation system: Settings that can be changed using the screen of the navigation system
  - 4 Vehicles with a navigation system: Settings that can be changed using the multi-information switches
  - 5 Vehicles without a Display Audio system and navigation system: Settings that can be changed using the multi-information switches
  - 6 Settings that can be changed by your Lexus dealer
- Definition of symbols: O = Available, – = Not available

## ► Door lock (→P. 72, 781)

Function	Default setting	Customized setting	1	2	3	4	5	6
Unlocking using a key	Driver's door unlocked in one step, all doors unlocked in two steps	All doors unlocked in one step	-	-	○	-	-	○
Speed-detecting automatic door lock function	Off	On	○	-	○	-	○	○
Shifting gears to position other than P locks all doors	On	Off	○	-	○	-	○	○
Shifting gears to P unlocks all doors	On	Off	○	-	○	-	○	○
Opening driver's door unlocks all doors	Off	On	○	-	○	-	○	○

► Smart access system with push-button start and wireless remote control (→P. 56, 69)

Function	Default setting	Customized setting	1	2	3	4	5	6
Operation buzzer volume	Level 7	Off to level 6	○	-	○	-	○	○
Operation signal (buzzer)	On	Off	○	-	○	-	○	○
Operation signal (emergency flashers)	On	Off	○	-	○	-	○	○
Open door warning buzzer	On	Off	-	-	-	-	-	○
Time elapsed before the automatic door lock function is activated if a door is not opened after being unlocked	60 seconds	Off						
		30 seconds	○	-	○	-	○	○
		120 seconds						
Smart door unlocking	Driver's door	All the doors	○	-	○	-	○	○
Smart access system with push-button start	On	Off	○	-	○	-	○	○

## ▶ Power back door (→P. 75)

Function	Default setting	Customized setting	1	2	3	4	5	6
Power back door opening operation using the back door opener button	On	Off	-	-	-	-	-	○

## ▶ Wireless remote control (→P. 69)

Function	Default setting	Customized setting	1	2	3	4	5	6
Unlocking operation	Driver's door unlocked in one step, all doors unlocked in two steps	All doors unlocked in one step	○	-	○	-	○	○
Panic function	On	Off	-	-	-	-	-	○

► Automatic light control system (→P. 217)

Function	Default setting	Customized setting	1	2	3	4	5	6
Time elapsed before the headlights turn off	30 seconds	Off						
		60 seconds	○	-	○	-	○	○
		90 seconds						
Light sensor sensitivity	Standard	-2 to 2	○	-	○	-	○	○
Light reminder buzzer	On	Off	-	-	-	-	-	○
Daytime running light system (except for Canada)	On	Off	○	-	○	-	○	○

## ► Illumination(→P. 582)

Function	Default setting	Customized setting	1	2	3	4	5	6
Time elapsed before the interior lights turn off	15 seconds	7.5 seconds	○	-	○	-	○	○
		30 seconds						
Time elapsed before the exterior lights turn off	15 seconds	7.5 seconds	○	-	○	-	○	○
		30 seconds						
Operation when the doors are unlocked	On	Off	-	-	-	-	-	○
Operation after the "POWER" switch turned off	On	Off	-	-	-	-	-	○
Operation when you approach the vehicle with the electronic key on your person	On	Off	-	-	-	-	-	○
Wireless remote control linked exterior lights when the surrounding area is dark	On	Off	-	-	-	-	-	○
Interior light control	On	Off	○	-	○	-	○	○
Exterior light control	On	Off	○	-	○	-	○	○
Shift lever lights	On	Off	-	-	-	-	-	○



▶ Seat belt reminder (→P. 736)

Function	Default setting	Customized setting	1	2	3	4	5	6
Vehicle speed linked seat belt reminder buzzer	On	Off	-	-	-	-	-	○

▶ Automatic air conditioning system (→P. 342, 350)

Function	Default setting	Customized setting	1	2	3	4	5	6
A/C auto switch operation	Auto	Manual	○	-	○	-	-	○
Exhaust gas sensor sensitivity	Standard	-3 to 3	○	-	○	-	-	○

## ► Driving position memory (→P. 93)

Function	Default setting	Customized setting	1	2	3	4	5	6
Driver's seat movement when exiting the vehicle (on some models)	Full	Off	○	-	○	-	○	○
		Partial						
Selecting whether the driver's door or all doors are linked to the power easy access system	Driver's door	All the doors	-	-	-	-	-	○

## ► Meter (→P. 197)

Function	Default setting	Customized setting	1	2	3	4	5	6
ECO lamp	On (Turns on/off according to driving conditions)	On (Stays on)	-	○	-	○	○	○
		Off (Stays off)						
SPORT lamp	On	Off	-	○	-	○	○	○

## ▶ Power windows (→P. 112)

Function	Default setting	Customized setting	1	2	3	4	5	6
Mechanical key linked operation	On	Off	-	-	-	-	-	○
Wireless remote control linked opening	On	Off	-	-	-	-	-	○
Wireless remote control linked opening buzzer	On	Off	-	-	-	-	-	○

## ▶ Moon roof (→P. 115)

Function	Default setting	Customized setting	1	2	3	4	5	6
Mechanical key linked operation	On	Off	-	-	-	-	-	○
Wireless remote control linked opening	On	Off	-	-	-	-	-	○
Linked operation of components when door key is used	Slide only	Tilt only	-	-	-	-	-	○
Linked operation of components when wireless remote control is used	Slide only	Tilt only	-	-	-	-	-	○

## ▶ Turn signal lever (→P.193)

Function	Default setting	Customized setting	1	2	3	4	5	6
Times of flashing of the lane change signal flashers	3	5						
		7						
		9	-	-	○	-	-	○
		11						
		Off						

## ▶ Intuitive parking assist (→P.248)

Function	Default setting	Customized setting	1	2	3	4	5	6
Buzzer volume	3	1 to 5	○	-	○	-	-	○
Detection distance of the front center sensors	Far	Near	○	-	○	-	-	○
Detection distance of the rear center sensors	Far	Near	○	-	○	-	-	○
Display setting (when intuitive parking assist is operating)	All sensors displayed	No sensors displayed	○	-	○	-	-	○

## Multi-information display (→P. 206)

Settings that can be changed using the multi-information switches

Available languages	English, French and Spanish
Available units	miles (MPG), km (km/L), km (L/100 km)

■ In the following situations, customize mode will automatically be turned off.

- A warning message appears after the customize mode screen is displayed.
- The “POWER” switch is turned off.
- The vehicle begins to move while the customize mode screen is displayed.

### CAUTION

#### ■ Cautions during customization

As the hybrid system needs to be operating during customization, ensure that the vehicle is parked in a place with adequate ventilation. In a closed area such as a garage, exhaust gases including harmful carbon monoxide (CO) may collect and enter the vehicle. This may lead to death or a serious health hazard.

### NOTICE

#### ■ During customization

To prevent 12-volt battery discharge, ensure that the hybrid system is operating while customizing features.



## 6-3. Initialization

### Items to initialize

The following items must be initialized for normal system operation in cases such as after the 12-volt battery is reconnected, or maintenance is performed on the vehicle.

Item	When to initialize	Reference
Power back door	<ul style="list-style-type: none"><li>• After reconnecting or changing the 12-volt battery</li><li>• After changing a fuse</li></ul>	P. 75
Maintenance data (U.S.A. only)	After the maintenance is performed	P. 641
Tire pressure warning system	<ul style="list-style-type: none"><li>• When rotating the tires</li><li>• When changing tire pressure (such as when changing traveling speed, load weight, etc.)</li><li>• When changing the tire size</li></ul>	P. 671





Reporting safety defects for U.S. owners.....	840
Seat belt instructions for Canadian owners (in French).....	841
SRS airbag instructions for Canadian owners (in French).....	843
Headlight aim instructions for Canadian owners (in French).....	852

## Reporting safety defects for U.S. owners

If you believe that your vehicle has a defect which could cause a crash or could cause injury or death, you should immediately inform the National Highway Traffic Safety Administration (NHTSA) in addition to notifying the Lexus Division of Toyota Motor Sales, U.S.A., Inc. (Toll-free: 1-800-25-LEXUS).

If NHTSA receives similar complaints, it may open an investigation, and if it finds that a safety defect exists in a group of vehicles, it may order a recall and remedy campaign. However, NHTSA cannot become involved in individual problems between you, your dealer, or Lexus Division of Toyota Motor Sales, U.S.A., Inc.

To contact NHTSA, you may call the Vehicle Safety Hotline toll-free at 1-888-327-4236 (TTY: 1-800-424-9153); go to <http://www.safercar.gov>; or write to: Administrator, NHTSA, 1200 New Jersey Ave, S.E., Washington, DC 20590. You can also obtain other information about motor vehicle safety from <http://www.safercar.gov>.

## Seat belt instructions for Canadian owners (in French)

The following is a French explanation of seat belt instructions extracted from the seat belt section in this manual.

See the seat belt section for more detailed seat belt instructions in English.

### Utilisation correcte des ceintures de sécurité



- Déroulez la sangle diagonale de telle sorte qu'elle passe bien sur l'épaule, sans pour autant être en contact avec votre cou ou glisser de votre épaule.
- Placez la sangle abdominale le plus bas possible sur les hanches.
- Réglez la position du dossier de siège. Asseyez-vous le dos le plus droit possible et caliez-vous bien dans le siège.
- Ne vrillez pas la ceinture de sécurité.

## Entretien et soin

### ■ Ceintures de sécurité

Nettoyez avec un chiffon ou une éponge humectée d'eau savonneuse tiède. Profitez de l'occasion pour vérifier régulièrement que les ceintures ne sont pas effilochées, entaillées, ou ne paraissent pas exagérément usées.

### ATTENTION

#### ■ Détérioration et usure des ceintures de sécurité

Inspectez les ceintures de sécurité périodiquement. Contrôlez qu'elles ne sont pas entaillées, effilochées, et que leurs ancrages ne sont pas desserrés. N'utilisez pas une ceinture de sécurité défectueuse avant qu'elle ne soit remplacée. Une ceinture de sécurité défectueuse n'apporte aucune garantie de protection de l'occupant en cas d'accident.

## SRS airbag instructions for Canadian owners (in French)

The following is a French explanation of SRS airbag instructions extracted from the SRS airbag section in this manual.

See the SRS airbag section for more detailed SRS airbag instructions in English.

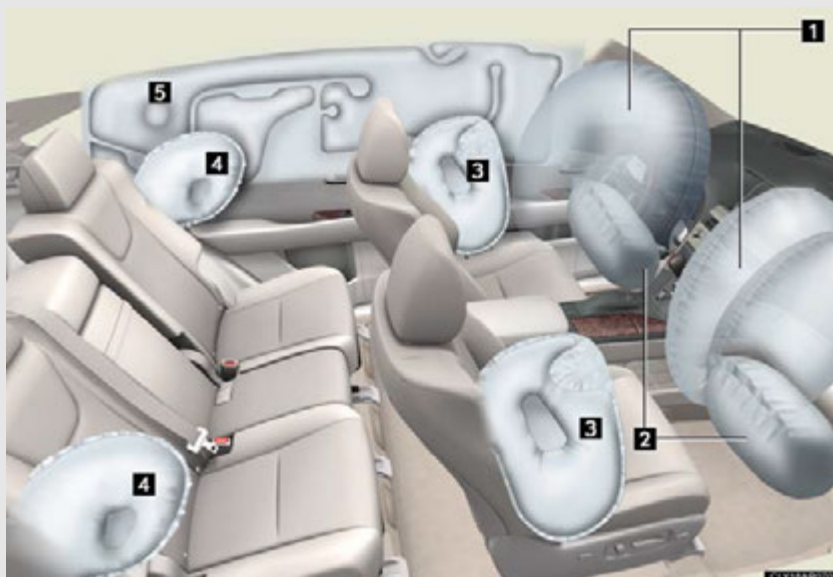

### ► Coussins gonflables SRS frontaux

- 1** Le coussin gonflable SRS conducteur/le coussin gonflable du passager avant

Participent à la protection de la tête et du thorax du conducteur et du passager avant contre les chocs contre les éléments de l'habitacle

- 2** Coussins gonflables SRS de genoux

Participent à la protection du conducteur et du passager avant

- ▶ Coussins gonflables SRS latéraux et rideaux
- 3 Coussins gonflables SRS latéraux avant  
Peuvent aider à protéger le torse des passagers avant
- 4 Coussins gonflables SRS latéraux arrière  
Peuvent aider à protéger le torse des passagers dans les sièges arrière extérieurs
- 5 Coussins gonflables SRS rideaux
  - Participent principalement à la protection de la tête des occupants assis aux places extérieures
  - Peuvent contribuer à empêcher les occupants d'être éjectés du véhicule en cas de tonneau

## Composition du système de coussin gonflable SRS

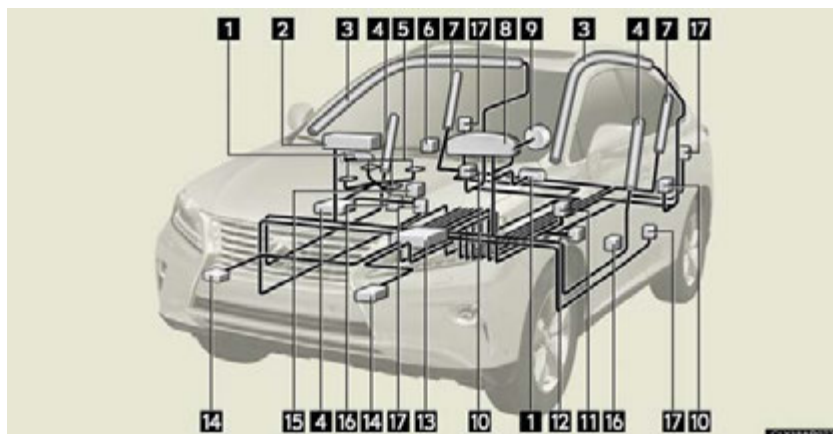

- |  |   |
|--|---|
| <b>1</b> Coussins gonflables de genoux   | <b>10</b> Capteurs de coussins gonflables rideaux et arrière              |
| <b>2</b> Coussin gonflable du passager avant   | <b>11</b> Commutateur de boucle de ceinture de sécurité conducteur        |
| <b>3</b> Coussins gonflables rideaux   | <b>12</b> Capteur de position du siège conducteur                         |
| <b>4</b> Coussins gonflables latéraux avant  | <b>13</b> Capteur de coussin gonflable                                    |
| <b>5</b> Système de classification de l'occupant du siège passager avant (ECU et capteurs) | <b>14</b> Capteurs de coussin gonflable frontal                           |
| <b>6</b> Témoins indicateurs "AIR BAG ON" et "AIR BAG OFF"                                 | <b>15</b> Commutateur de boucle de ceinture de sécurité du passager avant |
| <b>7</b> Coussins gonflables latéraux arrière  | <b>16</b> Capteurs de porte   |
| <b>8</b> Témoin d'avertissement SRS  | <b>17</b> Prétensionneurs de ceintures de sécurité et limiteurs de force  |
| <b>9</b> Coussin gonflable conducteur  |   |

Votre véhicule est équipé de COUSSINS GONFLABLES INTELLIGENTS conçus selon les normes de sécurité américaines applicables aux véhicules à moteur (FMVSS208). Le boîtier électronique (ECU) des coussins gonflables régule le déploiement de ces derniers sur la base des informations qu'il reçoit des capteurs, etc., indiqués ci-dessus dans le schéma illustrant les composants du système. Parmi ces informations figurent la gravité du choc et l'occupation du véhicule par les passagers. Le déploiement rapide des coussins gonflables est obtenu au moyen d'une réaction chimique dans les dispositifs pyrotechniques, qui produit un gaz inoffensif permettant d'amortir le mouvement des occupants.



## ATTENTION

### ■ Précautions avec les coussins gonflables SRS

Respectez les précautions suivantes avec les coussins gonflables SRS. Autrement, des blessures graves, voire mortelles, pourraient s'ensuivre.

- Le conducteur et les passagers du véhicule doivent porter correctement leur ceinture de sécurité.  
Les coussins gonflables SRS sont des dispositifs supplémentaires à utiliser avec les ceintures de sécurité.
- Le coussin gonflable SRS conducteur se déploie avec une violence considérable, qui peut être très dangereuse, voire mortelle, si le conducteur se trouve très près du coussin gonflable. L'autorité fédérale chargée de la sécurité routière aux États-Unis, la "NHTSA" (National Highway Traffic Safety Administration) conseille:

La zone à risque du coussin gonflable conducteur se situant dans les premiers 2 à 3 in. (50 - 75 mm) de déploiement, vous placer à 10 in. (250 mm) de votre coussin gonflable conducteur vous garantit une marge de sécurité suffisante. Cette distance est à mesurer entre l'axe du volant et le sternum. Si vous êtes assis à moins de 10 in. (250 mm), vous pouvez changer votre position de conduite de plusieurs façons:

- Reculez votre siège le plus possible, de manière à pouvoir encore atteindre confortablement les pédales.
- Inclinez légèrement le dossier du siège.  
Bien que les véhicules puissent être différents les uns des autres, la plupart des conducteurs peuvent s'asseoir à une distance de 10 in. (250 mm), même avec le siège conducteur complètement avancé, simplement en inclinant un peu le dossier de siège. Si vous avez des difficultés à voir la route après avoir incliné votre siège, utilisez un coussin ferme et antidérapant pour vous rehausser ou, si votre véhicule est équipé du réglage en hauteur du siège, remontez-le.
- Si votre volant est réglable, inclinez-le vers le bas. Cela a pour effet d'orienter le coussin gonflable en direction de votre poitrine plutôt que de votre tête et de votre cou.

Régalez votre siège selon ces recommandations de la NHTSA, tout en conservant le contrôle des pédales, du volant et la vue des commandes du tableau de bord.

## ATTENTION

### ■ Précautions avec les coussins gonflables SRS



- Si vous attachez une rallonge de ceinture de sécurité aux boucles de ceinture de sécurité avant, mais pas au pêne de la ceinture de sécurité, les coussins gonflables SRS frontaux détectent que le conducteur et le passager avant ont attaché leur ceinture de sécurité, alors même que ce n'est pas le cas. Dans ce cas, il se peut que les coussins gonflables SRS frontaux ne se déploient pas correctement en cas d'accident et vous risquez d'être tué ou grièvement blessé. Veillez à porter la ceinture de sécurité avec la rallonge de ceinture de sécurité.
- Le coussin gonflable SRS passager avant se déploie également avec une violence considérable, qui peut être très dangereuse, voire mortelle, si le passager avant se trouve très près du coussin gonflable. Éloignez le siège passager avant au maximum du coussin gonflable et réglez le dossier de siège de façon à être assis bien droit dans le siège.
- Les nourrissons et les enfants qui ne sont pas correctement assis et/ou protégés peuvent être grièvement blessés ou tués par le déploiement d'un coussin gonflable. Installez dans un siège de sécurité enfant les enfants trop jeunes pour pouvoir utiliser la ceinture de sécurité. Lexus recommande vivement d'installer tous les nourrissons et enfants sur les sièges arrière du véhicule et de prévoir pour eux des systèmes de retenue adaptés. Les sièges arrière sont plus sûrs pour les nourrissons et les enfants que le siège passager avant.
- N'installez jamais un siège de sécurité enfant type dos à la route sur le siège du passager avant, même si le témoin indicateur "AIR BAG OFF" est allumé. En cas d'accident, la force de déploiement rapide du coussin gonflable du passager avant peut grièvement, voire mortellement blesser l'enfant si le siège de sécurité enfant type dos à la route est installé sur le siège du passager avant.

## ⚠ ATTENTION

### ■ Précautions avec les coussins gonflables SRS



- Ne vous asseyez pas sur le bord du siège et ne vous appuyez pas contre le tableau de bord.



- Ne laissez pas un enfant rester debout devant le coussin gonflable SRS passager avant ou bien s'asseoir sur les genoux du passager avant.

- Ne laissez pas les occupants des sièges avant voyager avec un objet sur les genoux.



- Ne vous appuyez pas contre la porte, contre le rail latéral de toit ou contre les montants avant, latéraux et arrière.



- Ne laissez personne s'agenouiller sur les sièges passagers en appui contre la porte ou sortir la tête ou les mains à l'extérieur du véhicule.

## ATTENTION

### ■ Précautions avec les coussins gonflables SRS



- Ne rien fixer ou appuyer contre les zones telles que le tableau de bord, le volant ou des zones inférieures du tableau de bord. Ces éléments pourraient devenir des projectiles dans le cas du déploiement des coussins gonflables du conducteur SRS, passager avant et genoux.
  - Ne fixez rien aux portes, à la vitre du pare-brise, aux vitres latérales, aux montants avant et arrière, au rail latéral de toit et à la poignée d'assistance.
  - Ne suspendez aucun cintre nu ni objet dur aux crochets à vêtements. En cas de déploiement des coussins gonflables SRS rideaux, tous ces objets pourraient se transformer en projectiles et causer des blessures graves, voire mortelles.
- Si un cache en vinyle est mis dans la zone où les coussins gonflables SRS de genoux se déploie, assurez-vous de l'enlever.
  - N'utilisez aucun accessoire de siège venant recouvrir les zones de déploiement des coussins gonflables SRS latéraux, car il risquerait d'en gêner le déploiement. De tels accessoires peuvent empêcher les coussins gonflables latéraux de fonctionner correctement, désactiver le dispositif ou entraîner le déploiement accidentel des coussins gonflables latéraux, ce qui pourrait entraîner la mort ou des blessures graves.
  - Évitez de faire subir des chocs ou des pressions excessives aux zones renfermant les composants des coussins gonflables SRS. En effet, cela pourrait entraîner un fonctionnement anormal des coussins gonflables SRS.
  - Ne touchez aucun composant du système immédiatement après le déploiement (gonflage) des coussins gonflables SRS, car ils peuvent être chauds.

## ATTENTION

### ■ Précautions avec les coussins gonflables SRS

- Si vous avez des difficultés à respirer après le déploiement des coussins gonflables SRS, ouvrez une porte ou une vitre pour faire entrer de l'air frais, ou bien descendez du véhicule si cela ne présente pas de danger. Essayez tout résidu dès que possible afin d'éviter d'éventuelles irritations de la peau.
- Si les parties renfermant les coussins gonflables SRS, telles que la garniture du moyeu de volant et les garnitures de montants avant et arrière, apparaissent abîmées ou craquelées, faites-les remplacer par votre concessionnaire Lexus.
- Ne placez rien sur le siège du passager avant, comme un coussin par exemple. Cela a pour conséquence de répartir le poids du passager sur toute la surface du siège, ce qui empêche le capteur de détecter correctement le poids du passager. En conséquence, le coussin gonflable SRS du passager avant risque de ne pas se déployer en cas de choc.

### ■ Modification et mise au rebut des éléments du système de coussin gonflable SRS

Consultez impérativement votre concessionnaire Lexus si vous avez besoin d'intervenir sur votre véhicule, de vous en séparer ou de procéder à l'une des modifications suivantes.

Les coussins gonflables SRS peuvent ne pas fonctionner correctement ou se déployer (se gonfler) accidentellement, provoquant la mort ou de graves blessures.

- Installation, dépose, démontage et réparation des coussins gonflables SRS
- Réparations, modifications, démontage ou remplacement du volant, du tableau de bord, de la planche de bord, des sièges ou de leur garniture, des montants avant, latéraux et arrière ou des rails latéraux de toit
- Réparations ou modifications des ailes avant, du pare-chocs avant ou des flancs de l'habitacle
- Installation d'un protège-calandre (pare-buffle, pare-kangourou, etc.), de chasse-neiges ou de treuils
- Modifications des suspensions du véhicule
- Installation d'appareils électroniques tels que radio émetteur/récepteur ou lecteurs CD
- Aménagements du véhicule visant à permettre sa conduite par une personne atteinte d'un handicap physique

# Headlight aim instructions for Canadian owners (in French)\*

The following is a French explanation of headlight aim instructions from the headlight aim section in this manual.

## ■ Dépose des habillages du compartiment moteur

### ► Extérieur



### ► Avant



\*: Vehicles without LED headlights

## ■ Vis de réglage dans l'axe vertical

### ► Véhicules équipés de projecteurs à halogène

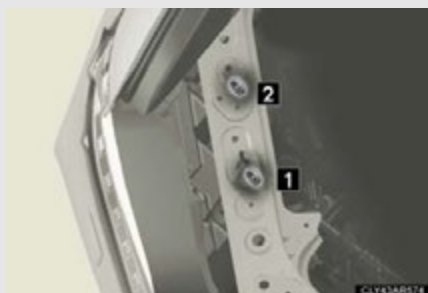

1 Vis de réglage A

2 Vis de réglage B

### ► Véhicules équipés de projecteurs à décharge



1 Vis de réglage A

2 Vis de réglage B

## ■ Avant de vérifier le réglage du faisceau des phares

**ÉTAPE 1** Vérifiez que le réservoir de carburant du véhicule est plein et que la carrosserie autour des projecteurs n'a pas subi de choc suffisant pour la déformer.

**ÉTAPE 2** Stationnez le véhicule bien à plat.

**ÉTAPE 3** Installez-vous dans le siège conducteur.

**ÉTAPE 4** Donnez plusieurs impulsions à la carrosserie du véhicule de manière à comprimer/détendre les suspensions.

## ■ Réglage du faisceau des phares

### ► Véhicules équipés de projecteurs à halogène

ÉTAPE 1

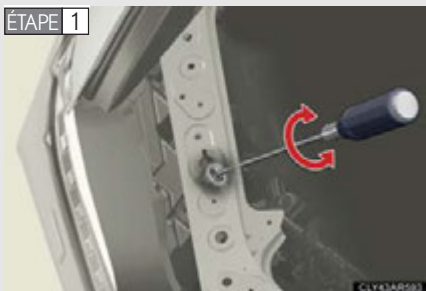

Tournez la vis A dans l'un ou l'autre sens au moyen d'un tournevis cruciforme (empreinte Phillips).

Mémorisez le sens dans lequel vous avez tourné et le nombre de tours.

ÉTAPE 2

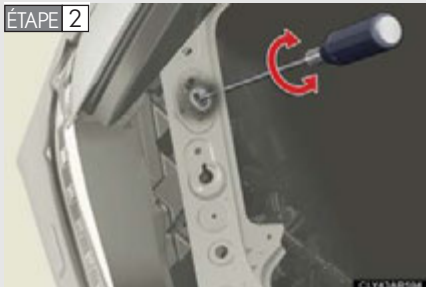

Tournez la vis B du même nombre de tours et dans le même sens qu'à l'étape 1, avec un tournevis cruciforme (empreinte Phillips).

Si vous n'arrivez pas à régler le projecteur en procédant de la sorte, confiez votre véhicule à votre concessionnaire Lexus pour qu'il règle le faisceau des phares.



## ► Véhicules équipés de projecteurs à décharge

ÉTAPE 1

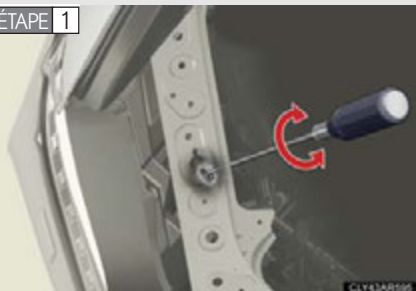

Tournez la vis A dans l'un ou l'autre sens au moyen d'un tournevis cruciforme (empreinte Phillips).

Mémo­ri­sez le sens dans lequel vous avez tourné et le nombre de tours.

ÉTAPE 2

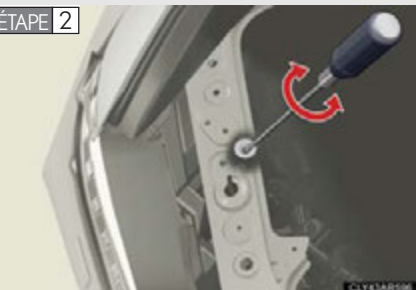

Tournez la vis B du même nombre de tours dans le même sens qu'en étape 1 au moyen d'un tournevis cruciforme (empreinte Phillips).

Si vous n'arrivez pas à régler le projecteur en procédant de la sorte, confiez votre véhicule à votre concessionnaire Lexus pour qu'il règle le faisceau des phares.



## Index

**Abbreviation list ..... 858**

**Alphabetical index ..... 860**

**What to do if... ..... 874**

For vehicles with a navigation system, refer to the “Navigation System Owner’s Manual” for information regarding the equipment listed below.

- Navigation system
- Air conditioning controls
- Windshield wiper de-icer
- Rear view monitor system
- Intuitive parking assist
- Audio/video system
- Rear window and outside rear view mirror defogging

## Abbreviation list

# Abbreviation/Acronym list

ABBREVIATIONS	MEANING
2WD	2 Wheel Drive
4WD	4 Wheel Drive
A/C	Air Conditioning
ABS	Anti-lock Brake System
AI-SHIFT	Artificial Intelligence Shift control
ALR	Automatic Locking Retractor
AWD	All Wheel Drive
BSM	Blind Spot Monitor
CRS	Child Restraint System
DISP	Display
ECO	Economy/Ecology
ECU	Electronic Control Unit
EDR	Event Data Recorder
ELR	Emergency Locking Retractor
EPS	Electric Power Steering
GAWR	Gross Axle Weight Ratings
GCWR	Gross Combination Weight Rating
GVWR	Gross Vehicle Weight Rating
I/M	Emission Inspection and Maintenance
LATCH	Lower Anchors and Tethers for Children
LED	Light Emitting Diode
MMT	Methylcyclopentadienyl Manganese Tricarbonyl
M + S	Mud and Snow
MTBE	Methyl Tertiary Butyl Ether
OBD	On Board Diagnostics

ABBREVIATIONS	MEANING
PCS	Pre-Collision System
PWR	Power
RF	Radio Frequency
SRS	Supplemental Restraint System
TIN	Tire Identification Number
TPMS	Tire Pressure Warning System
TRAC	Traction Control
TWR	Trailer Weight Rating
VDIM	Vehicle Dynamics Integrated Management
VIN	Vehicle Identification Number
VSC	Vehicle Stability Control

<b>A</b>	<p><b>A/C*</b></p> <ul style="list-style-type: none"> <li>Air conditioning filter ..... 685</li> <li>Automatic air conditioning system* ..... 342, 350</li> </ul> <p><b>ABS</b>.....271</p> <p><b>ACCESSORY mode</b> .....177</p> <p><b>Air conditioning system*</b></p> <ul style="list-style-type: none"> <li>Air conditioning filter ..... 685</li> <li>Automatic air conditioning system* .....342, 350</li> </ul> <p><b>Airbags</b></p> <ul style="list-style-type: none"> <li>Airbag operating conditions.....135</li> <li>Airbag precautions for your child..... 140</li> <li>Airbag warning light ..... 734</li> <li>Curtain shield airbag operating conditions.....136</li> <li>Curtain shield airbag precautions ..... 140</li> <li>Front passenger occupant classification system.....145</li> <li>General airbag precautions ..... 140</li> <li>Locations of airbags.....132</li> <li>Modification and disposal of airbags .....144</li> <li>Proper driving posture .....130, 140</li> <li>Side airbag operating conditions.....136</li> <li>Side airbag precautions ..... 140</li> <li>SRS airbags .....132</li> </ul>
	<ul style="list-style-type: none"> <li>Alarm.....126</li> <li>Antenna..... 377, 482</li> <li>Anti-lock brake system.....271</li> <li>Armrest ..... 607</li> <li>Assist grips ..... 609</li> <li>Audio input* .....408, 541</li> <li><b>Audio system*</b></li> <ul style="list-style-type: none"> <li>Antenna..... 482</li> <li>Audio input.....541</li> <li>AUX port.....541</li> <li>Bluetooth® audio system.....519</li> <li>CD player/changer .....485</li> <li>Hands-free system for mobile phone.....547</li> <li>iPod.....501</li> <li>MP3/WMA disc..... 493</li> <li>Optimal use ..... 539</li> <li>Portable audio device.....541</li> <li>Radio .....477</li> <li>Steering wheel audio switch..... 543</li> <li>USB memory .....510</li> <li>USB port .....501, 510</li> </ul> </ul>

**Audio system**  
**(Lexus Display Audio system)**  
 Antenna.....377  
 Audio input.....408  
 AUX port.....408  
 Bluetooth® audio system.....410  
 CD player.....380  
 Hands-free system for mobile  
 phone.....429  
 iPod.....391  
 MP3/WMA disc.....381  
 Optimal use.....424  
 Portable audio device.....408  
 Radio.....365  
 Steering wheel audio switch.....426  
 USB memory.....399  
 USB port.....391, 399  
**Automatic air conditioning system\***  
 Air conditioning filter.....685  
 Automatic air conditioning  
 system\*.....342, 350  
**Automatic headlight leveling**  
 system.....220  
**Automatic light control system**.....217  
**AUX port**.....408, 541  
**Auxiliary boxes**.....592, 612

**B** **Back door**  
 Back door.....75  
 Wireless remote control.....69  
**Back-up lights**  
 Replacing light bulbs.....708  
 Wattage.....809  
**Battery**  
 Checking.....664  
 Hybrid battery  
 (traction battery).....34  
 If the vehicle has a discharged  
 12-volt battery.....784  
 Preparing and checking  
 before winter.....302  
**Blind Spot Monitor**.....286  
**Bluetooth® audio\***.....410, 519  
**Bluetooth® phone\***.....429, 547  
**Bottle holders**.....587  
**Brake**  
 Fluid.....806  
 Parking brake.....195  
**Brake assist**.....271  
**Break-in tips**.....167  
**BSM**.....286

\*: For vehicles with a navigation system, refer to the "Navigation System Owner's Manual".

<b>C</b>	Card key.....	51	Moon roof precautions.....	118
	Care		Power window lock switch.....	112
	Exterior.....	634	Power window precautions.....	114
	Interior.....	637	Removed electronic key battery	
	Seat belts.....	638	precautions.....	688
	Cargo capacity.....	301	Seat belt extender precautions....	104
	Cargo hooks.....	612	Seat belt precautions.....	102
	CD changer		Seat heater precautions.....	605
	CD.....	380, 485	12-volt battery	
	MP3.....	381, 493	precautions.....	668, 784
	WMA disc.....	381, 493	<b>Child-protectors.....</b>	<b>73</b>
	CD player.....	380, 485	<b>Cleaning</b>	
	Chains.....	302	Exterior.....	634
	Child restraint system		Interior.....	637
	Booster seats, definition.....	150	Seat belts.....	638
	Booster seats, installation.....	154	<b>Clock*.....</b>	<b>597</b>
	Convertible seats, definition.....	150	<b>Coat hooks.....</b>	<b>608</b>
	Convertible seats, installation.....	154	<b>Coin holder.....</b>	<b>592</b>
	Front passenger occupant		<b>Compass.....</b>	<b>622</b>
	classification system.....	145	<b>Condenser.....</b>	<b>661</b>
	Infant seats, definition.....	150	<b>Console box.....</b>	<b>590</b>
	Infant seats, installation.....	154	<b>Coolant</b>	
	Installing CRS with LATCH		Engine coolant.....	659
	system.....	155	Power control unit coolant.....	659
	Installing CRS with seat belts.....	157	<b>Cooling system</b>	
	Installing CRS with top tether		Hybrid system overheating.....	788
	straps.....	161	<b>Cornering assist sensors.....</b>	<b>248</b>
	Child safety		<b>Cruise control</b>	
	Airbag precautions.....	140	Cruise control.....	232
	Back door precautions.....	80	Dynamic radar cruise control....	236
	Child restraint system.....	150	<b>Cup holders.....</b>	<b>588</b>
	Child-protectors.....	73	<b>Curtain shield airbags.....</b>	<b>132</b>
	How your child should wear		<b>Customizable features.....</b>	<b>825</b>
	the seat belt.....	101		
	Installing child restraints.....	154		



<b>D</b>	Daytime running light system.....	219
	Defogger*	
	Rear window.....	358
	Side mirrors.....	358
	Dimensions.....	798
	Dinghy towing.....	324
	Display	
	Energy flow.....	39
	Multi-information display.....	206
	Trip information.....	209
	Warning message.....	743
	Do-it-yourself maintenance.....	648
	Door courtesy lights	
	Door courtesy lights.....	582
	Wattage.....	809
	Door lock	
	Back door.....	75
	Side door.....	72
	Wireless remote control.....	69
	Door pockets.....	587
	Doors	
	Back door.....	75
	Door lock.....	56, 69, 72
	Door windows.....	112
	Power back door.....	75
	Side door.....	72
	Side mirrors.....	109
	Driver's seat belt reminder light.....	736
	Driving	
	Break-in tips.....	167
	Correct posture.....	130
	Procedures.....	166
	Utility vehicle	
	precautions.....	292
	Winter driving tips.....	302

	Driving position memory.....	93
<b>E</b>	Electric power steering.....	271
	Electronic features control.....	206
	Electronic key	
	If the electronic key does not operate properly.....	781
	Emergency flashers	
	Switch.....	724
	Emergency, in case of	
	If a warning buzzer sounds.....	733
	If a warning light turns on.....	733
	If a warning message is displayed.....	743
	If the back door opener is inoperative.....	79
	If the electronic key does not operate properly.....	781
	If the hybrid system will not start.....	777
	If the shift lever cannot be shifted from P.....	779
	If the vehicle has a discharged 12-volt battery.....	784
	If you have a flat tire.....	764
	If you lose your keys.....	780
	If you think something is wrong.....	732
	If your vehicle becomes stuck.....	793
	If your vehicle has to be stopped in an emergency.....	795
	If your vehicle needs to be towed.....	725
	If your vehicle overheats.....	788

\*: For vehicles with a navigation system, refer to the "Navigation System Owner's Manual".

**Engine**  
 Accessory mode .....177  
 Compartment .....654  
 Hood..... 651  
 How to start the hybrid  
 system.....177  
 Identification number.....799  
 If the hybrid system will  
 not start .....777  
 Ignition switch.....177  
 Overheating.....788  
 “POWER” switch .....177  
**Engine compartment cover .....655**  
**Engine coolant**  
 Capacity ..... 804  
 Checking .....659  
 Preparing and checking  
 before winter .....302  
**Engine coolant temperature**  
**gauge..... 197**  
**Engine oil**  
 Capacity.....802  
 Checking .....656  
 Preparing and checking  
 before winter .....302  
**EPS .....271**  
**EV drive mode .....183**  
**Event data recorder .....25**

**F** **Floor mat..... 610**  
**Fluid**  
 Brake.....806  
 Washer..... 663  
**Fog lights**  
 Replacing light bulbs.....708  
 Switch.....221  
 Wattage .....809  
**Footwell light .....582**  
**Front fog lights**  
 Replacing light bulbs.....708  
 Switch.....221  
 Wattage .....809  
**Front passenger occupant**  
**classification system.....145**  
**Front passenger's seat belt**  
**reminder light ..... 736**  
**Front seats**  
 Adjustment ..... 86  
 Driving position memory .....93  
 Flattening seatbacks .....87  
**Front side marker lights**  
 Replacing light bulbs.....708  
**Front turn signal lights**  
 Replacing light bulbs.....708  
 Wattage .....809

<b>Fuel</b>	
Capacity.....	800
Fuel gauge.....	197
Information.....	810
Refueling.....	119
Type.....	810
<b>Fuel consumption.....</b>	<b>45</b>
Fuel door.....	119
Fuel filler door.....	119
Fuses.....	689

<b>G</b>	Garage door opener.....	616
	Gauges.....	197
	Glove box.....	586

<b>H</b>	<b>Hands-free system for</b>	
	mobile phone* .....	429, 547
	<b>Hazard lights</b>	
	Switch .....	724
	<b>Head restraints</b>	
	Adjustment .....	97
	Headlight aim .....	706
	Headlight cleaner .....	231
	<b>Headlights</b>	
	Discharge headlight	
	precautions.....	722
	Replacing light bulbs .....	708
	Switch.....	217
	Wattage.....	809
	<b>Head-up display</b>	
	Display contrast adjustment	
	switch.....	212
	Display position adjustment	
	switch.....	212
	Head-up display main switch .....	212

<b>Heaters</b>	
Seat heaters.....	605
Side mirrors*.....	358
Steering wheel.....	604
<b>Hill-start assist control.....</b>	<b>276</b>
<b>Hood.....</b>	<b>651</b>
<b>Hooks</b>	
Cargo.....	612
Coat.....	608
<b>Horn.....</b>	<b>196</b>
<b>HUD</b>	
Display contrast adjustment	
switch.....	212
Display position adjustment	
switch.....	212
Head-up display main switch.....	212
<b>Hybrid system</b>	
Emergency shut off system.....	35
Energy monitor/consumption	
screen.....	39
High voltage components .....	34
Hybrid system indicator .....	201
"POWER" switch.....	177
Vehicle Proximity Notification	
System.....	31
<b>Hybrid transmission</b>	
Hybrid transmission.....	186
If the shift lever cannot be	
shifted from P .....	779
S mode.....	190

\*: For vehicles with a navigation system, refer to the "Navigation System Owner's Manual".

<b>I</b>	I/M test.....	647
	Identification	
	Electric motor.....	800
	Engine.....	800
	Vehicle.....	799
	Ignition switch.....	177
	Illuminated entry system.....	582
	Immobilizer system.....	124
	Indicator lights.....	201
	Initialization	
	Items to initialize.....	837
	Inside rear view mirror.....	107
	Instrument panel light control	
	buttons.....	198
	Interior lights	
	Interior lights.....	582
	Switch.....	583
	Wattage.....	809
	iPod*.....	391, 501
<b>J</b>	Jack	
	Positioning a floor jack.....	652
	Vehicle-equipped jack.....	764
	Jack handle.....	764

<b>K</b>	Keyless entry.....	69
	Keys	
	Electronic key.....	51
	If the electronic key does not	
	operate properly.....	781
	If you lose your keys.....	780
	Key number.....	51
	Keyless entry.....	69
	Keys.....	51
	Mechanical key.....	52
	"POWER" switch.....	177
	Wireless remote control key.....	69
<b>L</b>	Lexus Display Audio controller.....	328
	Lexus Display Audio system.....	328
	Lexus Enform with	
	Safety Connect*	
	Light bulbs	
	Replacing.....	708
	Wattage.....	809
	Lights	
	Door courtesy lights.....	582
	Emergency flasher switch.....	724
	Fog light switch.....	221
	Hazard light switch.....	724
	Headlight switch.....	217
	Interior light switch.....	583
	Luggage compartment light.....	77
	Outer foot lights.....	582
	Overhead courtesy light.....	582
	Personal light switch.....	583
	Replacing light bulbs.....	708
	Scuff lights.....	582

Shift lever light.....	582	<b>N</b> Noise from under vehicle.....	22
Turn signal lever.....	193	<b>O</b> Odometer.....	197
Vanity lights.....	596	Oil	
Wattage.....	809	Engine oil.....	656
<b>Load capacity.....</b>	<b>301</b>	<b>Opener</b>	
<b>Lock steering column.....</b>	<b>180</b>	Back door.....	75
<b>Luggage compartment lights</b>		Fuel filler door.....	119
Switch.....	77	Hood.....	651
Wattage.....	809	<b>Outer foot lights</b>	
<b>Luggage cover.....</b>	<b>613</b>	Outer foot lights.....	582
<b>M</b> <b>Maintenance</b>		Wattage.....	809
Do-it-yourself maintenance.....	648	<b>Outside rear view mirrors</b>	
General maintenance.....	643	Adjusting and folding.....	109
Maintenance data.....	798	Mirror position memory.....	93
Maintenance requirements.....	640	<b>Outside temperature display* .....</b>	<b>598</b>
<b>Meter</b>		<b>Overhead console.....</b>	<b>592</b>
Instrument panel light control.....	198	<b>Overhead courtesy lights</b>	
Meters.....	197	Overhead courtesy lights.....	582
<b>Mirrors</b>		Wattage.....	809
Inside rear view mirror.....	107	<b>Overheating, Hybrid system.....</b>	<b>788</b>
Side mirror heaters*.....	358		
Side mirrors.....	109		
Vanity mirrors.....	596		
<b>Mobile Assistant*.....</b>	<b>340</b>		
<b>Moon roof.....</b>	<b>115</b>		
<b>MP3 disc*.....</b>	<b>381, 493</b>		
<b>Multi-display light control.....</b>	<b>600</b>		
<b>Multi-information display</b>			
Switches.....	206		
Trip information.....	209		

\*: For vehicles with a navigation system, refer to the "Navigation System Owner's Manual".

**P**

- Parking assist sensors\* .....248
- Parking brake..... 195
- Parking lights
  - Replacing light bulbs.....708
  - Switch..... 217
- PCS
  - Function.....278
  - Pre-collision braking off
    - switch..... 279
  - Warning light.....734
- Personal lights
  - Switch.....583
- Phone\*..... 429, 552
- Power back door.....75
- Power control unit coolant
  - Capacity..... 804
  - Checking.....659
  - Preparing and checking
    - before winter.....302
- Power easy access system.....95
- Power outlet..... 601
- “POWER” switch.....177
- Power windows.....112
- Pre-collision system
  - Function.....278
  - Pre-collision braking off
    - switch..... 279
  - Warning light.....734

**R**

- Radar cruise control..... 236
- Radiator.....661
- Radio\* ..... 365, 477
- Rear seat entertainment system\*
- Rear seats
  - Folding down..... 89
  - Seat adjustment..... 89
- Rear turn signal lights
  - Replacing light bulbs..... 708
  - Wattage.....809
- Rear view mirror
  - Compass.....622
  - Inside rear view mirror.....107
  - Outside rear view mirrors.....109
- Rear view monitor
  - system\* ..... 258, 266
- Rear window defogger\* .....358
- Rear window wiper..... 229
- Remote Touch\*
- Replacing
  - Electronic key battery..... 687
  - Fuses.....689
  - Light bulbs..... 708
  - Tires.....764
  - Wireless remote control
    - battery..... 687
- Reporting safety defects for
  - U.S. owners.....840
- Reset the maintenance data .....641
- Roof luggage carrier.....296

<b>S</b>	Safety Connect* .....	626
	Scuff lights .....	582
	<b>Seat belts</b>	
	Adjusting the seat belt .....	100
	Automatic locking retractor.....	101
	Child restraint system	
	installation .....	154
	Cleaning and maintaining	
	the seat belts.....	638
	Emergency locking retractor .....	101
	How to wear your seat belt.....	99
	How your child should wear	
	the seat belt.....	101
	Pregnant women,	
	proper seat belt use.....	102
	Reminder light.....	736
	Seat belt extender .....	101
	Seat belt pretensioners.....	100
	Seat heaters.....	605
	Seat position memory .....	93
	Seat ventilators.....	605
	Seating capacity .....	301

<b>Seats</b>	
Adjustment .....	86, 89
Adjustment precautions .....	88, 91
Child seats/child restraint	
system installation.....	154
Cleaning .....	637
Flattening seat backs .....	87
Head restraint.....	97
Power easy access system .....	95
Properly sitting in the seat .....	130
Seat heaters .....	605
Seat position memory .....	93
Seat ventilators.....	605
<b>Service reminder indicators .....</b>	<b>201</b>
<b>Shift lever</b>	
Hybrid transmission.....	186
If the shift lever cannot be	
shifted from P .....	779
Shift lever light.....	582
Shift lock system.....	779
Side airbags.....	132
<b>Side marker lights</b>	
Switch.....	217
<b>Side mirror</b>	
Adjusting and folding.....	109
Mirror position memory.....	93
<b>Smart access system with</b>	
<b>push-button start</b>	
Entry function.....	56
Starting the hybrid system.....	177
<b>"SOS" button.....</b>	<b>626</b>

\*: For vehicles with a navigation system, refer to the "Navigation System Owner's Manual".

<b>Spare tire</b>	
Inflation pressure.....	807
Storage location.....	764
<b>Spark plug.....</b>	<b>804</b>
<b>Specifications .....</b>	<b>798</b>
<b>Speedometer.....</b>	<b>197</b>
<b>Steering</b>	
Column lock release .....	180
<b>Steering wheel</b>	
Adjustment.....	105
Audio switches* .....	426, 543
Heated steering wheel.....	604
Power easy access system.....	95
Steering wheel position memory.....	93
<b>Storage feature.....</b>	<b>585</b>
<b>Stuck vehicle</b>	
If your vehicle becomes stuck.....	793
<b>Sun visors .....</b>	<b>595</b>
<b>Sunshades.....</b>	<b>116</b>

<b>Switch</b>	
Display contrast adjustment switch.....	212
Display position adjustment switch.....	212
Driving mode selector switch.....	188
Emergency flasher switch.....	724
ENTER switch .....	206
Fog light switch .....	221
Hazard light switch .....	724
Head-up display main switch .....	212
Heated steering wheel switch .....	604
Ignition switch .....	177
Light switches.....	217
Menu switch.....	206
Power back door switch.....	75
Power door lock switch.....	72
"POWER" switch.....	177
Power window switch .....	112
Pre-collision braking off switch.....	279
Rear window wiper and washer switch.....	229
Window lock switch.....	112
Wiper and washer switch.....	223



<b>T</b>	Tachometer .....	197	Tools .....	764
	Tail lights		Total load capacity .....	301
	Replacing light bulbs .....	708	Towing	
	Switch .....	217	Dinghy towing .....	324
	Wattage .....	809	Emergency towing .....	725
	Talk switch* .....	429, 553	Trailer towing .....	306
	Telephone* .....	429, 552	TRAC .....	271
	Telephone switch* .....	429, 553	Traction control .....	271
	Theft deterrent system		Trailer towing .....	306, 323
	Alarm .....	126	Trip information display .....	206
	Immobilizer system .....	124	Trip meter .....	197
	Theft prevention labels .....	129	Turn signal lights	
	Tire inflation pressure .....	679	Replacing light bulbs .....	708
	Tire information		Switch .....	193
	Glossary .....	819	Wattage .....	809
	Size .....	815		
	Tire identification number .....	815		
	Uniform tire quality grading .....	817		
	<b>Tires</b>			
	Chains .....	302		
	Checking .....	670		
	If you have a flat tire .....	764		
	Inflation pressure .....	679		
	Inflation pressure sensor .....	671		
	Information .....	813		
	Replacing .....	764		
	Rotating tires .....	670		
	Size .....	807		
	Snow tires .....	302		
	Spare tire .....	764		
	Tire pressure warning			
	system .....	670, 736		

\*: For vehicles with a navigation system, refer to the "Navigation System Owner's Manual".

<b>U</b>	Under tray.....	594
	USB port* .....	391, 399, 501, 510
<b>V</b>	Vanity lights	
	Vanity lights .....	596
	Wattage.....	809
	Vanity mirrors .....	596
	VDIM.....	271
	Vehicle data recordings .....	23
	Vehicle dynamics integrated management .....	271
	Vehicle identification number .....	799
	Vehicle stability control.....	271
	Voice command switch* .....	429, 553
	Voice command system* .....	446
	VSC.....	271

<b>W</b>	Warning buzzers	
	Brake system.....	733
	Open door .....	736
	Seat belt reminder .....	736
	Warning lights	
	Anti-lock brake system .....	734
	Brake assist system .....	734
	Brake system.....	733
	Charging system.....	733
	Electric power steering.....	734
	Electronic engine control system.....	734
	Low fuel level.....	736
	Low tire pressure .....	736
	Malfunction indicator lamp .....	734
	Master warning light.....	736
	Open door .....	736
	Pre-collision system.....	734
	Pretensioners .....	734
	Seat belt reminder light .....	736
	Slip indicator .....	734
	SRS airbags.....	734
	Tire pressure.....	736

**Warning messages**

Anti-lock brake system .....	745
AWD system.....	744, 745
Brake lamp system.....	745
Brake system.....	743
Dynamic radar cruise control system.....	745, 748
Electric power steering.....	745
Engine oil maintenance.....	748
Engine oil pressure.....	744
Engine overheat.....	748
Headlight leveling.....	745
Hood.....	748
Intuitive parking assist.....	745, 748
Low fuel.....	748
Moon roof.....	748
Open door.....	748
Parking brake.....	748
Pre-collision system.....	745, 748
Smart access system with push-button start.....	756
SRS airbags.....	745
Steering lock.....	745
Washer fluid.....	748

**Washer**

Checking.....	663
Preparing and checking before winter.....	302
Switch.....	223
<b>Washing and waxing.....</b>	<b>634</b>
<b>Weight</b>	
Cargo capacity.....	301
Load limits.....	301
Weight.....	798
<b>Wheels.....</b>	<b>683</b>
<b>Window glasses.....</b>	<b>112</b>
<b>Window lock switch.....</b>	<b>112</b>
<b>Windows</b>	
Power windows.....	112
Rear window defogger*.....	358
Washer.....	223
<b>Windshield wiper de-icer*.....</b>	<b>360</b>
<b>Windshield wipers.....</b>	<b>223</b>
<b>Wireless remote control.....</b>	<b>69</b>
<b>Wireless remote control key</b>	
Replacing the battery.....	687
<b>WMA disc*.....</b>	<b>381, 493</b>

\*: For vehicles with a navigation system, refer to the "Navigation System Owner's Manual".

# What to do if... What to do if...



A tire punctures

P. 764 If you have a flat tire



The hybrid system does not start

P. 777 If the hybrid system will not start

P. 124 Immobilizer system

P. 784 If the vehicle 12-volt battery is discharged



The shift lever cannot be moved out

P. 779 If the shift lever cannot be shifted from P



The engine coolant temperature gauge enters the red zone

P. 788 If your vehicle overheats



Steam can be seen coming from under the hood



The key is lost

P. 780 If you lose your keys



The 12-volt battery runs out

P. 784 If the vehicle 12-volt battery is discharged



The doors cannot be locked

P. 72 Side doors

P. 75 Back door



The horn begins to sound

P. 126 Alarm



The vehicle is stuck in mud or sand

P. 793 If the vehicle becomes stuck

 A warning light or indicator light comes on

P.733 If a warning light turns on or a warning buzzer sounds...





■ Warning lights

**BRAKE** Brake system warning light  
or  
 P.733

 Malfunction indicator lamp  
or  
 P.734

 Brake system warning light P.734

 Driver's seat belt reminder light P.736

**ABS** ABS warning light  
or  
 P.734

 Front passenger's seat belt reminder light P.736

 Master warning light P.736

 Low fuel level warning light P.736

 Electric power steering system warning light P.734

 SRS warning light P.734

**PCS** Pre-collision system warning light\* P.734

 Open door warning light P.736

 Tire pressure warning light P.736

 Charging system warning light P.733

 Slip indicator P.734

\*: The light flashes to indicate a malfunction.

## GAS STATION INFORMATION



Fuel tank capacity (Reference)	17.1 gal. (65 L, 14.2 Imp. gal.)	
Fuel type	Unleaded gasoline only	P. 800
Cold tire inflation pressure		P. 807
Engine oil capacity (Drain and refill —reference)	With filter Without filter	qt. (L, Imp. qt.) 6.4 (6,1, 5,4) 6.0 (5,7, 5,0)
Engine oil type	"Toyota Genuine Motor Oil" or equivalent	P. 802