

QX30

2019 OWNER'S MANUAL
AND MAINTENANCE INFORMATION



INFINITI®

For your safety, read carefully and keep in this vehicle.

CALIFORNIA PROPOSITION 65 WARNING

WARNING

Operating, servicing and maintaining a passenger vehicle or off-highway motor vehicle can expose you to chemicals including engine exhaust, carbon monoxide, phthalates, and lead, which are known to the State of California to cause cancer and birth defects or other reproductive harm. To minimize exposure, avoid breathing exhaust, do not idle the engine except as necessary, service your vehicle in a well-ventilated area and wear gloves or wash your hands frequently when servicing your vehicle. For more information go to www.P65Warnings.ca.gov/passenger-vehicle.

FOREWORD

This manual was prepared to help you understand the operation and maintenance of your vehicle so that you may enjoy many miles (kilometers) of driving pleasure. Please read through this manual before operating your vehicle.

A separate Warranty Information Booklet is included in your Owner's literature portfolio. Always carry it with you when you take your vehicle to an INFINITI retailer. The Warranty Information Booklet contents provide complete information about all warranties covering this vehicle, the requirements to keep the warranties in effect as well as the INFINITI Roadside Assistance Program.

Additionally, a separate Customer Care and Lemon Law Information Booklet will explain how to resolve any concerns you may have with your vehicle, as well as clarify your rights under your state's lemon law.

In addition to factory-installed options, your vehicle may also be equipped with additional accessories prior to delivery. It is recommended that you visit an INFINITI retailer for this service. It is important that you familiarize yourself with all disclosures, warnings, cautions and instructions concerning proper use of such accessories prior to operating the vehicle and/or accessory. It is recommended that you visit an INFINITI retailer for details concerning the particular accessories with which your vehicle is equipped.

READ FIRST – THEN DRIVE SAFELY

Before driving your vehicle, read this Owner's Manual carefully. This will ensure familiarity with controls and maintenance requirements, assisting you in the safe operation of your vehicle.

WARNING

Important safety information reminders! Follow these important driving rules to help ensure a safe and complete trip for you and your passengers!

- NEVER drive under the influence of alcohol or drugs.
- ALWAYS observe posted speed limits and never drive too fast for conditions.

- ALWAYS use your seat belts and appropriate child restraint systems. Preteen children should be seated in the rear seat.
- ALWAYS give your full attention to driving and avoid using vehicle features or taking other actions that could distract you.
- ALWAYS provide information about the proper use of vehicle safety features to all occupants of the vehicle.
- ALWAYS review this Owner's Manual for important safety information.

As with other vehicles with features for off-road use, failure to operate all-wheel drive models correctly may result in loss of

control or an accident. Be sure to read "Driving safety precautions" in the "Starting and driving" section of this manual.

ON-PAVEMENT AND OFF-ROAD DRIVING

This vehicle will handle and maneuver differently from an ordinary passenger car because it has a higher center of gravity for off-road use. As with other vehicles with features of this type, failure to operate this vehicle correctly may result in loss of control or an accident.

For additional information, refer to “On-pavement and off-road driving precautions”, “Avoiding collision and rollover” and “Driving safety precautions” in the “Starting and driving” section of this manual.

MODIFICATION OF YOUR VEHICLE

This vehicle should not be modified. Modification could affect its performance, safety or durability and may even violate governmental regulations. In addition, damage or performance problems resulting from modifications may not be covered under INFINITI warranties.

WARNING

Installing an aftermarket On-Board Diagnostic (OBD) plug-in device that uses the port during normal driving, for example remote insurance company monitoring, remote vehicle diagnostics, telematics or engine reprogramming, may cause interference or damage to vehicle systems. We do not recommend or endorse the use of any aftermarket OBD plug-in devices, unless specifically approved by INFINITI. The vehicle warranty may not cover damage caused by any aftermarket plug-in device.

WHEN READING THE MANUAL

This manual includes information for all features and equipment available on this model. Features and equipment in your vehicle may vary depending on model, trim level, options selected, order, date of production, region or availability. Therefore, you may find information about features or equipment that are not included or installed on your vehicle.

All information, specifications and illustrations in this manual are those in effect at the time of printing. INFINITI reserves the right to change performance, design or component suppliers without notice and without obligation.

From time to time, INFINITI may update or revise this manual to provide Owners with the most accurate information currently available. Please carefully read and retain with this manual all revision updates sent to you by INFINITI to ensure you have access to accurate and up-to-date information regarding your vehicle. Current versions of vehicle Owner's Manuals and any updates can also be found in the Owner section of the INFINITI website at <https://owners.infiniti.com/owners/navigation/manualsandGuides>. If you have questions concerning any information in your Owner's Manual, contact INFINITI Consumer Affairs.

See the INFINITI CUSTOMER CARE PROGRAM page in this Owner's Manual for contact information.

IMPORTANT INFORMATION ABOUT THIS MANUAL

You will see various symbols in this manual. They are used in the following ways:

WARNING

This is used to indicate the presence of a hazard that could cause death or serious personal injury. To avoid or reduce the risk, the procedures must be followed precisely.

CAUTION

This is used to indicate the presence of a hazard that could cause minor or moderate personal injury or damage to your vehicle. To avoid or reduce the risk, the procedures must be followed carefully.

NOTE

Indicates additional helpful information.

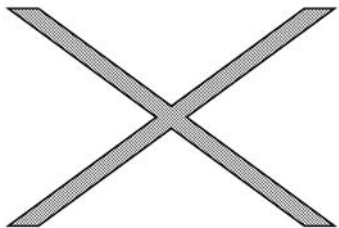

If you see this symbol, it means **“Do not do this”** or **“Do not let this happen”**.



If you see a symbol similar to these in an illustration, it means the arrow points to the front of the vehicle.



Arrows in an illustration that are similar to these indicate movement or action.



Arrows in an illustration that are similar to these call attention to an item in the illustration.

[]:

Square brackets are used to indicate messages, keys, or items displayed on a screen.

< >:

Chevrons or angle brackets are used to indicate texts on controls like buttons or switches inside or on the vehicle.

CALIFORNIA PERCHLORATE ADVISORY

Some vehicle parts, such as lithium batteries, may contain perchlorate material. The following advisory is provided: “Perchlorate Material - special handling may apply, See www.dtsc.ca.gov/hazardouswaste/perchlorate.”



© 2018 NISSAN MOTOR CO., LTD.

All rights reserved. No part of this Owner's Manual may be reproduced or stored in a retrieval system, or transmitted in any form, or by any means, electronic, mechanical, photocopying, recording or otherwise, without the prior written permission of Nissan Motor Co., Ltd.

INFINITI CUSTOMER CARE PROGRAM

INFINITI CARES ...

Both INFINITI and your INFINITI retailer are dedicated to serving all your automotive needs. Your satisfaction with your vehicle and your INFINITI retailer are our primary concerns. Your INFINITI retailer is always available to assist you with all your automobile sales and service needs.

However, if there is something that your INFINITI retailer cannot assist you with or you would like to provide INFINITI directly with comments or questions, please contact our (INFINITI's) Consumer Affairs Department using our toll-free number:

For U.S. customers

1-800-662-6200

For Canadian customers

1-800-361-4792

The Consumer Affairs Department will ask for the following information:

- Your name, address, and telephone number
- Vehicle identification number (on dash panel)
- Date of purchase

- Current odometer reading
- Your INFINITI retailer's name
- Your comments or questions

OR

You can write to INFINITI with the information on the left at:

For U.S. customers

INFINITI Division Nissan North America, Inc.

Consumer Affairs Department

P.O. Box 685003

Franklin, TN 37068-5003

or via e-mail at:

nnaconsumeraffairs@nissan-usa.com

For Canadian customers

INFINITI Division

Nissan Canada Inc.

5290 Orbitor Drive

Mississauga, Ontario L4W 4Z5

or via e-mail at:

information.center@nissancanada.com

If you prefer, visit us at:

www.infinitiUSA.com (for U.S. customers) or

www.infiniti.ca (for Canadian customers)

We appreciate your interest in INFINITI and thank you for buying a quality INFINITI vehicle.

Table of contents

Illustrated table of contents	0
Safety – seats, seat belts and supplemental restraint system	1
Instruments and controls	2
Pre-driving checks and adjustments	3
Display screen, heater and air conditioner, and audio system	4
Starting and driving	5
In case of emergency	6
Appearance and care	7
Do-it-yourself	8
Maintenance and Schedules	9
Technical information	10
Index	11

0 Illustrated table of contents

Seats, Seat belts and Supplemental Restraint System (SRS)0-2
Exterior front0-3
Exterior rear0-4
Passenger compartment0-5
Cockpit0-6

Instrument panel0-7
Meters and gauges.0-8
Engine compartment0-9
2.0L Gasoline engine0-9
Warning and indicator lights0-10

SEATS, SEAT BELTS AND SUPPLEMENTAL RESTRAINT SYSTEM (SRS)

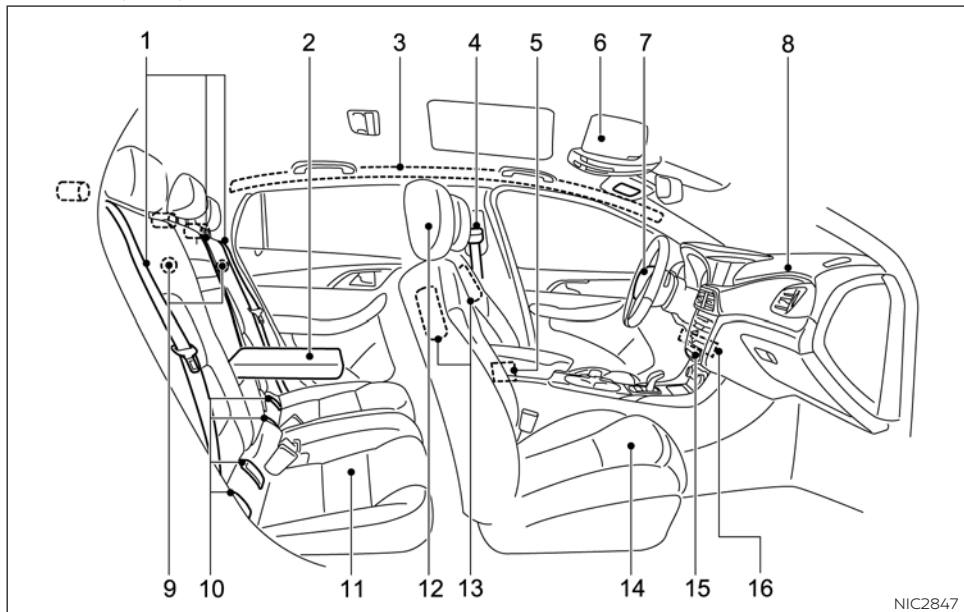

1. Rear seat belts (Page. 1-7)
3. Roof-mounted curtain side impact and rollover supplemental air bags (P. 1-37)
4. Front seat belts (P. 1-10)
5. Seat belt pretensioners (P. 1-52)
6. Air bag warning label (P. 1-53)

7. Driver Supplemental front-impact air bag (P. 1-37)
8. Passenger supplemental front-impact air bag (P. 1-37)
9. Top tether strap anchors (P. 1-22)

10. LATCH (Lower Anchors and Tethers for Children)/ ISOFIX child restraint system (P. 1-20)
11. Rear seats (P. 1-5)
 - Child restraints (P. 1-19)
12. Head restraints/headrests (P. 1-7)
13. Front seat-mounted side impact supplemental air bags (P. 1-37)
14. Front seats (P. 1-3)
 - Occupant Classification System (OCS) (P. 1-45)
15. Front passenger air bag status light (P. 1-45)
16. Driver and passenger supplemental knee air bags (P. 1-37)

*: if equipped

EXTERIOR FRONT

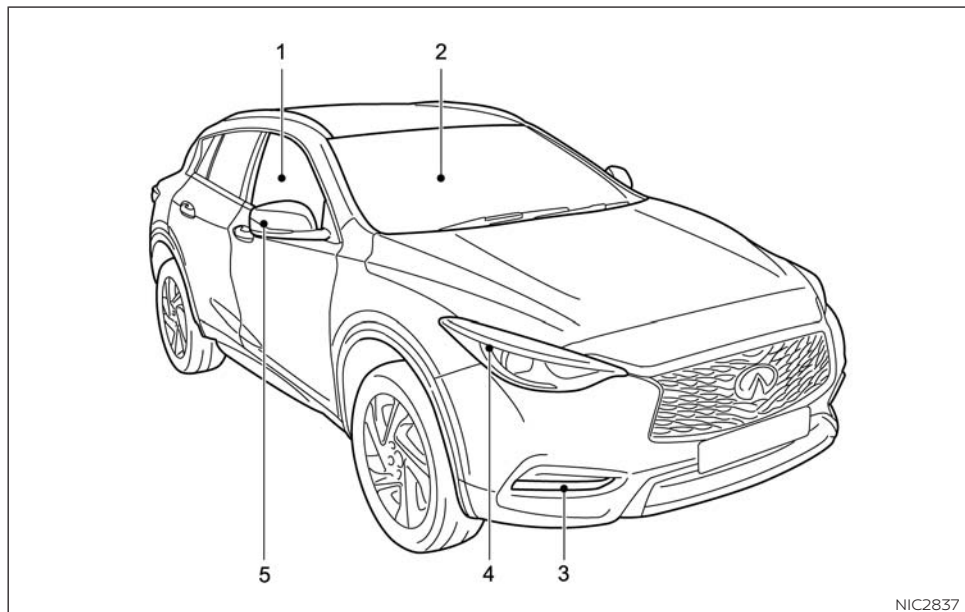

NIC2837

1. Power windows (P. 2-74)
2. Windshield wipers and washers
 - Switch operation (P. 2-61)
 - Blade replacement (P. 8-13)
 - Window washer fluid (P. 8-8)
 - Windshield de-icer* (P. 2-64)

3. Front fog lights (P. 2-71)
4. Headlights
 - Switch operation (P. 8-24)

5. Turn signal lights (P. 2-67, 8-23)
 - Side turn signal light (P. 8-23)Mirrors
 - Adjustment (P. 3-19)

*: if equipped

EXTERIOR REAR

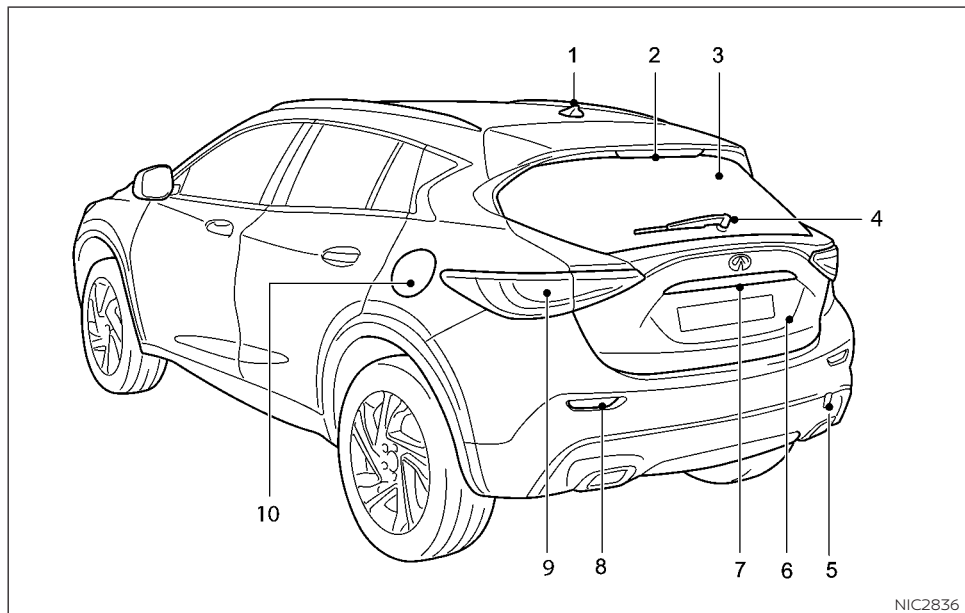

1. Antenna (P. 4-39)
2. High-mounted stop light (Bulb replacement) (P. 8-23)
3. Rear window defroster (P. 2-64)

4. Rear window wiper and washer
 - Operation (P. 2-63)
 - Wiper blade replacement (P. 2-13)
5. Recovery hook (P. 6-15)
6. Lift gate (P. 3-7)
 - Intelligent Key system (P. 6-4)

7. Rear view camera* (P. 4-3)
8. Rear reflector
9. Rear combination lights (P. 8-25)
10. Fuel-filler door
 - Operation (P. 3-16)
 - Fuel information (P. 8-2)

*: if equipped

PASSENGER COMPARTMENT

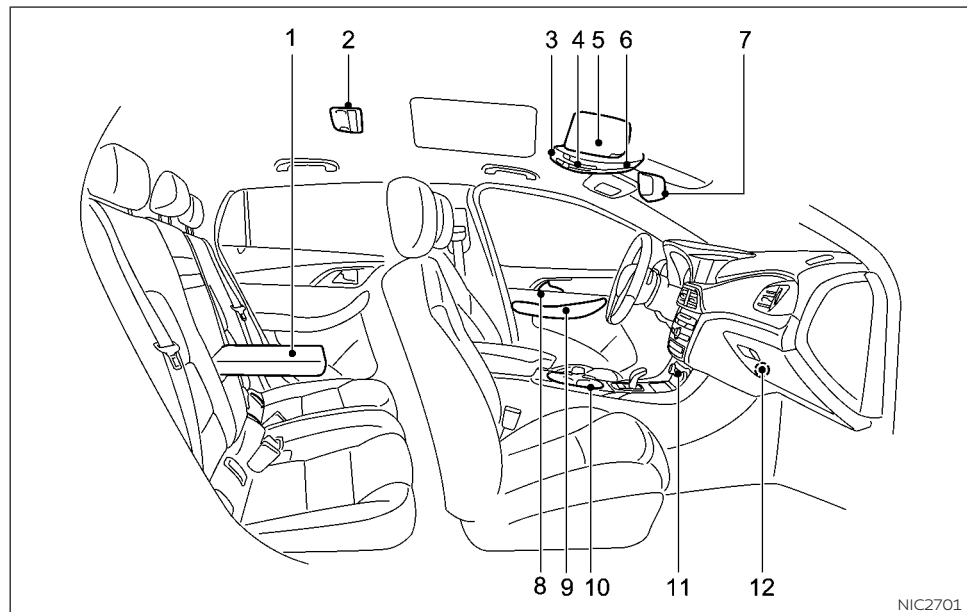

1. Rear armrest* (P. 1-7)
2. Rear personal lights (P. 2-88)
3. Overhead control panel (P. 2-78)
4. Sunshade switch* (P. 2-78)
5. Sun visor (P. 2-18)
6. Security system buttons (P. 3-60)

7. Interior rear-view mirror (P. 3-18)
8. Door handle (P. 3-6)
9. Door armrest
 - Power windows controls (P. 2-75)
 - Exterior rear view mirror remote control switch (P. 2-18)

10. Front cup holders (P. 2-82)
11. Air conditioner controls (P. 4-29)
12. Glove box/storage (P. 2-80)

*: if equipped

COCKPIT

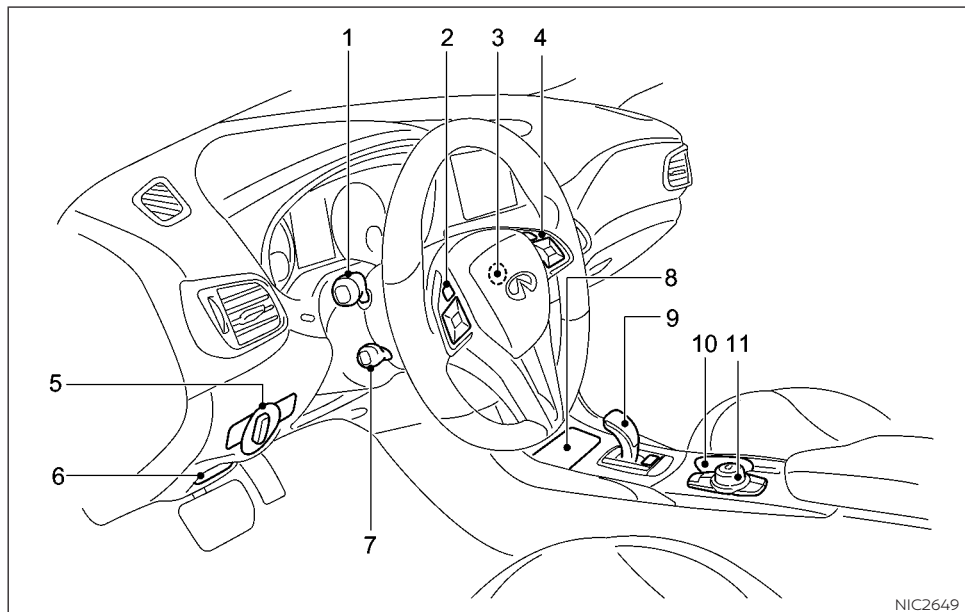

1. Turn signal, wiper, washer, and high beam switch (P. 2-67, 2-61)
2. Steering-wheel-mounted controls (left side) (P. 2-15)
3. Ignition switch (P. 5-13)
 - Push button ignition switch* (P. 5-14)

4. Steering-wheel-mounted controls (right side) (P. 4-2**)
5. Light switch
 - Headlight (P. 2-65)
 - Fog light (P. 2-71)
6. Parking brake (P. 3-27)

7. Cruise Control switch
 - Cruise Control (P. 5-46)
 - Intelligent Cruise Control (P. 2-49*)
8. USB connection ports (P. 4-2**)
9. Shift lever (P. 5-19)
10. Front cup holders (P. 2-82)
11. INFINITI controller (P. 4-2**)

* if equipped

** refer to the INFINITI InTouch Owner's Manual

INSTRUMENT PANEL

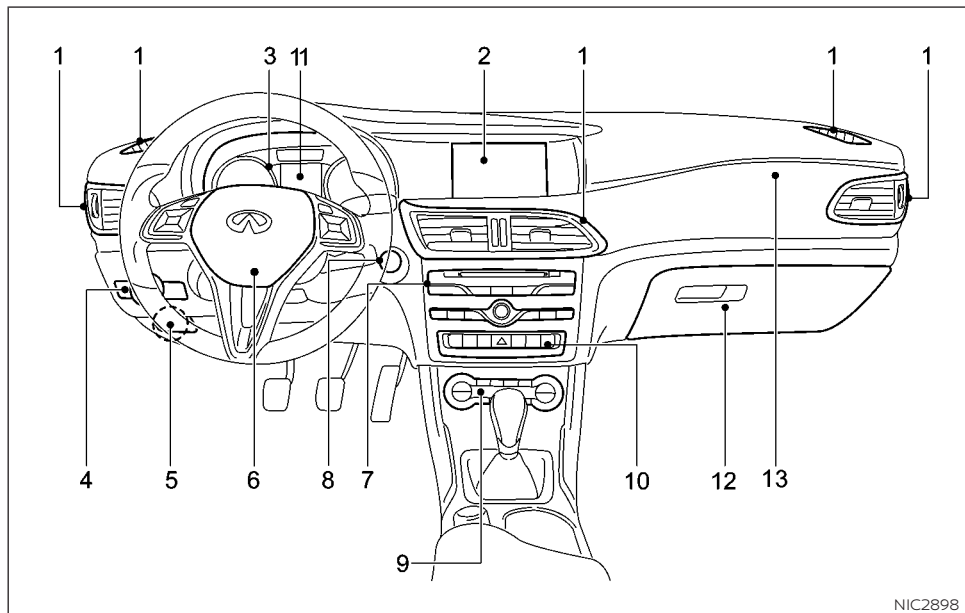

1. Ventilators (P. 4-28)
2. Center display* (P. 4-2**)
3. Meters and gauges (P. 2-4)
4. Light switch (P. 2-65)
5. Parking brake (P. 3-27)

6. Steering wheel
 - Power steering system (P. 5-89)
 - Horn (P. 2-72)
 - Driver's supplemental front-impact air bag (P. 1-37)
7. Audio system (P. 4-2**)

8. Ignition switch (P. 5-13)
 - Push button ignition switch* (P. 5-14)
9. Heater and air conditioner (P. 4-29)
10. Switch panel
 - Seat heater switches* (P. 2-73)
 - Hazard indicator flasher switch (P. 6-2)
 - Idle Stop/Start system on/off switch (P. 5-30)
 - Front passenger air bag status light (P. 1-45)
11. Vehicle Information Display (P. 2-15)
12. Glove box (P. 2-80)
13. Front passenger supplemental air bag (P. 1-37)

*: if equipped

** refer to the INFINITI InTouch Owner's Manual

METERS AND GAUGES

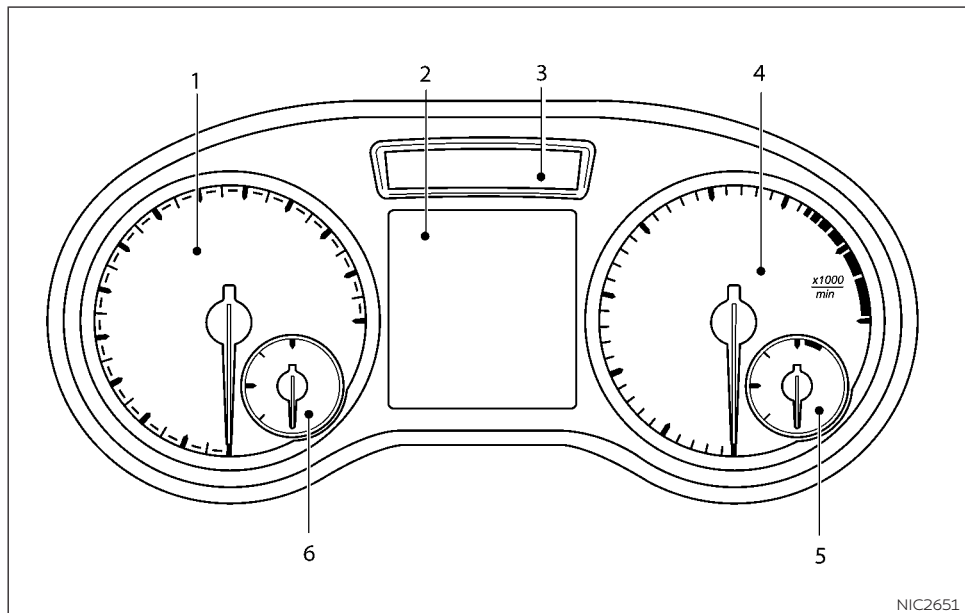

1. Speedometer (P. 2-4)
2. Vehicle information display (P. 2-15)
 - Odometer/twin trip odometer (P. 2-15)
3. Upper information display (P. 2-15)
4. Tachometer (P. 2-6)
5. Engine coolant temperature gauge (P. 2-6)
6. Fuel gauge (P. 2-7)

ENGINE COMPARTMENT

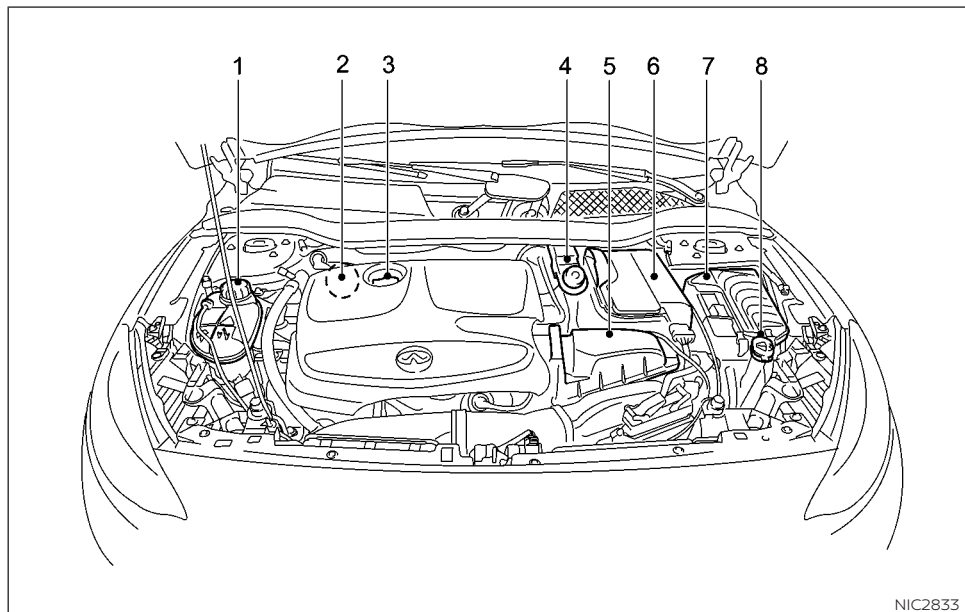





















2.0L GASOLINE ENGINE

1. Engine coolant reservoir (P. 8-3)
2. Engine oil dipstick (P. 8-5)
3. Engine oil filler cap (P. 8-5)
4. Brake fluid reservoir (P. 8-7)

5. Engine air cleaner filter (P. 8-13)
6. Battery (P. 8-9)
7. Fuse box (P. 8-17)
8. Window washer fluid reservoir (P. 8-8)

WARNING AND INDICATOR LIGHTS

Light	Name	Page	Light	Name	Page	Light	Name	Page
	Anti-lock Braking System (ABS) warning light	2-9		Seat belt (driver and front passenger) warning light	2-11		High beam assist indicator light *	2-14
BRAKE	Brake warning light (red)	2-11		Supplemental Restraint System (SRS) air bag warning light	2-12		High beam indicator light	2-14
	Low tire pressure warning light*	2-9		Low fuel warning light	2-13		Rear fog light indicator light	2-14
	Malfunction indicator light (yellow)	2-11		Vehicle Dynamic Control (VDC) warning light	2-13		Side light indicator light	2-14
	Distance warning light*	2-11		Turn signal/hazard indicator lights	2-13		Front passenger air bag status light**	2-14
PARK	Electric parking brake warning light (red)	2-11		Low beam indicator light	2-14			
	Electric parking brake warning light (yellow)	2-11		Vehicle Dynamic Control (VDC) OFF indicator light	2-13			
	Coolant warning light	2-13		Front fog light indicator light*	2-14			

*: if equipped
 **: located above heater and air conditioner controls

1 Safety – seats, seat belts and supplemental restraint system

Seats	1-2	Larger children	1-18
Front seats	1-3	Child restraints	1-19
Rear seats	1-5	Precautions on child restraints	1-19
Armrest (if equipped)	1-7	Rear-facing child restraint installation using LATCH	1-23
Head restraints/Headrests	1-7	Rear-facing child restraint installation using the seat belts	1-24
Adjustable head restraint components	1-8	Forward-facing child restraint installation using LATCH	1-27
Remove	1-8	Forward-facing child restraint installation using the seat belts	1-29
Install	1-9	Booster seats	1-34
Adjust	1-9	Supplemental Restraint System (SRS)	1-37
Seat belts	1-10	Precautions on Supplemental Restraint System (SRS)	1-37
Precautions on seat belt usage	1-10	Supplemental air bag systems	1-43
Pregnant women	1-12	Supplemental air bag warning labels	1-53
Injured persons	1-12	Supplemental air bag warning light	1-53
Seat belt warning light	1-13	Repair and replacement procedure	1-54
Three-point type seat belt with retractor	1-13		
Seat belt extenders	1-16		
Seat belt maintenance	1-16		
Child safety	1-17		
Infants	1-17		
Small children	1-18		

SEATS

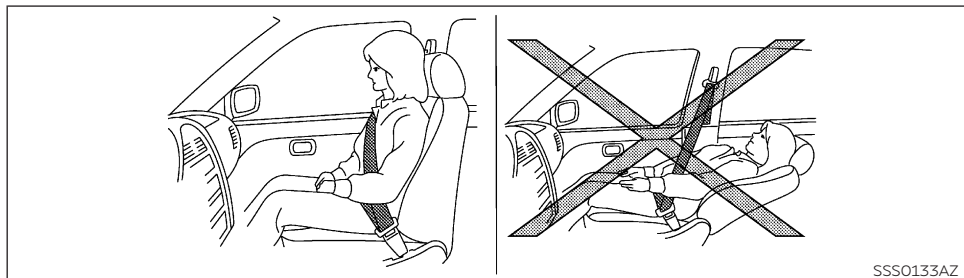

⚠ WARNING

- The seatback should not be reclined any more than needed for comfort. Seat belts are most effective when the passenger sits well back and straight up in the seat. If the seatback is reclined, the risk of sliding under the lap belt and being injured is increased.
- For the most effective protection when the vehicle is in motion, the seat should be upright. Always sit well back and upright in the seat with both feet on the floor and adjust the seat properly. (See "Seat belts" later in this section.)
- After adjustment, gently rock in the seat to make sure it is securely locked.

- To help avoid risk of injury or death through unintended operation of the vehicle and/or its systems, do not leave children, people who require the assistance of others, or pets unattended in your vehicle. Additionally, the temperature inside a closed vehicle on a warm day can quickly become high enough to cause a significant risk of injury or death to people and pets.
- Do not leave children unattended inside the vehicle. They could unknowingly activate switches or controls or make the vehicle move. Unattended children could become involved in serious accidents.

- Do not adjust the driver's seat while driving so full attention may be given to vehicle operation. The seat may move suddenly and could cause loss of control of the vehicle.

⚠ CAUTION

- When moving the seats forward or backward, or returning a reclined seatback to its upright position, make sure you hold onto the seatback while operating. If the seatback is not held, the seat or seatback may move suddenly and could cause injury.
- When adjusting the seat positions, be sure not to contact any moving parts to avoid possible injuries and/or damage.

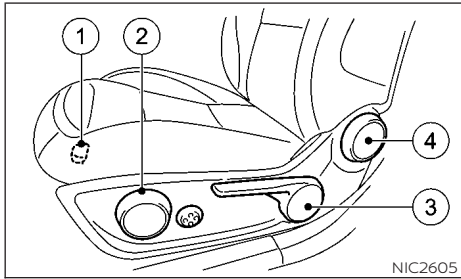

FRONT SEATS

Manual seat adjustment

Forward and backward:

Pull the lever ① up and hold it while sliding the seat forward or backward to the preferred position. Release the lever to lock the seat in position.

Seat cushion angle (if equipped):

Adjust the angles so that your thighs are lightly supported. Turn handwheel ② forwards or backwards.

Seat lifter (if equipped):

Repeatedly pull up or push down the adjusting lever ③, to adjust the seat height to the desired position.

Seatback angle:

Relieve the pressure on the seatback and turn handwheel ④ forwards or backwards.

The reclining feature allows the adjustment of the seatback for occupants of different sizes to help obtain the proper seat belt fit. (See "Seat belts" later in this section.)

The seatback may be reclined to allow occupants to rest when the vehicle is parked.

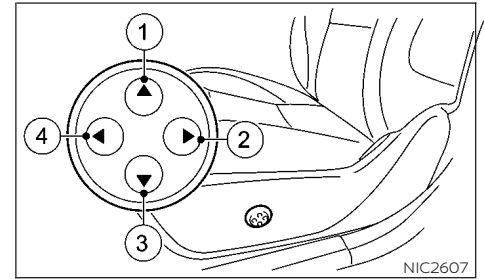

Lumbar support:

The lumbar support feature provides lower back support to the driver.

Push each side of the adjusting switch to adjust the seat lumbar area until the desired position is achieved.

- ① To raise the seatback contour
- ② To soften the seatback contour
- ③ To lower the seatback contour
- ④ To harden the seatback contour

Power seat adjustment

Operating tips:

- The power seat motor has an auto-reset overload protection circuit. If the motor stops during the seat adjustment, wait 30 seconds, then reactivate the switch.
- If the seat motor stops during seat adjustment, check for obstructions. Remove the obstruction before continuing.
- To avoid discharge of the battery, do not operate the power seats for a long period of time when the engine is not running.

NOTE

You can store the seat settings using the memory function (see "Memory function (if equipped)").

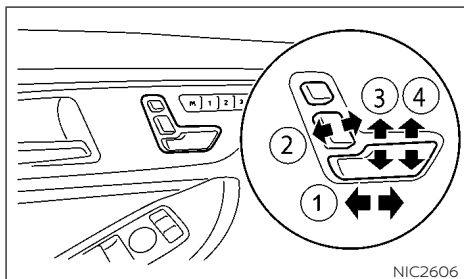

Forward and backward:

Move the adjusting switch ① forward or backward as shown to move the seat to the desired position.

Reclining:

Move the adjusting switch ② forward or backward as shown to move the seatback to the desired position.

The reclining feature allows the adjustment of the seatback for occupants of different sizes to help obtain the proper seat belt fit. (See "Seat belts" later in this section.)

The seatback may be reclined to allow occupants to rest when the vehicle is parked.

Seat lifter (if equipped):

1. Pull up or push down the adjusting switch ③ as shown to adjust the seat height until the desired position is achieved.
2. Tilt up or down the adjusting switch ④ as shown to adjust the front angle of the seat until the desired position is achieved.

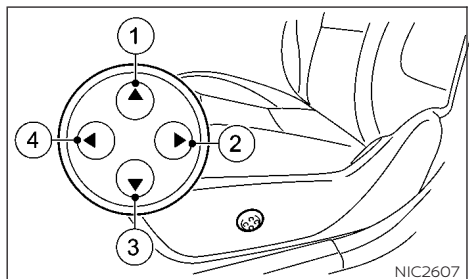

Lumbar support:

The lumbar support feature provides lower back support to the driver.

Push each side of the adjusting switch to adjust the seat lumbar area until the desired position is achieved.

- ① To raise the seatback contour
- ② To soften the seatback contour
- ③ To lower the seatback contour
- ④ To harden the seatback contour

REAR SEATS

⚠ WARNING

- Never allow anyone to ride in the cargo area or on the rear seat when it is in the fold-down position. Use of these areas by passengers without proper restraints could result in serious injury or death in an accident or sudden stop.
- Properly secure all cargo with ropes or straps to help prevent it from sliding or shifting. Do not place cargo higher than the seatbacks. In a sudden stop or collision, unsecured cargo could cause personal injury.
- Do not allow people to ride in any area of your vehicle that is not equipped with seats and seat belts. Be sure everyone in your vehicle is in a seat and using a seat belt properly.
- Do not allow more than one person to use the same seat belt.
- Do not fold down the rear seats when occupants are in the rear seat area or any luggage is on the rear seats.
 - Make sure that the seat path is clear before moving the seat.
 - Be careful not to allow hands or feet to get caught or pinched in the seat.

- Head restraints/headrests should be adjusted properly as they may provide significant protection against injury in an accident. Always replace and adjust them properly if they have been removed for any reason.
- If the head restraints/headrests are removed for any reason, they should be securely stored to prevent them from causing injury to passengers or damage to the vehicle in case of sudden braking or an accident.
- When returning the seatbacks to the upright position, be certain they are completely secured in the latched position. If they are not completely secured, passengers may be injured in an accident or sudden stop.

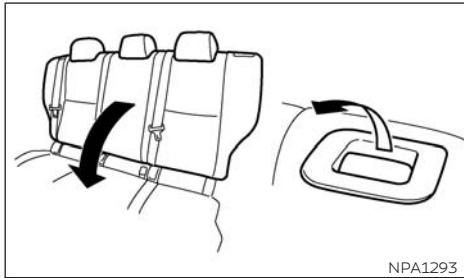

Folding

The luggage compartment loading capacity can be increased by folding the rear seatbacks forward.

To fold the seatback:

1. Ensure head restraints are properly stowed, see "Head restraints/Headrests" later in this section.
2. Move the front driver or passenger seat forward if necessary.
3. Release the seatback lock by pulling the release handle as shown.
4. Fold the seatback forward as shown.

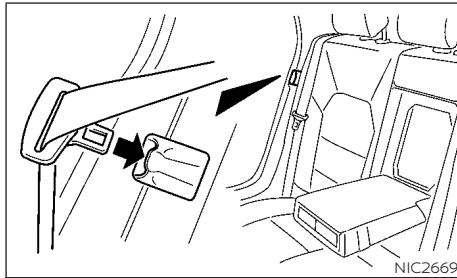

5. Insert the seat belt into the seat belt holder as shown.
6. Move the front driver or passenger seat back if necessary. Avoid contact between the rear seat and the front seat.

To return the seatback to an upright position:

1. Move the front driver or passenger seat forward if necessary.
2. Make sure the seat belts are clear of the seatback latch mechanism.
3. Lift the seatback up and push firmly to lock.
4. If the red marker is visible then the seatback has not latched properly – release and then re-latch the seat.

5. If the head restraint/headrest was removed, reinstall and properly adjust the head restraint/headrest before an occupant uses the seating position. See "Head restraints/Headrests" later in this section.

⚠ WARNING

Always use the seat belt holder, and ensure that the seat belt is not trapped in the seatback latch mechanism. Failure to do so may cause damage to the seat belt, and this may increase the risk of serious injury or death in a collision.

HEAD RESTRAINTS/HEADRESTS

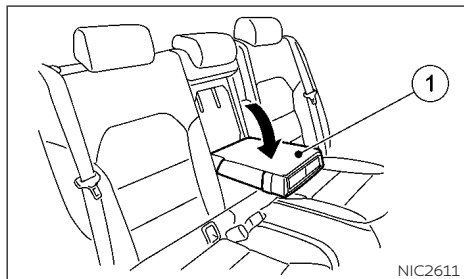

ARMREST (IF EQUIPPED)

Rear

Pull the tab and draw the armrest ① forward as shown until it is horizontal.

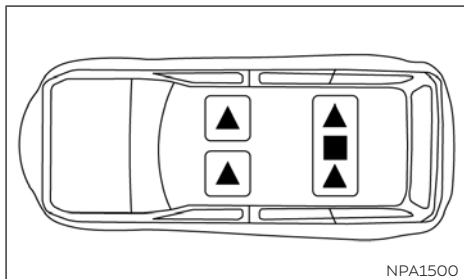

▲ Indicates that the seating position is equipped with a head restraint.

■ Indicates that the seating position is equipped with a non-removable head rest.

⚠ WARNING

Head restraints/headrests supplement the other vehicle safety systems. They may provide additional protection against injury in certain rear end collisions. Adjustable head restraints/headrests must be adjusted properly, as specified in this section. Check the adjustment after someone else uses the seat. Do not attach anything to the head restraint/headrest stalks or remove the head restraint/headrest. Do not use the seat if the head restraint/headrest has been removed. If the head restraint/headrest was removed, reinstall

and properly adjust the head restraint/headrest before an occupant uses the seating position. Failure to follow these instructions can reduce the effectiveness of the head restraints/headrests. This may increase the risk of serious injury or death in a collision.

- Your vehicle is equipped with head restraints/headrests that may be integrated, adjustable or non-adjustable.
- Adjustable head restraints/headrests have multiple notches along the stalk to lock them in a desired adjustment position.
- The non-adjustable head restraints/headrests have a single locking notch to secure them to the seat frame.
- Proper Adjustment:
 - For the adjustable type, align the head restraint/headrest so the center of your ear is approximately level with the center of the head restraint/headrest.
 - If your ear position is still higher than the recommended alignment, place the head restraint/headrest at the highest position.

- If the head restraint/headrest has been removed, ensure that it is reinstalled and locked in place before riding in that designated seating position.

NOTE

For vehicles with sports seats you cannot adjust the front head restraints/headrests or the outer rear head restraints/headrests.

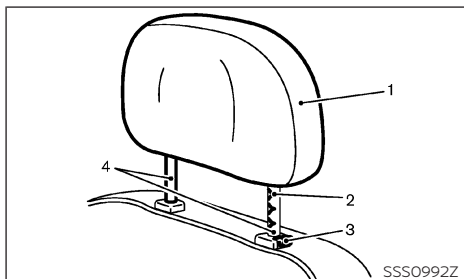

ADJUSTABLE HEAD RESTRAINT COMPONENTS

1. Removable head restraint/headrest
2. Multiple notches
3. Lock knob
4. Stalks

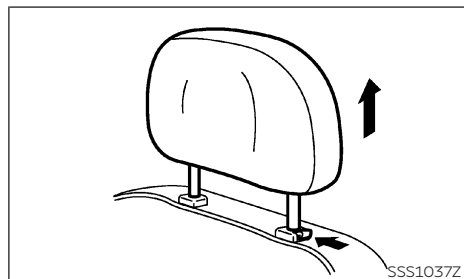

REMOVE

Use the following procedure to remove the head restraint/headrest.

1. Pull the head restraint/headrest up to the highest position.
2. Push and hold the lock knob.
3. Remove the head restraint/headrest from the seat.
4. Store the head restraint/headrest properly in a secure place so it is not loose in the vehicle.
5. Reinstall and properly adjust the head restraint/headrest before an occupant uses the seating position.

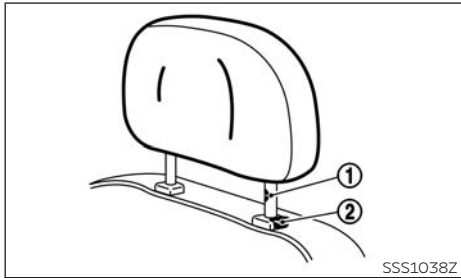

INSTALL

1. Align the head restraint/headrest stalks with the holes in the seat. Make sure that the head restraint/headrest is facing the correct direction. The stalk with the adjustment notch ① must be installed in the hole with the lock knob ②.
2. Push and hold the lock knob and push the head restraint/headrest down.
3. Properly adjust the head restraint/headrest before an occupant uses the seating position.

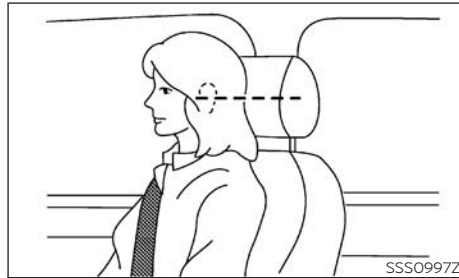

ADJUST

For adjustable head restraint/ headrest

Adjust the head restraint/headrest so the center is level with the center of your ears. If your ear position is still higher than the recommended alignment, place the head restraint/headrest at the highest position.

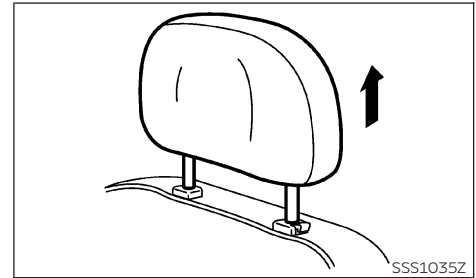

Raise

To raise the head restraint/headrest, pull it up.

Make sure the head restraint/headrest is positioned from the stored position or any non-latch position so the lock knob is engaged in the notch before riding in that designated seating position.

SEAT BELTS

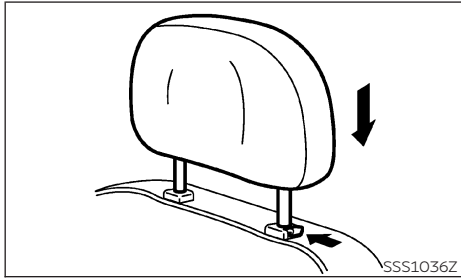

Lower

To lower, push and hold the lock knob ① and push the head restraint/headrest down.

Make sure the head restraint/headrest is positioned so the lock knob is engaged in the notch before riding in that designated seating position.

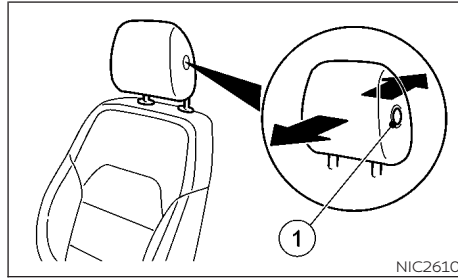

Fore-aft

This function allows you to adjust the distance between the head restraint/headrest and the back of the head.

- To move forwards: pull the head restraint/headrest forwards in the direction of the arrow until it engages. There are a number of detents.
- To move backwards: press and hold button ① and push the head restraint/headrest backwards.
- When the head restraint/headrest is in the desired position, release the button and make sure that the head restraint/headrest is engaged in position.

PRECAUTIONS ON SEAT BELT USAGE

If you are wearing your seat belt properly adjusted, and you are sitting upright and well back in your seat, your chances of being injured or killed in an accident and/or the severity of injury may be greatly reduced. INFINITI strongly encourages you and all of your passengers to buckle up every time you drive, even if your seating position includes a supplemental air bag.

Most U.S. states and Canadian provinces or territories specify that seat belts be worn at all times when a vehicle is being driven.

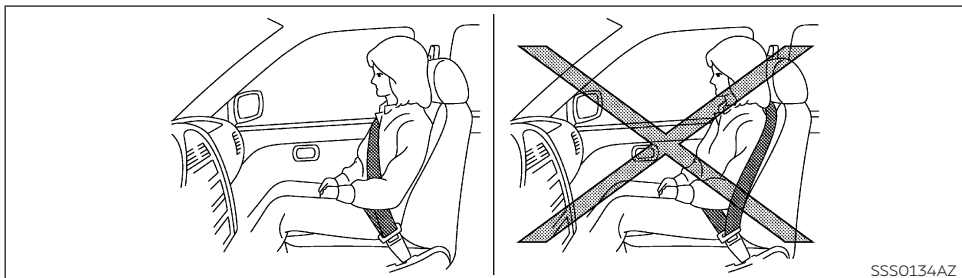

SSS0134AZ

Sit upright and well back

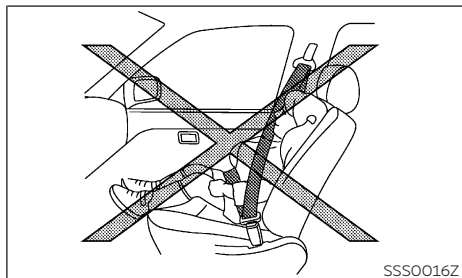

SSS0016Z

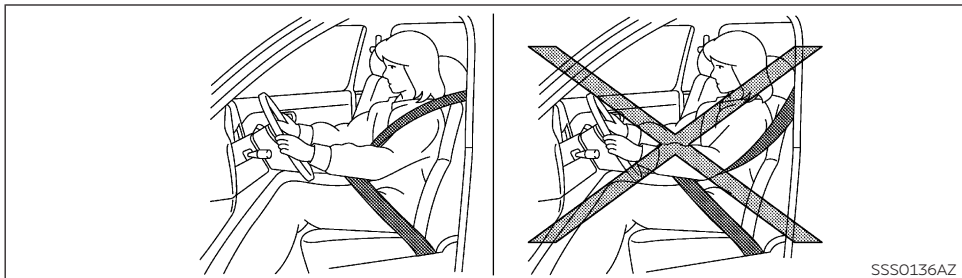

SSS0136AZ

Sit upright and well back

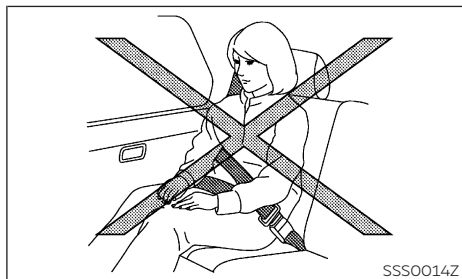

SSS0014Z

⚠ WARNING

- Every person who drives or rides in this vehicle should use a seat belt at all times. Children should be in the rear seats and in an appropriate restraint.

- The seat belt should be properly adjusted to a snug fit. Failure to do so may reduce the effectiveness of the entire restraint system and increase the chance or severity of injury in an accident. Serious injury or death can occur if the seat belt is not worn properly.
- Always route the shoulder belt over your shoulder and across your chest. Never put the belt behind your back, under your arm or across your neck. The belt should be away from your face and neck, but not falling off your shoulder.
- Position the lap belt as low and snug as possible **AROUND THE HIPS, NOT THE WAIST**. A lap belt worn too high could increase the risk of internal injuries in an accident.
- Be sure the seat belt tongue is securely fastened to the proper buckle.
- Do not wear the seat belt inside out or twisted. Doing so may reduce its effectiveness.
- Do not allow more than one person to use the same seat belt.
- Never carry more people in the vehicle than there are seat belts.

- If the seat belt warning light glows continuously while the ignition is turned ON with all doors closed and all seat belts fastened, it may indicate a malfunction in the system. Have the system checked. It is recommended that you visit an INFINITI retailer for this service.
- No changes should be made to the seat belt system. For example, do not modify the seat belt, add material or install devices that may change the seat belt routing or tension. Doing so may affect the operation of the seat belt system. Modifying or tampering with the seat belt system may result in serious personal injury.
- Once a seat belt pretensioner has activated, they cannot be reused and must be replaced together with the retractor. It is recommended that you visit an INFINITI retailer for this service.
- All seat belt assemblies, including retractors and attaching hardware, should be inspected after any collision. It is recommended that you visit an INFINITI retailer for this service. INFINITI recommends that all seat belt assemblies in use during a collision be replaced unless the collision was minor and the belts show no damage and con-

tinue to operate properly. Seat belt assemblies not in use during a collision should also be inspected and replaced if either damage or improper operation is noted.

- All child restraints and attaching hardware should be inspected after any collision. Always follow the restraint manufacturer's inspection instructions and replacement recommendations. The child restraints should be replaced if they are damaged.

PREGNANT WOMEN

INFINITI recommends that pregnant women use seat belts. The seat belt should be worn snug, and always position the lap belt as low as possible around the hips, not the waist. Place the shoulder belt over your shoulder and across your chest. Never put the lap/shoulder belt over your abdominal area. Contact your doctor for specific recommendations.

INJURED PERSONS

INFINITI recommends that injured persons use seat belts. Check with your doctor for specific recommendations.



THREE-POINT TYPE SEAT BELT WITH RETRACTOR

WARNING

- Every person who drives or rides in this vehicle should use a seat belt at all times. Children should be in the rear seats and in an appropriate restraint.
- Do not ride in a moving vehicle when the seatback is reclined. This can be dangerous. The shoulder belt will not be against your body. In an accident, you could be thrown into it and receive neck or other serious injuries. You could also slide under the lap belt and receive serious internal injuries.
- For the most effective protection when the vehicle is in motion, the seat should be upright. Always sit well back and upright in the seat with both feet on the floor and adjust the seat belt properly.

SEAT BELT WARNING LIGHT

The seat belt warning light reminds you to fasten your seat belts. The light illuminates if the engine is started, all doors are closed and the driver's and/or front passenger's seat belt is unfastened. It will remain illuminated until the driver and/or front passenger fastens their seat belt. A chime will sound once the vehicle is in motion.

If the seat belt warning light flashes, together with an intermittent warning tone, this means that the driver or passenger has not fastened their seat belt, and the speed of the vehicle is exceeding 15 MPH (25 km/h).

For additional information, refer to "Warning lights, indicator lights and audible reminders".

- Do not allow children to play with the seat belts. Most seating positions are equipped with Automatic Locking Retractor (ALR) mode seat belts. If the seat belt becomes wrapped around a child's neck with the ALR mode activated, the child can be seriously injured or killed if the seat belt retracts and becomes tight. This can occur even if the vehicle is parked. Unbuckle the seat belt to release the child. If the seat belt cannot be unbuckled or is already unbuckled, release the child by cutting the seat belt with a suitable tool (such as a knife or scissors) to release the seat belt.

Fastening the seat belts

1. Adjust the seat. (See "Seats" earlier in this section.)
2. Slowly pull the seat belt out of the retractor and insert the tongue into the buckle until you hear and feel the latch engage.

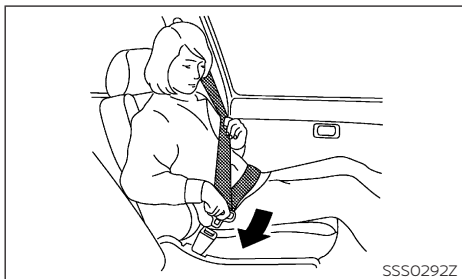

- **The retractor is designed to lock during a sudden stop or on impact. A slow pulling motion permits the belt to move and allows you some freedom of movement in the seat.**
 - **If the seat belt cannot be pulled from its fully retracted position, firmly pull the belt and release it. Then smoothly pull the belt out of the retractor.**
3. Position the lap belt portion **low and snug on the hips** as shown



4. Pull the shoulder belt portion toward the retractor to take up extra slack. Be sure the shoulder belt is routed over your shoulder and across your chest.

The front passenger seat and the rear seating positions three-point seat belts have two modes of operation:

- Emergency Locking Retractor (ELR)
- Automatic Locking Retractor (ALR)

The ELR mode allows the seat belt to extend and retract to allow the driver and passengers some freedom of movement in the seat. The ELR locks the seat belt when the vehicle slows down rapidly or during certain impacts.

The ALR mode (child restraint mode) locks the seat belt for child restraint installation. When the ALR mode is activated, the seat belt cannot be extended again until the seat belt tongue is detached from the buckle and fully retracted. The seat belt returns to the ELR mode after the seat belt fully retracts. For additional information, refer to "Child restraints" later in this section. The ALR mode should be used only for child restraint installation. During normal seat belt use by an occupant, the ALR mode should not be activated. If it is activated, it may cause uncomfortable seat belt tension. It can also change the operation of the front passenger air bag. For additional information, refer to "Front passenger air bag and status light".

WARNING

When fastening the seat belts, be certain that the seatbacks are completely secured in the latched position. If they are not completely secured, passengers may be injured in an accident or sudden stop.

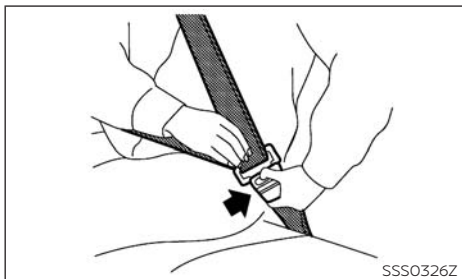

Unfastening the seat belts

To unfasten the seat belt, push the button on the buckle and guide the seat belt as it automatically retracts.

Checking seat belt operation

Seat belt retractors are designed to lock seat belt movement by two separate methods:

- When the belt is pulled quickly from the retractor.
- When the vehicle slows down rapidly.

To increase your confidence in the seat belts, check the operation as follows:

- Grasp the shoulder belt and pull forward quickly. The retractor should lock and restrict further belt movement.

If the retractor does not lock during this check, get the system checked. It is recommended that you visit an INFINITI retailer for this service, or to learn more about seat belt operation.

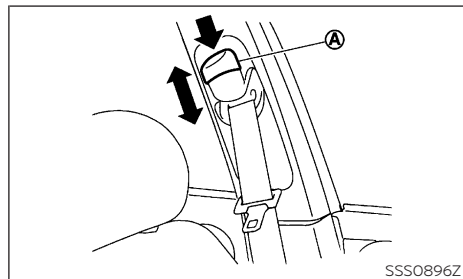

Shoulder belt height adjustment (if equipped)

The shoulder belt anchor height should be adjusted to the position that is best for you. (See "Fastening the seat belts" earlier in this section).

- To adjust, push the button (A) as shown and then move the shoulder belt anchor to the desired position so that the belt passes over the center of the shoulder. The belt should be away from your face and neck, but not falling off of your shoulder. Release the adjustment button to lock the shoulder belt anchor into position.

WARNING

- After adjustment, release the adjustment button and then try to move the shoulder belt down to make sure that it is securely fixed in position.
- The shoulder belt anchor height should be adjusted to the position that is best for you. Failure to do so may reduce the effectiveness of the entire restraint system and increase the chance or severity of injury in an accident.

SEAT BELT EXTENDERS

If, because of body size or driving position, it is not possible to properly fit the lap/shoulder belt and fasten it, an extender that is compatible with the installed seat belts is available that can be purchased. The extender adds approximately 8 in (200 mm) of length and may be used for either the driver or front passenger seating position. It is recommended you visit an INFINITI retailer for assistance with purchasing an extender if an extender is required.

WARNING

- Only INFINITI seat belt extenders, made by the same company which made the original equipment seat belts, should be used with the INFINITI seat belts.
- Adults and children who can use the standard seat belt should not use an extender. Such unnecessary use could result in serious personal injury in the event of an accident.
- Never use seat belt extenders to install child restraints. If the child restraint is not secured properly, the child could be seriously injured in a collision or a sudden stop.

SEAT BELT MAINTENANCE

- To clean the seat belt webbing, apply a mild soap solution or any solution recommended for cleaning upholstery or carpets. Then wipe with a cloth and allow the seat belts to dry in the shade. Do not allow the seat belts to retract until they are completely dry.
- If dirt builds up in the shoulder belt guide of the seat belt anchors, the seat belts may retract slowly. Wipe the shoulder belt guide with a clean, dry cloth.
- Periodically check to see that the seat belt and the metal components, such as buckles, tongues, retractors, flexible wires and anchors, work properly. If loose parts, deterioration, cuts or other damage on the webbing is found, the entire seat belt assembly should be replaced.

CHILD SAFETY

WARNING

Do not allow children to play with the seat belts. Most seating positions are equipped with Automatic Locking Retractor (ALR) mode seat belts. If the seat belt becomes wrapped around a child's neck with the ALR mode activated, the child can be seriously injured or killed if the seat belt retracts and becomes tight. This can occur even if the vehicle is parked. Unbuckle the seat belt to release the child. If the seat belt can not be unbuckled or is already unbuckled, release the child by cutting the seat belt with a suitable tool (such as a knife or scissors) to release the seat belt.

Children need adults to help protect them.

They need to be properly restrained.

In addition to the general information in this manual, child safety information is available from many other sources, including doctors, teachers, government traffic safety offices, and community organizations. Every child is different, so be sure to learn the best way to transport your child.

There are three basic types of child restraint systems:

- Rear-facing child restraint
- Forward-facing child restraint
- Booster seat

The proper restraint depends on the child's size. Generally, infants up to about 1 year and less than 20 lb (9 kg) should be placed in rear-facing child restraints. Forward-facing child restraints are available for children who outgrow rear-facing child restraints and are at least 1 year old. Booster seats are used to help position a vehicle lap/shoulder belt on a child who can no longer use a forward-facing child restraint.

WARNING

Infants and children need special protection. The vehicle's seat belts may not fit them properly. The shoulder belt may come too close to the face or neck. The lap belt may not fit over their small hip bones. In an accident, an improperly fitting seat belt could cause serious or fatal injury. Always use appropriate child restraints.

All U.S. states and Canadian provinces or territories require the use of approved child

restraints for infants and small children. See "Child restraints" for more information.

A child restraint may be secured in the vehicle by using either the LATCH (Lower Anchor and Tethers for CHildren) system or with the vehicle seat belt. For additional information, refer to "Child restraints".

INFINITI recommends that all pre-teens and children be restrained in the rear seat. Studies show that children are safer when properly restrained in the rear seat than in the front seat.

This is especially important because your vehicle has a supplemental restraint system (air bag system) for the front passenger. (See "Supplemental Restraint System (SRS)" later in this section.)

INFANTS

Infants up to at least 1 year old should be placed in a rear-facing child restraint. INFINITI recommends that infants be placed in child restraints that comply with Federal Motor Vehicle Safety Standards or Canadian Motor Vehicle Safety Standards. You should choose a child restraint which fits your vehicle and always follow the manufacturer's instructions for installation and use.

SMALL CHILDREN

Children that are over 1 year old and weigh at least 20 lbs (9 kg) should remain in a rear-facing child restraint as long as possible up to the height or weight limit of the child restraint. Children who outgrow the height or weight limit of the rear-facing child restraint and are at least 1 year old should be secured in a forward-facing child restraint with a harness. Refer to the manufacturer's instructions for minimum and maximum weight and height recommendations. INFINITI recommends that small children be placed in child restraints that comply with Federal Motor Vehicle Safety Standards or Canadian Motor Vehicle Safety Standards. You should choose a child restraint that fits your vehicle and always follow the manufacturer's instructions for installation and use.

LARGER CHILDREN

Children should remain in a forward-facing child restraint with a harness until they reach the maximum height or weight limit allowed by the child restraint manufacturer.

Children who are too large for child restraints should be seated and restrained by the seat belts which are provided. The seat belt may not fit properly if the child is less than 4 ft 9 in (142.5 cm) tall and weighs between 40 lbs

(18 kg) and 80 lbs (36 kg). A booster seat should be used to obtain proper seat belt fit.

Once a child outgrows the height or weight limit of the harness-equipped forward-facing child restraint, INFINITI recommends that the child be placed in a commercially available booster seat to obtain proper seat belt fit. For a seat belt to fit properly, the booster seat should raise the child so that the shoulder belt is properly positioned across the chest and the top, middle portion of the shoulder. The shoulder belt should not cross the neck or face and should not fall off the shoulder. The lap belt should lie snugly across the lower hips or upper thighs, not the abdomen. A booster seat can only be used in seating positions that have a three-point type seat belt. The booster seat should fit the vehicle seat and have a label certifying that it complies with Federal Motor Vehicle Safety Standards or Canadian Motor Vehicle Safety Standards.

A booster seat should be used until the child can pass the seat belt fit test below:

- Are the child's back and hips against the vehicle seatback?
- Is the child able to sit without slouching?
- Do the child's knees bend easily over the front edge of the seat with feet flat on the floor?

- Can the child safely wear the seat belt (lap belt low and snug across the hips and shoulder belt across mid-chest and shoulder)?
- Is the child able to use the properly adjusted head restraint/headrest?
- Will the child be able to stay in position for the entire ride?

If you answered no to any of these questions, the child should remain in a booster seat using a three-point type seat belt.

NOTE

Laws in some communities may follow different guidelines. Check local and state regulations to confirm your child is using the correct restraint system before traveling.

WARNING

Never let a child stand or kneel on any seat and do not allow a child in the cargo area. The child could be seriously injured or killed in a sudden stop or collision.

CHILD RESTRAINTS

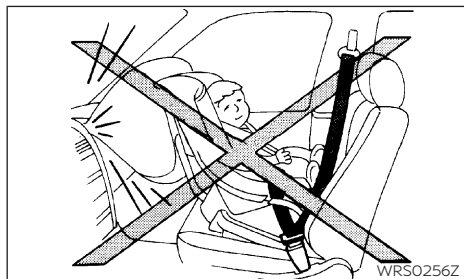
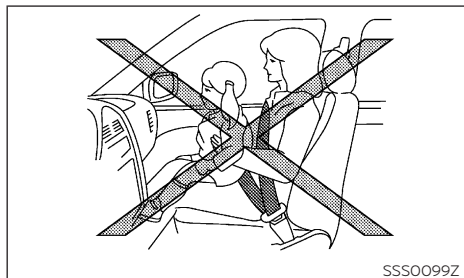

PRECAUTIONS ON CHILD RESTRAINTS

WARNING

- Failure to follow the warnings and instructions for proper use and installa-

tion of child restraints could result in serious injury or death of a child or other passengers in a sudden stop or collision:

- The child restraint must be used and installed properly. Always follow all of the child restraint manufacturer's instructions for installation and use.
- Infants and children should never be held on anyone's lap. Even the strongest adult cannot resist the forces of a collision.
- Do not put a seat belt around both a child and another passenger.
- INFINITI recommends that all child restraints be installed in the rear seat. Studies show that children are safer when properly restrained in the rear seat than in the front seat. If you must install a forward-facing child restraint in the front seat, see "Forward-facing child restraint installation using the seat belts".
- Even with the INFINITI Advanced Air bag System, never install a rear-facing child restraint in the front seat. An inflating air bag could seriously injure or kill a child. A rear-facing child restraint must only be used in the rear seat.

- Be sure to purchase a child restraint that will fit the child and vehicle. Some child restraints may not fit properly in your vehicle.
- Child restraint anchorages are designed to withstand only those loads imposed by correctly fitted child restraints. Under no circumstances are they to be used to attach adult seat belts, or other items or equipment to the vehicle. Doing so could damage the child restraint anchorages. The child restraint will not be properly installed using the damaged anchorages, and a child could be seriously injured or killed in a collision.
- Never use the anchor points for adult seat belts or harnesses.
- A child restraint with a top tether strap should not be used in the front passenger seat.
- Keep seatbacks as upright as possible after fitting the child restraint.
- Infants and children should always be placed in an appropriate child restraint while in the vehicle.
- When the child restraint is not in use, keep it secured with the LATCH system or a seat belt. In a sudden stop or collision, loose objects can injure occupants or damage the vehicle.

CAUTION

Remember that a child restraint left in a closed vehicle can become very hot. Check the seating surface and buckles before placing your child in a child restraint.

This vehicle is equipped with a universal child restraint anchor system, referred to as the LATCH (Lower Anchors and Tethers for CHildren) system. Some child restraints include rigid or webbing-mounted attachments that can be connected to these anchors.

For details, see "LATCH (Lower Anchors and Tethers for CHildren) system".

If you do not have a LATCH compatible child restraint, the vehicle seat belts can be used.

Several manufacturers offer child restraints for infants and small children of various sizes. When selecting any child restraint, keep the following points in mind:

- Choose only a restraint with a label certifying that it complies with Federal Motor Vehicle Safety Standard 213 or Canadian Motor Vehicle Safety Standard 213.
- Check the child restraint in your vehicle to be sure it is compatible with the vehicle's seat and seat belt system.

- If the child restraint is compatible with your vehicle, place your child in the child restraint and check the various adjustments to be sure the child restraint is compatible with your child. Choose a child restraint that is designed for your child's height and weight. Always follow all recommended procedures.
- If the combined weight of the child and child restraint is less than 65 lb (29.5 kg), you may use either the LATCH anchors or the seat belt to install the child restraint (not both at the same time).
- If the combined weight of the child and child restraint is greater than 65 lb (29.5 kg), use the vehicle's seat belt (not the lower anchors) to install the child restraint.
- Be sure to follow the child restraint manufacturer's instructions for installation.

NOTE

All U.S. states and Canadian provinces or territories require that infants and small children be restrained in an approved child restraint at all times while the vehicle is being operated. Canadian law requires the top tether strap on front-facing child restraints to be secured to the designated anchor point on the vehicle.

LATCH (Lower Anchors and Tethers for CHildren) system

Your vehicle is equipped with special anchor points that are used with LATCH system compatible child restraints. This system may also be referred to as the ISOFIX or ISOFIX compatible system. With this system, you do not have to use a vehicle seat belt to secure the child restraint unless the combined weight of the child and child restraint exceeds 65 lb (29.5 kg). If the combined weight of the child and child restraint is greater than 65 lb (29.5 kg), use the vehicle's seat belt (not the lower anchors) to install the child restraint. Be sure to follow the child restraint manufacturer's instructions for installation.

The LATCH anchor points are provided to install child restraints in the rear outboard seating positions only. Do not attempt to install a child restraint in the center position using the LATCH anchors.

LATCH lower anchor

WARNING

Failure to follow the warnings and instructions for proper use and installation of child restraints could result in serious injury or death of a child or other passengers in a sudden stop or collision:

- Attach LATCH system compatible child restraints only at the locations shown in the illustration.
- Do not secure a child restraint in the center rear seating position using the LATCH lower anchors. The child restraint will not be secured properly.
- Inspect the lower anchors by inserting your fingers into the lower anchor area. Feel to make sure there are no obstructions over the anchors such as seat belt webbing or seat cushion material. The child restraint will not be secured properly if the lower anchors are obstructed.

Child restraint anchorages are designed to withstand only those loads imposed by correctly fitted child restraints. Under no circumstances are they to be used to attach adult seat belts, or other items or equipment to the vehicle. Doing so could damage the child restraint anchorages. The child restraint will not be properly installed using the damaged anchorage, and a child could be seriously injured or killed in a collision.

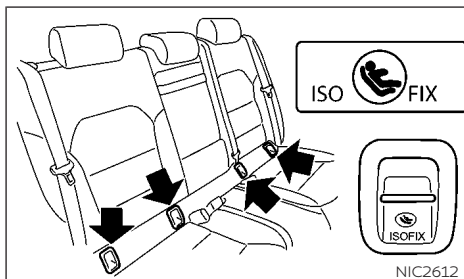

LATCH lower anchor locations

LATCH lower anchor location

The LATCH lower anchors are located at the rear of the seat cushion near the seatback, as shown. A label is attached to the seatback to help you locate the LATCH lower anchors.

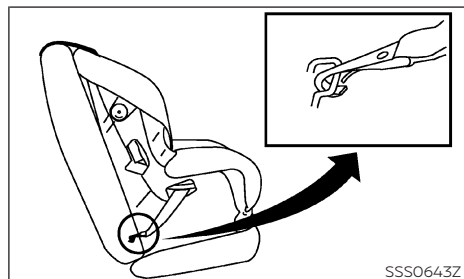

LATCH webbing-mounted attachment

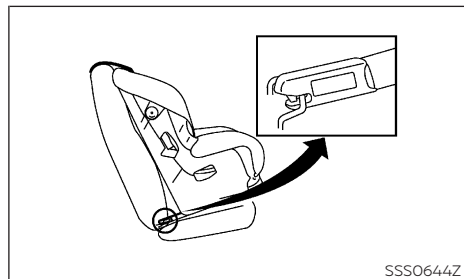

LATCH rigid-mounted attachment

Installing child restraint LATCH lower anchor attachments

LATCH compatible child restraints include two rigid or webbing-mounted attachments

that can be connected to two anchors located at certain seating positions in your vehicle. With this system, you do not have to use a vehicle seat belt to secure the child restraint. Check your child restraint for a label stating that it is compatible with LATCH. This information may also be in the instructions provided by the child restraint manufacturer. When installing a child restraint, carefully read and follow the instructions in this manual and those supplied with the child restraints.

Top tether anchor

WARNING

- **Child restraint anchorages are designed to withstand only those loads imposed by correctly fitted child restraints. Under no circumstances are they to be used to attach adult seat belts, or other items or equipment to the vehicle. Doing so could damage the child restraint anchorages. The child restraint will not be properly installed using the damaged anchorage, and a child could be seriously injured or killed in a collision.**

- **If the cargo cover (if so equipped) contacts the top tether strap when it is attached to the top tether anchor, remove the cargo cover from the vehicle or secure it on the cargo floor below its attachment location. If the cargo cover is not removed, it may damage the top tether strap during a collision. A child could be seriously injured or killed in a collision if the top tether strap is damaged.**
- **Do not allow cargo to contact the top tether strap when it is attached to the top tether anchor. Properly secure the cargo so it does not contact the top tether strap. Cargo that is not properly secured or cargo that contacts the top tether strap may damage it during a collision. A child could be seriously injured or killed in a collision if the top tether strap is damaged.**

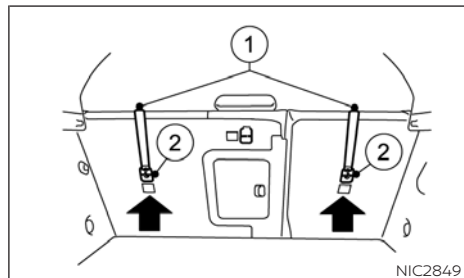

Top tether anchor point locations for LATCH:

- ① Top tether straps
- ② Anchor points

The LATCH anchor points are provided to install child restraints in the rear outboard seating positions only, as shown. Do not attempt to install a child restraint in the center position using the LATCH anchors.

If you have any questions when installing a top tether strap, it is recommended that you visit an INFINITI retailer for this service.

REAR-FACING CHILD RESTRAINT INSTALLATION USING LATCH

For additional information, refer to all Warnings and Cautions in the "Child safety" and "Child restraints" before installing a child restraint. Do not use the lower anchors if the combined weight of the child and the child restraint exceeds 65 lb (29.5 kg). If the combined weight of the child and the child restraint is greater than 65 lb (29.5 kg), use the vehicle seat belt (not the lower anchors) to install the child restraint. Be sure to follow the child restraint manufacturer's instructions for installation. Follow these steps to install a rear-facing child restraint in the 2nd row seats using the LATCH system:

1. Position the child restraint on the seat. Always follow the child restraint manufacturer's instructions.

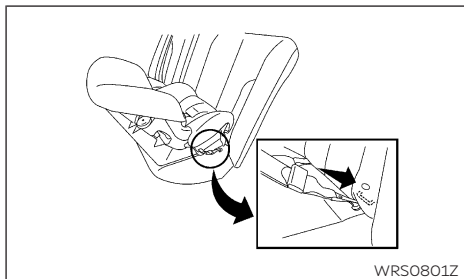

Rear-facing web-mounted – step 2

2. Secure the child restraint anchor attachments to the LATCH lower anchors. Check to make sure the LATCH attachment is properly attached to the lower anchors.

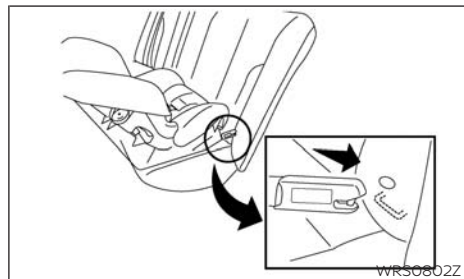

Rear-facing rigid-mounted – step 2

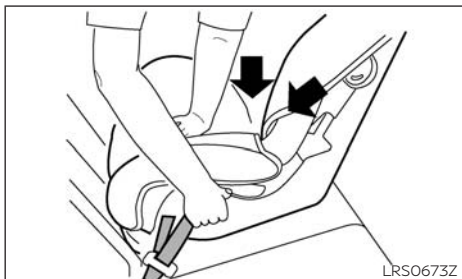

Rear-facing – step 3

3. For child restraints that are equipped with webbing-mounted attachments, remove any additional slack from the anchor attachments. Press downward and rearward firmly in the center of the child restraint with your hand to compress the vehicle seat cushion and seatback while tightening the webbing of the anchor attachments.

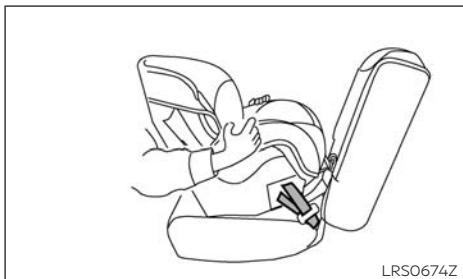

Rear-facing – step 4

4. After attaching the child restraint, test it before you place the child in it. Push it from side to side while holding the child restraint near the LATCH attachment path. The child restraint should not move more than 1 inch (25 mm), from side to side. Try to tug it forward and check to see if the LATCH attachment holds the restraint in place. If the restraint is not secure, tighten the LATCH attachment as necessary, or put the restraint in another seat and test it again. You may need to try a different child restraint or try installing by using the vehicle seat belt (if applicable). Not all child restraints fit in all types of vehicles.

5. Check to make sure the child restraint is properly secured prior to each use. If the child restraint is loose, repeat steps 2 through 4.

REAR-FACING CHILD RESTRAINT INSTALLATION USING THE SEAT BELTS

⚠ WARNING

The three-point seat belt with Automatic Locking Retractor (ALR) must be used when installing a child restraint. Failure to use the ALR mode will result in the child restraint not being properly secured. The restraint could tip over or be loose and cause injury to a child in a sudden stop or collision.

Rear-facing child restraints must not be used on the front seats.

For additional information, refer to all Warnings and Cautions in the "Child safety" and "Child restraints" before installing a child restraint.

Do not use the lower anchors if the combined weight of the child and the child restraint exceeds 65 lb (29.5 kg). If the combined weight of the child and the child restraint is greater than 65 lb (29.5 kg), use the vehicle seat belt (not the lower anchors) to install the child restraint. Be sure to follow the child restraint manufacturer's instructions for installation.

Follow these steps to install a rear-facing child restraint using the vehicle seat belts in the rear seats:

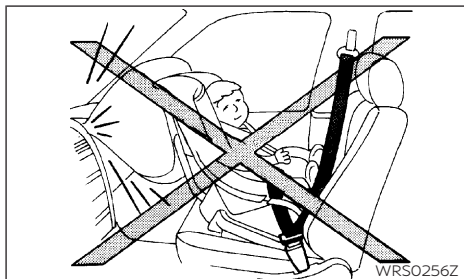

Rear-facing – step 1

1. **Child restraints for infants must be used in the rear-facing direction and therefore must not be used in the front seat.** Position the child restraint on the seat. Always follow the child restraint manufacturer's instructions.

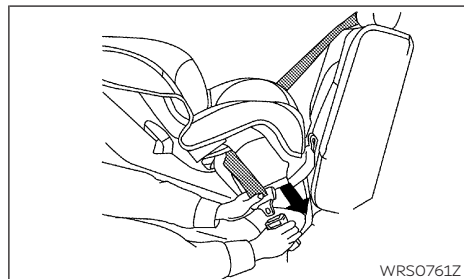

Rear-facing – step 2

2. Route the seat belt tongue through the child restraint and insert it into the buckle until you hear and feel the tongue engage. Be sure to follow the child restraint manufacturer's instructions for belt routing.

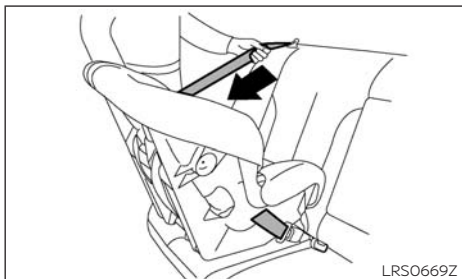

Rear-facing – step 3

3. Pull the shoulder belt until the belt is fully extended. At this time, the seat belt retractor is in the ALR mode (child restraint mode). It reverts to the ELR mode when the seat belt is fully retracted.

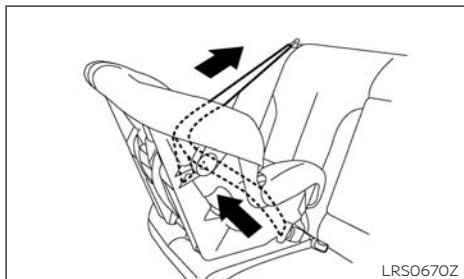

Rear-facing – step 4

4. Allow the seat belt to retract. Pull up on the shoulder belt to remove any slack in the belt.

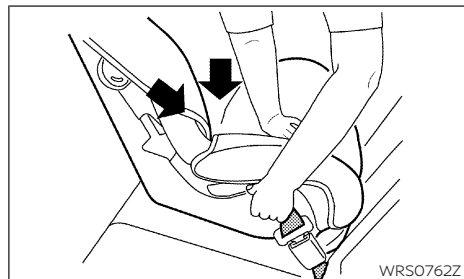

Rear-facing – step 5

5. Remove any additional slack from the seat belt; press downward and rearward firmly in the center of the child restraint to compress the vehicle seat cushion and seat-back while pulling up on the seat belt.

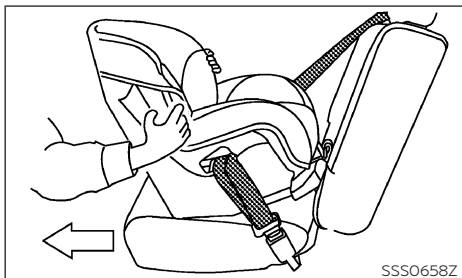

Rear-facing – step 6

6. After attaching the child restraint, test it before you place the child in it. Push it from side to side while holding the child restraint near the seat belt path. The child restraint should not move more than 1 inch (25 mm), from side to side. Try to tug it forward and check to see if the belt holds the restraint in place. If the restraint is not secure, tighten the seat belt as necessary, or put the restraint in another seat and test it again. You may need to try a different child restraint. Not all child restraints fit in all types of vehicles.
7. Check to make sure that the child restraint is properly secured prior to each use. If the seat belt is not locked, repeat steps 1 through 6.

After the child restraint is removed and the seat belt fully retracted, the ALR mode (child restraint mode) is canceled.

FORWARD-FACING CHILD RESTRAINT INSTALLATION USING LATCH

For additional information, refer to all Warnings and Cautions in the "Child safety" and "Child restraints" before installing a child restraint.

Do not use the lower anchors if the combined weight of the child and the child restraint exceeds 65 lb (29.5 kg). If the combined weight of the child and the child restraint is greater than 65 lb (29.5 kg), use the vehicle seat belt (not the lower anchors) to install the child restraint. Be sure to follow the child restraint manufacturer's instructions for installation.

Follow these steps to install a forward-facing child restraint in the rear seats using the LATCH system:

1. Position the child restraint on the seat. Always follow the child restraint manufacturer's instructions.

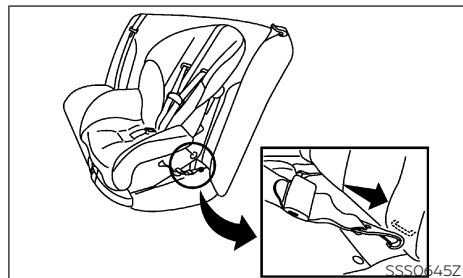

Forward-facing web-mounted – step 2

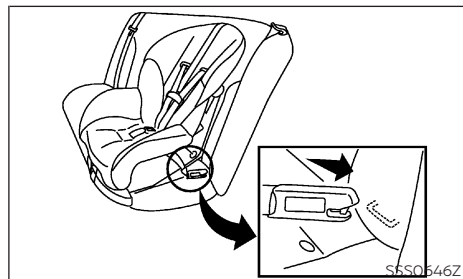

Forward-rigid web-mounted – step 2

2. Secure the child restraint anchor attachments to the LATCH lower anchors. Check to make sure the LATCH attachment is properly attached to the lower anchors.

If the child restraint is equipped with a top tether strap, route the top tether strap and secure the tether strap to the tether anchor point. For additional information, refer to "Installing top tether strap".

Do not install child restraints that require the use of a top tether strap in seating positions that do not have a top tether anchor.

3. The back of the child restraint should be secured against the vehicle seatback.

If necessary, adjust or remove the head restraint/headrest to obtain the correct child restraint fit. If the head restraint/headrest is removed, store it in a secure place. **Be sure to reinstall the head restraint/headrest when the child restraint is removed.** For additional information about head restraint/headrest adjustment, refer to "Head restraints/Headrests". If the seating position does not have an adjustable head restraint/headrest and it is interfering with the proper child restraint fit, try another seating position or a different child restraint.

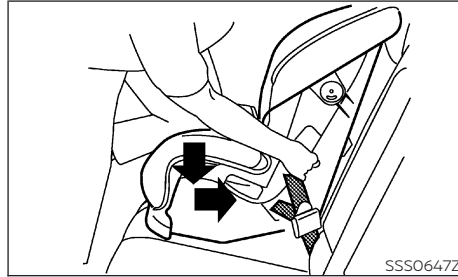

Forward-facing – step 4

4. For child restraints that are equipped with webbing-mounted attachments, remove any additional slack from the webbing of the anchor attachments. Press downward and rearward firmly in the center of the child restraint with your knee to compress the vehicle seat cushion and seatback while tightening the webbing of the anchor attachments.
5. Tighten the tether strap according to the manufacturer's instructions to remove any slack.

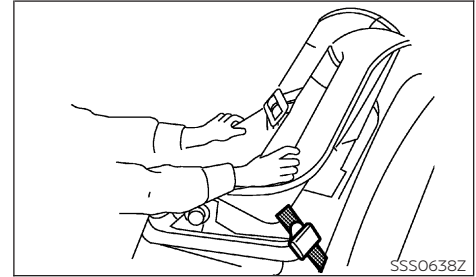

Forward-facing – step 6

6. After attaching the child restraint, test it before you place the child in it. Push it from side to side while holding the child restraint near the LATCH attachment path. The child restraint should not move more than 1 inch (25 mm), from side to side. Try to tug it forward and check to see if the LATCH attachment holds the restraint in place. If the restraint is not secure, tighten the LATCH attachment as necessary, or put the restraint in another seat and test it again. You may need to try a different child restraint. Not all child restraints fit in all types of vehicles.
7. Check to make sure the child restraint is properly secured prior to each use. If the child restraint is loose, repeat steps 3 through 6.

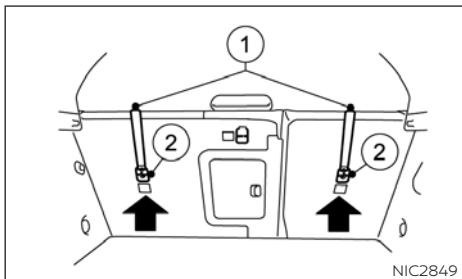

Installing top tether strap

The child restraint top tether strap must be used when installing the child restraint with the LATCH lower anchor attachments. First, secure the child restraint with the LATCH lower anchors (rear outboard seating positions only).

The LATCH anchor points are provided to install child restraints in the rear outboard seating positions only, as shown. Do not attempt to install a child restraint in the center position using the LATCH anchors.

⚠ WARNING

Child restraint anchorages are designed to withstand only those loads imposed by correctly fitted child restraints. Under no circumstances are they to be used to attach

adult seat belts, or other items or equipment to the vehicle. Doing so could damage the child restraint anchorages. The child restraint will not be properly installed using the damaged anchorage, and a child could be seriously injured or killed in a collision.

Outboard seating positions with removable head restraints/headrests:

1. If necessary, raise or remove the head restraint/headrest and store it in a secure place. Be sure to reinstall the head restraint/headrest when the child restraint is removed. For additional information about head restraint/headrest adjustment, removal and installation, refer to "Head restraints/Headrests".
2. Position the top tether strap ① over the seatback as shown.
3. Secure the tether strap to the tether anchor point ② on the seatback behind the child restraint as shown.
4. Tighten the tether strap according to the manufacturer's instructions to remove any slack.

Outboard seating positions with fixed head restraints/headrests:

1. If the child restraint has a single tether strap, route the strap ① over the top of the outer head restraint/headrest. If the child restraint has two tether straps, route them round each side of the outer head restraint/headrest.
2. Secure the tether strap to the tether anchor point ② on the seatback behind the child restraint as shown.
3. Tighten the tether strap according to the manufacturer's instructions to remove any slack.

If you have any questions when installing a top tether strap, it is recommended that you visit an INFINITI retailer for this service.

FORWARD-FACING CHILD RESTRAINT INSTALLATION USING THE SEAT BELTS

⚠ WARNING

The three-point seat belt with Automatic Locking Retractor (ALR) must be used when installing a child restraint. Failure to use the ALR mode will result in the child restraint not being properly secured. The

restraint could tip over or be loose and cause injury to a child in a sudden stop or collision. Also, it can change the operation of the front passenger air bag. For additional information, refer to "Front passenger air bag and status light".

For additional information, refer to all Warnings and Cautions in the "Child safety" and "Child restraints" before installing a child restraint.

Do not use the lower anchors if the combined weight of the child and the child restraint exceeds 65 lb (29.5 kg). If the combined weight of the child and the child restraint is greater than 65 lb (29.5 kg), use the vehicle seat belt (not the lower anchors) to install the child restraint. Be sure to follow the child restraint manufacturer's instructions for installation.

Follow these steps to install a forward-facing child restraint using the vehicle seat belt in the rear seats or in the front passenger seat:

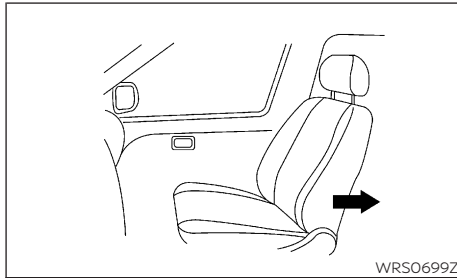

Forward-facing (front passenger seat) – step 1

1. **If you must install a child restraint in the front seat, it should be placed in a forward-facing direction only. Move the seat to the rearmost position. Child restraints for infants must be used in the rear-facing direction and, therefore, must not be used in the front seat.**

2. Position the child restraint on the seat. Always follow the child restraint manufacturer's instructions. The back of the child restraint should be secured against the vehicle seatback. If necessary, adjust or remove the head restraint/headrest to obtain the correct child restraint fit. If the head restraint/headrest is removed, store it in a secure place. **Be sure to reinstall the head restraint/headrest when the child restraint is removed.** For additional information about head restraint/headrest adjustment, removal and installation, refer to "Head restraints/Headrests".

If the seating position does not have an adjustable head restraint/headrest and it is interfering with the proper child restraint fit, try another seating position or a different child restraint.

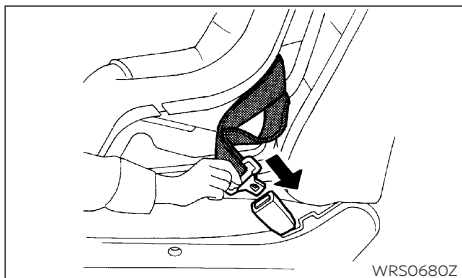

Forward-facing – step 3

3. Route the seat belt tongue through the child restraint and insert it into the buckle until you hear and feel the tongue engage. Be sure to follow the child restraint manufacturer's instructions for belt routing. If the child restraint is equipped with a top tether strap, route the top tether strap and secure the tether strap to the tether anchor point (rear seat installation only). For additional information, refer to "Installing top tether strap".

Do not install child restraints that require the use of a top tether strap in seating positions that do not have a top tether anchor.

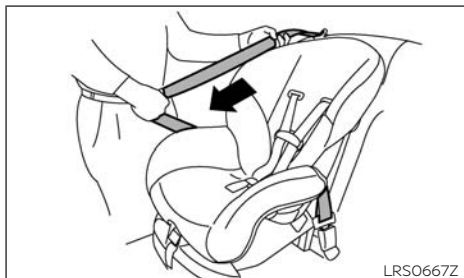

Forward-facing – step 4

4. Pull the shoulder belt until the belt is fully extended. At this time, the seat belt retractor is in the ALR mode (child restraint mode). It reverts to ELR mode when the seat belt is fully retracted.



Forward-facing – step 5

5. Allow the seat belt to retract. Pull up on the shoulder belt to remove any slack in the belt.

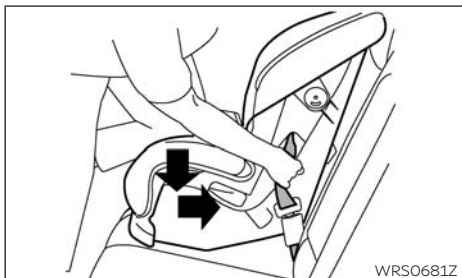

Forward-facing – step 6

6. Remove any additional slack from the seat belt; press downward and rearward firmly in the center of the child restraint with your knee to compress the vehicle seat cushion and seatback while pulling up on the seat belt.
7. Tighten the tether strap according to the manufacturer's instructions to remove any slack.

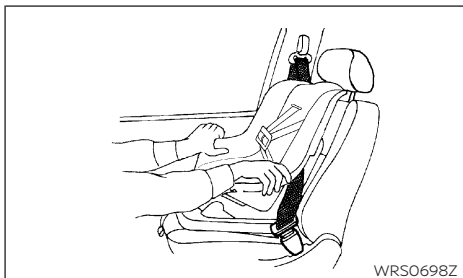

Forward-facing – step 8

8. After attaching the child restraint, test it before you place the child in it. Push it from side to side while holding the child restraint near the seat belt path. The child restraint should not move more than 1 inch (25 mm), from side to side. Try to tug it forward and check to see if the belt holds the restraint in place. If the restraint is not secure, tighten the seat belt as necessary, or put the restraint in another seat and test it again. You may need to try a different child restraint. Not all child restraints fit in all types of vehicles.
9. Check to make sure the child restraint is properly secured prior to each use. If the seat belt is not locked, repeat steps 2 through 8.



Forward-facing – step 10

10. If the child restraint is installed in the front passenger seat, place the ignition switch in the ON position. Either the <PASSENGER AIR BAG ON> indicator light or <PASSENGER AIR BAG OFF> indicator light will illuminate depending on the size of the child and the type of child restraint used. See "Front passenger air bag and status light". After the child restraint is removed and the seat belt is fully retracted, the ALR mode (child restraint mode) is canceled.

If necessary, system operation can be checked by using a special tool. It is recommended that you visit an INFINITI retailer for this service. Until you have confirmed system operation, move the child restraint to another position. See "Troubleshooting" later in this section.

Installing top tether strap

⚠ WARNING

Child restraint anchorages are designed to withstand only those loads imposed by correctly fitted child restraints. Under no circumstances are they to be used to attach adult seat belts, or other items or equipment to the vehicle. Doing so could damage the child restraint anchorages. The child restraint will not be properly installed using the damaged anchorage, and a child could be seriously injured or killed in a collision.

The child restraint top tether strap must be used when installing the child restraint with seat belts.

First, secure the child restraint with the seat belt.

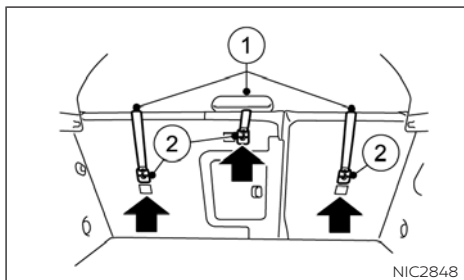

Rear seat - Type A

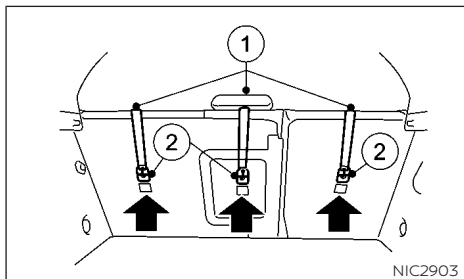

Rear seat - Type B

Outboard seating positions with removable head restraints/headrests:

1. If necessary raise or remove the head restraint/headrest and store it in a secure place. Be sure to reinstall the head restraint/headrest when the child restraint is removed. For additional information about head restraint/headrest adjustment, removal and installation, refer to "Head restraints/Headrests".
2. Position the top tether strap ① over the seatback as shown.
3. Secure the tether strap to the tether anchor point ② on the seatback behind the child restraint as shown.
4. Tighten the tether strap according to the manufacturer's instructions to remove any slack.

Outboard seating positions with fixed head restraints/headrests:

1. If the child restraint has a single tether strap, route the strap ① over the top of the outer head restraint/headrest. If the child restraint has two tether straps, route them round each side of the outer head restraint/headrest.
2. Secure the tether strap to the tether anchor point ② on the seatback behind the child restraint as shown.

3. Tighten the tether strap according to the manufacturer's instructions to remove any slack.

Center seating position with adjustable head restraint/headrest:

1. Raise the head restraint/headrest. For additional information about head restraint/headrest adjustment, removal and installation, refer to "Head restraints/Headrests".
2. Position the top tether strap ① under the head restraint/head rest and over the seatback, between the two head restraint/headrest stalks as shown.
3. Secure the tether strap to the tether anchor point ② on the seatback behind the child restraint as shown.
4. Tighten the tether strap according to the manufacturer's instructions to remove any slack.

If you have any questions when installing a top tether strap, it is recommended that you visit an INFINITI retailer for this service.

BOOSTER SEATS

For additional information on installing a booster seat in your vehicle, follow the instructions outlined in this section.

Precautions on booster seats

⚠ WARNING

If a booster seat and seat belt are not used properly, the risk of a child being injured or killed in a sudden stop or collision greatly increases:

- **Make sure the shoulder portion of the belt is away from the child's face and neck and the lap portion of the belt does not cross the stomach.**
- **Make sure the shoulder belt is not behind the child or under the child's arm.**
- **A booster seat must only be installed in a seating position that has a lap/shoulder belt.**



Booster seats of various sizes are offered by several manufacturers. When selecting any booster seat, keep the following points in mind:

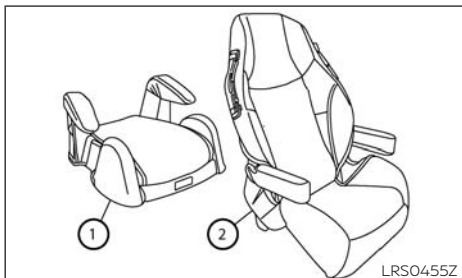

- If the booster seat is compatible with your vehicle, place the child in the booster seat and check the various adjustments to be sure the booster seat is compatible with the child. Always follow all recommended procedures.

All U.S. states and Canadian provinces or territories require that infants and small children be restrained in an approved child restraint at all times while the vehicle is being operated.

The instructions in this section apply to booster seat installation in the rear seats or the front passenger seat.

Booster seat installation

- Choose only a booster seat with a label certifying that it complies with Federal Motor Vehicle Safety Standard 213 or Canadian Motor Vehicle Safety Standard 213.
- Check the booster seat in your vehicle to be sure it is compatible with the vehicle's seat and seat belt system.
- Make sure the child's head will be properly supported by the booster seat or vehicle seat. The seatback must be at or above the center of the child's ears. For example, if a low back booster seat ① is chosen, the vehicle seatback must be at or above the center of the child's ears. If the seatback is lower than the center of the child's ears, a high back booster seat ② should be used.

- **Make sure the shoulder belt is not behind the child or under the child's arm.**
- **A booster seat must only be installed in a seating position that has a lap/shoulder belt.**

To avoid injury to a child, do not use the lap/shoulder belt in the Automatic Locking Retractor (ALR) mode when using a booster seat with the seat belts.

For additional information, refer to all Warnings and Cautions in the "Child safety", "Child restraints" and "Booster seats" before installing a child restraint.

⚠ WARNING

If a booster seat and seat belt are not used properly, the risk of a child being injured or killed in a sudden stop or collision greatly increases:

- **Make sure the shoulder portion of the belt is away from the child's face and neck and the lap portion of the belt does not cross the stomach.**

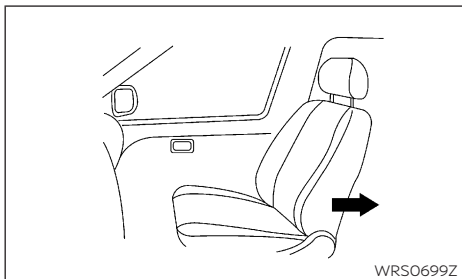

Follow these steps to install a booster seat in the rear seat or in the front passenger seat:

1. **If you must install a booster seat in the front seat, move the seat to the rearmost position.**
2. Position the booster seat on the seat. Only place it in a front-facing direction. Always follow the booster seat manufacturer's instructions.



Rear center position

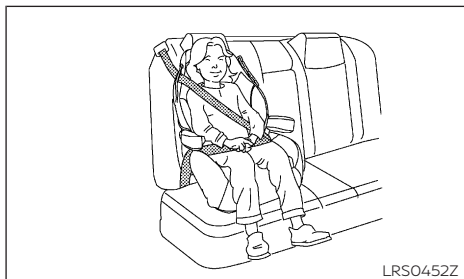

Rear outboard position

3. The booster seat should be positioned on the vehicle seat so that it is stable.
If necessary, adjust or remove the head restraint to obtain the correct booster seat fit. If the head restraint is removed,

store it in a secure place. **Be sure to reinstall the head restraint when the booster seat is removed.**

For additional information about head restraint/headrest adjustment, removal and installation, refer to "Head restraints/Headrests".

If the seating position does not have an adjustable head restraint/headrest and it is interfering with the proper booster seat fit, try another seating position or a different booster seat.

4. Position the lap portion of the seat belt low and snug on the child's hips. Be sure to follow the booster seat manufacturer's instructions for adjusting the seat belt routing.
5. Pull the shoulder belt portion of the seat belt toward the retractor to take up extra slack. Be sure the shoulder belt is positioned across the top, middle portion of the child's shoulder. Be sure to follow the booster seat manufacturer's instructions for adjusting the seat belt routing.
6. Follow the warnings, cautions and instructions for properly fastening a seat belt shown in "Precautions on seat belt usage" earlier in this section.

SUPPLEMENTAL RESTRAINT SYSTEM (SRS)

PRECAUTIONS ON SUPPLEMENTAL RESTRAINT SYSTEM (SRS)

This Supplemental Restraint System (SRS) section contains important information concerning the following systems:

- Driver and passenger supplemental front impact air bags (INFINITI Advanced Air Bag System)
- Driver and passenger supplemental knee air bags
- Front seat-mounted side-impact supplemental air bags
- Roof-mounted curtain side-impact and rollover supplemental air bags
- Seat belts with pretensioner

Supplemental front-impact air bag system

The INFINITI Advanced Air Bag System can help cushion the impact force to the head and chest of the driver and front passenger in certain frontal collisions.

Driver and passenger supplemental knee air bags

This system can help cushion the impact force to the driver's and passenger's knees in certain collisions.

Front seat-mounted side-impact supplemental air bag system

This system can help cushion the impact force to the chest and pelvis areas of the driver and front passenger in certain side-impact collisions. The side air bag is designed to inflate on the side where the vehicle is impacted.

Roof-mounted curtain side-impact and rollover supplemental air bags

This system can help cushion the impact force to the head of occupants in the outboard seating positions in certain side-impact or rollover collisions. In a side impact, the curtain air bags are designed to inflate on the side where the vehicle is impacted. In a rollover, curtain air bags on both sides are designed to inflate and remain inflated for a short time.

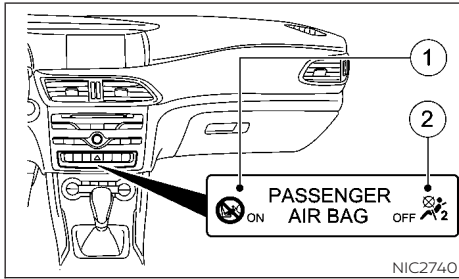

7. If the booster seat is installed in the front passenger seat, place the ignition switch in the ON position. Either the <PASSENGER AIR BAG ON> ① indicator light or <PASSENGER AIR BAG OFF> ② indicator light will illuminate depending on the size of the child and the type of booster seat used. See "Front passenger air bag and status light".

Curtain air bags are also designed to inflate in certain types of rollover collisions or near rollovers. As a result, certain vehicle movements (for example, during severe off-roading) may cause the curtain air bags to inflate.

The SRS is designed to **supplement** the crash protection provided by the driver and front passenger seat belts and is not a substitute for them. Seat belts should always be correctly worn and the occupant seated a suitable distance away from the steering wheel, instrument panel and front door finishers. For additional information, see "Seat belts" earlier in this section.

The supplemental air bags operate only when the ignition switch is placed in the ON position.

After placing the ignition switch in the ON, the air bag warning light will illuminate. The air bag warning light will turn off within a few seconds after the engine is started if the system is operational. See "Warning lights, indicator lights and audible reminders" for further details.

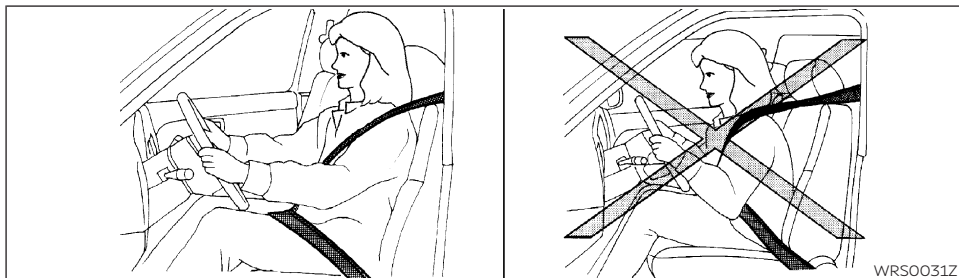

Sit upright and well back

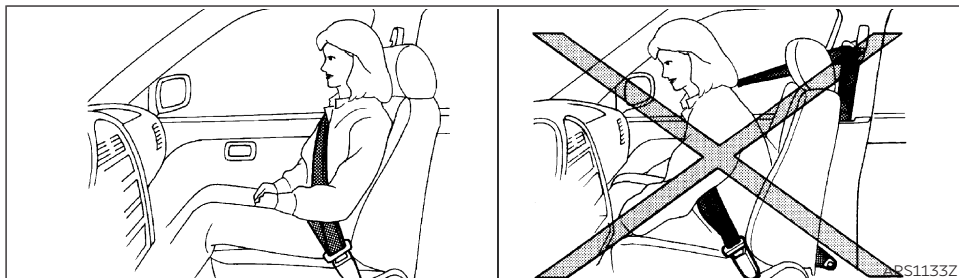

Sit upright and well back

WARNING

- The front-air bags ordinarily will not inflate in the event of a side impact, rear impact, rollover, or lower severity frontal collision. Always wear the seat belts to help reduce the risk or severity of injury in accidents.
- The front passenger air bag will not inflate if the <PASSENGER AIR BAG OFF>  indicator light is lit. For additional information, refer to "Front passenger air bag and status light".
- The seat belts and the front-impact air bags are most effective when you are sitting well back and upright in the seat. The front air bags inflate with great force. Even with the INFINITI Advanced Air Bag System, if you are unrestrained, leaning forward, sitting sideways, or out of position in any way, you are at greater risk of injury or death in a crash. You may also receive serious or fatal injuries from the front air bag if you are up against it when it inflates. Always sit back against the seatback and as far away as practical from the steering wheel. Always properly use the seat belts.

- The driver and front passenger seat belt buckles are equipped with sensors that detect if the seat belts are fastened. The INFINITI Advanced Air Bag System monitors the severity of a collision and seat belt usage then inflates the air bags as needed. Failure to properly wear seat belts can increase the risk or severity of injury in an accident.
- The front passenger seat is equipped with an occupant classification sensor (pressure sensor) that turns the front passenger air bag OFF under some conditions. This sensor is only used in this seat. Failure to be properly seated and wearing the seat belt can increase the risk or severity of injury in an accident. For additional information, refer to "Front passenger air bag and status light".
- Keep hands on the outside of the steering wheel. Placing them inside the steering wheel rim could increase the risk that they are injured when the front air bag inflates.

WARNING

Never let children ride unrestrained or extend their hands or face out of the window. Do not attempt to hold them in your lap or arms. Some examples of dangerous riding positions are shown in the illustrations.

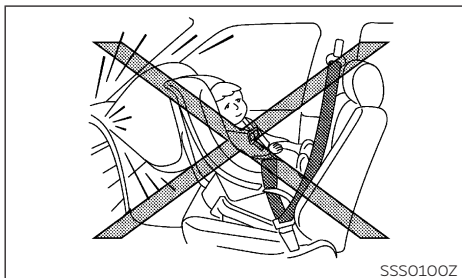

⚠ WARNING

- Even with the INFINITI Advanced Air Bag System, never install a rear-facing child restraint in the front seat. An inflating front air bag could seriously injure or kill your child. For additional information, refer to "Child restraints".
- Children may be severely injured or killed when the front air bags, side air bags or curtain air bags inflate if they are not properly restrained. Pre-teens and children should be properly restrained in the rear seat, if possible.

⚠ WARNING

Front seat-mounted side-impact supplemental air bags and roof-mounted curtain side-impact and rollover supplemental air bags:

- The side air bags and curtain air bags ordinarily will not inflate in the event of a frontal impact, rear impact, or lower severity side collision. Always wear your seat belts to help reduce the risk or severity of injury in various kinds of accidents.

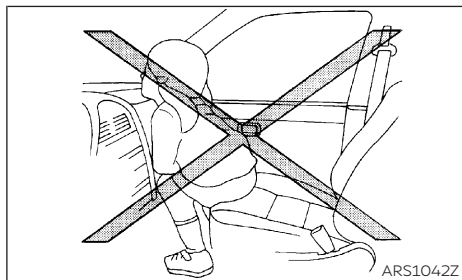
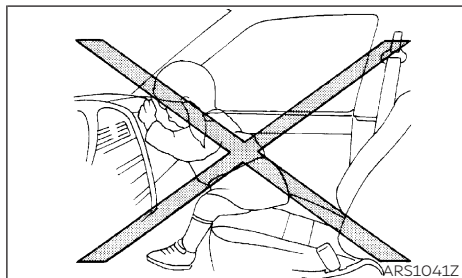

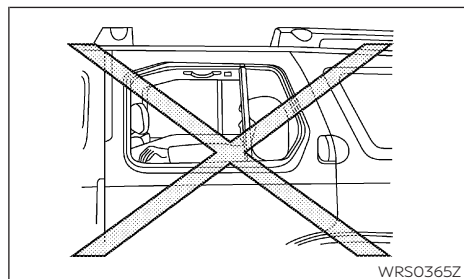
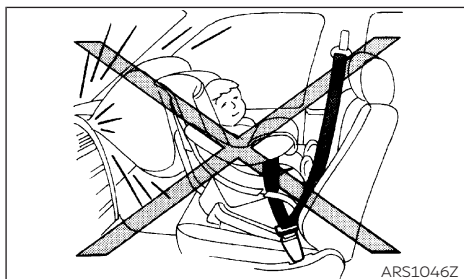
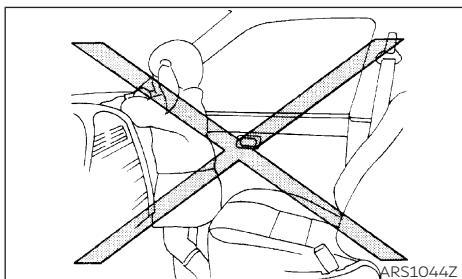
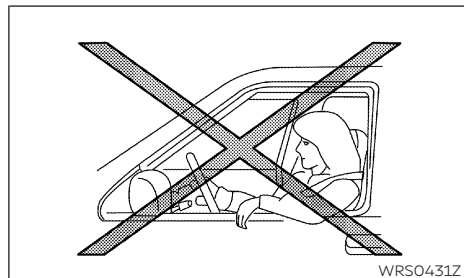
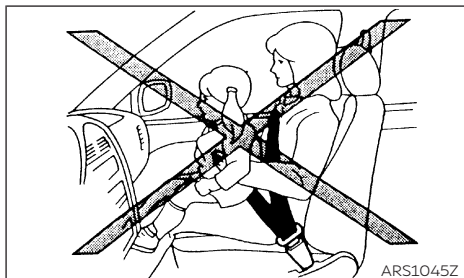
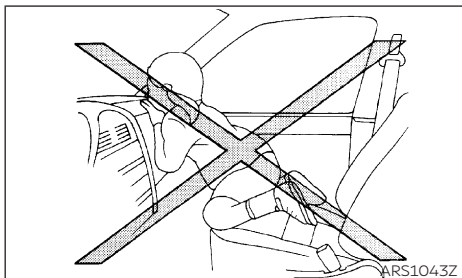

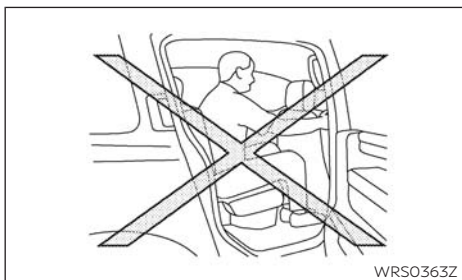
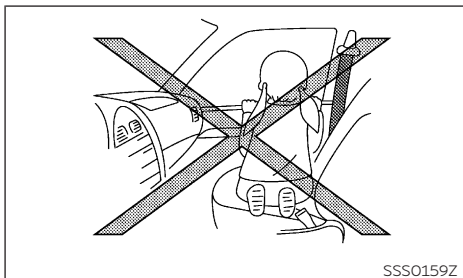
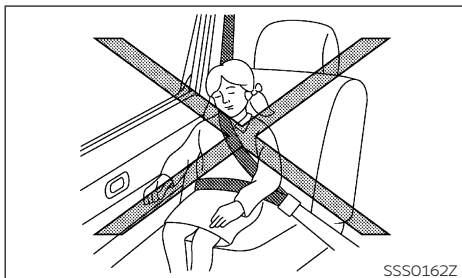

⚠ WARNING

- The seat belts, the side air bags and curtain air bags are most effective when you are sitting well back and upright in the seat with both feet on the floor. The side air bag and curtain air bag inflate with great force. Do not allow anyone to place their hand, leg or face near the side air bag on the side of the seatback of the front seat or near the side roof rails. Do not allow anyone sitting in the front seats or rear outboard seats to extend their hand out of the window or lean against the door. Some examples of dangerous riding positions are shown in the previous illustrations.

- When sitting in the rear seats, do not hold onto the seatback of the front seats. If side air bags and curtain air bags inflate, you may be seriously injured. Be especially careful with children, who should always be properly restrained. Some examples of dangerous riding positions are shown in the illustrations.
- Do not use seat covers on the front seatbacks. They may interfere with the side air bag inflation.

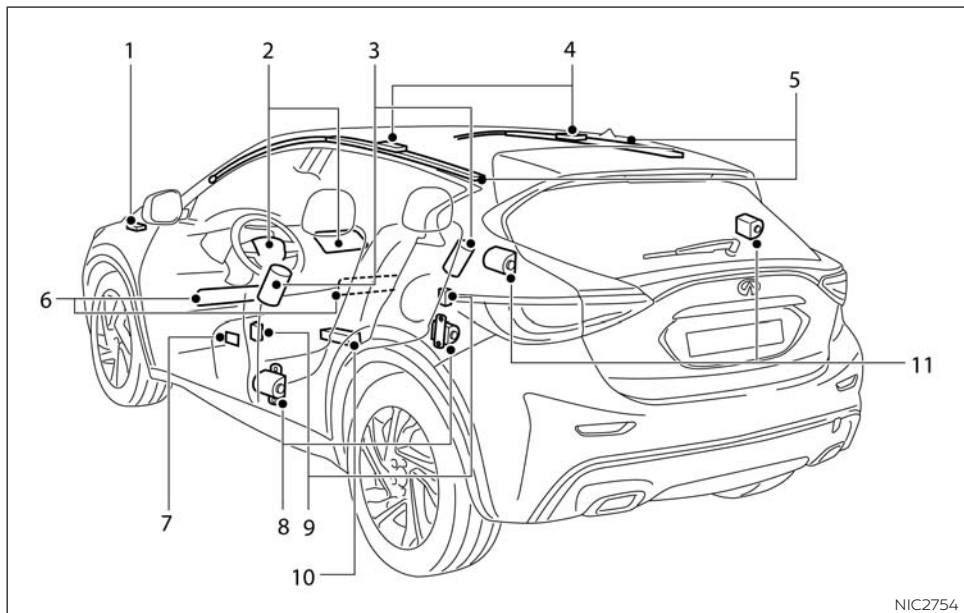

NIC2754

SUPPLEMENTAL AIR BAG SYSTEMS

1. Crash zone sensor
2. Supplemental front-impact air bag modules

3. Front seat-mounted side-impact supplemental air bag modules
4. Roof-mounted curtain side-impact and rollover supplemental air bag inflators
5. Roof-mounted curtain side-impact and rollover supplemental air bag modules

6. Driver and passenger supplemental knee air bags
7. Front door pressure sensors
8. Front seat belt with pretensioners
9. Satellite sensors
10. Air bag Control Unit (ACU)
11. Rear seat belt with pretensioners

Infiniti Advanced Air Bag System
(front seats)

⚠ WARNING

To ensure proper operation of the passenger's INFINITI Advanced Air Bag System, please observe the following items:

- If a forward-facing child restraint is installed in the front passenger seat, do not position the front passenger seat so the child restraint contacts the instrument panel. If the child restraint does contact the instrument panel, the system may determine the seat is occupied and the passenger air bag may deploy in a collision. For additional information about installing and using child restraints, refer to "Child restraints".
- **Confirm the operating condition with the front passenger air bag status light.**

- **If you notice that the front passenger air bag status light is not operating as described in this section. It is recommended that you visit an INFINITI retailer to check the occupant classification system.**
- **Until you have confirmed with a retailer that your passenger seat occupant classification system is working properly, position the occupants in the rear seating positions.**

This vehicle is equipped with the INFINITI Advanced Air Bag System for the driver and front passenger seats. This system is designed to meet certification requirements under U.S. regulations. It is also permitted in Canada.

All of the information, cautions and warnings in this manual still apply and must be followed. The driver supplemental front-impact air bag is located in the center of the steering wheel. The front passenger supplemental front-impact air bag is mounted in the dashboard above the glove box. The front air bags are designed to inflate in higher severity frontal collisions, although they may inflate if the forces in another type of collision are similar to those of a higher severity frontal impact. They may not inflate in certain frontal

collisions. Vehicle damage (or lack of it) is not always an indication of proper front air bag system operation.

The INFINITI Advanced Air Bag System monitors information from the crash zone sensor, the Air Bag Control Unit (ACU), seat belt buckle sensor and occupant classification sensor (pressure sensor). Inflator operation is based on the severity of a collision and seat belt usage for the driver. For the front passenger, the occupant classification sensor is also monitored. Based on information from the sensor, only one front air bag may inflate in a crash, depending on the crash severity and whether the front occupants are belted or unbelted. Additionally, the front passenger air bag may be automatically turned off under some conditions, depending on the information provided by the Occupation Classification System Sensor. If the front passenger air bag is OFF, the <PASSENGER AIR BAG OFF>  indicator light will be illuminated. For additional information, refer to "Front passenger air bag and status light". One front air bag inflating does not indicate improper performance of the system.

If a crash occurs in which the vehicle's air bags deploy, by design the vehicle may not restart. If this occurs, it is recommended that you visit an INFINITI retailer for repair.

If you have any questions about your air bag system, it is recommended that you visit an INFINITI retailer to obtain information about the system. If you are considering modification of your vehicle due to a disability, you may also contact INFINITI. Contact information is contained in the front of this Owner's Manual.

When a front air bag inflates, a fairly loud noise may be heard, followed by the release of smoke. This smoke is not harmful and does not indicate a fire. Care should be taken to not inhale it, as it may cause irritation and choking. Those with a history of a breathing condition should get fresh air promptly.

Front air bags, along with the use of seat belts, help to cushion the impact force on the face and chest of the front occupants. They can help save lives and reduce serious injuries. However, an inflating front air bag may cause facial abrasions or other injuries. Front air bags do not provide restraint to the lower body.

Even with INFINITI Advanced Air Bags, seat belts should be correctly worn and the driver and passenger seated upright as far as practical away from the steering wheel or instrument panel. The front air bags inflate quickly in order to help protect the front occupants. Because of this, the force of the front air bag inflating can increase the risk of injury if the

occupant is too close to, or is against, the front air bag module during inflation. The front air bags deflate quickly after a collision.



The front air bags operate only when the ignition switch is placed in the ON position. After placing the ignition switch in the ON position, the supplemental air bag warning light illuminates. The supplemental air bag warning light will turn off a few seconds after the engine starts if the system is operational.

Front passenger air bag and status light

⚠ WARNING

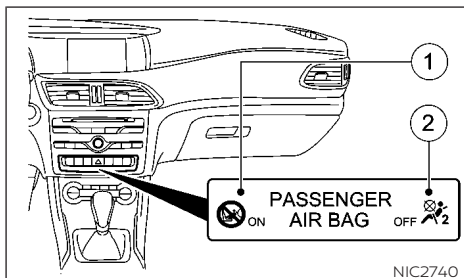
The front passenger air bag is designed to automatically turn OFF under some conditions. Read this section carefully to learn how it operates. Proper use of the seat, seat belt and child restraints is necessary for most effective protection. Failure to follow all instructions in this manual concerning the use of seats, seat belts and child restraints can increase the risk or severity of injury in an accident.



- ① <PASSENGER AIR BAG ON>  indicator light
- ② <PASSENGER AIR BAG OFF>  indicator light

Status light

The front passenger seat is equipped with an occupant classification sensor (pressure sensor) that turns the front passenger air bag on or off depending on the weight applied to the front passenger seat. The indicator lights inform you whether the front passenger front air bag is disabled or enabled.

Place the ignition in the ON position. The system carries out a self-diagnosis.

The <PASSENGER AIRBAG OFF> and <PASSENGER AIRBAG ON> indicator lights will light up simultaneously for approximately six seconds.

The indicator lights display the status of the front passenger front air bag:

- <PASSENGER AIRBAG ON> lights up: the front passenger front air bag is enabled. If, in the event of an accident, all deployment criteria are met, the front passenger front air bag is deployed.
- <PASSENGER AIRBAG OFF> lights up: the front passenger front air bag is disabled. It will then not be deployed in the event of an accident.

If the status of the front passenger front air bag changes while the vehicle is in motion, an air bag display message appears in the vehicle information display. When the front passenger seat is occupied, always pay attention to the <PASSENGER AIRBAG ON> and <PASSENGER AIRBAG OFF> indicator lights. Be aware of the status of the front passenger front air bag both before and during the journey.

If neither the <PASSENGER AIRBAG OFF> or the <PASSENGER AIRBAG ON> indicator lights light up, or if either indicator light only lights up intermittently during the journey, the front passenger seat may not be used for a

child restraint. Use another seating position for the child restraint. INFINITI recommends that all child restraints be installed in the rear seat. Preteen children should be seated in the rear seat. For further information see "Troubleshooting" later in this section.

Front passenger air bag

The front passenger air bag is designed to automatically turn OFF when the vehicle is operated under some conditions as described below in accordance with U.S. regulations. If the front passenger air bag is OFF, it will not inflate in a crash. The driver air bag and other air bags in your vehicle are not part of this system. The purpose of the regulation is to help reduce the risk of injury or death from an inflating air bag to certain front passenger seat occupants, such as children, by requiring the air bag to be automatically turned OFF under some conditions. Certain sensors are used to meet the requirements.

The occupant classification sensor in this vehicle is a pressure sensor. It is designed to detect an occupant and objects on the seat by weight. For example, if a child up to the approximate size and weight of a one year old is properly restrained in the front passenger seat, the INFINITI Advanced Air Bag System is designed to turn the front passenger air bag OFF. For a properly restrained child who is larger than the approximate size

and weight of a one year old, the front passenger air bag may or may not be automatically turned OFF, depending on the size of the child and the type of child restraint being used. After installing the child restraint and positioning the child, place the ignition switch in the ON position: if the <PASSENGER AIR BAG OFF> indicator light is illuminated, the air bag is OFF. If the <PASSENGER AIR BAG ON> indicator light is illuminated, the air bag will inflate in a crash. Front passenger seat adult occupants who are properly seated and using the seat belt as outlined in this manual should not cause the front passenger air bag to be automatically turned OFF. For small adults it may be turned OFF, however if the occupant takes his/her weight off the seat cushion (for example, by not sitting upright, by sitting on an edge of the seat, or by otherwise being out of position), this could cause the sensor to turn the air bag OFF. Always be sure to be seated and wearing the seat belt properly for the most effective protection by the seat belt and supplemental air bag. INFINITI recommends that pre-teens and children be properly restrained in a rear seat. INFINITI also recommends that appropriate child restraints and booster seats be properly installed in a rear seat. If this is not possible, the occupant classification sensor is designed to operate as described above to turn the front passenger air bag OFF for specified child restraints as required by the regulations.

Failing to properly secure child restraints and to use the ALR mode may allow the restraint to tip or move in a collision or sudden stop. This can also result in the passenger air bag inflating in a crash instead of being OFF. For additional information about proper use and installation, refer to "Child restraints".

If the front passenger seat is not occupied, the front passenger air bag is designed not to inflate in a crash. However, heavy objects placed on the seat could result in air bag inflation, because of the object's weight detected by the occupant classification sensor. Other conditions could also result in air bag inflation, such as if a child is standing on the seat, or if two children are on the seat, contrary to the instructions in this manual. Always be sure that you and all vehicle occupants are seated and restrained properly.

If the automatic front passenger air bag deactivation system detects that:

- The front passenger seat is unoccupied, the <PASSENGER AIRBAG OFF> indicator light lights up after the system self-test and remains lit. This indicates that the front passenger front air bag is disabled.

- The front passenger seat is occupied by a properly restrained child up to the approximate size and weight of a one year old, the <PASSENGER AIRBAG OFF> indicator light lights up after the system self-test and remains lit. This indicates that the front passenger front air bag is disabled.

If neither the <PASSENGER AIRBAG OFF> or the <PASSENGER AIRBAG ON> indicator lights light up, or if either indicator light only lights up intermittently during the journey, the front passenger seat may not be used for a child restraint. Use another seating position for the child restraint. For further information see "Troubleshooting" later in this section.

- The front passenger seat is occupied by a properly restrained child who is larger than the approximate size and weight of a one year old, either the <PASSENGER AIRBAG ON> or <PASSENGER AIRBAG OFF> indicator light lights up and remains lit after the system self-test depending on the result of the classification. The result of the classification is dependent on, among other factors, the child restraint system and the child's build.

Move the front passenger seat as far back as possible. See "Child restraints" earlier in this section.

- The front passenger seat is occupied by a person with a smaller build (e.g. a teenager or small adult), either the <PASSENGER AIRBAG ON> or <PASSENGER AIRBAG OFF> indicator light lights up and remains lit after the system self-test depending on the result of the classification.
 - If the <PASSENGER AIRBAG ON> indicator light lights up, move the front passenger seat as far back as possible. Alternatively, a person with a small build can sit on a rear seat.
 - If the <PASSENGER AIRBAG OFF> indicator light is lit, a person with a smaller build should not use the front passenger seat.
- The front passenger seat is occupied by an adult or a person with a build corresponding to that of an adult, the <PASSENGER AIRBAG ON> indicator light lights up after the system self-test and remains lit. This indicates that the front passenger front air bag is enabled.

If the automatic front passenger front air bag deactivation system is malfunctioning, the red  restraint system warning light in the combination meter and the <PASSENGER AIRBAG OFF> indicator light light up simultaneously. The front passenger front air bag is disabled in this case and does not deploy during an accident. Have the system checked as soon as possible by qualified technicians. It is recommended that you visit an INFINITI retailer for this service.

Troubleshooting

Problem	Possible causes/consequences and solutions
The <PASSENGER AIRBAG OFF> indicator lamp lights up and remains lit, even though the front passenger seat is occupied by an adult or a person with a build corresponding to that of an adult	<ul style="list-style-type: none">▪ Make sure the conditions for a correct classification of the person on the front passenger seat are met (see "Front passenger air bag" earlier in this section).▪ If the <PASSENGER AIRBAG OFF> indicator light remains lit, the front passenger seat may not be used.▪ Have the automatic front passenger front air bag deactivation system checked as soon as possible. It is recommended that you visit an INFINITI retailer for this service.
The <PASSENGER AIRBAG OFF> indicator lamp does not light up and/or does not stay on.	<ul style="list-style-type: none">▪ Make sure there is nothing between the seat and the child restraint system.▪ Make sure that the entire base of the child restraint system rests on the seat cushion of the front passenger seat.▪ When installing the child restraint system, make sure that the seat belt is tight. Do not pull the seat belt tight with the front passenger seat adjustment. This could result in the seat belt and the child restraint system being pulled too tightly.▪ Check that the child restraint system is installed correctly.▪ Make sure that no objects are applying additional weight to the seat.▪ Have the automatic front passenger front air bag deactivation system checked as soon as possible. It is recommended that you visit an INFINITI retailer for this service.

Other supplemental front-impact air bag precautions

WARNING

- Do not place any objects on the steering wheel pad or on the instrument panel. Also, do not place any objects between any occupant and the steering wheel or instrument panel. Such objects may become dangerous projectiles and cause injury if the front air bags inflate.
- Immediately after inflation, several front air bag system components will be hot. Do not touch them; you may severely burn yourself.
- No unauthorized changes should be made to any components or wiring of the supplemental air bag system. This is to prevent accidental inflation of the supplemental air bag or damage to the supplemental air bag system.
- Do not make unauthorized changes to your vehicle's electrical system, suspension system or front end structure. This could affect proper operation of the front air bag system.

- Tampering with the front air bag system may result in serious personal injury. Tampering includes changes to the steering wheel and the instrument panel assembly by placing material over the steering wheel pad and above the instrument panel or by installing additional trim material around the air bag system.
- Removing or modifying the front passenger seat may affect the function of the air bag system and result in serious personal injury.
- Modifying or tampering with the front passenger seat may result in serious personal injury. For example, do not change the front seats by placing material on the seat cushion or by installing additional trim material, such as seat covers, on the seat that are not specifically designed to assure proper air bag operation. Additionally, do not stow any objects under the front passenger seat or the seat cushion and seatback. Such objects may interfere with the proper operation of the occupant classification sensor (pressure sensor).

- No unauthorized changes should be made to any components or wiring of the seat belt system. This may affect the front air bag system. Tampering with the seat belt system may result in serious personal injury.
- It is recommended that you visit an INFINITI retailer for work on and around the front air bag. It is also recommended that you visit an INFINITI retailer for installation of electrical equipment. The Supplemental Restraint System (SRS) wiring harnesses* should not be modified or disconnected. Unauthorized electrical test equipment and probing devices should not be used on the air bag system.
- A cracked windshield should be replaced immediately by a qualified repair facility. A cracked windshield could affect the function of the supplemental air bag system.
* The SRS wiring harness connectors are yellow and orange for easy identification.

When selling your vehicle, we request that you inform the buyer about the front air bag system and guide the buyer to the appropriate sections in this Owner's Manual.

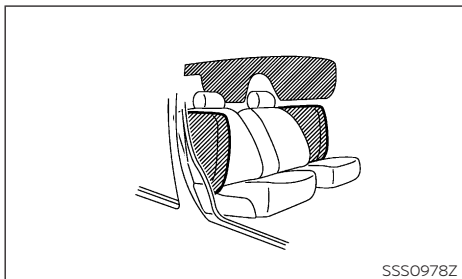

Front seat-mounted side-impact supplemental air bag and roof-mounted curtain side-impact and rollover supplemental air bag systems

The side air bags are located in the outside of the seatback of the front seats. The curtain air bags are located in the side roof rails. **All of the information, cautions and warnings in this manual apply and must be followed.** The side air bags and curtain air bags are designed to inflate in higher severity side collisions, although they may inflate if the forces in another type of collision are similar to those of a higher severity impact. They are designed to inflate on the side where the vehicle is impacted. They may not inflate in certain side collisions. Curtain air bags are also designed to inflate in certain types of

rollover collisions or near rollovers. As a result, certain vehicle movements (for example, during severe off-roading) may cause the curtain air bags to inflate.

Vehicle damage (or lack of it) is not always an indication of proper side air bag and curtain air bag operation.

When the side air bags and curtain air bags inflate, a fairly loud noise may be heard, followed by release of smoke. This smoke is not harmful and does not indicate a fire. Care should be taken not to inhale it, as it may cause irritation and choking. Those with a history of a breathing condition should get fresh air promptly.

Side air bags, along with the use of seat belts, help to cushion the impact force on the chest of the front occupants. Curtain air bags help to cushion the impact force to the head of occupants in the front and rear outboard seating positions in all rows. They can help save lives and reduce serious injuries. However, an inflating side air bag or curtain air bag may cause abrasions or other injuries. Side air bags and curtain air bags do not provide restraint to the lower body.

The seat belts should be correctly worn and the driver and front passenger seated upright as far as practical away from the side air bag. Rear seat passengers should be seated as far

away as practical from the door finishers and side roof rails. The side air bags and curtain air bags inflate quickly in order to help protect the occupants. Because of this, the force of the side air bags and curtain air bags inflating can increase the risk of injury if the occupant is too close to, or is against, these air bag modules during inflation. The side air bag will deflate quickly after the collision is over.

The curtain air bag will remain inflated for a short time.

The side air bags and curtain air bags operate only when the ignition switch is placed in the ON position. After placing the ignition switch in the ON position, the supplemental air bag warning light illuminates. The supplemental air bag warning light will turn off a few seconds after the engine starts if the system is operational.

WARNING

- **Do not place any objects near the seatback of the front seats. Also, do not place any objects (an umbrella, bag, etc.) between the front door finisher and the front seat. Such objects may become dangerous projectiles and cause injury if a side air bag inflates.**

- **Right after inflation, several side air bag and curtain air bag system components will be hot. Do not touch them; you may severely burn yourself.**
- **No unauthorized changes should be made to any components or wiring of the side air bag and curtain air bag systems. This is to prevent damage to or accidental inflation of the side air bag and curtain air bag systems.**
- **Do not make unauthorized changes to your vehicle's electrical system, suspension system or side panel. This could affect proper operation of the curtain air bag systems.**
- **Tampering with the side air bag system may result in serious personal injury. For example, do not change the front seats by placing material near the seatbacks or by installing additional trim material, such as seat covers, around the side air bag.**
- **It is recommended that you visit an INFINITI retailer for work on and around the front air bag. It is also recommended that you visit an INFINITI retailer for installation of electrical equipment. The SRS wiring harnesses* should not be modified or disconnected. Unauthorized**

electrical test equipment and probing devices should not be used on the side air bag or curtain air bag systems.

Driver and passenger supplemental knee air bags

The driver's knee air bag deploys under the steering column, while the passenger's knee air bag deploys under the glove box. All of the information, cautions and warnings in this manual apply and must be followed. The driver's and passenger's knee air bags are triggered together with the front air bag. The knee air bags are designed to inflate in higher severity frontal collisions, although they may inflate if the forces in another type of collision are similar to those of a higher severity frontal impact. They may not inflate in certain collisions.

Vehicle damage (or lack of it) is not always an indication of proper knee air bag operation.

When a knee air bag inflates, a fairly loud noise may be heard, followed by release of smoke. This smoke is not harmful and does not indicate a fire. Care should be taken not to inhale it, as it may cause irritation and choking. Those with a history of a breathing condition should get fresh air promptly

The knee air bags help to cushion the impact force on the knees of the driver and front passenger. They can help reduce serious injuries. However, an inflating knee air bag may cause abrasions or other injuries. The knee air bag provides restraint to the lower body.

The knee air bag inflates quickly in order to help protect the occupants. Because of this, the force of the knee air bag inflating can increase the risk of injury if the occupant is too close to, or is against, this air bag module during inflation. The knee air bag will deflate quickly after the collision is over OR the knee air bag will remain inflated for a short time.

The knee air bags operate only when the ignition switch is placed in the ON position. After placing the ignition switch in the ON position, the supplemental air bag warning light illuminates. The supplemental air bag warning light will turn off a few seconds after the engine starts if the system is operational.

WARNING

- **Do not place any objects between the knee bolster and the driver's seat. Such objects may become dangerous projectiles and cause injury if a knee air bag inflates.**

- Right after inflation, the knee air bag system components will be hot. Do not touch them; you may severely burn yourself.
- No unauthorized changes should be made to any components or wiring of the knee air bag system. This is to prevent damage to or accidental inflation of the knee air bag system.
- Do not make unauthorized changes to your vehicle's electrical system or suspension system. This could affect proper operation of the knee air bag system.
- Tampering with the knee air bag system may result in serious personal injury. For example, do not change the driver knee bolster or install additional trim material around the knee air bag.
- It is recommended that you visit an INFINITI retailer for work on and around the front air bag. It is also recommended that you visit an INFINITI retailer for installation of electrical equipment. The SRS wiring harnesses* should not be modified or disconnected. Unauthorized electrical test equipment and probing devices should not be used on the knee air bag system.

- * The SRS wiring harness or connectors are yellow or orange for easy identification.

When selling your vehicle, we request that you inform the buyer about the knee air bag system and guide the buyer to the appropriate sections in this manual.

Seat belt with pretensioner(s)

WARNING

- The pretensioner(s) cannot be reused after activation. They must be replaced together with the retractor and buckle as a unit.
- If the vehicle becomes involved in a collision but pretensioner(s) are not activated, be sure to have the pretensioner system checked and, if necessary, replaced. It is recommended that you visit an INFINITI retailer for this service.
- No unauthorized changes should be made to any components or wiring of the pretensioner system. This is to prevent damage to or accidental activation of the pretensioner(s). Tampering with the pretensioner system may result in serious personal injury.

- It is recommended that you visit an INFINITI retailer for work on and around the pretensioner system. It is also recommended that you visit an INFINITI retailer for installation of electrical equipment. Unauthorized electrical test equipment and probing devices should not be used on the pretensioner system.
- If you need to dispose of the pretensioner(s) or scrap the vehicle, it is recommended that you visit an INFINITI retailer for this service. Incorrect disposal procedures could cause personal injury.

The pretensioner system may activate with the supplemental air bag system in certain types of collisions. Working with the seat belt retractor, the pretensioner(s) help tighten the seat belt when the vehicle becomes involved in certain types of collisions, helping to restrain front seat and rear outboard occupants. The pretensioner(s) are encased within the seat belt retractor and to the seat belt anchor affixed to the floor of the vehicle. These seat belts are used the same way as conventional seat belts. When pretensioner(s) activate, smoke is released and a loud noise may be heard. This smoke is not harmful and does not indicate a fire. Care should be taken not to inhale it, as it may cause

irritation and choking. Those with a history of a breathing condition should get fresh air promptly. After the pretensioner(s)'s activation, load limiters allow the seat belt to release webbing (if necessary) to reduce forces against the chest. The supplemental air bag warning light is used to indicate malfunctions in the pretensioner system. For additional information, refer to Supplemental air bag warning light in this section. If the operation of the supplemental air bag warning light indicates there is a malfunction, have the system checked. It is recommended that you visit an INFINITI retailer for this service. When selling your vehicle, we request that you inform the buyer about the pretensioner system and guide the buyer to the appropriate sections in this Owner's Manual.

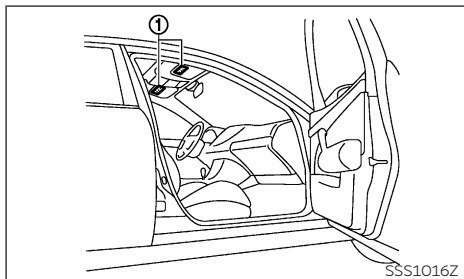

SUPPLEMENTAL AIR BAG WARNING LABELS

Warning labels about the supplemental front impact air bag system are placed in the vehicle as shown in the illustration.

WARNING

Do not use a rear-facing child restraint on a seat protected by an air bag in front of it. If the air bag deploys, it may cause serious injury or death.



SUPPLEMENTAL AIR BAG WARNING LIGHT

The supplemental air bag warning light, displaying  in the instrument panel, monitors the circuits for the air bag systems, pretensioner(s) and all related wiring.

When the ignition switch is placed in the ON position, the supplemental air bag warning light illuminates. The air bag warning light will turn off within a few seconds after the engine is started, if the system is operational.

If any of the following conditions occur, the front air bag, side air bag, curtain air bag and pretensioner systems need servicing:

- The supplemental air bag warning light remains on after approximately 7 seconds.

- The supplemental air bag warning light flashes intermittently.
- The supplemental air bag warning light does not come on at all.

Under these conditions, the front air bag, side air bag, curtain air bag, knee air bag or pretensioner systems may not operate properly. They must be checked and repaired. It is recommended that you visit an INFINITI retailer for this service.

WARNING

If the supplemental air bag warning light is on, it could mean that the front air bag, side air bag, knee air bag, curtain air bag and/or pretensioner systems will not operate in an accident. To help avoid injury to yourself or others, have your vehicle checked as soon as possible. It is recommended that you visit an INFINITI retailer for this service.

These systems should be repaired and/or replaced as soon as possible. It is recommended that you visit an INFINITI retailer for this service.

When maintenance work is required on the vehicle, the front air bags, side air bags, curtain air bags, knee air bags, pretensioner(s) and related parts should be pointed out to the person performing the maintenance. The ignition switch should always be in the LOCK position when working under the hood or inside the vehicle.

WARNING

- **Once a front air bag, side air bag, knee air bag, or curtain air bag has inflated, the air bag module will not function again and must be replaced. Additionally, the activated pretensioner(s) must also be replaced. The air bag module and pretensioner(s) should be replaced. It is recommended that you visit an INFINITI retailer for this service. However, the air bag module and pretensioner(s) cannot be repaired.**

REPAIR AND REPLACEMENT PROCEDURE

The front air bags, side air bags, curtain air bags, knee air bags and pretensioner(s) are designed to inflate on a one-time-only basis. As a reminder, unless it is damaged, the supplemental air bag warning light remains illuminated after inflation has occurred.

- **The front air bag, side air bag, knee air bag, curtain air bag systems and the pretensioner system should be inspected if there is any damage to the front end or side portion of the vehicle. It is recommended that you visit an INFINITI retailer for this service.**
- **If you need to dispose of a supplemental air bag or pretensioner systems or scrap the vehicle, it is recommended you visit an INFINITI retailer. Incorrect disposal procedures could cause personal injury.**
- **If there is an impact to your vehicle from any direction, your automatic front passenger air bag deactivation system should be checked to verify it is still functioning correctly. It is recommended that you visit an INFINITI retailer for this service. The system should be checked even if no air bags deploy as a result of the impact. Failure to verify proper automatic front passenger air bag deactivation system function may result in an improper air bag deployment resulting in injury or death.**

MEMO

2 Instruments and controls

Cockpit	2-2	Headlight switch	2-65
Instrument panel	2-3	Combination switch	2-67
Meters and gauges.	2-4	Adaptive front lighting system (LED headlight only) (if equipped)	2-67
Speedometer and odometer	2-4	High beam assist (LED headlight only)	2-69
Outside temperature display	2-5	Headlights misted up on the inside	2-71
Tachometer	2-6	Instrument brightness control	2-71
Engine coolant temperature gauge	2-6	Fog light switch (if so equipped)	2-71
Fuel gauge	2-7	Front fog lights	2-71
Warning lights, indicator lights and audible reminders	2-8	Rear fog light.	2-72
Checking lights	2-8	Horn	2-72
Warning lights	2-9	Seat heating (if equipped)	2-73
Indicator lights	2-13	Windows	2-74
Audible reminders	2-14	Power windows	2-74
Vehicle information display	2-15	Fixed glass roof (if equipped)	2-78
Menus and submenus	2-16	Sunshade operation	2-78
Display Messages	2-29	Clock	2-79
Security system	2-60	Adjusting time	2-79
Immobiliser	2-60	Power outlet	2-79
Anti-theft alarm system (if equipped)	2-60	Storage	2-80
Wiper and washer switch	2-61	Glove box	2-80
Switching the windshield wipers on/off	2-62	Front console compartment	2-81
Switching the rear window wiper on/off	2-63	Console box	2-81
Rear window and outside mirror defroster switch	2-64	Card holder	2-81
Windshield de-icer switch (if equipped)	2-64	Cup holders	2-82
Headlight and turn signal switches	2-65	Coat hooks	2-83
		Cargo tie-down hooks	2-83

Luggage hooks	2-84
Front seat storage boxes (if equipped).	2-84
Map pocket (if equipped)	2-84
Storage nets (if equipped).	2-85
Parcel shelf.	2-85
Roof rack (if equipped).	2-86
Ski hatch (if equipped)	2-87
Compartment under trunk floor	2-87
Interior lights	2-87
Front overhead control panel	2-88
Rear reading lights (if equipped).	2-88

Rear room light (if equipped)	2-88
Vanity mirror lights	2-89
Luggage compartment light	2-89
Battery saver system.	2-89
HomeLink® Universal Transceiver (if equipped)	2-89
Programming HomeLink®	2-90
Programming trouble diagnosis	2-92
Operating the HomeLink® Universal Transceiver	2-92
Clearing the programmed information	2-93
If your vehicle is stolen.	2-93



COCKPIT

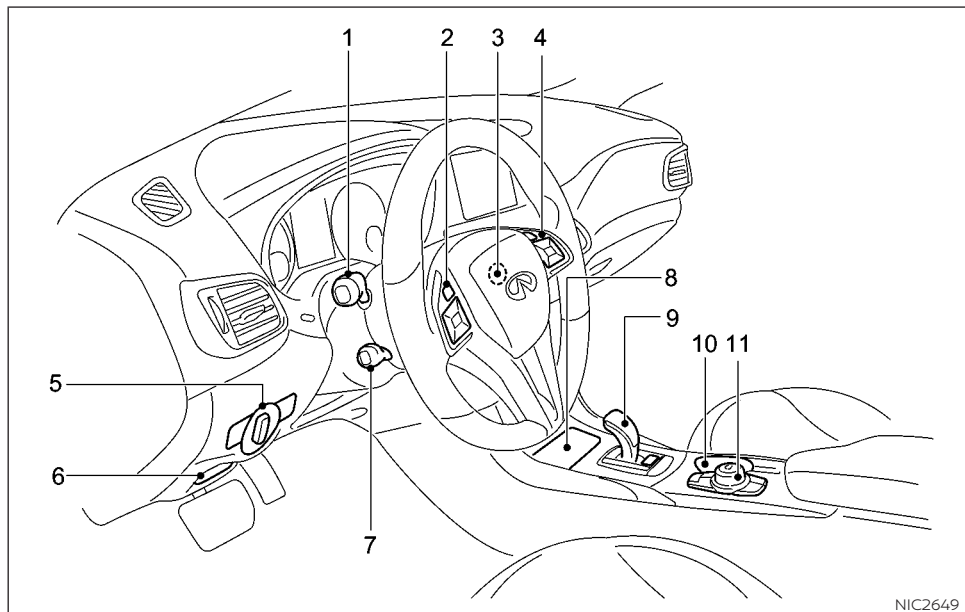

1. Turn signal, wiper, washer, and high beam switch (P. 2-67, 2-61)
2. Steering-wheel-mounted controls (left side) (P. 2-15)
3. Ignition switch (P. 5-13)
 - Push button ignition switch* (P. 5-14)

4. Steering-wheel-mounted controls (right side) (P. 4-2**)
5. Light switch
 - Headlight (P. 2-65)
 - Fog light (P. 2-71)
6. Parking brake (P. 3-27)

7. Cruise Control switch
 - Cruise Control (P. 5-46)
 - Intelligent Cruise Control (P. 2-49*)
8. USB connection ports (P. 4-2**)
9. Shift lever (P. 5-19)
10. Front cup holders (P. 2-82)
11. INFINITI controller (P. 4-2**)

* if equipped

** refer to the INFINITI InTouch Owner's Manual

2-2 Instruments and controls

INSTRUMENT PANEL

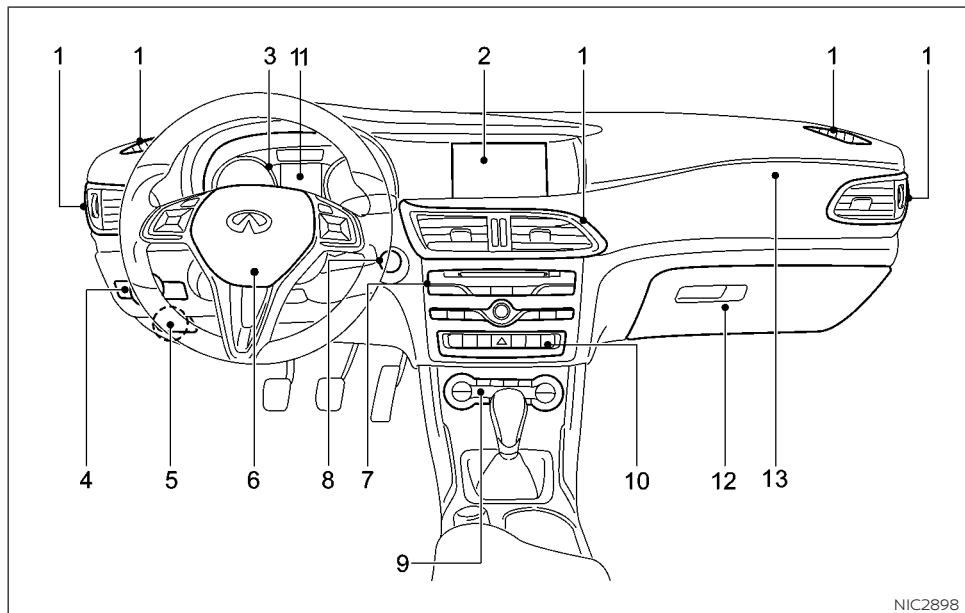

1. Ventilators (P. 4-28)
2. Center display* (P. 4-2**)
3. Meters and gauges (P. 2-4)
4. Light switch (P. 2-65)
5. Parking brake (P. 3-27)

6. Steering wheel
 - Power steering system (P. 5-89)
 - Horn (P. 2-72)
 - Driver's supplemental front-impact air bag (P. 1-37)
7. Audio system (P. 4-2**)

8. Ignition switch (P. 5-13)
 - Push button ignition switch* (P. 5-14)
9. Heater and air conditioner (P. 4-29)
10. Switch panel
 - Seat heater switches* (P. 2-73)
 - Hazard indicator flasher switch (P. 6-2)
 - Idle Stop/Start system on/off switch (P. 5-30)
 - Front passenger air bag status light (P. 1-45)
11. Vehicle Information Display (P. 2-15)
12. Glove box (P. 2-80)
13. Front passenger supplemental air bag (P. 1-37)

*: if equipped

** refer to the INFINITI InTouch Owner's Manual

METERS AND GAUGES

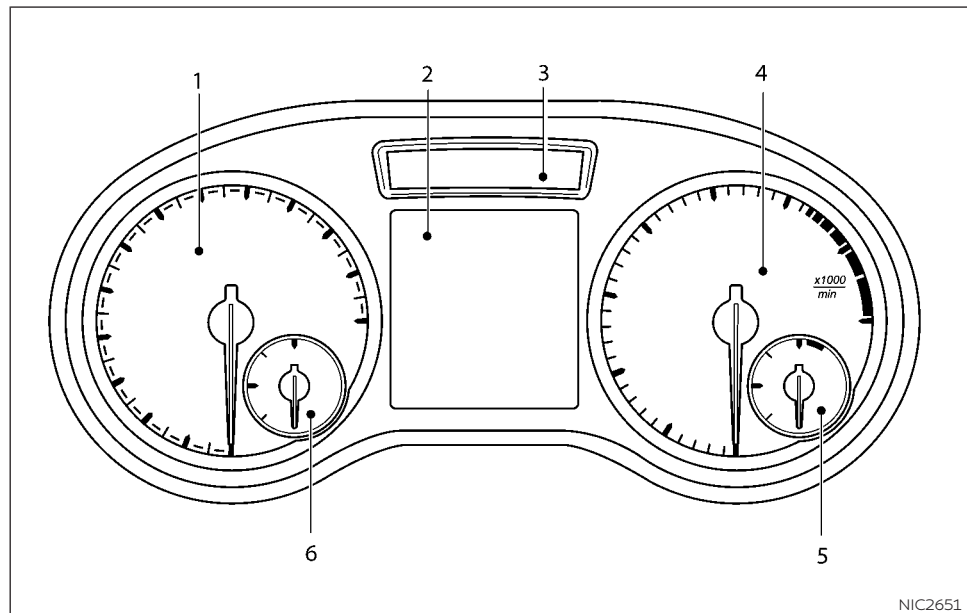

1. Speedometer (P. 2-4)
2. Vehicle information display (P. 2-15)
– Odometer/twin trip odometer (P. 2-15)
3. Upper information display (P. 2-15)
4. Tachometer (P. 2-6)

5. Engine coolant temperature gauge (P. 2-6)
6. Fuel gauge (P. 2-7)

NOTE

The needle indicators may move slightly after the ignition switch is put in the "OFF" position. This is not a malfunction.

CAUTION

- For cleaning, use a soft cloth, dampened with water. Never use a rough cloth, alcohol, thinner or any kind of solvent or paper towel with a chemical cleaning agent. They will scratch or cause discoloration to the lens.
- Do not spray any liquid such as water on the meter lens. Spraying liquid may cause the system to malfunction.

SPEEDOMETER AND ODOMETER

This vehicle is equipped with a speedometer and odometer. The speedometer is located on the right side of the meter cluster. The odometer is located below the vehicle information display.

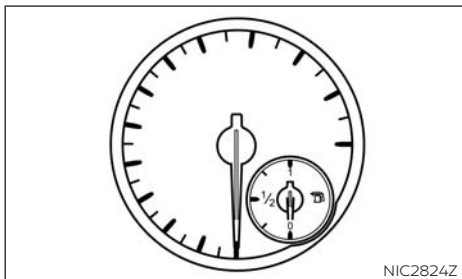

NIC2824Z

Speedometer

The speedometer indicates vehicle speed.

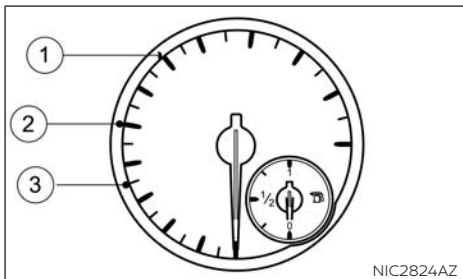

NIC2824AZ

With segments

The speedometer is divided into segments ①, ② and ③ only on vehicles with Intelligent Cruise Control.

The segments in the speedometer indicate which speed range is available (see "Displays in the speedometer").

Odometer/Twin trip odometer

The odometer and the twin trip odometer are displayed in the Vehicle Information Display see "Vehicle information display".

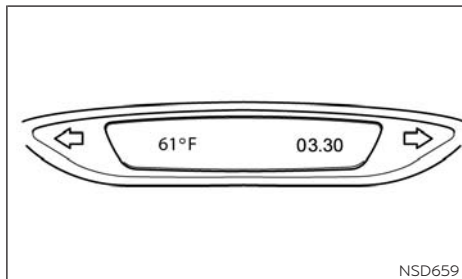

NSD659

OUTSIDE TEMPERATURE DISPLAY

You should pay special attention to road conditions when temperatures are around freezing point.

Bear in mind that the outside temperature display indicates the measured air temperature and not the road surface temperature

Depending on the vehicle specification, the outside temperature display is in either the upper display or the main screen of the vehicle information display. See "Vehicle information display".

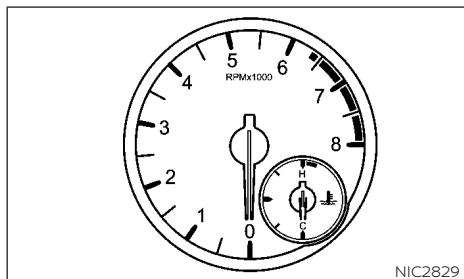

TACHOMETER

The tachometer indicates the engine speed in revolutions per minute (rpm). **Do not rev the engine in the red zone.**

CAUTION

When engine speed approaches the red zone, shift to a higher gear or reduce engine speed. Operating the engine in the red zone may cause serious engine damage.

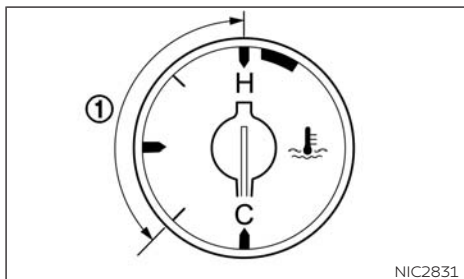

ENGINE COOLANT TEMPERATURE GAUGE

The gauge indicates the engine coolant temperature. The engine coolant temperature is within the normal range ① when the gauge needle points within the zone shown in the illustration. The engine coolant temperature varies with the outside air temperature and driving conditions.

CAUTION

If the gauge indicates coolant temperature near the hot (H) end of the normal range, reduce vehicle speed to decrease temperature. If the gauge is over the normal range, stop the vehicle as soon as safely possible. If the engine is overheated, continued operation of the vehicle may seriously damage the engine. For additional information, refer to "If your vehicle overheats" for immediate action required.

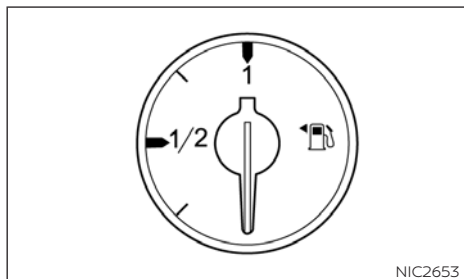

FUEL GAUGE

The fuel gauge indicates the **approximate** fuel level in the tank when the ignition switch is in the ON position.

The gauge may move slightly during braking, turning, accelerating, or going up and down hills due to movement of fuel in the tank.

The gauge needle returns to 0 (Empty) after the ignition switch is placed in the OFF position.

The low fuel warning  appears on the vehicle information display when the fuel level in the tank is getting low.























Refill the fuel tank before the gauge registers 0 (Empty).

The arrow, , indicates that the fuel-filler lid is located on the left side of the vehicle.

CAUTION

- **If the vehicle runs out of fuel, the Malfunction Indicator Light (MIL) may come on. Refuel as soon as possible. After a few driving trips, the light should turn off. If the light remains on after a few driving trips, have the vehicle inspected. It is recommended that you visit an INFINITI retailer for this service.**
- **For additional information, refer to " Malfunction Indicator light (MIL) (yellow)".**

WARNING LIGHTS, INDICATOR LIGHTS AND AUDIBLE REMINDERS









	Anti-lock Braking System (ABS) warning light		Seat belt (driver and front passenger) warning light		High beam assist indicator light *
	Brake warning light (red)		Supplemental Restraint System (SRS) air bag warning light		High beam indicator light
	Low tire pressure warning light*		Low fuel warning light		Rear fog light indicator light
	Malfunction indicator light (yellow)		Vehicle Dynamic Control (VDC) warning light		Side light indicator light
	Distance warning light*		Turn signal/hazard indicator lights		Front passenger air bag status light**
	Electric parking brake warning light (red)		Low beam indicator light		
	Electric parking brake warning light (yellow)		Vehicle Dynamic Control (VDC) OFF indicator light		
	Coolant warning light		Front fog light indicator light*		

*: if equipped

** : located above heater and air conditioner controls

Some indicators and warnings are also displayed in the vehicle information display between the speedometer and tachometer see "Vehicle information display".

CHECKING LIGHTS

With all doors closed, apply the parking brake, fasten the seat belts and place the ignition switch in the ON position without starting the engine. The following lights (if so equipped) will come on, <BRAKE>, , , , , , , , , . These lights should go out within a few seconds after starting the engine. If any light fails to come on or

operates in a way other than described, it may indicate a burned out bulb and/or a system malfunction. Have the system checked. It is recommended you visit an INFINITI retailer for this service.

WARNING LIGHTS

Also see "Vehicle information display" later in this section.

Anti-lock Braking System (ABS) warning light

When the ignition switch is in the ON position, the ABS warning light illuminates to indicate that the ABS is operational. The light then turns off within a few seconds after the engine is started.

If the ABS light comes on while the engine is running, it may indicate the anti-lock braking system is not functioning properly. Have the system checked. It is recommended that you visit an INFINITI retailer for this service.

If the ABS warning light comes on while driving, it may indicate the ABS is not functioning properly. Observe the additional display messages (if any) in the vehicle information display. Have the system checked by an INFINITI retailer.

If an ABS malfunction occurs, the anti-lock function is turned off. The brake system then operates normally, but without anti-lock assistance (see "Brake system").

BRAKE warning light (red)

WARNING

- **Your brake system may not be working properly if the warning light is on. Driving could be dangerous. If you judge it to be safe, drive carefully to the nearest service station for repairs. Otherwise, have your vehicle towed because driving it could be dangerous.**
- **Pressing the brake pedal when the ignition switch is not in the ON position and/or when the brake fluid level is low may increase the stopping distance and braking will require greater pedal effort as well as pedal travel.**
- **If the brake fluid level is below the minimum or MIN mark on the brake fluid reservoir, do not drive until the brake system has been checked. It is recommended that you visit an INFINITI retailer for this service.**

When the ignition switch is placed in the ON position, the light remains illuminated and turns off when the engine is started. If the light illuminates at any other time, it may indicate that the brake system is not functioning properly. If the BRAKE warning light

illuminates, stop the vehicle immediately and contact an INFINITI retailer.

This light functions for both the parking brake and the foot brake systems.

Low tire pressure warning light (if equipped)

Your vehicle is equipped with a Tire Pressure Monitoring System (TPMS) that monitors the tire pressure of all its tires.

The low tire pressure warning light warns of low tire pressure or indicates that the TPMS is not functioning properly.

When the ignition switch is in the ON position, the Low tire pressure warning light illuminates to indicate that the system is operational. The light then turns off within a few seconds after the engine is started.

Low tire pressure warning:

If the vehicle is being driven with low tire pressure, the warning light will illuminate. A tire pressure warning message also appears in the vehicle information display.

When the low tire pressure warning light illuminates, you should stop and adjust the tire pressure of all 4 tires to the recommended COLD tire pressure shown on the Tire and Loading Information label located in

the driver's door opening, see "Tire and load-
ing information label". The low tire pressure
warning light does not automatically turn
off when the tire pressure is adjusted. After
the tire is inflated to the recommended pres-
sure, the vehicle must be driven at speeds
above 16 MPH (25 km/h) to activate the
TPMS and turn off the low tire pressure
warning light. Use a tire pressure gauge to
check the tire pressure.

The low tire pressure warning message ap-
pears each time the ignition switch is placed
in the ON position as long as the low tire
pressure warning light remains illuminated.

For additional information, see "Vehicle in-
formation display" later in this section and
"Tire Pressure Monitoring System (TPMS)".

TPMS malfunction:

If the TPMS is not functioning properly, the
low tire pressure warning light will flash for
approximately 1 minute when the ignition
switch is placed in the ON position. The light
will remain on after 1 minute. Have the sys-
tem checked. It is recommended that you visit
an INFINITI retailer for this service. The low
tire pressure warning does not appear if the
low tire pressure warning light illuminates to
indicate a TPMS malfunction.

For additional information, see "Tire Pressure
Monitoring System (TPMS)".

2-10 Instruments and controls

⚠ WARNING

- Radio waves could adversely affect electric medical equipment. Those who use a pacemaker should contact the electric medical equipment manufacturer for the possible influences before use.
- If the light does not illuminate with the ignition switch pushed ON, have the vehicle checked. It is recommended you visit an INFINITI retailer for this service.
- If the light illuminates while driving, avoid sudden steering maneuvers or abrupt braking, reduce vehicle speed, pull off the road to a safe location and stop the vehicle as soon as possible. Driving with under-inflated tires may permanently damage the tires and increase the likelihood of tire failure. Serious vehicle damage could occur and may lead to an accident and could result in serious personal injury or death. Check the tire pressure for all four tires. Adjust the tire pressure to the recommended COLD tire pressure shown on the tire placard, located in the driver's door opening, to turn the low tire pressure warning light off. If the light still illuminates while driving after adjusting the tire pressure, a tire may be flat. If you

have a flat tire, replace it with a replace-
ment tire as soon as possible.

- If a replacement tire is mounted or a wheel is replaced without a TPMS sensor tire pressure will not be indicated, the TPMS will not function and the low tire pressure warning light will flash for approximately 1 minute. The light will remain on after 1 minute. Have your vehicle's tires replaced and/or TPMS system reset as soon as possible. It is recommended you visit an INFINITI retailer for these services.
- Replacing tires with those not originally specified by INFINITI could affect the proper operation of the TPMS.

⚠ CAUTION

- The TPMS is not a substitute for the regular tire pressure check. Be sure to check the tire pressure regularly.
- If the vehicle is being driven at speeds of less than 16 MPH (25 km/h), the TPMS may not operate correctly.
- Be sure to install the specified size of tires to all four wheels correctly.



Malfunction Indicator light (MIL) (yellow)

When the ignition switch is turned to the ON position, the yellow Malfunction Indicator light illuminates. This means that the system is operational.

If the yellow engine malfunction indicator light lights up while the engine is running, there may be a fault, for example:

- In the engine management
- In the fuel injection system
- In the exhaust system
- In the ignition system (for vehicles with gasoline engines)
- In the fuel system (including a loose or missing fuel filler cap).
- In other monitored items, for example the automatic transmission.

The emission limit values may be exceeded and the engine may be running in emergency mode.

CAUTION

Continued vehicle operation without having the engine control system checked and repaired as necessary could lead to poor drivability, reduced fuel economy and possible damage to the engine control system.

Incorrect setting of the engine control system may lead to non-compliance of local and national emission laws and regulations.

Have the vehicle checked as soon as possible. It is recommended you visit an INFINITI retailer for this service.



Distance warning light (if equipped)

This light illuminates if the distance to the vehicle in front is too small for the speed selected.

If a warning tone also sounds, you are approaching a vehicle or stationary obstacle in your line of travel at too high a speed. For additional information see "Forward emergency braking (FEB) system (if equipped)".

PARK



Electric parking brake warning light

The red indicator illuminates when the electric parking brake is engaged.

If the red indicator light for the electric parking brake flashes or is lit and/or the yellow warning light for the electric parking brake is lit, observe the additional messages displayed in the vehicle information display.

For further parking brake operation information see "Parking brake".



Seat belt (driver and front passenger) warning light

The seat belt warning light reminds you to fasten your seat belts. The light illuminates if the engine is started, all doors are closed and the driver's and/or front passenger's seat belt is unfastened. It will remain illuminated until the driver and/or front passenger fastens their seat belt. A chime will sound once the vehicle is in motion, see "Seat belt reminder chime" later in this section. See "Seat belts" for precautions on seat belt usage.

The seat belt warning light may also illuminate if there are objects on the front passenger seat. Remove the objects and stow them in a safe place.

If the seat belt warning light flashes, together with an intermittent warning tone, this means that the driver or passenger has not fastened their seat belt, and the speed of the vehicle is exceeding 15 MPH (25 km/h).



Supplemental Restraint System (SRS) air bag warning light

WARNING

If the supplemental air bag warning light is on, it could mean that the front air bag, driver's knee air bag, side air bag, curtain air bag and/or pretensioner systems will not operate in an accident. To help avoid injury to yourself or others, have your vehicle checked by an INFINITI retailer as soon as possible.

When the ignition switch is in the ON position, the Supplemental Restraint System (SRS) air bag warning light illuminates to indicate that the system is operational. The light then turns off within a few seconds after the engine is started.

If any of the following conditions occur, the front air bag, front seat-mounted side-impact air bag, roof-mounted curtain air bag and pretensioner systems need servicing:

- The supplemental air bag warning light remains on for longer than a few seconds once the engine is running.
- The supplemental air bag warning light flashes intermittently.
- The supplemental air bag warning light does not come on at all.

It is recommended you visit an INFINITI retailer for these services. Unless checked and repaired, the supplemental restraint system (air bag system) and/or the pretensioner systems may not function properly. For additional information, refer to "Supplemental Restraint System (SRS)".



Coolant warning light

WARNING

If the coolant warning light is lit, the engine may not be being cooled sufficiently and may be damaged. Never drive with an overheated engine. Driving when your engine is overheated can cause some fluids which may have leaked into the engine compartment to catch fire. In addition, steam from an overheated engine can cause serious burns, which can occur just by opening the hood. There is a risk of injury

If the red coolant warning light lights up while the engine is running and the coolant temperature gauge is at the start of the scale, the temperature sensor for the coolant temperature gauge is faulty. The coolant temperature is no longer being monitored. There is a risk of engine damage if the coolant temperature is too high.

Stop the vehicle immediately, paying attention to road and traffic conditions, and switch off the engine. Do not continue driving under any circumstances.

Consult an INFINITI retailer.

If the red coolant warning light comes on while the engine is running, with or without an accompanying warning tone, it could mean that:

- The coolant level is too low.
- If the coolant level is correct, the airflow to the engine radiator may be blocked or the electric engine radiator fan may be malfunctioning.
- The coolant is too hot and the engine is no longer being cooled sufficiently.

Observe the additional display messages in the vehicle information display.

Stop the vehicle immediately, paying attention to road and traffic conditions, and switch off the engine.

Secure the vehicle against rolling away.

Leave the vehicle and keep a safe distance from the vehicle until the engine has cooled down.

Check the coolant level and top up the coolant, observing the warning notes (see "If your vehicle overheats").

If you have to top up the coolant frequently, have the engine cooling system checked.

Make sure that the air supply to the engine radiator is not blocked, e. g. by frozen slush.

Do not start the engine again until the coolant temperature is below 250°F (120°C). The engine may otherwise be damaged.



Low fuel warning light

This light comes on when the fuel level in the fuel tank is getting low. Refuel as soon as it is convenient, preferably before the fuel gauge reaches 0 (Empty). **There will be a small reserve of fuel in the tank when the fuel gauge reaches 0 (Empty).**



Vehicle Dynamic Control (VDC) warning light

The VDC warning light blinks when the Vehicle Dynamic Control (VDC) system is operating, thus alerting the driver to the fact that the road surface is slippery and the vehicle is nearing its traction limits.

You may feel or hear the system working, this is normal.

The light will continue to blink for a few seconds after the VDC system stops limiting wheel spin.

Cruise control or Intelligent Cruise Control is deactivated.

For additional information see "Vehicle Dynamic Control (VDC) OFF indicator light" and "Vehicle Dynamic Control (VDC) system".

INDICATOR LIGHTS



Turn signal/hazard indicator lights

The appropriate light flashes when the turn signal switch is activated. Both lights flash when the hazard switch is turned on.



Low beam indicator light

This light comes on when the switch is turned to the position:  The headlights will come on and front side, tail, number plate and instrument lights remain on.



Vehicle Dynamic Control (VDC) OFF indicator light

The light comes on when the Vehicle Dynamic Control (VDC) has been disabled. This indicates that the VDC system is not operating.

Disabling the VDC system causes the Forward Emergency Braking system to become unavailable. See "Forward emergency braking (FEB) system (if equipped)" for more details.

This light also comes on briefly when the ignition switch is turned to the ON position. The light will turn off after approximately 1 second if the VDC system is operational.

When the VDC OFF indicator light and VDC warning light (see "Vehicle Dynamic Control (VDC) warning light" later in this section) come on with the VDC system turned on, it alerts the driver to the fact that the system's fail-safe mode is operating. This means that the system may not be functioning properly.

Have the system checked. It is recommended you visit an INFINITI retailer for these services.

If an abnormality occurs in the system, the VDC system function will be canceled, but the vehicle is still driveable. For additional information, see "Vehicle Dynamic Control (VDC) system".

WARNING

VDC should remain on unless freeing a vehicle from mud or snow.

While the VDC system is operating, you might feel a slight vibration or hear the system working when starting the vehicle or accelerating, but this is normal.

 Front fog light indicator light (if equipped)

The light comes on when the front fog lights are switched on (see "Fog light switch (If so equipped)" later in this section).

 High beam assist indicator light (if equipped)

The indicator light illuminates when the headlights come on while the headlight switch is in the AUTO position with the high beam selected. This indicates that the high beam assist system is operational. (See 2-65.)

 High beam indicator light

This blue light comes on when the headlight high beams are on and goes out when the low beams are selected.

The high beam indicator light also comes on when the passing signal is activated.



 Rear fog light indicator light

The light comes on when the rear fog light is switched on (see "Fog light switch (If so equipped)" later in this section).

 Side light and headlight indicator light

This light comes on when the side light or headlight position is selected, see "Headlight and turn signal switches" later in this section for further details.

 /  Front passenger air bag status light

The front passenger air bag status light () located on the center console above the shift lever will illuminate when the front passenger air bag is turned OFF. When the front passenger air bag is turned on, the front passenger air bag status light ON () will illuminate.

For more details, see "Front passenger air bag and status light".

AUDIBLE REMINDERS

Parking brake reminder chime

A chime will sound when driving away if the parking brake has not been released. Stop the vehicle and release the parking brake.

Light reminder chime

With the ignition switch placed in the OFF position, a chime sounds when the driver's door is opened if the side lights are on. Turn the headlight control switch off before leaving the vehicle.

Seat belt reminder chime

A chime will sound for approximately 120 seconds if the vehicle's speed exceeds 16 MPH (25 km/h) and the driver's seat belt or front passenger's seat belt, if occupied is not securely fastened. See "Seat belt warning light".

VEHICLE INFORMATION DISPLAY

Idle Stop/Start System reminder chime (if equipped)

The engine will shift to the normal stopped state if any of the following operations is made during Idle Stop/Start System activation, and the Idle Stop/Start System chime will sound if:

- The vehicle engine hood is open.

When the above condition continues for over 3 minutes the Idle Stop/Start System chime will sound in 5-minute intervals as a reminder to prevent the possibility of a discharged battery. Use the ignition switch to turn off the engine.

Close the hood or the driver's door, or fasten the seat belt then restart the engine using the ignition switch.

For more information, see "Idle Stop/Start System (if equipped)".

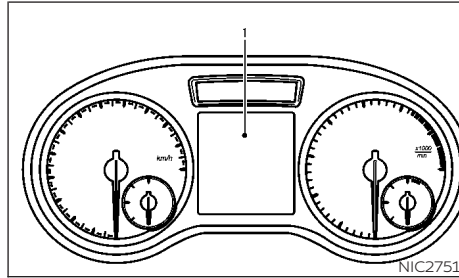

The vehicle information display ① is located between the tachometer and the speedometer.

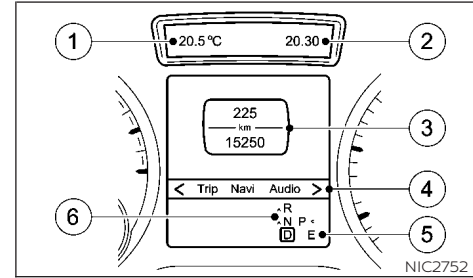

- ① Permanent display: depending on vehicle specification: outside temperature or speed
- ② Time
- ③ Text field
- ④ Menu bar
- ⑤ Drive program
- ⑥ Shift lever position

Text field ③ shows the selected menu or submenu as well as display messages.

NOTE

Set the time using the INFINITI controller and the [Settings] menu available in the central display (see your INFINITI InTouch Owner's Manual).

MENUS AND SUBMENUS

To call up the menu bar ④ and select a menu, press the ◀ or ▶ button on the steering wheel. Menu bar ④ disappears after a few seconds.

Depending on the equipment fitted in the vehicle, you can call up the following menus:

- [Trip] menu
- [Navi] menu (navigation instructions)
- [Audio] menu
- [DriveAssist] menu
- [Serv.] menu
- [Settings] menu

The [Audio] and [Navi] menus differ slightly in vehicles with an audio system and in vehicles with a navigation system. The examples given in this Owner's Manual apply to vehicles equipped with navigation.

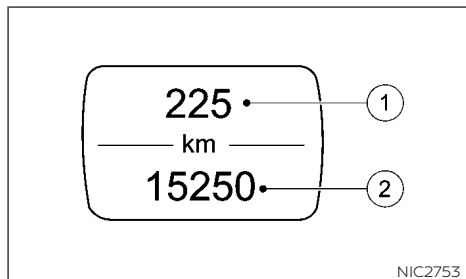

[Trip] menu

Standard display:

Press and hold the ⤴ button on the steering wheel until the [Trip] menu with trip meter ① and total distance recorder ② is shown.

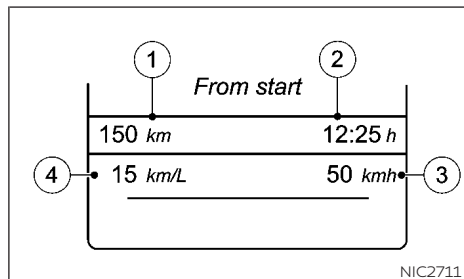

Trip computer [From start] or [From reset]:

- ① Distance
- ② Driving time
- ③ Average speed
- ④ Average fuel consumption

Press the ◀ or ▶ button on the steering wheel to select the [Trip] menu.

Press the ▲ or ▼ button to select [From start] or [From reset].

The values in the [From start] submenu are calculated from the start of a journey whilst the values in the [From reset] submenu are calculated from the last time the submenu was reset.

The [From start] trip computer is automatically reset when:

- The ignition has been switched off for more than four hours.
- 999 hours have been exceeded.
- 9999 kilometers have been exceeded.

The [From reset] trip computer is automatically reset if the value exceeds 9999 hours or 99999 kilometers.

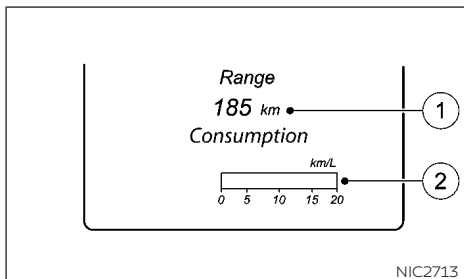

Displaying the range and current fuel consumption:

Press the ◀ or ▶ button on the steering wheel to select the [Trip] menu.

Press the ▲ or ▼ button to select approximate range ① and current fuel consumption ②.

Approximate range ① that can be covered is calculated according to your current driving style and the amount of fuel in the tank. If there is only a small amount of fuel left in the fuel tank, the display shows a vehicle being refueled instead of approximate range ①.

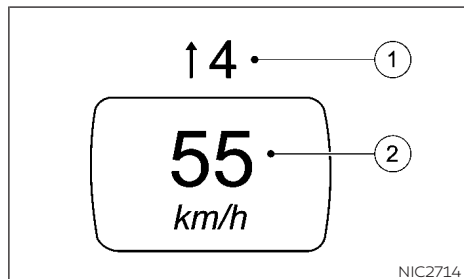

Digital speedometer:

Press the ◀ or ▶ button on the steering wheel to select the [Trip] menu.

Press the ▲ or ▼ button to select digital speedometer ②.

A gearshift recommendation ① can also be displayed.

Observe the information on gearshift recommendation ① for automatic transmission (shifting manually) (see "Driving with Automatic Transmission").

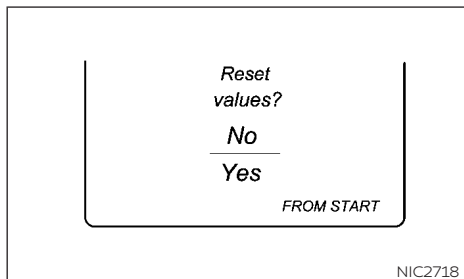

Resetting values:

Press the ◀ or ▶ button on the steering wheel to select the [Trip] menu.

Press the ▲ or ▼ button to select the function that you wish to reset.

Press the <OK> button.

Select ▼ [Yes] and press <OK> to confirm.

You can reset the values of the following functions:

- Trip meter
- [From start] trip computer
- [From reset] trip computer

Navigation menu ([Navi])

Displaying navigation instructions:

In the [Navi] menu, the vehicle information display shows navigation instructions.

You can find further information on navigation in the audio system or navigation system operating instructions.

Switch on the audio system or navigation system.

Press the ◀ or ▶ button on the steering wheel to select the [Navi] menu.

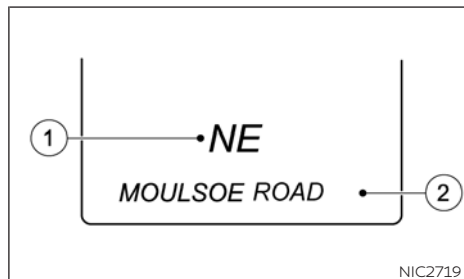

Route guidance not active:

- ① Direction of travel
- ② Current road

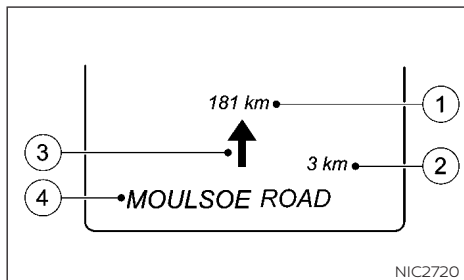

Route guidance active – No change of direction announced:

- ① Distance to the destination
- ② Distance to the next change of direction
- ③ Symbol indicating "follow the road's course".
- ④ Current road

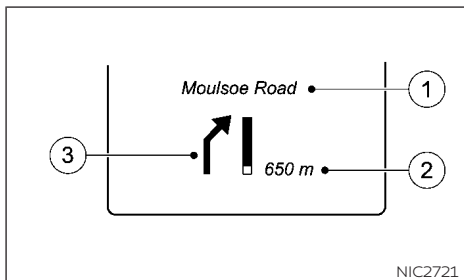

Route guidance active – Change of direction without lane recommendation:

- ① Road to which the change of direction leads
- ② Distance to change of direction and visual distance display
- ③ Change of direction symbol

When a change of direction is to be made, you will see symbol ③ for the change of direction and distance graphic ②. This shortens towards the top of the display as you approach the point of the announced change of direction. The change of direction starts once the distance display reaches zero.

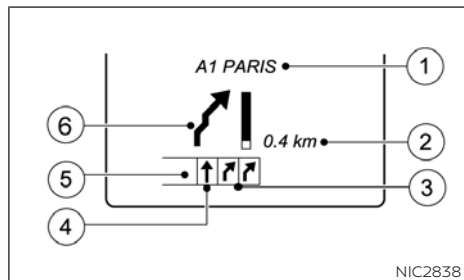

Route guidance active – Change of direction announced with a lane recommendation:

- ① Road to which the change of direction leads
- ② Distance to change of direction and visual distance display
- ③ Recommended lane and new lane during a change of direction
- ④ Recommended lane
- ⑤ Lanes not recommended
- ⑥ Change of direction symbol

On multi-lane roads, new lane recommendations can be displayed for the next change of direction if the digital map supports this data. During the change of direction, new lanes may be added.

Lane not recommended ⑤: you will not be able to complete the next change of direction if you stay in this lane.

Recommended lane and new lane during a change of direction ③: in this lane you will be able to complete the next two changes of direction without changing lane.

Recommended lane ④: in this lane you will be only able to complete the next change of direction without changing lane.

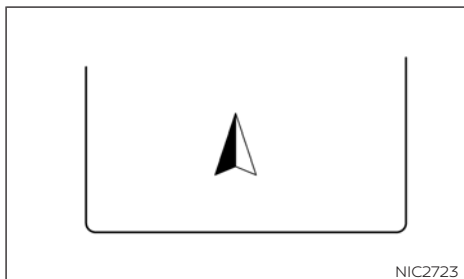

Other status indicators of the navigation system:

The navigation system displays additional information and the vehicle status. Possible displays:

- [New route...] or [Calculating route...]
A new route is calculated.
- [Off map] or [Off road]
The vehicle position is outside of the area of the digital map (off-map position).
- [No route]
No route could be calculated to the selected destination.
- 
You have reached the destination or an intermediate destination.

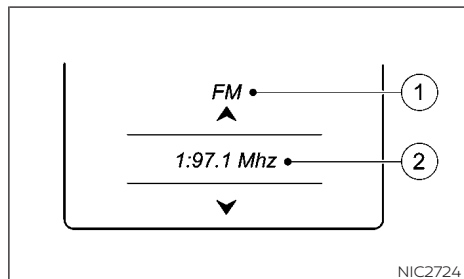

Audio menu

Selecting a radio station:

- ① Frequency range
- ② Station frequency/name with memory position

The memory position is only displayed along with station ② if this has been stored.

1. Switch on the audio system or navigation system and select Radio.
2. Press the ◀ or ▶ button on the steering wheel to select the [Audio] menu.
3. To select a stored station, briefly press ▲ or ▼ .

4. To select a station from the station list, press and briefly hold the ▲ or ▼ button.

If no station list is received:

5. To select a station using the station search: press and briefly hold the ▲ or ▼ button.

NOTE

DAB radio mode (Digital Audio Broadcasting) is an optimized digital transmission standard designed for the cellular reception of radio transmissions.

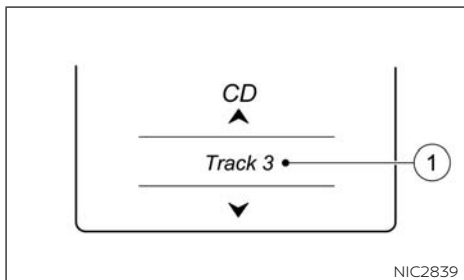

Audio player or audio media operation:

- ① Current track

Audio files from various audio players or media can be played, depending on the equipment fitted in the vehicle.

1. Switch on the audio system or navigation system and select audio CD or MP3 mode.
2. Press the ◀ or ▶ button on the steering wheel to select the [Audio] menu.
3. To select the next/previous track, briefly press ▲ or ▼.

4. To select a track from the track list (rapid scrolling): press and hold the ▲ or ▼ button until the desired track has been reached.

If you press and hold the ▲ or ▼ button, the rapid scrolling speed is increased. Not all audio players or media support this function.

If track information is stored on the audio player or media, the vehicle information display will show the number and title of the track.

The current track does not appear in audio AUX mode (Auxiliary audio mode: external audio source connected).

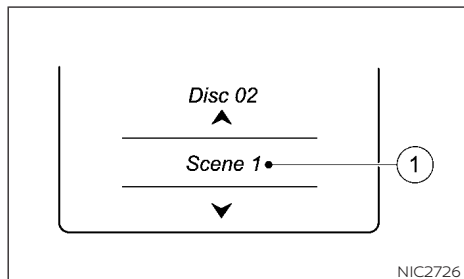

Video DVD operation (outside Europe only):

It is only possible to use the [Audio] menu to operate video DVDs on vehicles with navigation system.

1. Switch on the audio system or navigation system and select video DVD.
2. Press the ◀ or ▶ button on the steering wheel to select the [Audio] menu.
3. To select the next or previous scene, briefly press ▲ or ▼.
4. To select a scene from the scene list (rapid scrolling): press and hold the ▲ or ▼ button until the desired scene ① has been reached.

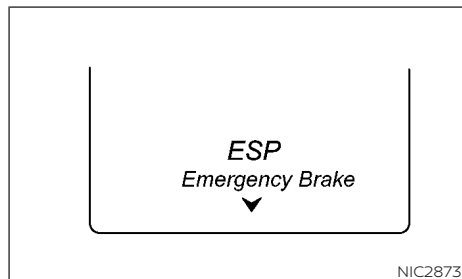

Assistance menu

Depending on the equipment fitted in the vehicle, you have the following options in the [DriveAssist] menu:

- Showing the assistance graphic
- Activating/deactivating VDC
- Activating/deactivating Forward Emergency Braking (FEB)
- Activating/deactivating Blind Spot Warning (BSW)
- Activating/deactivating Lane Departure Warning (LDW)

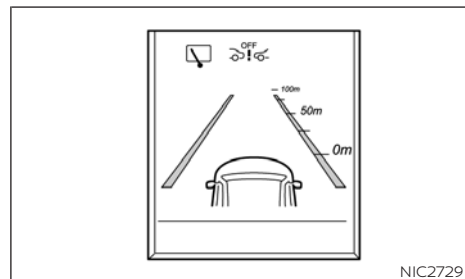

Showing the distance display:

1. Press the ◀ or ▶ button on the steering wheel to select the [DriveAssist] menu.
2. Press the ▲ or ▼ button to select [Distance display].
3. Press the <OK> button.

The vehicle information display shows the Intelligent Cruise Control (ICC) distance display in the assistance graphic.

The distance display also shows you the status of and/or information from the following driving systems or driving safety systems:

- Intelligent Cruise Control (ICC)
- Forward Emergency Braking (FEB)

- Lane Departure Warning (LDW)
- Blind Spot Warning (BSW)
- Rear window wiper

Deactivating/activating VDC:

The vehicle should be driven with the Vehicle Dynamic Control (VDC) system on for most driving conditions.

If the vehicle is stuck in mud or snow, the VDC system reduces the engine output to reduce wheel spin. The engine speed will be reduced even if the accelerator is depressed to the floor. If maximum engine power is needed to free a stuck vehicle, turn the VDC system off.



For further information about VDC, see "Vehicle Dynamic Control (VDC) system".

1. Start the engine.
2. Press the ◀ or ▶ button on the steering wheel to select the [DriveAssist] menu.
3. Press the ▲ or ▼ button to select [ESP].
4. Press the <OK> button.

The current selection is displayed.

5. To activate/deactivate: press the <OK> button again.

VDC is deactivated if the  warning light in the combination meter lights up continuously when the engine is running.

If both the  warning light and  warning light are lit continuously, VDC is not available due to a malfunction.

Activating/deactivating Forward Emergency Braking:

1. Press the ◀ or ▶ button on the steering wheel to select the [DriveAssist] menu.
2. Press the ▲ or ▼ button to select [Emergency Brake].
3. Press the <OK> button.

The current selection is displayed.

4. To activate/deactivate: press the <OK> button again.

When Forward Emergency Braking is deactivated, the  symbol appears in the vehicle information display in the assistance graphic display.

For further information about Forward Emergency Braking, see "Forward emergency braking (FEB) system (if equipped)".

Activating/deactivating Blind Spot Warning (BSW):

1. Press the ◀ or ▶ button on the steering wheel to select the [DriveAssist] menu.
2. Press the ▲ or ▼ button to select [Blind Spot Warning].
3. Press the <OK> button.

The current selection is displayed.

4. To activate/deactivate: press the <OK> button again.

For further information about Blind Spot Warning, see "Blind Spot Warning (BSW) system (if equipped)".

Activating/deactivating Lane Departure Warning (LDW):

1. Press the ◀ or ▶ button on the steering wheel to select the [DriveAssist] menu on the Menu bar.
2. Press the ▲ or ▼ button to select [Lane Departure Warning].
3. Press the <OK> button on the steering wheel. The current selection is displayed.
4. Press the <OK> to confirm.

5. Press the ▲ or ▼ button to set [Off], [Standard] or [Adaptive].

6. Press the <OK> button to save the setting.

For further information about Lane Departure Warning, see " Lane departure warning (LDW) system (if equipped) ".

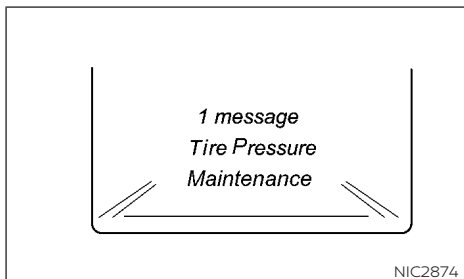

Service menu ([Serv.])

Depending on the equipment fitted in the vehicle, you have the following options in the [Serv.] menu:

- Calling up display messages in the message memory (see "Message memory" later in this section).
- Restarting the tire pressure monitoring system (TPMS) (see "Restarting TPMS").
- Checking the tire pressure electronically (see "Checking the tire pressure electronically").
- Calling up the service due date (see "Maintenance service messages").

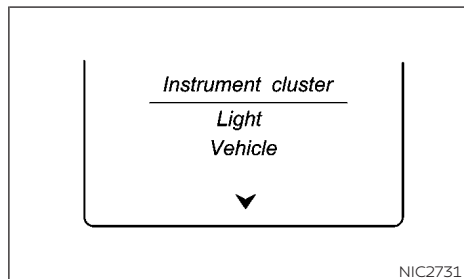

Settings menu

Depending on the equipment fitted in the vehicle, in the [Settings] menu you have the following options:

- Changing the instrument cluster settings.
- Changing the light setting.
- Changing the vehicle setting.
- Changing the convenience setting.
- Restoring the factory setting.

Instrument cluster:

Unit of measurement for distance: The Display unit Speed-/odometer function allows you to choose whether certain displays appear in kilometers or miles in the vehicle information display.

1. Press the ◀ or ▶ button on the steering wheel to select the [Settings] menu.
2. Press the ▲ or ▼ button to select [Instrument Cluster] submenu.
3. Press <OK> to confirm.
4. Press the ▲ or ▼ button to select the [Display Unit Speed-/Odometer] function.
You will see the selected setting: [miles] or [km].
5. Press the <OK> button to change the setting.

The selected unit of measurement for distance applies to:

- Digital speedometer in the [Trip] menu.
- Total distance recorder and the trip meter.
- Trip computer.
- Current fuel consumption and approximate range.
- Navigation instructions in the [Navi] menu.
- Cruise control.
- Speed limiter.
- Intelligent cruise control (ICC).
- Maintenance service interval display.

Switching the additional speedometer on/off.

The [Speedometer (mph)] or [Speedometer (km/h)] function allows you to choose whether the vehicle information display in the status area shows the speed in MPH or in km/h instead of the outside temperature.

1. Press the ◀ or ▶ button on the steering wheel to select the [Settings] menu.
2. Press the ▲ or ▼ button to select [Instrument Cluster] submenu.
3. Press <OK> to confirm.
4. Press the ▲ or ▼ button to select the [Speedometer (mph)] or [Speedometer (km/h)] function.
You will see the selected setting: [On] or [off].
5. Press the <OK> button to change the setting.

Selecting the permanent display function.

You can determine whether the vehicle information display permanently shows the outside temperature or the speed in MPH.

1. Press the ◀ or ▶ button on the steering wheel to select the [Settings] menu.

2. Press the ▲ or ▼ button to select [Instrument Cluster] submenu.
3. Press <OK> to confirm.
4. Press the ▲ or ▼ button to select the [Outside Temperature] function.
You will see the selected setting: [outside temperature] or [Speedometer (mph)].
5. Press the <OK> button to save the setting.

Lights

Switching the Adaptive Front Lighting System on/off:

1. Press the ◀ or ▶ button on the steering wheel to select the [Settings] menu.
2. Press the ▲ or ▼ button to select [Light] submenu.
3. Press <OK> to confirm.
4. Press the ▲ or ▼ button to select the [Adaptive front lighting system] function.
If the [Adaptive front lighting system] function has been switched on, the cone of light and the  symbol in the vehicle information display are shown in orange.
5. Press the <OK> button to save the setting.

When you switch the [Adaptive front lighting system] function on, you activate the following functions:

- Freeway mode
- Active light function
- Cornering light function

If you set the low beam headlights for driving on the right/left, the vehicle information display shows the [Adaptive front lighting system: System Inoperative Inactive For Left-side Traffic] or [Adaptive front lighting system: System Inoperative Inactive for Right-side Traffic] display message instead of the [Adaptive front lighting] function in the [Light] submenu.

For further information about the Adaptive Front Lighting system, see " Adaptive front lighting system (LED headlight only) (if equipped)" later in this section

Setting the low beam headlights for driving on the left/right:

This function is only available on vehicles with the Adaptive Front Lighting System (see " Adaptive front lighting system (LED headlight only) (if equipped)" later in this section).

2-26 Instruments and controls

1. Press the ◀ or ▶ button on the steering wheel to select the [Settings] menu.
2. Press the ▲ or ▼ button to select [Light] submenu.
3. Press <OK> to confirm.
4. Press the ▲ or ▼ button to select the [Low-b. Headl. Setting For:] function.

You will see the selected setting: [Right-side Traffic] or [Left-side Traffic].

5. Press the <OK> button to save the setting.
If you change the setting, conversion does not take place until the next time the vehicle is stationary.

If you set the low beam headlights for driving on the right/left, then freeway mode is unavailable. This is only deactivated if the setting for driving on the left/right is set opposite to your vehicle's country version.

An INFINITI retailer can set the low beam headlights for driving on the left/right.

Setting the brightness of the ambient lighting:

1. Press the ◀ or ▶ button on the steering wheel to select the [Settings] menu.

2. Press the ▲ or ▼ button to select [Light] submenu.
3. Press <OK> to confirm.
4. Press the ▲ or ▼ button to select the [Ambient Light Brightness] function.
You will see the selected setting.
5. Change the setting with <OK>.

If you change the setting, conversion does not take place until the next time the vehicle is stationary.

6. Press the ▲ or ▼ button to adjust the brightness to a level from [Off] to [Level 5] (bright).
7. Press the <OK> or ↻ button to save the setting.

Activating/deactivating the surround lighting and exterior lighting delayed switch-off:

If you have activated the Surround lighting function and the light switch is set to <AUTO>, the following functions are activated when it is dark:

- Surround lighting: the exterior lighting remains lit for 40 seconds after unlocking with the key. If you start the engine, the surround lighting is switched off and automatic headlight mode is activated.

- Exterior lighting delayed switch-off: the exterior lighting remains lit for 60 seconds after the engine is switched off. If you close all the doors and the lift gate, the exterior lighting goes off after 15 seconds.

1. Press the ◀ or ▶ button on the steering wheel to select the [Settings] menu.
2. Press the ▲ or ▼ button to select [Light] submenu.
3. Press <OK> to confirm.
4. Press the ▲ or ▼ button to select the [Surround Lighting] function.
5. Press the <OK> button to save the setting.

When the [Surround Lighting] function is activated, the light cone and the area around the vehicle are displayed in orange in the vehicle information display

6. Press the <OK> button to confirm the setting.

Deactivating delayed switch-off of the exterior lighting temporarily:

1. Before leaving the vehicle, switch the ignition switch to the OFF position.
2. Switch the ignition switch to the ON position.

The exterior lighting delayed switch-off is deactivated.

Delayed switch-off of the exterior lighting is reactivated the next time you start the engine.

Depending on your vehicle's equipment, when the surround lighting and delayed switch-off exterior lighting are on, the following light up:

- Side lights
- Fog lights
- Low beam headlights
- Daytime driving lights
- Surround lighting in the exterior mirrors

Activating/deactivating the interior lighting delay:

If you activate the [Interior Lighting Delay] function, the interior lighting remains on for 20 seconds after you remove the key from the ignition lock.

1. Press the ◀ or ▶ button on the steering wheel to select the [Settings] menu.
2. Press the ▲ or ▼ button to select [Light] submenu.
3. Press <OK> to confirm.

4. Press the ▲ or ▼ button to select the [Interior Lighting Delay] function. If the [Interior lighting delayed switch-off] function has been switched on, the vehicle interior is displayed in orange in the vehicle information display

5. Press the <OK> button to save the setting.

Vehicle

Setting permanent speed limiter:

You can set permanent speed limiter using the [Limit Speed (Winter Tires)] function.

1. Press the ◀ or ▶ button on the steering wheel to select the [Settings] menu.
2. Press the ▲ or ▼ button to select [Vehicle] submenu.
3. Press <OK> to confirm.
4. Press the ▲ or ▼ button to select the [Limit Speed (Winter Tires)] function.







You will see the selected setting.

5. Press <OK> to confirm.
6. Press the ▲ or ▼ button to adjust permanent speed limiter in increments of ten ([150 mph] to [100 mph]), [240 km/h] to [160 km/h]). The [Off] setting switches permanent speed limiter off).

7. Press the <OK> or  button to store the entry.

Activating/deactivating the acoustic lock- ing confirmation:

If you switch on the [Acoustic Lock Feedback] function, an acoustic signal sounds when you lock the vehicle.

1. Press the  or  button on the steering wheel to select the [Settings] menu.
2. Press the  or  button to select [Vehicle] submenu.
3. Press <OK> to confirm.
4. Press the  or  button to select the [Acoustic Lock Feedback] function.

If the [Acoustic Lock Feedback] function is activated, the  symbol in the vehicle information display lights up orange.

5. Press the <OK> button to save the setting.







Convenience

Switching the [Fold Mirrors in when Lock- ing] function on/off:

This function is only available when the vehicle is equipped with the electrical fold-in function.

When you activate the [Fold Mirrors in when Locking] function, the exterior mirrors are folded in when the vehicle is locked. If you unlock the vehicle and then open the driver's or front passenger door, the exterior mirrors fold out again.







If you have switched on the [Fold Mirrors in when Locking] function and you fold in the exterior mirrors using the button on the door (see "Folding"), they will not fold out automatically. The exterior mirrors can then only be folded out using the button on the door.

1. Press the  or  button on the steering wheel to select the [Settings] menu.
2. Press the  or  button to select [Convenience] submenu.
3. Press <OK> to confirm.
4. Press the  or  button to select the [Fold Mirrors in when Locking] function.

If the [Fold Mirrors in when Locking] function is activated, the vehicle's exterior mirror is shown in orange in the vehicle information display.

5. Press the <OK> button to save the setting.

Resetting to factory settings

1. Press the  or  button on the steering wheel to select the [Settings] menu.
2. Press the  or  button to select [Factory Setting] submenu.
3. Press <OK> to confirm.
The [Reset All Settings?] message appears.
4. Press the  or  button to select [No] or [Yes].
5. Press the <OK> button to confirm the selection.

If you have selected [Yes], the vehicle information display shows a confirmation message.

For safety reasons, not all functions are reset: the [Limit Speed (Winter Tires)] function in permanent speed limiter can only be set in the [Vehicle] submenu.

If you want to reset the Daytime driving lights function in the Lights submenu, you must switch the ignition switch to the ACC position.

DISPLAY MESSAGES

Display messages appear in the vehicle information display.

Display messages with graphic symbols are simplified in the Owner's Manual and may differ from the symbols in the vehicle information display.

Certain display messages are accompanied by an audible warning tone or a continuous tone.

When the ignition is switched off, all display messages are deleted apart from some high-priority display messages. Once the causes of the high-priority display messages have been rectified, these display messages are deleted as well.

When you stop and park the vehicle, please observe the notes on parking (see "Parking").

Hiding display messages



Press the <OK> or  button to hide the display message. The display message is hidden.

The vehicle information display shows high-priority display messages in red. Some high-priority display messages cannot be hidden.





The vehicle information display shows these messages continuously until the causes for the messages have been remedied.

Message memory







The vehicle information display saves certain messages in the message memory. You can call up these display messages:









1. Press the  or  button on the steering wheel to select the [Service] menu.









If there are display messages, the vehicle information display shows [2 messages], for example.

2. Press the  or  button to select the entry, e.g. [2 messages].
3. Press <OK> to confirm.
4. Press the  or  button to scroll through the display messages.

Safety systems

Message	Possible causes/consequences and solutions
<p data-bbox="95 215 227 256"> </p> <p data-bbox="71 260 320 306">[Currently Unavailable See Operator's Manual]</p>	<p data-bbox="340 213 1534 254">ABS (Anti-Lock Braking System), BAS (Brake Assist System), VDC (Vehicle Dynamic Control), and hill start assist are temporarily unavailable.</p> <p data-bbox="340 260 863 280">Forward Emergency Braking (FEB) may also have failed.</p> <p data-bbox="340 280 1197 306">In addition, the  ,  and  warning lights may light up in the combination meter.</p> <p data-bbox="340 327 492 348">Possible causes:</p> <ul data-bbox="340 353 756 399" style="list-style-type: none">• Self-diagnosis is not yet complete.• The on-board voltage may be insufficient. <p data-bbox="351 410 512 436"> WARNING</p> <p data-bbox="340 441 1534 487">The brake system continues to function normally, but without the functions listed above. The wheels could therefore lock if you brake hard, for example.</p> <p data-bbox="340 487 1534 534">The steering and braking characteristics may be severely affected. The braking distance may increase in an emergency braking situation.</p> <p data-bbox="340 534 1534 555">If VDC is not operational, VDC is unable to stabilize the vehicle. There is an increased danger of skidding and risk of an accident.</p> <p data-bbox="340 560 1534 601">Carefully drive on a suitable stretch of road, making slight steering movements, at a speed above 12 MPH (20 km/h). If the display message disappears, the functions mentioned above are available again.</p> <p data-bbox="340 601 1534 648">If the display message continues to be displayed, drive on carefully and have the system checked. It is recommended you visit an INFINITI retailer for this service.</p>

Message	Possible causes/consequences and solutions
  [Inoperative See Operator's Manual]	<p>ABS (Anti-Lock Braking System), BAS (Brake Assist System), VDC (Vehicle Dynamic Control), and hill start assist are not available due to a malfunction. Forward Emergency Braking (FEB) may also have failed. In addition, the , ,  and  warning lights may light up in the combination meter.</p> <p>⚠ WARNING The brake system continues to function normally, but without the functions listed above. The wheels could therefore lock if you brake hard, for example. The steering and braking characteristics may be severely affected. The braking distance may increase in an emergency braking situation. If VDC is not operational, VDC is unable to stabilize the vehicle. There is an increased danger of skidding and risk of an accident. Drive on carefully and have the system checked immediately. It is recommended you visit an INFINITI retailer for this service.</p>
 [Currently Unavailable See Operator's Manual]	<p>BAS (Brake Assist System), VDC (Vehicle Dynamic Control), and hill start assist are temporarily unavailable. Forward Emergency Braking (FEB) may also have failed. In addition, the  and  warning lights may light up in the combination meter.</p> <p>The self-diagnosis function, for example, may not be complete.</p> <p>⚠ WARNING The brake system continues to function normally, but without the functions listed above. The braking distance may increase in an emergency braking situation. If VDC is not operational, VDC is unable to stabilize the vehicle. There is an increased danger of skidding and risk of an accident. Carefully drive on a suitable stretch of road, making slight steering movements, at a speed above 12 MPH (20 km/h). If the display message disappears, the functions mentioned above are available again. If the display message continues to be displayed, drive on carefully and have the system checked. It is recommended you an INFINITI retailer for this service.</p>

Message	Possible causes/consequences and solutions
 [Inoperative See Operator's Manual]	<p>BAS (Brake Assist System), VDC (Vehicle Dynamic Control), and hill start assist are not available due to a malfunction. Forward Emergency Braking (FEB) may also have failed. In addition, the  and  warning lights may light up in the combination meter.</p> <p>⚠ WARNING</p> <p>The brake system continues to function normally, but without the functions listed above. The braking distance may increase in an emergency braking situation. If VDC is not operational, VDC is unable to stabilize the vehicle. There is an increased danger of skidding and risk of an accident. Drive on carefully and have the system checked. It is recommended you visit an INFINITI retailer for this service.</p>
<p>EBD </p>  [Inoperative See Operator's Manual]	<p>EBD (Electronic Brake Force Distribution) ABS (Anti-Lock Braking System), BAS (Brake Assist System), VDC (Vehicle Dynamic Control), and hill start assist are not available due to a malfunction. Forward Emergency Braking (FEB) may also have failed. A warning tone sounds. In addition, the ,  and  warning lights may light up in the combination meter.</p> <p>⚠ WARNING</p> <p>The brake system continues to function normally, but without the functions listed above. The front and rear wheels could therefore lock if you brake hard, for example. The steering and braking characteristics may be severely affected. The braking distance may increase in an emergency braking situation. If VDC is not operational, VDC is unable to stabilize the vehicle. There is an increased danger of skidding and risk of an accident. Drive on carefully and have the system checked immediately. It is recommended you visit an INFINITI retailer for this service.</p>
<p>PARK [Turn On The Ignition to Release the Parking Brake]</p>	<p>The red PARK indicator light lights up. You attempted to release the electric parking brake while the ignition was switched off. Key: turn the key to the ON position in the ignition switch</p>



Message	Possible causes/consequences and solutions
PARK [Please Release Parking Brake]	<p>The red PARK indicator light flashes and a warning tone sounds. A condition for automatic release of the electric parking brake is not fulfilled (see "Applying automatically (vehicles with automatic transmission)"). You are driving with the electric parking brake applied. Release the electric parking brake manually.</p> <p>The red PARK indicator light flashes and a warning tone sounds. You are making an emergency stop using the electric parking brake (see "Emergency braking")</p>
PARK [Parking Brake See Operator's Manual]	<p>The yellow (P) warning light lights up.</p> <p>The electric parking brake is malfunctioning.</p> <p>To apply:</p> <ol style="list-style-type: none"> 1. Switch the ignition off. 2. Press the electric parking brake handle for at least ten seconds. 3. Press the P (Park) button. 4. Have the system checked. It is recommended you consult an INFINITI retailer.
	<p>The yellow (P) warning light and the red PARK indicator light are lit.</p> <p>The electric parking brake is malfunctioning.</p> <p>To release:</p> <ol style="list-style-type: none"> 1. Switch the ignition off and turn it back on. 2. Release the electric parking brake manually.or 3. Release the electric parking brake automatically (see "Applying automatically (vehicles with automatic transmission)"). <p>If the electric parking brake still cannot be released: DO NOT drive on. It is recommended you consult an INFINITI retailer.</p>

Message	Possible causes/consequences and solutions
	<p>The yellow (P) warning light is lit. The red PARK indicator light flashes.</p> <p>The electric parking brake is malfunctioning.</p> <p>To release:</p> <ol style="list-style-type: none"> 1. Switch the ignition off and turn it back on. 2. Release the electric parking brake manually.or <p>To apply:</p> <ol style="list-style-type: none"> 1. Switch the ignition off and turn it back on. 2. Apply the electric parking brake manually. <p>If the red PARK . indicator light continues to flash:</p> <ol style="list-style-type: none"> 1. DO NOT drive on 2. Secure the vehicle against rolling away 3. Press the P (Park) button. 4. Turn the front wheels towards the curb. <p>It is recommended you consult an INFINITI retailer.</p>
	<p>The yellow (P) warning light is lit. The red PARK indicator light flashes for about ten seconds after the electric parking brake has been applied or released. It then goes out or remains lit.</p> <p>The electric parking brake is malfunctioning.</p> <p>To apply:</p> <ol style="list-style-type: none"> 1. Switch the ignition off and turn it back on. 2. Apply the electric parking brake manually.If it is not possible to apply the electric parking brake: 3. Press the P (Park) button. <p>It is recommended you consult an INFINITI retailer.</p> <p>If it is not possible to release the electric parking brake: Release the electric parking brake automatically (see " Applying automatically (vehicles with automatic transmission)").</p> <p>If the electric parking: brake still cannot be released, it is recommended you consult an INFINITI retailer.</p>

Message	Possible causes/consequences and solutions
	<p>The yellow (P) warning light is lit. If you manually apply or release the electric parking brake, the red PARK indicator light flashes.</p> <p>The electric parking brake is malfunctioning. It is not possible to apply the electric parking brake manually.</p> <p>or</p> <p>Insert the seat belt in the belt buckle and accelerate slightly more when pulling away.</p> <p>Press the P (Park) button, as the electric parking brake is not applied automatically.</p> <p>It is recommended you consult an INFINITI retailer.</p> <p>If you do not wish the electric parking brake to be applied, leave the ignition switched on, e. g. when washing the vehicle in an automatic car wash or when having the vehicle towed.</p>
<p>PARK [Parking Brake Inoperative]</p>	<p>The yellow (P) warning light is lit. The red PARK indicator light flashes for about ten seconds after the electric parking brake has been applied or released. It then goes out or remains lit.</p> <p>The electric parking brake is malfunctioning, e.g. because of overvoltage or undervoltage.</p> <ol style="list-style-type: none"> 1. Rectify the cause of the overvoltage or undervoltage, e.g. by charging the battery or restarting the engine. 2. Apply or release the electric parking brake. <p>If the electric parking brake still cannot be applied or released:</p> <ol style="list-style-type: none"> 1. Switch the ignition off and turn it back on. 2. Apply or release the electric parking brake manually. <p>If the electric parking brake still cannot be applied or released, it is recommended you consult an INFINITI retailer.</p>
<p>BRAKE [Brake Immediately]</p>	<p>The yellow (P) warning light is lit. The red PARK indicator light flashes.</p> <p>It is not possible to apply the electric parking brake manually.</p> <ol style="list-style-type: none"> 1. Press the P (Park) button. <p>Consult an INFINITI retailer.</p>
	<p>A tone may also sound at regular intervals. If you attempt to lock the vehicle, the tone becomes louder.</p> <p>You cannot start the engine.</p> <ol style="list-style-type: none"> 1. Paying attention to the traffic situation, immediately depress the brake pedal firmly and hold until the display message disappears. 2. Secure the vehicle against rolling away. You can restart the engine.

Message	Possible causes/consequences and solutions
<p>BRAKE [Check Brake Fluid Level]</p>	<p>There is insufficient brake fluid in the brake fluid reservoir. In addition, the red PARK warning light lights up in the combination meter and a warning tone sounds.</p> <ol style="list-style-type: none"> 1. Pull over and stop the vehicle safely as soon as possible, paying attention to road and traffic conditions. Do not continue driving under any circumstances. 2. Secure the vehicle against rolling away. 3. Check the brake fluid level. If brake fluid is necessary, add fluid and have the system checked. It is recommended you visit an INFINITI retailer for this service. See "Brake fluid". 4. If the brake fluid level is correct, have the warning system checked. It is recommended you visit an INFINITI retailer for this service. <p>⚠ WARNING</p> <ul style="list-style-type: none"> • Your brake system may not be working properly if the warning light is on. Driving could be dangerous. If you judge it to be safe, drive carefully to the nearest service station for repairs. Otherwise, have your vehicle towed because driving it could be dangerous. • Pressing the brake pedal with the engine stopped and/or low brake fluid level may increase your stopping distance and braking will require greater pedal effort as well as pedal travel. • If the brake fluid level is below the minimum or MIN mark on the brake fluid reservoir, do not drive until the brake system has been checked. It is recommended you visit an INFINITI retailer for this service.
<p> [Check Brake Pad Wear]</p>	<p>The brake pads/linings have reached their wear limit. It is recommended you visit an INFINITI retailer.</p>

Message	Possible causes/consequences and solutions
[Emergency Brake Currently Unavailable See Operator's Manual]	<p>Forward Emergency Braking is temporarily inoperative.</p> <p>Possible causes:</p> <ul style="list-style-type: none"> • The radar sensor system is temporarily inoperative, e.g. due to electromagnetic radiation emitted by nearby TV or radio stations or other sources of electromagnetic radiation. • The system is outside the operating temperature range. • The on-board voltage is too low. <p>Once the causes listed above no longer apply, the display message goes out. Forward Emergency Braking is operational again.</p> <p>If the display message does not disappear:</p> <ol style="list-style-type: none"> 1. Pull over and stop the vehicle safely as soon as possible, paying attention to road and traffic conditions. 2. Secure the vehicle against rolling away. 3. Restart the engine.
[Emergency Brake Inoperative]	<p>Forward Emergency Braking is temporarily inoperative due to a malfunction. Have the system checked. It is recommended you visit an INFINITI retailer for this service.</p>

Message	Possible causes/consequences and solutions
<p>[Radar Sensor (See Operator's Manual):]</p>	<p>At least one of the following driving systems or driving safety systems is temporarily restricted or inoperative:</p> <ul style="list-style-type: none"> • Forward Emergency Braking • Intelligent Cruise Control • Blind Spot Warning <p>Possible causes:</p> <ul style="list-style-type: none"> • The sensors in the radiator trim and/or at the sides of the rear bumpers are dirty. • The function of the driving system and/or driving safety system is impaired due to heavy rain or snow. <p>A warning tone also sounds.</p> <p>Once the causes listed above no longer apply, the display message goes out. All driving systems/driving safety systems are operative again.</p> <p>If the display message does not disappear:</p> <ol style="list-style-type: none"> 1. Pull over and stop the vehicle safely as soon as possible, paying attention to road and traffic conditions 2. Secure the vehicle against rolling away. 3. Switch off the engine. 4. Clean the sensors in the following locations: <ul style="list-style-type: none"> - In the radiator trim - At the sides of the rear bumper 5. Restart the engine. The display message disappears.
<p> [SRS Malfunction Service Required]</p>	<p>The restraint system needs servicing. The  warning light also lights up in the combination meter.</p> <p>It is recommended you visit an INFINITI retailer for these services.</p> <p>Unless checked and repaired, the Supplemental Restraint Systems and/or the pretensioner seat belt may not function properly.</p> <p>⚠ WARNING</p> <p>If this light is on, it could mean that the front air bag, side air bag, curtain air bag systems and/or pretensioner systems will not operate in an accident. To help avoid injury to yourself or others, have your vehicle checked as soon as possible. It is recommended you visit an INFINITI retailer for this service.</p> <p>For further information about the restraint system, see "Supplemental Restraint System (SRS)".</p>





Message	Possible causes/consequences and solutions
<p>[Front Passenger Airbag Disabled See Operator's Manual]</p>	<p>The front-passenger front air bag is disabled during the journey although an adult or person of corresponding stature is on the front passenger seat.</p> <p>Front passenger seat adult occupants who are properly seated and using the seat belt as outlined in this manual should not cause the front passenger air bag to be automatically turned OFF. For small adults it may be turned OFF, however if the occupant takes his/her weight off the seat cushion (for example, by not sitting upright, by sitting on an edge of the seat, or by otherwise being out of position), this could cause the sensor to turn the air bag OFF. Always be sure to be seated and wearing the seat belt properly for the most effective protection by the seat belt and supplemental air bag.</p> <p>If additional forces are applied to the seat, the system may interpret the occupant's weight as lower than it actually is.</p> <ol style="list-style-type: none"> 1. Stop the vehicle in a safe area away from traffic as soon as possible, paying attention to road and traffic conditions. 2. Secure the vehicle against rolling away. 3. Switch the ignition off. 4. Have the occupant on the front-passenger seat step out of the vehicle. 5. Make sure that the seat is unoccupied, close the front passenger door and switch on the ignition. 6. Observe the <PASSENGER AIR BAG> indicator lights in the center console and the vehicle information display and check the following. Seat unoccupied and ignition switched on: <ul style="list-style-type: none"> - The <PASSENGER AIR BAG OFF> and <PASSENGER AIR BAG ON> indicator lights must light up simultaneously for approximately six seconds. - The <PASSENGER AIR BAG OFF> indicator lights must then light up and remain lit. If the indicator light is on, the automatic front-passenger front air bag deactivation system has disabled the front-passenger front air bag (see "Front passenger air bag and status light") - the [Front Passenger Airbag Enabled See Operator's Manual] or [Front Passenger Airbag Disabled See Operator's Manual] display messages must not be shown in the vehicle information display. 7. Wait for a period of at least 60 seconds until the necessary system checks have been completed. 8. Make sure that the display messages do not appear in the vehicle information display. <p>If these conditions are met, the front-passenger seat can be occupied again. Whether the <PASSENGER AIR BAG OFF> or <ON> indicator light remains lit or goes out depends on how the automatic front passenger front air bag deactivation system classifies the occupant.</p> <p>If, after taking the steps above, you still believe the system is not operating properly, have it checked immediately. It is recommended you visit an INFINITI retailer for this service.</p> <p>For further information on the automatic front-passenger front air bag deactivation feature (see "Front passenger air bag and status light").</p>







Message	Possible causes/consequences and solutions
<p>[Front Passenger Airbag Enabled See Operator's Manual]</p>	<p>The front-passenger front air bag is enabled during the journey although:</p> <ul style="list-style-type: none"> • A child or child restraint as specified in U.S. regulations is located on the front-passenger seat. or • The front-passenger seat is not occupied. <p>The system may detect objects or forces that are adding to the weight applied to the seat.</p> <ol style="list-style-type: none"> 1. Stop the vehicle in a safe area away from traffic as soon as possible, paying attention to road and traffic conditions. 2. Secure the vehicle against rolling away. 3. Switch the ignition off. 4. Open the front-passenger door. 5. Remove the child and the child restraint system from the front passenger seat. 6. Make sure there are no objects applying additional force to the seat. The system may otherwise detect the additional force and interpret the seat occupant's weight as greater than it actually is. 7. Make sure that the seat is unoccupied, close the front passenger door and switch on the ignition. 8. Observe the <PASSENGER AIR BAG> indicator lights in the center console and the vehicle information display and check the following. Seat unoccupied and ignition switched on: <ul style="list-style-type: none"> - The <PASSENGER AIR BAG OFF> and <PASSENGER AIR BAG ON> indicator lights must light up simultaneously for approximately six seconds. - The <PASSENGER AIR BAG OFF> indicator light must then light up and remain lit. If the indicator light is on, the automatic front-passenger front air bag deactivation system has disabled the front-passenger front air bag (see "Front passenger air bag and status light"). - the [Front Passenger Airbag Enabled See Operator's Manual] or [Front Passenger Airbag Disabled See Operator's Manual] display messages must not be shown in the vehicle information display. 7. Wait for a period of at least 60 seconds until the necessary system checks have been completed. 8. Make sure that the display messages do not appear in the vehicle information display. <p>If these conditions are met, the front-passenger seat can be occupied again. Whether the <PASSENGER AIR BAG OFF> or <ON> indicator light remains lit or goes out depends on how the automatic front passenger front air bag deactivation system classifies the occupant.</p> <p>If, after taking the steps above, you still believe the system is not operating properly, have it checked immediately. It is recommended you visit an INFINITI retailer for this service.</p> <p>For further information on the automatic front-passenger front air bag deactivation feature (see "Front passenger air bag and status light").</p>







Lights

NOTE

Vehicles with LEDs in the light clusters: The display message for the corresponding light will only appear if all the LEDs have failed.



Message	Possible causes/consequences and solutions
 [Check Left Cornering Light] or [Check Right Cornering Light]	The left or right-hand cornering light is faulty. Have the system checked. It is recommended you visit an INFINITI retailer for this service.
 [Check Left Low Beam] or [Check Right Low Beam]	The left or right-hand low beam headlight is faulty. <ul style="list-style-type: none">• Check whether you are permitted to replace the bulb yourself (see "Lights").or:• Have the system checked. It is recommended you visit an INFINITI retailer for this service.
 [Check Rear Left Turn Signal] or [Check Rear Right Turn Signal]	The rear left or right-hand turn signal is faulty. Have the system checked. It is recommended you visit an INFINITI retailer for this service.
 [Check Front Left Turn Signal] or [Check Front Right Turn Signal]	The front left or right-hand turn signal is faulty. <ul style="list-style-type: none">• Check whether you are permitted to replace the bulb yourself (see "Lights").or:• Have the system checked. It is recommended you visit an INFINITI retailer for this service.



Message	Possible causes/consequences and solutions
 [Check Center Brake Lamp]	The third brake light is faulty. Have the system checked. It is recommended you visit an INFINITI retailer for this service.
 [Check Left Brake Lamp] or [Check Right Brake Lamp]	The left-hand or right-hand brake light is faulty. Have the system checked. It is recommended you visit an INFINITI retailer for this service.
 [Check Left Main Beam] or [Check Right Main Beam]	The left or right-hand high beam headlight is faulty. <ul style="list-style-type: none"> • Check whether you are permitted to replace the bulb yourself (see "Lights"). or: • Have the system checked. It is recommended you visit an INFINITI retailer for this service.
 [License Plate Lamp]	The left or right-hand license plate light is faulty. Have the system checked. It is recommended you visit an INFINITI retailer for this service.
 [Check Left Fog Lamp] or [Check Right Fog Lamp]	The left or right-hand fog light is faulty. Have the system checked. It is recommended you visit an INFINITI retailer for this service.
 [Rear Fog Lamp]	The rear fog light is faulty. Have the system checked. It is recommended you visit an INFINITI retailer for this service.
 [Check Front Left Side- marker Lamp] or [Check Front Right Sidemarker Lamp]	The front left or front right parking light is faulty. Have the system checked. It is recommended you visit an INFINITI retailer for this service.





Message	Possible causes/consequences and solutions
 [Backup Light]	The reversing light is faulty. Have the system checked. It is recommended you visit an INFINITI retailer for this service.
 [Check Left tail lamp] or [Check Right tail lamp]	The left or right-hand tail light is faulty. Have the system checked. It is recommended you visit an INFINITI retailer for this service.
 [Check Left Daytime Running Light] or [Check Right Daytime Running Light]	The left or right-hand daytime driving light is faulty. Have the system checked. It is recommended you visit an INFINITI retailer for this service.
 [Adaptive front lighting system Inoperative]	The Adaptive Front Lighting System is faulty. The lights remain available without the Adaptive Front Lighting System. Have the system checked. It is recommended you visit an INFINITI retailer for this service.
 [Malfunction See Operator's Manual]	The exterior lighting is faulty. Have the system checked. It is recommended you visit an INFINITI retailer for this service.
 [Auto Lamp Function inoperative]	The light sensor is faulty. Have the system checked. It is recommended you visit an INFINITI retailer for this service.
 [Switch Off Lights]	The side lights are still switched on when you leave the vehicle. A warning tone also sounds. Turn the light switch to AUTO .

Message	Possible causes/consequences and solutions
[High beam assist Currently Unavailable See Operator's Manual]	High beam assist is deactivated and temporarily inoperative. Possible causes: <ul style="list-style-type: none"> • The windshield is dirty in the camera's field of vision. • Visibility is impaired due to heavy rain, snow or fog. Clean the windshield. If the system detects that the camera is fully operational again, the [High beam assist Available Again] message is displayed.
[High beam assist Inoperative]	High beam assist is faulty. Have the system checked. It is recommended you visit an INFINITI retailer for this service.

Engine

Message	Possible causes/consequences and solutions
 <p data-bbox="71 265 310 308">[Check Coolant Level See Operators Manual]</p>	<p data-bbox="343 213 599 234">The coolant level is too low.</p> <p data-bbox="351 239 500 265">⚠ CAUTION</p> <p data-bbox="343 270 1450 296">Avoid making long journeys with too little coolant in the engine cooling system. The engine will otherwise be damaged.</p> <p data-bbox="343 296 1240 317">Top up the coolant, observing the warning notes before doing so (see "If your vehicle overheats").</p> <p data-bbox="343 317 1534 363">If the coolant needs topping up more often than usual, have the engine coolant system checked. It is recommended you visit an INFINITI retailer for this service.</p>
	<p data-bbox="343 373 558 394">The fan motor is faulty.</p> <p data-bbox="343 394 1534 420">If the coolant temperature is below 250°F (120°C), you can continue driving to the nearest place you can have the system checked. It is recommended that you visit an INFINITI retailer for this service.</p> <p data-bbox="343 420 1384 467">Avoid putting the engine under heavy load as you do so, e.g. driving in mountainous terrain and stop-start traffic.</p>
 <p data-bbox="71 519 302 565">[Coolant Too Hot Stop Vehicle Turn Engine Off]</p>	<p data-bbox="343 472 550 493">The coolant is too hot.</p> <p data-bbox="343 493 604 513">A warning tone also sounds.</p> <p data-bbox="351 519 500 544">⚠ CAUTION</p> <p data-bbox="343 550 1534 648">If the gauge indicates coolant temperature near the hot (H) end of the normal range, reduce vehicle speed to decrease temperature. If the gauge is over the normal range, stop the vehicle as soon as safely possible. If the engine is overheated, continued operation of the vehicle may seriously damage the engine. For additional information, refer to "If your vehicle overheats" for immediate action required.</p> <ol data-bbox="343 653 1534 860" style="list-style-type: none"> <li data-bbox="343 653 1331 674">1. Stop the vehicle immediately, paying attention to road and traffic conditions, and switch off the engine. <li data-bbox="343 674 736 695">2. Secure the vehicle against rolling away <li data-bbox="343 695 736 715">3. Wait until the engine has cooled down. <li data-bbox="343 715 1177 736">4. Make sure that the air supply to the engine radiator is not blocked, e.g. by frozen slush. <li data-bbox="343 736 1534 788">5. Do not start the engine again until the display message goes out and the coolant temperature is below 120°C. The engine may otherwise be damaged. <li data-bbox="343 788 835 809">6. Pay attention to the coolant temperature display. <li data-bbox="343 809 1534 860">7. If the temperature increases again, have the system checked immediately. It is recommended you visit an INFINITI retailer for this service. <p data-bbox="343 860 1488 881">Under normal operating conditions and with the specified coolant level, the coolant temperature may rise to 250°F (120°C).</p> <p data-bbox="343 881 624 902">See "If your vehicle overheats".</p>

Message	Possible causes/consequences and solutions
 [See Operator's Manual]	<p>The battery is not being charged. A warning tone also sounds.</p> <p>Possible causes:</p> <ul style="list-style-type: none"> • Faulty alternator. • Torn poly-V-belt. • A malfunction in the electronics. <p>⚠ CAUTION Do not continue driving. The engine could otherwise overheat.</p> <ol style="list-style-type: none"> 1. Stop the vehicle immediately, paying attention to road and traffic conditions, and switch off the engine. 2. Secure the vehicle against rolling away 3. Have the system checked. It is recommended you visit an INFINITI retailer for this service.
 [Stop Vehicle See Operator's Manual]	<p>The battery is no longer being charged and the battery charge level is too low. A warning tone also sounds.</p> <ol style="list-style-type: none"> 1. Stop the vehicle immediately, paying attention to road and traffic conditions, and switch off the engine. 2. Secure the vehicle against rolling away 3. Observe the instructions in the display message. 4. Have the system checked. It is recommended you visit an INFINITI retailer for this service.
 [Check Engine Oil At Next Refueling]	<p>The engine oil level has dropped to the minimum level. A warning tone also sounds.</p> <p>⚠ CAUTION Avoid long journeys when there is too little engine oil in the engine. Otherwise the engine will be damaged.</p> <ol style="list-style-type: none"> 1. Check the oil level when next refueling, at the latest (see "Engine oil"). 2. If necessary, top up the engine oil. 3. If the engine oil needs topping up more often than usual, have the engine checked. It is recommended you visit an INFINITI retailer for this service.

Message	Possible causes/consequences and solutions
 <p>[Check Engine Oil Level (Add 1 Liter)]</p>	<p>The engine oil level has dropped to the minimum level. A warning tone also sounds.</p> <p>⚠ CAUTION Avoid long journeys when there is too little engine oil in the engine. Otherwise the engine will be damaged.</p> <ol style="list-style-type: none"> 1. Check the oil level when next refueling, at the latest (see "Engine oil"). 2. If necessary, top up the engine oil. 3. If the engine oil needs topping up more often than usual, have the engine checked. It is recommended you visit an INFINITI retailer for this service.
 <p>[Engine Oil Level Low Stop vehicle Turn Engine Off]</p>	<p>The engine oil level is too low. There is risk of engine damage.</p> <ol style="list-style-type: none"> 1. Stop the vehicle immediately, paying attention to road and traffic conditions, and switch off the engine. 2. Secure the vehicle against rolling away 3. Check the engine oil level (see "Engine oil") 4. If necessary, top up the engine oil .
 <p>[Engine Oil Pressure Stop vehicle Turn Engine Off]</p>	<p>The engine oil pressure is too low. There is a serious risk of engine damage.</p> <ol style="list-style-type: none"> 1. Stop the vehicle immediately, paying attention to road and traffic conditions, and switch off the engine. 2. Secure the vehicle against rolling away 3. It is recommended you consult an INFINITI retailer. <p>⚠ CAUTION Running the engine while the engine oil pressure warning is displayed could cause serious damage to the engine.</p>
 <p>[Gasoline: Reserve Fuel Refuel Immediately]</p>	<p>The fuel level has dropped into the reserve range. Operation of the auxiliary heating is deactivated if the fuel level drops into the reserve range. Refuel at the nearest filling station.</p>
	<p>There is very little fuel in the fuel tank. Refuel at the nearest filling station.</p>

Driving systems

Message	Possible causes/consequences and solutions
<p>[Lane Departure Warning Currently Unavailable See Operator's Manual]</p>	<p>Lane Departure Warning is deactivated and temporarily inoperative.</p> <p>Possible causes:</p> <ul style="list-style-type: none"> • The windshield is dirty in the camera's field of vision. • Visibility is impaired due to heavy rain, snow or fog. • There have been no lane markings for an extended period. • The lane markings are worn, dark or covered, e.g. by dirt or snow. <p>Once the causes listed above no longer apply, the display message goes out. Lane Departure Warning is operational again.</p> <p>If the display message does not disappear:</p> <ol style="list-style-type: none"> 1. Pull over and stop the vehicle safely as soon as possible, paying attention to road and traffic conditions, and switch off the engine. 2. Secure the vehicle against rolling away. 3. Clean the windshield
<p>[Lane Departure Warning Inoperative]</p>	<p>Lane Departure Warning is faulty.</p> <p>Have the system checked. It is recommended you visit an INFINITI retailer for this service.</p>
<p>[Blind Spot Warning Currently Unavailable See Operator's Manual]</p>	<p>Blind Spot Warning is temporarily inoperative. Possible causes:</p> <ul style="list-style-type: none"> • The function is impaired due to heavy rain or snow. • The radar sensor system is temporarily inoperative, e.g. due to electromagnetic radiation emitted by nearby TV or radio stations or other sources of electromagnetic radiation. • The radar sensor system is outside the operating temperature range. <p>The yellow indicator lights also light up in the exterior mirrors.</p> <p>Once the causes listed above no longer apply, the display message goes out. Blind Spot Warning is operational again.</p> <p>If the display message does not disappear:</p> <ol style="list-style-type: none"> 1. Pull over and stop the vehicle safely as soon as possible, paying attention to road and traffic conditions, and switch off the engine. 2. Secure the vehicle against rolling away. 3. Restart the engine

Message	Possible causes/consequences and solutions
[Blind Spot Warning Not Available When Towing a Trailer See Operator's Manual]	Blind Spot Warning is deactivated while towing a trailer. You have established the electrical connection between the trailer and your vehicle. Press <OK> on the steering wheel to confirm the display message.
[Blind Spot Warning Inoperative]	Blind Spot Warning (BSW) is faulty. The BSW indicator lights also light up. Have the system checked. It is recommended you visit an INFINITI retailer for this service.
[Park Assist Canceled]	The driver's door is open and the driver's seat belt has not been fastened. Repeat the parking process with the seat belt fastened and the driver's door closed.
	You inadvertently touched the steering wheel while steering intervention was active. While steering intervention is active, make sure not to touch the steering wheel.
	The vehicle has started to skid and VDC has intervened. Use Intelligent Park Assist again later.
[Park Assist Inoperative]	You have just carried out a large number of turning or parking maneuvers. Intelligent Park Assist will become available again after approximately ten minutes. 1. Pull over and stop the vehicle safely as soon as possible, paying attention to road and traffic conditions, and switch off the engine. 2. Restart the engine. If the display message continues to be displayed, have the system checked. It is recommended you visit an INFINITI retailer for this service.
	The parking sensor system is faulty. Have the system checked. It is recommended you visit an INFINITI retailer for this service.
[Park Assist Finished]	The vehicle is parked. A warning tone also sounds. The display message disappears automatically.
[ICC Off]	Intelligent Cruise Control has been deactivated (see " Intelligent Cruise Control (ICC) system (Full speed range) (if equipped)"). If it was not deactivated by the driver, a warning tone also sounds.
[ICC Now Available]	Intelligent Cruise Control is operational again after having been temporarily unavailable. You can now reactivate Intelligent Cruise Control (see " Intelligent Cruise Control (ICC) system (Full speed range) (if equipped)")

Message	Possible causes/consequences and solutions
[ICC Currently Unavailable See Operator's Manual]	Intelligent Cruise Control is temporarily inoperative. Possible causes: <ul style="list-style-type: none"> • The function is impaired due to heavy rain or snow. • The radar sensor system is temporarily inoperative, e.g. due to electromagnetic radiation emitted by nearby TV or radio stations or other sources of electromagnetic radiation. • The system is outside the operating temperature range. • The on-board voltage is too low. A warning tone also sounds. Once the causes listed above no longer apply, the display message goes out. Intelligent Cruise Control is operational again. If the display message does not disappear: <ol style="list-style-type: none"> 1. Pull over and stop the vehicle safely as soon as possible, paying attention to road and traffic conditions, and switch off the engine. 2. Secure the vehicle against rolling away 3. Restart the engine
[ICC Inoperative]	Intelligent Cruise Control is faulty. Forward Emergency Braking may also have become inoperative. A warning tone also sounds. Have the system checked. It is recommended you visit an INFINITI retailer for this service.
[ICC Suspended]	You have depressed the accelerator pedal. Intelligent Cruise Control is no longer controlling the speed of the vehicle. Remove your foot from the accelerator pedal.
[ICC - - - MPH]	An activation condition for Intelligent Cruise Control is not fulfilled. Check the activation conditions for Intelligent Cruise Control (see " Intelligent Cruise Control (ICC) system (Full speed range) (if equipped)")
[ICC and Speed Limiter Inoperative]	Intelligent Cruise Control and Speed Limiter are faulty. A warning tone also sounds. Have the system checked. It is recommended you visit an INFINITI retailer for this service.
[Cruise Control and Speed Limiter Inoperative]	Cruise Control and Speed Limiter are faulty. A warning tone also sounds. Have the system checked. It is recommended you visit an INFINITI retailer for this service.

Message	Possible causes/consequences and solutions
[Speed Limiter Suspended]	While depressing the accelerator pedal beyond the pressure point (kickdown), Speed Limiter cannot be activated. If conditions permit, drive faster than 20 MPH (30 km/h) and store the speed.
[Cruise Control - - - MPH]	An activation condition for Intelligent Cruise Control is not fulfilled. You have tried to store a speed below 20 MPH (30 km/h), for example. If conditions permit, drive faster than 20 MPH (30 km/h) and store the speed. Check the activation conditions for Intelligent Cruise Control (see "Intelligent Cruise Control (ICC) system (Full speed range (if equipped))")

Tires





Message	Possible causes/consequences and solutions
[Please Correct Tire Pressure]	<p>The tire pressure is too low in at least one of the tires, or the tire pressure difference between the wheels is too great.</p> <ol style="list-style-type: none"> 1. Check the tire pressures at the next opportunity (see "Wheels and tires") 2. If necessary, correct the tire pressure. 3. Restart the tire pressure monitoring system (see "Restarting TPMS")
[Check Tire(s)]	<p>The tire pressure in one or more tires has dropped significantly The wheel position is displayed in the vehicle information display A warning tone also sounds.</p> <p>⚠ WARNING</p> <p>Underinflated tires pose the following risks:</p> <ul style="list-style-type: none"> • The tires may burst, especially as the load and vehicle speed increase. • The tires may wear excessively and/or unevenly, which may greatly impair tire traction. • The driving characteristics, as well as steering and braking, may be greatly impaired. <p>There is a risk of an accident.</p> <ol style="list-style-type: none"> 1. Stop the vehicle without making any sudden steering or braking maneuvers. Pay attention to the traffic conditions as you do so. 2. Secure the vehicle against rolling away. 3. Check the tires and, if necessary, follow the instructions for a flat tire (see "Flat tire"). 4. Check the tire pressures and, if necessary, correct the tire pressure.
[Warning Tire Malfunction]	<p>The tire pressure in one or more tires has dropped suddenly. The wheel position is displayed in the vehicle information display.</p> <p>⚠ WARNING</p> <p>If you drive with a flat tire, there is a risk of the following hazards:</p> <ul style="list-style-type: none"> • A flat tire affects the ability to steer or brake the vehicle. • You could lose control of the vehicle. • Continued driving with a flat tire will cause excessive heat buildup and possibly a fire. <p>There is a risk of an accident.</p> <ol style="list-style-type: none"> 1. Stop the vehicle without making any sudden steering or braking maneuvers. Pay attention to the traffic conditions as you do so. 2. Secure the vehicle against rolling away. 3. Check the tires and, if necessary, follow the instructions for a flat tire (see "Flat tire").



Message	Possible causes/consequences and solutions
[Tire Press. Monitor Currently Unavailable]	No signals can be received from the tire pressure sensors due to strong RF interference. The tire pressure monitor is temporarily malfunctioning. Drive on. The tire pressure monitoring system restarts automatically as soon as the cause has been rectified.
[Tire Press. Sensor(s) Missing]	There is no signal from the tire pressure sensor of one or several wheels. The pressure of the affected tire is not displayed in the vehicle information display. Have the faulty tire pressure sensor replaced. It is recommended you visit an INFINITI retailer for this service.
[Tire Press. Monitor Inoperative No Wheel Sensors]	The wheels fitted do not have suitable tire pressure sensors. The tire pressure monitoring system is deactivated. Fit wheels with suitable tire pressure sensors The tire pressure monitoring system is activated automatically after driving for a few minutes.
[Tire Press. Monitor Inoperative]	The tire pressure monitoring system is faulty.

Vehicle





Message	Possible causes/consequences and solutions
[Depress Brake to Start Engine]	(DCT models only). You have attempted to start the engine with the transmission in position N (Neutral) without depressing the brake pedal. Depress the brake pedal.
[To Deselect P or N, Depress Brake and Start Engine]	You have attempted to shift the shift lever to position R (Reverse) or D (Drive) without starting the engine. Start the engine and depress the brake pedal. NOTE <ul style="list-style-type: none"> • It is only possible to move the shift lever from position P (Park) to the desired position if you depress the brake pedal. Only then can the parking lock be deactivated. • At transmission fluid temperatures below -5°F (-20°C) you can only shift out of position P (Park) into another transmission position when the engine is running.
[Apply Brake to Shift From 'P']	You have attempted to shift the shift lever to position R (Reverse), N (Neutral) or D (Drive) without depressing the brake pedal. Depress the brake pedal.
[Risk of Rolling Transmission Not in P]	The driver's door is open/not fully closed and the shift lever is in position R (Reverse), N (Neutral) or D (Drive). A warning tone also sounds ⚠ WARNING The vehicle may roll away. There is a risk of an accident. <ol style="list-style-type: none"> 1. Press the P (Park) button. 2. Secure the vehicle against rolling away. 3. Close the driver's door fully.
[Service Required Do Not Shift Gears Visit Dealer]	You cannot change the transmission position due to a malfunction. A warning tone also sounds. If transmission position D (Drive) is selected, Drive to an INFINITI retailer without shifting the transmission from position D (Drive). If transmission position R (Reverse), N (Neutral) or P (Park), secure the vehicle against rolling away. It is recommended you consult an INFINITI retailer.



Message	Possible causes/consequences and solutions
[Only Shift to 'P' when Vehicle is Stationary]	The vehicle is moving. 1. Pull over and stop the vehicle safely as soon as possible, paying attention to road and traffic conditions. 2. Shift the shift lever to position P.
[Reversing Not Possible Service Required]	The automatic transmission is malfunctioning. You cannot drive in reverse. Have the system checked. It is recommended you visit an INFINITI retailer for this service.
[Transmission Malfunction]	The automatic transmission is malfunctioning. Have the system checked. It is recommended you visit an INFINITI retailer for this service.
[Transmission Malfunction Stop]	The automatic transmission is malfunctioning. 1. Pull over and stop the vehicle safely as soon as possible, paying attention to road and traffic conditions, and switch off the engine. 2. Secure the vehicle against rolling away 3. It is recommended you consult an INFINITI retailer.
[Stop vehicle Shift to P Leave Engine Running]	The automatic transmission has overheated. Drive on carefully. If the display message disappears, the automatic transmission is available again. If the display message continues to be displayed: 1. Pull over and stop the vehicle safely as soon as possible, paying attention to road and traffic conditions, and switch off the engine. 2. Secure the vehicle against rolling away 3. Wait until the automatic transmission has cooled down and the display message goes out.
[Auxiliary Battery Malfunction]	The auxiliary battery for the automatic transmission is no longer being charged. 1. It is recommended you visit an INFINITI retailer at the next opportunity. 2. Until then, press the P (Park) button before you switch off the engine. 3. Before leaving the vehicle, apply the electric parking brake.
[Trans. Oil Overheated Drive On With Care]	Manual drive program M and the temporarily active manual drive program are no longer available. Engine power output is reduced Allow the vehicle to cool down.
[4WD System Currently Unavailable]	The 4WD system has overheated. The vehicle is only driven by the front wheels. Drive on, the airflow cools the 4WD system more quickly. When the display message goes out, the 4WD system is available again and the vehicle is driven by all four wheels.
[4WD system Inoperative]	The 4WD system is malfunctioning. The vehicle is only driven by the front wheels. Have the system checked. It is recommended you visit an INFINITI retailer for this service.

Message	Possible causes/consequences and solutions
	<p>The lift gate is open.</p> <p>⚠ WARNING</p> <p>When the engine is running, exhaust gases can enter the vehicle interior if the lift gate is open.</p> <p>There is a risk of poisoning</p> <p>Close the lift gate.</p>
	<p>The hood is open. A warning tone also sounds.</p> <p>⚠ WARNING</p> <p>The open hood may then block your view when the vehicle is in motion.</p> <p>There is a risk of an accident.</p> <ol style="list-style-type: none"> 1. Pull over and stop the vehicle safely as soon as possible, paying attention to road and traffic conditions. 2. Secure the vehicle against rolling away. 3. Close the hood.
	<p>At least one door is open. A warning tone also sounds.</p> <p>Close all doors.</p>
<p></p> <p>[Power Steering Malfunction See Operator's Manual]</p>	<p>The power steering assistance is faulty. A warning tone also sounds.</p> <p>⚠ WARNING</p> <p>You will need to use more force to steer.</p> <p>There is a risk of an accident.</p> <ol style="list-style-type: none"> 1. Check whether you are able to apply the extra force required. 2. If you are able to steer safely: carefully drive on to a qualified specialist workshop. 3. If you are unable to steer safely: do not drive on. It is recommended you contact the nearest INFINITI retailer.

Message	Possible causes/consequences and solutions
 [Steering Malfunction See Operator's Manual]	<p>The electric steering lock is malfunctioning.</p> <p>⚠ WARNING The steering may be locked by the electric steering lock. There is a risk of an accident.</p> <ol style="list-style-type: none"> 1. Pull over and stop the vehicle safely as soon as possible, paying attention to road and traffic conditions. 2. Secure the vehicle against rolling away. 3. Do not drive on. It is recommended you contact the nearest INFINITI retailer.
	<p>The electric steering lock was unable to unlock the steering.</p> <ol style="list-style-type: none"> 1. Remove the key from the ignition switch. 2. To unlock the steering, move the steering wheel slightly. 3. Insert the key into the ignition lock again.
 [Check Washer Fluid]	<p>The washer fluid level in the washer fluid reservoir has dropped below the minimum. Top up the washer fluid (see "Window washer fluid")</p>
[Wiper Malfunctioning]	<p>The windshield wipers are defective. Have the system checked. It is recommended you visit an INFINITI retailer for this service.</p>
[Hazard Warning Flashers Malfunctioning]	<p>The hazard warning lights are faulty. Visit an INFINITI retailer.</p>

Key

Problem	Possible causes/consequences and solutions
 [Key Does Not Belong to Vehicle]	You have put the wrong key in the ignition switch. Use the correct key.
 [Obtain a New Key]	The key needs to be replaced. It is recommended you visit an INFINITI retailer for this service.
 [Replace Key Battery]	The key battery is discharged. Replace the battery (see "Checking the battery")
 [Key Not Detected] (red display message)	The key is not in the vehicle. A warning tone also sounds. If the engine is switched off, you can no longer lock the vehicle centrally or start the engine. <ol style="list-style-type: none">1. Pull over and stop the vehicle safely as soon as possible, paying attention to road and traffic conditions.2. Secure the vehicle against rolling away.3. Locate the key.
	Because there is interference from a strong source of radio waves, the key is not detected whilst the engine is running. A warning tone also sounds. If the engine is switched off, you can no longer lock the vehicle centrally or start the engine. <ol style="list-style-type: none">1. Pull over and stop the vehicle safely as soon as possible, paying attention to road and traffic conditions.2. Secure the vehicle against rolling away.3. Insert the key into the ignition lock and bring into key mode.

Problem	Possible causes/consequences and solutions
 <p data-bbox="71 232 290 275">[Remove 'Start' Button, Then Insert Key]</p>	<p data-bbox="337 180 650 200">The key is continually undetected.</p> <p data-bbox="337 204 1232 224">The key detection function has a temporary malfunction or is faulty. A warning tone also sounds.</p> <ul style="list-style-type: none"> <li data-bbox="337 227 1002 248">▪ Insert the key into the ignition lock and turn it to the desired position. <li data-bbox="337 251 839 272">▪ It is recommended you consult an INFINITI retailer.
 <p data-bbox="71 338 318 382">[Key Not Detected] (white display message)</p>	<p data-bbox="337 286 632 307">The key is currently undetected.</p> <p data-bbox="337 310 753 331">Change the location of the key in the vehicle.</p> <p data-bbox="337 334 1267 355">If the key still cannot be detected, operate the vehicle with the key in the ignition switch if necessary.</p>

SECURITY SYSTEM

IMMOBILISER

The immobiliser prevents your vehicle from being started without the correct key.

- **To activate with the key:** remove the key from the ignition lock.
- **To deactivate:** switch on the ignition.

When leaving the vehicle, always take the key with you and lock the vehicle. Anyone can start the engine if a valid key has been left inside the vehicle.

NOTE

The immobiliser is always deactivated when you start the engine.

FCC Notice:

For USA:

This device complies with Part 15 of the FCC Rules. Operation is subject to the following two conditions: (1) This device may not cause harmful interference, and (2) this device must accept any interference received, including interference that may cause undesired operation.

NOTE

Changes or modifications not expressly approved by the party responsible for compliance could void the user's authority to operate the equipment.

For Canada:

This device complies with Industry Canada license-exempt RSS standard(s). Operation is subject to the following two conditions: (1) this device may not cause interference, and (2) this device must accept any interference, including interference that may cause undesired operation of the device.

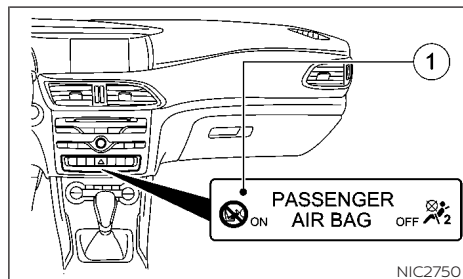

ANTI-THEFT ALARM SYSTEM (IF EQUIPPED)

To arm: lock the vehicle with the key or Intelligent Key. Indicator light ① flashes. The alarm system is armed after approximately 15 seconds.

To deactivate: unlock the vehicle with the key or Intelligent Key.

or

Insert the key into the ignition switch.

A visual and audible alarm is triggered if the alarm system is armed and you open:

- A door.
- The vehicle with the emergency key element.
- The lift gate.
- The hood.

WIPER AND WASHER SWITCH

To switch the alarm off with the key: press the  or  button on the key. The alarm is switched off

or

Vehicles with a push button ignition switch:

- Remove the start/stop button from the ignition lock (see " Push-button ignition switch (if equipped)")
- Insert the key into the ignition lock. The alarm stops.

The alarm is not switched off, even if you close the open door that has triggered it, for example.

WARNING

In freezing temperatures the washer solution may freeze on the windshield and obscure your vision which may lead to an accident. Warm the windshield with the defroster before you wash the windshield.

CAUTION

- **Do not operate the washer continuously for more than 30 seconds.**
- **Do not operate the washer if the window washer fluid reservoir is empty.**
- **Do not fill the window washer reservoir tank with washer fluid concentrates at full strength. Some methyl alcohol based washer fluid concentrates may permanently stain the grille if spilled while filling the window washer reservoir tank.**
- **Pre-mix washer fluid concentrates with water to the manufacturer's recommended levels before pouring the fluid into the window washer reservoir tank. Do not use the window washer reservoir tank to mix the washer fluid concentrate and water.**

NOTE

- **If the wiper operation is interrupted by snow or ice, the wiper may stop moving to protect its motor. If this occurs, turn the wiper switch to the "OFF" position and remove the snow or ice on and around the wiper arms. In approximately 1 minute, turn the switch on again to operate the wiper.**
- **Do not operate the windshield wipers when the windshield is dry, as this could damage the wiper blades. Moreover, dust that has collected on the windshield can scratch the glass if wiping takes place when the windshield is dry.**
- **If it is necessary to switch on the wipers in dry weather conditions, always operate them using washer fluid.**
- **If the windshield wipers leave smears on the windshield after the vehicle has been washed in an automatic car wash, this may be due to wax or other residue. Clean the windshield with washer fluid after an automatic car wash.**

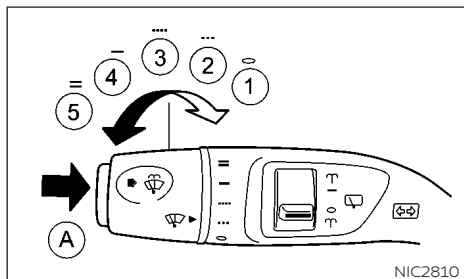

Combination switch

SWITCHING THE WINDSHIELD WIPERS ON/OFF

- ① Windshield wipers off.
- ② Intermittent wipe, low (rain sensor set to low sensitivity).
- ③ Intermittent wipe, high (rain sensor set to high sensitivity).
- ④ Continuous wipe, slow.
- ⑤ Continuous wipe, fast.
- Ⓐ Single wipe/

wipe the windshield using washer fluid.

The windshield wiper and washer operate when the ignition switch is in the ON position.

Turn the combination switch to the desired position.

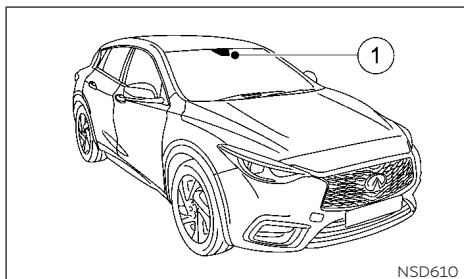

Rain sensor (if equipped)

The rain-sensing auto wiper system uses the rain sensor located on the upper part of the windshield ①.

CAUTION

- **Do not touch the rain sensor and around it ① when the wiper switch is in the or position and the ignition switch is in the ON position. The wipers may operate unexpectedly and cause an injury or may damage a wiper.**

- The rain-sensing auto wipers are intended for use during rain. If the switch is left in the or position, the

wipers may operate unexpectedly when dirt, fingerprints, oil film or insects are stuck on or around the sensor. The wipers may also operate when exhaust gas or moisture affect the rain sensor.

- When the windshield glass is coated with water repellent, the speed of the rain-sensing auto wipers may be higher even though the amount of the rainfall is small.
- Be sure to turn off the rain-sensing auto wiper system when you use a car wash.
- The rain-sensing auto wipers may not operate if rain does not hit the rain sensor even if it is raining.
- Using genuine wiper blades is recommended for proper operation of the rain-sensing auto wiper system. For additional information, refer to "Wiper blades".

- **Vehicles with a rain sensor:** if the windshield becomes dirty in dry weather conditions, the windshield wipers may be activated inadvertently. This could damage the windshield wiper blades or scratch the windshield. For this reason, you should always switch off the windshield wipers in dry weather.

Vehicles with a rain sensor: in the ■■■ or ■■■■ position, the appropriate wiping frequency is automatically set according to the intensity of the rain. In the ■■■■ position, the rain sensor is more sensitive than in the ■■■ position, causing the windshield wiper to wipe more frequently.

If the wiper blades are worn, the windshield will no longer be wiped properly. This could prevent you from observing the traffic conditions.

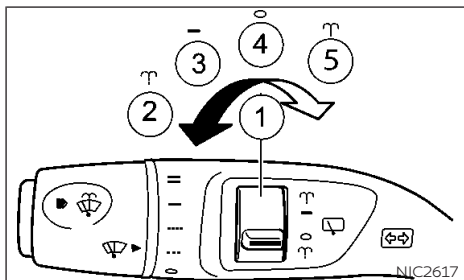

SWITCHING THE REAR WINDOW WIPER ON/OFF

⚠ WARNING

In freezing temperatures the washer solution may freeze on the windshield and obscure your vision which may lead to an accident. Warm the windshield with the defroster before you wash the windshield.

⚠ CAUTION

- **Do not operate the washer continuously for more than 30 seconds.**
- **Do not operate the washer if the window washer fluid reservoir is empty.**
- **Do not fill the window washer reservoir tank with washer fluid concentrates at**

full strength. Some methyl alcohol based washer fluid concentrates may permanently stain the grille if spilled while filling the window washer reservoir tank.

- **Pre-mix washer fluid concentrates with water to the manufacturer's recommended levels before pouring the fluid into the window washer reservoir tank. Do not use the window washer reservoir tank to mix the washer fluid concentrate and water.**

- ① Switch
- ② Wipes with washer fluid
- ③ Switches on intermittent wiping
- ④ Switches off intermittent wiping
- ⑤ Wipes with washer fluid

1. Switch the ignition switch to the ON position.
2. Turn switch ① on the combination switch to the corresponding position.

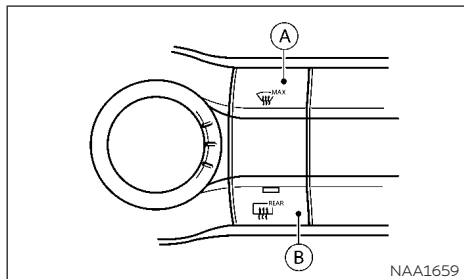

When the rear window wiper is switched on, the  symbol appears in the assistance graphic in the combination meter. Further information on the assistance graphic (see "Showing the distance display" earlier in this section).

REAR WINDOW AND OUTSIDE MIRROR DEFROSTER SWITCH



The defroster switch (B) operates when the ignition switch is in the ON position for the rear window, and (if equipped) for the outside rear view mirrors.

The defroster is used to reduce the moisture, fog or frost on the rear window surface and on the outside mirror surface to improve the rear view.

When the defroster switch  is pushed, the indicator light illuminates and the defroster operates for several minutes. After the preset time has passed, the defroster will turn off automatically. To turn off the defroster manually, push the defroster switch  again, and the indicator light turns off.

CAUTION

- When cleaning the inner side of the rear window, be careful not to scratch or damage the rear window defroster.
- When operating the defroster continuously, be sure to start the engine. Otherwise, it may cause the battery to discharge.
- When cleaning the inner side of the window, be careful not to scratch or damage the electrical conductors on the surface of the window.

WINDSHIELD DE-ICER SWITCH (IF EQUIPPED)

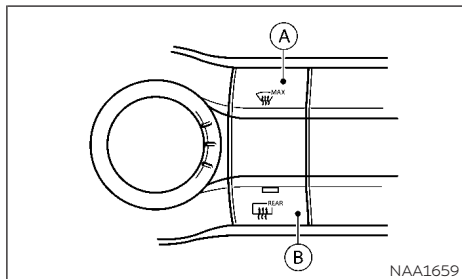

The windshield de-icer switch (defogger switch) (A) operates when the ignition switch is in the ON position.

You can use this function to defrost the windshield or to demist the inside of the windshield and the side windows

NOTE

You should only select the windshield de-icer function until the windshield is clear again.

When the switch  is pushed, the indicator light in the switch illuminates. The climate control system switches to the following functions:

- High airflow
- High temperature
- Air distribution to the windshield and front side windows
- Air recirculation mode off

HEADLIGHT AND TURN SIGNAL SWITCHES



NOTE

The "Windshield demisting" function automatically sets the blower output to the optimum demisting effect. As a result, the airflow may increase or decrease automatically after the  button is pressed

NOTE

You can adjust the blower output manually while the "Windshield demisting" function is in operation: by adjusting the airflow control for the air-conditioning or climate control system (see "Heater and air conditioner").

To deactivate the de-icer:

- Press the  button. The indicator light in the  button turns off. The previous settings are reactivated. Air-recirculation mode remains deactivated.
- or
- Automatic climate control: press the **<AUTO>** button. The indicator light in the  button turns off. Airflow and air distribution are set to automatic mode.
- or
- Air-conditioning system or automatic climate control: adjust the temperature control (see "Heater and air conditioner").

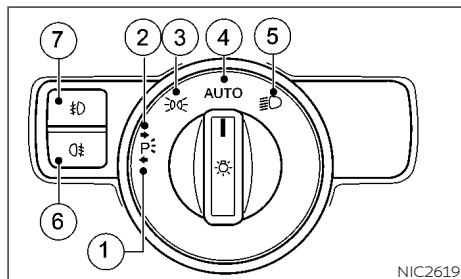



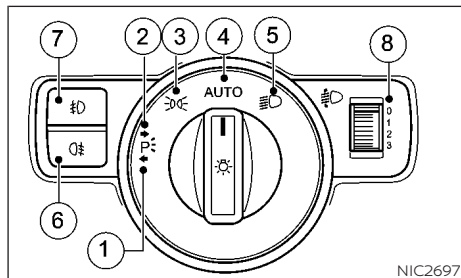



LED headlights



Halogen headlights

HEADLIGHT SWITCH

- ①  Left-hand parking lights
- ②  Right-hand parking lights
- ③  Side lights and license plate lighting
- ④ **<AUTO>** Automatic headlight mode, controlled by the light sensor
- ⑤  Low beam/high beam headlights
- ⑥  Rear fog light
- ⑦  Front fog lights (if equipped)
- ⑧ Headlight aiming control (halogen headlights only)

INFINITI recommends that you consult the local regulations concerning the use of lights.

If you hear a warning tone when you leave the vehicle, the side lights may still be switched on. Turn the light switch to **<AUTO>**.

The exterior lighting (except the side lights/parking lights) switches off automatically if you:

- Remove the key from the ignition switch (if equipped).
- Open the driver's door with the ignition switch in the OFF position.

CAUTION

Use the headlights with the engine running to avoid discharging the vehicle battery.

Automatic headlight mode

<AUTO> is the preferred light switch setting. The light setting is automatically selected according to the brightness of the ambient light (exception: poor visibility due to weather conditions such as fog, snow or spray):

- Ignition switch in ACC or ON position: the side lights are switched on or off automatically depending on the brightness of the ambient light.
- With the engine running: if you have switched on the daytime driving lights function in the vehicle information display, the side lights and low beam headlights are switched on or off automatically depending on the brightness of the ambient light.

To switch on automatic headlight mode: turn the light switch to **<AUTO>**.

WARNING

When the light switch is set to <AUTO>, the low-beam headlights may not be switched on automatically if there is fog, snow or other causes of poor visibility due to the weather conditions such as spray. There is a risk of an accident

In such situations, turn the light switch to





The automatic headlight feature is only an aid. The driver is responsible for the vehicle lighting at all times.

The daytime driving lights improve the detectability of your vehicle during the day.

WARNING

When the daytime running light system is active, tail lights on your vehicle are not on. It is necessary at dusk to turn on your headlights. Failure to do so could cause an accident injuring yourself and others.



When the side lights and low-beam headlights are switched on, the green  (side lights) and  (low-beam headlights) indicator lights in the combination meter light up.

Low-beam headlights

When the ignition is switched on and the light switch is in the  position, the side lights and low-beam headlights are switched on even if the light sensor does not sense dark ambient light conditions. This is advantageous when there is fog or rain.

To switch on the low-beam headlights:



- Switch the ignition switch to the ON position, or start the engine.

- Turn the light switch to . The green  indicator light in the combination meter lights up.

Side lights

NOTE



Always park your vehicle safely and sufficiently lit according to legal standards. To reduce the chance of a discharged vehicle battery, avoid the continuous use of the  sidelights or parking lights for several hours.

To switch on: turn the light switch to . The green  indicator light in the combination meter lights up.

Parking lights

Switching on the parking lights ensures that the corresponding side of the vehicle is illuminated.

To switch on the parking lights:

- The key is not in the ignition switch or the switch is in the OFF position.
- Turn the light switch to  (left-hand side of the vehicle) or  (right-hand side of the vehicle).

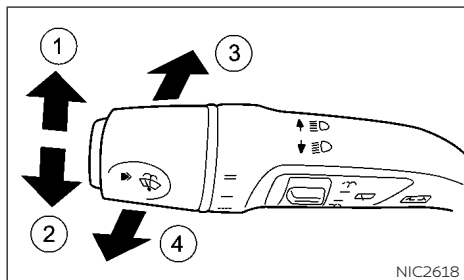

COMBINATION SWITCH

- ① Turn signal, right
- ② Turn signal, left
- ③ High beam headlights
- ④ Headlight flasher

Turn signal

Move the lever up or down to signal the turning direction. When the turn is completed, the turn signal cancels automatically.

Lane change signal

Move the lever up or down until the turn signal begins to flash, but the lever does not latch, to signal a lane change. Hold the lever until the lane change is completed. Move the lever up or down until the turn signal begins to flash, but the lever does not latch, and release the lever. The turn signal will auto-

matically flash three times. Choose the appropriate method to signal a lane change based on road and traffic conditions.

High beam headlights

To switch on the high beam headlights:

- Turn the ignition switch to the ON position or start the engine.
- Turn the light switch to  or <AUTO>.
- Press the combination switch beyond the pressure point in the direction of arrow ③. In the <AUTO> position, the high beam headlights are only switched on when it is dark and the engine is running.

The blue  indicator light in the combination meter lights up when the high beam headlights are switched on.

To switch off the high beam headlights:

- Move the combination switch back to its normal position. The blue  indicator light in the combination meter goes out.

NOTE

Vehicles with High beam Assist: when High beam Assist is active, it controls activation and deactivation of the high beam headlights (see "High beam assist (LED headlight only)" later in this section)

ADAPTIVE FRONT LIGHTING SYSTEM (LED HEADLIGHT ONLY) (IF EQUIPPED)

The Adaptive Front Lighting System is a system that adjusts the headlights automatically to suit the prevailing driving and weather conditions. It offers advanced functions for improved illumination of the road surface, e.g. depending on the vehicle speed or weather conditions. The system includes the active light function, cornering light function and freeway mode. The system is only active when it is dark.

You can activate or deactivate the "Adaptive Front Lighting System" function using the vehicle information display (see "Switching the Adaptive Front Lighting System on/off" earlier in this section)

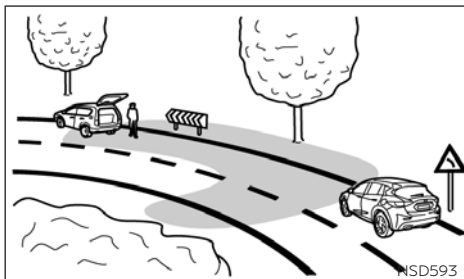

Active light function

The active light function is a system that moves the headlights according to the steering movements of the front wheels. In this way relevant areas remain illuminated while you are driving. This helps you to recognize pedestrians, cyclists and animals. It is active when the lights are switched on.

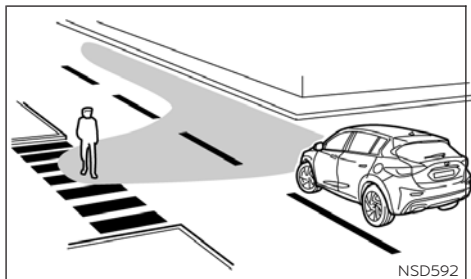

Cornering light function

The cornering light function improves the illumination of the road over a wide angle in the direction you are turning, enabling better visibility in tight bends, for example. It can only be activated when the low-beam headlights are switched on. It is active if you are driving at speeds below 25 MPH (40 km/h) and switch on the turn signal or turn the steering wheel.

The cornering light function may remain lit for a short time, but is automatically switched off after no longer than three minutes.

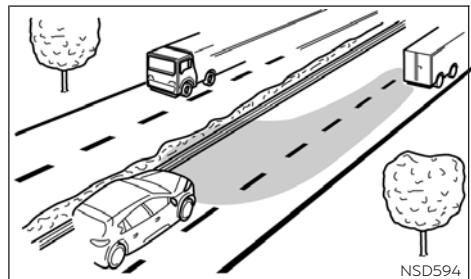

Freeway mode

Freeway mode adjusts the light beam to reduce the amount of light that shines on the opposite lane of the freeway, and oncoming traffic.

Freeway mode is active if you are driving at a speed above 68 MPH (110 km/h) and do not make any large steering movements for at least 3300 ft (1000 m) or if you are driving at a speed above 81 MPH (130 km/h).

It is not active if you are driving at speeds below 50 MPH (80 km/h) following activation.

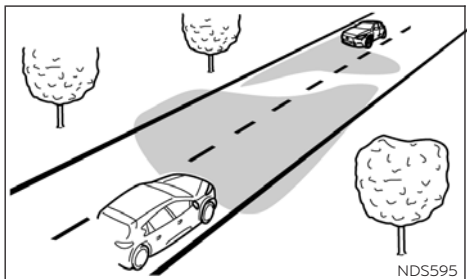

HIGH BEAM ASSIST (LED HEADLIGHT ONLY)

You can use this function to set the headlights to change between low beam and high beam automatically. The system recognizes vehicles with their lights on, either approaching from the opposite direction or traveling in front of your vehicle, and consequently switches the headlights from high beam to low beam.

The system automatically adapts the low beam headlight range depending on the distance to the other vehicle. Once the system no longer detects any other vehicles, it switches on the high beam headlights again.

The system's optical sensor is located behind the windshield near the overhead control panel.

⚠ WARNING

- The high beam assist system is a convenience but is not a substitute for safe driving operation. The driver should remain alert at all times, ensure safe driving practices and switch the high beams and low beam manually when necessary.
- The high beam or low beam may not switch automatically under the following conditions. Switch the high beam and low beam manually.
 - During bad weather (rain, fog, snow, wind, etc.).
 - When a light source similar to a headlight or tail light is in the vicinity of the vehicle.
 - When the headlights of the oncoming vehicle or the leading vehicle are turned off, when the color of the light is affected due to foreign materials on the lights, or when the light beam is out of position.
 - When there is a sudden, continuous change in brightness.
 - When driving on a road that passes over rolling hills, or a road that has level differences.
 - When driving on a road with many curves.
- When a sign or mirror-like surface is reflecting intense light towards the front of the vehicle.
- When the container, etc. being towed by a leading vehicle is reflecting intense light.
- When a headlight on your vehicle is damaged or dirty.
- When the vehicle is leaning at an angle due to a punctured tire, being towed, etc.
- The timing of switching the low beam and high beam may change under the following situations.
 - The brightness of the headlights of the oncoming vehicle or leading vehicle.
 - The movement and direction of the oncoming vehicle and the leading vehicle.
 - When only one light on the oncoming vehicle or the leading vehicle is illuminated.
 - When the oncoming vehicle or the leading vehicle is a two-wheeled vehicle.
 - Road conditions (incline, curve, the road surface, etc.).
 - The number of passengers and the amount of luggage.

- High beam Assist does not recognize road users:
 - Who have no lights, e.g. pedestrians.
 - Who have low intensity lighting, e.g. cyclists.
 - Whose lighting is blocked, e.g. by a barrier.
- In very rare cases, High beam Assist recognizes road users too late or not at all. In this, or in similar situations, the automatic high beam headlights will not be deactivated or activated regardless. There is a risk of an accident.
- Always carefully observe the traffic conditions and switch off the high beam headlights in good time.

⚠ CAUTION

High beam Assist cannot compensate for road and weather circumstances while driving. The system saves the driver from having to operate the switch. The driver always remains responsible for choosing the correct light setting.

Specific situations in which to operate the headlight switch manually:

- In heavy rain, snowy conditions. (general poor visibility and bad weather conditions).
- When the vehicle sensors are dirty, covered or broken.

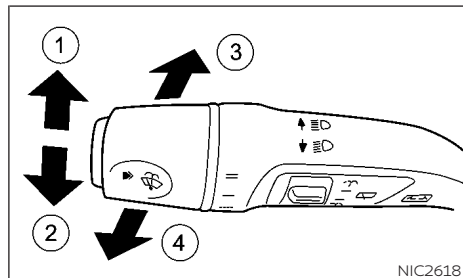



Switching High Beam Assist on/off

To switch on:

Turn the light switch to <AUTO> and press the combination switch beyond the pressure point in the direction of arrow ③. The  indicator light in the vehicle information display lights up when it is dark and the light sensor switches on the low-beam headlights.

If you are driving at speeds above approximately 28 MPH (45 km/h) the headlight range is set automatically depending on the distance between the vehicle and other road users.

If you are driving at speeds above approximately 34 MPH (55 km/h) and no other road users are detected, the high beam headlights are switched on automatically. The  indicator light in the combination meter also lights up.

If you are driving at speeds below approximately 28 MPH (45 km/h) or other road users are detected or the roads are adequately lit the high beam headlights are switched off automatically. The  indicator light in the combination meter goes out. The  indicator light in the vehicle information display remains lit.

To deactivate:

Move the combination switch back to its normal position. The  indicator light in the vehicle information display goes out.

HEADLIGHTS MISTED UP ON THE INSIDE

Certain climatic and physical conditions may cause moisture to form in the headlight. This moisture does not affect the functionality of the headlight.

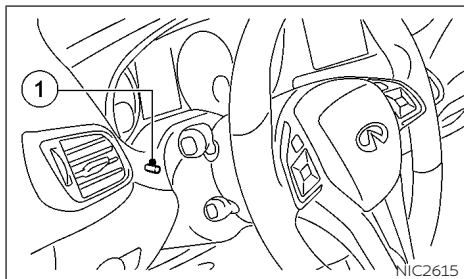



INSTRUMENT BRIGHTNESS CONTROL

The light sensor in the combination meter automatically controls the brightness of the instrument panel.

In daylight, the displays in the combination meter are not illuminated.

The lighting in the combination meter, displays and controls in the vehicle interior can be adjusted using the brightness control knob.

The brightness control knob  is located behind the steering wheel.

Turn the brightness control knob clockwise or counterclockwise. If the light switch is set to  or  the brightness is dependent upon the brightness of the ambient light.

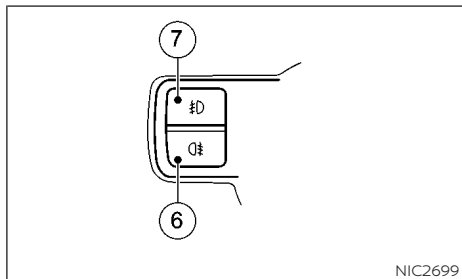

FOG LIGHT SWITCH (IF SO EQUIPPED)





FRONT FOG LIGHTS

In conditions where visibility is poor due to fog, snow or rain, the fog lights improve visibility as well as making it easier for other road users to see you. They can be operated together with the side lights or together with the side lights and low beam headlights.

To switch on the fog lights:

- Turn the ignition switch to the ON position or start the engine.
- Turn the light switch to  or **<AUTO>**.
- Press the  button. The green  indicator light in the combination meter lights up.

To switch off the front fog lights:

- press the  button The green  indicator light in the combination meter turns off.

Only vehicles with front fog lights are equipped with the "Fog lights" function.



REAR FOG LIGHT

The rear fog light improves the visibility of your vehicle in heavy fog for the following traffic. Please observe the country-specific laws on the use of rear fog lights.



NOTE

The front fog lights must be switched on before the rear fog light will operate.

To switch on the rear fog light:

- Turn the ignition switch to the ON position or start the engine.
- Turn the light switch to  or **<AUTO>**.
- Press the  button. The yellow  indicator light in the combination meter lights up

To switch off the rear fog light:

- press the  button The yellow  indicator light in the combination meter turns off.

The rear fog light should be used only when visibility is seriously reduced. (Generally, to less than 50 m (116 ft))

HORN

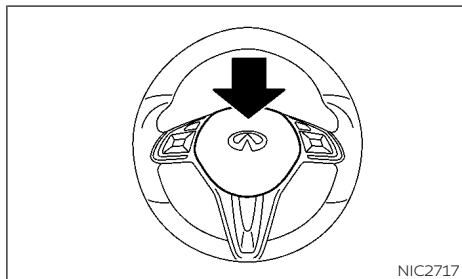

To sound the horn, push the center pad area of the steering wheel.

WARNING

Do not disassemble the horn. Doing so could affect proper operation of the supplemental front air bag system. Tampering with the supplemental front air bag system may result in serious personal injury.

SEAT HEATING (IF EQUIPPED)

WARNING

Do not use or allow occupants to use the seat heater if you or the occupants cannot monitor elevated seat temperatures or have an inability to feel pain in body parts that contact the seat. Use of the seat heater by such people could result in serious injury.

CAUTION

- The battery could run down if the seat heater is operated while the engine is not running.
- Do not use the seat heater for extended periods or when no one is using the seat.
- Do not put anything on the seat which insulates heat, such as a blanket, cushion, seat cover, etc. Otherwise, the seat may become overheated.
- Do not place anything hard or heavy on the seat or pierce it with a pin or similar object. This may result in damage to the heater.
- Any liquid spilled on the heated seat should be removed immediately with a dry cloth.

- When cleaning the seat, never use gasoline, benzine, thinner, or any similar materials.
- If any malfunctions are found or the heated seat does not operate, turn the switch off and have the system checked. It is recommended you visit an INFINITI retailer for this service.

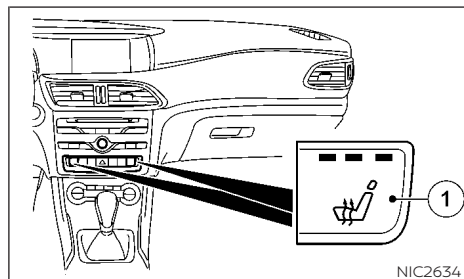

The front seats are warmed by built-in heaters.

The switches are located on the center console and can be operated independently, for the left-hand side seat and for the right-hand side seat.

The three red indicator lights in the button indicate the heating level you have selected. The system automatically switches from level 3 to level 2 after approximately eight minutes. The system automatically switches from level 2 to level 1 after approximately ten minutes. The system automatically switches off approximately 20 minutes after it is set to level 1.

1. Turn the ignition switch to the ON position.

WINDOWS

NOTE

The seat heater can only be activated when the ignition switch is in the ON position.

2. Start the engine.
3. Select the heat range:
 - To switch on: press button ① repeatedly until the desired heating level is set.
 - To switch off: press button ① repeatedly until all the indicator lights turn off.

NOTE

If the battery voltage is too low, the seat heating may switch off.

POWER WINDOWS

WARNING

- **Make sure that all passengers have their hands, etc. inside the vehicle while it is in motion and before closing the windows. Use the window lock switch to prevent unexpected use of the power windows.**
- **To help avoid risk of injury or death through unintended operation of the vehicle and or its systems, including entrapment in windows or inadvertent door lock activation, do not leave children, people who require the assistance of others or pets unattended in your vehicle. Additionally, the temperature inside a closed vehicle on a warm day can quickly become high enough to cause a significant risk of injury or death to people and pets.**

The switches for all side windows are located on the driver's door. There is also a switch on each door for the corresponding side window. The switches on the driver's door take precedence.

Auto-reverse function

The auto-reverse function can be activated when a window is closed by automatic operation.

Depending on the environment or driving conditions, the auto-reverse function may be activated if an impact or load similar to something being caught in the window occurs.

WARNING

There are some small distances immediately before the closed position which cannot be detected. Make sure that all passengers have their hands, etc., inside the vehicle before closing the window.

If the vehicle's battery is disconnected, replaced, or jump started, the power window auto-reverse function may not operate properly. If this occurs, it is recommended you visit an INFINITI retailer to re-initialize the power window auto-reverse system.

If the control unit detects something caught in a window equipped with automatic operation as it is closing, the window will be immediately lowered.

Driver's window switch

The power windows operate when the ignition switch is in the ON position.

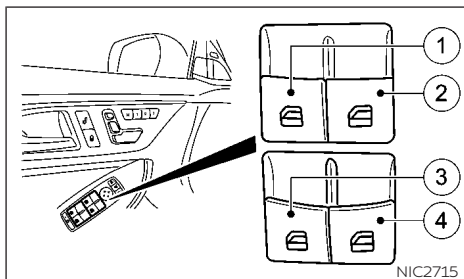

1. Front left side window
2. Front right side window
3. Rear left side window
4. Rear right side window

The driver's switch, the main switch, can control all windows.

- To open manually: press and hold the corresponding button.
- To open fully: press the button beyond the point of resistance to the second detent and release it. Automatic operation is started.
- To close manually: pull the corresponding button and hold it.

- To close fully: pull the button beyond the point of resistance and release it. Automatic operation is started.
- To interrupt automatic operation: press/pull the corresponding switch again.

NOTE

- **If you press/pull the switch beyond the point of resistance, automatic operation is started in the corresponding direction. You can stop automatic operation by pressing/pulling again.**
- **You can continue to operate the side windows after switching off the engine or removing the key. This function remains active for five minutes or until the driver's or front-passenger door is opened.**
- **The side windows cannot be operated from the rear when the override feature for the side windows is activated.**

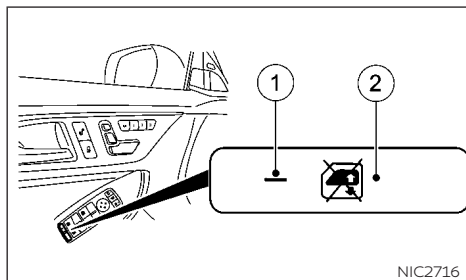

Locking rear side windows:

To enable/disable the override feature for the rear side windows, press button ②. If indicator light ① is lit, operation of the rear side windows is disabled. Operation is only possible using the switches in the driver's door. If indicator light ① is off, operation is possible using the switches in the rear compartment.

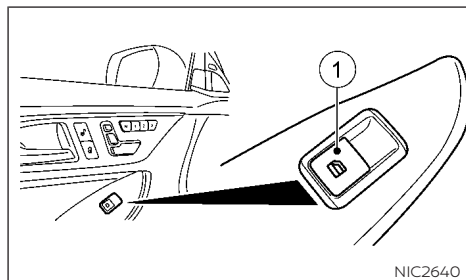

Passenger's window switch

The passenger's switch can control its corresponding window.

Convenience opening feature

For vehicles with Intelligent Key: you can ventilate the vehicle before you start driving. The key can also be used to carry out the following functions simultaneously:

- Unlock the vehicle
- Open the side windows

NOTE

The convenience opening feature can only be operated using the key.

The key must be in close proximity to the vehicle.

Press and hold the  button until the side windows are in the desired position.

To interrupt convenience opening: release the  button.

Convenience closing feature

WARNING

When the convenience closing feature is operating, parts of the body could become trapped in the closing area of the side window. There is a risk of injury. Observe the complete closing procedure when the convenience closing feature is operating. When closing make sure that no parts of the body are in the closing area.

For vehicles with Intelligent Key: The key can also be used to carry out the following functions simultaneously:

- Lock the vehicle
- Close the side windows

The driver's door and the door at which the handle is used must both be closed. The key must be outside the vehicle. The gap between the key and the corresponding door handle should not be greater than 1 m.

Press and hold the  button until the side windows are fully closed.

To interrupt convenience closing: release the button.

You can also use the keyless locking feature to activate convenience closing:

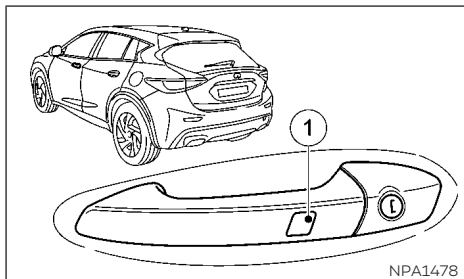

Touch recessed sensor surface ① on the door handle until the side windows are fully closed.

NOTE

Make sure you only touch recessed sensor surface ①.

To interrupt convenience opening: release the recessed sensor surface ① on the door handle.

Resetting the side windows

If a side window can no longer be closed fully, you must reset it.

1. Switch the ignition switch to the ON position.
2. Close the door.

3. Pull the corresponding switch on the door control panel until the side window is completely closed

4. Hold the switch for an additional second.

If the side window opens again slightly:

1. Immediately pull the corresponding switch on the door control panel until the side window is completely closed.

2. Hold the switch for an additional second.

3. If the corresponding side window remains closed after the button has been released, the side window has been reset correctly. If this is not the case, repeat the steps above again.

If the power window automatic function does not operate properly after performing the procedure above, have your vehicle checked. It is recommended you visit an INFINITI retailer for this service.

FIXED GLASS ROOF (IF EQUIPPED)

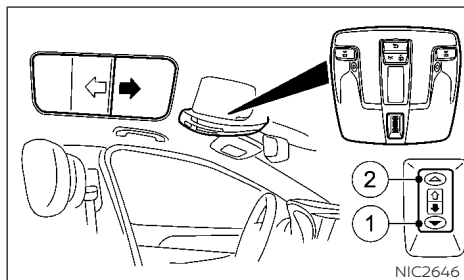

- ① Close
- ② Open

CAUTION

- Do not place heavy objects on the glass roof or surrounding area.
- Do not hang from the sunshade or hang any objects from it. It may cause damage or deformation to the sunshade.
- Close the sunshade when you leave the vehicle for extended periods of time to prevent the inside of the vehicle from reaching high temperatures.

SUNSHADE OPERATION

The sunshade operates only when the ignition switch is in the ON position.

WARNING

To avoid personal injury, keep your hands, fingers and head away from the sunshade arm, the arm rail and sunshade inlet port.

NOTE

The following notes cover situations where strong sun shining on the roof of the vehicle causes the area around the sunshade motor to reach high temperatures:

- If the temperature of the sunshade motor reaches a value between 185°F (85°C) and 212°F (100°C), "restricted mode" is enabled, and the sunshade will only be allowed to CLOSE.
- If the temperature of the sunshade motor exceeds 212°F (100°C), the sunshade will not operate.

Opening and closing

Manual control:

To close the sunshade, press and hold the "CLOSE" side of the switch ① To stop the sunshade from closing fully, release the switch.

To open the sunshade press and hold the "OPEN" side of the switch ② To stop the sunshade from opening fully, release the switch.

Automatic operation:

To fully open or close the sunshade automatically, press briefly on the open or close side of the switch and then release. To stop the sunshade from opening or closing, press either side of the switch.

Auto-reverse function:

When the control unit detects something caught by the sunshade, the sunshade will open automatically.

NOTE

The auto-reverse function remains active whether the sunshade is being closed manually or automatically.

CLOCK

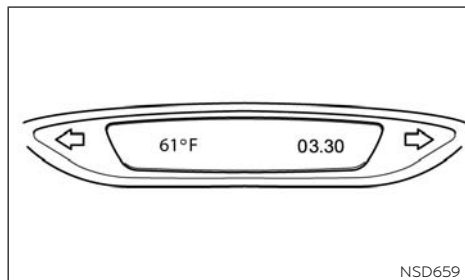

If the battery cable is disconnected, the clock will need to be re-adjusted to the correct time.

ADJUSTING TIME

Set the time using the INFINITI controller and the [Settings] menu available in the central display (see your INFINITI InTouch Owner's Manual).

NOTE

On vehicles fitted with a navigation system, the clock is automatically updated via GPS. The initial clock setting may be incorrect.

POWER OUTLET

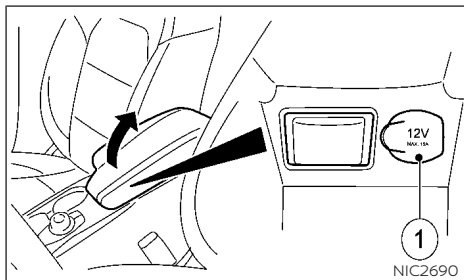

In the center console (LHD)

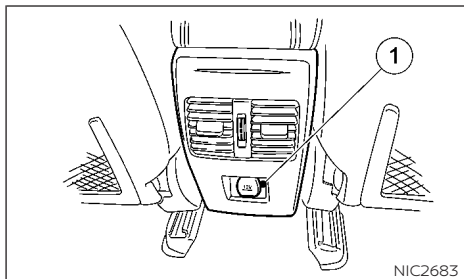

Rear console

The power outlet is used for powering electrical accessories such as a cellular telephone.

An emergency cut-off ensures that the on-board voltage does not drop too low. If the on board voltage is too low, the power to the sockets is automatically cut. This ensures that there is sufficient power to start the engine.

⚠ CAUTION

- **The outlet and plug may be hot during or immediately after use.**
- **Only certain power outlets are designed for use with a cigarette lighter unit. Do not use any other power outlet for an accessory lighter. It is recommended you visit an INFINITI retailer for additional information.**
- **Do not use with accessories that exceed a 12 volt, 180W (15A) power draw. Do not use double adapters or more than one electrical accessory.**
- **Use this power outlet with the engine running to avoid discharging the vehicle battery.**
- **Avoid using when the air conditioner, headlights or rear window defogger is on.**

STORAGE

- Push the plug in as far as it will go. If good contact is not made, the plug may overheat or the internal temperature fuse may blow.
- Before inserting or disconnecting a plug, be sure that the electrical accessory being used is turned OFF.
- When not in use, be sure to close the cap. Do not allow water to contact the outlet.

⚠ WARNING

Keep the storage lids closed while driving to help prevent injury in an accident or a sudden stop.

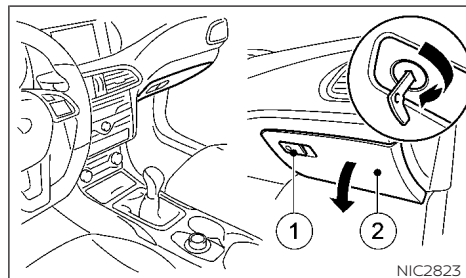

GLOVE BOX

To open the glove box, pull the handle ①.

To close, push the lid ② until the lock latches.

NOTE

To lock/unlock the glove box, use the mechanical key. For the mechanical key usage, see "Mechanical key".

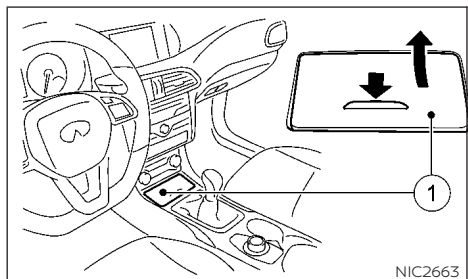

FRONT CONSOLE COMPARTMENT

To open the front console compartment, push lid ① down and release. The lid will open.

To close, push the lid ① down until the lock latches.

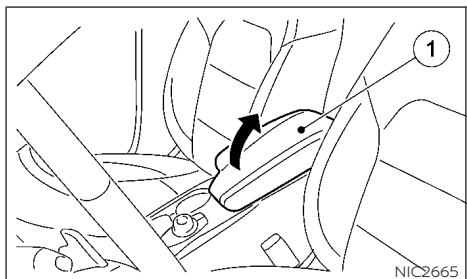

CONSOLE BOX

To open, pull up the lid from the front.

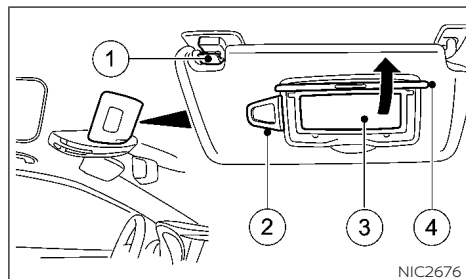

CARD HOLDER

Pull the sun visor down and slide a card in the card holder ②.

CUP HOLDERS

⚠ CAUTION

- **Avoid abrupt starting and braking when the cup holder is being used to prevent spilling the drink. If the liquid is hot, it can scald you or your passenger.**
- **Do not recline the rear seatback when you use the cup holders on the rear armrest (if equipped). Doing so may cause the beverages to spill over, and if they are hot, they may scald the passengers.**
- **Use only soft cups in the cup holder. Hard objects can injure you in an accident.**

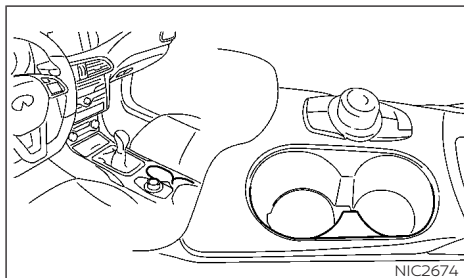

Front

The cup holders ① for rear passengers are located on the rear center armrest (if equipped).

To open the rear cup holders (if equipped), press the front of the cup holder ①.

To close, slide the cup holder ① back until it engages.

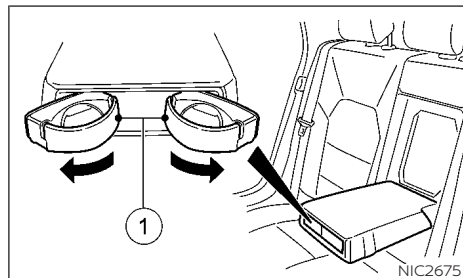

Rear (if equipped)

⚠ CAUTION

Close the cup holder before folding the rear armrest up, otherwise the cup holder could be damaged.

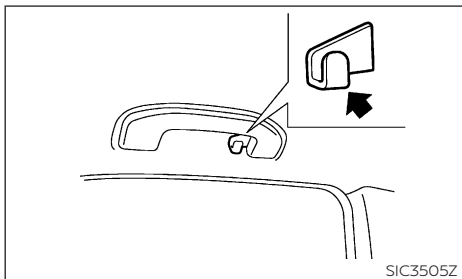

COAT HOOKS

CAUTION

Do not apply a total load of more than 2 lb (1 kg) to the hook.

The coat hooks are equipped at the rear assist grips.

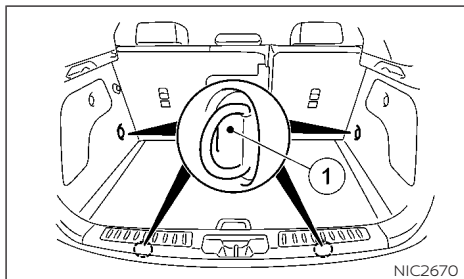

CARGO TIE-DOWN HOOKS

① Cargo tie-down hook

WARNING

- Properly secure all cargo with ropes or straps to help prevent it from sliding or shifting. Do not place cargo higher than the seatbacks. In a sudden stop or collision, unsecured cargo could cause personal injury.
- Use suitable ropes and hooks to secure cargo.
- Never allow anyone to ride in the cargo area or on the rear seat when it is in the fold-down position. Use of these areas by passengers without proper restraints could result in serious injury or death in an accident or sudden stop.

- Do not allow people to ride in any area of your vehicle that is not equipped with seats and seat belts.
- The child restraint top tether strap may be damaged by contact with items in the cargo area. Secure any items in the cargo area. Your child could be seriously injured or killed in a collision if the top tether strap is damaged.
- Be sure everyone in your vehicle is in a seat and using a seat belt properly.

CAUTION

- Do not apply a total load of more than 22 lb (10 kg) to a single eyelet.
- Secure the load using the cargo tie-down hooks.
- Distribute the load on the cargo tie-down hooks evenly.
- Do not use elastic straps or nets to secure a load. These are only intended as anti-slip protection for light loads.
- Do not route tie-down ropes or straps across sharp edges or corners.
- Pad sharp edges for protection.

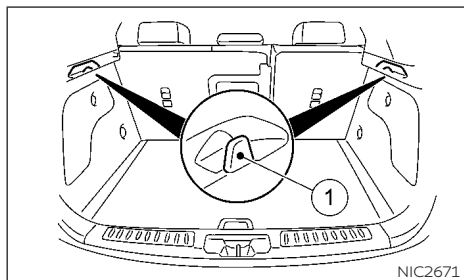

LUGGAGE HOOKS

The luggage hooks ① are for shopping bags, etc.

⚠ CAUTION

- Do not apply a total load of more than 7 lb (3 kg) to the hook.
- Do not use luggage hooks to secure a load.

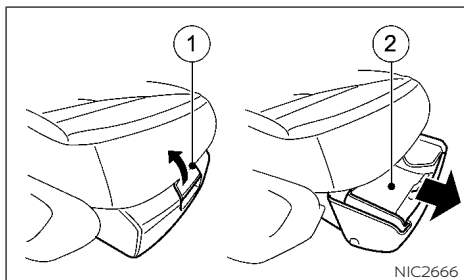

FRONT SEAT STORAGE BOXES (IF EQUIPPED)

To open the front seat storage boxes, pull handle ① up and fold cover ② forwards.

⚠ CAUTION

The maximum permissible load for the front seat storage box is 2.6 lb (1.2 kg).

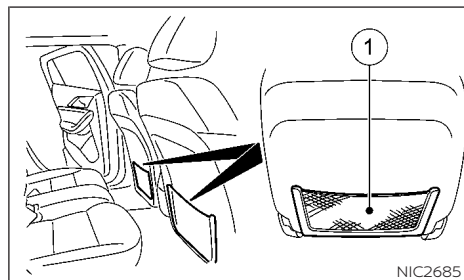

MAP POCKET (IF EQUIPPED)

Map pockets are located in the doors.

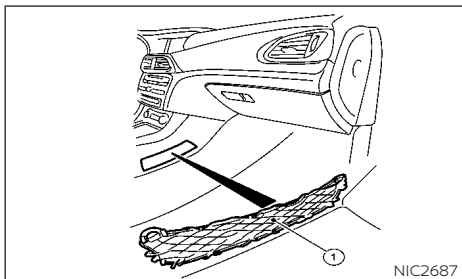

STORAGE NETS (IF EQUIPPED)

⚠ WARNING

Do not place sharp objects in the nets to help prevent injury in an accident or sudden stop.

Storage nets are fitted in the front-passenger footwell and on the back of the driver's and front passenger seat.

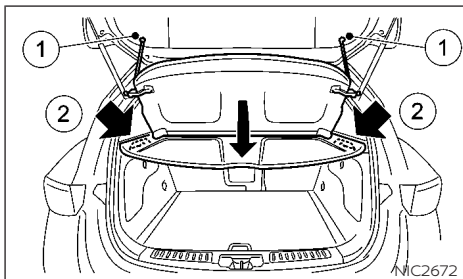

PARCEL SHELF

⚠ WARNING

- Never put anything on the parcel shelf, no matter how small. Any object on it could cause an injury in case of an accident or if the brakes are applied suddenly.
- Do not leave the parcel shelf in position when it is disengaged from the grooves.
- Properly secure all cargo to help prevent it from sliding or shifting. Do not place cargo higher than the seatbacks. In a sudden stop or collision, unsecured cargo could cause personal injury

- Properly secure cargo and do not allow it to contact the top tether strap when it is attached to the top tether anchor. Cargo that is not properly secured or cargo that contacts the top tether strap may damage the top tether strap during a collision. If the cargo cover contacts the top tether strap when it is attached to the top tether anchor, remove the cargo cover from the vehicle or secure it on the cargo floor below its attachment location. If the cargo cover is not removed, it may damage the top tether strap during a collision. Your child could be seriously injured or killed in a collision if the child restraint top tether strap is damaged.
- Do not use the cargo cover if the rear seats are folded down.

Removal

1. Open the lift gate (see "Lift gate lock").
2. Detach both of the cords (left and right) ① from the inside of the lift gate.
3. Detach the parcel shelf ② by simply pulling it rearwards through the lift gate opening.

CAUTION

Make sure the parcel shelf is carefully stored when not in use in order to prevent any damage.

Installation

1. Open the lift gate.
2. Insert the parcel shelf by pushing it forwards as far as possible through the lift gate opening.
3. Attach the corresponding cords to each side ① of the lift gate.
4. Close the lift gate (see "Lift gate lock").

ROOF RACK (IF EQUIPPED)

Genuine NISSAN accessory cross bars are available through an INFINITI retailer. It is recommended you visit an INFINITI retailer for cross bar or other equipment information.

Do not apply any load directly to the roof side rails. Cross bars (if so equipped) must be installed before applying load/cargo/luggage to the roof of the vehicle. Always distribute the luggage evenly on the cross bars. Do not load more than 221 lb (100 kg) on the roof rails. Observe the maximum load limit shown on the crossbars or roof carriers when you attach them on the roof rails.

Do not apply any load directly to the roof side rails.

Be careful that your vehicle does not exceed the Gross Vehicle Weight Rating (GVWR) or its Gross Axle Weight Rating (GAWR front and rear). The GVWR and GAWR are located on the F.M.V.S.S. or C.V.M.S.S. certification label (located on the driver's door pillar). For additional information, refer to "Vehicle loading information".

WARNING

- **Always install the cross bars onto the roof side rails before loading cargo of any kind. Loading cargo directly onto the roof side rails or the vehicle's roof may cause vehicle damage.**
- **Drive extra carefully when the vehicle is loaded at or near the cargo carrying capacity, especially if the significant portion of that load is carried on the cross bars/roof rack.**
- **Heavy loading of the cross bars/roof rack has the potential to affect the vehicle stability and handling during sudden or unusual handling maneuvers.**
- **Roof rack load should be evenly distributed.**

- **Do not exceed maximum cross bar/roof rack load weight capacity.**
- **Properly secure all cargo with ropes or straps to help prevent it from sliding or shifting. In a sudden stop or collision, unsecured cargo could cause personal injury.**

CAUTION

Always install the cross bars (if so equipped) onto the roof side rails before loading cargo of any kind. Loading cargo directly onto the roof side rails or the vehicle's roof may cause vehicle damage.

INTERIOR LIGHTS

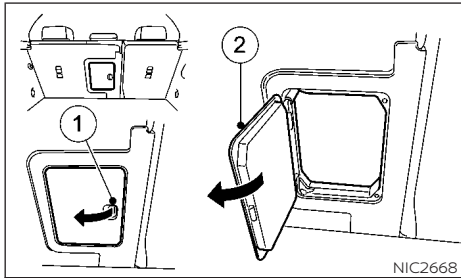

SKI HATCH (IF EQUIPPED)

To open the ski hatch:

1. Fold down rear seat armrest.
2. Pull the center head restraint on the rear bench seat into the uppermost position.
3. Slide locking mechanism ① in the direction of the arrow
4. Swing flap ② fully to the side. The flap is held open by a magnet.

To close the ski hatch:

1. Swing flap ① in the luggage compartment back until it engages.
2. Fold armrest fully up if necessary.

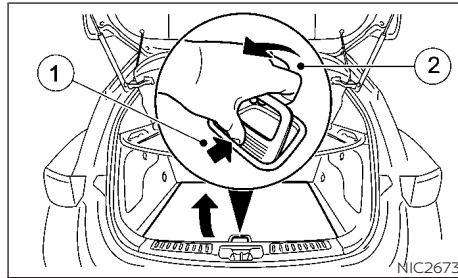

COMPARTMENT UNDER TRUNK FLOOR

Lift the trunk floor to access the underfloor storage area.

⚠ CAUTION

- Turn off the lights when you leave the vehicle.
- Do not use the lights for extended periods of time with the engine stopped. This could result in a discharged battery.

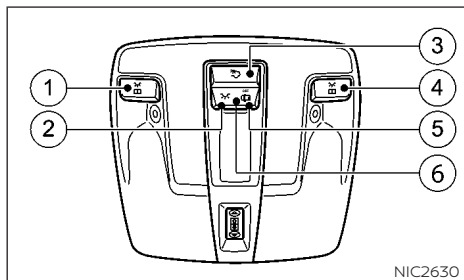

FRONT OVERHEAD CONTROL PANEL

- ① Switches the left-hand front reading light on/off
- ② Switches the front interior lighting on
- ③ Switches the rear interior lighting on/off
- ④ Switches the right-hand front reading light on/off
- ⑤ Switches the front interior lighting/automatic interior lighting control off
- ⑥ Switches the automatic interior lighting control on

Automatic interior lighting control

- To switch on: set the switch to center position ⑥.
- To switch off: press switch ⑤.

The interior lighting automatically switches on if you:

- Unlock the vehicle
- Open a door
- Remove the key from the ignition lock.

The interior lighting is activated for a short time when the key is removed from the ignition lock. You can activate this delayed switch-off using the vehicle information display (see "Activating/deactivating the interior lighting delay" earlier in this section).

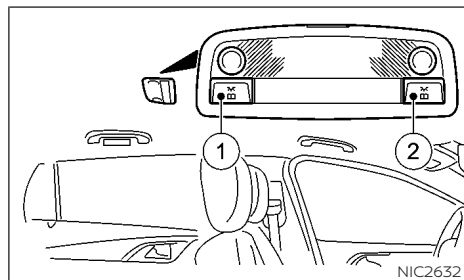

REAR READING LIGHTS (IF EQUIPPED)

- ① Switches the left hand reading light on/off
- ② Switches the right hand reading light on/off

REAR ROOM LIGHT (IF EQUIPPED)

The rear room light (without switches) can be switched on and off using the front overhead control panel.

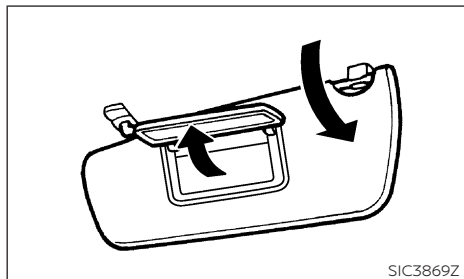

BATTERY SAVER SYSTEM

The interior light will automatically turn off after a period of time when the ignition switch has been put in the OFF position. To turn on the light again, put the ignition switch in the ON position.

VANITY MIRROR LIGHTS

To access the vanity mirror, pull the sun visor down and flip open the mirror cover.

The vanity mirror light illuminates when the vanity mirror cover is opened. When the cover is closed, the light will turn off.

LUGGAGE COMPARTMENT LIGHT

The light illuminates while the lift gate is opened. When the lift gate is closed, the light will turn off.

HOMELINK® UNIVERSAL TRANSCEIVER (IF EQUIPPED)

The HomeLink® Universal Transceiver, integrated in the vehicle's inside rear view mirror, provides a convenient way to consolidate the functions of up to three individual hand-held transmitters into one built-in device.

HomeLink® Universal Transceiver:

- Will operate most Radio Frequency (RF) devices such as garage doors, gates, home and office lighting, entry door locks and security systems.
- Is powered by your vehicle's battery. No separate batteries are required. If the vehicle's battery is discharged or is disconnected, HomeLink® will retain all programming.

When the HomeLink® Universal Transceiver is programmed, retain the original transmitter for future programming procedures (Example: new vehicle purchases). Upon sale of the vehicle, the programmed HomeLink® Universal Transceiver buttons should be erased for security purposes. For additional information, refer to "Programming HomeLink®" later in this section.

⚠ WARNING

- Do not use the HomeLink® Universal Transceiver with any garage door opener that lacks safety stop and reverse features as required by federal safety standards. (These standards became effective for opener models manufactured after April 1, 1982). A garage door opener which cannot detect an object in the path of a closing garage door and then automatically stop and reverse, does not meet current federal safety standards. Using a garage door opener without these features increases the risk of serious injury or death.
- During the programming procedure your garage door or security gate will open and close (if the transmitter is within range). Make sure that people or objects are clear of the garage door, gate, etc. that you are programming.
- Your vehicle's engine should be turned off while programming the HomeLink® Universal Transceiver.

NOTE

Certain garage door drives are incompatible with the integrated garage door opener. If you have difficulty programming the integrated garage door opener, it is recommended you contact your INFINITI retailer.

PROGRAMMING HOMELINK®

If you have any questions or are having difficulty programming your HomeLink® buttons, refer to the HomeLink® web site at: www.homelink.com or call 1-800-355-3515.

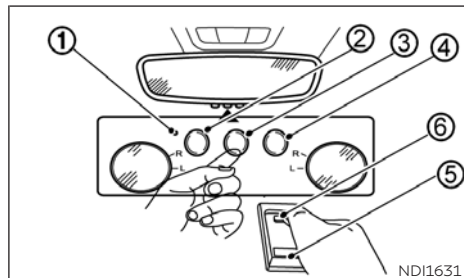

1. Turn the ignition key to the ON position.
2. Press and hold one of buttons (2) to (4) on the HomeLink®.

HomeLink® is now in programming mode. After a short time, indicator light (1) lights up yellow.

Indicator light (1) lights up yellow as soon as button (2), (3) or (4) is programmed for the first time. If the selected button has already been programmed, indicator light (1) will only light up yellow after ten seconds have elapsed.

3. Release button (2), (3) or (4). Indicator light (1) flashes yellow.
4. Position the end of your hand-held transmitter (5) 2-8 inches (5-20 cm) away from the HomeLink® surface, keeping the HomeLink® indicator light (1) in view.

5. Press and hold button ⑥ on the hand held transmitter until indicator light ① lights up green. When indicator light ① lights up green: programing is finished.

When indicator light ① flashes green: programing was successful. The next step is to synchronize the rolling code.

6. Release button ⑥ on the hand held transmitter ⑤ for the garage door drive system.

If indicator light ① lights up red: repeat the programing procedure for the corresponding button on the rear-view mirror. When doing so, vary the distance between the hand held transmitter ⑤ and the rear-view mirror.

The required distance between the hand held transmitter ⑤ and the integrated garage door opener depends on the garage door drive system. Several attempts might be necessary. You should test every position for at least 25 seconds before trying another position.

Synchronizing the rolling code

If the garage door system uses a rolling code, you will also have to synchronize the garage door system with the integrated garage door opener in the rear-view mirror. To do this you will need to use the programing button on the

door drive control panel. The programing button may be positioned at different locations depending on the manufacturer. It is usually located on the door drive unit on the garage ceiling.

Familiarize yourself with the garage door drive operating instructions before carrying out the following steps.

Your vehicle must be within reach of the garage door or gate opener drive. Make sure that neither your vehicle nor any persons/objects are present within the sweep of the door or gate.

1. Turn the ignition key to the ON position.
2. Get out of the vehicle.
3. Press the programing button on the door drive unit.
Usually, you now have 30 seconds to initiate the next step.
4. Get into the vehicle.
5. Press previously programed button ②, ③ or ④ on the HomeLink® until the door closes.

The rolling code synchronization is then complete.

If you live in Canada

Canadian radio frequency laws require a "break" (or interruption) of the transmission signals after broadcasting for a few seconds. Therefore, these signals may not last long enough for the integrated garage door opener. The signal is not recognized during programing. Comparable with Canadian law, some U.S. garage door openers also feature a "break".

Proceed as follows:

- If you live in Canada
 - If you have difficulties programing the garage door opener (regardless of where you live) when using the programing steps.
1. Press and hold one of buttons ② to ④ on the HomeLink®. After a short time, indicator light ① lights up yellow.
 2. Release the button.
Indicator light ① flashes yellow.
 3. Press button ⑥ of the hand held transmitter ⑤ for two seconds, then release it for two seconds.
 4. Press button ⑥ again for two seconds.
 5. Repeat this sequence on button ⑥ of the hand held transmitter ⑤ until indicator light ① lights up green.

When indicator light ① lights up green: programing is finished.

When indicator light ① flashes green: programing was successful. The next step is to synchronize the rolling code.

6. Release button ⑥ of the hand held transmitter ⑤ for the garage door drive.

If indicator light ① lights up red: repeat the programing process for the corresponding button on the rear-view mirror. When doing so, vary the distance between the hand held transmitter ⑤ and the rear-view mirror.

The required distance between the hand held transmitter ⑤ and the HomeLink® depends on the garage door drive system. Several attempts might be necessary. You should test every position for at least 25 seconds before trying another position.

PROGRAMMING TROUBLE DIAGNOSIS

If the HomeLink® does not quickly learn the hand-held transmitter information:

- Check the transmitter frequency used by garage door drive hand-held transmitter ⑤ and whether it is supported. The transmitter frequency can usually be found on

the back of the garage door drive hand-held transmitter. HomeLink® is compatible with devices that have units which operate in the frequency range of 280 to 433 MHz.

- Replace the hand-held transmitter ⑤ batteries with new batteries.

This increases the likelihood that the hand-held transmitter ⑤ will transmit a strong and precise signal to the HomeLink®.

- When programing, hold the hand-held transmitter ⑤ at varying distances and angles from the button which you are programing. Try various angles at a distance between 2 and 12 inches (5 to 30 cm) or at the same angle but at varying distances.
- If another hand-held transmitter is available for the same garage door drive, repeat the same programing steps with this hand-held transmitter ⑤. Before performing these steps, make sure that new batteries have been installed in the hand-held transmitter ⑤.
- Note that some hand-held transmitters only transmit for a limited amount of time (the indicator light on the hand-held transmitter goes out). Press button ⑥ on remote hand-held transmitter ⑤ again before transmission ends.

- Align the antenna cable of the garage door opener unit. This can improve signal reception/ transmission.

If you have any questions or are having difficulty programming your HomeLink® buttons, refer to the HomeLink® web site at: www.homelink.com or 1-800-355-3515.

OPERATING THE HOMELINK® UNIVERSAL TRANSCEIVER

The HomeLink® Universal Transceiver, after it is programmed, can be used to activate the programmed device.

1. Turn the ignition key to the ON position.
2. Press button ②, ③ or ④ which you have programed to operate the garage door.

Garage door system with a fixed code: indicator light ① lights up green

Garage door system with a rolling code: indicator light ① flashes green.

The transmitter will transmit a signal as long as the button is pressed. The transmission is halted after a maximum of ten seconds and indicator light ① lights up yellow. Press button ②, ③ or ④ again if necessary.

For convenience, the hand-held transmitter of the device may also be used at any time.

CLEARING THE PROGRAMMED INFORMATION

Make sure that you clear the memory of the integrated garage door opener before selling the vehicle.

1. Turn the ignition key to the ON position.
2. Press and hold buttons ② and ④.

The indicator light initially lights up yellow and then green.

3. Release buttons ② and ④.

The memory of the integrated garage door opener in the rear-view mirror is cleared.

IF YOUR VEHICLE IS STOLEN

If your vehicle is stolen, you should change the codes of any non-rolling code device that has been programmed into HomeLink®. Consult the Owner's Manual of each device or call the manufacturer of those devices for additional information or contact an INFINITI retailer.

MEMO

3 Pre-driving checks and adjustments

Keys	3-2	Changing the settings of the locking system	3-11
INFINITI Intelligent key	3-2	Troubleshooting guide	3-12
INFINITI Vehicle immobilizer system keys.	3-3	Hood	3-15
Doors	3-4	Fuel-filler door	3-16
Locking with the key.	3-4	Opening fuel-filler door	3-16
Locking with the mechanical key	3-5	Fuel-filler cap.	3-16
Locking with inside door knob	3-6	Steering wheel	3-17
Locking with Power door lock switch	3-6	Sun visors	3-18
Automatic door locks	3-7	Vanity mirror	3-18
Child safety rear door lock	3-7	Mirrors	3-18
Lift gate lock	3-7	Automatic anti-glare rear view mirror	3-18
INFINITI Intelligent Key system	3-8	Outside mirrors	3-18
Operating range.	3-9	Memory function (if equipped)	3-21
Door locks/unlocks precaution	3-10	Storing settings	3-22
INFINITI Intelligent Key operation	3-10	Calling up a stored setting	3-22



KEYS

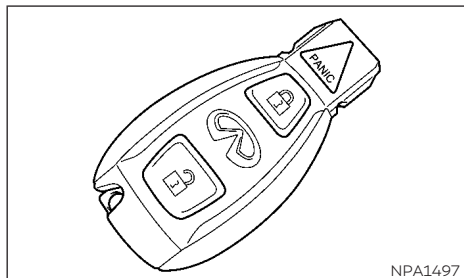

INFINITI INTELLIGENT KEY

Your vehicle can only be driven with the Intelligent Keys which are registered to your vehicle's Intelligent Key System components and INFINITI Vehicle Immobilizer System components.

Never leave the keys in the vehicle.

As many as four Intelligent Keys can be registered and used with one vehicle. The new keys must be registered prior to use with the Intelligent Key System and INFINITI Vehicle Immobilizer System of your vehicle. It is recommended that you visit an INFINITI retailer for this service. Since the registration process requires erasing all memory in the Intelligent Key components when registering new keys, be sure to take all Intelligent Keys that you have to the INFINITI retailer.

3-2 Pre-driving checks and adjustments

A key number plate is supplied with your keys. Record the key number and keep it in a safe place (such as your wallet), not in the vehicle. If you lose your keys, it is recommended that you visit an INFINITI retailer for duplicates by using the key number. INFINITI does not record key numbers so it is very important to keep track of your key number plate.

A key number is only necessary when you have lost all keys and do not have one to duplicate from. If you still have a key, it can be duplicated without knowing the key number.

⚠ CAUTION

Listed below are conditions or occurrences which will damage the Intelligent Key:

- **Do not allow the Intelligent Key, which contains electrical components, to come into contact with water or salt water. This could affect the system function.**
- **Do not drop the Intelligent Key.**
- **Do not strike the Intelligent Key sharply against another object.**
- **Do not change or modify the Intelligent Key.**
- **Wetting may damage the Intelligent Key. If the Intelligent Key gets wet, immediately wipe until it is completely dry.**

- **Do not place the Intelligent Key for an extended period in an area where temperatures exceed 140°F (60°C).**
- **Do not attach the Intelligent Key with a key holder that contains a magnet.**
- **Do not place the Intelligent Key near equipment that produces a magnetic field, such as a TV, audio equipment and personal computers.**

If an Intelligent Key is lost or stolen, INFINITI recommends erasing the ID code of that Intelligent Key. This will prevent the Intelligent Key from unauthorized use to unlock the vehicle. For information regarding the erasing procedure, please contact an INFINITI retailer.

Mechanical key

⚠ CAUTION

Always carry the mechanical key installed in the Intelligent Key.

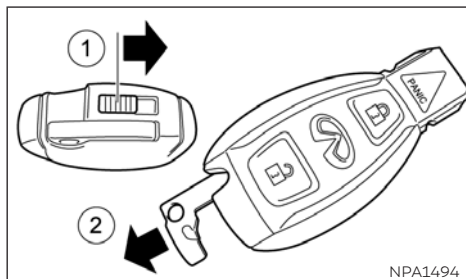

INFINITI VEHICLE IMMOBILIZER SYSTEM KEYS

You can only drive your vehicle using the Intelligent Keys which are registered to the INFINITI Vehicle Immobilizer System components in your vehicle.

The mechanical key can be used for all the locks.

Never leave the keys in the vehicle.

Additional or replacement keys:

If you still have a key, the key number is not necessary when you need extra INFINITI Vehicle Immobilizer System keys. Your existing key can be duplicated without knowing the key number. As many as four INFINITI Vehicle Immobilizer System keys can be used with one vehicle. You should bring all INFINITI Vehicle Immobilizer System keys that you have to the INFINITI retailer for registration. This is because the registration process will erase the memory of all key codes previously registered into the INFINITI Vehicle Immobilizer System. After the registration process, these components will only recognize keys coded into the INFINITI Vehicle Immobilizer System during registration. Any key that is not given to the retailer at the time of registration will no longer be able to start your vehicle.

Push release catch ① in the direction of the arrow and, at the same time, remove emergency key element ② from the key.

Valet hand-off

To prevent the glove box from being opened during valet hand-off, follow the procedure below.

1. Remove the mechanical key from the Intelligent Key.
2. Lock the glove box with the mechanical key.
3. Hand the Intelligent Key to the valet and keep the mechanical key with you.

For additional information, refer to "Storage".

CAUTION

Do not allow the immobilizer system key, which contains an electrical transponder, to come into contact with water or salt water. This could affect system function.

DOORS

When the doors are locked using one of the following methods, the doors cannot be opened using the inside or outside door handles. The doors must be unlocked to open the doors.

WARNING

- **Before opening any door, always look for and avoid oncoming traffic.**
- **Do not leave children unattended inside the vehicle. They could unknowingly activate switches or controls or move the vehicle. Unattended children could become involved in serious accidents.**
- **To help avoid risk of injury or death through unintended operation of the vehicle and/or its systems, do not leave children, people who require the assistance of others, or pets unattended in your vehicle. Additionally, the temperature inside a closed vehicle on a warm day can quickly become high enough to cause a significant risk of injury or death to people and pets.**

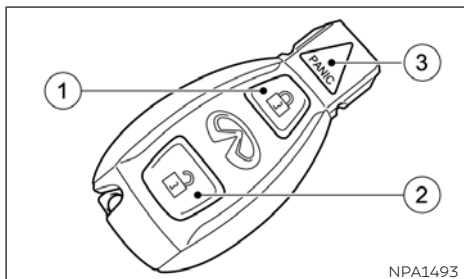

LOCKING WITH THE KEY

- ① Locks the vehicle.
- ② Unlocks the vehicle.
- ③ Panic button.

If you do not open the vehicle within approximately 40 seconds of unlocking, the vehicle will lock again and protection against theft is reactivated.

To lock centrally, press button ①. The key centrally locks:

- Doors
- Lift gate
- Fuel filler lid

When unlocking, the turn signals flash once
When locking, they flash three times.

Intelligent Key

You can combine the Intelligent Key functions with the functions of a conventional key. Unlock the vehicle by using Intelligent Key function, for instance, and lock it using the  button on the key.

The driver's door and the door at which the handle is used, must both be closed. The key must be outside the vehicle. When locking or unlocking with Intelligent Key, the distance between the key and the corresponding door handle must not be greater than 1 m.

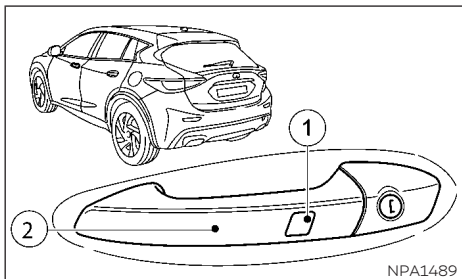

NPA1489

To unlock the vehicle: touch the inner surface of the door handle.

To lock the vehicle: touch sensor surface ① or ②.

Make sure that you do not touch the inner surface of the door handle.

Convenience closing feature: touch recessed sensor surface ① for an extended period. (See "Convenience closing feature").

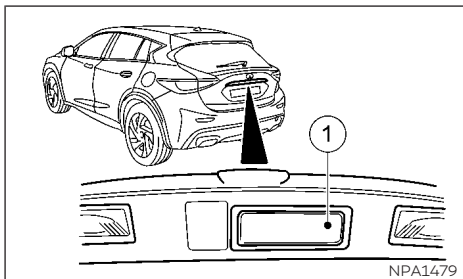

NPA1479

To unlock the lift gate: press the lift gate switch ①.

When unlocking, the turn signals flash once. When locking, they flash three times.

NOTE

When the locator lighting is activated, it lights up when it is dark after the vehicle is unlocked with the Intelligent Key (see separate operating instructions).

You can also set an audible signal to confirm that the vehicle has been locked. The audible signal can be activated or deactivated using the on-board computer (see "Activating/deactivating the acoustic locking confirmation")

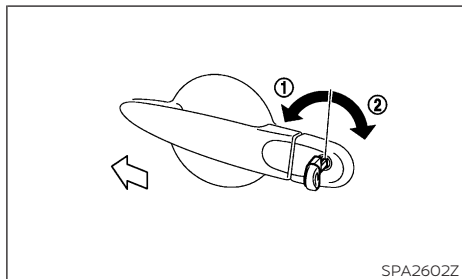

SPA2602Z

LOCKING WITH THE MECHANICAL KEY

The driver's door can be locked/unlocked from outside using the mechanical key if the battery is dead.

To lock the door, insert the mechanical key into the driver's door key cylinder and turn it towards the front of the vehicle ①.

To unlock the door, turn the key towards the rear of the vehicle ②.

See "Mechanical key" earlier in this section for instructions on accessing the Intelligent Key system mechanical key.

NOTE

The alarm system will be triggered when the door is opened using the mechanical key (alarm equipped models). To stop the alarm, turn the ignition key to the ON position or press the unlock button () on the key.

There are several ways to deactivate the alarm:

- **To deactivate the alarm with the key:** press the  or  button on the key.

or

Insert the key into the ignition lock.

- Lock or unlock the vehicle using Intelligent Key. The key must be outside the vehicle

If you unlock the vehicle using the emergency key element, the fuel filler lid will not be unlocked automatically. To unlock the fuel filler lid, insert the key into the ignition lock.

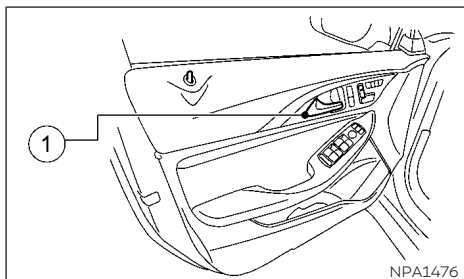

LOCKING WITH INSIDE DOOR KNOB

To unlock and open the door, pull the door lock knob and **1** up pull the inside door handle **1**.

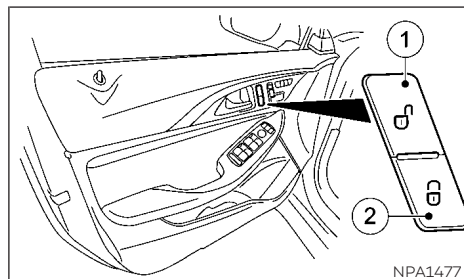

LOCKING WITH POWER DOOR LOCK SWITCH

- 1** Press to unlock
- 2** Press to lock

The power door lock switch, located on the door trimming, can be used to unlock **1** or lock **2** all doors.

AUTOMATIC DOOR LOCKS

The vehicle is locked automatically when the ignition is switched on and the vehicle speed reaches around 10 MPH (16 km/h).

All doors unlock automatically when the ignition is placed in the OFF position.

You could therefore be locked out if:

- The vehicle is being pushed.
- The vehicle is being towed.
- The vehicle is being tested on a dynamometer.

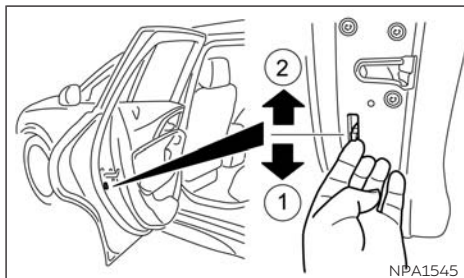

CHILD SAFETY REAR DOOR LOCK

The child safety lock helps prevent doors from being opened accidentally, especially when small children are in the vehicle.

When the switch is in the LOCK ② position, the rear door can only be opened from the outside.

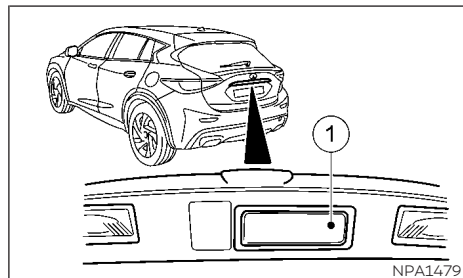

LIFT GATE LOCK

To open the lift gate, unlock it first with one of the following operations, then push the button ①.

- Push the  button on the key or Intelligent Key (if equipped). See "INFINITI Intelligent Key system" later in this section.
- Unlock all the doors using the key.

To close the lift gate, pull it down until it securely locks.

INFINITI INTELLIGENT KEY SYSTEM

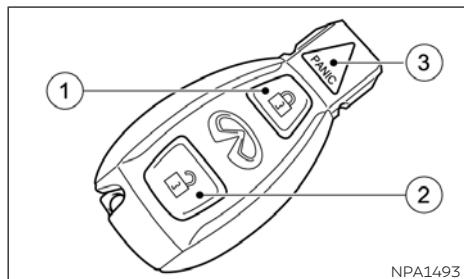

- ① Locks the vehicle.
- ② Unlocks the vehicle.
- ③ Panic button.

⚠ WARNING

- **Radio waves could adversely affect electric medical equipment. Those who use a pacemaker should contact the electric medical equipment manufacturer for the possible influences before use.**

- **The Intelligent Key transmits radio waves when the buttons are pushed. The FAA advises that the radio waves may affect aircraft navigation and communication systems. Do not operate the Intelligent Key while on an airplane. Make sure that the buttons are not operated unintentionally when the unit is stored for a flight.**

The Intelligent Key system can operate all the door locks using the remote control function or touching the request switch on the vehicle without taking the key out from a pocket or purse. The operating environment and/or conditions may affect the Intelligent Key system operation.

Be sure to read the following before using the Intelligent Key system.

⚠ CAUTION

- **Be sure to carry the Intelligent Key with you when operating the vehicle.**
- **Never leave the Intelligent Key in the vehicle when you leave the vehicle.**

The Intelligent Key is always communicating with the vehicle as it receives radio waves. The Intelligent Key system transmits weak

radio waves. Environmental conditions may interfere with the operation of the Intelligent Key system under the following operating conditions:

- When operating near a location where strong radio waves are transmitted, such as a TV tower, power station and broadcasting station.
- When in possession of wireless equipment, such as a cellular telephone, transceiver or a CB radio.
- When the Intelligent Key is in contact with or covered by metallic materials.
- When any type of radio wave remote control is used nearby.
- When the Intelligent Key is placed near an electric appliance such as a personal computer.
- When the vehicle is parked near a parking meter.

In such cases, correct the operating conditions before using the Intelligent Key function or use the mechanical key.

Although the life of the battery varies depending on the operating conditions, the battery's life is approximately two years. If the battery is discharged, replace it with a new one.

When the Intelligent Key battery is low, an indicator illuminates in the vehicle information display. For additional information, refer to "Safety systems".

Since the Intelligent Key is continuously receiving radio waves, if the key is left near equipment which transmits strong radio waves, such as signals from a TV and personal computer, the battery life may become shorter.

For additional information, refer to "Intelligent Key battery replacement".

As many as four Intelligent Keys can be registered and used with one vehicle. For information about the purchase and use of additional Intelligent Keys, it is recommended that you visit an INFINITI retailer.

CAUTION

Listed below are conditions or occurrences which will damage the Intelligent Key:

- **Do not allow the Intelligent Key, which contains electrical components, to come into contact with water or salt water. This could affect the system function.**
- **Do not drop the Intelligent Key.**
- **Do not strike the Intelligent Key sharply against another object.**

- **Do not change or modify the Intelligent Key.**
- **Wetting may damage the Intelligent Key. If the Intelligent Key gets wet, immediately wipe until it is completely dry.**
- **Do not place the Intelligent Key for an extended period in an area where temperatures exceed 140°F (60°C).**
- **Do not attach the Intelligent Key with a key holder that contains a magnet.**
- **Do not place the Intelligent Key near equipment that produces a magnetic field, such as a TV, audio equipment and personal computers.**

If an Intelligent Key is lost or stolen, INFINITI recommends erasing the ID code of that Intelligent Key from the vehicle. This may prevent the unauthorized use of the Intelligent Key to operate the vehicle. For information regarding the erasing procedure, it is recommended that you visit an INFINITI retailer.

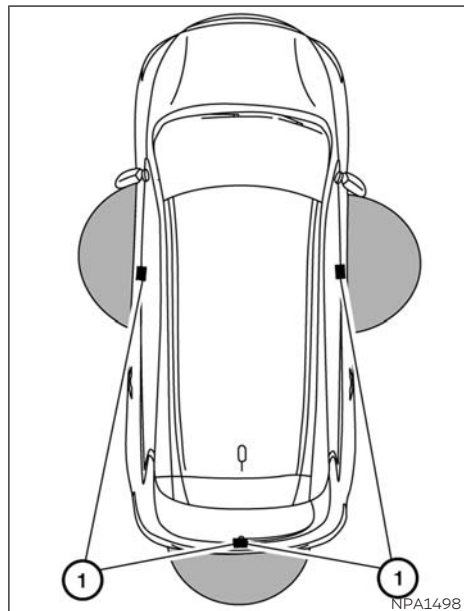

OPERATING RANGE

The Intelligent Key functions can only be used when the Intelligent Key is within the specified operating range from the request switch ①.

When the Intelligent Key battery is discharged or strong radio waves are present near the operating location, the Intelligent Key operating range becomes narrower, and the Intelligent Key may not function properly.

The operating range is within 31.5 m (100 ft) from each request switch ①.

If the Intelligent Key is too close to the door glass, handle or rear bumper, the request switches may not function.

When the Intelligent Key is within the operating range, it is possible for anyone, even someone who does not carry the Intelligent Key, to push the request switch to lock/unlock the doors.

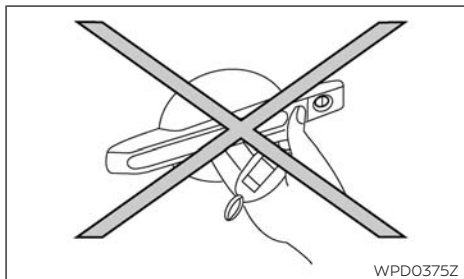

DOOR LOCKS/UNLOCKS PRECAUTION

- Do not touch the door handle request switch with the Intelligent Key held in your hand as illustrated. The close distance to the door handle will cause the Intelligent Key system to have difficulty recognizing that the Intelligent Key is outside the vehicle.
- To prevent the Intelligent Key from being left inside the vehicle, make sure you carry the Intelligent Key

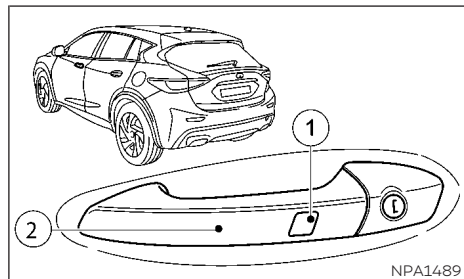

INFINITI INTELLIGENT KEY OPERATION

You can lock or unlock the doors without taking the Intelligent Key out of your pocket or bag.

When you carry the Intelligent Key with you, you can lock or unlock all doors by pushing the door handle request switch within the range of operation.

Locking doors

1. Push the P (Park) button to engage the P (Park) position, place the ignition switch in the LOCK position and make sure you carry the Intelligent Key with you.
2. Close all doors.
3. Touch any sensor surface ① or ②.

4. All doors and the lift gate will lock.
5. The turn signals flash three times.

NOTE

- **Doors do not lock by pushing the door handle request switch while any door is open. However, doors lock with the mechanical key even if any door is open.**
- **The driver's door and the door at which the handle is used, must both be closed.**
- **The doors may not lock when the Intelligent Key is in the same hand that is operating the request switch to lock the door. Put the Intelligent Key in a purse, pocket or your other hand.**

CAUTION

- **When locking the doors using the request switch, make sure to have the Intelligent Key in your possession before operating the request switch to prevent the Intelligent Key from being left in the vehicle.**
- **The request switch is operational only when the Intelligent Key has been detected by the Intelligent Key system.**

Unlocking doors

1. Carry the Intelligent Key.
2. Touch the inner surface of the door handle.
3. All doors and the lift gate will unlock.
4. The turn signals flash once.

Deactivating and activating

If you do not intend to use the vehicle for an extended period of time, you can deactivate the Intelligent Key. The key will then use very little power, thereby conserving battery power. For the purposes of activation/deactivation, the vehicle does not have to be nearby.

To deactivate: press the  button on the key twice in rapid succession. The battery check lamp of the key lights up twice briefly and Intelligent Key is deactivated.



To activate: press any button on the key or insert the key into the ignition lock. The Intelligent Key and all of its associated features are available again.

CHANGING THE SETTINGS OF THE LOCKING SYSTEM

You can change the settings of the locking system. This means that only the driver's door and the fuel-filler lid are unlocked when the vehicle is unlocked. This is useful if you frequently travel alone.

To change the setting: simultaneously press the  and  buttons for approximately 6 seconds.

NOTE

If the setting of the locking system is changed within the signal range of the vehicle, pressing the  and  button will lock or unlock the vehicle.

The key now functions as follows:

To unlock the driver's door: press the  button once.

To unlock centrally: press the  button twice.

To lock centrally: press the  button.

The Intelligent Key function is changed as follows:

To unlock the driver's door: touch the inner surface of the door handle on the driver's door.





To unlock centrally: touch the inner surface of the door handle on the front passenger door or the rear door.

To lock centrally: touch the outer sensor surface on one of the door handles

To restore the factory settings: simultaneously press the  and  button for approximately 6 seconds.

TROUBLESHOOTING GUIDE

Verify the location of all Intelligent Keys that are programmed for the vehicle. If another Intelligent Key is in range or inside the vehicle, the vehicle system may respond differently than expected.

Symptom	Possible cause	Remedy
You cannot lock or unlock the vehicle using the key	The key battery is discharged or nearly discharged:	<ul style="list-style-type: none">• Vehicles without Intelligent Key: try again to lock/unlock the vehicle using the remote control function of the key. Point the tip of the key at the driver's door handle from close range and press the  /  button. <p>If this does not work:</p> <ul style="list-style-type: none">• Check the key battery (see "Checking the battery") and replace it necessary• Unlock (see "Locking with the mechanical key" later in this section) or lock the vehicle using the emergency key element
	There is interference from a powerful source of radio waves	<ul style="list-style-type: none">• Vehicles without Intelligent Key: try again to lock/unlock the vehicle using the remote control function of the key. Point the tip of the key at the driver's door handle from close range and press the  /  button. <p>If this does not work:</p> <ul style="list-style-type: none">• Unlock (see "Locking with the mechanical key" later in this section) or lock the vehicle using the emergency key element
	The key is faulty	<ul style="list-style-type: none">• Unlock (see "Locking with the mechanical key" later in this section) or lock the vehicle using the emergency key element• Have the key checked. It is recommended you visit an INFINITI retailer for this service.

Symptom	Possible cause	Remedy
You can no longer lock or unlock the vehicle using Intelligent Key	The key battery is discharged or nearly discharged	<ul style="list-style-type: none"> ▪ Check the key battery (see "Checking the battery") and replace it necessary If this does not work: <ul style="list-style-type: none"> ▪ Unlock (see "Locking with the mechanical key" later in this section) or lock the vehicle using the emergency key element
	There is interference from a powerful source of radio waves	<ul style="list-style-type: none"> ▪ Unlock (see "Locking with the mechanical key" later in this section) or lock the vehicle using the emergency key element
	There is a fault with the Intelligent Key system	<ul style="list-style-type: none"> ▪ Lock/unlock the vehicle using the remote control function of the key. ▪ Have the vehicle and key checked. It is recommended you visit an INFINITI retailer for this service. If the vehicle can also not be locked/unlocked using the remote control function <ul style="list-style-type: none"> ▪ Unlock (see "Locking with the mechanical key" later in this section) or lock the vehicle using the emergency key element ▪ Have the vehicle and key checked. It is recommended you visit an INFINITI retailer for this service.
The engine cannot be started using the key	The on-board voltage is too low	<ul style="list-style-type: none"> ▪ Switch off non-essential consumers, e. g. seat heating or interior lighting, and try to start the engine again If this does not work: <ul style="list-style-type: none"> ▪ Check the starter battery and charge it if necessary (see "Battery") <li style="padding-left: 20px;">or ▪ Jump-start the vehicle (see "Jump starting") <li style="padding-left: 20px;">or ▪ Have the system checked. It is recommended you consult an INFINITI retailer.

Symptom	Possible cause	Remedy
The engine cannot be started using the push button ignition switch. The key is in the vehicle	The vehicle is locked with the Intelligent Key.	<ul style="list-style-type: none"> Unlock the vehicle and try to start the vehicle again.
	The key battery is weak or discharged.	<ul style="list-style-type: none"> Check the key battery (see "Checking the battery") and replace it necessary If this does not work: <ul style="list-style-type: none"> Start your vehicle with the key in the ignition lock.
	There is interference from a powerful source of radio waves.	<ul style="list-style-type: none"> Start the vehicle with the key in the ignition lock.
You have lost a key	–	<ul style="list-style-type: none"> Have the key deactivated. It is recommended you visit an INFINITI retailer for this service. Report the loss immediately to the vehicle insurers If necessary, have the locks changed as well
You have lost the emergency key element		<ul style="list-style-type: none"> Report the loss immediately to the vehicle insurers If necessary, have the locks changed as well.

HOOD

1. Make sure that the windshield wipers are switched off.

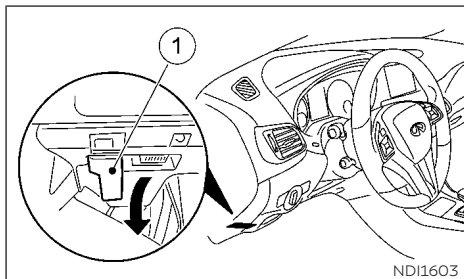

2. Pull the hood lock release lever ①, located below the instrument panel on the driver's side; the hood will spring up slightly.

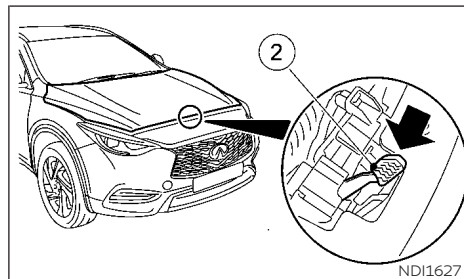

3. Push the lever ② at the front of the hood, to the left with your fingertips and raise the hood.

FUEL-FILLER DOOR

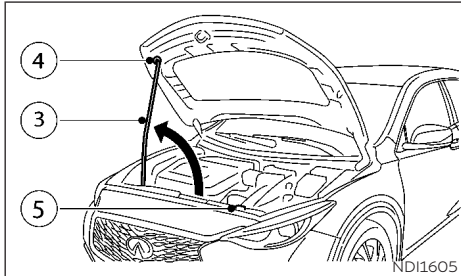

4. Insert the support rod ③ into the slot ④ on the underside of the hood.
5. When closing the hood, replace the support rod in its original position ⑤, slowly lower the hood to about 8 - 12 in. (20 - 30 cm) above the hood lock, then let it drop. Make sure the hood is securely latched.

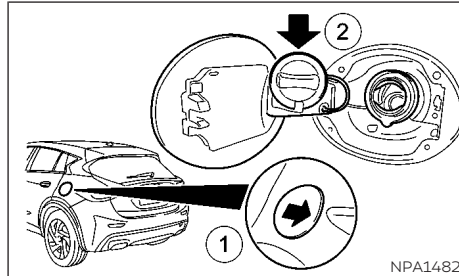

WARNING

- **Make sure the hood is completely closed and latched before driving. Failure to do so could cause the hood to fly open and result in an accident.**
- **If you see steam or smoke coming from the engine compartment, to avoid injury do not open the hood.**



OPENING FUEL-FILLER DOOR

To open the fuel-filler door, unlock it using one of the following operations, then push the right side of the door ①.

- Push the door handle request switch with the Intelligent Key carried with you.
- Push the "UNLOCK"  button on the Intelligent Key.
- Push the power door lock switch to the "UNLOCK"  position.

To close the fuel-filler door, close the door until it securely latches. To lock the fuel filler door, lock the vehicle using the intelligent key.

FUEL-FILLER CAP

Turn the fuel-filler cap counterclockwise to remove. To tighten, turn the cap clockwise until a single click is heard.

Put the fuel-filler cap on the cap holder ② while refueling.

WARNING

- **Gasoline is extremely flammable and highly explosive under certain conditions. You could be burned or seriously injured if it is misused or mishandled. Always stop the engine and do not smoke or allow open flames or sparks near the vehicle when refueling.**
- **Do not attempt to top off the fuel tank after the fuel pump nozzle shuts off automatically. Continued refueling may cause fuel overflow, resulting in fuel spray and possibly a fire.**
- **Use only an original equipment type fuel-filler cap as a replacement. It has a built-in safety valve needed for proper operation of the fuel system and emission control system. An incorrect cap can result in a serious malfunction and possible injury.**

STEERING WHEEL

WARNING

- Do not adjust the steering wheel while driving. You could lose control of your vehicle and cause an accident.
- Do not adjust the steering wheel any closer to you than is necessary for proper steering operation and comfort. The driver's air bag inflates with great force. If you are unrestrained, leaning forward, sitting sideways or out of position in any way, you are at greater risk of injury or death in a crash. You may also receive serious or fatal injuries from the air bag if you are up against it when it inflates. Always sit back against the seatback and as far away as practical from the steering wheel. Always use the seat belts.

CAUTION

- Do not use E-15 or E-85 fuel in your vehicle. For additional information, refer to "Fuel Recommendation" in the "Technical and consumer information" section of this manual.
- If fuel is spilled on the vehicle body, flush it away with water to avoid paint damage.

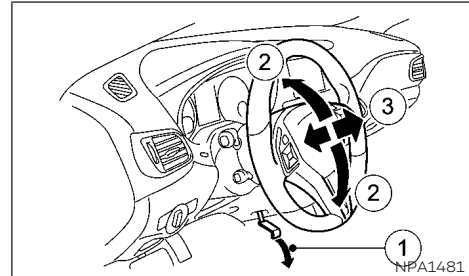

Release the lock lever ① as illustrated and adjust the steering wheel to the desired position (up or down ②, forwards or backwards ③). Firmly push the lock lever back into position to lock the steering wheel in place.

SUN VISORS

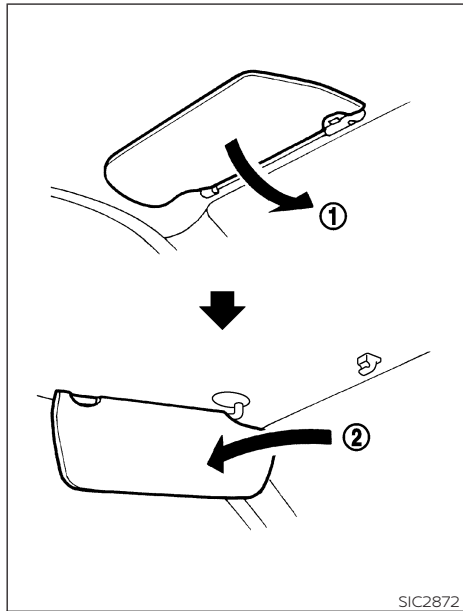

1. To block out glare from the front, swing down the sun visor ①.
2. To block glare from the side, remove the sun visor from the center mount and swing the visor to the side ②.

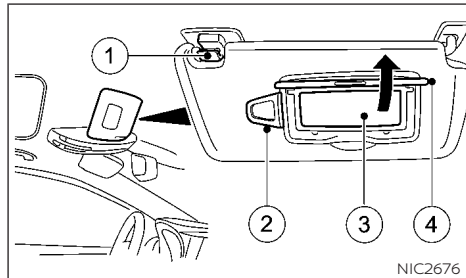

VANITY MIRROR

To use the front vanity mirror ③, pull down the sun visor ① and pull up the cover ④.

MIRRORS

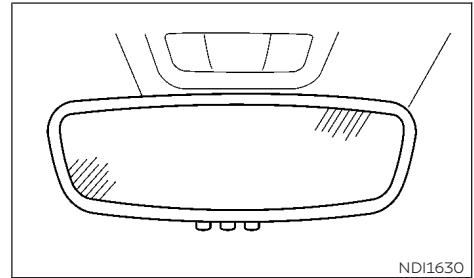

AUTOMATIC ANTI-GLARE REAR VIEW MIRROR

The inside mirror is designed so that it automatically dims according to the intensity of the headlights of the vehicle following you. The automatic anti-glare feature operates only when the ignition switch is in the ON position. It will not operate if reverse gear is engaged or if the interior lighting is switched on.

OUTSIDE MIRRORS

The driver's-side outside mirror is designed so that it automatically dims according to the intensity of the headlights of the vehicle following you. The automatic anti-glare feature operates only when the ignition switch is in the ON position. It will not operate if reverse gear is engaged or if the interior lighting is switched on.

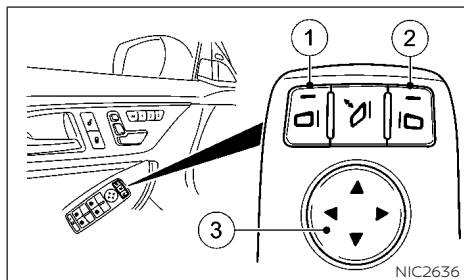

Adjusting

The outside rear view mirror remote control will operate only when the ignition switch is in the ACC or ON position.

1. Move the switch to select the left ① or right mirror ②.
2. Adjust each mirror to the desired position using the large switch ③.

Defogging

The exterior rear view mirrors will be heated when the rear window defogger switch is operated.

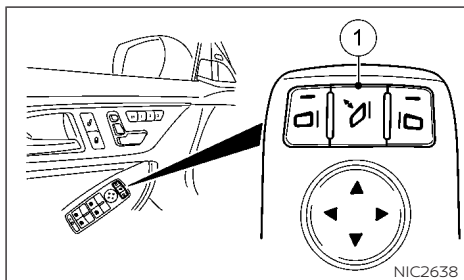

⚠ WARNING

- **Objects viewed in the outside mirror on the passenger side are closer than they appear. Be careful when moving to the right. Using only this mirror could cause an accident. Use the inside mirror or glance over your shoulder to properly judge distances to other objects.**
- **Do not adjust the mirrors while driving. You could lose control of your vehicle and cause an accident.**

Folding

Manual type (if equipped):

Fold the outside rear-view mirror by pushing it towards the rear of the vehicle.

Remote control type (if equipped):

The exterior rear view mirror remote control operates when the ignition switch is in the ACC or ON position.

Briefly press button ①. Both exterior mirrors fold in or out.

Power folding outside mirrors (if so equipped)

⚠ CAUTION

- **Do not touch the mirrors while they are moving. Your hand may be pinched, and the mirror may malfunction.**
- **Do not drive with the mirrors stored. You will be unable to see behind the vehicle.**

The exterior rear-view mirrors automatically unfold when the ignition is switched on or when the vehicle doors are unlocked. Use the [Fold Mirrors in when Locking] option under the [CONVENIENCE] menu of the Vehicle

Information Display to specify that the mirrors are to be automatically folded and unfolded. The Auto fold feature can also be switched off. See "Switching the [Fold Mirrors in when Locking] function on/off".

If the [Fold Mirrors in when Locking] option has been activated in the Vehicle information display:

- The exterior mirrors fold in automatically as soon as you lock the vehicle from the outside.
- The exterior mirrors fold out again automatically as soon as you unlock the vehicle and then open the driver's or front-passenger door.

Automatic parking positioner (if so equipped)

The Parking position for the exterior mirror on the front-passenger side function is only available if the vehicle is equipped with the Memory package.

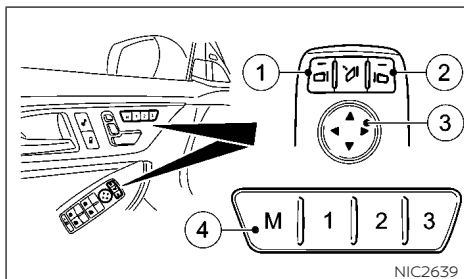

- ① Button for the exterior mirror on the left hand side.
- ② Button for the exterior mirror on the right hand side.
- ③ Adjustment button.
- ④ Memory button M.

Setting and storing the parking position using reverse gear:

You can set the front-passenger side exterior mirror so that you can see the rear wheel on that side as soon as you engage reverse gear. You can store this position.

1. Make sure that the vehicle is stationary.
2. Switch the ignition switch to the ON position.
3. Press button ② for the external mirror on the front-passenger side.

4. Engage reverse gear. The exterior mirror on the front-passenger side moves to the preset parking position.
5. Use adjustment button ③ to adjust the exterior mirror. You should see the rear wheel and the curb in the exterior mirror. The parking position is stored.

NOTE

- **If you shift the transmission to another position, the exterior mirror on the front passenger side returns to the driving position.**
- **If the driver's side mirror is currently selected, the passenger side mirror will not move when reverse gear is engaged.**

Setting and storing the parking position using the memory button:

You can set the front-passenger side exterior mirror so that you can see the rear wheel on that side as soon as you engage reverse gear. This setting can be stored using memory button M ④.

1. Make sure that the vehicle is stationary.
2. Switch the ignition switch to the ON position.
3. Press button ② for the external mirror on the front-passenger side.

4. Engage reverse gear. The exterior mirror on the front-passenger side moves to the preset parking position.
5. Use adjustment button ③ to adjust the exterior mirror. You should see the rear wheel and the curb in the exterior mirror.
6. Press memory button M ④ and one of the arrows on adjustment button ③ within three seconds. The parking position is stored if the exterior mirror does not move.
7. If the mirror moves out of position, repeat the steps.

Calling up a stored parking position:

1. Switch the ignition switch to the ON position.
2. Adjust the exterior mirror on the front passenger side with the corresponding button.
3. Engage reverse gear. The exterior mirror on the front-passenger side moves to the stored parking position

The exterior mirror on the front-passenger side moves back to its original position:

- As soon as you exceed a speed of 15 km/h.
- About ten seconds after you have disengaged reverse gear.
- If you press button ① for the exterior mirror on the driver's side.

MEMORY FUNCTION (IF EQUIPPED)

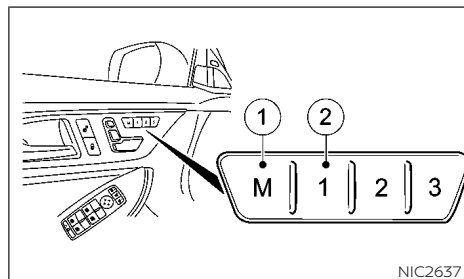

NIC2637

⚠ WARNING

- **If you use the memory function on the driver's side while driving, the adjustments could cause you to lose control of the vehicle. There is a risk of an accident. Only use the memory function on the driver's side while the vehicle is stationary. Only use the memory function on the driver's side while the vehicle is stationary.**
- **If the memory function adjusts the seat, you and other vehicle occupants—particularly children—could become trapped. There is a risk of injury. While the memory function is making adjustments, make sure that no one has any part of their body within the sweep of the**

seat. If someone becomes trapped, immediately release the memory function position button. The adjustment is stopped.

- **If children activate the memory function, they could become trapped, especially if they are unattended. There is a risk of injury.
When leaving the vehicle, always take the key with you and lock the vehicle. Never leave children unattended in the vehicle.**

The memory function can be used at any time, e.g. even when the key isn't in the ignition lock.

STORING SETTINGS

With the memory function, you can store up to three different settings, for example, for three different people. The following settings are stored as a single memory preset:

- Seat and seatback position
- Driver's side: position of the exterior mirrors on the driver's and front-passenger sides.

To store settings:

1. Adjust the seat (see "Power seat adjustment").
2. Adjust the exterior mirror on the driver's side (see "Adjusting").
3. Briefly press the M memory button **①**, and then press preset position button 1, 2 or 3 **②** within three seconds.

The settings are stored in the selected preset position. A tone sounds when the settings have been completed.

CALLING UP A STORED SETTING

Press and hold the relevant preset position button 1, 2 or 3 until the seat and exterior mirrors are in the stored position.

NOTE

The setting procedure is interrupted as soon as you release the storage position button.

4 Display screen, heater and air conditioner, and audio system

INFINITI InTouch Owner's Manual	4-2
Safety precautions	4-2
RearView monitor (if so equipped)	4-3
RearView Monitor system operation.	4-4
How to read the displayed lines.	4-4
Difference between predicted and actual distances	4-5
How to park with predicted course lines	4-6
Adjusting the screen	4-8
RearView Monitor setting	4-9
RearView Monitor system limitations	4-9
System maintenance	4-11
Around View® Monitor (if so equipped)	4-11
Around View® Monitor system operation.	4-12
Difference between predicted and actual distances	4-15
How to park with predicted course lines.	4-17
How to switch the display	4-19
Adjusting the screen	4-19
Around View® Monitor setting	4-20
Around View® Monitor system limitations	4-20
System maintenance	4-22
Sonar function settings (if so equipped)	4-23
Moving Object Detection (if so equipped)	4-24
MOD system operation	4-25
MOD setting	4-26
MOD system limitations.	4-26
MOD malfunction.	4-27
System maintenance	4-27
Ventilators	4-28
Center ventilators.	4-28
Side ventilators	4-28
Rear ventilators (if equipped).	4-28
Heater and air conditioner	4-29
Air conditioning system	4-30
Automatic climate control (2-zone).	4-34
Servicing air conditioner.	4-38
Antenna	4-39
Car phone or CB radio.	4-39

INFINITI INTOUCH OWNER'S MANUAL

Refer to the INFINITI InTouch Owner's Manual, that includes the following information:

- Center multi-function control panel and steering wheel switch
- Audio system
- Bluetooth® Hands-Free Phone system
- INFINITI InTouch Apps
- INFINITI InTouch™ Services (if equipped)
- Sirius XM Travel Link
- Sirius XM Travel
- Navigation system (where fitted)
- Voice recognition
- Information and settings viewable on INFINITI InTouch

SAFETY PRECAUTIONS

WARNING

- **Do not adjust the heater and air conditioner controls or audio controls while driving so that full attention may be given to vehicle operation.**
- **Do not use this system if you notice any abnormality, such as a frozen screen or lack of sound. Continued use of the system may result in accident, fire or electric shock.**
- **If you noticed any foreign objects entering the system hardware, spilled liquid on the system, or noticed smoke or fumes coming out from the system, or any other unusual operation is observed, stop using the system immediately. It is recommended that you contact the nearest INFINITI retailer. Ignoring such conditions may lead to an accident, fire or electric shock.**
- **Do not disassemble or modify this system. If you do, it may lead to an accident, fire, or electric shock.**
- **Park the vehicle in a safe location and apply the parking brake to view the images on the front center display screen.**

CAUTION

- **Do not use the system when the engine is not running for extended periods of time to prevent battery discharge.**
- **Do not attempt to operate the system in extreme temperature conditions [below -4°F (-20°C) and above 158°F (70°C)]. Operating this system under these conditions may result in system malfunctions.**

REARVIEW MONITOR (IF SO EQUIPPED)

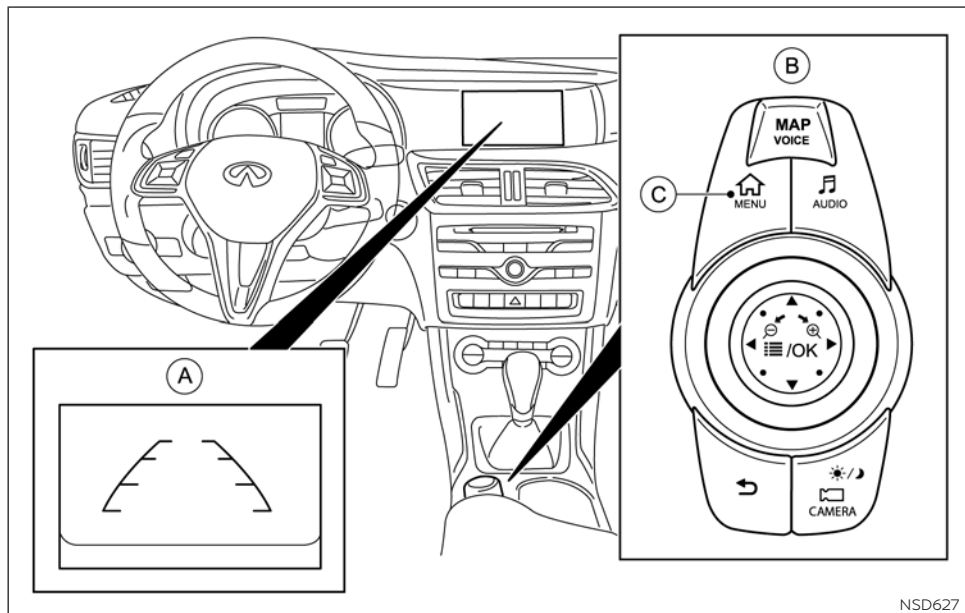

- (A) RearView Monitor display
- (B) INFINITI controller
- (C) <MENU> button

⚠ WARNING

Failure to follow the warnings and instructions for proper use of the RearView Monitor could result in serious injury or death.

- The RearView Monitor is a convenience feature but it is not a substitute for proper backing up. Always turn and look out the windows, and check mirrors to be sure that it is safe to move before operating the vehicle. Always back up slowly.
- The system is designed as an aid to the driver in showing large stationary objects directly behind the vehicle, to help avoid damaging the vehicle.
- The distance guide line and the vehicle width line should be used as a reference only when the vehicle is on a level paved surface. The distance viewed on the monitor is for reference only and may be different than the actual distance between the vehicle and displayed objects.

CAUTION

Do not scratch the camera lens when cleaning dirt or snow from the lens.

The RearView Monitor system automatically shows a rear view of the vehicle when the shift lever is placed in the R (Reverse) position. When activating the RearView Monitor, the guide lines, the icons and the messages may not be displayed immediately.

The radio can still be heard while the RearView Monitor is active.

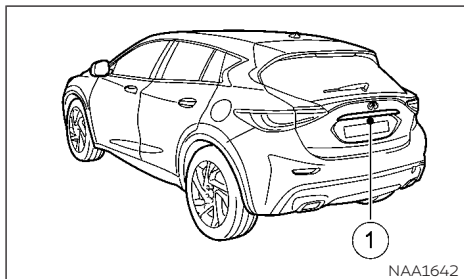

To display the rear view, the RearView Monitor system uses a camera located just above the vehicle's rear license plate **1**.

REARVIEW MONITOR SYSTEM OPERATION

With the ignition switch in the ON position, move the shift lever to the R (Reverse) position to operate the RearView Monitor. When activating the RearView Monitor, the guide lines, the icons and the messages may not be displayed immediately.

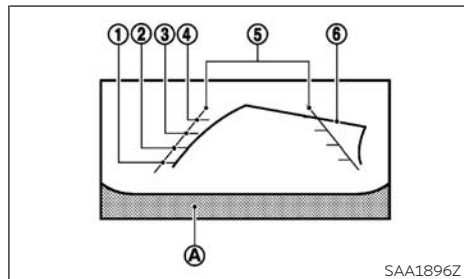

HOW TO READ THE DISPLAYED LINES

Guiding lines which indicate the vehicle width and distances to objects with reference to the bumper line **A** are displayed on the monitor.

Distance guide lines:

Indicate distances from the bumper.

- Red line **1**: approx. 1.5 ft (0.5 m)
- Yellow line **2**: approx. 3 ft (1 m)
- Green line **3**: approx. 7 ft (2 m)
- Green line **4**: approx. 10 ft (3 m)

Vehicle width guide lines **5**:

Indicate the approximate vehicle width when backing up.

Predicted course lines ⑥:

Indicate the predicted course when backing up. The predicted course lines will be displayed on the monitor when the shift lever is in the R (Reverse) position and the steering wheel is turned. The predicted course lines will move depending on how much the steering wheel is turned and will not be displayed while the steering wheel is in the neutral position.

The vehicle width guide lines and the width of the predicted course lines are wider than the actual width and course.

DIFFERENCE BETWEEN PREDICTED AND ACTUAL DISTANCES

The displayed guidelines and their locations on the ground are for approximate reference only. Objects on uphill or downhill surfaces or projecting objects will be actually located at distances different from those displayed in the monitor relative to the guidelines (refer to illustrations). When in doubt, turn around and view the objects as you are backing up, or park and exit the vehicle to view the positioning of objects behind the vehicle.

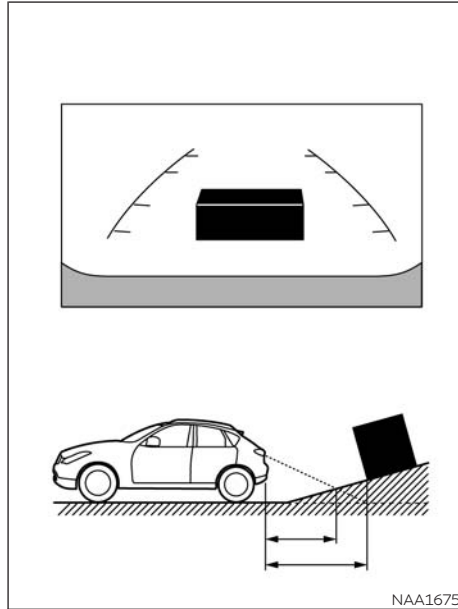

Backing up on a steep uphill

When backing up the vehicle up a hill, the distance guide lines and the vehicle width guide lines are shown closer than the actual distance. Note that any object on the hill is viewed in the monitor farther than it appears.

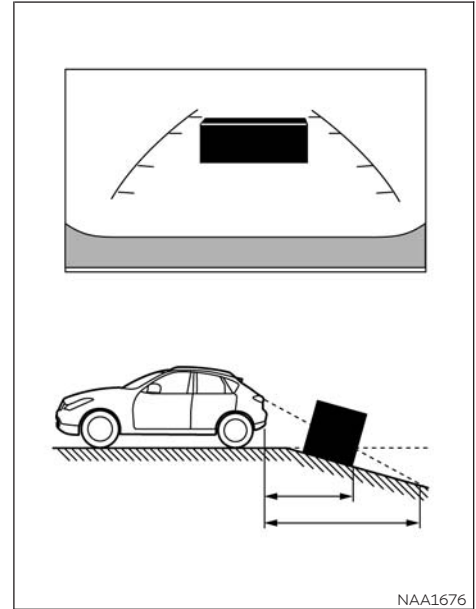

Backing up on a steep downhill

When backing up the vehicle down a hill, the distance guide lines and the vehicle width guide lines are shown farther than the actual distance. Note that any object on the hill is viewed in the monitor closer than it appears.

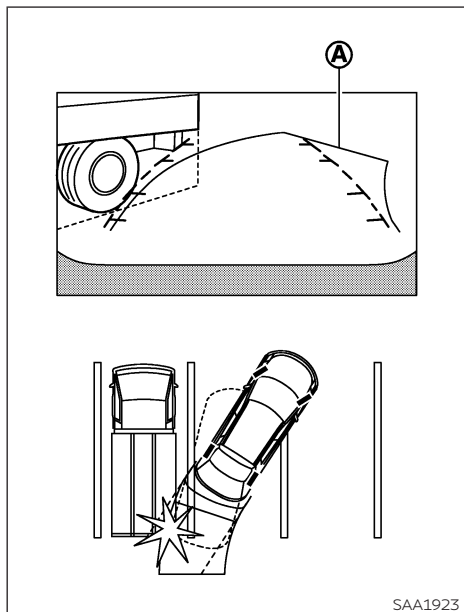

Backing up near a projecting object

The predicted course lines (A) do not touch the object in the display. However, the vehicle may hit the object if it projects over the actual moving course.

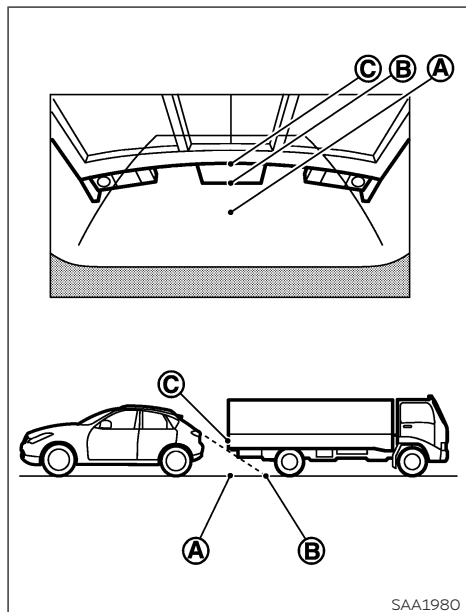

Backing up behind a projecting object

The position (C) is shown further than the position (B) in the display. However, the position (C) is actually at the same distance as

the position (A). The vehicle may hit the object when backing up to the position (A) if the object projects over the actual moving course.

HOW TO PARK WITH PREDICTED COURSE LINES

⚠ WARNING

- If the tires are replaced with different sized tires, the predicted course line may not be displayed correctly.
- On a snow-covered or slippery road, there may be a difference between the predicted course line and the actual course line.
- The displayed lines will appear slightly off to the right because the rear view camera is not installed in the rear center of the vehicle.
- If the battery is disconnected or becomes discharged, the predicted course lines may be displayed incorrectly. If this occurs, please perform the following procedures:
 - Turn the steering wheel from lock to lock while the engine is running.
 - Drive the vehicle on a straight road for more than 5 minutes.

- **When the steering wheel is turned with the ignition switch in the ACC position, the predicted course lines may be displayed incorrectly.**

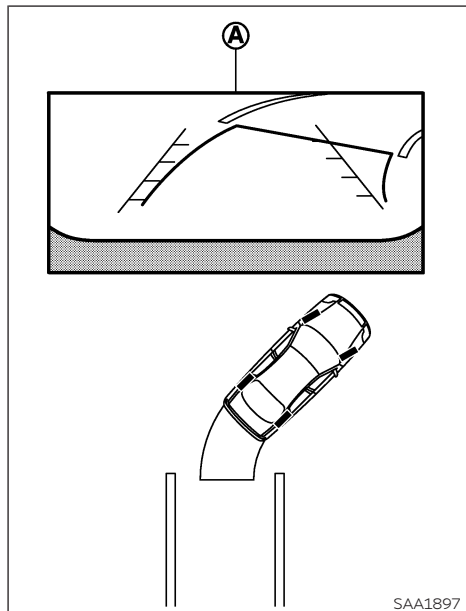

The vehicle width and predicted course lines are wider than the actual width and course.

1. Visually check that the parking space is safe before parking your vehicle.
2. The rear view of the vehicle is displayed on the screen (A) as illustrated when the shift lever is moved to the R (Reverse) position. When activating the RearView Monitor, the guide lines, the icons and the messages may not be displayed immediately.

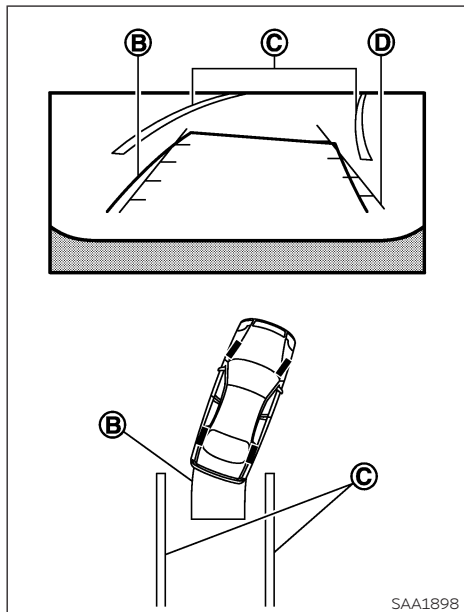

4. When the rear of the vehicle enters the parking space (C), maneuver the steering wheel to make the vehicle width guide lines (D) parallel to the parking space (C).
5. When the vehicle is parked in the space completely, press the P (Park) button and apply the parking brake.

ADJUSTING THE SCREEN

1. While the RearView Monitor is displayed, touch the settings icon .
2. Select the item you wish to adjust:

[Brightness]:

Adjust display settings by touching [+]/[-].

[Contrast]:

Adjust display settings by touching [+]/[-].

[Black level]:

Adjust display settings by touching [+]/[-].

[Tint]:

Adjust display settings by touching [+]/[-].

[Color]:

Adjust display settings by touching [+]/[-].

[Reset Settings]:

Return all the settings to default

NOTE

Do not adjust any of the display settings of the RearView Monitor while the vehicle is moving. Make sure the parking brake is firmly applied.

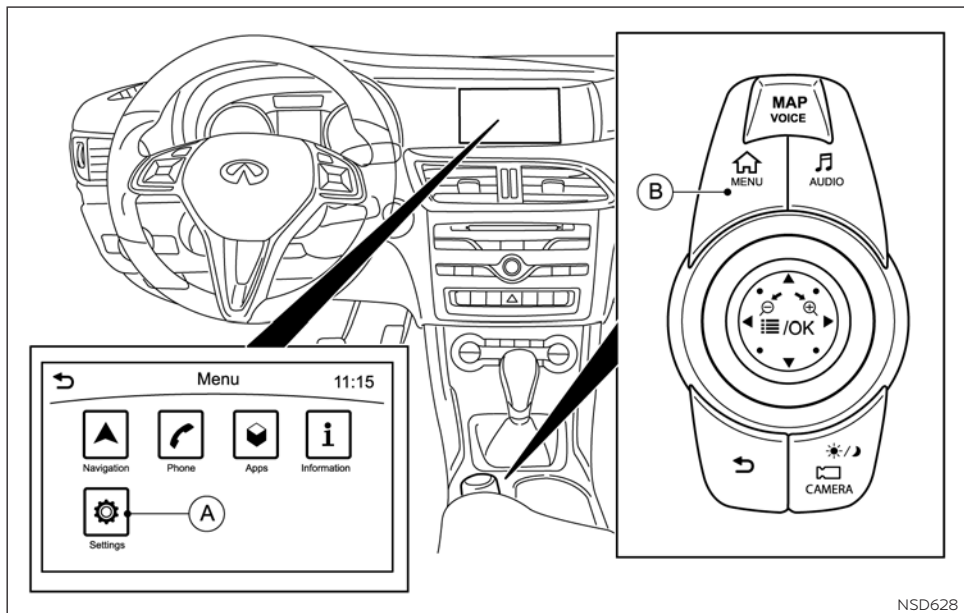

REARVIEW MONITOR SETTING

The RearView Monitor [Predictive Course Lines] setting can be changed using the following procedure.

1. Push the **<MENU>** button **(B)** on the INFINITI Controller and touch [Settings] **(A)** in the vehicle information display.
2. Touch [Camera]/[Sonar]
3. Touch [Camera]
4. Touch [Predictive Course Lines]

When this item is turned on, the predicted course line is displayed on the rear view screen when the shift lever is in the R (Reverse) position.

REARVIEW MONITOR SYSTEM LIMITATIONS

⚠ WARNING

Listed below are the system limitations for RearView Monitor. Failure to operate the vehicle in accordance with these system limitations could result in serious injury or death.

- The system cannot completely eliminate blind spots and may not show every object.

- (A) [Settings] key
(B) <MENU> button

- **Underneath the bumper and the corner areas of the bumper cannot be viewed on the RearView Monitor because of its monitoring range limitation. The system will not show small objects below the bumper, and may not show objects close to the bumper or on the ground.**
- **Objects viewed in the RearView Monitor differ from actual distance because a wide-angle lens is used.**
- **Objects in the RearView Monitor will appear visually opposite than when viewed in the rear view and outside mirrors.**
- **Use the displayed lines as a reference. The lines are highly affected by the number of occupants, fuel level, vehicle position, road conditions and road grade.**
- **Make sure that the lift gate is securely closed when backing up.**
- **Do not put anything on the rear view camera. The rear view camera is installed above the license plate.**

- **When washing the vehicle with high-pressure water, be sure not to spray it around the camera. Otherwise, water may enter the camera unit causing water condensation on the lens, a malfunction, fire or an electric shock.**
- **Do not strike the camera. It is a precision instrument. Otherwise, it may malfunction or cause damage resulting in a fire or an electric shock.**

The following are operating limitations and do not represent a system malfunction:

- When the temperature is extremely high or low, the screen may not clearly display objects.
- When strong light shines directly on to the camera, objects may not be displayed clearly.
- Vertical lines may be seen in objects on the screen. This is due to strong reflected light from the bumper.
- The screen may flicker under fluorescent light.
- The colors of objects on the RearView Monitor may differ somewhat from the actual color of objects.
- Objects on the monitor may not be clear in a dark environment.
- Do not use wax on the camera window. Wipe off any wax with a clean cloth dampened with mild detergent diluted with water.

AROUND VIEW® MONITOR (IF SO EQUIPPED)

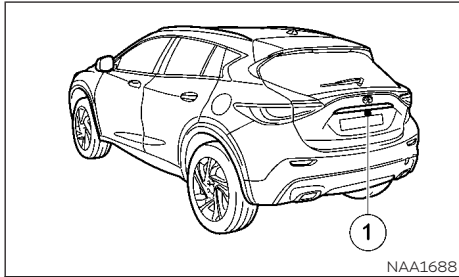

SYSTEM MAINTENANCE

⚠ CAUTION

- Do not use alcohol, benzine or thinner to clean the camera. This will cause discoloration. To clean the camera, wipe with a cloth dampened with diluted mild cleaning agent and then wipe with a dry cloth.
- Do not damage the camera as the monitor screen may be adversely affected.

If dirt, rain or snow accumulates on the camera ①, the RearView Monitor may not display objects clearly. Clean the camera by wiping it with a cloth dampened with a diluted mild cleaning agent and then wiping it with a dry cloth.

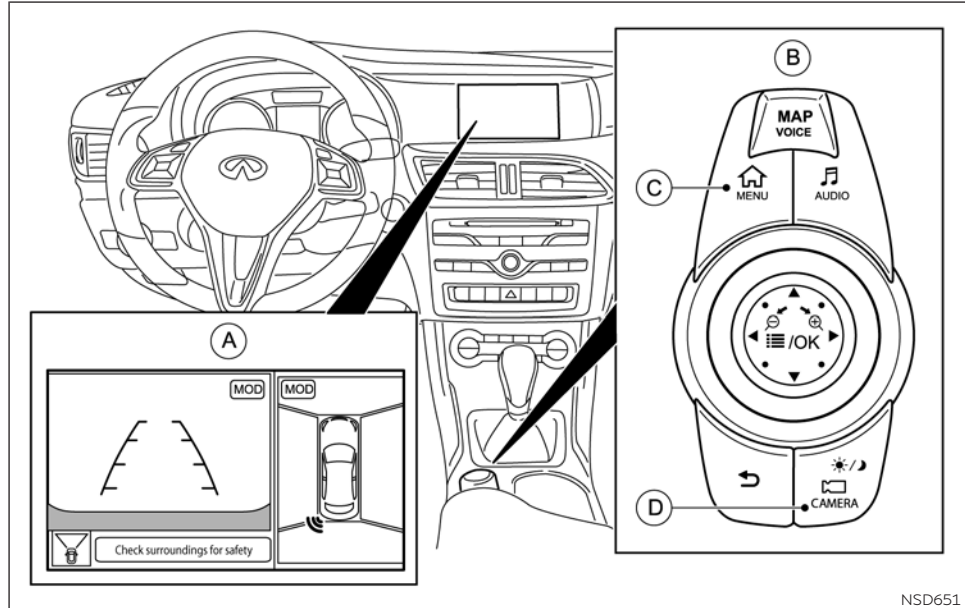

- Ⓐ Around View® Monitor display
- Ⓑ INFINITI controller
- Ⓒ <MENU> button
- Ⓓ <CAMERA> button

⚠ WARNING

Failure to follow the warnings and instructions for the proper use of the Around View® Monitor system could result in serious injury or death.

- **The Around View® Monitor is a convenience feature and is not a substitute for proper vehicle operation because it has areas where objects cannot be viewed. The four corners of the vehicle in particular, are areas where objects do not always appear in the bird's-eye, front, or rear views. Always check your surroundings to be sure that it is safe to move before operating the vehicle. Always operate the vehicle slowly.**
- **The driver is always responsible for safety during parking and other maneuvers.**

CAUTION

Do not scratch the lens when cleaning dirt or snow from the front of the camera.

The Around View® Monitor system is designed as an aid to the driver in situations such as slot parking or parallel parking.

The monitor displays various views of the position of the vehicle in a split screen format. All views are not available at all times.

Available views:

- **Front View**
An approximately 150-degree view of the front of the vehicle.
- **Rear View**
An approximately 150-degree view of the rear of the vehicle.
- **Bird's-Eye View**
The surrounding view of the vehicle from above.
- **Front-Side View**
The view around and ahead of the front passenger's side wheel.

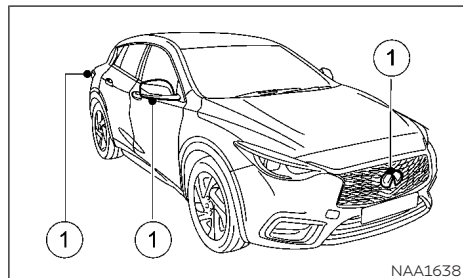

To display the multiple views, the Around View® Monitor system uses cameras ① located in the front grille, on the vehicle's outside mirrors and one just above the vehicle's rear number plate.

AROUND VIEW® MONITOR SYSTEM OPERATION

With the ignition switch in the ON position, move the shift lever to the R (Reverse) position or press the **<CAMERA>** button to operate the Around View® Monitor. When activating the Around View® Monitor, the icons and the messages may not be displayed immediately.

The screen displayed on the Around View® Monitor will automatically return to the previous screen 3 minutes after the <CAMERA> button has been pushed while the shift lever is in a position other than the R (Reverse) position.

Available views

WARNING

- The distance guide lines and the vehicle width lines should be used as a reference only when the vehicle is on a paved, level surface. The distance viewed on the monitor is for reference only and may be different than the actual distance between the vehicle and displayed objects.
- Use the displayed lines and the bird's-eye view as a reference. The lines and the bird's-eye view are greatly affected by the number of occupants, fuel level, vehicle position, road condition and road grade.
- When driving the vehicle up a hill, objects viewed in the monitor are farther than they appear. When driving the vehicle down a hill, objects viewed in the monitor are closer than they appear.

- **Objects in the monitor will appear visually opposite compared to when viewed in the rear view and outside mirrors.**
- Use the mirrors or actually look to properly judge distances to other objects.
- The distance between objects viewed in the rear view differs from actual distance because a wide-angle lens is used.
- The displayed lines on the rear view will appear slightly off to the right because the rear view camera is not installed in the rear center of the vehicle.

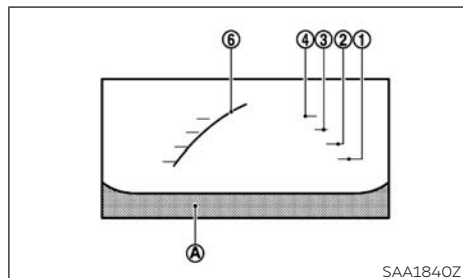

Front view

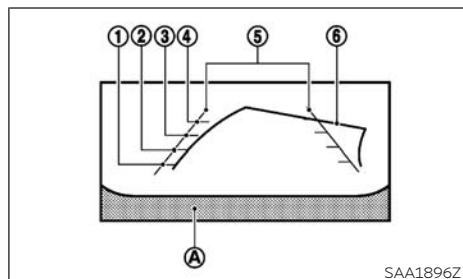

Rear view

Front and rear views:

Guiding lines, which indicate the vehicle width and distances to objects with reference to the vehicle body line (A), are displayed on the monitor.

Distance guide lines:

Indicate distances from the vehicle body:

- Red line (1): approx. 1.5 ft (0.5 m)
- Yellow line (2): approx. 3 ft (1 m)
- Green line (3): approx. 7 ft (2 m)
- Green line (4): approx. 10 ft (3 m)

Vehicle width guide lines (5):

Indicate the approximate vehicle width when backing up.

Predicted course lines (6):

Indicate the predicted course when operating the vehicle. The predicted course lines will be displayed on the monitor when the steering wheel is turned. The predicted course lines will move depending on how much the steering wheel is turned and will not be displayed while the steering wheel is in the straight ahead position.

The front view will not be displayed when the vehicle speed is above 10 km/h (6 MPH).

NOTE

When the monitor displays the front view and the steering wheel turns about 90 degrees or less from the neutral position, both the right and left predicted course lines (6) are displayed. When the steering wheel turns about 90 degrees or more, a line is displayed only on the opposite side of the turn.

Bird's-eye view:

WARNING

- **Objects in the bird's-eye view will appear farther than the actual distance.**
- **Tall objects, such as a curb or a vehicle, may be misaligned or not displayed at the seam of the views.**
- **Objects that are above the camera cannot be displayed.**
- **The view for the bird's-eye view may be misaligned when the camera position alters.**
- **A line on the ground may be misaligned and is not seen as being straight at the seam of the views. The misalignment will increase as the line proceeds away from the vehicle.**
- **Tire angle display does not indicate the actual tire angle.**

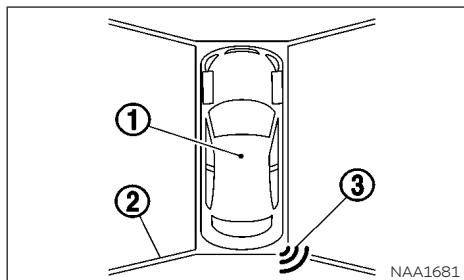

The bird's-eye view shows the overhead view of the vehicle, which helps confirm the vehicle position.

The vehicle icon ① shows the position of the vehicle.

NOTE

The size of the vehicle icon on the bird's-eye view may differ somewhat from the actual vehicle.

The areas that the cameras cannot cover ② are indicated in black.

The non-viewable area ② is highlighted in yellow for several seconds after the bird's-eye view is displayed. It will be shown only the first time after the ignition switch is placed in the ON position.

When the corner of the vehicle moves closer to an object, the corner sensor indicator ③ appears.

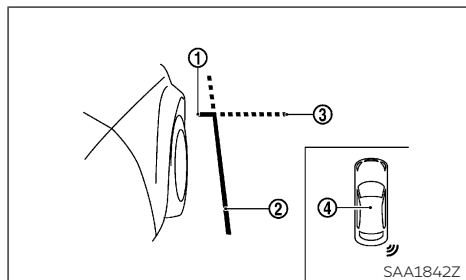

Left-Hand Drive (LHD) models* Front-side view:

Guiding lines that indicate the approximate width and the front end of the vehicle are displayed on the monitor.

The front-of-vehicle line ① shows the front part of the vehicle.

The side-of-vehicle line ② shows the approximate vehicle width including the outside mirrors.

The extensions ③ of both the front ① and side ② lines are shown with a green dotted line.

The corner sensor indicator ④ will appear when a corner of the vehicle moves closer to an object.

DIFFERENCE BETWEEN PREDICTED AND ACTUAL DISTANCES

The displayed guidelines and their locations on the ground are for approximate reference only. Objects on uphill or downhill surfaces or projecting objects will be actually located at distances different from those displayed in the monitor relative to the guidelines (refer to illustrations). When in doubt, turn around and view the objects as you are backing up, or park and exit the vehicle to view the positioning of objects behind the vehicle.

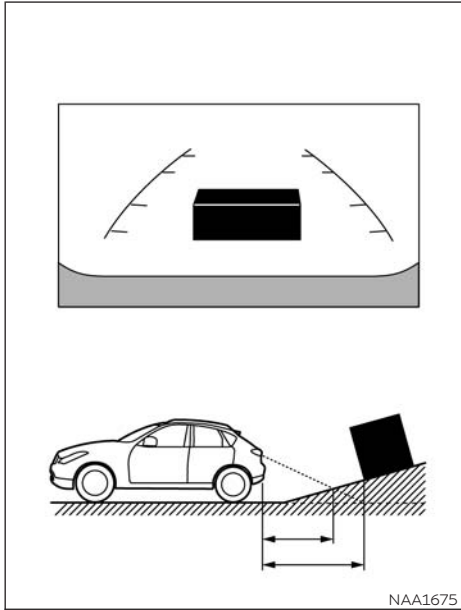

Backing up on a steep uphill

When backing up the vehicle up a hill, the distance guide lines and the vehicle width guide lines are shown closer than the actual distance. Note that any object on the hill is viewed in the monitor farther than it appears.

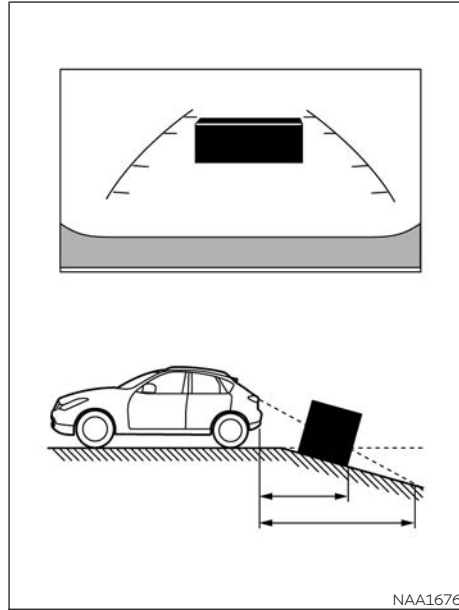

Backing up on a steep downhill

When backing up the vehicle down a hill, the distance guide lines and the vehicle width guide lines are shown farther than the actual distance. Note that any object on the hill is viewed in the monitor closer than it appears.

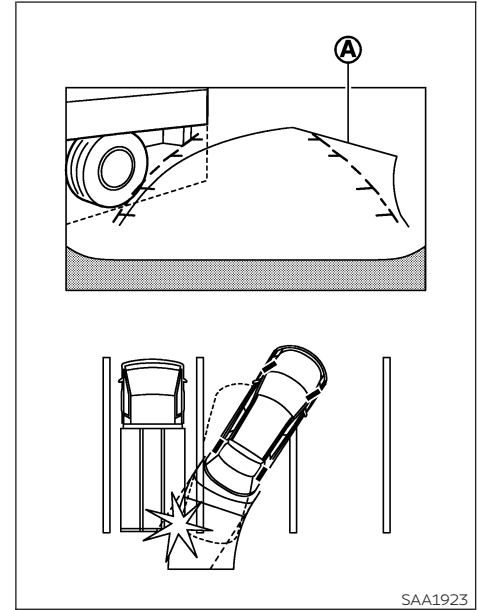

Backing up near a projecting object

The predicted course lines (A) do not touch the object in the display. However, the vehicle may hit the object if it projects over the actual moving course.

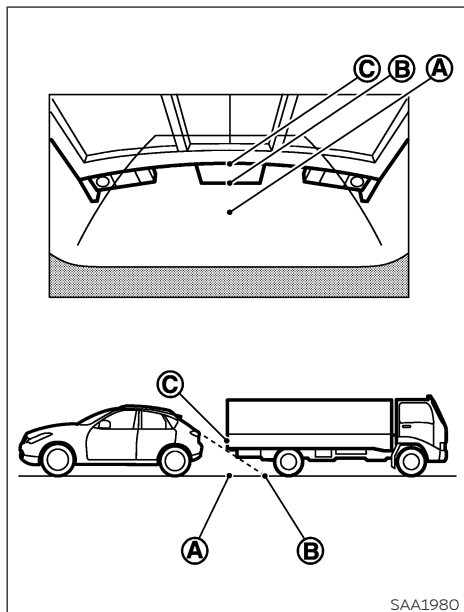

Backing up behind a projecting object

The position ③ is shown farther than the position ② in the display. However, the position ③ is actually at the same distance as

the position ①. The vehicle may hit the object when backing up to the position ① if the object projects over the actual moving course.

HOW TO PARK WITH PREDICTED COURSE LINES

⚠ WARNING

- If the tires are replaced with different sized tires, the predicted course lines may not be displayed correctly.
- On a snow-covered or slippery road, there may be a difference between the predicted course lines and the actual course.
- The displayed lines will appear slightly off to the right because the rear view camera is not installed in the rear center of the vehicle.
- If the battery is disconnected or becomes discharged, the predicted course lines may be displayed incorrectly. If this occurs, please perform the following procedures:
 - Turn the steering wheel from lock to lock while the engine is running.
 - Drive the vehicle on a straight road for more than 5 minutes.

- When the steering wheel is turned with the ignition switch in the ACC position, the predicted course lines may be displayed incorrectly.

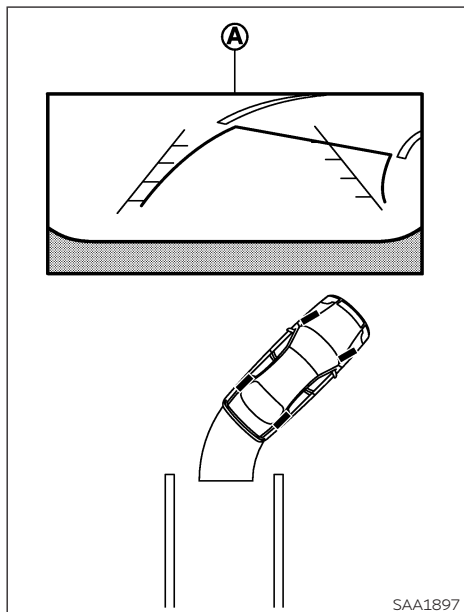

2. The rear view of the vehicle is displayed on the screen **A** as illustrated when the shift lever is moved to the R (Reverse) position. When activating the Around View® Monitor, the icons and the messages may not be displayed immediately.

The vehicle width and predicted course lines are wider than the actual width and course.

1. Visually check that the parking space is safe before parking your vehicle.

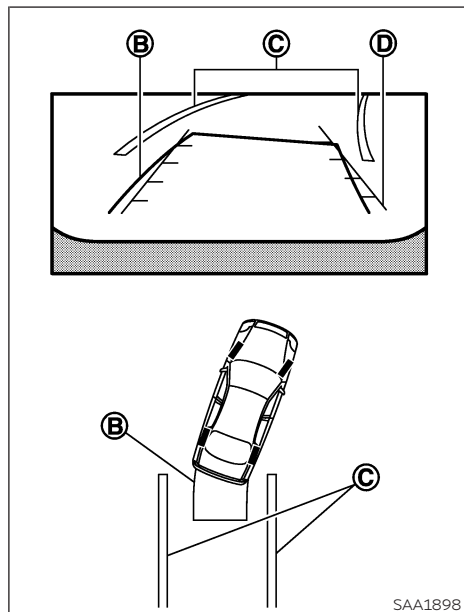

3. Slowly back up the vehicle adjusting the steering wheel so that the predicted course lines **B** enter the parking space **C**.

4. When the rear of the vehicle enters the parking space **(C)**, maneuver the steering wheel to make the vehicle width guide lines **(D)** parallel to the parking space **(C)**.
5. When the vehicle is parked in the space completely, press the P (Park) button and apply the parking brake.

HOW TO SWITCH THE DISPLAY

The view on the Around View® Monitor screen can be switched by pressing the **<CAMERA>** button or by changing the shift lever position.

Press the **<CAMERA>** button:

When the **<CAMERA>** button is pushed while a screen other than a camera screen is displayed, the Around View® Monitor operates and the front view and bird's-eye view are displayed. Push the **<CAMERA>** button to switch the display to the front view and front-side view screen.

ADJUSTING THE SCREEN

1. Push the **<MENU>** button **(B)** on the INFINITI Controller and touch [Settings] **(A)** in the vehicle information display.
2. Touch [Camera]/[Sonar]
3. Touch [Display]
4. Select the item you wish to adjust:

[Brightness]:

Adjust display settings by touching [+]/[-].

[Contrast]:

Adjust display settings by touching [+]/[-].

[Black level]:

Adjust display settings by touching [+]/[-].

[Tint]:

Adjust display settings by touching [+]/[-].

[Color]:

Adjust display settings by touching [+]/[-].

[Reset Settings]:

Return all the settings to default

NOTE

Do not adjust any of the display settings of the Around View® Monitor while the vehicle is moving. Make sure the parking brake is firmly applied.

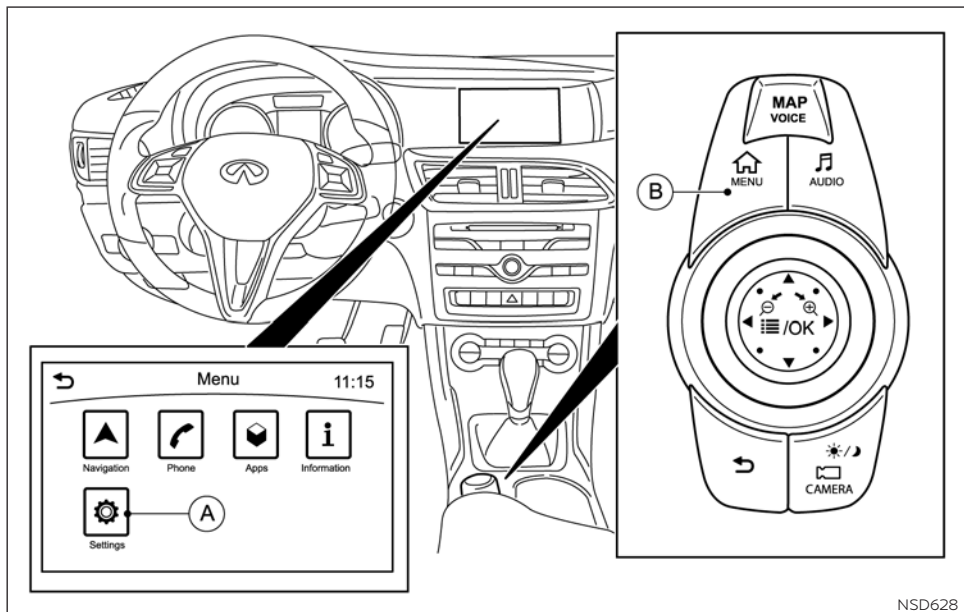

- (A) [Settings] key
- (B) <MENU> button

AROUND VIEW® MONITOR SETTING

Around View® Monitor settings can be changed using the following procedure:

1. Push the <MENU> button (B) on the INFINITI Controller and touch [Settings] (A) in the vehicle information display.
2. Touch [Camera]/[Sonar]
3. Touch [Camera]
4. Touch [Moving Object Detection]
 - Activate or deactivate the Moving Object Detection (MOD) mode.

AROUND VIEW® MONITOR SYSTEM LIMITATIONS

⚠ WARNING

Listed below are the system limitations for Around View® Monitor. Failure to operate the vehicle in accordance with these system limitations could result in serious injury or death.

- Do not use the Around View® Monitor with the outside mirror in the stored position, and make sure that the lift gate is securely closed when operating the vehicle using the Around View® Monitor.
- The apparent distance between objects viewed on the Around View® Monitor differs from the actual distance.

- **The cameras are installed on the front grille, the outside mirrors and above the rear license plate. Do not put anything on the cameras.**
- **When washing the vehicle with high-pressure water, be sure not to spray it around the cameras. Otherwise, water may enter the camera unit causing water condensation on the lens, a malfunction, fire or an electric shock.**
- **Do not strike the cameras. They are precision instruments. Doing so could cause a malfunction or cause damage resulting in a fire or an electric shock.**

The following are operating limitations and do not represent a system malfunction:

- There may be a delay when switching between views.
 - When the temperature is extremely high or low, the screen may not display objects clearly.
 - When strong light is directly shines on the camera, objects may not be displayed clearly.
- The screen may flicker under fluorescent light.
 - The colors of objects on the Around View® Monitor may differ somewhat from the actual color of objects.
 - Objects on the monitor may not be clear and the color of the object may differ in a dark environment.
 - There may be differences in sharpness between each camera view of the bird's-eye view.
 - Do not use wax on the camera lens. Wipe off any wax with a clean cloth that has been dampened with a diluted mild cleaning agent, then wipe with a dry cloth.

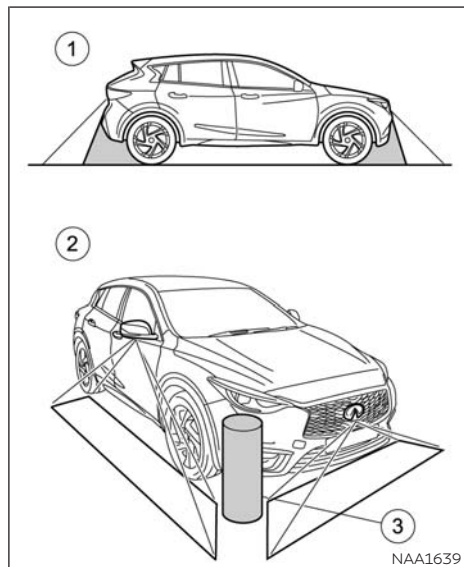

There are some areas where the system will not show objects and the system does not warn of moving objects. When in the front or the rear view display, an object below the bumper or on the ground may not be viewed ①. When in the bird's-eye view, a tall object near the seam ③ of the camera viewing areas will not appear in the monitor ②.

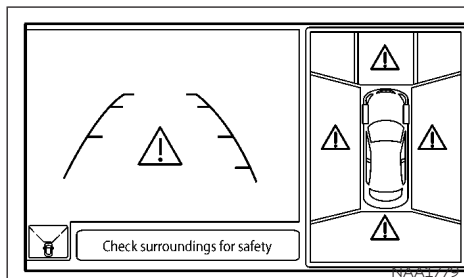

System temporarily unavailable

When the [!] icon is displayed on the screen, there are abnormal conditions in the Around View® Monitor. This will not hinder normal driving operation but the system should be inspected. It is recommended you visit an INFINITI retailer for this service.

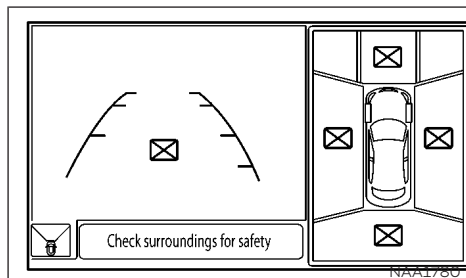

When the [X] icon is displayed on the screen, the camera image may be receiving temporary electronic disturbances from surrounding devices. This will not hinder normal driving operation but the system should be inspected. It is recommended you visit an INFINITI retailer for this service.

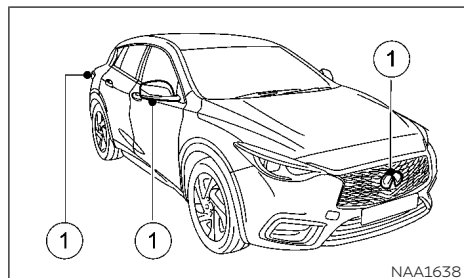

SYSTEM MAINTENANCE

CAUTION

- **Do not use alcohol, benzine or thinner to clean the camera. This will cause discoloration. To clean the camera, wipe with a cloth dampened with diluted mild cleaning agent and then wipe with a dry cloth.**
- **Do not damage the camera as the monitor screen may be adversely affected.**

If dirt, rain or snow accumulates on any of the cameras, the Around View® Monitor may not display objects clearly. Clean the cameras by wiping with a cloth dampened with a diluted mild cleaning agent and then wiping with a dry cloth.

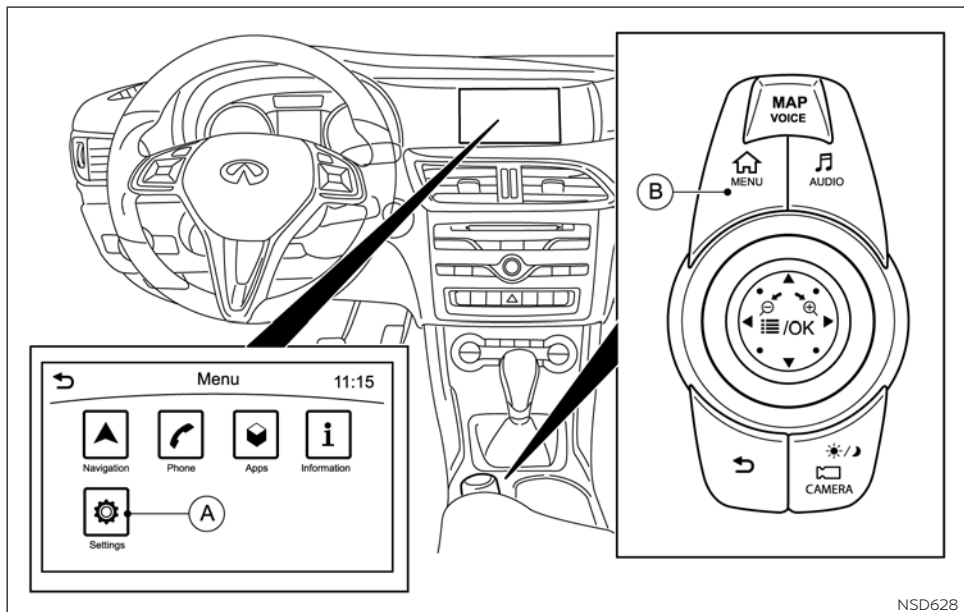

- Ⓐ [Settings] key
- Ⓑ <MENU> button

SONAR FUNCTION SETTINGS (IF SO EQUIPPED)

The sonar function settings can be changed using the following procedure.

1. Push <MENU>Ⓑ and touch [Settings] Ⓐ.
2. Touch [Camera/Sonar]
3. Touch [Sonar]

[Sonar sensitivity]:

Adjust the sonar sensor sensitivity level by touching [+]/[-].

[Sonar volume]:

Adjust the buzzer volume by touching [+]/[-].

MOVING OBJECT DETECTION (IF SO EQUIPPED)

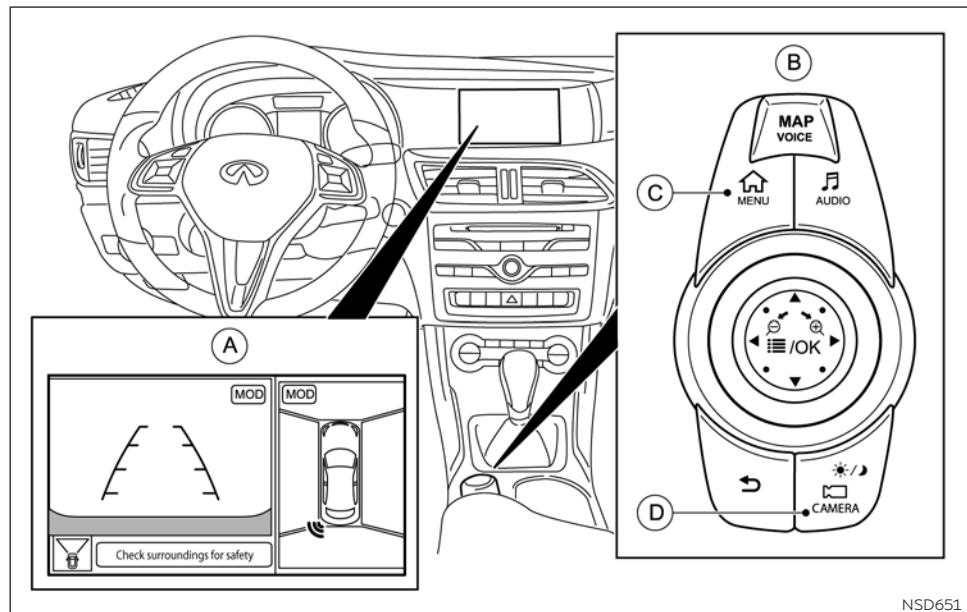

- (A) Around View Monitor display
- (B) INFINITI controller
- (C) <MENU> button
- (D) <CAMERA> button

⚠ WARNING

Failure to follow the warnings and instructions for proper use of the Moving Object Detection system could result in serious injury or death.

- The MOD system is not a substitute for proper vehicle operation and is not designed to prevent contact with objects surrounding the vehicle. When maneuvering, always use the outside mirror and rearview mirror and turn and check the surroundings to ensure it is safe to maneuver.
- The system is deactivated at speeds above 5 MPH (8 km/h). It is reactivated at lower speeds.
- The MOD system is not designed to detect the surrounding stationary objects.

The Moving Object Detection (MOD) system can inform the driver of moving objects surrounding the vehicle when driving out of garages, maneuvering into parking lots and in other such instances.

The MOD system detects moving objects by using image processing technology on the image shown on the display.

MOD SYSTEM OPERATION

The MOD system will activate automatically under the following conditions:

- When the shift lever is in the R (Reverse) position. When the shift lever is moved to the R (Reverse) position to activate the Around View Monitor and MOD, the icons and the messages may not be displayed immediately.
- When the **<CAMERA>** button is pressed to switch from a different screen to the camera view on the display.
- When vehicle speed decreases below approximately 5 MPH (8 km/h).
- When the ignition switch is placed in the OFF position and then back to the ON position.

NOTE

- **The MOD system does not detect moving objects in the front-side view. The MOD icon is not displayed on the screen when in this view.**
- **While the parking sensor warning tone is sounding, the MOD system does not chime.**

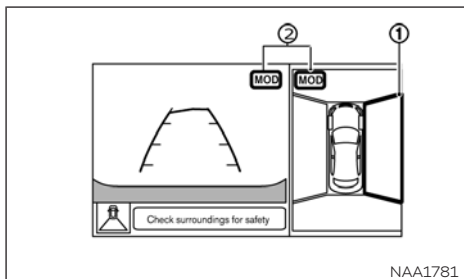

Bird's-eye view

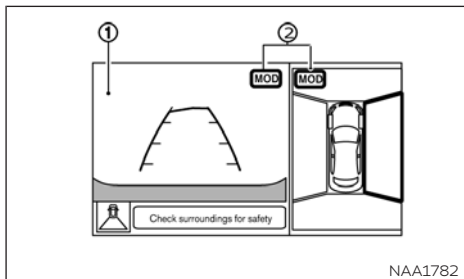

Front view / rear view

The MOD system operates in the following conditions when the camera view is displayed:

When the shift lever is in the R (Reverse) position and the vehicle speed is approximately 5 MPH (8 km/h) or less, the MOD system detects moving objects in the camera view. The MOD system will not operate if the lift gate is open.

When the MOD system detects moving objects near the vehicle, a chime will be heard and a yellow frame ① will be displayed on the monitor.

While the MOD system continues to detect moving objects, the yellow frame continues to be displayed.

The yellow frame ① is displayed on each view in the rear view modes.

A blue **<MOD>** icon is displayed in the view where the MOD system is operative. A gray MOD icon is displayed in the view where the MOD system is not operative.

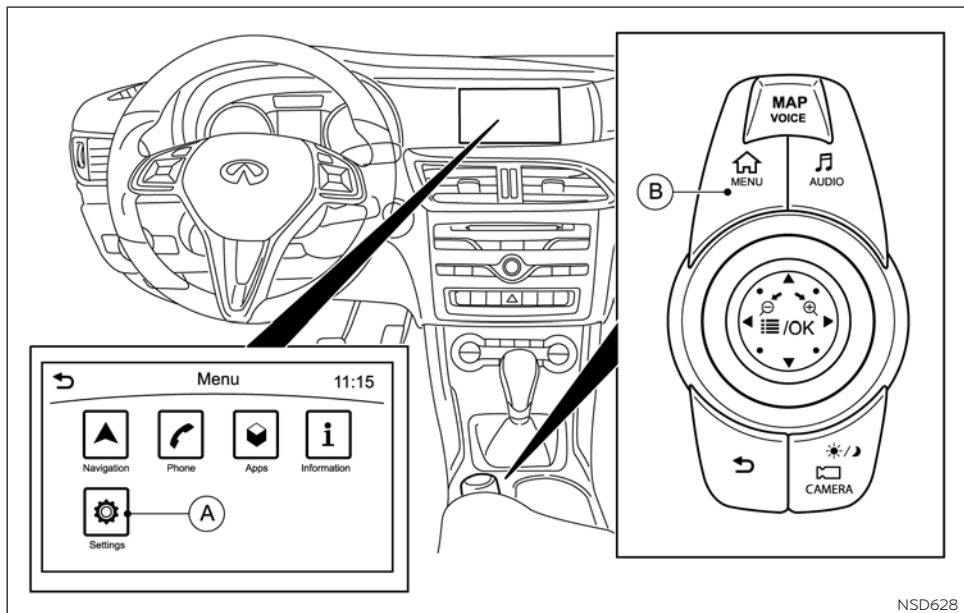

- Ⓐ [Settings] key
- Ⓑ <MENU> button

MOD SETTING

MOD system settings can be changed using the following procedure.

1. Push the <MENU> button Ⓑ on the INFINITI Controller and touch [Settings] Ⓐ in the vehicle information display.
2. Touch [Camera/Sonar]
3. Touch [Camera]
4. Touch [Moving Object Detection].
5. Turn the MOD system on/off.

MOD SYSTEM LIMITATIONS

⚠ WARNING

Listed below are the system limitations for MOD. Failure to operate the vehicle in accordance with these system limitations could result in serious injury or death.

- Do not use the MOD system when towing a trailer (if available). The system may not function properly.
- Excessive noise (for example, audio system volume or open vehicle window) will interfere with the chime sound, and it may not be heard.
- The MOD system performance will be limited according to environmental conditions and surrounding objects such as:
 - When there is low contrast between background and the moving objects.
 - When there is blinking source of light.

- When strong light such as another vehicle's headlight or sunlight is present.
- When camera orientation is not in its usual position, such as when mirror is folded.
- When there is dirt, water drops or snow on the camera lens.
- When the position of the moving objects in the display is not changed.

- The MOD system might detect something like flowing water droplets on the camera lens, white smoke from the muffler, moving shadows, etc.
- The MOD system may not function properly depending on the speed, direction, distance or shape of the moving objects.
- If your vehicle sustains damage to the parts where the camera is installed, leaving it misaligned or bent, the sensing zone may be altered and the MOD system may not detect objects properly.
- When the temperature is extremely high or low, the screen may not display objects clearly. This is not a malfunction.

MOD MALFUNCTION

The blue MOD icon will change to orange if one of the following has occurred

- When the system is malfunctioning.
- When the component temperature reaches a high level (icon will blink).

If the icon light continues to illuminate orange, have the MOD system checked. It is recommended you visit an INFINITI retailer for this service.

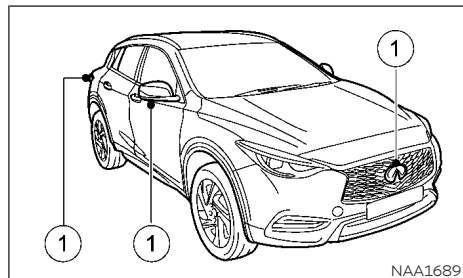

SYSTEM MAINTENANCE

⚠ CAUTION

- Do not use alcohol, benzine or thinner to clean the cameras. This will cause discoloration. To clean the cameras, wipe with a cloth dampened with diluted mild cleaning agent and then wipe with a dry cloth.
- Do not damage the cameras as the monitor screen may be adversely affected.

If dirt, rain or snow accumulates on any of the cameras ①, the MOD system may not operate properly. Clean the cameras by wiping with a cloth dampened with a diluted mild cleaning agent and then wiping with a dry cloth.

VENTILATORS

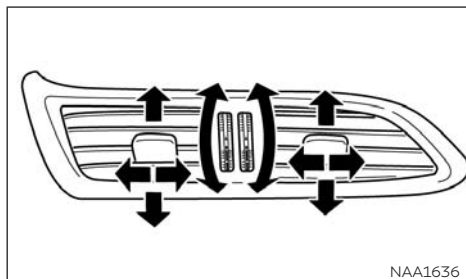

Center

CENTER VENTILATORS

Open/close the ventilators by turning the control wheel.

Adjust the air flow direction of the ventilators by moving the center knob (up/down, left/right) until the desired position is achieved.

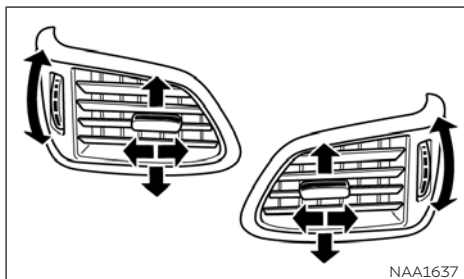

Side

SIDE VENTILATORS

Open/close the ventilators by turning the control wheel.

Adjust the air flow direction of the ventilators by moving the center knob (up/down, left/right) until the desired position is achieved.

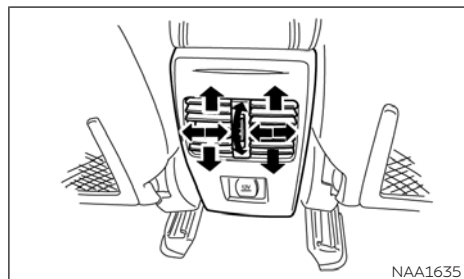

Rear

REAR VENTILATORS (IF EQUIPPED)

Open/close the ventilators by turning the control wheel.

Adjust the air flow direction of the ventilators by moving the center knob (up/down, left/right) until the desired position is achieved.

HEATER AND AIR CONDITIONER

WARNING

- The heater and air conditioner operate only when the engine is running.
- Never leave children or adults who would normally require the support of others alone in the vehicle. Pets should not be left alone either. They could unknowingly activate switches or controls and inadvertently become involved in a serious accident and injure themselves. On hot, sunny days, temperatures in a closed vehicle could quickly become high enough to cause severe or possibly fatal injuries to people or animals.
- Do not use the recirculation mode for long periods as it may cause the interior air to become stale and the windows to fog up.
- Do not adjust the heating and air conditioning controls while driving so that full attention may be given to vehicle operation.

The heater and air conditioner operate when the engine is running. The air blower will operate even if the engine is turned off and the ignition switch is in the ON position.

NOTE

- **Condensation forms inside the air conditioning unit when the air conditioner (if equipped) is running, and is safely discharged underneath your vehicle.**

Traces of water on the ground are therefore normal.

- **Odors from inside and outside the vehicle can build up in the air conditioner unit. Odor can enter the passenger compartment through the ventilators.**

When parking, set the heater and air conditioner controls to turn off air recirculation to allow fresh air into the passenger compartment. This should help reduce odors inside the vehicle.

Observe the settings recommended on the following pages. The windows could otherwise mist up. To prevent the windows from misting up

- Switch off climate control only briefly.
- Switch on air-recirculation mode only briefly.
- Switch on the cooling with air dehumidification function.
- Switch on the windshield demisting function briefly, if required.

The air-conditioning system/automatic climate control regulates the temperature and the humidity of the vehicle interior and filters undesirable substances from the air.

The air-conditioning system/automatic climate control can only be operated when the engine is running. Optimum operation is only achieved with the side windows closed.

Always keep the ventilation flaps behind the side panelling clear. Otherwise the vehicle will not be ventilated correctly.

NOTE

- **Ventilate the vehicle for a brief period during warm weather. This will speed up the cooling process and the desired interior temperature will be reached more quickly.**
- **The integrated filter filters out most particles of dust and soot and completely filters out pollen. With automatic climate control, gaseous pollutants and odors will also be reduced. A clogged filter reduces the amount of air supplied to the vehicle interior. For this reason, you should always observe the interval for replacing the filter, which is specified in the Service Booklet. As this depends on environmental conditions, for example heavy air pollution, the interval may be shorter than stated in the Service Booklet.**

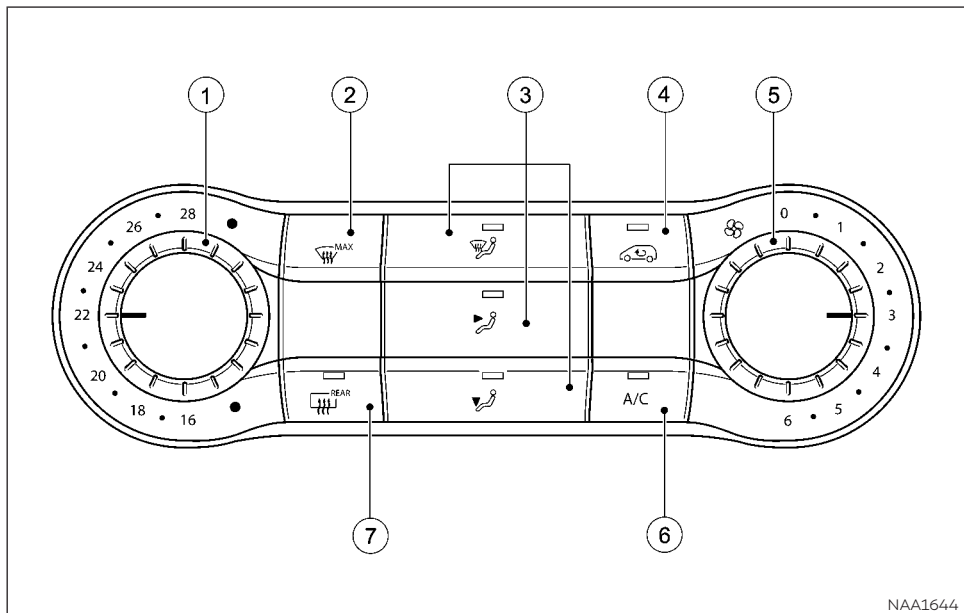

AIR CONDITIONING SYSTEM

- ① Sets the temperature
- ② De-ices/defogs the windshield
- ③ Set the air distribution
- ④ Activates/deactivates air-recirculation mode

- ⑤ Sets the airflow
- ⑥ Activates/deactivates cooling with air dehumidification
- ⑦ Switches the rear window defroster on/off

4-30 Display screen, heater and air conditioner, and audio system





Operating tips

A number of tips and recommendations for optimum use of the air-conditioning system are listed below:

- Switch on the air-conditioning system by turning control knob ⑤ clockwise to the desired position (except position 0)
- Set the temperature to 70° F (22° C)
- Recommendation for avoiding misted windows at low exterior temperatures or in rain: switch on the A/C cooling with dehumidification function. Set air distribution to and if possible switch off and . Deactivate air-recirculation mode .

Set airflow control ⑤ to a setting between 3 and 6.

- Recommendation for rapid cooling or heating of the vehicle interior: briefly set airflow control ⑤ to a setting between 3 and 6.
- Recommendation for a constant vehicle interior temperature: set airflow control ⑤ to a setting between 1 and 3.

- Recommendation for air distribution in winter: select the  and  settings. Recommendation for air distribution in summer: select the  or  and  settings.
- Only use the "Windshield demisting" function briefly until the windshield is clear again
- Only use air-recirculation mode briefly, for example if there are unpleasant outside odors or when in a tunnel. The windows could otherwise mist up as no fresh air is drawn into the vehicle in air-recirculation mode
- If you change the settings of the climate control system, the climate status display appears for approximately three seconds at the bottom of the screen in the central display (see separate operating instructions). You will see the current settings of the various climate control functions.

Switching air-conditioning system on/off

Make sure the ignition switch is in the ON position.

To switch on: turn control  clockwise to the desired position (except position **0**).

To switch off: turn control  counterclockwise to position **0**.

Activating/deactivating the cooling with air dehumidification function

If you deactivate the "Cooling with air dehumidification" function, the air inside the vehicle will not be cooled. The air inside the vehicle will also not be dehumidified. The windows can mist up more quickly. Therefore, only deactivate the "Cooling with air dehumidification" function briefly.



The "Cooling with air dehumidification" function is only available when the engine is running. The air inside the vehicle is cooled and dehumidified according to the temperature selected.

Condensation may drip from the underside of the vehicle when cooling mode is active. This is normal and not a sign that there is a malfunction.

To activate:

Press the  button. The indicator light in the  button lights up.

To deactivate:

Press the  button. The indicator light in the  button goes out. The cooling with air dehumidification function has a delayed switch-off feature.

Problems with the "Cooling with air dehumidification" function:

Problem: The indicator light in the  button flashes three times or remains off. The cooling with air dehumidification function cannot be activated.



Cause and solution: The cooling with air dehumidification function has been deactivated due to a malfunction. Have the system checked. It is recommended you visit an INFINITI retailer for this service.

Setting the temperature

You can set the temperature for the entire vehicle. The set temperature is automatically maintained at a constant level.

To increase or reduce the temperature: turn control  counterclockwise or clockwise. Only change the temperature setting in small increments. Start at 70° F (22° C).



Setting the air distribution

-  Directs the airflow through the demister ventilators.
-  Directs the airflow through the center and side air ventilators.
-  Directs the airflow through the footwell air ventilators.

NOTE

- You can also activate several of the air distribution settings simultaneously. In order to do this, press several of the air distribution buttons. The air is then routed through different air ventilators.
- Regardless of the air distribution setting, airflow is always directed through the side air ventilators. The side air ventilators can only be closed if the adjusters are turned clockwise until they engage.

To set air distribution:

1. Make sure the engine is running.
2. Press one or more of the , , or  buttons. The corresponding indicator light comes on.

Setting the airflow

1. Make sure the ignition switch is in the ON position.
2. To increase or reduce airflow: turn control ⑤ counterclockwise or clockwise.

Defogging the windshield

You can use this function to de-ice the windshield or to defog the inside of the windshield and the side windows.

NOTE

You should only select the "Windshield demisting" function until the windshield is clear again.

Activating the "Windshield demisting" function:

Make sure the ignition switch is in the ON position.

To activate: press the  button. The indicator light in the  button lights up.



The climate control system switches to the following functions:

- High airflow
- High temperature
- Air distribution to the windshield and front side windows
- Air-recirculation mode off

NOTE

- The "Windshield demisting" function automatically sets the blower output to the optimum demisting effect. As a result, the airflow may increase or decrease automatically after the  button is pressed.
- You can adjust the blower output manually while the "Windshield demisting" function is in operation. Turn airflow control ⑤ counterclockwise or clockwise.

Deactivating the "Windshield demisting" function:



Press the  button. The indicator light in the  button goes out. The previous settings are reactivated. Air-recirculation mode remains deactivated.

or

Turn temperature control ① counterclockwise or clockwise.

Defogging the windows



Windows misted up on the inside:

1. Activate the  "Cooling with air dehumidification" function.
2. If the windows continue to mist up, activate the  "Windshield demisting" function.

NOTE

You should only select this setting until the windshield is clear again.

Windows misted up on the outside:

1. Activate the windshield wipers.
2. Set the air distribution to  or .

NOTE

You should only select this setting until the windows are clear again.

Air recirculation mode

You can deactivate the flow of fresh air if unpleasant odors are entering the vehicle from outside. The air already inside the vehicle will then be recirculated.

If you activate air-recirculation mode, the windows can mist up more quickly, in particular at low temperatures. Only use air recirculation mode briefly to prevent the windows misting up.

Activating air recirculation mode:

Make sure the ignition switch is in the ON position.

Press the  button. The indicator light in the  button lights up.

Deactivating air recirculation mode:

Press the  button. The indicator light in the  button goes out.

NOTE

Air-recirculation mode is deactivated automatically:

- **After approximately five minutes at outside temperatures below approximately 45° F (7°C).**
- **After approximately five minutes if the "Cooling with air dehumidification" function is deactivated.**
- **After approximately 30 minutes at outside temperatures above approximately 45° F (7°C) if the cooling with air dehumidification function is activated.**

Idle Stop/Start function

During automatic engine switch-off, the Climate control only operates at a reduced capacity. If you require the full climate control output, you can switch off the Idle Stop/Start function by pressing the Idle Stop/Start button (see "Idle Stop/Start System (if equipped)").

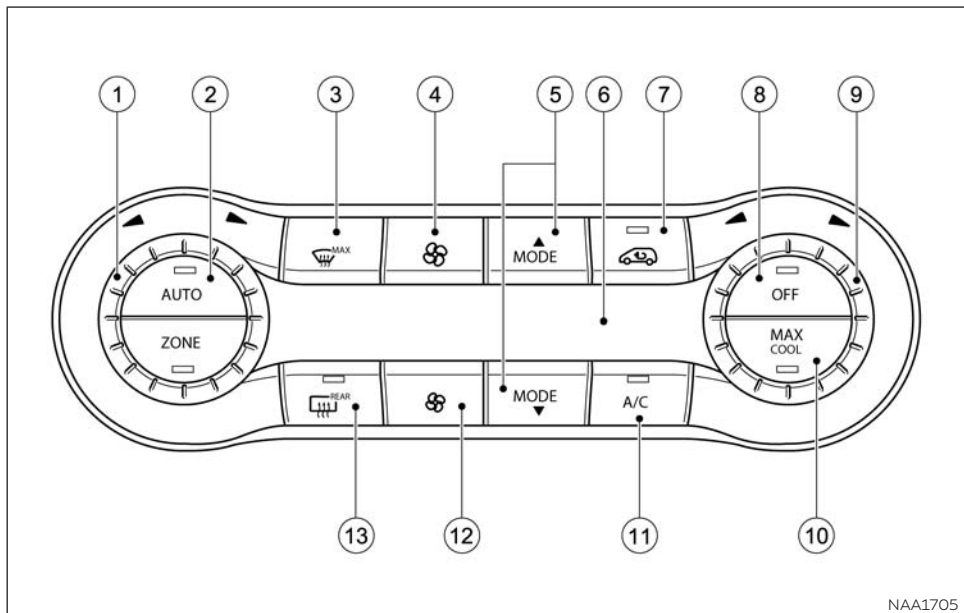

AUTOMATIC CLIMATE CONTROL (2-ZONE)

- ① Sets the temperature, left
- ② Sets climate control to automatic mode
- ③ Demists the windshield

- ④ Increases the airflow
- ⑤ Sets the air distribution
- ⑥ Display
- ⑦ Activates/deactivates air-recirculation mode
- ⑧ Switches climate control on/off
- ⑨ Sets the temperature, right

- ⑩ Activates/deactivates the Max Cool function
- ⑪ Activates/deactivates cooling with air dehumidification
- ⑫ Reduces the airflow
- ⑬ Switches the rear window heating on/off
- ⑭ Switches the ZONE function on/off

Operating tips

A number of tips and recommendations to enable you to get the most out of your automatic climate control are listed below:

- Activate climate control using the **AUTO** and **A/C** buttons. The indicator lights in the **AUTO** and **A/C** buttons light up.
- Set the temperature to 70° F (22° C)
- Only use the "Windshield demisting" function briefly until the windshield is clear again.
- Only use air-recirculation mode briefly, for example if there are unpleasant outside odors or when in a tunnel. The windows could otherwise mist up as no fresh air is drawn into the vehicle in air-recirculation mode
- Use the **ZONE** function to adopt the temperature settings on the driver's side for the front-passenger side as well. The indicator light in the **ZONE** button goes out.

- If you change the settings of the climate control system, the climate status display appears for approximately three seconds at the bottom of the screen in the center display (see separate operating instructions). You will see the current settings of the various climate control functions.

Idle Stop/Start function

During automatic engine switch-off, the Climate control only operates at a reduced capacity. If you require the full climate control output, you can switch off the Idle Stop/Start function by pressing the Idle Stop/Start button (see "Idle Stop/Start System (if equipped)").

Switching automatic climate control on/off

When the climate control is switched off, the air supply and air circulation are also switched off. The windows could mist up. Therefore, only switch off climate control briefly.

Make sure the ignition switch is in the ON position.

To activate:

Press the **AUTO** button. The indicator light in the **AUTO** button lights up. Airflow and air distribution are set to automatic mode.

or

Press the **OFF** button. The indicator light in the **OFF** button goes out. The previous settings are reactivated.

To deactivate:

Press the **OFF** button. The indicator light in the **OFF** button lights up.

NOTE

Automatic climate control: switch on climate control primarily using the **AUTO button.**

Activating/deactivating the cooling with air dehumidification function

If you deactivate the "Cooling with air dehumidification" function, the air inside the vehicle will not be cooled. The air inside the vehicle will also not be dehumidified. The windows can mist up more quickly. Therefore, only deactivate the "Cooling with air dehumidification" function briefly.

The "Cooling with air dehumidification" function is only available when the engine is running. The air inside the vehicle is cooled and dehumidified according to the temperature selected.

Condensation may drip from the underside of the vehicle when cooling mode is active. This is normal and not a sign that there is a malfunction.

To activate:

Press the **A/C** button. The indicator light in the **A/C** button lights up.

To deactivate:

Press the **A/C** button. The indicator light in the **A/C** button goes out. The cooling with air dehumidification function has a delayed switch-off feature.

Problems with the "Cooling with air dehumidification" function:

Problem: The indicator light in the **A/C** button flashes three times or remains off. The cooling with air dehumidification function cannot be activated.

Cause and solution: The cooling with air dehumidification function has been deactivated due to a malfunction. Have the system checked. It is recommended you visit an INFINITI retailer for this service.

Setting automatic climate control to automatic mode

Only automatic climate control features the "Control climate control automatically" function.

In automatic mode, the set temperature is maintained automatically at a constant level.

The system automatically regulates the temperature of the dispensed air, the airflow and the air distribution.

The automatic mode functions optimally when the "Cooling with air dehumidification" function is activated. If desired, cooling with air dehumidification can be deactivated.

If you deactivate the "Cooling with air-dehumidification" function, the air inside the vehicle will not be cooled. The air inside the vehicle will also not be dehumidified. The windows can mist up more quickly. Therefore, only deactivate the "Cooling with air-dehumidification" function briefly.

To set climate control to automatic mode:

Make sure the ignition switch is in the ON position.

Set the desired temperature.

To activate: press the **AUTO** button. The indicator light in the **AUTO** button lights up. Automatic air distribution and airflow are activated.

To switch to manual mode: press the **MODE**  or **MODE**  button

or



Press the  or  button. The indicator light in the **AUTO** button goes out. Automatic air distribution and airflow are deactivated.

4-36 Display screen, heater and air conditioner, and audio system

Setting the temperature

Different temperatures can be set for the driver's and front-passenger sides. The set temperature is automatically maintained at a constant level.

Make sure the ignition switch is in the ON position.

To increase or reduce temperature: turn control  or  counterclockwise or clockwise. Only change the temperature setting in small increments. Start at 70° F (22° C).

Setting the air distribution



Directs the airflow through the demister ventilators.



Directs the airflow through the center and side air ventilators.



Directs the airflow through the footwell air ventilators.



Directs the airflow through the center and side air ventilators as well as the footwell air ventilators.



Directs the airflow through the center and side air ventilators as well as the demister ventilators.



Directs the airflow through the footwell and demister ventilators.





Directs the airflow through the demister ventilators, the center and side air ventilators as well as the footwell air ventilators.



NOTE

Regardless of the air distribution setting, airflow is always directed through the side air ventilators. The side air ventilators can only be closed if the adjusters are turned clockwise until they engage.

To set the air distribution:

1. Make sure the engine is running.
2. Press the **MODE**  or **MODE**  button repeatedly until the desired symbol appears in the display.

Setting the airflow

1. Make sure the ignition switch is in the ON position.
2. To increase or reduce airflow: press the  or  button.

Switching the ZONE function on/off

This function is only available with automatic climate control.

To activate: press the **ZONE** button. The indicator light in the **ZONE** button lights up. The temperature setting for the driver's side is not adopted for the front-passenger side.

To deactivate: press the **ZONE** button. The indicator light in the **ZONE** button goes out.

The temperature setting for the driver's side is adopted for the front-passenger side.

Defogging the windshield

You can use this function to de-ice the windshield or to defog the inside of the windshield and the side windows.

NOTE

You should only select the "Windshield demisting" function until the windshield is clear again.

Activating the "Windshield demisting" function:



Make sure the ignition switch is in the ON position.

To activate: press the  button. The indicator light in the  button lights up.



The climate control system switches to the following functions:

- High airflow
- High temperature
- Air distribution to the windshield and front side windows
- Air-recirculation mode off

NOTE

- **The "Windshield demisting" function automatically sets the blower output to the optimum demisting effect. As a result, the airflow may increase or decrease automatically after the  button is pressed.**
- **You can adjust the blower output manually while the "Windshield demisting" function is in operation. Press the  or  button.**

Deactivating the "Windshield demisting" function:



Press the  button. The indicator light in the  button goes out. The previous settings are reactivated. Air-recirculation mode remains deactivated.

or

Turn temperature control  or  counter-clockwise or clockwise.

Defogging the windows

Windows misted up on the inside:



1. Activate the  "Cooling with air dehumidification" function.
2. Activate automatic mode .

3. If the windows continue to mist up, activate the  "Windshield demisting" function.

NOTE

You should only select this setting until the windshield is clear again.

Windows misted up on the outside:

1. Activate the windshield wipers.
2. Set the air distribution to  or .

NOTE

You should only select this setting until the windows are clear again.

Air recirculation mode

You can deactivate the flow of fresh air if unpleasant odors are entering the vehicle from outside. The air already inside the vehicle will then be recirculated.

If you activate air-recirculation mode, the windows can mist up more quickly, in particular at low temperatures. Only use air recirculation mode briefly to prevent the windows misting up.

Activating air recirculation mode:

Make sure the ignition switch is in the ON position.

Press the  button. The indicator light in the  button lights up.

Air-recirculation mode is activated automatically at high outside temperatures or high levels of pollution. When air-recirculation mode is activated automatically, the indicator light in the  button is not lit. Outside air is added after about 30 minutes.

Deactivating air recirculation mode:

Press the  button. The indicator light in the  button goes out.

NOTE

Air-recirculation mode is deactivated automatically:

- **After approximately five minutes at outside temperatures below approximately 45° F (7°C).**
- **After approximately five minutes if the "Cooling with air dehumidification" function is deactivated.**
- **After approximately 30 minutes at outside temperatures above approximately 45° F (7°C) if the cooling with air dehumidification function is activated.**

SERVICING AIR CONDITIONER

WARNING

The air conditioner system contains refrigerant under high pressure. To avoid personal injury, any air conditioner service should be done only by an experienced technician with the proper equipment.

The air conditioner system in your vehicle is charged with a refrigerant designed with the environment in mind.

This refrigerant will not harm the earth's ozone layer.

Special charging equipment and lubricant are required when servicing your vehicle's air conditioner. Using improper refrigerants or lubricants will cause severe damage to the air conditioner system. (See "Air conditioner system refrigerant and oil recommendations".)

An INFINITI retailer will be able to service your environmentally friendly air conditioner system.

Air conditioner filter

The air conditioner system is equipped with an air conditioner filter. To make sure the air conditioner heats, defogs, and ventilates efficiently, replace the filter in accordance with the specified maintenance intervals listed in the separate maintenance booklet. It is recommended you visit an INFINITI retailer for this service.

The filter should be replaced if the air flow decreases significantly or if windows fog up easily when operating the heater or air conditioner.

ANTENNA

In addition to the roof mounted antenna (where fitted) there is an antenna pattern printed inside the rear window.

CAUTION

- **Do not place metalised film near the rear window glass or attach any metal parts to it. This may cause poor reception or noise.**
- **When cleaning the inside of the rear window, be careful not to scratch or damage the rear window antenna. Lightly wipe along the antenna with a dampened soft cloth.**

CAR PHONE OR CB RADIO

When installing large capacity wireless equipment or a car phone in your vehicle, be sure to observe the following cautions, otherwise the new equipment adversely affect the electronic control modules and electronic control system harness.

WARNING

- **A cellular phone should not be used for any purpose while driving so full attention may be given to vehicle operation. Some jurisdictions prohibit the use of cellular phones while driving.**
- **If you must make a call while your vehicle is in motion, the hands-free cellular phone operational mode (if so equipped) is highly recommended. Exercise extreme caution at all times so full attention may be given to vehicle operation.**
- **If a conversation in a moving vehicle requires you to take notes, pull off the road to a safe location and stop your vehicle before doing so.**

CAUTION

- **Keep the antenna as far as possible away from the electronic control modules.**
- **Also keep the antenna wire more than 8 inches (20 cm) away from the electronic control system harness. Do not route the antenna wire next to any harness.**
- **Adjust the antenna standing-wave ratio as recommended by the manufacturer.**
- **Connect the ground wire from the CB radio chassis to the body.**
- **For details it is recommended you visit an INFINITI retailer.**

MEMO

5 Starting and driving

Precautions when starting and driving	5-2	Driving with Automatic Transmission	5-18
Exhaust gas (carbon monoxide)	5-2	Parking brake	5-27
Three-way catalyst (if equipped)	5-2	Applying/releasing manually	5-27
Tire Pressure Monitoring System (TPMS).	5-3	Applying automatically (vehicles with automatic transmission)	5-28
On pavement and off-road driving precautions	5-8	Releasing automatically	5-28
Avoiding collision and rollover	5-8	Emergency braking	5-28
Off-road recovery	5-9	Idle Stop/Start System (if equipped)	5-29
Rapid air pressure loss	5-9	Automatic engine switch-off	5-29
Drinking alcohol/drugs and driving	5-10	Automatic engine start	5-30
Driving safety precautions	5-10	Deactivating/activating the Idle Stop/Start function	5-30
All-wheel drive (AWD) driving safety precautions (if so equipped).	5-12	Lane departure warning (LDW) system (if equipped)	5-31
Infiniti Vehicle Immobilizer system.	5-13	LDW system operation	5-32
Ignition switch	5-13	How to enable/disable the LDW system	5-33
Key positions	5-13	LDW system limitations	5-33
Push-button ignition switch (if equipped)	5-14	LDW system temporarily unavailable.	5-35
Key positions with the push-button ignition switch	5-15	System malfunction	5-35
Removing the start/stop button.	5-15	System maintenance	5-36
Emergency engine shut off	5-16	Blind Spot Warning (BSW) system (if equipped).	5-36
Before starting engine	5-16	BSW system operation	5-38
Starting engine.	5-16	How to enable/disable the BSW system	5-40
Starting procedure with the key	5-16	BSW system limitations	5-40
Starting procedure using the push-button ignition switch (if equipped).	5-17	System temporarily unavailable	5-45
Driving the vehicle.	5-18	Radar maintenance.	5-46
		FCC Notice.	5-46

Cruise control	5-46	Canceling IPA	5-75
Cruise control operations	5-47	Camera Aiding Sonar (parking sensor) function (if equipped)	5-76
Intelligent Cruise Control (ICC) system (Full speed range) (if equipped)	5-49	Sonar function overview	5-77
ICC system operation	5-50	Range of the sensors	5-81
ICC switch (cruise control lever)	5-51	Sonar function OFF switch	5-81
ICC system display and indicators	5-52	Sonar function settings	5-82
Operating ICC	5-53	Sonar function limitations	5-82
ICC Limitations	5-56	Problems with sonar function	5-83
Tips for driving with the ICC system	5-58	System maintenance	5-84
System temporarily unavailable	5-60	Break-in schedule	5-84
System maintenance	5-62	Fuel efficient driving tips	5-85
Forward emergency braking (FEB) system (if equipped)	5-62	Increasing fuel economy	5-86
FEB system operation	5-63	Four-Wheel Drive (4WD) (if equipped)	5-86
Turning the FEB system on/off	5-66	Parking	5-87
FEB system limitations	5-67	Switching off the engine	5-88
System temporarily unavailable	5-67	Extended parking	5-89
System maintenance	5-68	Electric power steering system	5-89
FCC Notice	5-69	Brake system	5-90
Active sound enhancement	5-69	Brake precautions	5-90
Active sound enhancement	5-70	Anti-lock Braking System (ABS)	5-91
Intelligent Parking Assist (IPA) (if equipped)	5-70	Vehicle Dynamic Control (VDC) system	5-92
Important safety notes	5-70	Traction Control System (TCS)	5-94
Detecting parking spaces	5-71	Characteristics of VDC	5-94
Parking	5-73	EBD (electronic brake force distribution)	5-95
Exiting a parking space	5-74	Steer Control	5-95
		Hill Start Assist (HSA)	5-95

Cold weather driving5-96
Freeing a frozen door lock5-96
Antifreeze.5-96
Battery.5-96

Draining of engine coolant5-96
Tire equipment.5-96
Special winter equipment5-97
Driving on snow or ice5-97

PRECAUTIONS WHEN STARTING AND DRIVING

WARNING

- Never leave children or adults who would normally require the support of others alone in your vehicle. Pets should not be left alone either. They could unknowingly activate switches or controls and inadvertently become involved in a serious accident and injure themselves. On hot, sunny days, temperatures in a closed vehicle could quickly become high enough to cause severe or possibly fatal illness to people or animals.
- Properly secure all cargo to help prevent it from sliding or shifting. Do not place cargo higher than the seatbacks. In a sudden stop or collision, unsecured cargo could cause personal injury.
- To avoid raising the center of gravity excessively, do not exceed the rated capacity of the roof rack (if so equipped) and evenly distribute the load.

EXHAUST GAS (CARBON MONOXIDE)

WARNING

- Do not breathe exhaust gas; it contains colorless and odorless carbon monoxide. Carbon monoxide is dangerous. It can cause unconsciousness or death.
- If you suspect that exhaust fumes are entering the vehicle, drive with all windows fully open, and have the vehicle inspected immediately.
- Do not run the engine in closed spaces such as a garage.
- Do not park the vehicle with the engine running for an extended period of time.
- Keep the lift gate closed while driving, otherwise exhaust gas could be drawn into the passenger compartment. If you must drive with the lift gate open, follow these precautions:
 - Open all the windows.
 - Turn the air recirculation switch off and set the fan control to the highest level to circulate the air.

- If electrical wiring or other cable connections must pass to a trailer through the seal on the lift gate or body, follow the manufacturer's recommendations to prevent carbon monoxide entry into the vehicle.
- The exhaust system and body should be inspected by a qualified mechanic whenever:
 - You suspect that exhaust fumes are entering into the passenger compartment.
 - You notice a change in the sound of the exhaust system.
 - You have had an accident involving damage to the exhaust system, underbody, or rear of the vehicle.

THREE-WAY CATALYST (IF EQUIPPED)

The three-way catalyst is an emission control device installed in the exhaust system. Exhaust gas in the three-way catalyst is burned at high temperatures to help reduce pollutants.

WARNING

- The exhaust gas and the exhaust system are very hot. Keep people, animals and flammable materials away from the exhaust system components.
- Do not stop or park the vehicle over flammable materials such as dry grass, wastepaper or rags. They may ignite and cause a fire.

CAUTION

- Do not use leaded gasoline. (See "Recommended fluids/lubricants and capacities".) Deposits from leaded gasoline seriously reduce the ability of the three-way catalyst to help reduce exhaust pollutants and/or damage the three-way catalyst.
- Keep your engine tuned up. Malfunctions in the ignition, fuel injection, or electrical systems may cause overrich fuel to flow into the three-way catalyst, causing it to overheat. Do not keep driving if the engine misfires, or if noticeable loss of performance or other unusual operating conditions are detected. Have the vehicle inspected promptly. It is rec-

ommended you visit an INFINITI retailer for this service.

- **Avoid driving with an extremely low fuel level. Running out of fuel could cause the engine to misfire, damaging the three-way catalyst.**
- **Do not race the engine while warming it up.**
- **Do not push or tow your vehicle to start the engine.**

TIRE PRESSURE MONITORING SYSTEM (TPMS)

Each tire, including the spare (if present), should be checked monthly when cold and inflated to the inflation pressure recommended by the vehicle manufacturer on the vehicle placard or tire inflation pressure label. (If your vehicle has tires of a different size than the size indicated on the vehicle placard or tire inflation pressure label, you should determine the proper tire inflation pressure for those tires.)

As an added safety feature, your vehicle has been equipped with a tire pressure monitoring system (TPMS) that illuminates a low tire pressure telltale when one or more of your

tires is significantly under-inflated. Accordingly, when the low tire pressure telltale illuminates, you should stop and check your tires as soon as possible, and inflate them to the proper pressure. Driving on a significantly under-inflated tire causes the tire to overheat and can lead to tire failure. Under-inflation also reduces fuel efficiency and tire tread life, and may affect the vehicle's handling and stopping ability.

Please note that the TPMS is not a substitute for proper tire maintenance, and it is the driver's responsibility to maintain correct tire pressure, even if under-inflation has not reached the level to trigger illumination of the TPMS low tire pressure telltale.

Your vehicle has also been equipped with a TPMS malfunction indicator to indicate when the system is not operating properly. The TPMS malfunction indicator is combined with the low tire pressure telltale. When the system detects a malfunction, the telltale will flash for approximately one minute and then remain continuously illuminated. This sequence will continue upon subsequent vehicle start-ups as long as the malfunction exists. When the malfunction indicator is illuminated, the system may not be able to detect or signal low tire pressure as intended. TPMS

malfunctions may occur for a variety of reasons, including the installation of replacement or alternate tires or wheels on the vehicle that prevent the TPMS from working properly. Always check the TPMS telltale after replacing one or more tires or wheels on your vehicle to ensure that the replacement or alternate tires and wheels allow the TPMS to continue to function properly.

The vehicle's wheels have sensors fitted that monitor the tire pressures in all four tires. The tire pressure monitor warns you if the pressure drops in one or more of the tires. The tire pressure monitor only functions if the corresponding sensors are fitted to all wheels.

Information on tire pressures is shown in the vehicle information display. After a few minutes of driving, the current tire pressure of each tire is shown in the [Serv.] menu of the vehicle information display.

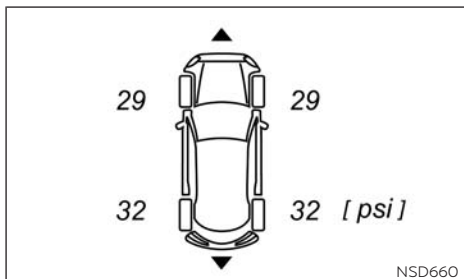

WARNING

- **Radio waves could adversely affect electrical medical equipment. Those who use a pacemaker should contact their electrical medical equipment manufacturer for the possible influences before use.**
- **If the low tire pressure warning light illuminates or a tire pressure-related warning is displayed by the vehicle information display while driving, avoid sudden steering maneuvers or abrupt braking, reduce vehicle speed, pull off the road to a safe location and stop the vehicle as soon as possible. Driving with under-inflated tires may permanently damage the tires and increase the likelihood of tire failure. Serious vehicle damage could occur and may lead to an accident and could result in serious personal injury. Check the tire pressure for all four tires. Adjust the tire pressure to the recommended COLD tire pressure shown on the tire and loading information label to turn the low tire pressure warning light OFF. If you have a flat tire, replace it with a replacement tire as soon as possible.**
- **If a replacement wheel is fitted without an INFINITI TPMS Sensor, the TPMS will not function and the low tire pressure warning light will flash for approximately 1 minute. The light will remain on after 1 minute. It is recommended you contact an INFINITI retailer as soon as possible for tire replacement and/or system resetting.**
- **For models with run-flat tires, although you can continue driving with a punctured run-flat tire, remember that vehicle handling stability is reduced, which could lead to an accident and personal injury. Also, driving a long distance at high speeds may damage the tires.**
 - **Do not drive at speeds above 50 MPH (80 km/h) and do not drive more than approximately 93 miles (150 km) with a punctured run-flat tire. The actual distance the vehicle**

can be driven on a flat tire depends on outside temperature, vehicle load, road conditions and other factors.

- If you detect any unusual sounds or vibrations while driving with a punctured run-flat tire, pull off the road to a safe location and stop the vehicle as soon as possible. The tire may be seriously damaged and need to be replaced.
- Replacing tires with those not originally specified by INFINITI could affect the proper operation of the TPMS.
- If you used Emergency Tire Sealant to repair a minor tire puncture, the TPMS sensor should be checked when repairing or replacing the tire (for models equipped with the emergency tire puncture repair kit). It is recommended you visit an INFINITI retailer for this service.
- INFINITI recommends using only INFINITI Genuine Emergency Tire Sealant provided with your vehicle. Other tire sealants may damage the valve stem seal which can cause the tire to lose air pressure (for models equipped with the emergency tire puncture repair kit).

CAUTION

- **The TPMS may not function properly when the wheels are equipped with snow chains or the wheels are buried in snow.**
- **Do not place metallized film or any metal parts (antenna, etc.) on the windows. This may cause poor reception of the signals from the tire pressure sensors, and the TPMS will not function properly.**

It is the driver's responsibility to set the tire pressure to the recommended cold tire pressure suitable for the operating situation (see "Wheels and tires"). Note that the correct tire pressure for the current operating situation must first be taught-in to the tire pressure monitor (see "Restarting TPMS" later in this section).

If there is a substantial loss of pressure, the warning threshold for the warning message is aligned to the reference values taught-in. Restart the tire pressure monitor after adjusting to the cold tire pressure. The current pressures are saved as new reference values. This will ensure that a warning message will only appear if the tire pressure drops significantly.

The tire pressure monitor does not warn you of an incorrectly set tire pressure.

TPMS is not able to warn you of a sudden loss of pressure, e. g. if the tire is penetrated by a foreign object. In the event of a sudden loss of pressure, bring the vehicle to a halt by braking carefully. Avoid abrupt steering maneuvers.

TPMS has a yellow warning light in the combination meter for indicating a pressure loss or malfunction. Depending on how the warning light flashes or lights up, a tire pressure that is too low or a malfunction in TPMS is indicated:

- If the warning light is lit continuously, the tire pressure on one or more tires is significantly too low. TPMS is not malfunctioning.
- If the warning light flashes for around a minute and then remains lit constantly, the TPMS is malfunctioning.

In addition to the warning light, a message appears in the vehicle information display. Observe the information on display messages (see "Safety systems")

It may take up to ten minutes for a malfunction of the tire pressure monitor to be indicated. A malfunction will be indicated by the

tire pressure warning light flashing for approximately one minute and then remaining lit. When the fault has been rectified, the tire pressure warning light goes out after you have driven for a few minutes.

The tire pressure values indicated by the vehicle information display may differ from those measured at a filling station using a pressure gauge. The tire pressures shown by the vehicle information display are those measured at sea level. At high altitudes, the tire pressure values indicated by a pressure gauge are higher than those shown by the vehicle information display. In this case, do not reduce the tire pressures.

The operation of the tire pressure monitor can be affected by interference from radio transmitting equipment (e.g. radio head phones, two-way radios) that may be being operated in or near the vehicle.

5-6 Starting and driving

Checking the tire pressure electronically

1. Make sure that the ignition switch is in the ON position.
2. Press the ◀ or ▶ button on the steering wheel to select the [Serv.] menu.
3. Press the ▲ or ▼ button to select [Tire Pressure].
4. Press <OK> to confirm.

The current tire pressure for each wheel will be displayed in the vehicle information display.

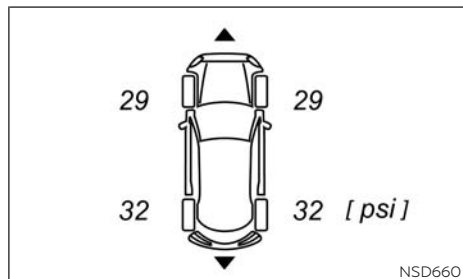

If the vehicle was parked for longer than 20 minutes, the [Tire pressures will be displayed after driving a few minutes] message is shown.

After a teach-in period, the tire pressure monitor automatically detects new wheels or new sensors. If a clear allocation of tire pressure to individual wheels is not possible, the Tire pressure monitor active message is shown instead of the tire pressure display. The tire pressures are already being monitored.

If a replacement wheel is fitted, for a few minutes the system may continue to show the tire pressure of the wheel that has been removed. If this occurs, note that the value displayed for the position where the replacement wheel is fitted is not the same as the current tire pressure of the replacement wheel.

Tire Pressure Monitoring System warning messages

If the tire pressure monitor detects a pressure loss in one or more tires, a warning message is shown in the vehicle information display and the yellow tire pressure monitor warning light comes on.

- If the [Please Correct Tire Pressure] (yellow) message appears in the vehicle information display, the tire pressure in at least one tire is too low and must be corrected at the next opportunity. If the system detects that new sensors have been fitted (IDs do not match those stored, and the pressure is not feasible, or is less than 14% under the norm then the [Please Correct Tire Pressure] message will be displayed in white.
- If the [Check Tires] (red) message appears in the vehicle information display, the tire pressure in one or more tires has dropped significantly and the tires must be checked.
- If the [Warning Tire Malfunction] (red) message appears in the vehicle information display, the tire pressure in one or more tires has dropped suddenly and the tires must be checked.

- If the [Tire Press. Sensor(s) Missing] message appears in the vehicle information display, one or more sensors are missing or cannot be detected. This could be the result of fitting a replacement wheel/tire.

Observe the instructions and safety notes in the display messages in the vehicle information display.

If the wheel positions on the vehicle are interchanged, the tire pressures may be displayed for the wrong positions for a short time. After a few minutes of driving, this is rectified and the tire pressures are displayed for the correct positions.

Restarting TPMS

To keep the TPMS functioning properly, the restart operation must be performed in the following cases:

- When the tire pressure is adjusted
- When a tire or a wheel is replaced
- When the tires are rotated

When you restart the tire pressure monitor, all existing warning messages are deleted and the warning lights go out. The monitor uses the currently set tire pressures as the reference values for monitoring. In most

cases, the tire pressure monitor will automatically detect the new reference values after you have changed the tire pressure. However, you can also define reference values manually as described here. The tire pressure monitor then monitors the new tire pressure values.

Perform the following procedures to restart the TPMS.

NOTE

Before restarting, make sure that the tire pressures are set properly on all four tires for the respective operating conditions. The recommended tire pressures can be found in the tire pressure placard on the driver' door pillar.

1. Make sure that the ignition switch is in the ON position.
2. Press the ◀ or ▶ button on the steering wheel to select the [Serv.] menu.
3. Press the ▲ or ▼ button to select [Tire Pressure].
4. Press <OK> to confirm.

The vehicle information display shows the current tire pressure for each tire or the [Tire pressures will be displayed after driving a few minutes] message.

If you wish to confirm the restart:

5. Press <OK> to confirm.

The [Tire Press. Monitor Restarted] message appears in the vehicle information display.

After you have driven for a few minutes, the system checks whether the current tire pressures are within the specified range. The new tire pressures are then accepted as reference values and monitored.

If you wish to cancel the restart:

6. Press the  button.

The tire pressure values stored at the last restart will continue to be monitored.

FCC Notice:

For USA:

This device complies with Part 15 of the FCC Rules. Operation is subject to the following two conditions: (1) This device may not cause harmful interference, and (2) this device must accept any interference received, including interference that may cause undesired operation.

5-8 Starting and driving

NOTE

Changes or modifications not expressly approved by the party responsible for compliance could void the user's authority to operate the equipment.

For Canada:

This device complies with Industry Canada license-exempt RSS standard(s). Operation is subject to the following two conditions: (1) this device may not cause interference, and (2) this device must accept any interference, including interference that may cause undesired operation of the device.

ON PAVEMENT AND OFF-ROAD DRIVING PRECAUTIONS

Utility vehicles have a significantly higher rollover rate than other types of vehicles.

They have higher ground clearance than passenger cars to make them capable of performing in a variety of on-pavement and off-road applications. This gives them a higher center of gravity than ordinary vehicles. An advantage of higher ground clearance is a better view of the road, allowing you to anticipate problems. However, they are not designed for cornering at the same speeds as conventional 2-wheel drive vehicles any more than low-slung sports cars are designed to perform satisfactorily under off-road condi-

tions. If at all possible, avoid sharp turns at high speeds. As with other vehicles of this type, failure to operate this vehicle correctly may result in loss of control or vehicle rollover. In a rollover crash, an unbelted person is significantly more likely to die than a person wearing a seat belt.

For additional information, refer to "Driving safety precautions" later in this section.

AVOIDING COLLISION AND ROLLOVER

WARNING

Failure to operate this vehicle in a safe and prudent manner may result in loss of control or an accident.

Be alert and drive defensively at all times. Obey all traffic regulations. Avoid excessive speed, high speed cornering, or sudden steering maneuvers, because these driving practices could cause you to lose control of your vehicle.

As with any vehicle, loss of control could result in a collision with other vehicles or objects or cause the vehicle to roll over, particularly if the loss of control causes the vehicle to slide sideways. Be attentive at all times, and avoid driving when tired. Never

drive when under the influence of alcohol or drugs (including prescription or over-the-counter drugs which may cause drowsiness). Always wear your seat belt as outlined in the "Safety – Seats, seat belts and supplemental restraint system" section of this manual, and also instruct your passengers to do so.

Seat belts help reduce the risk of injury in collisions and rollovers. **In a rollover crash, an unbelted or improperly belted person is significantly more likely to be injured or killed than a person properly wearing a seat belt.**

OFF-ROAD RECOVERY

While driving, the right side or left side wheels may unintentionally leave the road surface. If this occurs, maintain control of the vehicle by following the procedure below. Please note that this procedure is only a general guide. The vehicle must be driven as appropriate based on the conditions of the vehicle, road and traffic.

1. Remain calm and do not overreact.
2. Do not apply the brakes.
3. Maintain a firm grip on the steering wheel with both hands and try to hold a straight course.

4. When appropriate, slowly release the accelerator pedal to gradually slow the vehicle.
5. If there is nothing in the way, steer the vehicle to follow the road while vehicle speed is reduced. Do not attempt to drive the vehicle back onto the road surface until vehicle speed is reduced.
6. When it is safe to do so, gradually turn the steering wheel until both tires return to the road surface. When all tires are on the road surface, steer the vehicle to stay in the appropriate driving lane.

If you decide that it is not safe to return the vehicle to the road surface based on vehicle, road or traffic conditions, gradually slow the vehicle to a stop in a safe place off the road.

RAPID AIR PRESSURE LOSS

Rapid air pressure loss or a "blow-out" can occur if the tire is punctured or is damaged due to hitting a curb or pothole. Rapid air pressure loss can also be caused by driving on under-inflated tires.

Rapid air pressure loss can affect the handling and stability of the vehicle, especially at highway speeds.

Help prevent rapid air pressure loss by maintaining the correct air pressure and visually inspect the tires for wear and damage. For additional information, refer to "Wheels and tires" in the "Maintenance and do-it-yourself" section of this manual. If a tire rapidly loses air pressure or "blows-out" while driving, maintain control of the vehicle by following the procedure below. Please note that this procedure is only a general guide. The vehicle must be driven as appropriate based on the conditions of the vehicle, road and traffic.

WARNING

The following actions can increase the chance of losing control of the vehicle if there is a sudden loss of tire air pressure. Losing control of the vehicle may cause a collision and result in personal injury.

- **The vehicle generally moves or pulls in the direction of the flat tire.**
- **Do not rapidly apply the brakes.**
- **Do not rapidly release the accelerator pedal.**
- **Do not rapidly turn the steering wheel.**

1. Remain calm and do not overreact.

2. Maintain a firm grip on the steering wheel with both hands and try to hold a straight course.
3. When appropriate, slowly release the accelerator pedal to gradually slow the vehicle.
4. Gradually steer the vehicle to a safe location off the road and away from traffic if possible.
5. Lightly apply the brake pedal to gradually stop the vehicle.
6. Turn on the hazard warning flashers and contact a roadside emergency service to change the tire. For additional information, refer to "Flat tire".

DRINKING ALCOHOL/DRUGS AND DRIVING

WARNING

Never drive under the influence of alcohol or drugs. Alcohol in the bloodstream reduces coordination, delays reaction time and impairs judgement. Driving after drinking alcohol increases the likelihood of being involved in an accident injuring yourself and others. Additionally, if you are injured in an accident, alcohol can increase the severity of the injury.

INFINITI is committed to safe driving. However, you must choose not to drive under the influence of alcohol. Every year thousands of people are injured or killed in alcohol-related accidents. Although the local laws vary on what is considered to be legally intoxicated, the fact is that alcohol affects all people differently and most people underestimate the effects of alcohol.

Remember, drinking and driving don't mix! And that is true for drugs, too (over-the-counter, prescription, and illegal drugs). Don't drive if your ability to operate your vehicle is impaired by alcohol, drugs, or some other physical condition.

DRIVING SAFETY PRECAUTIONS

Your INFINITI is designed for both normal and off-road use. However, avoid driving in deep water or mud as your INFINITI is mainly designed for leisure use, unlike a conventional off-road vehicle.

Remember that 2-wheel drive vehicles are less capable than all-wheel drive (AWD) models for rough road driving and extrication when stuck in deep snow or mud, or the like.

Please observe the following precautions:

WARNING

- **Spinning the front wheels on slippery surfaces may cause the AWD warning message to display and the AWD system to automatically switch from the AWD to 2WD mode. This could reduce the traction. Be especially careful when towing a trailer. (AWD models)**
- **Drive carefully when off the road and avoid dangerous areas. Every person who drives or rides in this vehicle should be seated with their seat belt fastened. This will keep you and your passengers in position when driving over rough terrain.**
- **Do not drive across steep slopes. Instead drive either straight up or straight down the slopes. Off-road vehicles can tip over sideways much more easily than they can forward or backward.**
- **Many hills are too steep for any vehicle. If you drive up them, you may stall. If you drive down them, you may not be able to control your speed. If you drive across them, you may roll over.**

- Do not shift gears while driving on downhill grades as this could cause loss of control of the vehicle.
- Stay alert when driving to the top of a hill. At the top there could be a drop-off or other hazard that could cause an accident.
- If your engine stalls or you cannot make it to the top of a steep hill, never attempt to turn around. Your vehicle could tip or roll over. Always back straight down in R (Reverse) gear and apply brakes to control your speed.
- Heavy braking going down a hill could cause your brakes to overheat and fade, resulting in loss of control and an accident. Apply brakes lightly and use a low gear to control your speed.
- Unsecured cargo can be thrown around when driving over rough terrain. Properly secure all cargo so it will not be thrown forward and cause injury to you or your passengers.
- Secure heavy loads in the cargo area as far forward and as low as possible. Do not equip the vehicle with tires larger than specified in this manual. This could cause your vehicle to roll over.

- Do not grip the inside or spokes of the steering wheel when driving off-road. The steering wheel could move suddenly and injure your hands. Instead drive with your fingers and thumbs on the outside of the rim.
- Before operating the vehicle, ensure that the driver and all passengers have their seat belts fastened.
- Always drive with the floor mats in place as the floor may become hot.
- Lower your speed when encountering strong crosswinds. With a higher center of gravity, your INFINITI is more affected by strong side winds. Slower speeds ensure better vehicle control.
- Do not drive beyond the performance capability of the tires, even with AWD engaged.
- For AWD equipped vehicles, do not attempt to raise two wheels off the ground and shift the transmission to any drive or reverse position with the engine running. Doing so may result in drivetrain damage or unexpected vehicle movement which could result in serious vehicle damage or personal injury.

- Do not attempt to test an AWD equipped vehicle on a 2-wheel dynamometer (such as the dynamometers used by some states for emissions testing), or similar equipment even if the other two wheels are raised off the ground. Make sure you inform test facility personnel that your vehicle is equipped with AWD before it is placed on a dynamometer. Using the wrong test equipment may result in drivetrain damage or unexpected vehicle movement which could result in serious vehicle damage or personal injury.
- When a wheel is off the ground due to an unlevel surface, do not spin the wheel excessively.
- Accelerating quickly, sharp steering maneuvers or sudden braking may cause loss of control.
- If at all possible, avoid sharp turning maneuvers, particularly at high speeds. Your INFINITI vehicle has a higher center of gravity than a passenger car. The vehicle is not designed for cornering at the same speeds as passenger cars. Failure to operate this vehicle correctly could result in loss of control and/or a rollover accident.

- Always use tires of the same type, size, brand, construction (bias, bias-belted, or radial), and tread pattern on all four wheels. Install tire chains on the front wheels when driving on slippery roads and drive carefully.
- Be sure to check the brakes immediately after driving in mud or water. .
- Avoid parking your vehicle on steep hills. If you get out of the vehicle and it rolls forward, backward or sideways, you could be injured.
- Whenever you drive off-road through sand, mud or water as deep as the wheel hub, more frequent maintenance may be required. For additional information, refer to "Maintenance schedules".

ALL-WHEEL DRIVE (AWD) DRIVING SAFETY PRECAUTIONS (IF SO EQUIPPED)

WARNING

- Replacing tires with those not originally specified by INFINITI could affect the proper operation of the TPMS.
- Always use tires of the same type, size, brand, construction (bias, bias-belted or radial), and tread pattern on all four wheels. Install tire chains on the front wheels when driving on slippery roads and drive carefully.
- This vehicle is not designed for off-road (rough road) use. Do not drive on sandy or muddy roads that tires may get stuck in.
- For AWD equipped vehicles, do not attempt to raise two wheels off the ground and shift the transmission to any D (Drive) or R (Reverse) position with the engine running. Doing so may result in drivetrain damage or unexpected vehicle movement which could result in serious vehicle damage or personal injury

- Do not attempt to test an AWD equipped vehicle on a 2-wheel dynamometer, (such as the dynamometers used by some states for emissions testing), or similar equipment even if the other two wheels are raised off the ground. Make sure you inform test facility personnel that your vehicle is equipped with AWD before it is placed on a dynamometer. Using the wrong test equipment may result in drivetrain damage or unexpected vehicle movement which could result in serious vehicle damage or personal injury.
- When a wheel is off the ground due to an unlevel surface, do not spin the wheel excessively.

INFINITI VEHICLE IMMOBILIZER SYSTEM

The INFINITI Vehicle Immobilizer System will not allow the engine to start without the use of the registered key.

If the engine fails to start using the registered key, it may be due to interference caused by another registered key, an automated toll road device or automated payment device on the key ring. Restart the engine using the following procedures:

1. Leave the ignition switch in the ON position for approximately 5 seconds.
2. Turn the ignition switch to the OFF or LOCK position and wait approximately 5 seconds.
3. Repeat Step 1 and 2 again.
4. Restart the engine while holding the device (which may have caused the interference) separate from the registered key.

If the no start condition re-occurs, INFINITI recommends placing the registered key on a separate key ring to avoid interference from other devices.

IGNITION SWITCH

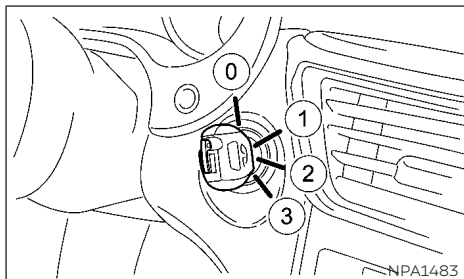

- ① OFF position
- ② ACC position
- ③ ON position
- ④ START position

⚠ WARNING

Never remove the key or turn the ignition switch to the OFF position while driving. The steering wheel will lock and could cause the driver to lose control of the vehicle. This could result in serious vehicle damage or personal injury.

⚠ CAUTION

Use electrical accessories with the engine running to avoid discharging the vehicle battery. If you must use accessories while the engine is not running, do not use them for extended periods of time and do not use multiple electrical accessories at the same time.

KEY POSITIONS

OFF (Normal parking position) ①

The ignition key can only be removed when in this position.

The steering lock can only be locked in this position.

ACC (Accessories)/ ②

The engine is turned off without locking the steering wheel. This position activates electrical accessories, such as the radio, when the engine is not running.

ON (Normal operating position) ③

This position turns on the ignition system and electrical accessories.

PUSH-BUTTON IGNITION SWITCH (IF EQUIPPED)

START ③

The engine starter activates and the engine will start. As soon as the engine has started, release the key immediately. It will return to the ON position.

NOTE

For vehicles fitted with Idle Stop/Start System:

When the engine is automatically stopped by the Idle Stop/Start System the ignition switch can still be operated as usual.

At the end of a journey turn the ignition OFF to avoid a discharged battery. The Idle Stop/Start System does not automatically turn ignition off.

Vehicles with Intelligent Key are equipped with keys featuring an integrated Intelligent Key function and in some cases a detachable push-button ignition switch (Start/Stop button).

A check which periodically establishes a radio connection between the vehicle and the key determines whether a valid key is in the vehicle. This occurs, for example, when starting the engine.

When you insert the push-button ignition switch into the ignition lock, the system needs approximately two seconds recognition time. You can then use the push-button ignition switch.

WARNING

Do not operate the push-button ignition switch while driving the vehicle except in an emergency. (The engine will stop when the ignition switch is pressed 3 consecutive times in quick succession or the ignition switch is pushed and held for more than 2 seconds.) If the engine stops while the vehicle is being driven, this could lead to a crash and serious injury.

Before operating the push-button ignition switch:

- Select P (Park).

Pressing the Start/Stop button several times in succession corresponds to the different key positions in the ignition lock. Prerequisite for this is that:

- You do not depress the brake pedal.

If you depress the brake pedal and press the Start/Stop button, the engine starts immediately.

To start the vehicle without actively using the key:

- The push-button ignition switch must be inserted in the ignition lock.
- The key must be in the vehicle.
- The vehicle must not be locked with the key or Intelligent Key (see "Keys").

Do not keep the Intelligent Key:

- With electronic devices, for example a mobile phone or another key.
- With metallic objects, for example coins or metal film.
- Inside metallic objects, for example a metal case.

This can affect the functionality of the Intelligent Key.

If you lock the vehicle with the key's remote control or with the Intelligent Key, after a short time:

- You will not be able to switch on the ignition with the push-button ignition switch.
- You will not be able to start the engine with the push-button ignition switch until the vehicle is unlocked again.

If you lock the vehicle centrally using the button on the front door (see "Locking with inside door knob"), you can continue to start the engine with the push-button ignition switch.

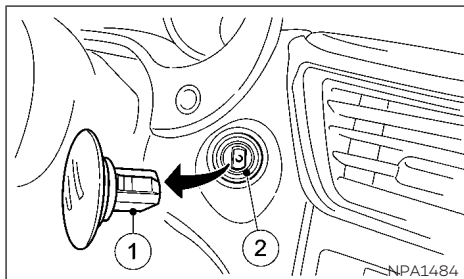

KEY POSITIONS WITH THE PUSH-BUTTON IGNITION SWITCH

- ① Start/Stop button
- ② Ignition lock

When you switch on the ignition, all of the indicator lights in the combination meter light up. For further information on situations where an indicator light either fails to go out after starting the engine or lights up while driving see "Warning lights, indicator lights and audible reminders".

If the push-button ignition switch ① has not yet been pressed, this corresponds to the key being removed from the ignition.

To switch on the power supply (accessory mode): press the push-button ignition switch ① once without depressing the brake pedal.

The power supply is switched on. You can now activate the windshield wipers, for example.

The power supply is switched off again if the driver's door is opened and you press the push-button ignition switch ① twice when in this position.

To switch on the ignition: press the push-button ignition switch ① twice without depressing the brake pedal. The ignition is switched on.

The ignition is switched off if the driver's door is opened and you press the push-button ignition switch ① when in this position.

REMOVING THE START/STOP BUTTON

You can remove the start/stop button from the ignition lock and start the vehicle as normal using the key.

You can only switch between push-button ignition switch mode and key operation when the vehicle is stationary.

You must also engage park position P (Park).

Remove the start/stop button ① from ignition lock ②.

BEFORE STARTING ENGINE

You do not have to remove the start/stop button from the ignition lock when you leave the vehicle. You should, however, always take the key with you when leaving the vehicle. As long as the key is in the vehicle:

- The vehicle can be started using the push-button ignition switch.
- The electrically powered equipment can be operated.

EMERGENCY ENGINE SHUT OFF

To shut off the engine in an emergency situation while driving, perform the following procedure:

- Rapidly push the push-button ignition switch 3 consecutive times in less than 1.5 seconds, or
- Push and hold the push-button ignition switch for more than 2 seconds.

- Make sure the area around the vehicle is clear.
- Check fluid levels such as engine oil, coolant, brake fluid, and windshield-washer fluid as frequently as possible, or at least whenever you refuel.
- Check that all windows and lights are clean.
- Visually inspect tires for their appearance and condition. Measure and check the tire pressure for proper inflation.
- Check that all doors are closed.
- Position seat and adjust head restraints/headrests.
- Adjust the inside and outside rear view mirrors.
- Fasten your seat belt and ask all passengers to do likewise.
- Check the operation of the warning lights when the ignition switch is pushed to the ON position.

STARTING ENGINE

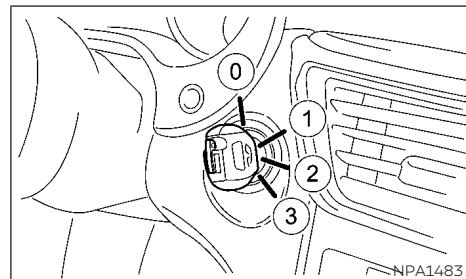

STARTING PROCEDURE WITH THE KEY

- ① OFF position
- ① ACC position
- ② ON position
- ③ START position

1. Apply the parking brake.
2. Shift the transmission to position P (Park) by pressing the <P> button.

The transmission position indicator in the vehicle information display shows <P>

When the transmission is in position N (Neutral), you can also start the engine with the brake pedal depressed.

The starter is designed not to operate if the shift lever is in any of the driving positions.

3. Turn the key to the START position ③ in the ignition lock and release it as soon as the engine is running.

If the engine is very hard to start because it is flooded, depress the accelerator pedal all the way to the floor and hold it. Turn the ignition switch to the START position to start cranking the engine. After 5 or 6 seconds, stop cranking by turning the ignition switch to OFF. After cranking the engine, release the accelerator pedal. Crank the engine with your foot off the accelerator pedal by depressing the brake pedal and turning the ignition switch to start the engine. If the engine starts, but fails to run, repeat the above procedure.

CAUTION

Do not operate the starter for more than 15 seconds at a time. If the engine does not start, turn the ignition key to the OFF position and wait 10 seconds before cranking again, otherwise the starter could be damaged.

4. Warm-up

Allow the engine to idle for at least 30 seconds after starting. Do not race the engine while warming it up. Drive at moderate speed for a short distance first, especially in cold weather. In cold weather, keep the engine running for a minimum of 2 - 3 minutes before shutting it off. Starting and stopping the engine over a short period of time may make the vehicle more difficult to start.

5. To stop the engine, Shift the transmission to position P (Park) by pressing the <P> button. and turn the ignition switch to the OFF position.

NOTE

Care should be taken to avoid situations that can lead to potential battery discharge and potential no-start conditions such as:

- **Installation or extended use of electronic accessories that consume battery power when the engine is not running (Phone chargers, GPS, DVD players, etc.)**
- **Vehicle is not driven regularly and/or only driven short distances. In these cases, the battery may need to be charged to maintain battery health.**

STARTING PROCEDURE USING THE PUSH-BUTTON IGNITION SWITCH (IF EQUIPPED)

The push-button ignition switch can be used to start the vehicle manually without inserting the key into the ignition lock. The key must be in the vehicle and the start/stop button must be inserted in the ignition lock (see "Removing the start/stop button" earlier in this section). This mode for starting the engine operates independently of the Idle Stop/Start automatic engine start function.

You can start the engine if a valid key is in the vehicle. Switch off the engine and always take the key with you when leaving the vehicle, even if you only leave it for a short time. Pay attention to the important safety notes.

- Depress the brake pedal and keep it depressed.
- Press the push button ignition switch once (see "Push-button ignition switch (if equipped)" earlier in this section). The engine starts.

DRIVING THE VEHICLE

DRIVING WITH AUTOMATIC TRANSMISSION

Driving precautions

- **Do not depress the accelerator pedal while shifting from P (Park) or N (Neutral) to R (Reverse), D (Drive), or M (Manual shift mode). Always depress the brake pedal until shifting is completed. Failure to do so could cause you to lose control and have an accident.**
- **Cold engine idle speed is high, so use caution when shifting into a forward or reverse gear before the engine has warmed up.**
- **Never shift to either the P (Park) or R (Reverse) position while the vehicle is moving forward and P (Park) or D (Drive) position while the vehicle is reversing. This could cause an accident or damage the transmission.**
- **Except in an emergency, do not shift to the N (Neutral) position while driving. Coasting with the transmission in the N (Neutral) position may cause serious damage to the transmission.**

WARNING

- **Do not downshift abruptly on slippery roads. this may cause a loss of control.**

CAUTION

- **To avoid possible damage to your vehicle; when stopping the vehicle on an uphill grade, do not hold the vehicle by depressing the accelerator pedal. The foot brake should be used for this purpose.**
- **Except in an emergency, do not shift to the N (Neutral) position while driving. Coasting with the transmission in the N (Neutral) position may cause serious damage to the transmission.**

Starting the vehicle

1. After starting the engine, fully depress the brake pedal before shifting the shift lever to R (Reverse), D (Drive) or Manual shift mode.
2. Keep the brake pedal depressed and push the shift lever to shift into a driving gear.
3. Release the parking brake and brake, then gradually put the vehicle in motion by pressing the accelerator pedal.

The automatic transmission is designed so that the brake pedal **MUST** be depressed before shifting from P (Park) to any drive position while the ignition switch is ON.

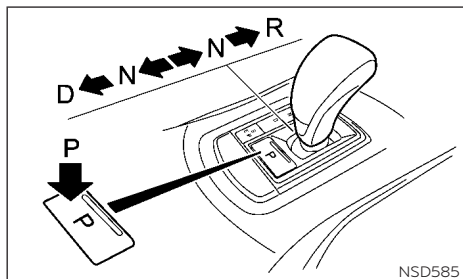

Shifting

- P Park position with parking lock
- R Reverse
- N Neutral
- D Drive

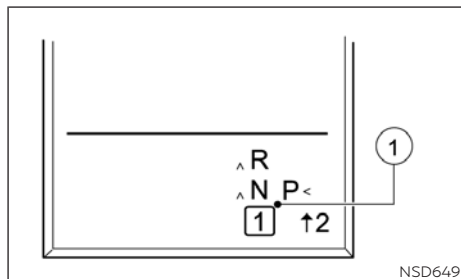

Transmission position display:

NOTE

If the transmission position display in the vehicle information display is not working, you should pull away carefully to check whether the desired transmission position IS engaged. Ideally, you should select transmission position D and automatic drive program E or S.

The shift lever indicator ① located in the lower part of the vehicle information display shows the current position of the transmission.

It shows the P,R,N,D modes when the transmission is in auto mode or the shift position when the transmission is in manual mode.

⚠ WARNING

Apply the parking brake if the shift lever is in any position while the engine is not running. Failure to do so could cause the vehicle to move unexpectedly or roll away and result in serious personal injury or property damage.

⚠ CAUTION

Use the P (Park) or R (Reverse) position only when the vehicle is completely stopped.

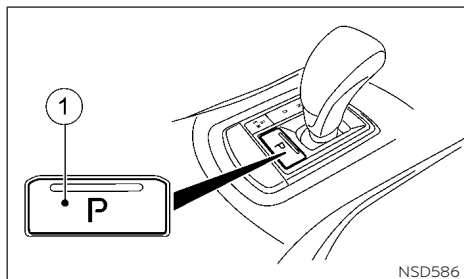

P (Park):

CAUTION

To prevent transmission damage, use the P (Park) position only when the vehicle is completely stopped.

Use this position when the vehicle is parked or when starting the engine. Always make sure that the vehicle is completely stopped before pressing button ① to engage the P (Park) position. For maximum safety, the brake pedal must be depressed before engaging the P (Park) position. Use this position together with the parking brake. When parking on a hill, first depress the brake pedal, apply the parking brake and then engage the P (Park) position. The parking lock should not be used as a brake when parking. In order to

secure the vehicle, always apply the electric parking brake in addition to the parking lock.

In the event of a malfunction of the vehicle's electronics, the transmission may lock in position P (Park). Have the vehicle electronics checked immediately. It is recommended you visit an INFINITI retailer for this service.

Park position P is automatically engaged if:

- You switch off the engine using the key and remove the key.
- You open the driver's door when the vehicle is stationary or driving at very low speed and the transmission is in position D (Drive) or R (Reverse).

R (Reverse):

CAUTION

To prevent transmission damage, use the R (Reverse) position only when the vehicle is completely stopped.

Use this position to back up the vehicle.

Make sure the vehicle is completely stopped before selecting the R (Reverse) position. **The brake pedal must be depressed and the shift lever button pushed in to move the shift lever from P (Park), N (Neutral) or any drive position to R (Reverse).**

N (Neutral):

Neither forward nor reverse gear is engaged. The engine can be started in this position. You may shift to N (Neutral) and restart a stalled engine while driving the vehicle.

D (Drive):

Use this position for all normal forward driving.

The automatic transmission changes gear automatically. All forward gears are available.

Changing gear

The automatic transmission shifts to the individual gears automatically when it is in transmission position D (Drive). Shifting is determined by:

- The selected drive program.
- The position of the accelerator pedal.
- The road speed.

Accelerator pedal position:

Your style of driving influences how the automatic transmission shifts gear:

- little throttle: early upshifts
- more throttle: late upshifts

Holding the vehicle stationary on uphill gradients

WARNING

If the transmission overheats, the electronic management system is automatically deactivated. This interrupts the power transmission from the engine to the wheels. The vehicle may, for example, roll backwards on gradients. There is a risk of an accident. Never hold the vehicle stationary on uphill gradients by depressing the accelerator.

The transmission may overheat if you hold the vehicle stationary on uphill gradients by depressing the accelerator pedal. If the transmission overheats, a warning tone sounds and the [Stop Vehicle Shift to P Leave Engine Running] display message appears in the vehicle information display. You will only be able to continue your journey once the transmission has cooled down and the display message in the vehicle information display has disappeared.

Never hold the vehicle stationary on uphill gradients by depressing the accelerator. Instead, only ever hold the vehicle stationary on uphill gradients by:

- Depressing the brake pedal.
- Engaging the electric parking brake.

Kickdown

Use kickdown for maximum acceleration:

- Depress the accelerator pedal beyond the pressure point.
The transmission shifts to a lower gear depending on the engine speed.
- Ease off the accelerator pedal once the desired speed is reached.
The automatic transmission shifts back up.

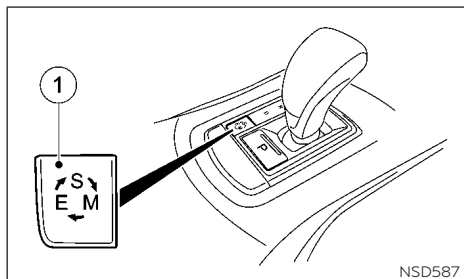

NSD587

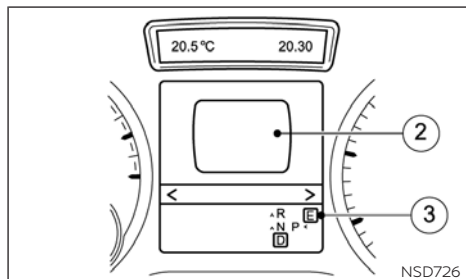

NSD726

Drive mode switch

The drive mode switch allows you to choose between drive programs with different driving characteristics.

Press drive mode switch ①. A popup ② will be displayed in the vehicle information display showing the current selection. After around 2 seconds, the selected drive program appears in the lower frame of the vehicle information display ③ and the popup will disappear.

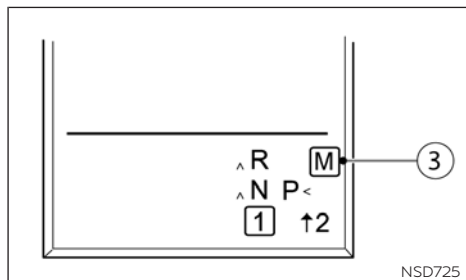

NSD725

The automatic transmission switches to drive program E each time the engine is started.

E (Economy): comfortable, economical driving

S (Sport): sporty driving style

M (Manual): manual gear shifting

For more details of the manual drive program see "Manual drive program" later in this section.

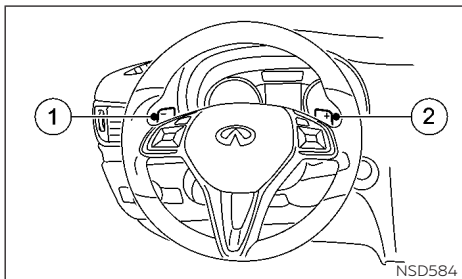

Steering wheel gearshift paddles

- ① Left steering wheel gearshift paddle (shifts down)
- ② Right steering wheel gearshift paddle (shifts up)

In drive program M, you can change gear yourself using the steering wheel gearshift paddles.

If you pull the left or right steering wheel gearshift paddle when in automatic drive program E or S, the automatic transmission shifts into drive program M for a limited time. Depending on which gearshift paddle is pulled, the automatic transmission immediately shifts into the next gear down or up.

Automatic drive programs

Drive program E is characterized by the following:

- Comfort-oriented engine settings.
- Optimal fuel consumption resulting from the automatic transmission shifting up sooner.
- The vehicle pulling away more gently in forward and reverse gears unless the accelerator pedal is depressed fully.
- Increased sensitivity. This improves handling on slippery road surfaces, for example.
- The automatic transmission shifting up sooner. This results in the vehicle being driven at lower engine speeds and the wheels being less likely to spin.

Drive program S is characterized by the following:

- Sporty engine settings.
- The automatic transmission shifting up later.
- As a result of the later automatic transmission shift points, the fuel consumption possibly being higher.

Manual drive program

In manual drive program M, you can change gear yourself by using the steering wheel gearshift paddles. For this, the transmission must be in position D (Drive). The gear currently selected and engaged is shown in the vehicle information display

Manual drive program M differs from drive programs E and S with regard to spontaneity, responsiveness and smoothness of gear changes.

Using manual gears:

- 3 To use the engine's braking effect
- 2 To use the braking effect of the engine on downhill gradients and for driving on steep mountain roads, in mountainous terrain or in arduous conditions.
- 1 To use the braking effect of the engine on extremely steep downhill gradients and on long downhill stretches.

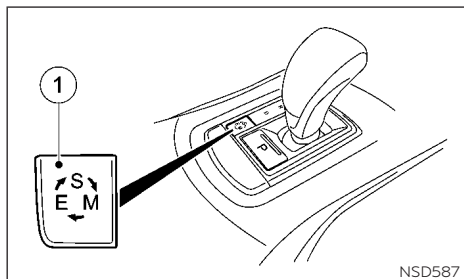

Activating the manual drive program:

- Permanently: Press the drive mode switch ① repeatedly until M appears in the vehicle information display. Manual drive program M remains active until drive program E or S is engaged.
- Temporarily: Pull the right or left steering wheel gearshift paddle (see "Steering wheel gearshift paddles" later in this section). Manual drive program M is temporarily active. Depending on which gearshift paddle is pulled, the automatic transmission immediately shifts into the next gear down or up.

When manual drive program M is activated via the steering wheel gearshift paddles, the temporarily active manual drive program M will be deactivated automatically after a lim-

ited time, if the driving situation permits. The automatic transmission switches to the previously activated drive program E or S. When driving on downhill gradients, the temporarily active manual drive program M will only be deactivated if the accelerator pedal is depressed while the vehicle is rolling downhill.

Upshifting:

Pull the right-hand steering wheel gearshift paddle (see "Steering wheel gearshift paddles" earlier in this section). The automatic transmission shifts up to the next gear.

In order to prevent engine damage the automatic transmission automatically shifts up if the maximum engine speed on the currently engaged gear is reached and you depress the accelerator pedal.

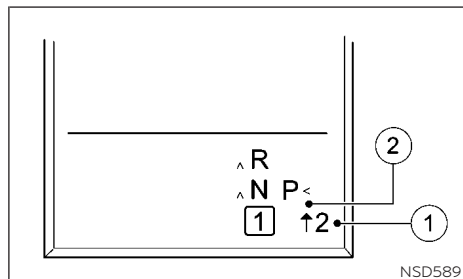

Gearshift recommendation:

The gearshift recommendations assist you in adopting an economical driving style. The recommended gear is shown in the vehicle information display.

Shift to recommended gear ① according to gearshift recommendation ② when shown in the vehicle information display.

Downshifting:

Pull the left-hand steering wheel gearshift paddle (see "Steering wheel gearshift paddles" earlier in this section). The automatic transmission shifts down to the next gear.

If you slow down or stop without shifting down, the automatic transmission automatically shifts down.

For maximum acceleration, pull the left-hand steering wheel gearshift paddle until the transmission selects the optimum gear for the current speed.

If the engine exceeds the maximum engine speed when shifting down, the automatic transmission protects against engine damage by not shifting down.

Kickdown:

You can also use kickdown for maximum acceleration in manual drive program M

- Depress the accelerator pedal beyond the pressure point. The transmission shifts to a lower gear depending on the engine speed.
- Shift back up once the desired speed is reached.

During kickdown, you cannot shift gears using the steering wheel gearshift paddles.

If you apply full throttle, the automatic transmission shifts up to the next gear when the maximum engine speed is reached. This prevents the engine from overrevving.

Deactivating the temporary manual drive program:

Pull and hold the right steering wheel gearshift paddle until the automatic transmission shifts into the last active automatic drive program E or S.

When manual drive program M is deactivated, the automatic transmission in automatic drive program E or S may shift from the current gear into a higher or lower gear. This is dependent on the position of the accelerator pedal, speed and load.

Problems with the transmission:

Problem	Possible causes/consequences and solutions
The transmission has problems shifting gear	The transmission is losing oil. Have the transmission checked immediately. It is recommended you visit an INFINITI retailer for this service.
The acceleration ability is deteriorating The transmission no longer shifts into all of the gears Reverse gear can no longer be engaged	The transmission is in emergency mode. <ul style="list-style-type: none">▪ Stop.▪ Shift the transmission to position P (Park).▪ Switch off the engine.▪ Wait at least ten seconds before restarting the engine.▪ Shift the transmission to position D (Drive).▪ Have the transmission checked immediately. It is recommended you visit an INFINITI retailer for this service.

PARKING BRAKE

WARNING

- **Be sure the parking brake is fully released before driving. Failure to do so can cause brake failure and lead to an accident.**
- **Do not release the parking brake from outside the vehicle.**
- **Do not use the shift lever in place of the parking brake. When parking, be sure the parking brake is fully engaged.**
- **To help avoid risk of injury or death through unintended operation of the vehicle and/or its systems, do not leave children, people who require the assistance of others, or pets unattended in your vehicle. Additionally, the temperature inside a closed vehicle on a warm day can quickly become high enough to cause a significant risk of injury or death to people and pets.**

The function of the electric parking brake is dependent on the on-board voltage. If the on-board voltage is low or if there is a malfunction in the system, it may not be possible to apply the released parking brake. If this is the case:

- Only park the vehicle on level ground and secure it to prevent it from rolling away.
- Shift the automatic transmission to position P (Park).
- It is recommended you contact an INFINITI retailer.

It may not be possible to release an applied parking brake if the on-board voltage is low or if there is a malfunction in the system. It is recommended you contact an INFINITI retailer.

The electric parking brake carries out a function check at regular intervals when the engine is switched off. Noises that occur are normal.

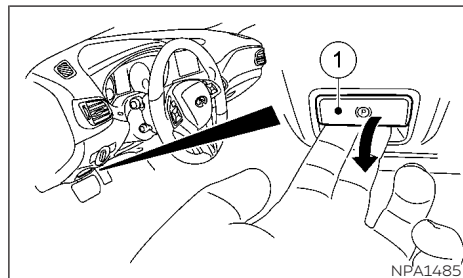

APPLYING/RELEASING MANUALLY

The electric parking brake can be applied or released by operating the parking brake handle ①.

To apply: Push handle ①.

When the electric parking brake is applied, the red **PARK** indicator light lights up in the combination meter.

The electric parking brake can also be applied when the ignition switch is in the OFF position or the key is removed.

To release: With the ignition switch in the ON position, pull handle ①.

Before driving, check that the brake warning light **PARK** goes out. For additional information, see "Warning lights, indicator lights and audible reminders".

The electric parking brake can only be released when the ignition switch is in the ON position.

APPLYING AUTOMATICALLY (VEHICLES WITH AUTOMATIC TRANSMISSION)

The electric parking brake is automatically applied if Intelligent Parking Assist (if equipped) is keeping the vehicle stationary.

The red **PARK** indicator light lights up in the combination meter.

The electric parking brake is not automatically applied if the engine is switched off by the Idle Stop/Start function.

RELEASING AUTOMATICALLY

The electric parking brake can only be released automatically in vehicles with automatic transmission.

The electric parking brake of your vehicle is released automatically when all of the following conditions are fulfilled:

- The engine is running.
- The transmission is in position D (Drive) or R (Reverse).
- The seat belt is fastened.
- You depress the accelerator pedal.

If the transmission is in position R, the lift gate must be closed.

If your seat belt is not fastened, the following conditions must be fulfilled to automatically release the electric parking brake:

- The driver's door is closed
- You have shifted out of transmission position P (Park) or you have previously driven faster than 2 MPH (3 km/h).

Ensure that you do not depress the accelerator pedal unintentionally. Otherwise, the parking brake will be released and the vehicle will start to move.

EMERGENCY BRAKING

The vehicle can also be braked during an emergency by using the electric parking brake.

While driving, push handle ① of the electric parking brake. The vehicle is braked as long as you keep handle ① of the electric parking brake pressed. The longer the electric parking brake handle ① is depressed, the greater the braking force.

During braking:

- A warning tone sounds.
- The [Please Release Parking Brake] message appears.
- The red **PARK** indicator light in the combination meter flashes.

When the vehicle has been braked to a standstill, the electric parking brake is applied.

IDLE STOP/START SYSTEM (IF EQUIPPED)

The Idle Stop/Start function switches the engine off automatically if the vehicle is stopped under certain conditions.

When pulling away again, the engine starts automatically. The Idle Stop/Start function thereby helps you to reduce the fuel consumption and emissions of your vehicle.

WARNING

If the engine is switched off automatically and you exit the vehicle, the engine is restarted automatically. The vehicle may begin moving. There is a risk of accident and injury.

If you wish to exit the vehicle, always turn off the ignition and secure the vehicle against rolling away.

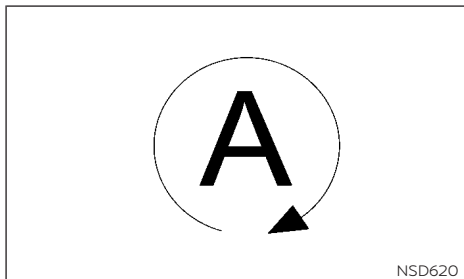

Idle Stop/Start symbol

If the  Idle Stop/Start symbol is shown in green in the vehicle information display, the Idle Stop/Start function switches the engine off automatically once the vehicle stops moving.

The Idle Stop/Start function is automatically activated each time you start the engine with the ignition switch.

If the Idle Stop/Start function has been manually deactivated (see "Deactivating/activating the Idle Stop/Start function" later in this section) or a malfunction has caused the system to be deactivated, the  Idle Stop/Start symbol is not displayed.

AUTOMATIC ENGINE SWITCH-OFF

The Idle Stop/Start function is operational and the  Idle Stop/Start symbol is displayed in green in the vehicle information display, if:

- The indicator light in the Idle Stop/Start button is lit green.
- The outside temperature is within the range that is suitable for the system.
- The engine is at normal operating temperature.
- The set temperature for the vehicle interior has been reached.
- The battery is sufficiently charged.
- The system detects that the windshield is not misted up when the air-conditioning system is switched on.
- The hood is closed.
- The driver's door is closed and the driver's seat belt is fastened.

If the conditions for automatic engine switch-off are not all fulfilled, the  Idle Stop/Start symbol is shown in yellow.

All of the vehicle's systems remain active when the engine is switched off automatically.

The engine can be switched off automatically a maximum of four times (initial stop, then three subsequent stops) in succession. The

Ⓐ Idle Stop/Start symbol is shown in yellow in the vehicle information display after the engine has been started automatically for the fourth time. When the Ⓐ Idle Stop/Start symbol is shown in green in the vehicle information display, automatic engine switch-off is again possible.

NOTE

If the hood is opened while the engine is running and the Idle Stop/Start function is operational, the engine will switch off automatically.

If the vehicle is brought to a standstill in D or N, the Idle Stop/Start function switches off the engine automatically.

AUTOMATIC ENGINE START

The engine is started automatically if:

- You switch off the Idle Stop/Start function by pressing the Idle Stop/Start button.
- You engage Reverse R or Drive D.
- You unfasten your seat belt or open the driver's door.

5-30 Starting and driving

- The vehicle starts to roll.
- The brake system requires this.
- The temperature in the vehicle interior deviates from the set range.
- The system detects air moisture on the windshield when the air-conditioning system is switched on.
- The battery's charge status is too low.

The engine is started automatically if you:

- Release the brake pedal in transmission position D (Drive) or N (Neutral).
- Depress the accelerator pedal.
- Move the transmission out of position P (Park).

Shifting the transmission to position P (Park) does not start the engine.

If you shift the transmission from R (Reverse) to D (Drive), the Idle Stop/Start function is available again once the Ⓐ Idle Stop/Start symbol reappears in green in the vehicle information display.

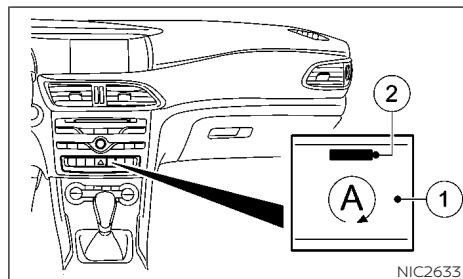

NIC2633

DEACTIVATING/ACTIVATING THE IDLE STOP/START FUNCTION

- **To deactivate:** press Idle Stop/Start button ①. Indicator light ② and the Ⓐ Idle Stop/Start symbol in the vehicle information display turn off.
- **To activate:** press Idle Stop/Start button ①. Indicator light ② lights up. If all conditions for automatic engine switch-off (see "Automatic engine switch-off" earlier in this section) are fulfilled, the Ⓐ Idle Stop/Start symbol is shown in green in the vehicle information display.

LANE DEPARTURE WARNING (LDW) SYSTEM (IF EQUIPPED)

If not all conditions for automatic engine switch-off are met, the **(A)** Idle Stop/Start symbol is lit yellow in the vehicle information display. If this is the case, the Idle Stop/Start function is not active.

If indicator light **(2)** on Idle Stop/Start button **(1)** is off, the Idle Stop/Start function has been deactivated manually or as the result of a malfunction. The engine will then not be switched off automatically when the vehicle stops.

⚠ WARNING

Failure to follow the warnings and instructions for proper use of the LDW system could result in serious personal injury or death. The LDW system will not steer the vehicle or prevent loss of control. It is the driver's responsibility to stay alert, drive safely, keep the vehicle in the traveling lane, and be in control of the vehicle at all times.

The LDW system warns the driver with a warning light and intermittent steering vibration that the vehicle is beginning to leave the traveling lane.

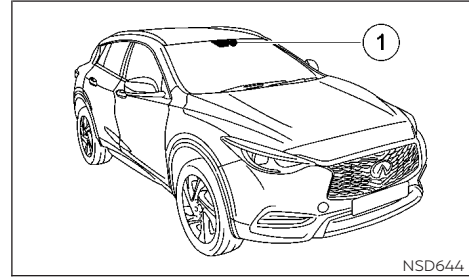

The LDW system uses a camera **(1)** installed behind the windshield to monitor the lane markers of your traveling lane.

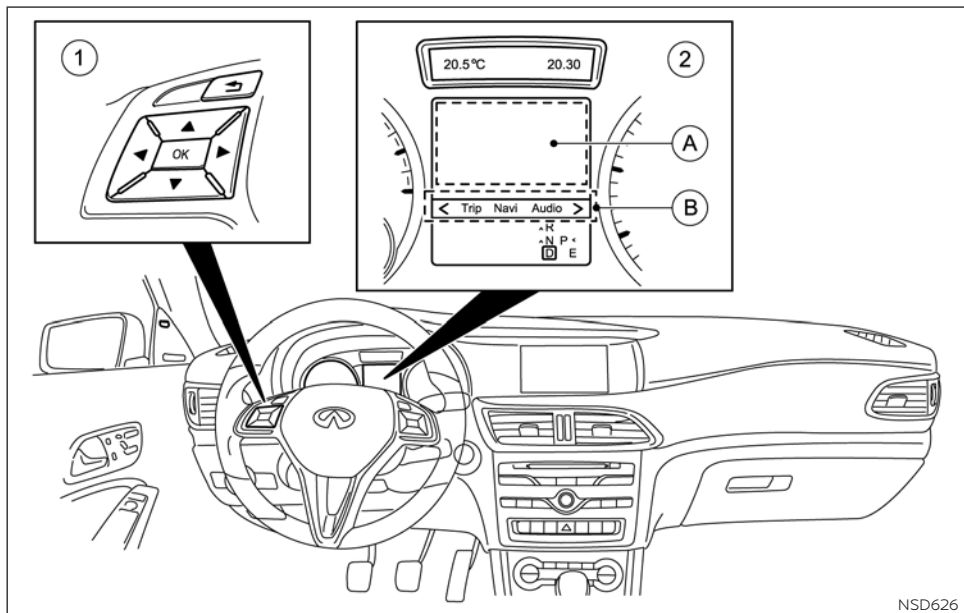

LDW SYSTEM OPERATION

- ① Steering wheel mounted controls
- ② Vehicle information display
- Ⓐ Display area
- Ⓑ Menu bar

The LDW system operates at speeds of approximately 40 MPH (60 km/h) and above, when the lane markings are clear.

If the system detects that the vehicle's front wheel has passed over the lane marking, a warning will be provided. It will warn you by means of intermittent vibration through the steering wheel for up to 1.5 seconds and a visual alert.

NOTE

The LDW system is designed not to warn when you operate the lane change signal and change traveling lanes in the direction of the signal.

No warning vibration occurs if you activate the turn signals. In this event, the warnings are suppressed for a certain period of time.

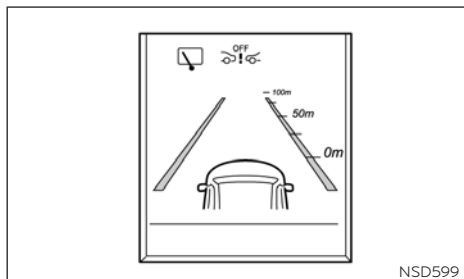

Assistance graphic

HOW TO ENABLE/DISABLE THE LDW SYSTEM

1. Press the ◀ or ▶ button on the steering wheel ① to select the [Drive-Assist] menu on the Menu bar ②.
2. Press the ▲ or ▼ button to select [Lane Departure Warning].
3. Press the <OK> button on the steering wheel ①. The current selection is displayed.
4. Press the <OK> to confirm.
5. Press the ▲ or ▼ button to set [Off], [Standard] or [Adaptive].

6. Press the <OK> button to save the setting. When the LDW is activated, the vehicle information display shows the lane markings as bright lines in the assistance graphic in the display area ③

When [Standard] is selected, no warning vibration occurs if:

- You have switched on the turn signals. In this event, the warnings are suppressed for a certain period of time.
- A driving safety system intervenes, such as ABS, brake assist system (BAS) or VDC.

When [Adaptive] is selected, no warning vibration occurs if:

- You have switched on the turn signals. In this case the warnings are suppressed for a certain period of time.
- A driving system intervenes, such as ABS, BAS or VDC.
- You accelerate forcefully.
- You brake forcefully.
- You steer actively, for example, swerve to avoid an obstacle or change lane quickly.
- You cut the corner on a sharp bend.

The system may detect certain conditions and warns you accordingly.

The warning vibration occurs earlier if:

- You approach the outer lane marking on a bend.
- The road has very wide lanes, for example, a freeway.
- The system detects solid lane markings.

The warning vibration occurs later if:

- The road has narrow lanes.
- You cut across a corner on a bend.

LDW SYSTEM LIMITATIONS

⚠ WARNING

Listed below are the system limitations for the LDW system. Failure to operate the vehicle in accordance with these system limitations could result in serious injury or death.

- **This system is only a warning device to inform the driver of a potential unintended lane departure. It will not steer the vehicle or prevent loss of control. It is the driver's responsibility to stay alert, drive safely, keep the vehicle in the traveling lane, and be in control of the vehicle at all times.**

- The system will not operate at speeds below approximately 40 MPH (60 km/h) or if it cannot detect lane markers.
- The LDW system is primarily intended for use on well-developed freeways or highways. It may not detect the lane markers in certain roads, weather or driving conditions.
- Do not use the LDW system under the following conditions as it may not function properly:
 - During bad weather (rain, fog, snow, etc.).
 - When driving on slippery roads, such as on ice or snow, etc.
 - When driving on winding or uneven roads.
 - When there is a lane closure due to road repairs.
 - When driving in a makeshift or temporary lane.
 - When driving on roads where the lane width is too narrow.
 - When driving without normal tire conditions (for example, tire wear, low tire pressure, installation of spare tire, tire chains, non-standard wheels).

- When the vehicle is equipped with non-original brake parts or suspension parts.
- The camera may not detect lane markers in the following situations and the LDW system may not operate properly.
 - On roads where there are multiple parallel lane markers; lane markers that are faded or not painted clearly; yellow painted lane markers; non-standard lane markers; or lane markers covered with water, dirt, snow, etc.
 - On roads where the discontinued lane markers are still detectable.
 - On roads where there are sharp curves.
 - On roads where there are sharply contrasting objects, such as shadows, snow, water, wheel ruts, seams or lines remaining after road repairs. (The LDW system could detect these items as lane markers.)
 - On roads where the traveling lane merges or separates.
 - When the vehicle's traveling direction does not align with the lane marker.

- When traveling close to the vehicle in front of you, which obstructs the lane camera unit detection range.
- When rain, snow or dirt adheres to the windshield in front of the lane camera unit.
- When the headlights are not bright due to dirt on the lens or if the aiming is not adjusted properly.
- When strong light enters the lane camera unit. (For example, the light directly shines on the front of the vehicle at sunrise or sunset.)
- When a sudden change in brightness occurs. (For example, when the vehicle enters or exits a tunnel or under a bridge.)
- When there is poor visibility. (For example, due to insufficient illumination of the road, or due to snow, rain, fog or spray.)
- When there is glare. (For example, from oncoming traffic, the sun or reflection when the road is wet).

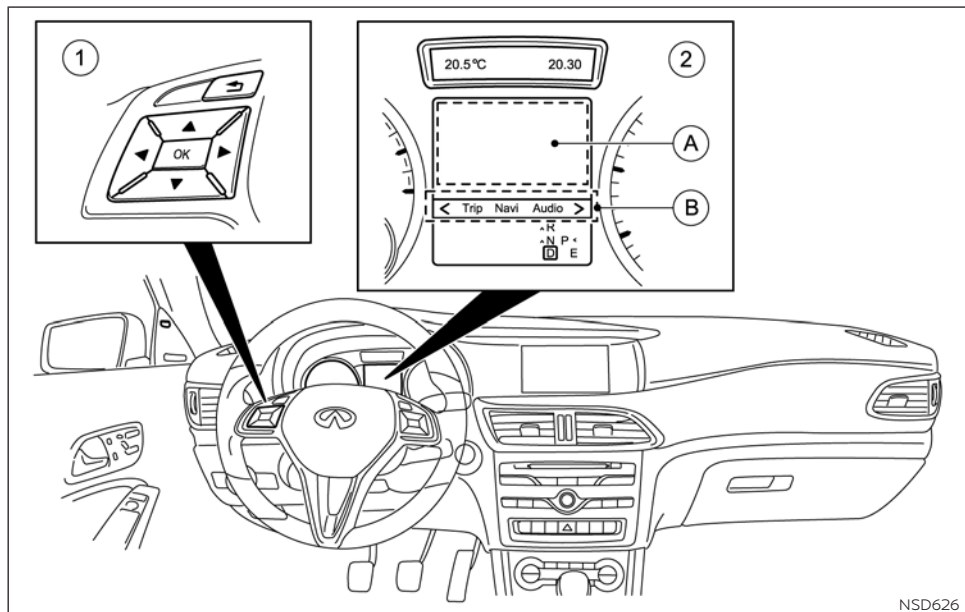

- ① Steering wheel mounted controls
- ② Vehicle information display
- Ⓐ Display area
- Ⓑ Menu bar

LDW SYSTEM TEMPORARILY UNAVAILABLE

Under the following conditions, the LDW system will be canceled automatically, and the message [Lane Departure Warning Currently Unavailable See Operator's Manual] is

displayed in the vehicle information display ②. The LDW system is temporarily unavailable.

- The windshield is dirty in the camera's field of vision.
- Visibility is impaired due to heavy rain, snow or fog.
- There have been no lane markings for an extended period.
- The lane markings are worn, dark, or covered by dirt or snow, etc.

Action to take: When the above conditions no longer exist, the message goes out and the LDW system is operational again. If the message continues to appear, stop the vehicle in a safe location, press the P (Park) button, and clean the windshield.

SYSTEM MALFUNCTION

If the LDW system malfunctions, it will cancel automatically, and the message [Lane Departure Warning Inoperative] will appear.

Action to take: Stop the vehicle in a safe location, engage P (Park), turn the engine off and restart the engine. If the message continues to appear, have the system checked. It is recommended you visit an INFINITI retailer for this service.

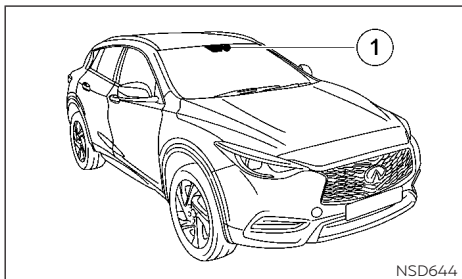

SYSTEM MAINTENANCE

The lane camera unit ① for the LDW system is located above the inside mirror.

To ensure the proper operation of the LDW system and prevent a system malfunction, be sure to observe the following:

- Always keep the windshield clean.
- Do not attach a sticker (including transparent material) or install an accessory near the camera unit.
- Do not place reflective materials, such as white paper or a mirror, on the instrument panel. The reflection of sunlight may adversely affect the camera unit's capability of detecting the lane markers.

BLIND SPOT WARNING (BSW) SYSTEM (IF EQUIPPED)

WARNING

Failure to follow the warnings and instructions for proper use of the BSW system could result in serious injury or death.

- **The Blind Spot Warning (BSW) system is not a replacement for proper driving procedure and is not designed to prevent contact with vehicles or objects. When changing lanes, always use the side and rear mirrors and turn and look in the direction you will move to ensure it is safe to change lanes. Never rely solely on the BSW system.**

The Blind Spot Warning (BSW) system can help alert the driver of other vehicles in adjacent lanes when changing lanes.

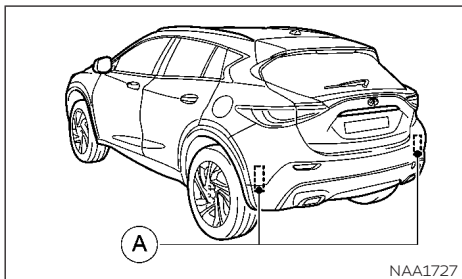

The BSW system uses radar sensors (A) installed near the rear bumper to detect other vehicles beside your vehicle in an adjacent lane.

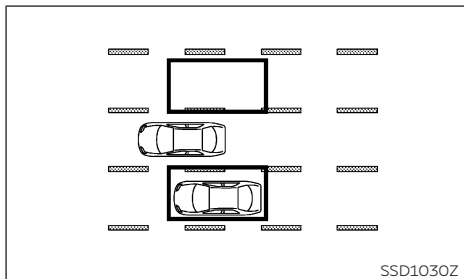

Detection zone

The radar sensors can detect vehicles on either side of your vehicle within the detection zone shown as illustrated. This detection zone starts from the outside mirror of your vehicle and extends approximately 10 ft (3 m) behind the rear bumper, and approximately 10 ft (3 m) sideways.

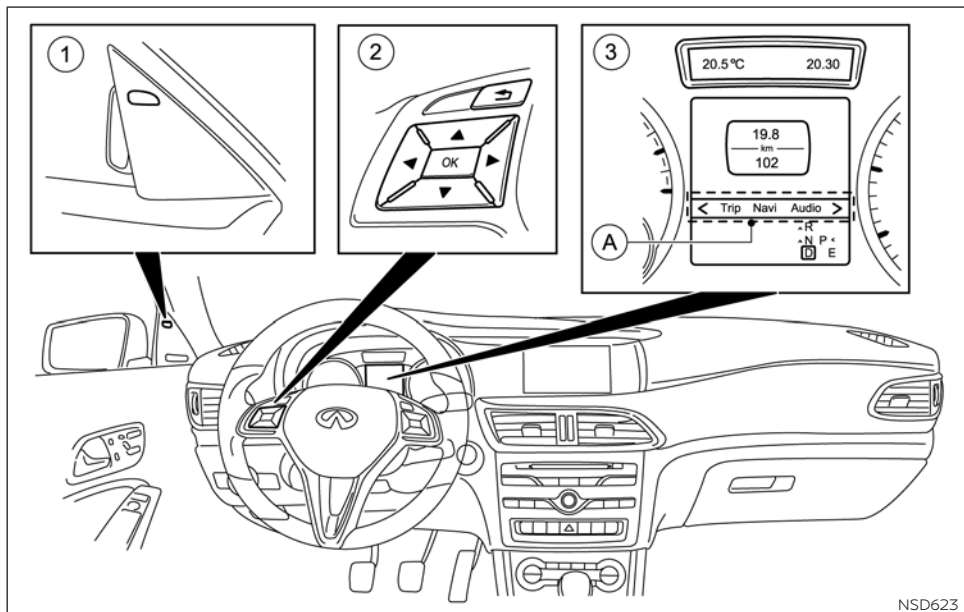

BSW SYSTEM OPERATION

- ① Side indicator light
- ② Steering wheel mounted controls
- ③ Vehicle information display
- Ⓐ MENU bar

The BSW system operates above approximately 20 MPH (30 km/h). When the BSW is activated, the side indicator light illuminates in yellow up to a speed of 20 MPH (30 km/h). At speeds above 20 MPH (30 km/h), the indicator light goes out and the BSW system is operational.

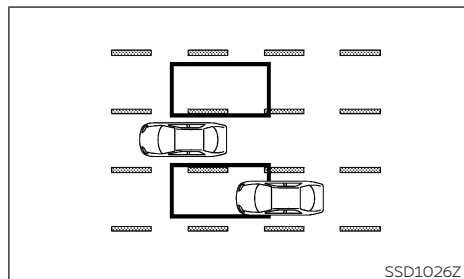

SSD1026Z

Illustration 1

Illustration 1: If the radar sensors detect a vehicle in the detection zone, the BSW indicator light ① located by the outside mirrors illuminates.

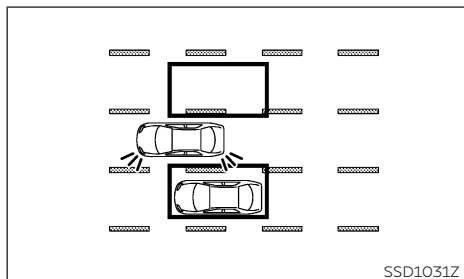

Illustration 2

Illustration 2: If the turn signal is then activated, the system chimes (twice) and the BSW indicator light flashes. The BSW indicator light continues to flash until the detected vehicles leave the detection zone.

NOTE

- The BSW indicator lights illuminate for a few seconds when the ignition switch is placed in the ON position.
- The brightness of the BSW indicator lights is adjusted automatically depending on the brightness of the ambient light.

- If a vehicle comes into the detection zone after the driver activates the turn signal, then only the BSW indicator light flashes and no chime sounds. (See "Another vehicle approaching from behind" later in this section.)

A chime sounds if the radar sensors have already detected vehicles when the driver activates the turn signal.

⚠ WARNING

- Do not use the BSW system when towing a trailer because the system may not function properly.
- Excessive noise (for example audio system volume, open vehicle window) will interfere with the chime sound, and it may not be heard.
- The radar sensors may not be able to detect and activate BSW when certain objects are present such as:
 - Pedestrians, bicycles, animals
 - Several types of vehicles such as motorcycles
 - Oncoming vehicles
 - Vehicles remaining in the detection zone when you accelerate from a stop.

- A vehicle merging into an adjacent lane at a speed approximately the same as your vehicle.
- A vehicle approaching rapidly from behind.
- A vehicle which your vehicle overtakes rapidly.

- Severe weather or road spray conditions may reduce the ability of the radar to detect other vehicles.
- The radar sensors detection zone is designed based on a standard lane width. When driving in a wider lane, the radar sensors may not detect vehicles in an adjacent lane. When driving in a narrow lane, the radar sensors may detect vehicles driving two lanes away.
- The radar sensors are designed to ignore most stationary objects, however objects such as guardrails, walls, foliage and parked vehicles may occasionally be detected. This is a normal operating condition.

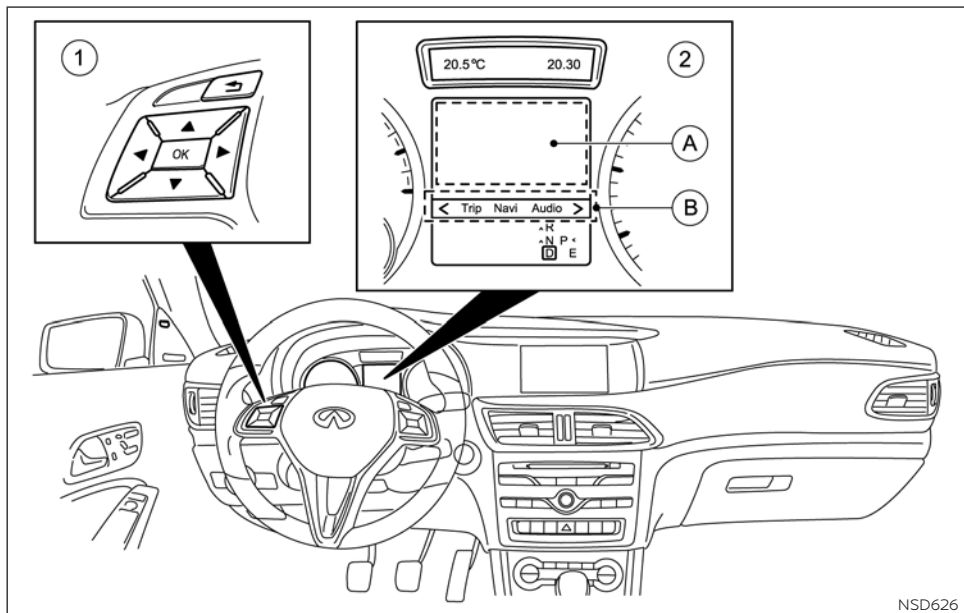

HOW TO ENABLE/DISABLE THE BSW SYSTEM

- ① Steering wheel mounted controls (left side)
- ② Vehicle information display

- A Display area
B MENU bar

To enable/disable the BSW system, use the following procedure:

1. Press the ◀ < or > ▶ button on the steering wheel ① to select the [Drive-Assist] menu on the Menu bar ②.
2. Press the ▲ or ▼ button ① to select Blind Spot Warning.
3. Press the <OK> button on the steering wheel ①. The current selection is displayed.
4. To activate/deactivate BSW: press the <OK> button ① again

BSW SYSTEM LIMITATIONS

⚠ WARNING

Listed below are the system limitations for the BSW system. Failure to operate the vehicle in accordance with these system limitations could result in serious injury or death.

- The BSW system cannot detect all vehicles under all conditions.
- The radar sensors may not be able to detect and activate BSW when certain objects are present such as:
 - Pedestrians, bicycles, or animals.

- Vehicles such as motorcycles, low height vehicles, or high ground clearance vehicles.
 - Oncoming vehicles.
 - Vehicles remaining in the detection zone when you accelerate from a stop.
 - A vehicle merging into an adjacent lane at a speed approximately the same as your vehicle.
 - A vehicle that is too close to your vehicle.
 - A vehicle approaching rapidly from behind.
 - A vehicle which your vehicle overtakes rapidly.
- The radar sensors detection zone is designed based on a standard lane width. When driving in a wider lane, the radar sensors may not detect vehicles in an adjacent lane. When driving in a narrow lane, the radar sensors may detect vehicles driving two lanes away.
 - The radar sensors are designed to ignore most stationary objects, however objects such as guardrails, walls, foliage and parked vehicles may occasionally be detected. This is a normal operating condition.

- The following conditions may reduce the ability of the radar to detect other vehicles:
 - Severe weather
 - Road spray
 - Ice/frost/dirt build-up on the vehicle
- Do not attach stickers (including transparent material), install accessories or apply additional paint near the radar sensors. These conditions may reduce the ability of the radar to detect other vehicles.
- Do not use the BSW system when towing a trailer because the system may not function properly.
- Excessive noise (e.g. audio system volume, open vehicle window) will interfere with the chime sound, and it may not be heard.
- The BSW system may not provide a warning for vehicles that pass through the detection zone quickly.

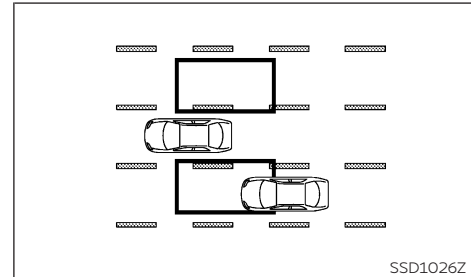
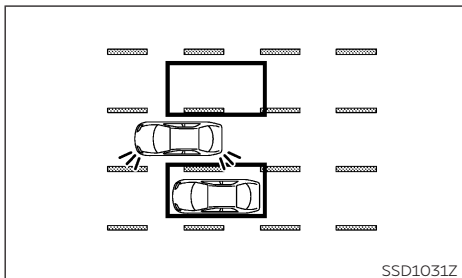

Illustration 1 – Approaching from behind
Another vehicle approaching from behind

Illustration 1: The BSW indicator light illuminates if a vehicle enters the detection zone from behind in an adjacent lane.

However, if the overtaking vehicle is traveling much faster than your vehicle, the indicator light may not illuminate before the detected vehicle is beside your vehicle. Always use the side and rear mirrors and turn and look in the direction your vehicle will move to ensure it is safe to change lanes.



SSD1031Z

Illustration 2 – Approaching from behind

Illustration 2: If the driver activates the turn signal, then the system chimes (twice) and the BSW indicator light flashes.

NOTE

- The radar sensors may not detect vehicles which are approaching rapidly from behind.
- If the driver activates the turn signal before a vehicle enters the detection zone, the BSW indicator light will flash but no chime will sound when the other vehicle is detected.

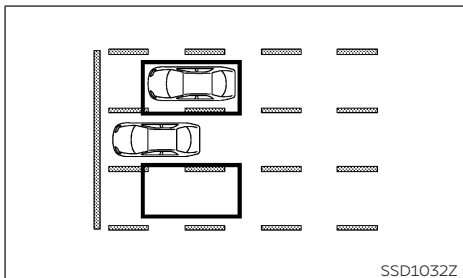

SSD1032Z

Illustration 3 – Accelerate from a stop

Accelerate from a stop

NOTE

Illustration 3: If you accelerate from a stop with a vehicle in the detection zone, the other vehicle may not be detected.

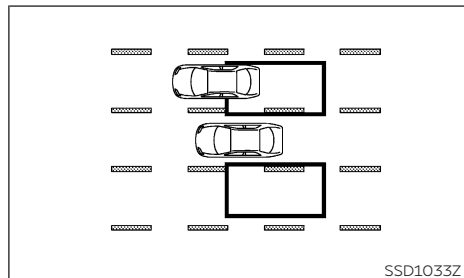

SSD1033Z

Illustration 4 – Overtaking another vehicle

Overtaking another vehicle

When you overtake a vehicle, the warning only occurs if the difference in speed is less than 7 MPH (12 km/h).

Illustration 4: The side indicator light illuminates if you overtake a vehicle and that vehicle stays in the detection zone for approximately 3 seconds.

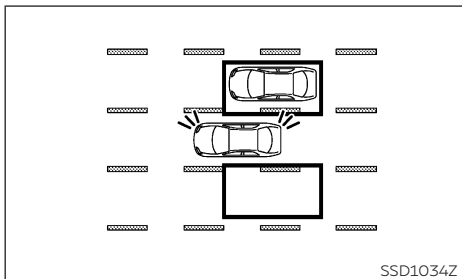

Illustration 5 – Overtaking another vehicle

Illustration 5: If the driver activates the turn signal while another vehicle is in the detection zone, then the system chimes (twice) and the BSW indicator light flashes.

NOTE

- **When overtaking several vehicles in a row, the vehicles after the first vehicle may not be detected if they are travelling close together.**
- **The radar sensors may not detect slower moving vehicles if they are passed quickly.**
- **If the driver activates the turn signal before a vehicle enters the detection zone, the side indicator light will flash but no chime will sound when the other vehicle is detected.**

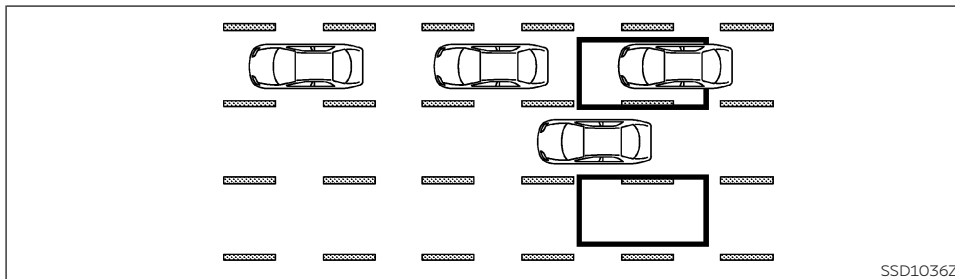

Illustration 6 – Overtaking several vehicles

Overtaking several vehicles

Illustration 6: When overtaking several vehicles in a row, the vehicles after the first vehicle may not be detected if they are travelling close together.

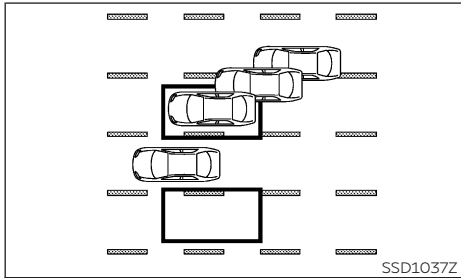

Illustration 7 – Entering from the side

Entering from the side

Illustration 7: The side indicator light illuminates if a vehicle enters the detection zone from either side.

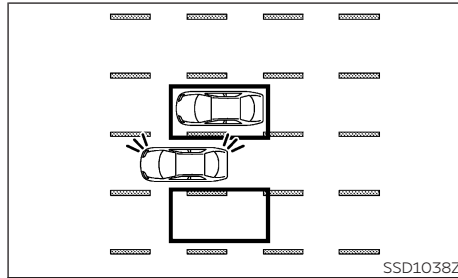
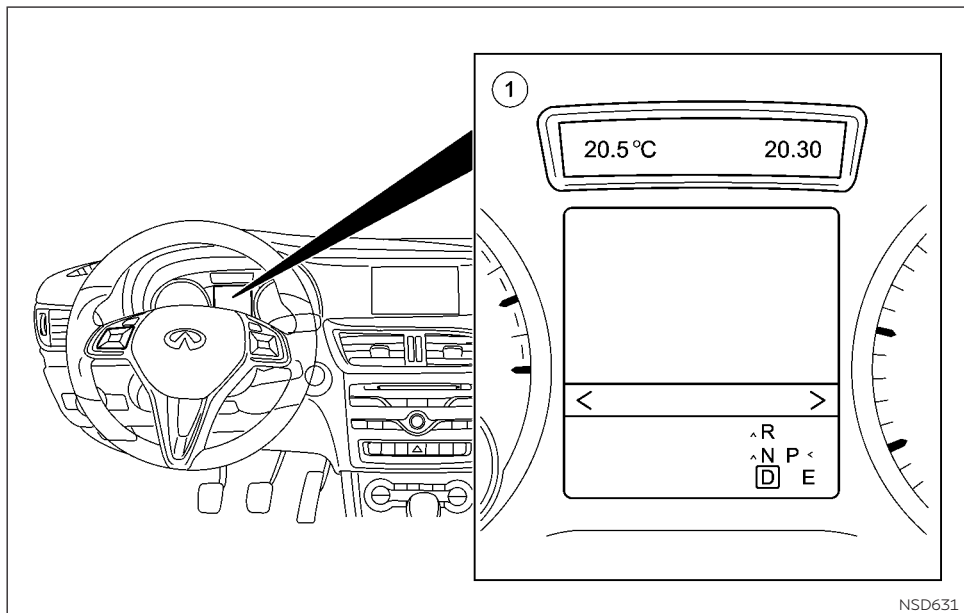

Illustration 8 – Entering from the side

Illustration 8: If the driver activates the turn signal, then the BSW indicator light flashes and a chime will sound twice.

NOTE

- **The radar sensors may not detect a vehicle which is travelling at about the same speed as your vehicle when it enters the detection zone.**
- **If the driver activates the turn signal before a vehicle enters the detection zone, the BSW indicator light will flash but no chime will sound when another vehicle is detected.**



SYSTEM TEMPORARILY UNAVAILABLE

① Vehicle information display

If radar blockage is detected, the system will be turned off automatically, and the [Blind

Spot Warning Currently Unavailable See Operator's Manual] message appears in the vehicle information display ①. The system is not available until the conditions no longer exist.

The radar sensors may be blocked by temporary ambient conditions such as splashing water, mist or fog. The blocked condition may also be caused by objects such as ice, frost or dirt obstructing the radar sensors.

Action to take: When the above conditions no longer exist, the system will resume automatically. If the message still appears, have the system checked. It is recommended you visit an INFINITI retailer for this service.

System malfunction

If the system malfunctions, it will be turned off automatically, and the [Blind Spot Warning Inoperative] message appears in the vehicle information display ①.

Action to take: Stop the vehicle in a safe location, place the vehicle in the P (Park) position, turn the engine off and restart the engine.

If the message still appears, have the system checked. It is recommended you visit an INFINITI retailer for this service.

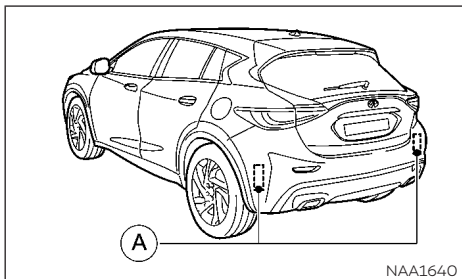

RADAR MAINTENANCE

The two radar sensor units (A) for the BSW system are located near the rear bumper. Always keep the area near the radar sensors clean.

The radar sensors may be blocked by temporary ambient conditions such as splashing water, mist or fog.

The blocked condition may also be caused by objects such as ice, frost or dirt obstructing the radar sensors.

Check for and remove objects obstructing the area around the radar sensors.

Do not attach stickers (including transparent material), install accessories or apply additional paint near the radar sensors.

Do not strike or damage the area around the radar sensors. It is recommended you consult an INFINITI retailer if the area around the radar sensors is damaged due to a collision.

FCC NOTICE

For USA:

This device complies with Part 15 of the FCC Rules. Operation is subject to the following two conditions: (1) This device may not cause harmful interference, and (2) this device must accept any interference received, including interference that may cause undesired operation.

NOTE

Changes or modification not expressly approved by the party responsible for compliance could void the user's authority to operate the equipment.

For Canada:

This device complies with Industry Canada license-exempt RSS standard(s). Operation is subject to the following two conditions: (1) this device may not cause harmful interference, and (2) this device must accept any interference received, including interference that may cause undesired operation of the device.

CRUISE CONTROL

Cruise control maintains a constant road speed for you. It brakes automatically in order to avoid exceeding the set speed. You must select a lower gear in good time on long and steep downhill gradients, especially if the vehicle is laden or towing a trailer.

⚠ WARNING

For vehicles with automatic transmission, you need to have selected manual drive program M (see "Manual drive program" earlier in this section). By doing so, you will make use of the braking effect of the engine. This relieves the load on the brake system and prevents the brakes from overheating and wearing too quickly.

Use cruise control only if road and traffic conditions are appropriate for maintaining a steady speed for a prolonged period. You can set the cruise control at any road speed above 20 MPH (30 km/h).

The speed indicated in the speedometer may differ slightly from the set speed.

WARNING

- If you fail to adapt your driving style, cruise control can neither reduce the risk of an accident nor override the laws of physics. Cruise control cannot take into account road, weather or traffic conditions. Cruise control is only an aid. You are responsible for the distance to the vehicle in front, for vehicle speed, for braking in good time, and for staying in lane.
- Always observe the posted speed limits and do not set the speed over them.
- Do not use the cruise control when driving under the following conditions. Doing so could cause a loss of vehicle control and result in an accident.
 - When it is not possible to keep the vehicle at a constant speed
 - When driving in heavy traffic
 - When driving in traffic that varies speed
 - When driving in windy areas
 - When driving on winding or hilly roads
 - When driving on slippery (rain, snow, ice, etc.) roads

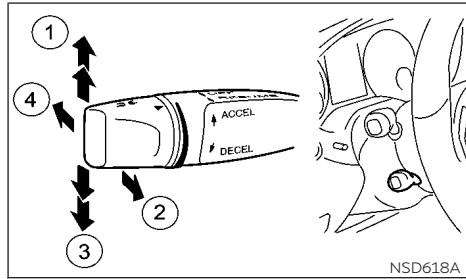

CRUISE CONTROL OPERATIONS

- ① Store the current speed or a higher speed
- ② Store the current speed, or if a speed has previously been stored, call up the last stored speed.
- ③ Store the current speed or a lower speed
- ④ Deactivate the cruise control system

When you activate cruise control, the stored speed is shown in the vehicle information display for five seconds.

Activation conditions

To activate cruise control, all of the following activation conditions must be fulfilled:

- The electric parking brake must be released.
- You are driving faster than 20 MPH (30 km/h).

- VDC must be switched on, but not intervening.

Storing, maintaining and calling up a speed

Storing and maintaining the current speed:

You can store the current speed if you are driving faster than 20 MPH (30 km/h):

1. Accelerate the vehicle to the desired speed.
2. Briefly press the cruise controller lever up ① or down ③.
3. Remove your foot from the accelerator pedal.

Cruise control is activated. The vehicle automatically maintains the speed.

NOTE

Cruise control may be unable to maintain the stored speed on uphill gradients. The stored speed is resumed when the gradient evens out. Cruise control maintains the stored speed on downhill gradients by automatically braking the vehicle.

Storing the current speed or calling up the last stored speed:

WARNING

If you call up a stored speed and this is different from the current speed, the vehicle accelerates or brakes. If you do not know what the stored speed is, the vehicle may accelerate or brake unexpectedly. There is a risk of an accident. Take the traffic conditions into account before calling up the stored speed. If you do not know what the stored speed is, store the desired speed again.

1. Briefly pull the cruise control lever towards you ②.
2. Remove your foot from the accelerator pedal. The first time cruise control is activated, it stores the current speed or if a speed has previously been stored, it regulates the speed of the vehicle to the previously stored speed.

Setting a speed

Bear in mind that it may take a brief moment until the vehicle has accelerated or braked to the set speed.

1. Press the cruise control lever up ① for a higher speed or down ③ for a lower speed.
2. Keep the cruise control lever pressed until the desired speed is reached.
3. Release the cruise control lever, The new speed is stored.
4. To adjust the set speed in 1 MPH (1 km/h) increments: briefly press the cruise control lever up ① or down ③ to the pressure point. The last stored speed increases or decreases in 1 MPH (1 km/h) increments.
5. To adjust the set speed in 10 MPH (10 km/h) increments: briefly press the cruise control lever up ① or down ③ beyond the pressure point. The last stored speed increases or decreases in 10 MPH (10 km/h) increments.

NOTE

Cruise control is not deactivated if you depress the accelerator pedal. For example, if you accelerate briefly to overtake, cruise control adjusts the vehicle's speed to the last speed stored after you have finished overtaking.

Deactivating cruise control

There are several ways to deactivate cruise control:

- Briefly press the cruise control lever forward ④.
- or
- Brake.

Cruise control is automatically deactivated if:

- The vehicle is secured with the electric parking brake.
- You are driving at less than 20 MPH (30 km/h).
- VDC intervenes or you deactivate VDC.

INTELLIGENT CRUISE CONTROL (ICC) SYSTEM (FULL SPEED RANGE) (IF EQUIPPED)

If cruise control is deactivated, you will hear a warning tone. You will see the [Cruise Control Off] message in the vehicle information display for approximately five seconds.

NOTE

The last speed stored is cleared when you switch off the engine.

WARNING

Failure to follow the warnings and instructions for proper use of the ICC system could result in serious injury or death.

- ICC is not a collision avoidance or warning device. For highway and freeway use only and not intended for congested areas or city driving. Failure to apply the brakes could result in an accident. It is the driver's responsibility to stay alert, drive safely, and be in control of the vehicle at all times.
- Always observe posted speed limits and do not set the speed over them.
- Always drive carefully and attentively when using the ICC. Read and understand the Owner's Manual thoroughly before using the ICC system. To avoid serious injury or death, do not rely on the system to prevent accidents or to control the vehicle's speed in emergency situations. Do not use the ICC system except in appropriate road and traffic conditions.

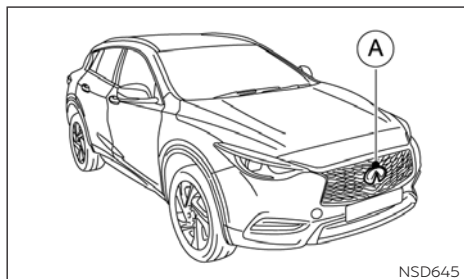

NSD645

ICC SYSTEM OPERATION

- ① Speedometer
- ② Distance warning light
- ③ Vehicle information display
- ④ Cruise control lever

The ICC system is intended to enhance the operation of the vehicle when following a vehicle traveling in the same lane and direction.

If the distance sensor ① detects a slower moving vehicle ahead, the system will reduce the vehicle speed so that your vehicle follows the vehicle in front at the selected distance.

5-50 Starting and driving

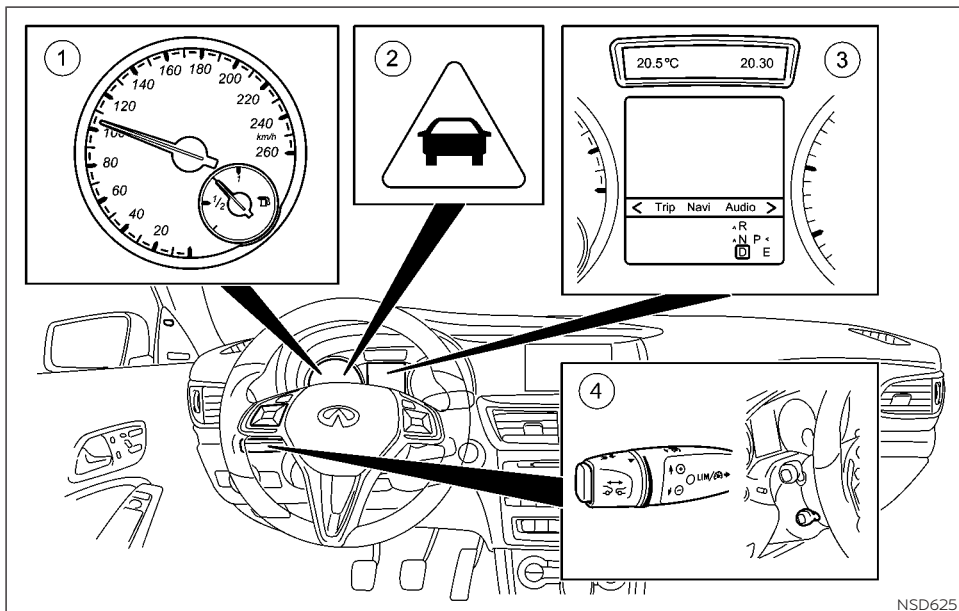

NSD625

The ICC system maintains a selected distance from the vehicle in front of you within the speed range of 0 to 125 MPH (0 to 200 km/h) up to the set speed. The set speed can be selected by the driver between 20 to 125 MPH (30 to 200 km/h).

The vehicle travels at a set speed when the road ahead is clear.

The ICC system is designed to maintain a selected distance from the vehicle in front of you and reduce the speed to match a slower vehicle ahead. The system will decelerate the

vehicle as necessary and if the vehicle ahead comes to a stop, the vehicle decelerates to a standstill. However, the ICC system can only apply up to 50% of the vehicle's total braking power. This system should only be used when traffic conditions allow vehicle speeds to remain fairly constant or when vehicle speeds change gradually. If a vehicle moves into the traveling lane ahead or if a vehicle traveling ahead rapidly decelerates, the distance between vehicles may become closer because the ICC system cannot decelerate the vehicle quickly enough. If this occurs, the ICC system will sound a warning chime and illuminate the distance warning light to notify the driver to take necessary action.

The following items are controlled in the ICC system:

- When there are no vehicles traveling ahead, the ICC system maintains the speed set by the driver. The set speed range is between approximately 20 and 125 MPH (30 and 200 km/h).

- When there is a vehicle traveling ahead, the ICC system adjusts the speed to maintain the distance, selected by driver, from the vehicle ahead. The adjusting speed range is up to the set speed. If the vehicle ahead comes to a stop, the vehicle decelerates to a standstill within the limitations of the system. Once the vehicle is stationary, it remains stationary and you do not need to depress the brake pedal.
- When the vehicle traveling ahead has moved out from its lane of travel, pull the cruise control lever or push the accelerator pedal briefly. The ICC system accelerates and maintains vehicle speed up to the set speed.

The ICC system does not control vehicle speed of stationary and slow moving vehicles. You must pay attention to vehicle operation to maintain proper distance from vehicles ahead when approaching toll gates or traffic congestion.

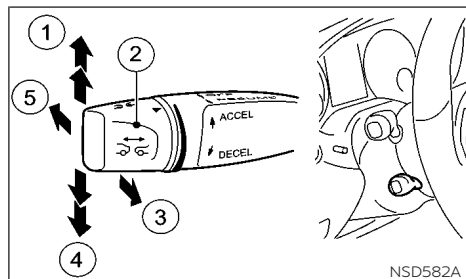

ICC SWITCH (CRUISE CONTROL LEVER)

- ① Store the current speed or a higher speed
- ② Set the specified minimum distance
- ③ Store the current speed or call up the last stored speed
- ④ Store the current speed or a lower speed
- ⑤ Deactivate the ICC system

The ICC system is operated by the cruise control lever, located on the steering column.

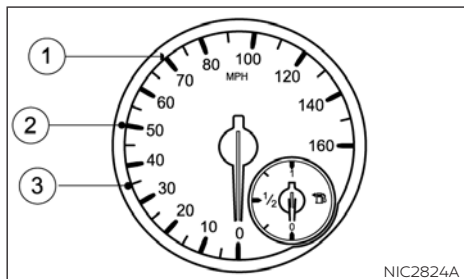

ICC SYSTEM DISPLAY AND INDICATORS

Displays in the speedometer

When the ICC system is activated and there are no vehicles detected ahead, one or two segments ② in the set speed range light up.

If the ICC system detects a vehicle ahead, segments ② between speed of the vehicle ahead ③ and stored speed ① light up.

NOTE

For design reasons, the speed displayed in the speedometer may differ slightly from the speed set for the ICC system.

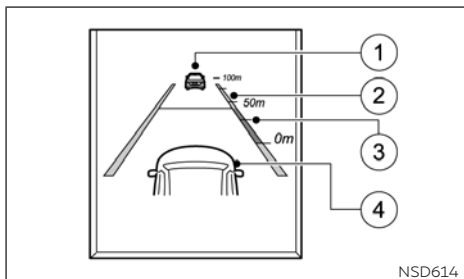

Display when the ICC system is deactivated

- ① Vehicle ahead, if detected
- ② Distance indicator: current distance to the vehicle ahead
- ③ Specified minimum distance to the vehicle ahead; adjustable
- ④ Own vehicle

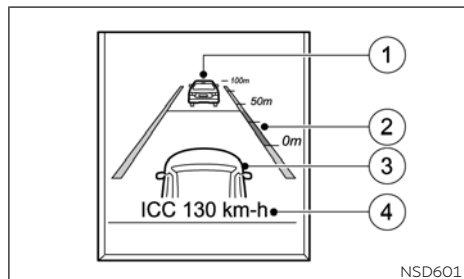

Display when the ICC system is activated

You will initially see the stored speed for about five seconds when you activate the ICC system.

- ① Vehicle ahead, if detected
- ② Specified minimum distance to the vehicle ahead; adjustable
- ③ Own vehicle
- ④ ICC stored speed (text only appears when the cruise control lever is actuated)

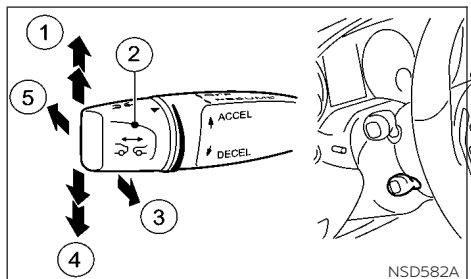

OPERATING ICC

To set cruising speed, accelerate your vehicle to the desired speed and quickly push the cruise control lever, up ① or down ④. Take your foot off the accelerator pedal. Your vehicle will maintain the set speed.

NOTE

If you do not fully release the accelerator pedal, the [ICC Suspended] message appears in the vehicle information display. The set distance to a slower-moving vehicle in front will then not be maintained. You will be driving at the speed you determine by the position of the accelerator pedal.

You can also activate the ICC when stationary. The lowest speed that can be set is 20 MPH (30 km/h).

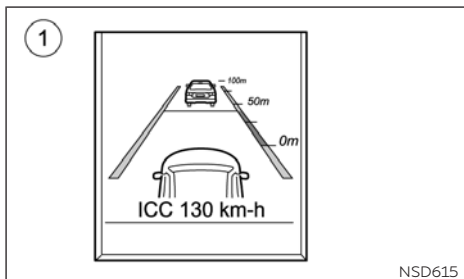

System set display with vehicle ahead System operation

The driver sets the desired vehicle speed based on the road conditions. The ICC system maintains the set vehicle speed, similar to standard cruise control, as long as no vehicle is detected in the lane ahead. The ICC system displays the set speed for 5 seconds after the cruise control lever is activated.

Vehicle detected ahead:

When a vehicle is detected in the lane ahead, the ICC system decelerates the vehicle by controlling the throttle and applying the brakes to match the speed of a slower vehicle ahead. The system then controls the vehicle speed based on the speed of the vehicle ahead to maintain the driver selected distance.

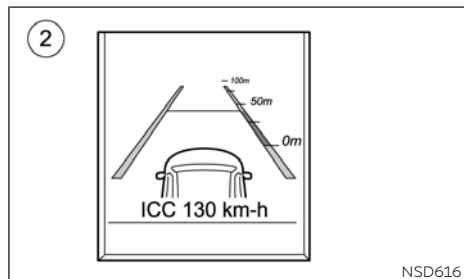

System set display without vehicle ahead

The brake lights of the vehicle come on when braking is performed by the ICC system. When the brake operates, a noise may be heard. This is not a malfunction.

When a vehicle ahead is detected, the vehicle ahead symbol ① appears in the vehicle information display.

Vehicle ahead not detected:

When a vehicle is no longer detected ahead, the ICC system gradually accelerates your vehicle to resume the previously set vehicle speed. The ICC system then maintains the set speed.

When a vehicle is no longer detected, the vehicle ahead display turns off ②.

If a vehicle ahead appears during acceleration to the set vehicle speed or any time the ICC system is in operation, the system controls the distance to that vehicle.

Changing lanes to pass another vehicle:

When you change lane to pass another vehicle, ICC supports the action if:

- The vehicle speed is more than 45 MPH (70 km/h)
- The ICC is maintaining the distance to a vehicle in front
- The respective turn signal is activated

If these conditions are met, the vehicle will be accelerated. Acceleration will be interrupted if changing lanes takes too long or if the distance between your vehicle and the vehicle in front becomes too small.

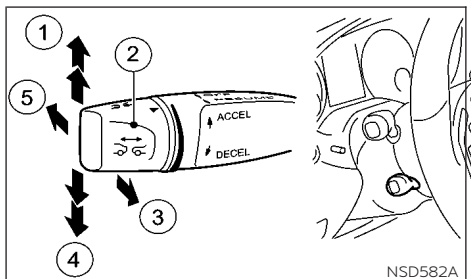

How to change the set vehicle speed

To cancel the preset speed, use any of these methods:

- Tap the brake pedal when the vehicle is moving.
- Quickly push the cruise control lever in the direction of arrow ⑤.

The message [ICC OFF] appears in the vehicle information display for 5 seconds.

To reset at a higher cruising speed, use one of the following methods:

- Depress the accelerator pedal. When the vehicle attains the desired speed, quickly pull the cruise control lever towards you ③.

- Pull the cruise control lever up ① beyond the pressure point. The set vehicle speed will increase by approximately 10 MPH (10 km/h).
- Pull the cruise control lever up (1) at the pressure point. The set vehicle speed will increase by approximately 1 MPH (1 km/h).

To reset at a lower cruising speed, use one of the following methods:

- Lightly tap the brake pedal. When the vehicle attains the desired speed, quickly pull the cruise control lever towards you ③.
- Pull the cruise control lever down ④ beyond the pressure point. The set vehicle speed will decrease by approximately 10 MPH (10 km/h).
- Pull the cruise control lever down ④ to the pressure point. The set vehicle speed will decrease by approximately 1 MPH (1 km/h).

To resume the preset speed, quickly pull the cruise control lever towards you ④. The vehicle will resume the last set cruising speed when the vehicle speed is over 20 MPH (30 km/h).

NOTE

If you do not fully release the accelerator pedal, the [ICC Deactivated Automatically] message appears in the vehicle information

display. The set distance to a slower-moving vehicle in front will then not be maintained. You will be driving at the speed you determine by the position of the accelerator pedal.

You can also activate ICC when stationary. The lowest speed that can be set is 20 MPH (30 km/h).

Stopping

WARNING

- To help avoid risk of injury or death through unintended operation of the vehicle and/or its systems, do not leave children, people who require the assistance of others, or pets unattended in your vehicle.
- The ICC system should only be used to keep the vehicle stationary when the driver is actively using the system. When parking the vehicle, make sure to turn OFF the ICC system, use the brake, press the PARK (P) button, and place the ignition switch in the LOCK position prior to exiting the vehicle. Failure to do so could lead to serious injury or death. The ICC system will not hold the vehicle

in place after coming to a stop when any of the following conditions occur:

- There is a malfunction in the system or in the voltage supply.
- The ICC system has been deactivated with the cruise control lever, e. g. by a vehicle occupant.
- The accelerator pedal has been depressed, e.g. by a vehicle occupant.

For further information on deactivating the ICC system, see "ICC switch (cruise control lever)" earlier in this section

If the ICC system detects that the vehicle in front is stopping, it brakes your vehicle until it is stationary (within the braking limitations of the system).

Once your vehicle is stationary, it remains stationary and you do not need to depress the brake.

NOTE

Depending on the specified minimum distance, your vehicle will come to a standstill at a sufficient distance behind the vehicle in front. The specified minimum distance is set using the control on the cruise control lever.

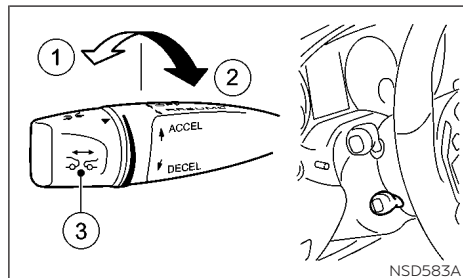

How to change the set distance to the vehicle ahead

The distance to the vehicle ahead can be selected at any time depending on the traffic conditions.

To increase the distance to the vehicle ahead, turn the knob (3) toward the rear (2). To decrease the distance to the vehicle ahead, turn the knob (3) toward the front (1).

You can see this distance in the vehicle information display.

The distance to the vehicle ahead will change according to the vehicle speed. The higher the vehicle speed, the longer the distance.

Approach warning

If your vehicle comes closer to the vehicle ahead due to rapid deceleration of that vehicle or if another vehicle cuts in, the system warns the driver with the chime and distance warning light. Decelerate by depressing the brake pedal to maintain a safe vehicle distance if:

- The chime sounds.
- The distance warning light is illuminated.

The warning chime may not sound and the distance warning light may not illuminate in some cases when there is a short distance between vehicles. Some examples are:

- When the vehicles are traveling at the same speed and the distance between vehicles is not changing. In this case, the distance warning light will be on.
- When the vehicle ahead is traveling faster and the distance between vehicles is increasing.
- When a vehicle cuts in near your vehicle
- The warning chime will not sound and the distance warning light will not illuminate when:
 - The vehicle approaches other vehicles that are parked or moving slowly.

- The accelerator pedal is depressed, overriding the system.

Also, the sensor sensitivity can be affected by vehicle operation (steering maneuver or driving position in the lane) or traffic or vehicle condition (for example, if a vehicle is being driven with some damage).

Automatic cancellation

A chime sounds and the message [ICC off] is displayed in the vehicle information display for 5 seconds under the following conditions and the control is automatically canceled.

- The electric parking brake is applied.
- The VDC intervenes or the VDC is deactivated.
- The P (Park), R (Reverse) or N (Neutral) position is engaged.
- The cruise control lever is pulled in order to pull away but the front passenger door or one of the rear doors is open.
- The vehicle is skidding or a wheel slips.
- Active Park Assist is activated.

ICC LIMITATIONS

WARNING

Listed below are the system limitations for the ICC system. Failure to operate the vehicle in accordance with these system limitations could result in serious injury or death.

- **This system is only an aid to assist the driver and is not a collision warning or avoidance device. It is the driver's responsibility to stay alert, drive safely and be in control of the vehicle at all times.**
- **The system is primarily intended for use on straight, dry, open roads with light traffic. It is not advisable to use the system in city traffic or congested areas.**
- **This system will not adapt automatically to road conditions. This system should be used in evenly flowing traffic. Do not use the system on roads with sharp curves, or on icy roads, in heavy rain or in fog.**

- As there is a performance limit to the distance control function, never rely solely on the ICC system. This system does not correct careless, inattentive or absent-minded driving, or overcome poor visibility in rain, fog, or other bad weather. Decelerate the vehicle speed by depressing the brake pedal, depending on the distance to the vehicle ahead and the surrounding circumstances in order to maintain a safe distance between vehicles.
- If the vehicle ahead comes to a stop, the vehicle decelerates to a standstill within the limitations of the system. Once the vehicle is stationary, it remains stationary and you do not need to depress the brake pedal.
- Always pay attention to the operation of the vehicle and be ready to manually control the proper following distance. The ICC system may not be able to maintain the selected distance between vehicles (following distance) or selected vehicle speed under some circumstances.
- Normally when controlling the distance to a vehicle ahead, this system automatically accelerates or decelerates

your vehicle according to the speed of the vehicle ahead. If required, depress the accelerator to properly accelerate your vehicle when acceleration is required for a lane change. Depress the brake pedal when deceleration is required to maintain a safe distance to the vehicle ahead due to its sudden braking or if a vehicle cuts in. Always stay alert when using the ICC system.

- The system may not detect the vehicle in front of you in certain road or weather conditions. To avoid accidents, never use the ICC system under the following conditions:
 - On roads where the traffic is heavy or there are sharp curves.
 - On slippery road surfaces such as on ice or snow, etc.
 - During bad weather (rain, fog, snow, etc.).
 - When rain, snow or dirt adhere to the system sensor.
 - On steep downhill roads (the vehicle may go beyond the set vehicle speed and frequent braking may result in overheating the brakes).
 - On repeated uphill and downhill roads.

- When traffic conditions make it difficult to keep a proper distance between vehicles because of frequent acceleration or deceleration.
- If there is interference by other radar sources.
- Do not use the ICC system if you are towing a trailer. The system may not detect a vehicle ahead.
- In some road or traffic conditions, a vehicle or object can unexpectedly come into the sensor detection zone and cause automatic braking. You may need to control the distance from other vehicles using the accelerator pedal. Always stay alert and avoid using the ICC system when it is not recommended in this section.
- The distance sensor will not detect the following objects:
 - Stationary and slow moving vehicles.
 - Pedestrians or objects in the roadway.
 - Oncoming vehicles in the same lane.
 - Motorcycles traveling offset in the travel lane.

The following are some conditions in which the sensor cannot properly detect a vehicle ahead and the system may not operate properly:

- When the snow or road spray from traveling vehicles reduces the sensor's visibility.
- When excessively heavy baggage is loaded in the rear seat or the luggage room of your vehicle.

The ICC system is designed to automatically check the sensor's operation within the limitation of the system. When the sensor is covered with dirt or is obstructed, the system will automatically be canceled. If the sensor is covered with ice, a transparent or translucent vinyl bag, etc., the ICC system may not detect them. In these instances, the ICC system may not cancel and may not be able to maintain the selected following distance from the vehicle ahead. Be sure to check and clean the sensor regularly.

TIPS FOR DRIVING WITH THE ICC SYSTEM

General notes

The following contains descriptions of certain road and traffic conditions in which you must be particularly attentive. In such situations, brake if necessary. The ICC system is then deactivated

5-58 Starting and driving

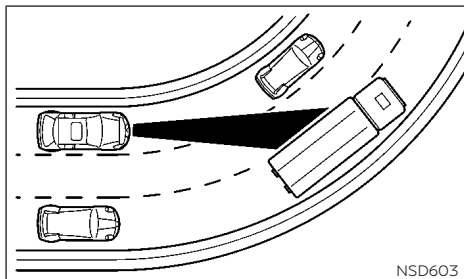

Cornering, entering and exiting a bend

The ability of the ICC system to detect vehicles when cornering is limited. Your vehicle may brake unexpectedly or late.

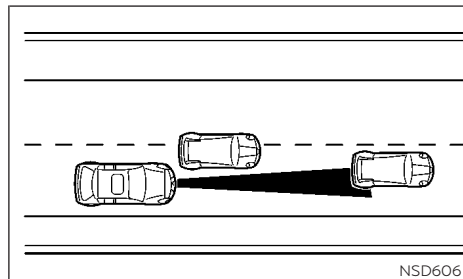

Vehicles that are not driving in the middle of their lane

The ICC system may not detect vehicles which are not driving in the middle of their lane. The system will not brake for or keep a following distance to the car which is offset.

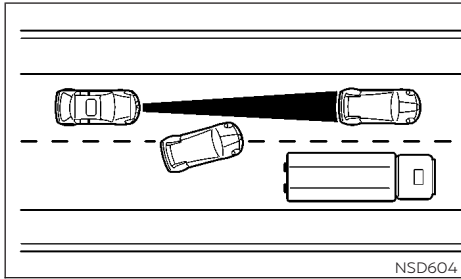

Other vehicles changing lanes

The ICC system has not detected the vehicle cutting in yet. The system will not brake for or keep a following distance to this vehicle.

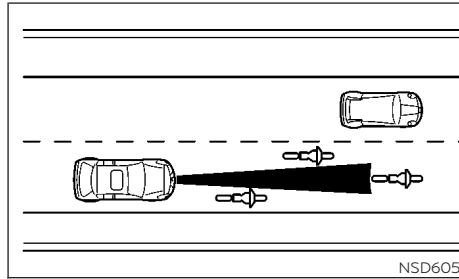

Narrow vehicles (including motorcycles)

The ICC system has not yet detected the vehicle ahead on the edge of the lane because of its narrow width. The system will not brake for or keep a following distance to this vehicle.

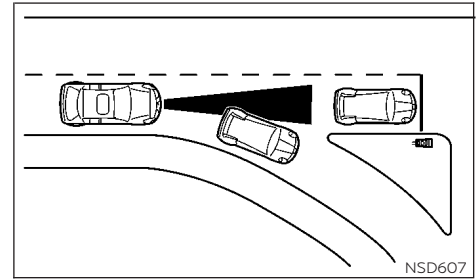

Obstructions and stationary vehicles

The ICC system does not brake for obstacles or stationary vehicles. If, for example, the detected vehicle turns a corner and reveals an obstacle or stationary vehicle The ICC system will not brake for these.

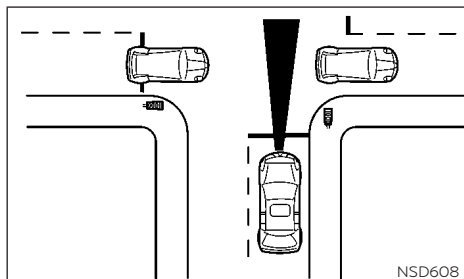

NSD608

Crossing vehicles

The ICC system may detect vehicles that are crossing your lane by mistake. Activating the ICC system at traffic lights with crossing traffic, for example, could cause your vehicle to pull away unintentionally.

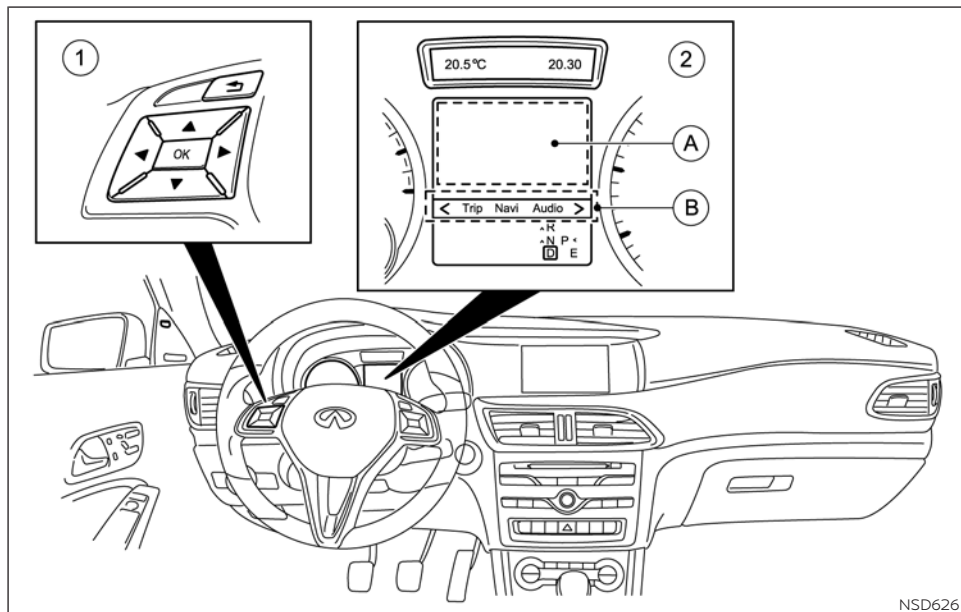

NSD626

- ① Steering wheel mounted controls (left side)
- ② Vehicle information display
- Ⓐ Display area
- Ⓑ MENU bar

SYSTEM TEMPORARILY UNAVAILABLE

When the radar sensor area is covered with dirt or is obstructed, the system will automatically be canceled. If the radar sensor area

is covered with ice, a transparent or translucent vinyl bag, etc., the ICC system may not detect them. In these instances, the ICC system may not cancel and may not be able to maintain the selected following distance from the vehicle ahead.

If the ICC system stops working due to a malfunction or some other reason, one of the following messages will be displayed in the vehicle information display ②.

- [ICC off]
- [ICC Now Available]
- [ICC Currently Unavailable See Operator's Manual]
- [ICC Inoperative]
- [ICC Suspended]
- [ICC - - - MPH]

[ICC off]: The ICC system has been deactivated. If it was not deactivated by the driver, a warning tone also sounds.

[ICC Now Available]: The ICC system is operational again after having been temporarily unavailable. You can now reactivate the ICC system.

[ICC Currently Unavailable See Operator's Manual]: The ICC system is temporarily inoperative. Possible causes:

- The function is impaired due to heavy rain or snow.
- The radar sensor system is temporarily inoperative, e. g. due to electromagnetic radiation emitted by nearby TV or radio stations or other sources of electromagnetic radiation.
- The system is outside the operating temperature range.
- The on-board voltage is too low.

A warning tone also sounds.

Once the causes listed above no longer apply, the display message goes out.

If the display message does not disappear:

- Pull over and stop the vehicle safely as soon as possible, paying attention to road and traffic conditions.
- Secure the vehicle against rolling away.
- Restart the engine.

[ICC Inoperative]: The ICC system is malfunctioning. The adaptive brake assist function may also have failed. A warning tone also sounds. Have the system checked. It is recommended you visit an INFINITI retailer for this service.

[ICC Suspended]: You have depressed the accelerator pedal. The ICC system is no longer controlling the speed of the vehicle.

The display message should disappear when you remove your foot from the accelerator pedal

[ICC - - - MPH]: An activation condition for the ICC system is not fulfilled.

Check the activation conditions for the ICC system.

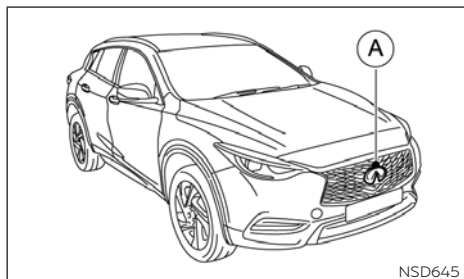

SYSTEM MAINTENANCE

The sensor for the ICC system (A) is located behind the INFINITI logo at the front of the vehicle.

To keep the ICC system operating properly, be sure to observe the following:

- Always keep area around the sensor clean.
- Do not strike or damage the areas around the sensor. Do not touch or remove the screw located on the sensor. Doing so could cause failure or malfunction. If the sensor is damaged due to an accident, it is recommended you contact an INFINITI retailer.
- Do not cover or attach stickers (including transparent material) or install an accessory near the sensor. This could cause failure or malfunction.

5-62 Starting and driving

Radio frequency statement

For USA:

This device complies with Part 15 of the FCC Rules. Operation is subject to the following two conditions: (1) This device may not cause harmful interference, and (2) this device must accept any interference received, including interference that may cause undesired operation.

NOTE

Changes or modification not expressly approved by the party responsible for compliance could void the user's authority to operate the equipment.

For Canada:

This device complies with Industry Canada license-exempt RSS standard(s). Operation is subject to the following two conditions: (1) this device may not cause harmful interference, and (2) this device must accept any interference received, including interference that may cause undesired operation of the device.

FORWARD EMERGENCY BRAKING (FEB) SYSTEM (IF EQUIPPED)

WARNING

Failure to follow the warnings and instructions for proper use of the FEB system could result in serious personal injury or death.

- **The FEB system is a supplemental aid to the driver. It is not a replacement for the driver's attention to traffic conditions or responsibility to drive safely. It cannot prevent accidents due to carelessness or dangerous driving techniques.**
- **The FEB system does not function in all driving, traffic, weather and road conditions.**

The FEB system can assist the driver when there is a risk of a forward collision with the vehicle ahead in the traveling lane.

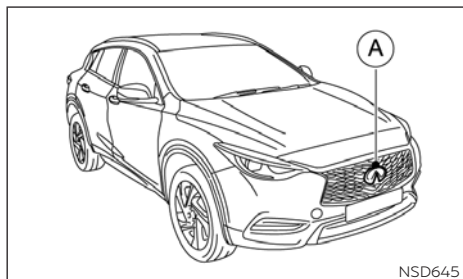

The FEB system uses a radar sensor (A) located behind the INFINITI logo to measure the distance to the vehicle ahead in the traveling lane.

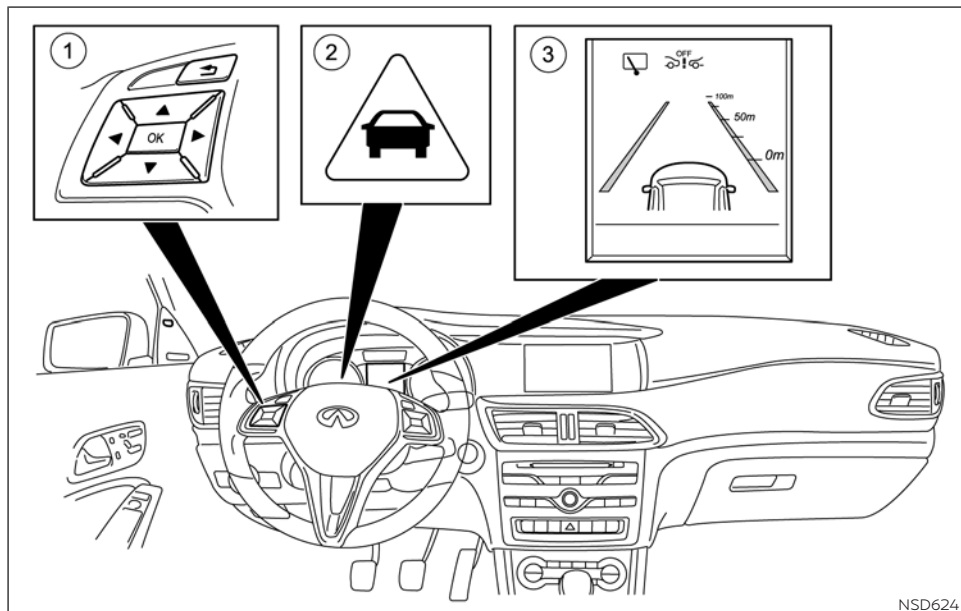

FEB SYSTEM OPERATION

- ① Steering wheel mounted controls (left side)
- ② Distance warning light
- ③ Forward emergency braking OFF display

The FEB system consists of a distance warning function with an autonomous emergency braking function and adaptive brake assist function.

The FEB system can help you to minimize the risk of a collision with the vehicle in front or reduce the effects of such a collision

If the FEB system detects that there is a risk of a collision, you will be warned visually and audibly. If you do not react to the visual and audible collision warning, autonomous braking can be initiated in critical situations. If you apply the brake yourself in a critical situation, the adaptive brake assist function assists you.

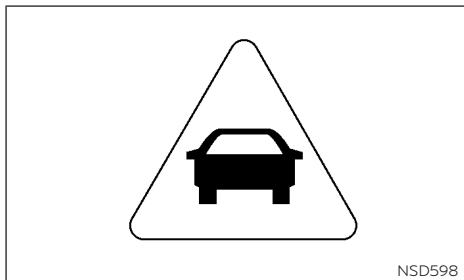

Distance warning light

Distance warning function

The distance warning function can help you to minimize the risk of a collision with the vehicle in front or reduce the effects of such a collision. If the distance warning function detects that there is a risk of a collision, you will be warned visually and audibly.

The distance warning function issues a warning at speeds:

- Of approximately 20 MPH (30 km/h) or more, if, over several seconds the distance maintained to the vehicle traveling in front is insufficient. The distance warning light then lights up in the combination meter.

- Of approximately 4 MPH (7 km/h) or more, if you rapidly approach a vehicle in front. An intermittent warning tone will then sound and the distance warning light will light up in the combination meter.

If a warning is issued:

- Brake immediately in order to increase the distance from the vehicle in front.

or

- Take evasive action provided it is safe to do so.

WARNING

Due to the nature of the system, particularly complicated but non-critical driving conditions may also cause the system to display a warning.

Up to a speed of approximately 45 MPH (70 km/h), the distance warning function can also react to stationary (stopped or parked) vehicles.

If you approach a stationary vehicle and the distance warning function detects a risk of a collision, the system will alert you both visually and acoustically.

Autonomous braking function

If the driver does not react to the distance warning signal in a critical situation, the FEB system can assist with the autonomous braking function

The autonomous braking function can help the driver to avoid an accident or reduces the effects of an accident.

The autonomous braking function is available in the following speed ranges:

- 4-125 MPH (7-200 km/h) for moving vehicles
- 4-30 MPH (7 -50 km/h) for stationary vehicles

Adaptive brake assist function

Adaptive brake assist function provides braking assistance in hazardous situations at speeds above 4 MPH (7 km/h). It uses radar sensor technology to assess the traffic situation.

If the system detects a risk of collision with the vehicle in front, it calculates the braking force necessary to avoid a collision. If you apply the brakes forcefully, the adaptive brake assist function will automatically increase the braking force to a level suitable for the traffic conditions.

If the adaptive brake assist function activates, keep the brake pedal depressed until the emergency braking situation is over. ABS prevents the wheels from locking.

The brakes will work normally again if:

- You release the brake pedal.
- There is no longer any danger of a collision.
- No obstacle is detected in front of your vehicle.

The brake assist function is then deactivated.

At high speeds, the adaptive brake assist function is capable of reacting to moving objects that have already been detected as such at least once over the period of observation.

Up to a speed of approximately 45 MPH (70 km/h), the adaptive brake assist function reacts to stationary vehicles.

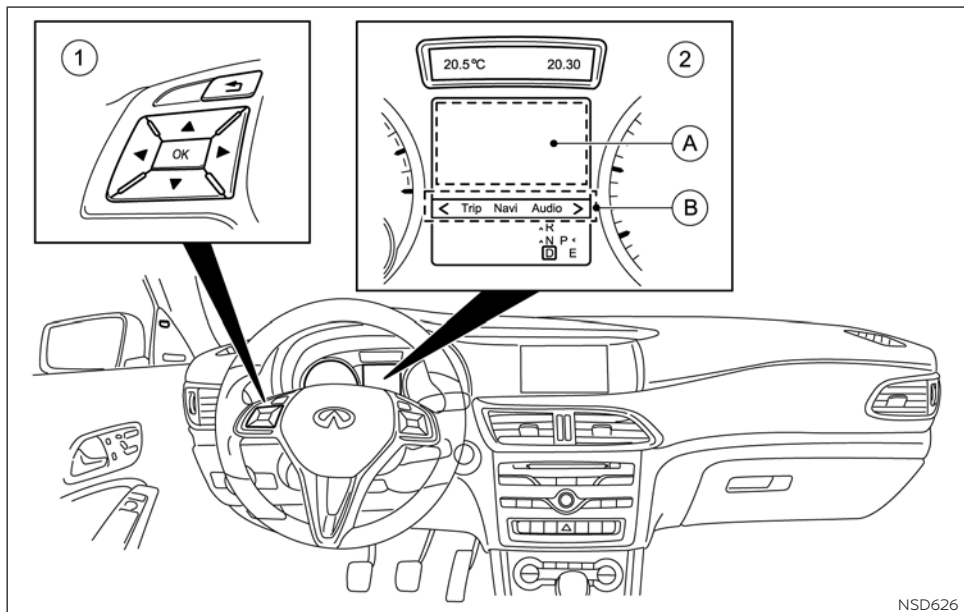

TURNING THE FEB SYSTEM ON/OFF

- ① Steering-wheel mounted controls (left side)
- ② Vehicle information display

- (A) Display area
- (B) Menu bar

NSD626

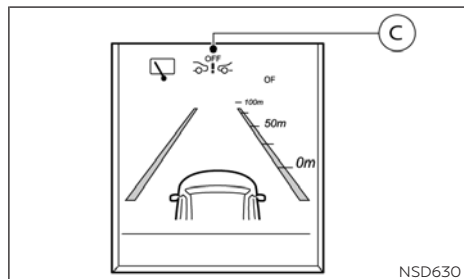

NSD630

Use the following procedure to turn the FEB system on or off:

1. Press the ◀ < or > ▶ button on the steering wheel ① to select the [Drive-Assist] menu on the Menu bar (B).
2. Press the ▲ or ▼ button to select [Emergency Brake].
3. Press the <OK> button on the steering wheel ①. The current selection is displayed.
4. To activate/deactivate the FEB system: press the <OK> button again

When the FEB system is deactivated, the symbol (C) appears in the vehicle information display.

NOTE

The FEB system will be automatically turned on when the engine is restarted.

FEB SYSTEM LIMITATIONS

WARNING

Listed below are the system limitations for the FEB system. Failure to operate the vehicle in accordance with these system limitations could result in serious injury or death.

- The FEB system cannot detect all vehicles under all conditions.
- The radar sensor does not detect the following objects:
 - Pedestrians or animals
 - Oncoming vehicles
 - Crossing vehicles
- The radar sensor has some performance limitations. For stationary vehicles, the FEB system will not function when the vehicle is driven at speeds over:
 - Approximately 31 MPH (50 km/h) for the Autonomous braking function.
- The radar sensor may not detect a vehicle ahead in the following conditions:
 - Dirt, ice, snow or other material covering the radar sensor.
 - Interference by other radar sources.
 - Snow or heavy rain.
 - If the vehicle ahead is narrow (e.g. motorcycle).

- If the vehicle ahead is in a different lane.
- Under strong radar reflections, for example, in a multi-level parking garage.
- New vehicle or after a maintenance of the FEB system. For additional information, see "Break-in schedule" later in this section
- When driving on a steep downhill slope or roads with sharp curves.
- When towing a trailer.
- In some road or traffic conditions, the FEB system may intervene unnecessarily or give an unnecessary warning. Always pay careful attention to the traffic situation. Do not rely solely on the distance warning function and terminate the intervention if necessary.
- Braking distances increase on slippery surfaces.
- The system is designed to automatically check the sensor's functionality, within certain limitations. The system may not detect some forms of obstruction of the sensor area such as ice, snow, stickers, for example. In these cases, the system may not be able to warn the driver properly. Be sure that you check, clean and clear the sensor area regularly.

- Excessive noise will interfere with the warning chime sound, and the chime may not be heard.

SYSTEM TEMPORARILY UNAVAILABLE

If the FEB stops working due to a malfunction or some other reason, one of the following three messages will be displayed in the vehicle information display.

- [Emergency Brake Currently Unavailable See Operator's Manual]
- [Emergency Brake Inoperative]
- [Radar Sensors Dirty See Operator's Manual]

For each of these messages, possible causes and solutions are listed below.

[Emergency Brake Currently Unavailable See Operator's Manual]: The FEB system is temporarily inoperative. Possible causes:

- The radar sensor system is temporarily inoperative, for example, due to electromagnetic radiation emitted by nearby TV or radio stations or other sources of electromagnetic radiation.

- The system is outside the operating temperature range.
- The on-board voltage is too low.

Once the causes listed above no longer apply, the display message goes out. The FEB system is operative again.

If the display message does not disappear:

- Pull over and stop the vehicle safely as soon as possible, paying attention to road and traffic conditions.
- Secure the vehicle against rolling away.
- Switch off the engine.

[Emergency Brake Inoperative]: The FEB system is temporarily inoperative due to a malfunction. The adaptive brake assist function may also have failed.

It is recommended you visit an INFINITI retailer.

[Radar Sensors Dirty See Operator's Manual]: The FEB system is temporarily restricted or inoperative. Possible causes:

- The sensor behind the INFINITI logo is dirty.
- The function of the FEB system is impaired due to heavy rain or snow.

A warning tone also sounds.

5-68 Starting and driving

Once the causes listed above no longer apply, the display message goes out. The FEB system is operative again.

If the display message does not disappear:

- Pull over and stop the vehicle safely as soon as possible, paying attention to road and traffic conditions.
- Secure the vehicle against rolling away.
- Switch off the engine.
- Clean the area around the sensors.
- Restart the engine. The display message disappears.

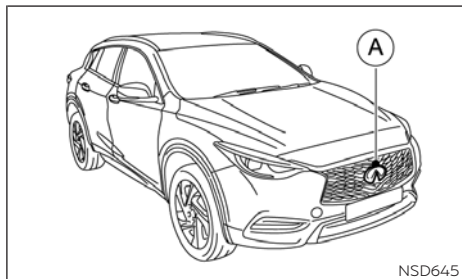

SYSTEM MAINTENANCE

The sensor **A** is located behind the INFINITI logo at the front of the vehicle.

To keep the system operating properly, be sure to observe the following:

- Always keep the sensor area of the INFINITI logo clean.
- Do not strike or damage the areas around the sensor.
- Do not cover or attach stickers or similar objects on the front bumper near the sensor area. This could cause failure or malfunction.
- Do not attach metallic objects near the sensor area (brush guard, etc.). This could cause failure or malfunction.
- Do not alter, remove or paint the front grille or INFINITI logo.

ACTIVE SOUND ENHANCEMENT

FCC NOTICE

For USA:

This device complies with Part 15 of the FCC Rules. Operation is subject to the following two conditions: (1) This device may not cause harmful interference, and (2) this device must accept any interference received, including interference that may cause undesired operation.

NOTE

Changes or modification not expressly approved by the party responsible for compliance could void the user's authority to operate the equipment.

For Canada:

This device complies with Industry Canada license-exempt RSS standard(s). Operation is subject to the following two conditions: (1) this device may not cause harmful interference, and (2) this device must accept any interference received, including interference that may cause undesired operation of the device.

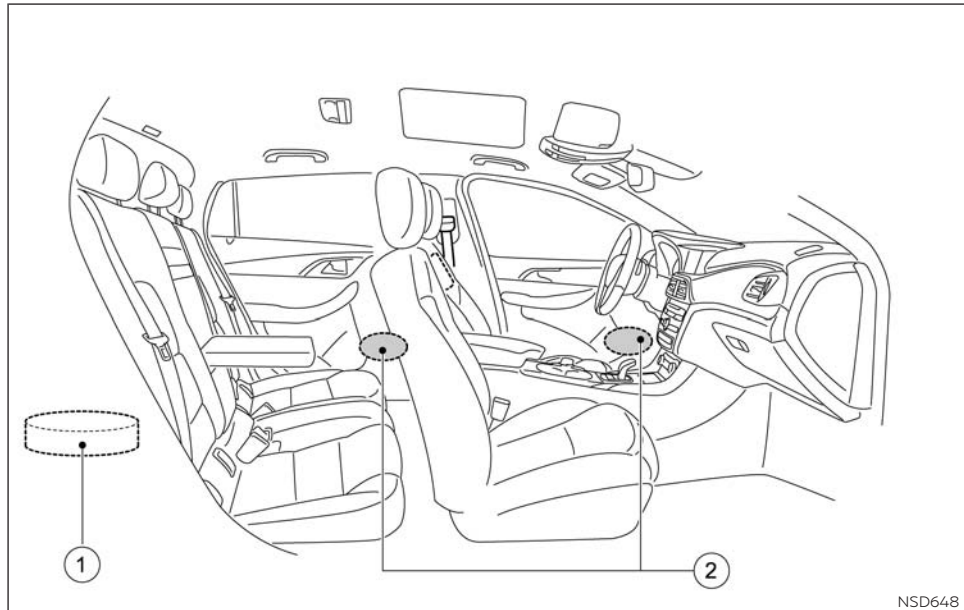

NOTE

To operate the active sound enhancement properly:

- Do not cover the speakers or woofer.
- Do not change or modify speakers including the woofer and any audio related parts such as the amplifier.
- Do not make any modification including sound deadening or modifications around the speakers or woofer.

INTELLIGENT PARKING ASSIST (IPA) (IF EQUIPPED)

ACTIVE SOUND ENHANCEMENT

The active sound enhancement generates sounds according to engine speed through the speakers ② and woofer ① (if equipped) to enhance the quality of the engine sound.

IPA is an electronic parking aid with ultrasound. It detects vehicles and open spaces on both sides of the vehicle. A parking symbol indicates a suitable parking space. Active steering intervention can assist you during parking and when exiting a parking space. The driver controls the accelerator, brake and gear shift. You may also use the Camera Aiding Sonar (parking sensor) function (see "Camera Aiding Sonar (parking sensor) function (if equipped)" later in this section).

IMPORTANT SAFETY NOTES

WARNING

- **IPA is only an aid. It is not a substitute for your attention to the immediate surroundings. The responsibility for safe maneuvering and parking remains with you.**
- **Make sure that no persons, animals or objects are in the maneuvering range**
- **When the sonar (parking sensor) function is deactivated, IPA is also unavailable.**

- **While parking or pulling out of a parking space, the vehicle swings out and can drive onto areas of the oncoming lane. This could cause you to collide with other road users. There is a risk of an accident.**
- **Pay attention to other road users. Stop the vehicle if necessary or cancel the IPA parking procedure**
- **This system is not designed to prevent contact with small or moving objects.**
- **If your vehicle sustains damage to the bumper fascia, leaving it misaligned or bent, the sensing zone may be altered causing inaccurate measurement of obstacles or false alarms.**
- **This system is not designed to prevent contact with small or moving objects.**
- **If your vehicle sustains damage to the bumper fascia, leaving it misaligned or bent, the sensing zone may be altered causing inaccurate measurement of obstacles or false alarms.**

CAUTION

Do not drive over obstacles such as curbs, as you may damage the wheels or tires.

IPA may also display spaces not suitable for parking, for example:

- Parking or stopping prohibition.
- In front of driveways or entrances and exits.
- Unsuitable surfaces.

Parking tips:

- On narrow roads, drive as closely as possible past the parking space.
- Parking spaces that are littered or overgrown might be identified or measured incorrectly.
- Parking spaces that are partly occupied by trailer towing bars might not be identified as such or be measured incorrectly.
- Snowfall or heavy rain may lead to a parking space being measured inaccurately.
- Pay attention to the sonar function warning messages during the parking procedure.

- You can intervene in the steering procedure to correct it at any time. IPA will then be canceled.
- When transporting a load which protrudes from your vehicle, you should not use IPA.
- Never use IPA when snow chains are fitted.
- Make sure that the tire pressures are always correct. This has a direct influence on the parking characteristics of the vehicle.

Use IPA for parking spaces that are:

- Parallel or at right angles to the direction of travel.
- On straight roads, not bends.
- On the same level as the road, e. g. not on the sidewalk.

For vehicles with the towbar folded out, the minimum length for parking spaces is slightly longer.

If you have attached a trailer to your vehicle, you may not use IPA. Once the electrical connection is established between your vehicle and the trailer, IPA is no longer available. The sonar function is deactivated for the rear area

DETECTING PARKING SPACES

The IPA system can only be used to park in spaces that have vehicles directly on either side of the parking space.

Objects located above the height range of IPA will not be detected when the parking space is measured. These are not taken into account when the parking procedure is calculated, e. g. overhanging loads, tail sections or loading ramps of goods vehicles.

WARNING

If there are objects above the detection range, IPA may steer too early. This could cause a collision. There is a risk of an accident.

If objects are located above the detection range, stop and switch off the IPA.

For further information on the detection range see "Range of the sensors" later in this section.

IPA does not assist you parking in spaces at right angles to the direction of travel if:

- Two parking spaces are located directly next to one another.
- The parking space is directly next to a low obstacle such as a low curb.
- You forward park.

IPA does not assist you parking in spaces that are parallel or at right angles to the direction of travel if:

- The parking space is on a curb.
- The system reads the parking space as being blocked, for example, by foliage or grass paving blocks.
- The area is too small for the vehicle to maneuver into.
- The parking space is bordered by an obstacle, e.g. a tree, a post or a trailer.

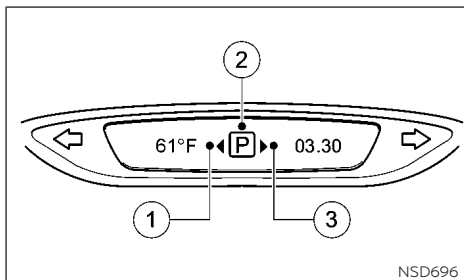

Upper display

- ① Detected parking space on the left.
- ② Parking symbol.
- ③ Detected parking space on the right.

IPA is activated automatically when driving forwards. The system is operational at speeds of up to approximately 19 MPH (30 km/h). While in operation, the system independently locates and measures parking spaces on both sides of the vehicle

IPA will only detect parking spaces:

- Adjacent to the vehicle.
- Parallel or at right angles to the direction of travel.
- That are parallel to the direction of travel and are at least 5 ft (1.5 m) wide.

- That are parallel to the direction of travel and at least 3.3 ft (1.0 m) longer than your vehicle.
- That are at right angles to the direction of travel and at least 3.3 ft (1.0 m) wider than your vehicle.

NOTE

IPA cannot measure the length of a parking space if it is at right angles to the direction of travel. You will need to judge whether your vehicle will fit in the parking space

When driving at speeds below 19 MPH (30 km/h) you will see parking symbol ② as a status indicator in the vehicle information display. When a parking space has been detected, an arrow towards the right ③ or the left ① also appears. IPA only displays parking spaces on the front-passenger side as standard. Parking spaces on the driver's side are displayed as soon as the turn signal on the driver's side is activated. When parking on the driver's side, this must remain activated until you confirm the use of IPA by pressing the **<OK>** button on the steering wheel. The system automatically determines whether the parking space is parallel or at right angles to the direction of travel.

A parking space is displayed while you are driving past it, and until you are approximately 50 ft (15 m) away from it.

PARKING

NOTE

When the sonar function detects obstacles, you are responsible for braking in good time.

1. Stop the vehicle when the parking symbol shows the desired parking space in the combination meter

2. Shift into position R.

The [Start Park Assist? Yes: OK No:]  message appears in the vehicle information display.

3. To cancel the procedure: press the  button on the steering wheel or pull away or

4. To park using IPA press the **<OK>** button on the steering wheel. The Park Assist [Observe surroundings] message appears in the vehicle information display.

5. Release the steering wheel.

6. Back up the vehicle, being ready to brake at all times. When backing up, drive at a speed below 5 MPH (10 km/h). Otherwise, IPA will be canceled.

7. Stop as soon as the sonar function sounds the continuous warning tone, if not before. Maneuvering may be required in tight parking spaces.

The [Park Assist active Select D Observe surroundings] message appears in the vehicle information display.

8. Select transmission position D (Drive) while the vehicle is stationary.

IPA immediately steers in the other direction.

The [Park Assist Observe surroundings] message appears in the vehicle information display.

NOTE

You will achieve the best results by waiting for the steering procedure to complete before pulling away.

9. Drive forwards and be ready to brake at all times.

Maneuvering may be required in tight parking spaces. Drive forward and back up as prompted by the IPA and sonar function warning displays, several times if necessary.

10. Stop as soon as the sonar function sounds the continuous warning tone, if not before.

The [Park Assist active Select R] [Observe surroundings] message appears in the vehicle information display.

As soon as the parking procedure is complete the [Park Assist switched off] message appears and a warning tone sounds. The vehicle is now parked.

11. Before leaving the vehicle, secure the vehicle against rolling away unintentionally:

- The electric parking brake must be applied.
- The transmission must be in position P (Park) and the transmission position display must show P in the vehicle information display.
- The key must be removed from the ignition switch.
- On uphill or downhill gradients, the front wheels must be turned towards the curb.

IPA no longer supports you with steering interventions. When IPA is finished, you must steer again yourself. The sonar function is still available.

Parking tips:

- The way your vehicle is positioned in the parking space after parking is dependent on various factors. These include the position and shape of the vehicles parked in front and behind it and the conditions of the location. It may be the case that IPA guides you too far into a parking space, or not far enough into it. In some cases, it may also lead you across or onto the curb. If necessary you should cancel the parking procedure with IPA.
- During the parking maneuver, the system will indicate when you should shift to R (Reverse) or D (Drive). However, you can freely choose to shift gear whenever you feel you need to. Should the transmission change take place too early, the parking procedure will be canceled. A sensible parking position can no longer be achieved from this position.

EXITING A PARKING SPACE

In order that IPA can support when exiting the parking space:

- You need to have parked using IPA.
- The border of the parking space must be high enough at the front and the rear. A curb stone is too small, for example.



- The border of the parking space must not be too wide, as the position of the vehicle must not exceed an angle of 45 degrees to the starting position as it is manoeuvred into the parking space.
- A total front and back maneuvering distance of at least 1.0 m must be available.

IPA can only assist you with exiting a parking space if you have parked the vehicle parallel to the direction of travel using IPA.

WARNING

- **IPA is only an aid. It is not a substitute for your attention to the immediate surroundings. The responsibility for safe maneuvering and parking remains with you.**
- **Make sure that no persons, animals or objects are in the maneuvering range.**
- **When the sonar function is deactivated, IPA is also unavailable.**
- **While parking or pulling out of a parking space, the vehicle swings out and can drive onto areas of the oncoming lane. This could cause you to collide with other road users. There is a risk of an accident.**

• **Pay attention to other road users. Stop the vehicle if necessary or cancel the IPA parking procedure.**

1. Start the engine.
2. Release the electric parking brake.
3. Switch on the turn signal in the direction you are pulling away.
4. **Vehicles with automatic transmission:** shift the transmission to position D or R
The [Start Park Assist? Yes: OK No:]  message appears in the vehicle information display.
5. To cancel the procedure: press the  button on the steering wheel or pull away or
6. To exit a parking space using IPA: press the **<OK>** button on the steering wheel
The Park Assist [Observe surroundings] message appears in the display.
7. Release the steering wheel.
8. Pull away, being ready to brake at all times Do not exceed a maximum speed of approximately 5 MPH (10 km/h) when exiting a parking space. Otherwise, IPA will be canceled.

WARNING

While parking or pulling out of a parking space, the vehicle swings out and can drive onto areas of the oncoming lane. This could cause you to collide with other road users. There is a risk of an accident.

9. Depending on the message or as required, shift the transmission to position D or R.

IPA immediately steers in the other direction. The [Observe surroundings] message appears in the display.

NOTE

You will achieve the best results by waiting for the steering procedure to complete before pulling away.

If you back up after activation, the steering wheel is moved to the straight-ahead position.

10. Drive forward and back up as prompted by the IPA and sonar function warning displays, several times if necessary.

Once you have exited the parking space completely, the steering wheel is moved to the straight-ahead position. You hear a tone and the [Park Assist switched off] message appears in the display. You will then have to steer and merge into traffic on your own. The sonar function is still available. You can take over the steering before the vehicle has exited the parking space completely. This is useful, for example when you recognize that it is already possible to pull out of the parking space.

CANCELING IPA

Stop the movement of the steering wheel or steer yourself. IPA will be immediately canceled. The [Park Assist canceled] message appears in the vehicle information display.

or

Press the sonar function OFF switch. The sonar function is switched off and IPA is immediately canceled. The [Park Assist canceled] message appears in the vehicle information display.

IPA is canceled automatically if:

- The electric parking brake is applied
- Parking using IPA is no longer possible
- You are driving faster than 5 MPH (10 km/h)
- A wheel spins and VDC intervenes or fails. The  warning light lights up in the combination meter.

A warning tone sounds. The parking symbol disappears and the vehicle information display shows the [Park Assist canceled] message.

When IPA is canceled, you must steer again yourself.

CAMERA AIDING SONAR (PARKING SENSOR) FUNCTION (IF EQUIPPED)

WARNING

- The sonar function is a convenience but it is not a substitute for proper parking. Always look around and check that it is safe to do so before parking. Always move slowly.
- Read and understand the limitations of the sonar function as contained in this section. Inclement weather may affect the function of the sonar function; this may include reduced performance or a false activation.
- The driver is always responsible for safety during parking and other maneuvers.
- The system is designed as an aid to the driver in detecting large stationary objects to help avoid damaging the vehicle. The system will not detect small objects below the bumper, and may not detect objects that are too close to the bumper or on the ground.
- Always look around and check that it is safe to move before parking.

CAUTION

- Keep the interior of the vehicle as quiet as possible to hear the tone clearly.
- Keep the sensors (located on the bumper fascia) free from snow, ice and large accumulations of dirt. Do not clean the sensors with sharp objects. If the sensors are covered, the accuracy of the sensor function will be diminished.

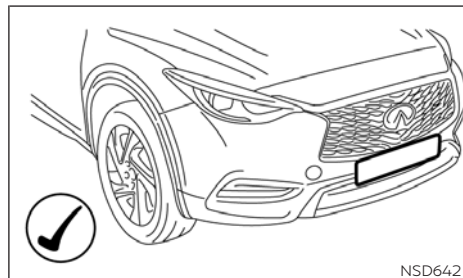

No frame/frameless

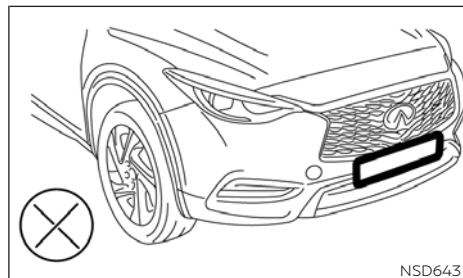

Frame type

WARNING

INFINITI recommends only to use frameless type license plate holders.

The sonar sensors may not function correctly if the license plate is placed in a frame as illustrated. Please contact an INFINITI retailer for advice.

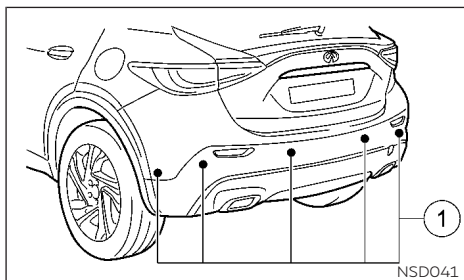
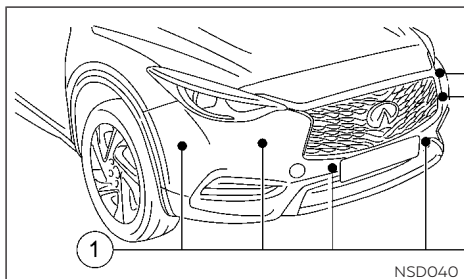

SONAR FUNCTION OVERVIEW

① Possible sonar sensor locations

The sonar function is an electronic parking aid with ultrasonic sensors. The sonar function indicates audibly the distance between your vehicle and an object. It monitors the area around your vehicle using sensors in the front and rear bumper. Possible sensor configurations include a 4 sensor, 10 sensor or 12 sensor configuration.

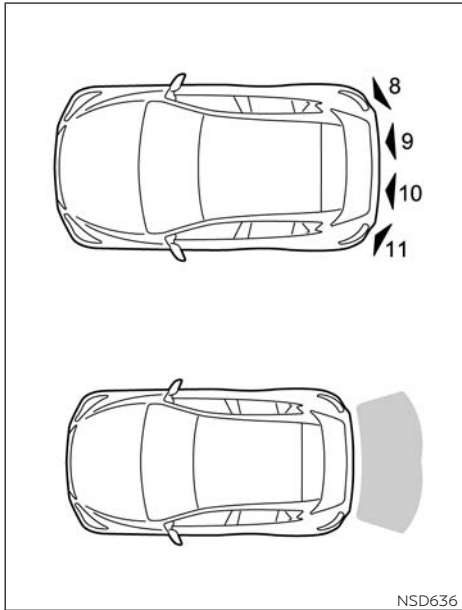

Type A: 4 sensor system

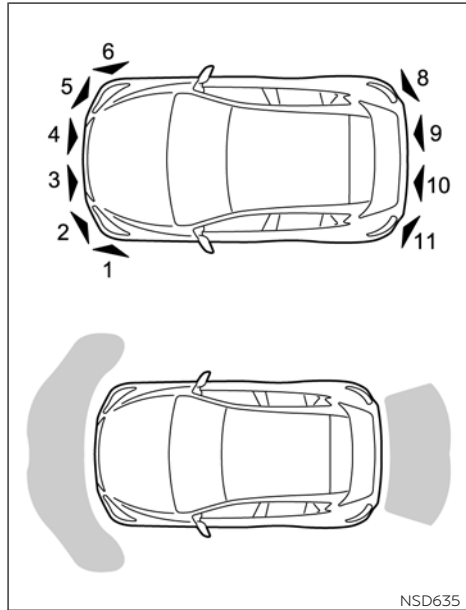

Type B: 10 sensor system

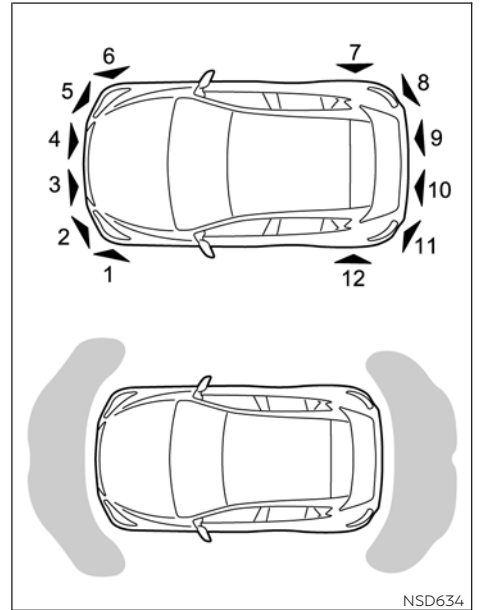

Type C: 12 sensor system

For the vehicle equipped with rear sensors (Type A):

The system informs you about rear obstacles with visual and audible signals when the shift lever is in the R (Reverse) position.

The intermittent tone will stop after 3 seconds when an obstacle is detected by only the corner sensor and the distance does not change. The tone will stop when the obstacle moves away from the vehicle.

For the vehicle equipped with front and rear sensors (Type B and C):

The system informs you about front obstacles with visual and audible signals when the shift lever is in the D (Drive) position and both front and rear obstacles when the shift lever is in the R (Reverse) position.

The intermittent tone will stop after 3 seconds when an obstacle is detected by only the corner sensor and the distance does not change. The tone will stop when the obstacle moves away from the vehicle.

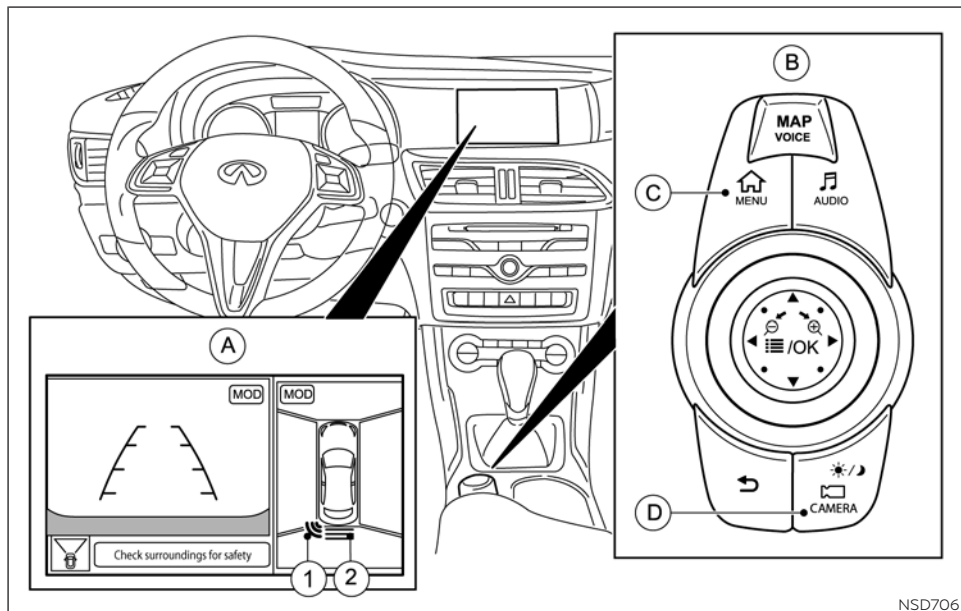

With Around View monitor

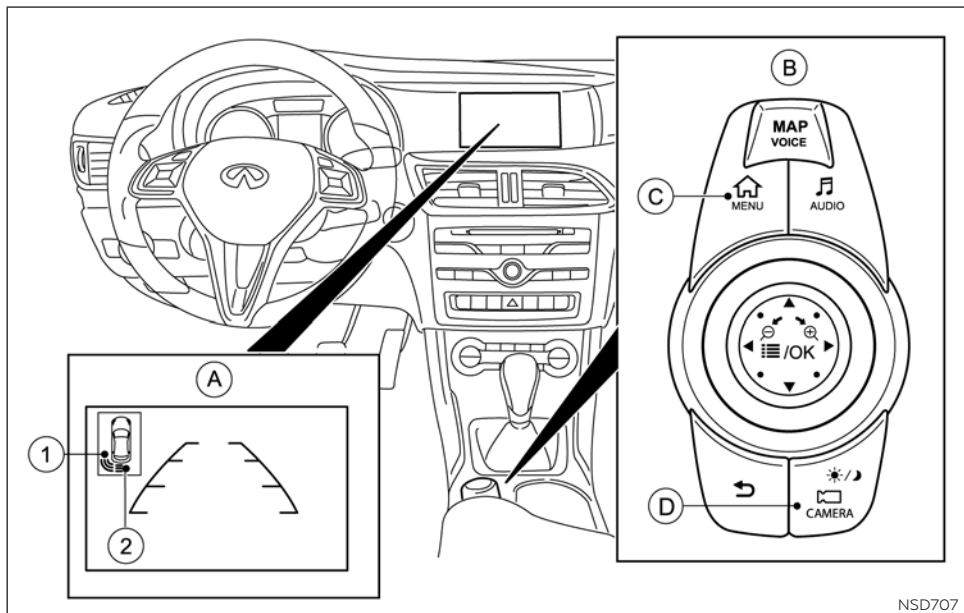

With RearView monitor

- (A) RearView/Around View monitor display
- (B) INFINITI controller
- (C) <MENU> button
- (D) <CAMERA> button

When the corner of the vehicle moves closer to an object, the corner sensor indicators ① appear (if equipped).

When the center of the vehicle moves close to an object, the center indicator ② appears.

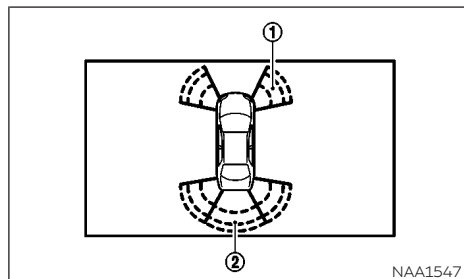

NAA1547

When the object is detected, the indicator (green) appears and blinks and the tone sounds intermittently. When the vehicle moves closer to the object, the color of the indicator turns yellow and the rate of the blinking increases. When the vehicle is very close to the object, the indicator stops blinking and turns red, and the tone sounds continuously.

The sonar function is activated automatically when you:

- Switch on the ignition
- Shift to position D (Drive), or R (Reverse) on vehicles with automatic transmission
- Release the electric parking brake

The sonar function is deactivated at speeds above 10 MPH (16 km/h). It is reactivated at lower speeds.

The sonar function is deactivated for the rear area when you establish an electrical connection between your vehicle and a trailer.

RANGE OF THE SENSORS

The sonar function does not take into account obstacles located:

- Below the detection range, e.g. persons, animals or objects.
- Above the detection range, e.g. overhanging loads, tail sections or loading ramps of goods vehicles.

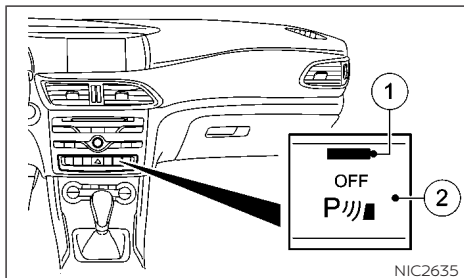

SONAR FUNCTION OFF SWITCH

The sonar function OFF switch ② on the lower side of the instrument panel allows the driver to turn the sonar function on and off. To turn the sonar function system on and off, the ignition switch must be in the ON position. The indicator light ① on the switch will illuminate when the system is turned off.

The sonar function will turn on automatically when the ignition switch is turned from the OFF position to the ON position.

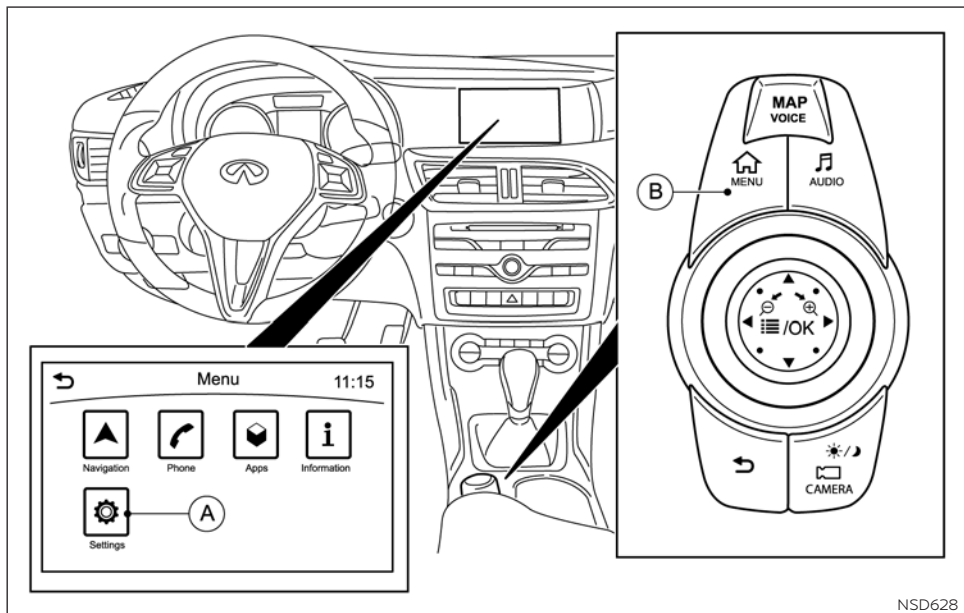

- (A) Settings key
- (B) <MENU> button

1. Push <MENU> (B) and touch [Settings] (A).
2. Touch [Camera/Sonar]
3. Touch [Sonar]

SONAR FUNCTION SETTINGS

The sonar function settings can be changed using the following procedure.

5-82 Starting and driving

[Sonar sensitivity]:

Adjust the sonar sensitivity by touching [+]/[-].

[Sonar volume]:

Adjust the warning tone volume by touching [+]/[-].

SONAR FUNCTION LIMITATIONS

⚠ WARNING

Listed below are the system limitations for the sonar function. Failure to operate the vehicle in accordance with these system limitations could result in serious injury or death.

- Inclement weather or ultrasonic sources such as an automatic car wash, a truck's compressed-air brakes or a pneumatic drill may affect the function of the system, including reduced performance or a false activation.
- The system is not designed to prevent contact with small or moving objects.
- The system will not detect small objects below the bumper, and may not detect objects close to the bumper or on the ground.

- **The system may not detect the following objects:**
 - Fluffy objects such as snow, cloth, cotton, grass or wool.
 - Thin objects such as rope, wire or chain.
 - Wedge-shaped objects.
- **If your vehicle sustains damage to the bumper fascia, leaving it misaligned or bent, the sensing zone may be altered causing inaccurate measurement of objects or false alarms.**

 **CAUTION**

Excessive noise (such as audio system volume or an open vehicle window) will interfere with the tone and it may not be heard.

PROBLEMS WITH SONAR FUNCTION

Problem	Possible causes/consequences and solutions
<p>Only the red segments in the sonar function displays are lit. You also hear a warning tone for approximately two seconds. The sonar function is then deactivated and the indicator light on the sonar function OFF switch lights up.</p>	<p>The sonar function has malfunctioned and has been deactivated. If problems persist, have the sonar function checked. It is recommended you visit an INFINITI retailer for this service.</p>
<p>Only the red segments in the sonar function displays are lit. The sonar function is then deactivated.</p>	<p>The sonar sensors are dirty or there is interference.</p> <ul style="list-style-type: none"> • Clean the sensors. • Switch the ignition back on. <p>The problem may be caused by an external source of radio or ultrasound waves. See if the sonar system functions in a different location.</p>

BREAK-IN SCHEDULE

SYSTEM MAINTENANCE

CAUTION

Keep the surface of the sonar sensors (if equipped) (located on the front and rear bumper fascia) free from accumulations of snow, ice and dirt. Do not scratch the surface of the sonar sensors when cleaning. If the sensors are covered, the accuracy of the sonar function will be diminished.

During the first 1,200 miles (2,000 km), follow these recommendations to obtain maximum engine performance and ensure the future reliability and economy of your new vehicle. Failure to follow these recommendations may result in shortened engine life and reduced engine performance.

- Avoid driving for long periods at constant speed, either fast or slow, and do not run the engine over 4,000 RPM.
- Do not accelerate at full throttle in any gear.
- Avoid quick starts.
- Avoid hard braking as much as possible.
- Do not tow a trailer for the first 500 mi (805 km). Your engine, axle or other parts could be damaged.

You should also observe these notes on break-in if the engine or parts of the drive train on your vehicle have been replaced.

CAUTION

In certain driving and driving safety systems, the sensors adjust automatically while a certain distance is being driven after the vehicle has been delivered or after repairs. Full system effectiveness is not reached until the end of this teach-in process.

Brake pads/linings and rotors that are either new or have been replaced only achieve optimum braking effect after several hundred miles of driving. Compensate for the reduced braking effect by applying greater force to the brake pedal

FUEL EFFICIENT DRIVING TIPS

Follow these easy-to-use Fuel Efficient Driving Tips to help you achieve the most fuel economy from your vehicle.

1. Use Smooth Accelerator and Brake Pedal Application

- Avoid rapid starts and stops.
- Use smooth, gentle accelerator and brake application whenever possible.
- Maintain constant speed while commuting and coast whenever possible.

2. Maintain Constant Speed

- Look ahead to try and anticipate and minimize stops.
- Synchronizing your speed with traffic lights allows you to reduce your number of stops.
- Maintaining a steady speed can minimize red light stops and improve fuel efficiency.

3. Use Air Conditioning (A/C) at Higher Vehicle Speeds

- Below 40 MPH (64 km/h), it is more efficient to open windows to cool the vehicle due to reduced engine load.
- Above 40 MPH (64 km/h), it is more efficient to use A/C to cool the vehicle due to increased aerodynamic drag.

- Recirculating the cool air in the cabin when the A/C is on reduces cooling load.

4. Drive at Economical Speeds and Distances

- Observing the speed limit and not exceeding 60 MPH (97 km/h) (where legally allowed) can improve fuel efficiency due to reduced aerodynamic drag.
- Maintaining a safe following distance behind other vehicles reduces unnecessary braking.
- Safely monitoring traffic to anticipate changes in speed permits reduced braking and smooth acceleration changes.
- Select a gear range suitable to road conditions.

5. Use Cruise Control

- Using cruise control during highway driving helps maintain a steady speed.
- Cruise control is particularly effective in providing fuel savings when driving on flat terrains.

Utilize a map or navigation system to determine the best route to save time.

6. Avoid Idling

- Shutting off your engine when safe for stops exceeding 30 seconds saves fuel and reduces emissions.

7. Buy an Automated Pass for Toll Roads

- Automated passes permit drivers to use special lanes to maintain cruising speed through the toll and avoid stopping and starting.

8. Winter Warm Up

- Limit idling time to minimize impact to fuel economy.
- Vehicles typically need no more than 30 seconds of idling at start-up to effectively circulate the engine oil before driving.
- Your vehicle will reach its ideal operating temperature more quickly while driving versus idling.

9. Keeping your Vehicle Cool

- Park your vehicle in a covered parking area or in the shade whenever possible.
- When entering a hot vehicle, opening the windows will help to reduce the inside temperature faster, resulting in reduced demand on your A/C system.

INCREASING FUEL ECONOMY

- Keep your engine tuned up.
 - Follow the recommended scheduled maintenance.
 - Keep the tires inflated to the correct pressure. Low tire pressure increases tire wear and lowers fuel economy.
 - Keep all the wheels in correct alignment. Improper alignment increases tire wear and lowers fuel economy.
 - Use the recommended viscosity engine oil.
- For additional information, see "Recommended fluids/lubricants and capacities"

FOUR-WHEEL DRIVE (4WD) (IF EQUIPPED)

WARNING

- **Do not drive beyond the performance capability of the tires, even with 4WD engaged. Accelerating quickly, sharp steering maneuvers or sudden braking may cause loss of control.**
 - **Always use tires of the same type, size, brand, construction (bias, bias-belted or radial), and tread pattern on all four wheels.**
 - **This vehicle is not designed for off-road (rough road) use. Do not drive on sandy or muddy roads that tires may get stuck in.**
 - **For 4WD equipped vehicles, do not attempt to raise two wheels off the ground and shift the transmission to any drive or reverse position with the engine running. Doing so may result in drivetrain damage or unexpected vehicle movement which could result in serious vehicle damage or personal injury.**
- **Do not attempt to test a 4WD equipped vehicle on a 2-wheel dynamometer (such as the dynamometers used by some states for emissions testing) or similar equipment even if the other two wheels are raised off the ground. Make sure that you inform the test facility personnel that your vehicle is equipped with 4WD before it is placed on a dynamometer. Using the wrong test equipment may result in drivetrain damage or unexpected vehicle movement which could result in serious vehicle damage or personal injury.**
 - **When a wheel is off the ground due to an uneven surface, do not spin the wheel excessively.**

PARKING

CAUTION

Never tow the vehicle with one axle raised. This may damage the differential. Damage of this sort is not covered by the warranty. All wheels must be fully raised (see "Four-Wheel Drive (4WD) models")

4WD, together with VDC, improves the traction of your vehicle whenever a drive wheel spins due to insufficient grip.

If you fail to adapt your driving style, 4WD can neither reduce the risk of an accident nor override the laws of physics. 4WD cannot take account of road, weather, and traffic conditions. 4WD is only an aid. You are responsible for the distance to the vehicle in front, for vehicle speed, for braking in good time, and for staying in lane.

If a drive wheel spins due to insufficient grip

- When pulling away, only depress the accelerator pedal as far as is necessary.
- Accelerate less when driving.

NOTE

In wintry driving conditions, the maximum effectiveness of 4WD can only be achieved if you use winter tires (M+S tires), with snow chains if necessary.

WARNING

- Do not stop or park the vehicle over flammable materials such as dry grass, waste paper or rags. They may ignite and cause a fire.
- Safe parking procedures require that both the parking brake be applied and the P (Park) position engaged. Failure to do so could cause the vehicle to move unexpectedly or roll away and result in an accident.
- When parking the vehicle, make sure the P (Park) position is engaged. The shift lever cannot be moved out of the P (Park) position without depressing the brake pedal.
- Never leave the engine running while the vehicle is unattended.
- Do not leave children unattended inside the vehicle. They could unknowingly activate switches or controls or move the vehicle. Unattended children could become involved in serious accidents.

- To help avoid risk of injury or death through unintended operation of the vehicle and/or its systems, do not leave children, people who require the assistance of others, or pets unattended in your vehicle. Additionally, the temperature inside a closed vehicle on a warm day can quickly become high enough to cause a significant risk of injury or death to people and pets.

CAUTION

Always secure the vehicle correctly against rolling away. Otherwise, the vehicle or its drive train could be damaged.

To ensure that the vehicle is secured against rolling away unintentionally:

- The electric parking brake must be applied.
- The transmission must be in position P (Park) and the transmission position display must show P in the vehicle information display.
- The key must be removed from the ignition switch.
- On uphill or downhill gradients, the front wheels must be turned towards the curb.

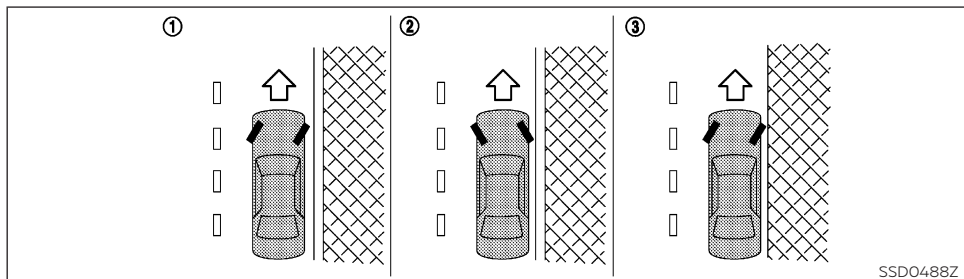

1. Firmly apply the parking brake.
2. Press the P (Park) button.
3. To help prevent the vehicle from moving into traffic when parked on an incline, it is a good practice to turn the wheels as illustrated.

HEADED DOWNHILL WITH CURB ①

Turn the wheels into the curb and move the vehicle forward until the curb side wheel gently touches the curb. Then apply the parking brake.

HEADED UPHILL WITH CURB ②

Turn the wheels away from the curb and allow the vehicle to move back until the curb side wheel gently touches the curb. Then apply the parking brake.

HEADED UPHILL OR DOWNHILL, WITHOUT CURB ③

Turn the wheels toward the side of the road so the vehicle will move away from the center of the road if the vehicle moves. Then apply the parking brake.

4. Put the ignition switch in the OFF position.

SWITCHING OFF THE ENGINE

⚠ WARNING

The automatic transmission switches to position N (Neutral) when you switch off the engine. The vehicle may roll away. There is a risk of an accident. After switching off the engine, always switch to position P (Park). Prevent the parked vehicle from rolling away by applying the parking brake.

Procedure

1. Apply the electric parking brake.
2. Shift the transmission to position P (Park).
3. **With the key:** turn the key to the position OFF in the ignition switch and remove it. The immobilizer is activated.

If you switch the engine off with the transmission in position R (Reverse) or D (Drive), the automatic transmission shifts to N (Neutral) automatically.

With the key: if you then open the driver's door or the front-passenger door or remove the key from the ignition, the automatic transmission shifts to P (Park) automatically.

If you want the automatic transmission to remain in neutral N (Neutral), e.g. when having the vehicle cleaned in an automatic car wash with a towing system:

With the key:

1. Switch the ignition on.
2. Depress the brake pedal and keep it depressed.
3. Shift to N (Neutral).

ELECTRIC POWER STEERING SYSTEM

4. Release the brake pedal.
5. Release the electric parking brake.
6. Switch off the ignition and leave the key in the ignition switch.

EXTENDED PARKING

If you leave the vehicle parked up for longer than four weeks, the battery may be damaged by exhaustive discharging.

If you leave the vehicle parked up for longer than six weeks, it may suffer from lack of use. Visit an INFINITI retailer and seek advice

NOTE

You can obtain information about trickle chargers from an INFINITI retailer.

The electric power steering system is designed to reduce the driver effort required to steer the vehicle.

WARNING

If during operation a fault is detected the following message will be displayed in the vehicle information display along with an audible warning tone.

[Power Steering Malfunction See Operators Manual]

In conjunction with this warning, steering assistance will no longer be provided by the system.

The effort required to steer the vehicle will increase. This will be most noticeable at low speed and when performing a tight turning maneuver.

Check whether you are able to provide the extra effort required.

If you are able to steer safely: Carefully drive on to an INFINITI retailer.

If you are unable to steer safely: Do NOT drive on. It is recommended you contact the nearest INFINITI retailer for assistance.

CAUTION

- **If wheels or tires other than INFINITI recommended ones are used, the power steering system may not operate properly and the [Power Steering Malfunction See Operators Manual] warning may appear in the vehicle information display.**
- **Do not modify the vehicle's suspension. If suspension parts such as shock absorbers, struts, springs, stabilizer bars, bushings and wheels are not INFINITI recommended for your vehicle or are extremely deteriorated, the power steering system may not operate properly and the [Power Steering Malfunction See Operators Manual] warning may appear in the vehicle information display.**
- **Do not modify the vehicle's steering. If steering parts are not INFINITI recommended for your vehicle or are extremely deteriorated, the power steering system may not operate properly and the [Power Steering Malfunction See Operators Manual] warning may appear in the vehicle information display.**

BRAKE SYSTEM

- **Do not place the ignition switch in the on position while the steering wheel or a tire is removed.**
- **Do not turn the steering wheel as much as possible while the ignition switch is in any position other than the ON position.**
- **Installing an accessory on the steering wheel, or changing the steering wheel, may reduce the steering performance.**

NOTE

When the steering wheel is operated repeatedly or continuously while parking or driving at a very low speed, the power assistance for the steering wheel will be reduced. This is to prevent overheating of the electric power steering system and protect it from becoming damaged. While the power assistance is reduced, steering wheel operation will become heavy. When the temperature of the electric power steering system decreases, the power assistance level will return to normal. Avoid repeating such steering wheel operations that could cause the electric power steering system to overheat.

The brake system has two separate hydraulic circuits. If one circuit malfunctions, you will still have braking ability at two wheels.

BRAKE PRECAUTIONS

WARNING

While driving on a slippery surface, be careful when braking, accelerating or downshifting. Abrupt braking or accelerating could cause the wheels to skid and result in an accident.

Vacuum assisted brakes

The brake booster aids braking by using engine vacuum. If the engine stops, you can stop the vehicle by depressing the brake pedal. However, greater foot pressure on the brake pedal will be required to stop the vehicle. The stopping distance will be longer.

WARNING

- **If the engine is not running or is turned off while driving, the power assist for the brakes will not work. Braking will be harder.**
- **Do not coast with the engine stopped.**

When the brake pedal is depressed slowly and firmly, you may hear a clicking noise and feel a slight pulsation. This is normal and indicates that the Brake Assist System is operating (if equipped).

Using brakes

Avoid resting your foot on the brake pedal while driving. This will overheat the brakes, wear out the brake linings/pads faster, and increase fuel consumption.

To help reduce brake wear and to prevent the brakes from overheating, reduce speed and downshift to a lower gear before going down a slope or long grade. Overheated brakes may reduce braking performance and could result in loss of vehicle control.

While driving on a slippery surface, be careful when braking, accelerating or downshifting. Abrupt braking or acceleration could cause the wheels to skid and result in an accident.

Wet brakes

When the vehicle is washed or driven through water, the brakes may get wet. As a result, your braking distance will be longer and the vehicle may pull to one side during braking.

To dry the brakes, drive the vehicle at a safe speed while lightly depressing the brake pedal to heat up the brakes. Do this until the

brakes return to normal. Avoid driving the vehicle at high speeds until the brakes function correctly.

Driving uphill

When starting on a steep gradient, it is sometimes difficult to operate the brake. Use the parking brake to hold the vehicle. When ready to start, make sure that the shift lever is in an appropriate forward or reverse driving position, release the parking brake while depressing the accelerator pedal. If your vehicle has an electric parking brake, this will automatically release when you depress the accelerator pedal (DCT models).

Driving downhill

The engine braking action is effective for controlling the vehicle while descending hills.

A low gear position in the manual shift mode, low enough to obtain sufficient engine braking, should be selected.

Parking brake break-in

Break in the parking brake shoes whenever the stopping effect of the parking brake is weakened or whenever the parking brake shoes and/or drums/rotors are replaced, in order to assure the best braking performance.

This procedure is described in the vehicle service manual and can be performed by an INFINITI retailer.

ANTI-LOCK BRAKING SYSTEM (ABS)

WARNING

The Anti-lock Braking System (ABS) is a sophisticated device, but it cannot prevent accidents resulting from careless or dangerous driving techniques. It can help maintain vehicle control during braking on slippery surfaces. Remember that stopping distances on slippery surfaces will be longer than on normal surfaces even with ABS. Stopping distances may also be longer on rough, gravel or snow covered roads, or if you are using tire chains. Always maintain a safe distance from the vehicle in front of you. Ultimately, the driver is responsible for safety.

Tire type and condition may also affect braking effectiveness.

- **When replacing tires, install the specified size of tires on all four wheels.**

- **When installing a replacement tire, make sure that it is the proper size and type as specified on the tire and loading information label. (See "Wheels and Tires".)**
- **For detailed information, see "Wheels and tires".**

The Anti-lock Braking System (ABS) controls the brakes so the wheels do not lock during hard braking or when braking on slippery surfaces. The system detects the rotation speed at each wheel and varies the brake fluid pressure to prevent each wheel from locking and sliding. By preventing each wheel from locking, the system helps the driver maintain steering control and helps to minimize swerving and spinning on slippery surfaces.

Using system

Depress the brake pedal and hold it down. Depress the brake pedal with firm steady pressure, but do not pump the brakes. The ABS will operate to prevent the wheels from locking up. Steer the vehicle to avoid obstacles.

WARNING

Do not pump the brake pedal. Doing so may result in increased stopping distances.

Self-test feature

The ABS includes electronic sensors, electric pumps, hydraulic solenoids and a computer. The computer has a built-in diagnostic feature that tests the system each time you start the engine and move the vehicle at a low speed in forward or reverse. When the self-test occurs, you may hear a "clunk" noise and/or feel a pulsation in the brake pedal. This is normal and does not indicate a malfunction. If the computer senses a malfunction, it switches the ABS off and illuminates the ABS warning light on the instrument panel. The brake system then operates normally, but without anti-lock assistance. If the ABS warning light illuminates during the self-test or while driving, have the vehicle checked. It is recommended you visit an INFINITI retailer for this service.

Normal operation

The ABS operates at speeds above 3 to 6 MPH (5 to 10 km/h). The speed varies according to road conditions.

When the ABS senses that one or more wheels are close to locking up, the actuator rapidly applies and releases hydraulic pressure. This action is similar to pumping the brakes very quickly. You may feel a pulsation in the brake pedal and hear a noise from under the hood or feel a vibration from the actuator when it is operating. This is normal and indicates that the ABS is operating properly. However, the pulsation may indicate that road conditions are hazardous and extra care is required while driving.

VEHICLE DYNAMIC CONTROL (VDC) SYSTEM

The Vehicle Dynamic Control (VDC) system uses various sensors to monitor driver inputs and vehicle motion. Under certain driving conditions, the VDC system helps to perform the following functions.

- Controls brake pressure to reduce wheel slip on one slipping drive wheel so power is transferred to a non slipping drive wheel on the same axle.
- Controls brake pressure and engine output to reduce drive wheel slip based on vehicle speed (traction control function).
- Controls brake pressure at individual wheels and engine output to help the driver maintain control of the vehicle in the following conditions:
 - understeer (vehicle tends to not follow the steered path despite increased steering input)
 - oversteer (vehicle tends to spin due to certain road or driving conditions).

The VDC system can help the driver to maintain control of the vehicle, but it cannot prevent loss of vehicle control in all driving situations.

When the VDC system operates, the VDC warning light in the instrument panel flashes so note the following:

- The road may be slippery or the system may determine some action is required to help keep the vehicle on the steered path.
- You may feel a pulsation in the brake pedal and hear a noise or vibration from under the hood. This is normal and indicates that the VDC system is working properly.
- Adjust your speed and driving to the road conditions.



See "Vehicle Dynamic Control (VDC) warning light".



If a malfunction occurs in the system, the VDC warning light  illuminates in the instrument panel. The VDC system automatically turns off.

WARNING



- **The VDC system is designed to help the driver maintain stability but does not prevent accidents due to abrupt steering operation at high speeds or by careless or dangerous driving techniques.**

Reduce vehicle speed and be especially careful when driving and cornering on slippery surfaces and always drive carefully.

- **Do not modify the vehicle's suspension. If suspension parts such as shock absorbers, struts, springs, stabilizer bars, bushings and wheels are not INFINITI recommended for your vehicle or are extremely deteriorated, the VDC system may not operate properly. This could adversely affect vehicle handling performance, and the VDC warning light  may illuminate.**
- **If brake related parts such as brake pads, rotors and calipers are not INFINITI recommended or are extremely deteriorated, the VDC system may not operate properly and the VDC warning light  may illuminate.**
- **If engine control related parts are not INFINITI recommended or are extremely deteriorated, the VDC warning light  may illuminate.**

- **When driving on extremely inclined surfaces such as higher banked corners, the VDC system may not operate properly and the VDC warning light  may illuminate. Do not drive on these types of roads.**
- **When driving on an unstable surface such as a turntable, ferry, elevator or ramp, the VDC warning light  may illuminate. This is not a malfunction. Restart the engine after driving onto a stable surface.**
- **If wheels or tires other than the INFINITI recommended ones are used, the VDC system may not operate properly and the VDC warning light  may illuminate.**
- **The VDC system is not a substitute for winter tires or tire chains on a snow covered road.**
- **If VDC is malfunctioning, VDC is unable to stabilize the vehicle. In addition, other driving safety systems are switched off. This increases the risk of skidding and an accident. Drive on carefully. Have VDC checked. It is recommended you visit an INFINITI retailer for this service.**

CAUTION

- When VDC is deactivated, the  VDC OFF warning light lights up continuously.
- If both the  warning light and  warning light are lit continuously, VDC is not available due to a malfunction.

TRACTION CONTROL SYSTEM (TCS)

The Traction Control System (TCS) is part of VDC.

Traction control brakes the drive wheels individually if they spin. This enables you to pull away and accelerate on slippery surfaces, for example if the road surface is slippery on one side. In addition, more drive torque is transferred to the wheel or wheels with traction.

Traction control remains active if you deactivate VDC.

CHARACTERISTICS OF VDC

If the  VDC warning light goes out before beginning the journey, VDC is automatically active.

5-94 Starting and driving

If VDC intervenes, the  VDC warning light flashes in the combination meter.

If VDC intervenes:

- Do not deactivate VDC under any circumstances.
- When pulling away, only depress the accelerator pedal as far as is necessary.
- Adapt your driving style to suit the prevailing road and weather conditions.

Deactivating/activating VDC

WARNING

If you deactivate VDC, VDC no longer stabilizes the vehicle. There is an increased risk of skidding and an accident. Only deactivate VDC in the situations described in the following section.

You can select between the following statuses of VDC:

- VDC is activated.
- VDC is deactivated.





It may be best to deactivate VDC in the following situations:

- When using snow chains.
- In deep snow.
- On sand or gravel.

NOTE

Activate VDC as soon as the situations described above no longer apply. VDC will otherwise not be able to stabilize the vehicle if the vehicle starts to skid or a wheel starts to spin.

You can activate/deactivate VDC using the vehicle information display. To activate/deactivate VDC:

1. Start the engine
2. Press the  or  button on the steering wheel to select the [DriveAssist] menu in the vehicle information display.
3. Press the  or  button to select VDC.
4. Press the **<OK>** button on the steering wheel. The current selection is displayed.
5. To activate/deactivate: press the **<OK>** button again.

VDC is deactivated if the  warning light in the combination meter lights up continuously when the engine is running.

Characteristics when VDC is deactivated:

If VDC is deactivated and one or more wheels start to spin, the  VDC warning light flashes in the combination meter. In such situations, VDC will not stabilize the vehicle.

If you deactivate VDC:

- VDC no longer intervenes in understeer or oversteer situations.
- Engine torque is no longer limited and the drive wheels are able to spin.

The spinning of the wheels results in a cutting action, so the tires cut through the loose surface until they hit solid ground, giving better traction.

- Traction control is still activated.
- VDC still provides support when you brake.

EBD (ELECTRONIC BRAKE FORCE DISTRIBUTION)

EBD monitors and controls the brake pressure on the rear wheels to help improve handling during braking.

WARNING

If EBD is malfunctioning, the EBD [Inoperative See Operator's Manual] warning is displayed in the vehicle information display. The  VDC warning light may also light up.

If EBD is malfunctioning as a result of a VDC malfunction, the rear wheels can lock, e.g. under full braking. This increases the risk of skidding and an accident.

You should therefore adapt your driving style to the different handling characteristics. Have the brake system checked. It is recommended you see an INFINITI retailer.

STEER CONTROL

STEER CONTROL helps you by transmitting a noticeable steering force to the steering wheel in the direction required for vehicle stabilisation.

This steering support is provided in particular if:

- Both right wheels or both left wheels are on a wet or slippery road surface when you brake.
- The vehicle starts to skid.

WARNING

No steering support is provided from STEER CONTROL, if:

- VDC is malfunctioning.
 - The steering is faulty.
- Power steering will, however, continue to function.

WARNING

- Never rely solely on the Hill Start Assist (HSA) system to prevent the vehicle from moving backward on a hill. Always drive carefully and attentively. Depress the brake pedal when the vehicle is stopped on a steep hill. Be especially careful when stopped on a hill on frozen or muddy roads. Failure to prevent the vehicle from rolling backwards may result in a loss of control of the vehicle and possible serious injury or death.
- The Hill Start Assist system is not designed to hold the vehicle at a standstill on a hill. Depress the brake pedal when the vehicle is stopped on a steep hill. Failure to do so may cause the vehicle to roll backwards and may result in a collision or serious personal injury.
- The Hill Start Assist system may not prevent the vehicle from rolling backwards on a hill under all load or road conditions. Always be prepared to depress the brake pedal to prevent the vehicle from rolling backwards. Failure to do so may result in a collision or serious personal injury.

COLD WEATHER DRIVING

- **After a short time, hill start assist will no longer brake your vehicle and it could roll away. There is a risk of an accident and injury. Therefore, quickly move your foot from the brake pedal to the accelerator pedal. Never leave the vehicle when it is held by hill start assist.**

Hill start assist helps you when pulling away forwards or in reverse on an uphill gradient. It holds the vehicle for a short time after you have removed your foot from the brake pedal. This gives you enough time to move your foot from the brake pedal to the accelerator pedal and depress it before the vehicle begins to roll.

Hill start assist is not active if

- You are pulling away on a level road or a downhill gradient.
- On vehicles with automatic transmission, the transmission is in position N.
- The electric parking brake is applied.
- VDC is malfunctioning.

FREEING A FROZEN DOOR LOCK

To prevent a door lock from freezing, apply deicer through the key hole. If the lock becomes frozen, heat the key before inserting it into the key hole, or use the INFINITI Intelligent Key.

ANTIFREEZE

In the winter when it is anticipated that the temperature will drop below 32°F (0°C), check the antifreeze to assure proper winter protection. For additional information, see "Engine cooling system".

BATTERY

If the battery is not fully charged during extremely cold weather conditions, the battery fluid may freeze and damage the battery. To maintain maximum efficiency, the battery should be checked regularly. For details, see "Battery" of this manual.

DRAINING OF ENGINE COOLANT

If the vehicle is to be left outside without antifreeze, drain the cooling system, including the engine block. Refill before operating the vehicle. For details, see "Changing engine coolant" of this manual.

TIRE EQUIPMENT

1. SUMMER tires have a tread designed to provide superior performance on dry pavement. However, the performance of these tires will be substantially reduced in snowy and icy conditions. If you operate your vehicle on snowy or icy roads, INFINITI recommends the use of MUD & SNOW or ALL SEASON TIRES on all four wheels. It is recommended that you visit an INFINITI retailer for the tire type, size, speed rating and availability information.
2. For additional traction on icy roads, studded tires may be used. However, some U.S. states and Canadian provinces prohibit their use. Check local, state and provincial laws before installing studded tires.

Skid and traction capabilities of studded snow tires, on wet or dry surfaces, may be poorer than that of non-studded snow tires.

3. Tire chains may be used if desired. Make sure they are the proper size for the tires on your vehicle and are installed according to the chain manufacturer's instructions. Use chain tensioners when recommended by the tire chain manufacturer to ensure a tight fit. Loose end links of the tire chains must be secured or removed to prevent the possibility of whipping action damage to the fenders or underbody. In addition, drive at a reduced speed, otherwise, your vehicle may be damaged and/or vehicle handling and performance may be adversely affected.

SPECIAL WINTER EQUIPMENT

It is recommended that the following items be carried in the vehicle during the winter:

- A scraper and stiff-bristled brush to remove ice and snow from the windows.
- A sturdy, flat board to be placed under the jack to give it firm support.
- A shovel to dig the vehicle out of snow-drifts.
- Extra washer fluid to refill the windshield washer fluid reservoir.

DRIVING ON SNOW OR ICE

WARNING

- **Wet ice (32°F, 0°C and freezing rain), very cold snow or ice can be slick and very hard to drive on. The vehicle will have much less traction or "grip" under these conditions. Try to avoid driving on wet ice until the road is salted or sanded.**
- **Whatever the condition, drive with caution. Accelerate and slow down with care. If accelerating or downshifting too fast, the drive wheels will lose even more traction.**
- **Allow more stopping distance under these conditions. Braking should be started sooner than on dry pavement.**
- **Allow greater following distances on slippery roads.**
- **Watch for slippery spots (glare ice). These may appear on an otherwise clear road in shaded areas. If a patch of ice is seen ahead, brake before reaching it. Try not to brake while on the ice, and avoid any sudden steering maneuvers.**
- **Do not use cruise control on slippery roads.**

- **Snow can trap dangerous exhaust gas under your vehicle. Keep snow clear of the exhaust pipe and from around your vehicle.**

MEMO

6 In case of emergency

Hazard warning flasher switch6-2	Removing and fitting wheels6-5
Flat tire6-2	Jump starting6-10
Tire Pressure Monitoring System (TPMS).6-2	Push starting6-12
Stopping vehicle.6-3	If your vehicle overheats.6-13
Warning triangle (if equipped)6-4	Towing your vehicle6-14
Run-flat tires.6-4	Towing recommended by INFINITI6-14



HAZARD WARNING FLASHER SWITCH

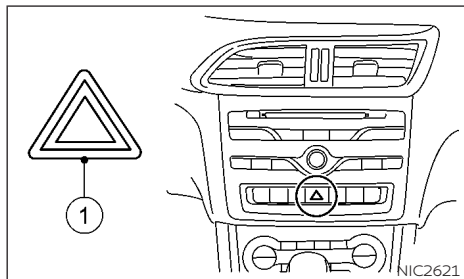

The hazard warning flasher switch ① operates regardless of the ignition switch position except when the battery is discharged.

The hazard warning flasher is used to warn other drivers when you have to stop or park under emergency conditions.

When the hazard warning flasher switch is pushed, all turn signal lights will flash. To turn off the hazard warning flasher, push the hazard warning switch again.

WARNING

- If stopping for an emergency, be sure to move the vehicle well off the road.

- Do not use the hazard warning flashers while moving on the highway unless unusual circumstances force you to drive so slowly that your vehicle might become a hazard to other traffic.
- Turn signals do not work when the hazard warning flasher lights are on.

Some jurisdictions may prohibit the use of the hazard warning flasher switch while driving.

FLAT TIRE

If you have a flat tire, follow the instructions in this section.

TIRE PRESSURE MONITORING SYSTEM (TPMS)

WARNING

- If the low tire pressure warning light illuminates or a tire pressure-related warning is displayed by the vehicle information display while driving, avoid sudden steering maneuvers or abrupt braking, reduce vehicle speed, pull off the road to a safe location and stop the vehicle as soon as possible. Driving with under-inflated tires may permanently damage the tires and increase the likelihood of tire failure. Serious vehicle damage could occur and may lead to an accident and could result in serious personal injury. Check the tire pressure for all four tires. Adjust the tire pressure to the recommended COLD tire pressure shown on the tire and loading information label to turn the low tire pressure warning light OFF. If you have a flat tire, replace it with a replacement tire as soon as possible.

- **When a replacement tire is mounted or a wheel is replaced, the TPMS will not function and the low tire pressure warning light will flash for approximately 1 minute. The light will remain on after 1 minute. It is recommended you Contact an INFINITI retailer as soon as possible for tire replacement and/or system resetting.**
- **Replacing tires with those not originally specified by INFINITI could affect the proper operation of the TPMS.**
- **If you used Emergency Tire Sealant to repair a minor tire puncture, the TPMS sensor should be checked when repairing or replacing the tire. It is recommended you visit an INFINITI retailer for this service.**

activate only when the vehicle is driven at speeds above 16 MPH (25 km/h).

For more details about the TPMS, see "Tire Pressure Monitoring System (TPMS)".

STOPPING VEHICLE

WARNING

- **Be sure to apply the parking brake firmly.**
- **Be sure that P (Park) is engaged.**
- **Never change tires when the vehicle is on a slope, ice or slippery area. This is hazardous.**
- **Never change tires when the oncoming traffic is close to your vehicle. Call for professional road assistance.**

The Tire Pressure Monitoring System (TPMS) monitors tire pressure of all tires. When the low tire pressure warning light is lit, and a tire pressure-related warning (if equipped) appears in the vehicle information display, one or more of your tires is significantly under-inflated. If the vehicle is being driven with low tire pressure, the TPMS will activate and warn you of it by the low tire pressure warning light (in the meter panel). This system will

1. Safely move the vehicle off the road away from traffic.
2. Turn on the hazard indicator flasher lights.
3. Park on a level surface.
4. Apply the parking brake.
5. Press the P (Park) button.
6. Turn off the engine.

7. Open the hood and set up the triangle reflector (if equipped):

- To warn other traffic.
- To signal professional road assistance personnel that you need assistance.

8. Have all passengers get out of the vehicle and stand in a safe place, away from other traffic and clear of the vehicle.

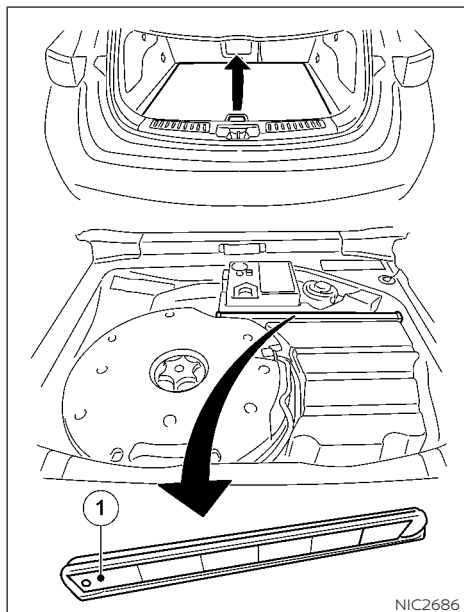

WARNING TRIANGLE (IF EQUIPPED)

Removing and refitting the warning triangle

To remove:

1. Open the lift gate and lift the luggage compartment floor upwards.
2. To release warning triangle, push back the retainers on the bracket.
3. Remove warning triangle ① from the bracket.

To refit:

1. Place warning triangle ① back into the bracket and push down to secure.
2. Fold down the luggage compartment floor.
3. Close the lift gate.

Setting up the warning triangle

1. Fold legs out to the side.
2. Fold side reflectors upwards to form a triangle and lock them at the top using press stud.

RUN-FLAT TIRES

With special run-flat tires, you can continue to drive your vehicle even if there is a total loss of pressure in one or more tires. The affected tire must not show any clearly visible damage.

You can recognize run-flat tires by the marking which appears on the tire side wall. You will find this marking next to the tire size designation, the load-bearing capacity and the speed index.

Run-flat tires may only be used in conjunction with an activated tire pressure loss warning system or tire pressure monitor.

Pressure loss warning message

If a pressure loss warning message appears in the vehicle information display:

- Observe the instructions in the display messages.
- Check the tire for damage.
- If driving on, observe the following notes.

The driving distance possible in run-flat mode is approximately 50 miles (80 km) when the vehicle is partially laden and approximately 20 miles (30 km) when the vehicle is fully laden.

In addition to the vehicle load, the driving distance possible depends upon:

- Vehicle speed.
- Road condition.
- Outside temperature.

The driving distance possible in run-flat mode may be reduced by extreme driving conditions/maneuvers, or it can be increased through a moderate style of driving.

The driving distance possible in run-flat mode is counted from the moment the tire pressure loss warning appears in the vehicle information display.

You must not exceed a maximum speed of 50 MPH (80 km/h).

When replacing one or all tires, observe the following specifications for your vehicle's tires:

- Size
- Type
- Run-flat mark

If a tire has gone flat and cannot be replaced with a run flat tire, a standard tire may be used as a temporary measure. Make sure that you use the proper size and type (summer or winter tire).

⚠ WARNING

Do not exceed the stated maximum speed. Avoid abrupt steering and driving maneuvers, and driving over obstacles (curbs, pot holes, off road). This applies in particular to a laden vehicle.

Stop driving in emergency mode if:

- **You hear banging noises.**
- **The vehicle starts to shake.**
- **You see smoke and smell rubber.**
- **VDC is intervening constantly.**
- **There are tears in the sidewalls of the tire.**

After driving in emergency mode, have the wheel rims checked with regard to their further use. It is recommended you visit an INFINITI retailer for this service. The faulty tire must be replaced.

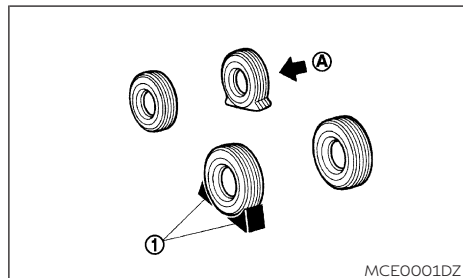

REMOVING AND FITTING WHEELS

NOTE

A spare wheel is not provided with your vehicle.

Blocking the wheels

⚠ WARNING

Make sure to block the appropriate wheel to prevent the vehicle from moving, which may cause personal injury.

Place suitable blocks ① in front of and behind the wheel diagonally opposite the flat tire ② to prevent the vehicle from moving when it is on the jack.

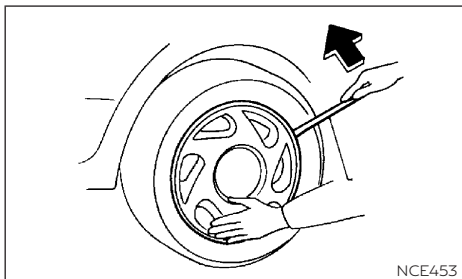

Removing the wheel

⚠ WARNING

- The jack must be placed on firm level ground. Failure to observe this instruction could result in vehicle damage, or serious injury or death.
- Make sure to read the caution label attached to the jack body before use.
- **DO NOT GET UNDER A VEHICLE THAT IS SUPPORTED BY A JACK.**
- Never use a jack which was not designed for your vehicle.

- Use the correct jacking points. Never use any other part of the vehicle for jack support.
- Never lift the vehicle more than necessary.
- Never use blocks on or under the jack.
- Do not start or run the engine while the vehicle is on the jack. The vehicle may move suddenly, and this may cause an accident.
- Never allow passengers to stay in the vehicle while the tire is off the ground.
- Remove all loads before lifting the vehicle with the jack.

NOTE

A jack and rod are not provided as standard equipment with your vehicle. These parts are dealer options. It is recommended that you contact an INFINITI retailer for more information about obtaining these parts.

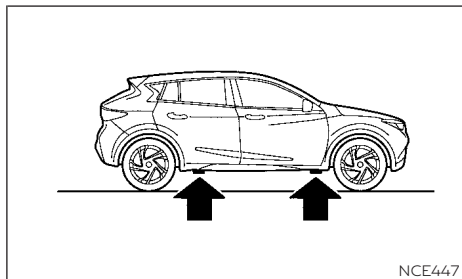

Jack-up points

1. **Vehicles without intelligent key:** Remove the key from the ignition lock.

Vehicles with a push button ignition switch: remove the start/stop button from the ignition lock (see "Push-button ignition switch (if equipped)").

2. Place the jack directly under the jack-up point as illustrated so that the top of the jack contacts the vehicle at the jack-up point.

The jack must be placed on firm level ground.

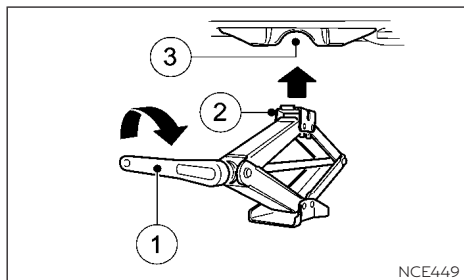

3. Align the center of both the jack head (2) and the notches at the jack-up point (3) as shown.
4. Fit the groove of the jack head between the two notches as shown.

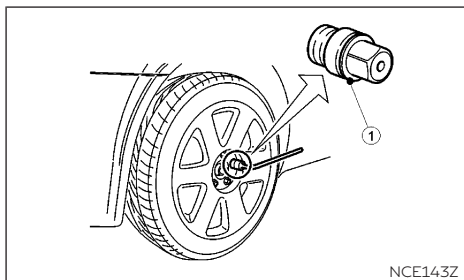

5. Loosen each wheel bolt by one or two turns counterclockwise with the wheel wrench.

Do not remove the wheel bolts until the tire is off the ground.

Models with wheel lock bolts (if equipped) :

If the wheel is equipped with a wheel lock bolt, insert the wheel lock key (1) and loosen it as previously described.

The wheel lock bolt can only be removed with the wheel lock key. A key number is necessary if you need to duplicate the wheel lock key.

Record the key number as shown on the key code card on the "Security information" page at the end of this manual and keep it in a safe place, not in the vehicle. If you lose the wheel lock key, it is recommended you see your INFINITI retailer for a duplicate with the original wheel lock key code.

Make sure to keep the lock key in the vehicle. Otherwise, wheels cannot be removed and the service cannot be performed.

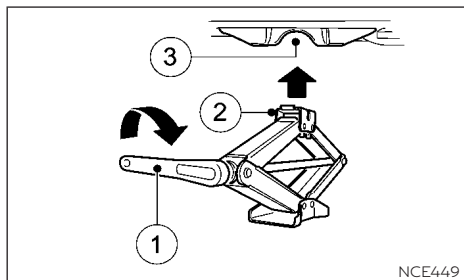

6. To lift the vehicle, securely hold and turn the ratchet handle ① clockwise as shown.
7. Carefully raise the vehicle until the tire clears the ground.
8. Remove the wheel bolts, then remove the wheel with the flat tire.

⚠ WARNING

The wheel is heavy. Be sure that your feet are clear of the wheel and use gloves as necessary to avoid injury.

Installing the wheel

⚠ WARNING

- **A temporary use spare wheel and tire is designed for emergency use.**
- **Never use wheel bolts other than those provided with your vehicle. Incorrect wheel bolts or improperly tightened wheel bolts may cause the wheel to become loose or come off. This could cause an accident.**
- **Never use oil or grease on the wheel bolts. This may cause the wheel bolts to become loose.**

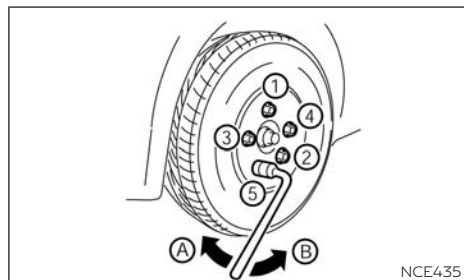

- Ⓐ Tighten
- Ⓑ Loosen

1. Clean any mud or dirt from the surface between the wheel and the hub.
2. Carefully fit the wheel and tighten the wheel bolts with your fingers. Check that all the wheel bolts contact the wheel surface horizontally and on the bevelled side.
Models with wheel lock bolt (if equipped):
Insert the wheel lock key into the wheel lock bolt and tighten into the wheel finger tight.
3. With the wheel wrench, tighten the wheel bolts alternately and evenly in the sequence as illustrated (① - ⑤) until they are tight.

4. Lower the vehicle slowly until the tire touches the ground.
5. Tighten the wheel bolts securely using the wheel wrench in the sequence as illustrated.
6. Lower the vehicle completely.
7. Install the wheel cover (if equipped).

Wheel bolt tightening torque:
96 ft-lb (130 N·m, 13 kg-m)

As soon as possible, tighten the wheel bolts to the specified torque with a torque wrench.

The wheel bolts must be kept tightened to specification at all times. It is recommended that the wheel bolts be tightened to specification at each maintenance interval.

Adjust the tire pressure to the COLD pressure.

COLD pressure is the tire pressure as measured after the vehicle has been parked for three hours or more or driven for less than 1 mile (1.6 km).

COLD tire pressures are shown on the tire and loading information label affixed to the driver's side center pillar.

Wheel lock bolts (if equipped)

In order to prevent theft, the specially designed wheel lock bolt is installed to each wheel. The wheel lock bolt cannot be removed with the commonly used tools.

When removing tires, use the lock key provided with your vehicle.

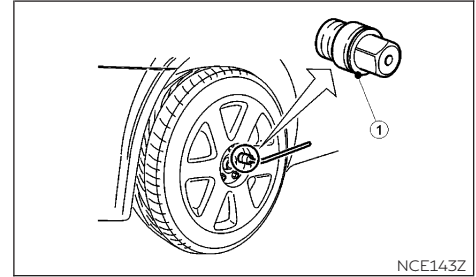

Removing the wheel lock bolt:

1. Insert the wheel lock key ① to the wheel lock bolt.
2. To remove the wheel lock bolt, turn the wheel lock key counterclockwise using the wheel wrench.

⚠ CAUTION

- **Do not use a power tool to remove the wheel lock bolts.**
- **When installing the wheel, tighten the wheel lock bolts to the same tightening torque as the normal wheel bolts. For details, see "Installing the wheel" earlier in this section.**

JUMP STARTING

NOTE

- **The wheel lock bolt has an individual code. A wheel lock key with other than the individual code cannot remove the wheel lock bolt. If you lose the wheel lock key, it is recommended you contact an INFINITI retailer for a duplicate with the original wheel lock key code.**
- **Record the key number and keep it in a safe place, not in the vehicle.**
- **When you ask for a service at an INFINITI retailer, make sure to keep the lock key in the vehicle. Otherwise, wheels cannot be removed and the service cannot be performed.**

For the jump-starting procedure, use only the jump-starting connection point, consisting of a positive terminal and an earth point, in the engine compartment.

WARNING

- **If done incorrectly, jump starting can lead to a battery explosion, resulting in severe injury or death. It could also damage your vehicle.**
- **Explosive hydrogen gas is always present in the vicinity of the battery. Keep all sparks and flames away from the battery.**
- **Do not allow battery fluid to come into contact with eyes, skin, clothes or painted surfaces. Battery fluid is a corrosive sulfuric acid which can cause severe burns. If the fluid should come into contact with anything, immediately flush the contacted area with water.**
- **Keep the battery out of the reach of children.**
- **The booster battery must be rated at 12 volts. Use of an improperly rated battery can damage your vehicle.**

- **Whenever working on or near a battery, always wear suitable eye protectors (for example, goggles or industrial safety spectacles) and remove rings, metal bands, or any other jewelry. Do not lean over the battery when jump starting.**
- **Do not attempt to jump start a frozen battery. It could explode and cause serious injury.**
- **Your vehicle has an automatic engine cooling fan. It could come on at any time. Keep hands and other objects away from it.**

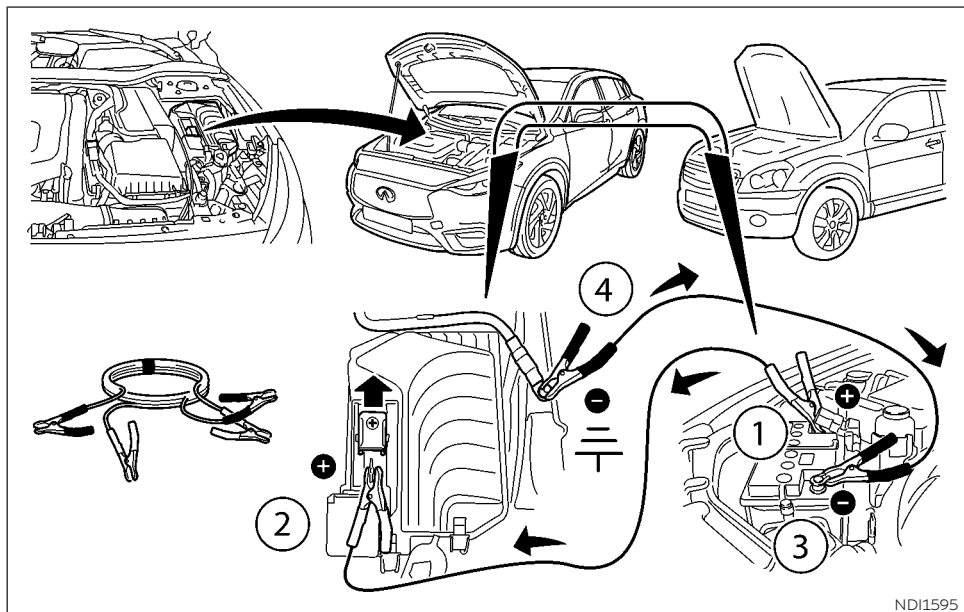

NDI1595

⚠ WARNING

Always follow the instructions below. Failure to do so could result in damage to the charging system and cause personal injury.

1. If the booster battery is in another vehicle, position the two vehicles to bring their batteries near each other.

Do not allow the two vehicles to touch.

2. Check if the parking brake is applied. If not, after connecting the vehicle with the booster battery (after step 8), apply the parking brake. The vehicle has an electric parking brake, for more information see, "Parking brake"
3. Press the P (Park) button.
4. Switch off all unnecessary electrical systems (headlights, hazard lights etc.).
5. Ensure that the ignition switch of the vehicle being jump-started is in the OFF position.
6. Open the hood. For details, see "Hood".
7. Remove the vent caps (if equipped) on the battery and cover the battery with an old cloth.
8. Connect the jump leads in the sequence (1) → (2) → (3) → (4) as illustrated.

⚠ CAUTION

- **Always connect positive (+) to positive (+) and negative (-) to body ground (for example, strut mounting bolt, engine lift bracket, etc.) - not to the battery's negative (-).**

- **Be sure that the jumper cables do not touch moving parts in the engine compartment and that the cable clamps do not contact any other metal.**

9. Start the engine of the other vehicle (A) and let it run for a few minutes. Keep the engine speed at about 2,000 rpm.
10. Start the engine of your vehicle (B) in the normal way.

CAUTION

Do not keep the starter motor engaged for more than 10 seconds. If the engine does not start right away, place the ignition switch in the OFF position and wait 10 seconds before trying again.

11. After starting the engine of your vehicle, carefully disconnect the negative lead and then the positive lead (4 → 3 → 2 → 1).
12. Remove and dispose of the cloth that was used to cover the ventilator holes as it may be contaminated with corrosive acid.
13. Install the ventilator caps (if equipped).
14. Close the hood.

6-12 In case of emergency

NOTE

For models which incorporate the Idle Stop/Start System:

- **Ensure that the battery fitted is the special battery that is enhanced with regard to the charge-discharge capacity and life performance. Avoid using any other battery for the Idle Stop/Start System, as this may cause early deterioration of the battery or a malfunction of the Idle Stop/Start System. It is recommended that a Genuine INFINITI battery is fitted. For more information, it is recommended you contact an INFINITI retailer.**
- **If the battery terminal is disconnected (for battery replacement, etc.) and then reconnected, there may be some delay before the Idle Stop/Start System reactivates.**

PUSH STARTING

Do not attempt to start the engine by pushing the vehicle.

CAUTION

- **Automatic Transmission (AT) model cannot be push-started or tow-started. Attempting to do so may cause damage to the transmission.**
- **Three-way catalyst equipped models should not be started by pushing. Attempting to do so may cause damage to the three-way catalyst.**
- **Never try to start the vehicle by towing it; when the engine starts, the forward surge could cause the vehicle to collide with the tow vehicle.**

IF YOUR VEHICLE OVERHEATS

WARNING

- **Do not continue to drive if your vehicle overheats. Doing so could cause engine damage or a vehicle fire.**
- **To avoid the danger of being scalded, never remove the radiator or coolant reservoir cap while the engine is hot. When the radiator or coolant reservoir cap is removed, pressurized hot water will spurt out, possibly causing serious injury.**
- **Do not open the hood if steam is coming out.**

If the engine of your vehicle is overheating (indicated by the engine coolant temperature gauge) or if you feel a lack of engine power, detect unusual noise, etc., proceed as follows:

1. Move and park the vehicle safely off the road and away from traffic.
2. Turn on the hazard warning flasher lights.
3. Apply the parking brake.
4. Press the P (Park) button.
DO NOT STOP THE ENGINE.
5. Open all windows.

6. Switch off the air conditioner system (if equipped).
7. Set the heater or air conditioner temperature control to maximum "HOT" and fan speed control to maximum speed.
8. Exit the vehicle.
9. Visually inspect and listen for steam or coolant escaping from the radiator before opening the hood.

WARNING

If steam or water is coming from the engine, stand clear to prevent getting burned.

10. Open the hood. For details, see "Hood".
11. Visually check if the cooling fan is running.
12. Visually check the radiator and radiator hoses for leakage.

WARNING

Be careful not to allow your hands, hair, jewelry or clothing to come into contact with, or get caught in, engine belts or the engine cooling fan. The engine cooling fan can start at any time.

13. After the engine cools down, check the coolant level in the engine coolant reservoir with the engine running. **Do not open the radiator cap (if equipped).**
14. If the level is low, remove the engine coolant reservoir cap and add coolant slowly into the reservoir. After refilling the reservoir to the MAX level, install the reservoir cap.
15. Close the hood.

Have your vehicle inspected or repaired. It is recommended you visit an INFINITI retailer.

TOWING YOUR VEHICLE

When towing your vehicle, all jurisdictions and local regulations for towing must be followed. Incorrect towing equipment could damage your vehicle. Towing instructions are available from an INFINITI retailer. Local service operators are generally familiar with the applicable laws and procedures for towing. To assure proper towing and to prevent accidental damage to your vehicle, INFINITI recommends having a service operator tow your vehicle. It is advisable to have the service operator carefully read the following precautions.

WARNING

- **Never ride in a vehicle that is being towed.**
- **Never get under your vehicle after it has been lifted by a tow truck.**

CAUTION

- **When towing, make sure that the transmission, axles, steering system and powertrain are in working condition. If any of these conditions apply, dollies or a flatbed tow truck must be used.**
- **Always attach safety chains before towing.**

TOWING RECOMMENDED BY INFINITI

INFINITI recommends towing your vehicle based upon the type of drivetrain. Please refer to the diagrams in this section to ensure that your vehicle is properly towed.

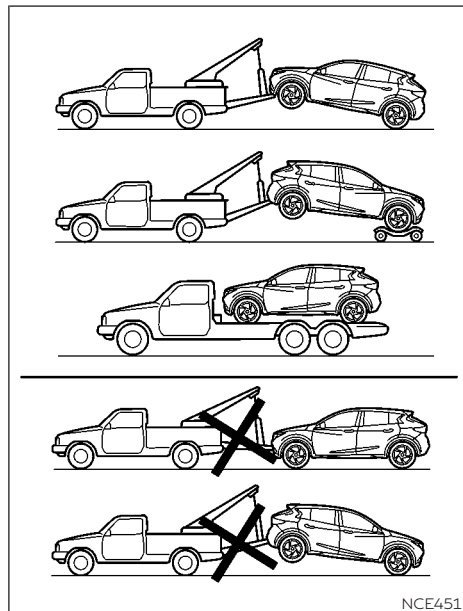

FWD (2WD) models

Two-Wheel Drive (FWD) models

⚠ CAUTION

NEVER tow automatic transmission (DCT) models with the front wheels on the ground or with all four wheels on the ground (forwards or backwards), as this may cause serious and expensive damage to the transmission. If it is necessary to tow the vehicle with the rear wheels raised, always use towing dollies under the front wheels.

Four-Wheel Drive (4WD) models

INFINITI recommends that towing dollies be used under the front or rear wheels when towing your vehicle or the vehicle be placed on a flatbed tow truck as illustrated.

⚠ CAUTION

Never tow 4WD models with any of the wheels on the ground. Doing so will cause serious and expensive damage to the drivetrain.

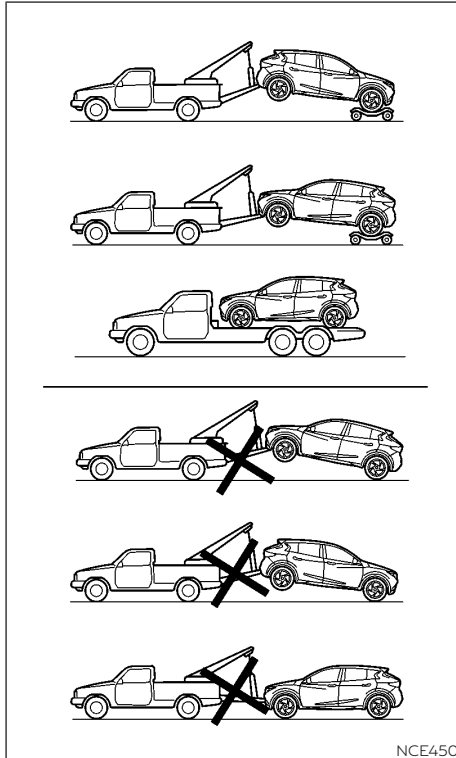

4WD models

Vehicle recovery (freeing a stuck vehicle)

⚠ WARNING

To avoid vehicle damage, serious personal injury or death when recovering a stuck vehicle:

- Contact a professional towing service to recover the vehicle if you have any questions regarding the recovery procedure.
- Tow chains or cables must be attached only to main structural members of the vehicle.
- Do not use the vehicle tie downs to tow or free a stuck vehicle.
- Only use devices specifically designed for vehicle recovery and follow the manufacturer's instructions.
- Always pull the recovery device straight out from the front of the vehicle. Never pull at an angle.
- Route recovery devices so they do not touch any part of the vehicle except the attachment point.

- **On vehicles with a push button ignition switch: you must remove the start/stop button and use the key (see " Push-button ignition switch (if equipped)"). Otherwise the automatic transmission may shift to position P (Park) when the driver's or front passenger door are opened, which could lead to damage to the transmission.**

If your vehicle is stuck in sand, snow, mud, etc., use a tow strap or other device designed specifically for vehicle recovery. Always follow the manufacturer's instructions for the recovery device.

Rocking a stuck vehicle

WARNING

- **To avoid potential injury, stand clear of a stuck vehicle.**
- **Do not spin your tires at high speed. This could cause them to explode and result in serious injury. Parts of your vehicle could also overheat and be damaged.**

If your vehicle is stuck in sand, snow, mud, etc., use the following procedure:

1. Turn off the Vehicle Dynamic Control (VDC) system.
2. Make sure the area in front and behind the vehicle is clear of obstructions.
3. Turn the steering wheel right and left to clear an area around the front tires.
4. Slowly rock the vehicle forward and backward.
 - Shift back and forth between R (Reverse) and D (Drive).
 - Apply the accelerator as little as possible to maintain the rocking motion.
 - Release the accelerator pedal before shifting between R (Reverse) and D (Drive).
 - Do not spin the tires above 35 MPH (55 km/h).
5. If the vehicle cannot be freed after a few tries, contact a professional towing service to remove the vehicle.

7 Appearance and care

Cleaning exterior	7-2	Air fresheners	7-4
Washing	7-2	Floor mats (if equipped)	7-5
Waxing	7-2	Seat belts	7-5
Removing spots	7-3	Cleaning the seat tracks	7-6
Underbody	7-3	Genuine leather seat covers	7-6
Glass	7-3	Corrosion protection	7-7
Wheels	7-3	Most common factors contributing to vehicle	
Aluminum alloy wheels	7-3	corrosion	7-7
Chrome parts	7-3	Environmental factors influence the rate of	
Tire dressings	7-3	corrosion	7-7
Cleaning interior	7-4	To protect your vehicle from corrosion	7-7



CLEANING EXTERIOR

In order to maintain the appearance of your vehicle, it is important to take proper care of it.

To protect the paint surfaces, please wash your vehicle as soon as you can:

- After a rainfall, to prevent possible damage from acid rain.
- After driving on coastal roads.
- When contaminants such as soot, bird droppings, tree sap, metal particles or bugs get on the paint surface.
- When dust or mud builds up on the surface.

Whenever possible, park your vehicle inside a garage or in a covered area to minimize the chances of damaging the paint surface of your vehicle.

When it is necessary to park outside, park in a shady area or protect the vehicle with a body cover. **Be careful not to scratch the paint surface when putting on or removing the body cover.**

WASHING

Wash dirt off with a wet sponge and plenty of water. Clean the vehicle thoroughly using a mild soap, a special vehicle soap or general purpose dishwashing liquid mixed with clean, lukewarm (never hot) water.

7-2 Appearance and care

CAUTION

- **Do not use car washes that use acid in the detergent. Some car washes, especially brushless ones, use some acid for cleaning. The acid may react with some plastic vehicle components, causing them to crack. This could affect their appearance, and also could cause them not to function properly. Always check with your car wash to confirm that acid is not used.**
- **Do not wash the vehicle with strong household soap, strong chemical detergents, gasoline or solvents.**
- **Do not wash the vehicle in direct sunlight or while the vehicle body is hot, as the paint surface may become water-spotted.**
- **Avoid using tight-napped or rough cloths, such as washing mitts. Care must be taken when removing caked-on dirt or other foreign substances so the paint surface is not scratched or damaged.**

Rinse the vehicle thoroughly with plenty of clean water.

Inside edges, seams and folds on the doors, hatches and hood are particularly vulnerable to the effects of road salt. Therefore, these areas must be cleaned regularly. Take care that the drain holes in the lower edge of the door are open. Spray water under the body and in the wheel wells to loosen the dirt and wash away road salt.

A damp chamois can be used to dry the vehicle to avoid water spots.

WAXING

Regular waxing protects the paint surface and helps maintain a new vehicle appearance.

After waxing, polishing is recommended to remove built-up residue and to avoid a weathered appearance.

An INFINITI retailer can assist you in choosing the appropriate waxing products.

- Wax your vehicle only after a thorough washing. Follow the instructions supplied with the wax.
- Do not use a wax containing any abrasives, cutting compounds or cleaners that may damage the vehicle finish.

Machine compounding or aggressive polishing on a base coat/clear coat paint finish may dull the finish or leave swirl marks.

REMOVING SPOTS

Remove tar and oil spots, industrial dust, insects, and tree sap as quickly as possible from the paint surface to avoid lasting damage or staining. Special cleaning products are available at an INFINITI retailer or any automotive accessory store.

UNDERBODY

In areas where road salt is used in the winter, it is necessary to clean the vehicle's underbody regularly in order to prevent dirt and salt from building up and causing the acceleration of corrosion on the underbody and suspension.

Before the winter and again in the spring, the underseal must be checked and, if necessary, re-treated.

GLASS

Use glass cleaner to remove smoke and dust film from the glass surfaces. It is normal for glass to become coated with a film after the vehicle is parked in the hot sun. Glass cleaner and a soft cloth will easily remove this film.

CAUTION

When cleaning the inside of the windows, do not use sharp-edged tools, abrasive cleaners or chlorine-based disinfectant cleaners. They could damage the electrical conductors, radio antenna elements or rear window defroster elements.

WHEELS

- Wash the wheels when washing the vehicle to maintain their appearance.
- Clean the inner side of the wheels when the wheel is changed or the underside of the vehicle is washed.
- Do not use abrasive cleaners when washing the wheels.
- Inspect wheel rims regularly for dents or corrosion. This may cause loss of pressure or damage the tire bead.
- INFINITI recommends that the road wheels be waxed to protect against road salt in areas where it is used during winter.

ALUMINUM ALLOY WHEELS

Wash the wheels regularly with a sponge dampened in a mild soap solution, especially during winter in areas where road salt is used.

The salt residue from road salt could discolor the wheels if it is not washed off regularly.

CAUTION

Follow the directions below to avoid staining or discoloring the wheels:

- **Do not use a cleaner that uses strong acid or alkali contents to clean the wheels.**
- **Do not apply wheel cleaners to the wheels when they are hot. The wheel temperature should be the same as ambient temperature.**
- **Rinse the wheel to completely remove the cleaner within 15 minutes after the cleaner is applied.**

CHROME PARTS

Clean all chrome parts regularly with a non-abrasive chrome polish to maintain the finish.

TIRE DRESSINGS

INFINITI does not recommend the use of tire dressings. Tire manufacturers apply a coating to the tires to help reduce discoloration of the rubber. If a tire dressing is applied to the tires, it may react with the coating and form a compound. This compound may come off the tire while driving and stain the vehicle paint.

CLEANING INTERIOR

If you choose to use a tire dressing, take the following precautions:

- Use a water-based tire dressing. The coating on the tire dissolves more easily than with an oil-based tire dressing.
- Apply a light coat of tire dressing to help prevent it from entering the tire tread/grooves (where it would be difficult to remove).
- Wipe off excess tire dressing using a dry towel. Make sure the tire dressing is completely removed from the tire tread/grooves.
- Allow the tire dressing to dry as recommended by tire dressing manufacturer.

Occasionally remove loose dust from the interior trim, plastic parts and seats using a vacuum cleaner or soft bristled brush. Wipe the vinyl and leather surfaces with a clean, soft cloth dampened in mild soap solution, then wipe clean with a dry, soft cloth.

Regular care and cleaning is required in order to maintain the appearance of the leather.

Before using any fabric protector, read the manufacturer's recommendations. Some fabric protectors contain chemicals that may stain or bleach the seat material.

Use a soft cloth dampened only with water to clean the meter and gauge lens covers.

WARNING

Do not use water or acidic cleaners (hot steam cleaners) on the seat. This can damage the seat or occupant classification sensor. This can also affect the operation of the air bag system and result in serious personal injury.

CAUTION

- **Never use benzine, thinner or any similar material on the interior surfaces or surface damage may occur. Such damage is not covered under the INFINITI warranty.**
- **Small dirt particles can be abrasive and damaging to leather surfaces and should be removed promptly. Do not use saddle soap, car waxes, polishes, oils, cleaning fluids, solvents, detergents or ammonia-based cleaners as they damage the leather's natural finish.**
- **Never use fabric protectors unless recommended by the manufacturer.**
- **Do not use glass or plastic cleaner on meter or gauge lens covers. It may damage the lens covers.**

AIR FRESHENERS

Most air fresheners use a solvent that could affect the vehicle interior. If you use an air freshener, take the following precautions:

- Hanging-type air fresheners can cause permanent discoloration when they contact vehicle interior surfaces. Place the air freshener in a location that allows it to hang free and not contact an interior surface.
- Liquid-type air fresheners typically clip on the ventilators. These products can cause immediate damage and discoloration when spilled on interior surfaces.

Carefully read and follow the manufacturer's instructions before using air fresheners.

FLOOR MATS (IF EQUIPPED)

⚠ WARNING

To avoid potential pedal interference that may result in a collision, injury or death:

- **NEVER place a floor mat on top of another floor mat in the driver front position.**
- **It is recommended you use only genuine INFINITI floor mats specifically designed for use in your vehicle model. For additional information, it is recommended you contact an INFINITI retailer.**
- **Properly position the mats in the floorwell using the floor mat positioning aid.**

The use of genuine INFINITI floor mats can extend the life of your vehicle carpet and make it easier to clean the interior. Mats should be maintained with regular cleaning and replaced if they become excessively worn.

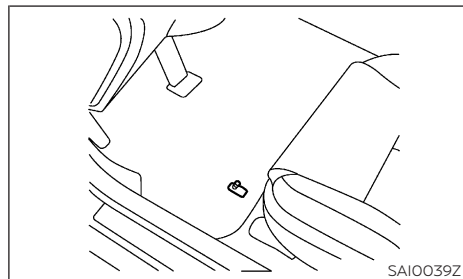

Example

Floor mat positioning aid

This vehicle includes a front floor mat bracket to act as a floor mat positioning aid. INFINITI floor mats have been specially designed for your vehicle model.

Position the mat by placing the floor mat bracket hook through the floor mat grommet hole while centring the mat in the foot area.

Periodically check that the mats are properly positioned.

SEAT BELTS

The seat belts can be cleaned by wiping them with a sponge dampened in a mild soap solution.

Allow the belts to dry completely in the shade before using them. For additional information, see "Seat belts".

WARNING

- **Do not allow wet seat belts to roll up in the retractor.**
- **NEVER use bleach, dye or chemical solvents to clean the seat belts, since these materials may severely weaken the seat belt webbing.**

CLEANING THE SEAT TRACKS

CAUTION

Periodically clean the seat tracks to prevent reduction of ability to move the seats. Clean periodically with a high-powered vacuum cleaner. Dirt and debris may reduce the ability to adjust the seat. A wet cleansing agent may be used if necessary.

GENUINE LEATHER SEAT COVERS

Automotive leather is typically finished with coatings which protect the surface from the sun's damaging rays as well as making it re-

sistant to soiling. The finishes used in automotive upholstery are unique; very different to furniture, garment or shoe leathers. Leather is extremely resilient and easy to clean and maintain.

- Before cleaning leather upholstery, vacuum it to remove dust.
- To clean leather, simply use a soft and lint-free cloth dampened with lukewarm water and mild soap. Do not soak the leather.
- Use a gentle, circular motion. Do not run the leather or apply extreme pressure when cleaning.
- Wipe the leather again with another clean, slightly damp cloth to remove soap residue. Dry with a soft cloth.

Leather should be cleaned whenever it becomes soiled. Dust and dirt may harm leather if allowed to work into the finish.

Never use alcohol, cleaning solvents, oils, varnishes or polishes on your leather, and avoid using unknown products as they damage the finish. Only use leather care agents approved by INFINITI.

Steaming or ironing is not recommended as it may damage the leather.

Leather is a natural product and has natural surface properties such as unevenness in structure, marks caused by injury, and subtle color differences. These are characteristics of leather and not material faults.

Leather cleaning kit (if equipped)

Spray onto the leather cleaning cloth, then gently wipe the surface of leather. Use a dry towel to absorb any excess moisture.

Please refer to the instruction manual provided with the leather cleaner kit.

Clean light-colored leather more frequently because soiling on such surfaces is much more visible.

You can obtain the leather cleaner kit from an INFINITI retailer.

CORROSION PROTECTION

MOST COMMON FACTORS CONTRIBUTING TO VEHICLE CORROSION

Most vehicle corrosion is caused by:

- The accumulation of moisture-retaining dirt and debris in body panel sections, cavities, and other areas.
- Damage to the paint surface and other protective coatings caused by gravel and stone chips or minor traffic accidents.

ENVIRONMENTAL FACTORS INFLUENCE THE RATE OF CORROSION

Moisture

The accumulation of sand, dirt and water on the inside floor of the vehicle can accelerate corrosion. Wet floor carpet/floor mats will not dry completely inside the vehicle. They should be removed and completely dried to avoid floor panel corrosion.

Relative humidity

Corrosion will be accelerated in areas of high relative humidity, especially those areas where the temperatures stay above freezing and where atmospheric pollution exists and road salt is used.

Temperature

High temperatures accelerate the rate of corrosion to those parts which are not well ventilated.

Air pollution

Industrial pollution, the presence of salt in the air in coastal areas, or heavy road salt use accelerates the corrosion process. Road salt also accelerates the disintegration of paint surfaces.

TO PROTECT YOUR VEHICLE FROM CORROSION

- Wash and wax your vehicle often to keep the vehicle clean.
- Always check for minor damage to the paint surface and repair it as soon as possible.
- Keep drain holes in the lower edge of the doors open to avoid water accumulation.
- Check the underbody for accumulation of sand, dirt or salt. If present, wash with water as soon as possible.

CAUTION

- **NEVER** remove dirt, sand or other debris from the passenger compartment by washing it out with a hose. Remove dirt with a vacuum cleaner or broom.
- **Never** allow water or other liquids to come in contact with electronic components inside the vehicle as this may damage them.

Chemicals used for road surface deicing are extremely corrosive. They accelerate corrosion and deterioration of underbody components such as the exhaust system, fuel and brake lines, brake cables, floor pan and fenders.

In winter, the underbody must be cleaned periodically.

For additional protection against rust and corrosion, which may be required in some areas, it is recommended that you visit an INFINITI retailer.

MEMO

8 Do-it-yourself

Maintenance precautions	8-2	Cleaning	8-13
Engine compartment check locations	8-3	Replacing front window wiper blades	8-14
2.0L Gasoline engine	8-3	Replacing rear window wiper blade	8-16
Engine cooling system	8-3	Brakes	8-17
Checking engine coolant level	8-4	Self-adjusting brakes	8-17
Changing engine coolant	8-4	Fuses	8-17
Engine oil	8-5	Before replacing a fuse	8-17
Checking engine oil level	8-5	Engine compartment	8-18
Changing engine oil	8-5	Passenger compartment	8-19
Changing engine oil filter	8-6	Intelligent Key battery replacement	8-20
Automatic Transmission Fluid (ATF)	8-7	Checking the battery	8-21
Brake fluid	8-7	Replacing the battery	8-21
Window washer fluid	8-8	Lights	8-23
Battery	8-9	Exterior and interior lights	8-23
Accessing Vehicle battery	8-9	Replacement procedures	8-25
Maintenance free battery	8-10	Wheels and tires	8-27
Models with Idle Stop/Start System	8-10	Tire Pressure	8-27
Battery replacement	8-10	Tire inflation pressure	8-30
Reinitialisation procedure after battery		Tire labeling	8-30
reconnection	8-12	Types of tires	8-32
Jump-starting	8-12	Tire chains	8-33
Drive belt	8-12	Tire wear and damage	8-33
Spark plugs	8-12	Tire rotation	8-34
Air cleaner filter	8-13	Replacing wheels and tires	8-34
Wiper blades	8-13	Wheel balance	8-36

MAINTENANCE PRECAUTIONS

When performing any inspection or maintenance work on your vehicle, always take care to prevent serious accidental injury to yourself or damage to the vehicle. The following are general precautions which should be closely observed.

WARNING

- Park the vehicle on a level surface, apply the parking brake securely and block the wheels to prevent the vehicle from moving. Press the P (Park) button.
- Be sure the ignition switch is in the OFF position when performing any parts replacement or repairs.
- Do not work under the hood while the engine is hot. Always turn off the engine and wait until it cools down.
- If you must work with the engine running, keep your hands, clothing, hair and tools away from moving fans, belts and any other moving parts.
- It is advisable to secure or remove any loose clothing and any jewelry, such as rings, watches, etc. before working on your vehicle.

- If you must run the engine in an enclosed space such as a garage, be sure there is proper ventilation for exhaust gases to escape.
- Never get under the vehicle while it is supported by a jack.
- Keep smoking materials, flame and sparks away from fuel and the battery.
- Never connect or disconnect either the battery or any transistorized component connector while the ignition switch is in the ON position.
- On gasoline engine models with the Multiport Fuel Injection system, the fuel filter and fuel lines should be serviced by an INFINITI retailer or qualified workshop because the fuel lines are under high pressure even when the engine is turned off.
- Your vehicle is equipped with an automatic engine cooling fan. It may come on at any time without warning, even if the ignition switch is in the OFF position and the engine is not running. To avoid injury, always disconnect the negative battery cable before working near the fan.

- Always wear eye protection whenever you work on your vehicle.
- Never leave the engine or the transmission related component harness connector disconnected while the ignition switch is in the ON position.
- Avoid direct contact with used engine oil and coolant. Improperly disposed engine oil, engine coolant, and/or other vehicle fluids can hurt the environment. Always conform to local regulations for disposal of vehicle fluids.

This " 8. Do-it-yourself" section provides instructions regarding only those items which are relatively easy for an owner to perform.

You should be aware that incomplete or improper servicing may result in operating difficulties or excessive emissions, and could affect your warranty coverage. **If in doubt about any servicing, it is recommended you have it done by an INFINITI retailer.**

ENGINE COMPARTMENT CHECK LOCATIONS

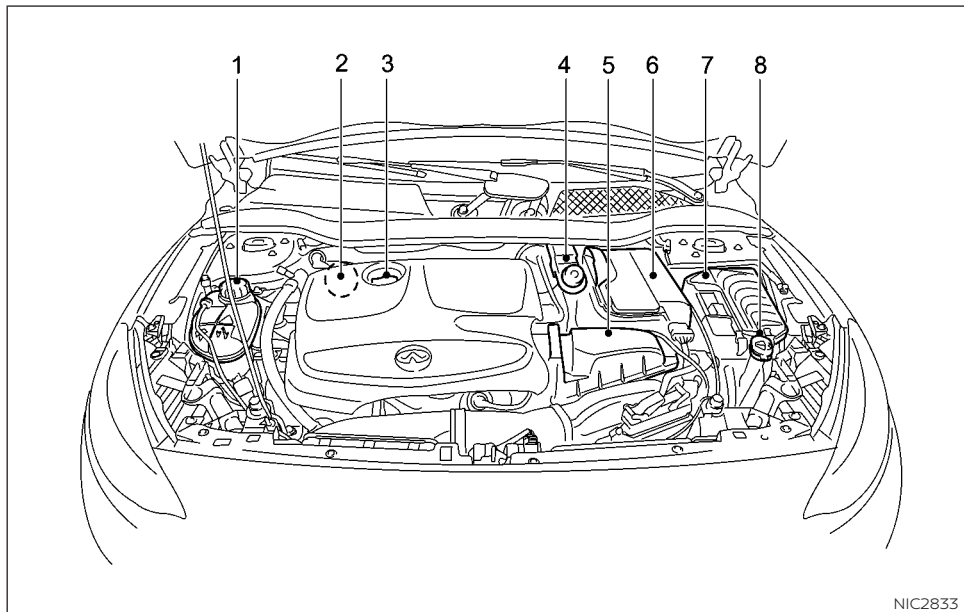

2.0L GASOLINE ENGINE

1. Engine coolant reservoir (P. 8-3)
2. Engine oil dipstick (P. 8-5)
3. Engine oil filler cap (P. 8-5)
4. Brake fluid reservoir (P. 8-7)

5. Engine air cleaner filter (P. 8-13)
6. Battery (P. 8-9)
7. Fuse box (P. 8-17)
8. Window washer fluid reservoir (P. 8-8)

ENGINE COOLING SYSTEM

⚠ WARNING

The engine cooling system is filled at the factory with a high-quality, year-round, antifreeze coolant solution. The antifreeze solution contains rust and corrosion inhibitors, therefore additional cooling system additives are not necessary.

- Never remove the radiator or coolant reservoir cap when the engine is hot. Wait until the engine and radiator cool down. Serious burns could be caused by high-pressure fluid escaping from the radiator. For additional information on precautions, refer to "If your vehicle overheats"
- The engine coolant reservoir tank is equipped with a pressure type cap. To prevent engine damage, use only a genuine INFINITI pressure cap.

⚠ CAUTION

- Never use any cooling system additives such as radiator sealer. Additives may clog the cooling system and cause damage to the engine, transmission and/or cooling system.

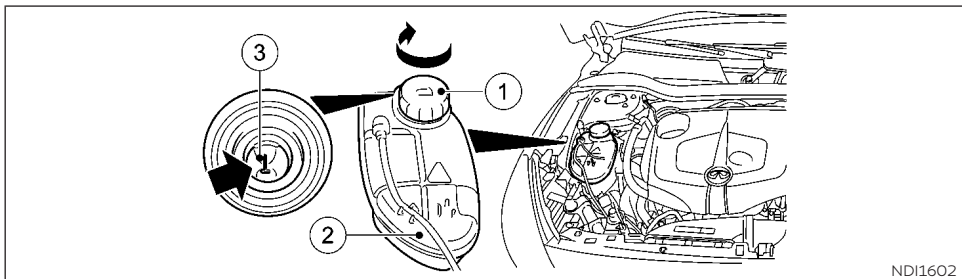

NDI1602

- When adding or replacing coolant, be sure to use only INFINITI Genuine Engine Coolant, BASF Glystantin G40 or equivalent in its quality. The use of other types of engine coolant may damage the engine cooling system.

CHECKING ENGINE COOLANT LEVEL

NOTE

The coolant level must only be checked and corrected when the engine is cold.

1. Park the vehicle on a level surface.

Only check the coolant level if the vehicle is on a level surface and the engine is cold.

2. Slowly turn cap ① half a turn counter-clockwise to allow excess pressure to escape.
3. Turn cap ① further counter-clockwise and remove it.

If the coolant is at the level of marker bar ③ in the filler neck when cold, there is enough coolant in coolant expansion tank ②.

4. If necessary, top up with INFINITI Genuine Engine Coolant, BASF Glystantin G40 or equivalent in its quality.
5. Replace cap ① and turn it clockwise as far as it will go.

If the cooling system frequently requires coolant, have it checked. It is recommended that you visit an INFINITI retailer for this service.

CHANGING ENGINE COOLANT

An INFINITI retailer can change the engine coolant.

Improper servicing can result in reduced heater performance and engine overheating.

⚠ WARNING

- To avoid being scalded, never change the coolant when the engine is hot.
- Never remove the radiator cap when the engine is hot. Serious burns could be caused by high pressure fluid escaping from the radiator.
- Avoid direct skin contact with used coolant. If skin contact is made, wash thoroughly with soap or hand cleaner as soon as possible.
- Keep coolant out of reach of children and pets.

Engine coolant must be disposed of properly. Check your local regulations.

ENGINE OIL

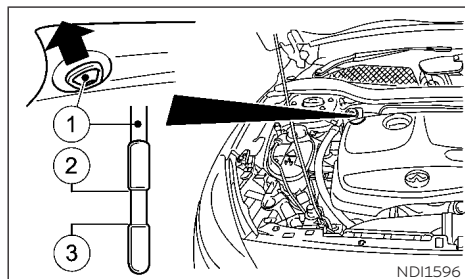

2.0L gasoline engine

CHECKING ENGINE OIL LEVEL

1. Park the vehicle on a level surface and apply the parking brake.
2. Start the engine and let it idle until it reaches the normal operating temperature.
3. Turn off the engine. Wait more than 15 minutes for the oil to drain back into the oil pan.
4. Remove the dipstick ① and wipe it clean. Reinsert it all the way.

5. Remove the dipstick and check the oil level. It should be within the range ② and ③.

If the oil level is below ③, remove the oil filler cap and pour the recommended oil into the opening. **Do not overfill** ②.

It is normal to add some oil between oil maintenance intervals or during the break-in period, depending on the severity of operating conditions.

⚠ CAUTION

The oil level should be checked regularly. Operating the engine with an insufficient amount of oil can damage the engine, and such damage is not covered by the warranty.

CHANGING ENGINE OIL

⚠ WARNING

- **Prolonged and repeated contact with used engine oil may cause skin cancer.**
- **Try to avoid direct skin contact with used oil. If skin contact is made, wash thoroughly with soap or hand cleaner and plenty of water as soon as possible.**
- **Keep used engine oil out of reach of children.**

⚠ CAUTION

Be careful not to burn yourself. The engine oil may be hot.

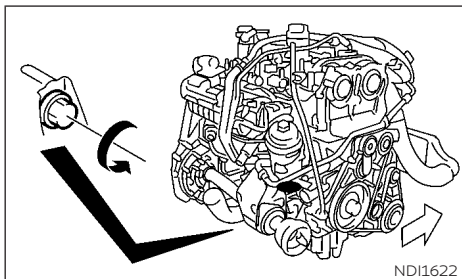

1. Park the vehicle on a level surface and apply the parking brake.
2. Start the engine and let it idle until it reaches the normal operating temperature, then turn it off.
3. Remove the oil filler cap by turning it counterclockwise.
4. Remove the engine undershield.
5. Place a large drain pan under the drain plug.
6. Remove the drain plug with a wrench by turning it counterclockwise and completely drain the oil. If the oil filter is to be changed, remove and replace it at this time. For additional information, refer to "Changing engine oil filter" later in this section.

- **Waste oil must be disposed of properly.**
- **Check your local regulations.**

7. Clean and reinstall the drain plug and a new washer. Securely tighten the drain plug with a wrench. Do not use excessive force.
Drain plug tightening torque: 22 ft-lb, 30 N-m

8. Refill engine with recommended oil through the oil filler opening, then install the oil filler cap securely.

For additional information on drain and refill capacity, refer to "Recommended fluids/lubricants and capacities".

The drain and refill capacity depends on the oil temperature and drain time. Use these specifications for reference only. Always use the dipstick to determine when the proper amount of oil is in the engine.

9. Start the engine. Check for leakage around the drain plug and oil filter. Correct as required.
10. Turn the engine off and wait more than 15 minutes. Check the oil level with the dipstick. Add engine oil if necessary.

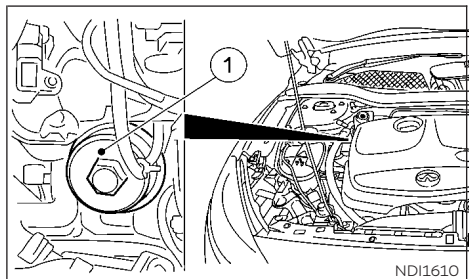

2.0L gasoline engine

CHANGING ENGINE OIL FILTER

1. Park the vehicle on a level surface and apply the parking brake.
2. Turn the engine off and wait more than 15 minutes.
3. Place a large drain pan under the oil filter ①.
4. Loosen the oil filter ① with an oil filter wrench by turning it counterclockwise. Then remove the oil filter by turning it by hand.

⚠ CAUTION

Be careful not to burn yourself. The engine oil may be hot.

AUTOMATIC TRANSMISSION FLUID (ATF)

It is recommended that you visit an INFINITI retailer if checking or replacement is required.

5. Wipe the engine oil filter sealing surface with a clean rag.

⚠ CAUTION

- **Be sure to remove any old gasket material remaining on the sealing surface of the engine. Failure to do so could lead to an oil leak and engine damage.**
- **The dipstick must be inserted in place to prevent oil spillage from the dipstick hole when filling the engine with oil.**

6. Coat the gasket on the new filter with clean engine oil.
7. Screw on the oil filter until a slight resistance is felt, then tighten an additional 2/3 turn.
Engine oil filter tightening torque: 19 ft-lb, 25 N·m
8. Start the engine and check for leakage around the oil filter. Correct as required.
9. Turn the engine off and wait more than 15 minutes. Check the oil level. Add engine oil if necessary.

⚠ CAUTION

- **Use only Shell DCT-M1 or equivalent. Do not mix with other fluids.**
- **Using automatic transmission fluid other than Shell DCT-M1 may cause deterioration in driveability and automatic transmission durability, and may damage the automatic transmission. Damage caused by the use of fluids other than as recommended is not covered by the warranty.**

BRAKE FLUID

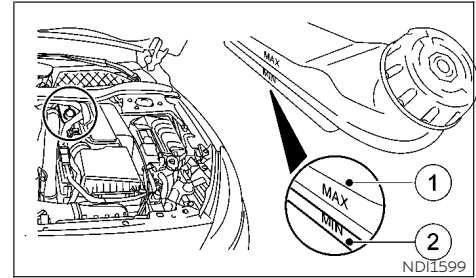

⚠ WARNING

- **Use only new fluid. Old, inferior, or contaminated fluid may damage the brake systems. The use of improper fluids can damage the brake system and affect the vehicle's stopping ability.**
- **Clean the filler cap before removing.**
- **Brake fluid is poisonous and should be stored carefully in marked containers out of the reach of children.**

⚠ CAUTION

- **Do not spill the fluid on painted surfaces. This will damage the paint. If fluid is spilled, wash with water.**

WINDOW WASHER FLUID

Check the fluid level in the reservoir. If the brake fluid is below the MIN line ②, the brake warning light will illuminate. Add brake fluid up to the MAX line ①. Use Genuine INFINITI brake fluid DOT4+ or equivalent. Never mix different types of fluids. For additional information on the recommended type of brake fluid, refer "Recommended fluids/lubricants and capacities".

If the brake fluid must be added frequently, the brake system should be thoroughly checked. It is recommended that you visit an INFINITI retailer for this service.

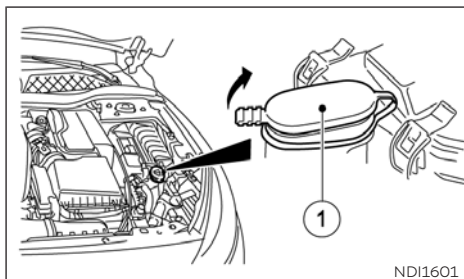

Fill the windshield-washer fluid reservoir periodically. Add fluid when the low washer fluid warning appears on the vehicle information display.

To fill the windshield-washer fluid reservoir, lift the cap off the reservoir and pour the windshield-washer fluid into the reservoir opening.

Add a washer solvent to the washer for better cleaning. In the winter season, add a windshield-washer antifreeze. Follow the manufacturer's instructions for the mixture ratio.

Refill the reservoir more frequently when driving conditions require an increased amount of windshield-washer fluid.

Recommended fluid is Genuine INFINITI Windshield Washer Concentrate Cleaner & Antifreeze or equivalent.

CAUTION

- **Do not substitute engine antifreeze coolant for window washer solution. This may result in damage to the paint.**
- **Do not fill the window washer reservoir tank with washer fluid concentrates at full strength. Some methyl alcohol based washer fluid concentrates may permanently stain the grille if spilled while filling the window washer reservoir tank.**
- **Pre-mix washer fluid concentrates with water to the manufacturer's recommended levels before pouring the fluid into the window washer reservoir tank. Do not use the window washer reservoir tank to mix the washer fluid concentrate and water.**

BATTERY

- Keep the battery surface clean and dry. Clean the battery with a solution of baking soda and water.
- Make certain the terminal connections are clean and securely tightened.
- If the vehicle is not used for 30 days or longer, disconnect the \ominus negative battery terminal cable to prevent discharge.

NOTE

Care should be taken to avoid situations that can lead to potential battery discharge and potential no-start conditions such as:

- Installation or extended use of electronic accessories that consume battery power when the engine is not running (Phone chargers, GPS, DVD players, etc).
- Vehicle is not driven regularly and/or only driven short distances.

In these cases, the battery may need to be charged to maintain battery health.

WARNING

- Do not expose the battery to flames, an electrical spark or a cigarette. Hydrogen gas generated by the battery is explosive. Explosive gases can cause blindness or injury. Do not allow battery fluid to contact your skin, eyes, fabrics or

Painted surfaces. Sulfuric acid can cause blindness or injury. After touching a battery or battery cap, do not touch or rub your eyes. Thoroughly wash your hands. If the acid contacts your eyes, skin or clothing, immediately flush with water for at least 15 minutes and seek medical attention.

- Do not operate the vehicle if the fluid in the battery is low. Low battery fluid can cause a higher load on the battery which can generate heat, reduce battery life, and in some cases lead to an explosion.
- When working on or near a battery, always wear suitable eye protection and remove all jewelry.
- Battery posts, terminals and related accessories contain lead and lead compounds. Wash hands after handling.
- Keep battery out of the reach of children.
- Do not tip the battery. Keep the vent caps tight and the battery level.

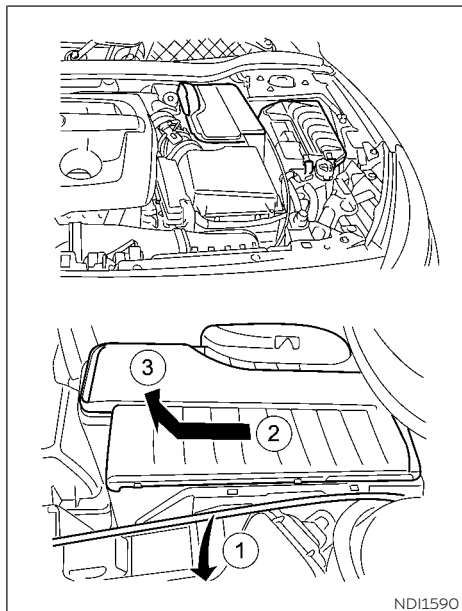

ACCESSING VEHICLE BATTERY

The vehicle battery is stored under a cover. To remove the cover to gain access to the battery:

1. Disconnect the hood release cable **1** and any other cables from the battery cover.

2. Hold the battery top cover firmly and slide it towards the front of the car ② and upwards ③.
3. Lift the cover up and away from the battery.

NOTE

When installing the battery cover, remember to replace cables in their original position.

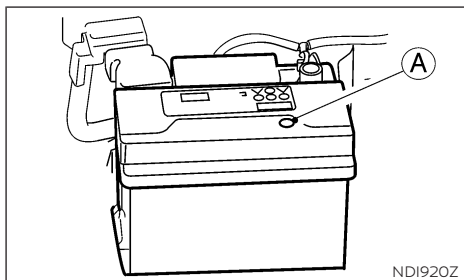

MAINTENANCE FREE BATTERY

For a maintenance free battery it is not required to check the fluid level. However, INFINITI recommends to visually check the status of the green indicator ① (if so equipped) periodically. If it is not visible, replace the battery as soon as possible.

MODELS WITH IDLE STOP/START SYSTEM

- Ensure that the battery fitted is the special battery that is enhanced with regard to the charge-discharge capacity and life performance. Avoid using any other battery for the Idle Stop/Start System, as this may cause early deterioration of the battery or a malfunction of the Idle Stop/Start System. It is recommended that a Genuine INFINITI battery is fitted. For more information, it is recommended that you contact an INFINITI retailer.
- If the battery terminal is disconnected (for battery replacement, etc.) and then reconnected, there may be some delay before the Stop/Start System reactivates.

BATTERY REPLACEMENT

It is recommended that a Genuine INFINITI battery is fitted. It is recommended that you visit an INFINITI retailer for this service.

Protective plate for battery

⚠ WARNING

Whenever the battery is replaced, always have the protective plate underneath the battery also reinstalled or replaced. If this plate is not reinstalled/replaced, in the

event of a collision a thermal incident could occur, causing vehicle damage and potentially causing serious injury of death.

If the vehicle battery is replaced, the protective plate underneath the battery must also be replaced. This protective plate must be fixed to the underside of the replacement battery using the adhesive tape supplied with the replacement plate. It is recommended that you visit an INFINITI retailer to purchase and replace the protective plate underneath the battery.

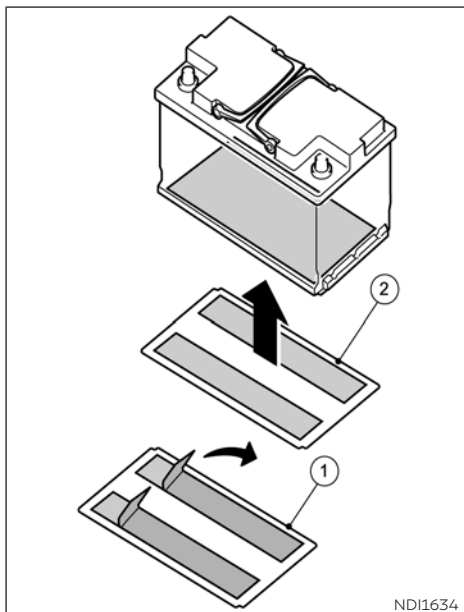

1. Make sure the underside of the replacement battery is dry and free of dust.
2. Remove the backing strips ① from the adhesive strips.
3. Fix the protective plate to the underside of the battery without any overlap ②.

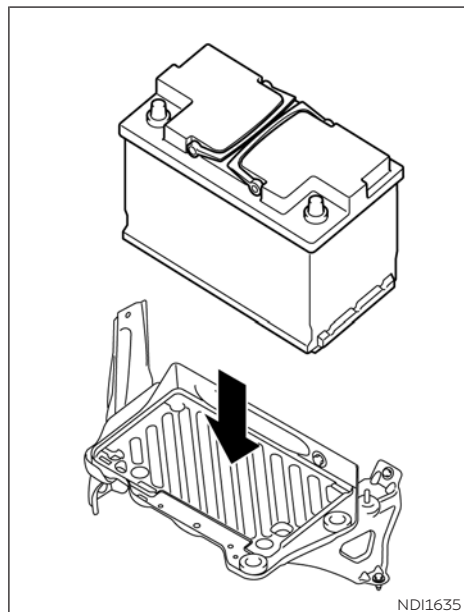

4. Fit the replacement battery in the vehicle.

REINITIALISATION PROCEDURE AFTER BATTERY RECONNECTION

If the battery has been reconnected, check the following items:

- Clock setting (if so equipped). For details, see "Clock", or the separately provided INFINITI InTouch Owner's Manual.
- Reset the desired radio stations to the pre-set station buttons. For details, see the audio device descriptions in the separately provided INFINITI InTouch Owner's Manual.

JUMP-STARTING

If jump-starting is necessary, see "Jump starting". If the engine does not start by jump starting, the battery may have to be replaced. It is recommended that you visit an INFINITI retailer for this service.

DRIVE BELT

WARNING

Be sure the ignition switch is in the OFF position before servicing drive belt. The engine could rotate unexpectedly.

1. Visually inspect each belt for signs of unusual wear, cuts, fraying or looseness. If the belt is in poor condition or loose, have it replaced or adjusted. It is recommended that you visit an INFINITI retailer for this service.
2. Have the belts checked regularly for condition and tension in accordance with the maintenance schedule as shown in a separately provided Warranty Information and Maintenance booklet.

SPARK PLUGS

Replace the spark plugs according to the maintenance schedule shown in a separate maintenance booklet.

If replacement is required, it is recommended that you visit an INFINITI retailer.

Always replace spark plugs with recommended or equivalent ones.

WARNING

Be sure the engine and ignition switch are off and that the parking brake is engaged securely.

CAUTION

- **Be sure to use the correct socket to remove the spark plugs. An incorrect socket can cause damage to the spark plugs.**

AIR CLEANER FILTER

It is recommended that you visit an INFINITI retailer if checking or replacement is required.

WARNING

- **Operating the engine with the air cleaner filter off can cause you or others to be burned. The air cleaner filter not only cleans the intake air, it also stops the flame if the engine backfires. If the air cleaner is not installed and the engine backfires, you could be burned. Never drive with the air cleaner filter off. Be cautious working on the engine when the air cleaner is off.**
- **Never pour fuel into the throttle body or attempt to start the engine with the air cleaner removed. Doing so could result in serious injury.**

WIPER BLADES

CLEANING

If the windshield or rear window is not clear after using the window washer or if a wiper blade chatters when running, wax or other material may be on the blade or windshield.

Clean the outside of the windshield or rear window with a washer solution or a mild detergent. The windshield or rear window is clean if beads do not form when rinsing with clear water.

Clean the blade by wiping it with a cloth soaked in a washer solution or a mild detergent. Then rinse the blade with clear water. If the windshield or rear window is still not clear after cleaning the blades and using the wiper, replace the blades.

CAUTION

Worn windshield wiper blades can damage the windshield and impair driver vision.

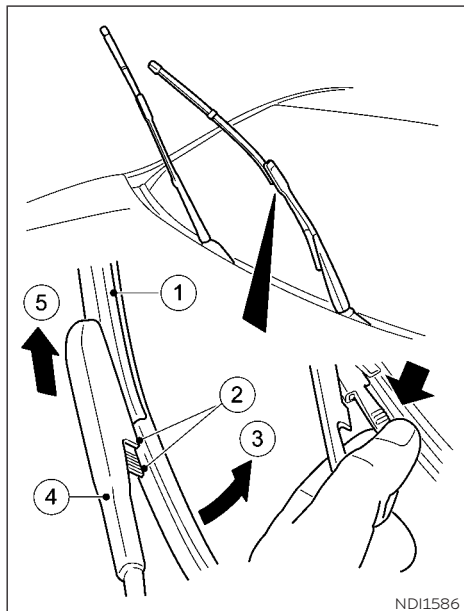

NDI1586

Replace the wiper blades if they are worn. To replace the windshield wiper blades, follow the procedure below:

1. Move the wiper arm away from the windshield.
2. Press both release clips ②.
3. Move the wiper blade ① in the direction of arrow ③ away from wiper arm ④.
4. Remove wiper blade ① in the direction of arrow ⑤.

REPLACING FRONT WINDOW WIPER BLADES

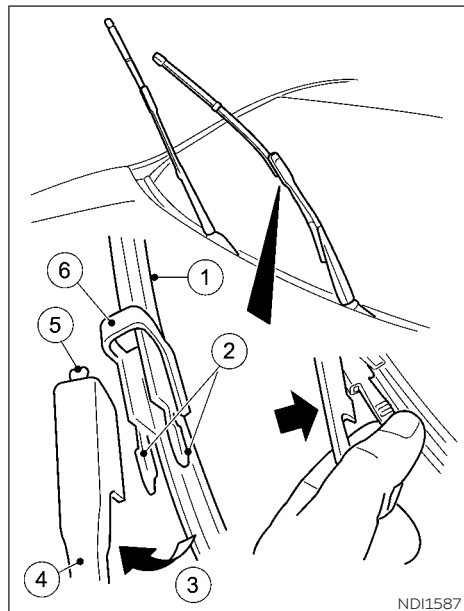

NDI1587

5. Position new wiper blade ① with recess ⑥ on lug ⑤.
6. Move wiper blade ① in the direction of arrow ③ onto the wiper arm until retaining clips ② engage in bracket ④.

7. Make sure that wiper blade ① is seated correctly.
8. Move the wiper arm back onto the windshield.

CAUTION

- **After wiper blade replacement, return the wiper arm to its original position; otherwise it may be damaged when the hood is opened.**
- **Make sure the wiper blades contact the glass; otherwise the arms may be damaged from wind pressure.**

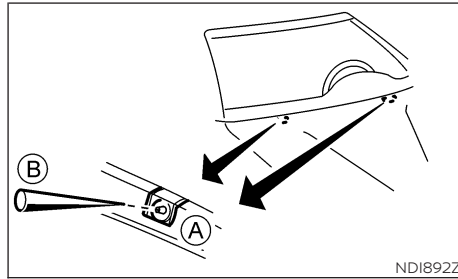

If you wax the surface of the engine hood, be careful not to let wax get into the washer nozzle (A). This may cause clogging or improper windshield washer operation. If wax gets into the nozzle, remove it with a needle or small pin (B).

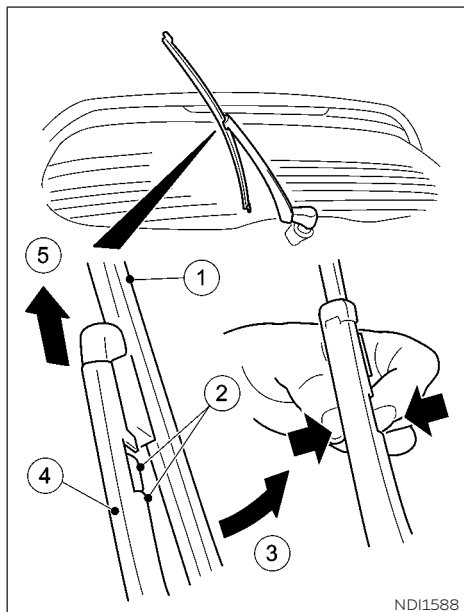

REPLACING REAR WINDOW WIPER BLADE

Replace the wiper blades if they are worn. To replace the rear window wiper blade, follow the procedure below:

1. Move wiper arm (4) away from the rear window.
2. Press both release clips (2).
3. Move wiper blade (1) in the direction of arrow (3) away from wiper arm (4).
4. Remove wiper blade (1) in the direction of arrow (5).

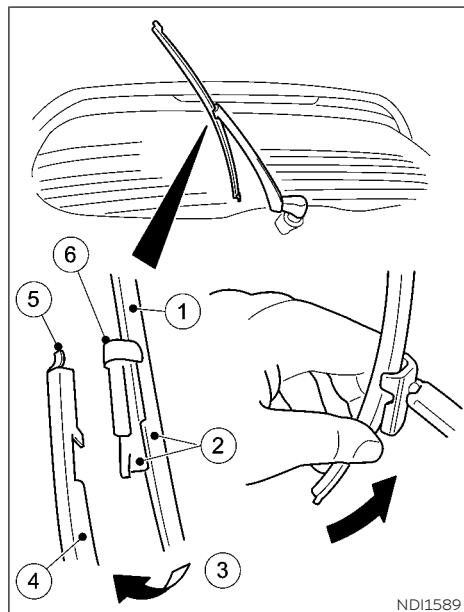

5. Position new wiper blade (1) with recess (6) on lug (5).
6. Move wiper blade (1) in the direction of arrow (3) onto the wiper arm until retaining clips (2) engage in bracket (4).

BRAKES

7. Make sure that wiper blade ① is seated correctly.
8. Move the wiper arm back onto the rear window.

If the brakes do not operate properly, it is recommended that you have the brakes checked. It is recommended that you visit an INFINITI retailer for this service.

SELF-ADJUSTING BRAKES

Your vehicle is equipped with self-adjusting brakes. The disc-type brakes self-adjust every time the brake pedal is applied.

FUSES

Blown fuses must be replaced with fuses of the same rating, which you can recognize by the color and fuse rating. The fuse ratings are listed in the fuse allocation chart.

If the newly inserted fuse also blows, have the cause traced and rectified. It is recommended you visit an INFINITI retailer for this service.

The fuses in your vehicle disconnect faulty circuits. If a fuse blows, all the components on the circuit and their functions will fail.

BEFORE REPLACING A FUSE

- Secure the vehicle against rolling away.
- Switch off all electrical consumers.
- Remove the key from the ignition lock.

The fuses are located in various fuse boxes:

- Fuse box in the engine compartment on the left-hand side of the vehicle, when viewed in the direction of travel.
- Fuse box in the front-passenger footwell.

The fuse allocation chart is on the fuse box in the front-passenger footwell.

ENGINE COMPARTMENT

WARNING

Never use a fuse of higher or lower amperage rating than that specified on the fuse box cover. This could damage the electrical system or electronic control units or cause a fire.

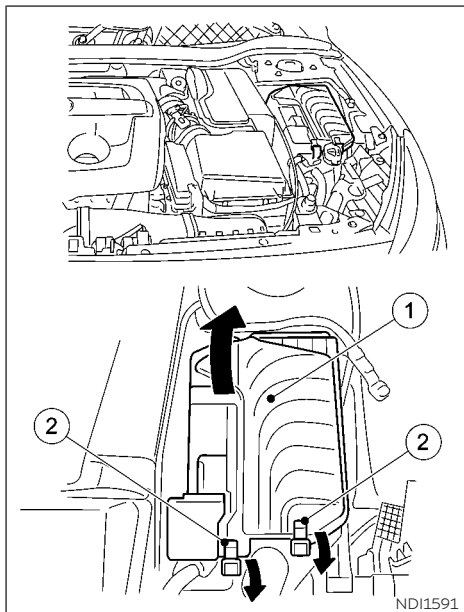

1. Open the hood
2. Remove any existing moisture from the fuse box using a dry cloth
3. To open: open clamps (2).
4. Fold cover (1) up in the direction of the arrow and remove it.

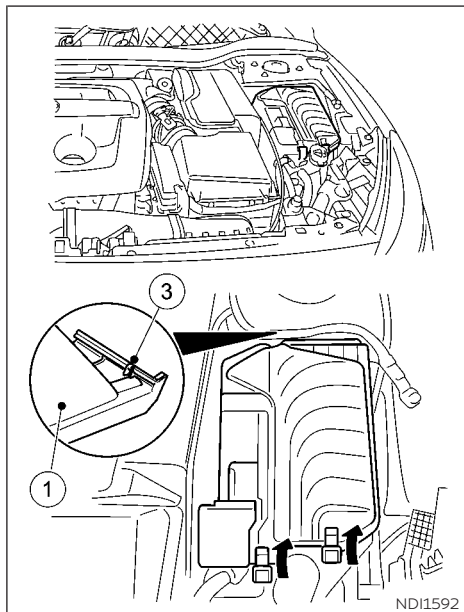

To close:

1. Check whether the seal is lying correctly in cover (1).
2. Insert cover (1) at the back into openings (3) on the fuse box.

3. Fold down cover ①.
4. Hook clamps into the fuse box and close
5. Close the hood.

PASSENGER COMPARTMENT

⚠ WARNING

Never use a fuse of higher or lower amperage rating than that specified on the fuse box cover. This could damage the electrical system or electronic control units or cause a fire.

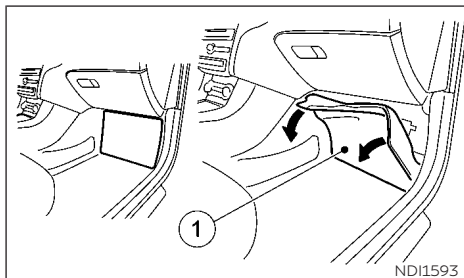

To open:

1. Open the front-passenger door.
2. Remove the floor mats.
3. Fold out perforated floor covering ① in the direction of the arrow.

INTELLIGENT KEY BATTERY REPLACEMENT

CAUTION

Be careful not to allow children to swallow the battery or removed parts.

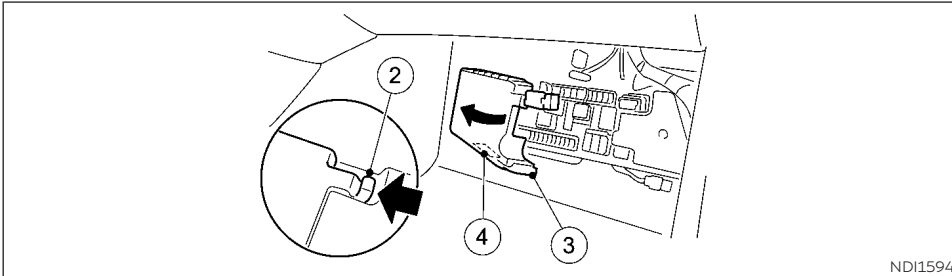

NDI1594

4. To release cover (3) press retaining clamp (2).
5. Fold out cover (3) in the direction of the arrow to the catch.
6. Remove cover (3) forwards.

NOTE

Fuse allocation chart (4) is located on the lower right-hand side of cover (3).

To close:

1. Insert cover (3) on the left-hand side of the fuse box into the retainer. Cover (3) engages in the retainers.
2. Fold down cover (3) until clamps (2) lock audibly.
3. Fold back perforated floor covering (1).
4. Fit the floor mats.

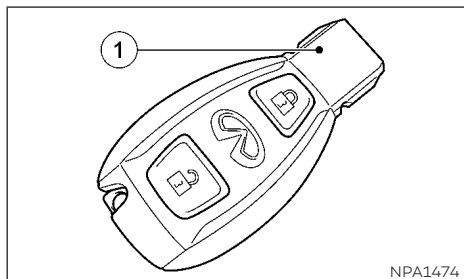

NPA1474



CHECKING THE BATTERY

Press the  (LOCK) or  (UNLOCK) button.

The battery is working properly if the battery check light  lights up briefly.

The battery is discharged if the battery check light  does not light up briefly. Replace the battery.

NOTE

- **If the key battery is checked within the signal reception range of the vehicle, pressing the  (LOCK) or  (UNLOCK) button locks or unlocks the vehicle.**
- **You can obtain a battery from an INFINITI retailer.**

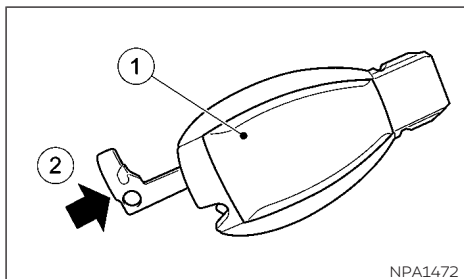





NPA1472

REPLACING THE BATTERY

You require a CR 2025 3 V cell battery.

Replace the battery in the Intelligent Key as follows:

1. Take the emergency key element out of the key (see "Mechanical key")
2. Press emergency key element  into the opening into the key in the direction of the arrow until the battery cover  opens. When doing so, do not hold cover  shut.
3. Remove battery tray cover .

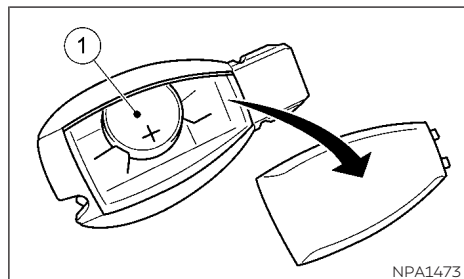

NPA1473

4. Repeatedly tap the key against your palm until battery  falls out.

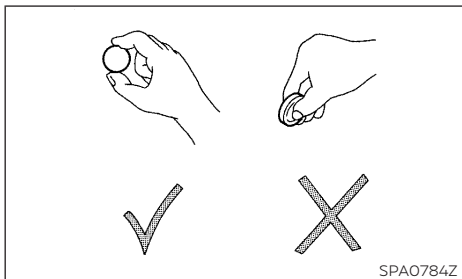

5. Insert the new battery with the positive terminal facing upwards. Use a lint-free cloth to do so.
6. Make sure that the surface of the battery is free of lint, grease and other contamination.
7. Insert the front tabs of battery cover ① and then press to close it.
8. Insert emergency key element into the key (see "Mechanical key").
9. Check the function of all key buttons on the vehicle.

If you need assistance with replacement, it is recommended that you visit an INFINITI retailer for this service.

FCC Notice:

For USA:

This device complies with Part 15 of the FCC Rules. Operation is subject to the following two conditions: (1) This device may not cause harmful interference, and (2) this device must accept any interference received, including interference that may cause undesired operation.

NOTE

Changes or modifications not expressly approved by the party responsible for compliance could void the user's authority to operate the equipment.

For Canada:

This device complies with Industry Canada license-exempt RSS standard(s). Operation is subject to the following two conditions: (1) this device may not cause interference, and (2) this device must accept any interference, including interference that may cause undesired operation of the device.

LIGHTS

EXTERIOR AND INTERIOR LIGHTS

Item	Wattage (W)
Front combination light	
Headlight (Low or high beam: H9 type)	14 / 28
Headlight (Low or high beam: LED type, if so equipped) *1	LED
Front turn signal light (with halogen headlights)	24
Front turn signal light (LED type, if so equipped)*1	LED
Front side light *1	LED
Daytime driving light *1	LED
Front fog light *1	LED
Side turn signal light *1	LED
Puddle light *1	LED
Rear combination light	
Turn signal light*1	LED
Stop/Tail light *1	LED
Reversing light *1	LED
Brake light *1	LED
High-mounted brake light *1	LED
License plate light*1	LED
Room light/Map lights (if so equipped)	5
Foot well light (if so equipped)	3
Reading light (rear)	5
Room light – rear (if so equipped)	5
Reading lights – rear (if so equipped)	8
Luggage compartment light	5

*1: It is recommended you visit an INFINITI retailer for replacement.

It is recommended you check with the Parts Department at an INFINITI retailer for the latest parts information.

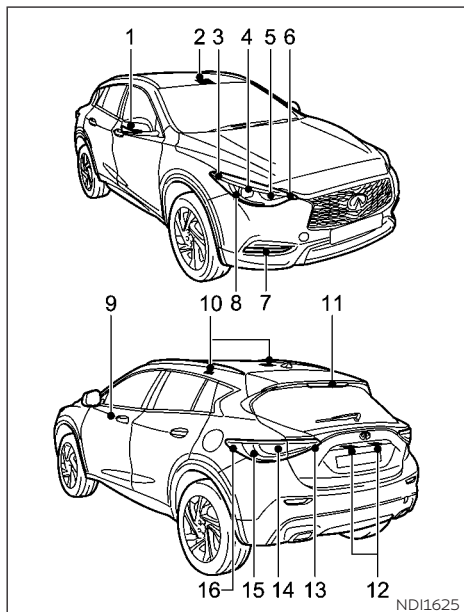

- ⑦ Front fog light (if so equipped)
- ⑧ Daytime driving light and sidelights
- ⑨ Footwell light (if so equipped)
- ⑩ Room light (if so equipped)
- ⑪ High mounted stop light
- ⑫ License plate light
- ⑬ Rear Fog and Reversing light
- ⑭ Brake light
- ⑮ Turn signal light
- ⑯ Tail light

- ① Side turn signal light
- ② Room light / Map lights (if so equipped)
- ③ Daytime driving light and sidelights and turn signal (if so equipped)
- ④ Low/High beam headlight
- ⑤ High beam headlight or turn signal
- ⑥ Cornering light (if so equipped)

8-24 **Do-it-yourself**

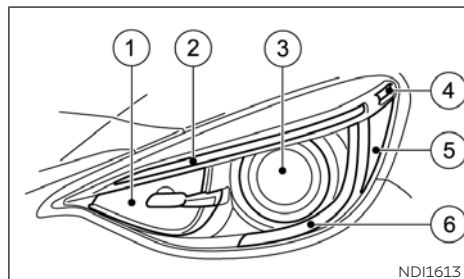

Front light unit

Halogen type:

- ① Turn signal light
- ② Daytime driving light and sidelight
- ③ High/Low beam halogen projector head-lights
- ④ Side marker light (if so equipped)
- ⑤ Reflector (if so equipped)
- ⑥ Daytime driving light and sidelights

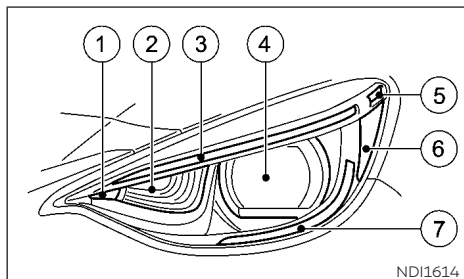

LED type:

- ① Cornering light
- ② Additional high-beam headlight
- ③ Daytime driving light and sidelight and turn signal light
- ④ High/Low beam LED projector head-lights and Adaptive Front Lighting system (if so equipped)
- ⑤ Side marker light (if so equipped)
- ⑥ Reflector (if so equipped)
- ⑦ Daytime driving light and sidelights

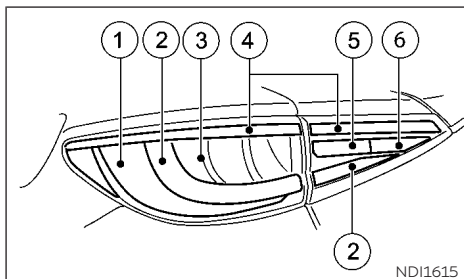

Rear light unit

- ① Tail light
- ② Turn signal light
- ③ Brake light
- ④ Tail light
- ⑤ Reversing light
- ⑥ Rear fog light (drivers side only)

REPLACEMENT PROCEDURES

LED lights (if so equipped)

The LED headlight is a projector style which uses a LED module without serviceable parts. If LED fog headlight, or any other LED light replacement is required, it is recommended that you visit an INFINITI retailer for this service.

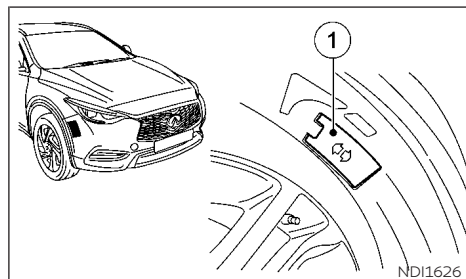

Halogen headlight bulb

Fitting/removing the access cover on the front wheel arch:

You must remove the cover of the front wheel arch before you can change the halogen headlight bulb.

To remove: switch off the lights, turn the steering so that the wheel behind the light in question is pointing inwards. Slide cover ① up and remove it.

To fit: inset cover ① again and slide it down until it engages.

The headlight is a semi-sealed beam type which uses a replaceable headlight (halogen) bulb. A bulb can be replaced from inside the engine compartment without removing the headlight assembly.

If you need assistance for bulb replacement, it is recommended that you visit an INFINITI retailer.

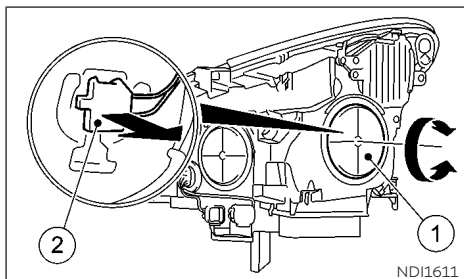

Low/High beam Headlight bulb replacement:

1. Open the hood. For details, see "Hood".
2. Disconnect the negative (-) battery cable.
3. Remove the corresponding access cover from the wheel arch.
4. Turn housing cover ① counterclockwise and remove it.
5. Turn bulb holder ② counterclockwise and pull out
6. Take the headlight bulb out of bulb holder ②.
7. Insert the new bulb into bulb holder ②.
8. Insert bulb holder ② and turn it clockwise.

9. Press on housing cover ① and turn it to the right.

10. Replace the cover in the front wheel arch

11. Reconnect the negative (-) battery cable and close the hood.

NOTE

Fog may temporarily form inside the lens of the exterior lights in the rain or in a car wash. The fog is caused by a temperature difference between the inside and the outside of the lens. This is not a malfunction. If large droplets can be seen, it is recommended that you visit an INFINITI retailer.

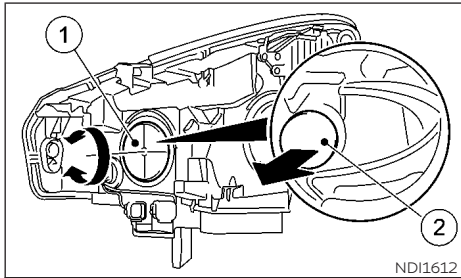

Front turn signal light bulb replacement (non-LED system only)

1. Open the hood. For details, see "Hood".
2. Disconnect the negative (-) battery cable.
3. Turn housing cover ① counterclockwise and remove it.
4. Turn bulb holder ② counterclockwise and pull out
5. Take the headlight bulb out of bulb holder ②.
6. Insert the new bulb into bulb holder ②.

7. Insert bulb holder ② and turn it clockwise.
8. Press on housing cover ① and turn it to the right.
9. Reconnect the negative (-) battery cable and close the hood.

WHEELS AND TIRES

If you have a flat tire, refer to "Flat tire".

TIRE PRESSURE

Tire Pressure Monitoring System (TPMS)

The Tire Pressure Monitoring System (TPMS) monitors tire pressure of all tires. When the low tire pressure warning light is lit, one or more of the tires is significantly under-inflated.

The TPMS will activate only when the vehicle is driven at speeds above 16 MPH (25 km/h). Also, this system may not detect a sudden drop in tire pressure (for example a flat tire while driving).

For additional information, refer to "Tire Pressure Monitoring System (TPMS)".

Tire inflation pressure

Check the tire pressures (including the spare) often and always prior to long distance trips. The recommended tire pressure specifications are shown on the F.M.V.S.S./C.M.V.S.S. label or the Tire and Loading Information label (if so equipped) under the Cold Tire Pressure heading. The Tire and Loading Information label is affixed to the driver side center pillar. Tire pressures should be checked regularly because:

- Most tires naturally lose air over time.
- Tires can lose air suddenly when driven over potholes or other objects or if the vehicle strikes a curb while parking.

The tire pressures should be checked when the tires are cold. The tires are considered COLD after the vehicle has been parked for 3 or more hours, or driven less than 1 mile (1.6 km) at moderate speeds.

WARNING

- **Improperly inflated tires can fail suddenly and cause an accident.**

- **The Gross Vehicle Weight rating (GVWR) is located on the F.M.V.S. S./C.M.V.S.S. certification label. The vehicle weight capacity is indicated on the Tire and Loading Information label (if so equipped). Do not load your vehicle beyond this capacity. Overloading your vehicle may result in reduced tire life, unsafe operating conditions due to premature tire failure, or unfavorable handling characteristics and could also lead to a serious accident. Loading beyond the specified capacity may also result in failure of other vehicle components.**
- **Before taking a long trip, or whenever you heavily load your vehicle, use a tire pressure gauge to ensure that the tire pressures are at the specified level.**
- **For additional information regarding tires, refer to "Important Tire Safety Information" (US) or "Tire Safety Information" (Canada) in the Warranty Information Booklet.**

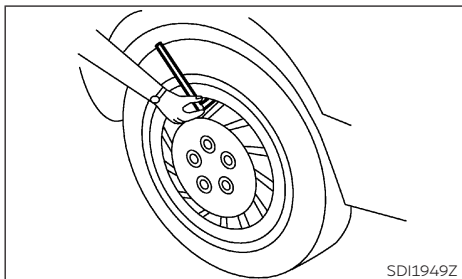

5. Add air to the tire as needed. If too much air is added, press the core of the valve stem briefly with the tip of the gauge stem to release pressure. Recheck the pressure and add or release air as needed.
6. Install the valve stem cap.
7. Check the pressure of all other tires, including the spare.

TIRE INFLATION PRESSURE

Checking tire pressure

1. Remove the valve stem cap from the tire.
2. Press the pressure gauge squarely onto the valve stem. Do not press too hard or force the valve stem sideways, or air will escape. If the hissing sound of air escaping from the tire is heard while checking the pressure, reposition the gauge to eliminate this leakage.
3. Remove the gauge.
4. Read the tire pressure on the gauge stem and compare it to the specification shown on the Tire and Loading Information label.

Tire Size		Cold Tire Inflation Pressure	
		Front	Rear
235/50 R18	(2WD)	35 psi, 240kPa	35 psi, 240kPa
	(4WD)	35 psi, 240kPa	29 psi, 200kPa
235/45 R19		32 psi, 220kPa	32 psi, 220kPa
Spare tire		NONE	

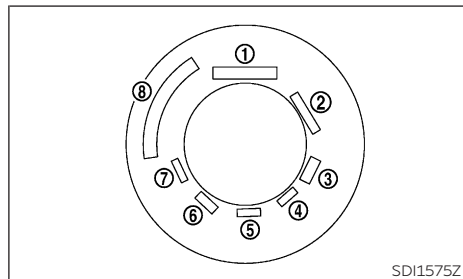

Example

TIRE LABELING

Federal law requires tire manufacturers to place standardized information on the sidewall of all tires. This information identifies and describes the fundamental characteristics of the tire and also provides the tire identification number (TIN) for safety standard certification. The TIN can be used to identify the tire in case of a recall.

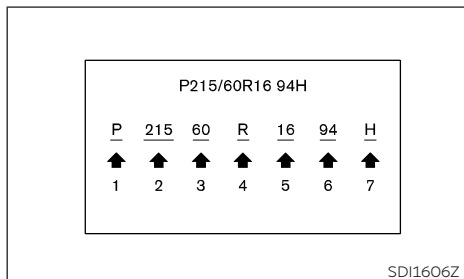

Example

- ① Tire size (example: P215/60R16 94H)
 - 1 P: The "P" indicates the tire is designed for passenger vehicles. (Not all tires have this information.)
 - 2 Three-digit number (215): This number gives the width in millimeters of the tire from sidewall edge to sidewall edge.
 - 3 Two-digit number (60): This number, known as the aspect ratio, gives the tire's ratio of height to width.
 - 4 R: The "R" stands for radial.
 - 5 Two-digit number (16): This number is the wheel or rim diameter in inches.
 - 6 Two- or three-digit number (94): This number is the tire's load index. It is a measurement of how much weight each tire can support. You may not find this information on all tires because it is not required by law.
 - 7 H: Tire speed rating. You should not drive the vehicle faster than the tire speed rating.

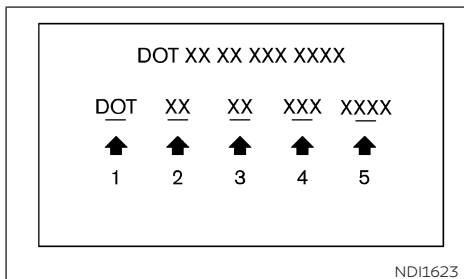

Example

- ② TIN (Tire Identification Number) for a new tire (example: DOT XX XX XXX XXXX)
 - 1 DOT: Abbreviation for the "Department of Transportation". The symbol can be placed above, below or to the left or right of the Tire Identification Number.
 - 2 Two-digit code: Manufacturer's identification mark
 - 3 Two-digit code: Tire size
 - 4 Three-digit code: Tire type code (Optional)
 - 5 Four numbers represent the week and year the tire was built. For example, the numbers 3103 means the 31st week of 2003. If these numbers are missing, then look on the other sidewall of the tire.
- ③ Tire ply composition and material

The number of layers or plies of rubber-coated fabric in the tire. Tire manufacturers also must indicate the materials in the

tire, which include steel, nylon, polyester, and others.

- ④ Maximum permissible inflation pressure

This number is the greatest amount of air pressure that should be put in the tire. Do not exceed the maximum permissible inflation pressure.

- ⑤ Maximum load rating

This number indicates the maximum load in kilograms and pounds that can be carried by the tire. When replacing the tires on the vehicle, always use a tire that has the same load rating as the factory installed tire.

- ⑥ Term of "tubeless" or "tube type"

Indicates whether the tire requires an inner tube ("tube type") or not ("tubeless").

- ⑦ The word "radial"

The word "radial" is shown, if the tire has radial structure.

- ⑧ Manufacturer or brand name"

Manufacturer or brand name is shown.

Other tire-related terminology:

In addition to the many terms that are defined throughout this section, Intended Outboard Sidewall is (1) the sidewall that contains a whitewall, bears white lettering or bears manufacturer, brand and/or model

name molding that is higher or deeper than the same molding on the other sidewall of the tire, or (2) the outward facing sidewall of an asymmetrical tire that has a particular side that must always face outward when mounted on a vehicle.

TYPES OF TIRES

WARNING

- **When changing or replacing tires, be sure all four tires are of the same type (i.e, summer, all season or snow) and construction. An INFINITI retailer may be able to help you with information about tire type, size, speed rating and availability.**
- **Replacement tires may have a lower speed rating than the factory equipped tires, and they may not match the potential maximum vehicle speed. Never exceed the maximum speed rating of the tire.**
- **Always use tires of the same type, size, brand, construction and tread pattern on all four wheels. Failure to do so may result in a circumference difference between tires on the front and rear axles which can cause the Vehicle Dynamic Control (VDC) system to malfunction**

resulting in personal injury or death, excessive tire wear and may damage the transmission, transfer case and differential gears.

- **For additional information regarding tires, refer to "Important Tire Safety Information" (US) or "Tire Safety Information" (Canada) in the Warranty Information Booklet.**

CAUTION

ONLY use spare tires specified for the model.

If excessive tire wear is found, it is recommended that all four tires be replaced with tires of the same size, brand, construction and tread pattern. The tire pressure and wheel alignment should also be checked and corrected as necessary. It is recommended that you visit an INFINITI retailer for this service.

All season tires

INFINITI specifies all season tires on some models to provide good performance all year, including snowy and icy road conditions. All season tires are identified by ALL SEASON and/or M&S on the tire sidewall. Snow tires have better snow traction than all season

tires and may be more appropriate in some areas.

Summer tires

INFINITI specifies summer tires on some models to provide superior performance on dry roads. Summer tire performance is substantially reduced in snow and ice. Summer tires do not have the tire traction rating M&S on the tire sidewall.

If you plan to operate your vehicle in snowy or icy conditions, INFINITI recommends the use of snow or all season tires on all four wheels.

Snow tires

If snow tires are needed, it is necessary to select tires equivalent in size and load rating to the original equipment tires. If you do not, it can adversely affect the safety and handling of your vehicle.

Generally, snow tires have lower speed ratings than factory equipped tires and may not match the potential maximum vehicle speed. Never exceed the maximum speed rating of the tire. If you install snow tires, they must be the same size, brand, construction and tread pattern on all four wheels.

For additional traction on icy roads, studded tires may be used. However, some U.S. states and Canadian provinces prohibit their use. Check local, state and provincial laws before

installing studded tires. Skid and traction capabilities of studded snow tires on wet or dry surfaces may be poorer than that of non-studded snow tires.

Four-Wheel Drive (4WD) models

If excessive tire wear is found, it is recommended that all four tires be replaced with tires of the same size, brand, construction and tread pattern. The tire pressure and wheel alignment should also be checked and corrected as necessary. It is recommended that you visit an INFINITI retailer.

TIRE CHAINS

CAUTION

Tire chains/cables should not be installed on 235/45 R19 or 235/50 R18 size tires. Installation of the tire chains/cables on 235/45 R19 or 235/50 R18 size tires will cause damage to the vehicle. If you plan to use tire chains/cables, you should install 215/60 R17 size tires on your vehicle.

Use of tire chains may be prohibited according to location. Check the local laws before installing tire chains. When installing tire chains, make sure that they are of proper size for the tires on your vehicle and are installed according to the chain manufacturer's instructions.

Use chain tensioners when recommended by the tire chain manufacturer to ensure a tight fit. Loose end links of the tire chains must be secured or removed to prevent the possibility of whipping action damage to the fenders or underbody. If possible, avoid fully loading your vehicle when using tire chains. In addition, drive at a reduced speed. Otherwise, your vehicle may be damaged and/or vehicle handling and performance may be adversely affected.

Tire chains must be installed only on the front wheels and not on the rear wheels.

Never install tire chains on a T-type spare tire (TEMPORARY USE ONLY).

Do not drive with tire chains on paved roads which are clear of snow. Driving with chains in such conditions can cause damage to the various mechanisms of the vehicle due to some overstress.

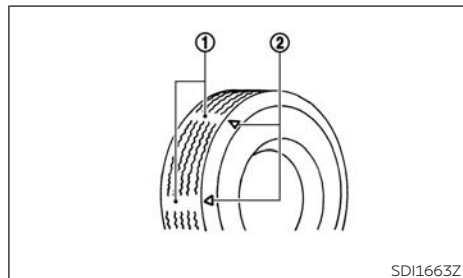

SDI1663Z

① : Wear indicator

② : Location mark

TIRE WEAR AND DAMAGE

WARNING

- **Tires should be periodically inspected for wear, cracking, bulging or objects caught in the tread. If excessive wear, cracks, bulging or deep cuts are found, the tire should be replaced immediately.**
- **The original tires have a built-in tread wear indicator. When the wear indicator is visible, the tire should be replaced.**

- **Tires degrade with age and use. Have tires, including the spare, over 6 years old checked by a qualified technician because some tire damage may not be obvious. Replace the tires as necessary to prevent tire failure and possible personal injury.**
- **Improper service of the spare tire may result in serious personal injury. If it is necessary to repair the spare tire, it is recommended that you visit an INFINITI retailer for this service.**
- **For additional information regarding tires, refer to "Important Tire Safety Information" (US) or "Tire Safety Information" (Canada) in the Warranty Information Booklet.**

Tires should be periodically inspected for wear, cracking, bulging or objects caught in the tread. If excessive wear, cracks, bulging or deep cuts are found, the tire should be replaced immediately.

The original tires have a built-in tread wear indicator. When the wear indicator is visible, the tire should be replaced.

Improper servicing of a tire may result in serious personal injury. If it is necessary to re-

pair a tire, it is recommended you contact an INFINITI retailer.

TIRE ROTATION

INFINITI recommends rotating the tires every 5,000 miles (8,000 km).

For additional information on tire replacing procedures, refer to "Flat tire". **As soon as possible, tighten the wheel nuts to the specified torque with a torque wrench.**

Wheel nut tightening torque: 96 ft-lb (130 N·m)

The wheel nuts must be kept tightened to specifications at all times. It is recommended that wheel nuts be tightened to specification at each tire rotation interval.

WARNING

- **After rotating the tires, check and adjust the tire pressure.**
- **Do not include the spare tire in the tire rotation.**
- **For additional information regarding tires, refer to "Important Tire Safety Information" (US) or "Tire Safety Information" in the Warranty Information Booklet.**

REPLACING WHEELS AND TIRES

WARNING

Do not install a deformed wheel or tire even if it has been repaired. Such wheels or tires could have structural damage and could fail without warning.

When replacing a tire, use the same size, speed rating and load carrying capacity as originally equipped. (See "Wheels and Tires" for recommended types and sizes of tires and wheels.)

If the wheels are changed for any reason, always replace with wheels which have the same offset dimension. Wheels of a different offset could cause early tire wear, possibly degraded vehicle handling characteristics and/or interference with the brake discs/drums. Such interference can lead to decreased braking efficiency and/or early brake pad/shoe wear.

Confirm the following for the TPMS:

WARNING

- **The use of tires other than those recommended or the mixed use of tires of different brands, construction (bias, bias-belted or radial), or tread patterns can**

adversely affect the ride, braking, handling, VDC system, ground clearance, body-to-tire clearance, tire chain clearance, speedometer calibration, headlight aim and bumper height. Some of these effects may lead to accidents and could result in serious personal injury.

- For 2WD models, if your vehicle was originally equipped with 4 tires that were the same size and you are only replacing 2 of the 4 tires, install the new tires on the rear axle. Placing new tires on the front axle may cause loss of vehicle control in some driving conditions and cause an accident and personal injury.
- If the wheels are changed for any reason, always replace with wheels which have the same offset dimension. Wheels of a different offset could cause premature tire wear, degrade vehicle handling characteristics, affect the VDC system and/or interference with the brake discs. Such interference can lead to decreased braking efficiency and/or early brake pad wear. For additional information on wheel offset dimensions, refer to "Wheels and Tires".

- When a replacement tire is mounted or a wheel is replaced, the TPMS will not function and the low tire pressure warning light will flash for approximately 1 minute. The light will remain on after 1 minute. Contact an INFINITI retailer as soon as possible for tire replacement and/or system resetting.
- Replacing tires with those not originally specified by INFINITI could affect the proper operation of the TPMS.
- The TPMS sensor may be damaged if it is not handled correctly. Be careful when handling the TPMS sensor.
- When replacing the TPMS sensor, the ID registration may be required. It is recommended that you visit an INFINITI retailer for ID registration.
- Do not use a valve stem cap that is not specified by INFINITI. The valve stem cap may become stuck.
- Be sure that the valve stem caps are correctly fitted. Otherwise the valve may be clogged up with dirt and cause a malfunction or loss of pressure.

- Do not install a damaged or deformed wheel or tire even if it has been repaired. Such wheels or tires could have structural damage and could fail without warning.
- The use of retread tires is not recommended.
- For additional information regarding tires, refer to "Important Tire Safety Information" (US) or "Tire Safety Information" (Canada) in the Warranty Information Booklet.

Care of wheels

- Wash the wheels when washing the vehicle to maintain their appearance.
- Clean the inner side of the wheels when the wheel is changed or the underside of the vehicle is washed.
- Do not use abrasive cleaners when washing the wheels.
- Inspect wheel rims regularly for dents or corrosion. Such damage may cause loss of pressure or poor seal at the tire bead.
- INFINITI recommends waxing the road wheels to protect against road salt in areas where it is used during winter.

WHEEL BALANCE

Unbalanced wheels may affect vehicle handling and tire life. Even with regular use, wheels can get out of balance. Therefore, they should be balanced as required.

Wheel balance service should be performed with the wheels off the vehicle. Spin balancing the wheels on the vehicle could lead to mechanical damage.

For additional information regarding tires, refer to "Important Tire Safety Information" (US) or "Tire Safety Information" (Canada) in the Warranty Information Booklet.

9 Maintenance and Schedules

Maintenance requirements	9-2	Maintenance schedules	9-7
General maintenance.	9-2	Oil change monitor	9-7
Scheduled maintenance.	9-2	Maintenance service messages	9-7
Where to go for service	9-2	Standard maintenance.	9-9
General maintenance.	9-2	Emission control system maintenance (For 2.0L turbo gasoline engine)	9-9
Explanation of general maintenance items	9-2	Chassis & body maintenance	9-11
Explanation of general maintenance items	9-5	Maintenance log.	9-13
Emission control system maintenance	9-5		
Chassis and body maintenance	9-6		



MAINTENANCE REQUIREMENTS

Some day-to-day and regular maintenance is essential to maintain your vehicle's good mechanical condition, as well as its emission and engine performance.

It is the owner's responsibility to make sure that the specified maintenance, as well as general maintenance, is performed.

As the vehicle owner, you are the only one who can ensure that your vehicle receives the proper maintenance care. You are a vital link in the maintenance chain.

GENERAL MAINTENANCE

General maintenance includes those items which should be checked during normal day-to-day operation of the vehicle. They are essential if your vehicle is to continue to operate properly. It is your responsibility to perform these procedures regularly as prescribed.

Performing general maintenance checks requires minimal mechanical skill and only a few general automotive tools.

These checks and inspections can be done by yourself, a qualified technician, or if you prefer, an INFINITI retailer.

SCHEDULED MAINTENANCE

The maintenance items listed under "Maintenance schedules" later in this section are required to be serviced at regular intervals.

WHERE TO GO FOR SERVICE

If maintenance service is required or your vehicle appears to malfunction, have the systems checked and serviced. It is recommended you visit an INFINITI retailer for this service.

INFINITI technicians are well-trained specialists and are kept up to date with the latest service information through technical bulletins, service tips and training programs. They are completely qualified to work on INFINITI vehicles **before** work begins.

You can be confident that an INFINITI retailer's service department can perform the service needed to meet the maintenance requirements on your vehicle.

GENERAL MAINTENANCE

During normal day-to-day operation of the vehicle, general maintenance should be performed regularly as prescribed in this section. If you detect any unusual sounds, vibrations or smells, be sure to check for the cause or have an INFINITI retailer do it promptly. In addition, it is recommended you notify an INFINITI retailer if you think that repairs are required.

When performing any checks or maintenance work, closely observe "Explanation of general maintenance items" later in this section.

EXPLANATION OF GENERAL MAINTENANCE ITEMS

Additional information on the following items with "*" is found later in the "Do-it-yourself" section of this manual.

Outside the vehicle

The maintenance items listed here should be performed from time to time, unless otherwise specified.

Doors and engine hood:

Check that all doors, the lift gate and the engine hood operate smoothly. Also make sure that all latches lock securely. Lubricate if necessary. Make sure that the secondary latch keeps the hood from opening when the

primary latch is released. When driving in areas using road salt or other corrosive materials, check lubrication frequently.

Lights*:

Clean the headlights on a regular basis. Make sure that the headlights, stop lights, tail lights, turn signal lights, and other lights are all operating properly and installed securely. Also check the aim of the headlights.

Road wheel nuts (lug nuts)*:

When checking the tires, make sure no wheel nuts are missing, and check for any loose wheel nuts. Tighten if necessary.

Tire rotation*:

Tires should be rotated every 5,000 miles (8,000 km). Tires marked with directional indicators can only be rotated between front and rear. Make sure that the directional indicators point in the direction of wheel rotation after the tire rotation is completed.

Tires*:

Check the pressure with a gauge often and always prior to long distance trips. Adjust the pressure in all tires to the pressure specified. Check carefully for damage, cuts or excessive wear.

Tire Pressure Monitoring System (TPMS) transmitter components:

Replace the TPMS transmitter grommet seal, valve core and cap when the tires are replaced due to wear or age.

Wheel alignment and balance:

If the vehicle should pull to either side while driving on a straight and level road, or if you detect uneven or abnormal tire wear, there may be a need for wheel alignment.

If the steering wheel or seat vibrates at normal highway speeds, wheel balancing may be needed.

For additional information regarding tires, refer to "Important Tire Safety Information" (US) or "Tire Safety Information" (Canada) in the INFINITI Warranty Information Booklet.

Windshield:

Clean the windshield on a regular basis. Check the windshield at least every six months for cracks or other damage. Have a damaged windshield repaired by a qualified repair facility.

Wiper blades*:

Check for cracks or wear if not functioning correctly. Replace as necessary.

Inside the vehicle

The maintenance items listed here should be checked on a regular basis, such as when performing scheduled maintenance, cleaning the vehicle, etc.

Accelerator pedal:

Check the pedal for smooth operation and make sure that the pedal does not catch or require uneven effort. Keep the floor mat away from the pedal.

Automatic transmission P (Park) mechanism:

On a fairly steep hill, check that your vehicle is held securely when P (Park) has been activated, without applying any brakes.

Brake pedal*:

Check the pedal for smooth operation. If the brake pedal suddenly goes down further than normal, the pedal feels spongy or the vehicle seems to take longer to stop, have your vehicle checked immediately. It is recommended you visit an INFINITI retailer for this service. Keep the floor mat away from the pedal.

Brakes:

Check that the brakes do not pull the vehicle to one side when applied.

Parking brake*:

Check the parking brake operation regularly. Also make sure that the vehicle is held securely on a fairly steep hill when only the parking brake is applied. If the parking brake needs adjustment, it is recommended you visit an INFINITI retailer for this service.

Seats:

Check seat position controls such as seat adjusters, seatback recliner, etc. to ensure they operate smoothly and that all latches lock securely in every position. Check that the head restraints move up and down smoothly and that the locks (if so equipped) hold securely in all latched positions.

Seat belts:

Check that all parts of the seat belt system (for example, buckles, anchors, adjusters and retractors) operate properly and smoothly, and are installed securely. Check the belt webbing for cuts, fraying, wear or damage.

Steering wheel:

Check for changes in the steering condition, such as excessive free play, hard steering or strange noises.

Warning lights and chimes:

Make sure that all warning lights and chimes are operating properly.

9-4 Maintenance and Schedules

Windshield defroster:

Check that the air comes out of the defroster outlets properly and in good quantity when operating the heater or air conditioner.

Windshield wiper and washer*:

Check that the wipers and washer operate properly and that the wipers do not streak.

Under the hood and vehicle

The maintenance items listed here should be checked periodically (for example, each time you check the engine oil or refuel).

Battery*:

Except for maintenance free battery, check the fluid level in each cell. It should be between the "UPPER" and "LOWER" lines.

NOTE

Care should be taken to avoid situations that can lead to potential battery discharge and potential no-start conditions such as:

- 1. Installation or extended use of electronic accessories that consume battery power when the engine is not running (Phone chargers, GPS, DVD players, etc.)**
- 2. Vehicle is not driven regularly and/or only driven short distances.**

In these cases, the battery may need to be charged to maintain battery health.

Brake fluid level*:

Make sure that the brake fluid level is between the "MAX" and "MIN" lines on the reservoir.

Coolant level*:

Check the coolant level when the engine is cold.

Engine drive belt(s)*:

Make sure that no belt is frayed, worn, cracked or oily.

Engine oil level*:

Check the level after parking the vehicle on a level spot and turning off the engine. Wait more than 15 minutes for the oil to drain back into the oil pan.

Exhaust system:

Make sure there are no loose supports, cracks or holes. If the sound of the exhaust seems unusual or there is a smell of exhaust fumes, immediately have the exhaust system inspected. It is recommended you visit an INFINITI retailer for this service. See "Precautions when starting and driving".

Fluid leaks:

Check under the vehicle for fuel, oil, water or other fluid leaks after the vehicle has been parked for a while. Water dripping from the

EXPLANATION OF GENERAL MAINTENANCE ITEMS

air conditioner after use is normal. If you should notice any leaks or if gasoline fumes are evident, check for the cause and have it corrected immediately.

Radiator and hoses:

Check the front of the radiator and clean off any dirt, insects, leaves, etc., that may have accumulated. Make sure the hoses have no cracks, deformation, rot or loose connections.

Underbody:

The underbody is frequently exposed to corrosive substances such as those used on icy roads or to control dust. It is very important to remove these substances, otherwise rust will form on the floor pan, frame, fuel lines and around the exhaust system. At the end of winter, the underbody should be thoroughly flushed with plain water, being careful to clean those areas where mud and dirt may accumulate. For additional information, see "Cleaning exterior".

Windshield washer fluid*:

Check that there is adequate fluid in the reservoir.

The following descriptions are provided to give you a better understanding of the scheduled maintenance items that should be regularly checked or replaced. The maintenance schedule indicates at which mileage/time intervals each item requires service.

In addition to scheduled maintenance, your vehicle requires that some items be checked during normal day-to-day operation. Refer to "General maintenance" in this section.

Items marked with "*" are recommended by INFINITI for reliable vehicle operation. You are not required to perform maintenance on these items in order to maintain the warranties which come with your vehicle. Other maintenance items and intervals are required.

When applicable, additional information can be found in the "Do-it-yourself" section in Chapter 8.

NOTE

INFINITI does not advocate the use of non-OEM approved aftermarket flushing systems and strongly advises against performing these services on an INFINITI product. Many of the aftermarket flushing systems use non-OEM approved chemicals or solvents, the use of which has not been validated by INFINITI.

For recommended fuel, lubricants, fluids, grease, and refrigerant, refer to "Recommended fluids/lubricants and capacities".

EMISSION CONTROL SYSTEM MAINTENANCE

Drive belts*:

Check engine drive belts for wear, fraying or cracking and for proper tension. Replace any damaged drive belts

Engine air filter*:

Replace at specified intervals. When driving for prolonged periods in dusty conditions, check/replace the filter more frequently.

Engine coolant*:

Replace coolant at the specified interval. When adding or replacing coolant, be sure to use only Genuine INFINITI Engine Coolant or equivalent in its quality (BASF Glysantin® G40®). (For additional information, refer to "Engine cooling system".)

NOTE

Mixing any other type of coolant or the use of non-distilled water may reduce the recommended service interval of the coolant.

Engine oil and oil filter:

Replace engine oil and oil filter at the specified intervals. For recommended oil grade and viscosity refer to "Recommended fluids/lubricants and capacities".

Fuel filter:

Replace the fuel filter and drain the water at the specified intervals.

Fuel lines*:

Check the fuel hoses, piping and connections for leaks, looseness, or deterioration. Tighten connections or replace parts as necessary.

Spark plugs:

Replace at specified intervals. Install new plugs of the type as originally equipped.

**CHASSIS AND BODY
MAINTENANCE****Brake lines and cables:**

Visually inspect for proper installation. Check for chafing, cracks, deterioration, and signs of leaking. Replace any deteriorated or damaged parts immediately.

Brake pads, rotors, drums, & linings:

Check for wear, deterioration and fluid leaks. Replace any deteriorated or damaged parts immediately.

Exhaust system:

Visually inspect the exhaust pipes, muffler and hangers for leaks, cracks, deterioration, and damage. Tighten connections or replace parts as necessary.

In-cabin microfilter:

Replace at specified intervals. When driving for prolonged periods in dusty conditions, replace the filter more frequently.

Propeller shaft(s):

Check for damage, looseness, and grease leakage. (4WD/AWD).

Steering gear and linkage, axle and suspension parts, drive shaft boots:

Check for damage, looseness, and leakage of oil or grease.

Tire rotation:

Tires should be rotated every 5,000 miles (8,000 km) according to the instructions under "Tire rotation*" earlier in this section. When rotating tires, check for damage and uneven wear. Replace if necessary.

Transmission fluid/oil, differential oil, transfer case oil:

Visually inspect for signs of leakage at specified intervals.

MAINTENANCE SCHEDULES

To ensure smooth, trouble-free, safe and economical driving, INFINITI provides two maintenance schedules that may be used, depending upon the conditions in which you usually drive. These schedules contain both distance and time intervals, up to 120,000 miles (192,000 km)/144 months. For most people, the odometer reading will indicate when service is needed. However, if you drive very little, your vehicle should be serviced at the regular time intervals shown in the schedule.

After 120,000 miles (192,000 km)/144 months, continue maintenance at the same mileage/time intervals.

OIL CHANGE MONITOR

This vehicle is equipped with oil change monitor. It calculates engine oil and filter change interval base on driving conditions. When the Engine Oil – Service Due Now warning appears in the vehicle information display, the engine oil and filter need to be replaced.

MAINTENANCE SERVICE MESSAGES

The maintenance service interval display informs you of the next service due date.

NOTE

The maintenance service interval display does not show any information on the engine oil level.

The vehicle information display shows a service message for a few seconds, for example:

- [Service A In .. days]
- [Service A Due]
- [Service A Exceeded by .. days]

Depending on the operating conditions of the vehicle, the remaining time or distance until the next service due date is displayed.

The letter indicates which service is due. A stands for a minor service and B for a major service. A number or another letter may be displayed after the letter.

Only for certain countries: the position after the letter A or B indicates any necessary additional maintenance work. If you notify an INFINITI retailer of this display, you will receive a statement on the associated costs.

The maintenance service interval display does not take into account any periods of time during which the battery is disconnected.

Maintaining the time-dependent service schedule:

Note down the service due date displayed in the vehicle information display before disconnecting the battery.





or

After reconnecting the battery, subtract the battery disconnection periods from the service date shown on the display.

Hiding service messages

Press the <OK> or  button on the steering wheel.

Displaying service messages

1. Switch the ignition on.
2. Press the  or  button on the steering wheel to select the [Serv.] menu.
3. Press the  or  button to select [Maintenance] submenu and confirm by pressing the OK button.

The service due date appears in the vehicle information display.

Information about service

Resetting the maintenance service interval display:

CAUTION

If the maintenance service interval display has been inadvertently reset, this setting can be corrected at an INFINITI retailer. Have service work carried out as described in the Maintenance Schedule. This may otherwise lead to increased wear and damage to the major assemblies or the vehicle.

An INFINITI retailer will reset the maintenance service interval display after the service work has been carried out. You can also obtain further information on maintenance work, for example.

Special service requirements:

The prescribed service interval is based on normal operation of the vehicle. Service work will need to be performed more often if the vehicle is operated under arduous conditions or increased loads, for example:

- Regular city driving with frequent intermediate stops
- If the vehicle is primarily used to travel short distance
- For frequent operation in mountainous terrain or on poor road surfaces
- If the engine is often left idling for long periods

In these or similar operating conditions, have, for example, the air filter, engine oil and oil filter changed more frequently. The tires must be checked more frequently if the vehicle is operated under increased loads. Further information can be obtained at an INFINITI retailer.

STANDARD MAINTENANCE

The following tables show the standard maintenance schedule. Depending upon weather and atmospheric conditions, varying road surfaces, individual driving habits and vehicle usage, additional or more frequent maintenance may be required. After 120,000 miles (192,000 km)/144 months, continue maintenance at the same mileage/time intervals.

EMISSION CONTROL SYSTEM MAINTENANCE (FOR 2.0L TURBO GASOLINE ENGINE)

Abbreviations: I = Inspect and correct or replace as necessary, R = Replace

MAINTENANCE OPERATION	miles x 1,000	MAINTENANCE INTERVAL											
		5	10	15	20	25	30	35	40	45	50	55	60
Perform at number of miles, kilometers or months, whichever comes first.	(km x 1,000)	(8)	(16)	(24)	(32)	(40)	(48)	(56)	(64)	(72)	(80)	(88)	(96)
	months	6	12	18	24	30	36	42	48	54	60	66	72
	Engine compartment	See NOTE (1)											
V-belt	See NOTE (2)				I*				I*				I*
Air cleaner filter		Replace every 155,000 miles or 180 months											
Fuel lines					I*				I*				I*
Fuel filter	See NOTE (3)												
Engine coolant*		Replace every 155,000 miles or 180 months											
Engine oil			R		R		R		R		R		R
Engine oil filter			R		R		R		R		R		R
Spark plugs		Replace every 45,000 miles or 48 months											

NOTE:

- (1) All visible parts checked for leaks and damage.
- (2) In visible area only.
- (3) Maintenance-free item.

* Maintenance items and intervals with "*" are recommended by INFiniti for reliable vehicle operation. The owner need not perform such maintenance in order to maintain the emission warranty or manufacturer recall liability. Other maintenance items and intervals are required

Abbreviations: I = Inspect and correct or replace as necessary, R = Replace

MAINTENANCE OPERATION Perform at number of miles, kilometers or months, whichever comes first.	miles x 1,000	MAINTENANCE INTERVAL											
	(km x 1,000)	65	70	75	80	85	90	95	100	105	110	115	120
	months	(104)	(112)	(120)	(128)	(136)	(144)	(152)	(160)	(168)	(176)	(184)	(192)
Engine compartment	See NOTE (1)												
V-belt	See NOTE (2)				I*				I*				I*
		Replace every 155,000 miles or 180 months											
Air cleaner filter		Replace every 45,000 miles or 48 months											
Fuel lines					I*				I*				I*
Fuel filter	See NOTE (3)												
Engine coolant*		Replace every 155,000 miles or 180 months											
Engine oil			R		R		R		R		R		R
Engine oil filter			R		R		R		R		R		R
Spark plugs		Replace every 45,000 miles or 48 months											

NOTE:

- (1) All visible parts checked for leaks and damage.
- (2) In visible area only.
- (3) Maintenance-free item.

* Maintenance items and intervals with "*" are recommended by INFINITI for reliable vehicle operation. The owner need not perform such maintenance in order to maintain the emission warranty or manufacturer recall liability. Other maintenance items and intervals are required

CHASSIS & BODY MAINTENANCE

Abbreviations: I = Inspect and correct or replace as necessary, R = Replace

MAINTENANCE OPERATION Perform at number of miles, kilometers or months, whichever comes first.	miles x 1,000	MAINTENANCE INTERVAL											
		5	10	15	20	25	30	35	40	45	50	55	60
	(km x 1,000)	(8)	(16)	(24)	(32)	(40)	(48)	(56)	(64)	(72)	(80)	(88)	(96)
	months	6	12	18	24	30	36	42	48	54	60	66	72
Brake lines and cables			I		I		I		I		I		I
Brake pads and rotors			I		I		I		I		I		I
Brake fluid					R				R				R
Automatic transmission fluid					I				I				I
Automatic transmission fluid and filter		Replace every 60,000 miles or 60 months											
Differential gear oil			I		I		I		I		I		I
Steering gear and linkage, axle and suspension parts					I				I				I
Tire rotation	See NOTE (1)												
Propeller shaft & drive shaft boots (4WD models)			I		I		I		I		I		I
Exhaust system					I				I				I
In-cabin microfilter					R				R				R
I-key battery				R			R			R			R

NOTE:

(1) Refer to "Tire rotation*" earlier in this section.

Abbreviations: I = Inspect and correct or replace as necessary, R = Replace

MAINTENANCE OPERATION Perform at number of miles, kilometers or months, whichever comes first.	miles x 1,000	MAINTENANCE INTERVAL											
		65	70	75	80	85	90	95	100	105	110	115	120
	(km x 1,000)	(104)	(112)	(120)	(128)	(136)	(144)	(152)	(160)	(168)	(176)	(184)	(192)
	months	78	84	90	96	102	108	114	120	126	132	138	144
Brake lines and cables			I		I		I		I		I		I
Brake pads and rotors			I		I		I		I		I		I
Brake fluid					R				R				R
Automatic transmission fluid					I				I				I
Automatic transmission fluid and filter		Replace every 60,000 miles or 60 months											
Differential gear oil			I		I		I		I		I		I
Steering gear and linkage, axle and suspension parts					I				I				I
Tire rotation	See NOTE (1)												
Propeller shaft & drive shaft boots (4WD models)			I		I		I		I		I		I
Exhaust system					I				I				I
In-cabin microfilter					R				R				R
I-key battery					R				R				R

NOTE:

(1) Refer to "Tire rotation*" earlier in this section.

MAINTENANCE LOG

<p>5,000 Miles or 6 Months</p> <p>Retailer Name:</p> <p>Date:</p> <p>Mileage:</p> <p>Retailer Stamp:</p>	<p>10,000 Miles or 12 Months</p> <p>Retailer Name:</p> <p>Date:</p> <p>Mileage:</p> <p>Retailer Stamp:</p>	<p>15,000 Miles or 18 Months</p> <p>Retailer Name:</p> <p>Date:</p> <p>Mileage:</p> <p>Retailer Stamp:</p>
<p>20,000 Miles or 24 Months</p> <p>Retailer Name:</p> <p>Date:</p> <p>Mileage:</p> <p>Retailer Stamp:</p>	<p>25,000 Miles or 30 Months</p> <p>Retailer Name:</p> <p>Date:</p> <p>Mileage:</p> <p>Retailer Stamp:</p>	<p>30,000 Miles or 36 Months</p> <p>Retailer Name:</p> <p>Date:</p> <p>Mileage:</p> <p>Retailer Stamp:</p>
<p>35,000 Miles or 42 Months</p> <p>Retailer Name:</p> <p>Date:</p> <p>Mileage:</p> <p>Retailer Stamp:</p>	<p>40,000 Miles or 48 Months</p> <p>Retailer Name:</p> <p>Date:</p> <p>Mileage:</p> <p>Retailer Stamp:</p>	<p>45,000 Miles or 54 Months</p> <p>Retailer Name:</p> <p>Date:</p> <p>Mileage:</p> <p>Retailer Stamp:</p>

<p>50,000 Miles or 60 Months</p> <p>Retailer Name:</p> <p>Date:</p> <p>Mileage:</p> <p>Retailer Stamp:</p>	<p>55,000 Miles or 66 Months</p> <p>Retailer Name:</p> <p>Date:</p> <p>Mileage:</p> <p>Retailer Stamp:</p>	<p>60,000 Miles or 72 Months</p> <p>Retailer Name:</p> <p>Date:</p> <p>Mileage:</p> <p>Retailer Stamp:</p>
<p>65,000 Miles or 78 Months</p> <p>Retailer Name:</p> <p>Date:</p> <p>Mileage:</p> <p>Retailer Stamp:</p>	<p>70,000 Miles or 84 Months</p> <p>Retailer Name:</p> <p>Date:</p> <p>Mileage:</p> <p>Retailer Stamp:</p>	<p>75,000 Miles or 90 Months</p> <p>Retailer Name:</p> <p>Date:</p> <p>Mileage:</p> <p>Retailer Stamp:</p>
<p>80,000 Miles or 96 Months</p> <p>Retailer Name:</p> <p>Date:</p> <p>Mileage:</p> <p>Retailer Stamp:</p>	<p>85,000 Miles or 102 Months</p> <p>Retailer Name:</p> <p>Date:</p> <p>Mileage:</p> <p>Retailer Stamp:</p>	<p>90,000 Miles or 108 Months</p> <p>Retailer Name:</p> <p>Date:</p> <p>Mileage:</p> <p>Retailer Stamp:</p>

<p>95,000 Miles or 114 Months</p> <p>Retailer Name:</p> <p>Date:</p> <p>Mileage:</p> <p>Retailer Stamp:</p>	<p>100,000 Miles or 120 Months</p> <p>Retailer Name:</p> <p>Date:</p> <p>Mileage:</p> <p>Retailer Stamp:</p>	<p>105,000 Miles or 126 Months</p> <p>Retailer Name:</p> <p>Date:</p> <p>Mileage:</p> <p>Retailer Stamp:</p>
<p>110,000 Miles or 132 Months</p> <p>Retailer Name:</p> <p>Date:</p> <p>Mileage:</p> <p>Retailer Stamp:</p>	<p>115,000 Miles or 138 Months</p> <p>Retailer Name:</p> <p>Date:</p> <p>Mileage:</p> <p>Retailer Stamp:</p>	<p>120,000 Miles or 144 Months</p> <p>Retailer Name:</p> <p>Date:</p> <p>Mileage:</p> <p>Retailer Stamp:</p>

MEMO

10 Technical information

Recommended fluids/lubricants and capacities	10-2	Installing front license plate	10-12
Fuel recommendation	10-3	Vehicle loading information	10-13
Engine oil and oil filter recommendations	10-5	TERMS	10-13
Air conditioner system refrigerant and oil recommendations	10-6	Vehicle load capacity	10-14
Engine specifications	10-7	Loading tips	10-15
Wheels and Tires	10-8	Measurement of weights	10-15
Dimensions	10-8	Trailer towing	10-15
When traveling or registering in another country	10-9	Uniform tire quality grading	10-16
Vehicle identification	10-9	Treadwear	10-16
Vehicle identification number (VIN) plate	10-9	Traction AA, A, B and C	10-16
Vehicle identification number (chassis number)	10-10	Temperature A, B and C	10-16
Engine serial number	10-10	Emission control system warranty	10-17
F.M.V.S.S./C.M.V.S.S. Certification label	10-10	Reporting safety defects	10-17
Emission control information label	10-11	Readiness for inspection/maintenance (I/M) test	10-18
Tire and loading information label	10-11	Event data recorders (EDR) (if so equipped)	10-19
Air conditioner specification label	10-11	Owner's manual/service manual order information	10-19



RECOMMENDED FLUIDS/ LUBRICANTS AND CAPACITIES

The following are approximate capacities. The actual refill quantities may be slightly different. When refilling, follow the procedures instructed in the "8. Maintenance and do-it-yourself" section to determine the proper refill capacity.

Fluid type	Capacity (approximate)			Recommended Fluids/Lubricants
	Metric Measure	US measure	Imperial Measure	
Fuel tank	50 L (4WD: 56 L)	13.2 gal (4WD: 14.8 gal)	11 gal (4WD: 12.3 gal)	– See "Fuel recommendation" later in this section.
Engine oil (*) Drain and refill with oil filter change	5.6 L	6 qt	5 qt	The approximate capacities listed are for refilling during an engine oil change. *: For additional information, see "Changing engine oil". 2.0L gasoline engine: – Engine oil meeting specification MB229.5, viscosity SAE OW-30 or equivalent – As an alternative to this recommended oil, engine oils meeting specification MB229.5, viscosity SAE OW-40, 5W-30 and 5W-40 may be used and meet all specifications and requirements necessary to maintain the new vehicle limited warranty. For additional information, see "Engine oil and oil filter recommendations" later in this section.
Cooling system with Reservoir	7.6	8.1 qt	6.7 qt	– Genuine INFINITI Engine Coolant or equivalent in its quality BASF Glyscant [®] G40 [®] – Use Genuine INFINITI Engine Coolant, or equivalent in its quality, in order to avoid possible aluminum corrosion within the engine cooling system caused by the use of non-genuine engine coolant. Note that any repairs for incidents with the engine cooling system while using non-genuine engine coolant may not be covered by the warranty even if such incidents occurred during the warranty period.
Automatic Transmission Fluid (ATF)	6.21 L	6.6 qt	5.5 qt	Shell DCT-M1
Brake fluid		Refill to the proper fluid level according to the instructions in the "8. Maintenance and do-it-yourself" section.		– Genuine INFINITI brake fluid DOT4+ or equivalent. – Never mix different types of fluids.
Differential gear oil	0.74 L	0.8 qt	0.65 qt	– Castrol BOT 355 75W-85
Multi-purpose grease	–	–	–	– NLGI No. 2 (Lithium soap base)

Fluid type	Capacity (approximate)			Recommended Fluids/Lubricants
	Metric Measure	US measure	Imperial Measure	
Air conditioner system refrigerant	–	–	–	– HFC-134a
Air conditioner system lubricant	–	–	–	– INFINITI A/C System Oil Type S or equivalent

FUEL RECOMMENDATION

INFINITI recommends the use of unleaded premium gasoline with an octane rating of at least 91 AKI (Anti-Knock Index) number (Research octane number 95).

If unleaded premium gasoline is not available, unleaded regular gasoline with an octane rating of at least 89 AKI number (Research octane number 93) may be temporarily used, but only under the following precautions:

- Have the fuel tank filled only partially with unleaded regular gasoline, and fill up with unleaded premium gasoline as soon as possible.
- Avoid full throttle driving and abrupt acceleration.

Use unleaded premium gasoline for maximum vehicle performance.

CAUTION

- **Using a fuel other than that specified could adversely affect the emission control system, and may also affect warranty coverage.**
- **Under no circumstances should a leaded gasoline be used, because this will damage the three-way catalyst.**
- **Do not use E-15 or E-85 fuel in your vehicle. Your vehicle is not designed to run on E-15 or E-85 fuel. Using E-15 or E-85 fuel in a vehicle not specifically designed for E-15 or E-85 fuel can adversely affect the emission control devices and systems of the vehicle. Damage caused by such fuel is not covered by the INFINITI New Vehicle Limited Warranty.**

- **Do not use fuel that contains the octane booster methylcyclopentadienyl manganese tricarbonyl (MMT). Using fuel containing MMT may adversely affect vehicle performance and vehicle emissions. Not all fuel dispensers are labeled to indicate MMT content, so you may have to consult your gasoline retailer for more details. Note that Federal and California laws prohibit the use of MMT in reformulated gasoline.**
- **U.S. government regulations require ethanol dispensing pumps to be identified by a small, square, orange and black label with the common abbreviation or the appropriate percentage for that region.**

Gasoline specifications

INFINITI recommends using gasoline that meets the World-Wide Fuel Charter (WWFC) specifications where it is available.

Many of the automobile manufacturers developed this specification to improve emission system and vehicle performance. Ask your service station manager if the gasoline meets the World-Wide Fuel Charter (WWFC) specifications.

Reformulated gasoline

Some fuel suppliers are now producing reformulated gasolines. These gasolines are specially designed to reduce vehicle emissions. INFINITI supports efforts towards cleaner air and suggests that you use reformulated gasoline when available.

Gasoline containing oxygenates

Some fuel suppliers sell gasoline containing oxygenates such as ethanol, MTBE and methanol with or without advertising their presence. INFINITI does not recommend the use of fuels of which the oxygenate content and the fuel compatibility for your INFINITI cannot be readily determined. If in doubt, ask your service station manager.

If you use oxygenate-blend gasoline, please take the following precautions as the usage of such fuels may cause vehicle performance problems and/or fuel system damage.

- **The fuel should be unleaded and have an octane rating no lower than that recommended for unleaded gasoline.**

10-4 Technical information

- **If an oxygenate-blend, other than a methanol blend, is used, it should contain no more than 10% oxygenate. (MTBE may, however, be added up to 15%.)**
- **E-15 fuel contains more than 10% oxygenate. E-15 fuel will adversely affect the emission control devices and systems of the vehicle and should not be used. Damage caused by such fuel is not covered by the INFINITI New Vehicle Limited Warranty.**
- **If a methanol blend is used, it should contain no more than 5% methanol (methyl alcohol, wood alcohol). It should also contain a suitable amount of appropriate cosolvents and corrosion inhibitors. If not properly formulated with appropriate cosolvents and corrosion inhibitors, such methanol blends may cause fuel system damage and/or vehicle performance problems.**

At this time, sufficient data is not available to ensure that all methanol blends are suitable for use in INFINITI vehicles.

If any driveability problems such as engine stalling and difficult hot-starting are experienced after using oxygenate-blend fuels, immediately change to a nonoxygenate fuel or a fuel with a low blend of MTBE.

Take care not to spill gasoline during refueling. Gasoline containing oxygenates can cause paint damage.

E-15 fuel

E-15 fuel is a mixture of approximately 15% fuel ethanol and 85% unleaded gasoline. E-15 can only be used in vehicles designed to run on E-15 fuel. Do not use E-15 in your vehicle. U.S. government regulations require fuel ethanol dispensing pumps to be identified with small, square, orange and black label with the common abbreviation or the appropriate percentage for that region.

E-85 fuel

E-85 fuel is a mixture of approximately 85% fuel ethanol and 15% unleaded gasoline. E-85 can only be used in a Flexible Fuel Vehicle (FFV). Do not use E-85 fuel in your vehicle. U.S. government regulations require fuel ethanol dispensing pumps to be identified by a small, square, orange and black label with the common abbreviation or the appropriate percentage for that region.

Fuel containing MMT

MMT, or methylcyclopentadienyl manganese tricarbonyl, is an octane boosting additive. INFINITI does not recommend the use of fuel containing MMT. Such fuel may adversely affect vehicle performance, including the emissions control system. Note that while some fuel pumps label MMT content, not all do, so you may have to consult your gasoline retailer for more details.

Aftermarket fuel additives

INFINITI does not recommend the use of any aftermarket fuel additives (Example: fuel injector cleaner, octane booster, intake valve deposit removers, etc.) which are sold commercially. Many of these additives intended for gum, varnish or deposit removal may contain active solvent or similar ingredients that can be harmful to the fuel system and engine.

Octane rating tips

Using unleaded gasoline with an octane rating lower than recommended above can cause persistent, heavy spark knock. (Spark knock is a metallic rapping noise.) If severe, this can lead to engine damage. If you detect a persistent heavy spark knock even when using gasoline of the stated octane rating, or if you hear steady spark knock while holding a steady speed on level roads, it is recommended you have an INFINITI retailer correct the condition. Failure to correct the condition is misuse of the vehicle, for which INFINITI is not responsible.

Incorrect ignition timing will result in knocking, after-run and/or overheating. This in turn may cause excessive fuel consumption or damage to the engine. If any of the above symptoms are encountered, have your vehicle checked. It is recommended you visit an INFINITI retailer.

However, now and then you may notice light spark knock for a short time while accelerating or driving up hills. This is no cause for concern, because you get the greatest fuel benefit when there is light spark knock for a short time under heavy engine load.

ENGINE OIL AND OIL FILTER RECOMMENDATIONS

Selecting the correct oil

It is essential to choose the correct grade, quality, and viscosity engine oil to ensure satisfactory engine life and performance. For additional information, refer to "Recommended fluids/lubricants and capacities" earlier in this section.

Select only engine oils that meet the MB229.5 specification and SAE viscosity standard. These oils have the MB229.5 specification label on the container. Oils which do not have the specified quality label should not be used as they could cause engine damage.

Oil additives

INFINITI does not recommend the use of oil additives. The use of an oil additive is not necessary when the proper oil type is used and maintenance intervals are followed.

Oil which may contain foreign matter or has been previously used should not be used.

Oil viscosity

The engine oil viscosity or thickness changes with temperature. Because of this, it is important that the engine oil viscosity be selected based on the temperatures at which the vehicle will be operated before the next oil change. Choosing an oil viscosity other than that recommended could cause serious engine damage.

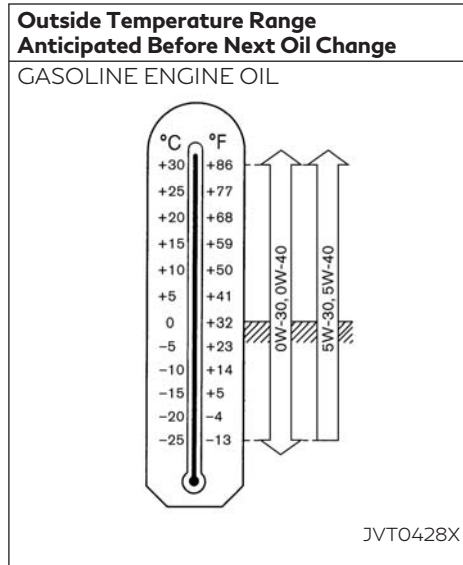

Selecting the correct oil filter

Your new vehicle is equipped with a high-quality genuine INFINITI oil filter. When replacing, it is recommended you use the genuine oil filter or its equivalent for the reason described in "Change intervals".

Change intervals

The oil and oil filter change intervals for your engine are based on the use of the specified quality oils and filters. Using engine oil and filters that are not of the specified quality, or exceeding recommended oil and filter change intervals could reduce engine life. Damage to engines caused by improper maintenance or use of incorrect oil and filter quality and/or viscosity is not covered by the new INFINITI New Vehicle Limited Warranty.

Your engine was filled with a high quality engine oil when it was built. You do not have to change the oil before the first recommended change interval. Oil and filter change intervals depend upon how you use your vehicle.

Operation under the following conditions may require more frequent oil and filter changes:

- Repeated short distance driving at cold outside temperatures
- Driving in dusty conditions
- Extensive idling
- Stop and go "rush hour" traffic

Refer to the "INFINITI Service and Maintenance Guide" for the maintenance schedule.

AIR CONDITIONER SYSTEM REFRIGERANT AND OIL RECOMMENDATIONS

The air conditioner system of your vehicle must be charged with the refrigerant HFC-134a and the lubricant INFINITI A/C System Oil Type S or the exact equivalents.

CAUTION

The use of any other refrigerant or oil may cause severe damage to the air conditioning system and will require the replacement of all air conditioner system components.

The refrigerant HFC-134a in your vehicle will not harm the Earth's ozone layer. However, it may contribute in a small part to the global warming effect.

Certain government regulations require the recovery and recycling of any refrigerant during automotive air conditioner system service. An INFINITI retailer has the trained technicians and equipment needed to recover and recycle your air conditioner system refrigerant.

It is recommended that you visit an INFINITI retailer when servicing your air conditioner system.

ENGINE SPECIFICATIONS

Model		2.0L Gasoline
Type		Gasoline, 4-cycle
Cylinder arrangement		4-cylinder in-line
Bore x Stroke	in (mm)	3.268 x 3.622 (83.0 x 92.0)
Displacement	cu in (cm ³)	121.55 (1,991)
Idling speed	rpm	
	DCT in N position	700
Ignition timing (BTDC)	degrees	
	DCT in N position	-10°CA to +35°CA BTDC at 700rpm
Spark plug	Standard	Platinum tipped
Spark plug gap	in (mm)	0.028 (0.7)
Camshaft operation		Timing chain

This spark ignition system complies with the Canadian standard ICES-002.

WHEELS AND TIRES

GT and Sport models:

Item	Offset in (mm)	Size
Road wheel	1.50 (38)	6.5J x 17
	1.81 (46)	7.0J x 18
	1.71 (43.5)	8.0J x 19
Tire size	215/60 R17 96V 235/50 R18 97V* 235/50 R18 97H* ** 235/45 R19 95V*	

*: Use of snow chains NOT permitted.

** : US only.

All Road models:

Item	Offset in (mm)	Size
Road wheel	1.61 (41)	6.5J x 17 (steel)
	1.61 (41)	7.0J x 18 (alloy)
Tire size	215/60 R17 96V 235/50 R18 97V* 235/50 R18 97H* **	

*: Use of snow chains NOT permitted.

** : US only.

DIMENSIONS

Dimension	Model	in (mm)
Overall length		174.2 (4425)
Overall width (incl. mirrors)		82.0 (2083)
Overall height	GT without roof rails	58.9 (1495)
	GT with roof rails	59.5 (1510)
	Sport without roof rails	58.1 (1475)
	Sport with roof rails	58.7 (1490)
	Allroad without roof rails	58.7 (1515)
	Allroad with roof rails	61.2 (1530)
Front track	GT 17" wheels	61.9 (1572)
	GT 18" wheels	61.3 (1556)
	GT 19" wheels	61.5 (1561)
	Sport 17" wheels	62 (1574)
	Sport 19" wheels	61.5 (1563)
	Allroad 17" wheels	61.7 (1566)
	Allroad 18" wheels	61.5 (1561)
Rear track	GT 17" wheels	61.9 (1573)
	GT 18" wheels	61.2 (1555)
	GT 19" wheels	61.7 (1566)
	Sport 17" wheels	62.2 (1580)
	Sport 19" wheels	61.7 (1567)
	Allroad 17" wheels	62.0 (1574)
	Allroad 18" wheels	61.7 (1566)
Wheelbase		106.3 (2700)

WHEN TRAVELING OR REGISTERING IN ANOTHER COUNTRY

When planning to drive your INFINITI VEHICLE in another country, you should first find out if the fuel available is suitable for your vehicle's engine.

Using fuel with an octane rating that is too low may cause engine damage. All gasoline vehicles must be operated with unleaded gasoline. Therefore, avoid taking your vehicle to areas where appropriate fuel is not available.

When transferring the registration of your vehicle to another country, state, province or district, it may be necessary to modify the vehicle to meet local laws and regulations.

The laws and regulations for motor vehicle emission control and safety standards vary according to the country, state, province or district; therefore, the vehicle specification may differ.

When any vehicles are to be taken into another country, state, province or district, its modification, transportation, registration, and any other expenses which may result, are the responsibility of the user. INFINITI is not responsible for any inconveniences that may result.

VEHICLE IDENTIFICATION

It is prohibited to cover, paint, weld, cut, drill, alter or remove the Vehicle Identification Number (VIN).

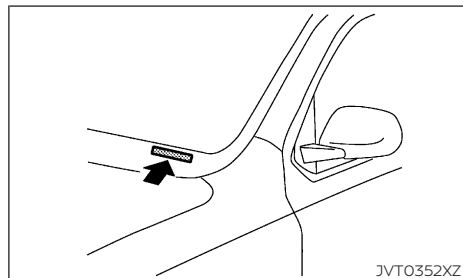

VEHICLE IDENTIFICATION NUMBER (VIN) PLATE

The vehicle identification number plate is attached as shown. This number is the identification for your vehicle and is used in the vehicle registration.

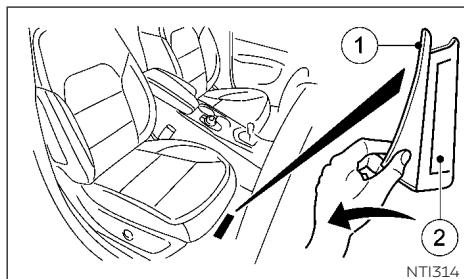

VEHICLE IDENTIFICATION NUMBER (CHASSIS NUMBER)

The vehicle identification number is stamped as shown.

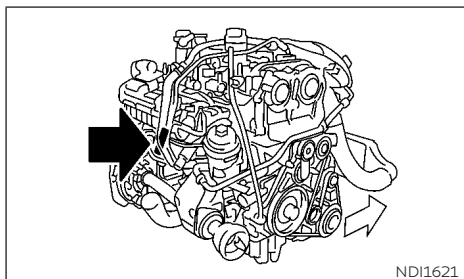

2.0L gasoline engines ENGINE SERIAL NUMBER

The number is stamped on the engine as shown.

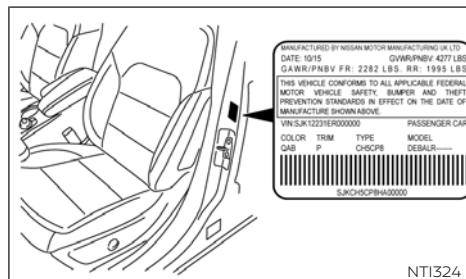

F.M.V.S.S./C.M.V.S.S. CERTIFICATION LABEL

The Federal/Canadian Motor Vehicle Safety Standards (F.M.V.S.S./C.M.V.S.S.) certification label is affixed as shown. This label contains valuable vehicle information, such as: GVWR, GAWR, month and year of manufacture, VIN, etc. Review it carefully.

INSTALLING FRONT LICENSE PLATE

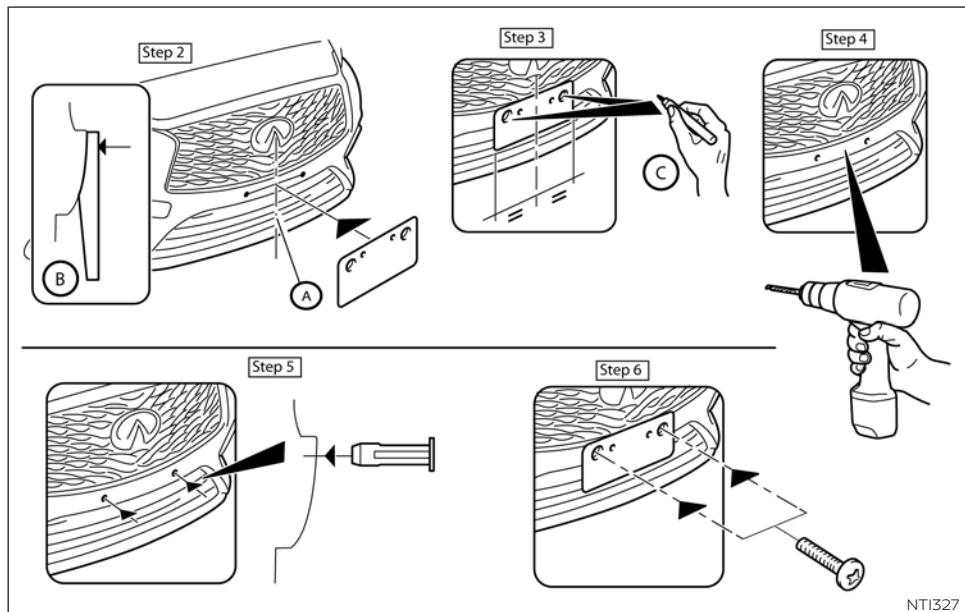

Use the following steps to mount the front license plate:

Before mounting the license plate, confirm that the following parts are enclosed in the plastic bag:

Only use the recommended mounting position, otherwise the obstruction of the Intelligent Cruise Control (ICC) sensor (if so equipped) may result.

- License plate bracket
- License plate screws x 2
- Screw grommets x 2

- 1) Park the vehicle on flat, level ground.
- 2) Locate the center position **(A)** as illustrated. Line up the license plate bracket under the top of the front bumper with the tabs **(B)**. Hold the license plate bracket in place.
- 3) Mark the center of the holes **(C)** with a felt-tip pen.
- 4) Carefully drill two pilot holes using a 10 mm (0.39 in) drill bit at the marked locations. **(Be sure that the drill only goes through the bumper fascia.)**
- 5) Insert the grommets into the holes in the bumper fascia.
- 6) Install the license plate bracket with the provided screws.
- 7) Install the license plate on to the bracket with bolts that are no longer than 14 mm (0.55 in).

VEHICLE LOADING INFORMATION

WARNING

- **It is extremely dangerous to ride in a cargo area inside a vehicle. In a collision, people riding in these areas are more likely to be seriously injured or killed.**
- **Do not allow people to ride in any area of vehicle that is not equipped with seats and seat belts.**
- **Be sure everyone in your vehicle is in a seat and using a seat belt properly.**

TERMS

It is important to familiarize yourself with the following terms before loading your vehicle:

- **Curb Weight** (actual weight of your vehicle) - vehicle weight including: standard and optional equipment, fluids, emergency tools, and spare tire assembly. This weight does not include passengers and cargo.
- **GVW (Gross Vehicle Weight)** - curb weight plus the combined weight of passengers and cargo.
- **GVWR (Gross Vehicle Weight Rating)** - maximum total combined weight of the unloaded vehicle, passengers, luggage, hitch, trailer tongue load and any other optional equipment. This information is located on the F.M.V.S.S./C.M.V.S.S. label.
- **GAWR (Gross Axle Weight Rating)** - maximum weight (load) limit specified for the front or rear axle. This information is located on the F.M.V.S.S./C.M.V.S.S. label.
- **GCWR (Gross Combined Weight Rating)** - The maximum total weight rating of the vehicle, passengers, cargo, and trailer.
- **Vehicle Capacity Weight, Load limit, Total load capacity** - maximum total weight limit specified of the load (passengers and cargo) for the vehicle. This is the maximum combined weight of occupants and cargo that can be loaded into the vehicle. If the vehicle is used to tow a trailer, the trailer tongue weight must be included as part of the cargo load. This information is located on the Tire and Loading Information label.
- **Cargo capacity** - permissible weight of cargo, the weight of total occupants weight subtracted from the load limit.

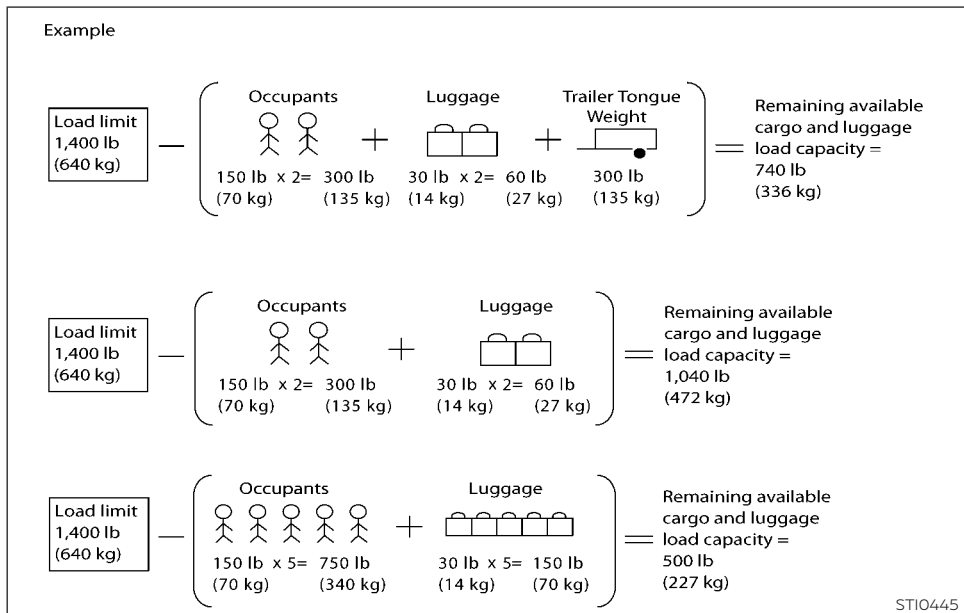

VEHICLE LOAD CAPACITY

Do not exceed the load limit of your vehicle shown as "The combined weight of occupants and cargo" on the Tire and Loading Information label. Do not exceed the number

of occupants shown as "Seating Capacity" on the Tire and Loading Information label.

To get "the combined weight of occupants and cargo", add the weight of all occupants, then add the total luggage weight. Examples are shown in the illustration.

Steps for determining correct load limit

1. Locate the statement "The combined weight of occupants and cargo should never exceed XXX kg or XXX lbs" on your vehicle's placard.
2. Determine the combined weight of the driver and passengers that will be riding in your vehicle.
3. Subtract the combined weight of the driver and passengers from XXX kg or XXX lbs.
4. The resulting figure equals the available amount of cargo and luggage load capacity. For example, if the XXX amount equals 1400 lbs. and there will be five 150 lb. passengers in your vehicle, the amount of available cargo and luggage load capacity is 650 lbs. $(1400 - 750 (5 \times 150) = 650 \text{ lbs})$ or $640 - 340 (5 \times 70) = 300 \text{ kg}$.
5. Determine the combined weight of luggage and cargo being loaded on the vehicle. That weight may not safely exceed the available cargo and luggage load capacity calculated in Step 4.
6. If your vehicle will be towing a trailer, load from your trailer will be transferred to your vehicle. Consult this manual to determine how this reduces the available cargo and luggage load capacity of your vehicle.

Before driving a loaded vehicle, confirm that you do not exceed the Gross Vehicle Weight Rating (GVWR) or the Gross Axle Weight Rating (GAWR) for your vehicle. (See "Measurement of weights" later in this section.)

Also check tires for proper inflation pressures. See the Tire and Loading Information label.

LOADING TIPS

- The GVW must not exceed GVWR or GAWR as specified on the F.M.V. S.S./C.M.V.S.S. certification label.
- Do not load the front and rear axle to the GAWR. Doing so will exceed the GVWR.

WARNING

- **Properly secure all cargo to help prevent it from sliding or shifting. Do not place cargo higher than the seatbacks. In a sudden stop or collision, unsecured cargo could cause personal injury.**
- **Do not load your vehicle any heavier than the GVWR or the maximum front and rear GAWRs. If you do, parts of your vehicle can break, tire damage could occur, or it can change the way your vehicle handles. This could result in loss of control and cause personal injury.**

- **Overloading could not only shorten the life of your vehicle and the tires, but also could cause unsafe vehicle handling and longer braking distances. This may cause a premature tire failure which could result in a serious accident and personal injury. Failures caused by overloading are not covered by the vehicle's warranty.**

MEASUREMENT OF WEIGHTS

Secure loose items to prevent weight shifts that could affect the balance of your vehicle. When the vehicle is loaded, drive to a scale and weigh the front and the rear wheels separately to determine axle loads. Individual axle loads should not exceed either of the gross axle weight ratings (GAWR). The total of the axle loads should not exceed the gross vehicle weight rating (GVWR). These ratings are given on the vehicle certification label. If weight ratings are exceeded, move or remove items to bring all weights below the ratings.

TRAILER TOWING

Your vehicle was designed to be used to carry passengers and luggage

CAUTION

Do not tow a trailer with your vehicle.

UNIFORM TIRE QUALITY GRADING

DOT (Department Of Transportation) Quality Grades: All passenger car tires must conform to federal safety requirements in addition to these grades.

Quality grades can be found where applicable on the tire sidewall between tread shoulder and maximum section width. For example:

Treadwear 200 Traction AA Temperature A

TREADWEAR

The treadwear grade is a comparative rating based on the wear rate of the tire when tested under controlled conditions on a specified government test course. For example, a tire graded 150 would wear one and one-half (1 1/2) times as well on the government course as a tire graded 100. The relative performance of tires depends upon actual conditions of their use, however, and may depart significantly from the norm due to variations in driving habits, service practices and differences in road characteristics and climate.

TRACTION AA, A, B AND C

The traction grades, from highest to lowest, are AA, A, B and C. Those grades represent the tire's ability to stop on wet pavement as measured under controlled conditions on specified government test surfaces of asphalt and concrete. A tire marked C may have poor traction performance.

WARNING

The traction grade assigned to this tire is based on straight-ahead braking traction tests, and does not include acceleration, cornering, hydroplaning, or peak traction characteristics.

TEMPERATURE A, B AND C

The temperature grades A (the highest), B, and C, representing the tire's resistance to the generation of heat and its ability to dissipate heat when tested under controlled conditions on a specified indoor laboratory test wheel. Sustained high temperature can cause the material of the tire to degenerate and reduce tire life, and excessive temperature can lead to sudden tire failure. The grade C corresponds to a level of performance which all passenger car tires must meet under the Federal Motor Vehicle Safety Standard No. 109. Grades B and A represent higher levels of performance on the laboratory test wheel than the minimum required by law.

WARNING

The temperature grade for this tire is established for a tire that is properly inflated and not overloaded. Excessive speed, underinflation, or excessive loading, either separately or in combination, can cause heat build-up and possible tire failure.

EMISSION CONTROL SYSTEM WARRANTY

Your INFINITI is covered by the following emission warranties.

For USA:

- Emission Defects Warranty
- Emissions Performance Warranty

Details of these warranties may be found with other vehicle warranties in your Warranty Information Booklet that comes with your INFINITI. If you did not receive a Warranty Information Booklet, or it has become lost, you may obtain a replacement by writing to:

- INFINITI Division
Nissan North America, Inc.
Consumer Affairs Department
P.O. Box 685003
Franklin, TN 37068-5003

For Canada:

Emission Control System Warranty

Details of these warranties may be found with other vehicle warranties in your Warranty and Roadside Assistance Information that comes with your INFINITI. If you did not receive a Warranty and Roadside Assistance Information, or it has become lost, you may obtain a replacement by writing to:

- Nissan Canada Inc.
5290 Orbitor Drive
Mississauga,
Ontario, L4W 4Z5

REPORTING SAFETY DEFECTS

For USA:

If you believe that your vehicle has a defect which could cause a crash or could cause injury or death, you should immediately inform the National Highway Traffic Safety Administration (NHTSA) in addition to notifying INFINITI.

If NHTSA receives similar complaints, it may open an investigation, and if it finds that a safety defect exists in a group of vehicles, it may order a recall and remedy campaign. However, NHTSA cannot become involved in individual problems between you, your retailer, or INFINITI.

To contact NHTSA, you may call the Vehicle Safety Hotline toll-free at 1-888-327-4236 (TTY: 1-800-424-9153); go to <http://www.safercar.gov>; or write to: Administrator, NHTSA, 400 Seventh Street, SW., Washington, D.C. 20590. You can also obtain other information about motor vehicle safety from <http://www.safercar.gov>.

You may notify INFINITI by contacting our Consumer Affairs Department, toll-free, at 1-800-662-6200.

READINESS FOR INSPECTION/ MAINTENANCE (I/M) TEST

For Canada:

If you believe that your vehicle has a defect which could cause a crash or could cause injury or death, you should immediately inform Transport Canada in addition to notifying INFINITI.

If Transport Canada receives complaints, it may open an investigation, and if it finds that a safety defect exists in a group of vehicles, it may request that INFINITI conduct a recall campaign. However, Transport Canada cannot become involved in individual problems between you, your retailer, or INFINITI.

You may contact Transport Canada's Defect Investigations and Recalls Division toll free at 1-800-333- 0510. You may also report safety defects online at:

<https://www.wapps.tc.gc.ca/Saf-Sec- Sur/7/PCDB-BDPP/Index.aspx>.

Additional information concerning motor vehicle safety may be obtained from Transport Canada's Road Safety Information Center at 1-800-333- 0371 or online at www.tc.gc.ca/roadsafety (English speakers) or www.tc.gc.ca/securiteroutiere (French speakers).

To notify INFINITI of any safety concerns please contact our Consumer Information Center toll free at 1-800- 361-4792.

10-18 Technical information

WARNING

A vehicle equipped with All-Wheel Drive (AWD) should never be tested using a two wheel dynamometer (such as the dynamometers used by some states for emissions testing), or similar equipment. Make sure you inform test facility personnel that your vehicle is equipped with AWD before it is placed on a dynamometer. Using the wrong test equipment may result in transmission damage or unexpected vehicle movement which could result in serious vehicle damage or personal injury.

Due to legal requirements in some states and Canadian Provinces, your vehicle may be required to be in what is called the "ready condition" for an Inspection/Maintenance (I/M) test of the emission control system.

The vehicle is set to the "ready condition" when it is driven through certain driving patterns. Usually, the "ready condition" can be obtained by ordinary usage of the vehicle.

If a powertrain system component is repaired or the battery is disconnected, the vehicle may be reset to a "not ready condition". Before taking the I/M test, check the vehicle's inspection/maintenance test readiness condition. Place the ignition switch in the ON position without starting the engine. If the

Malfunction Indicator Light (MIL) comes on steady for 20 seconds and then blinks for 10 seconds, the I/M test condition is "not ready". If the MIL does not blink after 20 seconds, the I/M test condition is "ready".

It is recommended you contact an INFINITI retailer to set the "ready condition" or to prepare the vehicle for testing.

EVENT DATA RECORDERS (EDR) (IF SO EQUIPPED)

This vehicle is equipped with an Event Data Recorder (EDR). The main purpose of an EDR is to record, in certain crash or near crash-like situations, such as an air bag deployment or hitting a road obstacle, data that will assist in understanding how a vehicle's systems performed. The EDR is designed to record data related to vehicle dynamics and safety systems for a short period of time, typically 30 seconds or less. The EDR in this vehicle is designed to record such data as:

- How various systems in your vehicle were operating.
- Whether or not the driver and passenger safety belts were buckled/fastened.
- How far (if at all) the driver was depressing the accelerator and/or brake pedal.
- How fast the vehicle was traveling.
- Sounds are not recorded.

This data can help provide a better understanding of the circumstances in which crashes and injuries occur.

NOTE: EDR data are recorded by your vehicle only if a nontrivial crash situation occurs; no data are recorded by the EDR under normal driving conditions and no personal data (e.g. name, gender, age and crash location) are recorded. However, other parties, such as law enforcement, could combine the EDR

data with the type of personally identifying data routinely acquired during a crash investigation.

To read data recorded by an EDR, special equipment is required and access to the vehicle or the EDR is needed. In addition to the vehicle manufacturer and INFINITI retailer, other parties, such as law enforcement, that have the special equipment, can read the information if they have access to the vehicle or the EDR. EDR data will only be accessed with the consent of the vehicle owner or lessee or as otherwise required or permitted by law.

OWNER'S MANUAL/SERVICE MANUAL ORDER INFORMATION

Genuine INFINITI Service Manuals for this model year and prior can be purchased. A Genuine INFINITI Service Manual is the best source of service and repair information for your vehicle. This manual is the same one used by the factory trained technicians working at INFINITI retailers. Genuine INFINITI Owner's Manuals can also be purchased.

For USA:

For current pricing and availability of Genuine **INFINITI Service Manuals**, contact: www.infiniti-techinfo.com For current pricing and availability of Genuine **INFINITI Owner's Manuals**, contact: 1-800-247-5321

For Canada:

To purchase a copy of a Genuine INFINITI Service Manual or Owner's Manual, for this model year and prior, it is recommended you contact your nearest INFINITI retailer. For the phone number and location of an INFINITI retailer in your area call the INFINITI Satisfaction Center at 1-800-361-4792 and a bilingual INFINITI representative will assist you.

MEMO

11 Index

A

ABS (Anti-lock Braking System)2-9
Warning light2-9
Active sound enhancement5-69
Operation5-69
Adaptive Front lighting System2-67
Aids5-62
Forward emergency braking system5-62
Hill Start Assist (HSA)5-95
Intelligent Parking Assist (IPA)5-70
Air bags1-45
Front passenger air bag switch1-45
Overview0-2
Repair and replacement1-54
Supplemental Restraint System1-37
Warning light1-53, 2-12
Air cleaner filter8-13
Air conditioner4-29
Heater and air conditioner4-29
Refrigerant and lubricant10-6
Servicing4-38
Specification label10-11
Air fresheners7-4
Antenna4-39
Anti-theft alarm system2-60
Around View Monitor4-11
Moving object detection (MOD)4-24

Settings4-20
Audible reminders2-14
Automatic transmission8-7
Fluid (ATF)8-7
Operation5-18

B

Battery8-9
Caution label8-9
Cold weather5-96
Jump-starting6-10
Replacement - Intelligent Key8-20
Saver system2-89
Vehicle battery8-9
Blind Spot Warning (BSW) system5-36
Booster seats1-34
Precautions1-34
Brakes8-17
ABS (Anti-Lock Braking System)5-91
Adjustment8-17
Fluid8-7
Forward emergency braking system5-62
Parking brake5-27
Precautions5-90
System5-90
Warning light2-9
Break-in schedule5-84

Brightness2-71
Instrument panel2-71

C

Capacities and recommendations10-2
Coolant10-2
Fuel10-2
Oil10-2
Refrigerant10-2
Card holder2-81
CB radio4-39
Changing8-4
Engine coolant8-4
Engine oil8-5
Engine oil filter8-6
Tires and wheels8-34
Checking8-4
Coolant level8-4
Engine oil level8-5
Child restraints1-19
Anchorage1-22
ISOFIX installation1-23
Precautions1-19
Child safety1-17
Rear door locks3-7
Cleaning7-3
Alloy wheels7-3

Chrome parts	7-3
Exterior	7-2
Glass	7-3
Interior	7-4
Leather seat covers	7-6
Removing spots	7-3
Seat belts	7-5
Underbody	7-3
Washing	7-2
Waxing	7-2
Clock	2-79
Adjusting time	2-79
Coat hooks	2-83
Cockpit	0-6
Overview	0-6, 2-2
Cold weather	5-96
Battery	5-96
Driving on snow or ice	5-97
Engine coolant	5-96
Precautions	5-96
Special equipment	5-97
Tire equipment	5-96
Compartment	2-89
Coolant	10-2
Capacities	10-2
Changing engine coolant	8-4
Checking coolant level	8-4
Cold weather	5-96
Engine cooling system	8-3
Temperature gauge	2-6

Corrosion protection	7-7
Environmental factors	7-7
Cruise control	5-46
Canceling	5-48
Operation	5-47
Cup holders	2-82

D

Defroster	2-64
Switch	2-64
Dimensions	10-8
Engine	10-7
Tires	10-8
Display	2-71
Brightness	2-71
Vehicle information display	2-15
Warnings and indicators	2-29
Doors	3-7
Lift gate	3-7
Locking key	3-5
Locks	3-4
Map pocket	2-84
Drive belts	8-12
Driving	5-18
Automatic Transmission	5-18
Cold weather	5-96
Idle Stop/Start System	5-29
On snow or ice	5-97
Precautions	5-2

E

Emergency key	3-2
Engine	5-16
Before starting	5-16
Changing engine coolant	8-4
Changing engine oil	8-5
Changing oil filter	8-6
Checking coolant level	8-4
Checking engine oil level	8-5
Cold weather	5-96
Compartment	0-9, 8-3
Cooling system	8-3
Data	10-7
Oil	8-5
Serial number	10-10
Spark plugs	8-12
Starting	5-16
Event data recorders (EDR)	10-19
Exhaust gas	5-2
Precautions	5-2
Exterior	7-2
Cleaning	7-2
Lights	8-23
Overview	0-3
Exterior rear view mirrors	3-18

F

Filter	8-13
Air cleaner	8-13
Engine Oil	8-6
Flat tire	6-2
Floor mats	7-5
Fluids	10-2
Air conditioner	10-2
Automatic transmission fluid (ATF)	8-7
Brake	8-7
Coolant	8-3
Engine Oil	8-5
Recommendations and capacities	10-2
Window washer	8-8
Fog lights	2-71
Bulb information	8-23
Location	2-71
Forward emergency braking system	5-62
Limitations	5-67
Four-wheel drive	5-86
Freeing trapped vehicle	6-15
Fuel	10-2
Capacities	10-2
Filler cap	3-16
Filler lid	3-16
Gauge	2-7
Fuel economy	5-86
Fuel efficient driving tips	5-85

Fuses	8-17
Engine compartment	8-18
Passenger compartment	8-19

G

Gasoline	2-7
Gauge	2-7
Gauges	2-6
Engine coolant temperature	2-6
Fuel	2-7
Meters and gauges	2-4
Speedometer	2-5
Tachometer	2-6
Glass	7-3
Cleaning	7-3
Glass roof	2-78
Sunshade operation	2-78
Glove box	2-80

H

Hazard	6-2
Warning flasher switch	6-2
Headlights	8-25
Bulb replacement	8-25
Replacement (bulb)	8-25
Switch	2-65

Head restraints/Headrests	1-7
Adjustment	1-8
Installation	1-9
Removal	1-8
Heated seats	2-73
Operation	2-73
Precautions	2-73
Heater and air conditioner	4-29
Hill Start Assist (HSA)	5-95
HomeLink® Universal Transceiver	2-89
If your vehicle is stolen	2-93
Operating	2-92
Programming	2-90
Troubleshooting	2-92
Hood	3-15
Closing	3-15
Engine compartment	0-9, 8-3
Opening	3-15
Hooks	2-83
Horn	2-72

I

Idle Stop/Start System	5-29
Ignition	5-13
Switch	5-13, 5-14
Switch positions	5-13
Indicator lights	0-10
Overview	0-10, 2-8

Indicators	2-29
Vehicle information display	2-29
INFINITI InTouch Owner's Manual.	4-2
Injured persons	1-12
Inspection	10-18
Test	10-18
Instrument panel	0-7
Overview	0-7, 2-3
Intelligent Cruise Control (ICC) system.	5-49
Intelligent Key	8-20
Battery replacement.	8-20
Intelligent Parking Assist (IPA).	5-70
Precautions	5-70
Interior	7-4
Cleaning	7-4
Lights – Operation.	2-87
Overview	0-5
Interior rear view mirror	3-18
Interior rear view mirrors	3-18
ISOFIX.	1-23
Installation.	1-23

J

Jump starting	6-10
-------------------------	------

K

Keys	3-2, 3-8
Emergency key	3-2

11-4 Index

Intelligent Key battery replacement.	8-20
Locking	3-5

L

Labels	10-11
Air conditioner.	10-11
Battery.	8-9
Chassis number.	10-10
Tires.	10-11
Lane Departure	5-33
Limitations	5-33
Warning (LDW)	5-31
Lights	8-23
Adaptive Front lighting System	2-67
Bulb information	8-23
Fog light switch.	2-71
Front fog lights	2-71
Headlights	2-65, 8-25
Interior.	2-87
LED headlight	8-25
Locations	8-23
Luggage compartment	2-89
Map lights.	2-88
Rear fog lights	2-72
Rear personal lights	2-88
Rear room light.	2-88
Vanity mirror lights.	2-89
Warning/Indicator lights	0-10, 2-8
Loading information.	10-13

Locks	3-7
Child safety	3-7
Door locks.	3-4
Lift gate	3-7
Locking inside lock knob	3-6
Locking key	3-5
Locking power door lock switch.	3-6
Unlocking inside door handle.	3-6

M

Maintenance	9-2
General maintenance	9-2, 9-5
Log	9-13
Precautions	8-2
Requirements.	9-2
Schedules	9-7
Seat belts	1-16
Standard maintenance	9-9
Map lights	2-88
Meters and gauges	2-4
Engine coolant temperature	2-6
Fuel.	2-7
Overview	0-8
Speedometer	2-5
Tachometer.	2-6
Mirrors	3-18
Anti-glare rear view mirror	3-18
Exterior rear view mirrors.	3-18
Interior rear view mirrors	3-18

Vanity mirror	3-18
Vanity mirror lights	2-89
Moving object detection (MOD)	4-24

O

Oil	10-2
Capacities and recommendations	10-2
Changing engine oil	8-5
Changing engine oil filter	8-6
Checking engine oil level	8-5
Overheating	6-13
Engine	6-13
Engine coolant temperature gauge	2-6
Overview	0-6
Cockpit	0-6, 2-2
Engine compartment	0-9, 8-3
Exterior	0-3
Interior	0-5
Seats, Seat belts, Supplemental restraint system	0-2

P

Parcel shelf	2-85
Installation	2-86
Removal	2-85
Parking	5-87
Brake	5-27
Parking sensor system	5-76

Sonar function	5-76
Parking sensors	5-81
OFF switch	5-81
Phone	4-39
Power	3-6
Door lock switch	3-6
Outlet	2-79
Seat adjustment	1-4
Steering	5-89
Windows	2-74
Precautions	1-34
Booster seats	1-34
Brake	5-90
Child restraints	1-19
Intelligent Parking Assist (IPA)	5-70
Maintenance	8-2
Safety	4-2
Seat belt usage	1-10
Starting and driving	5-2
Supplemental Restraint System	1-37
Tire Pressure Monitoring System (TPMS)	5-3
Pregnant women	1-12
Protection	7-7
Corrosion	7-7
Push-button ignition	5-14
Push-starting	6-12

R

Rear seats	1-5
Folding	1-6
RearView monitor	4-3
Maintenance	4-11
Repairing	8-25
Headlights	8-25
Replacement	1-54
Air bags	1-54
Air cleaner filter	8-13
Engine coolant	8-4
Engine oil	8-5
Engine oil filter	8-6
Intelligent Key battery	8-20
Spark plugs	8-12
Tires and wheels	8-34
Wiper blades	8-13
Roof	2-78
Glass	2-78
Sunshade operation	2-78
Roof Rack	2-86

S

Safety	1-17
Children	1-17
Child safety rear door locks	3-7
Head restraints	1-7
Injured persons	1-12

Precautions	4-2	Sonar function	5-81	Front passenger air bag	1-45
Pregnant women	1-12	OFF switch	5-81	Hazard warning flasher	6-2
Reporting safety defects	10-17	Spark plugs	8-12	Headlight	2-65
Seat belts	1-10, 1-13	Information	8-12	Ignition	5-13
Adjustment	1-15	Replacement	8-12	Ignition positions	5-13
Children - Infants	1-17	Speedometer	2-5	Parking brake	5-27
Children - Larger	1-18	Starting	5-16	Parking sensor system	5-81
Children - Small	1-18	Before starting the engine	5-16	Power door lock	3-6
Child safety	1-17	Engine	5-16	Push-button ignition	5-14
Cleaning	7-5	Jump-starting	6-10	Seat	3-21
Maintenance	1-16	Precautions	5-2	Seat adjustment	1-4
Overview	0-2	Push-starting	6-12	Sonar function	5-81
Precautions	1-10	Steering	5-89	Turn signal	2-67
Warning light	2-11	Power steering system	5-89	Windshield de-icer	2-64
Warnings	1-13	Steering wheel	3-17	Wiper and washer	2-61
Seats	1-2	Adjustment	3-17		
Adjustment	1-4	Storage	2-80		
Adjustment (Manual)	1-3	Luggage hooks	2-84		
Booster seats	1-34	Luggage net	2-85		
Head restraints	1-7	Map pocket	2-84		
Heating	2-73	Sunshade	2-78		
Leather	7-6	Operation	2-78		
Memory	3-21	Sun visors	3-18		
Overview	0-2	Supplemental Restraint System	1-37		
Rear	1-5	Overview	0-2		
Rear seats - Folding	1-6	Supplemental Restraint System (SRS)	0-2		
Seat belts	1-10	Air bags	0-2		
Security system	2-60	Switches	2-71		
Servicing	4-38	Brightness	2-71		
Air conditioner	4-38	Defroster	2-64		
		Fog lights	2-71		

T

Tachometer	2-6
Three-way catalyst	5-2
Precautions	5-2
Tire chains	8-33
Tires	8-34
Changing	8-34
Cold weather	5-96
Equipment	5-96
Flat tire	6-2
Inflation pressure	8-28
Placard	10-11
Quality grading	10-16

Sizes	10-8
tire chains	8-33
Wear and damage	8-33
Wheel balance	8-36
Wheels and tires	8-27, 10-8
Towing	6-14
Recommendations	6-14
Your vehicle	6-14
Trailer	10-15
Towing	10-15
Transferring registration to another country	10-9
Transmission	5-18
Automatic Transmission (AT) operation	5-18
Automatic transmission fluid (ATF)	8-7
Traveling	10-9
Turn signal	8-23
Bulb information	8-23
Operation	8-23

v

Vanity mirror	3-18
Lights	2-89
Vehicle Dynamic Control (VDC)	5-92
Vehicle identification	10-9
Air conditioner label	10-11
Engine serial number	10-10
Number (VIN) (chassis number)	10-10

Number (VIN) plate	10-9
Tire and loading information label	10-11
Vehicle Immobilizer system	5-13
Vehicle information display	2-15
Warnings and indicators	2-29
Vehicle loading information	10-13
Ventilators	4-28

w

Warning lights	0-10, 2-8
Air bag	1-53
Warnings	2-29
Vehicle information display	2-29
Warranty	10-17
Emission control system	10-17
Washing	7-2
Waxing	7-2
Wheel lock bolts	6-9
Wheels	8-36
Balancing	8-36
Blocking	6-5
Care	7-3
Changing tires and wheels	8-34
Installation	6-8
Removal	6-6
Sizes	10-8
Wheel lock bolts	6-9
Wheels and tires	8-27, 10-8
Windows	2-74

Window washer	8-8
Fluid	8-8
Windshield	2-64
Defroster	2-64
De-icer switch	2-64
Wiper and washer switch	2-62
Winter	5-96
Battery	5-96
Driving on snow or ice	5-97
Engine coolant	5-96
Precautions	5-96
Special equipment	5-97
Tire equipment	5-96
Wipers	8-13
Blade replacement	8-13
Rear - Operation	2-63
Washer nozzle	8-14
Wiper and washer switch	2-61, 2-62

GASOLINE STATION INFORMATION

FUEL INFORMATION

Gasoline engine

CAUTION

Do not use leaded gasoline. Using leaded gasoline will damage the three-way catalyst.

2.0L gasoline engine model:

Use unleaded premium gasoline with an octane rating of at least 91 AKI (Anti-Knock Index) number (Research octane number 95). If unleaded premium gasoline is not available, unleaded regular gasoline with an octane rating of at least 89 AKI number (Research octane number 93) may be temporarily used, but only under the following precautions:

- Have the fuel tank filled only partially with unleaded regular gasoline, and fill up with unleaded premium gasoline as soon as possible.
- Avoid full throttle driving and abrupt acceleration.

Use unleaded premium gasoline for maximum vehicle performance.

CAUTION

- **Using a fuel other than that specified could adversely affect the emission con-**

trol system, and may also affect warranty coverage.

- **Under no circumstances should a leaded gasoline be used, because this will damage the three-way catalyst.**
- **Do not use E-15 or E-85 fuel in your vehicle. Your vehicle is not designed to run on E-15 or E-85 fuel. Using E-15 or E-85 fuel in a vehicle not specifically designed for E-15 or E-85 fuel can adversely affect the emission control devices and systems of the vehicle. Damage caused by such fuel is not covered by the INFINITI new vehicle limited warranty.**
- **U.S. government regulations require ethanol dispensing pumps to be identified by a small, square, orange and black label with the common abbreviation or the appropriate percentage for that region.**

QUICK REFERENCE

- In case of emergency ... 6-2
(Flat tire, engine will not start, overheating, towing)
- How to start the engine ... 5-16
- How to read the meters and gauges ... 2-4
- Maintenance and do-it-yourself ... 9-2
- Technical information ... 10-2

RECOMMENDED ENGINE OIL

See "Recommended fluids/lubricants and capacities".

TIRE COLD PRESSURE

See the tire and loading information label affixed to the driver's side center pillar.



Printing : October 2018
Publication No.: OM19E0 OH15U0
Printed in the U.S.A.

H15-D