



2017

FIAT® 124 SPIDER ABARTH

OWNER'S MANUAL

## **VEHICLES SOLD IN CANADA**

With respect to any Vehicles Sold in Canada, the name FCA US LLC shall be deemed to be deleted and the name FCA Canada Inc. used in substitution therefore.

## **DRIVING AND ALCOHOL**

Drunken driving is one of the most frequent causes of accidents.

Your driving ability can be seriously impaired with blood alcohol levels far below the legal minimum. If you are drinking, don't drive. Ride with a designated non-drinking driver, call a cab, a friend, or use public transportation.

### **WARNING!**

**Driving after drinking can lead to an accident. Your perceptions are less sharp, your reflexes are slower, and your judgment is impaired when you have been drinking. Never drink and then drive.**

This manual illustrates and describes the operation of features and equipment that are either standard or optional on this vehicle. This manual may also include a description of features and equipment that are no longer available or were not ordered on this vehicle. Please disregard any features and equipment described in this manual that are not on this vehicle.

FCA US LLC reserves the right to make changes in design and specifications, and/or make additions to or improvements to its products without imposing any obligation upon itself to install them on products previously manufactured.



# DEAR CUSTOMER

## Dear Customer,

We would like to congratulate and thank you for choosing a Fiat 124 Spider.

We have written this Owner's Manual to help you get to know all the features of your vehicle and use it in the best possible way.

Here you will find information, advice and important warnings regarding use of your vehicle and how to achieve the best performance from the technical features of your vehicle.

You are advised to take the time to read these publications carefully before taking to the road for the first time, to become familiar with the controls and above all with those concerning brakes, steering and transmission; at the same time, you can understand the vehicle behavior on different road surfaces.

This document also provides a description of special features and tips, as well as essential information for the safe driving, care and maintenance of your vehicle over time.

After reading it, you are advised to keep the Owner's Manual inside the vehicle, for an easy reference and for making sure it remains in the vehicle should it be sold.

In the attached Warranty Booklet you will also find a description of the Services that FCA offers to its customers, and the detail of the terms and conditions for maintaining its validity.

We are sure that these will help you to get in touch with and appreciate your new vehicle and the service provided by the people at FCA.

Enjoy reading. Happy motoring!

**Note:** This Owner's Manual describes all models of the vehicle; please consider only the information relevant to your vehicle's trim level, engine and model. All data contained in this publication are purely indicative. FCA can modify the vehicle model described in this publication at any time, for technical or commercial purposes. For further information, contact your authorized dealer.

# Read This Carefully

## REFUELING



Only refuel with unleaded gasoline with a recommended rating of 91 octane. A rating less than 87 octane is not acceptable. Do not use gasoline containing methanol or ethanol E85. Using these mixtures may cause misfiring and handling issues, as well as damage fundamental components of the fuel supply system.

## STARTING THE ENGINE



**If equipped with a manual transmission:** Be sure that the parking brake is engaged; place the gear selector in NEUTRAL, fully depress the clutch pedal without pressing the accelerator, and then push the ignition button. The engine will start as soon as the ignition is pushed.

**If equipped with an automatic transmission:** Be sure that the parking brake is engaged and that the gear selector is in PARK (P) or NEUTRAL (N), depress the brake pedal, and then push the ignition button. The engine will start as soon as the ignition is pushed.

## PARKING ON FLAMMABLE MATERIAL



The catalytic converter develops high temperatures during operation. Do not park the vehicle on grass, dry leaves, pine needles or other flammable material: fire hazard.

## RESPECTING THE ENVIRONMENT



The vehicle is equipped with a system that carries out a continuous diagnosis of the emission-related components in order to help protect the environment.

## ELECTRICAL ACCESSORIES



Contact your authorized dealer if you decide to add electrical accessories (with the risk of gradually draining the battery) after buying the vehicle. They can calculate the overall electrical requirement and check that the vehicle's electric system can support the required load.

## SCHEDULED SERVICING



Correct maintenance of the vehicle is essential for ensuring that it maintains its performance and its safety features, its environmental friendliness and low running costs are unchanged over time.



# How To Use This Manual

## ESSENTIAL INFORMATION

Each time directions (left/right or forward/backwards) are listed, they are determined by facing forward from the rear of the vehicle or as from the point of view of being seated inside the car. Special cases not complying with this rule will be properly specified in the text.

The figures in the Owner's Manual are provided by way of example only: this might imply that some details of the image do not correspond to the actual arrangement of your vehicle. In addition, the Owner's Manual has been conceived considering vehicles with steering wheel on the left side; it is therefore possible that on vehicles with steering wheel on the right side, the position of some controls or elements is not exactly mirror-like with respect to the figure.

To identify the chapter with the information needed you can consult the index at the end of this Owner's Manual.

Chapters can be rapidly identified by graphic tabs, at the side of each odd page. A key showing the order of the chapter and the corresponding tab symbols appears on another page.

## SYMBOLS

While reading this Owner's Manual you will find a series of **WARNINGS** to prevent procedures that could damage your vehicle.

There are also **CAUTIONS** that must be carefully followed to prevent incorrect use of the components of the vehicle, which could cause accidents or injuries.

Therefore, all **WARNINGS** and **CAUTIONS** must always be carefully followed.

**WARNINGS** and **CAUTIONS** are recalled in the text with the following symbols:



Personal Safety



Vehicle Safety

# Vehicle Modifications / Alterations



## Warning!

*Any change or alteration of the vehicle might seriously affect its safety and road holding, thus causing accidents, in which the occupants could be fatally injured.*

### ACCESSORIES PURCHASED BY THE OWNER

If after buying the vehicle, you decide to install electrical accessories that require a permanent electrical supply (e.g. radio, satellite anti-theft system, etc.) or accessories that burden the electrical supply, contact your authorized dealer, whose personnel will check whether the vehicles's electrical system is able to withstand the load required , or whether it needs to be integrated with a more powerful battery.

**Note:** Use only floor mats that leave the pedal area unobstructed and that are firmly secured so that they cannot slip out of position and interfere with the pedals or impair safe operation of your vehicle in other ways.

### INSTALLING ELECTRICAL / ELECTRONIC DEVICES

The following regulatory statement applies to all radio frequency (RF) devices equipped in this vehicle:

This device complies with part 15 of the FCC Rules and with Industry Canada license-exempt RSS standard(s). Operation is subject to the following two conditions:

1. This device may not cause harmful interference.
2. This device must accept any interference received, including interference that may cause undesired operation.

**Note:** Changes or modifications not expressly approved by the party responsible for compliance could void the user's authority to operate the equipment.

## **RADIO TRANSMITTERS AND MOBILE PHONES**

Radio transmitter equipment (vehicle mobile phones, CB radios, amateur radio etc.) cannot be used inside the vehicle unless a separate aerial is mounted externally.

Transmission and reception of these devices may be affected by the shielding effect of the vehicle body. As far as the use of EC-approved mobile phones is concerned (GSM, GPRS, UMTS, LTE), follow the usage instructions provided by the mobile phone Manufacturer.











The use of these devices inside the vehicle (without an external aerial) may cause the electrical systems to malfunction. This could compromise the vehicle safety in addition to constituting a potential hazard for passengers' health.

If mobile phones/laptops/smartphones/tablets are inside the vehicle and/or close to the electronic key, a reduced performance of the Advanced Keyless Entry System may occur.

## **CELL PHONE WARNING**

**Note:** Please comply with the legal regulations concerning the use of communication equipment in vehicles in your country. Use of any electrical devices such as cell phones, computers, portable radios, vehicle navigation or other devices by the driver while the vehicle is moving is dangerous. Dialing a number on a cell phone while driving also ties-up the driver's hands. Use of these devices will cause the driver to be distracted and could lead to a serious accident. If a passenger is unable to use the device, pull off the right-of-way to a safe area before use. If use of a cell phone is necessary despite this warning, use a hands-free system to at least leave the hands free to drive the vehicle. Never use a cell phone or other electrical devices while the vehicle is moving and, instead, concentrate on the full-time job of driving.



<b>GRAPHICAL TABLE OF CONTENTS</b>	
<b>GETTING TO KNOW YOUR VEHICLE</b>	
<b>GETTING TO KNOW YOUR INSTRUMENT PANEL</b>	
<b>SAFETY</b>	
<b>STARTING AND OPERATING</b>	
<b>IN CASE OF EMERGENCY</b>	
<b>SERVICING AND MAINTENANCE</b>	
<b>TECHNICAL SPECIFICATIONS</b>	
<b>CUSTOMER ASSISTANCE</b>	
<b>INDEX</b>	



# GRAPHICAL TABLE OF CONTENTS

## FRONT VIEW

---



**Front View**

01020304-000-100AB

1 — Wheels And Tires  
2 — Windshield Wiper Blades

3 — Headlights  
4 — Engine Compartment

5 — Convertible Top

---



## REAR VIEW

---



1 — Decklid  
2 — Taillight

### Rear View

3 — Exterior Mirror  
4 — Wheels/Tires

---

01020304-001-100AB



# INSTRUMENT PANEL

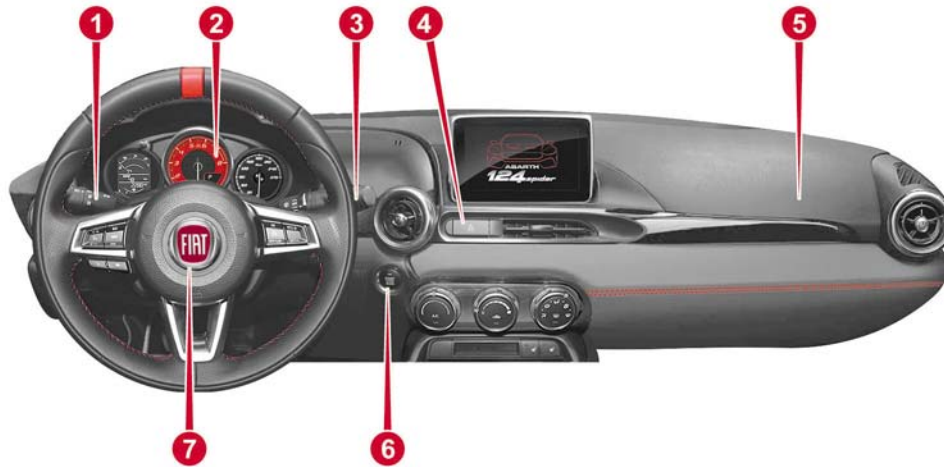

## Instrument Panel

02010200-129-555AB

- |                                  |                                  |                    |
|----------------------------------|----------------------------------|--------------------|
| 1 — Turn Signal/High Beams Lever | 4 — Hazard Warning Lights Button | 7 — Driver Air Bag |
| 2 — Instrument Cluster           | 5 — Passenger Air Bag            |                    |
| 3 — Windshield Wiper And Washers | 6 — Ignition Switch              |                    |



## INTERIOR OVERVIEW



### Interior Overview

01020304-002-100AB

1 — Instrument Cluster  
2 — Steering Wheel  
3 — Radio Systems

4 — Climate Control System  
5 — Transmission Gear Selector  
6 — Parking Brake

7 — Seats  
8 — Radio Controls

# GETTING TO KNOW YOUR VEHICLE

KEYS . . . . .	.14
IGNITION SWITCH . . . . .	.20
ADVANCED KEYLESS ENTRY SYSTEM — IF EQUIPPED . . . . .	.21
VEHICLE SECURITY ALARM SYSTEM — IF EQUIPPED . . . . .	.24
DOORS . . . . .	.26
SEATS . . . . .	.33
NON-ADJUSTABLE HEAD RESTRAINTS . . . . .	.34
STEERING WHEEL . . . . .	.35
MIRRORS . . . . .	.35
EXTERIOR LIGHTS . . . . .	.38
WINDSHIELD WIPERS / WASHER . . . . .	.42
CLIMATE CONTROL SYSTEM . . . . .	.45
POWER WINDOWS . . . . .	.56
HOMELINK — IF EQUIPPED . . . . .	.58
INTERNAL EQUIPMENT . . . . .	.60
TRUNK LID . . . . .	.66
TRUNK EMERGENCY RELEASE . . . . .	.68
HOOD . . . . .	.68
CONVERTIBLE TOP (SOFT TOP) . . . . .	.70
ELECTRIC POWER STEERING . . . . .	.74
ENVIRONMENT PROTECTION SYSTEMS . . . . .	.74



## KEYS

### Key Fob

A code number is stamped on the plate attached to the key set; detach this plate and store it in a safe place (not in the vehicle) for use if you need to make a replacement Emergency Key.

Also, write down the code number and keep it in a separate safe and convenient place, but not in the vehicle.

If your key fob is lost, contact an authorized dealer and have your code number ready.

**Note:** Your key fob configuration may vary with different feature button icons as well as the total number of feature buttons depending on your vehicle options/features. Key fob example as shown.



**Key Fob**

04010100-361-002AB

- 1 — Emergency Key
- 2 — Key Fob
- 3 — Key Code Number Plate

To use the Emergency Key, push the mechanical latch on the back side of the key fob and pull the emergency key out that's housed inside the key fob.

#### Note:

- Always keep a spare key fob in case one is lost. If a key fob is lost, see an authorized dealer as soon as possible.
- The driver must carry the key fob to ensure the Keyless Entry System functions properly.



#### Warning!

Before exiting a vehicle, always shift the automatic transmission into PARK or the manual transmission into FIRST gear or REVERSE, apply the parking brake, turn the engine OFF, remove the key fob from the vehicle and lock your vehicle.

Never leave children alone in a vehicle, or with access to an unlocked vehicle.

Allowing children to be in a vehicle unattended is dangerous for a number of reasons. A child or others could be seriously or fatally injured. Children should be warned not to touch the parking brake, brake pedal or the gear selector.

Do not leave the key fob in or near the vehicle, or in a location accessible to children. A child could operate power windows, other controls, or move the vehicle.

Do not leave children or animals inside parked vehicles in hot weather. Interior heat build-up may cause serious injury or death.

## Key Fob Functions

### With A Vehicle Security Alarm System

The hazard warning lights flash when the vehicle security alarm system is armed or disarmed.

### With Advanced Keyless Function

A beep can be heard for confirmation when the doors, trunk lid, and the fuel filler door are locked/unlocked using the key fob. The beep indication volume can be adjusted or turned off.

Use the following procedure to change the beep setting:

1. Verify or place the ignition in the OFF position and close both of the doors and the trunk lid.
2. Open the driver's door.
3. Within 30 seconds of opening the driver's door, push and hold the lock button on the key fob for five seconds or longer.

#### Note:

Both of the doors, the trunk lid, and fuel filler door will lock and the beep sound activates at the currently set volume (if the beep is currently set to not activate, it will not activate).

The setting changes each time the lock button on the key fob is pushed and the beep sound activates at the set volume (if the beep sound has been set to not activate, it will not activate).

Setting change is completed by doing any one of the following:

- Placing the ignition to ACC or ON position.
- Closing the driver's door.
- Opening the trunk lid.
- Not operating the key fob for ten seconds.
- Pushing any button, except the lock button on the key fob.
- Pushing a request switch on the exterior door handle.

**Note:** Refer to “Lock/Unlock With Advanced Keyless Entry Function — If Equipped” in “Doors” for further information.

The operation indicator light flashes when the buttons are pushed.

## Key Fob Buttons

### Lock Button

To lock the doors, trunk lid, and the fuel filler door, push the lock button and the hazard warning lights will flash once and a beep will be heard.

### Unlock Button

To unlock the doors and the trunk lid, push the unlock button and the hazard warning lights will flash twice.

The system can be set to unlock both doors. Use the following procedure to change the setting:

1. Place the ignition in the OFF position and close both of the doors and the trunk lid.
2. Open the driver's door.
3. Within 30 seconds of opening the driver's door, push and hold the unlock button on the key fob for five seconds or longer.

**Note:** The sound of the doors locking/unlocking can be heard. After this, the system changes the setting each time the unlock button is pushed (the sound of the doors locking/unlocking can be heard).

The setting change can be completed by doing any one of the following:

1. Placing the ignition in the ACC or ON position.
2. Closing the driver's door.
3. Opening the trunk lid.
4. Not operating the key fob for ten seconds.

5. Pushing any button except the unlock button on the key fob.

6. Pushing a request switch on the exterior door handle.

### Trunk Button

To open the trunk lid, push and hold the trunk button until the trunk lid opens.

### Panic Button

To turn the Panic Alarm feature on or off, push and hold the panic button on the key fob for at least one second and release. When the Panic Alarm is on, the headlights will turn on, the park lights will flash, the horn will pulse on and off, and the turn signal lights will flash.

**Note:** The panic button will work whether any door or the trunk lid is open or closed.

### Turning On The Alarm

Pushing the panic button for one second or more will trigger the alarm for about two minutes and thirty seconds, and the following will occur:

- The horn sounds intermittently.
- The hazard warning lights flash.

### Turning Off The Alarm

The alarm will stop by pushing any button on the key fob.



## Operational Range

The system operates only when the driver is in the vehicle or within operational range while the key fob is being carried or on your person.

### Starting The Engine

Starting the engine may be possible even if the key fob is outside of the vehicle and extremely close to a door and window, however, always start the engine from the driver's seat.

If the vehicle is started and the key fob is not in the vehicle, the vehicle will not restart after it is shut off and the ignition is placed in the OFF position.

The trunk is out of the assured operational range, however, if the key fob is operable the engine will start.

### Key Fob Antenna Location



04010202-12R-001

### Key Fob Antenna Location

- 1 — Interior Antenna
- 2 — Operational Range

**Note:** The engine may not start if the key fob is placed in or around the following areas:

- Around The Instrument Panel
- In The Storage Compartments

## Key Suspend Function

If a key fob is left in the vehicle, the functions of the key fob left in the vehicle are temporarily suspended to prevent unlawful use of the vehicle.

To restore the functions, push the unlock button on the functions-suspended key fob left in the vehicle.

## Key Fob Battery Replacement

If the buttons on the key fob are inoperable and the indicator light does not flash, the battery power level may be low or discharged.

Replace with a new battery (CR2025 type) before the key fob becomes unusable.

The following conditions indicate that the battery power is low:

-  Indicator light (green) flashes in the instrument cluster for about 30 seconds after the engine is placed in the OFF position.
- The system does not operate and the operation indicator light on the key fob does not flash when the buttons are pushed.

The system's operational range is reduced.

**Note:** Replacing the battery at an authorized dealer is recommended to prevent damage to the key fob. If replacing the battery by yourself, follow the instruction below.

### Replacing The Key Fob Battery

Proceed as follows:

1. Push the mechanical release button and remove the emergency key.

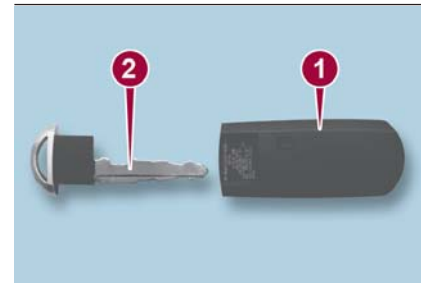

07031301-361-002

### Emergency Key Removed

- 1 — Key Fob Case With Mechanical Release Button
- 2 — Emergency Key

2. Insert a coin, a flat blade screw driver, or the tip of your emergency key into the now exposed slot and carefully pry in the direction of the arrows to open the cover (3) slightly.

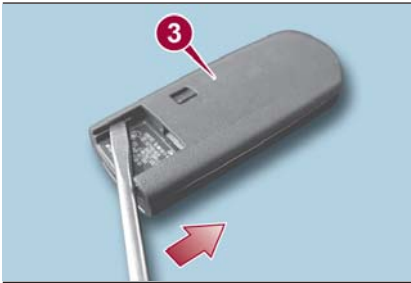

07031301-362-002

### Pry Case Left Side

3. Insert a coin, a flat blade screw driver, or the tip of your emergency key into the side gap and carefully pry in the direction of the arrow to open the cover (4).



07031301-363-002

### Pry Case Right Side

4. Separate the key fob case, then remove the battery.

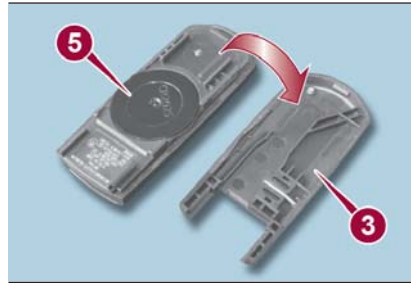

07031301-364-003

### Remove Back Cover For Battery Replacement

3 — Key Fob Case  
5 — Key Fob Battery

5. Insert a new battery with the positive pole facing up. Then, cover the battery with the battery cap.

6. Close the cover and reinsert the Emergency Key.



07031301-367-001

### Install New Battery

**Note:** Be careful not to allow the

rubber ring shown in call-out (6) to be scratched or damaged. If the rubber ring comes out, reinstall it before inserting a new battery.

## Engine Start Function When Key Fob Battery Is Discharged

When starting the engine by holding the key fob over the keyless ignition START/STOP button due to a discharged key fob battery or a malfunctioning key fob, be careful not to allow the following, otherwise the signal from the key fob will not be received correctly and the engine may not start:

- Metal parts of other key fobs or metal objects touch the key fob.
- Spare key fobs or key fobs for other vehicles equipped with an immobilizer system touch or come near the key .
- Devices for electronic purchases, or security passage touch or come near the key fob.





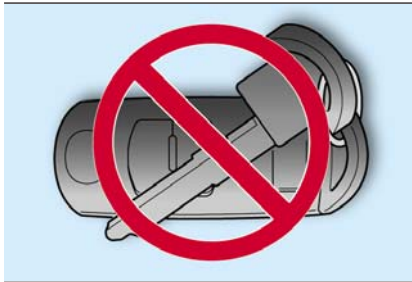

05010201-KY1-001AB

### No Keys Touching The Key Fob



05010201-KY2-001AB

### No Key Fob Touching The Key Fob

If the engine cannot be started due to a discharged key fob battery, the engine can be started using the following procedure:

1. Continue to depress the brake pedal firmly until the engine has completely started.

2. **Manual Transmission:** continue to depress the clutch pedal firmly until the engine has completely started.

3. Verify that the keyless ignition start indication light (green) flashes.

4. Touch the keyless ignition START/STOP button using the backside of the key fob while the keyless ignition start indicator light (green) flashes.

5. Verify that the keyless ignition start indicator light (green) turns on.

6. Push the keyless ignition START/STOP button to start the engine.



05010201-L12-001AB

### Discharged Key Fob Battery Start Procedure

When touching the keyless ignition START/STOP button using the backside of the key fob as shown in the illustration, touch the keyless ignition START/STOP button with the lock switch side of the key fob facing up.

The engine cannot be started unless the clutch pedal is fully depressed (manual transmission) or the brake pedal is fully depressed (automatic transmission).

If there is a malfunction with the keyless ignition START/STOP button function, the keyless ignition start indicator light (amber) flashes. In this case, the engine may start, however contact an authorized dealer as soon as possible.

If the keyless ignition start indicator light (green) does not illuminate, perform the operation from the beginning again. If it does not illuminate contact an authorized dealer.

To change the ignition position without starting the engine, perform the following operations after the keyless ignition start indicator light (green) turns on:

1. Release the clutch pedal (manual transmission) or brake pedal (automatic transmission).

2. Push the keyless ignition START/STOP button to change the ignition position. The ignition cycles in the order of ACC, ON, and OFF each time the keyless ignition START/STOP button is pushed.

**Note:** To change the ignition position again, perform the operation from the beginning.



## Emergency Operation For Starting The Engine

If the key warning light (red) illuminates, or the keyless ignition start indicator light (amber) flashes, this could indicate that the engine may not start using the usual starting method. Contact an authorized dealer as soon as possible. If this occurs, the engine can be force-started. push and hold the keyless ignition START/STOP button until the engine starts.

Other procedures necessary for starting the engine such as having the key fob in the vehicle, and depressing the clutch pedal (manual transmission) or the brake pedal (automatic transmission) are required.

## Key Fob Cautions

Because the key fob uses low-intensity radio waves, it may not function correctly under the following conditions:

- The key fob is carried with communication devices such as cellular phones.
- The key fob contacts or is covered by a metal object.

The key fob is near electronic devices such as personal computers.

Non-FCA genuine electronic equipment is installed in the vehicle.

There is equipment which discharges radio waves near the vehicle.

The key fob may consume battery power excessively if it receives high-intensity radio waves. Do not place the key fob near electronic devices such as televisions or personal computers.

To avoid damage to the key fob, DO NOT:

- Drop the key fob.
- Get the key fob wet.
- Disassemble the key fob unless replacing battery.
- Expose the key fob to high temperatures on places such as the instrument panel or engine compartment, under direct sunlight.
- Expose the key fob to any kind of magnetic field.
- Place heavy objects on the key fob.
- Put the key fob in an ultrasonic cleaner.
- Put any magnetized objects close to the key fob.

## General Information

The following regulatory statement applies to all Radio Frequency (RF) devices equipped in this vehicle:

This device complies with Part 15 of the FCC Rules and with Industry Canada license-exempt RSS standard(s). Operation is subject to the following two conditions:

1. This device may not cause harmful interference.
2. This device must accept any interference received, including interference that may cause undesired operation.

**Note:** Changes or modifications not expressly approved by the party responsible for compliance could void the user's authority to operate the equipment.



## IGNITION SWITCH

### Push Button Start Positions

The system operates only when the key fob is within operational range.

Each time the keyless ignition START/STOP button is pushed, the ignition cycles in the order of OFF, ACC, and ON. Pushing the START/STOP button again from ON position cycles the ignition to the OFF position.



05010101-L12-001AB

### Keyless START/STOP Ignition Button

#### Note:

□ The engine starts by pushing the keyless ignition START/STOP button while depressing the clutch pedal (manual transmission) or the brake pedal (automatic transmission). To change the ignition position, push the keyless ignition START/STOP button without depressing the clutch or brake pedal.

□ Do not leave the ignition in the ON position while the engine is not running, doing so could result in the battery being discharged. If the ignition is left in ACC position (for automatic transmission, the gear selector is in the P position, and the ignition is in ACC), the ignition cycles to the OFF position automatically after about 25 minutes.

#### OFF

The power supply to electrical devices turns off and the keyless ignition start indicator light (amber) also turns off. In the OFF position, the steering wheel is locked.

#### ACC (Accessory)

Some electrical accessories will operate and the indicator light (amber) illuminates. In the ACC position, the steering wheel is unlocked.

The Keyless Entry System does not function while the keyless ignition has been placed in the ACC position, and the doors will not lock/unlock even if they have been locked manually.

#### ON

This is the normal running position after the engine is started.

**Note:** The indicator light (amber) turns off (the indicator light amber illuminates when the ignition has been placed in the ON position and the engine is not running).

Some indicator lights/warning lights should be inspected before the engine is started.

When the keyless ignition has been placed in the ON position, the sound of the fuel pump motor operating near the fuel tank can be heard. This does not indicate an abnormality.



#### Warning!

□ *Never use the PARK position as a substitute for the parking brake. Always apply the parking brake fully when exiting the vehicle to guard against vehicle movement and possible injury or damage.*

□ *When leaving the vehicle, always make sure the ignition is in the OFF mode, remove the key fob from the vehicle, and lock your vehicle.*

□ *Never leave children alone in a vehicle, or with access to an unlocked vehicle. Allowing children to be in a vehicle unattended is dangerous for a number of reasons. A child or others could be seriously or fatally injured. Children should be warned not to touch the parking brake, brake pedal or the transmission gear selector.*

□ *Do not leave the key fob in or near the vehicle, (or in a location accessible to children), and do not leave the ignition in the ACC or ON/RUN mode. A child could operate power windows, other controls, or move the vehicle.*

❑ Be sure the parking brake is fully disengaged before driving; failure to do so can lead to brake failure and a collision.

❑ Always fully apply the parking brake when leaving your vehicle, or it may roll and cause damage or injury. Also be certain to leave the transmission in PARK. Failure to do so may allow the vehicle to roll and cause damage or injury.

❑ Driving the vehicle with the parking brake engaged, or repeated use of the parking brake to slow the vehicle may cause serious damage to the brake system.

## ADVANCED KEYLESS ENTRY SYSTEM – IF EQUIPPED

### Advanced Keyless Entry System

The Advanced Keyless Entry System is an enhancement that allows you to lock/unlock the doors, trunk lid, fuel filler door, and opens the trunk lid with the slow and careful push of a button.

The Advanced Keyless Entry System allows the driver to START/STOP the ignition with the push of a button as long as the key fob is in the passenger compartment.

If equipped, the vehicle security alarm system may be armed/disarmed with the push of the lock/unlock button located on the key fob.

#### System Malfunctions/Warnings

System malfunctions or warnings are indicated by the following warning lights or beeps (refer to “Getting To Know Your Instrument Panel” for further information) :

- ❑  Warning Light (Red)
- ❑ Ignition Not Turned OFF Warning Beep
- ❑ Key Fob Removed From Vehicle Warning Beep
- ❑ Request Switch Inoperable Warning Beep



- ❑ Key Fob Left-In-Trunk Warning Beep
- ❑ Key Fob Left-In-Vehicle Warning Beep

If you have a problem with the key fob, or the key fob is lost or stolen, contact an authorized dealer as soon as possible for a replacement and to make the lost or stolen key fob inoperative.

**Note:** Changes or modifications not expressly approved by the party responsible for compliance could void the user’s authority to operate the equipment.

- ❑ The Advanced Keyless Entry System operational range may vary due to local weather conditions.
- ❑ The Advanced Keyless Entry System is fully operational (door/trunk lid/fuel filler door lock/unlock) when the ignition is placed in the OFF position. The Advanced Keyless Entry System does not operate if the ignition is placed to any position other than the OFF position.
- ❑ If the key fob does not operate when pushing a button, the operational range becomes too small, or the warning light does not illuminate or flash, the battery may be weak or discharged. To install a new battery, refer to “Key Fob Battery Replacement.”



□ Battery life is about one year. Replace the battery with a new one if the  Warning light (green) flashes in the instrument cluster. Replacing the battery about once a year is recommended because the  Warning light may not illuminate or flash if the battery is low or discharged.

□ Additional key fobs may be obtained at an authorized dealer. Up to six key fobs may be used with the Advanced Keyless Entry System per vehicle. Bring all key fobs to an authorized dealer when additional keys are required.

The Advanced Keyless Entry function allows you to lock/unlock the door, trunk lid, and fuel filler door, or open the trunk lid while carrying the key fob.



### Warning!

*Radio waves from the key fob may affect medical devices such as pacemakers: before using the key fob near people who use medical devices, ask the medical device manufacturer or your physician if radio waves from the key fob will affect the device.*

**Note:** The Advanced Keyless Entry System functions can be deactivated to prevent any possible adverse effect on a user wearing a pacemaker or other medical device. If the system is deactivated, you will be unable to start the engine by carrying the key fob. Contact an authorized dealer for details. If the Advanced Keyless Entry System has been deactivated, you can start the engine by following the procedure indicated when the key fob battery becomes discharged.

### Operational Range

The system operates only when the driver is in the vehicle or within

operational range while the key fob is being carried.



04010202-12S-002

### Advanced Keyless Entry Sensors

- 1 — Interior Antenna
- 2 — Operational Range

**Note:** When the battery power is low, or in places where there are high-intensity radio waves or noise, the operational range may become narrower or the system may not operate.

## Locking/Unlocking The Doors And The Trunk Lid

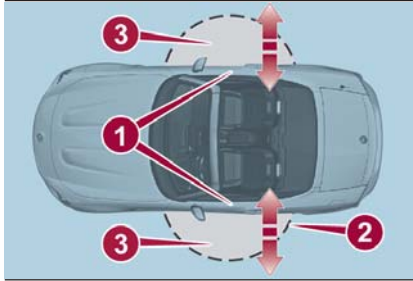

04020201-12A-003

### Request Switch Door Functions

- 1 — Exterior Antenna
- 2 — Operational Range
- 3 — Distance (31 inches)

**Note:** The system may not operate if you are too close to the windows or door handles.

## Opening The Trunk Lid

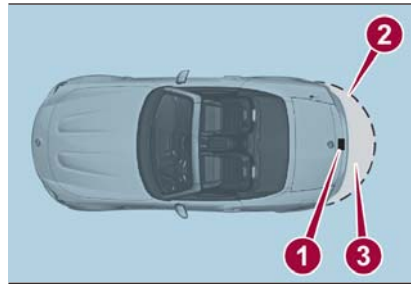

04020202-12A-003

### Electronic Trunk Release

- 1 — Exterior Antenna
- 2 — Operational Range
- 3 — Distance (31 inches)

## General Information

The following regulatory statement applies to all Radio Frequency (RF) devices equipped in this vehicle:

This device complies with Part 15 of the FCC Rules and with Industry Canada license-exempt RSS standard(s). Operation is subject to the following two conditions:

1. This device may not cause harmful interference.
2. This device must accept any interference received, including interference that may cause undesired operation.

**Note:** Changes or modifications not expressly approved by the party responsible for compliance could void the user's authority to operate the equipment.



## VEHICLE SECURITY ALARM SYSTEM — IF EQUIPPED

### Modifications And Add-On Equipment

FCA cannot guarantee the immobilizer and the vehicle security alarm system operation if the system has been modified or if any add-on equipment has been installed.

**Note:** To avoid damage to the vehicle, do not modify the system or install any add-on equipment to the immobilizer and the vehicle security alarm system or the vehicle.

### Immobilizer System

The immobilizer system allows the engine to start only with a key fob the system recognizes.

If someone attempts to start the engine with an unrecognized key fob, the engine will not start, thereby helping to prevent unlawful vehicle use.

If you have a problem with the immobilizer system or the key fob, contact an authorized dealer.

To avoid damage to the key fob, do not:

- Drop the key fob.
- Get the key fob wet.
- Expose the key fob to any kind of magnetic field.

Expose the key fob to high temperatures on places such as the instrument panel, hood, or under direct sunlight.

#### Note:

- Changes or modifications not expressly approved by the party responsible for compliance could void the user's authority to operate the equipment.
- If the engine does not start with the correct key fob, and the  warning light keeps illuminating or flashing, the system may have a malfunction. Contact an authorized dealer.
- The key fobs carry a unique electronic code. For this reason, and to assure your safety, obtaining a replacement key fob can only be done through your authorized dealer, and will require some waiting time.
- Always keep a spare key fob in case one is lost. If a key fob is lost, contact an authorized dealer as soon as possible.
- If you lose a key fob, an authorized dealer will reset the electronic codes of your remaining key fobs and immobilizer system. Bring all the remaining key fobs to an authorized dealer to reset. Starting the vehicle with a key fob that has not been reset is not possible.

### Operation



The engine may not start and  warning light may illuminate or flash if the key fob is placed in an area where it is difficult for the system to detect the signal, such as on the instrument panel. Move the key fob to a location within the signal range, cycle the ignition off, and then restart the engine.

**Note:** Signals from a TV, radio station, transceiver, or mobile telephone could interfere with your immobilizer system. If you are using the proper key fob and the engine fails to start, check the  warning light.

### Arming

The system is armed when the ignition is cycled from the ON to OFF position. The  warning light in the instrument cluster flashes every two seconds until the system is disarmed.



### Disarming

The system is disarmed when the ignition is placed in the ON position with the correct programmed key fob. The  warning light illuminates for about three seconds and then turns off. If the engine does not start with the correct key fob, and the  warning light remains illuminated or flashing, try the following:

- Make sure the key fob is within the operational range for signal transmission.

❑ Cycle the ignition off, and then restart the engine. If the engine does not start after three or more tries, contact an authorized dealer.

#### Note:

❑ If the  warning light flashes continuously while you are driving, do not turn the engine OFF. Contact an authorized dealer and have it checked. If the engine is shut off while the  warning light is flashing, you will not be able to restart it.

❑ Because the electronic codes are reset when the immobilizer system is repaired, the keys are needed. Make sure to bring all the key fobs to an authorized dealer so that they can be programmed.

### Vehicle Security Alarm System — If Equipped

If the vehicle security alarm system detects an inappropriate entry into the vehicle or the intrusion sensor detects movement in the vehicle which could result in the vehicle or its contents being stolen, the alarm alerts the surrounding area of an abnormality by sounding the siren/horn and flashing the hazard warning lights.

The system will not function unless it's properly armed. So when you leave the vehicle, follow the arming procedure correctly.

### Siren/Horn Triggering Conditions

The siren/horn sounds intermittently and the hazard warning lights flash for about 30 seconds when the system is triggered by any one of the following:

❑ Unlocking a door with an inside door-lock knob.

❑ Forcing open a door, the engine compartment or the trunk lid.

❑ Opening the hood by operating the hood release handle.

❑ Placing the ignition in the ON position without starting the engine.

❑ With the intrusion sensor: the intrusion sensor detects a movement in the vehicle.

The system will be triggered again (up to ten times) if one of the above conditions remains.

The trunk lid will not open when the vehicle security alarm system is activated.

If the battery becomes drained while the vehicle security alarm system is armed, the siren will activate and the hazard warning lights will flash during the battery charging or replacement process.

### How To Arm The System

❑ Close the windows and the convertible top securely.

❑ Place the ignition in the OFF position.

❑ Make sure the engine compartment, convertible top, the doors, and the trunk lid are closed.

❑ Push the lock button on the key fob or lock the driver's door from the outside with the emergency key. The hazard warning lights will flash once.

**With The Advanced Keyless Entry function:** push a request switch. The

 warning light in the instrument panel flashes twice per second for 20 seconds. After 20 seconds the system is fully armed.

The vehicle security alarm system can also be armed by activating the auto re-lock function with all the doors, the trunk lid and the engine compartment closed.

The system will disarm if one of the following operations takes place within 20 seconds after pushing the lock button: To rearm the system, perform the arming procedure again.

1. Unlocking any door.
2. Opening any door.
3. Opening the engine compartment.
4. Placing the ignition in the ON position.

The hazard warning lights will flash once to indicate that the vehicle security alarm system is armed when the doors are locked by pushing the lock button on the key fob, or using the emergency key.





**Note:**

❑ If any door or trunk lid remains closed for 30 seconds, the doors, and trunk lid automatically re-lock and the vehicle security alarm system arms even if a window open or the convertible top is left down.

❑ To reactivate the intrusion sensor, turn off the armed vehicle security alarm system and then rearm it.

❑ The intrusion sensor is operational when the vehicle security alarm system is armed. To cancel the intrusion sensor, push the intrusion sensor cancel button each time the vehicle security alarm system is armed.

**To Turn Off An Armed System**

An armed system can be turned off using any one of the following methods:

❑ Pushing the unlock button on the key fob.

❑ Starting the engine with the keyless ignition START/STOP button.

❑ **With The Advanced Keyless Entry function:** pushing a request switch on the exterior door handles.

**Note:** When the doors are unlocked by pushing the unlock button on the key fob while the vehicle security alarm system is turned off, the hazard warning lights will flash twice to indicate that the system is turned off.

**To Stop The Alarm**

A triggered alarm can be turned off using any one of the following methods:

❑ Pushing the unlock button on the key fob

❑ Starting the engine with the keyless ignition START/STOP button

❑ **With The Advanced Keyless Entry function:** pushing a request switch on the exterior door handles or the electric trunk release while the key fob is being carried.

The hazard warning lights will flash twice.

**DOORS****Lock/Unlock With Emergency Key**

Both doors, trunk lid, and fuel door lock automatically when the driver's door is locked using the emergency key.

❑ Lock With Emergency Key — Insert key into driver's door and turn to the left (toward front of car).

❑ Unlock With Emergency Key — Insert key into driver's door and turn to the right (toward back of car).

They both unlock when the driver's door is unlocked using the emergency key.

Turn the emergency key toward the front to lock, toward the back to unlock.

**Caution!**

*An unlocked vehicle is an invitation for thieves. Always remove key fob from the vehicle and lock all doors when leaving the vehicle unattended.*



## Manual Lock/Unlock Knob

### Operation From Inside

To lock any door from the inside, push the door-lock knob. To unlock, pull it outward. This does not operate the other door locks.

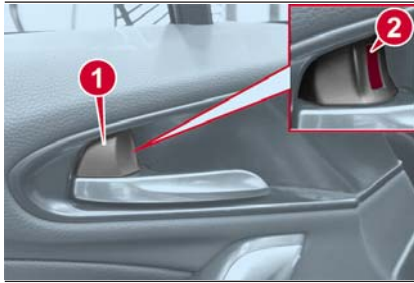

04030107-L21-001AB

### Inside Door-Lock Knob

- 1 — Door Knob Lock Position (Red Indicator Not Seen When Locked)
- 2 — Door Knob Unlock Position (Red Indicator Seen When Unlocked)

**Note:** The red indication can be seen when the door-lock knob is unlocked.

### Operation From Outside

To lock the passenger door with the door-lock knob from the outside, push the door-lock knob to the lock position and close the door (holding the door handle in the open position is not required).

**Note:** When locking the door this way, be careful not to leave the key fob inside the vehicle. The driver's door lock knob cannot be used while the driver's door is open.



### Warning!

- For personal security and safety in the event of a collision, lock the vehicle doors before you drive as well as when you park and leave the vehicle.
- When leaving the vehicle, always remove the key fob from the vehicle and lock your vehicle. If equipped with Advanced Keyless Entry, always make sure the keyless ignition is in "OFF" position, remove the key fob from the vehicle and lock the vehicle. Unsupervised use of vehicle equipment may cause severe personal injuries or death.
- Never leave children alone in a vehicle, or with access to an unlocked vehicle. Allowing children to be in a vehicle unattended is dangerous for a number of reasons. A child or others could be seriously or fatally injured. Children should be warned not to touch the parking brake, brake pedal or the gear selector.
- Do not leave the key fob in or near the vehicle, or in a location accessible to children, and do not leave the ignition of a vehicle equipped with Advanced Keyless Entry in the ACC or ON/RUN positions. A child could operate power windows, other controls, or move the vehicle.

## Central Lock/Unlock

Both doors, trunk lid, and fuel door lock automatically when the lock rocker switch is pushed with both doors closed.

### Note:

- The doors, trunk lid, and the fuel filler door cannot be locked while any other door is open.
- The key fob may not be able to be detected by the vehicle keyless-go system if it is located next to a mobile phone, laptop or other electronic device; these devices may block the key fob's wireless signal and prevent the keyless-go system from starting the vehicle.



04030105-12D-002

### Central/Power Door Lock Switch

Both unlock when the unlock rocker switch is pushed.

**Note:** The doors, trunk lid, and the fuel filler door cannot be locked while any other door is open.



## Double Locking System — If Equipped

The double locking system is designed to prevent someone who has broken into your vehicle from opening the door from the inside. If you have any problems with the double locking system, contact an authorized dealer.

### System Activation

Proceed as follows:

1. Close both the windows and the convertible top.
2. Place the ignition in the OFF position and take the key fob with you.
3. Close both doors and trunk lid.
4. Insert the emergency key in the driver's door, turn the emergency key to the lock position (counter clockwise/left), and return it to the center position. Then turn it to the lock position (counter clockwise/left) again within three seconds.
5. The  indicator light illuminates for about three seconds to indicate that the system has been activated.

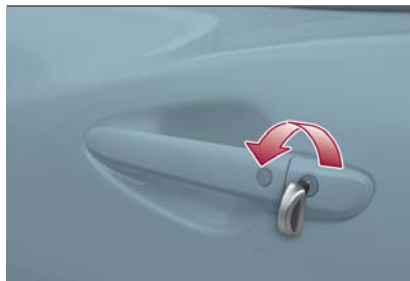

04030102-12A-001

### Emergency Key Lock Procedure

The system can be activated by pushing the lock button on the key fob twice within three seconds.

### With The Advanced Keyless

**Function:** the system can be activated by pushing the request switch on the exterior door handle twice within three seconds.

**Note:** The system cannot be activated when any door is open.

### System Deactivation

Unlock the driver's door or place the ignition in the ON position. If the power supply is interrupted (fuse blows or the battery is disconnected), the system can only be deactivated by unlocking a door with the emergency key.

## Lock/Unlock With Advanced Keyless Entry Function — If Equipped

Both doors, trunk lid, and the fuel filler door can be locked/unlocked by pushing the request switch on the exterior door handle while the key fob is being carried.



04000098-121-555

### Request Switch On Exterior Door Handle

### To Lock

To lock the doors, trunk lid, and the fuel filler door, push the request switch on the exterior door handle and the hazard warning lights will flash once. A beep sound will be heard once.

## To Unlock

Driver's door request switch located on the exterior door handle.

To unlock the doors, trunk lid, and the fuel filler door, push the request switch on the exterior door handle and the hazard warning lights will flash twice.

To unlock both doors and the fuel filler door, push the request switch on the exterior door handle again within three seconds and two more beep sounds will be heard.

### Front Passenger Door Request Switch:

To unlock both doors and the fuel filler door, push the request switch on the exterior door handle. A beep sound will be heard twice and the hazard warning lights will flash twice.

### Note:

- Confirm that both doors, and the fuel filler door are securely locked.
- For the trunk lid, move it without pushing the electric trunk lid opener to verify that the trunk lid has not been left open.
- Both doors and the fuel filler door cannot be locked when any door is open.
- It may require a few seconds for the doors to unlock after the request switch on the exterior door handle is pushed.

The key fob may not be able to be detected by the vehicle keyless-go system if it is located next to a mobile phone, laptop or other electronic device; these devices may block the key fob's wireless signal and prevent the keyless-go system from starting the vehicle.

A beep sound is heard for confirmation when the doors, and fuel filler door are locked/unlocked using the request switch on the exterior door handle. If you prefer, the beep sound can be turned off.

The volume of the beep sound can also be changed. Use the following procedure to change the setting:

1. Place the ignition in the OFF position and close both of the doors and the trunk lid.
2. Open the driver's door.
3. Within 30 seconds of opening the driver's door, push and hold the lock button on the key fob for five seconds or longer. The doors, and fuel filler door will lock, an audible beep will activate at the currently set volume (if the beep sound is currently set to not activate, it will not activate). The setting changes each time the lock button on the key fob is pushed and the beep sound activates at the set volume (if the beep sound has been set to not activate, it will not activate).

4. The setting change is completed by doing any one of the following:

- Place the ignition in the ACC or ON position.
- Closing the driver's door.
- Opening the trunk lid.
- Not operating the key fob for ten seconds.
- Pushing any button except the lock button on the key fob.
- Pushing a request switch on the exterior door handle.

### With Vehicle Security Alarm System

The hazard warning lights flash when the vehicle security alarm system is armed or disarmed (refer to "Vehicle Security Alarm System" found in "Getting To Know Your Vehicle" for further information).

The setting can be changed so that the doors and the fuel filler door are locked automatically without pushing the request switch on the exterior door handle, (refer to "Personalization Features" section in "Getting To Know Your Instrument Panel" for further information).



### Auto-Lock Function

A beep sound is heard when both doors are closed while the key is being carried. Both doors, the trunk lid, and fuel door are locked automatically after about three seconds when the Advanced Keyless Entry key fob is out of the operational range.

The hazard warning lights will flash once (even if the driver is in the operational range, both doors, trunk lid, and the fuel filler door are locked automatically after about 30 seconds).

If you are out of the operational range before the doors and the trunk lid are completely closed or another key fob is left in the vehicle, the auto-lock function will not work.

Always make sure that both doors and the trunk lid are closed and locked before leaving the vehicle. The auto-lock function does not close the power windows.

### Auto Re-Lock Function

After unlocking with the request switch on the exterior door handle, both doors, and the fuel filler door will automatically lock if any of the following operations are not performed within about 60 seconds.

If your vehicle has a vehicle security alarm system, the hazard warning lights will flash for confirmation.

The time required for the doors to lock automatically can be changed (refer to “Personalization Features” in “Getting To Know Your Instrument Panel” for further information).

- Opening a door or the trunk lid.
- Placing the ignition in any position other than the OFF position.

### Locking/Unlocking With A Key Fob

Both doors, trunk lid, and the fuel filler door can be locked/unlocked by operating the keyless entry system key fob: refer to “Keyless Entry System” in “Keys” for further information.

### Locking/Unlocking With Door-Lock Switch

Both doors and the fuel filler door lock automatically when the lock side is pushed. They unlock when the unlock side is pushed.

To lock both the doors and the fuel filler door from an open door, push the lock side of the door lock switch and then close the door.

**Note:** When locking the doors this way, be careful not to leave the key fob inside the vehicle.

## Auto Lock/Unlock Function — If Equipped

When the vehicle speed exceeds 12 MPH (20 km/h), both doors, and fuel filler door lock automatically.

When the ignition is placed in the OFF position, both doors, and fuel filler door unlock automatically.

These functions can also be disabled so that they do not operate.

### Auto Lock/Unlock Function Setting Change Using Door-Lock Switch (With Door-Lock Switch)

The doors, and fuel filler door can be set to lock or unlock automatically by selecting any one of the functions from the following table and using the door-lock switch on the interior door panel. There are only a total of six auto lock/unlock settings available for automatic transmission vehicles, and three for manual transmission vehicles. Be sure to push the unlock side of the driver's door-lock switch the correct number of times according to the selected function number. If the switch is mistakenly pushed seven times on an automatic transmission vehicle or four times on a manual transmission, the procedure will be cancelled. If this occurs, start the procedure from the beginning.

Function Number	Function (*)
1	The auto door-lock function is disabled.
2	Both the doors, and the fuel filler door lock automatically when the vehicle speed is about 12 MPH (20 km/h) or more.
3	Both the doors, and the fuel filler door lock automatically when the vehicle speed is about 12 MPH (20 km/h) or more. Both the doors, trunk lid, and the fuel filler door unlock when the ignition is cycled from the ON to OFF position.
4	<b>Automatic Transmission Vehicles Only:</b> when the ignition is placed in the ON position and the gear selector is shifted from park (P) to any other gear position, both the doors, and fuel filler door lock automatically.
5	<b>Automatic Transmission Vehicles Only:</b> when the ignition is placed in the ON position and the gear selector is shifted from PARK (P) to any other gear position, both the doors, and the fuel filler door lock automatically. When the gear selector is shifted to PARK (P) while the ignition is placed in the ON position, both the doors, and the fuel filler door unlock automatically.
6	<b>Automatic Transmission Vehicles Only:</b> both the doors, and the fuel filler door lock automatically when the vehicle speed is about 12 MPH (20 km/h) or more. When the gear selector is shifted to PARK (P) while the ignition is placed in the ON position, both the doors, and the fuel filler door unlock automatically.

(\*) For other settings for the auto door lock function contact an authorized dealer.

**Note:** Function number 3 is the factory setting for your vehicle.



## Settings Changing

Settings can be changed using the following procedure:

1. Safely park the vehicle. Both doors must remain closed.
2. Place the ignition in the ON position.
3. Push and hold the lock side of the driver's door-lock switch within 20 seconds of placing the ignition in the ON position, and make sure a beep sound is heard about eight seconds afterwards.
4. Refer to the auto lock/unlock function setting table, determine the function number for the desired setting. Push the unlock side of the driver's door-lock switch the same number of times as the selected function number (example: if you select function 2, push the unlock side of the switch only two times).
5. Three seconds after the function setting has been changed, a beep sound will beep in the amount of the selected function number (example: Function number 3 = three beep sounds).

## Automatic Transmission Vehicles

The doors cannot be locked or unlocked while the setting function is being performed.

The procedure can be cancelled by pushing the lock side of the door-lock switch.

### Note:

□ The vehicle lock-out prevention feature prevents you from locking yourself out of the vehicle. Both doors, trunk lid, and the fuel filler door will automatically unlock if they are locked using the power door locks with any door open. If both the doors are closed even though the trunk lid is open, both the doors and the fuel filler door will lock.

### □ Door Unlock (Control) System With Collision Detection – If

**Equipped:** this system automatically unlocks the doors, trunk lid, and the fuel filler door in the event the vehicle is involved in an accident to allow passengers to get out of the vehicle immediately and prevent being trapped inside. While the ignition is placed in the ON position and in the event the vehicle receives an impact strong enough to inflate the air bags, both the doors, the trunk lid, and fuel filler door are automatically unlocked after about six seconds have elapsed from the time of the accident. The doors, trunk lid, and the fuel filler door may not unlock depending on how an impact is applied, the force of the impact, and other conditions of the accident. If door-related systems or the battery is

malfunctioning, the doors, trunk lid, and the fuel filler door will not unlock.

□ When opening a door, the power windows open a little automatically. When closing the door, the power windows close automatically. This is a function for improving the sealing of the window, and it does not mean there is a problem. If the vehicle battery is disconnected for vehicle maintenance or other reasons, the power windows will not open or close automatically. If the power windows do not open or close, the automatic open/close mechanism for the windows must be reset.

# SEATS

## Manual Adjustment

### Forward / Rearward

To move the seat forward or rearward, pull the adjustment bar. Release the bar once the desired position is reached. Using body pressure, move forward and rearward on the seat to be sure that the seat adjusters have latched.



03010202-12A-003AB

### Manual Seat Adjustment

- 1 — Adjustment Bar
- 2 — Height Dial
- 3 — Recline Lever

### Height

To adjust the height for front edge of the seat bottom, rotate the dial to the desired position.

### Seat Recline

To recline the seatback, lift up the recline lever and lean back until the desired position has been reached, then release the lever. Make sure the

lever returns to its original position and the seatback is locked in place by attempting to push it forward and rearward.



### Warning!

- Adjusting a seat while driving may be dangerous. Moving a seat while driving could result in loss of control which could cause a collision and serious injury or death.*
- Seats should be adjusted before fastening the seat belts and while the vehicle is parked. Serious injury or death could result from a poorly adjusted seat belt.*
- Do not ride with the seatback reclined so that the shoulder belt is no longer resting against your chest. In a collision you could slide under the seat belt, which could result in serious injury or death.*

## Heated Seats

On some models, the front driver and passenger seats may be equipped with heaters in both the seat cushions and seatbacks. The controls for the front heated seats are located on the center instrument panel below the climate controls.

The heated seats have three settings: High, Medium, and Low. Push the switch once to turn the heated seats on High, twice for Medium, and three times

for Low. Pushing the switch a fourth time will turn the heated seat off.

### Note:

- If the ignition is switched OFF while the seat warmer is operating (High, Mid or Low), and then switched ON again, the seat warmer will automatically operate at the temperature set before switching the ignition OFF.
- Use the seat warmer when the engine is running. Leaving the seat warmer on for long periods with the engine not running could discharge the battery.
- The temperature of the seat warmer cannot be adjusted beyond High, Mid and Low.
- Once a heat setting is selected, heat will be felt within two to five minutes.



03010203-L12-002

### Heated Seat Switches





**Warning!**

- Persons who are unable to feel pain to the skin because of advanced age, chronic illness, diabetes, spinal cord injury, medication, alcohol use, exhaustion or other physical condition must exercise care when using the seat heater. It may cause burns even at low temperatures, especially if used for long periods of time.*
- Do not place anything on the seat or seatback that insulates against heat, such as a blanket or cushion. This may cause the seat heater to overheat. Sitting in a seat that has been overheated could cause serious burns due to the increased surface temperature of the seat.*

**Caution!**

*Do not use organic solvents to clean the seat. It may damage the seat surface and the heater.*

**NON-ADJUSTABLE HEAD RESTRAINTS**

The non-adjustable head restraints are form fitted into the upper structure of the seatback, and are designed to reduce the risk of injury by restricting head movement in the event of a rear impact. The seatback should be properly adjusted to an upright position where the head restraint is positioned as close as possible to the back of the occupant's head.

**Warning!**

*Be certain that the seatback is locked securely into position. Otherwise, the seat will not provide the proper stability for passengers. An improperly latched seatback could cause serious injury.*

**Driver And Passenger Head Restraints**

Your vehicle is equipped with non-adjustable head restraints on the driver's and passenger's seatbacks. The non-adjustable head restraints consist of a trimmed foam covering over the upper structure of the seatbacks and are intended to help protect occupants from neck injury. Adjust the seatbacks to their upright, on-road positions so that the head restraint is positioned as close as possible to the back of the occupant's head.

**Warning!**

*Be certain that the seatback is locked securely into position. Otherwise, the seat will not provide the proper stability for passengers. An improperly latched seatback could cause serious injury.*



## STEERING WHEEL

### Steering Wheel Adjustment

To change the angle of the steering wheel:

1. With the gear selector in the PARK position, pull the lock release lever, located under the steering column, downward.
2. Tilt the steering wheel to the desired position.
3. Push the lock release lever upward to lock the steering column.
4. Attempt to push the steering wheel upward and downward to ensure it is locked before driving.

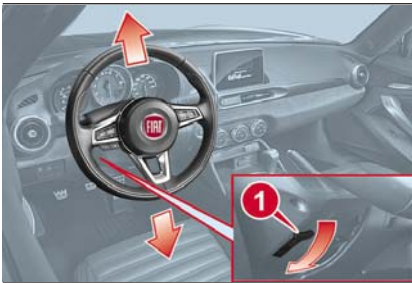

04050101-12A-001AB

#### Manual Tilt Adjustment

- 1 — Lock Release Lever



#### Warning!

*Do not adjust the steering column while driving. Adjusting the steering column while driving or driving with the steering column unlocked could cause the driver to lose control of the vehicle. Be sure the steering column is locked before driving your vehicle. Failure to follow this warning may result in serious injury or death.*

## MIRRORS

### Outside Mirrors

Be sure that all inside and outside mirrors are adjusted to the desired position prior to driving the vehicle.

#### Mirror Types:

Flat Type (Driver Side): flat surface mirror.

Convex Type (Passenger Side): this mirror has a slight curve.

**Note:** The passenger side convex outside mirror will give a much wider view toward the rear of the vehicle, and especially of the adjacent lane.

The outside mirrors may be equipped with a heated mirror system. Refer to “Climate Controls” for more information.

The perceived distance of objects in the outer and inner regions of the wide angle mirror is different.



#### Warning!

*Vehicles and other objects seen in the passenger side convex mirror will look smaller and farther away than they really are. Relying too much on your passenger side mirror could cause you to collide with another vehicle or other object. Use your inside mirror when judging the size or distance of a vehicle seen in the passenger side mirror.*



## Inside Day / Night Mirror

### Rear View Mirror Adjustment

Before driving, adjust the rear view mirror to center on the view through the rear window.

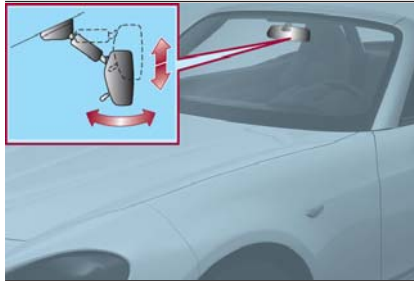

04060102-ADJ-001

### Manual Mirror Adjustment

**Note:** Before adjusting the manual mirror, place the mirror in the “day driving position” (see below).

### Reducing Glare From Headlights

1. Push the lever forward for day driving (A position).
2. Pull the lever rearward to reduce glare of headlights from vehicles at the rear (B position).

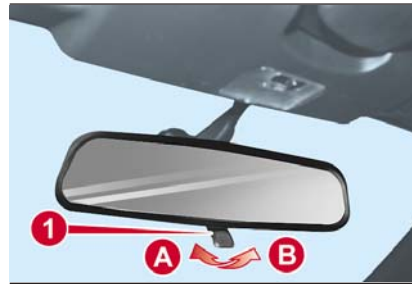

04060102-MAN-002AB

### Mirror Adjustment Lever

- 1 — Mirror Adjustment Lever
- A — Day Driving Position
- B — Reduced Glare Position

### Automatic Dimming Mirror – If Equipped

The automatic dimming mirror automatically reduces glare of headlights from vehicles at the rear when the ignition is switched ON.

Push the off button ( **O** ) to cancel the automatic dimming function. The indicator light will turn off.



04060102-36E-666

### Automatic Dimming Mirror Buttons

- 1 — Off
- 2 — On
- 3 — Light Sensor



### Caution!

*To avoid damage to the mirror during cleaning, never spray any cleaning solution directly onto the mirror. Apply the solution onto a clean cloth and wipe the mirror clean.*

Push the off button ( **O** ) to cancel the automatic dimming function. The indicator light will turn off.

To reactivate the automatic dimming function, push the on button ( **I** ). The indicator light will illuminate.

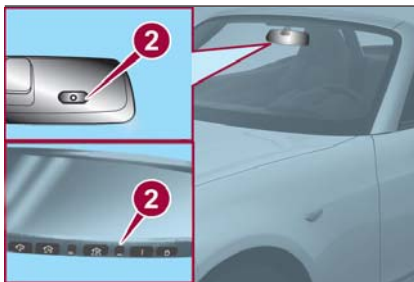

04060102-121-666

### Light/Rain Sensor

2 — Light Sensor

#### Note:

❑ Do not use glass cleaner or suspend objects on or around the light sensor. Otherwise, light sensor sensitivity will be affected and may not operate normally.

❑ The automatic dimming function is canceled when the ignition is switched ON and the gear selector is in REVERSE.

## Power Mirrors

The ignition must be in the ACC or ON position to adjust the outside power mirrors.

Rotate the mirror switch to the left ( L ) or right ( R ) to select which mirror to adjust.

Push the mirror control switch in the direction of the desired position.

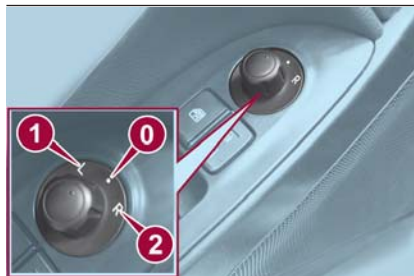

04060101-L12-001

### Power Mirror Switch

- 0 — Center Position
- 1 — Left Position
- 2 — Right Position

After adjusting the mirror, lock the control by rotating the switch to the center position to prevent accidental movements.

## Folding Mirrors

Manually fold the outside mirror rearward until it is flush with the vehicle.

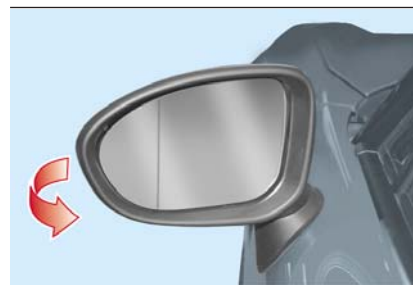

04060101-12R-001AB

### Outside Folding Mirror

Your vehicle may be equipped with a driver side automatic-dimming mirror. The automatic-dimming door mirror is linked with the automatic-dimming rearview mirror inside the vehicle to automatically reduce headlight glare from vehicles at the rear. Refer to “Automatic Dimming Mirror” in this section for further information.

**Note:** The passenger door mirror does not have the automatic-dimming feature.



## EXTERIOR LIGHTS

### Headlights

Rotate the headlight switch to activate/deactivate the headlights, other exterior lights and dashboard illumination.

When the lights are turned on, the  indicator in the instrument cluster illuminates.



05030101-132-001AB

### Headlight Switch

- 1 — Headlight Switch
- 2 — Fog Light Switch

**Note:** To prevent discharge of the battery, do not leave the lights on while the engine is OFF.

## Headlight Operation

### Without Auto-Light Control

Switch Position	OFF		Daytime Running Lights		High Beams	
Ignition Position	ON	ACC Or OFF	ON	ACC Or OFF	ON	ACC Or OFF
Headlights	Off	Off	Off	Off	On	Off
Daytime Running Lights	On	Off	Off	Off	Off	Off
Tail Lights / Position Lights / License Plate Lights / Instrument Panel Illumination	Off	Off	On	On	On	On (*)

(\*) If the driver's door is opened, or 30 seconds have elapsed with the lights turned on, the lights turn off.

### With Auto-Light Control

Switch Position	OFF		AUTO		Daytime Running Lights		High Beams	
Ignition Position	ON	ACC Or OFF	ON	ACC Or OFF	ON	ACC Or OFF	ON	ACC Or OFF
Headlights	Off	Off	Auto (*)	Off	Off	Off	On	Off
Daytime Running Lights	On	Off	Auto (*)	Off	Off	Off	Off	Off
Tail Lights / Position Lights / License Plate Lights / Instrument Panel Illumination	Off	Off	Auto	On (**)/ Off (***)	On	On	On	On (****)

(\*) The headlights and other light settings adjust automatically depending on the surrounding brightness detected by the sensor.

(\*\*) While the lights are turned on, they will remain on even if the ignition is switched to a position other than ON. If the driver's door is opened, or 30 seconds have elapsed with the lights turned on, the lights turn off.

(\*\*\*) When the ignition is switched to a position other than ON, the lights will not turn on even if the headlight switch is switched to AUTO.

(\*\*\*\*) If the driver's door is opened, or 30 seconds have elapsed with the lights turned on, the lights turn off.



## Daytime Running Lights (DRL)

The daytime running lights turn on automatically when the vehicle starts moving.

They turn off when the parking brake is engaged or the gear selector is shifted to the PARK position (if equipped with automatic transmission).

**Note:** In some markets, the daytime running lights can be deactivated. Refer to “Personalization Features” in “Getting To Know Your Instrument Panel” for further information.

## High Beams

The headlights can be switched between high and low beams by pushing the headlight switch lever forward for high beams, and pulling the lever rearward to return to low beams.

When the headlight high beams are on, the  high beam indicator is illuminated in the instrument cluster.

## Flash To Pass

You can signal another vehicle with your headlights by partially pulling the headlight lever toward the steering wheel. This will cause the high beam headlights to turn on until the lever is released.

The  high beam indicator in the instrument cluster illuminates while the high beams are active.

## Automatic Lighting

When the headlight switch is in the AUTO position and the ignition is switched ON, the light sensor will detect the surrounding light levels and automatically turns the headlights, other exterior lights and dashboard illumination on or off.

**Note:** Do not shade the light sensor by placing a sticker or a label on the windshield. Otherwise the light sensor will not operate correctly.



05030101-12A-003

### Light Sensor

The light sensor also works as a rain sensor for the auto-wiper control. Keep hands and scrapers clear of the windshield when the wiper lever is in the AUTO position and the ignition is switched ON, as fingers could be pinched or the wipers and wiper blades damaged when the wipers activate automatically. If you are going to clean the windshield, be sure the wipers are

turned off completely when the engine is running.

### Note:

The headlights, other exterior lights and dashboard lights may not turn off immediately even if the surrounding area becomes well-lit because the light sensor determines that it is night time if the surrounding area is continuously dark for several minutes such as inside long tunnels, traffic jams inside tunnels, or in indoor parking lots. In this case, the lights turn off if the light switch is turned to the OFF position.

When the headlight switch is in the AUTO position and the ignition is switched to ACC or OFF, the headlights, other exterior lights and dashboard illumination will turn off.

The dashboard lights can be adjusted by rotating the knob in the instrument cluster. The day/night mode can be changed by rotating the knob until a beep sound is heard.

The sensitivity of the automatic lights may be changed by an authorized dealer.

## Follow Me Home

The Follow Me Home Light System turns on the headlights (low beams) for a period of time after the ignition is switched OFF.

## System Activation

With the ignition switched to ACC or OFF, pull the headlight control lever rearward and the low beam headlights will turn on.

The headlights turn off after a period of time after all doors are closed.



The time until the headlights turn off after all of the doors are closed can be changed through the Connect system.

The headlights turn off if the lever is pulled again while the headlights are on, or after three minutes of no further action after the first pull of the lever.

## Front Fog Lights

The front fog light can be activated when the ignition is in the ON position and the headlights or parking lights are on.

### Activation

Turn the headlight switch to the  or  position.

Rotate the fog light switch to the  position.



05030101-132-001AB

### Headlight Switch

- 1 — Headlight Switch
- 2 — Fog Light Switch

The  fog light indicator in the instrument cluster illuminates while the front fog lights are on.

### Deactivation

Perform one of the following operations to turn off the front fog lights:

- Rotate the fog light switch to the OFF position.
- Turn the headlight switch to the OFF position.
- Switch the ignition to a position other than ON.

The  fog light indicator in the instrument cluster goes off when the front fog light is turned off.

### With Auto-Light Control

When the fog light switch is in  position and the headlight switch is

in AUTO position, the front fog lights will stay on.

## Turn Signals

The ignition must be in the ON position to use the turn signals and lane change assist.

Move the signal lever down (for a left turn) or up (for a right turn). The signal will self-cancel after the turn is completed.

If the indicator light continues to flash after a turn, manually return the lever to its original position.

The turn signal indicators (green)  in the instrument cluster flash according to the operation of the turn signal lever to show which signal is active.

**Note:** If an indicator light stays on without flashing or if it flashes abnormally, one of the turn signal bulbs may be burned out.

## Lane Change Assist

Move the lever halfway toward the direction of the lane change (until the indicator flashes) and hold it there. It will return to the off position when released.

### Three-Flash Turn Signal

After releasing the turn signal lever, the turn signal indicator flashes three times.

The operation can be cancelled by moving the lever in the direction opposite to which it was operated.



The three-flash turn signal function can be turned on or off using the personalization function in the radio.

### **Adaptive Front Lighting System (AFS) – If Equipped**

This system directs the main headlight beams and adapts it to the driving conditions around bends and turns, continuously and automatically.



The system directs the headlight beam to illuminate the road in the best way, taking into account the speed of the vehicle, the bend or corner angle and the speed of steering.

The Adaptive Front Lighting System is automatically activated when the vehicle is started.

### **Leaving Home Light System**

The Leaving Home Light System turns the headlights on when the unlock button on the key fob is pushed while away from the vehicle.

#### **Activation**



With the ignition switch in the OFF position, and the headlight switch is in the  or  position, the headlights will illuminate when the unlock button on the key fob is pushed, and the vehicle receives the signal.

The headlights turn off after 30 seconds.

The following lights turn on when the Leaving Home Light System is operated: low beams/parking lights/tail lights/license plate lights.

Operation of the Leaving Home Light System can be turned on or off through the Connect system.

When the lock button on the key fob is pushed, and the vehicle receives the signal, the headlights turn off.

When the headlight switch is in a position other than  or , the headlights turn off.

### **Headlamp Leveling System – If Equipped**

On some models, the angle of the headlights will be automatically adjusted when turning on the headlights.

### **Adjusting The Headlight When Abroad**

Dipped headlights are adjusted for driving in the country where the vehicle was originally purchased.

When travelling in countries with opposite driving direction, to avoid flashing the drivers on the other side of the road, you need to cover areas of the headlight. For this operation contact an authorized dealer.

## **WINDSHIELD WIPERS / WASHER**

### **Windshield Wipers And Washer**

The windshield wiper/washer lever is located on the right side of the steering wheel. The ignition must be in the ON position to use these features.

### **Windshield Wipers**

Activate the windshield wipers by pushing the wiper lever up or down.

#### **With Intermittent Wiper**

Set the lever to the intermittent position and choose the interval timing by rotating the center switch.

Switch positions:

-  or **MIST**: operation while pushing the lever upward
- OFF**: stop
- or **INT**: intermittent operation
- or **LO**: low speed operation
- =** or **HI**: high speed operation



## With Auto-Wiper Control

When the wiper lever is in the AUTO position, the rain sensor will sense the amount of rainfall on the windshield and turns the wipers on or off automatically (off/intermittent/low speed/high speed).

Switch positions:

 or **MIST**: operation while pulling up lever

**OFF**: stop

**AUTO**: auto control operation

**LO** or **LO**: low speed operation

**HI** or **HI**: high speed operation

### Adjusting Rain Sensor Sensitivity

The sensitivity of the rain sensor can be adjusted by rotating the switch on the wiper lever.

From the center position (normal), rotate the switch downward for higher sensitivity (+) (faster response) or rotate it upward for less sensitivity (-) (slower response).



### Windshield Wiper Lever

05030101-122-001

#### 1 — Rain Sensor Adjustment

**Note:** Do not shade the rain sensor by placing a sticker or a label on the windshield. Otherwise the rain sensor will not operate correctly.

When the wiper lever is in the AUTO position and the ignition is switched ON, the wipers may move automatically in the following cases:

If the windshield above the rain sensor is touched or wiped with a cloth.

If the windshield is struck with a hand or other object from either outside or inside the vehicle.



### Warning!

Keep hands and scrapers clear of the windshield when the wiper lever is in the AUTO position and the ignition is switched ON as fingers could be pinched or the wipers and wiper blades damaged when the wipers activate automatically.

If you are going to clean the windshield, be sure the wipers are turned off. This is important when clearing ice and snow.

Switching the auto-wiper lever from the OFF to the AUTO position while driving activates the windshield wipers once, after which they operate according to the rainfall amount.

The auto-wiper control may not operate when the rain sensor temperature is about 14 °F (-10 °C) or lower, or about 185 °F (85 °C) or higher.

If the windshield is coated with water repellent, the rain sensor may not be able to sense the amount of rainfall correctly and auto-wiper control may not operate properly.



If dirt or debris (such as ice or debris containing salt water) adheres to the windshield above the rain sensor or if the windshield is iced, it could cause the wipers to move automatically.

However, if the wipers cannot remove this ice, dirt or debris, the auto-wiper control will stop operation. In this case, set the wiper lever to the low speed position or high speed position for manual operation, or remove the ice, dirt or debris by hand to restore the auto-wiper operation.

If the auto-wiper lever is left in the AUTO position, the wipers could operate automatically from the effect of strong light sources, electromagnetic waves, or infrared light because the rain sensor uses an optical sensor.

It is recommended that the auto-wiper lever be switched to the OFF position other than when driving the vehicle under rainy conditions.

The auto-wiper control functions can be turned off.

Because heavy ice and snow can jam the wiper blades, the wiper motor is protected from motor breakdown, overheating and possible fire by a circuit breaker. This mechanism will automatically stop operation of the blades, but only for about five minutes. If this happens, turn off the wiper switch and park off the road and remove the snow and ice. After five minutes, turn on the switch and the blades should operate normally. If they do not resume functioning, contact an authorized dealer as soon as possible. Pull off to the side of the road to a safe location. Wait until the weather clears before trying to drive with the wipers inoperative.

### Windshield Washer

Pull the wiper/washer lever rearward and hold it to spray washer fluid onto the windshield.

With the wiper lever in the OFF, intermittent, or AUTO position, the wipers will operate continuously until the lever is released.



### Warning!

*Sudden loss of visibility through the windshield could lead to a collision. You might not see other vehicles or other obstacles. To avoid sudden icing of the windshield during freezing weather, warm the windshield with defroster before and during windshield washer use.*

If the fluid level is normal and the washer does not work, contact an authorized dealer.



04110109-115-001AB

### Windshield Washer Nozzles

#### With Headlight Washers

When the headlights are on, the headlight washers operate automatically once every fifth time the windshield washer operates.

# CLIMATE CONTROL SYSTEM

## Operating Tips

The air conditioning system will only operate with the engine running.

To prevent the battery from being discharged while the engine is off, do not leave the Blower Control Knob on for extended periods of time.

To improve system efficiency, clear all obstructions (leaves, snow and ice) from the hood and the air inlet in the grille.

Use the air conditioning system to defog the windows and dehumidify the air.

Recirculation mode should be used when driving through tunnels, while in a traffic jam, or when you would like to quickly cool the interior.

Use the outside air position for ventilation or windshield defrosting.

If the vehicle has been parked in direct sunlight during hot weather, open the windows to let warm air escape, and then run the air conditioning system.

To keep the internal parts lubricated and the system running smoothly, run the air conditioner about 10 minutes at least once a month.

Have the air conditioner checked before the weather gets hot. A lack of refrigerant may make the air conditioner less efficient. The refrigerant specifications are indicated on a label (A or B depending on the market) attached to the inside of the engine compartment. Check the label before refilling the refrigerant. If the wrong type of refrigerant is used, it could result in a serious malfunction of the air conditioner. For details, contact your authorized dealer.

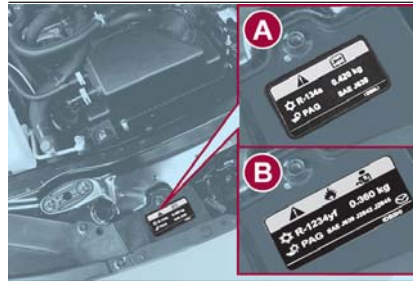

06010100121001

Label Location



## Caution!

*The system uses a coolant that is compatible with the laws in force in the countries where the vehicle is sold, R134a or R1234yf (indicated on a specific plate in the engine compartment). The use of other coolants affects the efficiency and condition of the system. Also the compressor coolants used must be compatible with the indicated coolant.*

## Vent Operation

### Adjusting The Vents

To adjust the direction of air flow, move the vent adjustment knob.

**Note:** When using the air conditioner in humid conditions, fog may blow from the vents. This is a result of humid air being suddenly cooled and does not indicate a system malfunction.



## Center Vents (Driver) and Side Vents

Center and side vents are located on the dashboard.

☐ *Air vent open/close*: the air vents can be fully opened and closed by using knob 1 (A = open / B = close).

☐ *Air flow direction adjustment*: use knob 1 to adjust the center vents to the desired position.

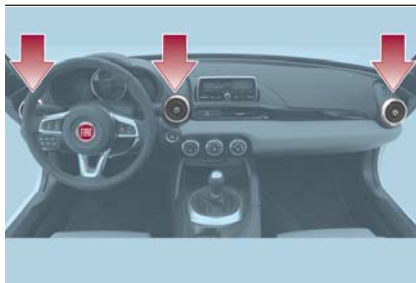

Side Air Vents

06010201-033-001

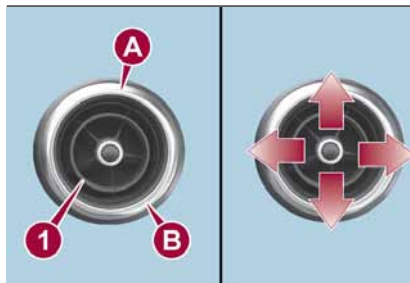

Operating the Side Air Vents

06010201-033-666

- 1 — Air Vent Knob  
A — Open Position  
B — Closed Position

## Center Vents (Front Passenger)

Center vents are located on the dashboard.

☐ *Air vent open/close*: use the Center Vent tab 1 to open/close the center vents (A = open / B = close).

☐ *Air flow direction adjustment*: use the Center Vent tab 1 to adjust the center vents to the desired position.

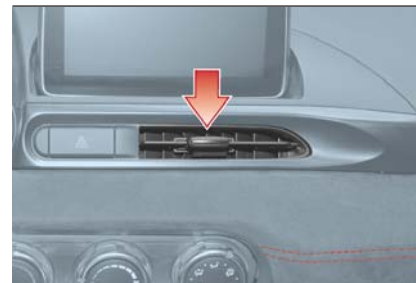

Central Air Vent

06010201-121-001AB

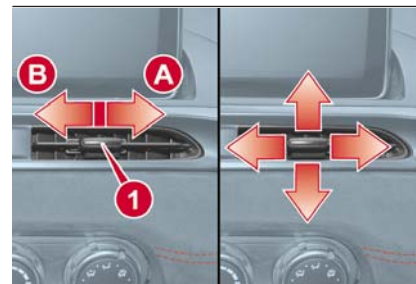

Operating The Central Air Vent

06010201-121-777AB

- 1 — Center Vent Tab  
A — Open Position  
B — Closed Position

## Airflow Mode



**Airflow Locations**

06010202-121-002

- 1 — Fixed Upper Air Diffuser
- 2 — Adjustable Side Air Vents
- 3 — Adjustable Center Air Vent
- 4 — Floor Vents



## Manual Climate Control System

With MAX A/C function



**Manual Climate Controls With MAX A/C**

06010300-122-002

- 1 — Temperature Control Knob
- 2 — Blower Control Knob
- 3 — Mode Selector Knob



- 4 — Rear Window Defrost Button
- 5 — Air Recirculation Button
- 6 — A/C Button

## Controls

### 1 – Temperature Control Knob

This dial controls the interior temperature of the vehicle.

Turn it clockwise for hotter temperatures and counterclockwise for colder temperatures.

**MAX A/C – If Equipped:** When the Mode Selector Knob is set to  or , the Blower Control Knob is in a position other than 0, and the temperature control knob is in the maximum cold position, the Recirculation Button will activate and the A/C will turn on automatically. If A/C is not desired, press the A/C Button to turn it off.

### 2 – Blower Control Knob



The blower has seven speeds. Turn the knob clockwise to increase blower speed or counterclockwise to decrease blower speed.

### 3 – Mode Selector Knob

Turn the Mode Selector Knob to select the air flow mode.

The mode selector dial can be set at the intermediate positions (●) between each mode.

Set the knob to an intermediate position if you want to split the air flow between the two modes.

For example, when the Mode Selector Knob is at the intermediate position (●) between the  and  positions, air

flow from the floor vents is less than that of the  position.

### 4 – Rear Window Defrost Button

The Rear Window Defrost Button clears fog and frost from the rear window. The ignition must be on to use the defroster. Push the button to turn on the Rear Window Defroster. The Rear Window Defroster operates for about 15 minutes and then turns off automatically. The button LED will illuminate when the defroster is operating.

To turn off the Rear Window Defroster before the end of 15 minutes, push the button again.



#### Caution!

*Failure to follow these cautions can cause damage to the heating elements:*

*Use care when washing the inside of the rear window. Do not use abrasive window cleaners on the interior surface of the window. Use a soft cloth and a mild washing solution, wiping parallel to the heating elements. Labels can be peeled off after soaking with warm water.*

*Do not use scrapers, sharp instruments, or abrasive window cleaners on the interior surface of the window.*

*Keep all objects a safe distance from the window.*

#### Note:

Before opening the convertible top, make sure the Rear Window Defrost Button is turned off. Otherwise, the heat generated from the defroster could damage the convertible top and the internal material.

This defroster is not designed for melting snow. If there is an accumulation of snow on the rear window, remove it before using the defroster.

**Mirror Defroster – If Equipped:** To turn on the mirror defroster, turn the ignition ON and push the Rear Window Defroster Button.

### 5 – Air Recirculation Button

Push the Air Recirculation Button to select between outside air and recirculated air positions.

**Recirculated Air Position:** (LED on) Outside air is shut off when this position has been activated. Use this position when going through tunnels, driving in congested traffic (high engine exhaust areas), or when quick cooling of the vehicle is desired.

**Outside Air Position:** (LED off) Outside air is allowed to enter the cabin. Use this mode for ventilation or windshield defrosting.





**Note:** Do not use the Outside Air Position in cold or rainy weather is dangerous as it will cause the windows to fog up. Your vision will be hampered, which could lead to a serious accident.

### 6 – A/C Button

Push the A/C Button to turn on the air conditioner.

The LED on the switch will illuminate when the Blower Control Knob is in any position except the OFF position.

Push the button again to turn off the air conditioner.

**Note:** The air conditioner may not function when the outside temperature approaches 32 °F (0 °C).

### Heating

Proceed as follows:

1. Set the Mode Selector Knob to the  position.
2. Set the Air Recirculation Button to the outside air position.
3. Set the Temperature Control Dial to the hot position.
4. Set the Blower Control Knob to the desired speed.

5. If dehumidified heating is desired, turn on the air conditioner.

If the windshield fogs up easily, set the Mode Selector Knob to the  position.

If cooler air is desired at face level, set the Mode Selector Knob to the  position and adjust the Temperature Control Knob to maintain comfort.

The floor vents will blow warmer air while the side air vents will blow cooler air (except when the temperature control dial is set at the maximum hot or cold position).

### Cooling (With Air Conditioner)

Proceed as follows:

1. Set the Mode Selector Knob to the  position.
2. Set the Temperature Control Knob to the cold position.
3. Set the Blower Control Knob to the desired speed.
4. Turn on the air conditioner by pushing the A/C Button.
5. After cooling begins, adjust the Blower Control Knob and Temperature Control Knob as needed to maintain comfort.

### Note:

If the air conditioner is used while driving up large hills or in heavy traffic, monitor the Engine Coolant Temperature Warning Light to see if it is illuminated or flashing. The air conditioner may cause engine overheating in these situations. If the warning light is illuminated or flashing, turn the air conditioning off immediately.

When maximum cooling is desired, set the Temperature Control Knob to the extreme cold position, push the Air Recirculation Button to activate the recirculated air position, and then turn the fan control dial fully clockwise.

If warmer air is desired at floor level, set the Mode Selector Knob to the  position, and adjust the Temperature Control Knob to maintain comfort.

The floor vents will blow warmer air while the side air vents will blow cooler air (except when the temperature control dial is set at the maximum hot or cold position).



## Ventilation

Proceed as follows:

1. Set the Mode Selector Knob to the  position.
2. Set the Air Recirculation Button to the outside air position.
3. Set the Temperature Control Knob to the desired position.
4. Set the Blower Control Knob to the desired speed.

## Windshield Defrosting And Defogging

Proceed as follows:

1. Set the Mode Selector Knob to the Front Defrost  position.
2. Set the Temperature Control Knob to the desired position.
3. Set the Blower Control Knob to the desired speed.
4. If dehumidified heating is desired, turn on the air conditioner.



### Warning!

*Set the temperature control to the hot or warm position when defogging (Front Defrost position). Using the Front Defrost position with the temperature control set to the cold position is dangerous as it will cause the outside of the windshield to fog up. Your vision will be hampered, which could lead to a serious accident.*

### Note:

- For maximum defrosting, turn on the air conditioner, set the Temperature Control Knob to the extreme hot position, and turn the Blower Control Knob fully clockwise.
- If warm air is desired from the floor vents, set the Mode Selector Knob to the  position.
- If equipped with MAX A/C, the Recirculation Button can be set to the Recirculated Air position, when the Blower Control Knob is ON, and the Mode Selector Knob is set to the Front Defrost position.

## Dehumidifying (With Air Conditioner)

Operate the air conditioner in cool or cold weather to help defog the windshield and side windows.

Proceed as follows:

1. Set the Mode Selector Knob to the desired position.
2. Set the Air Recirculation Knob to the outside air position.
3. Set the Temperature Control Knob to the desired position.
4. Set the Blower Control Knob to the desired speed.
5. Turn on the air conditioner by pressing the A/C Button.

**Note:** One of the functions of the air conditioner is dehumidifying the air. To use this function, the temperature does not have to be set to cold. Set the Temperature Control Knob to the desired position (hot or cold), and turn on the air conditioner to dehumidify the cabin air.



## Automatic Climate Control System



### Automatic Climate Controls — Type A

06010900-122-999

- 1 — Temperature Control Knob
- 2 — Blower Control Knob
- 3 — Mode Selector Knob

- 4 — Rear Window Defrost Button
- 5 — Air Recirculation Button
- 6 — A/C Button



06010900122

### Automatic Climate Controls – Type B

- 1 – Temperature Control Knob
- 2 – Blower Control Knob
- 3 – Mode Selector Knob

- 4 – Rear Window Defrost Button
- 5 – Air Recirculation Button
- 6 – A/C Button



## Controls

### 1 – Temperature Control Knob

This knob controls internal temperature of the vehicle. Turn it clockwise for hotter temperatures and counterclockwise for colder temperatures.

### 2 – Blower Control Knob

The fan has seven speeds. Turn the clockwise to increase blower speed or counterclockwise to decrease blower speed/enter Auto mode.

**AUTO Position:** The blower speed is automatically controlled by the system based upon the set temperature.

**0 Position:** To turn off the system, set the dial to 0 position.

### 3 – Mode Selector Knob

Turn the Mode Selector Knob to select the air flow mode.

**AUTO Position:** The air flow automatically adjusts based upon the selected temperature.

## Note:

With the air flow mode set to the  position, and the Temperature Control Knob is set to a medium temperature, the floor vents will blow warmer air, and the center and side air vents will blow cooler air.

When the Blower Control Knob is on, and the Mode Selector Knob is in the  position, the air conditioner is automatically turned on, and the Air Recirculation Button is automatically set to the outside air position for windshield defrosting.

### 4 – Rear Window Defrost Button

The Rear Window Defroster clears fog and frost from the rear window. The ignition must be switched ON to use the defroster.

Push the button to turn on the Rear Window Defroster.

The Rear Window Defroster operates for about 15 minutes, and then turns off automatically.

The button LED will illuminate when the defroster is operating.

To turn off the Rear Window Defroster before the end of 15 minutes, push the switch again.



## Caution!

*Failure to follow these cautions can cause damage to the heating elements:*

*Before opening the convertible top, make sure the Rear Window Defrost Button is turned OFF. Otherwise, the heat generated from the defroster could damage the convertible top and the internal material.*

*Use care when washing the inside of the rear window. Do not use abrasive window cleaners on the interior surface of the window. Use a soft cloth and a mild washing solution, wiping parallel to the heating elements. Labels can be peeled off after soaking with warm water.*

*Do not use scrapers, sharp instruments, or abrasive window cleaners on the interior surface of the window.*

*Keep all objects a safe distance from the window.*

**Note:** This defroster is not designed for melting snow. If there is an accumulation of snow on the rear window, remove it before using the defroster.

**Mirror Defroster – If Equipped:** To turn on the mirror defroster, switch the ignition on and push the Rear Window Defroster Button.

## 5 – Air Recirculation Button

Press the Air Recirculation Button to select between outside air and recirculated air positions.

**Recirculated Air Position:** (LED On)  
Outside air is shut off when this position has been activated. Use this position when going through tunnels, driving in congested traffic (high engine exhaust areas), or when quick cooling of the vehicle is desired.

**Outside Air Position:** (LED Off)  
Outside air is allowed to enter the cabin. Use this mode for ventilation or windshield defrosting.

**Note:** Do not use the Recirculated Air Position in cold or rainy weather. Using the Recirculated Air Position in cold or rainy weather is dangerous as it will cause the windows to fog up. Your vision will be hampered, which could lead to a serious accident.

## 6 – A/C Button

Push the A/C Button to turn on the air conditioner.

The LED on the switch will illuminate when the Blower Control Knob is in any position except the off position. Push the button again to turn off the air conditioner.

**Note:** The air conditioner may not function when the outside temperature approaches 32 °F ( 0 °C).

## Operation Of Automatic Air Conditioning

Proceed as follows:

1. Set the mode selector knob to the AUTO position.

2. Set the Air Recirculation Button to the outside air position (indicator light turned off).

**Note:** If the recirculated air position is used for long periods in cold weather or high humidity, the windshield may fog up more easily.

3. Set the Blower Control Knob to the AUTO position.

4. Push the A/C button to operate the air conditioning (indicator light on).

5. Set the Temperature Control Knob to the desired position.

6. To turn off the system, set the blower control knob to the 0 position. Setting the temperature to maximum hot or cold will not provide the desired temperature at a faster rate.

When selecting heat, the system will restrict air flow until it has warmed to prevent cold air from blowing out of the vents.

For an optimal cabin temperature, set the temperature close to 77°. Adjust to the desired temperature if necessary.

## Windshield Defrosting And Defogging

Set the mode selector knob to the  position and turn the blower control knob to the desired speed.

In this position, the outside air position is automatically selected, and when the blower control knob is on, the air conditioner automatically turns on. The air conditioner will directly dehumidify the air to the front windshield and side windows. Air flow amount will be increased.

Use the temperature control knob to increase the air flow temperature and defog the windshield more quickly.



### Warning!

*Set the temperature control to the hot or warm position when defogging (Front Defrost position). Using the Front Defrost position with the temperature control set to the cold position is dangerous as it will cause the outside of the windshield to fog up. Your vision will be hampered, which could lead to a serious accident.*



## Sunlight/Temperature Sensor

The air conditioning system measures inside and outside temperatures, and sunlight.

It then sets temperatures inside the cabin accordingly.



06010904333003

### Exterior Sensor

1 — Sunlight Sensor

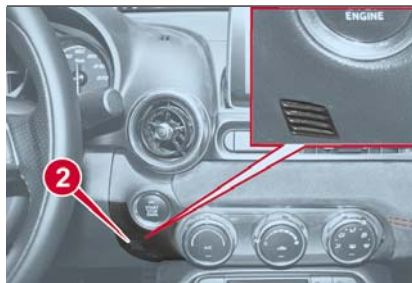

06010904-121-002AB

### Interior Sensor

2 — Interior Temperature Sensor

**Note:** Do not obstruct either sensor. Otherwise, the air-conditioning system will not operate properly.

## POWER WINDOWS

### Power Window Controls

The ignition must be placed in the ON position for the power windows to operate.

A power window may no longer open/close if you continue to push the switch after opening/closing the power window.

If the power window does not open/close, wait a moment and then operate the switch again.

**Note:** To prevent burning out the fuse and damaging the power window system, do not open or close both windows at once.

The passenger window can be operated with each door switch when the power window lock switch on the driver's door is in the unlocked position.

### Passenger Control Switches

The passenger window can also be operated using the master control switches on the driver's door.



04070103-LN2-002

### Power Window Switches

- 1 — Driver's Window
- 2 — Passenger's Window

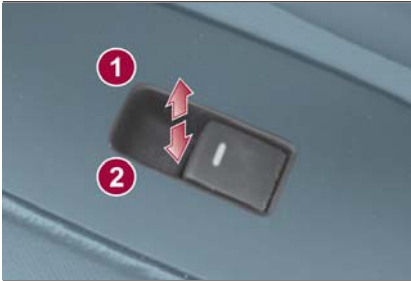

04070103-L12-001

### Power Window Switch Function

- 1 — Closing-Lightly Pull The Switch Up
- 2 — Opening-Lightly Hold The Switch Down

## Auto-Opening Power Windows

To fully open the window automatically push the switch completely down. To stop the window partway pull or push the switch in the opposite direction and then release it. The power window cannot be fully closed while the door is open.

## Power Window System Initialization Procedure

If the battery was disconnected during vehicle maintenance, or for other reasons (such as a switch continues to be operated after the window is open/closed), the window will not fully open automatically.

Resetting of the automatic function can be performed using the master control switches or each passenger door switch.

The power window auto function reset procedure can be done on both door switches. The power window auto function will only resume on the power window that has been reset:

1. Close the doors and the convertible top.
2. Place the ignition in the ON position.
3. Make sure that the power window lock switch located on the driver's door is not depressed.
4. Push the switch and fully open the window.

5. Pull up the switch to fully close the window and continue holding the switch for about two seconds after the window fully closed.

6. Repeat steps four and five for the passenger power window while seated in the passenger seat.

7. Make sure that the power windows operate correctly using the door switches.

After the system has been re-initialized, passenger window can be fully opened automatically using the master control switches. If the automatic power window operation does not operate normally while the doors or convertible top are opened/closed, reset it using the above procedures.

## Engine-Off Power Window Operation

The power window can be operated for about 40 seconds after the ignition has been cycled from ON to the OFF position with both doors closed. If any door is opened, the power window will stop operating.

For engine-off operation of the power window, the switch must be held up firmly throughout window closure because the auto-closing function will be inoperable.





**Warning!**

Never leave children unattended in a vehicle, and do not let children play with power windows. Do not leave the key fob in or near the vehicle, or in a location accessible to children, and do not leave the ignition of a vehicle equipped with the Keyless Entry System in the ACC or ON/RUN mode. Occupants, particularly unattended children, can become entrapped by the windows while operating the power window switches. Such entrapment may result in serious injury or death.

**Power Window Lock Switch**

This feature prevents the passengers power window from operating. Keep this switch in the locked position while children are in the vehicle.

- 1. Locked Position (Button Pushed):** only the driver's power window can be operated.
- 2. Unlocked Position (Button Not Pushed):** both power windows on each door can be operated.

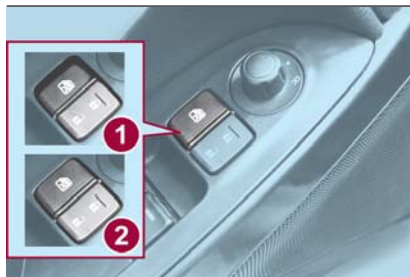

04070104-L-12-001

**Power Window Lockout Switch**

- 1 — Locked Position
- 2 — Unlocked Position

**Note:** When the power window lock switch is in the locked position, the light on the passenger power window switch turns off. The light may be difficult to see depending on the surrounding brightness.

**HOMELINK — IF EQUIPPED****General Information**

The HomeLink system replaces up to three hand-held transmitters with a single built-in component in the auto-dimming mirror. Pushing the HomeLink button on the auto-dimming mirror activates garage doors, gates and other devices surrounding your home.

**Note:** HomeLink and HomeLink house icon are registered trademarks of Gentex Corporation.

**Warning!**

- Vehicle exhaust contains carbon monoxide, a dangerous gas. Do not run your vehicle in the garage while programming the transceiver. Exhaust gas can cause serious injury or death.*
- Your motorized door or gate will open and close while you are programming the universal transceiver. Do not program the transceiver if people, pets or other objects are in the path of the door or gate. Only use this transceiver with a garage door opener that has a "stop and reverse" feature as required by Federal safety standards. This includes most garage door opener models manufactured after 1982. Do not use a garage door opener without these safety features. Call toll-free 1-800-355-3515 or, on the Internet at [HomeLink.com](http://HomeLink.com) for safety information or assistance.*



## Pre-Programming The System

**Note:** It is recommended that a new battery be placed in the hand-held transmitter of the device being programmed to HomeLink for quicker training and accurate transmission of the radio-frequency signal.

Proceed as follows:

1. Verify that there is a remote control transmitter available for the device you would like to program.
2. Disconnect the power to the device.

## Programming The System

**Note:** When programming a garage door opener or a gate, disconnect the power to these devices before programming. Continuous operation of the devices could damage the motor.

The HomeLink system provides three buttons which can be individually selected and programmed using the transmitters for current, on-market devices as follows:

1. Disconnect power to the device being programmed.
2. Position the end of your handheld transmitter one to three inches (2.5 - 7.5 cm) away from the HomeLink button you wish to program while keeping the indicator light in view.
3. Simultaneously press and hold both the chosen HomeLink and hand-held

transmitter buttons. **Do not release the buttons until step four has been completed.**



04060102-121-999

### HomeLink Buttons

- 1 — First HomeLink Button
- 2 — Second HomeLink Button
- 3 — Third HomeLink Button

4. After the HomeLink indicator light changes from a slow to a rapidly blinking light, release both the HomeLink and hand-held transmitter buttons.
5. Connect power to the device being programmed.
6. Firmly press and hold the programmed HomeLink button for five seconds, and then release it. Perform this operation two times to activate the door or gate. If the door or gate does not activate, press and hold the just-trained HomeLink button and observe the indicator light. If the indicator light stays on constantly,

programming is complete and your device should activate when the HomeLink button is pressed and released.

**Note:** To program the remaining two HomeLink buttons, begin with step one.

7. If the indicator light blinks **rapidly for two seconds and then turns to a constant light, continue with “Programming” steps (see below)** to complete the programming of a rolling code equipped device (most commonly a garage door opener).

8. At the garage door opener receiver (motor-head unit) in the garage, locate the “learn” or “smart” button. This can usually be found where the hanging antenna wire is attached to the motorhead unit.

9. Press and release the “learn” or “smart” button (the name and color of the button may vary by manufacturer).

**Note:** Complete the programming within 30 seconds.

10. Return to the vehicle and firmly **press, hold for two seconds and release** the programmed HomeLink button. Repeat the “**press/hold/release**” sequence a second time, and, depending on the brand of the garage door opener (or other rolling code equipped device), repeat this sequence a third time to complete the programming process. HomeLink



should now activate your rolling code equipped device.

**Note:** To program the remaining two HomeLink buttons, begin with step one.

For questions or comments, please contact HomeLink at [www.homelink.com](http://www.homelink.com) or 1-800-355-3515.

### Gate Operator/Canadian Programming

Canadian radio-frequency laws require transmitter signals to “time-out” (or quit) after several seconds of transmission - which may not be long enough for HomeLink to pick up the signal during programming.

Similar to this Canadian law, some U.S. gate operators are designed to “time-out” in the same manner.

If you live in Canada or you are having difficulties programming a gate operator by using the “Programming” procedures (regardless of where you live), replace “Programming The System” step three with the following:

**Note:** If programming a garage door opener or gate operator, it is advised to unplug the device during the “cycling” process to prevent possible overheating.

1. Continue to press and hold the HomeLink button while you **press and release - every two seconds** (“cycle”) your hand-held transmitter until the

frequency signal has successfully been accepted by HomeLink (the indicator light will flash slowly and then rapidly).

2. Proceed with the “Programming” steps to complete.

### Operating The System

Push the programmed HomeLink button to operate a programmed device.

The code will continue being transmitted for a maximum of 20 seconds.

### Reprogramming The System

To program a device to HomeLink using a HomeLink button previously trained, follow these steps:

1. Push and hold the desired HomeLink button. **DO NOT** release the button;
2. The indicator light will begin to flash after 20 seconds. Without releasing the HomeLink button, proceed with “Programming The System” step one.

### Erasing Programmed HomeLink Buttons

To erase the existing programming from all three operating channels, push and hold the two outside buttons 1 and 3 on the auto-dimming mirror until the HomeLink indicator light begins to flash after approximately 10 seconds.

Verify that the programming has been erased when you resell the vehicle.

## INTERNAL EQUIPMENT

### Storage Compartments

#### Center Console

The center console is located between the driver’s and passenger’s seats.



#### Warning!

*Keep storage compartments closed when driving. Driving with the storage compartments open is dangerous. To reduce the possibility of injury in an accident or a sudden stop, keep the storage compartments closed when driving.*



#### Caution!

*Do not leave lighters or eyeglasses in the storage compartments while parked under the sun. A lighter could explode or the plastic material in eyeglasses could deform and crack from high temperature.*

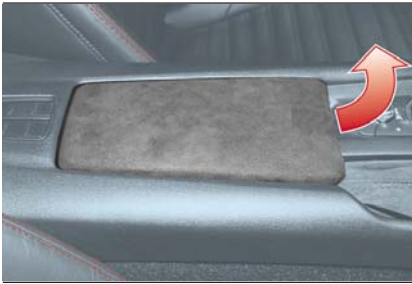

06040706-12A-001AB

### Center Console Lid

### Seat Side Compartment

The seat side compartment is located between the seats above the cupholders.



06040717-121-001AB

### Seat Side Compartment

- 1 — Release Handle
- 2 — Key Hole

To open, push the release handle down to open the seat side compartment.

Insert the emergency key in the lock and turn it clockwise to lock, counter clockwise to unlock.

**Note:** When using the rear console cup holders, remove any cups before opening the seat side compartment. If the seat side compartment is opened with a cup present, the lid will hit the cups and may cause the contents to spill.

### Back Trim Storage Compartment

Small items can be stored in the back trim storage compartment which is located behind the seats.

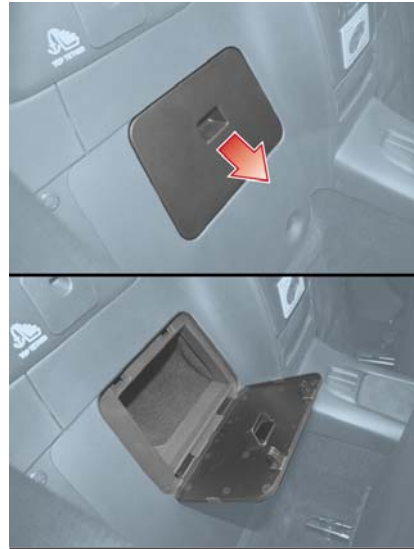

06040718-12A-002AB

### Back Trim Storage Compartment

To use the back trim storage compartment, slide the seat all the way forward and fold the seat back forward, then open the compartment.

When finished, close the compartment and return the seat to its original position and secure it.

After returning the seat to its original position, make sure the seat is secured by attempting to lightly move it forward and rearward.



### Caution!

*Do not forcefully push objects into the rear storage compartment. Otherwise, the box could be damaged.*

### Sun Visors

The sun visors are located at the sides of the interior rear view mirror. They can be adjusted forward toward the windshield, and sideways toward the side windows, to block sunlight.



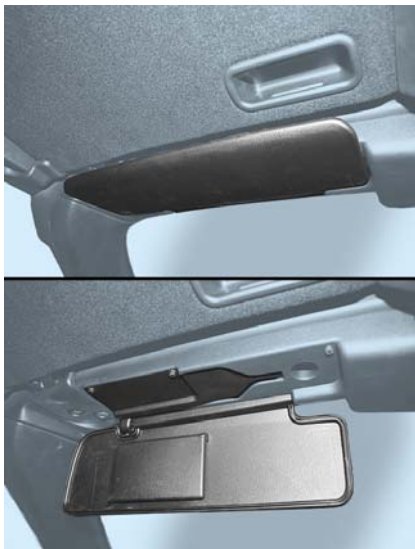

**Sun Visor**

06040100-L12-001AB

### Vanity Mirrors

To access the vanity mirror, fold the sun visor down and lift the cover toward the seats.

### Interior Lights

#### Overhead Light

The interior light is located in the headliner in between the sun visors. The interior light can be set to three different positions.



06040200-12A-002AB

#### Overhead Light Switch

- 1 — On
- 2 — Door
- 3 — Off

Light switch positions:

- On : Light is on at all times.
- Door : Light is on when any door is open. Light is on or off when the illuminated entry system is on.
- Off : Light is off at all times.

#### Trunk Light

The trunk light comes on when the lid is open and turns off when closed.



06040200-T12-003

#### Trunk Light Location

- 1 — Trunk Light Switch

**Note:** To prevent the battery from being discharged, do not leave the trunk open for a long period when the engine is not running.

#### Illuminated Entry System

The overhead light turns on when any of the following operations occurs with the overhead light switch in the door position and the ignition switched OFF:

- Turns on for about 30 seconds when the driver's door is unlocked.
- Turns on for about 15 seconds when a door is opened while a key fob is left in the vehicle and then the door is closed.
- Turns on for about five seconds when a door is opened from the outside with a key fob being carried and then the door is closed.

The overhead light turns on for about 15 seconds when the ignition is switched OFF with the overhead light switch in the door position.

The overhead light turns off immediately in the following cases:

- The ignition is switched ON and both doors are closed.
- The driver's door is locked.

### Battery Saver

If any door is left open with the overhead light switch in the door position or the trunk lid is left open, the overhead light or trunk light turns off after about 30 minutes to prevent discharge of the battery.

To prevent discharge of the battery, if the interior lights remain on (the interior light switch is in the on position), they will turn off automatically under the following conditions:

- No operations are done for about 30 minutes after the ignition is switched OFF.
  - The  button on the key fob is pushed, or the request switch located on the exterior door handle is pushed to lock the doors (vehicles with the advanced keyless function) after the ignition is switched OFF.
- In addition, if the following operations are performed after turning the interior lights off, they will turn on again if:

- The ignition is switched to a position other than OFF.
  - A door is opened.
  - A door is unlocked.
- The operation of the illuminated entry system can be changed through the Connect system.

### Accessory Socket

The accessory socket is located deep in the back of the footwell on the passenger side.

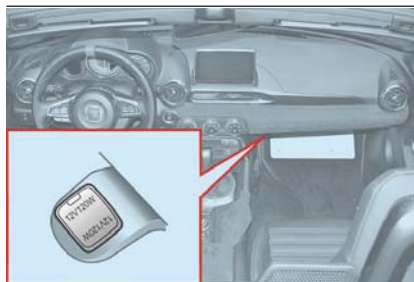

06040400-L12-002AB

### Accessory Socket

Only use genuine FCA accessories or the equivalent requiring no greater than 12V (120 W, 10A).

The ignition must be placed in ACC or ON.

To prevent accessory socket damage or electrical failure, pay attention to the following:

- Do not use accessories that require more than 12V (120 W, 10A).

- Do not use accessories that are not genuine FCA accessories or the equivalent.

- Close the cover when the accessory socket is not in use to prevent foreign objects and liquids from getting into the accessory socket.

- Correctly insert the plug into the accessory socket.

- Do not insert the cigarette lighter into the accessory socket.

- Noise may occur on the audio playback depending on the device connected to the accessory socket.

- Depending on the device connected to the accessory socket, the vehicle's electrical system may be affected, which could cause the warning light to illuminate. Disconnect the connected device and make sure that the problem is resolved. If the problem is resolved, disconnect the device from the socket and switch the ignition off. If the problem is not resolved, contact an authorized dealer.

**Note:** To prevent discharging of the battery, do not use the socket for long periods with the engine off or idling.



**Warning!**

To avoid serious injury or death:

- Only devices designed for use in this type of outlet should be inserted into any 12 Volt outlet.
- Do not touch with wet hands.
- Close the lid when not in use and while driving the vehicle.
- If this outlet is mishandled, it may cause an electric shock and failure.

**Cupholders — If Equipped**

Cupholders are available and can be inserted in the center console on the passenger side and the rear area of the center console.

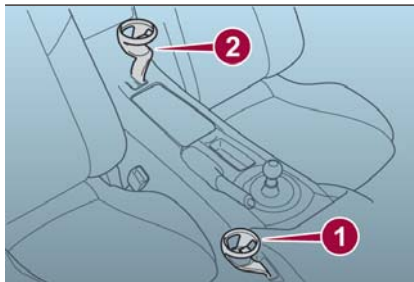

06040500L21002

**Cupholders**

- 1 — Front Cup Holder
- 2 — Rear Cup Holder (If Equipped)

**Warning!**

Never use a cup holder to hold hot liquids while the vehicle is moving. Using a cup holder to hold hot liquids while the vehicle is moving is dangerous. If the contents spill, you could be burned.

**Caution!**

- Do not place plastic bottles without caps in the cup holders. Otherwise, the contents may spill while the vehicle is being driven.
- Do not place excessive weight on the cup holders such as by resting your hands or elbows on them. Otherwise, the cup holders could be damaged.
- If a passenger is present, install the front cup holder to the rear console. Otherwise, a knee might hit it and cause the contents to spill.

**Removing Cup Holders**

Use both hands when removing the cup holder.



06040500-J12AEC1-001

**Removing Cupholders****Installing Cupholders**

When installing a cupholder, insert it firmly into the installation hole and make sure that it is secured in place.



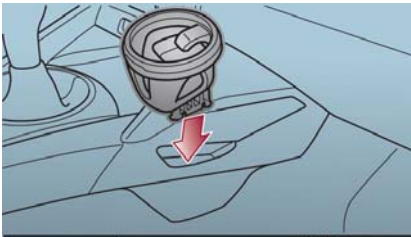

06040500-J12AEC2-001

### Installing Cupholders

The front cupholder can be removed and installed to the rear console.

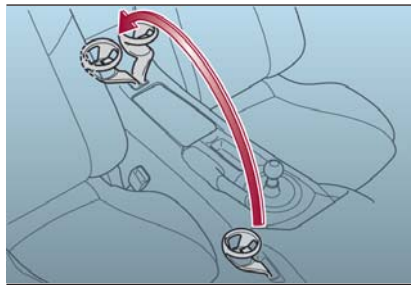

06040500-L25-002

### Correct Cupholder Placement

The rear cupholder is designed for use on the rear console and cannot be installed to the front side.

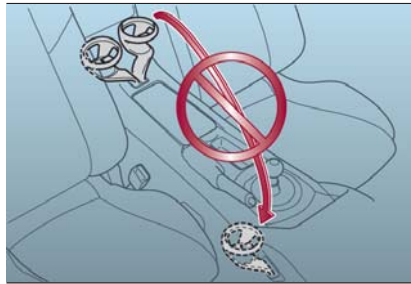

06040500-L26-001

### Incorrect Cupholder Placement

## Windblocker

This windblocker reduces rear wind coming into the cabin when driving with the convertible top down.



06041000-12A-003AB

### Windblocker



## TRUNK LID

### Opening



#### Warning!

- ❑ Before opening the trunk lid, remove any snow and ice accumulation on it. Otherwise, the trunk lid could close under the weight of the snow and ice resulting in injury.
- ❑ Be careful when opening/closing the trunk lid during strong winds. If a strong gust blows against the trunk lid, it could close suddenly resulting in injury.
- ❑ Fully open the trunk lid and make sure that it stays open. If the trunk lid is only opened partially, it could slam shut by vibration or wind gusts resulting in injury.
- ❑ When loading or unloading luggage in the trunk, turn off the engine. Otherwise, you could get burned by the heat of the exhaust gas.

### Using The Remote Release Button – If Equipped



04030201-R12-001

#### Interior Trunk Lid Release Button

The remote release button function can be disabled by locking the doors using the key fob, emergency key, or a request switch on the exterior door handle to prevent an intruder in the vehicle from opening the trunk lid.

To enable the remote release button operation, unlock the doors by using the key fob, emergency key, request switch on the exterior door handle, or place the ignition in the ON position.

**Note:** The remote release button cannot be disabled by locking the doors using the door-lock switch/door-lock knob.

### Using The Electric Trunk Lid Opener

With the remote release button: a trunk lid can also be opened while the key fob is being carried.

Push the electric trunk lid button and raise the trunk lid when the latch releases.



04030201-12A-001

#### Electric Trunk Release Button

Without the remote release button: unlock the doors and trunk lid, then push the electric trunk lid opener and raise it when the latch releases.



## With The Advanced Keyless Entry Function

A locked trunk lid can also be opened while the key fob is being carried. When opening the trunk lid with the doors locked, it may require a few seconds for the trunk lid latch to release after the electric trunk lid opener is pushed.

The trunk lid can be closed when the doors are locked with the key fob left in the vehicle. However, to prevent locking the key fob in the vehicle, the trunk lid can be opened by pushing the electric trunk lid opener. If the trunk lid cannot be opened despite doing this procedure, push the electric trunk lid opener to fully open the trunk lid after pushing the trunk lid completely closed. If the vehicle battery is discharged or there is a malfunction in the electrical system and the trunk lid cannot be unlocked, the trunk lid can be opened by performing the emergency procedure.

## When Trunk Lid Cannot Be Opened

If the battery is discharged, the trunk lid cannot be unlocked and opened. In this case, the trunk can be unlocked by taking care of the discharged battery situation.

If the trunk lid cannot be unlocked even if the discharged battery situation has been resolved, the electrical system may have a malfunction.

Proceed as follows:

1. Close the convertible top and remove the windblocker.



08080100-125-002

### Remove Windblocker

2. Remove the fasteners on the right side of the vehicle.

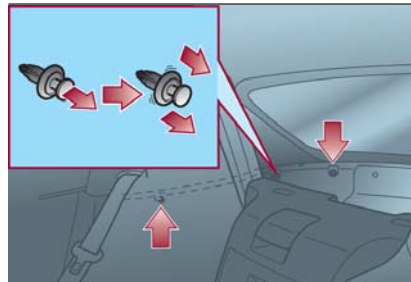

08080100-121-004

### Remove Fasteners

3. Partially peel back the cover on the right side of the vehicle.



08080100-122-001

### Cover Removal

4. Turn and loosen the cap screws until the screws start to spin free.

**Note:** Do not pull the screw when pulling the cap. Otherwise, the screw may fall off and become lost.

Refer to “Trunk Emergency Release” located in “Getting To Know Your Vehicle” for further information.

## Closing

1. Use both hands to push the trunk lid down until the lock snaps shut. Do not slam it.
2. Pull up on the trunk lid to make sure it is secure.



## TRUNK EMERGENCY RELEASE

As a security measure, a trunk internal emergency release lever is built into the rear tail panel. In the event of an adult or child being locked inside the trunk, the trunk can be simply opened by pulling down the lever and open the trunk lid. After performing this emergency measure, contact an authorized dealer as soon as possible.



08080100-123-004

**Trunk Emergency Release**

## Trunk Safety Warning



### Warning!

*Do not allow children to have access to the trunk, either by climbing into the trunk from outside, or through the inside of the vehicle. Always close the trunk lid when your vehicle is unattended. Once in the trunk, young children may not be able to escape, even if they entered through the rear seat. If trapped in the trunk, children can die from suffocation or heat stroke.*

## HOOD

### Opening The Hood

To open the hood, proceed as follows:

1. With the vehicle in PARK, pull the release handle located to the left of the steering wheel, below the instrument panel.

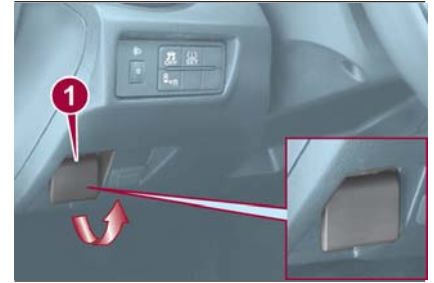

07030201-L12-001

### Releasing The Hood Latch

- 1 — Hood Release Handle

2. Move to the outside of the vehicle and insert your hand into the hood opening, then slide the latch lever to the right, and lift up the hood.



07030201-122-001AB

### Sliding The Latch Lever To The Right

2 — Latch Lever

3. Pull up the support rod from the clip, and insert it into the support rod hole indicated by the arrow to hold the hood open.

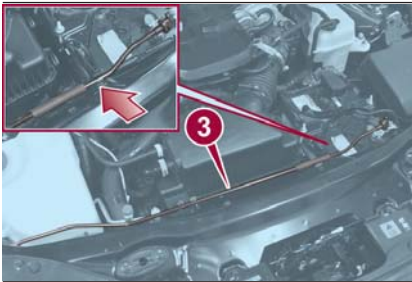

07030201-130-888

### Support Rod Location

3 — Support Rod

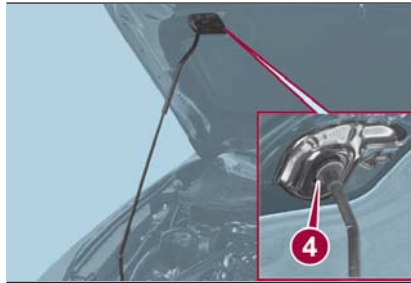

07030201-123-002

### Inserting Support Rod Into Hole

4 — Support Rod Hole

### Closing The Hood

To close the hood, proceed as follows:

1. Check under the hood area to make certain all filler caps are in place and all loose items (e.g. tools, oil containers, etc.) have been removed.
2. Lift the hood with one hand, and with the other hand grasp the padded area on the support rod.
3. Secure the support rod into the rod clip.
4. Verify that the support rod is secured in the clip before closing the hood.
5. Lower the hood slowly to a height of about 8 inches (20 cm) above its closed position and then let it drop.



### Warning!

Be sure the hood is fully latched before driving your vehicle. If the hood is not fully latched, it could open when the vehicle is in motion and block your vision. Failure to follow this warning could result in serious injury or death.



### Caution!

To prevent possible damage, do not slam the hood to close it. Lower hood to approximately 8 inches (20 cm) and drop the hood to close. Make sure hood is fully closed for both latches. Never drive vehicle unless hood is fully closed, with both latches engaged.



## CONVERTIBLE TOP (SOFT TOP)

### Lowering The Convertible Top



#### Warning!

*Do not sit on the folded convertible top, otherwise the convertible top could be damaged or you may fall off and be injured.*

To lower the convertible top, Proceed as follows:

1. Make sure the parking brake is applied and the engine is OFF.
2. Make sure there are no objects which have been placed in the area where the convertible top is to be retracted.
3. Push forward on the release latch. There is a red indicator showing that the latch is open.

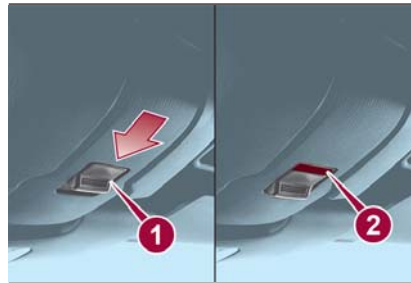

04110102-L36-006

#### Lock Release Latch

- 1 — Release Latch Closed
- 2 — Release Latch Open

4. With the lock release latch pushed forward (red indicator visible), pull the top latch handle rearward to unlock it.



04110102-L21-001

#### Pulling The Top Latch Handle Rearward

- 3 — Latch Release Handle

5. Remove the striker from the anchor.

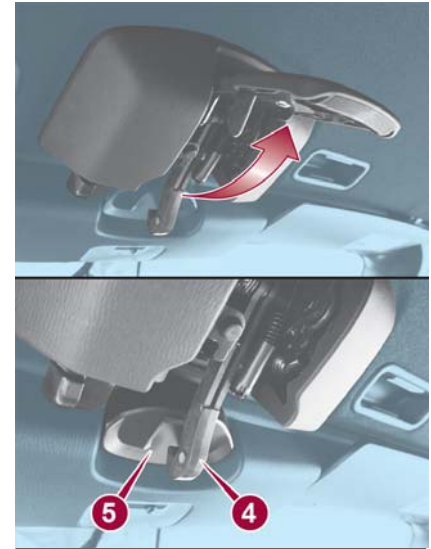

04110102-L22-002

#### Removing Striker From Anchor

- 4 — Striker
- 5 — Anchor

**Note:** The power windows will go down automatically when the convertible top is opened. If the power windows do not go down automatically, fully open the windows using the power window switch located on the doors.

6. Standing outside of the vehicle, hold the convertible top along the front edge and pull it toward the rear of the vehicle. To lower the convertible top from inside the vehicle, use the convertible top handles.



04110102-123-002AB

### Convertible Top Handles

6 — Handles

7. Move the convertible top rearward and while pushing the rear glass lightly with your hand.

8. With the back end of the convertible top pushed down, push the front end until a latching sound is heard. Lightly rock the retracted convertible top to make sure it is securely locked.



04110102-126-001AB

### Retracted Convertible Top



### Warning!

Always keep your hands and fingers away from the fastening mechanisms when moving the convertible top: it is dangerous to place your hands or fingers near the fastening mechanisms. Your hands or fingers could be caught and injured by the mechanism.

Sit in the seat with the seat belt correctly fastened when the vehicle is moving: standing in the vehicle, or sitting on the

*convertible top storage area or center console when the vehicle is moving is a dangerous way to ride. During a sudden maneuver or collision you could be seriously injured or even killed.*

### Raising The Convertible Top

To raise the convertible top, proceed as follows:

1. Make sure the parking brake is applied and the engine is OFF.
2. Pull the unlock lever upward to disengage the lock.

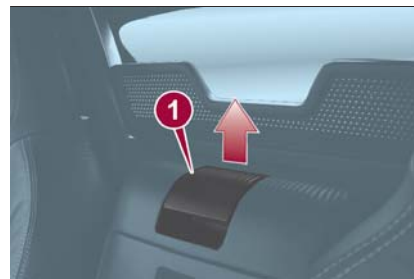

04110103-121-004

### Unlock Lever Location

1 — Unlock Lever



3. Standing outside of the vehicle, hold the convertible top along the front edge and pull it towards the vehicle front. To raise the convertible top from inside the vehicle, use the convertible top handles.



04110103-L23-002

### Convertible Handle Location

2 — Convertible Top Handles

4. While sitting in a seat, grasp the convertible top handles, and push the convertible top against the windshield. Make sure the striker engages with the anchor, move the top latch slowly, and then push the top latch upward until a latching sound is heard.

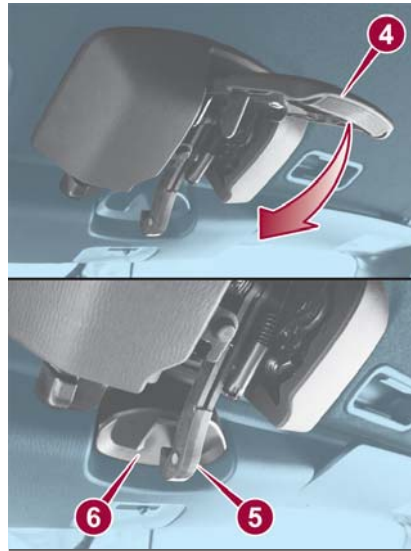

04110103-L24-003

### Convertible Top Components

4 — Closing Release Latch  
5 — Striker  
6 — Anchor

5. If the red indicator is visible on the lock release button, the convertible top is not locked. After locking the convertible top, verify that the red indicator is not visible.

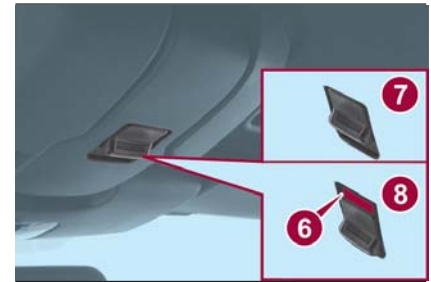

04110103-124-001

### Lock Release Button

6 — Red Indicator  
7 — Release Latch Locked  
8 — Release Latch Unlocked



### Caution!

*Driving with the convertible top not fully locked could damage the convertible top.*

### Note:

Do not spray water directly near the seam of the window and convertible top when flushing away dirt on the soft top with water. Otherwise, water may enter the vehicle (refer to “Convertible Top Maintenance” in “Servicing And Maintenance”).



❑ The convertible top may be constricted if it is left retracted for a long period. Therefore, if the top has become constricted, it may be difficult to hook the top latch striker to the anchor.

❑ Make sure the convertible top is securely locked by pushing up on it. If it still sounds loose (rattles) after being locked by the top latch, contact an authorized dealer.

## Convertible Top Precautions

❑ Remove leaves or other debris that may accumulate on and around the convertible top. If leaves or other debris block the drain filter, water may enter the vehicle. Clean the drain filter at least once a year.

❑ Before lowering or raising the convertible top, stop in a safe place off of the road and park on a level surface.

❑ When lowering the convertible top, make sure objects inside the vehicle are not blown away by the wind.

❑ Secure all loose objects inside before driving with the convertible top down.

❑ To help prevent theft or vandalism and to ensure that the passenger compartment stays dry, close the convertible top securely and lock both doors when leaving the vehicle.

❑ The soft top is made of high quality material and if it is not maintained correctly, the material could harden, become stained, or have an uneven gloss.

❑ Lowering the convertible top while it's wet can also cause water to drip into the cabin.

❑ The power windows go down automatically in conjunction with the convertible top opening/closing. However, this is a function for improving the operability, and it does not mean there is a problem. If the vehicle battery is disconnected for vehicle maintenance or other reasons, the power windows will not go down automatically. If the power windows do not go down, the automatic open/close mechanism for the windows must be reset.

❑ The windblocker reduces the amount of wind coming into the cabin from behind when driving with the convertible top opened.

❑ Before starting the vehicle make sure the convertible top is correctly locked.



### Caution!

❑ Before opening the convertible top, make sure the rear window defroster switch is turned off. Otherwise the heat generated from the window defroster could damage the convertible top and the internal material.

❑ Make sure nothing is on the convertible top or near the back window when raising or lowering the convertible top. Even small objects may interfere and cause damage.

❑ Do not drive through an automatic car wash; it may damage the convertible top.

❑ Do not raise or lower the convertible top when the temperature is below 41 °F (5 °C); this will damage the convertible top material.

❑ Do not lower the convertible top when it's wet. If the convertible top dries while folded, it will deteriorate and mold.

❑ Do not raise or lower the convertible top in a strong wind as it could damage the convertible top or cause an unexpected accident.



## ELECTRIC POWER STEERING

### Power Steering

Electric power steering is only operable when the engine is running.

If the engine is off or if the power steering system is inoperable, you can still steer, but it requires more physical effort.

If the steering feels stiffer than usual during normal driving or the steering vibrates, contact your authorized dealer.

The  warning light notifies the driver of system abnormalities and operation conditions.

**Note:** Never hold the steering wheel to the extreme left or right for more than five seconds with the engine running. This could damage the power steering system.

## ENVIRONMENT PROTECTION SYSTEMS

### Emission Control System

This vehicle is equipped with an emission control system (the catalytic converter is part of this system) that enables the vehicle to comply with existing exhaust emissions requirements.

Ignoring the following precautions could cause lead to accumulate on the catalyst inside the converter or cause the converter to get very hot. Either condition will damage the converter and cause poor performance:

- USE ONLY UNLEADED FUEL.
- Do not drive your vehicle with any sign of engine malfunction.
- Do not coast with the ignition OFF.
- Do not descend steep grades in gear with the ignition OFF.
- Do not operate the engine at high idle for more than two minutes.
- Do not tamper with the emission control system. All inspections and adjustments must be made by your authorized dealer.

Do not push-start or pull-start your vehicle.

Under U.S. federal law, any modification to the original-equipment emission control system before the first sale and registration of a vehicle is subject to penalties. In some states, such modification made on a used vehicle is also subject to penalties.

While the engine is off, the sound of a valve opening and closing can be heard at the rear of the vehicle, however this does not indicate an abnormality. The vehicle has a self-checking device and it operates while the engine is off.



### Warning!

*A hot exhaust system can start a fire if you park over materials that can burn. Such materials might be grass or leaves coming into contact with your exhaust system. Do not park or operate your vehicle in areas where your exhaust system can contact anything that can burn.*



# GETTING TO KNOW YOUR INSTRUMENT PANEL

CONTROL PANEL AND INSTRUMENTS . . . . .	76
MAINTENANCE MONITOR — IF EQUIPPED . . . . .	81
FUEL ECONOMY MONITOR — IF EQUIPPED . . . . .	84
WARNING LIGHTS AND MESSAGES . . . . .	86
PERSONALIZATION FEATURES . . . . .	105
ONBOARD DIAGNOSTIC SYSTEM — OBD II . . . . .	109
EMISSIONS INSPECTION AND MAINTENANCE PROGRAMS . . . . .	110



## CONTROL PANEL AND INSTRUMENTS

### Instrument Cluster



Instrument Cluster

05020103-121-001AB

- 1 — Odometer/Trip Computer And Trip Computer Button/Dashboard Illumination
- 2 — Tachometer
- 3 — Speedometer
- 4 — Automatic Transmission Info Display
- 5 — Odometer/Trip Computer Info/Engine Coolant Temperature Gauge/Fuel Gauge/Outside Temperature/Cruise Control/Info Switch Display

## Odometer/Trip Computer

The display mode can be changed from odometer to “Trip computer A” to “Trip computer B” and then back to odometer by pushing the selector while one of them is displayed. The selected mode will be displayed.

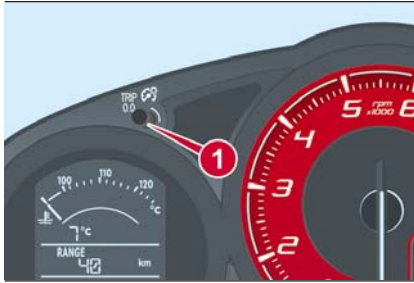

05020102-121-001AB

### Odometer/Trip Reset Button

#### 1 — Odometer/Trip Reset Button

When the ignition is placed in the ACC or OFF position, the odometer or trip cannot be displayed. Pushing the selector can switch the trip or reset it for a ten-minute period in the following cases:

- After the ignition is cycled to OFF from ON.
- After the driver's door is opened.

## Odometer

The odometer records the total distance the vehicle has been driven.

## Trip Computer

The trip computer can record the total distance of two trips. One is recorded in “Trip A”, and the other is recorded in “Trip B”.

For instance, “Trip A” can record the distance from the point of origin, and “Trip B” can record the distance from where the fuel tank is filled.

When “Trip A” is selected, pushing the selector again within one second will change to “Trip B” mode. When “Trip A” is selected, TRIP A will be displayed. When “Trip B” is selected, TRIP B will be displayed.

The trip computer records the total distance the vehicle is driven until the meter is again reset. Return it to “0.0” by depressing and holding the selector for one second or more.

Use this meter to measure trip distances and to compute fuel consumption.

If the fuel economy data is reset using the fuel economy monitor or Trip “A” is reset using the trip meter, the fuel economy data and Trip “A” are reset simultaneously when the fuel economy monitor with the trip meter is on.

**Note:** Only the trip records tenths of miles (kilometers).

## Trip Computer Reset

The trip computer will be erased when:

- The power supply is interrupted (blown fuse or the battery is disconnected).
- The vehicle is driven over 9999.9 miles.

## Speedometer

The speedometer indicates the speed of the vehicle.

## Instrument Panel Illumination

When the position lights are turned on with the ignition switched ON, the brightness of the instrument panel illumination is dimmed. When the position lights are turned on, the  warning light in the instrument cluster turns on (see “Headlights” in “Getting To Know Your Vehicle” chapter).

## Brightness Adjustment

The brightness of the instrument panel and dashboard illuminations can be adjusted by rotating the knob:

- The brightness decreases by rotating the knob to the left. A beep sound will be heard when the knob has been rotated to the maximum dim position.



- The brightness increases by rotating the knob to the right.

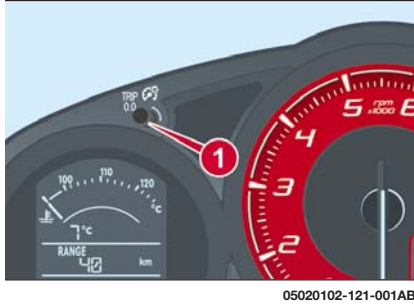

### Dimmer Knob

1 — Instrument Cluster Illumination Dimmer Knob

### Cancelling Illumination Dimmer

Rotate the knob to the right until a beep is heard while the instrument cluster is dimmed with the ignition switched ON. If the instrument cluster's visibility is reduced due to glare from surrounding brightness, cancel the illumination dimmer.

When the illumination dimmer is canceled, the instrument cluster cannot be dimmed even if the position lights are turned on. When the illumination dimmer is canceled, the screen in the center display switches to constant display of the daytime screen.

## Trip Computer And Info Switch

The following information can be selected by pushing the INFO switch with the ignition in the ON position:

- Distance-to-empty (approximate distance you can travel on the available fuel).
- Average fuel economy.
- Current fuel economy.
- Average vehicle speed.

If you have any problems with your trip computer, contact an authorized dealer.

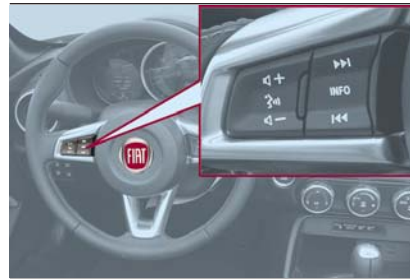

### Instrument Cluster Display Controls

#### Distance-To-Empty Mode

This mode displays the approximate distance you can travel on the remaining fuel based on the fuel economy.

The distance-to-empty will be calculated and displayed every second.

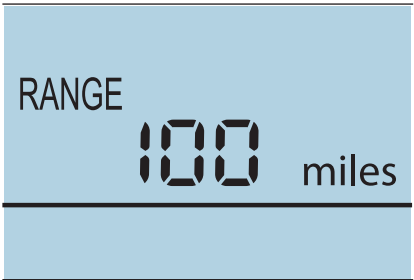

0502011019A019

### Distance To Empty Display Screen

#### Note:

- Even though the distance-to-empty display may indicate a sufficient amount of remaining driving distance before refueling is required, refuel as soon as possible if the fuel level is very low or the low fuel warning light illuminates.
- The display may not change unless you add more than approximately 2.3 gallons (9 liters) of fuel.
- The distance-to-empty is the approximate remaining distance the vehicle can be driven until all the graduation marks in the fuel gauge (indicating the remaining fuel supply) disappear.

□ If there is no past fuel economy information such as after first purchasing your vehicle or the information is deleted when the battery cables are disconnected, the actual distance-to empty/range may differ from the amount indicated.

### Average Fuel Economy Mode

This mode displays the average fuel economy by calculating the total fuel consumption and the total traveled distance since purchasing the vehicle, reconnecting the battery after disconnection, or resetting the data. The average fuel economy is calculated and displayed every minute. To clear the data being displayed, push the INFO switch for more than 1.5 seconds. After pushing the INFO switch, “- - - mpg” (“- - - L/100 km”) will be displayed for about 1 minute before the fuel economy is recalculated and displayed.

### Current Fuel Economy Mode

This mode displays the current fuel economy by calculating the amount of fuel consumption and the distance traveled. Current fuel economy will be calculated and displayed every two seconds.

When you've slowed to about 3 MPH (5 km/h), “- - - mpg” (“- - - L/100 km”) will be displayed.

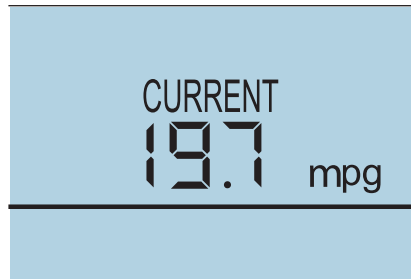

05020110199019

**Current Fuel Economy Display Screen**

### Average Vehicle Speed Mode

This mode displays the average vehicle speed by calculating the distance and the time traveled since connecting the battery or resetting the data.

Average vehicle speed will be calculated and displayed every 10 seconds. To clear the data being displayed, push the INFO switch for more than 1.5 seconds.

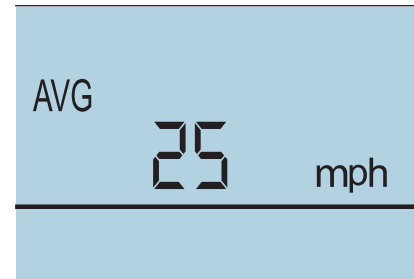

0502011020110C

**Average Vehicle Speed Display Screen**

After pushing the INFO switch, “- - - MPH” (“- - - km/h”) will be displayed for about 1 minute before the vehicle speed is recalculated and displayed.



## Tachometer

The tachometer shows engine speed in thousands of revolutions per minute (rpm).

The range varies depending on the type of gauge.



05020103-12A-002AB

**Tachometer**

1 — Tachometer Display

## Engine Coolant Temperature Gauge And Fuel Gauge

### Engine Coolant Temperature Gauge

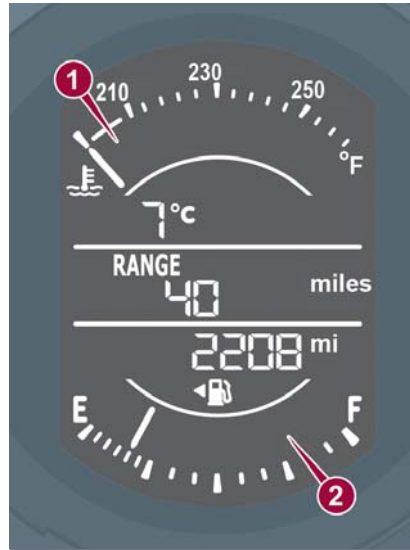

0502010417A007

**Fuel/Temperature Gauge**

1 — Engine Coolant Temperature  
2 — Fuel Gauge

**Note:** If the high engine coolant temperature warning light (red) turns on, there is a possibility of overheating.

Park the vehicle in a safe place immediately and take appropriate measures. If the vehicle continues to be driven, it could cause damage to the engine.

### Fuel Gauge

The fuel gauge 2 shows approximately how much fuel is remaining in the tank when the ignition is in the ON position. We recommend keeping the tank over 1/4 full.

**E** = Empty

**F** = Full

If the low fuel warning light illuminates or the fuel level is very low, refuel as soon as possible.

### Note:

After refueling, it may require some time for the indicator to stabilize. In addition, the indicator may deviate while driving on a slope or curve since the fuel moves in the tank.

The display indicating a quarter or less remaining fuel has more segments to show the remaining fuel level in greater detail.

The direction of the arrow on the fuel gauge indicates that the fuel door lid is on the left side of the vehicle.

## Outside Temperature Display

When the ignition is in the ON position, the outside temperature is displayed.

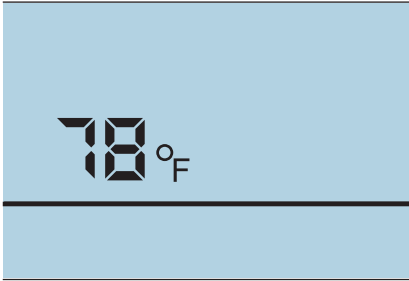

05020107345034

### Outside Temperature Screen Display

Under the following conditions, the outside temperature display may differ from the actual outside temperature depending on the surroundings and vehicle conditions:

- Significantly cold or hot temperatures.
- Sudden changes in outside temperature.
- The vehicle is parked.
- The vehicle is driven at low speeds.

## Changing The Temperature Unit Of The Outside Temperature Display

The outside temperature unit can be switched between Fahrenheit and Celsius using the following procedure. Settings can be changed through the Connect 7.0 radio screen. Refer to "Personalization Features" in this chapter.

**Note:** When the temperature unit indicated in the outside temperature display is changed, the temperature unit indicated in the engine coolant gauge display changes in conjunction with it.

## Cruise Control Set Vehicle Speed Display

The vehicle speed preset using the cruise control is displayed.

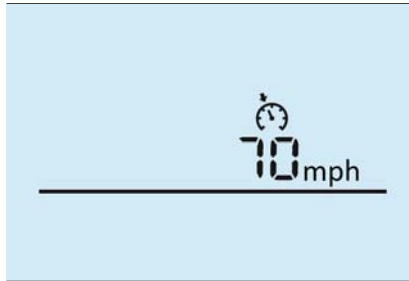

0502010819A019

### Cruise Control Display Screen

## MAINTENANCE MONITOR — IF EQUIPPED

### Oil Life Reset

Proceed as follows:

1. Select the icon  on the home screen to display the "Applications" screen.
2. Select "Maintenance" to display the maintenance list screen.
3. Switch the tab and select the setting item you want to change: "Scheduled," "Tire Rotation," or "Oil Change."



## Oil Life Monitor

You can customize settings in the setup display as follows:

Tab	Item	Explanation
Scheduled	Setting	Notification can be turned on/off.
	Time (months)	Displays the time or distance until maintenance is due. Select this item to set the maintenance period. "Scheduled Due!" is displayed in red, and the indicator light will illuminate in the instrument cluster when the remaining distance is less than 300 mi (500 km) or the remaining number of days is less than 15 (whichever comes first).
	Distance (mile or km)	Displays the time or distance until maintenance is due. Select this item to set the maintenance period. "Scheduled Due!" is displayed in red, and the indicator light will illuminate in the instrument cluster when the remaining distance is less than 300 mi (500 km) or the remaining number of days is less than 15 (whichever comes first).
	Reset	Resets the time and distance to the initial values. Once the system turns on, it needs to be reset whenever carrying out maintenance.
Tire Rotation	Setting	Notification can be switched on/off.
	Distance (mile or km)	Displays the distance until tire rotation is due. Select this item to set the tire rotation distance. "Tire Rotation Due!" is displayed in red and the wrench indicator light will illuminate in the instrument cluster when the remaining distance is less than 300 mi (500 km).
	Reset	Resets the remaining distance to the initial value. Once the system turns on, it needs to be reset whenever rotating the tires.



Tab	Item	Explanation
Oil Change	Setting	Notification can be switched on/off.
	Distance (mile or km)	Displays the distance until an oil change is due. Select this item to set the oil change distance. "Oil Change Due!" is displayed in red, and the indicator light will illuminate in the instrument cluster when the remaining distance is less than 300 mi (500 km).
	Reset	Resets the remaining distance to the initial value. Once the system turns on, it needs to be reset whenever replacing the engine oil.
	Oil life (%)	Displays the engine oil life until an oil change is due. "Oil Change Due!" is displayed in red and the indicator light will illuminate in the instrument cluster when remaining oil life distance is less than 300 mi (500 km), or remaining days are less than 15 (whichever comes first).
	Reset	Resets the remaining oil life to 100%. The system must be reset whenever replacing the engine oil.

(\*) The engine oil flexible maintenance setting is available (only some models). Consult an authorized dealer for details. When the engine oil flexible maintenance setting is selected, you will see the following items in the display.

The vehicle calculates the remaining oil life based on the engine operating conditions and lets you know when an oil change is due by illuminating the indicator light in the instrument cluster.



## FUEL ECONOMY MONITOR – IF EQUIPPED

### Description

The “Fuel Consumption” information is displayed by operating each icon in the display.

In addition, after completing a trip, the total energy efficiency to date is displayed in the ending display when the ending display is turned on.

Proceed as follows:

1. Select the  icon on the home screen to display the applications screen.
2. Select the “Fuel Economy Monitor”.

3. Operate the Multimedia Control Knob or touch the screen and display the menu.

**Note:** When the menu is displayed by touching the screen, the display is hidden automatically after 6 seconds.

Select the icon in the menu and perform the operation. Each icon operates as follows:

1. Hides the menu display.
2. Displays the application screen.
3. Resets the fuel economy data.
4. Displays the following setting screen: ending display on/off switching  
- On/off switching for function which synchronizes reset fuel economy data to trip meter (Trip A).

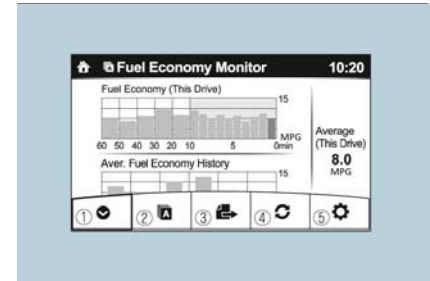

05240100-36A-003

**Fuel Economy Display Screen**

## Fuel Consumption Display

Information regarding fuel economy is displayed:

1. Displays the fuel economy for the past 60 minutes:

Displays the fuel economy every minute for the past 1 to 10 minutes.

Displays the fuel economy every 10 minutes for the past 10 to 60 minutes.

2. Displays the average fuel economy over the past five resets and after the current reset.

3. Calculates the average fuel economy every minute after vehicle travel begins, and displays it.

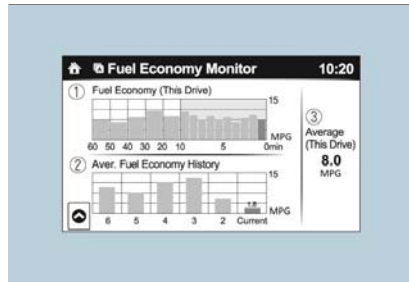

05240101-36A-004

### Average Fuel Economy Display Screen

**Note:** The fuel economy data can be reset by doing the following operation:

- Push the reset switch from the menu screen.
- When the function, which synchronizes the fuel economy monitor and the trip meter, is on, reset Trip A of the trip meter.
- Delete the average fuel economy information displayed in the trip computer.

After resetting the fuel economy data, "--" is displayed while the average fuel economy is calculated.

## Ending Screen Display

If the ending display on the fuel economy monitor is on when the ignition is cycled from ON position to the OFF position, the information regarding the fuel economy is displayed.



## WARNING LIGHTS AND MESSAGES

### Warning Lights And Messages

#### Note:

The warning light in the instrument panel appears together with a dedicated message and/or acoustic signal when applicable. These indications are indicative and precautionary and as such must not be considered as exhaustive and/or alternative to the information contained in the Owner's Manual, which you are advised to read carefully in all cases. Always refer to the information in this chapter in the event of a failure indication.

Failure indications displayed are divided into two categories: serious and less serious failures. Serious failures are indicated by a repeated and prolonged warning "cycle". Less serious failures are indicated by a warning "cycle" with a shorter duration. The display cycle of both categories can be interrupted. The instrument panel warning light will stay on until the cause of the failure is eliminated.

The warning contents can be verified on the audio system.

Proceed as follows:

1. If the warning light is turned on, select  icon on the home screen to display the application screen.

2. Select "**Warning Guidance**" to display the current warnings.

3. Select the applicable warning to view the warning details.

For the following warning/indicator lights:

- Master Warning Light
- Brake System Warning Light
- ABS Warning Light
- Charging System Warning Light
- Engine Oil Warning Light
- Electric Throttle Warning Light
- Cold Start Warning Light
- Check Engine Warning Light
- Coolant Temperature Warning Light
- Automatic Transmission Warning Light
- Power Steering Malfunction Indicator Light
- Air Bag/Seat Belt Pretensioner System Warning Light
- Check Fuel Cap Warning Light
- Low Fuel Warning Light

- Seat Belt Warning Light
- Door Ajar Warning Light
- Low Washer Fluid Level Warning Light
- Tire Pressure Monitoring System Warning Light
- KEY Warning Light
- LED Headlight KEY Warning Light
- BSM (Blind Spot Monitoring) OFF Indicator Light
- TCS/DSC Indicator Light
- DSC OFF Indicator Light
- Security Indicator Light
- Indicator Light
- Passenger Air Bag Deactivation Warning Light

The light turns on when the ignition is switched on for an operation check, and turns off a few seconds later or when the engine is started. If the light does not turn on or remains turned on, have the vehicle inspected at an authorized dealer.

**Note:** Only for "Brake System Warning Light:" the light turns on continuously when the parking brake is applied.

Warning Light	What It Means
---------------	---------------

# BRAKE



### Parking Brake Warning - Warning Light Inspection/Low Brake Fluid Level Warning Parking brake warning / Warning light inspection

The light illuminates when the parking brake is applied with the ignition switched to START or ON. It turns off when the parking brake is fully released.

#### Low brake fluid level warning

If the brake warning light remains illuminated even though the parking brake is released, the brake fluid may be low or there could be a problem with the brake system. Park the vehicle in a safe place immediately and contact an authorized dealer.

#### Note:

- Do not drive with the brake system warning light illuminated. Contact an authorized dealer to have the brakes inspected as soon as possible. Driving with the brake system warning light illuminated is dangerous. It indicates that your brakes may not work at all or that they could completely fail at any time. If this light remains illuminated, after checking that the parking brake is fully released, have the brakes inspected immediately.
- The effectiveness of the braking may diminish so you may need to push the brake pedal more strongly than normal to stop the vehicle. Stop the vehicle in a safe place immediately and contact an authorized dealer.



### EBD (Electronic Brake-force Distribution) System Warning

If the EBD (Electronic Brake-force Distribution) control unit determines that some components are operating incorrectly, the control unit may illuminate the brake system warning light and the ABS warning light simultaneously. The problem is likely to be the electronic brake force distribution system. Stop the vehicle in a safe place immediately and contact an authorized dealer.

#### Note:

- Do not drive with both the ABS warning light and brake warning light illuminated. Contact an authorized dealer to have the brakes inspected as soon as possible. Driving when the brake system warning light and ABS warning light are illuminated simultaneously is dangerous.
- When both lights are illuminated, the rear wheels could lock more quickly in an emergency stop than under normal circumstances.





Warning Light	What It Means
	<p><b>Alternator Failure</b> If the warning light illuminates while driving, it indicates a malfunction of the alternator or of the charging system. Drive to the side of the road and park off the right-of-way. Stop the vehicle in a safe place immediately and contact an authorized dealer.</p> <p><b>Note:</b> Do not continue driving when the charging system warning light is illuminated because the engine could stop unexpectedly.</p>
	<p><b>Low Engine Oil Pressure</b> This warning light indicates low engine oil pressure.</p> <p><b>Note:</b> Do not run the engine if the oil pressure is low. Otherwise, it could result in extensive engine damage. If the light illuminates or the warning indication is displayed while driving: Drive to the side of the road and park off the right-of-way on level ground. Turn off the engine and wait five minutes for the oil to drain back into the sump. Inspect the engine oil level. If it's low, add the appropriate amount of engine oil while being careful not to overfill. Start the engine and check the warning light.</p> <p><b>Note:</b> Do not run the engine if the oil level is low. Otherwise, it could result in extensive engine damage. If the light remains illuminated even though the oil level is normal or after adding oil, stop the engine immediately and contact an authorized dealer.</p>
	<p><b>Door-Open Warning Light</b> The light turns on if any door is not closed securely. Close the door securely.</p>



### Warning!



*Driving a vehicle with the red brake light on is dangerous. Part of the brake system may have failed. It will take longer to stop the vehicle. You could have a collision. Have the vehicle checked immediately.*

## Red Warning Lights

Warning Light	What It Means
	<p><b>High Engine Coolant Temperature Warning Light</b> The light flashes when the engine coolant temperature is extremely high, and illuminates when the engine coolant temperature increases further.</p> <p><b>Handling procedure</b></p> <ul style="list-style-type: none"><li><input type="checkbox"/> <b>Flashing light:</b> drive slowly to reduce engine load until you can find a safe place to stop the vehicle and wait for the engine to cool down.</li><li><input type="checkbox"/> <b>Illuminated light:</b> this indicates the possibility of overheating. Park the vehicle in a safe place immediately and stop the engine. Refer to “Overheating” in “In Case Of Emergency” for further information.</li></ul> <p><b>Note:</b> Do not drive the vehicle with the high engine coolant temperature warning light illuminated. Otherwise, it could result in damage to the engine.</p>
	<p><b>Air Bag/Seat Belt Pretensioner System Warning</b> A system malfunction is indicated if the warning light constantly flashes, constantly illuminates or does not illuminate at all when the ignition is placed in the ON position. If any of these occur, contact an authorized dealer as soon as possible. The system may not operate in an accident.</p>





## Red Warning Lights

Warning Light	What It Means
	<p><b>Key Warning Light — Illuminated</b> If any malfunction occurs in the keyless entry system, it illuminates continuously.</p> <p><b>Note:</b> If the key warning indicator light illuminates or the push button start indicator light (amber) flashes, the engine may not start. Contact an authorized dealer as soon as possible.</p> <hr/> <p><b>Key Warning Light — Flashing Advanced Key Fob Malfunction</b> Take the appropriate action and verify that the warning light turns off.</p> <ul style="list-style-type: none"> <li><input type="checkbox"/> <b>The advanced key fob battery is discharged:</b> replace the key fob battery.</li> <li><input type="checkbox"/> <b>The advanced key fob is not within the operation range/is placed in areas inside the cabin where it is difficult for the key to be detected:</b> bring the advanced key fob into the operation range.</li> <li><input type="checkbox"/> <b>A key fob from another manufacturer similar to the advanced key fob is in the operation range:</b> take the key fob from another manufacturer similar to the advanced key out of the operation range.</li> <li><input type="checkbox"/> <b>Without the ignition switched OFF, the advanced key is taken out of the vehicle, and then all the doors are closed:</b> bring the advanced key fob back into the vehicle.</li> </ul>
	<p><b>Vehicle Security Alarm System</b> The warning light switches on to report a failure of the vehicle security alarm system. Contact an authorized dealer as soon as possible.</p>



## Amber Warning Lights

Warning Light	What It Means
	<p><b>ABS Warning Light</b></p> <p>If the ABS warning light stays on while you're driving, when the ABS control unit has detected a system malfunction. If this occurs, your brakes will function normally as if the vehicle had no ABS. Should this happen contact an authorized dealer as soon as possible.</p> <p><b>Note:</b></p> <ul style="list-style-type: none"><li><input type="checkbox"/> When the engine is jump-started to charge the battery, uneven RPM occurs and the ABS warning light may illuminate. If this occurs, it is the result of the weak battery and does not indicate an ABS malfunction. Recharge the battery.</li><li><input type="checkbox"/> The brake assist system does not operate while the ABS warning light is illuminated.</li></ul>
	<p><b>Malfunction Indicator Light</b></p> <p>If this light illuminates while driving, the vehicle may have a problem. It is important to note the driving conditions when the light illuminated and contact an authorized dealer. The malfunction indicator light may illuminate in the following cases:</p> <ul style="list-style-type: none"><li><input type="checkbox"/> The engine's electrical system has a problem.</li><li><input type="checkbox"/> The emission control system has a problem.</li><li><input type="checkbox"/> The fuel tank level is very low or approaching empty.</li><li><input type="checkbox"/> The fuel-filler cap is missing or not tightened securely.</li></ul> <p>If the malfunction indicator light remains on, or it flashes continuously, do not drive at high speeds and contact an authorized dealer as soon as possible.</p>



**Warning!**

*A malfunctioning catalytic converter, as referenced above, can reach higher temperatures than in normal operating conditions. This can cause a fire if you drive slowly or park over flammable substances such as dry plants, wood, cardboard, etc. This could result in death or serious injury to the driver, occupants or others.*

**Caution!**

*Prolonged driving with the Malfunction Indicator Light (MIL) on could cause damage to the engine control system. It also could affect fuel economy and driveability. If the MIL is flashing, severe catalytic converter damage and power loss will soon occur. Immediate service is required.*

### Warning Light

### What It Means



#### **TPMS (Tire Pressure Monitoring System) Warning Light — If Equipped**

The warning light switches on and a message is displayed to indicate that the tire pressure is lower than the recommended value and/or that slow pressure loss is occurring. In these cases, optimal tire duration and fuel consumption may not be guaranteed.

Should one or more tires be in the condition mentioned above, the display will show the indications corresponding to each tire in sequence.

#### **Note:**

Do not continue driving with one or more flat tires as handling may be compromised. Stop the vehicle, avoiding sharp braking and steering. Repair immediately using the dedicated tire repair kit and contact your authorized dealer as soon as possible.

Each tire, including the spare (if provided), should be checked monthly when cold and inflated to the inflation pressure recommended by the vehicle manufacturer on the vehicle placard or tire inflation pressure label. (If your vehicle has tires of a different size than the size indicated on the vehicle placard or tire inflation pressure label, you should determine the proper tire inflation pressure for those tires.)

As an added safety feature, your vehicle has been equipped with a tire pressure monitoring system (TPMS) that illuminates a low tire pressure telltale when one or more of your tires is significantly under-inflated. Accordingly, when the low tire pressure telltale illuminates, you should stop and check your tires as soon as possible, and inflate them to the proper pressure. Driving on a significantly under-inflated tire causes the tire to overheat and can lead to tire failure. Under-inflation also reduces fuel efficiency and tire tread life, and may affect the vehicle's handling and stopping ability.

Please note that the TPMS is not a substitute for proper tire maintenance, and it is the driver's responsibility to maintain correct tire pressure, even if under-inflation has not reached the level to trigger illumination of the TPMS low tire pressure telltale.

The TPMS malfunction indicator is combined with the low tire pressure telltale. When the system detects a malfunction, the telltale will flash for approximately one minute and then remain continuously illuminated. This sequence will continue upon subsequent vehicle start-ups as long as the malfunction exists. When the malfunction indicator is illuminated, the system may not be able to detect or signal low tire pressure as intended. TPMS malfunctions may occur for a variety of reasons, including the installation of replacement or alternate tires or wheels on the vehicle that prevent the TPMS from functioning properly. Always check the TPMS malfunction telltale after replacing one or more tires or wheels on your vehicle to ensure that the replacement or alternate tires and wheels allow the TPMS to continue to function properly.



**Caution!**

*The TPMS has been optimized for the original equipment tires and wheels. TPMS pressures and warning have been established for the tire size equipped on your vehicle. Undesirable system operation or sensor damage may result when using replacement equipment that is not of the same size, type, and/or style. Aftermarket wheels can cause sensor damage. Using aftermarket tire sealants may cause the Tire Pressure Monitoring System (TPMS) sensor to become inoperable. After using an aftermarket tire sealant it is recommended that you take your vehicle to an authorized dealer to have your sensor function checked.*

## Amber Warning Lights

### Warning Light



### What It Means

#### Power Steering Malfunction Indicator Light





The light illuminates if the electric power steering has a malfunction. If the light illuminates, stop the vehicle in a safe place and do not operate the steering wheel. There is no problem if the light turns off after a while. Contact an authorized dealer if the light illuminates continuously.

#### Note:





- If the indicator light illuminates, the power steering will not operate normally. If this happens, the steering wheel can still be operated, however, the operation may feel heavy compared to normal, or the steering wheel could vibrate when turning.
- Repeatedly jerking the steering wheel left and right while the vehicle is stopped or moving extremely slowly will cause the power steering system to go into protective mode which will make the steering feel heavy, but this does not indicate a problem. If this occurs, park the vehicle safely and wait several minutes for the system to return to normal.



## Amber Warning Lights



Warning Light	What It Means
	<p><b>Automatic Transmission Warning Light — If Equipped</b> The light illuminates when the transmission has a problem.</p> <p><b>Note:</b> If the automatic transmission warning light illuminates, the transmission has an electrical problem. Continuing to drive your vehicle in this condition could cause damage to your transmission. Contact an authorized dealer as soon as possible.</p>
	<p><b>Master Warning Light</b> The warning light turns on when the system has a malfunction. Operate the center display and verify the content.</p>
	<p><b>Cold Start Disable Indicator Light</b> When the ambient temperature is extremely low, the engine may not crank even when the engine starting procedure is performed. At this time, the Cold Start Disable Indicator light in the instrument cluster flashes. However, this does not indicate a problem.</p> <p><b>Note:</b> Place your vehicle in a warm garage until the temperature has risen to a sufficient level to enable engine starting.</p>
	<p><b>Electric Throttle Control Warning Light</b> This light informs you of a problem with the Electronic Throttle Control (ETC) system. If a problem is detected while the engine is running, the light will either stay on or flash depending on the nature of the problem. Cycle the ignition key when the vehicle is safely and completely stopped and the transmission is placed in the PARK position. The light should turn off. If the light remains on with the engine running, your vehicle will usually be drivable; however, see an authorized dealer for service as soon as possible.</p> <p>If the light continues to flash when the engine is running, immediate service is required and you may experience reduced performance, an elevated/rough idle, or engine stall and your vehicle may require towing. The light will come on when the ignition is first turned to ON/RUN and remain on briefly as a bulb check. If the light does not come on during starting, have the system checked by an authorized dealer.</p>

## Amber Warning Lights

Warning Lights	What It Means
	<p><b>Led Headlight Warning Light</b> This light illuminates if there is a malfunction in the LED headlight. Contact an authorized dealer as soon as possible.</p>
	<p><b>BSM (Blind Spot Monitoring) Off Indicator Light — If Equipped</b> A problem in the system may be indicated under the following conditions:</p> <ul style="list-style-type: none"><li><input type="checkbox"/> The light does not turn on when the ignition is placed in the ON position.</li><li><input type="checkbox"/> The light remains turned on even if the Blind Spot Monitoring (BSM) switch is operated.</li><li><input type="checkbox"/> It turns on while driving the vehicle.</li></ul> <p>Contact an authorized dealer as soon as possible. If the vehicle is driven on a road with less traffic and few vehicles that the radar sensors can detect, the system may pause (the warning light illuminates). However, it does not indicate a malfunction.</p>
	<p><b>Low Fuel Warning Light</b> The light turns on when the remaining fuel is about 2.3 gallons (9.0 liters). The light illumination timing may vary because fuel inside the fuel tank moves around according to the driving conditions and the vehicle posture. Add fuel.</p>
	<p><b>Low Washer Fluid Level Warning Light — If Equipped</b> This warning light indicates that little washer fluid remains. Add washer fluid.</p>
	<p><b>Cruise Control Activation — If Equipped</b> The warning light illuminates when the cruise control system is activated.</p>







## Amber Warning Lights

Warning Light	What It Means
	<p><b>TCS / DSC System Indicator Light</b> The warning light turns on when the in case of intervention of TCS/DSC systems. This means that the vehicle is in critical stability and grip conditions.</p>
	<p><b>DSC Off Indicator Light</b> The warning light turns on when the DSC system is deactivated.</p>
	<p><b>Loose Fuel Filler Cap Indicator Light</b> If the check fuel filler cap warning light illuminates while driving, the fuel filler cap may not be installed properly. Stop the engine and reinstall the fuel filler cap.</p>





## Green Warning Lights

Warning Light	What It Means
	<b>Left Direction Indicator</b> The warning light turns on when the direction indicator control lever is moved downwards or, together with the right direction indicator, when the hazard warning light button is pushed.
	<b>Right Direction Indicator</b> The warning light turns on when the direction indicator control lever is moved upwards or, together with the left direction indicator, when the hazard warning light button is pushed.
	<b>Parking Lights And Normal Beam Headlights</b> The warning light turns on when parking lights or normal beam headlights are turned on.
	<b>Cruise Control – If Equipped</b> The warning light turns on when a cruising speed has been set.
	<b>Key Indicator Light</b> The warning light turns on when the engine is ready to start. <b>Warning light flashing</b> When the keyless START/STOP button is pushed from ON to ACC or OFF position, the warning light may flash for approximately 30 seconds indicating that the remaining battery power of the key is low. Replace with a new battery before the key becomes unusable.



## Blue Warning Light

Warning Light	What It Means
	<p><b>High Beam Headlights</b> The warning light switches on when the high beam headlights are turned on.</p>
	<p><b>Low Engine Coolant Temperature Indicator Light</b> The light illuminates continuously when the engine coolant temperature is low and turns off after the engine is warm. If the low engine coolant temperature indicator light remains illuminated after the engine has been sufficiently warmed up, the temperature sensor could have a malfunction. Contact an authorized dealer.</p>

## Warning Light (Red Color) On Dashboard Trim

Warning Light	What It Means
	<p><b>Seat Belt Warning Light</b> The seat belt warning light turns on if the driver or passengers seat is occupied and the seat belt is not fastened with the ignition placed in the ON position.</p> <p>If the driver or passengers seat belt is unfastened (only when the passenger seat is occupied) and the vehicle is driven at a speed faster than about 12 MPH (20 km/h), the warning light flashes. After a short time, the LED stops flashing, but remains illuminated.</p> <p>If a seat belt remains unfastened, the LED flashes again for a given period of time.</p> <p>If the driver or passengers seat belt is unfastened after the LED turns on, and the vehicle speed exceeds 12 MPH (20 km/h), the LED flashes again.</p> <p><b>With Passenger Occupant Classification System:</b> to allow the passenger occupant classification sensor to function properly, do not place and sit on an additional seat cushion on the passengers seat. The sensor may not function properly because the additional seat cushion could cause sensor interference.</p> <p><b>Without Passenger Occupant Classification System:</b> placing heavy items on the passengers seat may cause the passengers seat belt warning function to operate depending on the weight of the item. To allow the passengers seat weight sensor to function properly, do not place and sit on an additional seat cushion on the passengers seat. The sensor may not function properly because the additional seat cushion could cause sensor interference. If a small child is seated on the passengers seat, the warning light may not operate. Fasten the seat belts.</p>

## Warning Light (Amber Color) On Instrument Cluster Trim

Warning Light	What It Means
	<p><b>Passenger Air Bag Deactivation Indicator Light</b> The light turns on when the ignition is switched on for an operation check, and turns off a few seconds later or when the engine is started. If the light does not turn on or remains turned on, contact an authorized dealer.</p>



## Message Indicated On Display

If a message is displayed in the center display, take appropriate action (in a calm manner) according to the displayed message.

If the following messages are displayed in the center display, a vehicle system may be malfunctioning:

- ❑ **Engine Coolant Temperature High:** displays if the engine coolant temperature has increased excessively.
- ❑ **Charging System Malfunction:** displays if the charging system has a malfunction.
- ❑ **Temperature Warning:** the following message is displayed when the temperature around the center display is high. Lowering the temperature of the inside of the vehicle or the temperature around the center display by avoiding direct sunlight is recommended.

Stop the vehicle in a safe place and contact an authorized dealer.

## Warning Sound Is Activated

### Lights-On Reminder

If lights are on and the ignition is placed in the ACC position, or the ignition is placed in the OFF position, a continuous beep sound will be heard when the driver's door is opened.

### Note:

- ❑ When the ignition is placed in the ACC position, the "Ignition Not Cycled Off Warning Beep" overrides the lights-on reminder.
- ❑ A personalized function is available to change the sound volume for the lights-on reminder.

### Air Bag/Seat Belt Pretensioner System Warning Beep

If there is a problem with the air bag/seat belt pretensioner systems and the warning light illumination, a warning beep sound will be heard for about 5 seconds every minute.

The air bag and seat belt pretensioner system warning beep sound will continue to be heard for approximately 35 minutes. Contact an authorized dealer as soon as possible.



### Caution!

*Do not drive the vehicle with the air bag/seat belt pretensioner system warning beep sounding. Driving the vehicle with the air bag/seat belt pretensioner system warning beep sounding is dangerous. In a collision, the air bags and the seat belt pretensioner system will not deploy and this could result in death or serious injury. Contact an authorized dealer as soon as possible.*

## Seat Belt Warning Beep

### Except Mexico

If the driver's seat belt is not fastened when the ignition is in the ON position, a beep sound will be heard for about six seconds.

If the driver or the passengers seat belt is not fastened and the vehicle is driven at a speed faster than about 12 MPH (20 km/h), a beep sound will be heard again for a specified period of time.

Until a seat belt is fastened or a given period of time has elapsed, the beep sound will not stop even if the vehicle speed falls below 12 MPH (20 km/h).

### Note:

❑ To allow the passenger occupant classification sensor to function properly, do not place and sit on an additional seat cushion on the passengers seat. The sensor may not function properly because the additional seat cushion could cause sensor interference.

❑ If a small child is seated on the passengers seat, the warning beep may not operate.

### Mexico

If the vehicle speed exceeds about 12 MPH (20 km/h) with the driver or passengers seat belt unfastened, a warning beep sounds continuously. If the seat belt remains unfastened, the beep sound stops once and then

continues for about 90 seconds. The beep stops after the driver or passengers seat belt is fastened.

Until a seat belt is fastened or a given period of time has elapsed, the beep sound will not stop even if the vehicle speed falls below 12 MPH (20 km/h).



### Warning!

- Placing heavy items on the front passenger seat may cause the front passenger seat belt warning function to operate depending on the weight of the item.*
- To allow the front passenger seat weight sensor to function properly, do not place and sit on an additional seat cushion on the front passenger seat. The sensor may not function properly because the additional seat cushion could cause sensor interference.*
- When a small child sits on the front passenger seat, it is possible that the warning beep will not operate.*

### Ignition Not Switched OFF

If the driver's door is opened while the ignition is placed in the ACC position, a continuous beep sound will be heard to notify the driver that the ignition has not been placed in the OFF position.

Left in this condition, the keyless entry system will not operate, the car cannot be locked, and the battery power will be depleted.

### Key Removed From Vehicle Warning Beep

A beep sound will be heard six times and the  warning light (red) will flash continuously if the ignition has not been placed in the OFF position, all the doors are closed, and the key fob is removed from the vehicle.

This is to notify the driver that the key fob has been removed from the vehicle and the ignition has not been placed in the OFF position.

**Note:** Because the key fob uses low-intensity radio waves, the  warning may activate if the key fob is carried together with a metal object or it is placed in a poor signal reception area.

### Request Switch Inoperable Warning Beep — If Equipped With Advanced Keyless Function

If the request switch on the exterior door handle is pushed with a door open, or the ignition has not been placed in the OFF position, a beep will be heard for about two seconds to indicate that the doors, and trunk lid cannot be locked.

### Key Left-In-Trunk Compartment Warning Beep — If Equipped With Advanced Keyless Function

If the key fob is left in the trunk with all doors locked and the trunk lid closed, a beep sound is heard for about ten seconds to remind the driver the key fob has been left in the trunk.

If this happens, open the trunk lid by pushing the electric trunk lid opener and remove the key fob.

A key fob removed from the trunk may not function because its functions may have been temporarily suspended. To restore the key fob function, perform the applicable procedure (see paragraph “Keys” in “Getting to know your vehicle” chapter).



**Key Left-In-Vehicle Warning Beep**

(with the advanced keyless function)

If a key fob is left in the vehicle and all the doors and the trunk are locked using a separate key fob, a beep sound is heard for about ten seconds to remind the driver that the key fob has been left in the vehicle.

If this happens, open the door and remove the key fob. A key fob removed from the vehicle this way may not function because its functions may have been temporarily suspended.

Perform the applicable procedure to restore the functions of the key fob (see paragraph “Keys” in “Getting To Know Your Vehicle” chapter).

**Vehicle Speed Alarm — If Equipped**

The vehicle speed alarm function is designed to alarm the driver via a single beep sound and a warning indication in the instrument cluster that the previously set vehicle speed has been exceeded.

You can change the vehicle speed setting at which the warning is triggered (see paragraph “Trip Computer” in “Getting To Know Your Vehicle” chapter).

**Tire Inflation Pressure Warning Beep — If Equipped**

**Vehicle With Conventional Tires:** the warning beep sound will be heard for about three seconds when there is any abnormality in tire inflation pressures (see “TMPS” in “Safety” chapter).

**Vehicle With Run-Flat Tires (If Equipped):** the warning beep sound will be heard for about three seconds if the tire pressures decrease. If the tire pressure decreases extremely, a beep sound will be heard for approximately 30 seconds (see “TMPS” in “Safety” chapter).

**Blind Spot Monitoring (BSM) System Warning Beep — If Equipped**

**Driving Forward:** the warning beep operates when the direction indicator lever is operated to the side where the Blind Spot Monitoring (BSM) warning light is illuminated.

**Note:** A personalized function is available to change the Blind Spot Monitoring (BSM) warning beep sound volume.

**Reversing:** if a moving object such as a vehicle or two-wheeled vehicle approaches on the left or right from behind your vehicle, the Blind Spot Monitoring (BSM) warning sound is activated.

**Electronic Steering Lock Warning Beep**

The warning beep operates if the steering wheel is not unlocked after the keyless ignition START/STOP button is pushed.

**Speed Limiter Warning Beep — If Equipped**

If the vehicle speed exceeds the set speed by about 2 MPH (3 km/h) or more, a warning beep operates continuously.

The warning beep operates until the vehicle speed decreases to the set speed or less.

# PERSONALIZATION FEATURES

## Overview

The following Personalization Features can be set or changed by the customer or by an authorized dealer.

Personalization Features differ depending on the market and specification.

### Settings change method

#### 1. Settings can be changed by operating the center display screen

**A:** Refer to the “Settings” paragraph in Fiat Connect 7.0 Supplement for further information.

**B:** Refer to “Fuel Economy Monitor” paragraph in this chapter.

#### 2. Settings can be changed by operating the vehicle switches

**C:** Refer to “Auto Lock/Unlock Function” paragraph in “Getting To Know Your Vehicle” for further information.

**D:** Refer to “Key Fob” in “Getting To Know Your Vehicle” for further information.

**E:** Refer to “Lock/Unlock With Request Switch (With The Advanced Keyless Function)” (Doors) in “Getting To Know Your Vehicle” for further information.

#### 3. Settings can be changed by an authorized dealer (refer to the following table)

**X:** Refer to your authorized dealer for setting change.

Item	Feature	Factory Setting	Available Settings	Settings Change Method		
				1	2	3
<b>Safety</b>						
Blind Spot Monitoring System (if equipped)	Warning Beep Volume (*)	High	High/Low/Off	A	—	X



Item	Feature	Factory Setting	Available Settings	Settings Change Method		
				1	2	3
<b>Vehicle</b>						
Door Locks	Operation condition of auto lock/unlock function	Lock: When Driving/Unlock: IGN Off	Lock: When Driving/Unlock: In Park/Lock: Out of Park/Unlock: In Park/Lock: Shifting Out of Park/Lock: When Driving/Unlock: IGN Off/ Lock: When Driving/Off	A	C	X
Keyless Entry System	Time for locking door automatically	30 seconds	90 seconds/ 60 seconds/30 seconds	A	—	X
Advanced Keyless Entry System	Time for locking door automatically	30 seconds	90 seconds/ 60 seconds/30 seconds	A	—	X
	Auto-lock function operation/non operational	Off	On/Off	A	—	X
	Beep volume when locking/unlocking	Off or Medium	High/Medium/Low/Off	A	D/E	X
Illuminated Entry System	Time until interior lights turn off after closing door	15 seconds	60 seconds/ 30 seconds/15 seconds/7.5 seconds	A	—	X
	Time until interior lights turn off automatically when any door is not closed completely	30 minutes	60 minutes/ 30 minutes/10 minutes	A	—	X
Auto-Wiper Control	Operational/non-operational	On	On/Off (**)	A	—	X



Item	Feature	Factory Setting	Available Settings	Settings Change Method		
				1	2	3
Daytime Running Lights (DRL)	Operational/non-operational	On	On/Off	—	—	X
Auto headlight off (***)	Time until headlights turn off	30 second	120 seconds/ 90 seconds/ 60 seconds/ 30 seconds/Off (****)	A	—	X
Auto-Light Control	Timing by which lights turn on	Medium	High/Med. High/Medium/Med. Low/Low	A	—	X
Adaptive Front Lighting System (AFS)	Operational/non-operational (***)	On	On/Off	A	—	X
Lights-On Reminder	Warning beep volume	High	High/Low/Off	A	—	X
Coming Home System	Time until headlights turn off	30 seconds	120 seconds/ 90 seconds/60 seconds/30 seconds/ Off	A	—	X
Leaving Home Light System	Operational/Non-operational	On or Off	On/Off	A	—	X
Turn Signals	Beep volume	Low	High/Low	A	—	X
Three-Flash Turn Signal	Operational/Non-operational	On or Off	On/Off	A	—	X



Item	Feature	Factory Setting	Available Settings	Settings Change Method		
				1	2	3
<b>System</b>						
Language	Language indicated in display	English	Depends on market (****)	A	—	X
Temperature	Temperature unit indicated in display	°C	°F/°C	A	—	X
Distance	Distance unit indicated in display	mi or km	mi/km	A	—	X
<b>Fuel Economy Monitor</b>						
Ending Display	On/Off	Off	On/Off	B	—	X
Fuel Economy Resetting Procedure	Linkage/non-linkage with fuel economy reset and trip meter reset	Off	On/Off	B	—	X

(—) Feature setting change not available.

(\*) Only the volume of the warning beep during Blind Spot Monitoring (BSM) operation can be changed. The volume of the warning beep during Rear Cross Traffic Alert (RCTA) operation cannot be changed.

(\*\*) If the auto-wiper control is set to Off, the wiper lever **AUTO** position is set to intermittent operation.

(\*\*\*) Though these systems can be turned Off, doing so will defeat the purpose of the system and FCA recommends that these systems remain On.

(\*\*\*\*) Available only in display from the center display.

## ONBOARD DIAGNOSTIC SYSTEM – OBD II

Your vehicle is equipped with a sophisticated Onboard Diagnostic system called OBD II. This system monitors the performance of the emissions, engine, and automatic transmission control systems. When these systems are operating properly, your vehicle will provide excellent performance and fuel economy, as well as engine emissions well within current government regulations.

If any of these systems require service, the OBD II system will turn on the Malfunction Indicator Light (MIL). It will also store diagnostic codes and other information to assist your service technician in making repairs. Although your vehicle will usually be drivable and not need towing, see your authorized dealer for service as soon as possible.



### Caution!

- ❑ *Prolonged driving with the MIL on could cause further damage to the emission control system. It could also affect fuel economy and driveability. The vehicle must be serviced before any emissions tests can be performed.*
- ❑ *If the MIL is flashing while the vehicle is running, severe catalytic converter damage and power loss will soon occur. Immediate service is required.*

### Onboard Diagnostic System (OBD II) Cybersecurity

Your vehicle is required to have an Onboard Diagnostic system (OBD II) and a connection port to allow access to information related to the performance of your emissions controls. Authorized service technicians may need to access this information to assist with the diagnosis and service of your vehicle and emissions system.



### Warning!

- ❑ *ONLY an authorized service technician should connect equipment to the OBD II connection port in order to diagnose or service your vehicle.*
- ❑ *If unauthorized equipment is connected to the OBD II connection port, such as a driver-behavior tracking device, it may:*
  - ❑ *Be possible that vehicle systems, including safety related systems, could be impaired or a loss of vehicle control could occur that may result in an accident involving serious injury or death.*
  - ❑ *Access, or allow others to access, information stored in your vehicle systems, including personal information.*

For further information, refer to “Privacy Practices” and “Uconnect CyberSecurity” in “All About Uconnect Access” in your Owner’s Manual Radio Supplement.



## EMISSIONS INSPECTION AND MAINTENANCE PROGRAMS

In some localities, it may be a legal requirement to pass an inspection of your vehicle's emissions control system. Failure to pass could prevent vehicle registration.



For states that require an Inspection and Maintenance (I/M), this check verifies the "Malfunction Indicator Light (MIL)" is

functioning and is not on when the engine is running, and that the OBD II system is ready for testing.

Normally, the OBD II system will be ready. The OBD II system may **not** be ready if your vehicle was recently serviced, recently had a dead battery or a battery replacement. If the OBD II system should be determined not ready for the I/M test, your vehicle may fail the test.

Your vehicle has a simple ignition actuated test, which you can use prior to going to the test station. To check if your vehicle's OBD II system is ready, you must do the following:

1. Cycle the ignition switch to the ON position, but do not crank or start the engine.

**Note:** If you crank or start the engine, you will have to start this test over.

2. As soon as you cycle the ignition switch to the ON position, you will see the "Malfunction Indicator Light (MIL)" symbol come on as part of a normal bulb check.

3. Approximately 15 seconds later, one of two things will happen:

- ❑ The MIL will flash for about 10 seconds and then return to being fully illuminated until you turn OFF the ignition or start the engine. This means that your vehicle's OBD II system is **not ready** and you should **not** proceed to the I/M station.

- ❑ The MIL will not flash at all and will remain fully illuminated until you place the ignition in the off position or start the engine. This means that your vehicle's OBD II system is **ready** and you can proceed to the I/M station.

If your OBD II system is **not ready**, you should see your authorized dealer or repair facility. If your vehicle was recently serviced or had a battery failure or replacement, you may need to do nothing more than drive your vehicle as you normally would in order for your OBD II system to update. A recheck with the above test routine may then indicate that the system is **now ready**.

Regardless of whether your vehicle's OBD II system is ready or not, if the MIL is illuminated during normal vehicle operation you should have your vehicle serviced before going to the I/M station. The I/M station can fail your vehicle because the MIL is on with the engine running.

# SAFETY

SAFETY SYSTEMS . . . . .	112
AUXILIARY DRIVING SYSTEMS . . .	114
OCCUPANT RESTRAINT SYSTEMS . . . . .	122
SEAT BELT SYSTEMS . . . . .	122
CHILD RESTRAINT PRECAUTIONS . . . . .	128
SUPPLEMENTARY RESTRAINT SYSTEM SRS — AIR BAG . . . . .	131
EVENT DATA RECORDER (EDR) . . . . .	145
CONSTANT MONITORING . . . . .	147



## SAFETY SYSTEMS

### Safety Systems

The vehicle has the following safety systems:

- Anti-lock Braking System (ABS)
- Traction Control System (TCS)
- Dynamic Stability Control (DSC)

For the operation of the systems, see the following pages.

### ABS System (Anti-lock Braking System)

The ABS control unit continuously monitors the speed of each wheel. If one wheel is about to lock up, the ABS responds by automatically releasing and reapplying that wheel's brake. The driver will feel a slight vibration in the brake pedal and may hear a chattering noise from the brake system. This is normal ABS system operation. Continue to depress the brake pedal without pumping the brakes. The warning light turns on when the system has a malfunction. Refer to "Warning Lights And Messages" in "Getting To Know Your Instrument Panel" for further information.

#### Note:

- Braking distances may be longer on loose surfaces (snow or gravel, for example) which usually have a hard foundation. A vehicle with a normal braking system may require less distance to stop under these conditions because the tires will build up a wedge of surface layer when the wheels skid.
- The sound of the ABS operating may be heard when starting the engine or immediately after starting the vehicle; however, it does not indicate a malfunction.



#### Warning!

- The ABS contains sophisticated electronic equipment that may be susceptible to interference caused by improperly installed or high output radio transmitting equipment. This interference can cause possible loss of anti-lock braking capability. Installation of such equipment should be performed by qualified professionals.*
- Pumping of the Anti-Lock Brakes will diminish their effectiveness and may lead to a collision. Pumping makes the stopping distance longer. Just press firmly on your brake pedal when you need to slow down or stop.*

*The ABS cannot prevent the natural laws of physics from acting on the vehicle, nor can it increase braking or steering efficiency beyond that afforded by the condition of the vehicle brakes and tires or the traction afforded.*

*The ABS cannot prevent collisions, including those resulting from excessive speed in turns, following another vehicle too closely, or hydroplaning.*

*The capabilities of an ABS equipped vehicle must never be exploited in a reckless or dangerous manner that could jeopardize the user's safety or the safety of others.*

### TCS System (Traction Control System)



#### Warning!

*The capability of the TCS must never be tested irresponsibly and dangerously, in such a way as to compromise personal safety and the safety of others.*

The Traction Control System (TCS) enhances traction and safety by controlling engine torque and braking. When the TCS detects driving wheel slippage, it can lower engine torque and operate the brakes to prevent loss of traction. This means that on a slick surface, the engine adjusts automatically to provide optimum

power to the drive wheels, limiting wheel spin and loss of traction.

The indicator light turns on when the system has a malfunction. Refer to “Warning Lights And Messages” in “Getting To Know Your Instrument Panel” for further information.

### TCS / DSC Indicator Light

The  indicator light stays on for a few seconds when the ignition is placed in the ON mode.

If the TCS or DSC is operating, the indicator light flashes.

If the  indicator light stays on, the TCS, DSC or the brake assist system may have a malfunction and they may not operate correctly. Contact your authorized dealer.

#### Note:

- In addition to the indicator light flashing, a slight sound will come from the engine. This indicates that the TCS/DSC is operating properly.
- On slippery surfaces, such as fresh snow, it will be impossible to achieve high rpm when the TCS is on.

### DSC System (Dynamic Stability Control)

The Dynamic Stability Control (DSC) automatically controls braking and engine torque in conjunction with systems such as ABS and TCS to help control side slip when driving on slippery surfaces, or during sudden or evasive maneuvering, enhancing vehicle safety. Refer to “ABS System (Antilock Brake System)” and “TCS System (Traction Control System)” in this chapter for further information.

DSC operation is possible at speeds greater than 12 mph (20 km/h).

The indicator light turns on when the system has a malfunction. Refer to “Warning Lights And Messages” in “Getting To Know Your Instrument Panel” for further information.

**Note:** The DSC may not operate correctly unless the following are observed:

- Use tires of the correct size specified for your vehicle on all four wheels.
- Use tires of the same manufacturer, brand and tread pattern on all four wheels.
- Do not mix worn tires.

**Note:** The DSC may not operate correctly when tire chains are used.

### TCS / DSC Indicator Light

The  indicator light stays on for a few seconds when the ignition is placed in the ON mode. It also illuminates when the DSC OFF switch is pressed and TCS/DSC is switched off.

If the light stays on, the TCS, DSC or the brake assist system may have a malfunction and they may not operate correctly. Take your vehicle to an authorized dealer.

### DSC OFF Indicator Light

The  indicator light stays on for a few seconds when the ignition is placed in the ON mode. It also illuminates when the DSC OFF switch is pressed and TCS/DSC is switched off.

If the light remains illuminated and the TCS/DSC is not switched off, contact your authorized dealer. The DSC may have a malfunction.

### DSC OFF Switch

Push the switch to turn off the TCS/DSC. The  indicator light in the instrument cluster will illuminate. Push the switch again to turn the TCS/DSC back on. The indicator light will turn off.





05060301-12A-001

### DSC OFF Switch

#### Note:

- When DSC is on and you attempt to free the vehicle when it is stuck, or drive it out of freshly fallen snow, the TCS (part of the DSC system) will activate. Depressing the accelerator will not increase engine power and freeing the vehicle may be difficult. When this happens, turn off the TCS/DSC.
- If the TCS/DSC is off when the engine is turned off, it automatically activates when the ignition is placed in the ON mode.



#### Warning!

- *Dynamic Stability Control (DSC) cannot prevent the natural laws of physics from acting on the vehicle, nor can it increase the traction afforded by prevailing road conditions. DSC cannot prevent accidents, including those resulting from excessive speed in turns, driving on very slippery surfaces, or hydroplaning. DSC also cannot prevent accidents resulting from loss of vehicle control due to inappropriate driver input for the conditions. Only a safe, attentive, and skillful driver can prevent accidents. The capabilities of an DSC equipped vehicle must never be exploited in a reckless or dangerous manner which could jeopardize the user's safety or the safety of others.*
- *Vehicle modifications, or failure to properly maintain your vehicle, may change the handling characteristics of your vehicle, and may negatively affect the performance of the DSC system. Changes to the steering system, suspension, braking system, tire type and size or wheel size may adversely affect DSC performance. Improperly inflated and unevenly worn tires may also degrade DSC performance. Any vehicle modification or poor vehicle maintenance that reduces the effectiveness of the DSC system can increase the risk of loss of vehicle control, vehicle rollover, personal injury and death.*

## AUXILIARY DRIVING SYSTEMS

### Blind Spot Monitoring (BSM) System

The Blind Spot Monitoring (BSM) system is designed to assist the driver during lane changes by alerting the driver to the presence of vehicles approaching from the rear in an adjacent lane.

The system detects vehicles approaching from the rear while traveling in the forward direction at a speed of 19 mph (30 km/h) or faster, and will activate the BSM warning lights equipped within the door mirrors.

If the turn signal lever is operated to signal a lane change in the direction in which the warning light is illuminated, the system warns the driver of a vehicle in the detection area by flashing the warning light and activating an audible alert.

The detection area on this system covers the driving lanes on both sides of the vehicle and from the rear part of the doors to about 164 ft (50 m) behind the vehicle.



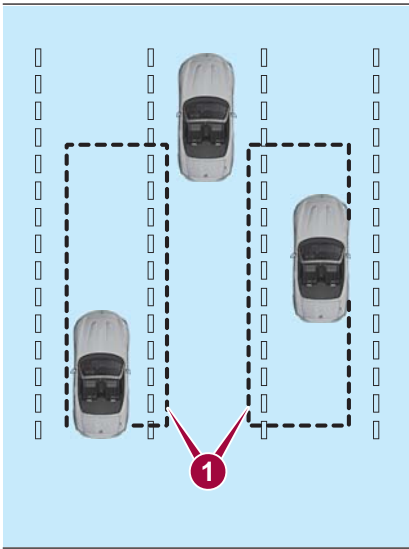

0528070012A002

### BSM Detection Areas

1 — Detection Area

### Activation / Deactivation

The Blind Spot Monitoring (BSM) system will operate when all of the following conditions are met:

- The ignition is ON.
- The BSM switch is pushed and the warning light in the instrument cluster is turned off.
- The vehicle speed is 19 mph (30 km/h) or faster.

The BSM system will not operate under the following conditions:

- The vehicle speed falls below about 15 mph (25 km/h) even though the warning light is turned off.
- The gear selector is shifted to REVERSE.

In the following cases, the warning light in the instrument cluster illuminates and operation of the BSM system is deactivated.

- A problem with the system (including the BSM warning lights) is detected.
- A large change in position of a rear radar sensor on the vehicle has occurred.
- There is a large accumulation of snow or ice on the rear bumper near a rear radar sensor. Remove any snow, ice or mud on the rear bumper.
- Driving on snow covered roads for long periods.
- The temperature near the rear radar sensors becomes extremely hot due to driving for long periods on inclines during warm weather.
- The battery voltage has decreased.

If the warning light in the instrument cluster remains illuminated, have the vehicle inspected at an authorized dealer as soon as possible.

**Note:** Under the following conditions, the rear radar sensors cannot detect

objects, or it may be difficult to detect them:

- A vehicle is in the detection area at the rear in an adjacent driving lane but it does not approach. The BSM system determines the condition based on radar detection data.
- A vehicle is traveling alongside your vehicle at nearly the same speed for an extended period of time.
- Vehicles approaching in the opposite direction.
- A vehicle in an adjacent driving lane is attempting to pass your vehicle.
- A vehicle is in an adjacent lane on a road with extremely wide driving lanes. The detection area of the rear radar sensors is set at the road width of expressways.

In the following cases, the activation of the BSM warning lights and the audible alert may not occur, or they may be delayed:

- A vehicle makes a lane change from a driving lane two lanes over to an adjacent lane.
- Driving on steep inclines.
- Crossing the summit of a hill or mountain pass.
- The turning radius is small (making a sharp turn or turning at intersections).



❑ When there is a difference in the height between your driving lane and the adjacent lane.

❑ Immediately after pushing the BSM switch and the system becomes operable.

If the road width is extremely narrow, vehicles two lanes over may be detected. The detection area of the rear radar sensors is set according to the road width of expressways.

The BSM warning lights may turn on in reaction to stationary objects on the road or the roadside such as guardrails, tunnels, sidewalls, and parked vehicles. A BSM warning light may flash or the audible alert may be activated several times when making a turn at a city intersection.

Turn off the BSM system while pulling a trailer or while an accessory such as a bicycle carrier is installed to the rear of the vehicle. Otherwise, the radar's sound system waves will be blocked causing the system to not operate normally.

In the following cases, it may be difficult to view the illumination/flashing of the BSM warning lights equipped on the door mirrors:

❑ Snow or ice is adhering to the door mirrors.

❑ The door glass is fogged or covered in snow, frost or dirt.

The system switches to the Rear Cross Traffic Alert function when the gear selector is shifted to the REVERSE position.

### BSM Warning Lights

The BSM warning lights are equipped on the left and right door mirrors.



05280701-12A-001

### BSM Warning Light

The warning lights turn on when a vehicle approaching from the rear in an adjacent lane is detected.

When the ignition is switched ON, the malfunction warning light in the instrument cluster illuminates momentarily and then turns off after a few seconds.

### Forward Driving (BSM System Operation)



The BSM system detects vehicles approaching from the rear and turns on the warning lights equipped on the door mirrors according to the conditions.

Additionally, while a warning light is illuminated, if the turn signal lever is operated to signal a turn in the direction in which the warning light is illuminated, the warning light flashes.

### Reverse Driving (RCTA System Operation)

The Rear Cross Traffic Alert (RCTA) system detects vehicles approaching from the left and right of your vehicle and flashes the BSM warning lights.

### Function For Cancelling Illumination Dimmer

When the headlight switch is in the  or  position, the brightness of the Blind Spot Monitoring (BSM) warning lights is dimmed. If the Blind Spot Monitoring (BSM) warning lights are difficult to see due to glare from surrounding brightness when traveling on snow-covered roads or under foggy conditions, push the dimmer cancellation button to cancel the dimmer and increase the brightness of Blind Spot Monitoring (BSM) warning lights when they turn on.

Refer to "Instrument Panel Illumination" in "Getting To Know Your Instrument Panel" for further information.

### BSM Warning Beep

The BSM audible alert is activated simultaneously with the flashing of a BSM warning light.

## BSM Switch

When the BSM switch is pushed, the BSM and RCTA systems are turned off and the BSM off indicator light in the instrument cluster turns on.

If the switch is pushed again, the BSM and RCTA systems become operable and the BSM off indicator light turns off.



05280703-12A-001

### BSM Switch Location

#### Note:

❑ When the ignition is switched OFF, the condition before the system was turned off is maintained. For example, if the ignition is switched OFF while the BSM and RCTA systems are operational, the BSM and RCTA systems remain operational the next time the ignition is switched ON.

❑ The BSM and RCTA systems are turned off when the battery is disconnected such as when the battery terminals or fuses have been removed and reinstalled. To turn the BSM and RCTA systems back on, push the BSM switch.

## RCTA (Rear Cross Traffic Alert) Function

The RCTA system is designed to assist the driver in checking the area to the rear of the vehicle on both sides while the vehicle is in REVERSE by alerting the driver to the presence of vehicles approaching the rear of the vehicle.

The RCTA system detects vehicles approaching from the left and right sides of the vehicle while the vehicle is reversing out of a parking space, and notifies the driver of possible danger using the BSM warning lights and an audible alert.

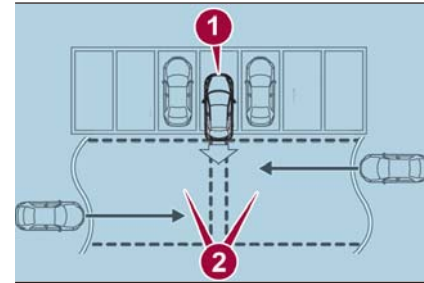

05281200-03A-001

### Rear Cross Traffic Alert

- 1 — Your Vehicle
- 2 — Approaching Vehicles Left And Right

## RCTA Operation

The RCTA system operates when the gear selector is shifted to the REVERSE position.

If there is the possibility of a collision with an approaching vehicle, the BSM warning light flashes and the audible alert is activated simultaneously.



### With Rear View Camera

The Rear Cross Traffic Alert (RCTA) warning indication in the rearview monitor also synchronizes with the Blind Spot Monitoring (BSM) warning indicator light on the door mirrors.

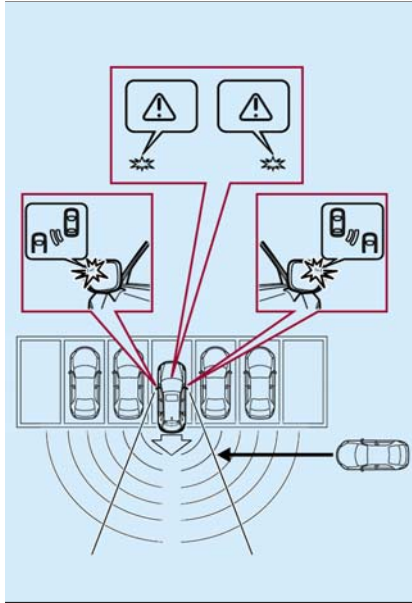

RCTA Detection

0528140012A002

In the following cases, the BSM off indicator light turns on and operation of the system is deactivated. If the BSM off indicator light in the instrument cluster remains illuminated:

- A problem with the system including the BSM warning lights has occurred.
  - A large change in the position of a rear radar sensor on the vehicle has occurred.
  - There is a large accumulation of snow or ice on the rear bumper near a rear radar sensor.
  - Driving on snow-covered roads for long periods.
  - The temperature near the radar sensors becomes extremely hot due to driving for long periods on inclines during warm weather.
  - The battery voltage has decreased.
- Have the vehicle inspected at an authorized dealer as soon as possible.

**Note:** Under the following conditions, the rear radar sensors cannot detect

objects or it may be difficult to detect them:

- The vehicle speed while in REVERSE is about 6 mph (10 km/h) or faster.
- The rear radar sensor detection area is obstructed by a nearby wall or parked vehicle (reverse the vehicle to a position where the radar sensor detection area is no longer obstructed).
- A vehicle is approaching directly to the rear of your vehicle.
- The vehicle is parked on an incline.
- Immediately after pushing the BSM switch and the system becomes operable.

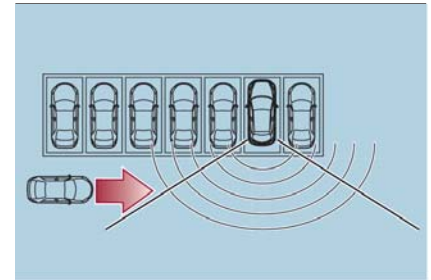

Sensors Obstructed By Nearby Vehicles

05281200-03A-003

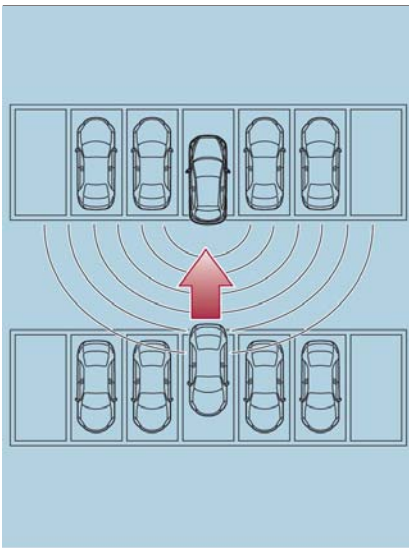

05281200-03A-004

### Another Vehicle Approaching Directly To The Rear Of Your Vehicle

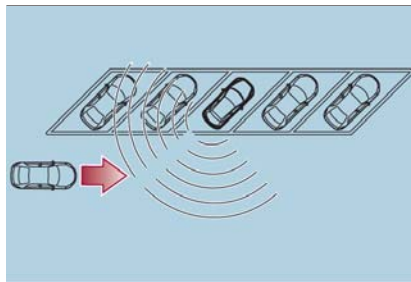

05281200-03A-005

### Your Vehicle Parked On An Incline

In the following cases, it may be difficult to view the illumination/flashing of the BSM warning lights equipped on the door mirrors:

- Snow or ice adheres to the door mirrors.
- The door glass is fogged or covered in snow, frost or dirt.

Turn off the RCTA system while pulling a trailer or while an accessory such as a bicycle carrier is installed to the rear of the vehicle.

Otherwise, the sound system waves emitted by the radar will be blocked causing the system to not operate normally.

## TPMS (Tire Pressure Monitoring System)

### Tire Pressure Monitoring System – Abarth

The TPMS system monitors the pressure for each tire.

If tire pressure is too low in one or more tires, the system will inform the driver via the (!) warning light in the instrument cluster and by the warning beep sound.

The tire pressure sensors installed on each wheel send tire pressure data by radio signal to the receiver unit in the vehicle.

TPMS does not alleviate your need to check the pressure and condition of all four tires regularly.

Each tire, including the spare (if equipped), should be checked monthly when cold and inflated to the inflation pressure recommended by the vehicle manufacturer on the vehicle placard or tire inflation pressure label. (If your vehicle has tires of a different size than the size indicated on the vehicle placard or tire inflation pressure label, you should determine the proper tire inflation pressure for those tires.)



As an added safety feature, your vehicle has been equipped with a tire pressure monitoring system (TPMS) that illuminates a low tire pressure telltale when one or more of your tires is significantly under-inflated. Accordingly, when the low tire pressure telltale illuminates, you should stop and check your tires as soon as possible, and inflate them to the proper pressure. Driving on a significantly under-inflated tire causes the tire to overheat and can lead to tire failure. Under-inflation also reduces fuel efficiency and tire tread life, and may affect the vehicle's handling and stopping ability. Please note that the TPMS is not a substitute for proper tire maintenance, and it is the driver's responsibility to maintain correct tire pressure, even if under-inflation has not reached the level to trigger illumination of the TPMS low tire pressure telltale. Your vehicle has also been equipped with a TPMS malfunction indicator to indicate when the system is not operating properly. When the system detects a malfunction, the telltale will flash for approximately one minute and then remain continuously illuminated. This sequence will continue upon subsequent vehicle start-ups as long as the malfunction exists. When the malfunction indicator is illuminated, the system may not be able to detect or signal low tire pressure as intended. TPMS malfunctions may occur for a variety of reasons, including the

installation of replacement or alternate tires or wheels on the vehicle that prevent the TPMS from functioning properly. Always check the TPMS malfunction telltale after replacing one or more tires or wheels on your vehicle to ensure that the replacement or alternate tires and wheels allow the TPMS to continue to function properly.

### System Error Activation

When the (!) warning light flashes, there may be a system malfunction. Contact your authorized dealer.

A system error activation may occur in the following cases:

- When there is equipment or a device near the vehicle using the same radio frequency as that of the tire pressure sensors.
- When a metallic device such as a non-genuine navigation system is equipped near the center of the dashboard, which may block radio signals from the tire pressure sensor to the receiver unit.
- When using the following devices in the vehicle that may cause radio interference with the receiver unit.
  - A digital device such as a personal computer.
  - A current converter device such as a DC-AC converter.

When excess snow or ice adheres to the vehicle, especially around the wheels.

When the tire pressure sensor batteries are discharged.

When using a wheel with no tire pressure sensor installed.

When using tires with steel wire reinforcement in the side walls.

When using tire chains.

### Tires And Wheels

**Note:** When inspecting or adjusting the tire air pressures, do not apply excessive force to the stem portion of the wheel unit. The stem portion could be damaged.

### Changing Tires And Wheels

The following procedure allows the TPMS to recognize a tire pressure sensor's unique ID signal code whenever tires or wheels are changed, such as changing to and from winter tires.

#### Note:

Each tire pressure sensor has a unique ID signal code. The signal code must be registered with the TPMS before it can work. The easiest way to do it is to have your authorized dealer change your tire and complete ID signal code registration.

❑ When your authorized dealer changes your vehicle's tires, they will complete the tire pressure sensor ID signal code registration.

If you or someone else changes tires, you or someone else can also undertake the steps for the TPMS to complete the ID signal code registration:

❑ After tires have been changed, place the ignition in the ON mode, then back to ACC or OFF modes.

❑ Wait for about 15 minutes.

❑ After about 15 minutes, drive the vehicle at a speed of at least 16 mph (25 km/h) for 20 minutes and the tire pressure sensor ID signal code will be registered automatically.

**Note:** If the vehicle is driven within about 15 minutes of changing tires, the (!) warning light will flash because the sensor ID signal code would not have been registered. If this happens, park the vehicle for about 15 minutes, after which the sensor ID signal code will register upon driving the vehicle for 20 minutes.

## Replacing Tires And Wheels

### Note:

❑ When replacing/repairing the tires or wheels or both, have the work done by your authorized dealer, or the tire pressure sensors may be damaged.

❑ The wheels equipped on your vehicle are specially designed for installation of the tire pressure sensors. Do not use non-genuine wheels, otherwise it may not be possible to install the tire pressure sensors.

Be sure to have the tire pressure sensors installed whenever tires or wheels are replaced.

When having a tire or wheel or both replaced, the following types of tire pressure sensor installations are possible:

❑ The tire pressure sensor is removed from the old wheel and installed to the new one.

❑ The same tire pressure sensor is used with the same wheel. Only the tire is replaced.

❑ A new tire pressure sensor is installed to a new wheel.

### Note:

❑ The tire pressure sensor ID signal code must be registered when a new tire pressure sensor is purchased. For purchase of a tire pressure sensor and registration of the tire pressure sensor ID signal code, consult your authorized dealer.

❑ When reinstalling a previously removed tire pressure sensor to a wheel, replace the grommet (seal between valve body/sensor and wheel) for the tire pressure sensor.



### Caution!

❑ *The TPMS has been optimized for the original equipment tires and wheels. TPMS pressures and warning have been established for the tire size equipped on your vehicle. Undesirable system operation or sensor damage may result when using replacement equipment that is not of the same size, type, and/or style. The TPM sensor is not designed for use on aftermarket wheels and may contribute to a poor overall system performance or sensor damage. Customers are encouraged to use OEM wheels to assure proper TPM feature operation.*

❑ *Using aftermarket tire sealants may cause the Tire Pressure Monitoring System (TPMS) sensor to become inoperable. After using an aftermarket tire sealant it is recommended that you take your vehicle to an authorized dealership to have your sensor function checked.*

❑ *After inspecting or adjusting the tire pressure always reinstall the valve stem cap. This will prevent moisture and dirt from entering the valve stem, which could damage the TPMS sensor.*





The following regulatory statement applies to all radio frequency (RF) devices equipped in this vehicle:

This device complies with Part 15 of the FCC Rules and with Industry Canada license-exempt RSS standard(s). Operation is subject to the following two conditions:

- (1) This device may not cause harmful interference, and
- (2) This device must accept any interference received, including interference that may cause undesired operation.

**Note:** Changes or modifications not expressly approved by the party responsible for compliance could void the user's authority to operate the equipment.

## OCCUPANT RESTRAINT SYSTEMS

---

The most important safety equipment of the vehicle comprise the following protection systems:

- Seat Belts
- SBA (Seat Belt Alert) System
- Head Restraints
- Child Restraint Systems
- Front Air Bags And Side Air Bags

Read the information given in the following pages with the utmost care.

It is of fundamental importance that the protection systems are used in the correct way to guarantee the maximum possible safety level for the driver and the passengers.

## SEAT BELT SYSTEMS

---

Buckle up even though you are an excellent driver, even on short trips. Someone on the road may be a poor driver and could cause a collision that includes you. This can happen far away from home or on your own street.

Research has shown that seat belts save lives, and they can reduce the seriousness of injuries in a collision. Some of the worst injuries happen when people are thrown from the vehicle. Seat belts reduce the possibility of ejection and the risk of injury caused by striking the inside of the vehicle. Everyone in a motor vehicle should be belted at all times.



## Seat Belt Precautions

Seat belts help to decrease the possibility of severe injury during accidents and sudden stops. FCA recommends that the driver and passengers always wear seat belts.

### Mexico

All the seats have lap/shoulder belts. These belts have retractors with inertia locks that keep them out of the way when not in use.

The locks allow the belts to remain comfortable on users, but they will lock in position during a collision.

### Except Mexico

All of the seat belt retractors are designed to keep the lap/shoulder belts out of the way when not in use.

The driver's seat belt has no provisions for child-restraint systems and has only an emergency locking mode.

The driver may wear it comfortably, and it will lock during a collision.

However, the passenger's seat lap/shoulder belt retractor operates in two modes: emergency locking mode, and for child-restraint systems, automatic locking mode. If you must use the passenger seat for a child, slide the passenger seat as far back as possible and make sure any child restraint system is secured properly.

Belt retraction may become difficult if the belts and seat belt guides are soiled, so try to keep them clean. Refer

to "Lap/Shoulder Belt" in "Interiors," found in Servicing And Maintenance" for further information.



03020100-12A-001

### Seat Belt Routing Guide



#### Warning!

Relying on the air bags alone could lead to more severe injuries in a collision. The air bags work with your seat belt to restrain you properly. In some collisions, the air bags won't deploy at all. Always wear your seat belt even though you have air bags.

In a collision, you and your passengers can suffer much greater injuries if you are not properly buckled up. You can strike the interior of your vehicle or other passengers, or you can be thrown out of the vehicle. Always be sure you and others in your vehicle are buckled up properly.

It is dangerous to ride in a cargo area, inside or outside of a vehicle. In a collision, people riding in these areas are more likely to be seriously injured or killed.

Do not allow people to ride in any area of your vehicle that is not equipped with seats and seat belts.

Be sure everyone in your vehicle is in a seat and using a seat belt properly. Occupants, including the driver, should always wear their seat belts whether or not an air bag is also provided at their seating position to minimize the risk of severe injury or death in the event of a crash.

Wearing your seat belt incorrectly could make your injuries in a collision much worse. You might suffer internal injuries, or you could even slide out of the seat belt. Follow these instructions to wear your seat belt safely and to keep your passengers safe, too.

Two people should never be belted into a single seat belt. People belted together can crash into one another in a collision, hurting one another badly. Never use a lap/shoulder belt or a lap belt for more than one person, no matter what their size.

A lap belt worn too high can increase the risk of injury in a collision. The seat belt forces won't be at the strong hip and pelvic bones, but across your abdomen. Always wear the lap part of your seat belt as low as possible and keep it snug.

A twisted seat belt may not protect you properly. In a collision, it could even cut into you. Be sure the seat belt is flat against your body, without twists. If you can't straighten a seat belt in your vehicle, take it to your authorized dealer immediately and have it fixed.



- ❑ *A seat belt that is buckled into the wrong buckle will not protect you properly. The lap portion could ride too high on your body, possibly causing internal injuries. Always buckle your seat belt into the buckle nearest you.*
- ❑ *A seat belt that is too loose will not protect you properly. In a sudden stop, you could move too far forward, increasing the possibility of injury. Wear your seat belt snugly.*
- ❑ *A seat belt that is worn under your arm is dangerous. Your body could strike the inside surfaces of the vehicle in a collision, increasing head and neck injury. A seat belt worn under the arm can cause internal injuries. Ribs aren't as strong as shoulder bones. Wear the seat belt over your shoulder so that your strongest bones will take the force in a collision.*
- ❑ *A shoulder belt placed behind you will not protect you from injury during a collision. You are more likely to hit your head in a collision if you do not wear your shoulder belt. The lap and shoulder belt are meant to be used together.*
- ❑ *A frayed or torn seat belt could rip apart in a collision and leave you with no protection. Inspect the seat belt system periodically, checking for cuts, frays, or loose parts. Damaged parts must be replaced immediately. Do not disassemble or modify the seat belt system. Seat belt assemblies must be replaced after a collision.*

## Seat Belts And Pregnant Women

### Pregnant Women And Persons With Serious Medical Conditions

Pregnant women should always wear seat belts. Ask your doctor for specific recommendations.

The lap belt should be worn **SNUGLY AND AS LOW AS POSSIBLE OVER THE HIPS**. The shoulder belt should be worn across your shoulder properly, but never across the stomach area.



06050100-CHD-003

### Seat Belts And Pregnant Women

Persons with serious medical conditions also should wear seat belts. Check with your doctor for any special instructions regarding specific medical conditions.

## Emergency Locking Mode

When the seat belt is fastened, it will always be in the emergency locking mode.

In the emergency locking mode, the belt remains comfortable on the occupant and the retractor will lock in position during a collision.

If the belt is locked and cannot be pulled out, retract the belt once, and then try pulling it out slowly. If this fails, pull the belt strongly one time and loosen, then pull it out again slowly.

### Seat Belt With Automatic Locking Mode

When the seat belt is fastened, it will always be in the emergency locking mode until it is switched to automatic locking mode by pulling it all the way out to its full length.

If the belt feels tight and hinders comfortable movement while the vehicle is stopped or in motion, it may be in the automatic locking mode because the belt has been pulled too far out.

To return the belt to the more comfortable emergency locking mode, wait until the vehicle has stopped in a safe, level area, retract the belt fully to convert it back to emergency locking mode and then extend it around you again.

## Automatic Locking Mode

Always use the automatic locking mode to keep the child-restraint system from shifting to an unsafe position in the event of an accident.

To enable seat belt automatic locking mode, pull it all the way out and connect it as instructed on the child restraint system. It will retract down to the child restraint system and stay locked on it.



### Warning!

The seat belt assembly must be replaced if the switchable Automatic Locking Retractor (ALR) feature or any other seat belt function is not working properly when checked according to the procedures in the Service Manual.

Failure to replace the seat belt assembly could increase the risk of injury in collisions.

Do not use the Automatic Locking Mode to restrain occupants who are wearing the seat belt or children who are using booster seats. The locked mode is only used to install rear-facing or forward-facing child restraints that have a harness for restraining the child.

## Lap/Shoulder Belts

### Fastening The Seat Belt

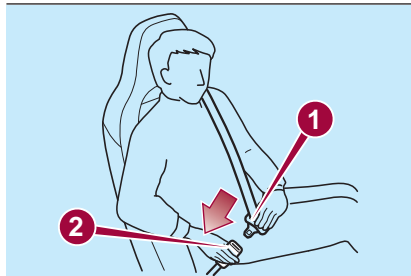

03020201121001

### Fastening The Seat Belt

- |                      |                      |
|----------------------|----------------------|
| 1 — Seat Belt Tongue | 2 — Seat Belt Buckle |
|----------------------|----------------------|

Position the lap belt as low as possible, not on the abdominal area 2, then adjust the shoulder belt 3 so that it fits snugly against your body.

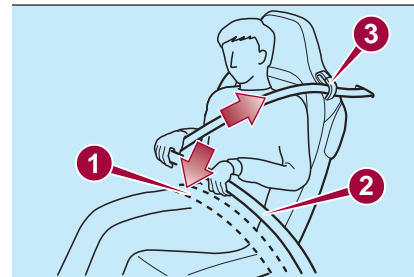

03020201122002

### Adjusting The Seat Belt

- |                                       |
|---------------------------------------|
| 1 — Position Lap Belt Across Lap Area |
| 2 — Lap Belt Routing                  |
| 3 — Shoulder Belt Routing             |



## Unfastening The Seat Belt

Depress the button on the seat belt buckle. If the belt does not fully retract, pull it out and check for kinks or twists. Then make sure it remains untwisted as it retracts.

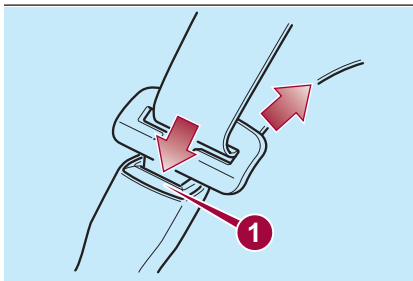

03020202UNF001

### Latching/Unlatching The Seat Belt

#### 1 — Seat Belt Release Button

#### Note:

❑ If a belt does not fully retract, inspect it for kinks and twists. If it is still not retracting properly, have it inspected: contact an authorized dealer.

❑ Always wear the seat belt with it correctly routed in its guide. Wearing a seat belt without the seat belt routed in its guide is dangerous because the seat belt would not be able to provide adequate protection in an accident, which could result in serious injury.

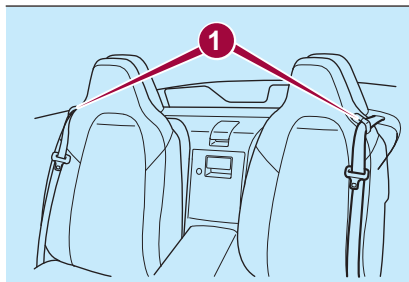

0302020012A001

### Seat Belt Routing Guides

#### 1 — Shoulder Belt Routing Guides

## Seat Belt Warning Systems

If it detects that the occupant seat belt is unfastened, the warning light or beep alerts the occupant.

Refer to “Warning Lights And Messages” in “Getting To Knowing Your Instrument Panel” for further information.

Refer to “Seat Belt Warning Light” in “Getting To Knowing Your Instrument Panel” for further information.

## Seat Belt Extender

If your seat belt is not long enough, even when fully extended, a seat belt extender may be available to you at no charge from authorized dealer.

This extender will be only for you and for the particular vehicle and seat. Even if it plugs into other seat belts, it may

not hold in the critical moment of a crash.

When ordering an extender, only order one that provides the necessary additional length to fasten the seat belt properly. Please contact authorized dealer for more information.

When not in use, remove the seat belt extender and store it in the vehicle. If the seat belt extender is left connected, the seat belt extender might get damaged as it will not retract with the rest of the seat belt and can easily fall out of the door when not in use and be damaged.

In addition, the seat belt warning light will not illuminate and function properly.



### Warning!

❑ Do not use a seat belt extender unless it is necessary. Using a seat belt extender when not necessary is dangerous. The seat belt will be too long and not fit properly. In an accident, the seat belt will not provide adequate protection and you could be seriously injured. Only use the extender when it is required to fasten the seat belt properly.

❑ Do not use an improper extender. Using a seat belt extender that is for another person or a different vehicle or seat is dangerous. The seat belt will not provide adequate protection and the user could be

seriously injured in an accident. Only use the extender provided for you and for the particular vehicle and seat.

NEVER use the extender in a different vehicle or seat. If you sell your vehicle, do not leave your seat belt extender in the vehicle. It could be used accidentally by the new owner of the vehicle. After removing the seat belt extender, discard it. Never use the seat belt extender in any other vehicle you may own in the future.

Do not use an extender that is too long. Using an extender that is too long is dangerous. The seat belt will not fit properly. In an accident, the seat belt will not provide adequate protection and you could be seriously injured. Do not use the extender or choose one shorter in length if the distance between the extender's buckle and the center of the user's body is less than 6 inches (15 cm).

Do not leave a seat belt extender connected to the buckle. Leaving a seat belt extender connected to the buckle without using the seat belt is dangerous. When the seat belt extender is connected to the driver's seat belt buckle (or passenger) seat, the SRS driver's (or passenger's) air bag system will determine that the driver (or passenger) is wearing the seat belt even if the driver (or passenger) is not wearing it. This condition could cause the driver's (or passenger's) air bag to not activate correctly and result in death or serious injury in the event of collision. Always wear the seat belt with the seat belt extender.

Do not use the seat belt extender when installing a child restraint system on the passenger seat. Using a seat belt extender to fasten a child restraint system on any seat is dangerous. Always follow the child

restraint system manufacturer's installation instructions and never use a seat belt extender.

## Driver And Passenger BeltAlert (If Equipped)

### Seat Belt Warning Systems

The LED on dashboard trim turns on if the driver or passenger's seat is occupied and the seat belt is not fastened with the ignition switched ON.

If the driver or passenger's seat belt is unfastened (only when the passenger seat is occupied) and the vehicle is driven at a speed faster than about 12 MPH (20 km/h), the  LED flashes. After a short time, the LED stops flashing, but remains illuminated.

If a seat belt remains unfastened, the LED flashes again for a given period of time. In this case, fasten the seat belt.

### Seat Belt Pretensioner

For optimum protection, the driver and passenger seat belts are equipped with pretensioner and load limiting systems. For both these systems to work properly you must wear the seat belt properly.

The seat belt pretensioners are designed to deploy in moderate or severe frontal, near frontal collisions. In addition, during a side collision, the pretensioner operates on the side in which the collision occurs. The

pretensioners operate differently depending on what types of air bags are equipped. For details on the seat belt pretensioner operation, refer to the "SRS Air Bag Deployment Criteria" paragraph in this chapter.

When a collision is detected, the pretensioners deploy simultaneously with the air bags. For deployment details, refer to the "SRS Air Bag Deployment Criteria" paragraph in this chapter.

The seat belt retractors remove slack quickly as the air bags are expanding. Any time the air bags and seat belt pretensioners have fired they must be replaced.

### With Passenger Occupant Classification System

In addition, the pretensioner system for the passenger, like the front and side passenger Air Bag, is designed to only deploy when the passenger occupant classification sensor detects a passenger sitting on the passenger's seat.

#### Note:

These devices are not a substitute for proper seat belt placement by the occupant. The seat belt still must be worn snugly and positioned properly.

The pretensioners are triggered by the Occupant Restraint Controller (ORC). Like the air bags, the pretensioners are single use items. A deployed pretensioner or a deployed air bag must be replaced immediately.



## Load Limiter

The load limiting system releases belt webbing in a controlled manner to reduce belt force on the occupant's chest.

While the most severe load on a seat belt occurs in frontal collisions, the load limiter has an automatic mechanical function and can activate in any accident mode with sufficient occupant movement.

Even if the pretensioners have not fired, the load limiting function must be checked by an authorized dealer.

## CHILD RESTRAINT PRECAUTIONS

### Child Restraints

FCA strongly urges the use of child-restraint systems for children small enough to use them.

FCA recommends use of a genuine child-restraint system or one that complies with regulation. If you would like to purchase a FCA genuine child-restraint system, please contact a authorized dealer.

Check your local and state or provincial laws for specific requirements regarding the safety of children riding in your vehicle.

Whatever child-restraint system you consider, please pick the appropriate one for the age and size of the child, obey the law and follow the instructions that come with the individual child-restraint system.

A child who has outgrown child-restraint systems should use seat belts, both lap and shoulder. If the shoulder belt crosses the neck or face, move the child closer to the center of the vehicle.

A rear-facing child-restraint system should **NEVER** be used on the passenger seat with the Air Bag system activated. In the event of an impact the Air Bag activation may cause fatal injuries to the transported child.

### With Passenger Occupant Classification System

To reduce the chance of injuries caused by deployment of the passenger Air Bag, the passenger occupant classification sensor work as a part of the supplementary restraint system.

This system deactivates the passenger front and side Air Bags and also the passenger seat belt pretensioner system when the  **OFF** passenger Air Bag deactivation indicator light illuminates.

When an infant or small child sits on the passenger seat, the system shuts off the passenger front and side Air Bags and seat belt pretensioner system, so make sure the  **OFF** passenger Air Bag deactivation indicator light illuminates. For more details, refer to "Passenger Occupant Classification Sensor" in "Supplementary Restraint System SRS — Air Bag" for additional information.

**Note:** A seat belt or child-restraint system can become very hot in a closed vehicle during warm weather. To avoid burning yourself or a child, check them before you or your child touches them.





## Warning!

- ❑ *Improper installation can lead to failure of an infant or child restraint. It could come loose in a collision. The child could be badly injured or killed. Follow the child restraint manufacturer's directions exactly when installing an infant or child restraint.*
- ❑ *After a child restraint is installed in the vehicle, do not move the vehicle seat forward or rearward because it can loosen the child restraint attachments. Remove the child restraint before adjusting the vehicle seat position. When the vehicle seat has been adjusted, reinstall the child restraint.*
- ❑ *When your child restraint is not in use, secure it in the vehicle with the seat belt or LATCH anchorages, or remove it from the vehicle. Do not leave it loose in the vehicle. In a sudden stop or accident, it could strike the occupants or seatbacks and cause serious personal injury.*

## Child Restraint System Types

In this Owner Handbook, explanation of child restraint systems secured with seat belts is provided for the following three types of popular child-restraint systems: infant seat, child seat, booster seat.

### Note:

- ❑ Installation position is determined by the type of child restraint system. Always read the manufacturer's instructions and this Owner Handbook carefully.
- ❑ Due to variations in the design of child restraint systems, vehicle seats and seat belts, not all child restraint may fit all seating positions.
- ❑ Before purchasing a child-restraint system, it should be tested in the specific vehicle seating position (or positions) where it is intended to be used. If a previously purchased child-restraint system does not fit, you may need to purchase a different one that will.

### Infant Seat

An infant seat provides restraint by bracing the infant's head, neck and back against the seating surface.

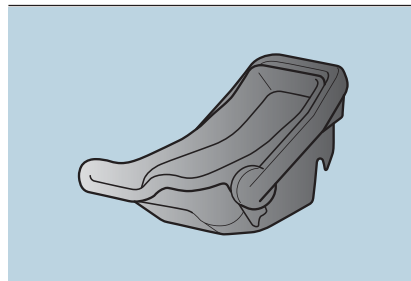

Infant Seat

06070809INF001

### Child Seat

A child seat restrains a child's body using the harness.



Child Seat

03030202CHD001

### Booster Seat

A booster seat is a child restraint accessory designed to improve the fit of the seat belt system around the child's body.

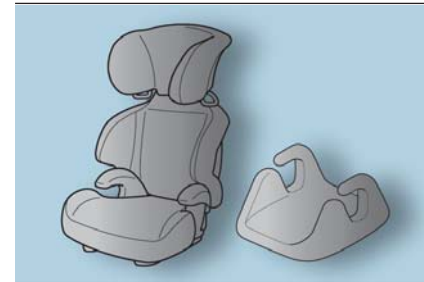

Booster Seat

03030202BOO001



**Warning!**

*Never allow a child to put the shoulder belt under an arm or behind their back. In a crash, the shoulder belt will not protect a child properly, which may result in serious injury or death. A child must always wear both the lap and shoulder portions of the seat belt correctly.*

**Child Seat Installation Position**

The passenger lap/shoulder belt can easily be converted into the automatic locking mode, which must be done to hold the child-restraint system.

**Note:** To check if your seats have side air bags: FCA vehicles equipped with side air bag will have an embossed "SRS AIRBAG" marking on the outboard shoulder of the seats.

Follow the child restraint system manufacturer's instructions carefully. Depending on the type of child restraint system, it may not employ seat belts which are in automatic locking mode, however if it uses an upper tether, it may not be mounted properly in this

vehicle as there is no safe way to anchor the tether. Confirm whether the child restraint system can be used with seat belts by reading the child restraint system manufacturer's instructions.

**Passengers Seat Child Restraint System Installation (With Passenger Occupant Classification System)**

Proceed as follows:

- Make sure the ignition is switched off.
- Slide the seat as far back as possible.
- Place the child-restraint system on the seat without putting your weight on the seat and secure the child-restraint system with the lap portion of the lap/shoulder belt. See the manufacturer's instructions on the child-restraint system for belt routing instructions.
- To get the retractor into the automatic locking mode, pull the shoulder belt portion of the seat belt until the entire length of the belt is out of the retractor.
- Push the child-restraint system firmly into the vehicle seat. Be sure the belt retracts as snugly as possible. A

clicking noise from the retractor will be heard during retraction if the system is in automatic locking mode. If the belt does not lock the seat down tight, repeat the previous step and also this one.

Seat your child safely in the child-restraint system and secure the child according to the instructions from the child-restraint system manufacturer.

**Note:** Inspect this function before each use of the child restraint system. You should not be able to pull the shoulder belt out of the retractor while the system is in the automatic locking mode. When you remove the child-restraint system, be sure the belt fully retracts to return the system to emergency locking mode before occupants use the seat belts.

Place the ignition in the ON position and make sure the passenger air bag deactivation indicator light illuminates after installing a child restraint system on the passenger seat. If the passenger air bag deactivation indicator light does not illuminate, remove the child restraint system, place the ignition in the OFF position, and then reinstall the child restraint system.





06070400567567

## Passenger Air Bag Deactivation Light



### Warning!

- Never place a rear-facing child restraint in front of an air bag. A deploying passenger Advanced Front Air Bag can cause death or serious injury to a child 12 years or younger, including a child in a rear-facing child restraint.
- Only use a rear-facing child restraint in a vehicle with a rear seat.
- An incorrectly anchored tether strap could lead to increased head motion and possibly injury to the child. Use only the anchorage position directly behind the child seat to secure a child restraint top tether strap.

## SUPPLEMENTARY RESTRAINT SYSTEM SRS – AIR BAG

### Description

The front and side Supplementary Restraint Systems (SRS) include different types of Air Bags.

**Note:** Please verify which kinds of Air Bags are equipped on your vehicle by locating the “SRS AIR BAG” location indicators.

These indicators are visible in the area where the Air Bags are installed. The Air Bags are installed in the following locations:

- The steering wheel hub (Driver Air Bag)
- The passenger dashboard (Passenger Air Bag)
- The outer sides of the seat backs (Side Air Bags)

This vehicle has front air bags and lap/shoulder belts for both the driver and front passenger. The front air bags are a supplement to the seat belt restraint systems.

The Air Bag supplementary restraint systems are designed to provide supplementary protection in certain situations so seat belts are always important in the following ways.

Without seat belt usage, the Air Bags cannot provide adequate protection

during an accident. Seat belt usage is necessary to:

- Keep the occupant from being thrown into an inflating Air Bag.
- Reduce the possibility of injuries during an accident that is not designed for Air Bag inflation, such as roll-over or rear impact.
- Reduce the possibility of injuries in frontal, near frontal or side collisions that are not severe enough to activate the Air Bags.
- Reduce the possibility of being thrown from your vehicle.
- Reduce the possibility of injuries to lower body and legs during an accident because the Air Bags provide no protection to these parts of the body.
- Hold the driver in a position which allows better control of the vehicle.



### Warning!

*In order for the Side Air Bags to work as intended, do not install any accessory items in your vehicle which could alter the roof. Do not add an aftermarket sunroof to your vehicle. Do not add roof racks that require permanent attachments (bolts or screws) for installation on the vehicle roof. Do not drill into the roof of the vehicle for any reason.*



**If your vehicle is also equipped with a passenger occupant classification system, refer to the “Passenger Occupant Classification System” paragraph for further information.**

If your vehicle is equipped with a passenger occupant classification system, the passenger Air Bag deactivation indicator light illuminates for a specified time after the ignition has been placed in the ON position.



06070400567567

**Passenger Air Bag Deactivated Light**

Small children must be protected by a child-restraint system as stipulated by law in every state and province. In certain states and provinces, larger children must use a child-restraint system. Carefully consider which child-restraint system is necessary for your child and follow the installation directions in this Owner's Manual as well as the child-restraint system manufacturer's instructions.

Do not use a child-restraint system which employs an upper tether because there is no appropriate means to anchor the tether.



**Warning!**

If the Indicator Light remains illuminated for an adult passenger, have an authorized dealer service the air bag system immediately. Failure to do so may cause serious injury or death. If the Indicator Light is illuminated with the words “PASS AIRBAG OFF,” the Passenger Advanced Front Air Bag will not deploy in the event of a collision.

Never place a rear-facing child restraint in front of an air bag. A deploying passenger front air bag can cause death or serious injury to a child 12 years or younger, including a child in a rear-facing child restraint.

Only use a rear-facing child restraint in a vehicle with a rear seat.

Children 12 years or younger should always ride buckled up in a vehicle with a rear seat.



**Warning!**

Unapproved modifications or service procedures to the passenger seat assembly, its related components, seat cover or cushion may inadvertently change the air bag deployment in case of a frontal collision. This could result in death or serious injury to the front passenger if the vehicle is involved in a collision. A modified vehicle may not comply with required Federal Motor Vehicle Safety Standards (FMVSS) and/or Canadian Motor Vehicle Safety Standards (CMVSS).

If it is necessary to modify the air bag system for persons with disabilities, contact your authorized dealer.

## Supplementary Restraint System Components

### With Passenger Occupant Classification System

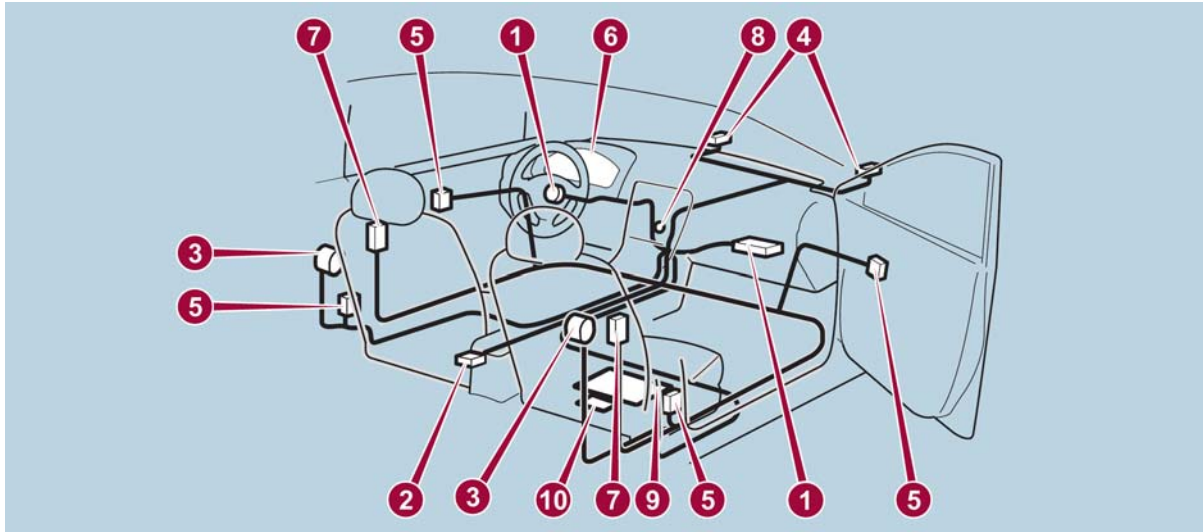

### With Passenger Occupant Classification System

03040300-121-002

1 — Driver/Passenger Inflators And Air Bags  
2 — Crash Sensors And Diagnostic Module (Sas Unit)  
3 — Seat Belt Pretensioners  
4 — Front Air Bag Sensors

5 — Side Crash Sensors  
6 — Air Bag/Seat Belt Pretensioner System Warning Light  
7 — Side Inflators And Air Bags  
8 — Passenger Air Bag Deactivation Indicator Light

9 — Passenger Occupant Classification Sensor  
10 — Passenger Occupant Classification Module



## Without Passenger Occupant Classification System

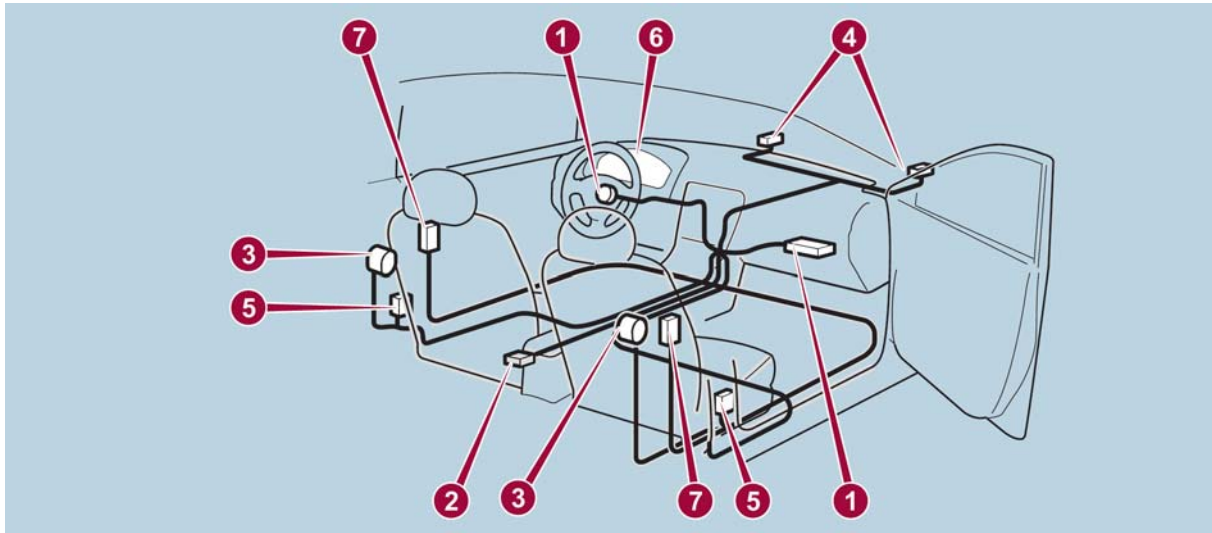

03040300-122-003

### Without Passenger Occupant Classification System

- |                                                    |                                                         |                                 |
|----------------------------------------------------|---------------------------------------------------------|---------------------------------|
| 1 — Driver/Passenger Inflators And Air Bags        | 4 — Front Air Bag Sensors                               | 7 — Side Inflators And Air Bags |
| 2 — Crash Sensors And Diagnostic Module (Sas Unit) | 5 — Side Crash Sensors                                  |                                 |
| 3 — Seat Belt Pretensioners                        | 6 — Air Bag/Seat Belt Pretensioner System Warning Light |                                 |

## How The SRS Air Bags Work

This vehicle has front air bags and lap/shoulder belts for both the driver and front passenger. The front air bags are a supplement to the seat belt restraint systems. The SRS Air Bags are designed to provide further protection for passengers in addition to the seat belt functions. Be sure to wear seat belts properly.

### Seat Belt Pretensioners

The seat belt pretensioners are designed to deploy in moderate or severe frontal, near frontal collisions. In addition, during a side collision, the pretensioner operates on the side in which the collision occurs.

The pretensioners operate differently depending on what types of air bags are equipped. For details on the seat belt pretensioner operation, refer to the "SRS Air Bag Deployment Criteria".

### Driver Air Bag

The driver's air bag is mounted in the steering wheel.



06010203-126-123

### Driver Side Air Bags

When Air Bag crash sensors detect a frontal impact of greater than moderate force, the driver's Air Bag inflates quickly helping to reduce injury mainly to the driver's head or chest caused by directly hitting the steering wheel. For more details about Air Bag deployment, refer to "SRS Air Bag Deployment Criteria" in this chapter for further information.

(With Passenger Occupant Classification System)

The driver's dual-stage air bag controls air bag inflation in two energy stages. During an impact of moderate severity, the driver's air bag deploys with lesser energy, whereas during more severe impacts, it deploys with more energy.

## Passenger Air Bag

(Dual Stage)

The passenger Air Bag is mounted in the passenger dashboard.



06010204-126-123

### Passenger Side Air Bag

The inflation mechanism for the passenger Air Bag is the same as the driver's Air Bag, as mentioned above. For more details about Air Bag deployment, refer to "SRS Air Bag Deployment Criteria" in this chapter. For further details about air bag deployment, refer to "SRS Air Bag Deployment Criteria" in this chapter.



## Side Air Bags

The side air bags are mounted in the outer sides of the seat backs. When the air bag crash sensors detect a side impact of greater than moderate force, the system inflates the side air bag only on the side in which the vehicle was hit.



06010205-126-123

### Side Air Bags

The side air bag inflates quickly to reduce injury to the driver or passenger's head and chest caused by directly hitting interior parts such as a door or window. For more details about air bag deployment, refer to "SRS Air

Bag Deployment Criteria" in this chapter for further information.



### Warning!

- ❑ Occupants, including children, who are up against or very close to SABs can be seriously injured or killed. Occupants, including children, should never lean on or sleep against the door, side windows, or area where the side air bags inflate, even if they are in an infant or child restraint.
- ❑ Seat belts (and child restraints where appropriate) are necessary for your protection in all collisions. They also help keep you in position, away from an inflating SAB. To get the best protection from the SABs, occupants must wear their seat belts properly and sit upright with their backs against the seats. Children must be properly restrained in a child restraint or booster seat that is appropriate for the size of the child.

### With Passenger Occupant Classification System

In addition, the passenger side bag is designed to only deploy when the passenger occupant classification sensor detects a passenger sitting on the passenger's seat.



### Warning!

- ❑ If a child restraint system, child, small teenager or adult in the front passenger seat is seated improperly, the occupant may provide an output signal to the OCS that is different from the occupant's properly seated weight input. This may result in serious injury or death in a collision.
- ❑ Always wear your seat belt and sit properly, with the seatback in an upright position, your back against the seatback, sitting upright, facing forward, in the center of the seat, with your feet comfortably on or near the floor.
- ❑ Do not carry or hold any objects (e.g., backpacks, boxes, etc.) while seated in the front passenger seat. Holding an object may provide an output signal to the OCS that is different than the occupant's properly seated weight input, which may result in serious injury or death in a collision.
- ❑ Placing an object on the floor under the front passenger seat may prevent the OCS from working properly, which may result in serious injury or death in a collision. Do not place any objects on the floor under the front passenger seat.



## Warning Light/Beep

A system malfunction or operation conditions are indicated by a warning. Refer to the beginning paragraph of “Warning Lights And Messages” in “Getting To Know Your Instrument Panel” for further information.



### Warning!

*Ignoring the Air Bag Warning Light in your instrument panel could mean you won't have the air bags to protect you in a collision. If the light does not come on as a bulb check when the ignition is first turned on, stays on after you start the vehicle, or if it comes on as you drive, have an authorized dealer service the air bag system immediately.*

## Passenger Side Front Air Bag And Child Restraint Systems

Rearward-facing child restraint systems must **NEVER** be fitted on the front seat with an active passenger side air bag since in the event of an impact the air bag activation may cause fatal injuries to the transported child.

**ALWAYS** comply with the instructions on the label stuck on the passenger side sun visor : **A** = Mexico market/ **B** = U.S.A. and Canada market.



03030101-121-001

### Sun Visor Air Bag Labels



### Warning!

*Do not use accessory seat covers or place objects between you and the Side Air Bags; the performance could be adversely affected and/or objects could be pushed into you, causing serious injury.*



### Warning!



- Side Air Bags need room to inflate. Do not lean against the door or window. Sit upright in the center of the seat.
- Being too close to the Side Air Bags during deployment could cause you to be severely injured or killed.
- Relying on the Side Air Bags alone could lead to more severe injuries in a collision. The Side Air Bags work with your seat belt to restrain you properly. In some collisions, Side Air Bags won't deploy at all. Always wear your seat belt even though you have Side Air Bags.



## SRS Air Bag Deployment Criteria

This chart indicates the applicable SRS equipment that will deploy depending on the type of collision (the illustrations are the representative cases of collisions).

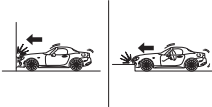
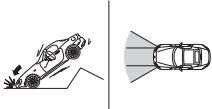
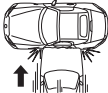
Deployed air bags and seat belt pretensioners cannot protect you in another collision. Have the air bags, seat belt pretensioners, and the seat belt retractor assemblies replaced by an authorized dealer immediately. Also, have the Occupant Restraint Controller System serviced as well.

SRS Equipment	Types Of Collision		
	A Severe Frontal/Near Frontal Collision	A Severe Side Collision (*)	A Rear Collision
			
			
			
Seat Belt Pretensioner	X (**)	X (**)	No air bag and seat belt pretensioner will be activated in a rear collision
Driver Air Bag	X		
Passenger Air Bag	X (**)		
Side Air Bag		X (**)	

X: the SRS air bag equipment is designed to deploy in a collision.

(\*) In a side collision, the seat belt pretensioners and the side air bags deploy (only on the side in which the collision occurs).



(\*\*) **Passenger Occupant Classification System:** the passenger front and side air bags and the seat belt pretensioner are designed to deploy when the passenger occupant classification sensor detects a passenger sitting on the passenger's seat.

**Note:** In a frontal offset collision, the equipped air bags and pretensioners may all deploy depending on the direction, angle, and rate of impact.



### Warning!

- Unapproved modifications or service procedures to the passenger seat assembly, its related components, seat cover, or cushion may inadvertently change the air bag deployment in case of a frontal collision. This could result in death or serious injury to the front passenger if the vehicle is involved in a collision. A modified vehicle may not comply with required Federal Motor Vehicle Safety Standards (FMVSS) and/or Canadian Motor Vehicle Safety Standards (CMVSS).
- If it is necessary to modify the air bag system for persons with disabilities, contact your authorized dealer.



### Warning!

Deployed air bags and seat belt pretensioners cannot protect you in another collision. Have the air bags, seat belt pretensioners, and the seat belt retractor assemblies replaced by an authorized dealer immediately. Also, have the Occupant Restraint Controller System serviced as well.



### Warning!

- Ignoring the Air Bag Warning Light in your instrument panel could mean you won't have the air bags to protect you in a collision. If the light does not come on as a bulb check when the ignition is first turned on, stays on after you start the vehicle, or if it comes on as you drive, have an authorized dealer service the air bag system immediately.
- Placing an object on the floor under the front passenger seat may prevent the occupant classification sensor from working properly, which may result in serious injury or death in a collision. Do not place any objects on the floor under the front passenger seat.
- If there is a fault present in the occupant classification sensor, both the Indicator Light and the Air Bag Warning Light will illuminate to show that the Passenger Advanced Front Air Bag is deactivated. Should this occur, the Passenger Advanced Front Air Bag will remain deactivated until the fault is cleared. This indicates that you should take the vehicle to an authorized dealer for service immediately.



## Limitations To SRS Air Bag

In severe collisions such as those described in "SRS Air Bag Deployment Criteria" paragraph, the applicable SRS air bag equipment will deploy.

However, in some accidents, the equipment may not deploy depending on the type of collision and its severity.

### Limitations To Front / Near Front Collision Detection

Front/near front collisions may not be detected as severe enough to deploy the SRS air bag equipment:

- Impacts involving trees or poles A.
- Frontal offset impact to the vehicle B.
- Rear-ending or running under a truck's tail gate.

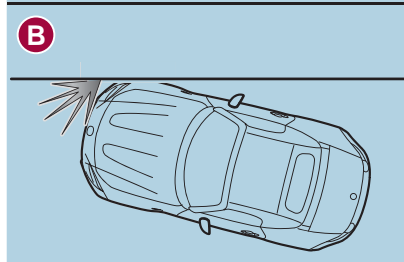
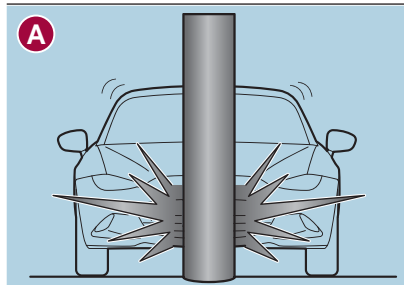

03040600-121-001  
**Front/Near Front Collision**

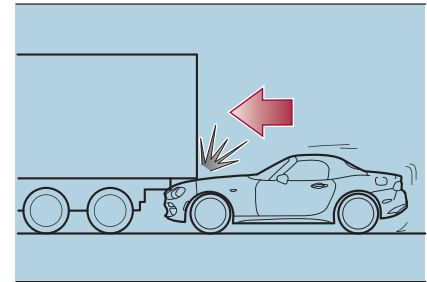

03040600-122-001

**Rear End Collision**

### Limitations To Side Collision Detection

Side collisions may not be detected as severe enough to deploy the SRS air bag equipment:

- Side impacts involving trees or poles A.
- Side impacts with two-wheeled vehicles B.
- Roll-over.

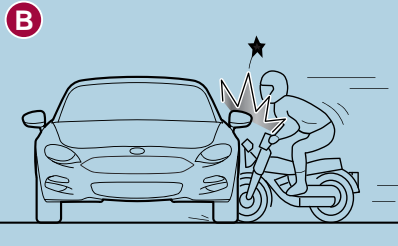
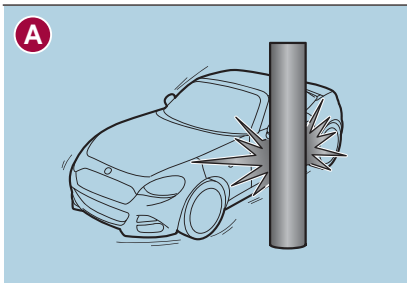

**Side Collision** 03040600-123-001

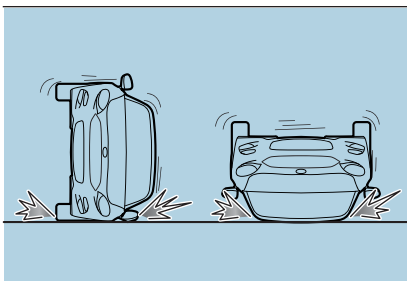

**Roll-Over Collision** 03040600-124-002

## Passenger Occupant Classification Sensor

Your vehicle is equipped with a passenger occupant classification sensor as a part of the supplementary restraint system. This sensor is equipped in the passenger's seat cushion. This sensor measures the electrostatic capacity of the passenger's seat.

The SRS unit is designed to prevent the passenger front and side Air Bags and seat belt pretensioner system from deploying if the passenger Air Bag deactivation indicator light turns on.

To reduce the chance of injuries caused by deployment of the passenger Air Bag, the system deactivates the passenger front and side Air Bags and also the seat belt pretensioner system when the passenger Air Bag deactivation indicator light turns on.

This system shuts off the passenger front and side Air Bags and seat belt pretensioner system, so make sure the passenger Air Bag deactivation indicator light turns on.

The air bag/seat belt pretensioner system warning light flashes and the passenger Air Bag deactivation indicator light illuminates if the sensors have a possible malfunction. If this happens, the passenger front and side Air Bags and seat belt pretensioner system will not deploy.

**Note:** If a passenger is seated as shown in the following figure the passenger occupant classification sensor cannot detect a passenger sitting on the passenger's seat correctly and the deployment/non-deployment of the Air Bags cannot be controlled as indicated in the passenger Air Bag deactivation indicator light on/off condition chart.

### **Warning!**

*If a child restraint system, child, small teenager or adult in the front passenger seat is seated improperly, the occupant may provide an output signal to the occupant classification sensor that is different from the occupant's properly seated weight input. This may result in serious injury or death in a collision.*

### **Warning!**

*Ignoring the Air Bag Warning Light in your instrument panel could mean you won't have the air bags to protect you in a collision. If the light does not come on as a bulb check when the ignition is first turned on, stays on after you start the vehicle, or if it comes on as you drive, have an authorized dealer service the air bag system immediately.*



❑ Placing an object on the floor under the front passenger seat may prevent the occupant classification sensor from working properly, which may result in serious injury or death in a collision. Do not place any objects on the floor under the front passenger seat.

❑ If there is a fault present in the occupant classification sensor, both the Indicator Light and the Air Bag Warning Light will illuminate to show that the Passenger Advanced Front Air Bag is deactivated. Should this occur, the Passenger Advanced Front Air Bag will remain deactivated until the fault is cleared. This indicates that you should take the vehicle to an authorized dealer for service immediately.

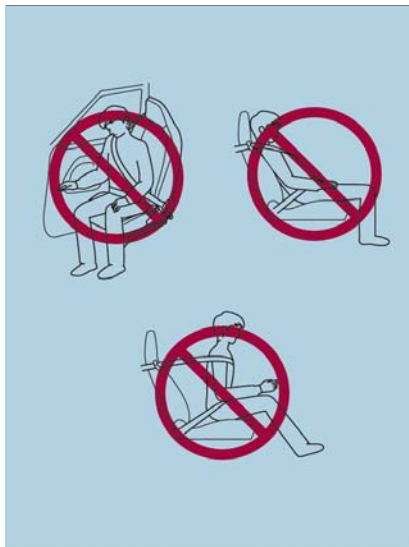

03040702-12A-001

### Passenger Not Sitting Correct



#### Warning!

Do not carry or hold any objects (e.g., backpacks, boxes, etc.) while seated in the front passenger seat. Holding an object may provide an output signal to the occupant classification sensor that is different than the occupant's properly seated weight input, which may result in serious injury or death in a collision.

### Passenger Air Bag Deactivation Indicator Lights

These indicator lights turn on to remind you that the passenger front and side Air Bags and seat belt pretensioner will or will not deploy during a collision.



06070400567567

### Passenger Air Bag Deactivated



#### Warning!

❑ If the Indicator Light remains illuminated for an adult passenger, have an authorized dealer service the air bag system immediately. Failure to do so may cause serious injury or death. If the Indicator Light is illuminated with the words "PASS AIRBAG OFF," the Passenger Advanced Front Air Bag will not deploy in the event of a collision.

❑ Never place a rear-facing child restraint in front of an air bag. A deploying passenger front air bag can cause death or

*serious injury to a child 12 years or younger, including a child in a rear-facing child restraint.*

Only use a rear-facing child restraint in a vehicle with a rear seat.

Children 12 years or younger should always ride buckled up in a vehicle with a rear seat.

**Note:**

The system requires about 10 seconds to alternate between turning the passenger front and side Air Bags and seat belt pretensioner system on or off.

The passenger air bag deactivation indicator light may turn on repeatedly if luggage or other items are put on the passenger seat, or if the temperature of the vehicle's interior changes suddenly.

The passenger air bag deactivation indicator light may turn on for 10 seconds if the electrostatic capacity on the passenger seat changes.

The air bag/seat belt pretensioner system warning light might turn on if the passenger seat receives a severe impact.

If the passenger Air Bag deactivation indicator light does not turn on after installing a child restraint system on the passenger seat, first, reinstall your child restraint system according to the procedure in this Owner Handbook. Then, if the passenger Air Bag deactivation OFF indicator light still does not turn on, contact an authorized dealer as soon as possible.

If the passenger Air Bag deactivation indicator light turns on when an occupant is seated directly in the passenger seat, have the passenger readjust their posture by sitting with their feet on the floor, and then refastening the seat belt. If the passenger Air Bag deactivation indicator light remains turned on, slide the passenger seat as far back as possible. Contact an authorized dealer as soon as possible.



### Passenger Air Bag Deactivation Indicator Light On/Off Condition Chart

If the passenger occupant classification sensor is normal, the indicator light turns on when the ignition is switched ON. The light turns off after a few seconds. Then, the indicator light turns on or is off under the following conditions:

Condition Detected By The Passenger Occupant Classification System	Passenger Air Bag Deactivation Indicator Light	Passenger Front And Side Air Bags	Passenger Seat Belt Pretensioner System
Empty (Not occupied)	On	Deactivated	Deactivated
A child is seated in a child restraint system (*)	On	Deactivated	Deactivated
Adult (**)	Off	Ready	Ready

(\*) The occupant classification sensor may not detect a child seated on the seat, in a child restraint system, or a junior seat depending on the child's physical size and seated posture.

(\*\*) If a smaller adult sits on the passenger seat, the sensors might detect the person as being a child depending on the person's physique.

If the passenger air bag deactivation indicator light does not turn on when the ignition is switched ON and does not turn on as indicated in the passenger air bag deactivation indicator light on/off condition chart, do not allow an occupant to sit in the passenger seat and contact an authorized dealer as soon as possible. The system may not work properly in an accident.



### Warning!

- Never place a rear-facing child restraint in front of an air bag. A deploying passenger front air bag can cause death or serious injury to a child 12 years or younger, including a child in a rear-facing child restraint.
- Only use a rear-facing child restraint in a vehicle with a rear seat.
- Children 12 years or younger should always ride buckled up in a vehicle with a rear seat.



### Warning!

- No objects should be placed over or near the air bag on the instrument panel or steering wheel because any such objects could cause harm if the vehicle is in a collision severe enough to cause the air bag to inflate.
- Do not put anything on or around the air bag covers or attempt to open them manually. You may damage the air bags and you could be injured because the air bags may no longer be functional. The protective covers for the air bag cushions are designed to open only when the air bags are inflating.
- Relying on the air bags alone could lead to more severe injuries in a collision. The air bags work with your seat belt to restrain you properly. In some collisions, air bags

won't deploy at all. Always wear your seat belts even though you have air bags.

## Maintaining Your Air Bag System



### Warning!

- Modifications to any part of the air bag system could cause it to fail when you need it. You could be injured if the air bag system is not there to protect you. Do not modify the components or wiring, including adding any kind of badges or stickers to the steering wheel hub trim cover or the upper right side of the instrument panel. Do not modify the front bumper, vehicle body structure, or add aftermarket side steps or running boards.
- It is dangerous to try to repair any part of the air bag system yourself. Be sure to tell anyone who works on your vehicle that it has an air bag system.
- Do not attempt to modify any part of your air bag system. The air bag may inflate accidentally or may not function properly if modifications are made. Take your vehicle to an authorized dealer for any air bag system service. If your seat, including your trim cover and cushion, needs to be serviced in any way (including removal or loosening/tightening of seat attachment bolts), take the vehicle to your authorized dealer. Only manufacturer approved seat accessories may be used. If it is necessary to modify the air bag system for persons with disabilities, contact your authorized dealer.

## EVENT DATA RECORDER (EDR)

This vehicle is equipped with an event data recorder (EDR).

The main purpose of an EDR is to record, in certain crash or near crash-like situations, such as an air bag deployment or hitting a road obstacle, data that will assist in understanding how a vehicle's systems performed. The EDR is designed to record data related to vehicle dynamics and safety systems for a short period of time, typically 30 seconds or less.

The EDR in this vehicle is designed to record such data as:

- How various systems in your vehicle were operating.
  - Whether or not the driver and passenger safety belts were buckled/fastened.
  - How far (if at all) the driver was pushing the accelerator and/or brake pedal.
  - How fast the vehicle was traveling.
- This data can help provide a better understanding of the circumstances in which crashes and injuries occur.



**Note:**

❑ EDR data are recorded by your vehicle only if a non-trivial crash or near crash-like situation occurs; no data are recorded by the EDR under normal driving conditions and no personal data (e.g., name, gender, age, and crash location) are recorded. However, other parties, such as law enforcement, could combine the EDR data with the type of personally identifying data routinely acquired during a crash investigation.

❑ To read data recorded by an EDR, special equipment is required, and access to the vehicle or the EDR is needed. In addition to the vehicle manufacturer, other parties, such as law enforcement, that have the special equipment, can read the information if they have access to the vehicle or the EDR. FCA will not disclose any of the data recorded in an EDR to a third party unless:

- ❑ A written agreement from the vehicle owner or the lessee is obtained.
- ❑ Officially requested by the police or other law enforcement authorities.
- ❑ Used as a defense for FCA in a law suit, claim, or arbitration.

❑ Ordered by a judge or court.

However, if necessary, FCA will:

- ❑ Use the data for research on FCA vehicle performance, including safety.
- ❑ Disclose the data or the summarized data to a third party for research purposes without disclosing vehicle or owner identification information.

**Recording Of Vehicle Data**

This vehicle is equipped with a computer which records the following main vehicle data related to vehicle controls, operation, and other driving conditions.

**Recorded Data**

- ❑ Vehicle conditions such as engine speed and vehicle speed.
- ❑ Driving operation conditions such as accelerator and brake pedals, and information related to the environmental circumstances while the vehicle is driven.
- ❑ Malfunction diagnosis information from each on-vehicle computer.
- ❑ Information related to controls of other on-vehicle computers.

The recorded data may vary depending on the vehicle grade and optional equipment. Voice and images are not recorded.

**Data Handling**

FCA and its subcontracting parties may obtain and use the recorded data for vehicle malfunction diagnosis, research and development, and quality improvement.

FCA will not disclose or provide any of the obtained data to a third party unless:

- ❑ An agreement from the vehicle owner (agreements from lessor and lessee for leased vehicle) is obtained.
- ❑ Officially requested by the police or other law enforcement authorities.
- ❑ For statistical processing by a research institution, after processing the data so that identification of the owner or the vehicle is impossible.



## CONSTANT MONITORING

The following components of the Air Bag systems are monitored by a diagnostic system:

- Crash Sensors, And Diagnostic Module (Sas Unit)
- Front Air Bag Sensors
- Air Bag Modules
- Side Crash Sensors
- Air Bag/Seat Belt Pretensioner System Warning Light
- Seat Belt Pretensioners
- Related Wiring

### With Passenger Occupant Classification System

- Passenger Air Bag Deactivation Indicator Light
- Passenger Occupant Classification Sensor
- Passenger Occupant Classification Module — If Equipped

The diagnostic module continuously monitors the system's readiness. This begins when the ignition is switched ON and continues while the vehicle is being driven.



# STARTING AND OPERATING

STARTING THE ENGINE . . . . .	149
BRAKE SYSTEM . . . . .	150
MANUAL TRANSMISSION . . . . .	152
AUTOMATIC TRANSMISSION — IF EQUIPPED . . . . .	153
SPORT MODE . . . . .	158
SPEED CONTROL . . . . .	159
RADAR SENSORS — IF EQUIPPED . . . . .	162
REAR PARK ASSIST — IF EQUIPPED . . . . .	163
PARKVIEW REAR BACKUP CAMERA — IF EQUIPPED . . . . .	167
REFUELING THE VEHICLE . . . . .	173
VEHICLE LOADING . . . . .	176
TOWING TRAILERS . . . . .	178
DRIVING TIPS . . . . .	178

# STARTING THE ENGINE

## Starting The Engine

Before starting the engine, adjust the seat, the interior rear view mirrors, and the door mirrors, and fasten the seat belt correctly.



### Warning!

- When leaving the vehicle, always remove the key fob from the vehicle and lock your vehicle.
- Never leave children alone in a vehicle, or with access to an unlocked vehicle.
- Allowing children to be in a vehicle unattended is dangerous for a number of reasons. A child or others could be seriously or fatally injured. Children should be warned not to touch the parking brake, brake pedal or the transmission gear selector.
- Do not leave the key fob in or near the vehicle, or in a location accessible to children, and do not leave the ignition of a vehicle equipped with Advanced Keyless Entry in the ACC or ON/RUN mode. A child could operate power windows, other controls, or move the vehicle.
- Do not leave children or animals inside parked vehicles in hot weather. Interior heat build-up may cause serious injury or death.

Never press the accelerator pedal for starting the engine.

## Models Equipped With A Manual Transmission

Proceed as follows:

1. Engage the parking brake and place the gear selector in NEUTRAL.
2. Place the start button in the ACC mode.
3. Fully depress the clutch pedal without touching the accelerator.
4. Place the start button in the ON mode, push and release it as soon as the engine starts. If the engine does not start within 10 seconds, push the start button to OFF mode and wait for 10-15 seconds before repeating the starting procedure.

## Models Equipped With An Automatic Transmission

Proceed as follows:

1. Engage the parking brake and place the gear selector to P (PARK) or N (NEUTRAL).
2. Fully depress the brake pedal without touching the accelerator.
3. Place the start button in the ACC mode.

4. Place the start button in the ON mode, push and release it as soon as the engine starts. If the engine does not start within 10 seconds, push the start button to OFF mode and wait for 10-15 seconds before repeating the starting procedure.

## Cold Weather Operation

### Regarding Cold Start Disable

When the ambient temperature is extremely low, the engine may not crank even when the engine starting procedure is performed. At this time, the Cold Start Disable Indicator light in the instrument cluster flashes. However, this does not indicate a problem.

Perform the necessary procedures (see “Warning lights And Messages” paragraph in “Getting To Know Your Instrument Panel” chapter).

### Regarding Ice Breaker

When the ambient temperature is low, the start of cranking may be delayed after engine starting procedure is performed. At this time, the Cold Start Disable Indicator light in the instrument cluster illuminates. However, this does not indicate a problem.

Refer to your authorized dealer regarding other related parts which are to be input such as function name, operating scenario (condition) of each function, indicator operation, and user operation/procedure information.



## Extended Park Starting

**Note:** Extended Park condition occurs when the vehicle has not been started or driven for at least 30 days.

1. Install a battery charger or jumper cables to the battery to ensure a full battery charge during the crank cycle.
2. Place the ignition in the START mode and release it when the engine starts.
3. If the engine fails to start within 10 seconds, place the ignition in the STOP (OFF/LOCK) mode, wait five seconds to allow the starter to cool, then repeat the Extended Park Starting procedure.
4. If the engine fails to start after eight attempts, allow the starter to cool for at least 10 minutes, then repeat the procedure.



### Caution!

*To prevent damage to the starter, do not crank continuously for more than 10 seconds at a time. Wait 10 to 15 seconds before trying again.*

## After Starting – Warming Up The Engine

Proceed as follows:

1. Travel slowly, letting the engine run at a reduced RPM, without accelerating suddenly.
2. It is recommended to wait until the digital engine coolant temperature indicator starts moving before demanding full performance.

## Stopping The Engine

Proceed as follows:

1. Park the car in a position that is not dangerous for oncoming traffic, if equipped with manual transmission place gear selector in FIRST (1st) or REVERSE (R) gear, if equipped with automatic transmission place the gear selector to PARK (P).
2. Push and release the ignition button to STOP the engine.

## BRAKE SYSTEM

This vehicle has power-assisted brakes that adjust automatically through normal use. Should power-assist fail, you can stop by applying greater force than normal to the brake pedal. But the distance required to stop will be greater than usual.

**Note:** Always depress the brake pedal with the right foot. Applying the brakes with the unaccustomed left foot could slow your reaction time to an emergency situation resulting in insufficient braking operation.

Do not drive with your foot held on the clutch pedal or brake pedal, or hold the clutch pedal depressed halfway unnecessarily. Doing so could result in the following:

- The clutch and brake parts will wear out more quickly.
- The brakes can overheat and adversely affect brake performance.



## Warning!

❑ *Riding the brakes can lead to brake failure and possibly a collision. Driving with your foot resting or riding on the brake pedal can result in abnormally high brake temperatures, excessive lining wear, and possible brake damage. You would not have your full braking capacity in an emergency.*

❑ *Driving a vehicle with the “Brake Warning Light” on is dangerous. A significant decrease in braking performance or vehicle stability during braking may occur. It will take you longer to stop the vehicle or will make your vehicle harder to control. You could have a collision. Have the vehicle checked immediately.*



## Caution!

*Wear shoes appropriate for driving in order to avoid your shoe contacting the brake pedal when depressing the accelerator pedal.*

## Parking Brake

**Note:** Driving with the parking brake on will cause excessive wear of the brake parts.



## Warning!

❑ *Never leave children alone in a vehicle, or with access to an unlocked vehicle.*

❑ *Allowing children to be in a vehicle unattended is dangerous for a number of reasons. A child or others could be seriously or fatally injured. Children should be warned not to touch the park brake, brake pedal or the gear selector.*

❑ *Do not leave the key fob in or near the vehicle or in a location accessible to children. A child could operate power windows, other controls, or move the vehicle.*

❑ *Be sure the park brake is fully disengaged before driving; failure to do so can lead to brake failure and a collision.*

❑ *Always fully apply the park brake when leaving your vehicle, or it may roll and cause damage or injury. Also be certain to leave a manual transmission in REVERSE (R) or FIRST (1st) gear. Failure to do so may allow the vehicle to roll and cause damage or injury.*

## Setting the Parking Brake

Depress the brake pedal and then firmly pull the parking brake lever fully upwards with sufficient force to hold the vehicle in a stationary position.

## Releasing the Parking Brake

Depress the brake pedal and pull the parking brake lever upwards, then press the release button. While holding the button, lower the parking brake lever all the way down to the released position.

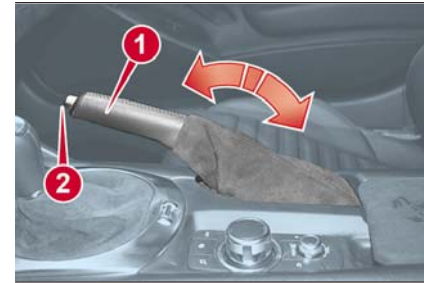

05050102-12A-001AB

## Parking Brake

- 1 — Parking Brake Lever
- 2 — Parking Brake Release Button

## Warning Light

The warning light turns on when the system has a malfunction. Refer to “Warning Lights And Messages” in “Getting To Know Your Instrument Panel” for further information.



### Brake Pad Wear Indicator

When the disc brake pads become worn, the built-in wear indicators contact the rotors. This causes a screeching noise to warn that the pads should be replaced. When you hear this noise contact your authorized dealer as soon as possible.

### Brake Assist

During emergency braking situations when it is necessary to depress the brake pedal with greater force, the brake assist system provides braking assistance, thus enhancing braking performance. When the brake pedal is depressed hard or depressed more quickly, the brakes apply more firmly.

#### Note:

- When the brake pedal is depressed hard or depressed more quickly, the pedal will feel softer but the brakes will apply more firmly. This is a normal effect of the brake assist operation and does not indicate a malfunction.
- When the brake pedal is depressed hard or depressed more quickly, a motor/pump operation noise may be heard. This is a normal effect of the brake assist and does not indicate a malfunction.
- The brake assist equipment does not supersede the functionality of the vehicle's main braking system.

## MANUAL TRANSMISSION

### Manual Transmission



#### Warning!

*You or others could be injured if you leave the vehicle unattended without having the park brake fully applied. The park brake should always be applied when the driver is not in the vehicle, especially on an incline.*



#### Caution!

*Never drive with your foot resting on the clutch pedal, or attempt to hold the vehicle on a hill with the clutch pedal partially engaged, as this will cause abnormal wear on the clutch.*

To engage the gears, press the clutch pedal fully and put the gear selector into the required position. The diagram for gear engagement is shown on the knob.



05987654-12A-001AB

### Gear Selector

Depress the clutch pedal all the way down while shifting, then release it slowly.

Your vehicle is equipped with a device to prevent shifting to REVERSE (R) by mistake. Push the gear selector downward and shift to REVERSE (R).

A natural driving posture can be achieved by lightly gripping the gear selector from the side without having to rest your elbow on the center console.

If shifting to REVERSE (R) is difficult, shift back into neutral, release the clutch pedal, and try again.

## With Parking Sensor System

When the gear selector is shifted to the REVERSE (R) position with the ignition placed in the ON mode, the parking sensor system is activated and an audible sound is heard.



### Caution!

- ❑ Keep your foot off the clutch pedal except when shifting gears. Also, do not use the clutch to hold the vehicle on an hill or grade. Riding the clutch will cause needless clutch wear and damage.
- ❑ Do not apply any excessive lateral force to the gear selector when changing from fifth to fourth gear. This could lead to the accidental selection of second gear, which could result in damage to the transmission.
- ❑ Make sure the vehicle comes to a complete stop before shifting to REVERSE (R). Shifting to REVERSE (R) while the vehicle is still moving may damage the transmission.
- ❑ Reverse can only be engaged when the vehicle is completely stationary. With the engine running, wait at least two seconds with the clutch pedal fully pressed before engaging reverse to prevent damage to the gears.

## AUTOMATIC TRANSMISSION — IF EQUIPPED

### Shift Interlock

This vehicle is equipped with an interlock system that holds the transmission gear selector in PARK (P) unless the brakes are applied. To shift the transmission out of PARK (P), the ignition must be placed in the ON/RUN mode (engine running or not) and the brake pedal must be pressed.



### Warning!

- ❑ It is dangerous to shift out of PARK or NEUTRAL if the engine speed is higher than idle speed. If your foot is not firmly pressing the brake pedal, the vehicle could accelerate quickly forward or in reverse. You could lose control of the vehicle and hit someone or something. Only shift into gear when the engine is idling normally and your foot is firmly pressing the brake pedal.
- ❑ Unintended movement of a vehicle could injure those in or near the vehicle. As with all vehicles, you should never exit a vehicle while the engine is running. Before exiting a vehicle, always apply the park brake, shift the transmission into PARK, and turn the ignition OFF. When the ignition is in the OFF mode, the transmission is locked in PARK, securing the vehicle against unwanted movement.

❑ When leaving the vehicle, always make sure the ignition is in the OFF mode, remove the key fob from the vehicle, and lock the vehicle.

❑ Never leave children alone in a vehicle, or with access to an unlocked vehicle. *Allowing children to be in a vehicle unattended is dangerous for a number of reasons. A child or others could be seriously or fatally injured. Children should be warned not to touch the parking brake, brake pedal or the transmission gear selector.*

❑ Do not leave the key fob in or near the vehicle (or in a location accessible to children), and do not leave the ignition in the ACC or ON/RUN mode. A child could operate power windows, other controls, or move the vehicle.



### Caution!

Damage to the transmission may occur if the following precautions are not observed:

- ❑ Shift into or out of PARK or REVERSE only after the vehicle has come to a complete stop.
- ❑ Do not shift between PARK, REVERSE, NEUTRAL, or DRIVE when the engine is above idle speed.
- ❑ Before shifting into any gear, make sure your foot is firmly pressing the brake pedal.



The gear selector must be in PARK (P) or NEUTRAL (N) to operate the starter. The transmission gear selector has PARK (P), REVERSE (R), NEUTRAL (N), DRIVE (D), and MANUAL (M)(+/-) shift positions.

The transmission may be shifted freely from REVERSE (R), to NEUTRAL (N), to DRIVE (D), to MANUAL (M)(+/-).

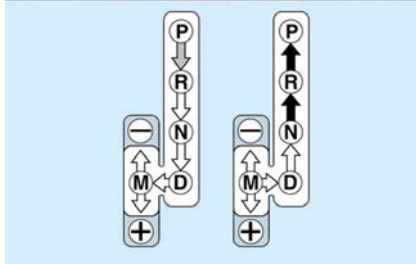

05210200-LHD12AT-001AB

### Gear Selector And Pattern

**Note:** Even if you intend to use the automatic transmission functions as a traditional automatic, you should also be aware that you can inadvertently shift into manual shift mode and an

inappropriate gear may be retained as the vehicle speed increases. If you notice the engine speed going higher or hear the engine racing, confirm you have not accidentally slipped into manual shift mode (refer to “Manual Shift Mode” paragraph in this section).

### Shift Position Indication

The gear selector position (PRNDM) is illuminated when the ignition is placed in the ON mode.

**Note:** If one of the following actions is performed, the gear selector position is displayed for five minutes even if the ignition is placed in a mode other than ON.

- The ignition is placed in the OFF mode.
- The driver's door is opened.

### Gear Position Indication

In MANUAL (M) shift mode, the “M” of the shift position indication illuminates and the number of the selected gear is displayed.

### Gear Selector Positions

#### PARK (P)

PARK (P) locks the transmission and prevents the driveshaft from rotating.



### Warning!

Never use the PARK position as a substitute for the park brake. Always apply the park brake fully when parked to guard against vehicle movement and possible injury or damage.

Your vehicle could move and injure you and others if it is not in PARK. Check by trying to move the gear selector out of PARK with the brake pedal released. Make sure the transmission is in PARK before leaving the vehicle.

It is dangerous to shift out of PARK or NEUTRAL if the engine speed is higher than idle speed. If your foot is not firmly pressing the brake pedal, the vehicle could accelerate quickly forward or in reverse. You could lose control of the vehicle and hit someone or something. Only shift into gear when the engine is idling normally and your foot is firmly pressing the brake pedal.

Unintended movement of a vehicle could injure those in or near the vehicle. As with all vehicles, you should never exit a vehicle while the engine is running. Before exiting a vehicle, always apply the park brake, shift the transmission into PARK, and turn the ignition OFF. When the ignition is in the OFF mode, the transmission is locked in PARK, securing the vehicle against unwanted movement.

When leaving the vehicle, always make sure the ignition is in the OFF mode, remove the key fob from the vehicle, and lock the vehicle.



❑ Never leave children alone in a vehicle, or with access to an unlocked vehicle. Allowing children to be in a vehicle unattended is dangerous for a number of reasons. A child or others could be seriously or fatally injured. Children should be warned not to touch the park brake, brake pedal or the transmission gear selector.

❑ Do not leave the key fob in or near the vehicle (or in a location accessible to children), and do not leave the ignition in the ACC or ON/RUN mode. A child could operate power windows, other controls, or move the vehicle.



### Caution!

❑ Before moving the transmission gear selector out of PARK, you must place the ignition from the LOCK/OFF mode to the ON/RUN mode, and also press the brake pedal. Otherwise, damage to the gear selector could result.

❑ DO NOT race the engine when shifting from PARK or NEUTRAL into another gear range, as this can damage the drivetrain.

### Note:

❑ Shifting into PARK (P), NEUTRAL (N) or REVERSE (R) while the vehicle is moving can damage your transmission.

❑ Shifting into DRIVE (D) or REVERSE (R) when the engine is running faster than idle can damage the transmission.

### REVERSE (R)

This range is for moving the vehicle backward. Shift into REVERSE only after the vehicle has come to a complete stop.

**With Parking Sensor system:** when the gear selector is shifted to the REVERSE (R) position with the ignition placed in the ON mode, the parking sensor system is activated and an audible sound is heard.

### NEUTRAL (N)

In NEUTRAL (N), the wheels and transmission are not locked. The vehicle will roll freely even on the slightest incline unless the parking brake or brakes are applied.



### Warning!

Do not coast in NEUTRAL and never turn off the ignition to coast down a hill. These are unsafe practices that limit your response to changing traffic or road conditions. You might lose control of the vehicle and have a collision.

**Note:** Do not shift into NEUTRAL (N) when driving the vehicle. Doing so will damage the transmission. Press the parking brake or depress the brake pedal before moving the gear selector from NEUTRAL (N) to prevent the vehicle from moving unexpectedly.

### DRIVE (D)

DRIVE (D) is the normal driving position. From a stop, the transmission will automatically shift through all available gears.

### MANUAL (M)

MANUAL (M) is the manual shift mode position. Gears can be shifted up or down by operating the gear selector. (Refer to “Manual Shift Mode” paragraph in this section).



### Warning!

Do not downshift for additional engine braking on a slippery surface. The drive wheels could lose their grip and the vehicle could skid, causing a collision or personal injury.



## Active Adaptive Shift (AAS)

Active Adaptive Shift (AAS) automatically controls the transmission shift points to best suit the road conditions and driver input. This improves driving feel.

The transmission may switch to AAS mode when driving up and down slopes, cornering, driving at high elevations, or depressing the accelerator pedal quickly while the gear selector is in the DRIVE (D) position. Depending on the road and driving conditions/vehicle operations, gear shifting could be delayed or not occur, however, this does not indicate a problem because the AAS mode will maintain the optimum gear position.

## Shift-Lock System

The shift-lock system prevents shifting out of PARK (P) unless the brake pedal is depressed.

To shift from PARK (P):

1. Depress and hold the brake pedal.
2. Turn the ignition to the ON/RUN mode.
3. Press and hold the lock-release button on the gear selector.
4. Move the gear selector.

When the ignition is in the ACC or OFF mode, the gear selector cannot be shifted from PARK (P).

The ignition cannot be placed in the OFF mode if the gear selector is not in PARK (P).

## Shift Lock Override

If the gear selector will not move from PARK (P) using the proper shift procedure, continue to press the brake pedal and proceed as follows:

1. Remove the shift lock override cover using a cloth wrapped flat head screwdriver.
2. Insert a screwdriver or similar tool into the Override Access Hole, and push the override button down.



05210206-12A-002

**Shift Lock Override Access Hole**

3. Push and hold the lock release button on the gear selector and move the gear selector.

4. Take the vehicle to an authorized dealer.

## For Some Models

Proceed as follows:

1. Push the lock release button on the gear selector while also pushing down on the Shift Lock Override button.
2. Move the gear selector.
3. Take the vehicle to an authorized dealer.



005210206-122-001

**Shift Lock Override**

## Manual Shift Mode

The manual shift mode gives you the feel of driving a manual transmission vehicle by allowing you to operate the gear selector manually.

This allows you to control engine rpm and torque to the drive wheels much like a manual transmission when more control is desired.

To change to MANUAL (M) shift mode, shift the gear selector from DRIVE (D) to MANUAL (M). To return to automatic shift mode, shift the gear selector from MANUAL (M) to DRIVE (D).

You can shift between DRIVE (D) and MANUAL (M) mode at any time, without taking your foot off the accelerator.

### Note:

- ❑ If you change to manual shift mode when the vehicle is stopped, the gear will shift to M1.
- ❑ If you change to manual shift mode while the vehicle is moving it will remain in the current gear until a manual shift request is made.

## Indicators

### Manual Shift Mode Indication

In manual shift mode, the “M” of the shift position indication in the instrument panel illuminates.

### Gear Position Indication

The numeral for the selected gear illuminates.



05210207-12A-002AB

### Instrument Panel

- 1 — Manual Shift Mode Indication
- 2 — Gear Position Indication

## Manually Shifting Up/Down

**To shift up** to a higher gear, tap the gear selector rearward once (or tap the [+] shift paddle on the steering wheel, if equipped).

**To shift down** to a lower gear, tap the gear selector forward once (or tap the [-] shift paddle on the steering wheel, if equipped).

### Note:

- ❑ If a requested downshift would cause the engine to over-speed, that shift will not occur.
- ❑ The system will ignore attempts to upshift at too low of a vehicle speed.
- ❑ Do not drive the vehicle with the tachometer needle in the red zone while in manual shift mode.
- ❑ During deceleration, the transmission may automatically shift down depending on vehicle speed.
- ❑ You can start out, from a stop, in first or second gear. Tapping the gear selector rearward (+) (at a stop) will allow starting in second gear. Starting out in second gear can be helpful in snowy or icy conditions.



## Paddle Mode — If Equipped

Tapping one of the steering wheel-mounted shift paddles (+/-), if equipped, while the gear selector is in DRIVE (D), will activate Paddle Mode (a temporary manual mode). The current gear will be displayed in the instrument cluster, with the "M" also illuminated.

The transmission will revert back to normal operation (if the gear selector remains in DRIVE) after a period of time, depending on accelerator pedal activity.

**Note:** Because Paddle mode is only temporary, use of the MANUAL (M) position is recommended if you need to drive the vehicle in a particular gear for long periods.

## Driving Tips

### Overtaking

For extra power when passing another vehicle or climbing steep grades, press the accelerator fully. The transmission will shift to a lower gear, depending on vehicle speed.

### Note:

□ The accelerator pedal may initially feel heavy as it is being pressed, then feel lighter as it is pressed further. This change in pedal force controls whether or not kickdown should be performed.

□ While the gear selector is in the MANUAL (M) position and the Dynamic Stability Control (DSC) is turned off, manual shift mode does not switch to automatic shift mode even if the accelerator pedal is completely pressed. Tap the gear selector forward or rearward to select the appropriate gear.

### Climbing steep grades from a stop

To climb a steep grade from a stopped position:

1. Press the brake pedal.
2. Shift to DRIVE (D) or M1, depending on the load weight and grade steepness.
3. Release the brake pedal while gradually accelerating.

### Descending steep grades

When descending a steep grade, shift to lower gears, depending on load weight and grade steepness.

Descend slowly, using the brakes only occasionally to prevent them from overheating.

## SPORT MODE

The Sport mode increases steering feedback to the driver with slight increase in effort and changes the transmission shift schedules for more aggressive shifting. This driving mode is useful while driving on twisty roads where more steering precision is desired in spirited cornering.

To activate Sport mode, toggle the Sport Mode button forward and hold for approximately 2 seconds. You will see "Sport" illuminate in the Instrument Panel cluster.



05210101-12A-001AB

**SPORT Button**

# SPEED CONTROL

## Speed Control

This is an electronically controlled driving assistance feature that allows the desired vehicle speed to be maintained, without having to press the accelerator pedal.

This feature can be used at a speed above 25 mph (40 km/h) on long stretches of dry, straight roads with few variations (e.g. motorways).

It is therefore not recommended to use this feature on city roads with traffic. Do not use it in town.



### Warning!

*Do not use Speed Control under the following conditions:*

- hilly terrain
- steep inclines
- heavy or unsteady traffic
- slippery or winding roads
- similar restrictions that require inconsistent speed

*Using the Speed Control under the following conditions is dangerous and could result in loss of vehicle control.*

## Activation / Deactivation

**Note:** When the ignition is placed in the OFF position, the system status before it was turned off is stored. For example, if the ignition is placed in the OFF position while the Speed Control is operating, the system will be operable when the ignition is placed in the ON position the next time.

### Activating Speed Control

Push the ON button located on the right side of the steering wheel with the other Speed Control buttons. The warning light (amber) in the instrument cluster will illuminate.



05100101-877-877AB

### Speed Control Buttons



### Warning!

*Leaving the Speed Control system on when not in use is dangerous. You could accidentally set the system or cause it to go faster than you want. You could lose control and have an accident. Always leave the system off when you are not using it.*



**Deactivating Speed Control**

Push the OFF/CAN button. The  warning light (amber) in the instrument cluster turns off.

**When a speed has been set:** the  warning light (green) in the instrument cluster is illuminated, push and hold the OFF/CAN button or push the OFF/CAN button twice to deactivate.

**When a speed has not been set:** the  warning light (amber) in the instrument cluster is illuminated, push the OFF/CAN button to deactivate.

**Setting A Desired Speed**

Proceed as follows:

1. Activate the Speed Control device by pushing the ON button. The cruise warning light (amber) illuminates.
2. Accelerate to the desired speed, which must be more than 25 mph (40 km/h).
3. Set the Speed Control by pushing the SET (-) button at the desired speed. The Speed Control is set at the moment the SET (-) button is pushed. Release the accelerator pedal simultaneously. The  warning light (green) illuminates.

**Note:** The Speed Control setting cannot be performed under the following conditions:

**Automatic transmission:** the gear selector is in the PARK or NEUTRAL position.

**Manual transmission:** the gear selector is in the NEUTRAL position or when the clutch is disengaged (clutch is depressed).

The parking brake is applied.

Release the SET (-) button at the desired speed, otherwise the speed will continue decreasing while the SET (-) button is pushed and held (except when the accelerator pedal is depressed).

**Note:**

Release the SET (-) button at the desired speed, otherwise the speed will continue decreasing while the SET (-) button is pushed and held (except when the accelerator pedal is depressed).

On a steep grade, the vehicle may momentarily slow down while ascending, or speed up while descending.

The Speed Control will cancel if the vehicle speed decreases below 16 mph (25 km/h) when climbing a steep incline.

The Speed Control may cancel at about 9 mph (15 km/h) below the preset speed such as when climbing a long, steep incline.

The vehicle's set speed is displayed in the instrument cluster.

**Increasing Speed****To increase speed using the Speed Control buttons:**

Push the RES (+) button and hold it, your vehicle will accelerate. Release the button at the desired speed.

Push the RES (+) button and release it immediately, to adjust the set speed. Multiple pushes of the button will increase the set speed according to the number of times it is pushed.

**Increasing speed with a single RES (+) button operation:**

If the instrument cluster display for vehicle speed is indicated in mph: speed will increase in 1 mph increments.

If the instrument cluster display for vehicle speed is indicated in km/h: speed will increase in 1 km/h increments.

**To increase speed using accelerator pedal:**

Press the accelerator pedal to accelerate to the desired speed.

Push the SET (-) button and release it immediately. This new set speed will be saved.

**Note:** Accelerate the vehicle to speed up temporarily with the accelerator pedal when the Speed Control is on. Increasing the speed will not interfere with, or change the set speed. Take your foot off the accelerator to return to the set speed.

## Decreasing Speed

**To decrease speed using the Speed Control buttons:**

Push the SET (-) button and hold it, the vehicle will gradually slow down. Release the button at the desired speed.

Push the SET (-) button and release it immediately to adjust the set speed. Multiple button pushes will decrease the set speed according to the number of times it is pushed.

**Decreasing speed with a single SET (-) button operation:**

If the instrument cluster display for vehicle speed is indicated in mph: the speed will decrease in 1 mph increments.

If the instrument cluster display for vehicle speed is indicated in km/h: the speed will decrease in 1 km/h increments.

## Resume Speed

If any other method besides the OFF/CAN button was used to cancel cruising speed (such as applying the brake pedal or pressing in the clutch pedal) and the system is still activated, the most recent set speed will automatically resume when the RES (+) button is pushed.

If vehicle speed is below 25 mph (40 km/h), increase the vehicle speed up to 16 mph (25 km/h) or more and push RES (+) button.

## Temporarily Canceling The System



### Warning!

*Leaving the Speed Control system on when not in use is dangerous. You could accidentally set the system or cause it to go faster than you want. You could lose control and have an accident. Always leave the system OFF when you are not using it.*

To temporarily cancel the system, use one of these methods:

- Slightly press the brake pedal.
- Press the clutch pedal (if equipped with a manual transmission).

Push OFF/CAN button.

If the RES (+) button is pushed when the vehicle speed is 25 mph (40 km/h) or higher, the system reverts to the previously set speed.

**Note:** If any of the following conditions occur, the Speed Control system is temporarily canceled:

The parking brake is applied.

**Automatic Transmission:** the gear selector is in the PARK or NEUTRAL position.

**Manual Transmission:** the gear selector is in the NEUTRAL position.

**Automatic Transmission:** the Speed Control cannot be canceled while driving in manual mode (gear selector shifted from D to M position). Therefore, engine braking will not be applied even if the transmission is shifted down to a lower gear. If deceleration is required, lower the set speed or press the brake pedal.

When the Speed Control system is temporarily canceled, the speed cannot be reset.





## RADAR SENSORS — IF EQUIPPED

### Rear Radar Sensors

The following systems use the rear radar sensors:

- Blind Spot Monitoring System (BSM)
- Rear Cross Traffic Alert (RCTA)

The radar sensors function by detecting the radio waves reflected off of a vehicle approaching from the rear, or an obstruction, sent from the radar sensor.

The radar sensors are installed inside the rear bumper, one each on the left and right sides.

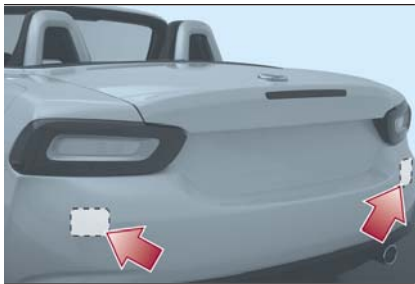

07080915112112

#### Radar Sensor Locations

Always keep the surface of the rear bumper near the radar sensors clean so that the radar sensors operate normally. Also, do not apply items such as stickers.



#### Caution!

*If the rear bumper receives a severe impact, the system may no longer operate normally. Stop the system immediately and contact an authorized dealer.*

The detection ability of the radar sensors has limitations. In the following cases, the detection ability may be decreased, and the system may not operate normally:

- The rear bumper near the radar sensors has been damaged.
- Snow, ice or mud has adhered to the radar sensors on the rear bumper.
- Operating in weather conditions such as rain, snow and fog.

**Note:** Under the following conditions, the radar sensors cannot detect objects or it may be difficult to detect them:

- Stationary objects on a road or a road side such as small, two-wheeled vehicles, bicycles, pedestrians, animals, and shopping carts.
- Vehicle shapes which do not reflect radar waves well such as empty trailers with a low vehicle height and sports cars.

Vehicles are shipped with the direction of the radar sensors adjusted for each vehicle to a loaded vehicle condition so that the radar sensors detect approaching vehicles correctly. If the direction of the radar sensors has changed, contact an authorized dealer.

The radar sensors are regulated by the relevant radio wave laws of the country in which the vehicle is driven. If the vehicle is driven abroad, authorization from the country in which the vehicle is driven may be required.

#### Note:

- For repairs or replacement of the radar sensors, bumper repairs, paint work, or replacement near the radar sensors, consult an authorized dealer.
- Turn off the radar system when pulling a trailer or while an accessory, such as a bicycle carrier, is installed to the rear of the vehicle. Otherwise, the radio waves emitted by the radar will be blocked causing the system to not operate normally.



## REAR PARK ASSIST — IF EQUIPPED

### Rear Park Assist



#### Warning!

❑ Do not rely completely on the parking sensor system and be sure to confirm the safety around your vehicle visually when driving. This system can assist the driver in operating the vehicle in the forward and backward directions while parking. The detection ranges of the sensors are limited, therefore, driving the vehicle while relying only on the system may cause an accident. Always confirm the safety around your vehicle visually when driving.

❑ Parking and other potentially dangerous maneuvers are, however, always the driver's responsibility. When performing these operations, always make sure that there are no other people (especially children) or animals on the route you want to drive into. The parking sensors are an aid for the driver, but the driver must never allow their attention to lapse during potentially dangerous maneuvers, even those executed at low speeds.

The Rear Park Assist System uses four ultrasonic sensors (two rear sensors and two rear corner sensors) to detect obstructions around the vehicle while parking the vehicle in a garage or during parallel parking when the gear selector is in REVERSE.

The system is equipped with an assist device to notify the driver of the approximate distance from the vehicle to the surrounding obstruction using an audible alert.

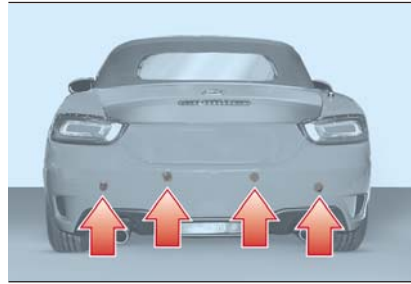

05200100-121-001AB

#### Parking Sensor Locations

#### Note:

- ❑ Do not install any accessories within the detection ranges of the sensors. It may affect the system operation.
- ❑ Depending on the type of obstruction and the surrounding conditions, the detection range of a sensor may narrow, or the sensors may not be able to detect obstructions.

❑ The system may not operate normally under the following conditions:

- ❑ Mud, ice, or snow adhered to the sensor area (operation will return to normal when removed).
- ❑ The sensor area is frozen (operation will return to normal when the ice is thawed).
- ❑ The sensor is covered by a hand or excessive force has been applied to the bumper.
- ❑ The vehicle is on a steep incline.
- ❑ Under extremely hot or cold weather conditions.
- ❑ The vehicle is driven on bumps, inclines, gravel, or grass covered roads.
- ❑ Anything which generates ultrasound is near the vehicle, such as another vehicle's horn, the engine sound of a motorcycle, the air brakes of a large-sized vehicle, or another vehicle's sensors.
- ❑ The vehicle is driven in heavy rain or in road conditions causing water splash.
- ❑ A antenna for a radio transmitter is installed to the vehicle.



- The vehicle is moving towards a tall or square curbstone.
- An obstruction is too close to the sensor.
- The following types of obstructions may not be detected:
  - Thin objects such as wire or rope.
  - Things which absorb sonic waves easily such as rain or snow.
  - Angular shaped objects.
  - Very tall objects, and those which are wide at the top.
  - Small, short objects.
- Obstructions under the bumper may not be detected. Obstructions that are lower than the bumper or thin which may have been initially detected but are no longer detected as the vehicle approaches more closely.
- Always have the system inspected by an authorized dealer if any force is applied to the bumpers, even in a minor accident. If the sensors have been repositioned in any way, they cannot detect obstructions.

- The system may have a malfunction if the audible signal does not operate. Contact an authorized dealer.
- The beeper which indicates a system malfunction may not be heard if the ambient temperature is extremely cold, or mud, ice, or snow adheres to the sensor area. Remove any foreign material from the sensor area.
- When installing a trailer hitch, contact an authorized dealer.



### Caution!

- Only have repairs on the bumper in the area of the sensors carried out by a authorized dealer. Repairs on the bumper that are not carried out properly may compromise the operation of the parking sensors.*
- Only have the bumpers repainted or any retouches to the paint work in the area of the sensors carried out by a authorized dealer. Incorrect paint application could affect the operation of the parking sensors.*

## Sensor Detection Range

The sensors detect obstructions within the following range:

- Lateral Detection Range:** 19 inches (50 cm)
- Rear Detection Range:** 59 inches (150 cm)

## System Operation

The system is operational when the ignition is in the ON position and the gear selector is shifted to REVERSE. When an audible signal sounds, the system is enabled for use.

## Parking Sensor Audible Alert

The audible alert will sound while the system is operating according to the following chart:

### Rear Sensor

Distance Detection Area	Distance Between Vehicle And Obstruction	Audible Alert (*)
Farthest distance	Approx. 59 - 23 inches (150 cm - 60 cm)	Slow intermittent sound
Far distance	Approx. 23 - 17 inches (60 - 45 cm)	Medium intermittent sound
Middle distance	Approx. 17 - 13 inches (45 - 35 cm)	Fast intermittent sound
Close distance	Within approx. 13 inches (35 cm)	Continuous sound

(\*) The rate at which the intermittent audible alert increases as the vehicle approaches the obstruction.

### Rear Corner Sensor

Distance Detection Area	Distance Between Vehicle And Obstruction	Audible Alert (**)
Far distance	Approx. 19 - 14 inches (50 - 38 cm)	Medium intermittent sound
Middle distance	Approx. 14 - 9.8 inches (38 - 25 cm)	Fast intermittent sound
Close distance	Within approx. 9.8 inches (25 cm)	Continuous sound

(\*\*) The rate at which the intermittent audible alert increases as the vehicle approaches the obstruction.

**Note:** If an obstruction is detected in a zone for six seconds or more, the audible alert stops, unless the obstruction is within the close distance zone. If the same obstruction is detected in another zone, the corresponding audible alert is heard.



## When A Warning Alert Is Activated

The system notifies the driver of an obstacle by activating the audible alert.

Beep	How To Check
The audible alert is not heard.	The system may have a malfunction. Contact an authorized dealer as soon as possible.
When the engine is turned ON, or if the parking sensor detects a problem while driving, an intermittent audible alert is heard one to four times ( * ).	Remove any foreign material from the sensor area. If the system continues to sound the audible alert, contact an authorized dealer as soon as possible.
( * ) The number of times the audible alert is heard changes depending on the malfunction location.	

## PARKVIEW REAR BACKUP CAMERA — IF EQUIPPED

### Operation

The camera is located on the trunk lid, above the license plate.

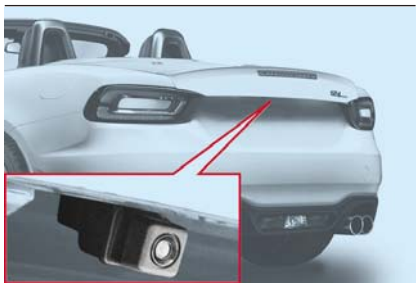

07040110-124-008AB

### Rear Camera Location

### Switching The Display To Rear View Camera Mode:

Place the gear selector in the REVERSE position, after the ignition is turned to ON, to switch the display to rear-view camera mode.

### Note:

- When the gear selector is moved from the REVERSE position and put in any other position, the screen returns to the previous display mode.
- When parking in REVERSE, take care over obstacles that may be above or under the camera's display range.

□ When the display is cold, the images could be more blurred than usual, making it difficult to check the conditions of the area around the vehicle. Always use extreme caution and verify the real conditions of the area behind the vehicle with your own eyes.

□ If water, snow, or mud is deposited on the camera lens, clean it with a soft cloth. If this does not clean it, use a mild detergent.

□ If the camera is subjected to abrupt temperature changes (from hot to cold or vice versa), the rear-view monitor may not work properly.

□ When replacing tires, contact an authorized dealer. Replacing the tires can cause the guide lines that appear on the display to be misaligned.



### Warning!

□ Always use extreme caution and verify the real conditions of the area behind the vehicle. Backing up while looking only at the screen is dangerous and can lead to an accident or collision with an object. The rear-view monitor is simply a system to aid reversing. The view on the display can show a situation that differs from the real one.

□ Do not use the rear-view monitor under the following conditions:

□ Roads covered in ice or snow.

□ When snow chains are mounted or the temporary space saver spare wheel is fitted.

□ The rear trunk is not completely closed.

□ The vehicle is on a sloping road.

□ Using the rear-view monitor under the conditions listed above is dangerous and can cause damage to persons and/or the vehicle.



### Caution!

□ Do not apply excessive force to the camera. You could alter the position and angle of the camera. Do not disassemble, modify or remove it as this could compromise the seal.

□ The camera's cover is made of plastic. Do not apply degreasers, organic solvents, wax or glass polish to the camera's cover. If some substance ends up on the cover, clean it off immediately with a soft cloth.

□ Do not rub the cover too much, nor polish it with abrasive compounds or hard brushes. The cover could be damaged and create image problems.

□ If the vehicle has been involved in a frontal, lateral or rear collision, the rear parking camera's alignment (location or installation angle) may have been altered. Contact an authorized dealer.

□ If the display shows "no video signal", there may be a problem with the camera. Contact an authorized dealer.



**Display**

**Note:** The images on the display can show a situation that differs from the actual view.

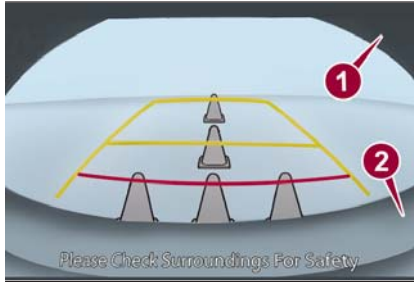

07080913987987

**Camera View**

- 1 — Blocked Area
- 2 — Rear Bumper

The field of view varies depending on the vehicle and the road conditions. The field of view is limited. Objects below the bumper or around its sides may not be displayed.

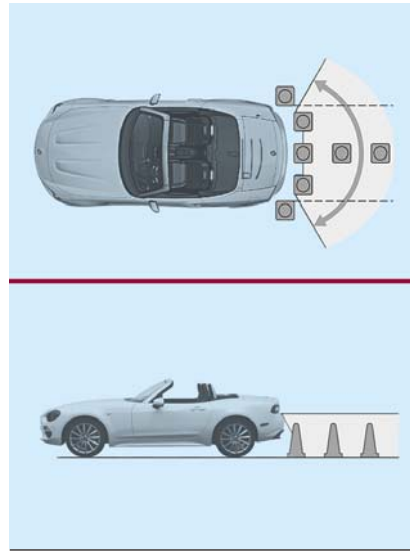

07080913988988

**Camera Field Of View**

The distance displayed by the camera view differs from the actual view, as the rear parking camera is equipped with a special lens.

The camera could capture any non-standard accessories installed on the vehicle. Do not install non-standard accessories that could interfere with the camera's view, such as lights or reflectors.

**Note:** If it is difficult to see the display under the following conditions, it does not mean that there is a malfunction:

- In dark areas.
- When the temperature around the lens is particularly high or low.
- When the camera is wet from rain or due to a high atmospheric humidity.
- When there is some foreign deposit around the camera, such as mud.
- When the camera lens reflects sunlight or a headlight beam.
- The image on the display may be delayed if the temperature around the camera is low.

**Caution!**

To avoid vehicle damage, ParkView should only be used as a parking aid. The ParkView camera is unable to view every obstacle or object in your drive path.

To avoid vehicle damage, the vehicle must be driven slowly when using ParkView to be able to stop in time when an obstacle is seen. It is recommended that the driver look frequently over his/her shoulder when using ParkView.

## Looking At The Display

The vehicle width guide lines are displayed on the screen as a reference to show the width of the vehicle compared to the width of the parking space to be entered while in REVERSE.

**Vehicle Width Guide Lines:** these guide lines serve as a reference showing the width of the vehicle.

**Distance Guide Lines:** these lines indicate the approximate distance from the rear of the vehicle (the rear edge of the bumper). The red and yellow lines indicates the points at about 19 inches (50 cm), for the red line and 39 inches (1 m) for the yellow line, from the rear bumper (central point of each line).

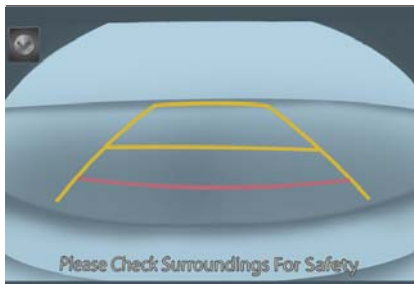

07080913-111-111

**Vehicle Width Guide Lines**



### Warning!

*Drivers must be careful when backing up even when using the ParkView Rear Back Up Camera. Always check carefully behind your vehicle, and be sure to check for pedestrians, animals, other vehicles, obstructions, or blind spots before backing up. You are responsible for the safety of your surroundings and must continue to pay attention while backing up. Failure to do so can result in serious injury or death.*

## Rear View Camera Operation

The operating modes of the rear view camera when the vehicle is in REVERSE vary depending on traffic, road, and vehicle conditions. Also, the amount of turning and the duration of the maneuver vary depending on the conditions. Therefore, it is important to check the surrounding conditions and adapt the steering as necessary.

**Note:** The images from the rear parking camera shown on the monitor are reversed (mirror image).

1. Place the gear selector in the REVERSE position to switch the display to rear view camera mode.
2. Check the surrounding conditions and begin backing up.

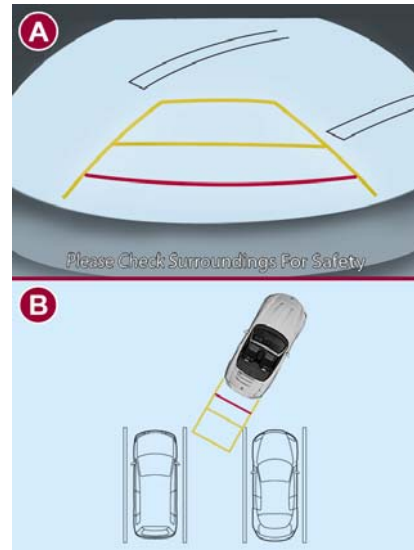

07080913989989

### Entering Parking Spot

- A — Rear Camera View  
B — Check Surrounding Area

3. Once the vehicle starts to enter the parking space, proceed slowly in REVERSE while keeping the vehicle width guide lines away from the two sides of the parking space.
4. Continue to adjust the steering wheel until the vehicle width guide lines are parallel with the two sides of the parking space.



5. Once the guide lines are parallel, straighten the steering wheel and reverse slowly into the parking space. Continue to check the vehicle's surroundings and stop in the best position possible (if the parking space has dividing lines, check that the vehicle width guide lines are parallel with them).

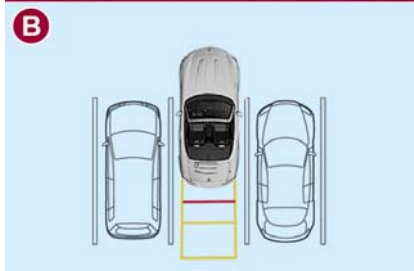
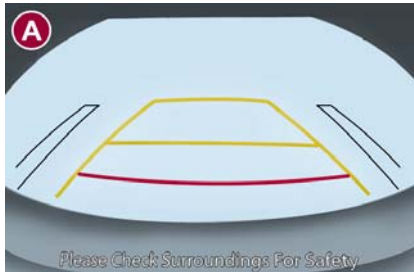

### Entering Parking Spot

- A — Rear Camera View  
B — Check Surrounding Area

6. When the gear selector is moved from the REVERSE position and put in any other position, the screen returns to the previous display mode.

#### Note:

- Since there may be some differences between the displayed image and the real conditions, always visually inspect the area behind the vehicle, and the surrounding areas, to make sure they are completely clear.
- In the image of the parking space (or garage) shown above, the rear of the vehicle and the distance guide lines may seem parallel on the monitor, but may not be when the parked vehicle is inspected.
- When you enter a parking space with a dividing line only on one side, the dividing line and the vehicle width guide lines may appear parallel on the monitor, but may not be when the parked vehicle is inspected.

### Road Conditions And Displayed Image

There are some differences between what is shown on the display, and the actual road conditions.

The different perceptions of distance could lead to an accident. The conditions that can lead to the different perceptions of distance, listed below, must be taken into consideration:

### □ When The Vehicle Slopes Due To The Weight Of Passengers And Load:

When the vehicle is rear heavy, the object on the screen seems to be further away than it really is.

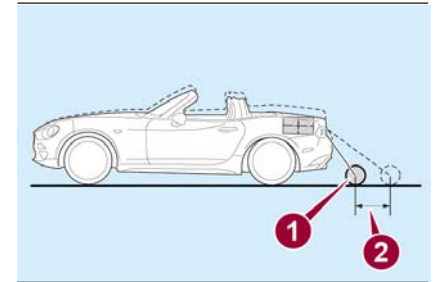

07080913991991

### Loaded Vehicle Camera Angle

- 1 — Object  
2 — Variance



## ❑ When The Road Behind The Vehicle Slopes Steeply:

When the vehicle is on a steep uphill (downhill) slope, the object on the screen seems to be further away than it really is.

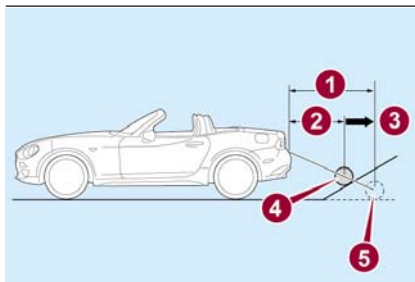

07080913992992

### Downhill Camera Angle

- 1 — Distance Between The Vehicle And Object Displayed On The Screen
- 2 — Actual Distance Between The Vehicle And Object
- 3 — Appears Farther Than Actual Distance
- 4 — Object At Actual Position
- 5 — Object On Screen

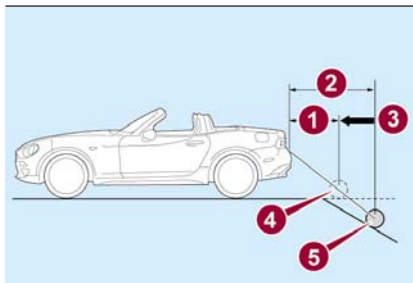

07080913993993

### Downgrade Camera Angle

- 1 — Distance Between The Vehicle And Object Displayed On The Screen
- 2 — Actual Distance Between The Vehicle And Object
- 3 — Appears Closer Than Actual Distance
- 4 — Object On Screen
- 5 — Object At Actual Position

## ❑ Three Dimensional Object Behind The Vehicle:

Since the distance guide line display is based on a flat surface, the distance to a three dimensional object on the screen differs from the actual distance.

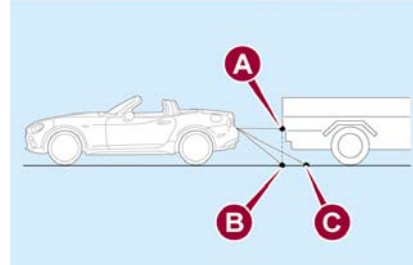
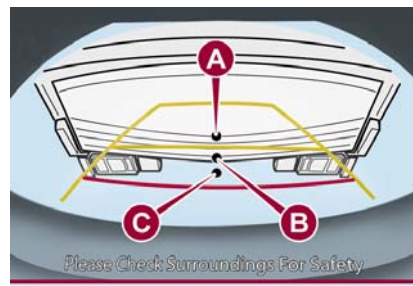

07080913994994

### Three-Dimensional Object Camera View

- A — Object In View
- B — Actual Distance To Object
- C — Appears Farther Than Actual



## Adjusting The Image Quality

The image quality can be adjusted with the gear selector in the REVERSE position.

Four adjustments can be made: brightness, contrast, tint and color. Give attention to the vehicle's surroundings while making adjustments:

1. Select the icon on the top left of the screen to display the tabs.
2. Select the desired tab.
3. Use the cursor to adjust the brightness, contrast, tint and color. If a reset is needed, press the reset button.
4. Select the icon on the top left of the screen to close the tabs.



07080914-111-111

### Image Quality Adjustments



### Warning!

*Adjusting the rear-view camera image quality must always be done when the vehicle is stationary. Do not adjust the rear-view camera image quality while vehicle driving. Adjusting the image quality (brightness, contrast, color and tint) of the rear-view camera while driving the vehicle is dangerous since it could distract the driver and cause a serious accident.*

# REFUELING THE VEHICLE

## Refueling The Vehicle

Stop the engine before refueling.

### Fuel Requirements

Vehicles with catalytic converters or oxygen sensors must use ONLY UNLEADED FUEL, which will reduce exhaust emissions and keep spark plug fouling to a minimum.



Unleaded fuel.

Octane Rating (Anti-knock index): 91 (R + M)/2 method or above (96 RON or above) (U.S. federal law requires that

octane ratings be posted on gasoline station pumps).

Regular unleaded fuel with an octane rating from 87 to 90 (91 to 95 RON) can be used, but this will reduce performance slightly, such as reduced engine output, and engine knocking.

Fuel with a rating lower than 87 octane (91 RON) will negatively affect the emission control system performance and could also cause engine knocking and serious engine damage.

While operating on gasoline with an octane number of 87, hearing a light knocking sound from the engine is not a cause for concern. However, if the engine is heard making a heavy

knocking sound, see your authorized dealer immediately. Use of gasoline with an octane number lower than 87 can cause engine failure and may void or not be covered by the New Vehicle Limited Warranty. Poor quality gasoline can cause problems such as hard starting, stalling, and hesitations. If you experience these symptoms, try another brand of gasoline before considering service for the vehicle.

Gasoline blended with oxygenates such as alcohol or ether compounds are generally referred to as oxygenated fuels.

The common gasoline blend that can be used with your vehicle is ethanol blended at no more than 15%. Gasoline containing alcohol, such as ethanol or methanol, may be marketed under the name "Gasohol".

Vehicle damage and problems resulting from the use of the following may not be covered by the New Vehicle Limited Warranty:

- Alcohol containing more than 15% ethanol.
- Gasoline or alcohol containing methanol.
- Leaded fuel or leaded alcohol.

### Reformulated Gasoline

Many areas of the country require the use of cleaner burning gasoline referred to as "Reformulated Gasoline".

Reformulated gasoline contains oxygenates and are specifically blended to reduce vehicle emissions and improve air quality.

The use of reformulated gasoline is recommended. Properly blended reformulated gasoline will provide improved performance and durability of engine and fuel system components.

### Gasoline/Oxygenate Blends

Some fuel suppliers blend unleaded gasoline with oxygenates such as ethanol.



#### Caution!

*DO NOT use gasoline containing methanol or gasoline containing more than 15% ethanol (E-15). Use of these blends may result in starting and drivability problems, damage critical fuel system components, cause emissions to exceed the applicable standard, and/or cause the "Malfunction Indicator Light" to illuminate. Please observe pump labels as they should clearly communicate if a fuel contains greater than 15% ethanol (E-15).*

Problems that result from using gasoline containing more than 15% ethanol (E-15) or gasoline containing methanol are not the responsibility of the manufacturer and may void or not



be covered under New Vehicle Limited Warranty.

### E-85 Usage In Non-Flex Fuel Vehicles

Non-Flex Fuel Vehicles (FFV) are compatible with gasoline containing up to 15% ethanol (E-15). Gasoline with higher ethanol content may void the New Vehicle Limited Warranty.

If a Non-FFV vehicle is inadvertently fueled with E-85 fuel, the engine will have some or all of these symptoms:

- ❑ Operate in a lean mode.
- ❑ OBD II “Malfunction Indicator Light” on.
- ❑ Poor engine performance.
- ❑ Poor cold start and cold drivability.
- ❑ Increased risk for fuel system component corrosion.

### MMT In Gasoline

Methylcyclopentadienyl Manganese Tricarbonyl (MMT) is a manganese-containing metallic additive that is blended into some gasoline to increase octane. Gasoline blended with MMT provides no performance advantage beyond gasoline of the same octane number without MMT. Gasoline blended with MMT reduces spark plug life and reduces emissions system performance in some vehicles. The manufacturer recommends that gasoline without

MMT be used in your vehicle. The MMT content of gasoline may not be indicated on the gasoline pump; therefore, you should ask your gasoline retailer whether the gasoline contains MMT. MMT is prohibited in Federal and California reformulated gasoline.

### Materials Added To Fuel

Besides using unleaded gasoline with the proper octane rating, gasolines that contain detergents, corrosion and stability additives are recommended. Using gasolines that have these additives will help improve fuel economy, reduce emissions, and improve engine performance.



Designated TOP TIER Detergent Gasoline contains a higher level of detergents to further aid in minimizing engine and fuel system deposits. When available, the usage of Top Tier Detergent gasoline is recommended. Visit [www.toptiergas.com](http://www.toptiergas.com) for a list of TOP TIER Detergent Gasoline Retailers.

Indiscriminate use of fuel system cleaning agents should be avoided. Many of these materials intended for gum and varnish removal may contain active solvents or similar ingredients. These can harm fuel system gasket and diaphragm materials.

## Fuel System Cautions



### Caution!

*Follow these guidelines to maintain your vehicle's performance:*

- ❑ *The use of leaded gasoline is prohibited by Federal law. Using leaded gasoline can impair engine performance and damage the emissions control system.*
- ❑ *An out-of-tune engine or certain fuel or ignition malfunctions can cause the catalytic converter to overheat. If you notice a pungent burning odor or some light smoke, your engine may be out of tune or malfunctioning and may require immediate service. Contact your authorized dealer for service assistance.*
- ❑ *The use of fuel additives, which are now being sold as octane enhancers, is not recommended. Most of these products contain high concentrations of methanol. Fuel system damage or vehicle performance problems resulting from the use of such fuels or additives is not the responsibility of the manufacturer and may void or not be covered under the New Vehicle Limited Warranty.*

**Note:** Intentional tampering with the emissions control system can result in civil penalties being assessed against you.

## Carbon Monoxide Warnings



### Warning!

Carbon monoxide (CO) in exhaust gases is deadly. Follow the precautions below to prevent carbon monoxide poisoning:

Do not inhale exhaust gases. They contain carbon monoxide, a colorless and odorless gas, which can kill. Never run the engine in a closed area, such as a garage, and never sit in a parked vehicle with the engine running for an extended period. If the vehicle is stopped in an open area with the engine running for more than a short period, adjust the ventilation system to force fresh, outside air into the vehicle.

Guard against carbon monoxide with proper maintenance. Have the exhaust system inspected every time the vehicle is raised. Have any abnormal conditions repaired promptly. Until repaired, drive with all side windows fully open.

## Refueling Procedure

### Fuel Filler Door

**Note:** Always use only a designated FCA fuel filler cap or an approved equivalent, available at your authorized dealer. The wrong cap can result in a serious malfunction of the fuel and emission control systems.

When the fuel filler door end is pressed with the doors unlocked, the fuel filler door rises.

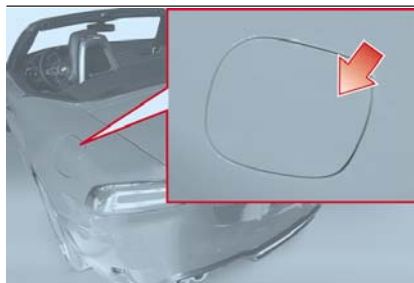

Fuel Filler Door

The fuel filler door operates in conjunction with the door locking/unlocking mechanism.

To close, press the fuel filler door until a click sound is heard.

### Note:

- Make sure to lock both the doors when leaving the vehicle.
- Lock the doors after closing the fuel filler door. If the fuel filler door is closed after locking the doors, the fuel filler door cannot be locked.

### Fuel Filler Cap

To remove the fuel filler cap, turn it counterclockwise. Attach the removed cap to the inner side of the fuel filler door.

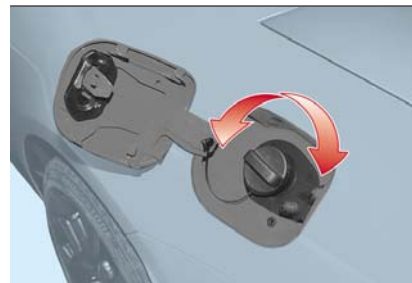

Fuel Filler Cap

To close the fuel filler cap, turn it clockwise until a click is heard.



### Warning!

- Never have any smoking materials lit in or near the vehicle when the gas cap is removed or the tank is being filled.
- Never add fuel when the engine is running. This is in violation of most state and federal fire regulations and may cause the MIL to turn on.
- A fire may result if gasoline is pumped into a portable container that is inside of a vehicle. You could be burned. Always place gas containers on the ground while filling.



❑ Do not apply any object/plug to the end of the filler which is not provided for the vehicle. The use of non-compliant objects/plugs could cause a pressure increase inside the tank, resulting in dangerous situations.

❑ Do not use a mobile phone near the refueling pump: risk of fire.

### Emergency Fuel Filler Door Release

If the battery is discharged, the fuel filler door cannot be opened. In this case, the fuel filler door can be opened by taking care of the discharged battery situation.

If the fuel filler door cannot be opened even if the discharged battery situation has been resolved, the electrical system may have a malfunction.

In this case, the fuel filler door can be opened using the following procedure as an emergency measure:

1. Open the trunk and pull the center section of the plastic fastener and remove the fastener.

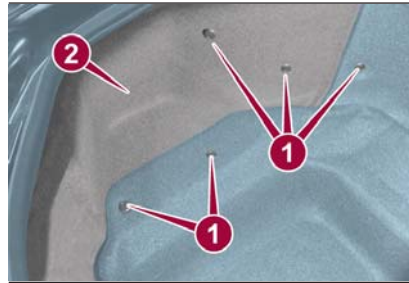

08100100-121-002

#### Trunk Interior

- 1 — Plastic Fasteners
- 2 — Cover

2. Partially peel back the cover inside the trunk, then pull the emergency release lever.

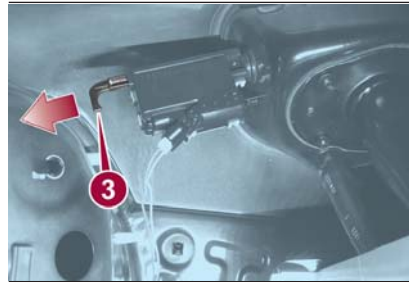

08100100-122-001

#### Fuel Door Emergency Release

- 3 — Emergency Release Lever

## VEHICLE LOADING

### Certification Label

As required by National Highway Traffic Safety Administration regulations, your vehicle has a certification label affixed to the driver's side door or pillar.

This label contains the month and year of manufacture, Gross Vehicle Weight Rating (GVWR), Gross Axle Weight Rating (GAWR) front and rear, and Vehicle Identification Number (VIN). A Month-Day-Hour (MDH) number is included on this label and indicates the Month, Day and Hour of manufacture. The bar code that appears on the bottom of the label is your VIN.

### Gross Vehicle Weight Rating (GVWR)

The GVWR is the total permissible weight of your vehicle including driver, passengers, vehicle, options and cargo. The label also specifies maximum capacities of front and rear axle systems (GAWR). Total load must be limited so GVWR and front and rear GAWR are not exceeded.

### Payload

The payload of a vehicle is defined as the allowable load weight a truck can carry, including the weight of the driver, all passengers, options and cargo.

## Gross Axle Weight Rating (GAWR)

The GAWR is the maximum permissible load on the front and rear axles. The load must be distributed in the cargo area so that the GAWR of each axle is not exceeded.

Each axle GAWR is determined by the components in the system with the lowest load carrying capacity (axle, springs, tires or wheels). Heavier axles or suspension components sometimes specified by purchasers for increased durability does not necessarily increase the vehicle's GVWR.

## Tire Size

The tire size on the Vehicle Certification Label represents the actual tire size on your vehicle. Replacement tires must be equal to the load capacity of this tire size.

## Rim Size

This is the rim size that is appropriate for the tire size listed.

## Inflation Pressure

This is the cold tire inflation pressure for your vehicle for all loading conditions up to full GAWR.

## Curb Weight

The curb weight of a vehicle is defined as the total weight of the vehicle with all fluids, including vehicle fuel, at full capacity conditions, and with no occupants or cargo loaded into the vehicle. The front and rear curb weight values are determined by weighing your vehicle on a commercial scale before any occupants or cargo are added.

## Loading

The actual total weight and the weight of the front and rear of your vehicle at the ground can best be determined by weighing it when it is loaded and ready for operation.

The entire vehicle should first be weighed on a commercial scale to insure that the GVWR has not been exceeded. The weight on the front and rear of the vehicle should then be determined separately to be sure that the load is properly distributed over the front and rear axle. Weighing the vehicle may show that the GAWR of either the front or rear axles has been exceeded but the total load is within the specified GVWR. If so, weight must be shifted from front to rear or rear to front as appropriate until the specified weight

limitations are met. Store the heavier items down low and be sure that the weight is distributed equally. Stow all loose items securely before driving.

Improper weight distributions can have an adverse effect on the way your vehicle steers and handles and the way the brakes operate.



### Caution!

*Do not load your vehicle any heavier than the GVWR or the maximum front and rear GAWR. If you do, parts on your vehicle can break, or it can change the way your vehicle handles. This could cause you to lose control. Also overloading can shorten the life of your vehicle.*





## TOWING TRAILERS

### Trailer Towing

Your car is not designed for towing.

### Recreational Towing

An example of "recreational towing" is towing your vehicle behind a motorhome.

The transmission is not designed for towing this vehicle on all four wheels.



#### Caution!

*DO NOT flat tow this vehicle. Damage to the drivetrain will result. If this vehicle requires towing, make sure the drive wheels are OFF the ground.*

*Towing this vehicle in violation of the above requirements can cause severe transmission damage. Damage from improper towing is not covered under the New Vehicle Limited Warranty.*

## DRIVING TIPS

### Engine Break-In Recommendation

No special break-in is necessary, but a few precautions in the first 620 miles (1000 km) may add to the performance, economy, and life of the vehicle:

- Do not race the engine.
- Do not maintain one constant speed, either slow or fast, for a long period of time.
- Do not drive constantly at full-throttle or high engine rpm for extended periods of time.
- Avoid unnecessary hard stops.
- Avoid full-throttle starts.

### Saving Fuel And Protection Of The Environment

How you operate your vehicle determines how far it will travel on a tank of fuel.

Use these suggestions to help save fuel and reduce CO<sub>2</sub>:

- Avoid long warm-ups. Once the engine runs smoothly, begin driving.
- Avoid fast starts.
- Drive at lower speeds.
- Anticipate when to apply the brakes (avoid sudden braking).

Follow the maintenance schedule and contact your authorized dealer.

Use the air conditioner only when necessary.

Slow down on rough roads.

Keep the tires properly inflated.

Do not carry unnecessary weight.

Do not rest your foot on the brake pedal while driving.

Keep the wheels in correct alignment.

Keep windows closed at high speeds.

Slow down when driving in crosswinds and headwinds.

### Hazardous Driving

When driving on ice or in water, snow, mud, sand, or similar hazards:

- Be cautious and allow extra distance for braking.
- Avoid sudden braking and sudden maneuvering.
- Do not pump the brakes. Continue to press down on the brake pedal.
- If you get stuck, select a lower gear and accelerate slowly. Do not spin the rear wheels.



❑ For more traction in starting on slippery surfaces such as ice or packed snow, use sand, rock salt, chains, carpeting, or other nonslip material under the rear wheels.

**Note:** Use snow chains only on the rear wheels.

## Floor Mat Safety Information

Always use floor mats designed to fit the footwell of your vehicle. Use only floor mats that leave the pedal area unobstructed and that are firmly secured so that they cannot slip out of position and interfere with the pedals or impair safe operation of your vehicle in other ways.

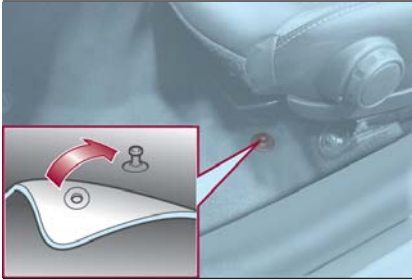

04090400-USA-001

### Floor Mat Retention Post Location



### Warning!

*An improperly attached, damaged, folded, or stacked floor mat, or damaged floor mat fasteners may cause your floor mat to interfere with the accelerator, brake, or clutch pedals and cause a loss of vehicle control. To prevent SERIOUS INJURY or DEATH:*

❑ ALWAYS securely attach  your floor mat using the floor mat fasteners. DO NOT install your floor mat upside down or turn your floor mat over. Lightly pull to confirm mat is secured using the floor mat fasteners on a regular basis.

❑ ALWAYS REMOVE THE EXISTING FLOOR MAT FROM THE VEHICLE

 before installing any other floor mat. NEVER install or stack an additional floor mat on top of an existing floor mat.

❑ ONLY install floor mats designed to fit your vehicle. NEVER install a floor mat that cannot be properly attached and secured to your vehicle. If a floor mat needs to be replaced, only use a FCA approved floor mat for the specific make, model, and year of your vehicle.

❑ ONLY use the driver's side floor mat on the driver's side floor area. To check for interference, with the vehicle properly parked with the engine off, fully depress the accelerator, the brake, and the clutch pedal (if present) to check for interference. If your floor mat interferes with the operation of any pedal, or is not secure to the floor, remove the floor mat from the vehicle and place the floor mat in your trunk.

❑ ONLY use the passenger's side floor mat on the passenger's side floor area.

❑ ALWAYS make sure objects cannot fall or slide into the driver's side floor area when the vehicle is moving. Objects can become trapped under accelerator, brake, or clutch pedals and could cause a loss of vehicle control.

❑ NEVER place any objects under the floor mat (e.g., towels, keys, etc.). These objects could change the position of the floor mat and may cause interference with the accelerator, brake, or clutch pedals.

❑ If the vehicle carpet has been removed and re-installed, always properly attach carpet to the floor and check the floor mat fasteners are secure to the vehicle carpet. Fully depress each pedal to check for interference with the accelerator, brake, or clutch pedals then re-install the floor mats.

❑ It is recommended to only use mild soap and water to clean your floor mats. After cleaning, always check your floor mat has been properly installed and is secured to your vehicle using the floor mat fasteners by lightly pulling mat.

## Rocking The Vehicle

**Note:** Too much rocking may cause engine overheating, transmission failure, and tire damage.

If you must rock the vehicle to free it from snow, sand or mud, depress the accelerator slightly and slowly move the gear selector from 1 (D) to R.



**Warning!**

*Fast spinning tires can be dangerous. Forces generated by excessive wheel speeds may cause damage, or even failure, of the axle and tires. A tire could explode and injure someone. Do not spin your vehicle's wheels faster than 30 mph (48 km/h) or for longer than 30 seconds continuously without stopping when you are stuck and do not let anyone near a spinning wheel, no matter what the speed.*

**Caution!**

- When "rocking" a stuck vehicle by shifting between DRIVE and REVERSE, do not spin the wheels faster than 15 mph (24 km/h), or drivetrain damage may result.
- Rewving the engine or spinning the wheels too fast may lead to transmission overheating and failure. It can also damage the tires. Do not spin the wheels above 30 mph (48 km/h) while in gear (no transmission shifting occurring).

**Winter Driving**

Carry emergency gear, including tire chains, window scraper, flares, a small shovel, jumper leads, and a small bag of sand or salt.

Contact an authorized dealer to check the following:

- Have the proper ratio of antifreeze in the radiator.
- Inspect the battery and its leads. Cold reduces battery capacity.
- Use an engine oil appropriate for the lowest ambient temperatures that the vehicle will be driven in.
- Inspect the ignition system for damage and loose connections.
- Use winter windshield washer fluid that will not freeze.

**Note:**

- Remove snow before driving. Snow left on the windshield is dangerous as it could obstruct vision.
- Drive slowly. Braking performance can be adversely affected if snow or ice adheres to the brake components. If this situation occurs, drive the vehicle slowly, releasing the accelerator pedal and lightly applying the brakes several times until the brake performance returns to normal.

Do not open or close the soft top when the temperature is 41 °F (5 °C) or less. The material of the soft top could be damaged by freezing.

Do not apply excessive force to a window scraper when removing ice or frozen snow on the mirror glass and windshield.

Never use warm or hot water for removing snow or ice from windows and mirrors as it could result in the glass cracking.

**Snow Tires**

If your vehicle is equipped with the tire pressure monitoring system (vehicle with run-flat tires), the system may not function correctly when using tires with steel wire reinforcement in the sidewalls.

**Use Snow Tires on all Four Wheels:**

Do not exceed the maximum permissible speed for your snow tires or legal speed limits.

When snow tires are used, select the specified size and pressure.

**Tire Chains**

Check local regulations before using tire chains.

If your vehicle is equipped with the TPMS system, the system may not function correctly when using tire chains.

Install the chains on the rear tires only.  
Do not use chains on the front tires.

#### Note:

- Chains may affect handling.
- Do not go faster than 30 mph (50 km/h) or the chain manufacturer's recommended limit, whichever is lower.
- Drive carefully and avoid bumps, holes, and sharp turns.
- Avoid locked-wheel braking.
- Do not use chains on roads that are free of snow or ice. The tires and chains could be damaged.
- Chains may scratch or chip aluminium wheels.



#### Warning!

Using tires of different size and type (M+S, Snow) between front and rear axles can cause unpredictable handling. You could lose control and have a collision.



#### Caution!

To avoid damage to your vehicle or tires, observe the following precautions:

Because of restricted traction device clearance between tires and other suspension components, it is important that only traction devices in good condition are used. Broken devices can cause serious damage. Stop the vehicle immediately if noise occurs that could indicate device breakage. Remove the damaged parts of the device before further use.

Install device as tightly as possible and then retighten after driving about 1/2 mile (0.8 km).

Do not exceed 30 mph (48 km/h).

Drive cautiously and avoid severe turns and large bumps, especially with a loaded vehicle.

Do not drive for a prolonged period on dry pavement.

Observe the traction device manufacturer's instructions on the method of installation, operating speed, and conditions for use. Always use the suggested operating speed of the device manufacturer's if it is less than 30 mph (48 km/h).

Do not use traction devices on a compact spare tire.

## Driving In Flooded Area

**Note:** Do not drive the vehicle on flooded roads as it could cause short circuit of electrical/electronic parts, or water enters the engine and causes it to lock up (hydro-lock) and stall. If the vehicle has been immersed in water contact your authorized dealer.

Although your vehicle is capable of driving through shallow standing water, consider the following Cautions and Warnings before doing so.



#### Warning!

Driving through standing water limits your vehicle's traction capabilities. Do not exceed 5 mph (8 km/h) when driving through standing water.

Driving through standing water limits your vehicle's braking capabilities, which increases stopping distances. Therefore, after driving through standing water, drive slowly and lightly press on the brake pedal several times to dry the brakes.

Failure to follow these warnings may result in injuries that are serious or fatal to you, your passengers, and others around you.



**Caution!**

- Always check the depth of the standing water before driving through it. Never drive through standing water that is deeper than the bottom of the tire rims mounted on the vehicle.
- Determine the condition of the road or the path that is under water and if there are any obstacles in the way before driving through the standing water.
- Do not exceed 5 mph (8 km/h) when driving through standing water. This will minimize wave effects.
- Driving through standing water may cause damage to your vehicle's drivetrain components. Always inspect your vehicle's fluids (i.e., engine oil, transmission, axle, etc.) for signs of contamination (i.e., fluid that is milky or foamy in appearance) after driving through standing water. Do not continue to operate the vehicle if any fluid appears contaminated, as this may result in further damage. Such damage is not covered by the New Vehicle Limited Warranty.
- Getting water inside your vehicle's engine can cause it to lock up and stall out, and cause serious internal damage to the engine. Such damage is not covered by the New Vehicle Limited Warranty.

**Overloading**

**Note:** Be careful not to overload your vehicle. The gross axle weight rating (GAWR) and the gross vehicle weight rating (GVWR) of the vehicle are on the Motor Vehicle Safety Standard Label on the driver's door frame. Exceeding these ratings can cause an accident or vehicle damage. You can estimate the weight of the load by weighing the items (or people) before putting them in the vehicle.

**Driving On Uneven Road**

Your vehicle's suspension and underbody can be damaged if driven on rough/uneven roads or over speed bumps at excessive speeds.

Use care and reduce speed when traveling on rough/uneven roads or over speed bumps.

Use care not to damage the vehicle's underbody, bumpers or muffler(s) when driving under the following conditions:

- Ascending or descending a slope with a sharp transition angle.
- Ascending or descending a driveway or trailer ramp with a sharp transition angle.

This vehicle is equipped with low profile tires allowing class-leading performance and handling. As a result, the sidewall of the tires are very thin and the tires and wheels can be damaged if driven through potholes or on rough/uneven roads at excessive speeds.

Use care and reduce speed when traveling on rough/uneven roads or through potholes.

# IN CASE OF EMERGENCY

HAZARD WARNING LIGHTS . . . . .	184
REPLACING A BULB. . . . .	184
REPLACING FUSES . . . . .	194
JACKING AND TIRE CHANGING . . . . .	203
TIRE SERVICE KIT . . . . .	208
JUMP STARTING . . . . .	217
IF YOUR ENGINE OVERHEATS . . . . .	219
TOWING THE VEHICLE . . . . .	220
EVENT DATA RECORDER (EDR) . . . . .	222



## HAZARD WARNING LIGHTS

### Control

The Hazard Warning Lights should always be used when you stop on or near a roadway in an emergency.

The Hazard Warning Light switch is located on the center instrument panel below the radio. Push the switch to turn the Hazard Warning Lights on or off.

**Note:** The Hazard Warning Lights warn other drivers that your vehicle is a traffic hazard and that they must take extreme caution when near it.



05031100-L12-001AB

**Hazard Warning Light Switch**

When the switch is pushed, the Hazard Warning Lights are active and all directional turn signals will flash on and off to warn oncoming traffic of an emergency. Push the switch a second time to turn off the Hazard Warning Lights. The hazard warning indicator lights in the instrument cluster will flash simultaneously.

### Note:

- The turn signals do not work while the Hazard Warning Lights are activated.
- Check local regulations about the use of Hazard Warning Lights while the vehicle is being towed to verify that it is not in violation of the law.
- If the brake pedal is pressed while driving on slippery roads, the emergency stop signal system could operate causing all of the directional turn signals to flash.
- While the emergency stop signal system is operating, all of the directional turn signals automatically flash rapidly to caution the driver of a vehicle following behind of a sudden braking situation.

## REPLACING A BULB

### General Instructions



#### Warning!

- Before proceeding with the replacement of the lamp wait for the exhaust pipes are cool: **DANGER OF BURNS!**
- Modifications or repair of the electrical system performed incorrectly and without taking into account the technical characteristics can cause malfunctions with the risk of fire.
- Halogen lamps contain gas under pressure, in the event of breakage be careful of the projection of fragments of glass.
- Halogen lamps must be handled by touching only the metallic part. If the transparent bulb is in contact with the fingers, reduces the intensity of the emitted light and you can also affect the life of the lamp. In case of accidental contact, rub the bulb with a cloth dampened with alcohol and allow to dry.

- ❑ Before replacing a bulb check the contacts for oxidation.
- ❑ Replace blown bulbs with others of the same type and power.
- ❑ After replacing a headlight bulb, always check its alignment.
- ❑ To replace the bulb, contact your authorized dealer.
- ❑ When a light is not working, check that the corresponding fuse is intact before replacing the bulb. For the location of fuses, refer to the section on “Replacing Fuses” in this chapter.



### Caution!

*Use the protective cover and carton for the replacement bulb to dispose of the old bulb promptly and out of the reach of children.*

### Note:

- ❑ When removing the lens or light unit using a flathead screwdriver, make sure that the flathead screwdriver does not contact the interior terminal. If the flathead screwdriver contacts the terminal, a short circuit may occur.
- ❑ When the weather is cold or damp or after heavy rain or washing, the surface of headlights or rear lights may steam up and/or form drops of condensation on the inside. This is a natural phenomenon due to the difference in temperature and humidity between the inside and the outside of the glass which does not indicate a fault and does not compromise the normal operation of lighting devices. The mist disappears quickly when the lights are turned on, starting from the center of the diffuser, extending progressively towards the edges.



## Replacement Bulbs

Light Bulbs	Type	Power
Front Position	LED	–
Front Side-Maker Lights (If Equipped With Full-LED Headlights)	W5W	5 W
Front Positions/Side-Maker Lights (If Equipped With Halogen Headlights)	WY5W	5 W
High Beam (If Equipped With Full-LED Headlights)	LED	–
High Beam/Daytime Running Lights (DRL) (If Equipped With Halogen Headlights)	HB3	60 W
Daytime Running Lights (DRL) (If Equipped With Full-LED Headlights)	LED	–
Low Beam (If Equipped With Full-LED Headlights)	LED	–
Low Beam (If Equipped With Halogen Headlights)	H11	55 W
Front Direction Indicator Light	WY21W	21 W
Side Direction Indicator Light	WY5W	5 W
Fog Light	H11	55 W
Rear Position Lights	LED	–
Stop Lights	LED	–
Center High Mount Stop Lamp (CHMSL)	LED	–
Rear Direction Indicator Light	WY21W	21 W
Rear Side Marker	W5W	5 W
Reverse Light	W21W	21 W
License Plate Light	W5W	5 W
Overhead Light		10 W
Trunk Lid Light		5 W



## Light Bulbs

### Front Lights

The bulbs are arranged as follows :

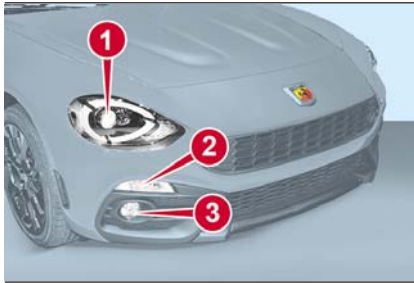

04110102-L38-008AB

### Head Lights

- 1 — High Beam with Daytime Running Lights (DRL)/Position Light/Low Beam/Side Marker
- 2 — Front Indicator Light
- 3 — Fog Light

### Rear Lights

The bulbs are arranged as follows :

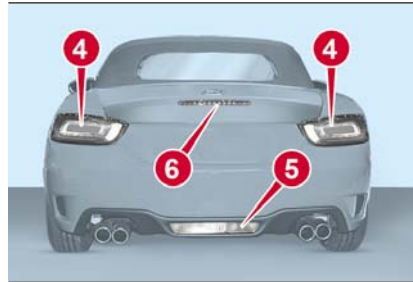

04110102-L40-010AB

### Rear Lights

- 4 — Position Light/Stop Light/Rear Direction Indicator Light
- 5 — Reverse Light — If Equipped
- 6 — Third Stop Light

## Replacing Exterior Lights

### Headlights (low beam) (If Equipped with halogen bulb)

Proceed as follows:

1. If you are changing the right bulb, start the engine, turn the steering wheel all the way to the right, and turn off engine. If you are changing the left bulb, turn the steering wheel to the left.
2. Make sure the ignition is placed in the OFF mode, and the headlight switch is off.

3. Remove the fasteners in the seven locations and partially peel back the mud guard.

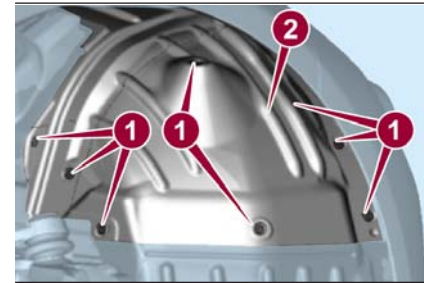

08020499000002

### Mud Guard

- 1 — Fasteners
- 2 — Mud Guard

4. Turn the cover counterclockwise and remove it, disconnect the connector from the unit by pressing the tab on the connector with your finger and pulling the connector.
5. Turn the socket and bulb assembly counterclockwise and remove it.
6. Disconnect the bulb from the socket.
7. Install the new bulb in the reverse order of the removal procedure.



## Headlights (High Beam) With Daytime Running Lights (If Equipped With LED Lamps)

Proceed as follows:

1. If you are changing the right bulb, start the engine, turn the steering wheel all the way to the right, and turn off engine. If you are changing the left bulb, turn the steering wheel to the left.
2. Make sure the ignition is placed in the OFF mode, and the headlight switch is off.
3. Remove the fasteners in the seven locations and partially peel back the mud guard.
4. Turn the socket and bulb assembly counterclockwise and remove it.
5. Turn the cover counterclockwise and remove it, disconnect the connector from the unit by pressing the tab on the connector with your finger and pulling the connector.
6. Turn the socket and bulb assembly counterclockwise and remove it.
7. Disconnect the bulb from the socket.
8. Install the new bulb in the reverse order of the removal procedure.

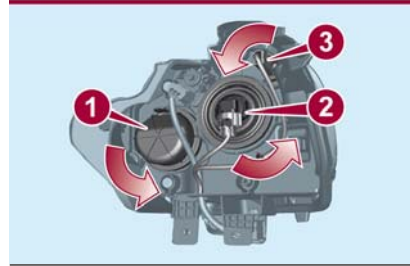
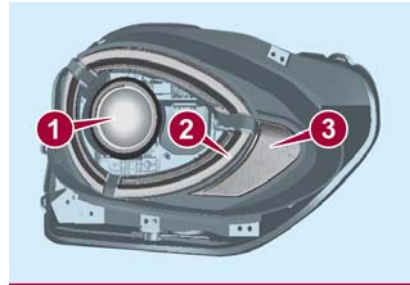

0802049900010

### Head Lamp Assembly

- 1 — High Beam Lamp
- 2 — Position Lamp
- 3 — Daytime Running Lamp

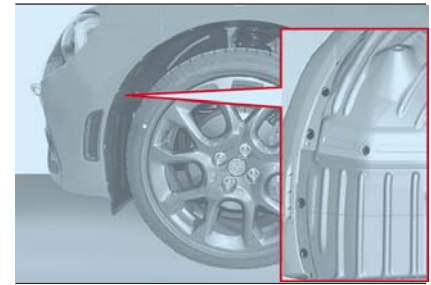

07031501-206-002AB

### Mud Guard

### Front Direction Indicator Lights

Proceed as follows:

1. If you are changing the right bulb, start the engine, turn the steering wheel all the way to the right, and turn off engine. If you are changing the left bulb, turn the steering wheel to the left.
2. Make sure the ignition is placed in the OFF mode, and the headlight switch is off.
3. Remove the fasteners in the five locations and partially peel back the mud guard.
4. Disconnect the connector from the unit by pressing the tab on the connector with your finger and pulling the connector rearward.
5. Turn the socket and bulb assembly counterclockwise and remove it.

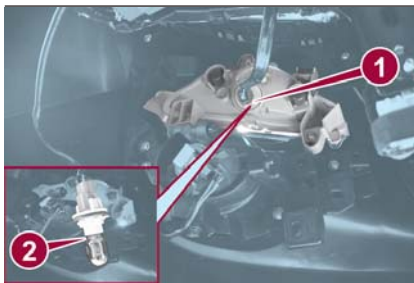

07031501-207-001

### Front Direction Indicator Housing

- 1 — Socket Assembly
- 2 — Bulb

6. Disconnect the bulb from the socket.



07031501-208-002AB

### Direction Indicator Lamp Connector

7. Install the new bulb in the reverse order of the removal procedure.

## Fog Lights

Proceed as follows:

1. If you are changing the right bulb, start the engine, turn the steering wheel all the way to the right, and turn off engine. If you are changing the left bulb, turn the steering wheel to the left.

2. Make sure the ignition is switched off, and the headlight switch is off.

3. Remove the fasteners in the five locations and partially peel back the mud guard.

4. Disconnect the connector from the unit by pressing the tab on the connector with your finger and pulling the connector.

5. Turn the socket and bulb assembly counterclockwise, extract the bulb and remove it.

6. Disconnect the bulb from the socket.

7. Install the new bulb in the reverse order of the removal procedure.

## Brake lights / Tail lights

Go to your authorized dealer when the replacement of this lights is necessary.

## Side Direction Indicator Lights

Proceed as follows:

1. Make sure the ignition is placed in the OFF mode, and the headlight switch is off.

2. If you are changing the right bulb, start the engine, turn the steering wheel all the way to the right, and turn off engine. If you are changing the left bulb, turn the steering wheel to the left.

3. Remove the fasteners in the five locations and partially peel back the mud guard.

4. Disconnect the electrical connector from the bulb by pressing the tab on the connector with your finger and pulling the connector.

5. Remove the lens assembly by pressing the tab on the unit with your finger and pulling the unit forward to compress in the internal catch, then pull the cluster outwards.

6. Lift up the lens assembly, and then remove the cluster and install the new side direction indicator lens assembly in the reverse order of the removal procedure.





08020499-000-011AB

**Side Direction Indicator**

1 – Fasteners

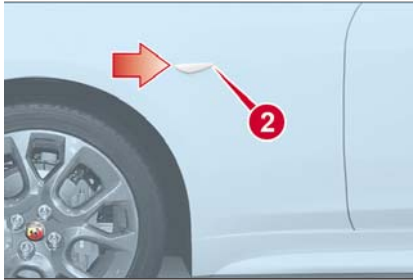

07031501-210-001AB

**Side Direction Indicator**

2 – Lens Assembly

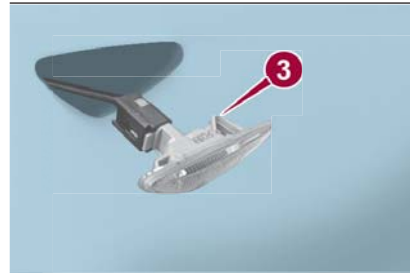

07031501211001

**Side Direction Indicator**

3 – Internal Catch  
4 – Lens Assembly

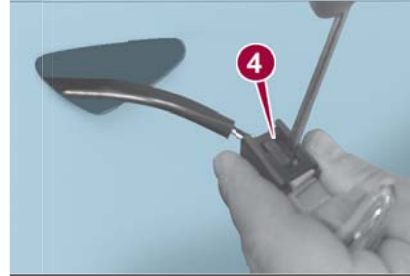

**Front Side Marker  
(If Equipped With Halogen Bulb)**

Proceed as follows:

1. Remove the fasteners in the seven locations and partially peel back the upper side of the mud guard.
2. Turn the socket counterclockwise, remove socket assembly then remove the bulb.



08070604-123-100

**Front Side Marker**

1 – Socket  
2 – Bulb Assembly



3. Install the new bulb in the reverse order of the removal procedure.

**Rear Direction Indicator Lights**

Proceed as follows:

1. Remove the retainers and the trunk lid end trim.

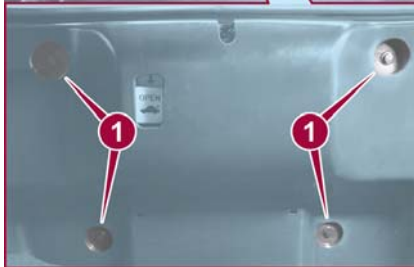

### Trunk Trim

07031501-212-002

1 — Retainers

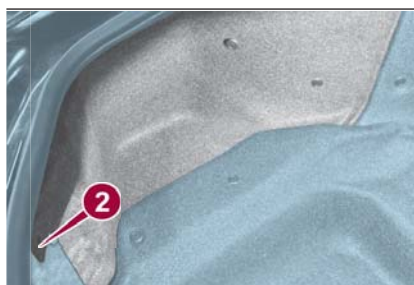

07031501214002

### Trunk Trim

2 — Connector

2. Disconnect the connector from the unit by pressing the tab on the connector with your finger.



07031501213002

### Rear Direction Indicator Socket

3 — Connector

3. Remove the screw and nuts.

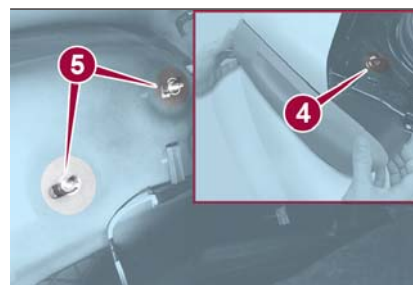

07031501-215-001

### Taillight Housing Fasteners

4 — Screw  
5 — Nuts

4. Pull the taillight housing rearward to remove it.



07031501-216-001AB

### Rear of Vehicle

6 — Taillight Housing



5. Turn the socket and bulb assembly counterclockwise to remove from taillight housing, and remove bulb.

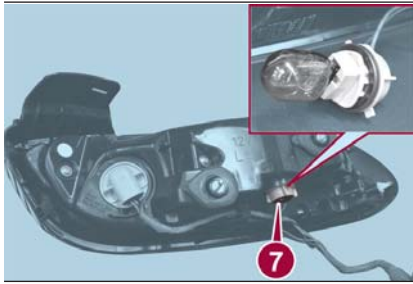

07031501-203-002

### Taillight Housing

7 — Socket and Bulb Assembly

6. Install the new bulb in the reverse order of the removal procedure.

### Reverse Light

Proceed as follows:

1. Make sure the ignition is placed in the OFF mode, and the headlight switch is off.
2. Turn the socket assembly counterclockwise to remove, and remove bulb.

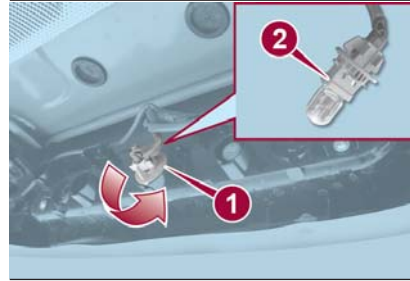

07031501-219-001

### Reverse Light

- 1 — Socket Assembly
- 2 — Bulb

3. Install the new bulb in the reverse order of the removal procedure.

### Rear Side Marker

Proceed as follows:

1. Push the lens assembly rearward to compress the internal catch, then pull the lens assembly outwards.

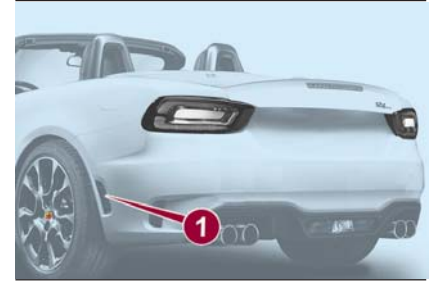

08070605AB

### Rear Side Marker

1 — Rear Side Marker Lens Assembly

2. Turn the socket and bulb assembly counterclockwise to remove, and remove bulb.



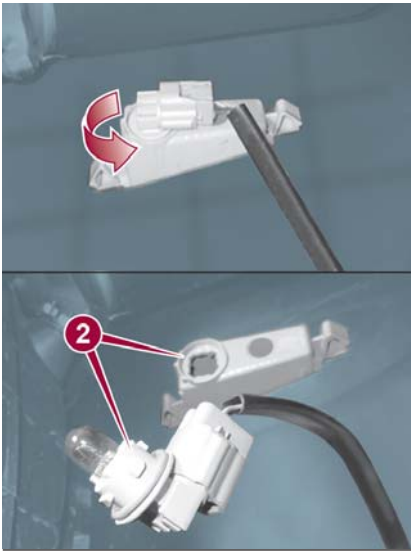

08070606-123-100

### Side Marker Housing

2 — Socket and Bulb Assembly

3. Install the new bulb and then reinstall the socket in the reverse order of the removal procedure.

### License Plate Lights

Proceed as follows:

1. Make sure the ignition is placed in the OFF mode, and the headlight switch is off.
2. Slide the unit as shown in the figure to remove it.

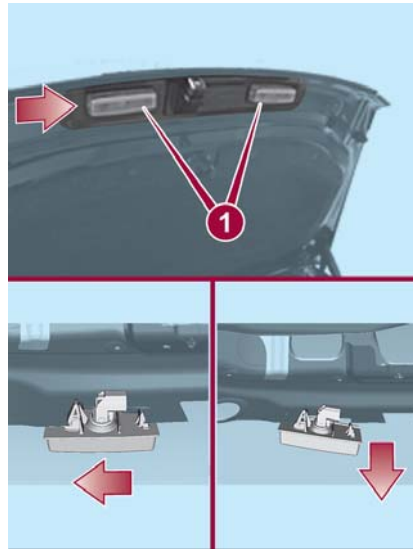

0703150122001

### Trunk Lid

1 — License Plate Light Assembly

3. Turn the socket and bulb assembly counterclockwise and remove, remove bulb.

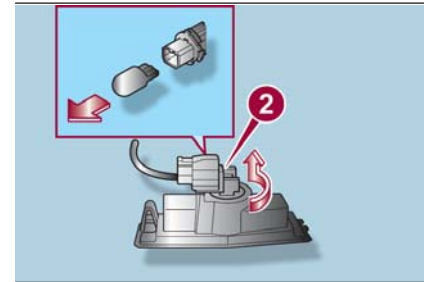

07031501-221-001

### License Plate Light Housing

2 — Socket and Bulb Assembly

4. Install the new bulb in the reverse order of the removal procedure. Insert catch and push the housing back into place.



## Replacing Interior Light Bulbs

### Overhead Light

Proceed as follows:

1. Using a suitable tool to prevent damage to the lens, remove the overhead light by carefully prying on the edge of the lens.

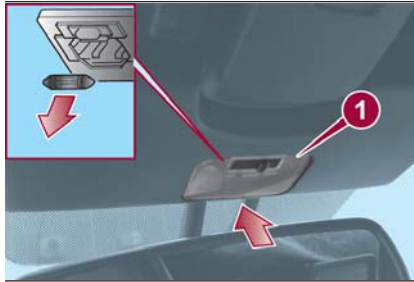

07031502-201-001

### Overhead Light Location

- 1 — Overhead Light Lens

2. Disconnect the bulb by pulling it out.
3. Install the new bulb in the reverse order of the removal procedure.

### Trunk Light

Proceed as follows:

1. Using a suitable tool to prevent damage to the lens, remove the trunk light lens by carefully prying on the edge of the lens.



07031502-202-001

### Trunk Light

- 1 — Trunk Light Lens

2. Disconnect the connector from the trunk light lens.

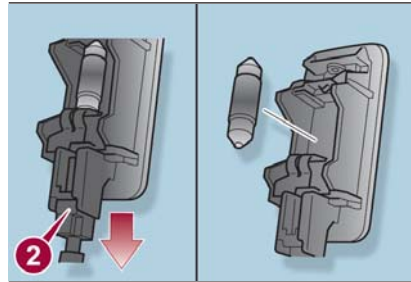

07031502-203-001

### Trunk Light Housing

- 2 — Connector

3. Disconnect the bulb by pulling it out.
4. Install the new bulb in the reverse order of the removal procedure.

## REPLACING FUSES

### General Information



### Warning!

❑ When replacing a blown fuse, always use an appropriate replacement fuse with the same amp rating as the original fuse. Never replace a fuse with another fuse of higher amp rating. Never replace a blown fuse with metal wires or any other material. Failure to use proper fuses may result in serious personal injury, fire and/or property damage.

❑ Before replacing a fuse, make sure that the ignition is off and that all the other services are switched off and/or disengaged.

❑ If the replaced fuse blows again, contact an authorized dealer.

❑ If a general protection fuse for safety systems (air bag system, braking system), power unit systems (engine system, transmission system) or steering system blows, contact an authorized dealer.

Your vehicle's electrical system is protected by fuses.

If any lights, accessories, or controls do not work, inspect the appropriate circuit protector. If a fuse has blown, the inside element will be melted. If the same fuse blows again, go to an authorized dealer as soon as possible.



## Fuse location

Fuses are grouped together in two fuse boxes located in the interior on the left side of the vehicle and under the hood.

## Interior Fuses

If the electrical system does not work, first inspect the fuses on the vehicle's left side.

Proceed as follows:

1. Make sure the ignition is placed in the OFF mode, and other switches are turned off.
2. Open the fuse panel cover (located near the door).

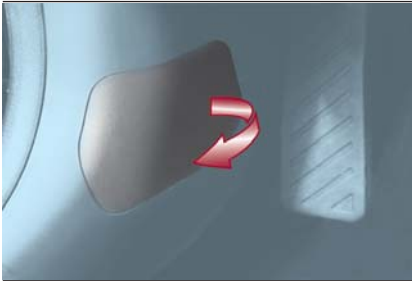

07031601-121-001

### Fuse Panel Cover

3. Press retaining clip and remove protection cover.
4. Pull the fuse straight out with the fuse puller provided on the fuse block located in the engine compartment.

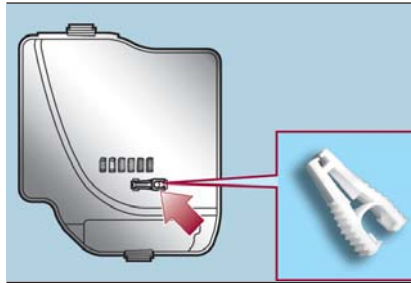

07031601-122-001

### Fuse Puller

5. Inspect the fuse and replace it if it is blown.

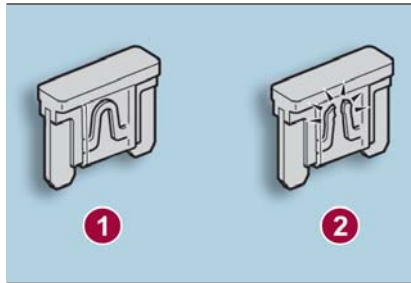

07031601-ALL-001

### Fuses

- 1 — Normal Fuse
- 2 — Blown Fuse

6. Insert a new fuse of the same amperage rating, and make sure it fits tightly. If it does not fit tightly, contact your authorized dealer. If you have no spare fuses, borrow one of the same rating from a circuit not essential to vehicle operation, such as the audio or outlet circuit.

7. Reinstall the cover and make sure that it is securely installed.

**Note:** Always replace a fuse with a genuine FCA fuse or equivalent of the same rating. Otherwise you may damage the electric system.



## Underhood Fuses

If the headlights or other electrical components do not work and the fuses in the cabin are normal, inspect the fuse block in the engine compartment. If a fuse is blown, it must be replaced.

Make sure the ignition is placed in the OFF mode, and other switches are turned off and remove the fuse block cover. If the lock is forcefully opened, the fuse block cover may come in contact with the frame when it is removed and become scratched.

When removing the cover, remove it slowly according to the following procedure:

1. Disengage the rear lock by pressing down on the front tab with your fingers.

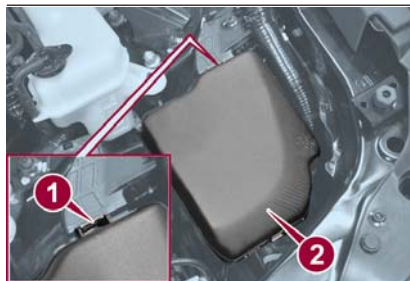

07031601-123-001

### Underhood Fuse Block

- 1 — Lock
- 2 — Cover

2. Remove the front tab while slightly lifting the front of the cover.
3. Remove the cover while lifting it and sliding it to the rear.

4. If any fuse but the main fuse is blown, replace it with a new one of the same amperage rating.

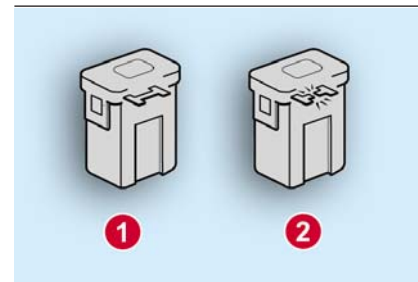

07031601-ALL-002AB

### Fuse

- 1 — Normal Fuse
- 2 — Blown Fuse

5. Reinstall the cover and make sure that it is securely installed.

## Fuse Block (Engine Compartment)

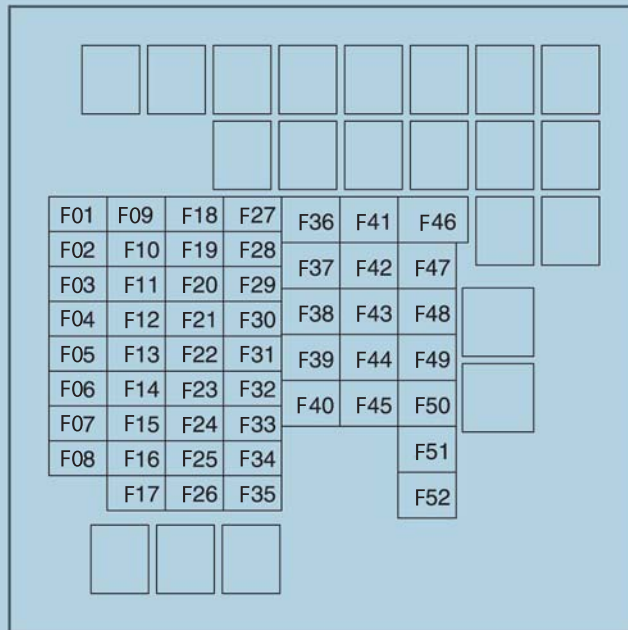

07031602-121-001



DESCRIPTION		FUSE RATING	PROTECTED COMPONENT
F01	ENG IG3	5 A	Engine Control Systems
F02	ENG IG2	5 A	Engine Control Systems
F03	HORN2	7.5 A	Horn
F04	C/U IG1	15 A	For Protection Of Various Circuits
F05	ENG IG1	7.5 A	Engine Control System
F06	—	—	—
F07	INTERIOR	15 A	Overhead Light
F08	—	—	—
F09	AUDIO2	15 A	Audio System
F10	METER1	10 A	Instrument Cluster
F11	SRS1	7.5 A	Air Bag
F12	—	—	—
F13	RADIO	7.5 A	Audio System
F14	ENGINE3	20 A	Engine Control System
F15	ENGINE1	10 A	Engine Control System
F16	ENGINE2	15 A	Engine Control System
F17	AUDIO1	25 A	Audio System
F18	A/C MAG	7.5 A	Air Conditioner
F19	AT PUMP H/L HI	20 A	Transmission Control System (If Equipped)
F20	AT	15 A	Transmission Control System (If Equipped)
F21	D LOCK	25 A	Power Door Locks
F22	H/L RH	20 A	Headlight (RH)
F23	ENG + B2	7.5 A	Engine Control System

DESCRIPTION		FUSE RATING	PROTECTED COMPONENT
F24	TAIL	20 A	Taillights/Number Plate Lights/Position Lights
F25	—	—	—
F26	ROOM	25 A	Overhead Light
F27	FOG	15 A	Fog Lights
F28	H/CLEAN	20 A	Headlight Washer (If Equipped)
F29	STOP	10 A	Stop Lights/Rear Fog Light (If Equipped)
F30	HORN	15 A	Horn
F31	H/L LH	20 A	Headlight (LH)
F32	ABS/DSC S	30 A	ABS/DSC System
F33	HAZARD	15 A	Hazard Warning Flashers/Direction Indicators Lights
F34	FUEL PUMP	15 A	Fuel System
F35	ENG + B3	5 A	Engine Control System
F36	WIPER	20 A	Windshield Wipers
F37	CABIN + B	50 A	For Protection Of Various Circuits
F38	—	—	—
F39	—	—	—
F40	ABS/DSC M	50 A	ABS/DSC System
F41	EVVT A/R PUMP	20 A	Engine Control System
F42	—	—	—
F43	—	—	—
F44	FAN2	40 A	Cooling Fan
F45	ENG.MAIN	40 A	Engine Control System



DESCRIPTION		FUSE RATING	PROTECTED COMPONENT
F46	EPS	60 A	Power Steering System
F47	DEFOG	30 A	Rear Window Defogger
F48	IG2	30 A	For Protection Of Various Circuits
F49	–	–	–
F50	HEATER	40 A	Air Conditioner
F51	–	–	–
F52	–	–	–

## Fuse Block Interior

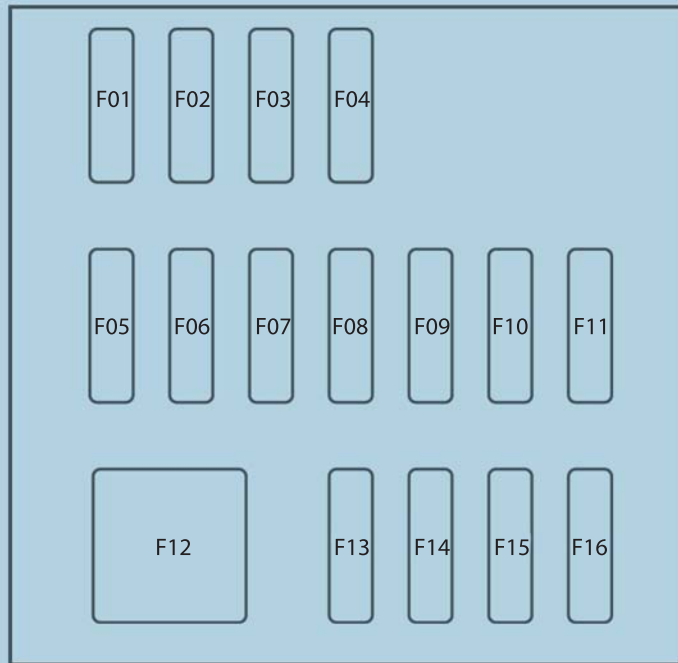

07031602-03F-002



DESCRIPTION		FUSE RATING	PROTECTED COMPONENT
F01	RHT R	30 A	—
F02	RHT L	30 A	—
F03	—	—	—
F04	—	—	—
F05	F.OUTLET	15 A	Accessory Sockets
F06	—	—	—
F07	AT IND	7.5 A	AT Shift Indicator — If Equipped
F08	MIRROR	7.5 A	Power Control Mirror
F09	R_DECK R	30 A	—
F10	R_DECK L	30 A	—
F11	F.WASHER	15 A	Windshield Washer
F12	P.WINDOW	30 A	Power Windows
F13	—	—	—
F14	SRS2/ESCL	15 A	—
F15	—	—	—
F16	—	—	—



# JACKING AND TIRE CHANGING



## Warning!

❑ Do not attempt to change a tire on the side of the vehicle close to moving traffic. Pull far enough off the road to avoid the danger of being hit when operating the jack or changing the wheel.

❑ Being under a jacked-up vehicle is dangerous. The vehicle could slip off the jack and fall on you. You could be crushed. Never put any part of your body under a vehicle that is on a jack. If you need to get under a raised vehicle, take it to a service center where it can be raised on a lift.

❑ The jack is designed to be used as a tool for changing tires only. The jack should not be used to lift the vehicle for service purposes. The vehicle should be jacked on a firm level surface only. Avoid ice or slippery areas.

## Tools Location

Your vehicle may be equipped with a spare tire, jack, lug wrench and tow eyes. For details, contact an authorized dealer.

Tools are stored in the trunk.

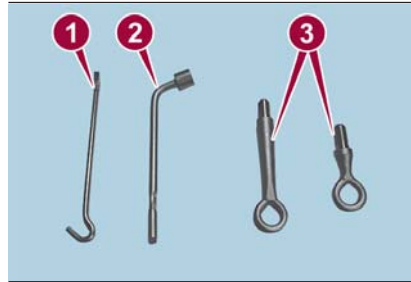

08020100-122-002

### Jack Tools

- 1 — Jack Lever
- 2 — Lug Wrench (If Equipped)
- 3 — Tow Eyes (If Equipped)

## Preparations For Jacking

### To Remove The Jack

Proceed as follows:

1. In the right side of the trunk, pull the cover tab to remove cover.

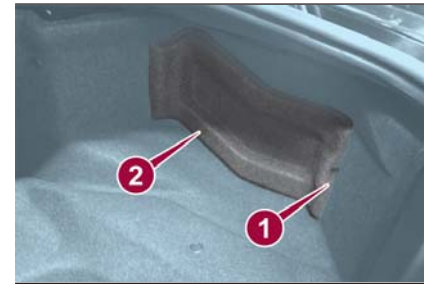

08020101-124-001

### Jack Location

- 1 — Cover Tab
- 2 — Jack And Tools Cover

2. Turn the wing bolt and jack screw counterclockwise.

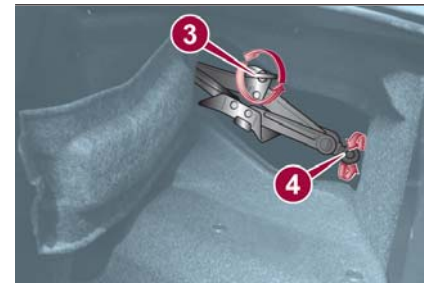

08020101-122-001

### Jack Components

- 3 — Wing Bolt
- 4 — Jack Screw



## To Secure The Jack

Proceed as follows:

1. Insert the wing bolt into the jack with the jack screw pointing back, and turn the wing bolt clockwise to temporarily tighten it.
2. Turn the jack screw clockwise.
3. Turn the wing bolt completely to secure the jack.
4. Insert the cover tabs and install the cover.



### Warning!

*A loose tire or jack thrown forward in a collision or hard stop could endanger the occupants of the vehicle. Always stow the jack parts and the spare tire in the places provided. Have the deflated (flat) tire repaired or replaced immediately.*

## Maintenance

- Always keep the jack clean.
- Make sure the moving parts are kept free from dirt or rust.
- Make sure the screw thread is adequately lubricated.

## Conditions Of Non-Use

- Temperatures below -40°F (-40°C)
- On sandy or muddy ground
- On uneven ground
- On steep roads
- In extreme weather conditions
- In direct contact with the engine or for repairs under the vehicle
- On boats

## Jacking Instructions

**Note:** Make sure the jack is well lubricated before using it.



### Warning!

*Do not attempt to change a tire on the side of the vehicle close to moving traffic, pull far enough off the road to avoid being hit when operating the jack or changing the wheel.*

Proceed as follows:

1. Stop the vehicle in a position that does not cause any danger to traffic and lets you change the tire in safety, as far as possible from the edge of the driving lane. The ground must be flat and sufficiently compact.

2. Turn on the Hazard Warning Lights and engage the parking brake.
3. For vehicles with automatic transmission, place the gear selector in PARK. For vehicles with manual transmission, place gear selector in REVERSE and turn the engine to OFF.
4. Stop the engine. The motor must be kept off as long as the vehicle is lifted off the ground.
5. Remove the jack and tools.
6. Block both the front and rear of the wheel diagonally opposite of the jacking position. For example, if changing the right front tire, block the left rear wheel.



08020300-121-001

## Blocking Right Front Tire And Left Rear Tire

## Removing A Tire



### Warning!

Carefully follow these tire changing warnings to help prevent personal injury or damage to your vehicle:

- Always park on a firm, level surface as far from the edge of the roadway as possible before raising the vehicle.
- Turn on the Hazard Warning flasher.
- Block the wheel diagonally opposite the wheel to be raised.
- Set the parking brake firmly and set the transmission in PARK.
- Do not let any passenger sit in the vehicle when it is on a jack.
- Do not get under the vehicle when it is on a jack. If you need to get under a raised vehicle, take it to a service center where it can be raised on a lift.
- Only use the jack in the positions indicated and for lifting this vehicle during a tire change.
- If working on or near a roadway, be extremely careful of motor traffic.

Proceed as follows:

1. Loosen the lug nuts by turning them counterclockwise one turn each, but do not remove any lug nuts until the tire has been raised off the ground.



08020301-123-001

### Loosen Lug Nuts Counterclockwise

2. Place the jack under the lift point closest to the tire being changed with the jack head squarely under the jacking location.

3. Turn the jack screw in the direction shown and adjust the jack head so that it is close to the jacking location.

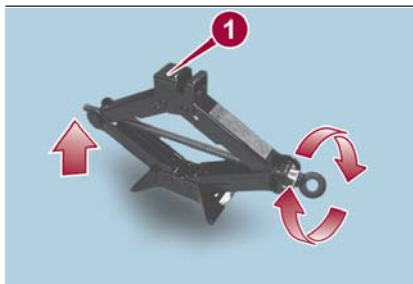

08020301-ALL-003

### Raising The Jack

1 — Jack Head

4. Continue raising the jack head gradually by rotating the screw with your hand until the jack head is inserted into the lift point.



### Caution!

Do not attempt to raise the vehicle by jacking on locations other than those indicated in the Jacking Instructions for this vehicle.

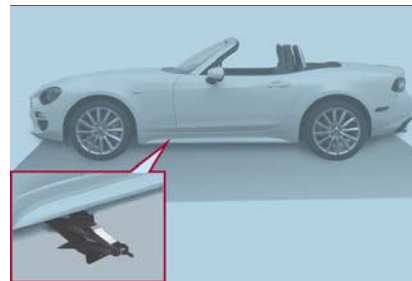

08020301-121-001

### Front Jacking Location

5. Insert the jack lever and attach the lug wrench to tire jack.





08020301-ALL-006

### Jack With Lug Wrench Attached



#### Warning!

*Being under a jacked-up vehicle is dangerous. The vehicle could slip off the jack and fall on you. You could be crushed. Never get any part of your body under a vehicle that is on a jack. If you need to get under a raised vehicle, take it to a service center where it can be raised on a lift.*

6. Turn the jack handle clockwise and raise the vehicle high enough so that the tire is just raised off the ground and can be removed. Before removing the lug nuts, make sure your vehicle is firmly in position and that it cannot slip or move.



#### Warning!

*Raising the vehicle higher than necessary can make the vehicle less stable. It could slip off the jack and hurt someone near it. Raise the vehicle only enough to remove the tire.*

7. Remove the lug nuts by turning them counterclockwise, then remove the wheel.

#### Locking Lug Nuts — If Equipped

If your vehicle has optional anti-theft wheel lug nuts, one on each wheel will lock the tires and you must use a special key to unlock them. This key will attach to the lug wrench.

Register them with the lock manufacturer by filling out the card provided in the glove compartment and mailing it in the accompanying envelope. If you lose this key, contact an authorized dealer or use the lock manufacturer's order form, which is with the registration card.

Accessory wheel locks cannot be used on steel wheels. This includes situations when the spare tire is installed. If the spare tire is installed, one of the original lug nuts (which should still be in the vehicle) must be installed in place of the wheel lock.

#### To Remove An Anti-theft Lug Nut

Proceed as follows:

1. Obtain the special key for the anti-theft lug nut.
2. Place the special key on top of the anti-theft lug nut, and be sure to hold the key square to it. If you hold the key at an angle, you may damage both key and nut. Do not use a power impact wrench.

3. Place the lug wrench on top of the key and apply pressure. Turn the wrench counterclockwise.

#### To Install The Anti-theft Lug Nut

Proceed as follows:

1. Place the special key on top of the nut, and be sure to hold the key square to it. If you hold the key at an angle, you may damage both key and nut. Do not use a power impact wrench.

2. Place the lug wrench on top of the special key, apply pressure, and turn it clockwise.

#### Mounting The Tire

Proceed as follows:

1. Remove dirt and grime from the mounting surfaces of the wheel and hub, including the hub bolts, with a cloth.

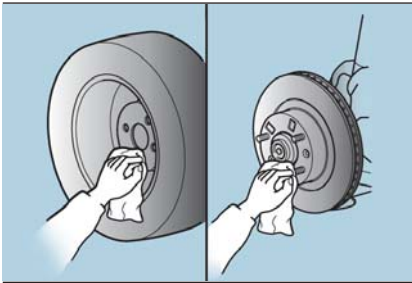

08020303-XX4-001

### Clean Mounting Surface

2. Mount the tire and install the lug nuts with the beveled edge inward, then tighten them by hand.



### Caution!

*Be sure to mount the spare tire with the valve stem facing outward. The vehicle could be damaged if the spare tire is mounted incorrectly.*

3. Turn the lug wrench counterclockwise and lower the vehicle. Use the lug wrench to tighten the nuts in the order shown.

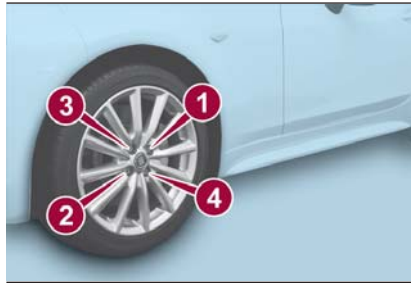

08020303-122-001

### Lug Nut Tightening Order



### Warning!

*To avoid the risk of forcing the vehicle off the jack, do not tighten the wheel nuts fully until the vehicle has been lowered. Failure to follow this warning may result in serious injury.*

4. After tightening the lug nuts, have them checked with a torque wrench by your authorized dealer or service station to verify correct tightness.
5. Remove the tire blocks and store the tools and jack.
6. Check the inflation pressure. Refer to “Recommended Tire Inflation Pressure” in “Technical Specifications” for more information.

### With TPMS

Do not push the tire pressure monitoring system set switch after installing the spare tire. The switch is only to be pushed after installing the repaired flat tire or installing a replacement tire.

**Note:** To prevent the jack and tool from rattling, store them properly.



### Warning!

*A loose tire or jack thrown forward in a collision or hard stop could endanger the occupants of the vehicle. Always stow the jack parts and the spare tire in the places provided. Have the deflated (flat) tire repaired or replaced immediately.*



## TIRE SERVICE KIT

### Tire Service Storage

The Tire Service Kit is located inside the trunk.

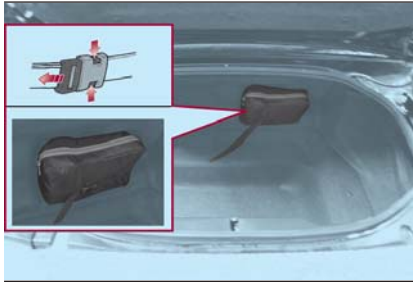

08020202-121-003

### Tire Service Kit Location

The Tire Service Kit included with your vehicle is for a temporary repair of a slightly damaged flat tire resulting from running over nails or similar sharp objects on the road surface.

Perform the emergency flat tire repair without removing the nail or similar sharp object which punctured the tire.

**Note:** Your vehicle is not equipped with a spare tire. In the event of a flat tire, use the Tire Service Kit to repair the tire temporarily. When doing the repair, refer to the instructions included in the Tire Service Kit. If an emergency repair was performed on a flat tire using the Tire Service Kit, contact an authorized dealer to repair or replace the tire as soon as possible.

## Tire Service Kit Components And Operation

The Tire Service Kit includes the following items:

### U.S.A. And Canada Markets:

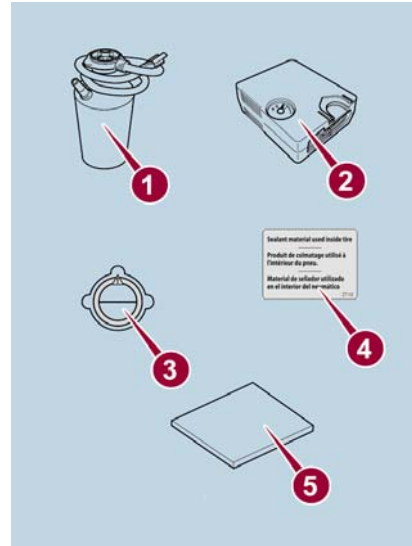

08070606457457

### Tire Service Kit Components — U.S.A. And Canada Markets

- 1 — Sealant Bottle
- 2 — Compressor
- 3 — Speed Restriction Sticker
- 4 — Repaired Tire Sticker
- 5 — Instructions

### Mexico Market:

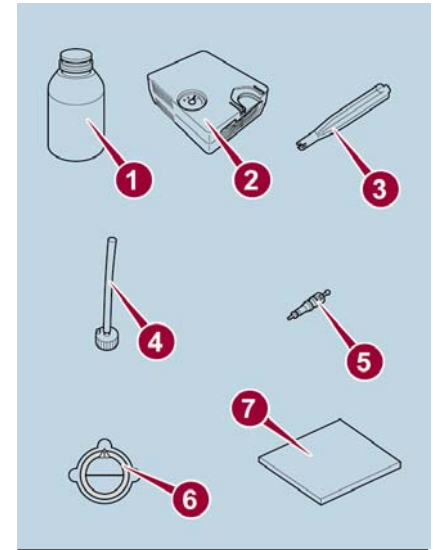

08070606456456

### Tire Service Kit Components — Mexico Markets

- 1 — Tire Sealant
- 2 — Compressor
- 3 — Valve Core Tool
- 4 — Injection Hose
- 5 — Spare Valve Core
- 6 — Speed Restriction Sticker
- 7 — Instructions

## Tire Service Usage Precautions

The tire sealant cannot be reused. If the sealant has been used, or is expired, purchase new tire sealant at an authorized dealer.

**Note:** The Tire Service Kit cannot be used in the following cases. Consult an authorized dealer if any of these conditions exist:

- The period of effective use for the tire sealant has expired (the period of effectiveness is indicated on the bottle label)
- The tear or puncture in the tire exceeds about 0.16 inches (4 mm)
- The damage has occurred to an area of the tire other than the tread
- The vehicle has been driven with nearly no air remaining in the tire
- The tire has come off the wheel rim
- Damage to the wheel rim has occurred
- The tire has two or more punctures

## Sealing A Tire With Tire Service Kit



### Warning!

- Do not attempt to seal a tire on the side of the vehicle closest to traffic. Pull far enough off the road to avoid the danger of being hit when using the Tire Service Kit.
- Do not use Tire Service Kit or drive the vehicle under the following circumstances:
  - If the puncture in the tire tread is approximately 1/4 inch (6 mm) or larger.
  - If the tire has any sidewall damage.
  - If the tire has any damage from driving with extremely low tire pressure.
  - If the tire has any damage from driving on a flat tire.
  - If the wheel has any damage.
  - If you are unsure of the condition of the tire or the wheel.
- Keep Tire Service Kit away from open flames or heat sources.
- A loose Tire Service Kit thrown forward in a collision or hard stop could endanger the occupants of the vehicle. Always stow the Tire Service Kit in the place provided. Failure to follow these warnings can result in injuries that are serious or fatal to you, your passengers, and others around you.
- Take care not to allow the contents of Tire Service Kit to come in contact with hair, eyes, or clothing. Tire Service Kit sealant is harmful if inhaled, swallowed, or

absorbed through the skin. It causes skin, eye, and respiratory irritation. Flush immediately with plenty of water if there is any contact with eyes or skin. Change clothing as soon as possible, if there is any contact with clothing.

Tire Service Kit Sealant solution contains latex. In case of an allergic reaction or rash, consult a physician immediately. Keep Tire Service Kit out of reach of children. If swallowed, rinse mouth immediately with plenty of water and drink plenty of water. Do not induce vomiting! Consult a physician immediately.

## U.S.A. And CANADA Markets:

Proceed as follows:

1. Pull over to a safe location and turn on the vehicle's Hazard Warning Lights.
2. Verify that the valve stem (on the wheel with the deflated tire) is in a position that is near to the ground. This will allow the Tire Service Kit hoses to reach the valve stem and keep the Tire Service Kit flat on the ground. This will provide the best positioning of the kit when injecting the sealant into the deflated tire and running the air pump. Move the vehicle as necessary to place the valve stem in this position before proceeding.
3. Place the gear selector in REVERSE for a manual transmission, and PARK for automatic transmission.





4. Apply the parking brake with the brake pedal pressed and turn the engine OFF.

5. Unload passengers and cargo, then remove the Tire Service Kit.

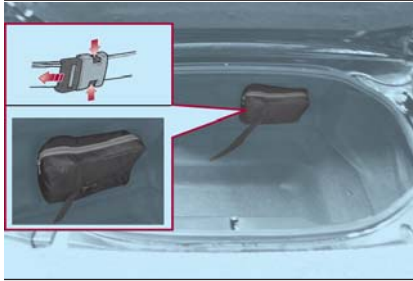

08020202-121-003

**Tire Service Kit Location**

6. Gently shake the sealant bottle to mix the contents. Then extend the injection hose.

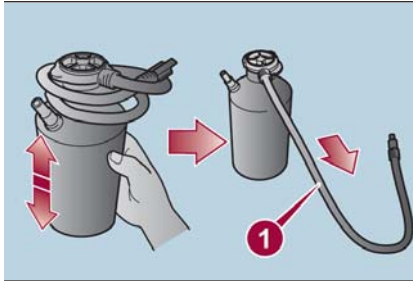

08020202-03A-666

**Sealant Bottle With Injection Hose**

1 — Injection Hose

**Note:**

- ❑ Do not shake the bottle excessively. Otherwise, the sealant could spray out of the injection hose. If the sealant contacts clothing or other objects, you may not be able to remove it.
- ❑ The sealant hardens easily, and injecting it will be difficult under cold weather conditions (32 °F (0 °C) or below). Warm the sealant inside the vehicle to facilitate injection.

7. Pull out the air compressor hose and the air compressor plug from the air compressor.

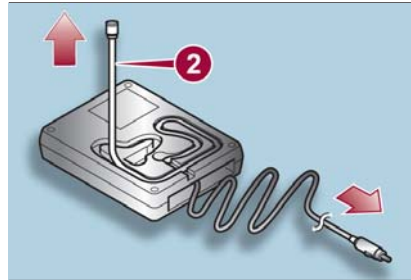

08020202-36A-004

**Air Compressor With Hose And Plug**

2 — Air Compressor Hose

8. Install the air compressor hose, which was pulled out of the air compressor, into the injection valve of the bottle.

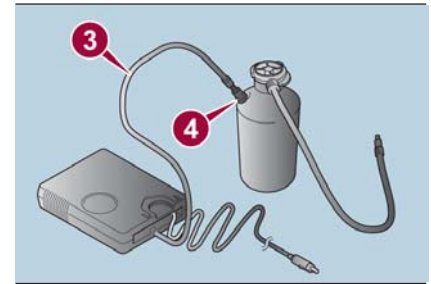

08020202-031-670

**Install Air Compressor To Sealant Bottle**

3 — Air Compressor Hose  
4 — Injection Valve

**Note:** Make sure that the air compressor switch is off before inserting the air compressor hose into the injection valve of the bottle. If the air compressor hose is not installed to the injection valve of the bottle securely, the sealant may leak.

9. Remove the valve cap from the valve of the flat tire, install the injection hose to the tire valve, and turn the sleeve to the right to tighten.



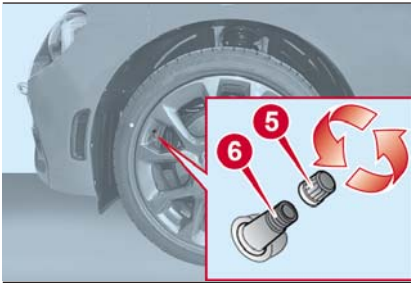

08020202-03A-004AB

### Valve And Valve Cover

- 5 — Valve Cap
- 6 — Valve

10. Install the bottle to the air compressor and push it in until the left and right tabs are engaged securely.

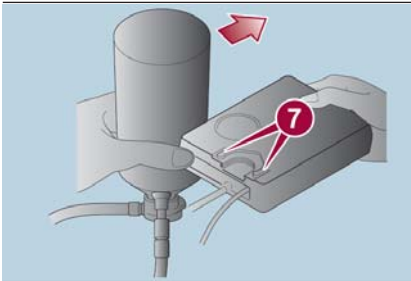

08020202-031-669

### Sealant Bottle Into Air Compressor

- 7 — Air Compressor Tabs

11. Insert the air compressor plug into the accessory socket inside the vehicle and place the ignition to ACC.

**Note:** When inserting the air compressor plug into or removing it from the accessory socket, make sure that the air compressor switch is off. When turning the air compressor on/off, use the air compressor switch. Before checking the tire inflation pressure using the tire pressure gauge, turn the air compressor switch off.

12. The sealant is injected into the tire when the air compressor is switched on. After the sealant is injected completely, wait until the tire inflation pressure increases to the specified tire inflation pressure. For the correct pressure, check the tire inflation pressure label on the driver's door frame.

**Note:** The inflation pressure may increase to about 43.5 psi (3 Bar) temporarily to inject the sealant through the valve. Normally, the inflation pressure decreases gradually and it reaches the actual inflation pressure after about 30 seconds.



### Warning!

*Never use the air compressor above 3 Bar (43.5 psi). Using the air compressor at an inflation pressure above 3 Bar (43.5 psi) continuously is dangerous. If the air compressor overheats, hot air will be exhausted and you could get burned.*



### Caution!

*If the tire inflation pressure does not increase, repair of the tire is not possible. If the tire does not reach the specified tire inflation pressure within 10 minutes, it may have received extensive damage. In this case, the repair using the tire service kit was not successful.*

*Do not operate the air compressor for a continuous 10 minutes or longer because using it for long periods could cause a malfunction.*

13. Adhere the speed restriction sticker to an area where it can be viewed easily by the driver.





**Warning!**

*Do not adhere the speed restriction sticker to the padded area on the steering wheel. Adhering the speed restriction sticker to the padded area on the steering wheel is dangerous because the air bag may not operate (deploy) normally resulting in serious injury. In addition, do not adhere the sticker to areas where warning lights or the speedometer cannot be viewed.*

14. Adhere the repaired tire sticker to the wheel of the flat tire.

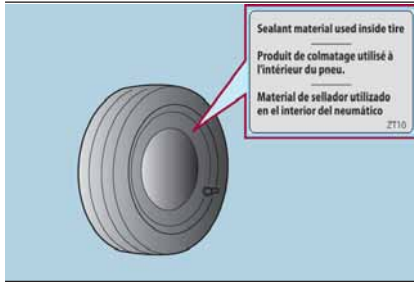

**Repaired Tire Sticker**

08020202-031-667

15. When the tire inflates to the specified tire inflation pressure, turn the air compressor switch off, turn the sleeve of the injection hose to the left, and pull it out of the tire valve.

16. Remove the air compressor hose from the injection valve of the bottle. Then, install the injection hose to the injection valve of the bottle to prevent leakage of any remaining sealant.

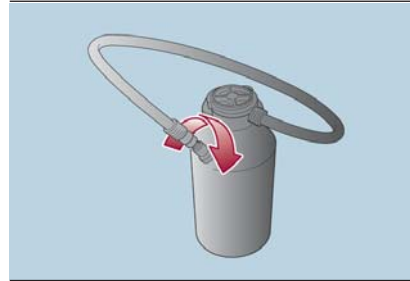

08020202-031-668

**Install Injection Hose To Sealant Bottle**

**Note:** The remaining sealant in the hose may spray out when the hose is removed. Remove the hose carefully because you may not be able to remove the sealant contacting clothing or other objects.

- 17. Install the tire valve cap.
- 18. Place the Tire Service Kit back into its storage location.
- 19. Start driving immediately to spread the sealant in the tire.

**Note:** Carefully drive the vehicle at a speed of 50 mph (80 km/h) or less. If the vehicle is driven at a speed of 50 mph (80 km/h) or more, the vehicle may vibrate.

**Note: With TPMS System:** if the tire is not properly inflated, the (!) warning light will illuminate.

□ After driving the vehicle for about 10 minutes or 3 miles (5 km), connect the air compressor to the tire using Step nine of the procedure, and check the tire inflation pressure using the tire pressure gauge on the air compressor. If the tire inflation pressure is lower than the specified tire inflation pressure, turn the air compressor on and wait until it reaches the specified tire inflation pressure.

□ The Tire Service Kit is completed successfully if the tire inflation pressure does not decrease. Carefully drive the vehicle to the nearest authorized dealer immediately and have the flat tire replaced. Replacement with a new tire is recommended. If the tire is to be repaired or reused, consult an authorized dealer.

**Note:**

□ If an emergency flat tire repair has been performed using the Tire Service Kit, FCA recommends that the tire be replaced with a new one as soon as possible. If the tire is to be repaired or reused, contact an authorized dealer.

□ The wheel can be reused if the sealant adhering to it is removed. However, replace the valve with a new one.

## Sealing A Tire With Tire Service Kit



### Warning!

- Do not attempt to seal a tire on the side of the vehicle closest to traffic. Pull far enough off the road to avoid the danger of being hit when using the Tire Service Kit.
- Do not use Tire Service Kit or drive the vehicle under the following circumstances:
  - If the puncture in the tire tread is approximately 1/4 inch (6 mm) or larger.
  - If the tire has any sidewall damage.
  - If the tire has any damage from driving with extremely low tire pressure.
  - If the tire has any damage from driving on a flat tire.
  - If the wheel has any damage.
  - If you are unsure of the condition of the tire or the wheel.
  - Keep Tire Service Kit away from open flames or heat sources.
  - A loose Tire Service Kit thrown forward in a collision or hard stop could endanger the occupants of the vehicle. Always stow the Tire Service Kit in the place provided. Failure to follow these warnings can result in injuries that are serious or fatal to you, your passengers, and others around you.
  - Take care not to allow the contents of Tire Service Kit to come in contact with hair, eyes, or clothing. Tire Service Kit sealant is harmful if inhaled, swallowed, or

absorbed through the skin. It causes skin, eye, and respiratory irritation. Flush immediately with plenty of water if there is any contact with eyes or skin. Change clothing as soon as possible, if there is any contact with clothing.

Tire Service Kit Sealant solution contains latex. In case of an allergic reaction or rash, consult a physician immediately. Keep Tire Service Kit out of reach of children. If swallowed, rinse mouth immediately with plenty of water and drink plenty of water. Do not induce vomiting! Consult a physician immediately.

### Mexico Market

Proceed as follows:

1. Pull over to a safe location and turn on the vehicle's Hazard Warning Lights.
2. Verify that the valve stem (on the wheel with the deflated tire) is in a position that is near to the ground. This will allow the Tire Service Kit hoses to reach the valve stem and keep the Tire Service Kit flat on the ground. This will provide the best positioning of the kit when injecting the sealant into the deflated tire and running the air pump. Move the vehicle as necessary to place the valve stem in this position before proceeding.
3. Place the gear selector in REVERSE for a manual transmission, or PARK for automatic transmission.

4. Apply the parking brake with the brake pedal pressed and turn the engine OFF.

5. Unload passengers and cargo, then remove the Tire Service Kit.

6. Gently shake the tire sealant. If the bottle is shaken after the injection hose is screwed on, tire sealant could spray out from the injection hose. Tire sealant contacting clothing or other objects may be impossible to remove. Shake the bottle before screwing on the injection hose.

### Note:

- Do not shake the bottle excessively. Otherwise, the sealant could spray out of the injection hose, and if the sealant contacts clothing or other objects, you may not be able to remove it.
- The sealant hardens easily and injecting it will be difficult under cold weather conditions 32 °F (0 °C) or below. Warm the sealant inside the vehicle to facilitate injection.

7. Remove the cap from the bottle and screw on the injection hose with the bottle's inner cap left on to break the inner cap.





08020203A003

### Attaching Injection Hose To Sealant Bottle

8. Remove the valve cap from the flat tire. Push the back of a valve core tool to the core of the tire valve and bleed out all of the remaining air.

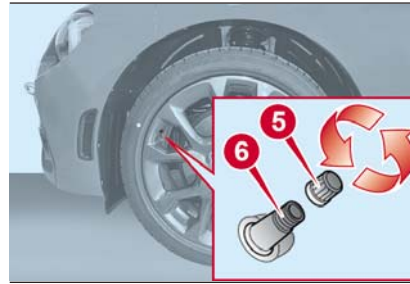

08020202-03A-004AB

### Valve And Valve Cover

- 5 — Valve Cap
- 6 — Tire Valve

**Note:** If there is air remaining in the tire when the valve core is removed, the valve core could fly out. Remove the valve core carefully.

9. Turn the valve core counterclockwise with the valve core tool and remove the valve core.

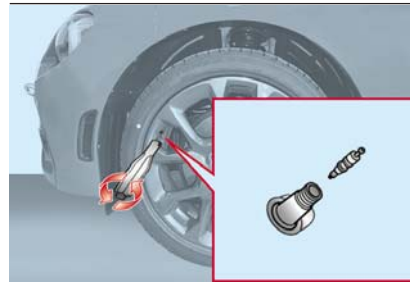

08020202-03A-005AB

### Turn Valve Core Counterclockwise

**Note:** Store the valve core in a place where it will not get dirty.

10. Insert the injection hose into the valve.

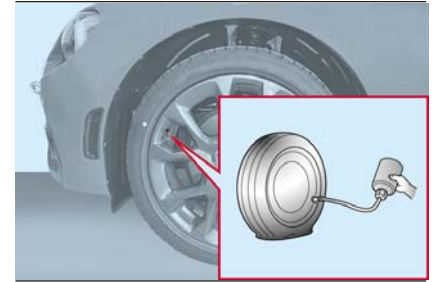

08020202-03A-008AB

### Injection Hose Into Valve

11. Hold the bottom of the bottle upright, squeeze the bottle with your hands, and inject the entire amount of tire sealant into the tire.

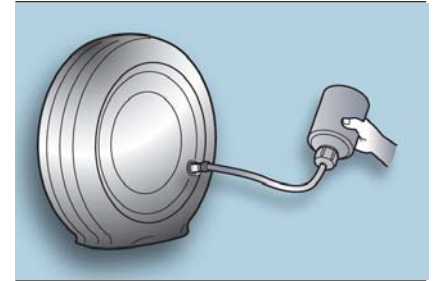

08020202-03A-008

### Squeeze Sealant Into Tire

12. Pull out the injection hose from the valve.

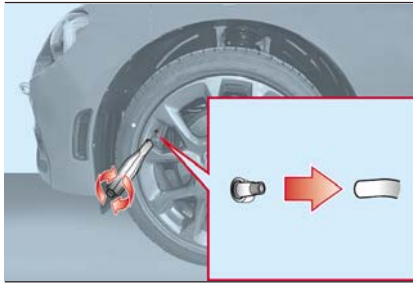

08020202-03A-007AB

### Turn Valve Core Clockwise To Reinstall

13. Reinsert the valve core into the valve and turn it clockwise to install.

#### Note:

- The tire sealant cannot be reused. If the tire sealant kit has been used, or is expired, purchase new one at an authorized dealer.
- Do not throw away the empty tire sealant bottle after use. Return the empty tire sealant bottle to an authorized dealer when replacing the tire. The empty tire sealant bottle will need to be used to extract and dispose of the used sealant from the tire.

14. Install the injection hose to the tab of the bottle to prevent leakage of any remaining sealant.

15. Adhere the speed restriction sticker to an area where it can be viewed easily by the driver.



### Warning!

*Do not adhere the speed restriction sticker to the padded area on the steering wheel. Adhering the speed restriction sticker to the padded area on the steering wheel is dangerous because the air bag may not operate (deploy) normally resulting in serious injury. In addition, do not adhere the sticker to areas where warning lights or the speedometer cannot be viewed.*

16. Pull out the air compressor hose and the air compressor plug from the air compressor.

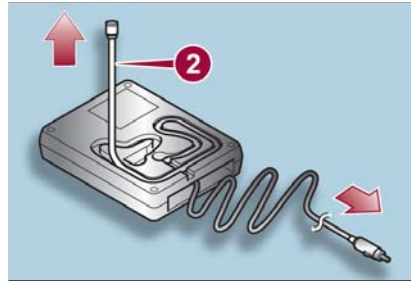

08020202-36A-004

### Air Compressor With Hose And Plug

- 2 — Air Compressor Hose

17. Install the air compressor hose to the tire valve.

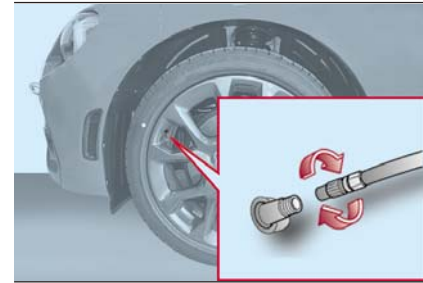

08020202-03A-008AB

### Air Compressor Hose Into Valve

18. Insert the air compressor plug into the accessory socket inside the vehicle and place the ignition to ACC.

19. Turn the air compressor switch on and inflate the tire carefully to the correct inflation pressure. For the correct pressure, check the tire inflation pressure label on the driver's door frame.

**Note:** When inserting the air compressor plug into or removing it from the accessory socket, make sure that the air compressor switch is off. When turning the air compressor on/off, use the air compressor switch. Before checking the tire inflation pressure using the tire pressure gauge, turn the air compressor switch off.



**Caution!**

❑ If the tire inflation pressure does not increase, repair of the tire is not possible. If the tire does not reach the specified tire inflation pressure within 10 minutes, it may have received extensive damage. In this case, the repair using the tire service kit was not successful.

❑ Do not operate the air compressor for a continuous 10 minutes or longer because using it for long periods could cause a malfunction.

**Note:** If the tire has been over inflated, loosen the screw cap on the air compressor and bleed some of the air out.

20. When the tire inflates to the specified tire inflation pressure, turn the air compressor switch off, turn the sleeve of the air compressor hose to the left, and pull it out of the tire valve.
21. Install the tire valve cap.
22. Place the Tire Service Kit back into its storage location.
23. Start driving immediately to spread the sealant in the tire.

**Note:**

❑ Carefully drive the vehicle at a speed of 50 mph (80 km/h) or less. If the vehicle is driven at a speed of 50 mph (80 km/h) or more, the vehicle may vibrate.

❑ **With TPMS System:** if the tire is not properly inflated, the (!) warning light will illuminate.

❑ After driving the vehicle for about 10 minutes or 3 miles (5 km), connect the air compressor to the tire using step nine of the procedure, and check the tire inflation pressure using the tire pressure gauge on the air compressor. If the tire inflation pressure is lower than the specified tire inflation pressure, turn the air compressor on and wait until it reaches the specified tire inflation pressure;

❑ The emergency flat tire repair is completed successfully if the tire inflation pressure does not decrease. Carefully drive the vehicle to the nearest authorized dealer and have the flat tire replaced. Replacement with a new tire is recommended. If the tire is to be repaired or reused, contact a authorized dealer.

❑ If an emergency flat tire repair has been performed using the Tire Service Kit, FCA recommends that the tire be replaced with a new one as soon as possible. If the tire is to be repaired or reused, contact an authorized dealer.

❑ The tire can be reused if the sealant adhering to it is removed. However, replace the valve with a new one.

**Replacing The Bottle**

**Note:** The tire sealant has a period of effective use. Check the period of effective use indicated on the bottle label and do not use it if it has expired. Have the tire sealant replaced at an authorized dealer before the period of effective use has expired.

Inspect the Tire Service Kit at regular intervals as well as the operation of the tire compressor.



## JUMP STARTING

### Preparations For Jump Starting

If the battery is discharged, a jump starting procedure can be performed using the battery and the cables of another vehicle, or using a booster battery.

Jump starting is dangerous if done incorrectly, so follow the procedure in this section carefully. If you feel unsure about jump starting, it is strongly recommended that you have a competent service technician do the work.

**Note:** When a booster battery is being used, comply with the utilization and precaution instructions specified by the manufacturer.

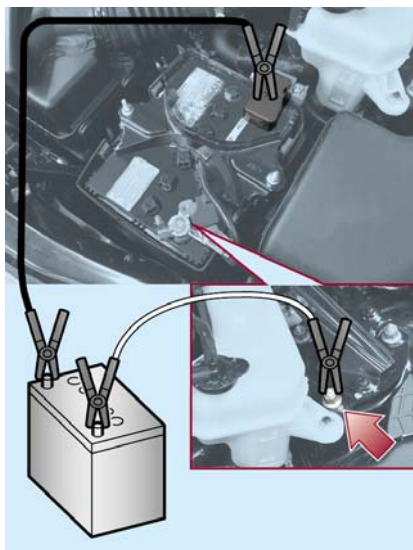

08030100121001

### Jump Start Locations



#### Warning!

*Do not attempt jump starting if the battery is frozen. It could rupture or explode and cause personal injury.*



#### Caution!

*Do not use a portable battery booster pack or any other booster source with a system voltage greater than 12 Volts or damage to the battery, starter motor, alternator or electrical system may occur.*

### Jump-Starting Procedure



#### Warning!

*Failure to follow this jump starting procedure could result in personal injury or property damage due to battery explosion.*



#### Caution!

*Failure to follow these procedures could result in damage to the charging system of the booster vehicle or the discharged vehicle.*



To jump start the vehicle, follow this procedure:

1. Remove the positive terminal cover.



08030100-122-001

### Positive Terminal Cover

2. Make sure the booster battery is 12 Volts and that the negative terminal is grounded.
3. Turn off the engine of the vehicle with the booster battery and all unnecessary electrical loads in both vehicles.



### Warning!

*Do not allow vehicles to touch each other as this could establish a ground connection and personal injury could result.*

4. Connect the positive end of the jumper cable to the positive terminal on the discharged battery.
5. Connect the opposite end of the positive jumper cable to the positive terminal on the booster battery.
6. Connect the negative end of the negative jumper cable to the negative terminal of the booster battery.
7. Connect the opposite end of the negative jumper cable to a good engine ground of the vehicle with the discharged battery (exposed metal part of the engine) away from the battery and the fuel injection system.
8. Start the engine of the booster vehicle and run it a few minutes. Then start the engine of the other vehicle.
9. Once the engine is started, remove the jumper cables in the reverse sequence.
10. Replace the positive terminal cover. Make sure cover is secure.

### Bump Starting

Never jump start the engine by pushing, towing or coasting downhill.

#### Note:

- You cannot start a vehicle with an automatic transmission by pushing it.

- Do not push-start a vehicle that has a manual transmission. It can damage the emission control system.

### Starting A Flooded Engine

If the engine fails to start, it may be flooded (excessive fuel in the engine).

Follow this procedure:

1. If the engine does not start within 5 seconds on the first try, wait 10 seconds and try again.
  2. Make sure the parking brake is on.
  3. Press the accelerator all the way and hold it there.
  4. Press the clutch pedal (manual transmission) or the brake pedal (automatic transmission), then push the push button start. If the engine starts, release the accelerator immediately because the engine will suddenly rev up.
  5. If the engine fails to start, crank it without pressing the accelerator.
- If the engine still does not start using the above procedure, have your vehicle inspected an authorized dealer.



## IF YOUR ENGINE OVERHEATS

### If Your Engine Overheats

In any of the following situations, you can reduce the potential for overheating by taking the appropriate action.

- ❑ On highways — slow down.
- ❑ In city traffic — while stopped, place the transmission in NEUTRAL, but do not increase engine idle speed.

**Note:** There are steps that you can take to slow down an impending overheat condition:

- ❑ If your air conditioner (A/C) is on, turn it off. The A/C system adds heat to the engine cooling system and turning the A/C off can help remove this heat.
- ❑ You can also turn the temperature control to maximum heat, the mode control to floor and the blower control to high. This allows the heater core to act as a supplement to the radiator and aids in removing heat from the engine cooling system.



#### Warning!

*You or others can be badly burned by hot engine coolant (antifreeze) or steam from your radiator. If you see or hear steam coming from under the hood, do not open the hood until the radiator has had time to cool. Never try to open a cooling system pressure cap when the radiator or coolant bottle is hot.*



#### Caution!

*Driving with a hot cooling system could damage your vehicle. If temperature gauge reads "H", pull over and stop the vehicle. Idle the vehicle with the air conditioner turned off until the pointer drops back into the normal range. If the pointer remains on the "H", turn the engine off immediately, and call for service.*

### If Steam Is Coming From The Engine Compartment:

Do not go near the front of the vehicle. Stop the engine. Wait until the steam dissipates, then open the hood and start the engine.

### If Neither Coolant Nor Steam Is Escaping:

Open the hood and idle the engine until it cools.

#### Note:

- ❑ If the cooling fan does not operate while the engine is running, the engine temperature will increase. Stop the engine and contact an authorized dealer.
- ❑ If the engine continues to overheat or frequently overheats, have the cooling system inspected. The engine could be seriously damaged unless repairs are made. Contact an authorized dealer.



## TOWING THE VEHICLE

### Attaching The Tow Eyes — If Equipped



#### Warning!

Stand clear of vehicles when pulling with tow eyes.

- Do not use a chain with a tow eye. Chains may break, causing serious injury or death.
- Do not use a tow strap with a tow eye. Tow straps may break or become disengaged, causing serious injury or death.
- Failure to follow proper tow eye usage may cause components to break resulting in serious injury or death.



#### Caution!

- The tow eye must be used exclusively for roadside assistance operations. Only use the tow eye with an appropriate device in accordance with the highway code (a rigid bar or rope) to flat tow the vehicle for a short distance to the nearest service location.
- Tow eyes **MUST NOT** be used to tow vehicles off the road or where there are obstacles.
- In compliance with the above conditions, towing with a tow eye must take place with two vehicles (one towing, the other towed) aligned as much as possible along the same center line. Damage to your vehicle may occur if these guidelines are not followed.
- When towing, only use a facility that can tow vehicles with low ground clearances as extensive damage can result by using a standard tow truck platform.

Proceed as follows:

1. Remove the towing eyelet and the lug wrench from the luggage compartment.
2. Wrap a flathead screwdriver or similar tool with a soft cloth to prevent damage to a painted bumper, and open the cap located on the front or rear bumper.

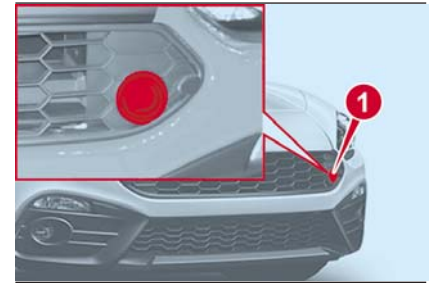

08060203-121-001AB

#### Front Bumper Cap Location

1 — Front Bumper Cap

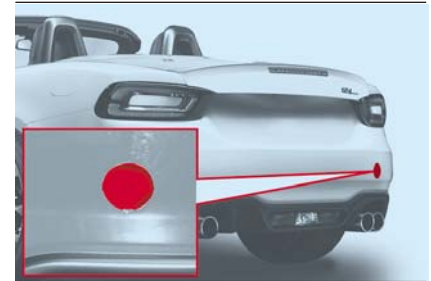

08060203-122-001AB

#### Rear Bumper Cap Location

**Note:** Do not use excessive force as it may damage the cap or scratch the painted bumper surface. Remove the cap completely and store it so as not to lose it.

3. Securely install the tow eye in front or rear using the lug wrench or equivalent.

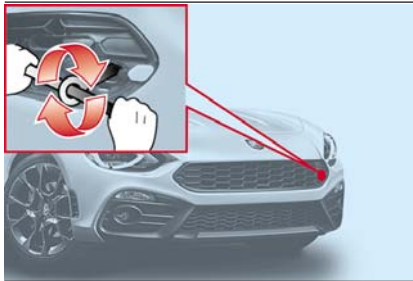

08060201-121-001AB

### Installing Front Towing Eye

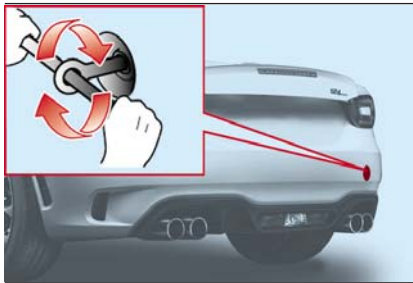

08060201-122-001AB

### Installing Rear Tow Eye

4. Hook the towing rope to the tow eye.



### Caution!

*Tow eyes are for emergency use only, to rescue a vehicle stranded off road. Do not use tow eyes for tow truck hookup or highway towing. You could damage your vehicle.*

When using the tow eyes, always pull the lead or chain in a straight direction with respect to the eyelet. Never apply a sideways force.

**Note:** Follow the precautions below to avoid damage to the towing eyelet and towing hook, vehicle body, or transmission system when towing:

- Do not tow a vehicle heavier than yours.
- Do not suddenly accelerate your vehicle as it will apply a severe shock to the tow eye and towing hook or rope.
- Do not attach any rope other than to the tow eye and towing hook.

## Emergency Towing

### Towing Description

Proper lifting and towing are necessary to prevent damage to the vehicle. Government and local laws must be followed.

A towed vehicle usually should have its drive wheels (rear wheels) OFF of the ground. If excessive damage or other conditions prevent this, use wheel dollies.

When towing with the rear wheels on the ground, release the parking brake.



### Caution!

**DO NOT** use sling-type equipment when towing. When securing the vehicle to a flatbed truck, do not attach to front or rear suspension components. Damage to your vehicle may result from improper towing.



If towing service is not available in an emergency, the vehicle may be towed with all four wheels on the ground using the towing hook at the front of the vehicle. Only tow the vehicle on paved surfaces for short distances at low speeds.

Follow these instructions when towing the vehicle with all wheels on the ground:

1. Shift to NEUTRAL for manual transmission or automatic transmission.
2. Place the ignition to ACC.
3. Release the parking brake.

**Note:** Remember that power assist for the brakes and steering will not be available when the engine is not running.

## **EVENT DATA RECORDER (EDR)**

This vehicle is equipped with an Event Data Recorder (EDR). The main purpose of an EDR is to record data that will assist in understanding how a vehicle's systems performed under certain crash or near crash-like situations, such as an air bag deployment or hitting a road obstacle.

Please refer to "Occupant Restraint Systems" in "Safety" for further information on the Event Data Recorder (EDR).

# SERVICING AND MAINTENANCE

INTRODUCTION . . . . .	.224
ENGINE COMPARTMENT . . . . .	.231
BATTERY RECHARGING . . . . .	.235
MAINTENANCE PROCEDURES . . . . .	.235
RAISING THE VEHICLE . . . . .	.237
WHEELS AND TIRES . . . . .	.238
DEPARTMENT OF TRANSPORTATION UNIFORM TIRE QUALITY GRADES . . . . .	.254
STORING THE VEHICLE . . . . .	.255
BODYWORK . . . . .	.256
INTERIORS . . . . .	.262



## INTRODUCTION

Be extremely careful and prevent injury to yourself and others or damage to your vehicle when using this Owner's Manual for inspection and maintenance.

If you are unsure about any procedure it describes, we strongly urge you to have a reliable and qualified service shop perform the work, preferably at your authorized dealer.

Factory-trained FCA technicians and genuine FCA parts are best for your vehicle. Without this expertise and the parts that have been designed and made especially for your vehicle, inadequate, incomplete, and insufficient servicing may result in problems. This could lead to vehicle damage or an accident and injuries.

For expert advice and quality service, contact your authorized dealer.

**Note:** Under no circumstances should oil change intervals exceed 10,000 miles (16,000 kilometers) or 1 year.

To continue New Vehicle Limited Warranty eligibility and to protect your investment, it is your responsibility to properly maintain your vehicle according to factory recommended schedules outlined in this Owner's Manual. As part of this you must keep your maintenance records, receipts, repair orders and any other documents as evidence this maintenance was performed. You must present these documents, should any New Vehicle

Limited Warranty coverage disagreement occur. Failure to do so can result in your New Vehicle Limited Warranty being voided either in whole or in part.

This evidence may consist of the following:

The FCA Scheduled Maintenance Record, refer to the Warranty Booklet, must be completely filled out showing mileage, repair order number, date for each service, and signed by a qualified automotive service technician who service vehicles.

Original copies of repair orders or other receipts that include the mileage and date the vehicle was serviced. Each receipt should be signed by a qualified automotive service technician.

For self maintenance, a statement that you completed the maintenance yourself, displaying mileage and the date the work was performed. Also, receipts for the replacement parts (fluid, filters, etc.) indicating the date and mileage must accompany this statement.

**Note:** If you elect to perform maintenance yourself or have your vehicle serviced at a location other than an authorized dealer, FCA requires that all fluids, parts and materials must meet FCA standards for durability and performance as described in this Owner's Manual.

Claims against the warranty resulting from lack of maintenance, as opposed to defective materials or authorized FCA workmanship, will not be honored.

Any auto repair shop using parts equivalent to your vehicle's original equipment may perform maintenance. But we recommend that it always be done by an authorized dealer using genuine FCA parts. Selecting "Maintenance Monitor" enables the system to notify you of your vehicle's approaching inspection/servicing period.

## Owner Maintenance Precautions

The owner or a qualified service technician should make these vehicle inspections at the indicated intervals to ensure safe and dependable operation. Bring any problem to the attention of an authorized dealer or qualified service technician as soon as possible.

### When refueling perform inspection of:

- Brake and clutch fluid level
- Engine coolant level
- Engine oil level
- Washer fluid level

## At least monthly perform inspection of:

Tire inflation pressures

## At least twice a year (for example, every spring and fall) perform inspection of:

Engine coolant

Engine oil

As explained in the “Introduction” paragraph, several procedures can be done only by a qualified service technician with special tools.

For details, read the separate Warranty Booklet provided with the vehicle. If you are unsure about any servicing or maintenance procedure, have it done by an authorized dealer.

There are strict environmental laws regarding the disposal of waste oil and fluids. Please dispose of your waste properly and with due regard to the environment.

We recommend that you entrust the oil and fluid changes of your vehicle to an authorized dealer.

## Periodic Checks

Every **620 miles (1,000 km)** or before long trips check and, if necessary, top off:

Engine coolant level.

Brake fluid level.

Windshield washer fluid level.

Tire inflation pressure and condition.

Operation of lighting system (headlights, direction indicators, hazard warning lights, etc.).

Operation of windshield washer/wiper system and positioning/wear of windshield wiper blades.

Every **1860 miles (3,000 km)** check and top off the engine oil level if required.

## Heavy-Duty Use Of The Vehicle

If the vehicle is used under one of the following conditions:

Dusty roads.

Short, repeated trips less than 4.4 - 5 miles (7 - 8 km) at sub-zero outside temperatures.

Engine idling for long periods of time or driving long distances at low speeds or long periods of inactivity.

The following checks must be carried out more often than indicated in the Scheduled Servicing Plan:

Check front disc brake pad condition and wear.

Check cleanliness of underhood area and all door and trunk locks, cleanliness and lubrication of linkage.

Visually inspect conditions of the: engine, transmission, lines and hoses (exhaust/fuel system/brakes) and rubber elements (hoses/belts/etc.).

Check battery charge and battery fluid level.

Visually inspect conditions of the accessory drive belts.

Check and, if necessary, change engine oil and replace oil filter.

Check and, if necessary, replace cabin air filter.

Check and, if necessary, replace air cleaner.

## Severe Duty All Models

Change Engine Oil at 4,000 miles (6,500 km) if the vehicle is operated in a dusty and off road environment or is operated predominately at idle or only very low engine RPM's. This type of vehicle use is considered Severe Duty.



## Scheduled Servicing Plan

Mileage or time passed (whichever comes first)	10,000	20,000	30,000	40,000	50,000	60,000	70,000	80,000	90,000	100,000	110,000	120,000	130,000	140,000	150,000
Or Years:	1	2	3	4	5	6	7	8	9	10	11	12	13	14	15
Or Kilometers:	16,000	32,000	48,000	64,000	80,000	96,000	112,000	128,000	144,000	160,000	176,000	192,000	208,000	224,000	240,000
Check tire condition/wear and adjust pressure, if necessary, check TIREKIT expiration date (if provided).	•	•	•	•	•	•	•	•	•	•	•	•	•	•	•
Check operation of lighting system (headlamps, direction indicators, hazard warning lights, luggage compartment, passenger compartment, glove compartment, instrument panel warning lights, etc.).	•	•	•	•	•	•	•	•	•	•	•	•	•	•	•
Check and, if necessary, top up fluid levels (brakes/hydraulic clutch, windshield washer, battery, engine coolant, etc.).	•	•	•	•	•	•	•	•	•	•	•	•	•	•	•



Mileage or time passed (whichever comes first)	10,000	20,000	30,000	40,000	50,000	60,000	70,000	80,000	90,000	100,000	110,000	120,000	130,000	140,000	150,000
Or Years:	1	2	3	4	5	6	7	8	9	10	11	12	13	14	15
Or Kilometers:	16,000	32,000	48,000	64,000	80,000	96,000	112,000	128,000	144,000	160,000	176,000	192,000	208,000	224,000	240,000
Check engine control system operation (via diagnostic tool).	•	•	•	•	•	•	•	•	•	•	•	•	•	•	•
Visually inspect condition of: exterior bodywork, underbody protection, pipes and hoses (exhaust - fuel system - brakes), rubber elements (boots, sleeves, bushings, etc.).		•		•		•		•		•		•		•	
Visually inspect conditions of steering elements and check their operation.		•		•		•		•		•		•		•	
Check the front and rear suspension, tie rods, CV Joints, and replace if necessary.		•		•		•		•		•		•		•	
Check endfloat of wheel bearings.		•		•		•		•		•		•		•	



Mileage or time passed (whichever comes first)	10,000	20,000	30,000	40,000	50,000	60,000	70,000	80,000	90,000	100,000	110,000	120,000	130,000	140,000	150,000
Or Years:	1	2	3	4	5	6	7	8	9	10	11	12	13	14	15
Or Kilometers:	16,000	32,000	48,000	64,000	80,000	96,000	112,000	128,000	144,000	160,000	176,000	192,000	208,000	224,000	240,000
Check windshield/rear window wiper blade position/wear.	•		•		•		•		•		•		•		•
Check operation of windshield washer system and adjust jets if necessary.	•		•		•		•		•		•		•		•
Check cleanliness of hood and trunk locks and cleanliness and lubrication of linkages.	•		•		•		•		•		•		•		•
Check parking brake lever travel and adjust, if necessary.	•	•	•	•	•	•	•	•	•	•	•	•	•	•	•
Visually check the condition and wear of the front and rear brakes.	•	•	•	•	•	•	•	•	•	•	•	•	•	•	•
Visually inspect condition of evaporation control system.			•			•			•			•			•

Mileage or time passed (whichever comes first)	10,000	20,000	30,000	40,000	50,000	60,000	70,000	80,000	90,000	100,000	110,000	120,000	130,000	140,000	150,000
Or Years:	1	2	3	4	5	6	7	8	9	10	11	12	13	14	15
Or Kilometers:	16,000	32,000	48,000	64,000	80,000	96,000	112,000	128,000	144,000	160,000	176,000	192,000	208,000	224,000	240,000
Visual inspect the condition and tensioning of the accessory drive belt.				•				•				•			
Replace the accessory drive belt. ****								•							
Inspect and replace PCV valve if necessary.										•					
Change engine oil and replace oil filter.*	In accordance with Oil Change Indicator System OR Severe Duty Mileage, whichever occurs first.														
Replace spark plugs (1.4L Turbo engine).**			•			•			•			•			•

\*\*\*\*Replace belt every 40,000 miles (60,000 km) for use on dusty roads.

\*The oil and oil filter replacement must be carried out when indicated by a warning light or message on the instrument panel, or in any case should not exceed one year.

\*\*The spark plug change is distance based only, yearly intervals do not apply. The following are essential to ensure correct operation and prevent serious damage to the engine:

- Only use spark plugs of the same make and type which are specially certified for such engines (refer to “Engine” in “Technical Specifications” for further information).
- Strictly comply with the spark plug replacement interval given in the scheduled servicing plan for spark plug replacement.
- Contact your authorized dealer if you have any questions.



Mileage or time passed (whichever comes first)	10,000	20,000	30,000	40,000	50,000	60,000	70,000	80,000	90,000	100,000	110,000	120,000	130,000	140,000	150,000
Or Years:	1	2	3	4	5	6	7	8	9	10	11	12	13	14	15
Or Kilometers:	16,000	32,000	48,000	64,000	80,000	96,000	112,000	128,000	144,000	160,000	176,000	192,000	208,000	224,000	240,000
Replace engine air filter.#			•			•			•			•			•
Replace Cabin Air Filter – If Equipped. ***		•		•		•		•		•		•		•	
Flush and replace the engine coolant at 10 years or 150,000 miles (240,000 km) whichever comes first.										•					•
Replace the timing belt (1.4L Turbo Engine).															•

#The engine air cleaner should be inspected at every oil change if used in dusty areas.

\*\*\*Replace every 20,000 miles (32,000 km) or two years. Replacement every 10,000 miles (16,000 km) or one year in dusty conditions or as optional/suggested replacement.



**Warning!**

- You can be badly injured working on or around a motor vehicle. Do only service work for which you have the knowledge and the right equipment. If you have any doubt about your ability to perform a service job, take your vehicle to a competent mechanic.
- Failure to properly inspect and maintain your vehicle could result in a component malfunction and effect vehicle handling and performance. This could cause an accident.

# ENGINE COMPARTMENT

## Checking Levels



07030300-121-003

- 1 — Window Washer Reservoir
- 2 — Engine Oil Dipstick
- 3 — Engine Oil Cap

- 4 — Engine Coolant Reservoir
- 5 — Brake/Clutch Fluid Reservoir
- 6 — Battery



## Engine Oil



### Warning!

- Be very careful when working in the engine compartment when the engine is hot: you may get burned.
- Do not get too close to the radiator cooling fan: the electric fan may start; danger of injury.
- Loose clothing might be pulled by moving parts.

### Recommended Oil

Refer to “Fluids And Lubricants” in “Technical Specifications” for further information.

### Inspecting engine oil level

Proceed as follows:

1. Be sure the vehicle is on a level surface.
2. Warm up the engine to normal operating temperature.
3. Turn it off and wait at least five minutes for the oil to return to the sump.
4. Pull out the dipstick, wipe it clean, and reinsert it fully.

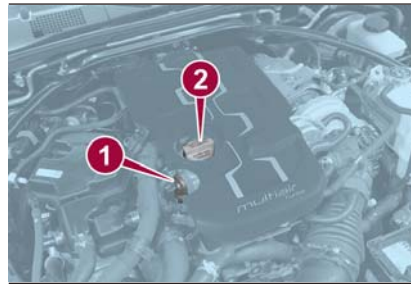

07030403-121-001

### Engine Compartment

- 1 — Engine Oil Dipstick
- 2 — Engine Oil Cap

5. Pull the dipstick out again and examine the level. The level is normal if it is between Low and Full. If it is near or below Low, open the engine oil cap/filler 2 and add enough oil to bring the level to Full.

**Note:** Do not overfill the engine oil. This may cause engine damage.

6. Make sure the O-ring on the dipstick is positioned properly before reinserting the dipstick.
7. Reinsert the dipstick fully.

### Engine oil consumption

During the initial period of use the engine oil consumption conditions should stabilize after the first 3000 – 3500 miles (5000 – 6000 km).

## Engine Coolant



### Warning!

- Turn vehicle off and disconnect the fan motor lead before working near the radiator cooling fan.
- You or others can be badly burned by hot engine coolant (antifreeze) or steam from your radiator. If you see or hear steam coming from under the hood, do not open the hood until the radiator has had time to cool. Never open a cooling system pressure cap when the radiator or coolant bottle is hot.
- Keep hands, tools, clothing, and jewelry away from the radiator cooling fan when the hood is raised. The fan starts automatically and may start at any time, whether the engine is running or not.
- When working near the radiator cooling fan, disconnect the fan motor lead or turn the ignition to the OFF mode. The fan is temperature controlled and can start at any time the ignition is in the ON mode.
- You or others can be badly burned by hot engine coolant (antifreeze) or steam from your radiator. If you see or hear steam coming from under the hood, do not open the hood until the radiator has had time to cool. Never try to open a cooling system pressure cap when the radiator is hot.

## Inspecting Coolant Level

**Note:** Changing the coolant should be done by your authorized dealer.

Inspect the antifreeze protection and coolant level in the coolant reservoir at least once a year, at the beginning of the winter season, and before traveling where temperatures may drop below freezing.

Inspect the condition and connections of all cooling system and heater hoses. Replace any that are worn or deteriorated.



07030501-121-001

### Coolant Reservoir

If it is at or near L (Low), add coolant by mixing a minimum solution of 50% Mopar Long Life Coolant Concentrate for FIAT Spider. Use higher concentrations (not to exceed 70%) if temperatures below  $-34^{\circ}\text{F}$  ( $-37^{\circ}\text{C}$ ) are anticipated. Bring the level to F (Full). Please contact your authorized dealer for assistance.

Securely tighten the coolant reservoir tank cap after adding coolant.

If the coolant reservoir is empty or new coolant is required frequently, contact your authorized dealer.

## Brake/Clutch Fluid

### Inspecting Brake/Clutch Fluid Level

- The brakes and clutch draw fluid from the same reservoir.
- Inspect the fluid level in the reservoir regularly.

It should be kept between the MAX and MIN lines.

The level normally drops with accumulated use, a condition associated with wear of brake and clutch linings. If it is excessively low, have the brake/clutch system inspected. Contact your authorized dealer.



07030601-121-002

### Brake Fluid Reservoir



#### Warning!

Use only manufacturer's recommended brake fluid. Refer to "Fluids And Lubricants" in "Technical Specifications" for further information. Using the wrong type of brake fluid can severely damage your brake system and/or impair its performance. The proper type of brake fluid for your vehicle is also identified on the original factory installed hydraulic master cylinder reservoir.



#### Warning!

Do not open hot engine cooling system. Never add engine coolant (antifreeze) when the engine is overheated. Do not loosen or remove the cap to cool an overheated engine. Heat causes pressure to build up in the cooling system. To prevent scalding or injury, do not remove the pressure cap while the system is hot or under pressure.

Do not use a pressure cap other than the one specified for your vehicle. Personal injury or engine damage may result.

The coolant should be at full in the radiator and between the F (Full) and L (Low) marks on the coolant reservoir when the engine is cool.



To avoid contamination from foreign matter or moisture, use only new brake fluid or fluid that has been in a tightly closed container. Keep the master cylinder reservoir cap secured at all times. Brake fluid in an open container absorbs moisture from the air resulting in a lower boiling point. This may cause it to boil unexpectedly during hard or prolonged braking, resulting in sudden brake failure. This could result in a collision.

Overfilling the brake fluid reservoir can result in spilling brake fluid on hot engine parts, causing the brake fluid to catch fire. Brake fluid can also damage painted and vinyl surfaces, care should be taken to avoid its contact with these surfaces.

Do not allow petroleum based fluid to contaminate the brake fluid. Brake seal components could be damaged, causing partial or complete brake failure. This could result in a collision.

## Windshield And Headlight Washer Fluid

### Inspecting Washer Fluid Level

Inspect fluid level in the washer fluid reservoir, open the cap and add fluid if necessary.



07030901-121-001

### Windshield Washer Fluid Reservoir

Use plain water if washer fluid is unavailable. But use only washer fluid in cold weather to prevent it from freezing.

### Automatic Transmission Control Unit

The transmission oil level should only be checked at your authorized dealer.

### Battery Maintenance

To get the best service from a battery:

- Keep it securely mounted.
- Keep the top clean and dry.
- Keep terminals and connections clean, tight, and coated with petroleum jelly or terminal grease.
- Rinse off spilled electrolyte immediately with a solution of water and baking soda.

If the vehicle will not be used for an extended time, disconnect the battery leads and charge the battery every six weeks.

### Battery Replacement

Contact your authorized dealer to purchase a replacement battery.



### Warning!

Battery fluid is a corrosive acid solution and can burn or even blind you. Do not allow battery fluid to contact your eyes, skin, or clothing. Do not lean over a battery when attaching clamps. If acid splashes in eyes or on skin, flush the area immediately with large amounts of water. Refer to "Jump-Starting Procedure" in "In Case Of Emergency" for further information.

Battery gas is flammable and explosive. Keep flame or sparks away from the battery. Do not use a booster battery or any other booster source with an output greater than 12 Volts. Do not allow cable clamps to touch each other.

Battery posts, terminals, and related accessories contain lead and lead compounds. Wash hands after handling.



## BATTERY RECHARGING

### BATTERY CHARGING PROCEDURE



#### Warning!

❑ Battery fluid is a corrosive acid solution and can burn or even blind you. Do not allow battery fluid to contact your eyes, skin, or clothing. Do not lean over a battery when attaching clamps. If acid splashes in eyes or on skin, flush the area immediately with large amounts of water. Refer to “Jump-Starting Procedure” in “In Case Of Emergency” for further information.

❑ Battery gas is flammable and explosive. Keep flame or sparks away from the battery. Do not use a booster battery or any other booster source with an output greater than 12 Volts. Do not allow cable clamps to touch each other.

❑ Battery posts, terminals, and related accessories contain lead and lead compounds. Wash hands after handling.



#### Caution!

❑ It is essential when replacing the cables on the battery that the positive cable is attached to the positive post and the negative cable is attached to the negative post. Battery posts are marked positive (+) and negative (-) and are identified on the battery case. Cable clamps should be tight on the terminal posts and free of corrosion.

❑ If a “fast charger” is used while the battery is in the vehicle, disconnect both vehicle battery cables before connecting the charger to the battery. Do not use a “fast charger” to provide starting voltage.

Charge battery as follows:

❑ Before recharging the battery, turn off all accessories and turn the engine off by placing the ignition in the OFF mode.

❑ Disconnect the negative battery cable.

❑ Connect the charger cables to the battery terminals, observing the polarity (+,-).

❑ Turn on the charger.

❑ When finished, turn the charger off before disconnecting the battery.

❑ Reconnect the negative battery terminal.

## MAINTENANCE PROCEDURES

The following pages contain instructions on the required maintenance from the technical personnel who designed the vehicle.

In addition to these specific maintenance instructions specified for routine scheduled servicing, there are other components which may require periodic maintenance or replacement over the vehicle's life cycle.

### Body Lubrication

Ensure that the locks and bodywork junction points, including components such as the seat guides, door hinges (and rollers), trunk and hood are periodically lubricated with lithium based grease to ensure correct, silent operation and to protect them from rust and wear.

Thoroughly clean the components, eliminating every trace of dirt and dust. After lubricating, eliminate excess oil and grease. Also pay particular attention to the hood closing devices, to ensure correct operation.

During operations on the hood, be sure to perform with the engine cold, also remember to check, clean and lubricate the locking, release and safety devices.

Make sure the hood's secondary latch keeps the hood from opening when the primary latch is released.



Lubricate the external lock cylinders twice a year. Apply a small amount of high-quality lubricant directly into the lock cylinder. If necessary, contact your authorized dealer.

### Wiper Blades

Contamination of either the windshield or the blades with foreign matter can reduce wiper effectiveness. Common sources are insects, tree sap, and hot wax treatments used by some commercial car washes.

If the blades are not wiping properly, clean the window and blades with a good cleaner or mild detergent; then rinse thoroughly with clean water. Repeat if necessary.

When the wiper lever is in the AUTO position and the ignition is placed in the ON mode, the wipers may move automatically in the following cases:

- ❑ If the windshield above the rain sensor is touched.
- ❑ If the windshield above the rain sensor is wiped with a cloth.
- ❑ If the windshield is struck with a hand or other object.
- ❑ If the rain sensor is struck with a hand or other object from inside the vehicle.

### Note:

- ❑ Hot waxes applied by automatic car washers have been known to affect the wiper's ability to clean windows.
- ❑ To prevent damage to the wiper blades, do not use gas, paraffin, paint thinner, or other solvents on or near them.
- ❑ Be careful not to pinch hands or fingers as it may cause injury, or damage the wipers. When washing or servicing the vehicle, make sure the wiper lever is in the OFF position.

### Replacing Windshield Wiper Blades

When the wipers no longer clean well, the blades are probably worn or cracked. Replace them.

When raising both windshield wiper arms, raise the driver's side wiper arm first.

When lowering the wiper arms, slowly lower the wiper arm from the passenger's side first while supporting it with your hand. Forcefully lowering the wiper arms could damage the wiper arm and blade, and may scratch or crack the windshield.

**Note:** To prevent damage to the wiper arms and other components, do not try to sweep the wiper arm by hand.

### Blade Replacement

Proceed as follows:

1. Raise the wiper arm.
2. Open the clip and slide the blade assembly in the direction of the arrow.

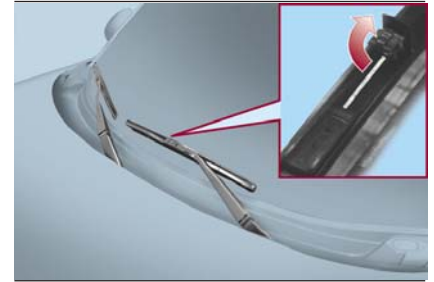

07031101-36A-001

### Clip

3. Tilt the blade assembly and remove it from the arm.

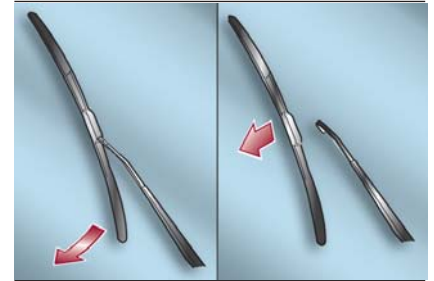

07031101-36A-002

### Blade Assembly and Arm



### Warning!

*To prevent damage to the windshield let the wiper arm down easily, do not let it slap down on the windshield.*

4. Pull down the blade rubber and slide it out of blade holder.

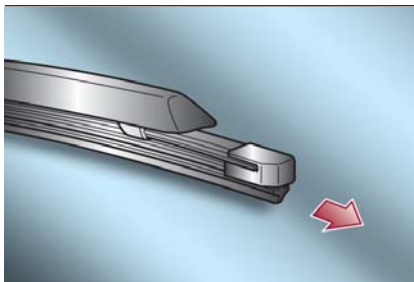

07031101-36A-003

### Blade Holder

5. Remove the metal stiffeners from each blade rubber and install them in the new blade.

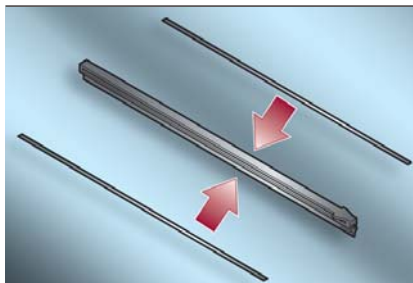

07031101-36A-004

### Metal Stiffeners

6. Carefully insert the new blade rubber. Then install the blade assembly in the reverse order of removal.

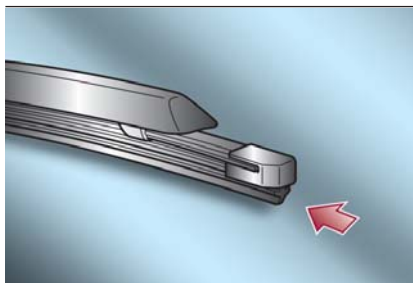

07031101-36A-005

### Reassemble Blade

## RAISING THE VEHICLE

If the vehicle needs to be raised, see an authorized dealer which is equipped with arm hoists or workshop lifts.

The vehicle's lifting points are marked on the side skirts with the ▼ symbols.



## WHEELS AND TIRES

### Tire Safety Information

Tire safety information will cover aspects of the following information: Tire Markings, Tire Identification Numbers, Tire Terminology and Definitions, Tire Pressures, and Tire Loading.

### Tire Markings

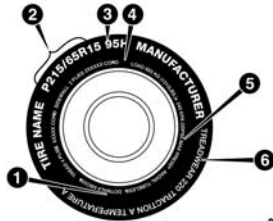

0601085395US

0601085395US

### Tire Markings

1 — U.S. DOT Safety Standards Code (TIN)	4 — Maximum Load
2 — Size Designation	5 — Maximum Pressure
3 — Service Description	6 — Treadwear, Traction and Temperature Grades

### Note:

❑ P (Passenger) — Metric tire sizing is based on U.S. design standards. P-Metric tires have the letter “P” molded into the sidewall preceding the size designation. Example: P215/65R15 95H.

❑ European — Metric tire sizing is based on European design standards. Tires designed to this standard have the tire size molded into the sidewall beginning with the section width. The letter “P” is absent from this tire size designation. Example: 215/65R15 96H.

❑ LT (Light Truck) — Metric tire sizing is based on U.S. design standards. The size designation for LT-Metric tires is the same as for P-Metric tires except for the letters “LT” that are molded into the sidewall preceding the size designation. Example: LT235/85R16.

❑ Temporary spare tires are designed for temporary emergency use only. Temporary high pressure compact spare tires have the letter “T” or “S” molded into the sidewall preceding the size designation. Example: T145/80D18 103M.

❑ High flotation tire sizing is based on U.S. design standards and it begins with the tire diameter molded into the sidewall. Example: 31x10.5 R15 LT.

## Tire Sizing Chart

### EXAMPLE:

**Example Size Designation: P215/65R15XL 95H, 215/65R15 96H, LT235/85R16C, T145/80D18 103M, 31x10.5 R15 LT**

**P** = Passenger car tire size based on U.S. design standards, or

**"...blank..."** = Passenger car tire based on European design standards, or

**LT** = Light truck tire based on U.S. design standards, or

**T or S** = Temporary spare tire or

**31** = Overall diameter in inches (in)

**215, 235, 145** = Section width in millimeters (mm)

**65, 85, 80** = Aspect ratio in percent (%)

– Ratio of section height to section width of tire, or

**10.5** = Section width in inches (in)

**R** = Construction code

– "R" means radial construction, or

– "D" means diagonal or bias construction

**15, 16, 18** = Rim diameter in inches (in)



**EXAMPLE:****Service Description:**

**95** = Load Index

– A numerical code associated with the maximum load a tire can carry

**H** = Speed Symbol

– A symbol indicating the range of speeds at which a tire can carry a load corresponding to its load index under certain operating conditions

– The maximum speed corresponding to the speed symbol should only be achieved under specified operating conditions (i.e., tire pressure, vehicle loading, road conditions, and posted speed limits)

**Load Identification:**

Absence of the following load identification symbols on the sidewall of the tire indicates a Standard Load (SL) tire:

**XL** = Extra load (or reinforced) tire, or

**LL** = Light load tire or

**C, D, E, F, G** = Load range associated with the maximum load a tire can carry at a specified pressure

**Maximum Load** – Maximum load indicates the maximum load this tire is designed to carry

**Maximum Pressure** – Maximum pressure indicates the maximum permissible cold tire inflation pressure for this tire

## Tire Identification Number (TIN)

The TIN may be found on one or both sides of the tire; however, the date code may only be on one side. Tires with white sidewalls will have the full TIN, including the date code, located on the white sidewall side of the tire. Look for the TIN on the outboard side of black sidewall tires as mounted on the vehicle. If the TIN is not found on the outboard side, then you will find it on the inboard side of the tire.

### EXAMPLE:

DOT MA L9 ABCD 0301

**DOT** = Department of Transportation

– This symbol certifies that the tire is in compliance with the U.S. Department of Transportation tire safety standards and is approved for highway use

**MA** = Code representing the tire manufacturing location (two digits)

**L9** = Code representing the tire size (two digits)

**ABCD** = Code used by the tire manufacturer (one to four digits)

**03** = Number representing the week in which the tire was manufactured (two digits)

– 03 means the 3rd week

**01** = Number representing the year in which the tire was manufactured (two digits)

– 01 means the year 2001

– Prior to July 2000, tire manufacturers were only required to have one number to represent the year in which the tire was manufactured. Example: 031 could represent the 3rd week of 1981 or 1991



## Tire Terminology And Definitions

Term	Definition
<b>B-Pillar</b>	The vehicle B-Pillar is the structural member of the body located behind the front door.
<b>Cold Tire Inflation Pressure</b>	Cold tire inflation pressure is defined as the tire pressure after the vehicle has not been driven for at least three hours, or driven less than 1 mile (1.6 km) after sitting for a minimum of three hours. Inflation pressure is measured in units of PSI (pounds per square inch) or kPa (kilopascals).
<b>Maximum Inflation Pressure</b>	The maximum inflation pressure is the maximum permissible cold tire inflation pressure for this tire. The maximum inflation pressure is molded into the sidewall.
<b>Recommended Cold Tire Inflation Pressure</b>	Vehicle manufacturer's recommended cold tire inflation pressure as shown on the tire placard.
<b>Tire Placard</b>	A label permanently attached to the vehicle describing the vehicle's loading capacity, the original equipment tire sizes and the recommended cold tire inflation pressures.

## Tire Loading And Tire Pressure

**Note:** The proper cold tire inflation pressure is listed on the driver's side B-Pillar or the rear edge of the driver's side door.

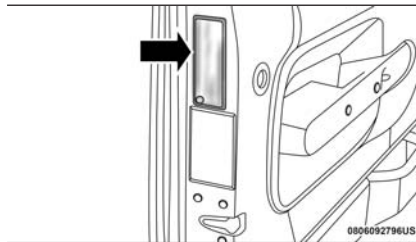

**Example Tire Placard Location  
(Door)**

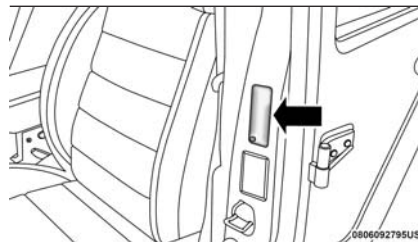

**Example Tire Placard Location  
(B-Pillar)**



## Tire And Loading Information Placard

TIRE AND LOADING INFORMATION			
SEATING CAPACITY - TOTAL 5 FRONT 2 REAR 3			
THE COMBINED WEIGHT OF OCCUPANTS AND CARGO SHOULD NEVER EXCEED XXX KG OR XXX LBS.			
TIRE	FRONT	REAR	SPARE
ORIGINAL TIRE SIZE	P195/70R14	P195/70R14	T125/70D15
COLD TIRE INFLATION PRESSURE	200kPa, 29PSI	200kPa, 29PSI	420kPa, 60PSI
SEE OWNER'S MANUAL FOR ADDITIONAL INFORMATION			
4N109208			

811b5a9a

GUID-054900418-high.tif

### Tire And Loading Information Placard

This placard tells you important information about the:

1. Number of people that can be carried in the vehicle.
2. Total weight your vehicle can carry.
3. Tire size designed for your vehicle.
4. Cold tire inflation pressures for the front, rear, and spare tires.

## Loading

The vehicle maximum load on the tire must not exceed the load carrying capacity of the tire on your vehicle. You will not exceed the tire's load carrying capacity if you adhere to the loading conditions, tire size, and cold tire inflation pressures specified on the Tire and Loading Information placard in "Vehicle Loading" in the "Starting And Operating" section of this manual.

**Note:** Under a maximum loaded vehicle condition, gross axle weight ratings (GAWRs) for the front and rear axles must not be exceeded.

For further information on GAWRs, vehicle loading, and trailer towing, refer to "Vehicle Loading" in the "Starting And Operating" section of this manual.

To determine the maximum loading conditions of your vehicle, locate the statement "The combined weight of occupants and cargo should never exceed XXX kg or XXX lbs" on the Tire and Loading Information placard. The combined weight of occupants, cargo/luggage and trailer tongue weight (if applicable) should never exceed the weight referenced here.

## Steps For Determining Correct Load Limit—

- (1) Locate the statement "The combined weight of occupants and cargo should never exceed XXX kg or XXX lbs." on your vehicle's placard.
- (2) Determine the combined weight of the driver and passengers that will be riding in your vehicle.
- (3) Subtract the combined weight of the driver and passengers from XXX kg or XXX lbs.
- (4) The resulting figure equals the available amount of cargo and luggage load capacity. For example, if "XXX" amount equals 1400 lbs. and there will be five 150 lb passengers in your vehicle, the amount of available cargo and luggage load capacity is 650 lbs.  $(1400-750 (5 \times 150) = 650 \text{ lbs.})$



(5) Determine the combined weight of luggage and cargo being loaded on the vehicle. That weight may not safely exceed the available cargo and luggage load capacity calculated in Step 4.

(6) If your vehicle will be towing a trailer, load from your trailer will be transferred to your vehicle. Consult this manual to determine how this reduces the available cargo and luggage load capacity of your vehicle.

**Metric Example For Load Limit**

For example, if “XXX” amount equals 635 kg and there will be five 68 kg passengers in your vehicle, the amount

of available cargo and luggage load capacity is 295 kg (635-340 (5x68) = 295 kg) as shown in step 4.

**Note:**

❑ If your vehicle will be towing a trailer, load from your trailer will be transferred to your vehicle. The following table shows examples on how to calculate total load, cargo/luggage, and towing capacities of your vehicle with varying seating configurations and number and size of occupants. This table is for illustration purposes only and may not be accurate for the seating and load carry capacity of your vehicle.

❑ For the following example, the combined weight of occupants and cargo should never exceed 865 lbs (392 kg).

Occupants			Combined weight of occupants and cargo from Tire Placard	MINUS	Combined Occupant's weight	=	AVAILABLE Cargo/Luggage and Trailer Tongue Weight
TOTAL	FRONT	REAR					
<b>EXAMPLE 1</b>			865 lbs	minus	670 lbs	=	195 lbs
5	2	3					
<b>EXAMPLE 2</b>			865 lbs	minus	540 lbs	=	325 lbs
3	2	1					
<b>EXAMPLE 3</b>			865 lbs	minus	400 lbs	=	465 lbs
2	2	0					

EXAMPLE

Occupant 1: 200 lbs  
 Occupant 2: 130 lbs  
 Occupant 3: 160 lbs  
 Occupant 4: 100 lbs  
 Occupant 5: 80 lbs  
 TOTAL WEIGHT: 670 lbs

Occupant 1: 210 lbs  
 Occupant 2: 180 lbs  
 Occupant 3: 150 lbs  
 TOTAL WEIGHT: 540 lbs

Occupant 1: 200 lbs  
 Occupant 2: 200 lbs  
 TOTAL WEIGHT: 400 lbs

811a4d11

GUID-054900419-high.tif

 **Warning!**

Overloading of your tires is dangerous. Overloading can cause tire failure, affect vehicle handling, and increase your stopping distance. Use tires of the recommended load capacity for your vehicle. Never overload them.



## Tires — General Information

### Tire Pressure

Proper tire inflation pressure is essential to the safe and satisfactory operation of your vehicle. Four primary areas are affected by improper tire pressure:

- Safety and Vehicle Stability
- Economy
- Tread Wear
- Ride Comfort

### Safety



#### Warning!

- Improperly inflated tires are dangerous and can cause collisions.*
- Underinflation increases tire flexing and can result in overheating and tire failure.*
- Overinflation reduces a tire's ability to cushion shock. Objects on the road and chuckholes can cause damage that result in tire failure.*
- Overinflated or underinflated tires can affect vehicle handling and can fail suddenly, resulting in loss of vehicle control.*
- Unequal tire pressures can cause steering problems. You could lose control of your vehicle.*

- Unequal tire pressures from one side of the vehicle to the other can cause the vehicle to drift to the right or left.*
- Always drive with each tire inflated to the recommended cold tire inflation pressure.*

Both under-inflation and over-inflation affect the stability of the vehicle and can produce a feeling of sluggish response or over responsiveness in the steering.

#### Note:

- Unequal tire pressures from side to side may cause erratic and unpredictable steering response.
- Unequal tire pressure from side to side may cause the vehicle to drift left or right.

#### Fuel Economy

Underinflated tires will increase tire rolling resistance resulting in higher fuel consumption.

#### Tread Wear

Improper cold tire inflation pressures can cause abnormal wear patterns and reduced tread life, resulting in the need for earlier tire replacement.

#### Ride Comfort And Vehicle Stability

Proper tire inflation contributes to a comfortable ride. Over-inflation produces a jarring and uncomfortable ride.

## Tire Inflation Pressures

The proper cold tire inflation pressure is listed on the driver's side B-Pillar or rear edge of the driver's side door.

At least once a month:

- Check and adjust tire pressure with a good quality pocket-type pressure gauge. Do not make a visual judgement when determining proper inflation. Tires may look properly inflated even when they are under-inflated.
- Inspect tires for signs of tire wear or visible damage.



#### Caution!

*After inspecting or adjusting the tire pressure, always reinstall the valve stem cap. This will prevent moisture and dirt from entering the valve stem, which could damage the valve stem.*

Inflation pressures specified on the placard are always "cold tire inflation pressure". Cold tire inflation pressure is defined as the tire pressure after the vehicle has not been driven for at least three hours, or driven less than 1 mile (1.6 km) after sitting for a minimum of three hours. The cold tire inflation pressure must not exceed the maximum inflation pressure molded into the tire sidewall.

Check tire pressures more often if subject to a wide range of outdoor temperatures, as tire pressures vary with temperature changes.

Tire pressures change by approximately 1 psi (7 kPa) per 12°F (7°C) of air temperature change. Keep this in mind when checking tire pressure inside a garage, especially in the Winter.

Example: If garage temperature = 68°F (20°C) and the outside temperature = 32°F (0°C) then the cold tire inflation pressure should be increased by 3 psi (21 kPa), which equals 1 psi (7 kPa) for every 12°F (7°C) for this outside temperature condition.

Tire pressure may increase from 2 to 6 psi (13 to 40 kPa) during operation. DO NOT reduce this normal pressure build up or your tire pressure will be too low.

## Tire Pressures For High Speed Operation

The manufacturer advocates driving at safe speeds and within posted speed limits. Where speed limits or conditions are such that the vehicle can be driven at high speeds, maintaining correct tire inflation pressure is very important. Increased tire pressure and reduced vehicle loading may be required for high-speed vehicle operation. Refer to your authorized tire dealer or original equipment vehicle dealer for

recommended safe operating speeds, loading and cold tire inflation pressures.



### Warning!

*High speed driving with your vehicle under maximum load is dangerous. The added strain on your tires could cause them to fail. You could have a serious collision. Do not drive a vehicle loaded to the maximum capacity at continuous speeds above 75 mph (120 km/h).*

## Radial Ply Tires



### Warning!

*Combining radial ply tires with other types of tires on your vehicle will cause your vehicle to handle poorly. The instability could cause a collision. Always use radial ply tires in sets of four. Never combine them with other types of tires.*

## Tire Repair

If your tire becomes damaged, it may be repaired if it meets the following criteria:

- The tire has not been driven on when flat.
- The damage is only on the tread section of your tire (sidewall damage is not repairable).

The puncture is no greater than a ¼ of an inch (6 mm).

Consult an authorized tire dealer for tire repairs and additional information.

Damaged Run Flat tires, or Run Flat tires that have experienced a loss of pressure should be replaced immediately with another Run Flat tire of identical size and service description (Load Index and Speed Symbol).

## Run Flat Tires — If Equipped

Run Flat tires allow you the capability to drive 50 miles (80 km) at 50 mph (80 km/h) after a rapid loss of inflation pressure. This rapid loss of inflation is referred to as the Run Flat mode. A Run Flat mode occurs when the tire inflation pressure is of/or below 14 psi (96 kPa). Once a Run Flat tire reaches the run flat mode it has limited driving capabilities and needs to be replaced immediately. A Run Flat tire is not repairable.

It is not recommended driving a vehicle loaded at full capacity or to tow a trailer while a tire is in the run flat mode.

See the tire pressure monitoring section for more information.

## Tire Spinning

When stuck in mud, sand, snow, or ice conditions, do not spin your vehicle's wheels above 30 mph (48 km/h) or for longer than 30 seconds continuously without stopping.



**Warning!**

*Fast spinning tires can be dangerous. Forces generated by excessive wheel speeds may cause tire damage or failure. A tire could explode and injure someone. Do not spin your vehicle's wheels faster than 30 mph (48 km/h) for more than 30 seconds continuously when you are stuck, and do not let anyone near a spinning wheel, no matter what the speed.*

**Tread Wear Indicators**

Tread wear indicators are in the original equipment tires to help you in determining when your tires should be replaced.

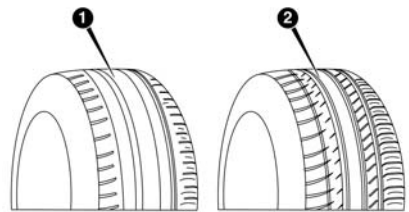
**Tire Tread**

- 1 — Worn Tire  
2 — New Tire

These indicators are molded into the bottom of the tread grooves. They will appear as bands when the tread depth

becomes a 1/16 of an inch (1.6 mm). When the tread is worn to the tread wear indicators, the tire should be replaced. Refer to “Replacement Tires” in this section for further information.

**Life Of Tire**

The service life of a tire is dependent upon varying factors including, but not limited to:

- Driving style.
- Tire pressure - Improper cold tire inflation pressures can cause uneven wear patterns to develop across the tire tread. These abnormal wear patterns will reduce tread life, resulting in the need for earlier tire replacement.
- Distance driven.
- Performance tires, tires with a speed rating of V or higher, and Summer tires typically have a reduced tread life. Rotation of these tires per the vehicle maintenance schedule is highly recommended.

**Warning!**

*Tires and the spare tire should be replaced after six years, regardless of the remaining tread. Failure to follow this warning can result in sudden tire failure. You could lose control and have a collision resulting in serious injury or death.*

Keep dismantled tires in a cool, dry place with as little exposure to light as possible. Protect tires from contact with oil, grease, and gasoline.

**Replacement Tires**

The tires on your new vehicle provide a balance of many characteristics. They should be inspected regularly for wear and correct cold tire inflation pressures. The manufacturer strongly recommends that you use tires equivalent to the originals in size, quality and performance when replacement is needed. Refer to the paragraph on “Tread Wear Indicators” in this section. Refer to the Tire and Loading Information placard or the Vehicle Certification Label for the size designation of your tire. The Load Index and Speed Symbol for your tire will be found on the original equipment tire sidewall.

See the Tire Sizing Chart example found in the “Tire Safety Information” section of this manual for more information relating to the Load Index and Speed Symbol of a tire.

It is recommended to replace the two front tires or two rear tires as a pair. Replacing just one tire can seriously affect your vehicle's handling. If you ever replace a wheel, make sure that the wheel's specifications match those of the original wheels.

It is recommended you contact your authorized tire dealer or original equipment dealer with any questions you may have on tire specifications or capability. Failure to use equivalent replacement tires may adversely affect the safety, handling, and ride of your vehicle.



### Warning!

Do not use a tire, wheel size, load rating, or speed rating other than that specified for your vehicle. Some combinations of unapproved tires and wheels may change suspension dimensions and performance characteristics, resulting in changes to steering, handling, and braking of your vehicle. This can cause unpredictable handling and stress to steering and suspension components. You could lose control and have a collision resulting in serious injury or death. Use only the tire and wheel sizes with load ratings approved for your vehicle.

Never use a tire with a smaller load index or capacity, other than what was originally equipped on your vehicle. Using a tire with a smaller load index could result in tire overloading and failure. You could lose control and have a collision.

Failure to equip your vehicle with tires having adequate speed capability can result in sudden tire failure and loss of vehicle control.



### Caution!

*Replacing original tires with tires of a different size may result in false speedometer and odometer readings.*

## Tire Types

### All Season Tires – If Equipped

All Season tires provide traction for all seasons (Spring, Summer, Fall, and Winter). Traction levels may vary between different all season tires. All season tires can be identified by the M+S, M&S, M/S or MS designation on the tire sidewall. Use all season tires only in sets of four; failure to do so may adversely affect the safety and handling of your vehicle.

### Summer Or Three Season Tires – If Equipped

Summer tires provide traction in both wet and dry conditions, and are not intended to be driven in snow or on ice. If your vehicle is equipped with Summer tires, be aware these tires are not designed for Winter or cold driving conditions. Install Winter tires on your vehicle when ambient temperatures are less than 40°F (5°C) or if roads are covered with ice or snow. For more information, contact an authorized dealer.

Summer tires do not contain the all season designation or mountain/snowflake symbol on the tire sidewall. Use Summer tires only in sets of four; failure to do so may adversely affect the safety and handling of your vehicle.



### Warning!

*Do not use Summer tires in snow/ice conditions. You could lose vehicle control, resulting in severe injury or death. Driving too fast for conditions also creates the possibility of loss of vehicle control.*

## Snow Tires

Some areas of the country require the use of snow tires during the Winter. Snow tires can be identified by a “mountain/snowflake” symbol on the



If you need snow tires, select tires equivalent in size and type to the original equipment tires. Use snow tires only in sets of four;

failure to do so may adversely affect the safety and handling of your vehicle.

Snow tires generally have lower speed ratings than what was originally equipped with your vehicle and should not be operated at sustained speeds over 75 mph (120 km/h). For speeds above 75 mph (120 km/h) refer to



original equipment or an authorized tire dealer for recommended safe operating speeds, loading and cold tire inflation pressures.

While studded tires improve performance on ice, skid and traction capability on wet or dry surfaces may be poorer than that of non-studded tires. Some states prohibit studded tires; therefore, local laws should be checked before using these tire types.

### Spare Tires — If Equipped

**Note:** For vehicles equipped with Tire Service Kit instead of a spare tire, please refer to “Tire Service Kit” in “In Case Of Emergency” for further information.



#### Caution!

*Because of the reduced ground clearance, do not take your vehicle through an automatic car wash with a compact or limited use temporary spare installed. Damage to the vehicle may result.*

### Spare Tire Matching Original Equipped Tire And Wheel — If Equipped

Your vehicle may be equipped with a spare tire and wheel equivalent in look and function to the original equipment tire and wheel found on the front or rear

axle of your vehicle. This spare tire may be used in the tire rotation for your vehicle. If your vehicle has this option, refer to an authorized tire dealer for the recommended tire rotation pattern.

### Compact Spare Tire — If Equipped

The compact spare is for temporary emergency use only. You can identify if your vehicle is equipped with a compact spare by looking at the spare tire description on the Tire and Loading Information Placard located on the driver’s side door opening or on the sidewall of the tire. Compact spare tire descriptions begin with the letter “T” or “S” preceding the size designation. Example: T145/80D18 103M.

T, S = Temporary Spare Tire

Since this tire has limited tread life, the original equipment tire should be repaired (or replaced) and reinstalled on your vehicle at the first opportunity.

Do not install a wheel cover or attempt to mount a conventional tire on the compact spare wheel, since the wheel is designed specifically for the compact spare tire. Do not install more than one compact spare tire and wheel on the vehicle at any given time.



#### Warning!

*Compact and collapsible spares are for temporary emergency use only. With these spares, do not drive more than 50 mph (80 km/h). Temporary use spares have limited tread life. When the tread is worn to the tread wear indicators, the temporary use spare tire needs to be replaced. Be sure to follow the warnings, which apply to your spare. Failure to do so could result in spare tire failure and loss of vehicle control.*

### Collapsible Spare Tire — If Equipped

The collapsible spare is for temporary emergency use only. You can identify if your vehicle is equipped with a collapsible spare by looking at the spare tire description on the Tire and Loading Information Placard located on the driver’s side door opening or on the sidewall of the tire.

Collapsible spare tire description example: 165/80-17 101P.

Since this tire has limited tread life, the original equipment tire should be repaired (or replaced) and reinstalled on your vehicle at the first opportunity.

Inflate collapsible tire only after the wheel is properly installed to the vehicle. Inflate the collapsible tire using the electric air pump before lowering the vehicle.



Do not install a wheel cover or attempt to mount a conventional tire on the collapsible spare wheel, since the wheel is designed specifically for the collapsible spare tire.



### Warning!

*Compact and Collapsible spares are for temporary emergency use only. With these spares, do not drive more than 50 mph (80 km/h). Temporary use spares have limited tread life. When the tread is worn to the tread wear indicators, the temporary use spare tire needs to be replaced. Be sure to follow the warnings, which apply to your spare. Failure to do so could result in spare tire failure and loss of vehicle control.*

## Full Size Spare — If Equipped

The full size spare is for temporary emergency use only. This tire may look like the originally equipped tire on the front or rear axle of your vehicle, but it is not. This spare tire may have limited tread life. When the tread is worn to the tread wear indicators, the temporary use full size spare tire needs to be replaced. Since it is not the same as your original equipment tire, replace (or repair) the original equipment tire and reinstall on the vehicle at the first opportunity.

## Limited Use Spare — If Equipped

The limited use spare tire is for temporary emergency use only. This tire is identified by a label located on the limited use spare wheel. This label contains the driving limitations for this spare. This tire may look like the original equipped tire on the front or rear axle of your vehicle, but it is not. Installation of this limited use spare tire affects vehicle handling. Since it is not the same as your original equipment tire, replace (or repair) the original equipment tire and reinstall on the vehicle at the first opportunity.



### Warning!

*Limited use spares are for emergency use only. Installation of this limited use spare tire affects vehicle handling. With this tire, do not drive more than the speed listed on the limited use spare wheel. Keep inflated to the cold tire inflation pressures listed on your Tire and Loading Information Placard located on the driver's side B-Pillar or the rear edge of the driver's side door. Replace (or repair) the original equipment tire at the first opportunity and reinstall it on your vehicle. Failure to do so could result in loss of vehicle control.*

## Wheel And Wheel Trim Care

All wheels and wheel trim, especially aluminum and chrome plated wheels, should be cleaned regularly using mild (neutral Ph) soap and water to maintain their luster and to prevent corrosion. Wash wheels with the same soap solution recommended for the body of the vehicle.

Your wheels are susceptible to deterioration caused by salt, sodium chloride, magnesium chloride, calcium chloride, etc., and other road chemicals used to melt ice or control dust on dirt roads. Use a soft cloth or sponge and mild soap to wipe away promptly. Do not use harsh chemicals or a stiff brush. They can damage the wheel's protective coating that helps keep them from corroding and tarnishing.

**Note:** Many aftermarket wheel cleaners contain strong acids or strong alkaline additives that can harm the wheel surface.



**Caution!**

*Avoid products or automatic car washes that use acidic solutions or strong alkaline additives or harsh brushes. These products and automatic car washes may damage the wheel's protective finish. Such damage is not covered by the New Vehicle Limited Warranty. Only car wash soap, Mopar Wheel Cleaner or equivalent is recommended.*

When cleaning extremely dirty wheels including excessive brake dust, care must be taken in the selection of tire and wheel cleaning chemicals and equipment to prevent damage to the wheels. Mopar Wheel Treatment or Mopar Chrome Cleaner or their equivalent is recommended or select a non-abrasive, non-acidic cleaner for aluminum or chrome wheels. Do not use any products on Dark Vapor or Black Satin Chrome Wheels. They will permanently damage this finish and such damage is not covered by the New Vehicle Limited Warranty.

**Caution!**

*Do not use scouring pads, steel wool, a bristle brush, metal polishes or oven cleaner. These products may damage the wheel's protective finish. Such damage is not covered by the New Vehicle Limited Warranty. Only car wash soap, Mopar Wheel Cleaner or equivalent is recommended.*

**Note:** If you intend parking or storing your vehicle for an extended period after cleaning the wheels with wheel cleaner, drive your vehicle for a few minutes before doing so. Driving the vehicle and applying the brakes when stopping will reduce the risk of brake rotor corrosion.

**Dark Vapor Or Black Satin Chrome Wheels****Caution!**

*If your vehicle is equipped with Dark Vapor or Black Satin Chrome wheels DO NOT USE wheel cleaners, abrasives or polishing compounds. They will permanently damage this finish and such damage is not covered by the New Vehicle Limited Warranty. USE ONLY MILD SOAP AND WATER WITH A SOFT CLOTH. Used on a regular basis; this is all that is required to maintain this finish.*

**Snow Chains**

The use of snow chains should be in compliance with local regulations of each country. In certain countries, tires marked with code M+S (Mud and Snow) are considered as winter equipment; therefore their use is equivalent to that of the snow chains.

The snow chains may be applied only to the front wheel tires. Check the tension of the snow chains after the first few feet have been driven.

**Warning!**

*Using tires of different size and type (M+S, Snow) between front and rear axles can cause unpredictable handling. You could lose control and have a collision.*



### Caution!

To avoid damage to your vehicle or tires, observe the following precautions:

Because of restricted traction device clearance between tires and other suspension components, it is important that only traction devices in good condition are used. Broken devices can cause serious damage. Stop the vehicle immediately if noise occurs that could indicate device breakage. Remove the damaged parts of the device before further use.

Install device as tightly as possible and then retighten after driving about ½ mile (0.8 km).

Do not exceed 30 mph (48 km/h).

Drive cautiously and avoid severe turns and large bumps, especially with a loaded vehicle.

Do not drive for a prolonged period on dry pavement.

Observe the traction device manufacturer's instructions on the method of installation, operating speed, and conditions for use. Always use the suggested operating speed of the device manufacturer's if it is less than 30 mph (48 km/h).

Do not use traction devices on a compact spare tire.



### Caution!

Using snow chains with tires with non-original dimensions may damage the vehicle.

Using different size or type (M+S, snow, etc.) tires between front and rear axle may adversely affect vehicle driveability, with the risk of losing control of the vehicle and resulting accidents.

## Tire Rotation Recommendations

The front and rear tires are subject to different loads and stress due to steering, maneuver and braking. For this reason they are subject to uneven wear. To resolve this problem, tires should be rotated at the appropriate time.

The following rotation methods must NOT be used with one-way unidirectional tires! This type of tires can only be switched from the front axle to the rear axle and vice versa, keeping them on the same side of the vehicle.

Rotate one-way unidirectional tires and radial tires that have an asymmetrical tread pattern only from front to rear, not from side to side. Tire performance will be reduced if rotated from side to side.

Tire rotation means moving the wheels to a different position, with respect to the vehicle. During rotation, inspect tires for correct balance.

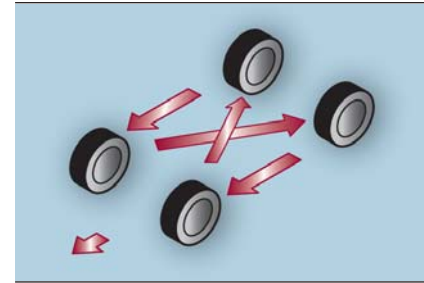

07031402-FRT-001

### Rotation Diagram

The single wheel will therefore operate on a different axle and, where possible, on the opposite side of the vehicle.

#### Note:

Rotate tires periodically. Irregular tire wear is dangerous. To equalize tread wear for maintaining good performance in handling and braking, rotate the tires every 6,200 miles (10,000 km), or sooner if irregular wear develops.

To equalize tread wear, rotate the tires every 7,500 miles (12,000 km) at the latest or sooner if irregular wear develops. FCA recommends to rotate every 5,000 miles (8,000 km) to help increase tire life and distribute wear more evenly.



❑ Because your vehicle is not equipped with a spare tire, you cannot do a tire rotation safely with the jack that may come with your vehicle if so equipped. Contact an authorized dealer for tire rotation.

Also, inspect them for uneven wear and damage. Abnormal wear is usually caused by one or a combination of the following:

- ❑ Incorrect tire pressure
- ❑ Improper wheel alignment
- ❑ Out-of-balance wheel
- ❑ Severe braking

After rotation, inflate all tire pressures to specification and inspect the wheel nuts for tightness.

### With Tire Pressure Monitor System (TPMS)

The TPM system must be initialized after adjusting the tire pressure, to make the system operate normally. Refer to “Tire Pressure Monitoring System” in “Safety” for further information.

Rotate unidirectional tires and radial tires that have an asymmetrical tread pattern only from front to rear, not from side to side. Tire performance will be reduced if rotated from side to side.

## DEPARTMENT OF TRANSPORTATION UNIFORM TIRE QUALITY GRADES

The following tire grading categories were established by the National Highway Traffic Safety Administration. The specific grade rating assigned by the tire's manufacturer in each category is shown on the sidewall of the tires on your vehicle.

All passenger vehicle tires must conform to Federal safety requirements in addition to these grades.

### Treadwear

The Treadwear grade is a comparative rating, based on the wear rate of the tire when tested under controlled conditions on a specified government test course. For example, a tire graded 150 would wear one and one-half times as well on the government course as a tire graded 100. The relative performance of tires depends upon the actual conditions of their use, however, and may depart significantly from

the norm due to variations in driving habits, service practices, and differences in road characteristics and climate.

### Traction Grades

The Traction grades, from highest to lowest, are AA, A, B, and C. These grades represent the tire's ability to stop on wet pavement, as measured under controlled conditions on specified government test surfaces of asphalt and concrete. A tire marked C may have poor traction performance.



### Warning!

*The traction grade assigned to this tire is based on straight-ahead braking traction tests, and does not include acceleration, cornering, hydroplaning, or peak traction characteristics.*

### Temperature Grades

The Temperature grades are A (the highest), B, and C, representing the tire's resistance to the generation of heat and its ability to dissipate heat,

when tested under controlled conditions on a specified indoor laboratory test wheel.

Sustained high temperature can cause the material of the tire to degenerate and reduce tire life, and excessive temperature can lead to sudden tire failure. The grade C corresponds to a level of performance, which all passenger vehicle tires must meet under the Federal Motor Vehicle Safety Standard No. 109. Grades B and A represent higher levels of performance on the laboratory test wheel, than the minimum required by law.



### Warning!

*The temperature grade for this tire is established for a tire that is properly inflated and not overloaded. Excessive speed, under-inflation, or excessive loading, either separately or in combination, can cause heat buildup and possible tire failure.*

## STORING THE VEHICLE

If the vehicle is left inactive for longer than a month, the following precautions should be observed:

- Park the vehicle in covered, dry and if possible well-ventilated premises and slightly open the windows.
- Check that the parking brake is not activated.
- Disconnect the negative battery terminal and check the battery charge. Repeat this check once every three months during storage.
- If the battery is not disconnected from the electrical system, check its state of charge every thirty days.
- Clean and protect the painted parts using protective wax.
- Clean and protect the shiny metal parts using special compounds available commercially.
- Sprinkle talcum powder on the windshield and rear window wiper rubber blades and lift them off the glass.
- Cover the vehicle with a fabric or perforated plastic sheet, paying particular care not to damage the painted surface by dragging any dust that may have accumulated on it. Do not use compact plastic sheets which

do not allow humidity to evaporate from the surface of the vehicle.

- Inflate the tires at a pressure of +7.25 psi (+0.5 bar) higher than recommended on the tire placard and check it periodically.
- Do not drain the engine cooling system.
- Any time the vehicle is left inactive for two weeks or more, operate the air conditioning system with engine idling for at least five minutes, setting external air and with fan set to maximum speed. This operation will ensure appropriate lubrication for the system, thus minimizing the possibility of damage to the compressor when the system is operated again.

**Note:** After placing the ignition in the OFF mode and having closed the driver side door, wait at least one minute before disconnecting the electrical supply from the battery. When reconnecting the electrical supply to the battery, make sure that the ignition in the OFF mode and the driver side door is closed.



## BODYWORK

### Protection From Atmospheric Agents

The vehicle is equipped with the best available technological solutions to protect the bodywork against corrosion. These include:

- ❑ Painting products and systems which give the vehicle resistance to corrosion and abrasion.
- ❑ Use of galvanized (or pre-treated) steel sheets, with high resistance to corrosion.
- ❑ Spraying of plastic parts, with a protective function in the more exposed points: underdoor, inner fender, edges, etc.
- ❑ Use of “open” boxed sections to prevent condensation and pockets of moisture which could favor the formation of rust inside.
- ❑ Use of special films to protect against abrasion in exposed areas (e.g. rear fender, doors, etc.).

### Corrosion Warranty

Your vehicle is covered by Corrosion Warranty against perforation due to rust of any original element of the structure or bodywork. For the general terms of this Corrosion Warranty, refer to the Warranty Booklet.

### Preserving The Paintwork

Touch up abrasions and scratches immediately to prevent the formation of rust.

Maintenance of paintwork consists of washing the vehicle: the frequency depends on the conditions and environment in which the vehicle is used.

For example, it is advisable to wash the vehicle more often in areas with high levels of atmospheric pollution or salted roads.

To correctly wash the vehicle, follow these instructions:

- ❑ If high pressure jets or cleaners are used to wash the vehicle, keep a distance of at least 1.3 ft (40 cm) from the bodywork to avoid damage or alteration. Build up of water could cause damage to the vehicle in the long term.
  - ❑ Wash the vehicle using a low pressure jet of water if possible.
  - ❑ Wipe a sponge with a slightly soapy solution over the bodywork, frequently rinsing the sponge.
  - ❑ Rinse well with water and dry with a jet of air or a chamois leather.
- Dry the less visible parts (e.g. door frames, hood, headlight frames, etc.) with special care, as water may stagnate more easily in these areas. Do

not wash the vehicle after it has been left in the sun or with the hood hot: this may alter the shine of the paintwork. Exterior plastic parts must be cleaned in the same way as the rest of the vehicle.

#### Note:

- ❑ Avoid parking under trees; the sap dropped by trees makes the paint work go dull and increases the possibility of corrosion.
- ❑ Bird droppings must be washed off immediately and thoroughly as the acid they contain is particularly aggressive.

### Etching caused by acid rain or industrial fallout

#### Cause:

Industrial pollutants and vehicle emissions drift into the air and mix with rain or dew to form acids. These acids can settle on a vehicle's finish. As the water evaporates, the acid becomes concentrated and can damage the finish.

The longer the acid remains on the surface, the greater the chance is for damage.

#### Prevention:

It is necessary to wash and wax your vehicle to preserve its finish according to the instructions in this section. These steps should be taken immediately after you suspect that acid rain has settled on your vehicle's finish.

## Damage caused by bird dropping/insects/tree sap

### Problem:

Bird droppings contain acids. If these are not removed they can eat away the clear and color base coat of the vehicle's paintwork.

When insects stick to the paint surface and decompose, corrosive compounds form. These can erode the clear and color base coat of the vehicle's paintwork if they are not removed.

Tree sap will harden and adhere permanently to the paint finish. If you scratch the sap off while it is hard, some vehicle paint could come off with it.

### Prevention:

It is necessary to have your vehicle washed and waxed to preserve its finish according to the instructions in this section. This should be done as soon as possible.

Bird droppings can be removed with a soft sponge and water. If you are travelling and these are not available, a moistened tissue may also take care of the problem. The cleaned area should be waxed according to the instructions in this section. Insects and tree sap are best removed with a soft sponge and water or a commercially available chemical cleaner.

Another method is to cover the affected area with dampened newspaper for one to two hours. After removing the newspaper, rinse off the loosened debris with water.

### Water marks

#### Problem:

Rain, fog, dew, and even tap water can contain harmful minerals such as salt and lime. If moisture containing these minerals settles on the vehicle and evaporates, the minerals will concentrate and harden to form white rings. The rings can damage your vehicle's finish.

#### Prevention:

It is necessary to wash and wax your vehicle to preserve its finish according to the instructions in this section. These steps should be taken immediately after you find water marks on your vehicle's finish.

### Paint chipping

#### Problem:

Paint chipping occurs when gravel thrown in the air by another vehicle's tires hits your vehicle.

#### How to avoid paint chipping:

Keeping a safe distance between you and the vehicle ahead reduces the chances of having your paint chipped by flying gravel.

### Note:

❑ The paint chipping zone varies with the speed of the vehicle. For example, when travelling at 55 mph (90 km/h), the paint chipping zone is 164 ft (50 m).

❑ In low temperatures, a vehicle's finish hardens. This increases the chance of paint chipping.

❑ Chipped paint can lead to rust forming on your vehicle. Before this happens, repair the damage by using FCA touch-up paint according to the instructions in this section. Failure to repair the affected area could lead to serious rusting and expensive repairs.

Follow all label and container directions when using a chemical cleaner or polish. Read all warnings and cautions.

## Maintaining The Finish

### Washing

To help protect the finish from rust and deterioration, wash your vehicle thoroughly and frequently, at least once a month, with lukewarm or cold water. If the vehicle is washed improperly, the paint surface could be scratched. Here are some examples of how scratching could occur:

❑ The vehicle is washed without first rinsing off dirt and other foreign matter.





- ❑ The vehicle is washed with a rough, dry, or dirty cloth.
- ❑ The vehicle is washed at a car wash that uses brushes that are dirty or too stiff.
- ❑ Cleansers or wax containing abrasives are used.

**Note:** FCA is not responsible for scratches caused by automatic car washes or improper washing. Scratches are more noticeable on vehicles with darker paint finishes. When the wiper lever is in the AUTO position and the ignition is placed in the ON mode, the wipers may move automatically in the following cases:

- ❑ If the windshield above the rain sensor is touched or wiped with a cloth.
- ❑ If the windshield is struck with a hand or other object from either outside or inside the vehicle.

**Note:**

- ❑ Keep hands and scrapers clear of the windshield when the wiper lever is in the AUTO position and the ignition is placed in the ON mode as fingers could be pinched or the wipers and wiper blades damaged when the wipers activate automatically. If you are going to clean the windshield, be sure the wipers are turned off completely (when it is most likely that the engine is left running) this is particularly important when clearing ice and snow.

- ❑ Do not spray water in the engine compartment. Otherwise, it could result in engine-starting problems or damage to electrical parts.

- ❑ When washing and waxing the vehicle, be careful not to apply excessive force to any single area of the vehicle hood. Otherwise, you could dent the vehicle.

- ❑ Do not use automatic car washing machines and car washing devices using high water pressure.

- ❑ Make sure that the fuel door is closed and lock the doors. Otherwise, the fuel door may be forcefully opened by water pressure causing damage to the vehicle or fuel door.

To minimize scratches on the vehicle's paint finish:

- ❑ Rinse off any dirt or other foreign matter using lukewarm or cold water before washing.

- ❑ Use plenty of lukewarm or cold water and a soft cloth when washing the vehicle. Do not use a nylon cloth.

- ❑ Rub gently when washing or drying the vehicle.

- ❑ Take your vehicle only to a car wash that keeps its brushes well maintained.

- ❑ Do not use abrasive cleansers or wax that contain abrasives.



**Caution!**

*Do not use steel wool, abrasive cleaners, or strong detergents containing highly alkaline or caustic agents on chrome plated or anodized aluminium parts. This may damage the protective coating; also, cleaners and detergents may discolor or deteriorate the paint.*

Pay special attention to removing salt, dirt, mud, and other foreign material from the underside of the fenders, and make sure the drain holes in the lower edges of the doors and rocker panels are clean.

Insects, tar, tree sap, bird droppings, industrial fallout, and similar deposits can damage the finish if not removed immediately. When prompt washing with plain water is ineffective, use a mild soap made for use on vehicles.

Thoroughly rinse off all soap with lukewarm or cold water. Do not allow soap to dry on the finish.

After washing the vehicle, dry it with a clean chamois to prevent water spots from forming.

**Waxing**

Your vehicle needs to be waxed when water no longer beads on the finish.

Always wash and dry the vehicle before waxing it. In addition to the vehicle



body, wax the metal trim to maintain its lustre:

- ❑ Use wax which contains no abrasives. Waxes containing abrasive will remove paint and could damage bright metal parts.
- ❑ Use a good grade of natural wax for metallic, mica, and solid colors.
- ❑ When waxing, coat evenly with the sponge supplied or a soft cloth.
- ❑ Wipe off the wax with a soft cloth.

**Note:** A spot remover to remove oil, tar, and similar materials will usually also take off the wax. Rewax these areas even if the rest of the vehicle does not need it.

## Repairing Damage To The Finish

Deep scratches or chips on the finish should be repaired promptly. Exposed metal quickly rusts and can lead to major repairs.

**Note:** If your vehicle is damaged and needs metal parts repaired or replaced, make sure the body shop applies corrosion prevention materials to all parts, both repaired and new. This will prevent them from rusting.

## Bright-Metal Maintenance

Use tar remover to remove road tar and insects. Never do this with a knife or similar tool.

To prevent corrosion on bright-metal surfaces, apply wax or chrome preservative and rub it to a high lustre. During cold weather or in coastal areas, cover bright-metal parts with a coating of wax or preservative heavier than usual. It would also help to coat them with noncorrosive petroleum jelly or some other protective compound.



### Caution!

*Do not use steel wool, abrasive cleaners, or strong detergents containing highly alkaline or caustic agents on chrome plated or anodized aluminium parts. This may result in damage to the protective coating and cause discoloration or paint deterioration.*

## Underbody Maintenance

Road chemicals and salt used for ice and snow removal and solvents used for dust control may collect on the underbody. If not removed, they will speed up rusting and deterioration of such underbody parts as fuel lines, frame, floor pan, and exhaust system, even though these parts may be coated with anti-corrosive material.

Thoroughly flush the underbody and wheel housings with lukewarm or cold water at the end of each winter. Try also to do this every month.

Pay special attention to these areas because they easily hide mud and dirt.

It will do more harm than good to wet down the road grime without removing it.

The lower edges of doors, rocker panels, and frame members have drain holes that should not be clogged. Water trapped there will cause rusting.

## Aluminium Wheel Maintenance

A protective coating is provided over the aluminium wheels. Special care is needed to protect this coating.

**Note:** Do not use any detergent other than mild detergent. Before using any detergent, verify the ingredients. Otherwise, the product could discolor or stain the aluminium wheels.



### Caution!

*Do not use a wire brush or any abrasive cleaner, polishing compound, or solvent on aluminium wheels. They may damage the coating.*

**Note:** Always use a sponge or soft cloth to clean the wheels. Rinse the wheels thoroughly with lukewarm or cold water. Also, be sure to clean the wheels after driving on dusty or salted roads to help prevent corrosion.



## Convertible Top Maintenance

The convertible top is made of a special high-grade material, but if it's not taken good care of, hardening, staining, and loss of lustre will result. Maintain it under these guidelines.

### Washing

Do not wait until the convertible top gets really dirty before cleaning it. Dirt that's there too long will cause deterioration.

- ❑ Before washing, remove dust and coarse particulate with a soft brush.
- ❑ Gently clean the convertible top with a synthetic neutral detergent, lots of water, and a soft brush.
- ❑ Rinse it thoroughly with clean water to remove all the soap.
- ❑ Wipe it as dry as you can before the water dries on it.
- ❑ Then allow it to dry completely before lowering it.



### Caution!

- ❑ *Automatic and high-pressure car washes are harmful to a convertible top. Avoid them.*
- ❑ *Do not spray water directly on the area where the window glass and the convertible top meet. This would probably cause water to enter the interior.*
- ❑ *Do not spray water directly on the seam area of the body and the convertible top as it could result in water penetrating the interior.*
- ❑ *Do not wipe the convertible top using alcohol, chlorine bleach, or organic solvents such as thinner, benzene, or gasoline. Otherwise, they may cause discoloration or stains.*
- ❑ *Too much treatment on the convertible top can be as damaging as too little. Follow the manufacturer's directions. Do not over do it!*

### Note:

- ❑ Some leather treatment products can ruin the convertible top's gloss. Be careful of the one you choose.
- ❑ Test on an inconspicuous, small corner of the convertible top if you are not sure.

- ❑ Do not get any car wax on the convertible top.
- ❑ If you do, remove it with a good leather cleaner or mild detergent (about 5% solution).
- ❑ Let the convertible top dry completely before lowering after applying treatment or dressing.

### Drain Filter Cleaning

If leaves or other matter block the drain filter, water may enter the vehicle. Clean the drain filter at least once a year.

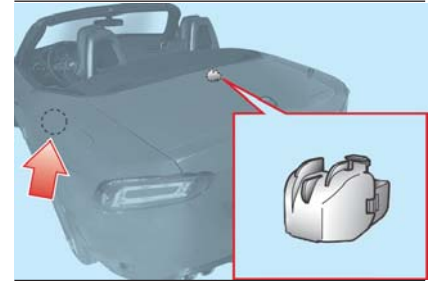

07040110-122-001AB

### Drain Filter

Proceed as follows:

1. Check the position of the drain filter with your hand from behind the bow.

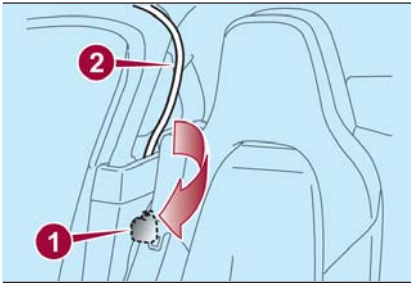

07040110123001

### Drain Filter Location

- 1 — Drain Filter
- 2 — Bow

2. Remove the drain filter while pressing the tab.

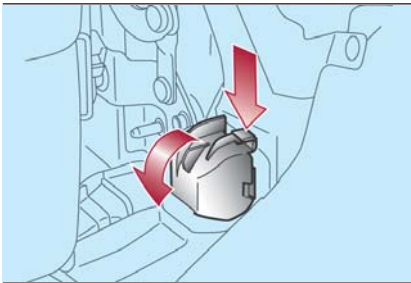

07040110124001

### Drain Filter Tab

3. Remove leaves and other matter accumulated in the drain filter.
4. Reinstall the drain filter in the reverse order of the removal procedure.

**Note:** Make sure that the drain filter is securely attached to its designated position by pushing it until the tab locks. Water may enter the vehicle if the drain filter is not secured to its designated position. For this operation go to an authorized dealer.

### Plastic Part Maintenance

When cleaning the plastic lenses of the lights, do not use gasoline, paraffin, rectified spirit, paint, thinner, highly acidic detergents, or strongly alkaline detergents.

Otherwise, these chemical agents can discolor or damage the surfaces resulting in a significant loss in functionality. If plastic parts become inadvertently exposed to any of these chemical agents, flush with water immediately.

If plastic parts such as the bumpers become inadvertently exposed to chemical agents or fluids such as gasoline, oil, engine coolant, or battery fluid, it could cause discoloration, staining, or paint peeling. Wipe off any such chemical agents or fluids using a soft cloth immediately.



### Caution!

❑ High water temperature and high water pressure car washers are available depending on the type of high pressure car washer device. If the car washer nozzle is put too close to the vehicle or aimed at one area for an extended period of time, it could deform plastic parts or damage the paint.

❑ Do not use wax containing compounds (polish). Otherwise, it could result in paint damage.

❑ In addition, do not use an electrical or air tool to apply wax. Otherwise, the frictional heat generated could result in deformation of plastic parts or paint damage.



## INTERIORS

### Seats And Fabric Parts



#### Warning!

*Do not use volatile solvents for cleaning purposes. Many are potentially flammable, and if used in closed areas they may cause respiratory harm.*

*Do not keep aerosol cans in the car: they might explode. Aerosol cans must not be exposed to a temperature exceeding 122°F (50°C). When the vehicle is exposed to sunlight the internal temperature can greatly exceed this value.*



#### Caution!

*Direct contact of air fresheners, insect repellents, suntan lotions, or hand sanitizers, to the plastic, painted, or decorated surfaces of the interior may cause permanent damage. Wipe away immediately.*

*Damage caused by these type of products may not be covered by your New Vehicle Limited Warranty.*

*Rubbing the interior side of the convertible top vigorously with a stiff brush or cloth may cause damage.*

#### Vinyl

Remove dust and loose dirt from vinyl with a whisk broom or vacuum cleaner. Clean vinyl with a leather-and-vinyl cleaner.

#### Fabric

Remove dust and loose dirt from fabric with a whisk broom or vacuum cleaner. Clean it with a mild soap solution good for upholstery and carpets.

Remove fresh spots immediately with a fabric spot cleaner.

To keep the fabric looking clean and fresh, take care of it. Otherwise its color will be affected, it can be stained easily, and its fire-resistance may be reduced.

**Note:** Use only recommended cleaners and procedures. Others may affect appearance and fire-resistance.

#### Interior Panels

When the interior panels need to be cleaned, use soft material such as a soft cloth soaked in clean water and wrung out well and lightly wipe off dirt from the surface.

If a panel requires further cleaning, wipe dirt off using a soft cloth soaked in mild detergent (about 5% solution) and wipe off any remaining detergent using a cloth soaked in clean water and wrung out well.



#### Caution!

*Do not wipe leather parts using alcohol, chlorine bleach, or organic solvents such as thinner, benzene, or gasoline. Otherwise, it may cause discoloration or stains.*

#### Note:

- Scratches or nicks on the panels and metallic trim resulting from the use of a hard brush or cloth may not be repairable.
- Be particularly careful when cleaning high gloss panels and metallic trim as they can be easily scratched.

#### Lap / Shoulder Belt



#### Warning!

*A frayed or torn belt could rip apart in a collision and leave you with no protection. Inspect the belt system periodically, checking for cuts, frays, or loose parts. Damaged parts must be replaced immediately. Do not disassemble or modify the system. Seat belt assemblies must be replaced after a collision if they have been damaged (i.e., bent retractor, torn webbing, etc.).*

Clean the webbing with a mild soap solution recommended for upholstery or carpets. Follow instructions. Do not bleach or dye the belts, this may weaken them.

After cleaning the belts, thoroughly dry the belt webbing and make sure there is no remaining moisture before retracting them.

## Plastic And Coated Parts

Clean interior plastic parts with a damp cloth (if possible made from microfiber), and a solution of water and neutral, non-abrasive detergent.

To clean oily or persistent stains, use specific products free from solvents and designed to maintain the original appearance and color of the components.

Remove any dust using a microfiber cloth, if necessary moistened with water. The use of paper tissues is not recommended as these may leave residues.

## Instrument panel precautions

Prevent caustic solutions such as perfume and cosmetic oils from contacting the instrument panel. They will damage and discolor the instrument panel. If these solutions get on the instrument panel, wipe them off immediately.

**Note:** Never use alcohol, gasoline and derivatives to clean the instrument panel lens.



### Caution!

*Do not use glazing agents. Glazing agents contain ingredients which may cause discoloration, wrinkling, cracks and peeling.*

## Instrument Panel Top

When cleaning, it is recommended that you use a clean towel dampened in a mild detergent to remove debris.



### Caution!

*If the surface is rubbed harshly, it could result in the surface being damaged leaving white scratch marks.*

## Window Interiors

If the windows become covered with an oily, greasy, or waxy film, clean them with glass cleaner. Follow the directions on the container.

**Note:** Do not scrape or scratch the inside of the window glass. It could damage the thermal filaments.



### Caution!

*When washing the inside of the window glass, use a soft cloth dampened in lukewarm water, gently wiping the thermal filaments. Use of glass cleaning products could damage the thermal filaments.*



## Leather Parts – If Equipped



### Caution!

*Do not use Alcohol and Alcohol-based and/or Ketone based cleaning products to clean leather seats, as damage to the seat may result.*

Remove dust and sand first using a vacuum cleaner or other means, then wipe dirt off using a soft cloth with a leather cleaner or a soft cloth soaked in mild soap.

Wipe off the remaining cleaner or soap using a cloth soaked in clean water and wrung out well.

Remove moisture with a dry, soft cloth and allow the leather to further dry in a well-ventilated, shaded area.

If the leather gets wet such as from rain, also remove moisture and dry it as soon as possible.

### Note:

- ❑ Because genuine leather is a natural material, its surface is not uniform and it may have natural scars, scratches, and wrinkles.
- ❑ To maintain the quality for as long as possible, periodical maintenance, about twice a year, is recommended.



### Caution!

- ❑ Sand and dust on the seat surface may damage the overcoat of the genuine leather surfaces and accelerate wear.
- ❑ Greasy soiling on genuine leather may cause molding and stains.
- ❑ Rubbing hard with a stiff brush or cloth may cause damage.
- ❑ Do not wipe the leather using alcohol, chlorine bleach, or organic solvents such as thinner, benzene, or gasoline. Otherwise, it may cause discoloration or stains.
- ❑ If the seats get wet, promptly remove moisture with a dry cloth. Remaining moisture on the surface may cause deterioration such as hardening and shrinkage.
- ❑ Exposure to direct sunlight for long periods may cause deterioration and shrinkage. When parking the car under direct sunlight for long periods, shade the interior using sunshades.
- ❑ Do not leave vinyl products on the seats for long periods as they may affect the leather quality and coloring. If the cabin temperature becomes hot, the vinyl may deteriorate and adhere to the genuine leather.

# TECHNICAL SPECIFICATIONS

IDENTIFICATION DATA . . . . .	.266
RECOMMENDED TIRE INFLATION PRESSURE . . . . .	.267
ENGINE . . . . .	.269
TRANSMISSION . . . . .	.270
BRAKES . . . . .	.271
SUSPENSIONS . . . . .	.272
STEERING . . . . .	.273
DIMENSIONS . . . . .	.274
FLUID CAPACITIES . . . . .	.275
FLUIDS AND LUBRICANTS . . . . .	.276
PERFORMANCE . . . . .	.278

## IDENTIFICATION DATA

### Identification Numbers

#### Model Plate

The model plate is located on the left side of door pillar.



10010103121001

#### Model Plate Location

#### Chassis Number/Vehicle Identification Number

The Vehicle Identification Number is located below the left side (driver side) of the windshield.

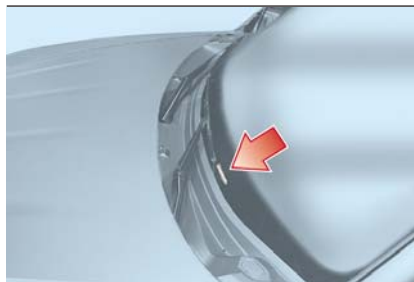

10010104-122-001AB

#### Vehicle Identification Number

#### Motor Vehicle Safety Standard Label

(U.S.A. and Canada)

The motor vehicle safety standard label is located on the left side of door pillar.

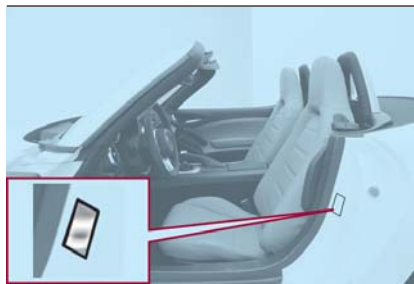

10010109-121-001

#### Motor Vehicle Safety Standard Label

#### Vehicle Emission Control Information Label

(U.S.A. and Canada)

The vehicle emission control information label is located under the hood.



10010106-121-001

#### Vehicle Emission Control Information Label

#### Tire Pressure Label

The tire pressure label is located on the left side of door pillar.



10010107-121-002

#### Tire Pressure Label

#### Engine Number

The engine number label is located on the engine.



## RECOMMENDED TIRE INFLATION PRESSURE

On the tire label you will find the recommended tire inflation pressure in both psi and kPa for the tires installed as original equipment on the vehicle.

It is very important that the inflation pressure of the tires on your vehicle is maintained at the recommended pressure.

You should check the tire pressure regularly to insure that the proper inflation pressure is maintained.

### Note:

□ Tire pressures listed on the vehicle placard or tire information label indicate the recommended cold tire inflation pressure, measured when the tires are cold, after the vehicle has been parked for at least three hours. As you drive, the temperature in the tire warms up, increasing the tire pressure.

□ Always check the tire inflation pressures on a regular basis according to the recommended tire inflation pressure on the tire label and in conjunction with the information in this Owner's Manual. Driving your vehicle with under-inflated tires is dangerous. Under-inflation is the most common cause of failures in any kind of tire and may result in severe cracking, tread separation or "blowout", with unexpected loss of vehicle control and increased risk of injury. Under-inflation increases sidewall flexing and rolling resistance, resulting in heat buildup and internal damage to the tire. It results in unnecessary tire stress, irregular wear, loss of control and accidents. A tire can lose up to half of its air pressure and not appear to be flat. It is impossible to determine whether or not tires are properly inflated just by looking at them.

## Checking Tire Pressure

Proceed as follows:

1. When you check the air pressure, make sure the tires are cold - meaning they are not hot from driving even a mile.
2. Remove the cap from the valve on one tire.
3. Firmly press a tire gauge onto the valve.
4. Add air to achieve recommended air pressure.
5. If you overfill the tire, release air by pushing on the metal stem in the center of the valve. Then recheck the pressure with your tire gauge.
6. Replace the valve cap.
7. Visually inspect the tires to make sure there are no nails or other objects embedded that could poke a hole in the tire and cause an air leak.
8. Check the sidewalls to make sure there are no gouges, cuts, bulges, cracks or other irregularities.



## Glossary Of Terms

### Tire Placard

A label indicating the OE (Original Equipment) tire sizes, recommended inflation pressure, and the maximum weight the vehicle can carry.

### Tire Identification Number (TIN)

A number on the sidewall of each tire providing information about the tire brand and manufacturing plant, tire size, and date of manufacture.

### Inflation Pressure

A measure of the amount of air in a tire.

### kPa

Kilopascal, the metric unit for air pressure.

### psi

Pounds per square inch, the English unit for air pressure.

### B-pillar

The structural member at the side of the vehicle behind the front door.

### Original Equipment (OE)

Describes components originally equipped on the vehicle.

### Vehicle Load Limit

The maximum value of the combination weight of occupants and cargo.

### Bead Area of the Tire

Area of the tire next to the rim.

### Sidewall Area of the Tire

Area between the bead area and the tread.

### Tread Area of the Tire

Area on the perimeter of the tire that contacts the road when it's mounted on the vehicle.

# ENGINE

## Engine

	1.4 Turbo Multi Air
Cycle	Four
Number and position of cylinders	4 in line
Piston bore and stroke (mm)	72.0 x 80.4
Total displacement (cm <sup>3</sup> )	1368
Compression ratio	9.8:1
Maximum power (kW)	122
Maximum power (HP)	164
Corresponding engine speed (rpm)	5500
Maximum torque (Nm)	250
Maximum torque (lb.-ft.)	184
Corresponding engine speed (rpm)	2500
Spark plugs	We recommend you use Mopar Spark Plugs.
Fuel	91 Octane Recommended (87 Octane Acceptable) Maximum 15% Ethanol Content

**Note:** When cleaning the iridium plugs, do not use a wire brush. The fine particulate coating on the iridium alloy and platinum tips could be damaged.



### Warning!

*Modifications or repairs to the fuel supply system that are not carried out correctly or do not take the system's technical specifications into account, can cause malfunctions leading to the risk of fire.*



**TRANSMISSION**

Engine	Traction	Type	Description
<b>1.4 Turbo Multi Air</b>	RWD	Manual/Automatic	6-speed manual (*) / 6-speed Automatic Transmission(**)

(\*) If equipped with manual transmission

(\*\*) If equipped with automatic transmission

## BRAKES

Engine	Front brakes	Rear brakes	Parking brake
<b>1.4 Turbo Multi Air</b>	Ventilated (floating type 11 in diameter)	Solid (floating type 11 in diameter)	Mechanical (lever type)

**Note:** Water, ice, and salt spread on the roads may deposit on the brake disks reducing braking efficiency the first time the brakes are applied.



## SUSPENSIONS

Engine	Front	Rear
<b>1.4 Turbo Multi Air</b>	Double wishbone with stabilizer bars	Multilink with stabilizer bars

## STEERING

Engine	Turning circle curb to curb, ft (m)	Type
1.4 Turbo Multi Air	30.8 (9.4)	Double pinion electric power assist system (DP - EPAS) - rack and pinion



## DIMENSIONS

### Dimensions

Dimensions are expressed in inches and refer to the vehicle equipped with its standard-supplied tires. Height is measured with vehicle unloaded.

**Trunk Volume:** 4.9 cu. ft. (140 Liters)

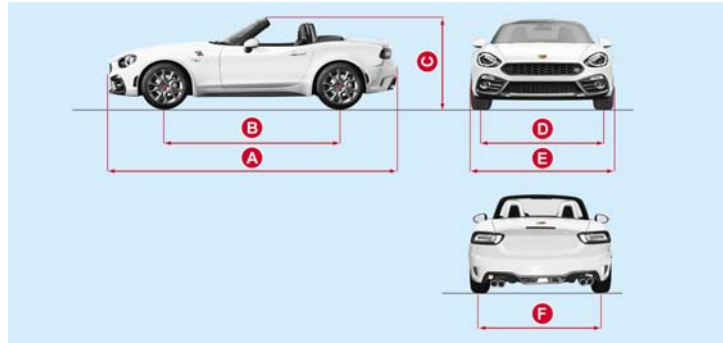

Vehicle Dimension Chart

10000555-122-333AB

A	B	C	D	E	F
159.6 (4054 mm)	90.9 (2309 mm)	48.5 (1232 mm)	58.9 (1496 mm)	68.5 (1740 mm)	59.1 (1503 mm)

### Weights

**Curb Weight:** 2477 lbs (1124 kg) (if equipped with manual transmission) / 2516 lbs (1141 kg) (if equipped with automatic transmission).



## FLUID CAPACITIES

Item	Capacities
Fuel tank	11.9 (gallons) / 45 (liters)
Engine oil (without oil filter replacement)	3.3 (quarts) / 3.2 (liters)
Engine oil (with oil filter replacement)	4.0 (quarts) / 3.8 (liters)
Coolant (with manual transmission)	7.6 (quarts) / 7.2 (liters)
Coolant (with automatic transmission)	7.5 (quarts) / 7.1 (liters)
Manual transmission oil	2.2 (quarts) / 2.1 (liters)
Automatic transmission fluid	7.8 (quarts) / 7.5 (liters)
Rear differential oil	0.63 (quarts) / 0.6 (liters)
Limited slip differential oil	0.63 (quarts) / 0.6 (liters)
Brake fluid (& clutch fluid)	0.57 (quarts) / 0.55 (liters)



## FLUIDS AND LUBRICANTS

### Fluids And Lubricants

Your vehicle is equipped with an engine oil that has been thoroughly developed and tested in order to meet the requirements of the Scheduled Servicing Plan.

Constant use of the prescribed lubricants guarantees the fuel consumption and emission specifications. Lubricant quality is crucial for engine operation and duration.

Lubricant	Specification	Replacement interval
Engine oil	We recommend you use API Certified SAE 5W-40 Full Synthetic Engine Oil, meeting the requirements of FCA Material Standard MS-12991. Refer to your engine oil filler cap for correct SAE grade.	According to Scheduled Servicing Plan
Coolant	Mopar Long Life Coolant Concentrate for FIAT Spider	According to Scheduled Servicing Plan
Manual transmission oil	Mopar Manual Transmission Long Life Gear Oil for FIAT Spider	
Automatic transmission fluid	Mopar Automatic Transmission Long Life Fluid for FIAT Spider	
Rear differential oil	Mopar Long Life Hypoid Gear Oil for FIAT Spider	
Limited slip differential oil	Mopar Long Life Limited Slip Additive for FIAT Spider	
Brake/clutch fluid	We recommend you use Mopar DOT 3. If DOT 3 brake fluid is not available, then DOT 4 is acceptable.	

If lubricants compliant with the required specifications are not available, products that comply with the minimum required characteristics can be used for topping up; in this case optimal performance of the engine is not guaranteed.



### Caution!

- ❑ *Mixing of engine coolant (antifreeze) other than specified Organic Additive Technology (OAT) engine coolant (antifreeze), may result in engine damage and may decrease corrosion protection. Organic Additive Technology (OAT) engine coolant is different and should not be mixed with Hybrid Organic Additive Technology (HOAT) engine coolant (antifreeze) or any "globally compatible" coolant (antifreeze). If a non-OAT engine coolant (antifreeze) is introduced into the cooling system in an emergency, the cooling system will need to be drained, flushed, and refilled with fresh OAT coolant (conforming to MS.90032), by an authorized dealer as soon as possible.*
- ❑ *Do not use water alone or alcohol-based engine coolant (antifreeze) products. Do not use additional rust inhibitors or antirust products, as they may not be compatible with the radiator engine coolant and may plug the radiator.*
- ❑ *This vehicle has not been designed for use with propylene glycol-based engine coolant (antifreeze). Use of propylene glycol-based engine coolant (antifreeze) is not recommended.*



## PERFORMANCE

---

### Performance

Top speed after the initial period of usage of the vehicle.

Version	MPH (km/h)
<b>1.4 Turbo Multi Air 164HP</b>	<b>130 (209.2)</b>

---

# CUSTOMER ASSISTANCE

SUGGESTIONS FOR OBTAINING SERVICE FOR YOUR VEHICLE . . .	.280
IF YOU NEED ASSISTANCE . . . . .	.280
WARRANTY INFORMATION . . . . .	.282
REPORTING SAFETY DEFECTS . . .	.282
PUBLICATION ORDER FORMS . . .	.283



## SUGGESTIONS FOR OBTAINING SERVICE FOR YOUR VEHICLE

### Prepare For The Appointment

If you are having warranty work done, be sure to bring the right papers with you, as well as your warranty folder. All work to be performed may not be covered by the warranty. Discuss additional charges with the service manager. Keep a maintenance log of your vehicle's service history, as this can often provide a clue to the current problem.

### Prepare A List

Make a written list of your vehicle's problems or the specific work you want done. If you've had an accident or work done that is not on your maintenance log, let the service advisor know.

### Be Reasonable With Requests

If you list a number of items and you must have your vehicle by the end of the day, discuss the situation with the service advisor and list the items in order of priority. At many authorized dealers, you may obtain a rental vehicle at a minimal daily charge. If you need a rental, it is advisable to make these arrangements when you call for an appointment.

## IF YOU NEED ASSISTANCE

The manufacturer and its authorized dealer are vitally interested in your satisfaction. We want you to be happy with our products and services.

Warranty service must be done by an authorized dealer. We strongly recommend that you take the vehicle to an authorized dealer. They know your vehicle the best, and are most concerned that you get prompt and high quality service. The manufacturer's authorized dealer have the facilities, factory-trained technicians, special tools, and the latest information to ensure the vehicle is fixed correctly and in a timely manner.

This is why you should always talk to an authorized dealer service manager first. Most matters can be resolved with this process.

If for some reason you are still not satisfied, talk to the general manager or owner of the authorized dealer. They want to know if you need assistance.

If an authorized dealer is unable to resolve the concern, you may contact the manufacturer's customer center.

Any communication to the manufacturer's customer center should include the following information:

Owner's name and address

Owner's telephone number (home and office)

Authorized dealer name

Vehicle Identification Number (VIN)

Vehicle delivery date and mileage

### FIAT Customer Center

P.O. Box 21-8004 Auburn Hills, MI 48321-8004

Phone:

1-888-242-6342

### FIAT Canada Customer Center

P.O. Box 1621

Windsor, Ontario N9A 4H6

Phone: (800) 465-2001 English / (800) 387-9983 French

### In Mexico Contact

Av. Prolongacion Paseo de la Reforma, 1240

Sante Fe C.P. 05109

Mexico, D. F.

In Mexico City: 5081-7568

Outside Mexico City:

1-800-505-1300

## Puerto Rico And U.S. Virgin Islands

Customer Service Chrysler International Services LLC

P.O. Box 191857

San Juan 00919-1857

Tel.: (787) 782-5757

Fax: (787) 782-3345

## Customer Assistance For The Hearing Or Speech Impaired (TDD/TTY)

To assist customers who have hearing difficulties, the manufacturer has installed special TDD (Telecommunication Devices for the Deaf) equipment at its customer center. Any hearing or speech impaired customer, who has access to a TDD or a conventional teletypewriter (TTY) in the United States, can communicate with the manufacturer by dialing 1-800-380-CHRY.

Canadian residents with hearing difficulties that require assistance can use the special needs relay service offered by Bell Canada. For TTY teletypewriter users, dial 711 and for Voice callers, dial 1-800-855-0511 to connect with a Bell Relay Service operator.

## Service Contract

You may have purchased a service contract for a vehicle to help protect you from the high cost of unexpected repairs after the manufacturer's New Vehicle Limited Warranty expires. The manufacturer stands behind only the manufacturer's service contracts. If you purchased a manufacturer's service contract, you will receive Plan Provisions and an Owner Identification Card in the mail within three weeks of the vehicle delivery date. If you have any questions about the service contract, call the manufacturer's Service Contract National Customer Hotline at 1-800-521-9922 (Canadian residents, call (800) 465-2001 English / (800) 387-9983 French).

The manufacturer will not stand behind any service contract that is not the manufacturer's service contract. It is not responsible for any service contract other than the manufacturer's service contract. If you purchased a service contract that is not a manufacturer's service contract, and you require service after the manufacturer's New Vehicle Limited Warranty expires, please refer to the contract documents, and contact the person listed in those documents.

We appreciate that you have made a major investment when you purchased the vehicle. An authorized dealer has also made a major investment in

facilities, tools, and training to assure that you are absolutely delighted with the ownership experience. You will be pleased with their sincere efforts to resolve any warranty issues or related concerns.



### Warning!

*Engine exhaust (internal combustion engines only), some of its constituents, and certain vehicle components contain, or emit, chemicals known to the State of California to cause cancer and birth defects, or other reproductive harm. In addition, certain fluids contained in vehicles and certain products of component wear contain, or emit, chemicals known to the State of California to cause cancer and birth defects, or other reproductive harm.*



## **WARRANTY INFORMATION**

---

See the Warranty Information Booklet, for the terms and provisions of FCA US LLC warranties applicable to this vehicle and market.

## **REPORTING SAFETY DEFECTS**

---

### **In The 50 United States And Washington, D.C.**

If you believe that your vehicle has a defect that could cause a crash or cause injury or death, you should immediately inform the National Highway Traffic Safety Administration (NHTSA) in addition to notifying FCA US LLC.

If NHTSA receives similar complaints, it may open an investigation, and if it finds that a safety defect exists in a group of vehicles, it may order a recall and remedy campaign. However, NHTSA cannot become involved in individual problems between you, your authorized dealer or FCA US LLC.

To contact NHTSA, you may call the Vehicle Safety Hotline toll free at 1-888-327-4236 (TTY: 1-800-424-9153); or go to <http://www.safercar.gov> ; or write to: Administrator, NHTSA, 1200 New Jersey Avenue, SE., West Building, Washington, D.C. 20590. You can also obtain other information about motor vehicle safety from <http://www.safercar.gov> .

### **In Canada**

If you believe that your vehicle has a safety defect, you should contact the Customer Service Department immediately. Canadian customers who wish to report a safety defect to the Canadian government should contact Transport Canada, Motor Vehicle Defect Investigations and Recalls at 1-800-333-0510 or go to <http://www.tc.gc.ca/roadsafety/> .



## **PUBLICATION ORDER FORMS**

---

To order the following manuals, you may use either the website or the phone numbers listed below. Visa, Mastercard, American Express, and Discover orders are accepted.

### **Service Manuals**

These comprehensive Service Manuals provide the information that students and professional technicians need in diagnosing/troubleshooting, problem solving, maintaining, servicing, and repairing FCA US LLC vehicles. A complete working knowledge of the vehicle, system, and/or components is written in straightforward language with illustrations, diagrams, and charts.

### **Diagnostic Procedure Manuals**

Diagnostic Procedure Manuals are filled with diagrams, charts and detailed illustrations. These practical manuals make it easy for students and technicians to find and fix problems on computer-controlled vehicle systems and features. They show exactly how to find and correct problems the first time, using step-by-step troubleshooting and drivability procedures, proven diagnostic tests, and a complete list of all tools and equipment.

### **Owner's Manuals**

These Owner's Manuals have been prepared with the assistance of service and engineering specialists to acquaint you with specific FCA US LLC vehicles. Included are starting, operating, emergency and maintenance procedures as well as specifications, capabilities and safety tips.

Call toll free at:

**1-800-890-4038 (U.S.)**

**1-800-387-1143 (Canada)**

Or

Visit us on the Worldwide Web at:

[www.techauthority.com](http://www.techauthority.com)



**INDEX**

About Your Brakes . . . . .	150	Automatic Temperature Control (ATC) . . . . .	52	Checking levels. . . . .	231
ABS system. . . . .	112	Automatic Transmission . . . . .	153	Child Restraint . . . . .	128
Active Adaptive Shift (AAS) . . . . .	156	Auxiliary Power Outlet . . . . .	63	Child Restraints Child Restraints . . . . .	128
Adaptive Front Lighting System (AFS) . . . . .	42	B-Pillar Location . . . . .	242	Clean Air Gasoline. . . . .	173
Additives, Fuel . . . . .	174	Battery (maintenance). . . . .	234	Cleaning Wheels . . . . .	251
Advanced Keyless Entry System Key Left In Trunk . . . . .	21	Battery charging procedure . . . . .	235	Climate Control . . . . .	45
Key left In Vehicle . . . . .	21	Battery recharging. . . . .	235	Close The Hood . . . . .	69
Locking Doors . . . . .	21	Blind Spot Monitoring. . . . .	114	Compact Spare Tire. . . . .	250
Passive Entry . . . . .	21	Body and underbody warranty . . . . .	256	Contract, Service . . . . .	281
Request Switch . . . . .	21	Body lubrication . . . . .	235	Convertible Top . . . . .	70
Unlocking Doors . . . . .	21	Bodywork (care and maintenance). . . . .	256	Convertible top maintenance . . . . .	260
Air Bag . . . . .	131,135	Boot, Convertible Top Lowering . . . . .	70	Cooling Air Conditioning . . . . .	50
Advance Front Air Bag . . . . .	131,135	Boot, Convertible Top Precautions . . . . .	73	Cupholders . . . . .	64
Air Bag Warning Light . . . . .	147	Boot, Convertible Top Raising . . . . .	71	Customer Assistance. . . . .	280
Event Data Recorder (EDR) . . . . .	145,222	Brake System. . . . .	150	Data Recorder, Event . . . . .	145
Front Air Bag . . . . .	147	Brake/clutch fluid (level check) . . . . .	233	Daytime Running Lights . . . . .	40
Maintaining Your Air Bag System . . . . .	145	Brakes . . . . .	150,271	Diagnostic System, Onboard . . . . .	109
Air Bag Maintenance . . . . .	145	Bright-metal maintenance . . . . .	259	Dimensions . . . . .	274
Air Pressure, Tires . . . . .	246	Camera, Rear. . . . .	167	Disabled Vehicle Towing . . . . .	220,221
Alarm Vehicle Security Alarm . . . . .	24,25	Carbon Monoxide Warning . . . . .	175	Driver's Seat Back Tilt . . . . .	33
Alarm (Security Alarm) . . . . .	24,25	Center Seat Storage Compartment . . . . .	60	Driving in flooded area . . . . .	181
Aluminium wheel maintenance . . . . .	259	Certification Label . . . . .	176	Driving tips . . . . .	178
Automatic Dimming Mirror. . . . .	36	Changing A Flat Tire. . . . .	203,204,237	Electric power steering. . . . .	74
Automatic Headlights. . . . .	40	Chart, Tire Sizing. . . . .	239	Electric Remote Mirrors . . . . .	37
		Check Engine Light (Malfunction Indicator Light) . . . . .	110		

Electronic Brake Control System	Exhaust Gas Caution . . . . .	175	Gasoline, Clean Air . . . . .	173
Traction Control System . . . . .	Exterior Lights . . . . .	38	Gasoline, Reformulated . . . . .	173
Electronic Speed Control (Cruise	Flash-To-Pass . . . . .	40	Gear selector positions . . . . .	154
Control) . . . . .	Flashers		GVWR . . . . .	176
Emergency fuel filler door release . .	Hazard Warning . . . . .	184	Hazard Warning Flasher . . . . .	184
Emergency Key . . . . .	Turn Signal . . . . .	41	Hazardous driving . . . . .	178
Emergency, In Case Of . . . . .	Flooded Engine Starting . . . . .	218	Head Restraints . . . . .	34
Hazard Warning Flasher . . . . .	Fluid And Lubricants . . . . .	276	Headlight . . . . .	38
Jacking . . . . .	Fluid Capacities . . . . .	275	Headlights	
Jump Starting . . . . .	Fog Lights . . . . .	41	Adjusting The Headlight Abroad . .	42
Overheating . . . . .	Follow Me Home . . . . .	40	High Beam . . . . .	40
Towing . . . . .	Front lights (light bulbs) . . . . .	187	Passing . . . . .	40
Emission control system . . . . .	Front Wipers		Heavy-duty use of the vehicle	
Emission Control System	Wiper Operation . . . . .	42	(scheduled servicing) . . . . .	225
Maintenance . . . . .	Fuel		HomeLink (Garage Door Opener) . .	58
. . . . .	Additives . . . . .	174	Hood Release . . . . .	68
Engine . . . . .	Clean Air . . . . .	173	How to use this manual . . . . .	3
Exhaust Gas Caution . . . . .	Ethanol . . . . .	173	Identification Data . . . . .	266
Fails To Start . . . . .	Materials Added . . . . .	174	Inside Rearview Mirror . . . . .	36
Flooded, Starting . . . . .	Methanol . . . . .	173	Instrument Cluster Display	
Jump Starting . . . . .	Fuel Consumption Display . . . . .	85	Information Display . . . . .	76,77
Overheating . . . . .	Fuel Economy Monitor . . . . .	84	Interior Lights . . . . .	62
Starting . . . . .	Fuel filler cap . . . . .	175	Interiors . . . . .	262
. . . . .	Fuel filler door . . . . .	175	Internal Equipment . . . . .	60
Engine compartment . . . . .	Fuse block (engine compartment) .	197	Jack Location . . . . .	203
Engine coolant (level check) . . . .	Fuse block (interior) . . . . .	201	Jack Operation . . . . .	203,204,237
Engine oil (level check) . . . . .	Fuses (interior) . . . . .	195	Jump Starting . . . . .	217
Environment protection systems . . .	Fuses (underhood) . . . . .	196		
Essential information . . . . .				
Ethanol . . . . .				
Event Data Recorder . . . . .				



Key Fob . . . . .	.14	Manual, Service . . . . .	.283	Power	
Emergency Key . . . . .	.14	Methanol. . . . .	.173	Brakes . . . . .	.150
Programming Additional Key		Mirrors . . . . .	.35	Door Locks . . . . .	.26,31
Fobs . . . . .	.24	Automatic Dimming . . . . .	.36	Mirrors . . . . .	.37
Key-In Reminder. . . . .	.20	Electric Remote . . . . .	.37	Pregnant Women And Seat Belts . .	.124
Lane Change And Turn Signals . . . .	.41	Exterior Folding . . . . .	.37	Pretensioners	
Lane Change Assist. . . . .	.41	Outside . . . . .	.35	Seat Belts . . . . .	.127
Lap/Shoulder Belts . . . . .	.123,125	Rearview . . . . .	.36	Protection from atmospheric	
Leaving Home Light System . . . . .	.42	Occupant Restraints . . . . .	.122	agents (bodywork) . . . . .	.256
Life Of Tires . . . . .	.248	Onboard Diagnostic System . . . . .	.109	Radar Sensors . . . . .	.162
Lights		Operating Precautions . . . . .	.109	Radial Ply Tires. . . . .	.247
Daytime Running . . . . .	.40	Outside Rearview Mirrors . . . . .	.35,36	Radio Frequency	
Fog . . . . .	.41	Overhead light (bulb replacement) .	.194	General Information . . . . .	.19,23
Hazard Warning Flasher . . . . .	.184	Overheating, Engine. . . . .	.219	Radio transmitter and mobile	
Passing . . . . .	.40	Overloading . . . . .	.182	phones . . . . .	.5
Turn Signal . . . . .	.41	Owner's Manual (Operator		Rear Camera . . . . .	.167
Loading Vehicle . . . . .	.176	Manual) . . . . .	.283	Rear lights (light bulbs) . . . . .	.187
Tires . . . . .	.242	Paint damage touch-up . . . . .	.259	Rear Park Assist System. . . . .	.163
Locks		Parking Brake. . . . .	.151	Rearview Mirrors. . . . .	.36
Power Door . . . . .	.26,31	Passing Light. . . . .	.40	Recommended Tire Inflation	
Maintaining the finish . . . . .	.257	Performance . . . . .	.278	Pressure . . . . .	.267
Maintenance Monitor . . . . .	.81	Periodic checks (scheduled		Recorder, Event Data . . . . .	.145
Maintenance procedures. . . . .	.235	servicing) . . . . .	.225	Recreational towing . . . . .	.178
Malfunction Indicator Light (Check		Personal Settings . . . . .	.105	Reformulated Gasoline . . . . .	.173
Engine) . . . . .	.110	Personalization Features . . . . .	.105	Refueling procedure. . . . .	.175
Manual Climate Control System . . . .	.48	Placard, Tire And Loading		Refueling the vehicle . . . . .	.173
Heating . . . . .	.50	Information. . . . .	.242	Reminder, Seat Belt. . . . .	.127
Manual transmission . . . . .	.152	Plastic part maintenance. . . . .	.261	Replacement Tires. . . . .	.248

Replacing exterior light bulbs . . . . .	187	Adjustment . . . . .	.33	Wheel, Tilt . . . . .	.35
Replacing fuses . . . . .	194	Heated . . . . .	.33	Storage . . . . .	.60
Replacing interior light bulbs . . . . .	194	Seatback Release . . . . .	.33	Storing the vehicle . . . . .	.255
Reporting Safety Defects . . . . .	.282	Tilting . . . . .	.33	Sun Visor . . . . .	.61
Restraint, Head . . . . .	.34	Seats and fabric parts (cleaning) . . . . .	.262	Supplemental Restraint System - Air Bag . . . . .	.131,135
Restraints, Child . . . . .	.128	Security Alarm . . . . .	.24,25	Suspensions . . . . .	.272
Safety Defects, Reporting . . . . .	.282	Security Alarm . . . . .	.24,25	Symbols . . . . .	.3
Safety Information, Tire . . . . .	.238	Sentry Key . . . . .	.24	Tilt Steering Column . . . . .	.35
safety systems . . . . .	.112	Key Programming . . . . .	.24	Tire And Loading Information Placard . . . . .	.242
Saving fuel and protection of the environment . . . . .	.178	Service Assistance . . . . .	.280	Tire chains . . . . .	.180
Scheduled servicing . . . . .	.224	Service Contract . . . . .	.281	Tire Markings . . . . .	.238
Seat Belt . . . . .		Service Manuals . . . . .	.283	Tire Rotation . . . . .	.253
Energy Management Feature . . . . .	.128	Shift Lever Override . . . . .	.156	Tire Safety Information . . . . .	.238
Lap/Shoulder Belts . . . . .	.123,125	Shift position indication . . . . .	.154	Tire Service Kit . . . . .	.208
Pregnant Women . . . . .	.124	Shoulder Belts . . . . .	.123,125	Tires . . . . .	.246,250,254
Seat Belt Extender . . . . .	.126	Signals, Turn . . . . .	.41	Aging (Life Of Tires) . . . . .	.248
Seat Belt Pretensioner . . . . .	.127	Snow chains . . . . .	.252	Air Pressure . . . . .	.246
Seat Belt Reminder . . . . .	.127	Snow Tires . . . . .	.249	Changing . . . . .	.203,204,237
Seat Belt Reminder . . . . .	.127	Spare Tire . . . . .	.203,250,251	Compact Spare . . . . .	.250
Seat Belts . . . . .	.122	Sport Mode . . . . .	.158	Flat Changing . . . . .	.208
Child Restraint . . . . .	.128	Starting . . . . .	.20,218	General Information . . . . .	.246,250
Extender . . . . .	.126	Engine Fails To Start . . . . .	.218	High Speed . . . . .	.247
Front Seat . . . . .	.122,123	Starting And Operating . . . . .	.20,218	Inflation Pressures . . . . .	.246
Pregnant Women . . . . .	.124	Starting Procedures . . . . .	.20,218	Jacking . . . . .	.203,204,237
Pretensioners . . . . .	.127	Starting the engine . . . . .	.149	Life Of Tires . . . . .	.248
Rear Seat . . . . .	.123	Steering . . . . .	.273	Load Capacity . . . . .	.242,243
Seats . . . . .	.33	Column Lock . . . . .	.35		
		Tilt Column . . . . .	.35		



Pressure Monitor System (TPMS) . . . . .	114	Transmission . . . . .	.270	Wheel And Wheel Trim . . . . .	.251
Quality Grading . . . . .	.254	Tread Wear Indicators. . . . .	.248	Wheel And Wheel Trim Care. . . . .	.251
Radial . . . . .	.247	Trunk Lid		Wheels and tires . . . . .	.238
Replacement . . . . .	.248	Closing . . . . .	.67	Window and headlight washer fluid (level check) . . . . .	.234
Safety . . . . .	.238,246	Opening . . . . .	.66	Window interiors (cleaning) . . . . .	.263
Sizes . . . . .	.239	Trunk light (bulb replacement). . . . .	.194	Windows	
Snow Tires . . . . .	.249	Turn Signals. . . . .	.41	Driver/Passenger Window Controls . . . . .	.56
Spare Tire . . . . .	.203,250,251	Undercoating . . . . .	.259	Power Windows . . . . .	.56
Spinning . . . . .	.247	Uniform Tire Quality Grades . . . . .	.254	Window Lockout . . . . .	.58
Tread Wear Indicators . . . . .	.248	Vehicle Loading . . . . .	.176,243	Windshield.wiper.blades (replacing) .236	
To Open Deck Lid . . . . .	.66	Vehicle modifications/alterations. . . . .	.4	Windshield Wipers . . . . .	.42
To Open Hood . . . . .	.68	Vent Operation . . . . .	.45	Windstop . . . . .	.65
Towing		Warning Flasher, Hazard . . . . .	.184	Winter driving. . . . .	.180
Disabled Vehicle . . . . .	.220,221	Warranty Information . . . . .	.282	Wiper blades . . . . .	.236
Towing Eyes. . . . .	.220	Washer Operation. . . . .	.42,44	Wrecker Towing . . . . .	.220,221
Towing trailers . . . . .	.178	Washers, Windshield . . . . .	.42		
TPMS (Tire Pressure Monitoring System). . . . .	.119				

## **INSTALLATION OF RADIO TRANSMITTING EQUIPMENT**

Special design considerations are incorporated into this vehicle's electronic system to provide immunity to radio frequency signals. Mobile two-way radios and telephone equipment must be installed properly by trained personnel. The following must be observed during installation.

The positive power connection should be made directly to the battery and fused as close to the battery as possible. The negative power connection should be made to body sheet metal adjacent to the negative battery connection. This connection should not be fused.

Antennas for two-way radios should be mounted on the roof or the rear area of the vehicle. Care should be used in mounting antennas with magnet bases. Magnets may affect the accuracy or operation of the compass on vehicles so equipped.

The antenna cable should be as short as practical and routed away from the vehicle wiring when possible. Use only fully shielded coaxial cable.

Carefully match the antenna and cable to the radio to ensure a low Standing Wave Ratio (SWR).

Mobile radio equipment with output power greater than normal may require special precautions.

All installations should be checked for possible interference between the communications equipment and the vehicle's electronic systems.



17BAFX-124-AC  
©2016 FCA US LLC. All Rights Reserved.  
FIAT is a registered trademark of FCA Group  
Marketing S.p.A., used under license by FCA US LLC.



Third Edition  
Printed in U.S.A.