



2015

OWNER'S MANUAL

FIAT 500

VEHICLES SOLD IN CANADA

With respect to any Vehicles Sold in Canada, the name Chrysler Group LLC shall be deemed to be deleted and the name Chrysler Canada Inc. used in substitution therefore.

DRIVING AND ALCOHOL

Drunken driving is one of the most frequent causes of accidents.

Your driving ability can be seriously impaired with blood alcohol levels far below the legal minimum. If you are drinking, don't drive. Ride with a designated non-drinking driver, call a cab, a friend, or use public transportation.

WARNING!

Driving after drinking can lead to an accident. Your perceptions are less sharp, your reflexes are slower, and your judgment is impaired when you have been drinking. Never drink and then drive.

This manual illustrates and describes the operation of features and equipment that are either standard or optional on this vehicle. This manual may also include a description of features and equipment that are no longer available or were not ordered on this vehicle. Please disregard any features and equipment described in this manual that are not on this vehicle.

Chrysler Group LLC reserves the right to make changes in design and specifications, and/or make additions to or improvements to its products without imposing any obligation upon itself to install them on products previously manufactured.

FIAT is a registered trademark of Fiat Group Marketing & Corporate Communication S.p.A., used under license by Chrysler Group LLC.

Copyright © 2014 Chrysler Group LLC



TABLE OF CONTENTS

SECTION		PAGE
1	INTRODUCTION	3
2	THINGS TO KNOW BEFORE STARTING YOUR VEHICLE	9
3	UNDERSTANDING THE FEATURES OF YOUR VEHICLE	81
4	UNDERSTANDING YOUR INSTRUMENT PANEL	139
5	STARTING AND OPERATING	223
6	WHAT TO DO IN EMERGENCIES	309
7	MAINTAINING YOUR VEHICLE	351
8	MAINTENANCE SCHEDULES	411
9	IF YOU NEED CONSUMER ASSISTANCE	419
10	INDEX	429

INTRODUCTION

CONTENTS

■ INTRODUCTION	4	■ VEHICLE IDENTIFICATION NUMBER	7
■ HOW TO USE THIS MANUAL	5	■ VEHICLE MODIFICATIONS/ALTERATIONS	8
■ WARNINGS AND CAUTIONS	7		

INTRODUCTION

Congratulations on selecting your new vehicle. Be assured that it represents precision workmanship, distinctive styling, and high quality - all essentials that are traditional to our vehicles.

This Owner's Manual has been prepared with the assistance of service and engineering specialists to acquaint you with the operation and maintenance of your vehicle. It is supplemented by Warranty Information, and various customer-oriented documents. Please take the time to read these publications carefully. Following the instructions and recommendations in this manual will help assure safe and enjoyable operation of your vehicle.

The enclosed Warranty Information lists the services that FIAT Group Automobiles offers to its customers:

- The Warranty Certificate with terms and conditions for maintaining its validity
- The range of additional services available to FIAT Group Automobiles customers

NOTE: After reviewing the owner information, it should be stored in the vehicle for convenient referencing and remain with the vehicle when sold.

When it comes to service, remember that your authorized dealer knows your vehicle best, has factory-trained technicians and genuine parts, and cares about your satisfaction.

































































HOW TO USE THIS MANUAL

Consult the Table of Contents to determine which section contains the information you desire.

Since the specification of your vehicle depends on the items of equipment ordered, certain descriptions and illustrations may differ from your vehicle's equipment.

The detailed index at the back of this Owner's Manual contains a complete listing of all subjects.

Consult the following table for a description of the symbols that may be used on your vehicle or throughout this Owner's Manual:

											ESP BAS ELECTRONIC STABILITY PROGRAM / BRAKE ASSIST SYSTEM	
											BRAKE BRAKE SYSTEM WARNING PARKING BRAKE	
										AWD!	(ABS) FAILURE OF ANTI-LOCK BRAKING SYSTEM	
										4WD!	BRAKE BRAKE SYSTEM WARNING PARKING BRAKE	
											TOW/ HAUL TOW / HAUL	
											4 LOW FOUR WHEEL DRIVE LOW	
			SRS AIRBAG SUPPLEMENTAL RESTRAINT SYSTEM							A/C PUSH AIR CONDITIONER		ELECTRONIC STABILITY CONTROL OFF

WARNINGS AND CAUTIONS

This Owners Manual contains **WARNINGS** against operating procedures that could result in a collision or bodily injury. It also contains **CAUTIONS** against procedures that could result in damage to your vehicle. If you do not read this entire Owners Manual, you may miss important information. Observe all Warnings and Cautions.

VEHICLE IDENTIFICATION NUMBER

The Vehicle Identification Number (VIN) is found on the left front corner of the instrument panel, visible through the windshield. This number also appears engraved on the right front door sill under the sill scuff plate, on an adhesive label applied to the right door opening on the B-Pillar, on the vehicle registration and title.



Vehicle Identification Number

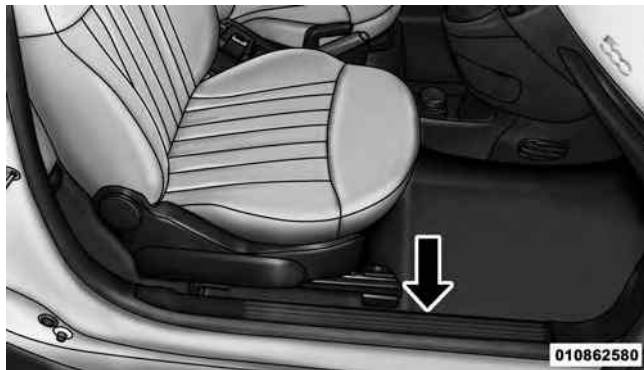

Stamped VIN Location

NOTE: It is illegal to remove or alter the VIN.

VEHICLE MODIFICATIONS/ALTERATIONS

WARNING!

Any modifications or alterations to this vehicle could seriously affect its roadworthiness and safety and may lead to a collision resulting in serious injury or death.

THINGS TO KNOW BEFORE STARTING YOUR VEHICLE

CONTENTS

2

■ A WORD ABOUT YOUR KEYS	11	□ Remote Key Unlock, Driver Door/All Doors 1st Press	16
□ Ignition Key Removal	11	□ To Lock The Doors And Liftgate	16
□ Locking Doors With A Key.	13	□ Programming Additional Transmitters.	16
□ Key-In-Ignition Reminder	13	□ Transmitter Battery Replacement	16
■ SENTRY KEY®	13	□ General Information	18
□ Replacement Keys	14	■ DOOR LOCKS	19
□ General Information	15	□ Power Door Locks — If Equipped	21
■ REMOTE KEYLESS ENTRY (RKE) — IF EQUIPPED	15	□ Auto Door Locks	21
□ To Unlock The Doors And Liftgate	16	■ POWER WINDOWS	22

10 THINGS TO KNOW BEFORE STARTING YOUR VEHICLE

□ Power Window Switches22	□ Transporting Pets74
□ Auto-Down23	■ ENGINE BREAK-IN RECOMMENDATIONS74
□ Wind Buffeting23	■ SAFETY TIPS75
■ LIFTGATE24	□ Transporting Passengers.75
■ OCCUPANT RESTRAINT SYSTEMS25	□ Exhaust Gas76
□ Important Safety Precautions25	□ Safety Checks You Should Make Inside The Vehicle77
□ Seat Belt Systems27	□ Periodic Safety Checks You Should Make Outside The Vehicle79
□ Supplemental Restraint System (SRS)39		
□ Child Restraints55		

A WORD ABOUT YOUR KEYS

The key fob contains the Remote Keyless Entry (RKE) transmitter with an integrated key. To use the mechanical key simply push the mechanical key release button.



020274421

Mechanical Key Release Button

The vehicle is supplied with a code card containing key code numbers to order duplicate keys, and the authorized dealer that sold you your new vehicle has the key code numbers for your vehicle locks. These numbers can be used to order duplicate keys.

Ignition Key Removal

1. Place the shift lever in PARK (if equipped with an automatic transmission).
2. Rotate the key to the OFF/LOCK position.
3. Remove the key from the ignition switch lock cylinder.

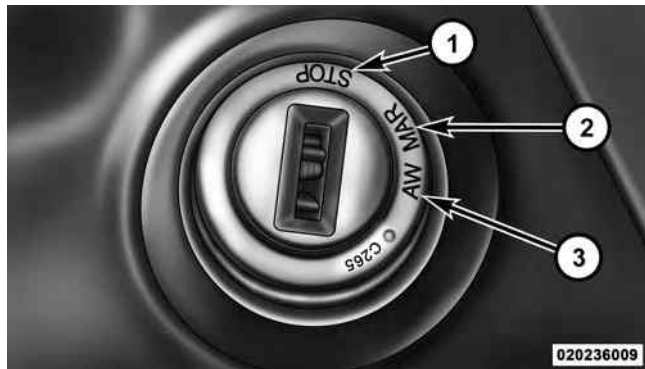

Ignition Switch Positions

1 — STOP (OFF/LOCK)

3 — AVV (START)

2 — MAR (ACC/ON/RUN)

WARNING!

- Before exiting a vehicle, always apply the parking brake, shift the transmission into PARK and remove the Key Fob from the vehicle. When leaving the vehicle, always lock your vehicle.
- Never leave children alone in a vehicle, or with access to an unlocked vehicle.
- Allowing children to be in a vehicle unattended is dangerous for a number of reasons. A child or others could be seriously or fatally injured. Children should be warned not to touch the parking brake, brake pedal or the gear selector.
- Do not leave the Key Fob in or near the vehicle, or in a location accessible to children. A child could operate power windows, other controls, or move the vehicle.

(Continued)

WARNING! (Continued)

- Do not leave children or animals inside parked vehicles in hot weather. Interior heat build-up may cause serious injury or death.

CAUTION!

An unlocked car is an invitation to thieves. Always remove the key from the ignition and lock all the doors when leaving the vehicle unattended.

Locking Doors With A Key

You can insert the key with either side up. To lock the door, turn the key to the left. To unlock the door, turn the key to the right. Refer to "Body Lubrication" in "Maintaining Your Vehicle" for maintenance procedures.

Key-In-Ignition Reminder

Opening the driver's door when the key is in the ignition and the ignition switch position is OFF/LOCK sounds a signal to remove the key.

SENTRY KEY®

The Sentry Key® Immobilizer System prevents unauthorized vehicle operation by disabling the engine. The system does not need to be armed or activated. Operation is automatic, regardless of whether the vehicle is locked or unlocked.

The system uses ignition keys which have an embedded electronic chip (transponder) to prevent unauthorized vehicle operation. Therefore, only keys that are programmed to the vehicle can be used to start and operate the vehicle.

NOTE: A key which has not been programmed is also considered an invalid key, even if it is cut to fit the ignition switch lock cylinder for that vehicle.

If the Vehicle Security Light is on after the key is turned to the ON/RUN position, it indicates that there is a problem with the electronics.

CAUTION!

- **Always remove the Sentry Key® from the vehicle and lock all doors when leaving the vehicle unattended.**
- **The Sentry Key® Immobilizer system is not compatible with some aftermarket remote starting systems. Use of these systems may result in vehicle starting problems and loss of security protection.**

All of the keys provided with your new vehicle have been programmed to the vehicle electronics.

Replacement Keys

NOTE: Only keys that have been programmed to the vehicle electronics can be used to start the vehicle. Once a Sentry Key® has been programmed to a vehicle, it cannot be programmed to any other vehicle. When having the Sentry Key® Immobilizer System serviced, bring all vehicle keys with you to an authorized dealer.

At the time of purchase, the original owner is provided with a five digit Personal Identification Number (PIN). This PIN is required for authorized dealer replacement of keys. Duplication of keys may be performed at an authorized dealer.

General Information

The Sentry Key® system complies with FCC rules part 15 and with RSS-210 of Industry Canada. Operation is subject to the following conditions:

- This device may not cause harmful interference.
- This device must accept any interference that may be received, including interference that may cause undesired operation.

NOTE: Changes or modifications not expressly approved by the party responsible for compliance could void the user's authority to operate the equipment.

REMOTE KEYLESS ENTRY (RKE) – IF EQUIPPED

This system allows you to lock or unlock the doors and liftgate from distances up to approximately 66 ft (20 m) using a hand-held Remote Keyless Entry (RKE) transmitter. The RKE transmitter does not need to be pointed at the vehicle to activate the system.



020274421

Remote Keyless Entry Transmitter With Mechanical Key Release Button

NOTE: The line of transmission must not be blocked with metal objects.

To Unlock The Doors And Liftgate

Push and release the UNLOCK button on the RKE transmitter once to unlock the driver's door or twice, within five seconds, to unlock all doors and the liftgate. The turn signal lights will flash to acknowledge the unlock signal. The illuminated entry system will also turn on.

Remote Key Unlock, Driver Door/All Doors 1st Press

This feature lets you program the system to unlock either the driver's door or all doors on the first push of the UNLOCK button on the RKE transmitter. To change the current setting, refer to "Personal Settings (Customer-Programmable Features)" in "Understanding Your Instrument Panel" for further information.

To Lock The Doors And Liftgate

Push and release the LOCK button on the RKE transmitter to lock all doors and the liftgate. The turn signal lights will flash and the horn will chirp to acknowledge the signal.

Programming Additional Transmitters

Refer to Sentry Key® "Customer Key Programming."

If you do not have a programmed RKE transmitter, contact your authorized dealer for details.

Transmitter Battery Replacement

NOTE: Perchlorate Material – special handling may apply. See www.dtsc.ca.gov/hazardouswaste/perchlorate

The recommended replacement battery is CR2032.

1. Push the mechanical key release button and release the mechanical key to access the battery case screw located on the side of the Key Fob.
2. Rotate the screw located on the side of the Key Fob using a small screwdriver.



020274421

Mechanical Key Release Button



021441822

Key Fob Screw Location

18 THINGS TO KNOW BEFORE STARTING YOUR VEHICLE

3. Take out the battery case. Remove and replace the battery observing its polarity.



021336637

Battery Case Removed

4. Refit the battery case inside the Key Fob and turn the screw to lock it into place.

General Information

This device complies with Part 15 of the FCC rules and RSS 210 of Industry Canada. Operation is subject to the following conditions:

- This device may not cause harmful interference.
- This device must accept any interference received, including interference that may cause undesired operation.

NOTE: Changes or modifications not expressly approved by the party responsible for compliance could void the user's authority to operate the equipment.

If your RKE transmitter fails to operate from a normal distance, check for these two conditions:

1. A weak battery in the transmitter. The expected life of the battery is a minimum of three years.
2. Closeness to a radio transmitter such as a radio station tower, airport transmitter, and some mobile or CB radios.

DOOR LOCKS

The door locks can be manually locked or unlocked from inside the vehicle by using the door handle. If the door handle is pushed a red lock indicator will show on the door handle (indicating locked) when the door is closed, the door will lock.



Driver's Door Lock Handle

WARNING!

- Do not leave children or animals inside parked vehicles in hot weather. Interior heat build-up may cause serious injury or death.
- For personal security and safety in the event of a collision, lock the vehicle doors as you drive as well as when you park and leave the vehicle.
- Before exiting a vehicle, always turn the ignition to the OFF/LOCK position, apply the parking brake, shift the transmission into REVERSE gear, and remove the Key Fob from the vehicle. When leaving the vehicle, always lock your vehicle.
- Never leave children alone in a vehicle, or with access to an unlocked vehicle.

(Continued)

WARNING! (Continued)

- Allowing children to be in a vehicle unattended is dangerous for a number of reasons. A child or others could be seriously or fatally injured. Children should be warned not to touch the parking brake, brake pedal or the gear selector.
- Do not leave the Key Fob in or near the vehicle, or in a location accessible to children. A child could operate power windows, other controls, or move the vehicle.

CAUTION!

An unlocked vehicle is an invitation to thieves. Always remove the key from the ignition and lock all of the doors when leaving the vehicle unattended.

Power Door Locks — If Equipped

A power door lock switch is incorporated into the driver door handle. Push or pull the handle to lock or unlock the doors and liftgate. If the driver's door handle is pushed a red lock indicator will show on the driver's door handle (indicating locked) when the door is closed, the door will lock.

NOTE: To prevent the key from being locked in the vehicle, the doors will automatically unlock if the driver's door handle is pushed when the key is in the ignition.







2

Driver's Power Door Lock Handle

Auto Door Locks

When enabled, the door locks will lock automatically when the vehicle's speed exceeds 15 mph (24 km/h).

To change the setting proceed as follows:

1. Briefly push the **MENU** button to enter the **MENU** screen.
2. Push the UP  or DOWN  button to highlight "Auto Door Locks". Push the **MENU** button, use the UP  or DOWN  buttons to turn setting ON or OFF
3. Briefly push the **MENU** button to go back to the menu screen, or push and hold the **MENU** button (approximately one second) to go back to the main screen without storing the settings.

NOTE: Use the Automatic Door Locks feature in accordance with local laws.

Refer to "Electronic Vehicle Information Center (EVIC)" in "Understanding Your Instrument Panel" in your owner manual on your DVD for further information.

POWER WINDOWS

Power Window Switches

There are single window controls located on the shifter bezel, below the climate controls, which operate the driver and passenger door windows. The window controls will operate when the ignition switch is in the ON/RUN position.

WARNING!

Never leave children unattended in a vehicle, and do not let children play with power windows. Do not leave the Key Fob in or near the vehicle, or in a location accessible to children. Occupants, particularly unattended children, can become entrapped by the windows while operating the power window switches. Such entrapment may result in serious injury or death.

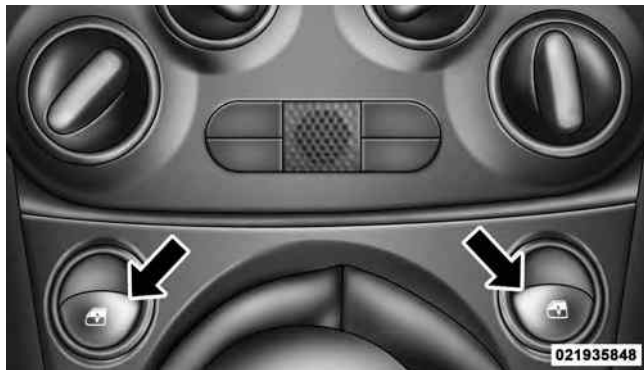

Power Window Switches

Auto-Down

The driver's door window switch has an Auto-Down feature. Push the window switch for approximately one second, release, and the window will go down automatically. To cancel the Auto-Down movement, operate the switch in either the up or down direction and release the switch.

Wind Buffeting

Wind buffeting can be described as the perception of pressure on the ears or a helicopter-type sound in the ears. Your vehicle may exhibit wind buffeting with the windows down, or the sunroof (if equipped) in certain open or partially open positions. This is a normal occurrence and can be minimized. If the buffeting occurs with the sunroof open, adjust the sunroof opening to minimize the buffeting or open any window.

LIFTGATE

To unlock the liftgate, use the Remote Keyless Entry (RKE) transmitter or activate the power door lock switches located on the driver door handle.

To open the liftgate, squeeze the liftgate release handle and pull the liftgate open with one fluid motion.



022235849

Liftgate Handle

WARNING!

- Driving with the liftgate open can allow poisonous exhaust gases into your vehicle. You and your passengers could be injured by these fumes. Keep the liftgate closed when you are operating the vehicle.
- If you are required to drive with the liftgate open, make sure that all windows are closed, and the climate control blower switch is set at high speed. Do not use the recirculation mode.

NOTE: Gas props support the liftgate in the open position. However, because the gas pressure drops with temperature, it may be necessary to assist the props when opening the liftgate in cold weather.

OCCUPANT RESTRAINT SYSTEMS

Some of the most important safety features in your vehicle are the restraint systems:

- Seat Belt Systems
- Supplemental Restraint Systems (SRS) Air Bags
- Child Restraints

Important Safety Precautions

Please pay close attention to the information in this section. It tells you how to use your restraint system properly, to keep you and your passengers as safe as possible.

26 THINGS TO KNOW BEFORE STARTING YOUR VEHICLE

Here are some simple steps you can take to minimize the risk of harm from a deploying air bag:

1. Children 12 years old and under should always ride buckled up in a vehicle with a rear seat.
2. If a child from 2 to 12 years old (not in a rear-facing child restraint) must ride in the front passenger seat, move the seat as far back as possible and use the proper child restraint. (Refer to "Child Restraints")
3. Children that are not big enough to wear the vehicle seat belt properly (Refer to "Child Restraints") should be secured in a vehicle with a rear seat in child restraints or belt-positioning booster seats. Older children who do not use child restraints or belt-positioning booster seats should ride properly buckled up in a vehicle with a rear seat.
4. Never allow children to slide the shoulder belt behind them or under their arm.
5. You should read the instructions provided with your child restraint to make sure that you are using it properly.
6. All occupants should always wear their lap and shoulder belts properly.
7. The driver and front passenger seats should be moved back as far as practical to allow the Advanced Front Air Bags room to inflate.
8. Do not lean against the door or window. If your vehicle has side air bags, and deployment occurs, the side air bags will inflate forcefully into the space between you and the door and you could be injured.
9. If the air bag system in this vehicle needs to be modified to accommodate a disabled person, contact the Customer Center. Phone numbers are provided under "If You Need Assistance."

WARNING!

- Never place a rear-facing child restraint in front of an air bag. A deploying Passenger Advanced Front Air Bag can cause death or serious injury to a child 12 years or younger, including a child in a rear-facing child restraint.
- Only use rear-facing child restraint in a vehicle with a rear seat.

Seat Belt Systems

Buckle up even though you are an excellent driver, even on short trips. Someone on the road may be a poor driver and could cause a collision that includes you. This can happen far away from home or on your own street.

Research has shown that seat belts save lives, and they can reduce the seriousness of injuries in a collision. Some of the worst injuries happen when people are thrown from the vehicle. Seat belts reduce the possibility of

ejection and the risk of injury caused by striking the inside of the vehicle. Everyone in a motor vehicle should be belted at all times.

Enhanced Seat Belt Use Reminder System (BeltAlert)

 BeltAlert is a feature intended to remind the driver and outboard front passenger (if equipped with outboard front passenger BeltAlert) to buckle their seat belts. The feature is active whenever the ignition switch is in the START or ON/RUN position. If the driver or outboard front seat passenger is unbelted, the Seat Belt Reminder Light will turn on and remain on until both outboard front seat belts are buckled.

The BeltAlert warning sequence begins after the vehicle speed is over 5 mph (8 km/h) by blinking the Seat Belt Reminder Light and sounding an intermittent chime. Once the sequence starts, it will continue for the entire duration or until the respective seat belts are buckled.

After the sequence completes, the Seat Belt Reminder Light remains illuminated until the respective seat belts are buckled. The driver should instruct all other occupants to buckle their seat belts. If an outboard front seat belt is unbuckled while traveling at speeds greater than 5 mph (8 km/h), BeltAlert will provide both audio and visual notification.

The outboard front passenger seat BeltAlert is not active when the outboard front passenger seat is unoccupied. BeltAlert may be triggered when an animal or heavy object is on the outboard front passenger seat or when the seat is folded flat (if equipped). It is recommended that pets be restrained in the rear seat (if equipped) in pet harnesses or pet carriers that are secured by seat belts, and cargo is properly stowed.

BeltAlert can be activated or deactivated by your authorized dealer. Chrysler Group LLC does not recommend deactivating BeltAlert.

NOTE: If BeltAlert has been deactivated, the Seat Belt Reminder Light will continue to illuminate while the driver's or outboard front passenger's (if equipped with BeltAlert) seat belt remains unbuckled.

Lap/Shoulder Belts

All seating positions in your vehicle are equipped with lap/shoulder belts.

The seat belt webbing retractor will lock only during very sudden stops or collisions. This feature allows the shoulder part of the seat belt to move freely with you under normal conditions. However, in a collision the seat belt will lock and reduce your risk of striking the inside of the vehicle or being thrown out of the vehicle.

WARNING!

- Relying on the air bags alone could lead to more severe injuries in a collision. The air bags work with your seat belt to restrain you properly. In some collisions, the air bags won't deploy at all. Always wear your seat belt even though you have air bags.
- In a collision, you and your passengers can suffer much greater injuries if you are not properly buckled up. You can strike the interior of your vehicle or other passengers, or you can be thrown out of the vehicle. Always be sure you and others in your vehicle are buckled up properly.
- It is dangerous to ride in a cargo area, inside or outside of a vehicle. In a collision, people riding in these areas are more likely to be seriously injured or killed.

(Continued)

WARNING! (Continued)

- Do not allow people to ride in any area of your vehicle that is not equipped with seats and seat belts.
- Be sure everyone in your vehicle is in a seat and using a seat belt properly.
- Wearing your seat belt incorrectly could make your injuries in a collision much worse. You might suffer internal injuries, or you could even slide out of the seat belt. Follow these instructions to wear your seat belt safely and to keep your passengers safe, too.
- Two people should never be belted into a single seat belt. People belted together can crash into one another in a collision, hurting one another badly. Never use a lap/shoulder belt or a lap belt for more than one person, no matter what their size.

(Continued)

WARNING! (Continued)

- A lap belt worn too high can increase the risk of injury in a collision. The seat belt forces won't be at the strong hip and pelvic bones, but across your abdomen. Always wear the lap part of your seat belt as low as possible and keep it snug.
- A twisted seat belt may not protect you properly. In a collision, it could even cut into you. Be sure the seat belt is flat against your body, without twists. If you can't straighten a seat belt in your vehicle, take it to your authorized dealer immediately and have it fixed.
- A seat belt that is buckled into the wrong buckle will not protect you properly. The lap portion could ride too high on your body, possibly causing internal injuries. Always buckle your seat belt into the buckle nearest you.

(Continued)

WARNING! (Continued)

- A seat belt that is too loose will not protect you properly. In a sudden stop, you could move too far forward, increasing the possibility of injury. Wear your seat belt snugly.
- A seat belt that is worn under your arm is dangerous. Your body could strike the inside surfaces of the vehicle in a collision, increasing head and neck injury. A seat belt worn under the arm can cause internal injuries. Ribs aren't as strong as shoulder bones. Wear the seat belt over your shoulder so that your strongest bones will take the force in a collision.

(Continued)

WARNING! (Continued)

- A shoulder belt placed behind you will not protect you from injury during a collision. You are more likely to hit your head in a collision if you do not wear your shoulder belt. The lap and shoulder belt are meant to be used together.
- A frayed or torn seat belt could rip apart in a collision and leave you with no protection. Inspect the seat belt system periodically, checking for cuts, frays, or loose parts. Damaged parts must be replaced immediately. Do not disassemble or modify the seat belt system. Seat belt assemblies must be replaced after a collision.

Lap/Shoulder Belt Operating Instructions

1. Enter the vehicle and close the door. Sit back and adjust the seat.
2. The seat belt latch plate is above the back of the front seat, and next to your arm in the rear seat (for vehicles equipped with a rear seat). Grasp the latch plate and pull out the seat belt. Slide the latch plate up the webbing as far as necessary to allow the seat belt to go around your lap.

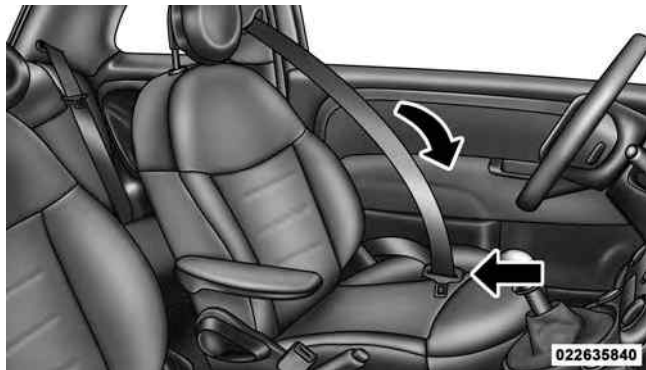

Pulling Out The Latch Plate

3. When the seat belt is long enough to fit, insert the latch plate into the buckle until you hear a “click.”



Inserting Latch Plate Into Buckle

4. Position the lap belt so that it is snug and lies low across your hips, below your abdomen. To remove slack in the lap belt portion, pull up on the shoulder belt. To loosen the lap belt if it is too tight, tilt the latch plate and pull on the lap belt. A snug seat belt reduces the risk of sliding under the seat belt in a collision.

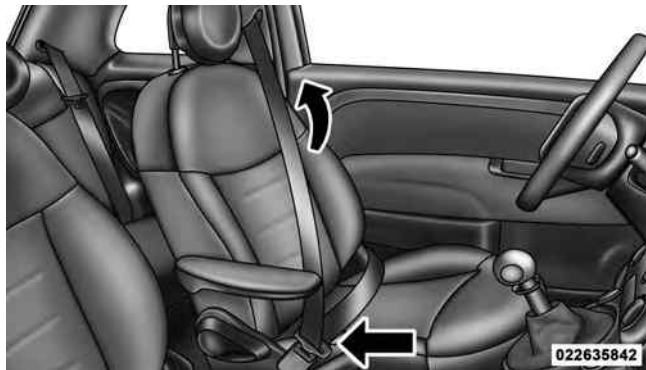

Positioning The Lap Belt

5. Position the shoulder belt across the shoulder and chest with minimal, if any slack so that it is comfortable and not resting on your neck. The retractor will withdraw any slack in the shoulder belt.

6. To release the seat belt, push the red button on the buckle. The seat belt will automatically retract to its stowed position. If necessary, slide the latch plate down the webbing to allow the seat belt to retract fully.

Lap/Shoulder Belt Untwisting Procedure

Use the following procedure to untwist a twisted lap/shoulder belt.

1. Position the latch plate as close as possible to the anchor point.
2. At about 6 to 12 inches (15 to 30 cm) above the latch plate, grasp and twist the seat belt webbing 180° to create a fold that begins immediately above the latch plate.

34 THINGS TO KNOW BEFORE STARTING YOUR VEHICLE

3. Slide the latch plate upward over the folded webbing. The folded webbing must enter the slot at the top of the latch plate.
4. Continue to slide the latch plate up until it clears the folded webbing and the seat belt is no longer twisted.

Seat Belt Extender

If a seat belt is not long enough to fit properly, even when the webbing is fully extended and the adjustable upper shoulder belt anchorage (if equipped) is in its lowest position, your authorized dealer can provide you with a Seat Belt Extender. The Seat Belt Extender should be used only if the existing seat belt is not long enough. When the Seat Belt Extender is not required for a different occupant, it must be removed.

WARNING!

- **ONLY** use a Seat Belt Extender if it is physically required in order to properly fit the original seat belt system. **DO NOT USE** the Seat Belt Extender if, when worn, the distance between the front edge of the Seat Belt Extender buckle and the center of the occupant's body is **LESS** than 6 inches.
- Using a Seat Belt Extender when not needed can increase the risk of serious injury or death in a collision. Only use the Seat Belt Extender when the lap belt is not long enough and only use in the recommended seating positions. Remove and store the Seat Belt Extender when not needed.

Seat Belts And Pregnant Women

We recommend that pregnant women use the seat belts throughout their pregnancy. Keeping the mother safe is the best way to keep the baby safe.

Pregnant women should wear the lap part of the seat belt across the thighs and as snug across the hips as possible. Keep the seat belt low so that it does not come across the abdomen. That way the strong bones of the hips will take the force if there is a collision.

Seat Belt Pretensioner

The front seat belt system is equipped with pretensioning devices that are designed to remove slack from the seat belt in the event of a collision. These devices may improve the performance of the seat belt by removing slack from the seat belt early in a collision. Pretensioners work for all size occupants, including those in child restraints.

NOTE: These devices are not a substitute for proper seat belt placement by the occupant. The seat belt still must be worn snugly and positioned properly.

The pretensioners are triggered by the Occupant Restraint Controller (ORC). Like the air bags, the pretensioners are single use items. A deployed pretensioner or a deployed air bag must be replaced immediately.



Energy Management Feature

This vehicle has a seat belt system with an Energy Management feature in the front seating positions that may help further reduce the risk of injury in the event of a collision. This seat belt system has a retractor assembly that is designed to release webbing in a controlled manner.

Switchable Automatic Locking Retractor (ALR) — If Equipped

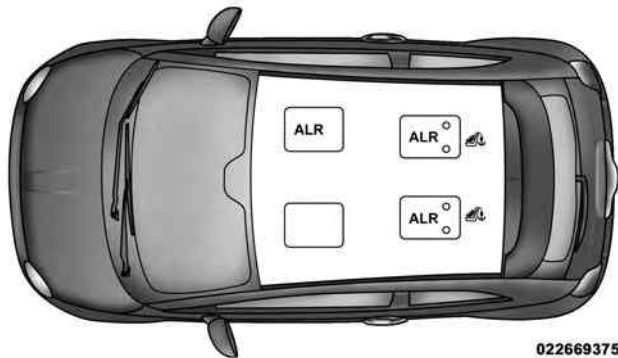
The seat belts in the passenger seating positions may be equipped with a switchable Automatic Locking Retractor (ALR) which is used to secure a child restraint system. For additional information, refer to “Installing Child Restraints Using The Vehicle Seat Belt” under the “Child Restraints” section of this manual. The table below defines the type of feature for each seating position.



-  Lower Anchorage Symbol 2 anchorages per seating position
-  Top Tether Anchorage Symbol

	Driver	Center	Passenger
First Row	N/A	N/A	ALR
Second Row	ALR	N/A	ALR

- N/A — Not Applicable
- ALR — Automatic Locking Retractor

If the passenger seating position is equipped with an ALR and is being used for normal usage:

Only pull the seat belt webbing out far enough to comfortably wrap around the occupant's mid-section so as to not activate the ALR. If the ALR is activated, you will hear a clicking sound as the seat belt retracts. Allow the webbing to retract completely in this case and then carefully pull out only the amount of webbing necessary to comfortably wrap around the occupant's mid-section. Slide the latch plate into the buckle until you hear a "click."

In Automatic Locking Mode, the shoulder belt is automatically pre locked. The seat belt will still retract to remove any slack in the shoulder belt. The Automatic Locking Mode is available on all passenger seating positions with a combination lap/shoulder belt. Use the Automatic Locking Mode anytime a child restraint is installed in a seating position that has a seat belt with this feature. Children 12 years old and under should always be properly restrained in a vehicle with a rear seat.

WARNING!

- **Never place a rear-facing child restraint in front of an air bag. A deploying Passenger Advanced Front Air Bag can cause death or serious injury to a child 12 years or younger, including a child in a rear-facing child restraint.**
- **Only use rear-facing child restraint in a vehicle with a rear seat.**

How To Engage The Automatic Locking Mode

1. Buckle the combination lap and shoulder belt.
2. Grasp the shoulder portion and pull downward until the entire seat belt is extracted.
3. Allow the seat belt to retract. As the seat belt retracts, you will hear a clicking sound. This indicates the seat belt is now in the Automatic Locking Mode.

How To Disengage The Automatic Locking Mode

Unbuckle the combination lap/shoulder belt and allow it to retract completely to disengage the Automatic Locking Mode and activate the vehicle sensitive (emergency) locking mode.

WARNING!

- The seat belt assembly must be replaced if the switchable Automatic Locking Retractor (ALR) feature or any other seat belt function is not working properly when checked according to the procedures in the Service Manual.
- Failure to replace the seat belt assembly could increase the risk of injury in collisions.
- Do not use the Automatic Locking Mode to restrain occupants who are wearing the seat belt or children who are using booster seats. The locked mode is only used to install rear-facing or forward-facing child restraints that have a harness for restraining the child.

Supplemental Restraint System (SRS)

Air Bag System Components

Your vehicle may be equipped with the following air bag system components:

- Occupant Restraint Controller (ORC)
- Air Bag Warning Light 
- Steering Wheel and Column
- Instrument Panel
- Knee Impact Bolsters
- Advanced Front Air Bags
- Supplemental Side Air Bags

- Supplemental Knee Air Bag
- Front and Side Impact Sensors
- Seat Belt Pretensioners
- Seat Belt Buckle Switch
- Seat Track Position Sensors

Advanced Front Air Bags

This vehicle has Advanced Front Air Bags for both the driver and front passenger as a supplement to the seat belt restraint systems. The driver's Advanced Front Air Bag is mounted in the center of the steering wheel. The passenger's Advanced Front Air Bag is mounted in the instrument panel, above the glove compartment. The words SRS AIRBAG are embossed on the air bag covers.



Advanced Front Air Bag And Knee Bolster Locations

- 1 — Driver And Passenger Advanced Front Air Bags
2 — Passenger Knee Impact Bolster
3 — Supplemental Driver Side Knee Air Bag/Driver Knee Impact Bolster

WARNING!

- Being too close to the steering wheel or instrument panel during Advanced Front Air Bag deployment could cause serious injury, including death. Air bags need room to inflate. Sit back, comfortably extending your arms to reach the steering wheel or instrument panel.
- Never place a rear-facing child restraint in front of an air bag. A deploying Passenger Advanced Front Air Bag can cause death or serious injury to a child 12 years or younger, including a child in a rear-facing child restraint.
- Only use a rear-facing child restraint in a vehicle with a rear seat.

Advanced Front Air Bag Features

The Advanced Front Air Bag system has multistage driver and front passenger air bags. This system provides output appropriate to the severity and type of collision as determined by the Occupant Restraint Controller (ORC), which may receive information from the front impact sensors or other system components.

The first stage inflator is triggered immediately during an impact that requires air bag deployment. A low energy output is used in less severe collisions. A higher energy output is used for more severe collisions.

This vehicle may be equipped with driver and/or front passenger seat track position sensors that may adjust the inflation rate of the Advanced Front Air Bags based upon seat position.

This vehicle may be equipped with a driver and/or front passenger seat belt buckle switch that detects whether

the driver or front passenger seat belt is buckled. The seat belt buckle switch may adjust the inflation rate of the Advanced Front Air Bags.

WARNING!

- **No objects should be placed over or near the air bag on the instrument panel or steering wheel, because any such objects could cause harm if the vehicle is in a collision severe enough to cause the air bags to inflate.**
- **Do not put anything on or around the air bag covers or attempt to open them manually. You may damage the air bags and you could be injured because the air bags may no longer be functional. The protective covers for the air bag cushions are designed to open only when the air bags are inflating.**

(Continued)

WARNING! (Continued)

- **Relying on the air bags alone could lead to more severe injuries in a collision. The air bags work with your seat belt to restrain you properly. In some collisions, air bags won't deploy at all. Always wear your seat belts even though you have air bags.**

Advanced Front Air Bag Operation

Advanced Front Air Bags are designed to provide additional protection by supplementing the seat belts. Advanced Front Air Bags are not expected to reduce the risk of injury in rear, side, or rollover collisions. The Advanced Front Air Bags will not deploy in all frontal collisions, including some that may produce substantial vehicle damage — for example, some pole collisions, truck underrides, and angle offset collisions.

On the other hand, depending on the type and location of impact, Advanced Front Air Bags may deploy in crashes with little vehicle front-end damage but that produce a severe initial deceleration.

Because air bag sensors measure vehicle deceleration over time, vehicle speed and damage by themselves are not good indicators of whether or not an air bag should have deployed.

Seat belts are necessary for your protection in all collisions, and also are needed to help keep you in position, away from an inflating air bag.

When the ORC detects a collision requiring the Advanced Front Air Bags, it signals the inflator units. A large quantity of non-toxic gas is generated to inflate the Advanced Front Air Bags.

The steering wheel hub trim cover and the upper right side of the instrument panel separate and fold out of the way as the air bags inflate to their full size. The Advanced Front Air Bags fully inflate in less time than it takes to blink your eyes. The air bags then quickly deflate while helping to restrain the driver and front passenger.

Knee Impact Bolsters

The Knee Impact Bolsters help protect the knees of the driver and front passenger, and position the front occupants for improved interaction with the Advanced Front Air Bags.

WARNING!

- **Do not drill, cut, or tamper with the knee impact bolsters in any way.**
- **Do not mount any accessories to the knee impact bolsters such as alarm lights, stereos, citizen band radios, etc.**

Supplemental Driver Knee Air Bag

This vehicle is equipped with a Supplemental Driver Knee Air Bag mounted in the instrument panel below the steering column.

The Supplemental Driver Knee Air Bag provides enhanced protection during a frontal impact by working together with the seat belts, pretensioners, and Advanced Front Air Bags.

Supplemental Side Air Bags

Your vehicle is equipped with two types of side air bags:

- **Supplemental Seat-Mounted Side Air Bags (SABs):** Located in the outboard side of the front seats. The SABs are marked with a SRS AIRBAG label sewn into the outboard side of the seats.

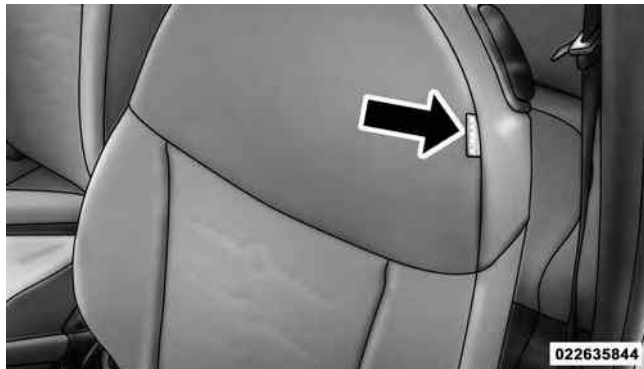

Supplemental Seat-Mounted Side Air Bag Label

The SABs may help to reduce the risk of occupant injury during certain side impacts, in addition to the injury reduction potential provided by the seat belts and body structure.

When the SAB deploys, it opens the seam on the out-board side of the seatback's trim cover. The inflating SAB deploys through the seat seam into the space between the occupant and the door. The SAB moves at a very high speed and with such a high force that it could injure you if you are not seated properly, or if items are positioned in the area where the SAB inflates. Children are at an even greater risk of injury from a deploying air bag.

WARNING!

Do not use accessory seat covers or place objects between you and the Side Air Bags; the performance could be adversely affected and/or objects could be pushed into you, causing serious injury.

- **Supplemental Side Air Bag Inflatable Curtains (SABICs):** Located above the side windows. The trim covering the SABICs is labeled SRS AIRBAG.

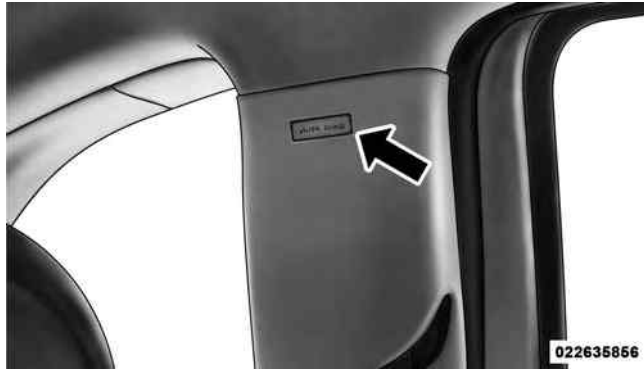

**Supplemental Side Air Bag Inflatable Curtain (SABIC)
Label Location**

SABICs may help reduce the risk of head injury to front and rear seat outboard occupants in certain side impacts. SABICs may reduce the risk of injuries in certain side impacts, in addition to the injury reduction potential provided by the seat belts and body structure.

The SABIC deploys downward, covering the side windows. An inflating SABIC pushes the outside edge of the headliner out of the way and covers the window. The SABICs inflate with enough force to injure you if you are not belted and seated properly, or if items are positioned in the area where the SABICs inflate. Children are at an even greater risk of injury from a deploying air bag.

The SABICs may help reduce the risk of partial or complete ejection of vehicle occupants through side windows in certain side impact events.

WARNING!

- **Your vehicle is equipped with left and right Supplemental Side Air Bag Inflatable Curtains (SABICs). Do not stack luggage or other cargo up high enough to block the deployment of the SABICs. The trim covering above the side windows where the SABIC and its deployment path are located should remain free from any obstructions.**
- **Your vehicle is equipped with SABICs. In order for the SABICs to work as intended, do not install any accessory items in your vehicle which could alter the roof. Do not add an aftermarket sunroof to your vehicle. Do not add roof racks that require permanent attachments (bolts or screws) for installation on the vehicle roof. Do not drill into the roof of the vehicle for any reason.**

The SABICs and SABs (“Side Air Bags”) are designed to activate in certain side impacts. The Occupant Restraint Controller (“ORC”) determines whether the deployment of the Side Air Bags in a particular impact event is appropriate, based on the severity and type of collision. The side impact sensors aid the ORC in determining the appropriate response to impact events. The system is calibrated to deploy the Side Air Bags on the impact side of the vehicle during impacts that require Side Air Bag occupant protection. In side impacts, the Side Air Bags deploy independently; a left side impact deploys the left Side Air Bags only and a right-side impact deploys the right Side Air Bags only. Vehicle damage by itself is not a good indicator of whether or not Side Air Bags should have deployed.

The Side Air Bags will not deploy in all side collisions, including some collisions at certain angles, or some side collisions that do not impact the area of the passenger

compartment. The Side Air Bags may deploy during angled or offset frontal collisions where the Advanced Front Air Bags deploy.

Side Air Bags are a supplement to the seat belt restraint system. Side Air Bags deploy in less time than it takes to blink your eyes. Occupants, including children, who are up against or very close to Side Air Bags can be seriously injured or killed. Occupants, including children, should never lean on or sleep against the door, side windows, or area where the Side Air Bags inflate, even if they are in an infant or child restraint.

Seat belts (and child restraints where appropriate) are necessary for your protection in all collisions. They also help keep you in position, away from inflating Side Air Bags. To get the best protection from the Side Air Bags, occupants must wear their seat belts properly and sit upright with their backs against the seats. Children must be properly restrained in a child restraint or booster seat that is appropriate for the size of the child.

WARNING!

- **Side Air Bags need room to inflate. Do not lean against the door or window. Sit upright in the center of the seat.**
- **Being too close to the Side Air Bags during deployment could cause you to be severely injured or killed.**
- **Relying on the Side Air Bags alone could lead to more severe injuries in a collision. The Side Air Bags work with your seat belt to restrain you properly. In some collisions, Side Air Bags won't deploy at all. Always wear your seat belt even though you have Side Air Bags.**

NOTE: Air bag covers may not be obvious in the interior trim, but they will open during air bag deployment.

If A Deployment Occurs

The Advanced Front Air Bags are designed to deflate immediately after deployment.

NOTE: Front and/or side air bags will not deploy in all collisions. This does not mean something is wrong with the air bag system.

If you do have a collision, which deploys the air bags, any or all of the following may occur:

- The air bag material may sometimes cause abrasions and/or skin reddening to the occupants as the air bags deploy and unfold. The abrasions are similar to friction rope burns or those you might get sliding along a carpet or gymnasium floor. They are not caused by contact with chemicals. They are not permanent and normally heal quickly. However, if you haven't healed significantly within a few days, or if you have any blistering, see your doctor immediately.

- As the air bags deflate, you may see some smoke-like particles. The particles are a normal by-product of the process that generates the non-toxic gas used for air bag inflation. These airborne particles may irritate the skin, eyes, nose, or throat. If you have skin or eye irritation, rinse the area with cool water. For nose or throat irritation, move to fresh air. If the irritation continues, see your doctor. If these particles settle on your clothing, follow the garment manufacturer's instructions for cleaning.

Do not drive your vehicle after the air bags have deployed. If you are involved in another collision, the air bags will not be in place to protect you.

WARNING!

Deployed air bags and seat belt pretensioners cannot protect you in another collision. Have the air bags, seat belt pretensioners, and the seat belt retractor assemblies replaced by an authorized dealer immediately. Also, have the Occupant Restraint Controller System serviced as well.

NOTE:

- Air bag covers may not be obvious in the interior trim, but they will open during air bag deployment.
- After any collision, the vehicle should be taken to an authorized dealer immediately.

Enhanced Accident Response System

In the event of an impact, if the communication network remains intact, and the power remains intact, depending on the nature of the event, the ORC will determine whether to have the Enhanced Accident Response System perform the following functions:

- Cut off fuel to the engine.
- Flash hazard lights as long as the battery has power or until the ignition switch is turned to the “OFF” position.
- Turn on the interior lights, which remain on as long as the battery has power or until the ignition switch is turned to the “OFF” position.
- Unlock the doors automatically.

System Reset Procedure

Depending on the nature of the event the left and right turn signal lights, located in the instrument panel cluster, may both be blinking and will continue to blink until the

ignition switch is turned to the OFF position. In order to move your vehicle to the side of the road, you must follow the system reset procedure.

Customer Action	Customer Will See
1. Turn ignition OFF. (Turn Signal Switch Must be placed in Neutral State).	
2. Turn ignition ON.	Left Turn Light is OFF. Right Turn Light BLINKS.
3. Turn Right Turn Signal Switch ON.	Right Turn Light is ON SOLID. Left Turn Light BLINKS.
4. Turn Left Turn Signal Switch ON.	Left Turn Light is ON SOLID. Right Turn Light BLINKS.
5. Turn Right Turn Signal Switch ON.	Right Turn Light is ON SOLID. Left Turn Light BLINKS.
6. Turn Left Turn Signal Switch ON.	Left Turn Light is ON SOLID. Right Turn Light is ON SOLID.

Customer Action	Customer Will See
7. Turn Left Turn Signal Switch OFF. (Turn Signal Switch Must be placed in Neutral State).	Left Turn Light is OFF. Right Turn Light is OFF.
8. Turn ignition OFF.	System is now reset and the engine may be started.
9. Turn Hazard Flashers OFF (Manually).	

If a reset procedure step is not completed within 45 seconds, then the turn signal lights will turn off and the reset procedure must be performed again in order to be successful.

Air Bag Warning Light



The air bags must be ready to inflate for your protection in a collision. The Occupant Restraint Controller (ORC) monitors the internal circuits and interconnecting wiring associated with air bag system electrical components.

The ORC monitors the readiness of the electronic parts of the air bag system whenever the ignition switch is in the START or ON/RUN position. If the ignition switch is in the OFF position, the air bag system is not on and the air bags will not inflate.

The ORC contains a backup power supply system that may deploy the air bags even if the battery loses power or it becomes disconnected prior to deployment.

The ORC turns on the Air Bag Warning Light in the instrument panel for approximately four to eight seconds for a self-check when the ignition switch is first turned to the ON/RUN position. After the self-check, the Air Bag

Warning Light will turn off. If the ORC detects a malfunction in any part of the system, it turns on the Air Bag Warning Light, either momentarily or continuously. A single chime will sound to alert you if the light comes on again after initial startup.

The ORC also includes diagnostics that will illuminate the instrument panel Air Bag Warning Light if a malfunction is detected that could affect the air bag system. The diagnostics also record the nature of the malfunction. While the air bag system is designed to be maintenance free, if any of the following occurs, have an authorized dealer service the air bag system immediately.

- The Air Bag Warning Light does not come on during the four to eight seconds when the ignition switch is first turned to the ON/RUN position.
- The Air Bag Warning Light remains on after the four to eight-second interval.

- The Air Bag Warning Light comes on intermittently or remains on while driving.

NOTE: If the speedometer, tachometer, or any engine related gauges are not working, the Occupant Restraint Controller (ORC) may also be disabled. In this condition the air bags may not be ready to inflate for your protection. Have an authorized dealer service the air bag system immediately.

WARNING!

Ignoring the Air Bag Warning Light in your instrument panel could mean you won't have the air bags to protect you in a collision. If the light does not come on as a bulb check when the ignition is first turned on, stays on after you start the vehicle, or if it comes on as you drive, have an authorized dealer service the air bag system immediately.

Maintaining Your Air Bag System

WARNING!

- Modifications to any part of the air bag system could cause it to fail when you need it. You could be injured if the air bag system is not there to protect you. Do not modify the components or wiring, including adding any kind of badges or stickers to the steering wheel hub trim cover or the upper right side of the instrument panel. Do not modify the front bumper, vehicle body structure, or add aftermarket side steps or running boards.
- It is dangerous to try to repair any part of the air bag system yourself. Be sure to tell anyone who works on your vehicle that it has an air bag system.

(Continued)

WARNING! (Continued)

- Do not attempt to modify any part of your air bag system. The air bag may inflate accidentally or may not function properly if modifications are made. Take your vehicle to an authorized dealer for any air bag system service. If your seat, including your trim cover and cushion, needs to be serviced in any way (including removal or loosening/tightening of seat attachment bolts), take the vehicle to your authorized dealer. Only manufacturer approved seat accessories may be used. If it is necessary to modify the air bag system for persons with disabilities, contact your authorized dealer.

Event Data Recorder (EDR)

This vehicle is equipped with an event data recorder (EDR). The main purpose of an EDR is to record, in certain crash or near crash-like situations, such as an air bag deployment or hitting a road obstacle, data that will assist in understanding how a vehicle's systems performed. The EDR is designed to record data related to vehicle dynamics and safety systems for a short period of time, typically 30 seconds or less. The EDR in this vehicle is designed to record such data as:

- How various systems in your vehicle were operating;
- Whether or not the driver and passenger safety belts were buckled/fastened;
- How far (if at all) the driver was pushing the accelerator and/or brake pedal; and,
- How fast the vehicle was traveling.

These data can help provide a better understanding of the circumstances in which crashes and injuries occur.

NOTE: EDR data are recorded by your vehicle only if a non-trivial crash situation occurs; no data are recorded by the EDR under normal driving conditions and no personal data (e.g., name, gender, age, and crash location) are recorded. However, other parties, such as law enforcement, could combine the EDR data with the type of personally identifying data routinely acquired during a crash investigation.

To read data recorded by an EDR, special equipment is required, and access to the vehicle or the EDR is needed. In addition to the vehicle manufacturer, other parties, such as law enforcement, that have the special equipment, can read the information if they have access to the vehicle or the EDR.

Child Restraints

Everyone in your vehicle needs to be buckled up at all times, including babies and children.

Every state in the United States, and every Canadian province, requires that small children ride in proper restraint systems. This is the law, and you can be prosecuted for ignoring it.

Children 12 years or younger should ride properly buckled up in a rear seat, if available. According to crash statistics, children are safer when properly restrained in the rear seats rather than in the front.

WARNING!

In a collision, an unrestrained child can become a projectile inside the vehicle. The force required to hold even an infant on your lap could become so

(Continued)

WARNING! (Continued)

great that you could not hold the child, no matter how strong you are. The child and others could be badly injured. Any child riding in your vehicle should be in a proper restraint for the child's size.

There are different sizes and types of restraints for children from newborn size to the child almost large enough for an adult seat belt. Always check the child seat Owner's Manual to make sure you have the correct seat for your child. Carefully read and follow all the instructions and warnings in the child restraint Owner's Manual and on all the labels attached to the child restraint.

Before buying any restraint system, make sure that it has a label certifying that it meets all applicable Safety Standards. You should also make sure that you can install it in the vehicle where you will use it.

NOTE:

- For additional information, refer to www.seatcheck.org or call 1-866-SEATCHECK (732-8243). Canadian residents should refer to Transport Canada's website for additional information:
- www.tc.gc.ca/eng/roadsafety/safedrivers-childsafety-index-53.htm

Summary Of Recommendations For Restraining Children In Vehicles

	Child Size, Height, Weight Or Age	Recommended Type Of Child Restraint
Infants and Toddlers	Children who are two years old or younger and who have not reached the height or weight limits of their child restraint	Either an Infant Carrier or a Convertible Child Restraint, facing rearward in the rear seat of the vehicle

	Child Size, Height, Weight Or Age	Recommended Type Of Child Restraint
Small Children	Children who are at least two years old or who have out-grown the height or weight limit of their rear-facing child restraint	Forward-Facing Child Restraint with a five-point Harness, facing forward in the rear seat of the vehicle
Larger Children	Children who have out-grown their forward-facing child restraint, but are too small to properly fit the vehicle's seat belt	Belt Positioning Booster Seat and the vehicle seat belt, seated in the rear seat of the vehicle
Children Too Large for Child Restraints	Children 12 years old or younger, who have out-grown the height or weight limit of their booster seat	Vehicle Seat Belt, seated in the rear seat of the vehicle

Infants And Child Restraints

Safety experts recommend that children ride rear-facing in the vehicle until they are two years old or until they reach either the height or weight limit of their rear-facing child restraint. Two types of child restraints can be used rear-facing: infant carriers and convertible child seats.

The infant carrier is only used rear-facing in the vehicle. It is recommended for children from birth until they reach the weight or height limit of the infant carrier. Convertible child seats can be used either rear-facing or forward-facing in the vehicle. Convertible child seats often have a higher weight limit in the rear-facing direction than infant carriers do, so they can be used rear-facing by children who have outgrown their infant carrier but are still less than at least two years old.

Children should remain rear-facing until they reach the highest weight or height allowed by their convertible child seat.

WARNING!

- **Never place a rear-facing child restraint in front of an air bag. A deploying passenger Advanced Front Air Bag can cause death or serious injury to a child 12 years or younger, including a child in a rear-facing child restraint.**
- **Only use a rear-facing child restraint in a vehicle with a rear seat.**

Older Children And Child Restraints

Children who are two years old or who have outgrown their rear-facing convertible child seat can ride forward-facing in the vehicle. Forward-facing child seats and convertible child seats used in the forward-facing direction are for children who are over two years old or who have outgrown the rear-facing weight or height limit of their rear-facing convertible child seat. Children should remain in a forward-facing child seat with a harness for as long as possible, up to the highest weight or height allowed by the child seat.

All children whose weight or height is above the forward-facing limit for the child seat should use a belt-positioning booster seat until the vehicle's seat belts fit properly. If the child cannot sit with knees bent over the vehicle's seat cushion while the child's back is against the seatback, they should use a belt-positioning booster seat. The child and belt-positioning booster seat are held in the vehicle by the seat belt.

WARNING!

- **Improper installation can lead to failure of an infant or child restraint. It could come loose in a collision. The child could be badly injured or killed. Follow the child restraint manufacturer's directions exactly when installing an infant or child restraint.**
- **After a child restraint is installed in the vehicle, do not move the vehicle seat forward or rearward because it can loosen the child restraint attachments. Remove the child restraint before adjusting the vehicle seat position. When the vehicle seat has been adjusted, reinstall the child restraint.**
- **When your child restraint is not in use, secure it in the vehicle with the seat belt or LATCH anchorages, or remove it from the vehicle. Do not leave it loose in the vehicle. In a sudden stop or accident, it could strike the occupants or seatbacks and cause serious personal injury.**

Children Too Large For Booster Seats

Children who are large enough to wear the shoulder belt comfortably, and whose legs are long enough to bend over the front of the seat when their back is against the seatback, should use the seat belt in a rear seat. Use this simple 5-step test to decide whether the child can use the vehicle's seat belt alone:

1. Can the child sit all the way back against the back of the vehicle seat?
2. Do the child's knees bend comfortably over the front of the vehicle seat – while they are still sitting all the way back?
3. Does the shoulder belt cross the child's shoulder between their neck and arm?
4. Is the lap part of the seat belt as low as possible, touching the child's thighs and not their stomach?
5. Can the child stay seated like this for the whole trip?

If the answer to any of these questions was “no,” then the child still needs to use a booster seat in this vehicle. If the child is using the lap/shoulder belt, check belt fit periodically and make sure the seat belt buckle is latched. A child's squirming or slouching can move the seat belt out of position. If the shoulder belt contacts the face or neck, move the child closer to the center of the vehicle, or use a booster seat to position the seat belt on the child correctly.

WARNING!

Never allow a child to put the shoulder belt under an arm or behind their back. In a crash, the shoulder belt will not protect a child properly, which may result in serious injury or death. A child must always wear both the lap and shoulder portions of the seat belt correctly.

Recommendations For Attaching Child Restraints

Restraint Type	Combined Weight of the Child + Child Restraint	Use any attachment method shown with an "X" Below			
		LATCH – Lower Anchors Only	Seat Belt Only	LATCH – Lower Anchors + Top Tether Anchor	Seat Belt + Top Tether Anchor
Rear-Facing Child Restraint	Up to 65 lbs (29.5 kg)	X	X		
Rear-Facing Child Restraint	More than 65 lbs (29.5 kg)		X		
Forward-Facing Child Restraint	Up to 65 lbs (29.5 kg)			X	X
Forward-Facing Child Restraint	More than 65 lbs (29.5 kg)				X

Lower Anchors And Tethers For Children (LATCH) Restraint System





022668173

Your vehicle is equipped with the child restraint anchor-age system called LATCH, which stands for Lower Anchors and Tethers for CHildren. The LATCH system

has three vehicle anchor points for installing LATCH-equipped child seats. There are two lower anchorages located at the back of the seat cushion where it meets the seatback and one top tether anchorage located behind the seating position. These anchorages are used to install LATCH-equipped child seats without using the vehicle's seat belts. Some seating positions may have a top tether anchorage but no lower anchorages. In these seating positions, the seat belt must be used with the top tether anchorage to install the child restraint. Please see the following table for more information.

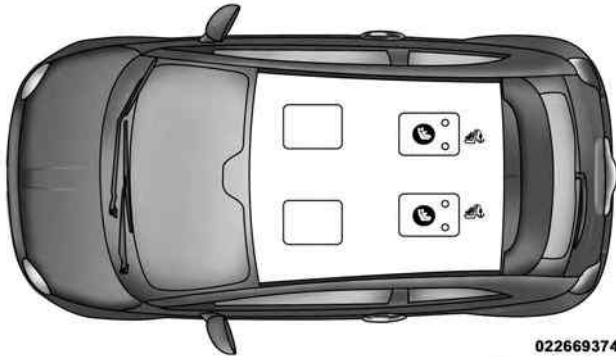
LATCH Positions For Installing Child Restraints In This Vehicle



-  Lower Anchorage Symbol 2 anchorages per seating position
-  Top Tether Anchorage Symbol

What is the weight limit (child's weight + weight of the child restraint) for using the LATCH anchorage system to attach the child restraint?	65 lbs (29.5 kg)	Use the LATCH anchorage system until the combined weight of the child and the child restraint is 65 lbs (29.5 kg). Use the seat belt and tether anchor instead of the LATCH system once the combined weight is more than 65 lbs (29.5 kg).
Can the LATCH anchorages and the seat belt be used together to attach a rear-facing or forward-facing child restraint?	No	Do not use the seat belt when you use the LATCH anchorage system to attach a rear-facing or forward-facing child restraint.
Can two child restraints be attached using a common lower LATCH anchorage?	No	Never "share" a LATCH anchorage with two or more child restraints. If the center position does not have dedicated LATCH lower anchorages, use the seat belt to install a child seat in the center position next to a child seat using the LATCH anchorages in an outboard position.

Can the rear-facing child restraint touch the back of the front passenger seat?	Yes	The child seat may touch the back of the front passenger seat if the child restraint manufacturer also allows contact. See your child restraint owner's manual for more information.
Can the head restraints be removed?	Yes	Yes, all may be removed

Locating The LATCH Anchorages



The lower anchorages are round bars that are found at the rear of the seat cushion where it meets the seatback, below the anchorage symbols on the seatback. They are just visible when you lean into the rear seat to install the child restraint. You will easily feel them if you run your finger along the gap between the seatback and seat cushion.

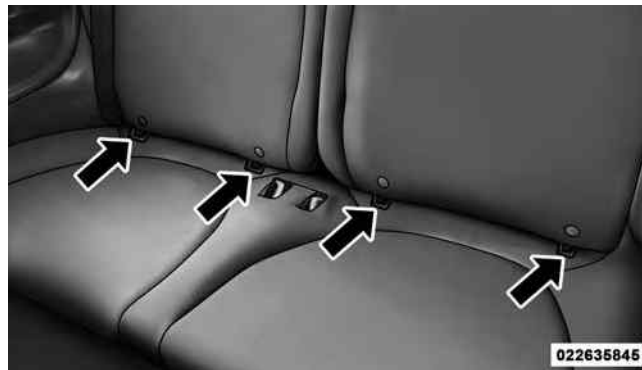

LATCH Anchorages

Locating The Upper Tether Anchorages



There are tether strap anchorages behind each rear seating position located on the back of the seat.

LATCH-compatible child restraint systems will be equipped with a rigid bar or a flexible strap on each side. Each will have a hook or connector to attach to the lower anchorage and a way to tighten the connection to the anchorage. Forward-facing child restraints and some rear-facing child restraints will also be equipped with a tether strap. The tether strap will have a hook at the end to attach to the top tether anchorage and a way to tighten the strap after it is attached to the anchorage.

Center Seat LATCH

WARNING!

This vehicle does not have a center seating position. Do not use the center lower LATCH anchorages to install a child seat in the center of the back seat.

Always follow the directions of the child restraint manufacturer when installing your child restraint. Not all child restraint systems will be installed as described here.

To Install A LATCH-Compatible Child Restraint

If the selected seating position has a Switchable Automatic Locking Retractor (ALR) seat belt, stow the seat belt, following the instructions below. See the section “Installing Child Restraints Using the Vehicle Seat Belt” to check what type of seat belt each seating position has.

1. Loosen the adjusters on the lower straps and on the tether strap of the child seat so that you can more easily attach the hooks or connectors to the vehicle anchorages.
2. Place the child seat between the lower anchorages for that seating position. For some second row seats, you may need to recline the seat and/or raise the head restraint to get a better fit. If the rear seat can be moved forward and rearward in the vehicle, you may wish to move it to its rear-most position to make room for the child seat. You may also move the front seat forward to allow more room for the child seat.
3. Attach the lower hooks or connectors of the child restraint to the lower anchorages in the selected seating position.
4. If the child restraint has a tether strap, connect it to the top tether anchorage. See the section “Installing Child Restraints Using the Top Tether Anchorage” for directions to attach a tether anchor.
5. Tighten all of the straps as you push the child restraint rearward and downward into the seat. Remove slack in the straps according to the child restraint manufacturer’s instructions.
6. Test that the child restraint is installed tightly by pulling back and forth on the child seat at the belt path. It should not move more than 1 inch (25.4 mm) in any direction.

How To Stow An Unused ALR Seat Belt:

When using the LATCH attaching system to install a child restraint, stow all ALR seat belts that are not being used by other occupants or being used to secure child restraints. An unused belt could injure a child if they play with it and accidentally lock the seat belt retractor. Before installing a child restraint using the LATCH system, buckle the seat belt behind the child restraint and out of the child's reach. If the buckled seat belt interferes with the child restraint installation, instead of buckling it behind the child restraint, route the seat belt through the child restraint belt path and then buckle it. Do not lock the seat belt. Remind all children in the vehicle that the seat belts are not toys and that they should not play with them.

WARNING!

- **Improper installation of a child restraint to the LATCH anchorages can lead to failure of the restraint. The child could be badly injured or killed. Follow the child restraint manufacturer's directions exactly when installing an infant or child restraint.**
- **Child restraint anchorages are designed to withstand only those loads imposed by correctly-fitted child restraints. Under no circumstances are they to be used for adult seat belts, harnesses, or for attaching other items or equipment to the vehicle.**

Installing Child Restraints Using The Vehicle Seat Belt

The seat belts in the passenger seating positions are equipped with a Switchable Automatic Locking Retractor (ALR) that is designed to keep the lap portion of the seat belt tight around the child restraint so that it is not necessary to use a locking clip. The ALR retractor can be “switched” into a locked mode by pulling all of the webbing out of the retractor and then letting the webbing retract back into the retractor. If it is locked, the ALR will make a clicking noise while the webbing is pulled back into the retractor. For additional information on ALR, refer to the “Automatic Locking Mode” description under “Occupant Restraints.”

Lap/Shoulder Belt Systems for Installing Child Restraints in this Vehicle

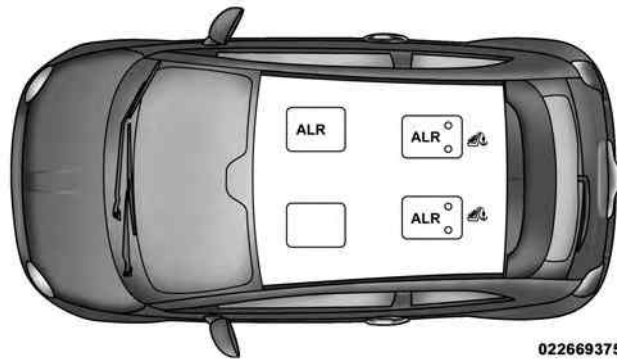

2

- ALR = Switchable Automatic Locking Retractor
-  Top Tether Anchorage Symbol

70 THINGS TO KNOW BEFORE STARTING YOUR VEHICLE

<p>What is the weight limit (child's weight + weight of the child restraint) for using the Tether Anchor with the seat belt to attach a forward facing child restraint?</p>	<p>Weight limit of the Child Restraint</p>	<p>Always use the tether anchor when using the seat belt to install a forward facing child restraint, up to the recommended weight limit of the child restraint.</p>
<p>Can the rear-facing child restraint touch the back of the front passenger seat?</p>	<p>Yes</p>	<p>Contact between the front passenger seat and the child restraint is allowed, if the child restraint manufacturer also allows contact.</p>
<p>Can the head restraints be removed?</p>	<p>Yes</p>	<p>Yes, all may be removed</p>
<p>Can the buckle stalk be twisted to tighten the seat belt against the belt path of the child restraint?</p>	<p>No</p>	<p>Do not twist the buckle stalk in a seating position with an ALR retractor.</p>

Installing A Child Restraint With A Switchable Automatic Locking Retractor (ALR)

1. Place the child seat in the center of the seating position. For some second row seats, you may need to recline the seat and/or raise the head restraint to get a better fit. If the rear seat can be moved forward and rearward in the vehicle, you may wish to move it to its rear-most position to make room for the child seat. You may also move the front seat forward to allow more room for the child seat.
2. Pull enough of the seat belt webbing from the retractor to pass it through the seat belt path of the child restraint. Do not twist the belt webbing in the belt path.
3. Slide the latch plate into the buckle until you hear a "click."
4. Pull on the webbing to make the lap portion tight against the child seat.
5. To lock the seat belt, pull down on the shoulder part of the seat belt until you have pulled all the seat belt webbing out of the retractor. Then, allow the webbing to retract back into the retractor. As the webbing retracts, you will hear a clicking sound. This means the seat belt is now in the Automatic Locking mode.
6. Try to pull the webbing out of the retractor. If it is locked, you should not be able to pull out any webbing. If the retractor is not locked, repeat step 5.
7. Finally, pull up on any excess webbing to tighten the lap portion around the child restraint while you push the child restraint rearward and downward into the vehicle seat.
8. If the child restraint has a top tether strap and the seating position has a top tether anchorage, connect the tether strap to the anchorage and tighten the tether strap. See the section "Installing Child Restraints Using the Top Tether Anchorage" for directions to attach a tether anchor.

72 THINGS TO KNOW BEFORE STARTING YOUR VEHICLE

9. Test that the child restraint is installed tightly by pulling back and forth on the child seat at the seat belt path. It should not move more than 1 inch (25.4 mm) in any direction.

Any seat belt system will loosen with time, so check the seat belt occasionally, and pull it tight if necessary.

Installing Child Restraints Using The Top Tether Anchorage

WARNING!

Do not attach a tether strap for a rear-facing car seat to any location in front of the car seat, including the seat frame or a tether anchorage. Only attach the tether strap of a rear-facing car seat to the tether anchorage that is approved for that seating position, located behind the top of the vehicle seat. See the section "Lower Anchors

(Continued)

WARNING! (Continued)

and Tethers for Children (LATCH) Restraint System" for the location of approved tether anchorages in your vehicle.

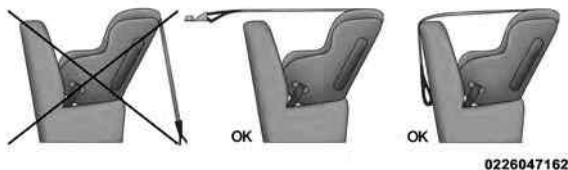

1. Look behind the seating position where you plan to install the child restraint to find the tether anchorage. You may need to move the seat forward to provide better access to the tether anchorage. If there is no top tether anchorage for that seating position, move the child restraint to another position in the vehicle if one is available.

2. Route the tether strap to provide the most direct path for the strap between the anchor and the child seat. If your vehicle is equipped with adjustable rear head restraints, raise the head restraint, and where possible, route the tether strap under the head restraint and between the two posts. If not possible, lower the head restraint and pass the tether strap around the outboard side of the head restraint.
3. Attach the tether strap hook of the child restraint to the top tether anchorage as shown in the diagram.



Rear Seat Tether Strap Mounting

4. Remove slack in the tether strap according to the child restraint manufacturer's instructions.

WARNING!

- **An incorrectly anchored tether strap could lead to increased head motion and possible injury to the child. Use only the anchorage position directly behind the child seat to secure a child restraint top tether strap.**
- **If your vehicle is equipped with a split rear seat, make sure the tether strap does not slip into the opening between the seatbacks as you remove slack in the strap.**

Transporting Pets

Air Bags deploying in the front seat could harm your pet. An unrestrained pet will be thrown about and possibly injured, or could injure a passenger during panic braking or in a collision.

Pets should be restrained in the rear seat in pet harnesses or pet carriers that are secured by seat belts.

ENGINE BREAK-IN RECOMMENDATIONS

A long break-in period is not required for the engine and drivetrain (transmission and axle) in your vehicle.

Drive moderately during the first 300 miles (500 km). After the initial 60 miles (100 km), speeds up to 50 or 55 mph (80 or 90 km/h) are desirable.

While cruising, brief full-throttle acceleration within the limits of local traffic laws contributes to a good break-in. Wide-open throttle acceleration in low gear can be detrimental and should be avoided.

The engine oil installed in the engine at the factory is a high-quality energy conserving type lubricant. Oil changes should be consistent with anticipated climate conditions under which vehicle operations will occur. For the recommended viscosity and quality grades, refer to "Maintenance Procedures" in "Maintaining Your Vehicle."

CAUTION!

Never use Non-Detergent Oil or Straight Mineral Oil in the engine or damage may result.

NOTE: A new engine may consume some oil during its first few thousand miles (kilometers) of operation. This should be considered a normal part of the break-in and not interpreted as a problem.

SAFETY TIPS**Transporting Passengers**

NEVER TRANSPORT PASSENGERS IN THE CARGO AREA.

WARNING!

- Do not leave children or animals inside parked vehicles in hot weather. Interior heat build-up may cause serious injury or death.
- It is extremely dangerous to ride in a cargo area, inside or outside of a vehicle. In a collision, people riding in these areas are more likely to be seriously injured or killed.
- Do not allow people to ride in any area of your vehicle that is not equipped with seats and seat belts.
- Be sure everyone in your vehicle is in a seat and using a seat belt properly.

Exhaust Gas

WARNING!

Exhaust gases can injure or kill. They contain carbon monoxide (CO), which is colorless and odorless. Breathing it can make you unconscious and can eventually poison you. To avoid breathing (CO), follow these safety tips:

- Do not run the engine in a closed garage or in confined areas any longer than needed to move your vehicle in or out of the area.
- If you are required to drive with the trunk/liftgate/rear doors open, make sure that all windows are closed and the climate control BLOWER switch is set at high speed. DO NOT use the recirculation mode.

(Continued)

WARNING! *(Continued)*

- If it is necessary to sit in a parked vehicle with the engine running, adjust your heating or cooling controls to force outside air into the vehicle. Set the blower at high speed.

The best protection against carbon monoxide entry into the vehicle body is a properly maintained engine exhaust system.

Whenever a change is noticed in the sound of the exhaust system, when exhaust fumes can be detected inside the vehicle, or when the underside or rear of the vehicle is damaged, have a competent mechanic inspect the complete exhaust system and adjacent body areas for broken, damaged, deteriorated, or mispositioned parts. Open seams or loose connections could permit exhaust fumes to seep into the passenger compartment. In addition, inspect the exhaust system each time the vehicle is raised for lubrication or oil change. Replace as required.

Safety Checks You Should Make Inside The Vehicle

Seat Belts

Inspect the seat belt system periodically, checking for cuts, frays, and loose parts. Damaged parts must be replaced immediately. Do not disassemble or modify the system.

Front seat belt assemblies must be replaced after a collision. Rear seat belt assemblies must be replaced after a collision if they have been damaged (i.e., bent retractor, torn webbing, etc.). If there is any question regarding seat belt or retractor condition, replace the seat belt.

Air Bag Warning Light



The light should come on and remain on for four to eight seconds as a bulb check when the ignition switch is first turned ON. If the light is

not lit during starting, see your authorized dealer. If the light stays on, flickers, or comes on while driving, have the system checked by an authorized dealer.

Defroster

Check operation by selecting the defrost mode and place the blower control on high speed. You should be able to feel the air directed against the windshield. See your authorized dealer for service if your defroster is inoperable.

Floor Mat Safety Information

Always use floor mats designed to fit the footwell of your vehicle. Use only floor mats that leave the pedal area unobstructed and that are firmly secured so that they cannot slip out of position and interfere with the pedals or impair safe operation of your vehicle in other ways.

WARNING!

Pedals that cannot move freely can cause loss of vehicle control and increase the risk of serious personal injury.

- Always make sure that floor mats are properly attached to the floor mat fasteners.
- Never place or install floor mats or other floor coverings in the vehicle that cannot be properly secured to prevent them from moving and interfering with the pedals or the ability to control the vehicle.
- Never put floor mats or other floor coverings on top of already installed floor mats. Additional floor mats and other coverings will reduce the size of the pedal area and interfere with the pedals.

(Continued)

WARNING! (Continued)

- Check mounting of mats on a regular basis. Always properly reinstall and secure floor mats that have been removed for cleaning.
- Always make sure that objects cannot fall into the driver footwell while the vehicle is moving. Objects can become trapped under the brake pedal and accelerator pedal causing a loss of vehicle control.
- If required, mounting posts must be properly installed, if not equipped from the factory.

Failure to properly follow floor mat installation or mounting can cause interference with the brake pedal and accelerator pedal operation causing loss of control of the vehicle.

Periodic Safety Checks You Should Make Outside The Vehicle

Tires

Examine tires for excessive tread wear and uneven wear patterns. Check for stones, nails, glass, or other objects lodged in the tread or sidewall. Inspect the tread for cuts and cracks. Inspect sidewalls for cuts, cracks and bulges. Check the wheel bolts for tightness. Check the tires (including spare) for proper cold inflation pressure.

Lights

Have someone observe the operation of brake lights and exterior lights while you work the controls. Check turn signal and high beam indicator lights on the instrument panel.

Door Latches

Check for positive closing, latching, and locking.

Fluid Leaks

Check area under vehicle after overnight parking for fuel, engine coolant, oil, or other fluid leaks. Also, if gasoline fumes are detected or if fuel, power steering fluid (if equipped), or brake fluid leaks are suspected. The cause should be located and corrected immediately.

UNDERSTANDING THE FEATURES OF YOUR VEHICLE

CONTENTS

■ POWER CONVERTIBLE TOP — IF EQUIPPED84	□ Heated Mirrors — If Equipped90
□ Lowering The Power Top84	□ Sun Visors91
□ Raising The Power Top84	■ BLUE&ME™ HANDS-FREE COMMUNICATION.91
□ Power Convertible Top Relearn Procedure86	□ Blue&Me™ Hands-Free Communication Overview — If Equipped91
□ Wind Stop87	□ The Hands-Free Kit92
■ MIRRORS87	■ SEATS99
□ Inside Day/Night Mirror87	□ Forward/Rearward Adjustment99
□ Automatic Dimming Mirror — If Equipped88	□ Recline Adjustment100
□ Power Mirrors89		
□ Folding Mirrors.90		

82 UNDERSTANDING THE FEATURES OF YOUR VEHICLE

- Seat Height Adjustment101
- EZ Entry Feature101
- Memory Feature102
- Heated Seats — If Equipped103
- Head Restraints104
- TO OPEN AND CLOSE THE HOOD106
- LIGHTS108
 - Multifunction Lever108
 - Headlights108
 - High Beams109
 - Flash-To-Pass109
 - Parking Lights109
 - Daytime Running Lights — If Equipped110
 - Turn Signals110
 - Lane Change Assist111
 - Follow Me Home/Headlight Delay111
 - Interior Lights111
 - Front Fog Lights — If Equipped113
- WINDSHIELD WIPERS AND WASHERS113
 - Front Windshield Wiper Operation114
 - Rear Windshield Wiper116
- TILT STEERING COLUMN — IF EQUIPPED . . .117
- ELECTRONIC SPEED CONTROL118
 - To Activate119
 - To Set A Desired Speed119
 - To Deactivate120

<ul style="list-style-type: none"> □ To Resume Speed120 □ To Vary The Speed Setting120 □ To Accelerate For Passing121 ■ REAR PARK ASSIST — IF EQUIPPED122 <ul style="list-style-type: none"> □ Rear Park Assist Sensors122 □ Rear Park Assist Warning Display123 □ Rear Park Assist Display123 □ Rear Park Assist Audible Alerts124 □ Failure Indications125 □ Cleaning The Rear Park Assist System126 □ Park Assist System Usage Precautions126 ■ POWER SUNROOF — IF EQUIPPED128 <ul style="list-style-type: none"> □ To Open129 	<ul style="list-style-type: none"> □ To Close129 □ Pinch Protect Feature130 □ Wind Buffeting130 □ Emergency Operation.130 □ Sun Shade — If Equipped130 ■ ELECTRICAL POWER OUTLETS131 ■ CIGAR LIGHTER — IF EQUIPPED134 ■ CUPHOLDERS134 ■ STORAGE135 <ul style="list-style-type: none"> □ Glove Compartment135 ■ CARGO AREA FEATURES136 ■ REAR WINDOW FEATURES137 <ul style="list-style-type: none"> □ Rear Window Defroster137
--	--

POWER CONVERTIBLE TOP — IF EQUIPPED

On vehicles equipped with a power convertible top, the power convertible top switch is located on the overhead console. The switch contains two buttons. The passenger side button, is used to open the power top, and the driver side button, is used to close the power top.



Power Convertible Top Switch

NOTE: The power top buttons will operate when the ignition switch is turned to the ACC/ON/RUN position.

Lowering The Power Top

Press the top open button approximately one second for the three-quarter open position. Press the top open button for approximately one second a second time to fully open the convertible top.

Raising The Power Top

From the convertible top fully open position, press the top close button for approximately one second for the three-quarter open position. Press the top close button for approximately one second a second time for the one-quarter open position. Press and hold close button to fully close convertible top.

NOTE: Rail lubrication is recommended every 2000 cycles, or if scratching noises due to dust are present. Refer to “Fluids, Lubes, and Genuine Part” in “Maintaining Your Vehicle” for information.

CAUTION!

Failure to follow these cautions may cause interior water damage, stains or mildew on the top material:

- Avoid high-pressure car washes, as they can damage the top material. Also, increased water pressure may force water past the weather strips.
- Remove any standing water from the top and dry the surface before opening it. Operating the top, opening a door or lowering a window while the top is wet may allow water to drip into the vehicle’s interior.

(Continued)

CAUTION! *(Continued)*

- Use care when washing the vehicle, water pressure directed at the weather strip seals may cause water to leak into the vehicle’s interior.

WARNING!

The convertible top does not provide the structural protection that a reinforced metal roof does and the fabric top cannot be expected to prevent the ejection of the occupants in a collision. Therefore, it is important that all occupants wear their seat belts at all times. Death or serious injuries could occur if you are ejected from the vehicle during a collision.

Power Convertible Top Relearn Procedure

If your power convertible top does not operate in the Auto Opening/Closing mode (automatically opening/closing to the one-quarter open and three-quarter open comfort stops), or if the trunk lid does not open - the following relearn procedure may be necessary.

1. Confirm that the door/trunk lid are closed.
2. Begin with the top in the fully closed position (using manual mode).
3. Hold the OPEN button to move the top to the fully open position.
4. CONTINUE to hold the OPEN button for an additional three seconds.
5. Release the OPEN button.

6. Hold the CLOSED button to move the top to the fully closed position.
7. CONTINUE to hold the CLOSED button until the top begins to cycle fully open, then release the CLOSED button.

At the end of step 7 the top will automatically cycle to the fully open position, and then close to the 1/4 open position.

This will confirm that the relearn procedure was successful.

Auto Open/Close will now be functional. Trunk lid operation will be functional.

NOTE: DO NOT interrupt this activity.

If the power convertible top does not relearn repeat the procedure a second time.

Wind Stop

The Wind Stop installs in the backseat area of the vehicle. The Wind Stop will not interfere with power top operation. Therefore, it can remain installed when the top is up.

MIRRORS

Inside Day/Night Mirror

The mirror can be adjusted up, down, left, and right for various drivers. The mirror should be adjusted to center on the view through the rear window.

Headlight glare from vehicles behind you can be reduced by moving the small control under the mirror to the night position (toward the rear of the vehicle). The mirror should be adjusted while set in the day position (toward the windshield).



Adjusting Rearview Mirror

Automatic Dimming Mirror — If Equipped

This mirror automatically adjusts for headlight glare from vehicles behind you. You can turn the feature on or off by pressing the button at the base of the mirror. A light to the left of the button will illuminate to indicate when the dimming feature is activated. The sensor to the right of the button does not illuminate.

NOTE: This feature is disabled when the vehicle is moving in reverse.



030406002

Automatic Dimming Mirror

CAUTION!

To avoid damage to the mirror during cleaning, never spray any cleaning solution directly onto the mirror. Apply the solution onto a clean cloth and wipe the mirror clean.

Power Mirrors

The power mirror controls are located on the driver's door trim panel.



Power Mirror Switches

The power mirror controls consist of a mirror select switch and a four-way mirror control switch. To adjust a mirror, press the mirror select switch to either the L (left) or R (right) to select the mirror you need to adjust.

Using the mirror control switch, press on any of the four arrows for the direction that you want the mirror to move.

WARNING!

Vehicles and other objects seen in the passenger side convex mirror will look smaller and farther away than they really are. Relying too much on your passenger side mirror could cause you to collide with another vehicle or other object. Use your inside mirror when judging the size or distance of a vehicle seen in the passenger side convex mirror.

Spotter Mirror — If Equipped

Some models are equipped with a driver's side spotter mirror. The spotter mirror allows for a greater range of visibility on the driver's side of the vehicle.

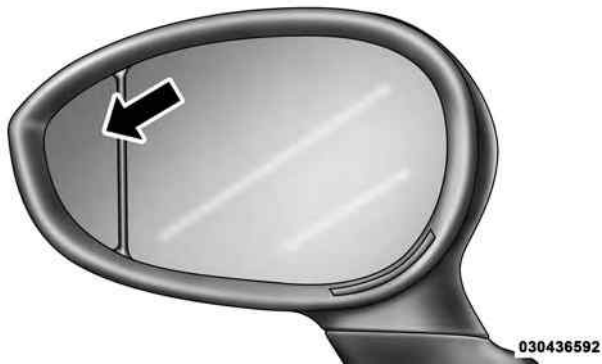

Spotter Mirror

Folding Mirrors

The exterior mirrors are hinged to allow the mirror to pivot forward or rearward to help avoid damage. The mirror has three detent positions: full forward, normal and full rearward.

Heated Mirrors — If Equipped



These mirrors are heated to melt frost or ice. This feature can be activated whenever you turn on the rear window defroster (if equipped). Refer to “Rear Window Features” in “Understanding The Features Of Your Vehicle” for further information.

Sun Visors

The driver and passenger sun visors are located on the headliner, near the front windshield. The sun visor can be rotated downward or up against the door glass. Both sun visors are equipped with courtesy mirrors.

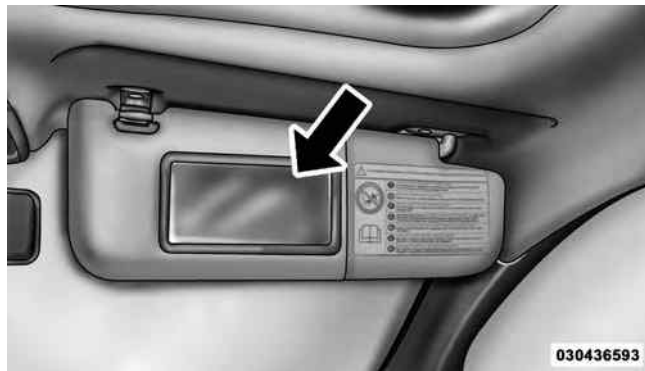

Sun Visor (Passenger Side Shown)

BLUE&ME™ HANDS-FREE COMMUNICATION

Blue&Me™ Hands-Free Communication Overview — If Equipped

Windows Mobile™-based FIAT BLUE&ME™ is a personal telematic system enabling you to use communication and entertainment applications expressly designed for use in the car.

The BLUE&ME™ system installed on your car is equipped with a hands-free kit, message reader and media player, and it is preset for future installation of additional services.

The BLUE&ME™ system, fully integrated with voice commands, buttons on the steering wheel and multifunction display messages, gives you the possibility of interacting with your Bluetooth® wireless technology mobile phone (even if you keep it in your pocket or bag) without

having to take your eyes off the road or remove your hands from the steering wheel. To use voice commands you are not required to train the voice recognition system to recognize your voice. This implies that the system is nearly equally performing with different persons, i.e.: the voice recognition system is of the “speaker independent” type.

With this system you can also play your favorite music stored on USB device and select tracks and playback modes with both voice commands or buttons on the steering wheel.

This device complies with Part 15 of the FCC rules subject to the following two conditions:

- This device may not cause harmful interference.
- This device must accept all interference received, including interference that may cause undesired operation.

The Hands-Free Kit

The basic characteristic of this hands-free kit is voice recognition with Bluetooth® wireless technology. With this system you can make and receive calls safely and securely by using either voice commands or buttons on the steering wheel. This can be done under any driving condition without ever having to take your eyes off the road or remove your hands from the steering wheel, as required by current laws.

Bluetooth® wireless technology enables wireless connection between your mobile phone and the hands-free kit installed on your car.

To use the hands-free kit, you need a Bluetooth® wireless technology enabled mobile phone. This hands-free kit gives you the possibility of interacting vocally with your mobile phone while driving, even if your mobile device does not feature Voice Recognition. You can also interact with your mobile phone manually and visually using the

steering wheel controls and the instrument panel multi-function display. Please refer to the Fiat Blue & Me Radio Supplement for further information.

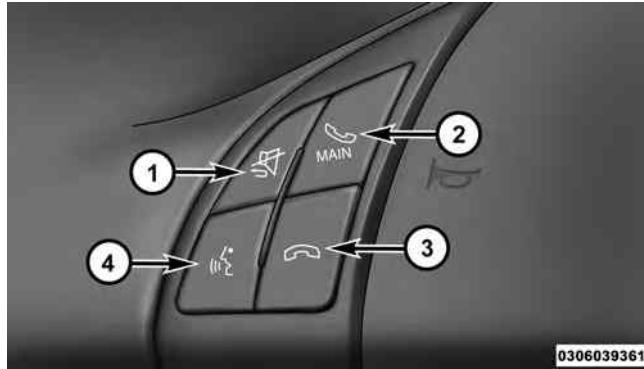

Steering Wheel Hands Free Buttons

- | | |
|----------------|----------------------------|
| 1 — Mute/ESC | 3 — Phone Hang Up |
| 2 — Phone/Main | 4 — Voice Recognition (VR) |

To get started with BLUE&ME™ hands-free kit with voice recognition, you have to simply pair your Bluetooth® wireless technology enabled mobile phone with the system.

Pairing is an operation that has to be made only once.

NOTE:

- During the mobile phone pairing procedure, BLUE&ME™ attempts to detect a phone equipped with Bluetooth® wireless technology within range and then establishes the connection using a Personal Identification Number (PIN).
- Once your phone is paired, you have the option to transfer your mobile phone contacts to the hands-free kit, to make a phone call either by using the contacts list or directly pronouncing the phone number, to answer a call and also to answer another incoming phone call.

- To interact with BLUE&ME™ you can use either the buttons on the steering wheel or voice commands. With voice recognition, you can perform system functions by speaking voice commands, also identified as “keywords”. When the system recognizes a keyword, it will respond with the appropriate action. Voice recognition is an easy and convenient way to use BLUE&ME™.

All the system functions are available within the BLUE&ME™ Main Menu. When the car is not moving, you can scroll through the complete menu by using either the buttons on the steering wheel or the voice commands. When you are traveling, you can interact with BLUE&ME™ by using the buttons on the steering wheel or voice commands relevant only to phone functions (LAST CALLS and PHONEBOOK) and the media player. To activate settings when travelling you can only use voice commands.

The hands-free kit enables the following operations:

- **Contact Calling By Voice** — You can call a contact in your mobile phone phonebook using your voice. You can also call a contact in your phonebook by scanning through the entries on the multifunction display. (To use this option you have to transfer your mobile phone contacts to the hands-free kit phonebook).
- **Digit Dialing By Voice** — You can dial a phone number by pushing the VR button on the steering wheel and speaking the digits to be dialed.
- **To Call The SMS Text Sender** — Call directly the last SMS text sender or the sender of a message received and stored in the BLUE&ME™ inbox.
- **To Answer A Call** — You can answer an incoming call by pushing the MAIN/Phone button on the steering wheel.

- **Conference Call** — You can call another contact while you are engaged in a phone conversation (with Bluetooth® phones supporting this option).
- **Call Waiting** — While engaged in a phone conversation, you can receive notification of another incoming phone call, answer the other incoming phone call, and switch between two ongoing phone conversations. (Call waiting is only supported by a subset of compatible mobile phones).
- **Refusing Incoming Call Or Ending A Call** — You can refuse an incoming call or end a current call by pushing the Phone Hang-up button on the steering wheel.

After pairing and connecting your phone with the BLUE&ME™ system, you can make phone calls by speaking keywords or pushing buttons on the steering wheel. When using the hands-free phone, the audio output of a phone conversation is heard through your car sound speakers.

Message Reader

The BLUE&ME™ message reader enables automatic reading, through the car sound system, of the SMS texts you receive on your Bluetooth® wireless technology mobile phone that are received when the phone is paired and connected to the BLUE&ME™ system. It does not provide access to messages that were received before the device was connected with the BLUE&ME™ system. The message reader will also interpret many abbreviations and emoticons contained in the SMS text.

NOTE: Not all mobile phones support the SMS text message reader function or automatic phonebook transfer via Bluetooth®. For further information on the list of compatible mobile phones go to <http://www.fiatusa.com>, find the SUPPORT section near the bottom of web page and click on the Bluetooth® logo.

Message reader functions are managed by the control buttons on the steering wheel or by the BLUE&ME™ voice commands.

The BLUE&ME™ message reader enables the following operations:

- To display an indicator on the instrument panel that indicates you have received a new SMS text. It will display the sender's number/name and will ask you whether to read the text of the message to you.

- To manage the list of SMS texts received on your BLUE&ME™ paired mobile phone.
- To read the messages received and stored. Messages can be read multiple times.
- To call the SMS text sender using the buttons on the steering wheel or voice commands.
- To delete individual messages or the entire inbox using the buttons on the steering wheel or voice commands.

The BLUE&ME™ system can also recognize and read abbreviations, if any (e.g. "ILUVU" will be read like "I love you") and interpret the most usual emoticons (e.g. :-)) will be read like "Smile"), that are currently used to write SMS texts.

Media Player

With the BLUE&ME™ media player you can play the digital audio files stored on a USB device by simply connecting it to the USB port located in the center console of the car. A second USB port, used for charging only, is located in the glovebox.

In this way, while you are driving you can play your favorite music collections.

- **iPod® Player** — See dedicated paragraph under Media Player Functions.

The media player enables the following operations:

- **Digital Audio Playback** — You can play all your digital audio files (.mp3, .wma, .wav, .aac) or play a customized playlist (.m3u or .wpl format).

- **Audio File Selection By Category** — You can play all audio files of a certain category, e.g.: album, artist or genre.
- **Playback Options** — While playing tracks you can select the following options: Play, Stop, Next track, Previous track, Shuffle and Loop track.

NOTE:

- The media player does not support audio files compressed with other formats and DRM (Digital Rights Management) protected audio files. Non-supported audio files that may be present on the USB device will be ignored.

- To use the media player, you have to simply connect (directly or by an extension lead) your USB device to the center console USB port. After turning the ignition key to ON, BLUE&ME™ will start building your media library. At the end of this operation you can surf the complete library and scroll its categories as required using the buttons on the steering wheel or voice commands. BLUE&ME™ will then play your selection via the car sound system.

WARNING!

- Driving while distracted can result in loss of vehicle control, accident and injury. It is strongly recommended that you use extreme caution when using any device or feature that may take your focus off the road or your hands off the steering wheel. Your primary responsibility is the safe operation of your vehicle.

(Continued)

WARNING! (Continued)

- The use of any handheld device while driving is not recommended. Use voice-operated systems when possible. Follow all applicable laws that may affect the use of electronic devices while driving.
- Keep the Owner's Manual in the car: when kept in the car, the Owner's Manual will be available for you and other users unfamiliar with the system. Please make certain that before using the system for the first time, all persons have access to the Owner's Manual and read its instructions and safety information carefully.

SEATS

Seats are a part of the Occupant Restraint System of the vehicle.

WARNING!

- It is dangerous to ride in a cargo area, inside or outside of a vehicle. In a collision, people riding in these areas are more likely to be seriously injured or killed.
- Do not allow people to ride in any area of your vehicle that is not equipped with seats and seat belts. In a collision, people riding in these areas are more likely to be seriously injured or killed.
- Be sure everyone in your vehicle is in a seat and using a seat belt properly.

Forward/Rearward Adjustment

The adjusting bar is located at the front of the seats, near the floor.

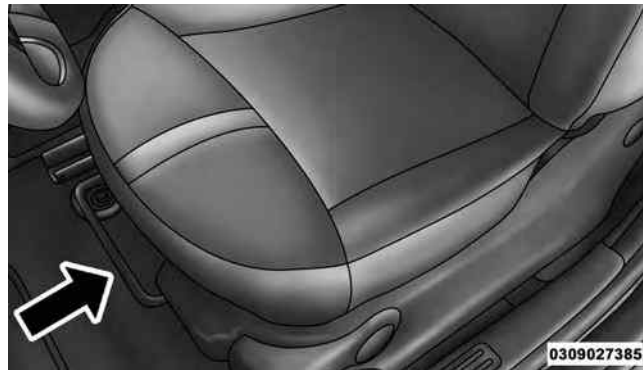

Adjusting Bar

While sitting in the seat, lift up on the bar and move the seat forward or rearward. Release the bar once the desired position is reached. Then, using body pressure, move forward and rearward on the seat to be sure that the seat adjusters have latched.

WARNING!

- **Adjusting a seat while driving may be dangerous. Moving a seat while driving could result in loss of control which could cause a collision and serious injury or death.**
- **Seats should be adjusted before fastening the seat belts and while the vehicle is parked. Serious injury or death could result from a poorly adjusted seat belt.**

Recline Adjustment

The recline adjustment lever is located on the inboard side of the seat. To recline the seatback, lift up the recline lever, lean back until the desired position has been reached, and release the lever.

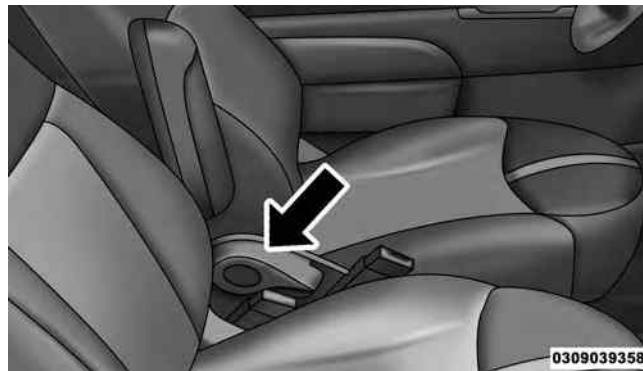

Recline Lever

WARNING!

Do not ride with the seatback reclined so that the shoulder belt is no longer resting against your chest. In a collision you could slide under the seat belt, which could result in serious injury or death.

Seat Height Adjustment

The driver's seat height can be raised or lowered by using a lever, located on the outboard side of the seat. Pump the lever upward to raise the seat height, or pump the lever downward to lower the seat height.

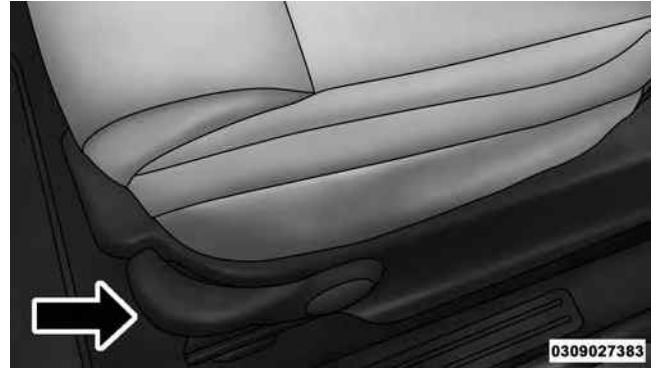

Height Adjuster

EZ Entry Feature

The driver and front passenger seats have an EZ entry feature for rear seat passengers. Pull forward on the release lever, located on the outboard side of the seatback, dump the seatback forward, then slide the seat forward to allow access in and out of the rear seat.

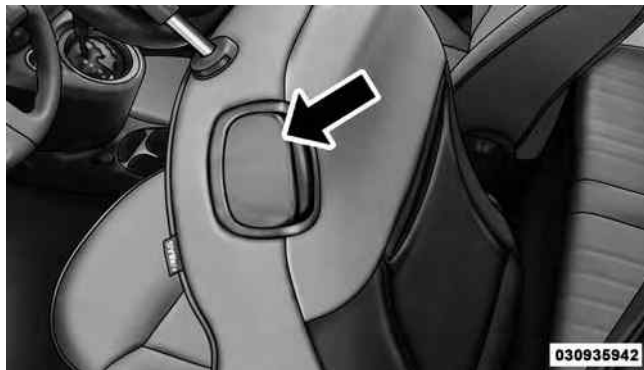

EZ Entry Lever

Lift the seatback upright and push the seat rearward to its locked position once the rear passengers are seated.

Memory Feature

Both front seats have a memory feature, which can operate in two ways:

Memory Function Option 1 — Full Seat Back And Track Fore/Aft Position Memory:

After using the EZ entry function, the seatback angle and the Track fore/aft adjuster can both re-lock into the position they were most recently adjusted to. This is accomplished if the seat is moved fully rearward to its last fore/aft position on the tracks before the seat back is returned upright.

Memory Function Option 2 — Seat Back Only Memory:

After using the EZ entry function, the seat back may first be returned upright prior to going back to the last fore/aft (memory) position on the tracks. This results in the seat back memory being set only – The track will then be locked forward of its last set fore/aft memory position. To then reset the fore/aft track memory feature (to reestablish Memory Function Option 1), the seat has to be returned fully rearward to its last fore/aft memory track position as described in Memory Function Option 1.

Heated Seats — If Equipped

On some models, the front driver and passenger seats may be equipped with heaters in both the seat cushions and seatbacks. The controls for the front heated seats are located on the center instrument panel area.



Press the switch once to turn on the heated seats. Press the switch a second time to shut the heating elements off.

NOTE: Once a heat setting is selected, heat will be felt within two to five minutes.

WARNING!

- **Persons who are unable to feel pain to the skin because of advanced age, chronic illness, diabetes, spinal cord injury, medication, alcohol use, exhaustion or other physical condition must exercise care when using the seat heater. It may cause burns even at low temperatures, especially if used for long periods of time.**

(Continued)

WARNING! *(Continued)*

- Do not place anything on the seat or seatback that insulates against heat, such as a blanket or cushion. This may cause the seat heater to overheat. Sitting in a seat that has been overheated could cause serious burns due to the increased surface temperature of the seat.

Head Restraints

Head restraints are designed to reduce the risk of injury by restricting head movement in the event of a rear-impact. Head restraints should be adjusted so that the top of the head restraint is located above the top of your ear.

WARNING!

The head restraints for all occupants must be properly adjusted prior to operating the vehicle or occupying a seat. Head restraints should never be adjusted while the vehicle is in motion. Driving a vehicle with the head restraints improperly adjusted or removed could cause serious injury or death in the event of a collision.

Reactive Head Restraints — Front Seats

The front driver and passenger seats are equipped with Reactive Head Restraints. In the event of a rear impact the Reactive Head Restraints will automatically extend forward minimizing the gap between the back of the occupant's head and the Reactive Head Restraint.

To raise the head restraint, pull upward on the head restraint. To lower the head restraint, press the push button, located at the base of the head restraint, and push downward on the head restraint.

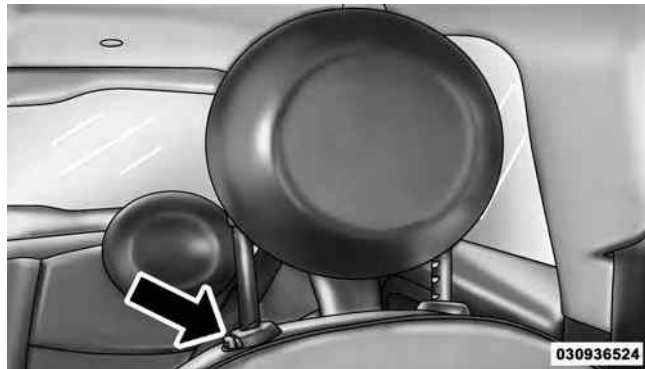

Push Button

The Reactive Head Restraints will automatically return to their normal position following a rear impact. If the Reactive Head Restraints do not return to their normal position, see your authorized dealership immediately.

NOTE: The head restraints should only be removed by qualified technicians, for service purposes only. If either of the head restraints require removal, see your authorized dealership.

3

WARNING!

Do not place items over the top of the Reactive Head Restraint, such as coats, seat covers or portable DVD players. These items may interfere with the operation of the Reactive Head Restraint in the event of a collision and could result in serious injury or death.

Rear Head Restraints

To raise the head restraint, pull upward on the head restraint. To lower the head restraint, press the push button, located at the base of the head restraint, and push downward on the head restraint. Refer to "Occupant Restraints" in "Things To Know Before Starting Your Vehicle" for information on tether routing.



Push Button

TO OPEN AND CLOSE THE HOOD

To open the hood, two latches must be released.

1. Pull the bottom of the RED hood release lever, located on the left kick panel, rearward.

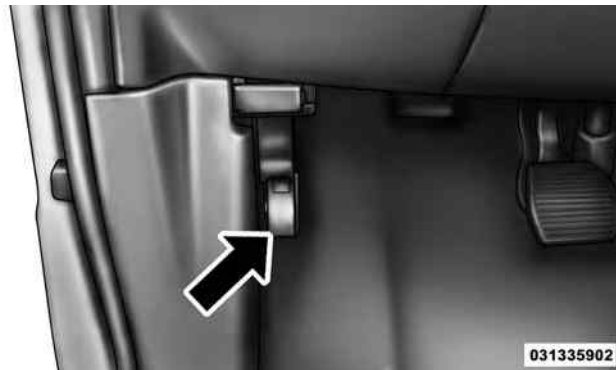

Hood Release Lever

2. Rotate the safety catch under the front edge of the hood, near the center, and raise the hood.



Hood Safety Latch Location

031335904

3. Lift the hood prop rod that clips to the right side (left side when standing in front of the hood) of the engine compartment. Place the hood prop rod in the hole of hood hinge to secure the hood in the open position.

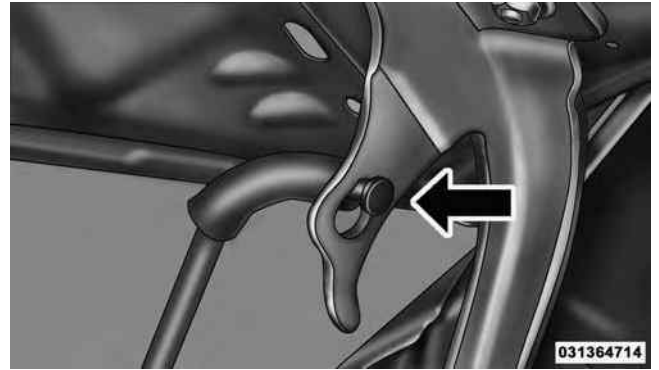

Hood Prop Rod

In hot climates, the prop rod may be hot. Pick up the prop rod at the foam on the end of the prop rod.

CAUTION!

To prevent possible damage, do not slam the hood to close it. Lower the hood until it is open approximately 6 in (15 cm), and then drop it. This should secure both latches. Never drive your vehicle unless the hood is fully closed, with both latches engaged.

WARNING!

Be sure the hood is fully latched before driving your vehicle. If the hood is not fully latched, it could open when the vehicle is in motion and block your vision. Failure to follow this warning could result in serious injury or death.

LIGHTS**Multifunction Lever**

The multifunction lever, located on the left side of the steering wheel, controls the operation of the headlights, headlight beam selection, passing light and turn signals.

NOTE: The external lights can only be turned on with the ignition in the ON/RUN position.

Headlights

Rotate the end of the multifunction lever upward to the first detent for headlight operation.

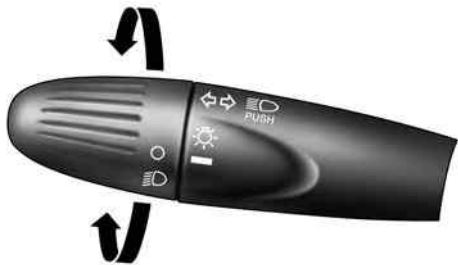

031410253

Headlight Operation

NOTE: When the headlights are turned on, the Daytime Running Lights will be deactivated.

High Beams

 With the low beams activated, push the multifunction lever towards the instrument panel to turn on the high beams. Pull the multifunction lever toward the steering wheel to turn off the high beams.

3

Flash-To-Pass

You can signal another vehicle with your headlights by partially pulling the multifunction lever toward the steering wheel. This will cause the high beam headlights to turn on until the lever is released.

Parking Lights

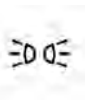

To turn on the parking lights, remove the key or turn the ignition to OFF/LOCK position and turn on the headlights.

Daytime Running Lights — If Equipped

To activate the Daytime Running Lights (DRL), rotate the end of the multifunction lever to the **O** symbol.

NOTE: The low beams and side/taillights will not be on with DRL.

If allowed by law in the country in which the vehicle was purchased the DRL function can be turned on or off using the display menus. Refer to “Electronic Vehicle Information Center (EVIC)” in “Understanding Your Instrument Panel” for further information.

Turn Signals

Push the multifunction lever upward to signal a right turn or downward to signal a left turn. The corresponding indicator in the instrument cluster will blink to indicate the operation of the turn signal.

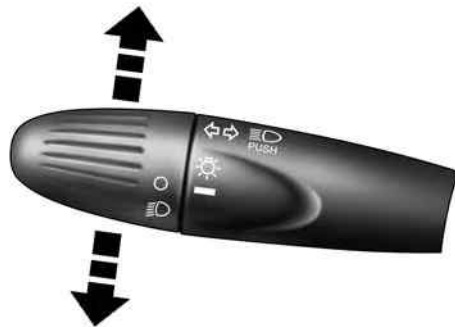

031410254

Turn Signal Operation

NOTE: The indicators will automatically turn off when the turn has been completed and the steering wheel is returned to a straight position.

Lane Change Assist

Tap the lever up or down once, without moving beyond the detent, and the turn signal (right or left) will flash three times then automatically turn off.

Follow Me Home/Headlight Delay

When this feature is selected the driver can choose to have the headlights remain on for a preset period of time.

Activation

Remove the key or turn the ignition to the OFF/LOCK position, and pull the multifunction lever toward the steering wheel, within two minutes. Each time the lever is pulled, the activation of the lights will be extended by 30 seconds. The activation of the lights can be extended to a maximum of 210 seconds.

Deactivation

Pull the multifunction lever toward the steering wheel and hold it for more than two seconds.

Interior Lights

The interior light switches are located in the overhead console. The interior lights can be set to three different positions (Off/Left Position, Center Position, On/Right Position).

Using the switch on the left overhead, press the switch to the right from its center position and the lights are always on. Press the switch to the left from its center position and the lights are always off. Leave the switch in the center position, and the lights are turned on and off when the doors are opened or closed. The switch on the right side of the overhead console controls the map or reading function of the lights. Press the switch to the right to turn on the right light and press the switch to the left to turn on the left light.

CAUTION!

Before getting out of the vehicle be sure that the switch is in the center position or that the lights are off to avoid draining the battery.

Interior Light Timing (Center Position)

There are four different modes of operation that can be activated in this position:

- When one door is opened a three minute timer is activated.
- When the key is removed from the ignition (within two minutes of the ignition being turned off), a 10 second timer is activated.

- When the doors are unlocked with the Key Fob a 10 second timer is activated.
- When the doors are locked with the Key Fob the lights will turn off.

Interior Light Timing (On/Right Position)

- When all doors are closed a 15 minute timer is activated.

NOTE: The timer is deactivated when the key is moved into the ON/RUN position.

Front Fog Lights — If Equipped

The fog light switch is located on the center stack of the instrument panel, just below the radio.



Fog Light Switch

Press the switch once to turn the front fog lights on. Press the switch a second time to turn the front fog lights off.

WINDSHIELD WIPERS AND WASHERS

The windshield wiper/washer lever is located on the right side of the steering column.

NOTE: The windshield wipers/washers will only operate with the ignition in the ON/RUN position.

Front Windshield Wiper Operation

There are five different modes of operation for the front windshield wipers. The windshield wiper lever can be raised or lowered to access these modes:



Windshield Wiper Operation

031570041

Windshield Wiper Off

This is the normal position of the wiper lever.

Intermittent Wiper Operation

Push the lever downward to the first detent. The wipers will operate intermittently.

NOTE: The Intermittent function only has one detent but wiper delay will vary with changes in vehicle speed. As vehicle speed increases the delay time will decrease.

Low Speed

Push the lever downward to the second detent. The wipers will operate at low speed.

High Speed

Push the lever downward to the third detent. The wipers will operate at high speed.

Manual High Speed/Mist

Push the lever upward from the off position. The wipers will operate at high speed to clear off road mist or spray from a passing vehicle. This operation will continue until the lever is released. When the lever is released, the wipers will return to the off position and automatically shut off.

Front Windshield Washer Operation

Pull the windshield wiper/washer lever toward the steering wheel to activate the washers. The wipers will activate automatically for three cycles after the lever is released.

CAUTION!

- Turn the windshield wipers off when driving through an automatic car wash. Damage to the windshield wipers may result if the wiper control is left in any position other than off.
- In cold weather, always turn off the wiper switch and allow the wipers to return to the "Park" position before turning off the engine. If the wiper switch is left on and the wipers freeze to the windshield, damage to the wiper motor may occur when the vehicle is restarted.
- Always remove any buildup of snow that prevents the windshield wiper blades from returning to the off position. If the windshield wiper control is turned off and the blades cannot return to the off position, damage to the wiper motor may occur.

Rear Windshield Wiper

Rotate the end of the windshield wiper/washer lever upward to the first detent past the intermittent settings for intermittent wipe operation. With the front windshield wiper active, rotate the end of the windshield wiper/washer lever upward. The rear wiper will operate in the same mode as the front windshield wipers, but at half the frequency. When the transmission is shifted into REVERSE, the rear wiper will automatically operate at Low Speed and return to normal operation when the transmission is shifted out of REVERSE.



031570084

Rear Wiper Operation

NOTE: The windshield wipers/washers will only operate with the ignition in the ON/RUN position.

Rear Windshield Washer Operation

Push the windshield wiper/washer lever toward the instrument panel to activate the rear washer. Push and hold the lever for more than a half second and the wipers will activate automatically for three cycles after the lever is released.

TILT STEERING COLUMN — IF EQUIPPED

This feature allows you to tilt the steering column upward or downward. The tilt control lever is located on the left-side of the steering column, below the turn signal controls.

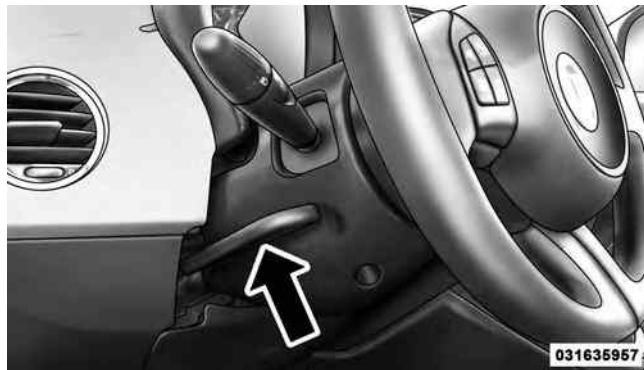

Tilt Control Lever

Push down on the lever to unlock the column. With one hand firmly on the steering wheel, move the steering column up or down as desired. Push the lever up to lock the column firmly in place.

WARNING!

Do not adjust the steering column while driving. Adjusting the steering column while driving or driving with the steering column unlocked, could cause the driver to lose control of the vehicle. Failure to follow this warning may result in serious injury or death.

ELECTRONIC SPEED CONTROL

When engaged, the Electronic Speed Control takes over accelerator operations at speeds greater than 25 mph (40 km/h).

The Electronic Speed Control buttons are located on the right side of the steering wheel.



Electronic Speed Control Buttons

NOTE: In order to ensure proper operation, the Electronic Speed Control system has been designed to shut down if multiple Speed Control functions are operated at the same time. If this occurs, the Electronic Speed Control system can be reactivated by pushing the Electronic Speed Control ON/OFF button and resetting the desired vehicle set speed.

To Activate

Push the ON/OFF button. The Cruise Indicator Light in the instrument cluster will illuminate. To turn the system off, push the ON/OFF button a second time. The Cruise Indicator Light will turn off. The system should be turned off when not in use.

WARNING!

Leaving the Electronic Speed Control system on when not in use is dangerous. You could accidentally set the system or cause it to go faster than you want. You could lose control and have an accident. Always leave the system OFF when you are not using it.

To Set A Desired Speed

Turn the Electronic Speed Control ON. When the vehicle has reached the desired speed, press the SET (-) button and release. Release the accelerator and the vehicle will operate at the selected speed.

NOTE: The vehicle should be traveling at a steady speed and on level ground before pressing the SET (-) button.

To Deactivate

A soft tap on the brake pedal, pushing the CANC button, or normal brake pressure while slowing the vehicle will deactivate Electronic Speed Control without erasing the set speed memory. Pressing the ON/OFF button or turning the ignition switch OFF erases the set speed in memory.

To Resume Speed

To resume a previously set speed, push the RES (+) button and release. Resume can be used at any speed above 25 mph (40 km/h).

To Vary The Speed Setting

To Increase Speed

When the Electronic Speed Control is set, you can increase speed by pushing the RES (+) button.

The drivers preferred units can be selected through the instrument panel settings if equipped. Refer to “Understanding Your Instrument Panel” for more information. The speed increment shown is dependent on the selected speed unit of U.S. (mph) or Metric (km/h):

U.S. Speed (mph)

- Pressing the RES (+) button once will result in a 1 mph increase in set speed. Each subsequent tap of the button results in an increase of 1 mph.
- If the button is continually pressed, the set speed will continue to increase until the button is released, then the new set speed will be established.

Metric Speed (km/h)

- Pressing the RES (+) button once will result in a 1 km/h increase in set speed. Each subsequent tap of the button results in an increase of 1 km/h.

- If the button is continually pressed, the set speed will continue to increase until the button is released, then the new set speed will be established.

To Decrease Speed

When the Electronic Speed Control is set, you can decrease speed by pushing the SET (-) button.

The drivers preferred units can be selected through the instrument panel settings if equipped. Refer to “ Understanding Your Instrument Panel” for more information. The speed decrement shown is dependant on the selected speed unit of U.S. (mph) or Metric (km/h):

U.S. Speed (mph)

- Pressing the SET (-) button once will result in a 1 mph decrease in set speed. Each subsequent tap of the button results in a decrease of 1 mph.

- If the button is continually pressed, the set speed will continue to decrease until the button is released, then the new set speed will be established.

Metric Speed (km/h)

- Pressing the SET (-) button once will result in a 1 km/h decrease in set speed. Each subsequent tap of the button results in a decrease of 1 km/h.
- If the button is continually pressed, the set speed will continue to decrease until the button is released, then the new set speed will be established.

To Accelerate For Passing

Press the accelerator as you would normally. When the pedal is released, the vehicle will return to the set speed.

Using Electronic Speed Control On Hills

The transmission may downshift on hills to maintain the vehicle set speed.

NOTE: The Electronic Speed Control system maintains speed up and down hills. A slight speed change on moderate hills is normal.

On steep hills, a greater speed loss or gain may occur so it may be preferable to drive without Electronic Speed Control.

WARNING!

Electronic Speed Control can be dangerous where the system cannot maintain a constant speed. Your vehicle could go too fast for the conditions, and you could lose control and have an accident. Do not use Electronic Speed Control in heavy traffic or on roads that are winding, icy, snow-covered or slippery.

REAR PARK ASSIST — IF EQUIPPED

The Rear Park Assist system provides visual and audible indications of the distance between the rear fascia/bumper and a detected obstacle when backing up, e.g. during a parking maneuver. Refer to the “Park Assist System Usage Precautions” for the limitations of this system and recommendations.

The Rear Park Assist is automatically activated when the transmission is placed into REVERSE.

Rear Park Assist Sensors

The four Rear Park Assist sensors, located in the rear fascia/bumper, monitor the area behind the vehicle that is within the sensors’ field of view. The sensors can detect obstacles, in the horizontal direction, from approximately 12 in (30 cm) up to 55 in (140 cm) from the center of the rear fascia/bumper and up to 24 in (60 cm) from the corners of the rear fascia/bumper, depending on the location, type and orientation of the obstacle.

If several obstacles are detected, the Rear Park Assist system indicates the nearest obstacle.

The minimum height of a detectable obstacle corresponds to the maximum height of an obstacle that would clear the underside of the car during the parking maneuver.

Rear Park Assist Warning Display

The Rear Park Assist Warning screen is located within the Electronic Vehicle Information Center (EVIC). It provides audible and visual warnings to indicate the distance between the rear fascia/bumper and the detected obstacle. Refer to "Electronic Vehicle Information Center (EVIC)" in "Understanding Your Instrument Panel" for further information.

Rear Park Assist Display

When the vehicle is in REVERSE, the warning display will turn ON indicating the system status.

The system will indicate a detected obstacle by showing arcs in one or more regions based on the obstacle's distance and location relative to the vehicle.

If an obstacle is detected in the center rear region, the display will show solid arcs in the center rear region and will produce an audible alert. As the vehicle moves closer to the obstacle, the display will show fewer arcs and the audible alert becomes more frequent.

If an obstacle is detected in the left and/or right rear region, the display will show solid arcs in the left and/or right rear region and will produce an audible alert. As the vehicle moves closer to the obstacle, the display will show fewer arcs and the audible alert becomes more frequent.

Rear Park Assist Audible Alerts

If an obstacle is behind the vehicle when the transmission is placed into REVERSE, an audible alert is activated.

The tones emitted by the loudspeaker inform the driver that the vehicle is approaching an obstacle. The pauses

between the tones are directly proportional to the distance from the obstacle. Pulses emitted in quick succession indicate the presence of a very close obstacle. A continuous tone indicates that the obstacle is less than 12 in (30 cm) away.

Audible And Visual Signals Supplied By The Rear Park Assist System

SIGNAL	MEANING	INDICATION
<p>Obstacle Distance</p>	<p>An obstacle is present within the sensors' field of view</p>	<p>Audible signal (dashboard loudspeaker)</p> <ul style="list-style-type: none"> • Sound pulses emitted at a rate that increases as the distance decreases. • Emits continuous tone at 12 in (30 cm). • Adjustable volume level. (Refer to "Electronic Vehicle Information Center (EVIC)" in "Understanding Your Instrument Panel" for further information). <p>Visual signal (EVIC)</p> <ul style="list-style-type: none"> • Arcs are shown based on the obstacle's distance and location relative to the vehicle. (Refer to "Rear Park Assist Display" for further information).

SIGNAL	MEANING	INDICATION
Failure	Sensor or System failures	Visual Signal (instrument panel) <ul style="list-style-type: none"> • Icon appears on display. • Message is displayed on the Electronic Vehicle Information Center (EVIC) (where provided).

While audible signals are emitted, the audio system is not muted.

The audible signal is turned off immediately if the distance increases. The tone cycle remains constant if the distance measured by the inner sensors is constant. If this condition occurs for the external sensors, the signal is turned off after 3 seconds (stopping warnings during maneuvers parallel to walls).

Failure Indications

A malfunction of the Rear Park Assist sensors or system is indicated, during REVERSE gear engagement, by the instrument panel warning icon and message displayed on the Electronic Vehicle Information Center (EVIC) display.



The warning icon is illuminated and a message is displayed on the EVIC display (if equipped). Refer to "Electronic Vehicle Information Center (EVIC)" in "Understanding Your Instrument Panel" for further information.

The sensors and wiring are tested continuously when the ignition is in the ON/RUN position. Failures are indicated immediately if they occur when the system is ON.

Even if the system is able to identify that a specific sensor is in failure condition, the EVIC shall indicate that the Rear Park Assist system is unavailable, without reference to the sensor in failure condition. If even a single sensor fails, the entire system must be disabled. The system is turned off automatically.

Cleaning The Rear Park Assist System

Clean the Rear Park Assist sensors with water, car wash soap and a soft cloth. Do not use rough or hard cloths. In washing stations, clean sensors quickly keeping the vapor jet/high pressure washing nozzles at least 4 in (10 cm) from the sensors. Do not scratch or poke the sensors. Otherwise, you could damage the sensors.

Park Assist System Usage Precautions

NOTE:

- Ensure that the outer surface and the underside of the rear bumper is clean and clear of snow, ice, mud, dirt or other obstruction to keep the Rear Park Assist system operating properly.
- Jackhammers, large trucks, and other vibrations could affect the performance of Rear Park Assist.
- Clean the Rear Park Assist sensors regularly, taking care not to scratch or damage them. The sensors must not be covered with ice, snow, slush, mud, dirt or debris. Failure to do so can result in the system not working properly. The Rear Park Assist system might not detect an obstacle behind the fascia/bumper, or it could provide a false indication that an obstacle is behind the fascia/bumper.

- Objects such as bicycle carriers, etc., must not be placed within 12 in (30 cm) from the rear fascia/bumper while driving the vehicle. Failure to do so can result in the system misinterpreting a close object as a sensor problem, causing a failure indication to be displayed in the instrument cluster.

CAUTION!

- Rear Park Assist is only a parking aid and it is unable to recognize every obstacle, including small obstacles. Parking curbs might be temporarily detected or not detected at all. Obstacles located above or below the sensors will not be detected when they are in close proximity.

(Continued)

CAUTION! (Continued)

- The vehicle must be driven slowly when using Rear Park Assist in order to be able to stop in time when an obstacle is detected. It is recommended that the driver looks over his/her shoulder when using Rear Park Assist.

WARNING!

- Drivers must be careful when backing up even when using the Rear Park Assist system. Always check carefully behind your vehicle, look behind you, and be sure to check for pedestrians, animals, other vehicles, obstructions, and blind spots before backing up. You are responsible for safety and must continue to pay attention to your surroundings. Failure to do so can result in serious injury or death.

(Continued)

WARNING! (Continued)

- Before using the Rear Park Assist System, it is strongly recommended that the ball mount and hitch ball assembly is disconnected from the vehicle when the vehicle is not used for towing. Failure to do so can result in injury or damage to vehicles or obstacles because the hitch ball will be much closer to the obstacle than the rear fascia when the warning display turns on the single flashing arc and sounds the continuous tone. Also, the sensors could detect the ball mount and hitch ball assembly, depending on its size and shape, giving a false indication that an obstacle is behind the vehicle.

POWER SUNROOF — IF EQUIPPED

The power sunroof roof switch is located in the overhead console.



Power Sunroof Switch

WARNING!

- **Never leave children alone in a vehicle, or with access to an unlocked vehicle. Never leave the Key Fob in or near the vehicle, or in a location accessible to children. Occupants, particularly unattended children, can become entrapped by the power sunroof while operating the power sunroof switch. Such entrapment may result in serious injury or death.**
- **In a collision, there is a greater risk of being thrown from a vehicle with an open sunroof. You could also be seriously injured or killed. Always fasten your seat belt properly and make sure all passengers are properly secured.**
- **Do not allow small children to operate the sunroof. Never allow your fingers, other body parts, or any object to project through the sunroof opening. Injury may result.**

To Open

Press and hold the power sunroof switch rearward for approximately one second and the sunroof will stop at the vented position. Press the switch a second time and hold for approximately one second and release, the sunroof will open fully, then stop automatically. This is called “Express Open”. During Express Open operation, any movement of the sunroof switch will stop the sunroof.

To Close

With the sunroof in the full open position, pull the power sunroof button and hold it for approximately one second, the sunroof will return to the vented position. Pull the switch a second time and hold for approximately one second to completely close the sunroof.

Pinch Protect Feature

This feature will detect an obstruction in the opening of the sunroof during Express Close operation. If an obstruction in the path of the sunroof is detected, the sunroof will automatically retract. Remove the obstruction if this occurs. Next, press the switch forward and release to Express Close.

Wind Buffeting

Wind buffeting can be described as the perception of pressure on the ears or a helicopter-type sound in the ears. Your vehicle may exhibit wind buffeting with the windows down, or the sunroof (if equipped) in certain open or partially open positions. This is a normal occurrence and can be minimized. If the buffeting occurs with the rear windows open, open the front and rear windows together to minimize the buffeting. If the buffeting occurs with the sunroof open, adjust the sunroof opening to minimize the buffeting or open any window.

Emergency Operation

In case of electrical failure the sunroof can be operated with the hex wrench that is located in the glove box. There is a plug located in the rear of the sunroof opening at the center of the vehicle. Removing the plug reveals a hex opening in the motor assembly of the sunroof. Insert the hex wrench and turn, moving the sunroof to the desired location.

Sun Shade — If Equipped

For vehicles equipped with either a power sunroof or a fixed glass roof, there is a sun shade that can be open or closed. To open the sun shade press the tab and move the shade to a full open position.



Manual Sun Shade

ELECTRICAL POWER OUTLETS

There is a standard 12 Volt (13 Amp) power outlet, located in the floor console, for added convenience. This power outlet can power mobile phones, electronics and other low power devices.

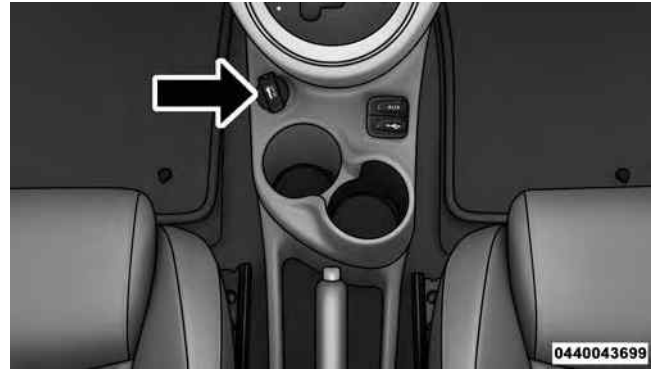

Power Outlet

Power is available when the ignition switch is in the ON/RUN or START position. Insert the cigar lighter or accessory plug into the outlet for use. To preserve the heating element, do not hold the lighter in the heating position.

CAUTION!

- Do not exceed the maximum power of 160 Watts (13 Amps) at 12 Volts. If the 160 Watts (13 Amps) power rating is exceeded, the fuse protecting the system will need to be replaced.
- Power outlets are designed for accessory plugs only. Do not insert any other object in the power outlets as this will damage the outlet and blow the fuse. Improper use of the power outlet can cause damage not covered by your New Vehicle Limited Warranty.

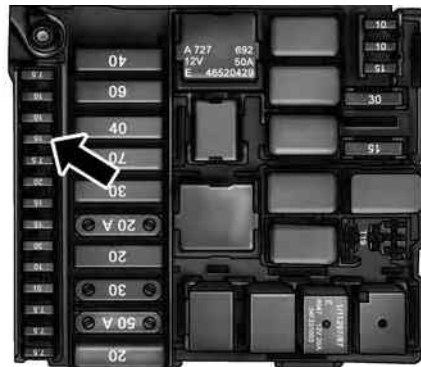

Power Outlet Fuse Location Underhood

F15 Fuse 15 A Blue Cigar Lighter Front Console

WARNING!

To avoid serious injury or death:

- Only devices designed for use in this type of outlet should be inserted into any 12 Volt outlet.
- Do not touch with wet hands.
- Close the lid when not in use and while driving the vehicle.
- If this outlet is mishandled, it may cause an electric shock and failure.

CAUTION!

- Many accessories that can be plugged in draw power from the vehicle's battery, even when not in use (i.e., cellular phones, etc.). Eventually, if plugged in long enough, the vehicle's battery will discharge sufficiently to degrade battery life and/or prevent the engine from starting.
- Accessories that draw higher power (i.e., coolers, vacuum cleaners, lights, etc.) will degrade the battery even more quickly. Only use these intermittently and with great caution.
- After the use of high power draw accessories, or long periods of the vehicle not being started (with accessories still plugged in), the vehicle must be driven a sufficient length of time to allow the generator to recharge the vehicle's battery.

CIGAR LIGHTER — IF EQUIPPED

This is located on the center console, in front of the cup holders. To activate the cigar lighter, push and release the knob. After a few seconds the knob automatically returns to its initial position, and the cigar lighter is ready for use.

WARNING!

When the cigar lighter is in use it becomes very hot. To avoid serious injury, handle the cigar lighter with care. Always check that the cigar lighter has turned off.

CUPHOLDERS

For the driver and front passenger, cupholders are located on the floor console between the front seats.

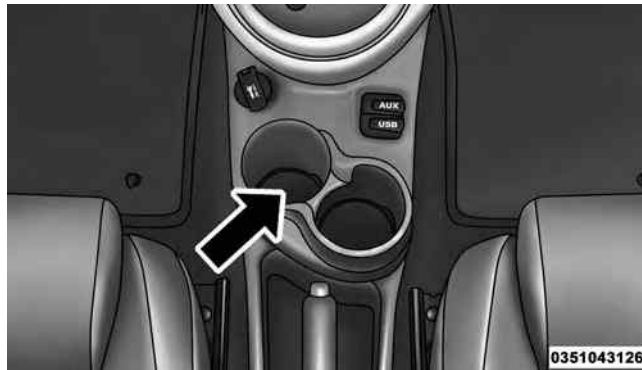

Front Cupholders

For rear passengers, there are cupholders located on the floor between the front driver and passenger seats.

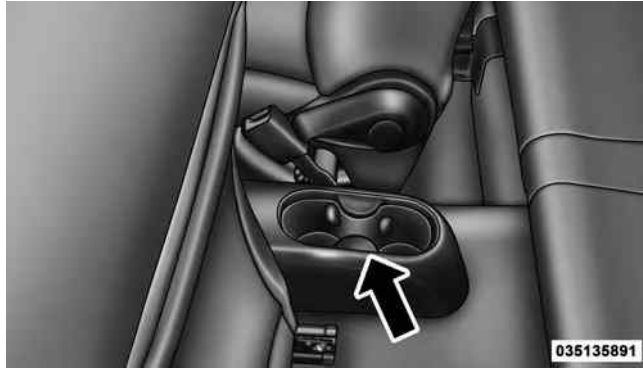

Rear Cupholders

STORAGE

Glove Compartment

The glove compartment is located on the right side of the instrument panel. Pull outward on the glove compartment latch to open the glove compartment. Push the glove compartment door upward to close it.

3

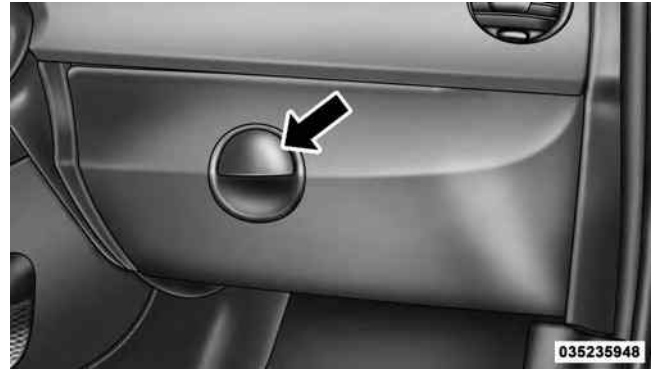

Glove Compartment Latch

CARGO AREA FEATURES

The rear seatbacks have a fold down feature to allow increased cargo capacity.

Push down the release button, located at the outboard top of the seatback and move the seatback to its folded-down position to provide a flat load floor cargo area. When returning the seatback to its upright position, push rearward until the seatback is properly latched.

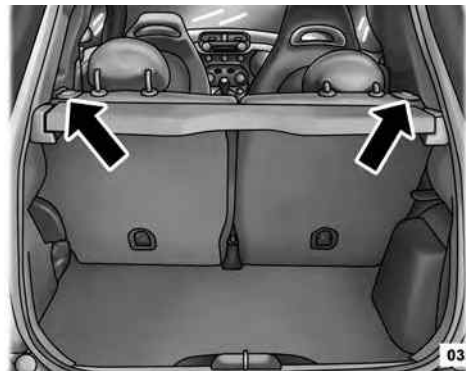

Rear Seat Release Buttons

REAR WINDOW FEATURES

Rear Window Defroster



Folded Rear Seats



The rear window defroster button is located in the center of the instrument panel, below the radio. Press this button to turn on the rear window defroster. An indicator in the instrument cluster will illuminate when the rear window defroster is on. The rear window defroster automatically turns off after approximately 20 minutes. To manually shut the defroster off, push the button a second time.

NOTE: To prevent excessive battery drain, use the rear window defroster only when the engine is operating.

CAUTION!

Failure to follow these cautions can cause damage to the heating elements:

- Use care when washing the inside of the rear window. Do not use abrasive window cleaners on the interior surface of the window. Use a soft cloth and a mild washing solution, wiping parallel to the heating elements. Labels can be peeled off after soaking with warm water.
- Do not use scrapers, sharp instruments, or abrasive window cleaners on the interior surface of the window.
- Keep all objects a safe distance from the window.

UNDERSTANDING YOUR INSTRUMENT PANEL

CONTENTS

■ INSTRUMENT PANEL FEATURES141	□ Electronic Vehicle Information Center (EVIC) Setup Menu162
■ INSTRUMENT CLUSTER142	□ Change Engine Oil Indicator System164
■ INSTRUMENT CLUSTER — ECO143	□ Trip Computer165
■ INSTRUMENT CLUSTER — POP, LOUNGE, 500C144	□ Trip Button165
■ INSTRUMENT CLUSTER DESCRIPTIONS145	□ Trip Functions166
■ ELECTRONIC VEHICLE INFORMATION CENTER (EVIC)159	□ Values Displayed167
□ EVIC Displays160	□ Personal Settings (Customer-Programmable Features).168
□ EVIC Control Buttons161	■ SALES CODE (RAB) RADIO180

140 UNDERSTANDING YOUR INSTRUMENT PANEL

- Introduction181
- Suggestions.181
- Technical Specifications183
- Quick Guide184
- General Information.187
- Functions And Adjustments189
- Radio196
- SiriusXM Satellite Radio — If Equipped.198
- CD Player.201
- CD MP3 Player204
- Troubleshooting.206
- iPod®/USB/MEDIA PLAYER CONTROL — IF EQUIPPED207
- STEERING WHEEL AUDIO CONTROLS208
 - Radio Operation209
 - CD Player Operation209
 - Operating Instructions — Hands-Free Phone (If Equipped).209
- CD/DVD DISC MAINTENANCE209
- RADIO OPERATION AND MOBILE PHONES210
- CLIMATE CONTROLS210
 - Manual Heating And Air Conditioning211
 - Automatic Temperature Control (ATC)213
 - Operating Tips219

INSTRUMENT PANEL FEATURES

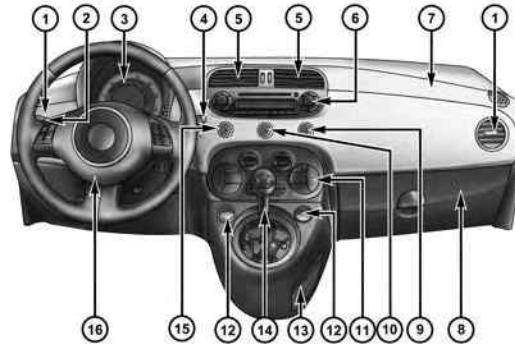

040140268

- 1 — Side Vent
- 2 — Multifunction Lever – Light Control
- 3 — Instrument Cluster And Warning Lights
- 4 — Windshield Wiper, Washer, Trip Computer
- 5 — Central Air Vents
- 6 — Storage Compartment/Radio

- 7 — Passenger Air Bag
- 8 — Glove Compartment
- 9 — Rear Defrost Button
- 10 — Hazard Button
- 11 — Climate Controls
- 12 — Power Windows Control

- 13 — Storage Compartment
- 14 — Shift Lever
- 15 — Sport Button
- 16 — Horn/Driver Airbag

INSTRUMENT CLUSTER

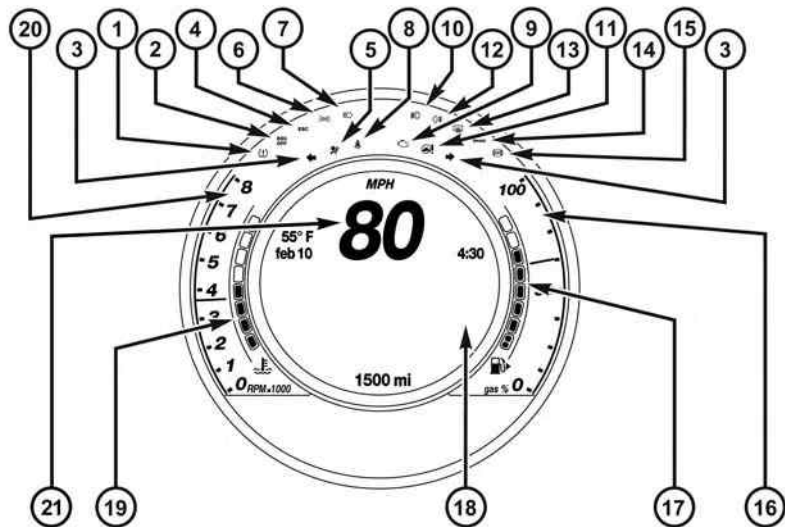

INSTRUMENT CLUSTER — ECO

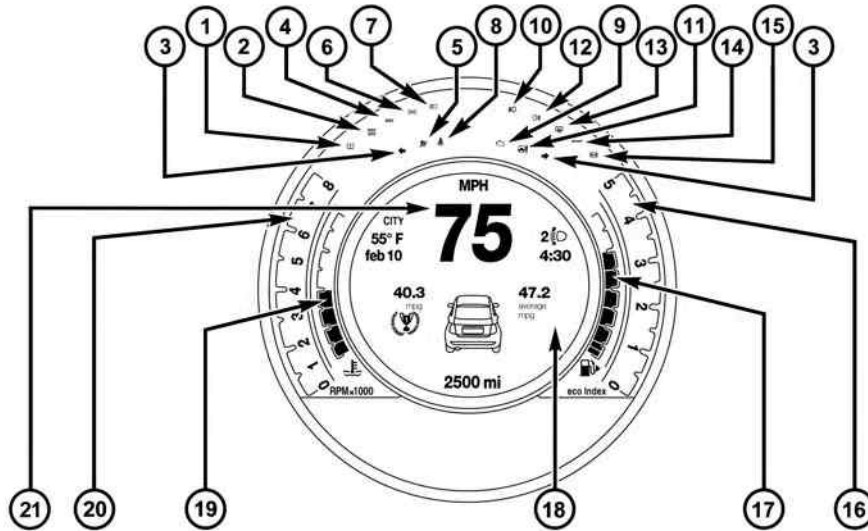

INSTRUMENT CLUSTER — POP, LOUNGE, 500C

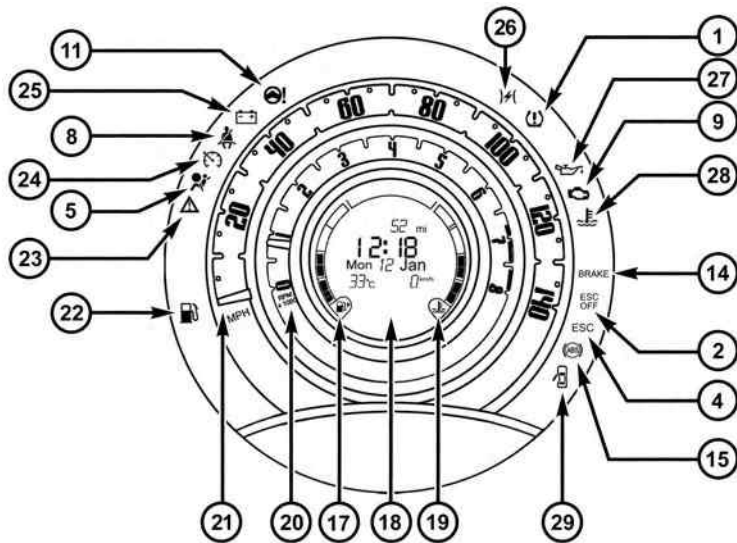

INSTRUMENT CLUSTER DESCRIPTIONS

1. *Tire Pressure Monitoring Telltale Light — If Equipped*



Each tire, including the spare (if provided), should be checked monthly when cold and inflated to the inflation pressure recommended by the vehicle manufacturer on the vehicle placard or tire inflation pressure label. (If your vehicle has tires of a different size than the size indicated on the vehicle placard or tire inflation pressure label, you should determine the proper tire inflation pressure for those tires.)

As an added safety feature, your vehicle has been equipped with a Tire Pressure Monitoring System (TPMS) that illuminates a low tire pressure telltale when one or more of your tires is significantly under-inflated. Accordingly, when the low tire pressure telltale illuminates, you should stop and check your tires as soon as possible, and inflate them to the proper pressure. Driving on a significantly under-inflated

tire causes the tire to overheat and can lead to tire failure. Under-inflation also reduces fuel efficiency and tire tread life, and may affect the vehicle's handling and stopping ability.

Please note that the TPMS is not a substitute for proper tire maintenance, and it is the driver's responsibility to maintain correct tire pressure, even if under-inflation has not reached the level to trigger illumination of the TPMS low tire pressure telltale.

Your vehicle has also been equipped with a TPMS malfunction indicator to indicate when the system is not operating properly. The TPMS malfunction indicator is combined with the low tire pressure telltale. When the system detects a malfunction, the telltale will flash for approximately one minute and then remain continuously illuminated. This sequence will continue upon subsequent vehicle start-ups as long as the malfunction exists.

When the malfunction indicator is illuminated, the system may not be able to detect or signal low tire pressure as intended. TPMS malfunctions may occur for a variety of reasons, including the installation of replacement or alternate tires or wheels on the vehicle that prevent the TPMS from functioning properly. Always check the TPMS malfunction telltale after replacing one or more tires or wheels on your vehicle, to ensure that the replacement or alternate tires and wheels allow the TPMS to continue to function properly.

CAUTION!

The TPMS has been optimized for the original equipment tires and wheels. TPMS pressures and warning have been established for the tire size

(Continued)

CAUTION! *(Continued)*

equipped on your vehicle. Undesirable system operation or sensor damage may result when using replacement equipment that is not of the same size, type, and/or style. Aftermarket wheels can cause sensor damage. Using aftermarket tire sealants may cause the Tire Pressure Monitoring System (TPMS) sensor to become inoperable. After using an aftermarket tire sealant it is recommended that you take your vehicle to an authorized dealership to have your sensor function checked.

2. *Electronic Stability Control (ESC) OFF Indicator Light — If Equipped*

ESC OFF This light indicates the Electronic Stability Control (ESC) is off.

3. Turn Signal Indicators



The arrow will flash with the exterior turn signal when the turn signal lever is operated.

NOTE:

- A continuous chime will sound if the vehicle is driven more than 1 mile (1.6 km) with either turn signal on.
- Check for an inoperative outside light bulb if either indicator remains on and does not flash, or flashes at a rapid rate.

4. Electronic Stability Control (ESC) Activation/ Malfunction Indicator Light

ESC

The “ESC Activation/Malfunction Indicator Light” in the instrument cluster will come on when the ignition switch is turned to the ON/RUN position. It should go out with the engine running. If the “ESC Activation/Malfunction Indicator Light” comes on continuously with the engine running, a malfunction has been detected in the ESC system. If this light remains on after several ignition cycles, and the vehicle has been driven several miles (kilometers) at speeds greater than 30 mph (48 km/h), see your authorized dealer as soon as possible to have the problem diagnosed and corrected.

NOTE:

- The “ESC Off Indicator Light” and the “ESC Activation/Malfunction Indicator Light” come on momentarily each time the ignition switch is turned to ON/RUN.
- Each time the ignition is turned to ON/RUN, the ESC system will be ON, even if it was turned off previously.
- The ESC system will make buzzing or clicking sounds when it is active. This is normal; the sounds will stop when ESC becomes inactive following the maneuver that caused the ESC activation.

5. Air Bag Warning Light

This light will turn on for four to eight seconds as a bulb check when the ignition switch is first turned to ON/RUN. If the light is either not on during starting, stays on, or turns on while

driving, have the system inspected at an authorized dealer as soon as possible. Refer to “Occupant Restraints” in “Things To Know Before Starting Your Vehicle” for further information.

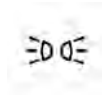
6. Park/Headlight ON Indicator — If Equipped

This indicator will illuminate when the park lights or headlights are turned on.

7. High Beam Indicator

This light shows that the high beam headlights are on. Push the multifunction control lever away from you to switch the headlights to high beam. Pull the lever toward you to switch the headlights back to low beam. If the driver’s door is open, and the headlights or park lights are left on, the high beam indicator light will remain illuminated and a chime will sound.

8. *Seat Belt Reminder Light*



When the ignition switch is first turned to ON/RUN, this light will turn on for four to eight seconds as a bulb check. During the bulb check, if the driver's seat belt is unbuckled, a chime will sound. After the bulb check or when driving, if the driver's seat belt remains unbuckled, the seat belt reminder light will flash or remain on continuously. Refer to "Occupant Restraints" in "Things To Know Before Starting Your Vehicle" for further information.

9. *Malfunction Indicator Light (MIL)*



The Malfunction Indicator Light (MIL) is part of an onboard diagnostic (OBDII) system which monitors the emissions and engine control system. If the vehicle is ready for emissions

testing, the light will come on when the ignition is first turned on and remain on, as a bulb check, until the engine is started. If the vehicle is not ready for emissions testing the light will come on when the ignition is first turned on and remain on for 15 seconds, then blink for 5 seconds, and remain on until the vehicle is started. If the bulb does not come on during starting, have the condition investigated promptly.

If this light comes on and remains on while driving, it suggests a potential engine control problem and the need for system service.

Although your vehicle will usually be drivable and not need towing, see your authorized dealer for service as soon as possible.

CAUTION!

Prolonged driving with the Malfunction Indicator Light (MIL) on could cause damage to the engine control system. It also could affect fuel economy and driveability. If the MIL is flashing, severe catalytic converter damage and power loss will soon occur. Immediate service is required.

WARNING!

A malfunctioning catalytic converter, as referenced above, can reach higher temperatures than in normal operating conditions. This can cause a fire if you drive slowly or park over flammable substances such as dry plants, wood, cardboard, etc. This could result in death or serious injury to the driver, occupants or others.

10. Front Fog Light Indicator — If Equipped

This indicator will illuminate when the front fog lights are on.

11. Electric Power Steering Malfunction Warning Light

This telltale is on when the Electric Power Steering is not operating and needs service.

12. Rear Fog Light Indicator — If Equipped

This indicator will illuminate when the rear fog lights are on.

13. Rear Defrost Indicator

This indicator will illuminate when the rear window defroster is on. The rear window defroster automatically turns off after 20 minutes.

CAUTION!

Failure to follow these cautions can cause damage to the heating elements:

- Use care when washing the inside of the rear window. Do not use abrasive window cleaners on the interior surface of the window. Use a soft cloth and a mild washing solution, wiping parallel to the heating elements. Labels can be peeled off after soaking with warm water.
- Do not use scrapers, sharp instruments, or abrasive window cleaners on the interior surface of the window.
- Keep all objects a safe distance from the window.

14. Brake Warning Light

BRAKE

This light monitors various brake functions, including brake fluid level and parking brake application. If the brake light turns on it may indicate that the parking brake is applied, that the brake fluid level is low, or that there is a problem with the Anti-lock Brake System reservoir.

If the light remains on when the parking brake has been disengaged, and the fluid level is at the full mark on the master cylinder reservoir, it indicates a possible brake hydraulic system malfunction or that a problem with the Brake Booster has been detected by the Anti-Lock Brake System (ABS) / Electronic Stability Control (ESC) system. In this case, the light will remain on until the condition has been corrected. If the problem is related to the brake booster, the ABS pump will run when applying the brake and a brake pedal pulsation may be felt during each stop.

The dual brake system provides a reserve braking capacity in the event of a failure to a portion of the hydraulic system. A leak in either half of the dual brake system is indicated by the Brake Warning Light, which will turn on when the brake fluid level in the master cylinder has dropped below a specified level.

The light will remain on until the cause is corrected.

NOTE: The light may flash momentarily during sharp cornering maneuvers, which change fluid level conditions. The vehicle should have service performed, and the brake fluid level checked.

If brake failure is indicated, immediate repair is necessary.

WARNING!

Driving a vehicle with the red brake light on is dangerous. Part of the brake system may have failed. It will take longer to stop the vehicle. You could have a collision. Have the vehicle checked immediately.

Vehicles equipped with the ABS, are also equipped with Electronic Brake Force Distribution (EBD). In the event of an EBD failure, the Brake Warning Light will turn on along with the ABS Light. Immediate repair to the ABS system is required.

Operation of the Brake Warning Light can be checked by turning the ignition switch from the OFF position to the ON/RUN position. The light should illuminate for approximately two seconds. The light should then turn off unless the parking brake is applied or a brake fault is detected. If the light does not illuminate, have the light inspected by an authorized dealer.

The light also will turn on when the parking brake is applied with the ignition switch in the ON/RUN position.

NOTE: This light shows only that the parking brake is applied. It does not show the degree of brake application.

15. *Anti-Lock Brake (ABS) Light*



This light monitors the Anti-lock Brake System (ABS). The light will turn on when the ignition switch is turned to the ON/RUN position and may stay on for as long as four seconds.

If the ABS light remains on or turns on while driving, it indicates that the anti-lock portion of the brake system is not functioning and that service is required. However, the conventional brake system will continue to operate normally if the BRAKE warning light is not on.

If the ABS light is on, the brake system should be serviced as soon as possible to restore the benefits of anti-lock brakes. If the ABS light does not turn on when the ignition switch is turned to the ON/RUN position, have the light inspected by an authorized dealer.

16. Gas Pedal Percentage Gauge/Turbo Gauge/ ECO Index Gauge

Depending on what options and trim level your vehicle is equipped with there are three gauges available.

- Gas Pedal Percentage Gauge: This gauge shows what percent the gas pedal is currently depressed at.
- Turbo Gauge: This gauge shows the current turbo usage.
- ECO Index Gauge: The ECO Index gauge allows the driver to monitor their driving style in order to increase fuel economy. The efficiency of the driving style is displayed on a gauge located on the right side of the instrument cluster and ranges from a minimum value of 0 up to a maximum value of 5 (0 = low, 5 = high). A higher “ECO” index indicates a more fuel efficient drive style and will increase your fuel economy. A lower “ECO” index indicates

frequent accelerations/decelerations and will decrease your fuel economy. The index is recalculated approximately every second and takes into account a combination of the instant fuel economy and your driving style during the current trip.

NOTE: Different trips may have different values even if the same driving style is maintained. Some factors that may impact the calculated index value are:

- Traffic conditions
- Trip duration
- Temperature (engine and ambient)

17. Fuel Gauge

Shows level of fuel in tank when ignition switch is in the ON/RUN position.

18. *Electronic Vehicle Information Center (EVIC)*

The EVIC features a driver-interactive display that is located in the instrument cluster. For further information, refer to “Electronic Vehicle Information Center (EVIC)” in “Understanding Your Instrument Panel.”

19. *Temperature Gauge*

The temperature gauge shows engine coolant temperature. Any reading within the normal range indicates that the engine cooling system is operating satisfactorily.

The gauge pointer will likely indicate a higher temperature when driving in hot weather, up mountain grades, or when towing a trailer. It should not be allowed to exceed the upper limits of the normal operating range.

CAUTION!

Driving with a hot engine cooling system could damage your vehicle. If the temperature gauge reads “H” pull over and stop the vehicle. Idle the vehicle with the air conditioner turned off until the pointer drops back into the normal range. If the pointer remains on the “H” and you hear continuous chimes, turn the engine off immediately and call an authorized dealer for service.

WARNING!

A hot engine cooling system is dangerous. You or others could be badly burned by steam or boiling coolant. You may want to call an authorized dealer for service if your vehicle overheats. If you decide to look under the hood yourself, see “Maintaining Your Vehicle.” Follow the warnings under the “Cooling System Pressure Cap” paragraph.

20. Tachometer

The tachometer indicates engine speed in Revolutions Per Minute (RPM x 1000).

21. Speedometer / Trip Odometer / Electronic Vehicle Information Center (EVIC) Display Area

This display indicates the total distance the vehicle has been driven.

U.S. Federal regulations require that upon transfer of vehicle ownership, the seller certify to the purchaser the correct mileage that the vehicle has been driven. If your odometer needs to be repaired or serviced, the repair technician should leave the odometer reading the same as it was before the repair or service. If s/he cannot do so, then the odometer must be set at zero, and a sticker must be placed in the door jamb stating what the mileage was

before the repair or service. It is a good idea for you to make a record of the odometer reading before the repair/service, so that you can be sure that it is properly reset, or that the door jamb sticker is accurate if the odometer must be reset at zero.

NOTE: If the vehicle is equipped with the Electronic Vehicle Information Center (EVIC) in the instrument cluster, all warnings including “door” and “gate” and “Change Engine Oil” will only be displayed in the EVIC display. Refer to “Electronic Vehicle Information Center (EVIC) in “Understanding Your Instrument Panel.”

22. Low Fuel Light



When the fuel level reaches approximately 1.0 gallon (3.8L) this light will turn on, and remain on until fuel is added.

23. *Generic Warning Light*



The Generic Warning Light will illuminate if any of the following conditions occur: Oil Change Request, Engine Oil Pressure Sensor Failure, External Light Failure, Fuel Cut-Off Intervention, Fuel Cut-Off Not Available, Parking Sensor Failure.

24. *Cruise On Indicator — If Equipped*



This light will turn on when the electronic speed control is ON. For further information, refer to “Electronic Speed Control” in “Understanding Your Instrument Panel.”

25. *Charging System Light*



This light shows the status of the electrical charging system. The light should come on when the ignition switch is first turned to ON/RUN and remain on briefly as a bulb check. If the light stays on or comes on while driving, turn off some of the vehicle’s non-essential electrical devices or increase engine speed (if at idle). If the charging system light remains on, it means that the vehicle is experiencing a problem with the charging system. Obtain SERVICE IMMEDIATELY. See an authorized dealer.

If jump starting is required, refer to “Jump Starting Procedures” in “What To Do In Emergencies”.

26. *Electronic Throttle Control (ETC) Light*



This light informs you of a problem with the Electronic Throttle Control (ETC) system. If a problem is detected, the light will come on while the engine is running. Cycle the ignition key when the vehicle has completely stopped and the shift lever is placed in the NEUTRAL position. The light should turn off. If the light remains lit with the engine running, your vehicle will usually be drivable; however, see an authorized dealer for service as soon as possible. If the light is flashing when the engine is running, immediate service is required and you may experience reduced performance, an elevated/rough idle or engine stall and your vehicle may require towing. The light will come on when the ignition is first turned to ON/RUN and remain on briefly as a bulb check. If the light does not come on during starting, have the system checked by an authorized dealer.

27. *Oil Pressure Warning Light*



This light indicates low engine oil pressure. The light should turn on momentarily when the engine is started. If the light turns on while driving, stop the vehicle and shut off the engine as soon as possible. A chime will sound for four minutes when this light turns on.

Do not operate the vehicle until the cause is corrected. This light does not indicate how much oil is in the engine. The engine oil level must be checked under the hood.

28. *Engine Temperature Warning Light*



This light warns of an overheated engine condition. The engine coolant temperature indicator will illuminate and a single chime will sound after reaching a set threshold.

If the light turns on while driving, safely pull over and stop the vehicle. If the A/C system is on, turn it off. Also, shift the transmission into NEUTRAL and idle the vehicle. If the temperature reading does not return to normal, turn the engine off immediately and call for service. Refer to “If Your Engine Overheats” in “What To Do In Emergencies” for further information.

ELECTRONIC VEHICLE INFORMATION CENTER (EVIC)

The Electronic Vehicle Information Center (EVIC) features a driver-interactive display that is located in the instrument cluster.



0409043146

Electronic Vehicle Information Center (EVIC) Display

The EVIC consists of the following:

- System Status
- Vehicle Information Warning Message Displays
- Personal Settings (Customer-Programmable Features)
- Outside Temperature Display
- Trip Computer Functions
- Tire Pressure Monitoring Display

EVIC Displays

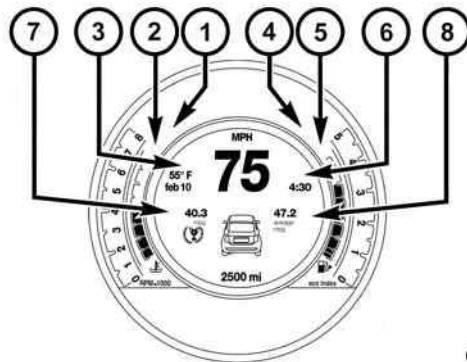

0409043148

Instrument Cluster

1. Red Telltales (Left Bank)
 - Hood Ajar
 - Low Oil Pressure
 - Electronic Throttle Control

- Door Ajar
 - Speed Limiter — If Equipped
2. Amber Telltales
 - Ice Risk
 - Fuel Cut Off
 - Fuel Cut Off Failed
 - Hill Holder Failed
 - Oil Change Request
 - Check Lights
 - Vehicle Lock
 3. Electronic Speed Control Active
 4. Amber Telltales
 - Generic Warning Light
 - Glow Plug Light
 - Park Sensor Failed
 - Stop Lamp Failed

5. Red Telltales (Right Bank)
 - Trunk Ajar
 - Transmission Failure
 - Battery Charge Indicator
6. Exceeded Speed Limiter
7. Shift Up or Down Indicators
8. Gear Indicator

EVIC Control Buttons

Push and release the **MENU** button briefly to access the EVIC. Push and hold the **MENU** button (approximately one second) to return to the main screen.

Push and release the UP  button to scroll upward through the displayed menu and the related options or to increase the displayed value.

Push and release the DOWN ▽ button to scroll downward through the displayed menu and the related options or to decrease the value displayed.

NOTE: UP ▲ and DOWN ▽ buttons activate different functions according to the following situations:

- To scroll the menu options upwards or downwards.
- To increase or decrease values during settings.

NOTE: When opening one of the front doors, the EVIC display will turn on the clock and the miles or kilometers covered (for versions/markets, where provided) for a few seconds.

Electronic Vehicle Information Center (EVIC) Setup Menu



The menu comprises a series of functions arranged in a cycle. Push and release the UP ▲ and DOWN ▽ buttons to access the different options and settings (setup).

The setup menu can be activated by pushing the MENU button. A single push on the UP ▲ or DOWN ▽ buttons will scroll through the setup menu options. The menu includes the following functions:



- Speed Beep
- Trip B Data
- Set Time
- Set Date



- See Radio
- Speed Display
- Autoclose
- Units
- Language
- Buzzer Volume
- Button Volume
- Daylights (D.R.L.)
- Hill Start
- Tire Pressure
- Unlock Driver Door First
- Unlock All Doors
- Exit Menu

Selecting An Option Of The Main Menu Without Submenu

1. Briefly push and release the **MENU** button to select the main menu option to set.
2. Push and release the UP  or DOWN  button (by single pushes) to select the new setting.
3. Briefly push and release the **MENU** button to store the new setting and go back to the main menu option previously selected.

Selecting An Option Of The Main Menu With Submenu

1. Briefly push and release the **MENU** button to display the first submenu option.
2. Push and release the UP  or DOWN  button (by single pushes) to scroll through all the submenu options.

3. Briefly push and release the **MENU** button to select the displayed submenu option and to open the relevant setup menu.
4. Push and release the UP  or DOWN  button (by single pushes) to select the new setting for this submenu option.
5. Briefly push and release the **MENU** button to store the new setting and go back to the previously selected submenu option.
6. Push and hold the **MENU** button to return to the main menu (short hold) or the main screen (longer hold).

Change Engine Oil Indicator System

Change Engine Oil

Your vehicle is equipped with an engine oil change indicator system. The “Change Engine Oil” message will flash in the EVIC display for approximately 10 seconds

after a single chime has sounded to indicate the next scheduled oil change interval. The engine oil change indicator system is duty cycle based, which means the engine oil change interval may fluctuate, dependent upon your personal driving style.

Unless reset, this message will continue to display each time you turn the ignition switch to the ON/RUN position. To turn off the message temporarily, push and release the **MENU** button. To reset the oil change indicator system (after performing the scheduled maintenance), refer to the following procedure.

1. Turn the ignition switch to the ON position. (do not start the engine.)
2. Fully push the accelerator pedal slowly, three times within 10 seconds.
3. Turn the ignition switch to the OFF/LOCK position.

NOTE: If the indicator message illuminates when you start the vehicle, the oil change indicator system did not reset. If necessary, repeat this procedure.

Trip Computer

The Trip Computer is located in the instrument cluster. It features a driver-interactive display (displays information such as trip information, range, fuel consumption, average speed, and travel time).

Trip Button

The **TRIP** button, located on the right steering column stalk, can be used to display and to reset the previously described values.

- A short button push displays the different values.
- A long button push resets the system and then starts a new trip.

New Trip

To reset:

- Push and hold the **TRIP** button to reset the system manually.
- When the “Trip distance” reaches 9999.9 miles or kilometers or when the “Travel time” reaches 999.59 (999 hours and 59 minutes), the system is reset automatically.
- Disconnecting/Reconnecting the battery resets the system.

NOTE: If the reset operation occurs in the presence of the screens concerning Trip A or Trip B, only the information associated with Trip A or Trip B functions will be reset.

Start Of Trip Procedure

With the ignition on, push and hold the **TRIP** button for over one second to reset.

Exit Trip

To exit the Trip function, wait until all the values have been displayed or hold the **MENU** button for longer than one second.

Briefly push and release the **MENU** button to go back to the menu screen or push and hold the **MENU** (approximately one second) to go back to the main screen without storing settings.

Trip Functions

Both trip functions are resettable (reset — start of new trip).

“Trip A” can be used to display the figures relating to:

- Range
- Trip distance A

- Average consumption
- Instantaneous consumption
- Average speed A
- Travel time A (driving time)

“Trip B” can be used to display the figures relating to:

- Trip distance B
- Average consumption
- Average speed B
- Travel time B (driving time)

NOTE: “Trip B” functions may be excluded (see “Trip B Data”). “Range” and “Instantaneous consumption” cannot be reset.

Values Displayed

Range

This indicates the distance which may be traveled with the fuel remaining in the tank, assuming that driving conditions will not change. The message “----” will appear on the display in the following cases:

- Distance less than 30 miles (or 50 km).
- The vehicle is parked for a long time with the engine running.

NOTE: The range depends on several factors: driving style, type of route (freeway, residential, mountain roads, etc.), conditions of use of the car (load, tire pressure, etc.). Trip planning must take into account the above notes.

Distance Traveled

This value shows the distance covered since the last reset.

Average Economy

This value shows the approximate average consumption since the last reset.

Instant Economy

This indicates the fuel consumption. The value is constantly updated. The message “----” will appear on the display if the car is parked with the engine running.

Average Speed

This value shows the vehicle’s average speed as a function of the overall time elapsed since the last reset.

Travel Time

This value shows the time elapsed since the last reset.



Personal Settings (Customer-Programmable Features)

Dimmer

The EVIC display is provided with a light sensor capable of detecting environmental light conditions and adjusting the brightness of the instruments accordingly.

NOTE: The brightness of the instrument panel may change while travelling following an event that causes switching from “day” to “night” conditions (or vice versa) in the passenger compartment (e.g. in a tunnel, on avenues in shadows, under bridges, etc.).







To adjust the brightness, proceed as follows:

1. Push and release the UP  or DOWN  button to set the required brightness level.
2. Briefly push and release the **MENU** button to go back to the menu screen or push and hold the **MENU** (approximately one second) to go back to the main screen without storing settings.

Speed Beep (Speed Limit)

With this function, it is possible to set the car speed limit (mph or km/h) to immediately alert the driver when the set limit is exceeded.

To set the speed limit, proceed as follows:

1. Briefly push and release the **MENU** button to enter the Main **MENU**.
2. Push and release the UP  or DOWN  button to select Speed Beep. Push and release the **MENU** button, push and release the UP  or DOWN  buttons to select Speed Limit activation (On) or deactivation (Off).
3. When the function is activated (On), briefly push and release the **MENU** button to display the presently set activation speed. Pushing the UP  or DOWN  buttons selects the speed limit. Push and release the **MENU** button to confirm selection.

NOTE: The setting can be increased or decreased by 5 mph or km/h each time the UP/DOWN button is pushed for speed settings above 20 mph (32 km/h). To increase or decrease the set speed rapidly, push and hold the UP/DOWN button. Save the setting by briefly pushing the button when you approach the required setting.

- Briefly push and release the **MENU** button to go back to the menu screen, or push and hold the **MENU** button (approximately one second) to go back to the main screen without storing the settings.

To cancel the setting, proceed as follows:

1. Briefly push and release the **MENU** button. “On” will flash on the display.
2. Push and release the **DOWN**  button. “Off” will flash on the display.





3. Briefly push and release the **MENU** button to go back to the menu screen, or push and hold the **MENU** button (approximately one second) to go back to the main screen without storing the settings.

Trip B Data (Trip B On)

Through this option, it is possible to activate (On) or deactivate (Off) the Trip B (partial trip) display.

For further information see “Trip Computer.”

For activation / deactivation, proceed as follows:









1. Briefly push and release the **MENU** button.
2. Push and release the **UP**  or **DOWN**  button to select Trip B data. Push and release the **UP**  or **DOWN**  buttons to turn ON or OFF

3. Briefly push and release the **MENU** button to go back to the menu screen, or push and hold the **MENU** button (approximately one second) to go back to the main screen without storing the settings.
4. When accessing the “Time” sub-menu item, briefly push and release the **MENU** button and “hours” will flash on the display.



Set Time (Clock)



This function may be used to set the clock through two submenu items: “Time” and “Mode.”

Proceed as follows:

1. Briefly push and release the **MENU** button. Push and release the UP  or DOWN  buttons to highlight Set Time — Push and release the **MENU** button.
2. Push and release the UP  or DOWN  button to navigate the two sub-menu items.
3. Select the required option and then push and release the **MENU** button.
5. Push and release the UP  or DOWN  button for setting.
6. Briefly push and release the **MENU** button and “minutes” will flash on the display.
7. Push and release the UP  or DOWN  button for setting.

NOTE:

- The setting will increase or decrease by one unit each time the UP  or DOWN  button is pushed. Push and hold the button to increase/decrease the setting rapidly. Save the setting by briefly pushing the button when you approach the required setting.









- Briefly push and release the **MENU** button to return to the “Time” sub-function.
- When accessing the “Mode” submenu, briefly push and release the **MENU** button. The previously set display format will flash on the display.
- Push and release the UP  or DOWN  button to select “24h” or “12h.”





When you have selected the required settings, briefly push and release the **MENU** button to go back to the Time, Mode sub-menu screen, or push and hold the **MENU** button (approximately one second) to go back to the main screen without storing the settings.

Set Date

This function may be used to set the date (day - month - year).

To change the date proceed as follows:

1. Briefly push and release the **MENU** button. Push and release the UP  or DOWN  button to highlight Date, push and release the **MENU** button and Year will begin to flash.
2. Push and release the UP  or DOWN  button for setting.
3. Briefly push and release the **MENU** button and “month” will flash on the display.
4. Push and release the UP  or DOWN  button for setting.
5. Briefly push and release the **MENU** button and “day” will flash on the display.
6. Push and release the UP  or DOWN  button for setting.

NOTE: The setting will increase or decrease by one unit each time the UP  or DOWN  button is pushed. Push and hold the UP  or DOWN  button to increase/decrease the setting rapidly. Save the setting by briefly pushing the button when you approach the required setting.





- Briefly push and release the **MENU** button to go back to the menu screen, or push and hold the **MENU** button (approximately one second) to go back to the main screen without storing the settings.

See Radio (Repeat Audio Information)

With this function active, the EVIC display shows information relevant to the sound system.

- Radio: tuned radio station frequency, automatic tuning activation or AutoStore.
- CD audio, CD MP3: track number.

To activate (On) or to deactivate (Off) the sound system info displaying proceed as follows:





1. Briefly push and release the **MENU** button. Push and release the UP  or Down  button to highlight See Radio and push and release the **MENU** button.
2. Push and release the UP  or DOWN  button for setting.
3. Briefly push and release the **MENU** button to go back to the menu screen, or push and hold the **MENU** button (approximately one second) to go back to the main screen without storing the settings.

If the radio has BLUE&ME™, refer to the appropriate “BLUE&ME™ Radio Supplement” for further information.

Speed Display

When this function is activated the cluster will display the vehicle speed (MPH or km/h).





To activate (On) or to deactivate (Off) the speed display feature, proceed as follows:

1. Briefly push and release the **MENU** button. Push and release the UP  or DOWN  button to highlight Speed Display. Push and release the **MENU** button to enter the Speed Display **MENU**.
2. Push and release the UP  or DOWN  button to select display deactivation "Off", "MPH" or "km/h".
3. Briefly push and release the **MENU** button to go back to the menu screen, or push and hold the **MENU** button (approximately one second) to go back to the main screen.

Autoclose

With this function active, the doors will automatically lock at when the vehicle's speed exceeds 15 mph (24 km/h).





To change the setting proceed as follows:



1. Briefly push and release the **MENU** button. Push the UP  or DOWN  button to highlight Autoclose. Push and release the **MENU** button to enter Autoclose **MENU**.
2. Push and release the UP  or DOWN  button for setting.
3. Briefly push and release the **MENU** button to go back to the menu screen, or push and hold the **MENU** button (approximately one second) to go back to the main screen without storing the settings.

Units (Set Units)

This function may be used to set the measurement unit in three submenus: "Distance," "Temperature" and "Fuel Economy, and Tire Pressure."



To set the required unit, proceed as follows:



1. Briefly push and release the **MENU** button. Push and release the UP  or DOWN  button to highlight Units. Push and release the **MENU** button to enter Units **MENU**.
2. Push and release the UP  or DOWN  button to navigate the three sub-menus.
3. Select the required sub-menu and then briefly push and release the **MENU** button.
4. When accessing the "Distance" submenu: briefly push and release the **MENU** button. Either "mi" or "km" will appear on the display (according to the previous setting).

5. Push and release the UP  or DOWN  button for setting.
6. Briefly push and release the **MENU** button to return to the sub-menu.
7. When accessing the "Fuel Economy" submenu, briefly push and release the **MENU** button. Either "mpg," "km/l " or "l/100km" will appear on the display (according to the previous setting).

If the distance unit set is "mi," the fuel economy unit will be displayed in "mpg."

If the distance unit set is "km," the fuel economy unit will be displayed in either km/l or l/100km.

1. Push and release the UP  or DOWN  button for setting.
2. Briefly push and release the **MENU** button to return to the sub-menu.





3. When accessing the “Temperature” submenu: briefly push and release the **MENU** button. Either “°F” or “°C” will appear on the display (according to the previous setting).
4. Push and release the UP  or DOWN  button for setting.
5. Briefly push and release the **MENU** button to return to the Tire Pressure — PSI/KPA sub-menu.

When you have made the required settings, briefly push and release the **MENU** button to go back to the sub-menu screen, or push and hold the **MENU** button (approximately one second) to go back to the main screen without storing the settings.

Language (Selecting The Language)

The messages can be displayed in the following languages: Italian, English, Turkce, Nederlands, Spanish, French, Dutch, Polish, Brasilian.





To set the required language, proceed as follows:

1. Briefly push and release the **MENU** button. Push and release the UP  or DOWN  button to highlight Language. Push and release the **MENU** button to enter the Language **MENU**.
2. Push and release the UP  or DOWN  button for setting.
3. Briefly push and release the **MENU** button to go back to the menu screen, or push and hold the **MENU** button (approximately one second) to go back to the main screen without storing the settings.



Buzzer Volume (Adjusting The Failure/Warning Buzzer Volume)

With this function the volume of the buzzer accompanying any failure/warning indication can be adjusted to one of eight volume levels.





To adjust the volume proceed as follows:

1. Briefly push and release the **MENU** button. Push and release the UP  or DOWN  button, then highlight the Buzzer Volume. Push and release the **MENU** button to enter the Buzzer Volume **MENU**.
2. Push and release the UP  or DOWN  button for setting.
3. Briefly push and release the **MENU** button to go back to the menu screen, or push and hold the **MENU** button (approximately one second) to go back to the main screen without storing the settings.

Button Volume (Button Volume Adjustment)

This function may be used to adjust the volume of the beep accompanying the buttons. **MENU**, UP  or DOWN  buttons can be adjusted according to 8 levels.

To adjust the volume, proceed as follows:

1. Briefly push and release the **MENU** button. Push and release the UP  or DOWN  button to highlight the Buzzer Volume, push and release the **MENU** button.
2. Push and release the UP  or DOWN  button for setting.
3. Briefly push and release the **MENU** button to go back to the menu screen, or push and hold the **MENU** button (approximately one second) to go back to the main screen without storing the settings.



Belt Buzzer (Buzzer Activation For S.B.R. Indication)



This function will only be displayed after a FIAT Group Automobiles dealership has deactivated the S.B.R. system.

Daytime Running Lamps (DRL)

This function may be used to activate / deactivate the Daytime Running Lamps.

Proceed as follows to switch this function on or off:

1. Briefly push and release the **MENU** button. Push and release the Up  or DOWN  button to highlight Daytime Running Lamps (DRL). Push and release the **MENU** button to enter the **DRL MENU**.
2. Briefly push and release the **MENU** button. "On" or "Off" will flash on the display (according to previous setting).





3. Push and release the UP  or DOWN  button for setting.
4. Briefly push and release the **MENU** button to go back to the menu screen, or push and hold the button (approximately one second) to go back to the main screen without storing the settings.

GSI (Gear Shift Indicator)

This function may be used to set the Gear Shift Indicator in two submenus: "Fuel Econ On" and "Fuel Econ Off."

- Fuel Econ On – turns on a fuel economy upshift light in the instrument cluster, for optimum fuel economy, when operating in base driving mode.
- Fuel Econ Off – the fuel economy upshift light is disabled.

To set the required unit, proceed as follows:





1. Briefly push and release the **MENU** button to display the two sub-menus.
2. Push and release the UP  or DOWN  button to navigate the two sub-menus.
3. Select the required sub-menu and then briefly push and release the **MENU** button.
4. Push and release the UP  or DOWN  button for setting.
5. Briefly push and release the **MENU** button to return to the sub-menu.

When you have made the required settings, briefly push and release the **MENU** button to go back to the sub-menu screen, or push and hold the **MENU** button (approximately one second) to go back to the main screen without storing the settings.

Hill Start Assist

This function is used when starting a vehicle from a stop on a hill. Hill Start Assist maintains the same level of brake pressure the driver applied for a short period of time after the foot has been removed from the brake pedal.



Proceed as follows to switch this function on or off:

1. Briefly push and release the **MENU** button. Push and release the UP  or DOWN  button to highlight the Hill Start Assist. Push and release the **MENU** button to enter the Hill Start Assist **MENU**.
2. Push and release the UP  or DOWN  button for setting.
3. Briefly push and release the **MENU** button to go back to the menu screen, or push and hold the button (approximately one second) to go back to the main screen without storing the settings.

Tire Pressure

This function will be used to display the tire pressures individually for all four tires by location.

Proceed as follows:

1. Briefly push and release the **MENU** button. Push and release the UP  or DOWN  button to highlight the Tire Pressure. Push and release the **MENU** button to enter the Tire Pressure **MENU**.
2. Push and release the UP or DOWN button to scroll through all four tire pressure value locations.
3. Briefly push and release the **MENU** button to go back to the menu screen, or push and hold the button (approximately one second) to go back to the main screen.

Lock

When **Unlock Driver Door** is selected, only the driver's door will unlock on the first push of the Remote Keyless Entry (RKE) transmitter UNLOCK button. When **Unlock Drivers Door** is selected, you must push the RKE transmitter UNLOCK button twice to unlock the passenger door. When **All Doors** is selected, both of the doors will unlock on the first push of the RKE transmitter UNLOCK button. To make your selection, push and release the **SELECT** button until "Unlock Driver Door" or "All Doors" appears.

Exit Menu

This function closes the initial menu screen.

Briefly push and release the **MENU** button to go back to the main screen.

Push and release the **▲** button to return to the first menu option (Speed Beep).

Push and release the **▼** button to return to the last menu option (Daylights).

SALES CODE (RAB) RADIO



0415039362

RAB Radio

Introduction

The radio has been designed according to the specifications of the passenger compartment, with a personalized design to match the style of the dashboard.

If the radio has BLUE&ME™, refer to the appropriate “BLUE&ME™ User’s Manual” for further information.

The instructions for use are given below and we recommend you to read them carefully.

Suggestions

Road Safety

Please, learn how to use all different radio functions (e.g. store stations) before beginning to drive.

Reception Conditions

Reception conditions change constantly while driving. Reception may be interfered with by the presence of mountains, buildings or bridges, or when you are far away from the broadcaster.

WARNING!

Having the volume turned up high can cause the driver to not be able to hear important traffic sounds, i.e. sirens, horns, etc. Failure to hear traffic sounds and other important audible information can result in serious injury or death. Always adjust the volume so that you can still hear background noises.

Care And Maintenance

Clean the cover with a soft antistatic cloth only. Cleaning and polishing products could damage the surface.

CDs

The presence of dirt, scratches or distortions on the CDs could cause skipping and poor sound quality while it is playing. For optimal playback conditions, follow these guidelines:

- Only use branded CDs.
 - Clean every CD thoroughly removing any finger marks or dust using a soft cloth. Hold CDs by the outside and clean them from the middle outwards.
 - Never use chemicals (e.g. antistatics or thinners or sprays) for cleaning as they could damage the surface of the CDs.
 - After listening to them place CDs back in their boxes to prevent them from being damaged.
 - Do not expose CDs to direct sunlight, high temperatures or moisture for long periods.
- Do not stick labels on the CD surface or write on the recorded surface with pencils or pens.
 - Do not use CDs that are very scratched, flawed, distorted, etc. Using discs like these will result in malfunctions or damage to the player.
 - The use of original CD media is required for the best quality audio production. Correct operation is not guaranteed when CD-R/RW media are used that were not correctly burned and/or with a maximum capacity above 650 Mb.
 - Do not use commercially available protective sheets for CDs or discs, with stabilizers, etc. as they could get stuck in the internal mechanism and damage the disc.

- If a copy-protected CD is used, it may take a few seconds before the system starts to play it. The CD player cannot be guaranteed to play all protected discs. The fact that the CD is protected from being copied is often shown in very small letters or is difficult to read on the actual CD cover where it may be, for example, "COPY CONTROL," "COPY PROTECTED," "THIS CD CANNOT BE PLAYED ON A PC/MAC."
- The CD player is capable of reading most compression systems currently in use, following the development of these systems, the reading of all compression formats is not guaranteed.

Technical Specifications

The complete system consists of:

- Two 165 mm diameter midwoofer speakers, one speaker in each of the front doors.
- Two 22 mm diameter tweeter speakers, one speaker in each of the front pillars.
- Two 100 mm diameter full range speakers, one speaker in each of the rear side panels.
- Antenna on the car roof.
- Radio with CD/MP3 player.

With Alpine Premium Audio system (if equipped):

- Two 165 mm diameter midwoofer speakers.
- Two 11 mm tweeter speakers in the front pillars.
- Two 100 mm full range speakers, one speaker in each of the rear side panels.
- An amplifier in the trunk on the right-hand side panel.

- Antenna on the car roof.

- Radio with CD/MP3 player.

With BEATS Premium Audio system (if equipped):



- A subwoofer in the trunk on the left-hand side panel.

Quick Guide

Radio Controls

BUTTON	GENERAL FUNCTIONS	MODE
⏻	On	Short button push
	Off	Short button push
TUNER	AM, FM, SAT (if equipped) source selection	Short repeated button push
A-B-C	Cycles A, B, C presets for AM, FM, SAT (if equipped)	Short repeated button push

BUTTON	GENERAL FUNCTIONS	MODE
MEDIA	CD/AUX/Media Player (if equipped and present) source selection	Short repeated button push

BUTTON	GENERAL FUNCTIONS	MODE
 (Mute/Volume Button)	Volume activation/deactivation (Mute/Volume)	Short button push
AUDIO	Audio adjustments: low tones (BASS), high tones (TREBLE), left/right balance (BALANCE), front/rear balance (FADER)	Menu activation: short button push Adjustment type selection: push Δ or ∇ Adjustment of values: push \blacktriangleleft or \blacktriangleright
 (Information Button)	Song, Artist, Album, Genre, Playlist, Folder information (if available) in CD, Media Player and Satellite (if so equipped); Toggles RBDS information in FM	

BUTTON	GENERAL FUNCTIONS	MODE
MENU	Advanced functions adjustment	Menu activation: short button push Adjustment type selection: push Δ or ∇ Adjustment of values: push \blacktriangleleft or \blacktriangleright
+Vol/-Vol	Volume adjustment	Push + button: volume increase Push - button: volume decrease

BUTTON	RADIO FUNCTIONS	MODE
\blacktriangleleft \blacktriangleright Δ ∇	Radio Station Search: <ul style="list-style-type: none"> • Automatic Search • Manual Search 	Automatic search: push buttons \blacktriangleleft or \blacktriangleright (long push for fast forward) Manual search: push buttons Δ or ∇ (long push for fast forward)
1 2 3 4 5	Current radio station storing	Long button push for memory preset 1 to 5 respectively
	Stored station recall	Short button push for memory preset 1 to 5 respectively

BUTTON	CD FUNCTIONS	MODE
▲	CD ejection	Short button push
◀ ▶	Previous/next track play	Short button push ◀ or ▶
◀ ▶	CD track fast forward/rewind	Long button push ◀ or ▶
△ ▽	Previous/next folder play (for CD-MP3)	Short button push △ or ▽

General Information

The radio offers the following functions:

Radio Section

- PLL tuning with FM/AM bands
- RBDS (Radio Broadcast Data System)
- Automatic/manual station tuning
- FM Multipath detector
- Manual storing of 25 stations (base radio) and 40 stations (if equipped with Satellite): 15 on FM band (5 on FMA, 5 on FMB, 5 on FMC), 10 on AM band (5 on AMA, 5 on AMB), 15 on Satellite Band - if equipped (5 on SATA, 5 on SATB, 5 on SATC)
- SPEED VOLUME function: Customer selectable automatic volume adjustment depending on the car speed
- Automatic Stereo/Mono selection

CD Section

- Track selection (forward/backward)
- Fast forward/rewind through tracks
- CD Display function: display of track number and on mp3 discs (song title, artist) and time elapsed since start of the track
- Playing Audio CD, CD-R and CD-RW

CAUTION!

On multimedia CDs, besides audio tracks, there are data tracks too. Playing this type of CD could cause hissing at a volume that could damage the speakers.

CD/MP3 Section

- MP3-Info function (ID3-TAG)
- Folder selection (previous/next)

- Track selection (forward/backward)
- Fast forward/rewind through tracks
- MP3 Display function: display of folder name, ID3-TAG information, time elapsed since the start of the track, name of the file
- Playing audio or data CD, CD-R and CD-RW

Audio Section

- Mute/pause function
- Soft mute function
- Loudness function
- Graphic 7 band equalizer (if equipped)
- Separate bass/treble tone adjustment
- Right/left channel balancing
- Front/rear fader

Functions And Adjustments

Turning The Car Radio On

The car radio comes on when the  (ON/OFF) button is pushed briefly.

When the car radio is turned on and the on volume limit is on, the volume is limited to a setting of five even if it had been set higher when previously used.

Turning The Car Radio Off

Push the  (ON/OFF) button to turn the radio off.

Selecting The Radio Functions

By pushing the TUNER button briefly and repeatedly, the following audio sources can be selected cyclically:

- AM, FM and Satellite Bands (if equipped)

Selecting The CD Function

By briefly pushing the MEDIA button, the CD audio source can be selected (only if a CD is loaded).

Volume Adjustment

To adjust the volume, push the buttons +Vol or -Vol to increase/decrease the volume.

Mute/Pause Function

Push the  button briefly to activate the MUTE function. The volume will gradually decrease and the wording "TUNER Mute" will be shown on the display (in radio mode) or "CD Pause" (in CD mode).

Push the  button again to deactivate the MUTE function. The volume will gradually increase until it reaches the previously set level.

When the volume level is changed using the dedicated controls, the Mute function is deactivated and the volume is adjusted to the new level selected.

Audio Adjustment

The functions that can be selected from the audio menu change depending on the context: AM/FM/MEDIA/SATELLITE.

Push the AUDIO button briefly to change the Audio functions. After the AUDIO button is first pushed, the display will show the Bass level value for the source activated at that time (e.g. in FM mode the display will show the wording “FM Bass +2”).

Use the buttons Δ or ∇ to scroll through the Menu functions. To change the setting of the selected function, use the \blacktriangleleft or \blacktriangleright buttons.

The current status of the selected function appears on the display.

The functions managed by the Audio Menu are:

- BASS (Bass adjustment)
- MIDRANGE (Midrange adjustment)
- TREBLE (Treble adjustment)
- BALANCE (right/left Balance adjustment)
- FADER (front/rear Balance adjustment)
- LOUDNESS — if equipped (Loudness function activation/deactivation)
- EQUALIZER — if equipped (activation and selection of factory equalization adjustments)
- USER EQUALIZER — if equipped (customized equalization adjustment)

Tone Adjustment

Proceed as follows:

1. Push the AUDIO button.
2. Push the Δ or ∇ button to select “Bass,” “Mid-range” or “Treble” in the AUDIO menu.
3. Push the \blacktriangleleft or \blacktriangleright button to increase/decrease the bass or treble adjustments.

By pushing the \blacktriangleleft or \blacktriangleright buttons briefly, the levels will change progressively. By pushing them down longer, the levels will change quickly.

Balance Adjustment

Proceed as follows:

1. Push the AUDIO button.
2. Push the Δ or ∇ button to set “Balance” in the AUDIO menu.
3. Push the \blacktriangleleft button to increase the sound from the left speakers or the \blacktriangleright button to increase the sound from the right speakers.

By pushing the \blacktriangleleft or \blacktriangleright buttons briefly, the levels will change progressively. By pushing them down longer, the levels will change quickly.

Select the value “0” to set the right and left audio outputs at the same level.

Fader Adjustment

Proceed as follows:

1. Push the AUDIO button.
2. Push the Δ or ∇ button to set “Fader” in the AUDIO menu.
3. Push the \blacktriangleleft button to increase the sound coming from the rear speakers or the \blacktriangleright button to increase the sound coming from the front speakers.

By pushing the \blacktriangleleft or \blacktriangleright buttons briefly, the levels will change progressively. By pushing them down longer, the levels will change quickly.

Select the value “0” to set the right and left audio outputs at the same level.

Loudness Function — If Equipped

The Loudness function improves the volume of the sound while listening at low volumes, increasing the bass and treble.

To activate/deactivate this function, select the “Loudness” setting in the AUDIO menu. The condition of the function (on or off) is shown on the display for a few seconds by the wording “Loudness On” or “Loudness Off”.

Preset/User/Classic/Rock/Jazz Functions — If Equipped

The built-in equalizer can be activated/deactivated. When the equalizer function is off, the audio settings can only be changed by adjusting the “Bass” and “Treble” settings, whereas when the function is on, the acoustic curves can be adjusted. To deactivate the equalizer, select the “EQ Preset” function in the audio menu.

To activate the equalizer, use the AUDIO button to select one of the adjustments:

- “EQ User” (adjustment of 7 equalizer bands that can be changed by the user)
- “Classic” (equalizer preset for optimal classic music sound)
- “Rock” (equalizer preset for optimal rock and pop music sound)
- “Jazz” (equalizer preset for optimal jazz music sound)

When one of the equalizer adjustments is activated the wording “EQ” lights up.

User EQ Settings Function — If Equipped

To set a personalized equalizer adjustment:

1. Push the AUDIO button.
2. Use the Δ or ∇ buttons to set EQ function.
3. Use \blacktriangleleft or \blacktriangleright buttons to select “EQ User.”
4. Push the MENU button to start adjusting equalizer.
5. On the display a seven bar graph will appear, in which each bar represents a frequency. Select the bar to be adjusted by using the \blacktriangleleft or \blacktriangleright buttons. The selected bar will start to flash and it can be adjusted using Δ or ∇ buttons.
6. To store the setting, push the MENU or AUDIO buttons.

Menu

MENU Button Functions

Push the MENU button briefly to activate the Menu function.

Use the Δ or ∇ buttons to scroll through the menu functions. To change the setting of the selected function, use the \blacktriangleleft or \blacktriangleright buttons.

The current status of the selected function appears on the display.

The functions managed by the Menu are:

- Speech Volume
- Aux Audio Offset
- Radio Off
- Sat ID
- SiriusXM Telephone Number

- System Reset
- Speed Volume
- On Volume Limit

Push the MENU button again to exit the Menu function.

Speed Volume Function — If Equipped

This function automatically adapts the volume level to the speed of the car, turning up the volume when the speed increases to maintain the ratio with the noise level inside the passenger compartment. To activate/deactivate the function, use the buttons. The wording “Speed volume” appears on the display, followed by the current status of the function:

- Off: function deactivated
- Low: function activated (low sensitivity)
- High: function activated (high sensitivity)

On Volume Limit

This function makes it possible to activate/deactivate the maximum volume limit when turning the radio on.

The display shows the function status:

- “On volume limit: on” – when the radio is turned on the volume level will be:
 - If the volume level is equal to or higher than the maximum value, the radio will come on at the maximum volume.
 - If the volume level is between the minimum and maximum values, the radio will come on at the same volume as before it was switched off.
 - If the volume level is equal to or lower than the minimum value, the radio will come on at the minimum volume.

- “On volume limit: off” – The radio will come on at the same volume as before it was switched off. The volume level can be between 0 and 40.

Use the buttons ◀ or ▶ to change the setting.

NOTE:

- Using the Menu it is only possible to adjust the activation/deactivation of the function and not the minimum or maximum volume value.
- If the battery charge is too low, the volume cannot be adjusted between the minimum and the maximum level.

Radio Off Function

This function makes it possible to set the radio switching off mode by choosing between two methods.

The chosen mode appears on the display:

- “Radio off: 00 min” — The radio turns off in connection with the ignition key; the radio is turned automatically off as soon as the key is turned to the STOP position.
- “Radio off: 20 min” — The radio turns off independently from the ignition key; the radio remains on for a maximum period of 20 minutes after the key has been turned to the STOP position.

System Reset Function

This function is used to restore all settings to the factory values. The options are:

- NO — No restore intervention.
- YES — The default parameters will be restored. During such operation, the wording “Resetting” appears on the display. At the end of the operation, the source does not change and the previous situation will be displayed.

Radio

(Tuner) Introduction

When the car radio is turned on, the last function that was selected before turning it off (Radio, CD, CD MP3, AUX) is activated.

To select the Radio function when another audio source is being listened to, briefly push the TUNER button.

Once the Radio mode has been activated, the display will show the name (RBDS stations only) or the frequency of the selected radio station, the frequency band selected (e.g. FMA) and the preset button number (e.g. P1).

Frequency Band Selection

With the Radio mode active, press the FM or AM tuner button briefly and repeatedly to select the desired reception band.

Each time the button is pressed the following bands are selected cyclically:

- AM, FM or SAT (if equipped)

Each band is highlighted by the corresponding wordings on the display. The radio will be tuned to last station selected on the respective frequency band.

Preset Buttons

The buttons numbered from 1 to 5 are used to set the following pre-selections:

- 15 in the FM band (5 in FMA, 5 in FMB, 5 in FMC)
- 10 in the AM band (5 in AMA, 5 in AMB)
- 15 in SAT (if so equipped) (5 SATA, 5 SATB, 5 SATC)

To listen to a preset station, select the desired frequency band and then briefly push the corresponding preset button (from 1 to 5).

By pushing the preset button for more than two seconds, the tuned station will be stored. Pushing the A-B-C button will change between the preset memory group in the current frequency band.

Automatic Tuning

Briefly push the ◀ or ▶ button to start the automatic tuning search for the next station that can be received in the selected direction.

If the ◀ or ▶ button is pushed for longer, the rapid search is started. When the button is released, the tuner will stop on the next station that can be received.

Manual Tuning

This is used to manually search for stations in the preselected band.

Select the desired frequency band and then push briefly and repeatedly the Δ or ▽ button to start the search in the desired direction. If the Δ or ▽ button is pushed longer, the fast search starts and then stops when the button is released.

Stereophonic Broadcasters

If the incoming signal is weak, the reproduction is automatically switched from Stereo to Mono.

SiriusXM Satellite Radio — If Equipped

SiriusXM Satellite Radio

With over 130 channels, SiriusXM Satellite Radio brings you more of what you love. Get 69 channels of 100% commercial-free music, plus all of your favorite sports, news, talk and entertainment. Hear every NFL game, every NASCAR race, college sports and more. The biggest and most compelling names in talk with Howard Stern and Martha Stewart, laugh-out-loud comedy with Jamie Foxx's *The Foxxhole* and *Blue Collar Comedy*, plus kids' programming, world-class news, local traffic and weather. All of this with crystal clear, coast-to-coast coverage. Everything worth listening to is now on SiriusXM. A one-year SiriusXM Satellite Radio subscription is included. SiriusXM and all related marks and

logos are trademarks of SiriusXM Radio Inc. and its subsidiaries. SiriusXM Radio requires a subscription, sold separately after trial subscription included with vehicle purchase. Prices and programming are provided by SiriusXM and are subject to change. Subscriptions governed by Terms & Conditions available at www.siriusxm.com/customeragreement. SiriusXM Radio U.S. service only available to those at least 18 years of age in the 48 contiguous United States, D.C., and PR. Service available in Canada; see www.siriusxm.ca.

SiriusXM Satellite Radio Program Types

Program Types can be selected by pushing the Δ or ∇ buttons. The Program Type will change to the next category and the radio will then tune to first station in that program type. Pushing \blacktriangleleft or \blacktriangleright buttons will tune to only the stations in that program type.

Pushing the Δ or ∇ buttons until "All" is displayed will allow normal tuning to all stations.

The Program Types available are: All, Pop, Rock, Electronic/Dance, Hip-Hop/R&B, Country, Christian, Jazz/Standards, Classical, Latin/World, Sports, Entertainment, Talk, News, NPR, Comedy, Family & Health, Religion, Traffic/Weather.

You can find the SiriusXM current terms and conditions at www.siriusxm.com.

Re-Subscribe To SiriusXM Satellite Radio

New vehicle purchasers or lessees will receive a free limited time subscription to SiriusXM Satellite Radio with their radio. Following expiration of the free services, it will be necessary to access the information on the Subscription Information screen in order to re-subscribe. Press the UP/DOWN button to scroll through the Menu Functions, and the Left/Right button to change the selected Set-up Menu function.

Write down the Electronic Serial Number (ESN) for your receiver. To retrieve the Electronic Serial Number of SiriusXM Satellite Receiver Module tune to Channel 0. Make sure that when the order is placed, the ESN are correct. If any of the ESN numbers are not entered correctly, then the SiriusXM subscription will not be able to be transferred to the new radio and will not be active when installed in the customer's vehicle. To reactivate your service, either call the number listed on the display or visit the provider online.

CAUTION!

Neither SIRIUS nor FIAT is responsible for any errors in accuracies in the SIRIUS data services or its use in vehicles.

SiriusXM and all related marks and logos are trademarks of SiriusXM Radio Inc. and its subsidiaries. SiriusXM Radio requires a subscription, sold separately after trial subscription included with vehicle purchase. Prices and programming are provided by SiriusXM and are subject to change. Subscriptions governed by Terms & Conditions available at www.siriusxm.com/customeragreement. SiriusXM Radio U.S. service only available to those at least 18 years of age in the 48 contiguous United States, D.C., & PR. www.siriusxm.com.

Sirius Subscription Issues When Replacing A Sirius Radio

When a radio needs to be replaced, the Dealer will need the SIRIUS information to order a new radio (even if the SIRIUS subscription has lapsed). The ESN number contains 12 digits.

The following are instructions for retrieving the Electronic Serial Number (ESN) from FIAT 500 NAFTA model radios:

To retrieve the ESN of SIRIUS Satellite Receiver Module tune to Channel 0. Make sure that when the order is placed, the ESN are correct. If any of the ESN numbers are not entered correctly, then the SIRIUS subscription will not be able to be transferred to the new radio and will not be active when installed in the customer's vehicle.

Satellite Radio Antenna — If Equipped

The antenna for the satellite radio is mounted on the roof of the vehicle. Do not place items on the roof around the roof top antenna location. Objects placed within the line of sight of the antenna will cause decreased performance. Larger luggage items should be placed as far from the antenna as possible. Do not place items directly on or above the antenna.

CD Player

Introduction

This chapter describes the operation of the CD player only. To operate the radio, refer to the description in the “Functions and Adjustments” chapter.

CD Player Selection

To activate the CD player built into the equipment, proceed as follows:

- Load a CD with the equipment switched on. The first track will start to play.

Or

- If a CD has already been loaded, turn on the radio and then briefly push the MEDIA button to select the “CD” function mode. The last track listened to will start to play.

It is advisable to use original CDs to ensure optimal playing. If CD-R/RWs are used, we recommend using good quality media that are burned at the slowest speed possible.

CD Loading/Ejecting

To load the CD, insert it gently into the slot to activate the motorized loading system, which will position it correctly.

The CD can be loaded with the radio off and the ignition key turned to ON/RUN. In this case, the radio will remain off. When the radio is turned on, the last source listened to before being switched off, will be activated.

When a CD is inserted, the display will show the symbol "CD" and the wording "CD Reading." They will remain displayed for the whole time required for the radio to read the CD. When this time has elapsed the radio automatically starts playing the first track.

Push the  button with the radio turned on, to activate the motorized CD ejection system. After ejection, the last audio source listened to before playing the CD will be heard.

If the CD is not removed from the radio, it will automatically be reloaded about 20 seconds later but will not resume playing until the "MEDIA" button is pushed to select the CD mode. The radio will switch to the last source prior to CD mode.

The CD cannot be ejected if the radio is off.

Possible Error Messages

If the loaded CD cannot be read (e.g. a CD ROM has been inserted or the CD is inserted the wrong way or there is a reading error) the display shows the wording "CD Disc error."

The CD will then be ejected and the audio source activated before the CD mode selection will be heard.

A CD which cannot be read will not be ejected until these functions are over. At the end, with the CD mode activated, the display will show the wording “CD Disc error” for a few seconds and then the CD will be ejected.

Display Information

When the CD player is operating, information will appear on the display with the following meaning:

- “Track 5” indicates the CD track number.
- “03:42” indicates the time elapsed since the start of the track (if the relevant Menu function is activated).

Track Selection

Briefly push the ◀ button to play the previous CD track and the ▶ button to play the next track. The tracks are selected cyclically: the first track is selected after the last track and vice versa.

If the track has been played for more than 3 seconds, pushing the ◀ button, starts the track again from the beginning. In this case, if you want to play the previous track, push the ◀ button twice consecutively.

Track Fast Forward/Rewind

Keep the ▶ button pushed down to fast forward the selected track and keep the ◀ button pushed down to fast rewind the track. The fast forward/rewind will stop once the button is released.

Pause Function

To pause the CD player, push the ⏸ button. The wording “CD Pause” appears on the display.

To resume listening to the track, push the ⏸ button again.

CD MP3 Player

Introduction

This chapter describes the operation of the CD MP3 player.

NOTE: Layer-3 audio decoding technology is licensed from Fraunhofer IIS and Thomson multimedia.

MP3 Mode

In addition to playing regular audio CDs, the radio is also enabled to play CDRoms on which compressed audio files have been recorded in an MP3 format.

To guarantee optimal reproduction, it is advisable to use good quality CDs burned at the lowest speed possible.

The files on an MP3 CD are structured in folders that create lists of all the folders containing MP3 tracks (folders or subfolders are all on the same level). The folders that do not contain MP3 tracks cannot be selected.

The specifications and operating conditions for playing MP3 files are the following:

- The CD-ROMs used should be burned in accordance with ISO standard 9660.
- The music files should have the extension “.mp3” or “.wma” files with a different extension will not be reproduced.
- The sampling frequencies that can be reproduced are: 44.1 kHz, stereo (from 96 to 320 kbit/s) – 22.05 kHz, mono or stereo (from 32 to 80 kbit/s).
- Tracks with a variable bit-rate can be reproduced.

NOTE: The track names must not include the following characters: spaces, ‘ (apostrophes), (and) (open and close brackets). During the burning of a MP3 CD, make sure that the names of the files do not contain these characters; if not, the radio will not be able to play the tracks involved.

Selecting MP3 Sessions With Hybrid Discs

If a hybrid disc is inserted (Mixed Mode, Enhanced, CD-Extra) also containing MP3 files, the radio automatically starts playing the audio session. It is possible to move to the MP3 session while playing by keeping the CD button pressed for more than two seconds.

NOTE: When the function is activated the radio may take a few seconds to start playing. While checking the disc the display will show "CD Reading." If no MP3 files are detected, the radio will resume playing the audio session from the point where it was interrupted.

Display Information

ID3-Tag Information Display

In addition to the information relating to the time elapsed, folder name and file name, the radio is also capable of displaying ID3-TAG information relating to Title Track, Artist and Author.

When one of the ID3-TAG pieces of information is chosen to be displayed (Title, Artist, Album) and this information has not been recorded for the track played, the text "UNKNOWN" will be displayed for that field.

Selection Of Next/Previous Folder

Push the Δ button to select a next folder or the ∇ button to select the previous folder. The display will show the number of the folder.

The folders are selected cyclically. The first folder is selected after the last folder and vice versa.

If no other folder/track is selected in the next two seconds, the first track on the new folder will be played.

After the last track in a folder is played, the next folder will be played.

Structure Of The Folders

The radio with MP3 player:

- Recognizes only the folders that effectively contain MP3 format files.
- If the MP3 files on a CD-ROM are structured in sub-folders their structure is compressed to a single level structure, where the sub-folders are taken to the level of the main folders.

Troubleshooting

General

Sound Volume Low

The Fader function should be adjusted to the values “F” (front) only to prevent the reduction in radio output power and the cancelling of the volume if the Fader level adjustment is equal to R+9.

Source Can Not Be Selected

Nothing has been loaded. Load the CD or the MP3 CD to be listened to.

CD Player

The CD Does Not Play:

The CD is dirty. Clean the CD.

The CD is scratched. Try using another CD.

The CD Can Not Be Loaded:

A CD is already loaded. Press the ▲ button and remove the CD.

MP3 File Reading

Track Skips While Playing Mp3 Files:

The CD is scratched or dirty.

The Duration Of The Mp3 Tracks Is Not Correctly Displayed:

In some cases (due to the recording mode) the duration of the MP3 tracks can be displayed incorrectly.

Operating Instructions — Hands-Free Phone

Refer to the appropriate “BLUE&ME™ User’s Manual” for further information.

Personal/Portable Navigation Device (PND)

A Personal/Portable Navigation Device (PND) is available as optional equipment for this vehicle, refer to the Navigation User Guide for further information.

iPod®/USB/MEDIA PLAYER CONTROL — IF EQUIPPED

This feature allows an iPod® or external USB device to be plugged into the USB or AUX port, located in the center console.

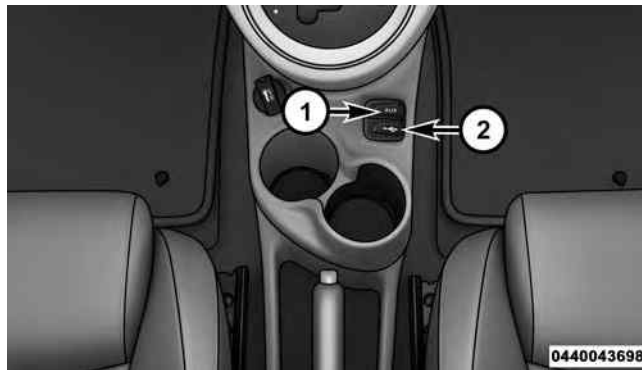

USB/AUX Port

- 1 — AUXiliary Cable Jack
- 2 — USB Connector

Refer to the appropriate Blue&Me™ radio User’s Manual for iPod® or external USB device support capability.

STEERING WHEEL AUDIO CONTROLS

The remote sound system controls are located on the rear surface of the steering wheel. Reach behind the wheel to access the switches.



045033001

Remote Sound System Controls (Back View Of Steering Wheel)

The right-hand control is a rocker-type switch with a pushbutton in the center and controls the volume and mode of the sound system. Pushing the top of the rocker switch will increase the volume, and pushing the bottom of the rocker switch will decrease the volume.

Pushing the center button will make the radio switch between the various modes available (AM/FM/SAT/CD/AUX/Media Player, etc.) and can also be used to select/enter an item while scrolling through menu.

The left-hand control is a rocker-type switch with a pushbutton in the center. The function of the left-hand control is different depending on which mode you are in.

The following describes the left-hand control operation in each mode.

Radio Operation

Pushing the top of the switch will “Seek” up for the next listenable station and pushing the bottom of the switch will “Seek” down for the next listenable station.

The button located in the center of the left-hand control will tune to the next preset station that you have programmed in the radio preset button.

CD Player Operation

Pushing the top of the switch once will go to the next track on the CD. Pushing the bottom of the switch once will go to the beginning of the current track, or to the beginning of the previous track if it is within one second after the current track begins to play.

If you push the switch up or down twice, it plays the second track; three times, it will play the third, etc.

Operating Instructions — Hands-Free Phone (If Equipped)

Refer to the appropriate Blue&Me™ User’s Manual for further information.

CD/DVD DISC MAINTENANCE

To keep a CD/DVD in good condition, take the following precautions:

1. Handle the disc by its edge; avoid touching the surface.
2. If the disc is stained, clean the surface with a soft cloth, wiping from center to edge.
3. Do not apply paper or tape to the disc; avoid scratching the disc.

4. Do not use solvents such as benzene, thinner, cleaners, or anti-static sprays.
5. Store the disc in its case after playing.
6. Do not expose the disc to direct sunlight.
7. Do not store the disc where temperatures may become too high.

NOTE: If you experience difficulty in playing a particular disc, it may be damaged (e.g., scratched, reflective coating removed, a hair, moisture or dew on the disc) oversized, or have protection encoding. Try a known good disc before considering disc player service.

RADIO OPERATION AND MOBILE PHONES

Under certain conditions, the mobile phone being on in your vehicle can cause erratic or noisy performance from your radio. This condition may be lessened or eliminated by relocating the mobile phone antenna. This condition is not harmful to the radio. If your radio performance does not satisfactorily “clear” by the repositioning of the antenna, it is recommended that the radio volume be turned down or off during mobile phone operation.

CLIMATE CONTROLS

The air conditioning and heating system is designed to make you comfortable in all types of weather.

Manual Heating And Air Conditioning

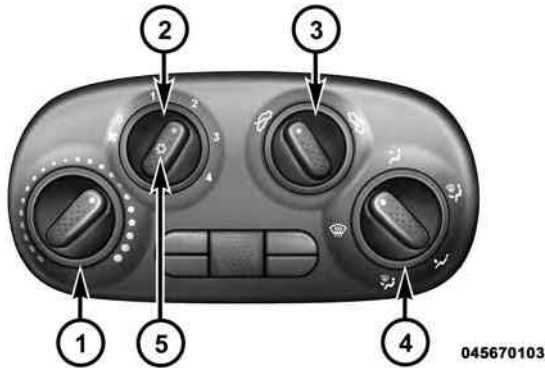

045670103

Manual Temperature Control (MTC)

The Manual Climate controls consist of a series of rotary dials and one inner push knob.

1. Temperature Control

Rotate this control to regulate the temperature of the air inside the passenger compartment. Rotating the dial to the left into the blue area of the scale indicates cooler temperatures, while rotating to the right into the red area indicates warmer temperatures.

2. Blower Control

Rotate this control to regulate the amount of air forced through the ventilation system in any mode. The blower speed increases as you move the control to the right from the "0" (OFF) position. There are four blower speeds.

3. Recirculation Control

Rotate this control to change the system between recirculation mode and outside air mode. Recirculation can be used when outside conditions such as smoke, odors, dust, or high humidity are present.

NOTE:

- Continuous use of the Recirculation mode may make the inside air stuffy and window fogging may occur. Extended use of this mode is not recommended.
- The use of the Recirculation mode in cold or damp weather could cause windows to fog on the inside, because of moisture buildup inside the vehicle. Select the outside air position for maximum defogging.
- Recirculation can be used in all modes except for Defrost.
- The A/C can be deselected manually without disturbing the mode control selection.

4. Mode Control

Rotate this control to change the system between Modes (Panel, Bi-Level, Floor, Mix, Defrost).

- *Panel*



Air is directed through the outlets in the instrument panel. These outlets can be adjusted to direct airflow.

NOTE: The center instrument panel outlets can be aimed so that they are directed toward the rear seat passengers for maximum airflow to the rear.

- *Bi-Level*



Air is directed through the panel and floor outlets.

- *Floor*



Air is directed through the floor outlets with a small amount flowing through the defrost and side window demister outlets.

- *Mix*



Air is directed through the floor, defrost, and side window demister outlets. This setting works best in cold or snowy conditions that

require extra heat to the windshield. This setting is good for maintaining comfort while reducing moisture on the windshield.

- *Defrost*



Air is directed through the windshield and side window demister outlets. Use this mode with maximum blower and temperature settings for best windshield and side window defrosting.

NOTE: The air conditioning compressor operates in Mix or Defrost, even if the Air Conditioning (A/C) button is not pushed. This dehumidifies the air to help dry the windshield. To improve fuel economy, use these modes only when necessary.

5. *A/C Button*

Push this button to engage the Air Conditioning. A light will illuminate when the Air Conditioning system is engaged.

MAX A/C

For maximum cooling, use the A/C and recirculation modes at the same time.

ECONOMY MODE

If economy mode is desired, push the A/C button to turn OFF the indicator light and the A/C compressor. Then, move the temperature control to the desired temperature.

Automatic Temperature Control (ATC)

- The Automatic Temperature Control (ATC) allows the occupant to select a comfort settings.
- The system provides set-and-forget operation for optimum comfort and convenience.
- The system can be controlled manually, if desired.

The ATC system automatically maintains the interior comfort level desired by the occupant.

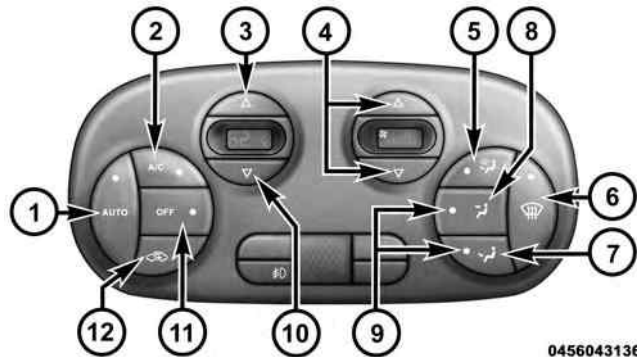

0456043136

Automatic Temperature Control (ATC)

1. *AUTO Temperature Control (ATC) Button*

Controls airflow, temperature, distribution, and air recirculation automatically. Push and release to select. Performing this function will cause the ATC to switch

between manual mode and automatic modes. Refer to "Automatic Operation" for more information.

2. *A/C Button*

Push and release to change the current Air Conditioning (A/C) setting. Performing this function will cause the ATC to switch into manual mode.

3. *Temperature Control Up Button*

Provides temperature up control. Push the button for warmer temperature settings.

4. *Blower Control Up/Down Buttons*

There are 12 fixed blower speeds. The blower control up/down buttons regulate the amount of air forced through the system in any mode you select. The blower speed increases as you push, or hold, the blower control up button and decreases when you push, or hold, the blower control down button.

The blower fan speed may be set to any fixed speed by pushing the blower control up or down buttons. The fan will now operate at a fixed speed until additional speeds are selected. This allows the front occupants to control the volume of air circulated in the vehicle and cancel the AUTO mode.

The operator can also select the direction of the airflow by selecting one of the following positions.

5. *Mix Mode*



Air is directed through the floor, defrost, and side window demister outlets. This setting works best in cold or snowy conditions that require extra heat to the windshield. This setting is good for maintaining comfort while reducing moisture on the windshield. Performing this function will cause the ATC to switch into manual mode.

6. *Front Defrost*



Push and release to change the current airflow setting to Defrost mode. The indicator illuminates when this feature is ON. Air comes from the windshield and side window demist outlets. When the defrost button is selected, the blower level will increase. Use Defrost mode with maximum temperature settings for best windshield and side window defrosting and defogging. Performing this function will cause the ATC to switch into manual mode. If the front defrost mode is turned off the climate system will return the previous setting.

7. *Floor Mode*



Air is directed through the floor outlets with a small amount flowing through the defrost and side window demister outlets. Performing this function will cause the ATC to switch into manual mode.

8. Panel Mode



Air is directed through the outlets in the instrument panel. These outlets can be adjusted to direct airflow. Performing this function will cause the ATC to switch into manual mode.

NOTE: The center instrument panel outlets can be aimed so that they are directed toward the rear seat passengers for maximum airflow to the rear.

9. Bi-Level



Air is directed through the panel and floor outlets. Press and release the Panel mode button and Floor mode button to enter Bi-Level mode, the indicators illuminate when ON. Performing this function will cause the ATC to switch into manual mode.

10. Temperature Control Down Button

Provides temperature down control. Push the button for cooler temperature settings.

NOTE: If the temperature is lowered until "Lo" is displayed, all high voltage Heating, Ventilation, and Air Conditioning (HVAC) systems are deactivated and ambient air is circulated according to the Heating, Ventilation, and Air Conditioning (HVAC) control settings.

11. Climate Control ON/OFF Button

Push and release to turn the Climate Control ON or OFF.

12. Recirculation Control Button

Push and release to change the current setting. The indicator illuminates when ON.

NOTE: When in Defrost mode, the Recirculation button will flash if pushed. This indicates that you can not proceed to this mode due to fogging risk.

Climate Control Functions

Air Conditioning (A/C)

The Air Conditioning (A/C) button allows the operator to manually activate or deactivate the air conditioning system. When in A/C mode with the ATC set to a cool temperature, dehumidified air flows through the air outlets. If Economy mode is desired, push the A/C button to turn off the A/C mode in the ATC display and deactivate the A/C system.

NOTE:

- If the system is in Mix or Defrost Mode, the A/C can be turned off, but the A/C system shall remain active to prevent fogging of the windows.
- If fog or mist appears on the windshield or side glass, select Defrost mode and adjust blower speed if needed.

Recirculation Control

 When outside air contains smoke, odors, or high humidity, or if rapid cooling is desired, you may wish to recirculate interior air by pushing the RECIRCULATION control button. Recirculation mode should only be used temporarily. The recirculation LED will illuminate when this button is selected. Push the button a second time to turn off the Recirculation mode LED and allow outside air into the vehicle.

NOTE: In cold weather, use of Recirculation mode may lead to excessive window fogging. The recirculation feature may be unavailable (indicator light shall blink) if conditions exist that could create fogging on the inside of the windshield. On systems with Manual Climate Controls, the Recirculation mode is not allowed in Defrost mode to improve window clearing operation. Recirculation will be disabled automatically if this mode is selected. Attempting to use Recirculation while in this mode will cause the LED in the control button to blink and then turn off.

Automatic Operation

1. Push the AUTO button on the Automatic Temperature Control (ATC) Panel, the indicator will illuminate when on.
2. Next, adjust the temperature you would like the system to maintain by adjusting the temperature control buttons. Once the desired temperature is displayed, the system will achieve and automatically maintain that comfort level.
3. When the system is set up for your comfort level, it is not necessary to change the settings. You will experience the greatest efficiency by simply allowing the system to function automatically.

NOTE:

- It is not necessary to move the temperature settings for cold or hot vehicles. The system automatically adjusts the temperature, mode and fan speed to provide comfort as quickly as possible.
- The temperature can be displayed in U.S. or Metric units by selecting the US/M customer-programmable feature. Refer to the “Electronic Vehicle Information Center (EVIC) — Customer-Programmable Features” in this section of the manual.

Manual Operation

The system allows for manual selection of blower speed, air distribution mode, A/C status and recirculation control.

The blower fan speed can be set to any fixed speed by adjusting the blower control. The fan will now operate at a fixed speed until additional speeds are selected. This allows the front occupants to control the volume of air circulated in the vehicle and cancel the Auto mode.

The operator can also select the direction of the airflow by selecting one of the available mode settings. A/C operation and Recirculation control can also be manually selected in Manual operation.

Operating Tips

NOTE: Refer to the chart at the end of this section for suggested control settings for various weather conditions.

Window Fogging

Windows will fog on the inside when the humidity inside the vehicle is high. This often occurs in mild or cool temperatures when it's rainy or humid. In most cases, turning the air conditioning (pressing the A/C button) on will clear the fog. Adjust the temperature control, air direction, and blower speed to maintain comfort.

As the temperature gets colder, it may be necessary to direct air onto the windshield. Adjust the temperature control and blower speed to maintain comfort. Higher blower speeds will reduce fogging. Interior fogging on the windshield can be quickly removed by selecting the Defrost mode.

Regular cleaning of the inside of the windows with a non-filming cleaning solution (vinegar and water works very well) will help prevent contaminants (cigarette smoke, perfumes, etc.) from sticking to the windows. Contaminates increase the rate of window fogging.

NOTE: Automatic Temperature Controls (ATC) will automatically adjust the climate control settings to reduce or eliminate window fogging on the front windshield. When this occurs, recirculation will be unavailable.

Summer Operation

NOTE: In some cases during high temperature operation, the air conditioning system performance may be reduced. This is to help protect the engine from overheating during the high load condition.

Your air conditioning system is also equipped with an automatic recirculation system. When the system senses a heavy load or high heat conditions, it may use Recirculation A/C mode to provide additional comfort while in automatic mode.





















Winter Operation

When operating the system during the winter months, make sure the air intake, located directly in front of the windshield, is free of ice, slush, snow, or other obstructions.

Vacation Storage

Anytime you store your vehicle, or keep it out of service (i.e., vacation) for two weeks or more, run the air conditioning system at idle for about five minutes in the fresh air using the high blower setting. This will ensure adequate system lubrication to minimize the possibility of compressor damage when the air conditioning system is started again.

Operating Tips Chart

WEATHER	CONTROL SETTINGS
<p>HOT WEATHER AND VEHICLE INTERIOR IS VERY HOT</p>  	<p>Open the windows, start the vehicle, set the Mode control to Panel  or Bi-Level , and turn on A/C. Set the Fan control to the High position (full clockwise). Set the temperature control to full cool. After the hot air is flushed from the vehicle, set the Mode control to Recirculate  with A/C on and roll up the windows. Once you are comfortable, set the Mode control to Panel  or Bi-Level  with A/C on.</p>
<p>WARM WEATHER</p>  	<p>If it's sunny, set the Mode control to Panel  and turn on A/C. If it's cloudy or dark, set the Mode control to Bi-Level  with A/C on. Adjust Temperature control for comfort.</p>
<p>COOL OR COLD HUMID CONDITIONS</p>  	<p>Set the Mode control to Defrost/Floor  or Defrost .</p> <p>Set the Fan Control to the High position (full clockwise). Adjust Fan and Temperature control for comfort if windows are clear.</p>
<p>COLD DRY CONDITIONS</p>  	<p>Set the Mode control to Floor . If it's sunny, you may want more upper air. In this case, set the Mode control to Bi-Level . In very cold weather, if you need extra heat at the windshield, set the Mode control to Defrost/Floor  or Defrost  as needed. Adjust Fan and Temperature control for comfort.</p>

81352266

STARTING AND OPERATING

CONTENTS

■ STARTING PROCEDURES227	□ Five-Speed Manual Transmission.230
□ Manual Transmission — If Equipped227	□ Recommended Shift Speeds232
□ Automatic Transmission — If Equipped227	□ Downshifting233
□ Normal Starting.228	■ AUTOMATIC TRANSMISSION —	
□ Cold Weather Operation228	IF EQUIPPED233
□ Extended Park Starting.228	□ Key Ignition Park Interlock.235
□ If Engine Fails To Start229	□ Brake/Transmission Shift Interlock System235
□ After Starting230	□ Six-Speed Automatic Transmission235
□ Turbocharger “Cool Down”230	□ Gear Ranges237
■ MANUAL TRANSMISSION — IF EQUIPPED230	■ AUTOSTICK242

□ Operation242	■ ELECTRONIC BRAKE CONTROL SYSTEM252
■ DRIVING ON SLIPPERY SURFACES244	□ Four-Wheel Anti-Lock Brake System (ABS) . .	.252
□ Acceleration244	□ Brake Assist System (BAS)254
□ Traction244	□ Traction Control System (TCS)255
■ DRIVING THROUGH WATER245	□ Hill Start Assist (HSA)255
□ Flowing/Rising Water245	□ Electronic Stability Control (ESC)257
□ Shallow Standing Water245	□ ESC Activation/Malfunction Indicator Light And ESC OFF Indicator Light260
■ POWER STEERING247	■ TIRE SAFETY INFORMATION261
■ PARKING BRAKE248	□ Tire Markings261
■ SPORT MODE250	□ Tire Identification Number (TIN).265
□ Manual Transmission — If Equipped.250	□ Tire Terminology And Definitions266
□ Automatic Transmission — If Equipped.251	□ Tire Loading And Tire Pressure268
■ BRAKE SYSTEM252		

■ TIRES — GENERAL INFORMATION273	■ TIRE ROTATION RECOMMENDATIONS287
□ Tire Pressure273	■ TIRE PRESSURE MONITORING	
□ Tire Inflation Pressures275	SYSTEM (TPMS)288
□ Tire Pressures For High Speed Operation276	□ Base System291
□ Radial Ply Tires276	□ Enhanced System — If Equipped294
□ Tire Types277	□ Premium TPM System294
□ Run Flat Tires — If Equipped279	□ General Information298
□ Spare Tires — If Equipped279	■ FUEL REQUIREMENTS — 1.4L Engine298
□ Tire Spinning282	■ FUEL REQUIREMENTS — 1.4L Turbo299
□ Tread Wear Indicators283	□ Reformulated Gasoline299
□ Life Of Tire283	□ Gasoline/Oxygenate Blends300
□ Replacement Tires284	□ E-85 Usage In Non-Flex Fuel Vehicles300
■ TIRE CHAINS (TRACTION DEVICES)286	□ MMT In Gasoline301

226 STARTING AND OPERATING

- Materials Added To Fuel301
- Fuel System Cautions.302
- Carbon Monoxide Warnings303
- ADDING FUEL303
 - Fuel Filler Cap (Gas Cap)303
 - Loose Fuel Filler Cap Message305
- TRAILER TOWING305
- RECREATIONAL TOWING (BEHIND MOTORHOME, ETC.)306
 - Towing This Vehicle Behind Another Vehicle . .306

STARTING PROCEDURES

Before starting your vehicle, adjust your seat, adjust both inside and outside mirrors, and fasten your seat belts.

WARNING!

- Never leave children alone in a vehicle, or with access to an unlocked vehicle.
- Allowing children to be in a vehicle unattended is dangerous for a number of reasons. A child or others could be seriously or fatally injured. Children should be warned not to touch the parking brake, brake pedal or the shift lever.
- Do not leave the Key Fob in or near the vehicle (or in a location accessible to children). A child could operate power windows, other controls, or move the vehicle.

Manual Transmission — If Equipped

Apply the parking brake, place the shift lever in NEUTRAL, and press the clutch pedal before starting the vehicle. This vehicle is equipped with a clutch interlocking ignition system. It will not start unless the clutch pedal is pressed to the floor.

Automatic Transmission — If Equipped

The shift lever must be in the PARK or NEUTRAL position before you can start the engine. Depress the brake pedal before shifting to any driving gear.

NOTE: You must press the brake pedal before shifting out of PARK.

Normal Starting

NOTE: Normal starting of either a cold or a warm engine is obtained without pumping or pressing the accelerator pedal.

Turn the ignition switch to the AVV/ACC (START) position and release it when the engine starts. If the engine fails to start within 10 seconds, turn the ignition switch to the STOP (OFF/LOCK) position, wait 10 to 15 seconds, then repeat the “Normal Starting” procedure.

Cold Weather Operation

To prevent possible engine damage while starting at low temperatures, this vehicle will inhibit engine cranking when the ambient temperature is less than -22°F (-30°C) and the oil temperature sensor reading indicates an engine block heater has not been used. An externally-powered electric engine block heater is available as optional equipment or from your authorized dealer.

The message “plug in engine heater” will be displayed in the instrument cluster when the ambient temperature is below 5°F (-15°C) at the time the engine is shut off as a reminder to avoid possible crank delays at the next cold start.

CAUTION!

Use of the recommended oil and adhering to the prescribed oil change intervals is important to prevent engine damage and ensure satisfactory starting in cold conditions.

Extended Park Starting

NOTE: Extended Park condition occurs when the vehicle has not been started or driven for at least 35 days.

1. Install a battery charger or jumper cables to the battery to ensure a full battery charge during the crank cycle.

2. Cycle the ignition in the START position and release it when the engine starts.
3. If the engine fails to start within ten seconds, cycle the ignition to the STOP (OFF/LOCK) position, wait five seconds to allow the starter to cool, then repeat the Extended Park Starting procedure.
4. If the engine fails to start after eight attempts, allow the starter to cool for at least 10 minutes, then repeat the procedure.

CAUTION!

To prevent damage to the starter, do not continuously crank the engine for more than 10 seconds at a time. Wait 10 to 15 seconds before trying again.

If Engine Fails To Start**WARNING!**

Never pour fuel or other flammable liquids into the throttle body air inlet opening in an attempt to start the vehicle. This could result in a flash fire causing serious personal injury.

CAUTION!

- Do not attempt to push or tow your vehicle to get it started. Vehicles equipped with an automatic transmission cannot be started this way. Unburned fuel could enter the catalytic converter and once the engine has started, ignite and damage the converter and vehicle.

(Continued)

CAUTION! *(Continued)*

- To prevent damage to the starter, do not continuously crank the engine for more than 15 seconds at a time. Wait 10 to 15 seconds before trying again.

After Starting

The idle speed is controlled automatically and it will decrease as the engine warms up.

Turbocharger “Cool Down”

This vehicle is equipped with an after-run pump to cool the turbocharger after the engine is shut off. Depending on the type of driving and the amount of cargo, the pump will run for up to 10 minutes after the engine has been shut off to circulate coolant through the turbocharger. Although the pump is rubber-mounted for quiet operation, it is normal to hear it running during this time.

MANUAL TRANSMISSION — IF EQUIPPED**Five-Speed Manual Transmission****WARNING!**

You or others could be injured if you leave the vehicle unattended without having the parking brake fully applied. The parking brake should always be applied when the driver is not in the vehicle, especially on an incline.



Shift Lever

Fully press the clutch pedal before you shift gears. As you release the clutch pedal, lightly press the accelerator pedal.

NOTE: To shift into REVERSE from NEUTRAL, lift the ring under the knob and, at the same time move the gearshift lever to the right and then backward.

Use each gear in numerical order; do not skip a gear. Be sure the transmission is in first gear, not third, when starting from a standing position. Damage to the clutch can result from starting in third gear.

For most city driving, you will find it easier to use only the lower gears. For steady highway driving with light accelerations, fifth gear is recommended.

Never drive with your foot resting on the clutch pedal, and never try to hold the vehicle on a hill with the clutch pedal partially engaged. This will cause abnormal wear on the clutch.

REVERSE gear is not synchronized and the vehicle must be at a complete stop to shift into REVERSE gear. When selecting REVERSE gear, the driver should pause (approximately 2 seconds) after pushing in the clutch pedal and prior to shifting into REVERSE which allows gears to stop spinning. Should an unwanted clash noise be produced, the pause length should be increased.

NOTE:

- Clashing REVERSE gear, especially if vehicle is moving, can result in transmission damage.
- During cold weather, until the transmission lubricant is warm, you may experience slightly higher shift efforts. This is normal and not harmful to the transmission.

Recommended Shift Speeds

To use your manual transmission for optimal fuel economy, it should be upshifted as listed in the following table.

Manual Transmission Recommended Shift Speeds					
Units In mph (km/h)					
Engine Size	Acceleration Rate	1 to 2	2 to 3	3 to 4	4 to 5
1.4L/1.4L Turbo Engine	Accel	14 (23)	23 (37)	29 (47)	38 (61)
	Cruise	12 (19)	18 (29)	25 (40)	32 (52)

Downshifting

Proper downshifting will improve fuel economy and prolong engine life.

CAUTION!

If you skip a gear while downshifting or downshift at too high of a vehicle speed, these conditions may cause the engine to overspeed if too low of a gear is selected and the clutch pedal is released. Damage to the clutch and the transmission can result from skipping a gear while downshifting or downshifting at too high of a vehicle speed even if the clutch pedal is held pressed (i.e., not released).

To maintain a safe speed and prolong brake life, shift down to second or first gear when descending a steep grade.

When turning a corner or driving up a steep grade, downshift early so that the engine will not be overburdened.

AUTOMATIC TRANSMISSION — IF EQUIPPED

CAUTION!

Damage to the transmission may occur if the following precautions are not observed:

- Shift into or out of PARK or REVERSE only after the vehicle has come to a complete stop.
- Do not shift between PARK, REVERSE, NEUTRAL, or DRIVE when the engine is above idle speed.
- Before shifting into any gear, make sure your foot is firmly pressing the brake pedal.

NOTE: You must press and hold the brake pedal while shifting out of PARK.

WARNING!

- It is dangerous to shift out of PARK or NEUTRAL if the engine speed is higher than idle speed. If your foot is not firmly pressing the brake pedal, the vehicle could accelerate quickly forward or in reverse. You could lose control of the vehicle and hit someone or something. Only shift into gear when the engine is idling normally and your foot is firmly pressing the brake pedal.
- Unintended movement of a vehicle could injure those in or near the vehicle. As with all vehicles, you should never exit a vehicle while the engine is running. Before exiting a vehicle, always apply the parking brake, shift the transmission into PARK, turn the engine OFF, and remove the ignition key. Once the key is removed, the transmission is

WARNING! (Continued)

- locked in PARK, securing the vehicle against unwanted movement.
- When leaving the vehicle, always remove the ignition key from the vehicle and lock the vehicle.
 - Never leave children alone in a vehicle, or with access to an unlocked vehicle. Allowing children to be in a vehicle unattended is dangerous for a number of reasons. A child or others could be seriously or fatally injured. Children should be warned not to touch the parking brake, brake pedal or the transmission gear selector.
 - Do not leave the ignition key in or near the vehicle (or in a location accessible to children). A child could operate power windows, other controls, or move the vehicle.

(Continued)

Key Ignition Park Interlock

This vehicle is equipped with a Key Ignition Park Interlock which requires the transmission to be in PARK before the ignition switch can be turned to the LOCK/OFF (key removal) position. The key can only be removed from the ignition when the ignition is in the LOCK/OFF position, and once removed, the transmission is locked in PARK.

Brake/Transmission Shift Interlock System

This vehicle is equipped with a Brake Transmission Shift Interlock System (BTSI) that holds the shift lever in PARK unless the brakes are applied. To shift the transmission out of PARK, the ignition switch must be turned to the ON/RUN position (engine running or not) and the brake pedal must be pressed.

Six-Speed Automatic Transmission

The transmission gear position display (located in the instrument cluster) indicates the transmission gear range. You must press the brake pedal to move the shift lever out of PARK (Refer to “Brake/Transmission Shift Interlock System” in this section). To drive, move the shift lever from PARK or NEUTRAL to the DRIVE position.

The electronically-controlled transmission provides a precise shift schedule. The transmission electronics are self-calibrating; therefore, the first few shifts on a new vehicle may be somewhat abrupt. This is a normal condition, and precision shifts will develop within a few hundred miles (kilometers).



Shift Lever

Only shift from DRIVE to PARK or REVERSE when the accelerator pedal is released and the vehicle is stopped. Be sure to keep your foot on the brake pedal when shifting between these gears.

The transmission shift lever has PARK, REVERSE, NEUTRAL, DRIVE, and AutoStick shift positions. Manual shifts can be made using the AutoStick shift control (refer to “AutoStick” in this section for further information). Toggling the shift lever forward (-) or rearward (+) while in the AutoStick position (beside the DRIVE position) will manually select the transmission gear, and will display the current gear in the instrument cluster as 1, 2, 3, etc.

NOTE: If the shift lever cannot be moved to the PARK, REVERSE, or NEUTRAL position (when pushed forward) it is probably in the AutoStick (+/-) position (beside the DRIVE position). In AutoStick mode, the transmission gear (1, 2, 3, etc.) is displayed in the instrument cluster. Move the shift lever to the right (into the DRIVE [D] position) for access to PARK, REVERSE, and NEUTRAL.

Gear Ranges

DO NOT race the engine when shifting from PARK or NEUTRAL into another gear range.

NOTE: After selecting any gear range, wait a moment to allow the selected gear to engage before accelerating. This is especially important when the engine is cold.

PARK (P)

This range supplements the parking brake by locking the transmission. The engine can be started in this range. Never attempt to use PARK while the vehicle is in motion. Apply the parking brake when leaving the vehicle in this range.

When parking on a level surface, you may shift the transmission into PARK first, and then apply the parking brake.

When parking on a hill, apply the parking brake before shifting the transmission to PARK, otherwise the load on the transmission locking mechanism may make it difficult to move the shift lever out of PARK. As an added precaution, turn the front wheels toward the curb on a downhill grade and away from the curb on an uphill grade.

WARNING!

- **Never use the PARK position as a substitute for the parking brake. Always apply the parking brake fully when parked to guard against vehicle movement and possible injury or damage.**
- **Your vehicle could move and injure you and others if it is not completely in PARK. Check by trying to move the shift lever out of PARK with the brake pedal released. Make sure the transmission is in PARK before leaving the vehicle.**

(Continued)

WARNING! (Continued)

- It is dangerous to shift out of PARK or NEUTRAL if the engine speed is higher than idle speed. If your foot is not firmly pressing the brake pedal, the vehicle could accelerate quickly forward or in reverse. You could lose control of the vehicle and hit someone or something. Only shift into gear when the engine is idling normally and your foot is firmly pressing the brake pedal.
- Unintended movement of a vehicle could injure those in or near the vehicle. As with all vehicles, you should never exit a vehicle while the engine is running. Before exiting a vehicle, always apply the parking brake, shift the transmission into PARK, turn the engine OFF, and remove the ignition key. Once the key is removed, the transmission is

WARNING! (Continued)

- locked in PARK, securing the vehicle against unwanted movement.
- When leaving the vehicle, always remove the ignition key from the vehicle and lock the vehicle.
 - Never leave children alone in a vehicle, or with access to an unlocked vehicle. Allowing children to be in a vehicle unattended is dangerous for a number of reasons. A child or others could be seriously or fatally injured. Children should be warned not to touch the parking brake, brake pedal or the shift lever.
 - Do not leave the ignition key in or near the vehicle (or in a location accessible to children). A child could operate power windows, other controls, or move the vehicle.

(Continued)

CAUTION!

- Before moving the shift lever out of PARK, you must turn the ignition switch from the LOCK/OFF position to the ON/RUN position, and also press the brake pedal. Otherwise, damage to the shift lever could result.
- DO NOT race the engine when shifting from PARK or NEUTRAL into another gear range, as this can damage the drivetrain.

The following indicators should be used to ensure that you have engaged the transmission into the PARK position:

- When shifting into PARK, press the lock button on the shift lever and firmly move the lever all the way forward and to the left until it stops and is fully seated.

- Look at the transmission gear position display and verify that it indicates the PARK position.
- With brake pedal released, verify that the shift lever will not move out of PARK.

REVERSE (R)

This range is for moving the vehicle backward. Shift into REVERSE only after the vehicle has come to a complete stop.

NEUTRAL (N)

Use this range when the vehicle is standing for prolonged periods with the engine running. The engine may be started in this range. Apply the parking brake and shift the transmission into PARK if you must leave the vehicle.

WARNING!

Do not coast in NEUTRAL and never turn off the ignition to coast down a hill. These are unsafe practices that limit your response to changing traffic or road conditions. You might lose control of the vehicle and have a collision.

CAUTION!

Towing the vehicle, coasting, or driving for any other reason with the transmission in NEUTRAL can cause severe transmission damage. Refer to "Recreational Towing" in "Starting And Operating" and "Towing A Disabled Vehicle" in "What To Do In Emergencies" for further information.

DRIVE (D)

This range should be used for most city and highway driving. It provides the smoothest upshifts and downshifts, and the best fuel economy. The transmission automatically upshifts through all forward gears. The DRIVE position provides optimum driving characteristics under all normal operating conditions.

When frequent transmission shifting occurs (such as when operating the vehicle under heavy loading conditions, in hilly terrain, or traveling into strong head winds), use the AutoStick shift control (refer to AutoStick in this section for further information) to select a lower gear. Under these conditions, using a lower gear will improve performance and extend transmission life by reducing excessive shifting and heat buildup.

If the transmission temperature exceeds normal operating limits, the transmission controller will expand the range of torque converter clutch engagement. This is done to prevent transmission damage due to overheating.

During cold temperatures, transmission operation may be modified depending on engine coolant temperature. Normal operation will resume once the engine temperature has risen to a suitable level.

Transmission Limp Home Mode

Transmission function is monitored electronically for abnormal conditions. If a condition is detected that could result in transmission damage, Transmission Limp Home Mode is activated. In this mode, the transmission remains in third gear regardless of which forward gear is selected. PARK, REVERSE, and NEUTRAL will continue to operate. The Malfunction Indicator Light (MIL) may be illuminated.

Limp Home Mode allows the vehicle to be driven to an authorized dealer for service without damaging the transmission.

In the event of a momentary problem, the transmission can be reset to regain all forward gears by performing the following steps:

1. Stop the vehicle.
2. Shift the transmission into PARK.
3. Turn the ignition switch to the OFF position.
4. Wait approximately 10 seconds.
5. Restart the engine.
6. Shift into the desired gear range. If the problem is no longer detected, the transmission will return to normal operation.

NOTE: Even if the transmission can be reset, we recommend that you visit your authorized dealer at your earliest possible convenience. Your authorized dealer has diagnostic equipment to determine if the problem could recur.

If the transmission cannot be reset, authorized dealer service is required.

AUTOSTICK

AutoStick is a driver-interactive transmission feature providing manual shift control, giving you more control of the vehicle. AutoStick allows you to maximize engine braking, eliminate undesirable upshifts and downshifts, and improve overall vehicle performance. This system can also provide you with more control during passing, city driving, cold slippery conditions, mountain driving, and many other situations.

Operation

When the shift lever is in the AutoStick position (beside the Drive position), it can be moved forward and rearward. This allows the driver to manually select the transmission gear being used. Moving the shift lever forward (-) triggers a downshift, and rearward (+) an upshift. The current gear is displayed in the instrument cluster.

NOTE: In AutoStick mode, the transmission will only shift up or down when the driver moves the shift lever rearward (+) or forward (-), except as described below.

- The transmission will automatically upshift when necessary to prevent engine over-speed.
- The transmission will automatically downshift as the vehicle slows (to prevent engine lugging) and will display the current gear.

- The transmission will automatically downshift to first gear when coming to a stop. After a stop, the driver should manually upshift (+) the transmission as the vehicle is accelerated.
- You can start out (from a stop) in first, second, or third gear. Starting out in second or third gear can be helpful in snow or icy conditions. To select second or third gear after the vehicle is brought to a stop, tap the shift lever rearward (+) once or twice.
- The system will ignore shift commands that would cause engine lugging or overspeed. An audible beep will sound if an inappropriate gear is requested.
- Avoid using speed control when AutoStick is engaged because the transmission will not shift automatically.
- Transmission shifting will be more noticeable when AutoStick is engaged.
- The system may revert to automatic shift mode if a fault or overheat condition is detected.

To disengage AutoStick mode, return the shift lever to the DRIVE position. You can shift in or out of the AutoStick position at any time without taking your foot off the accelerator pedal.

WARNING!

Do not downshift for additional engine braking on a slippery surface. The drive wheels could lose their grip and the vehicle could skid, causing a collision or personal injury.

DRIVING ON SLIPPERY SURFACES

Acceleration

Rapid acceleration on snow covered, wet, or other slippery surfaces may cause the driving wheels to pull erratically to the right or left. This phenomenon occurs when there is a difference in the surface traction under the front (driving) wheels.

WARNING!

Rapid acceleration on slippery surfaces is dangerous. Unequal traction can cause sudden pulling of the front wheels. You could lose control of the vehicle and possibly have a collision. Accelerate slowly and carefully whenever there is likely to be poor traction (ice, snow, wet, mud, loose sand, etc.).

Traction

When driving on wet or slushy roads, it is possible for a wedge of water to build up between the tire and road surface. This is hydroplaning and may cause partial or complete loss of vehicle control and stopping ability. To reduce this possibility, the following precautions should be observed:

1. Slow down during rainstorms or when the roads are slushy.
2. Slow down if the road has standing water or puddles.
3. Replace the tires when tread wear indicators first become visible.
4. Keep tires properly inflated.
5. Maintain sufficient distance between your vehicle and the vehicle in front of you to avoid a collision in a sudden stop.

DRIVING THROUGH WATER

Driving through water more than a few inches/centimeters deep will require extra caution to ensure safety and prevent damage to your vehicle.

Flowing/Rising Water

WARNING!

Do not drive on or across a road or path where water is flowing and/or rising (as in storm run-off). Flowing water can wear away the road or path's surface and cause your vehicle to sink into deeper water. Furthermore, flowing and/or rising water can carry your vehicle away swiftly. Failure to follow this warning may result in injuries that are serious or fatal to you, your passengers, and others around you.

Shallow Standing Water

Although your vehicle is capable of driving through shallow standing water, consider the following Cautions and Warnings before doing so.

WARNING!

- Driving through standing water limits your vehicle's traction capabilities. Do not exceed 5 mph (8 km/h) when driving through standing water.
- Driving through standing water limits your vehicle's braking capabilities, which increases stopping distances. Therefore, after driving through standing water, drive slowly and lightly press on the brake pedal several times to dry the brakes.
- Failure to follow these warnings may result in injuries that are serious or fatal to you, your passengers, and others around you.

CAUTION!

- Always check the depth of the standing water before driving through it. Never drive through standing water that is deeper than the bottom of the tire rims mounted on the vehicle.
- Determine the condition of the road or the path that is under water and if there are any obstacles in the way before driving through the standing water.
- Do not exceed 5 mph (8 km/h) when driving through standing water. This will minimize wave effects.

(Continued)

CAUTION! (Continued)

- Driving through standing water may cause damage to your vehicle's drivetrain components. Always inspect your vehicle's fluids (i.e., engine oil, transmission, axle, etc.) for signs of contamination (i.e., fluid that is milky or foamy in appearance) after driving through standing water. Do not continue to operate the vehicle if any fluid appears contaminated, as this may result in further damage. Such damage is not covered by the New Vehicle Limited Warranty.
- Getting water inside your vehicle's engine can cause it to lock up and stall out, and cause serious internal damage to the engine. Such damage is not covered by the New Vehicle Limited Warranty.

POWER STEERING

The electric power steering system will give you good vehicle response and increased ease of maneuverability in tight spaces. The system will vary its assist to provide light efforts while parking and good feel while driving. If the electric steering system experiences a fault that prevents it from providing assist, you will still have the ability to steer the vehicle manually.

WARNING!

Continued operation with reduced or no power steering assist could pose a safety risk to yourself and others. Service should be obtained as soon as possible.

If the Steering icon is flashing, it indicates that the vehicle needs to be taken to an authorized dealer for service. It is likely the vehicle has lost power steering assistance.

If the Steering icon is displayed and the "SERVICE POWER STEERING" message is displayed on the EVIC screen, they indicate that extreme steering maneuvers may have occurred which caused an over temperature condition in the power steering system. Once driving conditions are safe, pull over and let the vehicle idle for a few moments until the icon and message turn off. Refer to "Electronic Vehicle Information (EVIC)" in "Understanding Your Instrument Panel" for further information.

If the Steering icon, and the "SERVICE POWER STEERING - ASSIST OFF" message is displayed on the EVIC screen, the vehicle needs to be taken to an authorized dealer for service. Refer to "Electronic Vehicle Information (EVIC)" in "Understanding Your Instrument Panel" for further information.

NOTE:

- Even if the power steering assistance is no longer operational, it is still possible to steer the vehicle. Under these conditions there will be a substantial increase in steering effort, especially at low speeds and during parking maneuvers.
- If the condition persists, see your authorized dealer for service.

PARKING BRAKE

Before leaving the vehicle, make sure that the parking brake is fully applied. Also, be certain to leave the manual transmission in REVERSE or first gear.

The parking brake lever is located in the center console. To apply the parking brake, pull the lever up as firmly as possible. To release the parking brake, pull the lever up slightly, press the center button, then lower the lever completely.

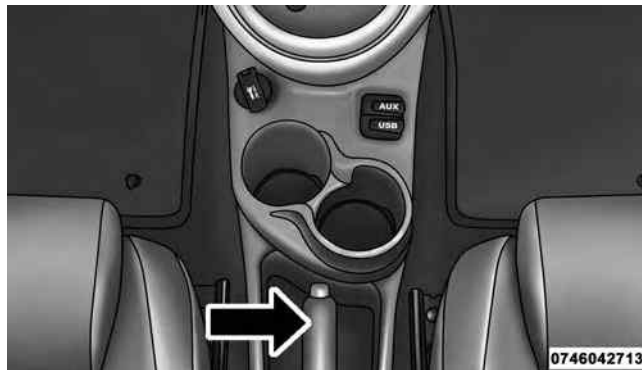

Parking Brake

When the parking brake is applied with the ignition switch in the MAR (ACC/ON/RUN) position, the Brake Warning Light in the instrument cluster will illuminate.

When parking on a hill, it is important to turn the front wheels toward the curb on a downhill grade and away from the curb on an uphill grade. The parking brake should always be applied whenever the driver is not in the vehicle.

WARNING!

- Never leave children alone in a vehicle, or with access to an unlocked vehicle.
- Allowing children to be in a vehicle unattended is dangerous for a number of reasons. A child or others could be seriously or fatally injured. Children should be warned not to touch the parking brake, brake pedal or the shift lever.

(Continued)

WARNING! (Continued)

- Do not leave the Key Fob in or near the vehicle or in a location accessible to children. A child could operate power windows, other controls, or move the vehicle.
- Be sure the parking brake is fully disengaged before driving; failure to do so can lead to brake failure and a collision.
- Always fully apply the parking brake when leaving your vehicle, or it may roll and cause damage or injury. Also be certain to leave a manual transmission in REVERSE or first (1st) gear. Failure to do so may allow the vehicle to roll and cause damage or injury.

CAUTION!

If the Brake Warning Light remains on with the parking brake released, a brake system malfunction is indicated. Have the brake system serviced by an authorized dealer immediately.

SPORT MODE**Manual Transmission — If Equipped**

The Sport mode increases steering feedback to the driver with slight increases in effort and throttle pedal-to-engine response. This driving mode is useful while driving on twisty roads where more steering precision is desired in spirited cornering.

1. To activate the Sport mode, press the SPORT button.

**SPORT Button**

Once activated, a SPORT message will be displayed in the instrument cluster.

2. Momentarily release the accelerator pedal.
3. Press the accelerator pedal again to activate.

Automatic Transmission — If Equipped

The Sport mode increases steering feedback to the driver with slight increase in effort and changes the transmission shift schedules for more aggressive shifting. This driving mode is useful while driving on twisty roads where more steering precision is desired in spirited cornering.

1. To activate the Sport mode, press the SPORT button.

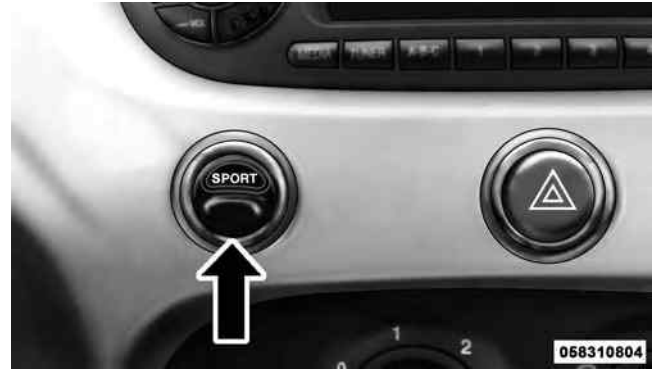

SPORT Button

Once activated, a SPORT message will be displayed in the instrument cluster.

2. Press the SPORT button again to return to the standard driving mode.

BRAKE SYSTEM

Your vehicle is equipped with dual hydraulic brake systems. If either of the two hydraulic systems loses normal capability, the remaining system will still function. However, there will be some loss of overall braking effectiveness. You may notice increased pedal travel during application, greater pedal force required to slow or stop, and potential activation of the “Brake System Warning Light.”

In the event power assist is lost for any reason (i.e., repeated brake applications with the engine off) the brakes will still function. However, the effort required to brake the vehicle will be much greater than that required with the power system operating.

ELECTRONIC BRAKE CONTROL SYSTEM

Your vehicle is equipped with a advanced electronic brake control system that includes the Anti-Lock Brake System (ABS), Brake Assist System (BAS), Traction Control System (TCS), Hill Start Assist (HSA), and Electronic Stability Control (ESC). All systems work together to enhance vehicle stability and control in various driving conditions and are commonly referred to as ESC.

Four-Wheel Anti-Lock Brake System (ABS)

The Four-Wheel ABS is designed to aid the driver in maintaining vehicle control under adverse braking conditions. The system operates with a separate computer to modulate hydraulic pressure, to prevent wheel lock-up and to help avoid skidding on slippery surfaces.

The system’s pump motor runs during an ABS stop to provide regulated hydraulic pressure. The pump motor makes a low humming noise during operation, which is normal.

The ABS includes an amber ABS Warning Light. When the light is illuminated, the ABS is not functioning. The system reverts to standard non-anti-lock brakes. Turning the ignition Off and On again may reset the ABS if the fault detected was only momentary.

WARNING!

- Pumping the Anti-Lock Brakes will diminish their effectiveness and may lead to a collision. Pumping makes the stopping distance longer. Just press firmly on your brake pedal when you need to slow down or stop.
- The Anti-Lock Brake System (ABS) cannot prevent the natural laws of physics from acting on the vehicle, nor can it increase braking or steering efficiency beyond that afforded by the condition of the vehicle brakes and tires or the traction afforded.

(Continued)

WARNING! (Continued)

- The ABS cannot prevent collisions, including those resulting from excessive speed in turns, following another vehicle too closely, or hydroplaning.
- The capabilities of an ABS-equipped vehicle must never be exploited in a reckless or dangerous manner, which could jeopardize the user's safety or the safety of others.

When you are in a severe braking condition involving the use of the ABS, you will experience some pedal drop as the vehicle comes to a stop. This is the result of the system reverting to the base brake system.

Engagement of the ABS may be accompanied by a pulsing sensation. You may also hear a clicking noise. These occurrences are normal and indicate that the system is functioning properly.

Brake Assist System (BAS)

The BAS is designed to optimize the vehicle's braking capability during emergency braking maneuvers. The system detects an emergency braking situation by sensing the rate and amount of brake application and then applies optimum pressure to the brakes. This can help reduce braking distances. The BAS complements the Anti-Lock Brake System (ABS). Applying the brakes very quickly results in the best BAS assistance. To receive the benefit of the system, you must apply **continuous** braking pressure during the stopping sequence (do not "pump" the brakes). Do not reduce brake pedal pressure unless braking is no longer desired. Once the brake pedal is released, the BAS is deactivated.

WARNING!

- The Brake Assist System (BAS) cannot prevent the natural laws of physics from acting on the vehicle, nor can it increase the traction afforded by prevailing road conditions.
- The BAS cannot prevent collisions, including those resulting from excessive speed in turns, driving on very slippery surfaces, or hydroplaning.
- The capabilities of a BAS-equipped vehicle must never be exploited in a reckless or dangerous manner which could jeopardize the user's safety or the safety of others.

Traction Control System (TCS)

This system monitors the amount of wheel spin of each of the driven wheels. If wheel spin is detected, brake pressure is applied to the slipping wheel(s) and engine power is reduced to provide enhanced acceleration and stability. A feature of the TCS system, Brake Limited Differential (BLD), functions similar to a limited slip differential and controls the wheel spin across a driven axle. If one wheel on a driven axle is spinning faster than the other, the system will apply the brake of the spinning wheel. This will allow more engine torque to be applied to the wheel that is not spinning. This feature remains active even if TCS and ESC are in the Partial Off mode. Refer to “Electronic Stability Control (ESC)” in this section for further information.

Hill Start Assist (HSA)

The HSA system is designed to assist the driver when starting a vehicle from a stop on a hill. HSA will maintain the level of brake pressure the driver applied for a short period of time after the driver takes his foot off the brake pedal. If the driver does not apply the throttle during this short period of time, the system will release brake pressure and the vehicle will roll down the hill. The system will release brake pressure in proportion to the amount of throttle applied as the vehicle starts to move in the intended direction of travel.

HSA Activation Criteria

The following criteria must be met in order for HSA to activate:

- Vehicle must be stopped.
- Vehicle must be on a 2.5% (manual transmission) or 7% grade or greater (automatic transmission) hill.
- Gear selection matches vehicle uphill direction (i.e., vehicle in NEUTRAL (manual transmission), vehicle facing uphill is in forward gear; vehicle backing uphill is in REVERSE gear).

WARNING!

There may be situations on minor hills with a loaded vehicle, or while pulling a trailer, when the system will not activate and slight rolling may occur. This

(Continued)

WARNING! (Continued)

could cause a collision with another vehicle or object. Always remember the driver is responsible for braking the vehicle.

Disabling/Enabling HSA

If you wish to turn the HSA system on or off, it can be done using the Customer Programmable Features in the Electronic Vehicle Information Center (EVIC). Refer to “Electronic Vehicle Information Center (EVIC)” in “Understanding Your Instrument Panel” for further information.

Electronic Stability Control (ESC)

The Electronic Stability Control (ESC) system enhances directional control and stability of the vehicle under various driving conditions. ESC corrects for oversteering or understeering of the vehicle by applying the brake of the appropriate wheel to assist in counteracting the oversteering or understeering condition. Engine power may also be reduced to help the vehicle maintain the desired path. ESC uses sensors in the vehicle to determine the vehicle path intended by the driver and compares it to the actual path of the vehicle. When the actual path does not match the intended path, ESC applies the brake of the appropriate wheel to assist in counteracting the oversteer or understeer condition.

- Oversteer - when the vehicle is turning more than appropriate for the steering wheel position.
- Understeer - when the vehicle is turning less than appropriate for the steering wheel position.



ESC Off Switch (Automatic Transmission)



ESC Off Switch (Manual Transmission)

NOTE: The ESC Off switch is located left of the steering column (Manual Transmission Only).

WARNING!

The Electronic Stability Control (ESC) cannot prevent the natural laws of physics from acting on the vehicle, nor can it increase the traction afforded by prevailing road conditions. ESC cannot prevent all accidents, including those resulting from excessive speed in turns, driving on very slippery surfaces, or hydroplaning. ESC also cannot prevent collisions resulting from loss of vehicle control due to inappropriate driver input for the conditions. Only a safe, attentive, and skillful driver can prevent accidents. The capabilities of an ESC equipped vehicle must never be exploited in a reckless or dangerous manner which could jeopardize the user's safety or the safety of others.

ESC Operating Modes

The ESC system has two available operating modes.

Full On

This is the normal operating mode for ESC. Whenever the vehicle is started, the ESC system will be in On mode. This mode should be used for most driving situations. ESC should only be turned to Partial Off for specific reasons as noted below.

Partial Off

This mode is entered by momentarily pushing the ESC Off switch. This mode is intended to be used if the vehicle is in deep snow, sand or gravel conditions and more wheel spin than ESC would normally allow is required to gain traction.

To turn ESC on again, momentarily pushing the switch again. This will restore the normal ESC On mode of operation.

NOTE: To improve the vehicle's traction when driving with snow chains, or starting off in deep snow, sand or gravel, it may be desirable to switch to the Partial Off mode by pressing the switch. Once the situation requiring ESC to be switched to the Partial Off mode is overcome, turn ESC back on by momentarily pressing the switch. This may be done while the vehicle is in motion.

WARNING!

- When in "Partial Off" mode, the TCS functionality of ESC, (except for the limited slip feature described in the TCS section), has been disabled and the "ESC Off Indicator Light" will be illuminated. When in "Partial Off" mode, the engine power reduction feature of TCS is disabled, and the enhanced vehicle stability offered by the ESC system is reduced.

ESC Activation/Malfunction Indicator Light And ESC OFF Indicator Light

ESC The ESC Activation/Malfunction Indicator Light in the instrument cluster will come on when the ignition switch is turned to the MAR (ACC/ON/RUN) position for four seconds. If the ESC Activation/Malfunction Indicator Light comes on continuously with the engine running, a malfunction has been detected in the ESC system. If this light remains on after several ignition cycles, and the vehicle has been driven several miles (kilometers) at speeds greater than 30 mph (48 km/h), see your authorized dealer as soon as possible to have the problem diagnosed and corrected.

The ESC Activation/Malfunction Indicator Light (located in the instrument cluster) starts to flash as soon as the tires lose traction and the ESC system becomes active.

The ESC Activation/Malfunction Indicator Light also flashes when TCS is active. If the ESC Activation/Malfunction Indicator Light begins to flash during acceleration, ease up on the accelerator and apply as little throttle as possible. Be sure to adapt your speed and driving to the prevailing road conditions.

NOTE:

- The ESC Activation/Malfunction Indicator Light and the ESC OFF Indicator Light come on momentarily each time the ignition switch is turned ON.
- Each time the ignition is turned ON, the ESC system will be ON even if it was turned off previously.

ESC OFF

The ESC OFF Indicator Light indicates the Electronic Stability Control (ESC) is partially off.

TIRE SAFETY INFORMATION

Tire Markings

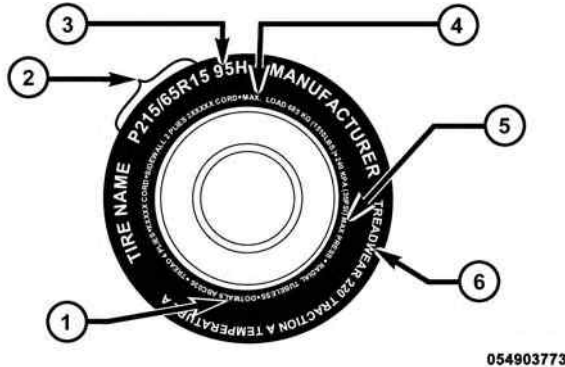

054903773

- | | |
|--|--|
| 1 — U.S. DOT Safety Standards Code (TIN) | 4 — Maximum Load |
| 2 — Size Designation | 5 — Maximum Pressure |
| 3 — Service Description | 6 — Treadwear, Traction and Temperature Grades |

NOTE:

- P (Passenger) — Metric tire sizing is based on U.S. design standards. P-Metric tires have the letter “P” molded into the sidewall preceding the size designation. Example: P215/65R15 95H.
- European — Metric tire sizing is based on European design standards. Tires designed to this standard have the tire size molded into the sidewall beginning with the section width. The letter “P” is absent from this tire size designation. Example: 215/65R15 96H.
- LT (Light Truck) — Metric tire sizing is based on U.S. design standards. The size designation for LT-Metric tires is the same as for P-Metric tires except for the letters “LT” that are molded into the sidewall preceding the size designation. Example: LT235/85R16.

- Temporary spare tires are designed for temporary emergency use only. Temporary high pressure compact spare tires have the letter "T" or "S" molded into the sidewall preceding the size designation. Example: T145/80D18 103M.
- High flotation tire sizing is based on U.S. design standards and it begins with the tire diameter molded into the sidewall. Example: 31x10.5 R15 LT.

Tire Sizing Chart

EXAMPLE:

Example Size Designation: P215/65R15XL 95H, 215/65R15 96H, LT235/85R16C, T145/80D18 103M, 31x10.5 R15 LT

P = Passenger car tire size based on U.S. design standards, or

"...blank..." = Passenger car tire based on European design standards, or

LT = Light truck tire based on U.S. design standards, or

T or S = Temporary spare tire or

31 = Overall diameter in inches (in)

215, 235, 145 = Section width in millimeters (mm)

EXAMPLE:

65, 85, 80 = Aspect ratio in percent (%)

- Ratio of section height to section width of tire, or

10.5 = Section width in inches (in)

R = Construction code

- "R" means radial construction, or
 - "D" means diagonal or bias construction
-

15, 16, 18 = Rim diameter in inches (in)

Service Description:

95 = Load Index

- A numerical code associated with the maximum load a tire can carry
-

EXAMPLE:

H = Speed Symbol

- A symbol indicating the range of speeds at which a tire can carry a load corresponding to its load index under certain operating conditions
 - The maximum speed corresponding to the speed symbol should only be achieved under specified operating conditions (i.e., tire pressure, vehicle loading, road conditions, and posted speed limits)
-

Load Identification:

Absence of the following load identification symbols on the sidewall of the tire indicates a Standard Load (SL) tire:

- **XL** = Extra load (or reinforced) tire, or
 - **LL** = Light load tire or
 - **C, D, E, F, G** = Load range associated with the maximum load a tire can carry at a specified pressure
-

Maximum Load – Maximum load indicates the maximum load this tire is designed to carry

Maximum Pressure – Maximum pressure indicates the maximum permissible cold tire inflation pressure for this tire

Tire Identification Number (TIN)

The TIN may be found on one or both sides of the tire, however, the date code may only be on one side. Tires with white sidewalls will have the full TIN, including the date code, located on the white sidewall side of the tire.

Look for the TIN on the outboard side of black sidewall tires as mounted on the vehicle. If the TIN is not found on the outboard side, then you will find it on the inboard side of the tire.

EXAMPLE:

DOT MA L9 ABCD 0301

DOT = Department of Transportation

– This symbol certifies that the tire is in compliance with the U.S. Department of Transportation tire safety standards and is approved for highway use

MA = Code representing the tire manufacturing location (two digits)

L9 = Code representing the tire size (two digits)

ABCD = Code used by the tire manufacturer (one to four digits)

03 = Number representing the week in which the tire was manufactured (two digits)

– 03 means the 3rd week

EXAMPLE:**DOT MA L9 ABCD 0301****01** = Number representing the year in which the tire was manufactured (two digits)

– 01 means the year 2001

– Prior to July 2000, tire manufacturers were only required to have one number to represent the year in which the tire was manufactured. Example: 031 could represent the 3rd week of 1981 or 1991

Tire Terminology And Definitions

Term	Definition
B-Pillar	The vehicle B-Pillar is the structural member of the body located behind the front door.
Cold Tire Inflation Pressure	Cold tire inflation pressure is defined as the tire pressure after the vehicle has not been driven for at least three hours, or driven less than 1 mile (1.6 km) after sitting for a minimum of three hours. Inflation pressure is measured in units of PSI (pounds per square inch) or kPa (kilopascals).

Term	Definition
Maximum Inflation Pressure	The maximum inflation pressure is the maximum permissible cold tire inflation pressure for this tire. The maximum inflation pressure is molded into the sidewall.
Recommended Cold Tire Inflation Pressure	Vehicle manufacturer's recommended cold tire inflation pressure as shown on the tire placard.
Tire Placard	A label permanently attached to the vehicle describing the vehicle's loading capacity, the original equipment tire sizes and the recommended cold tire inflation pressures.

Tire Loading And Tire Pressure

Tire And Loading Information Placard Location

NOTE: The proper cold tire inflation pressure is listed on the driver's side B-Pillar or the rear edge of the driver's side door.

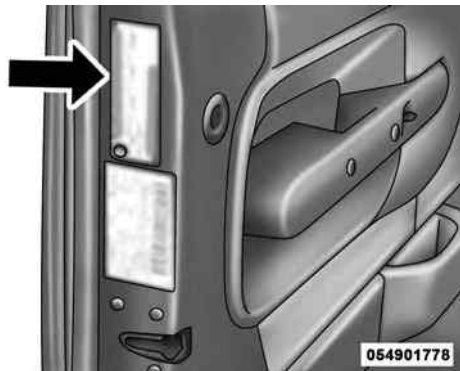

Example Tire Placard Location (Door)

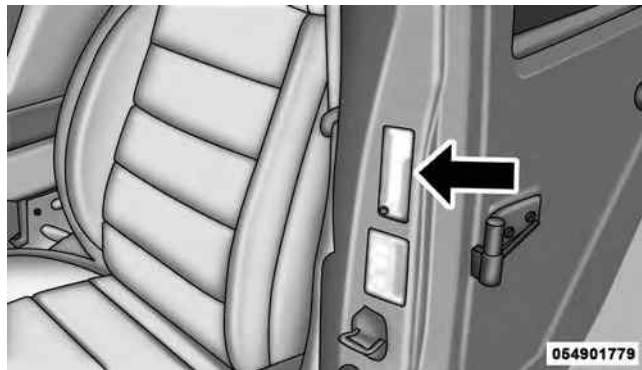

Example Tire Placard Location (B-Pillar)

Tire And Loading Information Placard

TIRE AND LOADING INFORMATION			
SEATING CAPACITY - TOTAL 5 FRONT 2 REAR 3			
THE COMBINED WEIGHT OF OCCUPANTS AND CARGO SHOULD NEVER EXCEED XXX KG OR XXX LBS.			
TIRE	FRONT	REAR	SPARE
ORIGINAL TIRE SIZE	P195/70R14	P195/70R14	T125/70D15
COLD TIRE INFLATION PRESSURE	200kPa, 29PSI	200kPa, 29PSI	420kPa, 60PSI
SEE OWNER'S MANUAL FOR ADDITIONAL INFORMATION			4N109268

811b5a9a

Tire And Loading Information Placard

This placard tells you important information about the:

1. Number of people that can be carried in the vehicle.
2. Total weight your vehicle can carry.
3. Tire size designed for your vehicle.
4. Cold tire inflation pressures for the front, rear, and spare tires.

Loading

The vehicle maximum load on the tire must not exceed the load carrying capacity of the tire on your vehicle. You will not exceed the tire's load carrying capacity if you adhere to the loading conditions, tire size, and cold tire inflation pressures specified on the Tire and Loading Information placard and in the "Vehicle Loading" section of this manual.

NOTE: Under a maximum loaded vehicle condition, gross axle weight ratings (GAWRs) for the front and rear axles must not be exceeded. For further information on GAWRs, vehicle loading, and trailer towing, refer to “Vehicle Loading” in this section.

To determine the maximum loading conditions of your vehicle, locate the statement “The combined weight of occupants and cargo should never exceed XXX lbs or XXX kg” on the Tire and Loading Information placard. The combined weight of occupants, cargo/luggage and trailer tongue weight (if applicable) should never exceed the weight referenced here.

Steps For Determining Correct Load Limit

1. Locate the statement “The combined weight of occupants and cargo should never exceed XXX lbs or XXX kg” on your vehicle’s placard.
2. Determine the combined weight of the driver and passengers that will be riding in your vehicle.
3. Subtract the combined weight of the driver and passengers from XXX lbs or XXX kg.

4. The resulting figure equals the available amount of cargo and luggage load capacity. For example, if “XXX” amount equals 1,400 lbs (635 kg) and there will be five 150 lb (68 kg) passengers in your vehicle, the amount of available cargo and luggage load capacity is 650 lbs (295 kg) (since $5 \times 150 \text{ lbs (68 kg)} = 750 \text{ lbs (340 kg)}$, and $1400 \text{ lbs (635 kg)} - 750 \text{ lbs (340 kg)} = 650 \text{ lbs [295 kg]}$).
5. Determine the combined weight of luggage and cargo being loaded on the vehicle. That weight may not safely exceed the available cargo and luggage load capacity calculated in step 4.

NOTE:

- If your vehicle will be towing a trailer, load from your trailer will be transferred to your vehicle. The following table shows examples on how to calculate total load, cargo/luggage, and towing capacities of your vehicle with varying seating configurations and number and size of occupants. This table is for illustration purposes only and may not be accurate for the seating and load carry capacity of your vehicle.
- For the following example, the combined weight of occupants and cargo should never exceed 865 lbs (392 kg).

Occupants			Combined weight of occupants and cargo from Tire Placard	MINUS	Combined Occupant's weight	=	AVAILABLE Cargo/Luggage and Trailer Tongue Weight
TOTAL	FRONT	REAR					
EXAMPLE 1			↓ 865 lbs	MINUS	Occupant 1: 200 lbs Occupant 2: 130 lbs Occupant 3: 160 lbs Occupant 4: 100 lbs Occupant 5: 80 lbs TOTAL WEIGHT: 670 lbs	=	↓ 195 lbs
5	2	3					
EXAMPLE 2			↓ 865 lbs	minus	Occupant 1: 210 lbs Occupant 2: 180 lbs Occupant 3: 150 lbs TOTAL WEIGHT: 540 lbs	=	↓ 325 lbs
3	2	1					
EXAMPLE 3			↓ 865 lbs	minus	Occupant 1: 200 lbs Occupant 2: 200 lbs TOTAL WEIGHT: 400 lbs	=	↓ 465 lbs
2	2	0					

WARNING!

Overloading of your tires is dangerous. Overloading can cause tire failure, affect vehicle handling, and increase your stopping distance. Use tires of the recommended load capacity for your vehicle. Never overload them.

TIRES — GENERAL INFORMATION**Tire Pressure**

Proper tire inflation pressure is essential to the safe and satisfactory operation of your vehicle. Four primary areas are affected by improper tire pressure:

- Safety and Vehicle Stability
- Economy
- Tread Wear
- Ride Comfort

Safety**WARNING!**

- Improperly inflated tires are dangerous and can cause collisions.
- Under-inflation increases tire flexing and can result in overheating and tire failure.
- Over-inflation reduces a tire's ability to cushion shock. Objects on the road and chuckholes can cause damage that result in tire failure.
- Overinflated or under-inflated tires can affect vehicle handling and can fail suddenly, resulting in loss of vehicle control.
- Unequal tire pressures can cause steering problems. You could lose control of your vehicle.

(Continued)

WARNING! (Continued)

- Unequal tire pressures from one side of the vehicle to the other can cause the vehicle to drift to the right or left.
- Always drive with each tire inflated to the recommended cold tire inflation pressure.

Both under-inflation and over-inflation affect the stability of the vehicle and can produce a feeling of sluggish response or over responsiveness in the steering.

NOTE:

- Unequal tire pressures from side to side may cause erratic and unpredictable steering response.
- Unequal tire pressure from side to side may cause the vehicle to drift left or right.

Economy

Underinflated tires will increase tire rolling resistance resulting in higher fuel consumption.

Tread Wear

Improper cold tire inflation pressures can cause abnormal wear patterns and reduced tread life, resulting in the need for earlier tire replacement.

Ride Comfort And Vehicle Stability

Proper tire inflation contributes to a comfortable ride. Over-inflation produces a jarring and uncomfortable ride.

Tire Inflation Pressures

The proper cold tire inflation pressure is listed on the driver's side B-Pillar or rear edge of the driver's side door.

At least once a month:

- Check and adjust tire pressure with a good quality pocket-type pressure gauge. Do not make a visual judgement when determining proper inflation. Tires may look properly inflated even when they are under-inflated.
- Inspect tires for signs of tire wear or visible damage.

CAUTION!

After inspecting or adjusting the tire pressure, always reinstall the valve stem cap. This will prevent moisture and dirt from entering the valve stem, which could damage the valve stem.

Inflation pressures specified on the placard are always "cold tire inflation pressure." Cold tire inflation pressure is defined as the tire pressure after the vehicle has not been driven for at least three hours, or driven less than 1 mile (1.6 km) after sitting for a minimum of three hours. The cold tire inflation pressure must not exceed the maximum inflation pressure molded into the tire sidewall.

Check tire pressures more often if subject to a wide range of outdoor temperatures, as tire pressures vary with temperature changes.

Tire pressures change by approximately 1 psi (7 kPa) per 12°F (7°C) of air temperature change. Keep this in mind when checking tire pressure inside a garage, especially in the winter.

Example: If garage temperature = 68°F (20°C) and the outside temperature = 32°F (0°C) then the cold tire inflation pressure should be increased by 3 psi (21 kPa), which equals 1 psi (7 kPa) for every 12°F (7°C) for this outside temperature condition.

Tire pressure may increase from 2 to 6 psi (13 to 40 kPa) during operation. DO NOT reduce this normal pressure build up or your tire pressure will be too low.

Tire Pressures For High Speed Operation

The manufacturer advocates driving at safe speeds and within posted speed limits. Where speed limits or conditions are such that the vehicle can be driven at high speeds, maintaining correct tire inflation pressure is very important. Increased tire pressure and reduced vehicle loading may be required for high-speed vehicle operation. Refer to your authorized tire dealer or original equipment vehicle dealer for recommended safe operating speeds, loading and cold tire inflation pressures.

WARNING!

High speed driving with your vehicle under maximum load is dangerous. The added strain on your tires could cause them to fail. You could have a serious collision. Do not drive a vehicle loaded to the maximum capacity at continuous speeds above 75 mph (120 km/h).

Radial Ply Tires

WARNING!

Combining radial ply tires with other types of tires on your vehicle will cause your vehicle to handle poorly. The instability could cause a collision. Always use radial ply tires in sets of four. Never combine them with other types of tires.

Tire Repair

If your tire becomes damaged, it may be repaired if it meets the following criteria:

- The tire has not been driven on when flat.
- The damage is only on the tread section of your tire (sidewall damage is not repairable).
- The puncture is no greater than a $\frac{1}{4}$ of an inch (6 mm).

Consult an authorized tire dealer for tire repairs and additional information.

Damaged Run Flat tires, or Run Flat tires that have experienced a loss of pressure should be replaced immediately with another Run Flat tire of identical size and service description (Load Index and Speed Symbol).

Tire Types

All Season Tires — If Equipped

All Season tires provide traction for all seasons (spring, summer, fall and winter). Traction levels may vary between different all season tires. All season tires can be identified by the M+S, M&S, M/S or MS designation on the tire sidewall. Use all season tires only in sets of four; failure to do so may adversely affect the safety and handling of your vehicle.

Summer Or Three Season Tires — If Equipped

Summer tires provide traction in both wet and dry conditions, and are not intended to be driven in snow or on ice. If your vehicle is equipped with summer tires, be aware these tires are not designed for winter or cold

driving conditions. Install winter tires on your vehicle when ambient temperatures are less than 40°F (5°C) or if roads are covered with ice or snow. For more information, contact an authorized dealer.

Summer tires do not contain the all season designation or mountain/snowflake symbol on the tire sidewall. Use summer tires only in sets of four; failure to do so may adversely affect the safety and handling of your vehicle.

WARNING!

Do not use summer tires in snow/ice conditions. You could lose vehicle control, resulting in severe injury or death. Driving too fast for conditions also creates the possibility of loss of vehicle control.

Snow Tires

Some areas of the country require the use of snow tires during the winter. Snow tires can be identified by a “mountain/snowflake” symbol on the tire sidewall.



If you need snow tires, select tires equivalent in size and type to the original equipment tires. Use snow tires only in sets of four; failure to do so may adversely affect the safety and handling of your vehicle.

Snow tires generally have lower speed ratings than what was originally equipped with your vehicle and should not be operated at sustained speeds over 75 mph (120 km/h). For speeds above 75 mph (120 km/h) refer to original equipment or an authorized tire dealer for recommended safe operating speeds, loading and cold tire inflation pressures.

While studded tires improve performance on ice, skid and traction capability on wet or dry surfaces may be poorer than that of non-studded tires. Some states prohibit studded tires; therefore, local laws should be checked before using these tire types.

Run Flat Tires — If Equipped

Run Flat tires allow you the capability to drive 50 miles (80 km) at 50 mph (80 km/h) after a rapid loss of inflation pressure. This rapid loss of inflation is referred to as the Run Flat mode. A Run Flat mode occurs when the tire inflation pressure is of/or below 14 psi (96 kPa). Once a Run Flat tire reaches the run flat mode it has limited driving capabilities and needs to be replaced immediately. A Run Flat tire is not repairable.

It is not recommended driving a vehicle loaded at full capacity or to tow a trailer while a tire is in the run flat mode.

See the tire pressure monitoring section for more information.

Spare Tires — If Equipped

NOTE: For vehicles equipped with Tire Service Kit instead of a spare tire, please refer to “Tire Service Kit” in “What To Do In Emergencies” for further information.

CAUTION!

Because of the reduced ground clearance, do not take your vehicle through an automatic car wash with a compact or limited-use temporary spare installed. Damage to the vehicle may result.

Spare Tire Matching Original Equipped Tire And Wheel — If Equipped

Your vehicle may be equipped with a spare tire and wheel equivalent in look and function to the original equipment tire and wheel found on the front or rear axle of your vehicle. This spare tire may be used in the tire rotation for your vehicle. If your vehicle has this option, refer to an authorized tire dealer for the recommended tire rotation pattern.

Compact Spare Tire — If Equipped

The compact spare is for temporary emergency use only. You can identify if your vehicle is equipped with a compact spare by looking at the spare tire description on the Tire and Loading Information Placard located on the driver's side door opening or on the sidewall of the tire. Compact spare tire descriptions begin with the letter "T" or "S" preceding the size designation. Example: T145/80D18 103M.

T, S = Temporary Spare Tire

Since this tire has limited tread life, the original equipment tire should be repaired (or replaced) and reinstalled on your vehicle at the first opportunity.

Do not install a wheel cover or attempt to mount a conventional tire on the compact spare wheel, since the wheel is designed specifically for the compact spare tire. Do not install more than one compact spare tire and wheel on the vehicle at any given time.

WARNING!

Compact spares are for temporary emergency use only. With these spares, do not drive more than 50 mph (80 km/h). Temporary use spares have limited tread life. When the tread is worn to the tread wear indicators, the temporary use spare tire needs to be

(Continued)

WARNING! (Continued)

replaced. Be sure to follow the warnings, which apply to your spare. Failure to do so could result in spare tire failure and loss of vehicle control.

Full Size Spare — If Equipped

The full size spare is for temporary emergency use only. This tire may look like the originally equipped tire on the front or rear axle of your vehicle, but it is not. This spare tire may have limited tread life. When the tread is worn to the tread wear indicators, the temporary use full size spare tire needs to be replaced. Since it is not the same as your original equipment tire, replace (or repair) the original equipment tire and reinstall on the vehicle at the first opportunity.

Limited-Use Spare — If Equipped

The limited-use spare tire is for temporary emergency use only. This tire is identified by a label located on the limited-use spare wheel. This label contains the driving limitations for this spare. This tire may look like the original equipped tire on the front or rear axle of your vehicle, but it is not. Installation of this limited-use spare tire affects vehicle handling. Since it is not the same as your original equipment tire, replace (or repair) the original equipment tire and reinstall on the vehicle at the first opportunity.

WARNING!

Limited-use spares are for emergency use only. Installation of this limited-use spare tire affects vehicle handling. With this tire, do not drive more than the speed listed on the limit-use spare wheel. Keep inflated to the cold tire inflation pressures listed on your Tire and Loading Information Placard located on the driver's side B-Pillar or the rear edge of the driver's side door. Replace (or repair) the original equipment tire at the first opportunity and reinstall it on your vehicle. Failure to do so could result in loss of vehicle control.

Tire Spinning

When stuck in mud, sand, snow, or ice conditions, do not spin your vehicle's wheels above 30 mph (48 km/h) or for longer than 30 seconds continuously without stopping.

Refer to "Freeing A Stuck Vehicle" in "What To Do In Emergencies" for further information.

WARNING!

Fast spinning tires can be dangerous. Forces generated by excessive wheel speeds may cause tire damage or failure. A tire could explode and injure someone. Do not spin your vehicle's wheels faster than 30 mph (48 km/h) for more than 30 seconds continuously when you are stuck, and do not let anyone near a spinning wheel, no matter what the speed.

Tread Wear Indicators

Tread wear indicators are in the original equipment tires to help you in determining when your tires should be replaced.

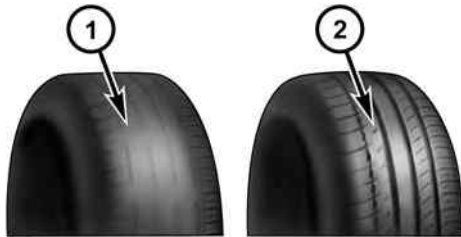

055007576

1 — Worn Tire
2 — New Tire

These indicators are molded into the bottom of the tread grooves. They will appear as bands when the tread depth becomes a 1/16 of an inch (2 mm). When the tread is worn to the tread wear indicators, the tire should be replaced. Refer to “Replacement Tires” in this section for further information.

Life Of Tire

The service life of a tire is dependent upon varying factors including, but not limited to:

- Driving style.
- Tire pressure - Improper cold tire inflation pressures can cause uneven wear patterns to develop across the tire tread. These abnormal wear patterns will reduce tread life, resulting in the need for earlier tire replacement.
- Distance driven.

- Performance tires, tires with a speed rating of V or higher, and summer tires typically have a reduced tread life. Rotation of these tires per the vehicle maintenance schedule is highly recommended.

WARNING!

Tires and the spare tire should be replaced after six years, regardless of the remaining tread. Failure to follow this warning can result in sudden tire failure. You could lose control and have a collision resulting in serious injury or death.

Keep dismounted tires in a cool, dry place with as little exposure to light as possible. Protect tires from contact with oil, grease, and gasoline.

Replacement Tires

The tires on your new vehicle provide a balance of many characteristics. They should be inspected regularly for wear and correct cold tire inflation pressures. The manufacturer strongly recommends that you use tires equivalent to the originals in size, quality and performance when replacement is needed. Refer to the paragraph on "Tread Wear Indicator." Refer to the Tire and Loading Information placard or the Vehicle Certification Label for the size designation of your tire. The Load Index and Speed Symbol for your tire will be found on the original equipment tire sidewall. See the Tire Sizing Chart example found in the Tire Safety Information section of this manual for more information relating to the Load Index and Speed Symbol of a tire.

It is recommended to replace the two front tires or two rear tires as a pair. Replacing just one tire can seriously affect your vehicle's handling. If you ever replace a wheel, make sure that the wheel's specifications match those of the original wheels.

It is recommended you contact your authorized tire dealer or original equipment dealer with any questions you may have on tire specifications or capability. Failure to use equivalent replacement tires may adversely affect the safety, handling, and ride of your vehicle.

WARNING!

- Do not use a tire, wheel size or rating other than that specified for your vehicle. Some combinations of unapproved tires and wheels may change suspension dimensions and performance characteristics, resulting in changes to steering, handling, and

(Continued)

WARNING! (Continued)

braking of your vehicle. This can cause unpredictable handling and stress to steering and suspension components. You could lose control and have a collision resulting in serious injury or death. Use only the tire and wheel sizes with load ratings approved for your vehicle.

- Never use a tire with a smaller load index or capacity, other than what was originally equipped on your vehicle. Using a tire with a smaller load index could result in tire overloading and failure. You could lose control and have a collision.
- Failure to equip your vehicle with tires having adequate speed capability can result in sudden tire failure and loss of vehicle control.

CAUTION!

Replacing original tires with tires of a different size may result in false speedometer and odometer readings.

WARNING!

Using tires of different size and type (M+S, Snow) between front and rear axles can cause unpredictable handling. You could lose control and have a collision.

TIRE CHAINS (TRACTION DEVICES)

Use of traction devices require sufficient tire-to-body clearance. Follow these recommendations to guard against damage:

- Traction device must be of proper size for the tire, as recommended by the traction device manufacturer.
- Install on Front Tires.
- Due to limited clearance, a 185/55R15 tire with a Security Chain Company (SCC) Super Z6 low profile traction device or equivalent is recommended.

CAUTION!

To avoid damage to your vehicle or tires, observe the following precautions:

- Because of restricted traction device clearance between tires and other suspension components, it is important that only traction devices in good condition are used. Broken devices can cause serious damage. Stop the vehicle immediately if noise occurs that could indicate device breakage. Remove the damaged parts of the device before further use.

(Continued)

CAUTION! *(Continued)*

- Install device as tightly as possible and then re-tighten after driving about ½ mile (0.8 km).
- Do not exceed 30 mph (48 km/h).
- Drive cautiously and avoid severe turns and large bumps, especially with a loaded vehicle.
- Do not drive for a prolonged period on dry pavement.
- Observe the traction device manufacturer's instructions on the method of installation, operating speed, and conditions for use. Always use the suggested operating speed of the device manufacturer's if it is less than 30 mph (48 km/h).
- Do not use traction devices on a compact spare tire.

TIRE ROTATION RECOMMENDATIONS

The tires on the front and rear of your vehicle operate at different loads and perform different steering, driving, and braking functions. For these reasons, they wear at unequal rates.

These effects can be reduced by timely rotation of tires. The benefits of rotation are especially worthwhile with aggressive tread designs such as those on all season type tires. Rotation will increase tread life, help to maintain mud, snow and wet traction levels, and contribute to a smooth, quiet ride.

Refer to the "Maintenance Schedule" for the proper maintenance intervals. The reasons for any rapid or unusual wear should be corrected prior to rotation being performed.

The suggested rotation method is the “rearward cross” shown in the following diagram. This rotation pattern does not apply to some directional tires that must not be reversed.

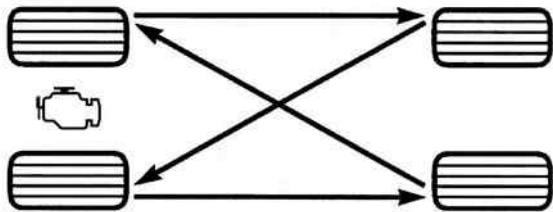

Tire Rotation

055707139

TIRE PRESSURE MONITORING SYSTEM (TPMS)

The Tire Pressure Monitor System (TPMS) will warn the driver of a low tire pressure based on the vehicle recommended cold tire pressure.

The tire pressure will vary with temperature by about 1 psi (7 kPa) for every 12° F (6.5° C). This means that when the outside temperature decreases, the tire pressure will decrease. Tire pressure should always be set based on cold inflation tire pressure. This is defined as the tire pressure after the vehicle has not been driven for at least three hours, or driven less than 1 mile (1.6 km) after a three hour period. The cold tire inflation pressure must not exceed the maximum inflation pressure molded into the tire sidewall. Refer to “Tires – General Information” in “Starting and Operating” for information on how to properly inflate the vehicle’s tires. The tire pressure will also increase as the vehicle is driven, this is normal and there should be no adjustment for this increased pressure.

The TPMS will warn the driver of a low tire pressure if the tire pressure falls below the low pressure warning limit for any reason, including low temperature effects, or natural pressure loss through the tire.

The TPMS will continue to warn the driver of low tire pressure as long as the condition exists, and will not turn off until the tire pressure is at or above the recommended cold tire pressure on the placard. Once the low tire pressure warning (Tire Pressure Monitoring Telltale Light) illuminates, you must increase the tire pressure to the recommended cold tire pressure in order for the Tire Pressure Monitoring Telltale Light to turn off. The system will automatically update and the Tire Pressure Monitoring Telltale Light will turn off once the system receives the updated tire pressures. The vehicle may need to be driven for up to 20 minutes above 15 mph (24 km/h) in order for the TPMS to receive this information.

For example, your vehicle may have a recommended cold (parked for more than three hours) tire pressure of 30 psi (207 kPa). If the ambient temperature is 68° F (20° C) and the measured tire pressure is 27 psi (186 kPa), a temperature drop to 20° F (-7° C) will decrease the tire pressure to approximately 23 psi (159 kPa). This tire pressure is sufficiently low enough to turn on the Tire Pressure Monitoring Telltale Light. Driving the vehicle may cause the tire pressure to rise to approximately 27 psi (186 kPa), but the Tire Pressure Monitoring Telltale Light will still be on. In this situation, the Tire Pressure Monitoring Telltale Light will turn off only after the tires are inflated to the vehicle's recommended cold tire pressure value.

CAUTION!

- The TPMS has been optimized for the original equipment tires and wheels. TPMS pressures and warnings have been established for the tire size equipped on your vehicle. Undesirable system operation or sensor damage may result when using replacement equipment that is not of the same size, type, and/or style. Aftermarket wheels can cause sensor damage. Using aftermarket tire sealants may cause the Tire Pressure Monitoring System (TPMS) sensor to become inoperable. After using an aftermarket tire sealant it is recommended that you take your vehicle to your an authorized dealership to have your sensor function checked.

(Continued)

CAUTION! (Continued)

- After inspecting or adjusting the tire pressure, always reinstall the valve stem cap. This will prevent moisture and dirt from entering the valve stem, which could damage the Tire Pressure Monitoring Sensor.

NOTE:

- The TPMS is not intended to replace normal tire care and maintenance, or to provide warning of a tire failure or condition.
- The TPMS should not be used as a tire pressure gauge while adjusting your tire pressure.

- Driving on a significantly under-inflated tire causes the tire to overheat and can lead to tire failure. Under-inflation also reduces fuel efficiency and tire tread life, and may affect the vehicle's handling and stopping ability.
- The TPMS is not a substitute for proper tire maintenance, and it is the driver's responsibility to maintain correct tire pressure using an accurate tire gauge, even if under-inflation has not reached the level to trigger illumination of the Tire Pressure Monitoring Telltale Light.
- Seasonal temperature changes will affect tire pressure, and the TPMS will monitor the actual tire pressure in the tire.

Base System



This is the TPMS warning indicator located in the instrument cluster.

The TPMS uses wireless technology with wheel rim mounted electronic sensors to monitor tire pressure levels. Sensors, mounted to each wheel as part of the valve stem, transmit tire pressure readings to the Receiver Module.

NOTE: It is particularly important for you to check the tire pressure in all of the tires on your vehicle regularly and to maintain the proper pressure.

The TPMS consists of the following components:

- Receiver Module.
- Four Tire Pressure Monitoring Sensors.
- Tire Pressure Monitoring Telltale Light.

Tire Pressure Monitoring Low Pressure Warnings

The Tire Pressure Monitoring Telltale Light will illuminate in the instrument cluster, an audible chime will be activated, and the “Check left or right front/rear tire xxx.x psi” text message will display when one or more of the four active road tire pressures are low. Should this occur, you should stop as soon as possible, check the inflation pressure of each tire on your vehicle, and inflate each tire to the vehicle’s recommended cold placard pressure value. The system will automatically update and the Tire Pressure Monitoring Light will extinguish once the updated tire pressures have been received. The vehicle may need to be driven for up to 20 minutes above 15 mph (24 km/h) to receive this information.

Check TPMS Warnings

The Tire Pressure Monitoring Telltale Light will flash on and off for 75 seconds and remain on solid when a system fault is detected, an audible chime will be activated and

the “Service Tire Pressure Monitoring System” text message will display. If the ignition key is cycled, this sequence will repeat providing the system fault still exists. The Tire Pressure Monitoring Telltale Light will turn off when the fault condition no longer exists. A system fault can occur with any of the following scenarios:

1. Jamming due to electronic devices or driving next to facilities emitting the same radio frequencies as the TPM sensors.
2. Installing some form of aftermarket window tinting that affects radio wave signals.
3. Snow or ice around the wheels or wheel housings.
4. Using tire chains on the vehicle.
5. Using wheels/tires not equipped with TPM sensors.

NOTE: Your vehicle may be equipped with a compact spare wheel and tire assembly.

1. The compact spare tire does not have a tire pressure monitoring sensor. Therefore, the TPMS will not monitor the tire pressure in the compact spare tire.
2. If you install the compact spare tire in place of a road tire that has a pressure below the low-pressure warning limit, upon the next ignition key cycle, a chime will sound and the Tire Pressure Monitoring Telltale Light will still turn ON due to the low tire.
3. However, after driving the vehicle for up to 20 minutes above 15 mph (24 km/h), the Tire Pressure Monitoring Telltale Light will flash on and off for 75 seconds and then remain on solid.
4. This occurs for each subsequent ignition key cycle, a chime will sound and the Tire Pressure Monitoring Telltale Light will flash on and off for 75 seconds and then remain on solid.
5. Once you repair or replace the original road tire and reinstall it on the vehicle in place of the compact spare tire, the TPMS will update automatically and the Tire Pressure Monitoring Telltale Light will turn OFF, as long as no tire pressure is below the low-pressure warning limit in any of the four active road tires. The vehicle may need to be driven for up to 20 minutes above 15 mph (24 km/h) in order for the TPMS to receive this information.

Enhanced System — If Equipped

When the vehicle is equipped with an enhanced TPM system, the driver can view text messages showing the actual tire pressure value by position by selecting the tire pressure menu command in the instrument cluster. Refer to the instrument panel features section of the owners manual.

Premium TPM System

The Tire Pressure Monitor System (TPMS) uses wireless technology with wheel rim mounted electronic sensors to monitor tire pressure levels. Sensors, mounted to each wheel as part of the valve stem, transmit tire pressure readings to the receiver module.

The TPMS consists of the following components:

- Receiver module
- Four Tire Pressure Monitoring Sensors

- Various Tire Pressure Monitoring System messages, which display in the Electronic Vehicle Information Center (EVIC)
- Tire Pressure Monitoring Telltale Light

Tire Pressure Monitoring Low Pressure Warnings

 The “Tire Pressure Monitoring Telltale Light” will illuminate in the instrument cluster and a chime will sound when tire pressure is low in one or more of the four active road tires. In addition, the Electronic Vehicle Information Center (EVIC) will display a graphic showing the pressure values of each tire with the low tire pressure tire highlighted in a different color.



Low Tire Indicator

Should this occur, you should stop as soon as possible and inflate the tires with low pressure to the vehicle's recommended cold placard pressure value. Once the system

receives the updated tire pressures, the system will automatically update and the "Tire Pressure Monitoring Telltale Light" will turn off. The vehicle may need to be driven for up to 20 minutes above 15 mph (24 km/h) in order for the TPMS to receive this information.

TPMS Warning

When a system fault is detected, the "Tire Pressure Monitoring Telltale Light" will flash on and off for 75 seconds and then remain on solid. The system fault will sound a chime and also display a "Service Tire Pressure Monitoring System" message in the EVIC for approximately 5 seconds and then display dashes (- -) in place of the pressure value to indicate which sensor is not being received.



Service TPM System Message

If the ignition switch is cycled, this sequence will repeat, providing the system fault still exists. If the system fault no longer exists, the "Tire Pressure Monitoring Telltale Light" will no longer flash, and the "Service Tire Pressure Monitoring System" message will no longer display, and a pressure value will display in place of the dashes.

A system fault can occur due to any of the following:

1. Signal interference due to electronic devices or driving next to facilities emitting the same radio frequencies as the TPM sensors.
2. Installing aftermarket window tinting that contains materials that may block radio wave signals.
3. Accumulation of snow or ice around the wheels or wheel housings.
4. Using tire chains on the vehicle.
5. Using wheels/tires not equipped with TPM sensors.

The EVIC will also display a "Service Tire Pressure Monitoring System" message for a minimum of five seconds when a system fault related to an incorrect sensor location fault is detected. In this case, the "Service Tire Pressure Monitoring System" message is then followed with a graphic display with pressure values still

shown. This indicates that the pressure values are still being received from the TPM sensors but they may not be located in the correct vehicle position. The system still needs to be serviced as long as the "Service Tire Pressure Monitoring System" message is displayed.

NOTE:

- The TPMS will not monitor the pressure in a replacement tire installed without a tire pressure sensor.
 - If you install a replacement tire in place of a road tire that has a pressure below the low-pressure warning limit, upon the next ignition switch cycle, the "Tire Pressure Monitoring Telltale Light" will remain on and a chime will sound. In addition, the graphic in the EVIC will still display a pressure value highlighted in a different color.
- After driving the vehicle for up to 20 minutes above 15 mph (24 km/h), the "Tire Pressure Monitoring Telltale Light" will flash on and off for 75 seconds and then remain on solid. In addition, the EVIC will display a "Service TPM System" message and then display dashes (- -) in place of the pressure value.
 - For each subsequent ignition switch cycle, a chime will sound, the "Tire Pressure Monitoring Telltale Light" will flash on and off for 75 seconds and then remain on solid, and the EVIC will display a "Service Tire Pressure Monitoring System" message and dashes (- -) in place of the pressure value.

Once you repair or replace the original road tire and reinstall it, the TPMS will update automatically. In addition, the "Tire Pressure Monitoring Telltale Light" will turn off and the graphic in the EVIC will display a new

pressure value instead of dashes (- -), as long as no tire pressure is below the low-pressure warning limit in any of the four active road tires. The vehicle may need to be driven for up to 20 minutes above 15 mph (24 km/h) in order for the TPMS to receive this information.

General Information

This device complies with Part 15 of the FCC rules and RSS 210 of Industry Canada. Operation is subject to the following conditions:

- This device may not cause harmful interference.
- This device must accept any interference received, including interference that may cause undesired operation.

The tire pressure sensors are covered under one of the following licenses:

United States	MRXC4W4MA4
Canada	2546A-C4W4MA4 (Single)

FUEL REQUIREMENTS — 1.4L Engine



This engine is designed to meet all emission regulations and provide satisfactory fuel economy and performance when using high-quality unleaded "regular" gasoline with a minimum octane rating of 87. For optimum performance and fuel economy the use of 91 octane or higher is recommended.

Light spark knock at low engine speeds is not harmful to your engine. However, continued heavy spark knock at high speeds can cause damage and immediate service is required.

Poor quality gasoline can cause problems such as hard starting, stalling and hesitations. If you experience these symptoms, try another brand of gasoline (with the appropriate octane rating for your engine) before considering service for the vehicle.

FUEL REQUIREMENTS — 1.4L Turbo



This engine is designed to meet all emission regulations and provide satisfactory fuel economy and performance when using high-quality unleaded "regular" gasoline with a minimum octane rating of 87.

For optimum performance and fuel economy the use of 91 octane or higher is recommended.

Light spark knock at low engine speeds is not harmful to your engine. However, continued heavy spark knock at high speeds can cause damage and immediate service is required.

Poor quality gasoline can cause problems such as hard starting, stalling and hesitations. If you experience these symptoms, try another brand of gasoline (with the appropriate octane rating for your engine) before considering service for the vehicle.

Reformulated Gasoline

Many areas of the country require the use of cleaner burning gasoline referred to as "Reformulated Gasoline." Reformulated gasoline contain oxygenates and are specifically blended to reduce vehicle emissions and improve air quality.

The manufacturer supports the use of reformulated gasoline. Properly blended reformulated gasoline will provide excellent performance and durability of engine and fuel system components.

Gasoline/Oxygenate Blends

Some fuel suppliers blend unleaded gasoline with oxygenates such as 10% Ethanol, Methyl Tert-Butyl Ether (MTBE), and Ethyl Tert-Butyl Ether (ETBE). Oxygenates are required in some areas of the country during the winter months to reduce carbon monoxide emissions. Fuels blended with these oxygenates may be used in your vehicle.

CAUTION!

Do not use gasoline containing Methanol or E-85 Ethanol. Use of these blends may result in starting and drivability problems and may damage critical fuel system components.

Problems that result from using methanol/gasoline blends are not the responsibility of the manufacturer. While MTBE is an oxygenate made from Methanol, it does not have the negative effects of Methanol.

E-85 Usage In Non-Flex Fuel Vehicles

Non-Flex Fuel Vehicles (FFV) are compatible with gasoline containing 10% ethanol (E10). Gasoline with higher ethanol content may void the New Vehicle Limited Warranty.

If a Non-FFV vehicle is inadvertently fueled with E-85 fuel, the engine will have some or all of these symptoms:

- Operate in a lean mode.
- OBD II “Malfunction Indicator Light” on.
- Poor engine performance.
- Poor cold start and cold drivability.
- Increased risk for fuel system component corrosion.

To fix a Non-FFV vehicle inadvertently fueled once with E-85 perform the following:

- Drain the fuel tank (see your authorized dealer).
- Change the engine oil and oil filter.
- Disconnect and reconnect the battery to reset the engine controller memory.

More extensive repairs will be required for prolonged exposure to E-85 fuel.

MMT In Gasoline

Methylcyclopentadienyl Manganese Tricarbonyl (MMT) is a manganese-containing metallic additive that is blended into some gasoline to increase octane. Gasoline blended with MMT provides no performance advantage beyond gasoline of the same octane number without

MMT. Gasoline blended with MMT reduces spark plug life and reduces emissions system performance in some vehicles. The manufacturer recommends that gasoline without MMT be used in your vehicle. The MMT content of gasoline may not be indicated on the gasoline pump, therefore, you should ask your gasoline retailer whether the gasoline contains MMT. MMT is prohibited in Federal and California reformulated gasoline.

Materials Added To Fuel

All gasoline sold in the United States is required to contain effective detergent additives. Use of additional detergents or other additives is not needed under normal conditions and they would result in additional cost. Therefore, you should not have to add anything to the fuel.

Fuel System Cautions

CAUTION!

Follow these guidelines to maintain your vehicle's performance:

- The use of leaded gas is prohibited by Federal law. Using leaded gasoline can impair engine performance and damage the emissions control system.
- An out-of-tune engine or certain fuel or ignition malfunctions can cause the catalytic converter to overheat. If you notice a pungent burning odor or some light smoke, your engine may be out of tune or malfunctioning and may require immediate service. Contact your authorized dealer for service assistance.

(Continued)

CAUTION! *(Continued)*

- The use of fuel additives, which are now being sold as octane enhancers, is not recommended. Most of these products contain high concentrations of methanol. Fuel system damage or vehicle performance problems resulting from the use of such fuels or additives is not the responsibility of the manufacturer.

NOTE: Intentional tampering with the emissions control system can result in civil penalties being assessed against you.

Carbon Monoxide Warnings

WARNING!

Carbon monoxide (CO) in exhaust gases is deadly. Follow the precautions below to prevent carbon monoxide poisoning:

- Do not inhale exhaust gases. They contain carbon monoxide, a colorless and odorless gas, which can kill. Never run the engine in a closed area, such as a garage, and never sit in a parked vehicle with the engine running for an extended period. If the vehicle is stopped in an open area with the engine running for more than a short period, adjust the ventilation system to force fresh, outside air into the vehicle.

(Continued)

WARNING! *(Continued)*

- Guard against carbon monoxide with proper maintenance. Have the exhaust system inspected every time the vehicle is raised. Have any abnormal conditions repaired promptly. Until repaired, drive with all side windows fully open.

ADDING FUEL

Fuel Filler Cap (Gas Cap)

The gas cap is located on the passenger side of the vehicle. If the gas cap is lost or damaged, be sure the replacement cap is the correct one for this vehicle.

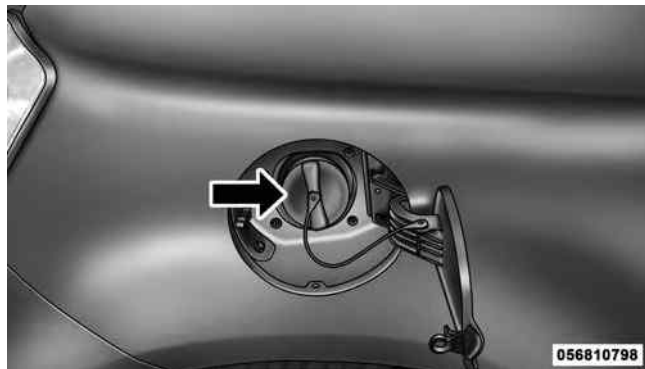

Fuel Filler Cap

CAUTION!

- Damage to the fuel system or emission control system could result from using an improper fuel filler cap. A poorly fitting cap could let impurities

(Continued)

CAUTION! (Continued)

into the fuel system. Also, a poorly fitting aftermarket cap can cause the “Malfunction Indicator Light (MIL)” to illuminate, due to fuel vapors escaping from the system.

- To avoid fuel spillage and overfilling, do not “top off” the fuel tank after filling.

WARNING!

- Never have any smoking materials lit in or near the vehicle when the gas cap is removed or the tank is being filled.
- Never add fuel when the engine is running. It may cause the MIL to turn on and could cause a fire.

(Continued)

WARNING! (Continued)

- A fire may result if gasoline is pumped into a portable container that is inside of a vehicle. You could be burned. Always place gas containers on the ground while filling.

NOTE:

- When the fuel nozzle “clicks” or shuts off, the fuel tank is full.
- Tighten the gas cap about 1/4 turn until you hear one click. This is an indication that the cap is properly tightened.
- If the gas cap is not tightened properly, the MIL will come on. Be sure the gas cap is tightened every time the vehicle is refueled.

Loose Fuel Filler Cap Message

After fuel has been added, the vehicle diagnostic system can determine if the fuel filler cap is possibly loose, improperly installed, or damaged. If the system detects a malfunction, the “gASCAP” message will display in the odometer display. Tighten the gas cap until a “clicking” sound is heard. This is an indication that the gas cap is properly tightened. Press the odometer reset button to turn the message off. If the problem persists, the message will appear the next time the vehicle is started. This might indicate a damaged cap. If the problem is detected twice in a row, the system will turn on the MIL. Resolving the problem will turn the MIL off.

TRAILER TOWING

Trailer towing with this vehicle is not recommended.

RECREATIONAL TOWING (BEHIND MOTORHOME, ETC.)**Towing This Vehicle Behind Another Vehicle**

Towing Condition	Wheels OFF the Ground	Manual Transmission	Automatic Transmission
Flat Tow	NONE	Transmission in NEUTRAL	NOT ALLOWED
Dolly Tow	Front	OK	OK
	Rear	NOT ALLOWED	NOT ALLOWED
On Trailer	ALL	OK	OK

This vehicle may be towed on a flatbed or vehicle trailer provided all four wheels are OFF the ground.

This vehicle may also be towed using a tow dolly (with the front wheels OFF the ground).

Vehicles equipped with **manual transmissions** may be flat towed (with all four wheels on the ground) at any legal highway speed, for any distance, if the manual transmission is in NEUTRAL.

CAUTION!

DO NOT flat tow any vehicle equipped with an automatic transmission. Damage to the drivetrain will result. If these vehicles require towing, make sure all drive wheels are OFF the ground.

CAUTION!

Towing this vehicle in violation of the above requirements can cause severe transmission damage. Damage from improper towing is not covered under the New Vehicle Limited Warranty.

WHAT TO DO IN EMERGENCIES

CONTENTS

■ HAZARD WARNING FLASHERS311	■ JACKING AND TIRE CHANGING — IF EQUIPPED324
■ IF YOUR ENGINE OVERHEATS311	□ Jack Location325
■ TIRE SERVICE KIT — IF EQUIPPED312	□ Spare Tire Removal326
□ Tire Service Kit Storage313	□ Preparations For Jacking328
□ Tire Service Kit Components And Operation . .	.313	□ Jacking Instructions329
□ Tire Service Kit Usage Precautions.314	□ Road Tire Installation.335
□ Sealing A Tire With Tire Service Kit.317	□ Spare Tire Stowage337
■ WHEEL AND TIRE TORQUE SPECIFICATIONS323	■ JUMP-STARTING PROCEDURE337
□ Torque Specifications323	□ Preparations For Jump-Start338

310 WHAT TO DO IN EMERGENCIES

- Jump-Starting Procedure340
- FREEING A STUCK VEHICLE342
- SHIFT LEVER OVERRIDE343
- TOWING A DISABLED VEHICLE345
 - Automatic Transmission346
 - Manual Transmission347
- ENHANCED ACCIDENT RESPONSE SYSTEM347

HAZARD WARNING FLASHERS

The Hazard Warning flasher switch is located on the instrument panel below the radio.



Press the switch to turn on the Hazard Warning flashers. When the switch is activated, all directional turn signals will flash on and off to warn oncoming traffic of an emergency. Press the switch a second time to turn off the Hazard Warning flashers.

Do not use this emergency warning system when the vehicle is in motion. Use it when your vehicle is disabled and it is creating a safety hazard for other motorists.

If it is necessary to leave the vehicle to go for service, the Hazard Warning flashers will continue to operate with the ignition key removed and the vehicle locked.

NOTE: With extended use, the Hazard Warning flashers may wear down your battery.

IF YOUR ENGINE OVERHEATS

In any of the following situations, you can reduce the potential for overheating by taking the appropriate action.

- On the highways — slow down.
- In city traffic — while stopped, place the transmission in NEUTRAL, but do not increase engine idle speed.

NOTE: There are steps that you can take to slow down an impending overheat condition:

- If your air conditioner (A/C) is on, turn it off. The A/C system adds heat to the engine cooling system and turning the A/C off can help remove this heat.
- You can also turn the temperature control to maximum heat, the mode control to floor and the blower control to high. This allows the heater core to act as a supplement to the radiator and aids in removing heat from the engine cooling system.

CAUTION!

Driving with a hot cooling system could damage your vehicle. If the pointer rises to the H (red) mark, the instrument cluster will sound a chime. When safe, pull over and stop the vehicle with the engine at idle. Turn off the air conditioning and wait until the pointer drops back into the normal range. If the pointer remains on the H (red) mark for more than a minute, turn the engine off immediately and call for service.

WARNING!

You or others can be badly burned by hot engine coolant (antifreeze) or steam from your radiator. If

(Continued)

WARNING! (Continued)

you see or hear steam coming from under the hood, do not open the hood until the radiator has had time to cool. Never try to open a cooling system pressure cap when the radiator or coolant bottle is hot.

TIRE SERVICE KIT — IF EQUIPPED

Small punctures up to ¼" (6 mm) in the tire tread can be sealed with Tire Service Kit. Foreign objects (e.g., screws or nails) should not be removed from the tire. Tire Service Kit can be used in outside temperatures down to approximately -4°F (-20°C).

This kit will provide a temporary tire seal, allowing you to drive your vehicle up to 100 miles (160 km) with a maximum speed of 55 mph (90 km/h).

Tire Service Kit Storage

The Tire Service Kit is located under the front driver's seat.

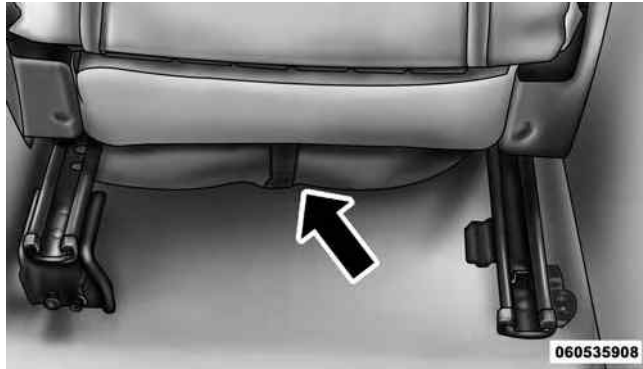

Tire Service Kit Location

Tire Service Kit Components And Operation

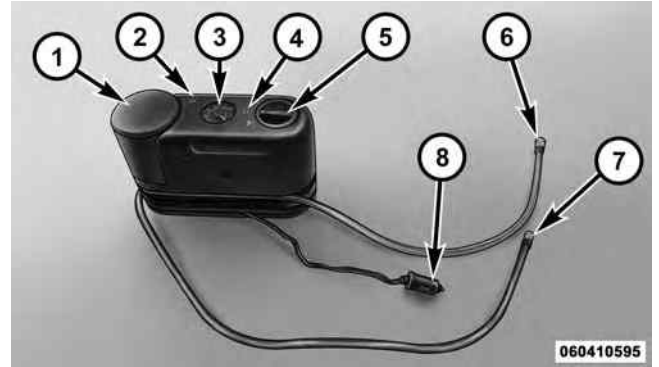

Tire Service Kit Components

- | | |
|----------------------|---|
| 1 — Sealant Bottle | 5 — Mode Select Knob |
| 2 — Deflation Button | 6 — Sealant Hose (Clear) |
| 3 — Pressure Gauge | 7 — Air Pump Hose (Black) |
| 4 — Power Button | 8 — Power Plug (located on the bottom side of the Tire Service Kit) |

Using The Mode Select Knob And Hoses

Your Tire Service Kit is equipped with the following symbols to indicate the air or sealant mode.

Selecting Air Mode



Push in the Mode Select Knob (5) and turn to this position for air pump operation only. Use the Black Air Pump Hose (7) when selecting this mode.

Selecting Sealant Mode



Push in the Mode Select Knob (5) and turn to this position to inject the Tire Service Kit Sealant and to inflate the tire. Use the Sealant Hose (clear hose) (6) when selecting this mode.

Using The Power Button



Push and release the Power Button (4) once to turn On the Tire Service Kit. Push and release the Power Button (4) again to turn Off the Tire Service Kit.

Using The Deflation Button



Press the Deflation Button (2) to reduce the air pressure in the tire if it becomes over-inflated.

Tire Service Kit Usage Precautions

- Replace the Tire Service Kit Sealant Bottle (1) and Sealant Hose (6) prior to the expiration date (printed at the lower right hand corner on the bottle label) to assure optimum operation of the system. Refer to “Sealing a Tire with Tire Service Kit” section (F) “Sealant Bottle and Hose Replacement”.



0604018634

Tire Service Kit Expiration Date Location

- The Sealant Bottle (1) and Sealant Hose (6) are a one tire application use and need to be replaced after each use. Always replace these components immediately at your original equipment vehicle dealer.

- When the Tire Service Kit sealant is in a liquid form, clean water, and a damp cloth will remove the material from the vehicle or tire and wheel components. Once the sealant dries, it can easily be peeled off and properly discarded.
- For optimum performance, make sure the valve stem on the wheel is free of debris before connecting the Tire Service Kit.
- You can use the Tire Service Kit air pump to inflate bicycle tires. The kit also comes with two needles, located in the Accessory Storage Compartment (on the bottom of the air pump) for inflating sport balls, rafts, or similar inflatable items. However, use only the Air Pump Hose (7) and make sure the Mode Select Knob (5) is in the Air Mode when inflating such items to avoid injecting sealant into them. The Tire Service Kit Sealant is only intended to seal punctures less than ¼" (6 mm) diameter in the tread of your vehicle.
- Do not lift or carry the Tire Service Kit by the hoses.

WARNING!

- Do not attempt to seal a tire on the side of the vehicle closest to traffic. Pull far enough off the road to avoid the danger of being hit when using the Tire Service Kit.
- Do not use Tire Service Kit or drive the vehicle under the following circumstances:
 - If the puncture in the tire tread is approximately 1/4" (6 mm) or larger.
 - If the tire has any sidewall damage.
 - If the tire has any damage from driving with extremely low tire pressure.
 - If the tire has any damage from driving on a flat tire.
 - If the wheel has any damage.
 - If you are unsure of the condition of the tire or the wheel.

(Continued)

WARNING! (Continued)

- Keep Tire Service Kit away from open flames or heat source.
- A loose Tire Service Kit thrown forward in a collision or hard stop could endanger the occupants of the vehicle. Always stow the Tire Service Kit in the place provided. Failure to follow these warnings can result in injuries that are serious or fatal to you, your passengers, and others around you.
- Take care not to allow the contents of Tire Service Kit to come in contact with hair, eyes, or clothing. Tire Service Kit is harmful if inhaled, swallowed, or absorbed through the skin. It causes skin, eye, and respiratory irritation. Flush immediately with plenty of water if there is any contact with eyes or skin. Change clothing as soon as possible, if there is any contact with clothing.

(Continued)

WARNING! (Continued)

- **Tire Service Kit Sealant solution contains latex. In case of an allergic reaction or rash, consult a physician immediately. Keep Tire Service Kit out of reach of children. If swallowed, rinse mouth immediately with plenty of water and drink plenty of water. Do not induce vomiting! Consult a physician immediately.**

Sealing A Tire With Tire Service Kit**(A) Whenever You Stop To Use Tire Service Kit:**

1. Pull over to a safe location and turn on the vehicle's Hazard Warning flashers.
2. Verify that the valve stem (on the wheel with the deflated tire) is in a position that is near to the ground. This will allow the Tire Service Kit Hoses (6) and (7) to reach the valve stem and keep the Tire Service Kit flat

on the ground. This will provide the best positioning of the kit when injecting the sealant into the deflated tire and running the air pump. Move the vehicle as necessary to place the valve stem in this position before proceeding.

3. Place the transmission in PARK (auto transmission) or in Gear (manual transmission) and turn Off the ignition.
4. Set the parking brake.

(B) Setting Up To Use Tire Service Kit:

1. Push in the Mode Select Knob (5) and turn to the Sealant Mode position.
2. Uncoil the Sealant Hose (6) and then remove the cap from the fitting at the end of the hose.
3. Place the Tire Service Kit flat on the ground next to the deflated tire.

4. Remove the cap from the valve stem and then screw the fitting at the end of the Sealant Hose (6) onto the valve stem.
5. Uncoil the Power Plug (8) and insert the plug into the vehicle's 12 Volt power outlet.

NOTE: Do not remove foreign objects (e.g., screws or nails) from the tire.

(C) Injecting Tire Service Kit Sealant Into The Deflated Tire:

- Always start the engine before turning ON the Tire Service Kit.

NOTE: Manual transmission vehicles must have the parking brake engaged and the shift lever in NEUTRAL.

- After pressing the Power Button (4), the sealant (white fluid) will flow from the Sealant Bottle (1) through the Sealant Hose (6) and into the tire.

NOTE: Sealant may leak out through the puncture in the tire.

If the sealant (white fluid) does not flow within 0 – 10 seconds through the Sealant Hose (6):

1. Press the Power Button (4) to turn Off the Tire Service Kit. Disconnect the Sealant Hose (6) from the valve stem. Make sure the valve stem is free of debris. Reconnect the Sealant Hose (6) to the valve stem. Check that the Mode Select Knob (5) is in the Sealant Mode position and not Air Mode. Press the Power Button (4) to turn On the Tire Service Kit.
2. Connect the Power Plug (8) to a different 12 Volt power outlet in your vehicle or another vehicle, if available. Make sure the engine is running before turning ON the Tire Service Kit.
3. The Sealant Bottle (1) may be empty due to previous use. Call for assistance.

NOTE: If the Mode Select Knob (5) is on Air Mode and the pump is operating, air will dispense from the Air Pump Hose (7) only, not the Sealant Hose (6).

If the sealant (white fluid) does flow through the Sealant Hose (6):

1. Continue to operate the pump until sealant is no longer flowing through hose (typically takes 30 - 70 seconds). As the sealant flows through the Sealant Hose (6), the Pressure Gauge (3) can read as high as 70 psi (4.8 Bar). The Pressure Gauge (3) will decrease quickly from approximately 70 psi (4.8 Bar) to the actual tire pressure when the Sealant Bottle (1) is empty.
2. The pump will start to inject air into the tire immediately after the Sealant Bottle (1) is empty. Continue to operate the pump and inflate the tire to the pressure indicated on the tire pressure label on the driver-side latch pillar (recommended pressure). Check the tire pressure by looking at the Pressure Gauge (3).

If the tire does not inflate to at least 26 psi (1.8 Bar) pressure within 15 minutes:

- The tire is too badly damaged. Do not attempt to drive the vehicle further. Call for assistance.

NOTE: If the tire becomes over-inflated, press the Deflation Button to reduce the tire pressure to the recommended inflation pressure before continuing.

If the tire inflates to the recommended pressure or is at least 26 psi (1.8 Bar) pressure within 15 minutes:

1. Press the Power Button (4) to turn off the Tire Service Kit.
2. Remove the Speed Limit sticker from the top of the Sealant Bottle (1) and place the sticker on the instrument panel.

3. Immediately disconnect the Sealant Hose (6) from the valve stem, reinstall the cap on the fitting at the end of the hose, and place the Tire Service Kit in the vehicle storage location. Quickly proceed to (D) "Drive Vehicle."

CAUTION!

- The metal end fitting from Power Plug (8) may get hot after use, so it should be handled carefully.
- Failure to reinstall the cap on the fitting at the end of the Sealant Hose (6) can result in sealant contacting your skin, clothing, and the vehicle's interior. It can also result in sealant contacting internal Tire Service Kit components which may cause permanent damage to the kit.

(D) Drive Vehicle:

Immediately after injecting sealant and inflating the tire, drive the vehicle 5 miles (8 km) or 10 minutes to ensure distribution of the Tire Service Kit Sealant within the tire. Do not exceed 55 mph (90 km/h).

WARNING!

Tire Service Kit is not a permanent flat tire repair. Have the tire inspected and repaired or replaced after using Tire Service Kit. Do not exceed 55 mph (90 km/h) until the tire is repaired or replaced. Failure to follow this warning can result in injuries that are serious or fatal to you, your passengers, and others around you.

(E) After Driving:

Pull over to a safe location. Refer to “Whenever You Stop to Use Tire Service Kit” before continuing.

1. Push in the Mode Select Knob (5) and turn to the Air Mode position.
2. Uncoil the power plug and insert the plug into the vehicle’s 12 Volt power outlet.
3. Uncoil the Air Pump Hose (7) (black in color) and screw the fitting at the end of hose (7) onto the valve stem.
4. Check the pressure in the tire by reading the Pressure Gauge (3).

If tire pressure is less than 19 psi (1.3 Bar):

The tire is too badly damaged. Do not attempt to drive the vehicle further. Call for assistance.

If the tire pressure is 19 psi (1.3 Bar) or higher:

1. Press the Power Button (4) to turn on Tire Service Kit and inflate the tire to the pressure indicated on the tire and loading information label on the driver-side door opening.

NOTE: If the tire becomes over-inflated, press the Deflation Button to reduce the tire pressure to the recommended inflation pressure before continuing.

2. Disconnect the Tire Service Kit from the valve stem, reinstall the cap on the valve stem and unplug from 12 Volt outlet.
3. Place the Tire Service Kit in its proper storage area in the vehicle.
4. Have the tire inspected and repaired or replaced at the earliest opportunity at an authorized dealer or tire service center.

5. Remove the Speed Limit sticker from the instrument panel after the tire has been repaired.
6. Replace the Sealant Bottle (1) and Sealant Hose (6) assembly at your authorized dealer as soon as possible. Refer to (F) "Sealant Bottle and Hose Replacement".

NOTE: When having the tire serviced, advise the authorized dealer or service center that the tire has been sealed using the Tire Service Kit.

(F) Sealant Bottle And Hose Replacement:

1. Uncoil the Sealant Hose (6) (clear in color).
2. Locate the round Sealant Bottle release button in the recessed area under the sealant bottle.
3. Press the Sealant Bottle release button. The Sealant Bottle (1) will pop up. Remove the bottle and dispose of it accordingly.
4. Clean any remaining sealant from the Tire Service Kit housing.
5. Position the new Sealant Bottle (1) in the housing so that the Sealant Hose (6) aligns with the hose slot in the front of the housing. Press the bottle into the housing. An audible click will be heard indicating the bottle is locked into place.
6. Verify that the cap is installed on the fitting at the end of the Sealant Hose (6) and return the hose to its storage area (located on the bottom of the air pump).
7. Return the Tire Service Kit to its storage location in the vehicle.

WHEEL AND TIRE TORQUE SPECIFICATIONS

Proper lug nut/bolt torque is very important to ensure that the wheel is properly mounted to the vehicle. Any time a wheel has been removed and reinstalled on the vehicle the lug nuts/bolts should be torqued using a properly calibrated torque wrench.

Torque Specifications

Lug Nut/Bolt Torque	**Lug Nut/ Bolt Size	Lug Nut/ Bolt Socket Size
66 Ft-Lbs (90 N·m) Steel Wheels Only	M12 x 1.25	17 mm
75 Ft-Lbs (100 N·m) Aluminum Wheels Only		

**Use only Chrysler recommended lug nuts/bolts and clean or remove any dirt or oil before tightening.

Inspect the wheel mounting surface prior to mounting the tire and remove any corrosion or loose particles.

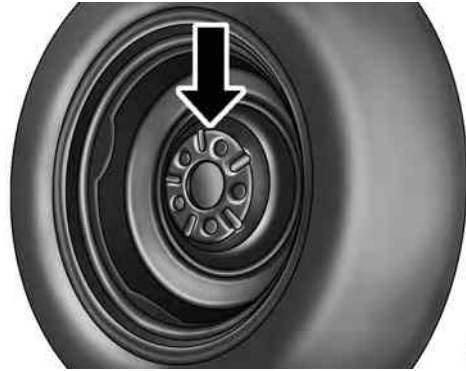

Wheel Mounting Surface

0605005441

Tighten the lug nuts/bolts in a star pattern until each nut/bolt has been tightened twice.

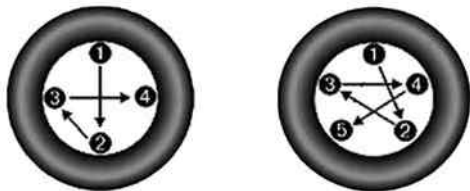

Torque Patterns

After 25 miles (40 km) check the lug nut/bolt torque to be sure that all the lug nuts/bolts are properly seated against the wheel.

WARNING!

To avoid the risk of forcing the vehicle off the jack, do not tighten the lug nuts fully until the vehicle has been lowered. Failure to follow this warning may result in personal injury.

JACKING AND TIRE CHANGING – IF EQUIPPED

WARNING!

- Do not attempt to change a tire on the side of the vehicle close to moving traffic. Pull far enough off the road to avoid the danger of being hit when operating the jack or changing the wheel.

(Continued)

WARNING! (Continued)

- Being under a jacked-up vehicle is dangerous. The vehicle could slip off the jack and fall on you. You could be crushed. Never put any part of your body under a vehicle that is on a jack. If you need to get under a raised vehicle, take it to a service center where it can be raised on a lift.
- Never start or run the engine while the vehicle is on a jack.
- The jack is designed to be used as a tool for changing tires only. The jack should not be used to lift the vehicle for service purposes. The vehicle should be jacked on a firm level surface only. Avoid ice or slippery areas.

Jack Location

The jack and jack wrench tool are stowed in a bag under the front driver's seat.

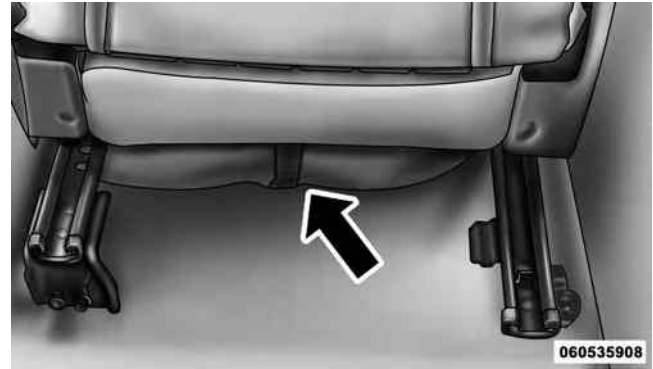

Jack And Jack-Handle Location

Spare Tire Removal

The spare tire is stowed to the underbody below the cargo area.

1. Remove the plug located in the rear cargo area.

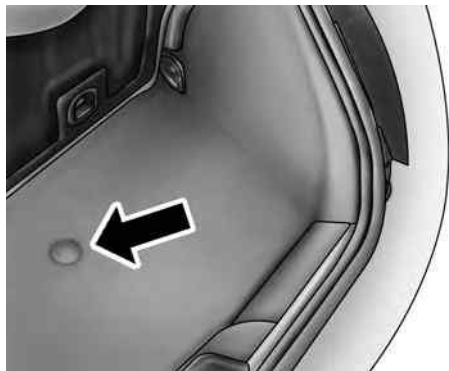

Winch Access Plug

0605001773

2. Fit the wrench tool over the drive nut. Use the wrench to rotate the nut counterclockwise until the spare is on the ground with enough slack in the cable to allow you to pull the tire out from under the vehicle.

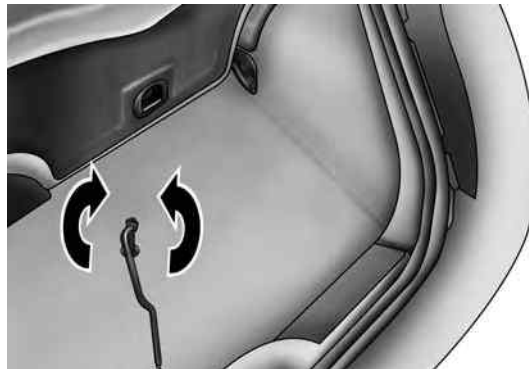

0605011841

Lowering/Raising Spare Tire

CAUTION!

The winch mechanism is designed for use with the jack wrench tool only. Use of an air wrench or other power tools is not recommended and they can damage the winch.

3. Pull the spare tire out from under the vehicle.



Spare Tire

4. Tilt the retainer at the end of the cable and pull it through the center of the wheel.

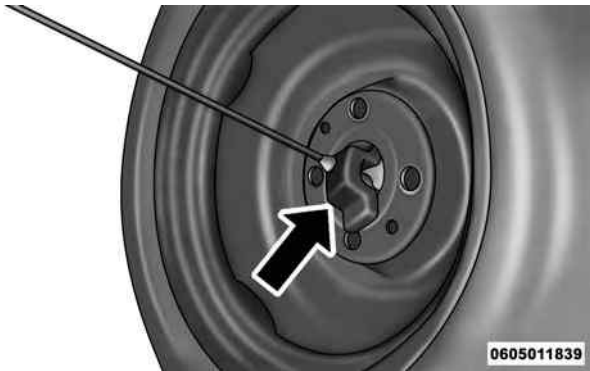

Retainer

Preparations For Jacking

1. Park the vehicle on a firm level surface, avoiding ice or slippery areas.

WARNING!

Do not attempt to change a tire on the side of the vehicle close to moving traffic, pull far enough off the road to avoid the danger of being hit when operating the jack or changing the wheel.

2. Turn on the Hazard Warning flashers.
3. Set the parking brake.
4. Place the shift lever in PARK (automatic transmission) or REVERSE (manual transmission).

5. Turn Off the ignition.
6. Block both the front and rear of the wheel diagonally opposite of the jacking position. For example, if changing the right front tire, block the left rear wheel.



NOTE: Passengers should not remain in the vehicle while the vehicle is being jacked.

Jacking Instructions

WARNING!

Carefully follow these tire changing warnings to help prevent personal injury or damage to your vehicle:

- Always park on a firm, level surface as far from the edge of the roadway as possible before raising the vehicle.
- Turn on the Hazard Warning flashers.
- Block the wheel diagonally opposite the wheel to be raised.
- Set the parking brake firmly and set an automatic transmission in PARK; a manual transmission in REVERSE.
- Never start or run the engine with the vehicle on a jack.

(Continued)

WARNING! *(Continued)*

- Do not let anyone sit in the vehicle when it is on a jack.
- Do not get under the vehicle when it is on a jack. If you need to get under a raised vehicle, take it to a service center where it can be raised on a lift.
- Only use the jack in the positions indicated and for lifting this vehicle during a tire change.
- If working on or near a roadway, be extremely careful of motor traffic.
- To assure that spare tires, flat or inflated, are securely stowed, spares must be stowed with the valve stem facing the ground.



Jack Warning Label

NOTE: Refer to the “Compact Spare Tire” section of the “Tires-General Information” under “Starting And Operating” for information about the spare tire, its use, and operation.

CAUTION!

Do not attempt to raise the vehicle by jacking on locations other than those indicated in the Jacking Instructions for this vehicle.

1. Remove the scissors jack and tool bag from under the driver's seat.

2. Remove center cap.



Center Cap Removal

NOTE: Before using the swivel wrench to remove the wheel bolts be sure to remove the center cap of the wheel by inserting the angled tab end of the swivel wrench into the notched part of the center cap.

3. Loosen, but do not remove, the wheel bolts by turning them to the left one turn while the wheel is still on the ground.

NOTE: There are front and rear jacking locations on each side of the body (as indicated by the triangular lift point symbol on the sill molding).

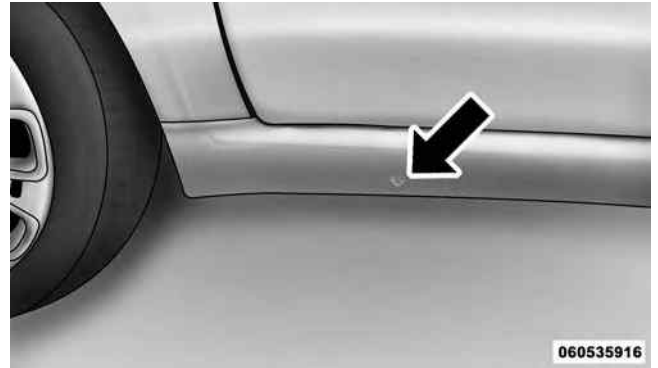

Front Jacking Location

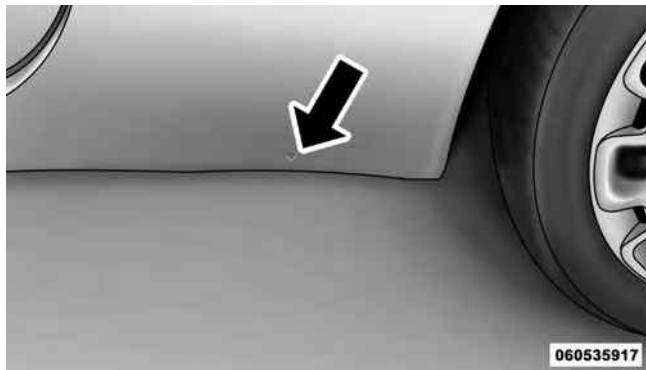

Rear Jacking Location

Do not raise the vehicle until you are sure the jack is securely engaged.

4. Turn the jack screw to the left until the jack can be placed under the jacking location. Once the jack is positioned, turn the jack screw to the right until the jack head is properly engaged with the lift area closest to the wheel to be changed.

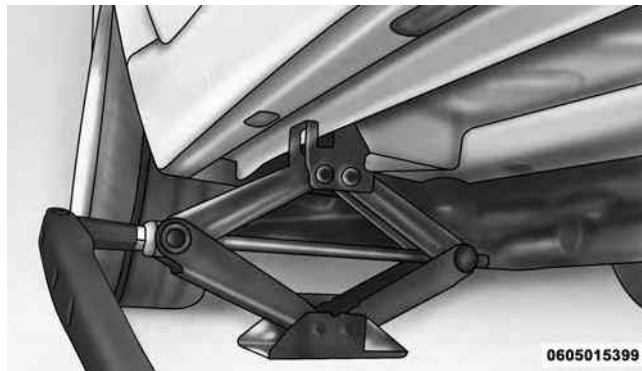

Jack Location

WARNING!

Raising the vehicle higher than necessary can make the vehicle less stable. It could slip off the jack and hurt someone near it. Raise the vehicle only enough to remove the tire.

- Using the swivel wrench, raise the vehicle by turning the jack screw to the right. Raise the vehicle only until the tire just clears the surface and enough clearance is obtained to install the spare tire. Minimum tire lift provides maximum stability.
- Remove the wheel bolts and pull the wheel off the hub. For vehicles equipped with aluminum wheels, the center caps must be removed to remove the wheel bolts. For vehicles equipped with steel wheels the wheel covers must be removed to remove the wheel bolts.

WARNING!

To avoid the risk of forcing the vehicle off the jack, do not fully tighten the wheel bolts until the vehicle has been lowered. Failure to follow this warning may result in personal injury.

CAUTION!

Be sure to mount the spare tire with the valve stem facing outward. The vehicle could be damaged if the spare tire is mounted incorrectly.

WARNING!

To avoid possible personal injury, handle the wheel covers with care to avoid contact with any sharp edges.

7. Install the spare wheel and wheel bolts with the cone shaped end of the bolts toward the wheel. Lightly tighten the bolts. To avoid the risk of forcing the vehicle off the jack, do not tighten the bolts fully until the vehicle has been lowered.
8. Lower the vehicle by turning the jack screw to the left.
9. Finish tightening the wheel bolts. Push down on the wrench while at the end of the handle for increased leverage. Tighten the wheel bolts in a star pattern until each bolt has been tightened twice. For the correct wheel bolt torque refer to Torque Specifications in this section. If in doubt about the correct tightness, have them checked with a torque wrench by your authorized dealership or service station.
10. Disassemble the jack and tools and place them in the bag. Stow it under the driver's seat and secure the bag to the floor with the straps attached to the floor of the vehicle.

WARNING!

A loose tire or jack thrown forward in a collision or hard stop could endanger the occupants of the vehicle. Always stow the jack parts and the spare tire in the places provided.

11. Place the deflated (flat) tire in the cargo area. Have the tire repaired or replaced as soon as possible.

WARNING!

A loose tire thrown forward in a collision or hard stop could injure the occupants in the vehicle. Have the deflated (flat) tire repaired or replaced immediately.

12. Check the spare tire pressure as soon as possible. Correct the tire pressure as required.

Road Tire Installation

Vehicles Equipped With Wheel Covers

1. Mount the road tire on the axle.
2. Align the valve notch in the wheel cover with the valve stem on the wheel. Install the cover by hand. Do not use a hammer or excessive force to install the cover.

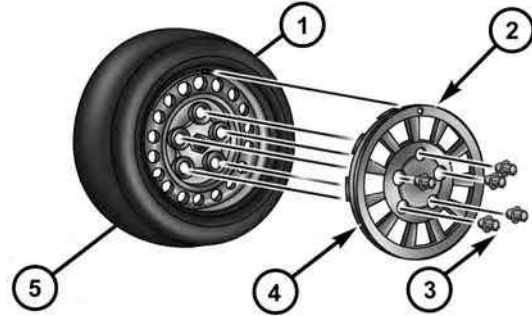

060668307

6

Tire And Wheel Cover Or Center Cap

- | | |
|-----------------|-----------------|
| 1 — Valve Stem | 4 — Wheel Cover |
| 2 — Valve Notch | 5 — Road Wheel |
| 3 — Wheel Bolt | |

3. Install the four wheel bolts with the cone shaped end of the nut toward the wheel. Lightly tighten the wheel bolts.

WARNING!

To avoid the risk of forcing the vehicle off the jack, do not tighten the wheel bolts fully until the vehicle has been lowered. Failure to follow this warning may result in personal injury.

4. Lower the vehicle to the ground by turning the jack handle counterclockwise.
5. Finish tightening the wheel bolts. Push down on the wrench while at the end of the handle for increased leverage. Refer to "Torque Specifications" in this section for correct wheel bolt torque.
6. After 25 miles (40 km) check the wheel bolt torque with a torque wrench to ensure that all wheel bolts are properly seated against the wheel.

Vehicles Without Wheel Covers

1. Mount the road tire on the axle.
2. Install the remaining wheel bolts with the cone shaped end of the nut toward the wheel. Lightly tighten the wheel bolts.

WARNING!

To avoid the risk of forcing the vehicle off the jack, do not fully tighten the lug nuts until the vehicle has been lowered. Failure to follow this warning may result in personal injury.

3. Lower the vehicle to the ground by turning the jack handle counterclockwise.

4. Finish tightening the wheel bolts. Push down on the wrench while at the end of the handle for increased leverage. Refer to “Torque Specifications” in this section for correct wheel bolt torque.
5. After 25 miles (40 km) check the wheel bolt torque with a torque wrench to ensure that all wheel bolts are properly seated against the wheel.

Spare Tire Stowage

Reverse instructions of the spare removal section.

Rotate the jack wrench tool on the winch drive nut clockwise until effort becomes heavy and an audible click is heard indicating the spare is properly stowed.

CAUTION!

The winch mechanism is designed for use with the jack wrench extension tool only. Use of air wrench or power tool may damage the winch.

JUMP-STARTING PROCEDURE

If your vehicle has a discharged battery, it can be jump-started using a set of jumper cables and a battery in another vehicle or by using a portable battery booster pack. Jump-starting can be dangerous if done improperly so please follow the procedures in this section carefully.

NOTE: When using a portable battery booster pack, follow the manufacturer’s operating instructions and precautions.

WARNING!

Do not attempt jump-starting if the battery is frozen. It could rupture or explode and cause personal injury.

CAUTION!

Do not use a portable battery booster pack or any other booster source with a system voltage greater than 12 Volts or damage to the battery, starter motor, alternator or electrical system may occur.

Preparations For Jump-Start

The battery in your vehicle is located between the left front headlight assembly and the left front wheel splash shield.

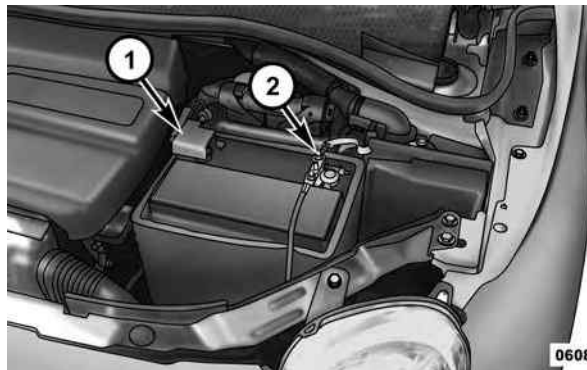
**Battery Posts**

- 1 — Positive (+) Post (Covered With Protective Cap)
- 2 — Negative (-) Post

WARNING!

- Take care to avoid the radiator cooling fan whenever the hood is raised. It can start anytime the ignition switch is ON. You can be injured by moving fan blades.
- Remove any metal jewelry such as rings, watch bands and bracelets that could make an inadvertent electrical contact. You could be seriously injured.
- Batteries contain sulfuric acid that can burn your skin or eyes and generate hydrogen gas which is flammable and explosive. Keep open flames or sparks away from the battery.

1. Set the parking brake, shift the automatic transmission into PARK and turn the ignition to LOCK.
2. Turn off the heater, radio, and all unnecessary electrical accessories.

3. Remove the protective cover over the positive (+) battery post. To remove the cover, press the locking tab and pull upward on the cover.
4. If using another vehicle to jump-start the battery, park the vehicle within the jumper cables reach, set the parking brake and make sure the ignition is OFF.

WARNING!

Do not allow vehicles to touch each other as this could establish a ground connection and personal injury could result.

Jump-Starting Procedure

WARNING!

Failure to follow this jump-starting procedure could result in personal injury or property damage due to battery explosion.

CAUTION!

Failure to follow these procedures could result in damage to the charging system of the booster vehicle or the discharged vehicle.

Connecting The Jumper Cables

1. Connect the positive (+) end of the jumper cable to the positive (+) post of the discharged vehicle.
2. Connect the opposite end of the positive (+) jumper cable to the positive (+) post of the booster battery.

3. Connect the negative end (-) of the jumper cable to the negative (-) post of the booster battery.
4. Connect the opposite end of the negative (-) jumper cable to a good engine ground (exposed metal part of the discharged vehicle's engine) away from the battery and the fuel injection system.

WARNING!

Do not connect the jumper cable to the negative (-) post of the discharged battery. The resulting electrical spark could cause the battery to explode and could result in personal injury. Only use the specific ground point, do not use any other exposed metal parts.

5. Start the engine in the vehicle that has the booster battery, let the engine idle a few minutes, and then start the engine in the vehicle with the discharged battery.
6. Once the engine is started, remove the jumper cables in the reverse sequence:

Disconnecting The Jumper Cables

1. Disconnect the negative (-) jumper cable from the engine ground (-) of the vehicle with the discharged battery.
2. Disconnect the negative end (-) of the jumper cable from the negative (-) post of the booster battery.
3. Disconnect the opposite end of the positive (+) jumper cable from the positive (+) post of the booster battery.

4. Disconnect the positive (+) end of the jumper cable from the positive (+) post of the discharged vehicle.

If frequent jump-starting is required to start your vehicle, you should have the battery and charging system inspected at your authorized dealer.

CAUTION!

Accessories plugged into the vehicle power outlets draw power from the vehicle's battery, even when not in use (i.e., cellular phones, etc.). Eventually, if plugged in long enough without engine operation, the vehicle's battery will discharge sufficiently to degrade battery life and/or prevent the engine from starting.

FREEING A STUCK VEHICLE

If your vehicle becomes stuck in mud, sand or snow, it can often be moved using a rocking motion. Turn the steering wheel right and left to clear the area around the front wheels. Then shift back and forth between DRIVE and REVERSE (with automatic transmission) or 2nd gear and REVERSE (with manual transmission), while gently pressing the accelerator. Use the least amount of accelerator pedal pressure that will maintain the rocking motion, without spinning the wheels, or racing the engine.

CAUTION!

Racing the engine or spinning the wheels may lead to transmission overheating and failure. Allow the engine to idle with the transmission in NEUTRAL for at least one minute after every five rocking-motion cycles. This will minimize overheating and reduce

(Continued)

CAUTION! (Continued)

the risk of clutch or transmission failure during prolonged efforts to free a stuck vehicle.

NOTE: Press the "ESC Off" switch, to place the Electronic Stability Control (ESC) system in "Partial Off" mode, before rocking the vehicle. Refer to "Electronic Brake Control" in "Starting And Operating" for further information. Once the vehicle has been freed, press the "ESC Off" switch again to restore "ESC On" mode.

CAUTION!

- When "rocking" a stuck vehicle by shifting between DRIVE/2nd gear and REVERSE, do not spin the wheels faster than 15 mph (24 km/h), or drivetrain damage may result.

(Continued)

CAUTION! *(Continued)*

- Revving the engine or spinning the wheels too fast may lead to transmission overheating and failure. It can also damage the tires. Do not spin the wheels above 30 mph (48 km/h) while in gear (no transmission shifting occurring).

WARNING!

Fast spinning tires can be dangerous. Forces generated by excessive wheel speeds may cause damage, or even failure, of the axle and tires. A tire could explode and injure someone. Do not spin your vehicle's wheels faster than 30 mph (48 km/h) or for longer than 30 seconds continuously without stopping when you are stuck and do not let anyone near a spinning wheel, no matter what the speed.

SHIFT LEVER OVERRIDE

If a malfunction occurs and the shift lever cannot be moved out of the PARK position, you can use the following procedure to temporarily move the shift lever:

1. Turn the engine OFF.
2. Firmly apply the parking brake.
3. Remove the shift lever override access cover (located on the right side of the shift lever housing) by prying at the bottom edge of the cover.



Shift Lever Override Access Hole

4. Press and maintain firm pressure on the brake pedal.
5. Insert a small screwdriver or similar tool into the access hole, and push and hold the override release lever in.
6. Move the shift lever to the NEUTRAL position.
7. The vehicle may then be started in NEUTRAL.
8. Reinstall the shift lever override access cover.

TOWING A DISABLED VEHICLE

This section describes procedures for towing a disabled vehicle using a commercial towing service.

Towing Condition	Wheels OFF The Ground	AUTOMATIC TRANSMISSION	MANUAL TRANSMISSION
Flat Tow	NONE	NOT ALLOWED	If transmission is operable: <ul style="list-style-type: none"> • Transmission in NEUTRAL • 65 mph (104 km/h) max speed
Wheel Lift	Rear	NOT ALLOWED	NOT ALLOWED
	Front	OK	OK
Flatbed	ALL	BEST METHOD	BEST METHOD

Proper towing or lifting equipment is required to prevent damage to your vehicle. Use only tow bars and other equipment designed for this purpose, following equipment manufacturer's instructions. Use of safety chains is mandatory. Attach a tow bar or other towing device to main structural members of the vehicle, not to bumpers or associated brackets. State and local laws regarding vehicles under tow must be observed.

If you must use the accessories (wipers, defrosters, etc.) while being towed, the ignition must be in the ON/RUN position.

CAUTION!

- Do not use sling-type equipment when towing. Vehicle damage may occur.
- When securing the vehicle to a flatbed truck, do not attach to front or rear suspension components. Damage to your vehicle may result from improper towing.

Automatic Transmission

- Vehicle can be towed with the front wheels elevated.
- Vehicle can be towed on a flatbed truck (all wheels off the ground).

If the ignition key is unavailable, or the battery is discharged, refer to "Shift Lever Override" in this section for instructions on shifting the transmission out of PARK in order to move the vehicle.

CAUTION!

- DO NOT flat tow any vehicle equipped with a conventional automatic transmission. Damage to the drivetrain will result. If these vehicles require towing, make sure all drive wheels are OFF the ground.

(Continued)

CAUTION! *(Continued)*

- Towing this vehicle in violation of the above requirements can cause severe transmission damage. Damage from improper towing is not covered under the New Vehicle Limited Warranty.

Manual Transmission

- Vehicle can be flat towed (all four wheels on the ground) with the transmission in NEUTRAL.
- Vehicle can be towed with the front wheels elevated.
- Vehicle can be towed on a flatbed truck (all wheels off the ground).

CAUTION!

Towing this vehicle in violation of the above requirements can cause severe engine and/or transmission damage. Damage from improper towing is not covered under the New Vehicle Limited Warranty.

ENHANCED ACCIDENT RESPONSE SYSTEM

In the event of an impact causing airbag deployment, if the communication network remains intact, and the power remains intact, depending on the nature of the event the ORC will determine whether to have the Enhanced Accident Response System perform the following functions:

- Cut off fuel to the engine.
- Flash hazard lights as long as the battery has power or until the ignition key is turned off.

- Turn on the interior lights, which remain on as long as the battery has power or until the ignition key is removed.
- Unlock the doors automatically.

After the event occurs, when the system is active, the message "Fuel Cutoff See Handbook" is displayed.

Carefully check the vehicle for fuel leaks in the engine compartment and on the ground near the engine compartment and fuel tank before resetting the system and starting the engine.

System Reset Procedure

After an impact causing airbag deployment, the left and right turn signal lights, located in the instrument panel cluster, will both be blinking, until the ignition is turned off.

In order to move your vehicle to the side of the road you must follow the system reset procedure.

Customer Action	Customer Will See
1. Turn ignition OFF. (Turn Signal Switch Must be placed in Neutral State).	
2. Turn ignition ON.	Left Turn Light is OFF. Right Turn Light BLINKS.
3. Turn Right Turn Signal Switch ON.	Right Turn Light is ON SOLID. Left Turn Light BLINKS.
4. Turn Left Turn Signal Switch ON.	Left Turn Light is ON SOLID. Right Turn Light BLINKS.

Customer Action	Customer Will See
5. Turn Right Turn Signal Switch ON.	Right Turn Light is ON SOLID. Left Turn Light BLINKS.
6. Turn Left Turn Signal Switch ON.	Left Turn Light is ON SOLID. Right Turn Light is ON SOLID.
7. Turn Left Turn Signal Switch OFF. (Turn Signal Switch Must be placed in Neutral State).	Left Turn Light is OFF. Right Turn Light is OFF.

Customer Action	Customer Will See
8. Turn ignition OFF.	System is now reset and the engine may be started.
9. Turn Hazard Flashers OFF (Manually).	

If a reset procedure step is not completed within 45 seconds, then the turn signal lights will turn off and the reset procedure must be performed again in order to be successful.

MAINTAINING YOUR VEHICLE

CONTENTS

■ ENGINE COMPARTMENT — 1.4L353	□ Engine Air Cleaner Filter362
■ ENGINE COMPARTMENT — 1.4L TURBO354	□ Maintenance-Free Battery363
■ ONBOARD DIAGNOSTIC SYSTEM — OBD II .	.355	□ Air Conditioner Maintenance365
■ EMISSIONS INSPECTION AND MAINTENANCE PROGRAMS356	□ Body Lubrication369
■ REPLACEMENT PARTS357	□ Wiper Blades369
■ DEALER SERVICE357	□ Adding Washer Fluid372
■ MAINTENANCE PROCEDURES358	□ Exhaust System372
□ Engine Oil359	□ Cooling System375
□ Engine Oil Filter362	□ Brake System381
		□ Manual Transmission — If Equipped383

352 MAINTAINING YOUR VEHICLE

- Automatic Transmission — If Equipped384
- Appearance Care And Protection From Corrosion386
- Convertible Top Care — If Equipped392
- FUSES394
 - Interior Fuses395
 - Underhood Fuses.397
- VEHICLE STORAGE400
- REPLACEMENT BULBS401
- BULB REPLACEMENT402
 - Headlamps Low Beam and High Beam402
 - Front Turn Signal, Parking And Daytime Running Lamps.403
 - Front Fog Lamps403
 - Front/Rear Side Marker Lamps.403
 - Rear Tail, Stop, Backup And Turn Signal Lamps404
 - Center High Mounted Stop Lamp (CHMSL). . .405
- FLUID CAPACITIES406
- FLUIDS, LUBRICANTS AND GENUINE PARTS407
 - Engine407
 - Chassis409

ENGINE COMPARTMENT — 1.4L

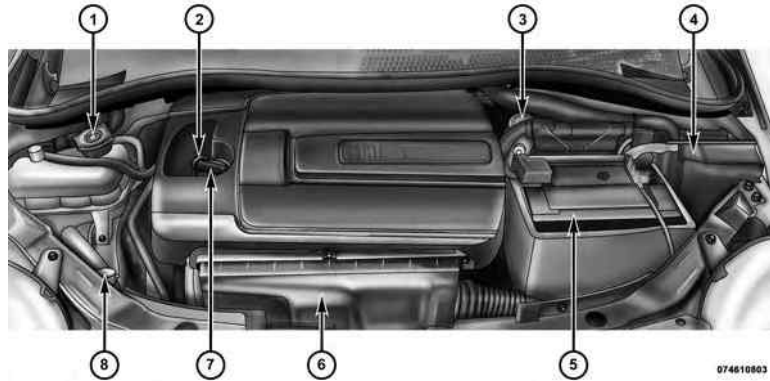

1 — Engine Coolant Reservoir

2 — Engine Oil Dipstick

3 — Brake Fluid Reservoir

4 — Front Distribution Unit (Fuses)

5 — Battery

6 — Air Cleaner Filter

7 — Engine Oil Fill

8 — Washer Fluid Reservoir

ENGINE COMPARTMENT — 1.4L TURBO

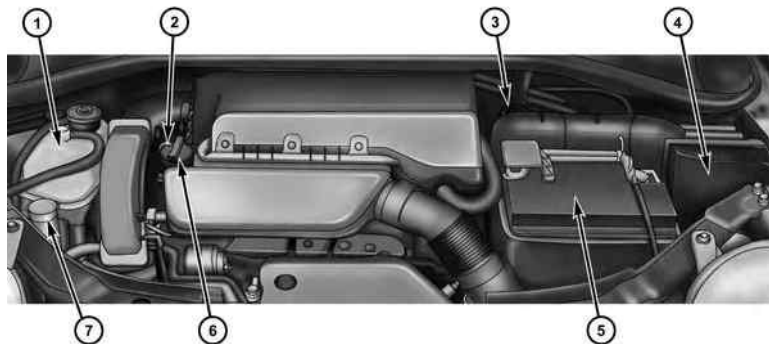

074664691

1 — Engine Coolant Reservoir

2 — Engine Oil Dipstick

3 — Brake Fluid Reservoir

4 — Front Distribution Unit (Fuses)

5 — Battery

6 — Engine Oil Fill

7 — Washer Fluid Reservoir

ONBOARD DIAGNOSTIC SYSTEM — OBD II

Your vehicle is equipped with a sophisticated onboard diagnostic system called OBD II. This system monitors the performance of the emissions, engine, and automatic transmission control systems. When these systems are operating properly, your vehicle will provide excellent performance and fuel economy, as well as engine emissions well within current government regulations.

If any of these systems require service, the OBD II system will turn on the “Malfunction Indicator Light (MIL).” It will also store diagnostic codes and other information to assist your service technician in making repairs. Although your vehicle will usually be drivable and not need towing, see your authorized dealer for service as soon as possible.

CAUTION!

- **Prolonged driving with the MIL on could cause further damage to the emission control system. It could also affect fuel economy and driveability. The vehicle must be serviced before any emissions tests can be performed.**
- **If the MIL is flashing while the engine is running, severe catalytic converter damage and power loss will soon occur. Immediate service is required.**

EMISSIONS INSPECTION AND MAINTENANCE PROGRAMS

In some localities, it may be a legal requirement to pass an inspection of your vehicle's emissions control system. Failure to pass could prevent vehicle registration.



For states that require an Inspection and Maintenance (I/M), this check verifies the "Malfunction Indicator Light (MIL)" is functioning and is not on when the engine is running, and that the OBD II system is ready for testing.

Normally, the OBD II system will be ready. The OBD II system may **not** be ready if your vehicle was recently serviced, recently had a dead battery or a battery replacement. If the OBD II system should be determined not ready for the I/M test, your vehicle may fail the test.

Your vehicle has a simple ignition actuated test, which you can use prior to going to the test station. To check if your vehicle's OBD II system is ready, you must do the following:

1. Cycle the ignition switch to the ON position, but do not crank or start the engine.

NOTE: If you crank or start the engine, you will have to start this test over.

2. As soon as you cycle the ignition switch to the ON position, you will see the Malfunction Indicator Light (MIL) symbol come on as part of a normal bulb check.
3. Approximately 15 seconds later, one of two things will happen:
 - The MIL will flash for about 10 seconds and then return to being fully illuminated until you turn OFF the ignition or start the engine. This means that your vehicle's OBD II system is **not ready** and you should **not** proceed to the I/M station.

- The MIL will not flash at all and will remain fully illuminated until you turn OFF the ignition or start the engine. This means that your vehicle's OBD II system is **ready** and you can proceed to the I/M station.

If your OBD II system is **not ready**, you should see your authorized dealer or repair facility. If your vehicle was recently serviced or had a battery failure or replacement, you may need to do nothing more than drive your vehicle as you normally would in order for your OBD II system to update. A recheck with the above test routine may then indicate that the system is **now ready**.

Regardless of whether your vehicle's OBD II system is ready or not, if the MIL is illuminated during normal vehicle operation you should have your vehicle serviced before going to the I/M station. The I/M station can fail your vehicle because the MIL is on with the engine running.

REPLACEMENT PARTS

Use of genuine parts for normal/scheduled maintenance and repairs is highly recommended to ensure the designed performance. Damage or failures caused by the use of parts which are not quality-equivalent to genuine parts for maintenance and repairs will not be covered by the manufacturer's warranty.

DEALER SERVICE

Your authorized dealer has the qualified service personnel, special tools, and equipment to perform all service operations in an expert manner. Service Manuals are available which include detailed service information for your vehicle. Refer to these Service Manuals before attempting any procedure yourself.

NOTE: Intentional tampering with emissions control systems may void your warranty and could result in civil penalties being assessed against you.

WARNING!

You can be badly injured working on or around a motor vehicle. Only do service work for which you have the knowledge and the proper equipment. If you have any doubt about your ability to perform a service job, take your vehicle to a competent mechanic.

MAINTENANCE PROCEDURES

The pages that follow contain the **required** maintenance services determined by the engineers who designed your vehicle.

Besides those maintenance items specified in the fixed maintenance schedule, there are other components which may require servicing or replacement in the future.

CAUTION!

- Failure to properly maintain your vehicle or perform repairs and service when necessary could result in more costly repairs, damage to other components or negatively impact vehicle performance. Immediately have potential malfunctions examined by an authorized dealer or qualified repair center.
- Your vehicle has been built with improved fluids that protect the performance and durability of your vehicle and also allow extended maintenance intervals. Do not use chemical flushes in these components as the chemicals can damage your engine, transmission, or air conditioning. Such damage is not covered by the New Vehicle Limited Warranty. If a flush is needed because of component malfunction, use only the specified fluid for the flushing procedure.

Engine Oil

Checking Oil Level

To assure proper engine lubrication, the engine oil must be maintained at the correct level. Check the oil level at regular intervals, such as every fuel stop. The best time to check the engine oil level is about five minutes after a fully warmed engine is shut off. Do not check oil level before starting the engine after it has sat overnight. Checking engine oil level when the engine is cold will give you an incorrect reading.

Checking the oil while the vehicle is on level ground, and about five minutes after a fully warmed engine is shut off, will improve the accuracy of the oil level readings. Maintain the oil level between the range markings on the dipstick. The safe range is indicated by a crosshatch zone. Adding 1 qt (1L) of oil when the reading is at the low end of the indicated range will result in the oil level at the full end of the indicator range.

CAUTION!

Do not overfill the engine with oil. Overfilling the engine with oil will cause oil aeration, which can lead to loss of oil pressure and an increase in oil temperature. This loss of oil pressure and increased oil temperature could damage your engine.

Change Engine Oil

The oil change indicator system will remind you that it is time to take your vehicle in for scheduled maintenance. Refer to the “Maintenance Schedule” for further information.

NOTE: Under no circumstances should oil change intervals exceed 10,000 miles (16,000 km) or twelve months, whichever occurs first.

Engine Oil Selection — 1.4L Engine

For best performance and maximum protection under all types of operating conditions, the manufacturer only recommends engine oils that are API Certified and meet the requirements of Chrysler Material Standard MS-6395.

Engine Oil Selection — 1.4L Turbo Engine

For best performance and maximum protection under all types of operating conditions, the manufacturer only recommends engine oils that are API Certified and meet the requirements of Chrysler Material Standard MS-12991.

American Petroleum Institute (API) Engine Oil Identification Symbol



This symbol means that the oil has been certified by the American Petroleum Institute (API). The manufacturer only recommends API Certified engine oils.

CAUTION!

Do not use chemical flushes in your engine oil as the chemicals can damage your engine. Such damage is not covered by the New Vehicle Limited Warranty.

Engine Oil Viscosity — 1.4L Engine (SAE Grade)

SAE 5W-30 engine oil recommended for all operating temperatures. This engine oil improves low temperature starting and vehicle fuel economy.

You may use synthetic engine oils provided the recommended oil quality requirements are met, and the recommended maintenance intervals for oil and filter changes are followed.

Lubricants which do not have both the engine oil certification mark and the correct SAE viscosity grade number should not be used.

The engine oil filler cap also shows the recommended engine oil viscosity for your engine. For information on engine oil filler cap location, refer to “Engine Compartment” in “Maintaining Your Vehicle” for further information.

Engine Oil Viscosity — 1.4L Turbo Engine (SAE Grade)

SAE 5W-40 full synthetic engine oil is recommended for all operating temperatures. This engine oil improves low temperature starting and vehicle fuel economy.

Lubricants which do not have both the engine oil certification mark and the correct SAE viscosity grade number should not be used.

The engine oil filler cap also shows the recommended engine oil viscosity for your engine. For information on engine oil filler cap location, refer to “Engine Compartment” in “Maintaining Your Vehicle” for further information.

Synthetic Engine Oils

You may use synthetic engine oils provided the recommended oil quality requirements are met, and the recommended maintenance intervals for oil and filter changes are followed.

Materials Added To Engine Oil

The manufacturer strongly recommends against the addition of any additives (other than leak detection dyes) to the engine oil. Engine oil is an engineered product and its performance may be impaired by supplemental additives.

Disposing Of Used Engine Oil And Oil Filters

Care should be taken in disposing of used engine oil and oil filters from your vehicle. Used oil and oil filters, indiscriminately discarded, can present a problem to the environment. Contact your authorized dealer, service station or governmental agency for advice on how and where used oil and oil filters can be safely discarded in your area.

Engine Oil Filter

The engine oil filter should be replaced with a new filter at every engine oil change.

Engine Oil Filter Selection

This manufacturer's engines have a full-flow type disposable oil filter. Use a filter of this type for replacement. The quality of replacement filters varies considerably. Only high quality filters should be used to assure most efficient service. MOPAR® engine oil filters are high quality oil filters and are recommended.

Engine Air Cleaner Filter

Refer to the "Maintenance Schedule" for the proper maintenance intervals.

WARNING!

The air induction system (air cleaner, hoses, etc.) can provide a measure of protection in the case of engine backfire. Do not remove the air induction system (air cleaner, hoses, etc.) unless such removal is necessary for repair or maintenance. Make sure that no one is near the engine compartment before starting the vehicle with the air induction system (air cleaner, hoses, etc.) removed. Failure to do so can result in serious personal injury.

Engine Air Cleaner Filter Selection

The quality of replacement engine air cleaner filters varies considerably. Only high quality filters should be used to assure most efficient service. MOPAR® engine air cleaner filters are a high quality filter and are recommended.

Maintenance-Free Battery

Your vehicle is equipped with a maintenance-free battery. You will never have to add water, nor is periodic maintenance required.

WARNING!

- Battery fluid is a corrosive acid solution and can burn or even blind you. Do not allow battery fluid to contact your eyes, skin, or clothing. Do not lean over a battery when attaching clamps. If acid splashes in eyes or on skin, flush the area immediately with large amounts of water. Refer to "Jump-Starting Procedures" in "What To Do In Emergencies" for further information.

(Continued)

WARNING! (Continued)

- Battery gas is flammable and explosive. Keep flame or sparks away from the battery. Do not use a booster battery or any other booster source with an output greater than 12 Volts. Do not allow cable clamps to touch each other.
- Battery posts, terminals, and related accessories contain lead and lead compounds. Wash hands after handling.
- The battery in this vehicle has a vent hose that should not be disconnected and should only be replaced with a battery of the same type (vented).

CAUTION!

- It is essential when replacing the cables on the battery that the positive cable is attached to the positive post and the negative cable is attached to the negative post. Battery posts are marked positive (+) and negative (-) and are identified on the battery case. Cable clamps should be tight on the terminal posts and free of corrosion.
- If a "fast charger" is used while the battery is in the vehicle, disconnect both vehicle battery cables before connecting the charger to the battery. Do not use a "fast charger" to provide starting voltage.

Air Conditioner Maintenance

For best possible performance, your air conditioner should be checked and serviced by an authorized dealer at the start of each warm season. This service should include cleaning of the condenser fins and a performance test. Drive belt tension should also be checked at this time.

WARNING!

- Use only refrigerants and compressor lubricants approved by the manufacturer for your air conditioning system. Some unapproved refrigerants are flammable and can explode, injuring you. Other unapproved refrigerants or lubricants can cause the system to fail, requiring costly repairs. Refer to Warranty Information Book, located on the DVD, for further warranty information.

(Continued)

WARNING! *(Continued)*

- The air conditioning system contains refrigerant under high pressure. To avoid risk of personal injury or damage to the system, adding refrigerant or any repair requiring lines to be disconnected should be done by an experienced technician.

CAUTION!

Do not use chemical flushes in your air conditioning system as the chemicals can damage your air conditioning components. Such damage is not covered by the New Vehicle Limited Warranty.

Refrigerant Recovery And Recycling R134a — If Equipped

R-134a Air Conditioning Refrigerant is a hydrofluorocarbon (HFC) that is endorsed by the Environmental Protection Agency and is an ozone-saving product. However, the manufacturer recommends that air conditioning service be performed by authorized dealer or other service facilities using recovery and recycling equipment.

NOTE: Use only manufacturer approved A/C system PAG compressor oil and refrigerants.

Refrigerant Recovery And Recycling HFO 1234yf — If Equipped

HFO 1234yf Air Conditioning Refrigerant is a hydrofluorocarbon (HFC) that is endorsed by the Environmental Protection Agency and is an ozone-saving product with a low GWP (Global Warming Potential). However, the manufacturer recommends that air conditioning service be performed by authorized dealer or other service facilities using recovery and recycling equipment.

NOTE: Use only manufacturer approved A/C system PAG compressor oil and refrigerants.

A/C Air Filter

WARNING!

Do not remove the A/C air filter while the blower is operating or personal injury may result.

The A/C air filter is located in the fresh air inlet on the lower right of center console. Perform the following procedure to replace the filter:

1. Remove the Torx® screw that secures the passenger side console closeout cover.

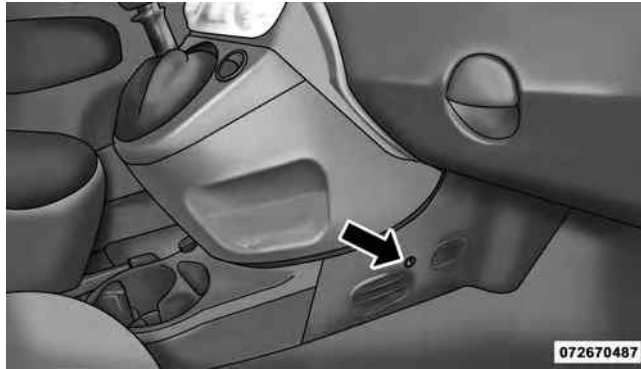

Torx® Screw Location

2. Pull the console closeout cover rearward to disengage the front retaining tab and remove the cover.

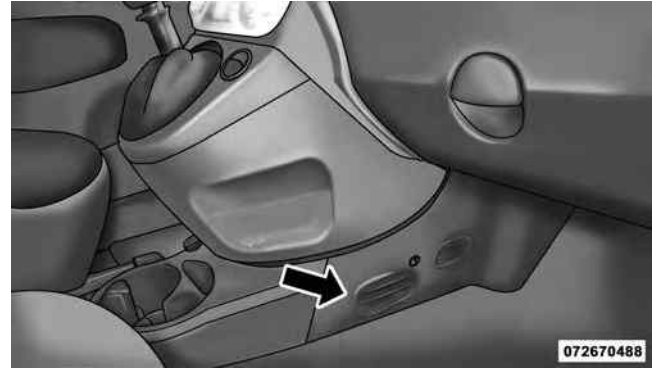

Console Closeout Panel

3. Remove the two 5.5 mm screws (1 and 2) that secure the particulate air filter cover to the HVAC housing.

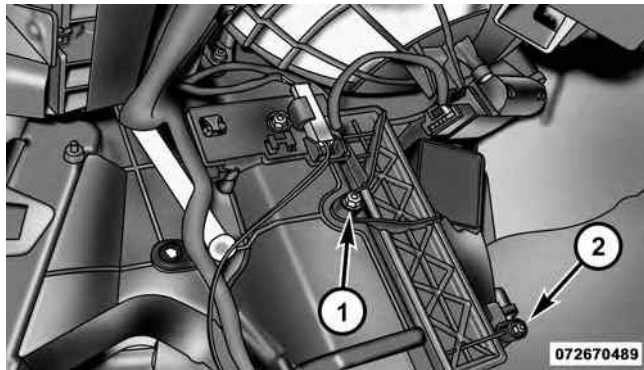

Air Filter Cover Screw Locations

4. Remove the A/C air filter by pulling it straight out of the housing. Take note of the air filter position indicators.

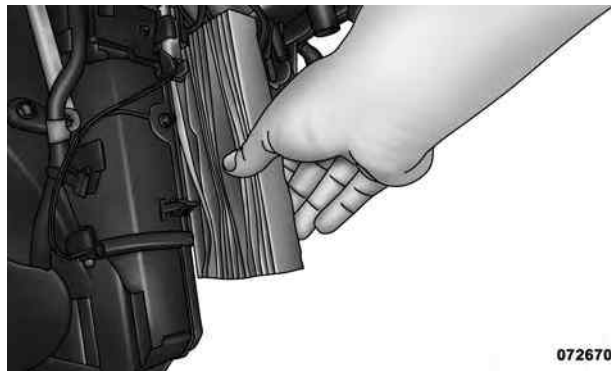

072670493

A/C Air Filter

5. Install the A/C air filter with the air filter position indicators pointing in the same direction as removal.

CAUTION!

The A/C air filter is identified with an arrow to indicate airflow direction through the filter. Failure to properly install the filter will result in the need to replace it more often.

6. Install the passenger side console closeout.

Refer to the “Maintenance Schedule” for the proper maintenance intervals.

Body Lubrication

Locks and all body pivot points, including such items as seat tracks, door hinge pivot points and rollers, liftgate, tailgate, decklid, sliding doors and hood hinges, should be lubricated periodically with a lithium based grease, such as MOPAR® Spray White Lube to assure quiet, easy operation and to protect against rust and wear. Prior to

the application of any lubricant, the parts concerned should be wiped clean to remove dust and grit; after lubricating excess oil and grease should be removed. Particular attention should also be given to hood latching components to ensure proper function. When performing other underhood services, the hood latch, release mechanism and safety catch should be cleaned and lubricated.

The external lock cylinders should be lubricated twice a year, preferably in the Fall and Spring. Apply a small amount of a high quality lubricant, such as MOPAR® Lock Cylinder Lubricant directly into the lock cylinder.

Wiper Blades

Clean the rubber edges of the wiper blades and the windshield and rear window periodically with a sponge or soft cloth and a mild nonabrasive cleaner. This will remove accumulations of salt, waxes, or road film, and help reduce streaking and smearing.

Operation of the wipers on dry glass for long periods may cause deterioration of the wiper blades. Always use washer fluid when using the wipers to remove salt or dirt from a dry windshield or rear window.

Avoid using the wiper blades to remove frost or ice from the windshield or rear window. Make sure that they are not frozen to the glass before turning them on to avoid damaging the blade. Keep the blade rubber out of contact with petroleum products such as engine oil, gasoline, etc.

NOTE: Life expectancy of wiper blades varies depending on geographical area and frequency of use. Poor performance of blades may be present with chattering, marks, water lines or wet spots. If any of these conditions are present, clean the wiper blades or replace as necessary.

Rear Wiper Blade Removal/Installation

1. Lift the pivot cap on the rear wiper arm upward, this will allow the rear wiper blade to be raised off of the liftgate glass.

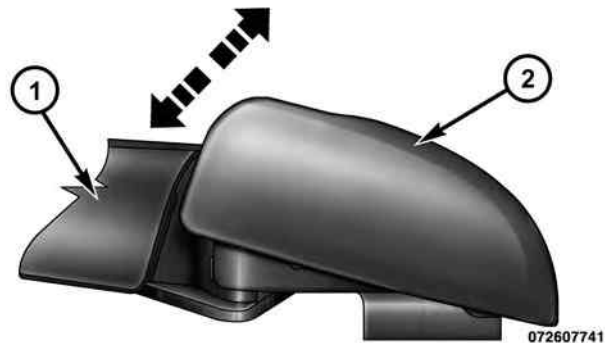

- 1 — Wiper Arm
2 — Pivot Cap

NOTE: The rear wiper arm cannot be raised fully upward unless the pivot cap is raised first.

2. Lift the rear wiper arm upward to raise the wiper blade off of the liftgate glass.
3. Grab the bottom of the wiper blade and rotate it forward to unsnap the blade pivot pin from the wiper blade holder.

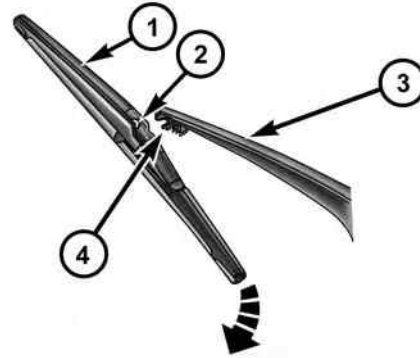

072607742

- 1 — Wiper Blade
- 2 — Blade Pivot Pin
- 3 — Wiper Arm
- 4 — Wiper Blade Holder

4. Install the wiper blade pivot pin into the wiper blade holder at the end of the wiper arm, and firmly press the wiper blade until it snaps into place.
5. Lower the wiper blade and snap the pivot cap into place.

Adding Washer Fluid

The windshield washer fluid reservoir is located in the engine compartment, and the fluid level should be checked at regular intervals. Fill the reservoir with windshield washer solvent (not engine coolant/ antifreeze). Refer to "Engine Compartment" in "Maintaining Your Vehicle" for further information.

WARNING!

Commercially available windshield washer solvents are flammable. They could ignite and burn you. Care must be exercised when filling or working around the washer solution.

Exhaust System

The best protection against carbon monoxide entry into the vehicle body is a properly maintained engine exhaust system.

If you notice a change in the sound of the exhaust system; or if the exhaust fumes can be detected inside the vehicle; or when the underside or rear of the vehicle is damaged; have an authorized technician inspect the complete exhaust system and adjacent body areas for broken, damaged, deteriorated, or mispositioned parts. Open seams or loose connections could permit exhaust fumes to seep into the passenger compartment. In addition, have the exhaust system inspected each time the vehicle is raised for lubrication or oil change. Replace as required.

WARNING!

- Exhaust gases can injure or kill. They contain carbon monoxide (CO), which is colorless and odorless. Breathing it can make you unconscious and can eventually poison you. To avoid breathing CO, refer to “Safety Tips/Exhaust Gas” in “Things To Know Before Starting Your Vehicle” for further information.
- A hot exhaust system can start a fire if you park over materials that can burn. Such materials might be grass or leaves coming into contact with your exhaust system. Do not park or operate your vehicle in areas where your exhaust system can contact anything that can burn.

CAUTION!

- The catalytic converter requires the use of unleaded fuel only. Leaded gasoline will destroy the effectiveness of the catalyst as an emissions control device and may seriously reduce engine performance and cause serious damage to the engine.
- Damage to the catalytic converter can result if your vehicle is not kept in proper operating condition. In the event of engine malfunction, particularly involving engine misfire or other apparent loss of performance, have your vehicle serviced promptly. Continued operation of your vehicle with a severe malfunction could cause the converter to overheat, resulting in possible damage to the converter and vehicle.

Under normal operating conditions, the catalytic converter will not require maintenance. However, it is important to keep the engine properly tuned to assure proper catalyst operation and prevent possible catalyst damage.

NOTE: Intentional tampering with emissions control systems can result in civil penalties being assessed against you.

In unusual situations involving grossly malfunctioning engine operation, a scorching odor may suggest severe and abnormal catalyst overheating. If this occurs, stop the vehicle, turn off the engine and allow it to cool. Service, including a tune-up to manufacturer's specifications, should be obtained immediately.

To minimize the possibility of catalytic converter damage:

- Do not shut off the engine or interrupt the ignition, when the transmission is in gear and the vehicle is in motion.
- Do not try to start the engine by pushing or towing the vehicle.
- Do not idle the engine with any spark plug wires disconnected or removed, such as when diagnostic testing, or for prolonged periods during very rough idle or malfunctioning operating conditions.

Cooling System

WARNING!

- When working near the radiator cooling fan, disconnect the fan motor lead or turn the ignition switch to the OFF position. The fan is temperature controlled and can start at any time the ignition switch is in the ON position.
- You or others can be badly burned by hot engine coolant (antifreeze) or steam from your radiator. If you see or hear steam coming from under the hood, do not open the hood until the radiator has had time to cool. Never try to open a cooling system pressure cap when the radiator is hot.

Coolant Checks

Check engine coolant (antifreeze) protection every 12 months (before the onset of freezing weather, where applicable). If the engine coolant (antifreeze) is dirty or rusty in appearance, the system should be drained, flushed and refilled with fresh engine coolant (antifreeze). Check the front of the A/C condenser for any accumulation of bugs, leaves, etc. If dirty, clean by gently spraying water from a garden hose vertically down the face of the condenser.

Cooling System — Drain, Flush And Refill

NOTE: Some vehicles require special tools to add coolant properly. Failure to fill these systems properly could lead to severe internal engine damage. If any coolant is needed to be added to the system please contact your local authorized dealer.

If the engine coolant (antifreeze) is dirty or contains visible sediment, have an authorized dealer clean and flush with OAT coolant (antifreeze) (conforming to MS.90032).

Refer to the “Maintenance Schedule” for the proper maintenance intervals.

Selection Of Coolant

Refer to “Fluids, Lubricants, and Genuine Parts” in “Maintaining Your Vehicle” for further information.

CAUTION!

- **Mixing of engine coolant (antifreeze) other than specified Organic Additive Technology (OAT) engine coolant (antifreeze), may result in engine damage and may decrease corrosion protection. Organic Additive Technology (OAT) engine coolant is different and should not be mixed with Hybrid Organic Additive Technology (HOAT) engine coolant (antifreeze) or any “globally compatible” coolant (antifreeze). If a non-OAT engine coolant (antifreeze) is introduced into the cooling system in an emergency, the cooling system will need to be drained, flushed, and refilled with fresh OAT coolant (conforming to MS.90032), by an authorized dealer as soon as possible.**

(Continued)

CAUTION! *(Continued)*

- Do not use water alone or alcohol-based engine coolant (antifreeze) products. Do not use additional rust inhibitors or antirust products, as they may not be compatible with the radiator engine coolant and may plug the radiator.
- This vehicle has not been designed for use with propylene glycol-based engine coolant (antifreeze). Use of propylene glycol-based engine coolant (antifreeze) is not recommended.

Adding Coolant

Your vehicle has been built with an improved engine coolant (OAT coolant conforming to MS.90032) that allows extended maintenance intervals. This engine coolant (antifreeze) can be used up to ten years or 150,000 miles (240,000 km) before replacement. To prevent reducing this

extended maintenance period, it is important that you use the same engine coolant (OAT coolant conforming to MS.90032) throughout the life of your vehicle.

Please review these recommendations for using Organic Additive Technology (OAT) engine coolant (antifreeze) that meets the requirements of Chrysler Material Standard MS.90032. When adding engine coolant (antifreeze):

- We recommend using MOPAR® Antifreeze/Coolant 10 Year/150,000 Mile Formula OAT (Organic Additive Technology) that meets the requirements of Chrysler Material Standard MS.90032.
- Mix a minimum solution of 50% OAT engine coolant that meets the requirements of Chrysler Material Standard MS.90032 and distilled water. Use higher concentrations (not to exceed 70%) if temperatures below -34°F (-37°C) are anticipated.

- Use only high purity water such as distilled or deionized water when mixing the water/engine coolant (antifreeze) solution. The use of lower quality water will reduce the amount of corrosion protection in the engine cooling system.

Please note that it is the owner's responsibility to maintain the proper level of protection against freezing according to the temperatures occurring in the area where the vehicle is operated.

NOTE:

- Some vehicles require special tools to add coolant properly. Failure to fill these systems properly could lead to severe internal engine damage. If any coolant is needed to be added to the system please contact your local authorized dealer.

- Mixing engine coolant (antifreeze) types is not recommended and can result in cooling system damage. If HOAT and OAT coolant are mixed in an emergency, have a authorized dealer drain, flush, and refill with OAT coolant (conforming to MS.90032) as soon as possible.

Cooling System Pressure Cap

The cap must be fully tightened to prevent loss of engine coolant (antifreeze) and to ensure that engine coolant (antifreeze) will return to the radiator from the coolant recovery tank.

The cap should be inspected and cleaned if there is any accumulation of foreign material on the sealing surfaces.

WARNING!

- **Do not open hot engine cooling system. Never add engine coolant (antifreeze) when the engine is overheated. Do not loosen or remove the cap to cool an overheated engine. Heat causes pressure to build up in the cooling system. To prevent scalding or injury, do not remove the pressure cap while the system is hot or under pressure.**
- **Do not use a pressure cap other than the one specified for your vehicle. Personal injury or engine damage may result.**

Disposal Of Used Engine Coolant

Used ethylene glycol-based engine coolant (antifreeze) is a regulated substance requiring proper disposal. Check with your local authorities to determine the disposal rules for your community. To prevent ingestion by animals or children, do not store ethylene glycol-based

engine coolant in open containers or allow it to remain in puddles on the ground. If ingested by a child or pet, seek emergency assistance immediately. Clean up any ground spills immediately.

Coolant Level

The coolant expansion bottle provides a quick visual method for determining that the coolant level is adequate. With the engine off and cold, the level of the engine coolant (antifreeze) in the bottle should be between the bottom and top lines marked "COLD FILL RANGE".

As long as the engine operating temperature is satisfactory, the coolant bottle need only be checked once a month.

When additional engine coolant (antifreeze) is needed to maintain the proper level, it should be added to the coolant bottle. Do not overfill.

Points To Remember

NOTE: When the vehicle is stopped after a few miles/kilometers of operation, you may observe vapor coming from the front of the engine compartment. This is normally a result of moisture from rain, snow, or high humidity accumulating on the radiator and being vaporized when the thermostat opens, allowing hot engine coolant (antifreeze) to enter the radiator.

If an examination of your engine compartment shows no evidence of radiator or hose leaks, the vehicle may be safely driven. The vapor will soon dissipate.

- Do not overfill the coolant expansion bottle.
- Check the coolant freeze point in the radiator and in the coolant expansion bottle. If engine coolant (antifreeze) needs to be added, the contents of the coolant expansion bottle must also be protected against freezing.

- If frequent engine coolant (antifreeze) additions are required, the cooling system should be pressure tested for leaks.
- Maintain engine coolant (antifreeze) concentration at a minimum of 50% OAT coolant (conforming to MS.90032) and distilled water for proper corrosion protection of your engine which contains aluminum components.
- Make sure that the coolant expansion bottle overflow hoses are not kinked or obstructed.
- Keep the front of the radiator clean. If your vehicle is equipped with air conditioning, keep the front of the condenser clean.
- Do not change the thermostat for Summer or Winter operation. If replacement is ever necessary, install **ONLY** the correct type thermostat. Other designs may result in unsatisfactory engine coolant (antifreeze) performance, poor gas mileage, and increased emissions.

Brake System

In order to assure brake system performance, all brake system components should be inspected periodically. Refer to the “Maintenance Schedule” for the proper maintenance intervals.

WARNING!

Riding the brakes can lead to brake failure and possibly a collision. Driving with your foot resting or riding on the brake pedal can result in abnormally high brake temperatures, excessive lining wear, and possible brake damage. Riding the brakes may also reduce braking capacity in an emergency.

Brake Master Cylinder

The fluid level in the master cylinder should be checked when performing under hood services, or immediately if the “Brake Warning Light” is on.

Be sure to clean the top of the master cylinder area before removing the cap. If necessary, add fluid to bring the fluid level up to the requirements described on the brake fluid reservoir. Fluid level can be expected to fall as the brake pads wear. The brake fluid level should be checked when the pads are replaced. However, low fluid level may be caused by a leak and a checkup may be needed.

NOTE: If your vehicle is equipped with a **manual transmission**, the brake fluid reservoir supplies fluid to both the brake system and the clutch release system. The two systems are separated in the reservoir, and a leak in one system will not affect the other system. The **manual transmission** clutch release system should not require fluid replacement during the life of the vehicle. If the brake fluid reservoir is low and the brake system does not indicate any leaks or other problems, it may be a result of a leak in the hydraulic clutch release system. See your local authorized dealer for service.

Use only manufacturer's recommended brake fluid. Refer to "Fluids, Lubricants, and Genuine Parts" in "Maintaining Your Vehicle" for further information.

WARNING!

- Use only manufacturer's recommended brake fluid. Refer to "Fluids, Lubricants, and Genuine Parts" in "Maintaining Your Vehicle" for further information. Using the wrong type of brake fluid can severely damage your brake system and/or impair its performance. The proper type of brake fluid for your vehicle is also identified on the original factory installed hydraulic master cylinder reservoir.

(Continued)

WARNING! (Continued)

- To avoid contamination from foreign matter or moisture, use only new brake fluid or fluid that has been in a tightly closed container. Keep the master cylinder reservoir cap secured at all times. Brake fluid in an open container absorbs moisture from the air resulting in a lower boiling point. This may cause it to boil unexpectedly during hard or prolonged braking, resulting in sudden brake failure. This could result in a collision.
- Overfilling the brake fluid reservoir can result in spilling brake fluid on hot engine parts, causing the brake fluid to catch fire. Brake fluid can also damage painted and vinyl surfaces, care should be taken to avoid its contact with these surfaces.

(Continued)

WARNING! (Continued)

- Do not allow petroleum-based fluid to contaminate the brake fluid. Brake seal components could be damaged, causing partial or complete brake failure. This could result in a collision.

CAUTION!

Use of improper brake fluids will affect overall clutch system performance. Improper brake fluids may damage the clutch system resulting in loss of clutch function and the ability to shift the transmission.

Manual Transmission — If Equipped**Lubricant Selection**

Use only the manufacturers recommended transmission fluid. Refer to “Fluids, Lubricants, and Genuine Parts” in “Maintaining Your Vehicle” for further information.

Fluid Level Check

Check the fluid level by removing the fill plug. The fluid level should be between the bottom of the fill hole and a point not more than 3/16 in (4.7 mm) below the bottom of the hole.

Add fluid, if necessary, to maintain the proper level.

Frequency Of Fluid Change

Under normal operating conditions, the fluid installed at the factory will give satisfactory lubrication for the life of the vehicle. Fluid changes are not necessary unless lubricant has become contaminated with water.

NOTE: If contaminated with water, the fluid should be changed immediately.

Automatic Transmission — If Equipped

Selection Of Lubricant

It is important to use the proper transmission fluid to ensure optimum transmission performance and life. Use only the manufacturer's specified transmission fluid. Refer to "Fluids, Lubricants, and Genuine Parts" in this section for fluid specifications. It is important to maintain the transmission fluid at the correct level using the recommended fluid. No chemical flushes should be used in any transmission; only the approved lubricant should be used.

CAUTION!

Using a transmission fluid other than the manufacturer's recommended fluid may cause deterioration in transmission shift quality and/or torque converter shudder. Refer to "Fluids, Lubricants, and Genuine Parts" in this section for fluid specifications.

Special Additives

The manufacturer strongly recommends against using any special additives in the transmission.

Automatic Transmission Fluid (ATF) is an engineered product and its performance may be impaired by supplemental additives. Therefore, do not add any fluid additives to the transmission. The only exception to this policy is the use of special dyes for diagnosing fluid leaks. Avoid using transmission sealers as they may adversely affect seals.

CAUTION!

Do not use chemical flushes in your transmission as the chemicals can damage your transmission components. Such damage is not covered by the New Vehicle Limited Warranty.

Fluid Level Check

The fluid level is preset at the factory and does not require adjustment under normal operating conditions. Routine fluid level checks are not required, therefore the transmission has no dipstick. Your authorized dealer can check your transmission fluid level using special service tools. If you notice fluid leakage or transmission malfunction, visit your authorized dealer immediately to have the transmission fluid level checked. Operating the vehicle with an improper fluid level can cause severe transmission damage.

CAUTION!

If a transmission fluid leak occurs, visit your authorized dealer immediately. Severe transmission damage may occur. Your authorized dealer has the proper tools to adjust the fluid level accurately.

Fluid And Filter Changes

Under normal operating conditions, the fluid installed at the factory will provide satisfactory lubrication for the life of the vehicle. Routine fluid and filter changes are not required. However, change the fluid and filter if the fluid becomes contaminated (with water, etc.), or if the transmission is disassembled for any reason.

Appearance Care And Protection From Corrosion

Protection Of Body And Paint From Corrosion

Vehicle body care requirements vary according to geographic locations and usage. Chemicals that make roads passable in snow and ice and those that are sprayed on trees and road surfaces during other seasons are highly corrosive to the metal in your vehicle. Outside parking, which exposes your vehicle to airborne contaminants, road surfaces on which the vehicle is operated, extreme hot or cold weather and other extreme conditions will have an adverse effect on paint, metal trim, and underbody protection.

The following maintenance recommendations will enable you to obtain maximum benefit from the corrosion resistance built into your vehicle.

What Causes Corrosion?

Corrosion is the result of deterioration or removal of paint and protective coatings from your vehicle.

The most common causes are:

- Road salt, dirt and moisture accumulation.
- Stone and gravel impact.
- Insects, tree sap and tar.
- Salt in the air near seacoast localities.
- Atmospheric fallout/industrial pollutants.

Washing

- Wash your vehicle regularly. Always wash your vehicle in the shade using MOPAR® Car Wash, or a mild car wash soap, and rinse the panels completely with clear water.

- If insects, tar, or other similar deposits have accumulated on your vehicle, use MOPAR® Super Kleen Bug and Tar Remover to remove.
- Use a high quality cleaner wax, such as MOPAR® Cleaner Wax to remove road film, stains and to protect your paint finish. Take care never to scratch the paint.
- Avoid using abrasive compounds and power buffing that may diminish the gloss or thin out the paint finish.

CAUTION!

- **Do not use abrasive or strong cleaning materials such as steel wool or scouring powder that will scratch metal and painted surfaces.**
- **Use of power washers exceeding 1,200 psi (8 274 kPa) can result in damage or removal of paint and decals.**

Special Care

- If you drive on salted or dusty roads or if you drive near the ocean, hose off the undercarriage at least once a month.
- It is important that the drain holes in the lower edges of the doors, rocker panels, and trunk be kept clear and open.
- If you detect any stone chips or scratches in the paint, touch them up immediately. The cost of such repairs is considered the responsibility of the owner.
- If your vehicle is damaged due to a collision or similar cause that destroys the paint and protective coating, have your vehicle repaired as soon as possible. The cost of such repairs is considered the responsibility of the owner.

- If you carry special cargo such as chemicals, fertilizers, de-icer salt, etc., be sure that such materials are well packaged and sealed.
- If a lot of driving is done on gravel roads, consider mud or stone shields behind each wheel.
- Use MOPAR® Touch Up Paint on scratches as soon as possible. Your authorized dealer has touch up paint to match the color of your vehicle.

Wheel And Wheel Trim Care

- All wheels and wheel trim, especially aluminum and chrome plated wheels, should be cleaned regularly with a mild soap and water to prevent corrosion.
- To remove heavy soil and/or excessive brake dust, use MOPAR® Wheel Cleaner.

NOTE: If your vehicle is equipped with Dark Vapor or Black Satin Chrome wheels DO NOT USE wheel cleaners, abrasives or polishing compounds. They will permanently damage this finish and such damage is not covered by the New Vehicle Limited Warranty. USE ONLY MILD SOAP AND WATER WITH A SOFT CLOTH. Used on a regular basis this is all that is required to maintain this finish.

CAUTION!

Do not use scouring pads, steel wool, a bristle brush, or metal polishes. Do not use oven cleaner. These products may damage the wheel's protective finish. Avoid automatic car washes that use acidic solutions or harsh brushes that may damage the wheel's protective finish. Only MOPAR® Wheel Cleaner or equivalent is recommended.

Stain Repel Fabric Cleaning Procedure — If Equipped

Stain Repel seats may be cleaned in the following manner:

- Remove as much of the stain as possible by blotting with a clean, dry towel.
- Blot any remaining stain with a clean, damp towel.
- For tough stains, apply MOPAR® Total Clean, or a mild soap solution to a clean, damp cloth and remove stain. Use a fresh, damp towel to remove soap residue.
- For grease stains, apply MOPAR® Multi-Purpose Cleaner to a clean, damp cloth and remove stain. Use a fresh, damp towel to remove soap residue.
- Do not use any harsh solvents or any other form of protectants on Stain Repel products.

Interior Care

Use MOPAR® Total Clean to clean fabric upholstery and carpeting.

Use MOPAR® Total Clean to clean vinyl upholstery.

MOPAR® Total Clean is specifically recommended for leather upholstery.

Your leather upholstery can be best preserved by regular cleaning with a damp soft cloth. Small particles of dirt can act as an abrasive and damage the leather upholstery and should be removed promptly with a damp cloth. Stubborn soils can be removed easily with a soft cloth and MOPAR® Total Clean. Care should be taken to avoid soaking your leather upholstery with any liquid. Please do not use polishes, oils, cleaning fluids, solvents, detergents, or ammonia-based cleaners to clean your leather upholstery. Application of a leather conditioner is not required to maintain the original condition.

WARNING!

Do not use volatile solvents for cleaning purposes. Many are potentially flammable, and if used in closed areas they may cause respiratory harm.

CAUTION!

Do not use Alcohol and Alcohol-based and/or Keton based cleaning products to clean leather seats, as damage to the seat may result.

Cleaning Headlights

Your vehicle has plastic headlights that are lighter and less susceptible to stone breakage than glass headlights.

Plastic is not as scratch resistant as glass and therefore different lens cleaning procedures must be followed.

To minimize the possibility of scratching the lenses and reducing light output, avoid wiping with a dry cloth. To remove road dirt, wash with a mild soap solution followed by rinsing.

Do not use abrasive cleaning components, solvents, steel wool or other aggressive material to clean the lenses.

Glass Surfaces

All glass surfaces should be cleaned on a regular basis with MOPAR® Glass Cleaner, or any commercial household-type glass cleaner. Never use an abrasive type cleaner. Use caution when cleaning the inside rear window equipped with electric defrosters or the right rear quarter window equipped with the radio antenna. Do not use scrapers or other sharp instrument that may scratch the elements.

When cleaning the rear view mirror, spray cleaner on the towel or rag that you are using. Do not spray cleaner directly on the mirror.

Instrument Panel Cover

The instrument panel cover has a low glare surface which minimizes reflections on the windshield. Do not use protectants or other products which may cause undesirable reflections. Use soap and warm water to restore the low glare surface.

Instrument Panel Bezels

CAUTION!

When installing hanging air fresheners in your vehicle, read the installation instructions carefully. Some air fresheners will damage the finish of painted or decorated parts if allowed to directly contact any surface.

Cleaning Plastic Instrument Cluster Lenses

The lenses in front of the instruments in this vehicle are molded in clear plastic. When cleaning the lenses, care must be taken to avoid scratching the plastic.

1. Clean with a wet soft rag. A mild soap solution may be used, but do not use high alcohol content or abrasive cleaners. If soap is used, wipe clean with a clean damp rag.
2. Dry with a soft cloth.

Seat Belt Maintenance

Do not bleach, dye or clean the belts with chemical solvents or abrasive cleaners. This will weaken the fabric. Sun damage can also weaken the fabric.

If the belts need cleaning, use a mild soap solution or lukewarm water. Do not remove the belts from the car to wash them. Dry with a soft cloth.

Replace the belts if they appear frayed or worn or if the buckles do not work properly.

WARNING!

A frayed or torn belt could rip apart in a collision and leave you with no protection. Inspect the belt system periodically, checking for cuts, frays, or loose parts. Damaged parts must be replaced immediately. Do not disassemble or modify the system. Seat belt assemblies must be replaced after a collision if they have been damaged (i.e., bent retractor, torn webbing, etc.).

Convertible Top Care — If Equipped

NOTE: Lubricate the top rails with Berulub FR 43 every 2000 cycles or if scratching noises due to dust are present.

CAUTION!

Failure to follow these cautions may cause interior water damage, stains or mildew on the top material:

- Avoid high-pressure car washes, as they can damage the top material. Also, increased water pressure may force past the weather strips.
- Remove any standing water from the top and dry the surface before opening it. Operating the top, opening a door or lowering a window while the top is wet may allow water to drip into the vehicles interior.
- Use care when washing the vehicle, water pressure directed at the weather strip seals may cause water to leak into the vehicles interior.

Immediate removal of any contaminant is recommended. Regular washing of the top will enhance its life and appearance, and make successive cleanings easier. Do not subject the top to excessive heat. Frequently vacuum the top and storage compartment.

Washing

Hand washing is highly recommended. Automatic car washing equipment can damage the top material. If you must use an automatic car wash, soft cloth systems are preferred.

CAUTION!

Avoid high-pressure car washes, as they can damage the top material. Also, increased water pressure may force water past the weather strips.

General Cleaning

Careful vacuuming of the top before washing is helpful in removing dust and other foreign particles. Wash in partial shade instead of direct sun. Wet the entire vehicle before washing the top. The top should be washed with a soft, natural bristle scrub brush, and a mild soap solution such as liquid dishwashing soap. Do not use detergent.

CAUTION!

Never use an abrasive type cleaner or bleaches. Cleaners should not contain silicones, organic solvents, petroleum distillates, or plasticizers. Always wait until the top is thoroughly dry before lowering it into the storage area.

Scrub in all directions, covering an area of about two square feet at a time. Avoid heavy scrubbing. Rinse the entire vehicle with water to remove all soap and dirt from the top fabric and to prevent streaking on painted and chrome surfaces. Allow the top to dry before lowering. Vacuuming the top with a wet/dry shop vacuum will decrease the top's drying time, ensure removal of all dirt, and delete streaks in the material. Multiple cleanings may be necessary to remove stubborn stains. If stains persist, contact your local authorized dealer for further suggestions.

FUSES

WARNING!

- When replacing a blown fuse, always use an appropriate replacement fuse with the same amp rating as the original fuse. Never replace a fuse with another fuse of higher amp rating. Never replace a blown fuse with metal wires or any other material. Failure to use proper fuses may result in serious personal injury, fire and/or property damage.
- Before replacing a fuse, make sure that the ignition is off and that all the other services are switched off and/or disengaged.
- If the replaced fuse blows again, contact an authorized dealer.

(Continued)

WARNING! (Continued)

- If a general protection fuse for safety systems (air bag system, braking system), power unit systems (engine system, gearbox system) or steering system blows, contact an authorized dealer.

Interior Fuses

The interior fuse panel is part of the Body Control Module (BCM) and is located on the driver's side under the instrument panel.

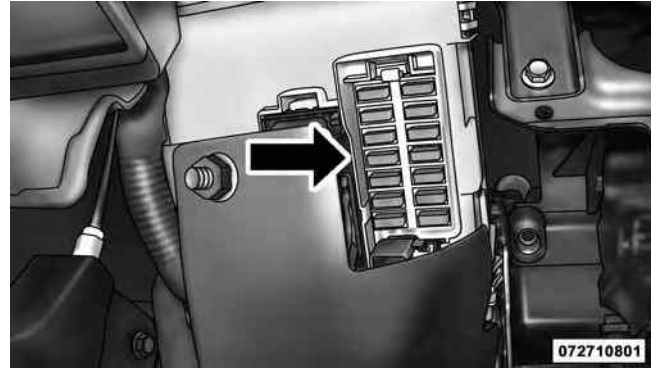

Fuse Panel

Cavity	Vehicle Fuse Number	Mini Fuse	Description
1	F12	7.5 Amp Brown	Right Low Beam
2	F32	5 Amp Tan	Front and Rear Ceiling Lights Trunk and Door Courtesy Lights

Cavity	Vehicle Fuse Number	Mini Fuse	Description
3	F53	5 Amp Tan	Instrument Panel Node
4	F38	20 Amp Yellow	Central Door Locking
5	F36	10 Amp Red	Diagnostic Socket, Car Radio, Climate Control System
6	F43	20 Amp Yellow	Bi-Directional Washer
7	F48	20 Amp Yellow	Passenger Power Window
8	F13	7.5 Amp Brown	Left Low Beam, Headlamp Leveling
9	F50	7.5 Amp Brown	Airbag
10	F51	5 Amp Tan	Car Radio Switch, Climate Control System, Stop Light, Clutch
11	F37	5 Amp Tan	Stop Light Switch, Instrument Panel Node
12	F49	5 Amp Tan	Exterior Mirror, GPS, Electric Mirror, Parking Sensor
13	F31	5 Amp Tan	Ignition, Climate Control
14	F47	20 Amp Yellow	Driver Power Window

Underhood Fuses

The Front Distribution Unit is located on the right side of the engine compartment, next to the battery. To access the fuses, press the release tabs and remove the cover.



Front Distribution Unit

The ID number of the electrical component corresponding to each fuse can be found on the back of the cover.

Cavity	Maxi Fuse	Mini Fuse	Description
F01	60 Amp Blue	–	Body Controller
F02	20 Amp Yellow	–	Audio Amplifier
F03	20 Amp Yellow	–	Ignition Switch
F04	40 Amp Orange	–	Anti-Lock Brake Pump
F05	70 Amp Tan	–	Electric Power Steering
F06	20 Amp Yellow	–	Radiator Fan - Single Speed
F06	30 Amp Green	–	Radiator Fan - Low Speed
F07	40 Amp Orange	–	Radiator Fan - High Speed
F08	40 Amp Orange	–	Blower Motor
F09	–	10 Amp Red	Powertrain
F10	–	10 Amp Red	Horn
F11	–	15 Amp Blue	Powertrain
F11	–	10 Amp Red	Powertrain (Multiair – If Equipped)
F14	–	5 Amp Tan	High Beam (Shutter)
F15	–	15 Amp Blue	Cigar Lighter

Cavity	Maxi Fuse	Mini Fuse	Description
F16	–	7.5 Amp Brown	Transmission
F17	–	25 Amp Clear	Powertrain (Multiair – If Equipped)
F17	–	15 Amp Blue	Powertrain
F18	–	15 Amp Blue	Powertrain
F18	–	5 Amp Tan	Powertrain (Multiair – If Equipped)
F19	–	7.5 Amp Brown	Air Conditioning
F20	–	15 Amp Blue	Heated Seats – If Equipped
F21	–	15 Amp Blue	Fuel Pump
F22	–	20 Amp Yellow	Powertrain
F23	–	20 Amp Yellow	Anti-Lock Brake Valves
F24	–	7.5 Amp Brown	Stability Control System
F30	–	15 Amp Blue	Fog Lamps
F82	30 Amp Green	–	Sunroof/Convertible Top
F83	20 Amp Yellow	–	Cooling Pump – If Equipped
F84	–	10 Amp Red	Transmission

Cavity	Maxi Fuse	Mini Fuse	Description
F85	30 Amp Green (ATO)	–	Rear Defroster
F87	–	5 Amp Tan	Rear Defroster
F90	–	5 Amp Tan	Heated Mirrors – If Equipped

VEHICLE STORAGE

If you are leaving your vehicle dormant for more than 21 days, you may want to take these steps to protect your battery.

- Disconnect the negative cable from the battery.
- Anytime you store your vehicle, or keep it out of service (e.g., vacation) for two weeks or more, run the air conditioning system at idle for about five minutes in the fresh air and high blower setting. This will ensure adequate system lubrication to minimize the possibility of compressor damage when the system is started again.

REPLACEMENT BULBS

Interior Bulbs

	Bulb Number
Overhead Lamp	C5W
Courtesy Lamp	W5W

Exterior Bulbs

	Bulb Number
Front Low and High Beam Headlamp	HIR2LL
Front Parking/Daytime Running Lamps	W21/5W
Front Fog Lamps	H11LL
Front Side Marker Lamps	W3W
Front Turn Signal Lamps	WY21W
Side Direction Lamps	WY5W
Rear Turn Signal Lamps	PY21W
Rear Side Marker Lamps	W3W

	Bulb Number
Rear Tail and Stop Lamps	P21/5W
Rear Backup Lamps	W16W
Center High Mounted Stop Lamp	W5W
License Plate Lamps	LED (See Authorized dealer)
NOTE: Numbers refer to commercial bulb types that can be purchased from your authorized dealer.	
If a bulb needs to be replaced, visit your authorized dealer or refer to the applicable Service Manual.	

BULB REPLACEMENT

NOTE: Lens fogging can occur under certain atmospheric conditions. This will usually clear as atmospheric conditions change to allow the condensation to change back into a vapor. Turning the lamps on will usually accelerate the clearing process.

Headlamps Low Beam and High Beam

1. Remove the plastic cap from the back of the headlamp housing.
2. Rotate the bulb counter-clockwise.
3. Remove the bulb and replace as needed.
4. Install the bulb and rotate clockwise to lock in place.
5. Reinstall the plastic cap.

Front Turn Signal, Parking And Daytime Running Lamps

1. Turn the steering wheel completely to the left or right.
2. Open the wheel housing access door.

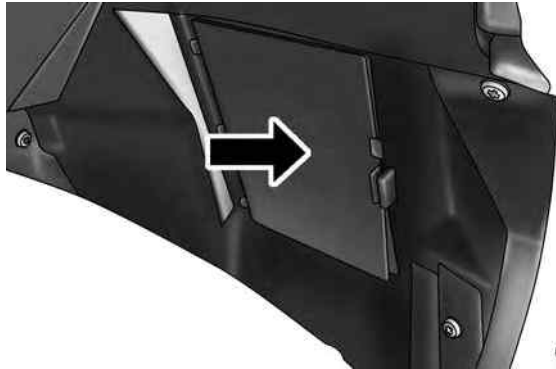

073310799

Wheel Housing Access Door

3. Remove the plastic cap from the back of the lamp housing.
4. Rotate bulb/socket counter-clockwise.
5. Remove the bulb and replace as needed.
6. Install the bulb into socket, and rotate bulb/socket clockwise into lamp locking it in place.
7. Reinstall the plastic cap.

Front Fog Lamps

To replace the front fog lights, see your authorized dealer.

Front/Rear Side Marker Lamps

1. Remove portion of the wheel liner to allow hand access to side marker lamp.
2. Rotate the bulb socket counterclockwise, and remove the bulb and socket assembly from the housing.

3. Pull the bulb from the socket and insert the replacement bulb.
4. Install the bulb and socket assembly into the housing, and rotate the socket clockwise to lock it in place.
5. Reinstall the wheel liner.

Rear Tail, Stop, Backup And Turn Signal Lamps

1. Open the liftgate.
2. Remove the two screws and remove the tail lamp assembly.



Tail Lamp Assembly Screws

3. Remove four screws and separate the backplate from the lamp housing.

4. Remove the tail, stop, or turn signal bulbs by pushing them slightly and turning counter-clockwise.
 5. Remove the backup lamp bulb by pulling straight out.
 6. Replace lamps as required and reinstall lamp.
- Center High Mounted Stop Lamp (CHMSL)**
1. Remove the two guard caps and the two fastening screws.
 2. Remove the center high mounted stop lamp assembly.
 3. Disconnect the electric connector.
 4. Press the retaining device and open the bulb holder.
 5. Remove the snap-fitted bulb to be replaced and replace it.
 6. Close the back cap locking it properly.
 7. Reinstall the two fastening screws and reinstall the guard caps.

FLUID CAPACITIES

	U.S.	Metric
Fuel (Approximate)	10.5 Gallons	40 Liters
Engine Oil with Filter		
1.4L/1.4L Turbo Engine	4 Quarts	3.8 Liters
Cooling System		
1.4L/1.4L Turbo Engine (MOPAR® Antifreeze/Engine Coolant 10 Year/150,000 Mile Formula) — with Manual Transmission	4.6 Quarts	4.4 Liters
1.4L/1.4L Turbo Engine (MOPAR® Antifreeze/Engine Coolant 10 Year/150,000 Mile Formula) — with Automatic Transmission	5.8 Quarts	5.5 Liters

FLUIDS, LUBRICANTS AND GENUINE PARTS

Engine

Component	Fluid, Lubricant, or Genuine Part
Engine Coolant - 1.4L/1.4L Turbo Engine	We recommend you use MOPAR® Antifreeze/Coolant 10 Year/150,000 Mile Formula OAT (Organic Additive Technology) meeting the requirements of Chrysler Material Standard MS-90032.
Engine Oil - 1.4L Engine	We recommend you use API Certified SAE 5W-30 Engine Oil, meeting the requirements of Chrysler Material Standard MS-6395. Refer to your engine oil filler cap for correct SAE grade.
Engine Oil - 1.4L Turbo Engine	Use API Certified SAE 5W-40 Full Synthetic Engine Oil, meeting the requirements of Chrysler Material Standard MS-12991. Refer to your engine oil filler cap for correct SAE grade.
Engine Oil Filter - 1.4L/1.4L Turbo Engine	We recommend you use a MOPAR® Engine Oil Filter.
Spark Plugs - 1.4L Engine	We recommend you use MOPAR® Spark Plugs
Spark Plugs - 1.4L Turbo Engine	We recommend you use MOPAR® Spark Plugs

Component	Fluid, Lubricant, or Genuine Part
Fuel Selection - 1.4L/1.4L Turbo Engine	87 Octane Acceptable — 91 Octane Recommended

CAUTION!

- Mixing of engine coolant (antifreeze) other than specified Organic Additive Technology (OAT) engine coolant (antifreeze), may result in engine damage and may decrease corrosion protection. Organic Additive Technology (OAT) engine coolant is different and should not be mixed with Hybrid Organic Additive Technology (HOAT) engine coolant (antifreeze) or any “globally compatible” coolant (antifreeze). If a non-OAT engine coolant (antifreeze) is introduced into the cooling system in an emergency, the cooling system will need to be drained, flushed, and refilled with fresh

CAUTION! (Continued)

- OAT coolant (conforming to MS.90032), by an authorized dealer as soon as possible.
- Do not use water alone or alcohol-based engine coolant (antifreeze) products. Do not use additional rust inhibitors or antirust products, as they may not be compatible with the radiator engine coolant and may plug the radiator.
- This vehicle has not been designed for use with propylene glycol-based engine coolant (antifreeze). Use of propylene glycol-based engine coolant (antifreeze) is not recommended.

(Continued)

Chassis

Component	Fluid, Lubricant, or Genuine Part
Manual Transmission – If Equipped	We recommend you use MOPAR® C635 DDCT/MTX Transmission Fluid
Automatic Transmission – If Equipped	Use only MOPAR® AW-1 Automatic Transmission Fluid or equivalent. Failure to use the correct fluid may affect the function or performance of your transmission.
Brake Master Cylinder	We recommend you use MOPAR® DOT 3, SAE J1703 should be used. If DOT 3, SAE J1703 brake fluid is not available, then DOT 4 is acceptable.
Convertible Top Rails – If Equipped	We recommend you use Berulub FR 43.

MAINTENANCE SCHEDULES

CONTENTS

■ MAINTENANCE SCHEDULE412	□ Maintenance Chart414
----------------------------------	------	-------------------------------	------

MAINTENANCE SCHEDULE

Your vehicle is equipped with an automatic oil change indicator system. The oil change indicator system will remind you that it is time to take your vehicle in for scheduled maintenance.

Based on engine operation conditions, the oil change indicator message will illuminate. This means that service is required for your vehicle. Operating conditions such as frequent short-trips, trailer tow, extremely hot or cold ambient temperatures, and E85 fuel usage will influence when the “Change Oil” or “Oil Change Required” message is displayed. Severe Operating Conditions can cause the change oil message to illuminate as early as 3,500 miles (5,600 km) since last reset. Have your vehicle serviced as soon as possible, within the next 500 miles (805 km).

Your authorized dealer will reset the oil change indicator message after completing the scheduled oil change. If a scheduled oil change is performed by someone other than your authorized dealer, the message can be reset by referring to the steps described under “Electronic Vehicle Information Center (EVIC)” in “Understanding Your Instrument Panel” for further information.

NOTE: Under no circumstances should oil change intervals exceed 10,000 miles (16,000 km) or twelve months, whichever comes first.

Severe Duty All Models

Change Engine Oil at 4,000 miles (6,500 km) if the vehicle is operated in a dusty and off road environment. This type of vehicle use is considered Severe Duty.

Once A Month Or Before A Long Trip:

Check engine oil level.

Check windshield washer fluid level.

Check the tire inflation pressures and look for unusual wear or damage.

Check the fluid levels of the coolant reservoir and brake master cylinder, and fill as needed.

Check function of all interior and exterior lights.

Required Maintenance Intervals

Refer to the maintenance schedules on the following page for the required maintenance intervals.

At Every Oil Change Interval As Indicated By Oil Change Indicator System:
Change oil and filter.
Rotate the tires. Rotate at the first sign of irregular wear, even if it occurs before the oil indicator system turns on.
Inspect battery and clean and tighten terminals as required.
Inspect brake pads, rotors, and hoses.
Inspect engine cooling system protection and hoses.
Check and adjust hand brake.
Inspect exhaust system.
Inspect engine air cleaner if using in dusty or off-road conditions.

Mileage or time passed (whichever comes first)	20,000	30,000	40,000	50,000	60,000	70,000	80,000	90,000	100,000	110,000	120,000	130,000	140,000	150,000
Or Years:	2	3	4	5	6	7	8	9	10	11	12	13	14	15
Or Kilometers:	32,000	48,000	64,000	80,000	96,000	112,000	128,000	144,000	160,000	176,000	192,000	208,000	224,000	240,000
Inspect parking brake function. Adjust as necessary.	X		X		X		X		X		X		X	
Additional Maintenance														
Replace engine air filter.		X			X			X			X			X
Replace cabin air filter.	X		X		X		X		X		X		X	
Clean and lube sun roof tracks.	X	X	X	X	X	X	X	X	X	X	X	X	X	X
Replace spark plugs (1.4L Engine). **									X					
Replace spark plugs (1.4L Turbo Engine). **		X			X			X			X			X

416 MAINTENANCE SCHEDULES

Mileage or time passed (whichever comes first)	20,000	30,000	40,000	50,000	60,000	70,000	80,000	90,000	100,000	110,000	120,000	130,000	140,000	150,000
Or Years:	2	3	4	5	6	7	8	9	10	11	12	13	14	15
Or Kilometers:	32,000	48,000	64,000	80,000	96,000	112,000	128,000	144,000	160,000	176,000	192,000	208,000	224,000	240,000
Flush and replace the engine coolant at 10 years or 150,000 miles (240,000 km) whichever comes first.									X					X
Inspect and replace PCV valve if necessary.									X					
Replace the timing belt.														X

** The spark plug change interval is mileage based only, yearly intervals do not apply.

WARNING!

- You can be badly injured working on or around a motor vehicle. Do only service work for which you have the knowledge and the right equipment. If you have any doubt about your ability to perform a service job, take your vehicle to a competent mechanic.
- Failure to properly inspect and maintain your vehicle could result in a component malfunction and effect vehicle handling and performance. This could cause an accident.

IF YOU NEED CONSUMER ASSISTANCE

CONTENTS

■ SUGGESTIONS FOR OBTAINING SERVICE FOR YOUR VEHICLE421	□ Service Contract423
□ Prepare For The Appointment.421	■ WARRANTY INFORMATION424
□ Prepare A List421	■ REPORTING SAFETY DEFECTS424
□ Be Reasonable With Requests421	□ In The 50 United States And Washington, D.C..424
■ IF YOU NEED ASSISTANCE421	□ In Canada.425
□ FIAT Customer Center422	■ PUBLICATION ORDER FORMS425
□ FIAT Canada Customer Center422		
□ Customer Assistance For The Hearing Or Speech Impaired (TDD/TTY)423		

■ DEPARTMENT OF TRANSPORTATION UNIFORM TIRE QUALITY GRADES426
□ Treadwear.427
□ Traction Grades.427
□ Temperature Grades.428

SUGGESTIONS FOR OBTAINING SERVICE FOR YOUR VEHICLE

Prepare For The Appointment

If you are having warranty work done, be sure to have the right papers with you. Take your warranty folder. All work to be performed may not be covered by the warranty. Discuss additional charges with the service manager. Keep a maintenance log of your vehicle's service history. This can often provide a clue to the current problem.

Prepare A List

Make a written list of your vehicle's problems or the specific work you want done. If you've had an accident or work done that is not on your maintenance log, let the service advisor know.

Be Reasonable With Requests

If you list a number of items and you must have your vehicle by the end of the day, discuss the situation with the service advisor and list the items in order of priority. At many authorized dealers, you may obtain a rental vehicle at a minimal daily charge. If you need a rental, it is advisable to make these arrangements when you call for an appointment.

IF YOU NEED ASSISTANCE

The manufacturer and its authorized dealer are vitally interested in your satisfaction. We want you to be happy with our products and services.

Warranty service must be done by an authorized dealer. We strongly recommend that you take the vehicle to an authorized dealer. They know your vehicle the best, and

are most concerned that you get prompt and high quality service. The manufacturer's authorized dealer have the facilities, factory-trained technicians, special tools, and the latest information to ensure the vehicle is fixed correctly and in a timely manner.

This is why you should always talk to an authorized dealer service manager first. Most matters can be resolved with this process.

- If for some reason you are still not satisfied, talk to the general manager or owner of the authorized dealer. They want to know if you need assistance.
- If an authorized dealer is unable to resolve the concern, you may contact the manufacturer's customer center.

Any communication to the manufacturer's customer center should include the following information:

- Owner's name and address
- Owner's telephone number (home and office)
- Authorized dealer name
- Vehicle Identification Number (VIN)
- Vehicle delivery date and mileage

FIAT Customer Center

P.O. Box 21-8004 Auburn Hills, MI 48321-8004 Phone:
1-800-423-6343

FIAT Canada Customer Center

P.O. Box 1621 Windsor, Ontario N9A 4H6 Phone:
1-800-465-2001 (English) Phone: 1-800-387-9983 (French)

Customer Assistance For The Hearing Or Speech Impaired (TDD/TTY)

To assist customers who have hearing difficulties, the manufacturer has installed special TDD (Telecommunication Devices for the Deaf) equipment at its customer center. Any hearing or speech impaired customer, who has access to a TDD or a conventional teletypewriter (TTY) in the United States, can communicate with the manufacturer by dialing 1-800-380-CHRY.

Canadian residents with hearing difficulties that require assistance can use the special needs relay service offered by Bell Canada. For TTY teletypewriter users, dial 711 and for Voice callers, dial 1-800-855-0511 to connect with a Bell Relay Service operator.

Service Contract

You may have purchased a service contract for a vehicle to help protect you from the high cost of unexpected repairs after the manufacturer's New Vehicle Limited

Warranty expires. The manufacturer stands behind only the manufacturer's service contracts. If you purchased a manufacturer's service contract, you will receive Plan Provisions and an Owner Identification Card in the mail within three weeks of the vehicle delivery date. If you have any questions about the service contract, call the manufacturer's Service Contract National Customer Hotline at 1-800-521-9922 (Canadian residents, call (800) 465-2001 English / (800) 387-9983 French).

The manufacturer will not stand behind any service contract that is not the manufacturer's service contract. It is not responsible for any service contract other than the manufacturer's service contract. If you purchased a service contract that is not a manufacturer's service contract, and you require service after the manufacturer's New Vehicle Limited Warranty expires, please refer to the contract documents, and contact the person listed in those documents.

We appreciate that you have made a major investment when you purchased the vehicle. An authorized dealer has also made a major investment in facilities, tools, and training to assure that you are absolutely delighted with the ownership experience. You will be pleased with their sincere efforts to resolve any warranty issues or related concerns.

WARNING!

Engine exhaust (internal combustion engines only), some of its constituents, and certain vehicle components contain, or emit, chemicals known to the State of California to cause cancer and birth defects, or other reproductive harm. In addition, certain fluids contained in vehicles and certain products of component wear contain, or emit, chemicals known to the State of California to cause cancer and birth defects, or other reproductive harm.

WARRANTY INFORMATION

See the Warranty Information Booklet, located on the DVD, for the terms and provisions of FIAT Group Automobiles warranties applicable to this vehicle and market.

REPORTING SAFETY DEFECTS**In The 50 United States And Washington, D.C.**

If you believe that your vehicle has a defect that could cause a crash or cause injury or death, you should immediately inform the National Highway Traffic Safety Administration (NHTSA) in addition to notifying the manufacturer.

If NHTSA receives similar complaints, it may open an investigation, and if it finds that a safety defect exists in a group of vehicles, it may order a recall and remedy

campaign. However, NHTSA cannot become involved in individual problems between you, your authorized dealer, and the manufacturer.

To contact NHTSA, you may either call the Auto Safety Hotline toll free at 1-888-327-4236 (TTY: 1-800-424-9153), or go to <http://www.safercar.gov>; or write to: Administrator, NHTSA, 1200 New Jersey Avenue, SE., West Building, Washington, D.C. 20590. You can also obtain other information about motor vehicle safety from <http://www.safercar.gov>.

In Canada

If you believe that your vehicle has a safety defect, you should contact the Customer Service Department immediately. Canadian customers who wish to report a safety defect to the Canadian government should contact Transport Canada, Motor Vehicle Defect Investigations and Recalls at 1-800-333-0510 or go to <http://www.tc.gc.ca/roadsafety/>

PUBLICATION ORDER FORMS

To order the following manuals, you may use either the website or the phone numbers listed below. Visa, Mastercard, American Express, and Discover orders are accepted. If you prefer mailing your payment, please call for an order form.

NOTE: A street address is required when ordering manuals (no P.O. Boxes).

Service Manuals

These comprehensive Service Manuals provide the information that students and professional technicians need in diagnosing/troubleshooting, problem solving, maintaining, servicing, and repairing FIAT Group Automobiles vehicles. A complete working knowledge of the vehicle, system, and/or components is written in straightforward language with illustrations, diagrams, and charts.

Diagnostic Procedure Manuals

Diagnostic Procedure Manuals are filled with diagrams, charts and detailed illustrations. These practical manuals make it easy for students and technicians to find and fix problems on computer-controlled vehicle systems and features. They show exactly how to find and correct problems the first time, using step-by-step troubleshooting and drivability procedures, proven diagnostic tests and a complete list of all tools and equipment.

Owner's Manuals

These Owner's Manuals have been prepared with the assistance of service and engineering specialists to acquaint you with specific FIAT Group Automobiles vehicles. Included are starting, operating, emergency and maintenance procedures as well as specifications, capabilities and safety tips.

• *Call toll free at:*

1-800-890-4038 (U.S.)

1-800-387-1143 (Canada)

Or

• *Visit us on the Worldwide Web at:*

www.techauthority.com

DEPARTMENT OF TRANSPORTATION UNIFORM TIRE QUALITY GRADES

The following tire grading categories were established by the National Highway Traffic Safety Administration. The specific grade rating assigned by the tire's manufacturer in each category is shown on the sidewall of the tires on your vehicle.

All passenger car tires must conform to Federal safety requirements in addition to these grades.

Treadwear

The Treadwear grade is a comparative rating, based on the wear rate of the tire when tested under controlled conditions on a specified government test course. For example, a tire graded 150 would wear one and one-half times as well on the government course as a tire graded 100. The relative performance of tires depends upon the actual conditions of their use, however, and may depart significantly from the norm due to variations in driving habits, service practices, and differences in road characteristics and climate.

Traction Grades

The Traction grades, from highest to lowest, are AA, A, B, and C. These grades represent the tire's ability to stop on wet pavement, as measured under controlled conditions on specified government test surfaces of asphalt and concrete. A tire marked C may have poor traction performance.

WARNING!

The traction grade assigned to this tire is based on straight-ahead braking traction tests, and does not include acceleration, cornering, hydroplaning, or peak traction characteristics.

Temperature Grades

The temperature grades are A (the highest), B, and C, representing the tire's resistance to the generation of heat and its ability to dissipate heat, when tested under controlled conditions on a specified indoor laboratory test wheel. Sustained high temperature can cause the material of the tire to degenerate and reduce tire life, and excessive temperature can lead to sudden tire failure. The grade C corresponds to a level of performance, which all passenger car tires must meet under the Federal Motor Vehicle Safety Standard No. 109. Grades B and A represent higher levels of performance on the laboratory test wheel, than the minimum required by law.

WARNING!

The temperature grade for this tire is established for a tire that is properly inflated and not overloaded. Excessive speed, under-inflation, or excessive loading, either separately or in combination, can cause heat buildup and possible tire failure.

INDEX

Adding Engine Coolant (Antifreeze)377	Air Conditioner Maintenance365
Adding Fuel303	Air Conditioning211
Adding Washer Fluid372	Air Conditioning Controls211
Additives, Fuel301	Air Conditioning Filter366
Air bag39	Air Conditioning, Operating Tips219
Air Bag		Air Conditioning Refrigerant365
Air bag Operation42	Air Conditioning System211
Air Bag Warning Light51	Air Pressure, Tires275
Driver Knee Air Bag43	Alterations/Modifications, Vehicle8
Enhanced Accident Response49	Antifreeze (Engine Coolant)376
Event Data Recorder (EDR)54	Capacities406
Front Air Bag39	Disposal379
If A Deployment Occurs48	Anti-Lock Brake System (ABS)252
Knee Impact Bolsters43	Anti-Lock Warning Light153
Maintaining Your Air Bag System53	Appearance Care386
Air bag Deployment39	Automatic Dimming Mirror88
Air bag Light51	Automatic Oil Change Indicator412
Air bag Maintenance53	Automatic Temperature Control (ATC)213
Air Cleaner, Engine (Engine Air Cleaner Filter)362	Automatic Transaxle11

Automatic Transmission233	Brakes381
Adding Fluid385	Brake System252
Fluid and Filter Changes385	Anti-Lock (ABS)252
Fluid Change385	Master Cylinder381
Fluid Level Check385	Parking248
Fluid Type409	Warning Light151
Gear Ranges237	Brake/Transmission Interlock235
Special Additives384	Bulb Replacement401
Autostick242	Bulbs, Light79
Battery363	Capacities, Antifreeze (Engine Coolant)406
Jump Starting337	Capacities, Fluid406
Keyless Transmitter Replacement (RKE)16	Caps, Filler	
Belts, Seat77	Fuel303
Body Mechanism Lubrication369	Oil (Engine)361
B-Pillar Location268	Carbon Monoxide Warning76
Brake Assist System254	Cargo Area Features136
Brake Fluid407	Car Washes386
Brake, Parking248	CD (Compact Disc) Player180

Cellular Phone210	Older Children And Child Restraints59
Chains, Tire286	Seating Positions61
Change Oil Indicator412	Clean Air Gasoline299
Changing A Flat Tire324	Cleaning	
Chart, Tire Sizing262	Wheels388
Check Engine Light (Malfunction Indicator Light)149	Windshield Wiper Blades369
Checking Your Vehicle For Safety75	Climate Control210
Checks, Safety75	Clutch381
Child Restraint55	Clutch Fluid381
Child Restraints		Compact Disc (CD) Maintenance209
Booster Seats60	Compact Spare Tire280
Child Restraints55	Connector	
Child Seat Installation71	UCI207
How To Stow An Unused ALR Seat Belt68	Universal Consumer Interface (UCI)207
Infants And Child Restraints58	Contract, Service423
Install A LATCH-compatible Child Restraint67	Convertible Top Maintenance392
Installing Child Restraints Using The Vehicle Seat Belt69	Coolant (Antifreeze)406
Lower Anchors And Tethers For Children62	Cooling System375
		Adding Coolant (Antifreeze)377

Coolant Capacity407	Dipsticks	
Coolant Level375	Automatic Transmission385
Disposal of Used Coolant379	Disposal	
Drain, Flush, and Refill376	Antifreeze (Engine Coolant)379
Inspection379	Door Locks19
Points to Remember378	Door Locks, Automatic21
Pressure Cap378	Downshifting233
Selection of Coolant (Antifreeze)376	Driving	
Corrosion Protection386	Through Flowing, Rising, or Shallow Standing	
Cruise Light157	Water245
Cupholders134	Electrical Power Outlets131
Customer Assistance421	Electric Remote Mirrors89
Data Recorder, Event54	Electronic Brake Control System252
Daytime Running Lights110	Brake Assist System254
Dealer Service357	Electronic Speed Control (Cruise Control)118
Defroster, Windshield77	Electronic Stability Control (ESC)257
Diagnostic System, Onboard355	Electronic Vehicle Information Center (EVIC)159
		Exit Trip166

New Trip165	Fuel Requirements298
Start Of Trip Procedure166	Oil359
Trip Computer165	Oil Filler Cap361
Trip Functions166	Oil Selection360
Emergency, In Case of		Oil Synthetic362
Hazard Warning Flasher311	Overheating311
Jacking324	Starting227
Jump Starting337	Enhanced Accident Response Feature49
Towing345	Euro Twin Clutch Transmission	
Emission Control System Maintenance356	Fluid Type384
Engine		Event Data Recorder54
Air Cleaner362	Exhaust Gas Caution76
Break-In Recommendations74	Exhaust System76
Checking Oil Level359	Exterior Lights79
Compartment353	Filters	
Cooling375	Air Cleaner362
Exhaust Gas Caution76	Air Conditioning366
Fails to Start229	Engine Fuel407
Flooded, Starting229		

Engine Oil362	Filler Cap (Gas Cap)303
Engine Oil Disposal362	Gasoline298
Flashers		Light156
Turn Signal79	Materials Added301
Flooded Engine Starting229	Octane Rating299
Fluid, Brake409	Requirements298
Fluid Capacities406	Specifications407
Fluid Leaks79	Tank Capacity406
Fluid Level Checks		Fueling303
Automatic Transmission385	Fuses394
Fluids407	Gas Cap (Fuel Filler Cap)303
Fluids, Lubricants and Genuine Parts407	Gasoline, Clean Air299
Fog Lights113	Gasoline (Fuel)298
Freeing A Stuck Vehicle342	Gasoline, Reformulated299
Fuel298	Gauges	
Adding303	Odometer156
Additives301	Gear Ranges237
Capacity406	Gear Select Lever Override343
Clean Air299		

General Information298	Key11
General Maintenance.358	Ignition Key Removal11
Glass Cleaning390	Immobilizer (Sentry Key)13
Hazard		Information Center, Vehicle159
Driving Through Flowing, Rising, or Shallow		Instrument Cluster142
Standing Water245	Instrument Panel and Controls.141
Headlights108	Instrument Panel Cover.391
Cleaning390	Instrument Panel Lens Cleaning.391
Passing109	Interior Appearance Care.389
Switch109	Interior Lighting111
Heated Mirrors.90	Introduction4
Heated Seats.103	Jacking Instructions.329
Heater211	Jack Location325
Hill Start Assist.255	Jack Operation324
Holder, Cup134	Jump Starting.337
Hood Release106	Key-In Reminder13
Ignition11	Key, Replacement14

Keys11	Engine Temperature Warning158
Key, Sentry (Immobilizer)13	Exterior79
Lane Change Assist111	Fog150
Lap/Shoulder Belts28	High Beam109
Latches79	High Beam Indicator148
Hood106	Low Fuel156
Lead Free Gasoline298	Oil Pressure158
Leaks, Fluid79	Park109
Life of Tires283	Passing109
Liftgate (Sedan)24	Seat Belt Reminder149
Light Bulbs79	Service402
Lights79	Tire Pressure Monitoring (TPMS)145
Airbag51	Traction Control260
Anti-Lock153	Turn Signal79
Brake Assist Warning260	Voltage157
Brake Warning151	Warning (Instrument Cluster Description)145
Bulb Replacement402	Loading Vehicle	
Check Engine (Malfunction Indicator)149	Tires268

Locks		Media Hub97
Automatic Door21	Mirrors87
Door19	Automatic Dimming88
Power Door21	Electric Powered89
Lubrication, Body369	Heated90
Lug Nuts323	Modifications/Alterations, Vehicle8
Maintenance Free Battery363	Monitor, Tire Pressure System288
Maintenance, General358	Multi-Function Control Lever108
Maintenance Procedures358	New Vehicle Break-In Period74
Maintenance Schedule412	Occupant Restraints25
Maintenance Schedules412	Octane Rating, Gasoline (Fuel)299
Malfunction Indicator Light (Check Engine).356	Odometer156
Manual, Service425	Trip156
Manual Transmission230	Oil Change Indicator164
Fluid Level Check383	Oil Change Indicator, Reset164
Frequency of Fluid Change384	Oil, Engine359
Lubricant Selection383	Capacity406
Master Cylinder (Brakes)381		

Change Interval359	Passing Light109
Checking359	Pets.74
Disposal362	Placard, Tire and Loading Information269
Filter362	Power	
Filter Disposal362	Door Locks21
Identification Logo360	Mirrors89
Materials Added to362	Outlet (Auxiliary Electrical Outlet)131
Recommendation360	Steering247
Synthetic362	Sunroof128
Viscosity361	Windows22
Oil Filter, Selection362	Pregnant Women and Seat Belts35
Onboard Diagnostic System355	Preparation for Jacking328
Operating Precautions355	Pretensioners	
Operator Manual (Owner's Manual)5	Seat Belts35
Overheating, Engine155	Radial Ply Tires276
Owner's Manual (Operator Manual)5	Radio Operation180
Paint Care386	Radio Reception180
Parking Brake248	Radio (Sound Systems)180

Rear Liftgate (Sedan)24	Safety Checks Inside Vehicle77
Rear Window Features137	Safety Checks Outside Vehicle79
Recorder, Event Data54	Safety Defects, Reporting424
Recreational Towing306	Safety, Exhaust Gas.76
Reformulated Gasoline299	Safety Information, Tire261
Refrigerant366	Safety Tips75
Release, Hood.106	Schedule, Maintenance412
Remote Keyless Entry (RKE)		Seat Belt	
FCC General Information18	Disengage The Automatic Locking Mode38
Remote Sound System (Radio) Controls208	Energy Management Feature35
Replacement Bulbs401	Engage The Automatic Locking Mode38
Replacement Keys14	Lap/Shoulder Belts28
Replacement Parts.357	Lap/Shoulder Belt Untwisting33
Replacement Tires.284	Pregnant Women35
Reporting Safety Defects424	Seat Belt Extender34
Restraints, Child.55	Seat Belt Pretensioner35
Restraints, Occupant25	Seat Belt System25
Rotation, Tires287	Seat Belt Maintenance391
		Seat Belts.27

Child Restraint55	Shift Lever Override343
Extender34	Shift Speeds, Manual Transmission232
Front Seat27	Shoulder Belts28
Inspection77	Signals, Turn79
Operating Instructions31	Snow Chains (Tire Chains).286
Pregnant Women35	Snow Tires278
Pretensioners35	Spare Tire.280
Rear Seat28	Spark Plugs407
Reminder149	Speed Control (Cruise Control).118
Untwisting Procedure33	Sport Mode250
Seats99	Starting227
Adjustment99	Automatic Transmission227
Heated103	Cold Weather228
SENTRY KEY®		Engine Fails to Start229
FCC General Information15	Manual Transmission227
Sentry Key (Immobilizer)13	Steering	
Service Assistance421	Power247
Service Contract423	Tilt Column117
Service Manuals425	Wheel, Tilt117

Steering Wheel Audio Controls208	Changing324
Steering Wheel Mounted Sound System Controls208	Compact Spare280
Storage400	General Information273
Storage, Vehicle.220	High Speed276
Storing Your Vehicle400	Inflation Pressures275
Stuck, Freeing.342	Jacking324
Sun Roof128	Life of Tires283
Supplemental Restraint System - Airbag39	Load Capacity268
Synthetic Engine Oil362	Pressure Monitor System (TPMS)288
Temperature Control, Automatic (ATC)213	Pressure Warning Light145
Temperature Gauge, Engine Coolant.312	Quality Grading426
Tilt Steering Column117	Radial276
Tire and Loading Information Placard.268	Replacement284
Tire Markings.261	Rotation287
Tires79	Safety261
Aging (Life of Tires)283	Sizes262
Air Pressure273	Snow Tires278
Chains286	Spinning282
		Tread Wear Indicators283

Tire Safety Information261	Trip Odometer156
Tire Service Kit312	Turn Signals110
To Open Hood106	UCI Connector207
Towing305	Uniform Tire Quality Grades426
Disabled Vehicle345	Universal Consumer Interface (UCI) Connector207
Recreational306	Unleaded Gasoline298
Towing Vehicle Behind a Motorhome306	Untwisting Procedure, Seat Belt33
Traction244	Vehicle Identification Number (VIN)7
Traction Control255	Vehicle Loading269
Trailer Towing305	Vehicle Modifications/Alterations8
Transaxle		Vehicle Storage220
Automatic11	Warning Lights (Instrument Cluster Description)145
Transmission384	Warnings and Cautions.7
Automatic233	Warranty Information4
Fluid384	Washer	
Manual230	Adding Fluid372
Transmitter Battery Service (Remote Keyless Entry)16		
Transporting Pets74		
Tread Wear Indicators283		

Washers, Windshield113	Windows22
Washing Vehicle386	Power22
Water		Windshield Defroster77
Driving Through245	Windshield Washers113
Wheel and Wheel Trim388	Windshield Wiper Blades369
Wheel and Wheel Trim Care388	Windshield Wipers113
Wind Buffeting23	Wiper Blade Replacement369
Window Fogging219		

INSTALLATION OF RADIO TRANSMITTING EQUIPMENT

Special design considerations are incorporated into this vehicle's electronic system to provide immunity to radio frequency signals. Mobile two-way radios and telephone equipment must be installed properly by trained personnel. The following must be observed during installation.

The positive power connection should be made directly to the battery and fused as close to the battery as possible. The negative power connection should be made to body sheet metal adjacent to the negative battery connection. This connection should not be fused.

Antennas for two-way radios should be mounted on the roof or the rear area of the vehicle. Care should be used in mounting antennas with magnet bases. Magnets may affect the accuracy or operation of the compass on vehicles so equipped.

The antenna cable should be as short as practical and routed away from the vehicle wiring when possible. Use only fully shielded coaxial cable.

Carefully match the antenna and cable to the radio to ensure a low Standing Wave Ratio (SWR).

Mobile radio equipment with output power greater than normal may require special precautions.

All installations should be checked for possible interference between the communications equipment and the vehicle's electronic systems.

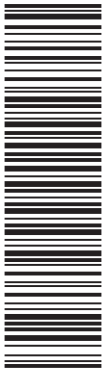

Chrysler Group LLC

15FF500-126-AB



Second Edition Rev 1

Printed in U.S.A.