

## ***Kia, THE COMPANY***

---



Thank you for becoming the owner of a new Kia vehicle.

As a global car manufacturer focused on building high-quality vehicles with exceptional value, Kia Motors is dedicated to providing you with a customer service experience that exceeds your expectations.

All information contained in this Owner's Manual was accurate at the time of publication. However, Kia reserves the right to make changes at any time so that our policy of continual product improvement can be carried out.

This manual applies to all models of this vehicle and includes descriptions and explanations of optional as well as standard equipment. As a result, you may encounter material in this manual that is not applicable to your specific Kia vehicle.

***Drive safely and enjoy your Kia!***

## FOREWORD

---

Thank you for choosing a Kia vehicle.

When you require service, remember that your Kia dealer knows your vehicle best. Your dealer has factory-trained technicians, recommended special tools and genuine Kia replacement parts. It is dedicated to your complete customer satisfaction.

Because subsequent owners require this important information as well, this publication should remain with the vehicle if it is sold.

This manual will familiarize you with operational, maintenance and safety information about your new vehicle. It is supplemented by a Warranty and Consumer Information manual that provides important information on all warranties regarding your vehicle.

We urge you to read these publications carefully and follow the recommendations to help assure enjoyable and safe operation of your new vehicle.

Kia offers a great variety of options, components and features for its various models. Therefore, some of the equipment described in this manual, along with the various illustrations, may not be applicable to your particular vehicle.

The information and specifications provided in this manual were accurate at the time of printing. Kia reserves the right to discontinue or change specifications or design at any time without notice and without incurring any obligation. If you have questions, always check with your Kia dealer.

We assure you of our continuing interest in your motoring pleasure and satisfaction in your Kia vehicle.

© 2015 Kia Canada Inc.

All rights reserved. Reproduction by any means, electronic or mechanical, including photocopying, recording, or by any information storage and retrieval system or translation in whole or part is not permitted without written authorization from Kia Canada Inc..

Printed in Korea

## TABLE OF CONTENTS

### **Introduction**

How to use this manual / Fuel requirements / Vehicle break-in process

**1**

### **Your vehicle at a glance**

Exterior overview / Interior overview / Instrument panel overview / Engine compartment

**2**

### **Safety features of your vehicle**

Seats / Seat belts / Child restraint system / Air bag

**3**

### **Features of your vehicle**

Keys / Door locks / Tailgate / Windows / Hood / Fuel filler lid / Panoramic sunroof / Steering wheel / Mirrors / Instrument cluster / Lighting / Wipers & Washers / Climate control system / Audio system / Etc.

**4**

### **Driving your vehicle**

Before driving / Engine start/stop button / Transaxle / Brake system / Cruise control system / Active ECO system / Winter driving / Vehicle load limit / Etc.

**5**

### **What to do in an emergency**

Road warning / Emergency while driving / Emergency starting / Engine overheat / Flat tire / Towing / Etc.

**6**

### **Maintenance**

Engine compartment / Maintenance service / Engine oil / Engine coolant / Brake fluid / Washer fluid / Parking brake / Air cleaner / Wiper blades / Battery / Tire and wheels / Fuses / Etc.

**7**

### **Specifications & Consumer information**

**8**

### **Index**

**I**

# Introduction

**How to use this manual . . . . . 1-2**

**Fuel requirements . . . . . 1-3**

- Gasoline containing alcohol and methanol . . . . . 1-3
- Gasoline containing MMT . . . . . 1-4
- Use of MTBE . . . . . 1-4
- Do not use methanol . . . . . 1-4
- Fuel Additives . . . . . 1-5

**Vehicle handling instructions . . . . . 1-5**

**Vehicle Break-In Process . . . . . 1-6**

### HOW TO USE THIS MANUAL

We want to help you get the greatest possible driving pleasure from your vehicle. Your Owner's Manual can assist you in many ways. We strongly recommend that you read the entire manual. In order to minimize the chance of death or injury, you must read the **WARNING** and **CAUTION** sections in the manual.

Illustrations complement the words in this manual to best explain how to enjoy your vehicle. By reading your manual, you will learn about features, important safety information, and driving tips under various road conditions.

The general layout of the manual is provided in the Table of Contents. Use the index when looking for a specific area or subject; it has an alphabetical listing of all located in the back of this manual.

**Sections:** This manual has eight sections plus an index. Each section begins with a brief list of contents so you can tell at a glance if that section has the information you want.

You will find various types of safety instructions in this manual. These instructions were prepared to enhance your personal safety.

Carefully read and follow ALL procedures and recommendations provided in these instructions.

#### **WARNING**

**A WARNING indicates a situation in which harm, serious bodily injury or death could result if the warning is ignored.**

#### **CAUTION**

**A CAUTION indicates a situation in which damage to your vehicle could result if the caution is ignored.**

#### **\* NOTICE**

**A NOTICE indicates interesting or helpful information is being provided.**

## FUEL REQUIREMENTS

Your new Kia vehicle is designed to use only unleaded fuel having a pump octane number  $((R+M)/2)$  of 87 (Research Octane Number 91) or higher. (Do not use methanol blended fuels)

Your new vehicle is designed to obtain maximum performance with UNLEADED FUEL, as well as minimize exhaust emissions and spark plug fouling.

Never add any fuel system cleaning agents to the fuel tank other than what has been specified. (Consult an authorized Kia dealer for details.)

### **WARNING - Refueling**

- Do not "top off" after the nozzle automatically shuts off. Attempts to force more fuel into the tank can cause fuel overflow onto you and the ground causing a risk of fire.
- Always check that the fuel cap is installed securely to prevent fuel spillage, especially in the event of an accident.

Tighten the cap until it clicks one time, otherwise the fuel cap open warning indicator  light (or LCD display) will illuminate.

### *Gasoline containing alcohol and methanol*

Gasohol, a mixture of gasoline and ethanol (also known as grain alcohol), and gasoline or gasohol containing methanol (also known as wood alcohol) are being marketed along with or instead of leaded or unleaded gasoline.

Pursuant to EPA regulations, ethanol may be used in your vehicle. Do not use gasohol containing more than 10% ethanol, and do not use gasoline or gasohol containing any methanol. Ethanol provides less energy than gasoline and it attracts water, and it is thus likely to reduce your fuel efficiency and could lower your MPG results. Methanol may cause drivability problems and damage to the fuel system, engine control system and emission control system.

Discontinue using gasohol of anykind if drivability problems occur. Vehicle damage or drivability problems may not be covered by the manufacturer's warranty if they result from the use of:

1. Gasoline or gasohol containing methanol.
2. Leaded fuel or leaded gasohol.

"E85" fuel is an alternative fuel comprised of 85 percent ethanol and 15 percent gasoline, and is manufactured exclusively for use in Flexible Fuel Vehicles. "E85" is not compatible with your vehicle. Use of "E85" may result in poor engine performance and damage to your vehicle's engine and fuel system. Kia recommends that customers do not use fuel with an ethanol content exceeding 10 percent.

### **\* NOTICE**

**Your New Vehicle Limited Warranty does not cover damage to the fuel system or any performance problems caused by the use of "E85" fuel.**

### **Other fuels**

Using fuels that contain Silicone (Si), MMT (Manganese, Mn), Ferrocene (Fe), and Other metallic additives, may cause vehicle and engine damage or cause misfiring, poor acceleration, engine stalling, catalyst melting, clogging, abnormal corrosion, life cycle reduction, etc.

Also, the Malfunction Indicator Lamp (MIL) may illuminate.

### **\* NOTICE**

Damage to the fuel system or performance problem caused by the use of these fuels may not be covered by your New Vehicle Limited Warranty.

### **Gasoline containing MMT**

Some gasoline contains harmful manganese-based fuel additives such as MMT (Methylcyclopentadienyl Manganese Tricarbonyl).

Kia does not recommend the use of gasoline containing MMT.

This type of fuel can reduce vehicle performance and affect your emission control system.

The malfunction indicator lamp on the cluster may come on.

### **Use of MTBE**

Kia recommends avoiding fuels containing MTBE (Methyl Tertiary Butyl Ether) over 15.0% vol. (Oxygen Content 2.7% weight) in your vehicle.

Fuel containing MTBE over 15.0% vol. (Oxygen Content 2.7% weight) may reduce vehicle performance and produce vapor lock or hard starting.



### **CAUTION**

***Your New Vehicle Limited Warranty may not cover damage to the fuel system and any performance problems that are caused by the use of fuels containing methanol or fuels containing MTBE (Methyl Tertiary Butyl Ether) over 15.0% vol. (Oxygen Content 2.7% weight.)***

***Do not use methanol***

Fuels containing methanol (wood alcohol) should not be used in your vehicle. This type of fuel can reduce vehicle performance and damage components of the fuel system, engine control system and emission control system.

***Fuel Additives***

Kia recommends that you use good quality gasolines treated with detergent additives such as TOP TIER Detergent Gasoline, which helps prevent deposit formation in the engine. These gasolines will help the engine run cleaner and enhance performance of the Emission Control System. For more information on TOP TIER Detergent Gasoline, please go to the website ([www.top-tiergas.com](http://www.top-tiergas.com)).

For Customers who do not use TOP TIER Detergent Gasoline regularly, and have problems starting or the engine does not run smoothly, additives that you can buy separately may be added to the gasoline. If TOP TIER Detergent Gasoline is not available, one bottle of additive added to the fuel tank at 7,500 miles or every engine oil change is recommended. Additives are available from your authorized Kia dealer along with information on how to use them. Do not mix other additives.

***Operation in foreign countries***

If you are going to drive your vehicle in another country, be sure to:

- Observe all regulations regarding registration and insurance.
- Determine that acceptable fuel is available.



### VEHICLE HANDLING INSTRUCTIONS

As with other vehicles of this type, failure to operate this vehicle correctly may result in loss of control, an accident or vehicle rollover.

Specific design characteristics (higher ground clearance, track, etc.) give this vehicle a higher center of gravity than other types of vehicles. It is not designed for cornering at the same speeds as a conventional 2-wheel drive sedans or sports coupe. Avoid sharp turns or abrupt maneuvers. Failure to operate this vehicle correctly may result in loss of control, an accident or vehicle rollover. **Be sure to read the “Reducing the risk of a rollover” driving guidelines, in section 5 of this manual.**

### VEHICLE BREAK-IN PROCESS

No special break-in period is needed. By following a few simple precautions for the first 1,000 km (600 miles) you may add to the performance, economy and life of your vehicle.

- Do not race the engine.
- While driving, keep your engine speed (rpm, or revolutions per minute) between 2,000 rpm and 4,000 rpm.
- Do not maintain a single speed for long periods of time, either fast or slow. Varying engine speed is needed to properly break-in the engine.
- Avoid hard stops, except in emergencies, to allow the brakes to seat properly.
- Don't tow a trailer during the first 2,000 km (1,200 miles) of operation.

## VEHICLE DATA COLLECTION AND EVENT DATA RECORDERS

This vehicle is equipped with an event data recorder (EDR). The main purpose of an EDR is to record, in certain crash or near crash-like situations, such as an air bag deployment or hitting a road obstacle, data that will assist in understanding how a vehicle's systems performed. The EDR is designed to record data related to vehicle dynamics and safety systems for a short period of time, typically 30 seconds or less. The EDR in this vehicle is designed to record such data as:

- How various systems in your vehicle were operating;
- Whether or not the driver and passenger safety belts were buckled/ fastened;
- How far (if at all) the driver was depressing the accelerator and/or brake pedal; and,
- How fast the vehicle was traveling.

These data can help provide a better understanding of the circumstances in which crashes and injuries occur. NOTE: EDR data are recorded by your vehicle only if a non-trivial crash situation occurs; no data are recorded by the EDR under normal driving conditions and no personal data (e.g., name, gender, age, and crash location) are recorded. However, other parties, such as law enforcement, could combine the EDR data with the type of personally identifying data routinely acquired during a crash investigation.

To read data recorded by an EDR, special equipment is required, and access to the vehicle or the EDR is needed. In addition to the vehicle manufacturer, other parties, such as law enforcement, that have the special equipment, can read the information if they have access to the vehicle or the EDR.

## Your vehicle at a glance

Exterior overview .....	2-2
Interior overview .....	2-4
Instrument panel overview .....	2-5
Engine compartment .....	2-6

## EXTERIOR OVERVIEW

■ Front view

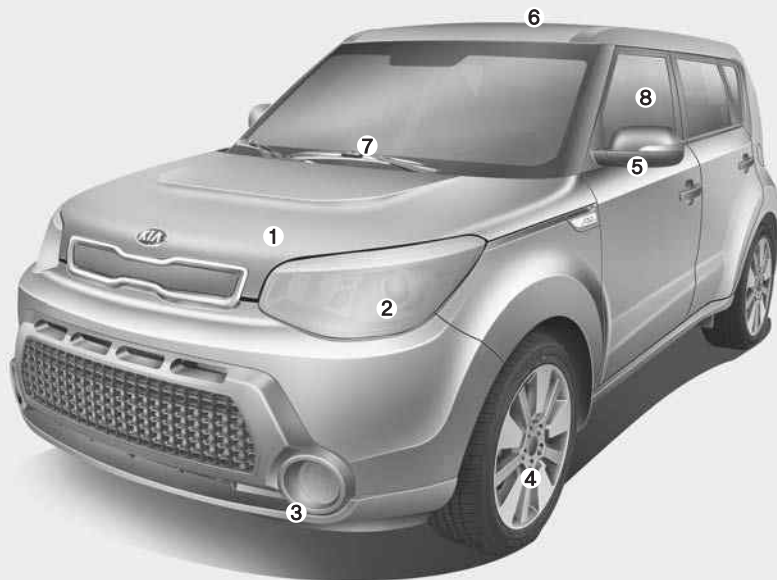

- 1. Hood .....4-32
- 2. Head lamp .....4-90, 7-84
- 3. Fog lamp .....4-93, 7-90
- 4. Tire and wheel .....7-56, 8-4
- 5. Outside rearview mirror .....4-51
- 6. Panoramic sunroof .....4-37
- 7. Front windshield wiper blades .....4-94, 7-50
- 8. Windows .....4-26

\* The actual shape may differ from the illustration.

OPS013001N

■ Rear view

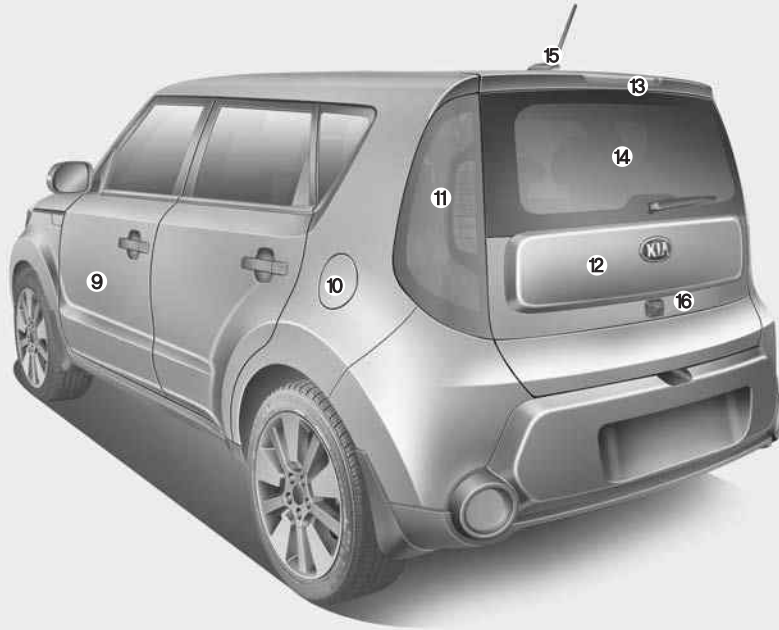

9. Door .....	4-19
10. Fuel filler lid .....	4-34
11. Rear combination lamp.....	7-91
12. Tail gate .....	4-24
13. High mounted stop lamp .....	7-93
14. Rear window defroster.....	4-102
15. Antenna .....	4-147
16. Rearview camera.....	4-88

\* The actual shape may differ from the illustration.

## INTERIOR OVERVIEW

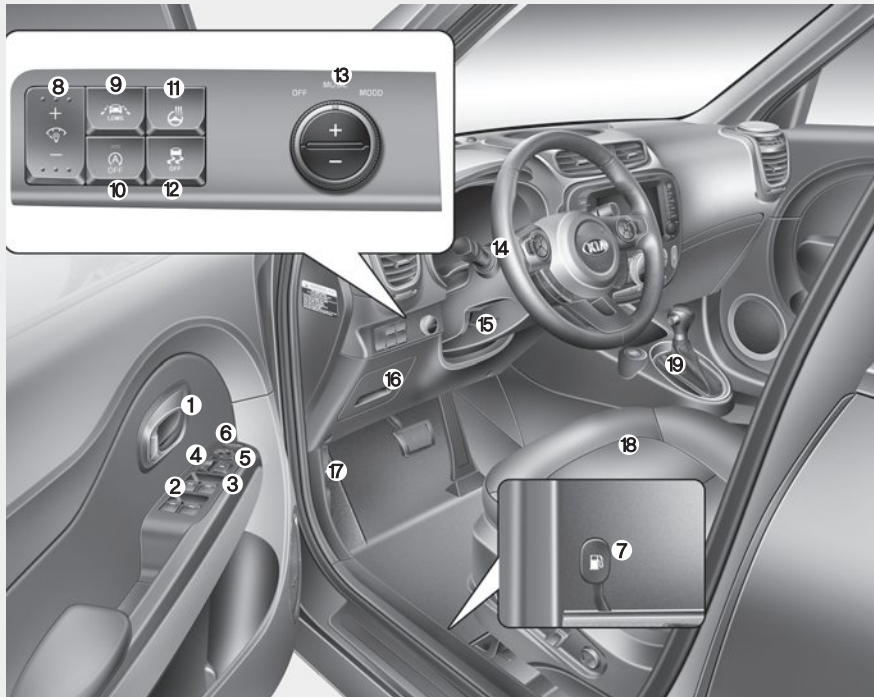

- 1. Inside door handle .....4-19
- 2. Power window switch .....4-27
- 3. Power window lock button.....4-30
- 4. Central door lock switch.....4-21
- 5. Outside rearview mirror control.....4-51
- 6. Outside rearview mirror folding.....4-52
- 7. Fuel filler lid open lever .....4-34
- 8. Instrument panel illumination control switch .....4-55
- 9. LDWS On/Off button .....5-48
- 10. Idle Stop and Go (ISG) OFF button...5-44
- 11. Steering wheel heater On/Off button .4-45
- 12. ESC Off button.....5-29
- 13. Advanced Lighting Speaker .....4-150
- 14. Steering wheel .....4-43
- 15. Tilt and telescopic steering control lever.....4-44
- 16. Inner fuse panel .....7-73
- 17. Hood release lever .....4-32
- 18. Seat.....3-2
- 19. Transaxle shift lever .....5-14, 5-17

\* The actual shape may differ from the illustration.

OPS015004N

## INSTRUMENT PANEL OVERVIEW

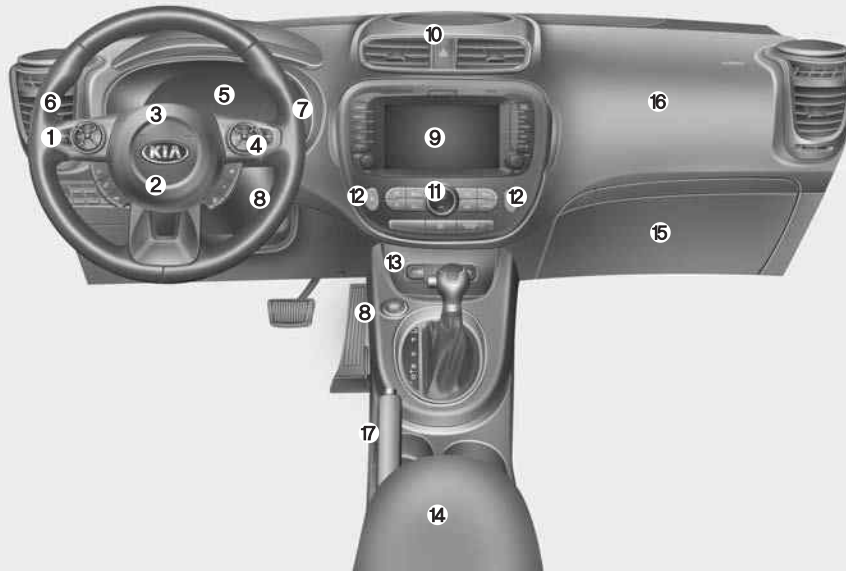

- 1. Audio remote control buttons.....4-148
- 2. Driver's front air bag .....3-51
- 3. Horn .....4-46
- 4. Cruise control button .....5-38
- 5. Instrument cluster .....4-54
- 6. Lighting control lever.....4-90
- 7. Wiper and washer control lever .....4-94
- 8. Ignition switch or Engine start/stop button.....5-6, 5-9
- 9. Audio.....4-147
- 10. Hazard warning flasher.....6-2
- 11. Climate control system.....4-104, 4-114
- 12. Front seat warmer/  
Seat air ventilation.....4-136, 4-138
- 13. Power outlet.....4-140
- 14. Center console storage box.....4-132
- 15. Glove box.....4-132
- 16. Passenger's front air bag.....3-51
- 17. Parking brake.....5-25

\*The actual shape may differ from the illustration.

OPS013003N

## ENGINE COMPARTMENT

### ■ 1.6L GDI



1. Windshield washer fluid reservoir .....7-43
2. Engine oil filler cap .....7-36
3. Engine oil dipstick .....7-36
4. Engine coolant reservoir .....7-39
5. Radiator cap .....7-40
6. Brake/clutch fluid reservoir .....7-41
7. Positive battery terminal .....7-53
8. Negative battery terminal.....7-53
9. Fuse box .....7-74
10. Air cleaner.....7-45

\* The actual engine compartment in the vehicle may differ from the illustration.

OPS073001



■ 2.0L GDI

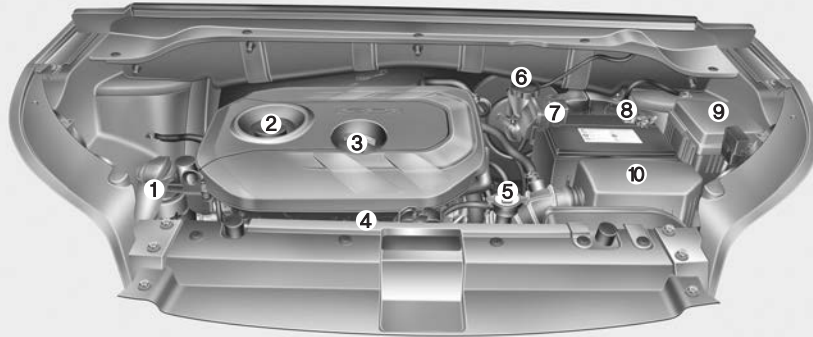

- 1. Windshield washer fluid reservoir .....7-43
- 2. Engine oil filler cap .....7-36
- 3. Engine oil dipstick .....7-36
- 4. Engine coolant reservoir .....7-39
- 5. Radiator cap .....7-40
- 6. Brake/clutch fluid reservoir .....7-41
- 7. Positive battery terminal .....7-53
- 8. Negative battery terminal.....7-53
- 9. Fuse box .....7-74
- 10. Air cleaner.....7-45

\* The actual engine room in the vehicle may differ from the illustration.

OPS073002

# Safety features of your vehicle

Seats . . . . . 3-2

- Front seat adjustment - Manual . . . . . 3-5
- Front seat adjustment - Power . . . . . 3-6
- Seatback pocket . . . . . 3-11
- Rear seat adjustment . . . . . 3-11

Seat belts . . . . . 3-16

- Seat belt restraint system . . . . . 3-16
- Pre-tensioner seat belt . . . . . 3-24
- Seat belt precautions . . . . . 3-26
- Care of seat belts . . . . . 3-28

Child restraint system . . . . . 3-30

- Using a child restraint system . . . . . 3-31
- Tether anchor system . . . . . 3-35
- Lower anchor system . . . . . 3-36

Air bag -  
advanced supplemental restraint system . . . . . 3-39

- How does the air bag system operate . . . . . 3-40
- Do not Installing a child restraint on a front passenger's seat . . . . . 3-42
- Air bag warning light . . . . . 3-42
- SRS components and functions . . . . . 3-43
- Occupant Detection System (ODS) . . . . . 3-46
- Driver's and passenger's front air bag . . . . . 3-51
- Side air bag . . . . . 3-54
- Curtain air bag . . . . . 3-56

- Inflation and non-inflation conditions of the air bag . . 3-57
- SRS care . . . . . 3-62
- Additional safety precautions . . . . . 3-63
- Adding equipment to or modifying your air bag-equipped vehicle . . . . . 3-63
- Air bag warning label . . . . . 3-63

## SEATS

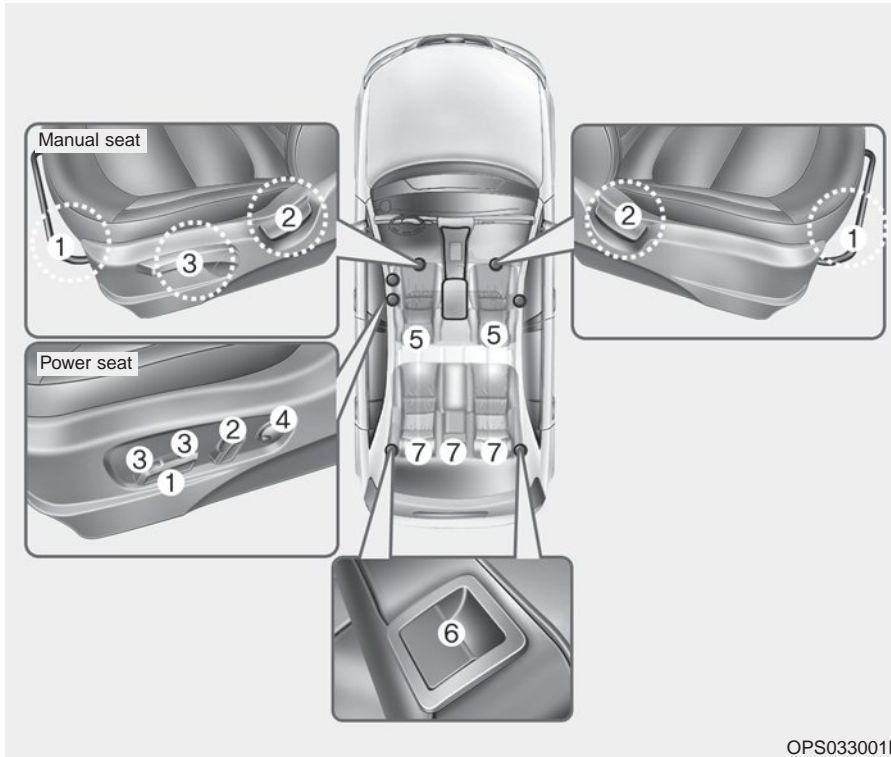

### Front seat

- (1) Forward and backward
- (2) Seatback angle
- (3) Seat cushion height (Driver's seat)
- (4) Lumbar support (Driver's seat)
- (5) Headrest

### Rear seats

- (6) Seatback folding
- (7) Headrest

OPS033001N

**⚠ WARNING - Loose objects**  
Do not place anything in the driver's foot well or under the front seats. Loose objects in the driver's foot area could interfere with the operation of the foot pedals.

**⚠ WARNING - Uprighting seat**  
Do not press the release lever on a manual seatback without holding and controlling the seatback. The seatback will spring upright possibly impacting you or other passengers.

**⚠ WARNING- Seat cushion**  
Occupants should never sit on aftermarket seat cushions or sitting cushions. The passenger's hips may slide under the lap portion of the seat belt during an accident or a sudden stop.

**⚠ WARNING**  
- Driver responsibility for passengers

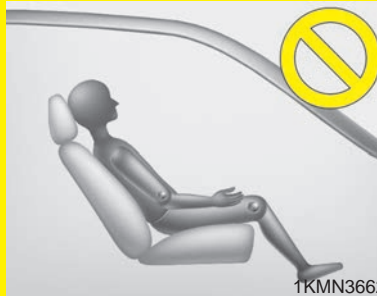

The driver must advise the passenger to keep the seatback in an upright position whenever the vehicle is in motion. If a seat is reclined during an accident, the occupant's hips may slide under the lap portion of the seat belt, applying great force to the unprotected abdomen.

**⚠ WARNING - Driver's seat**

- Never attempt to adjust the seat while the vehicle is moving. This could result in loss of control of your vehicle.
- Do not allow anything to interfere with the normal position of the seatback and seatback adjustment.
- Sit as far back as possible from the steering wheel while still maintaining comfortable control of your vehicle. A distance of at least 10" from your chest to the steering wheel is recommended. Failure to do so could result in air bag inflation injuries to the driver.

**⚠ WARNING - Rear seat-backs**

Always lock the rear seatback before driving. Failure to do so could result in passengers or objects being thrown forward injuring vehicle occupants.

**⚠ WARNING - Luggage and Cargo**

Do not stack pile or stack luggage or cargo higher than the seatback in the cargo area. In an accident the cargo could strike and injure a passenger. If objects are large, heavy or must be piled, they must be secured in the cargo area.

**⚠ WARNING - Unexpected Seat Movement**

After adjusting a manual seat, always check that it is locked by shifting your weight to the front and back. Sudden or unexpected movement of the driver's seat could cause you to lose control of the vehicle.

**⚠ WARNING - Seat adjustment**

- Do not adjust the seat while wearing seat belts. Moving the seat forward will cause strong pressure on the abdomen.
- Do not place your hand near the seat bottom or seat track while adjusting the seat. Your hand could get caught in the seat mechanism.

**⚠ WARNING - Small Objects**

Use extreme caution when picking up small objects trapped under the seats or between the seat and the center console. Your hands might be cut or injured by the sharp edges of the seats mechanism.

**⚠ WARNING - Cargo Area**

Do not allow passengers to ride in the cargo area under any circumstance. The cargo area is solely for the purpose of transporting luggage or cargo.

## Front seat adjustment - manual

### Forward and backward

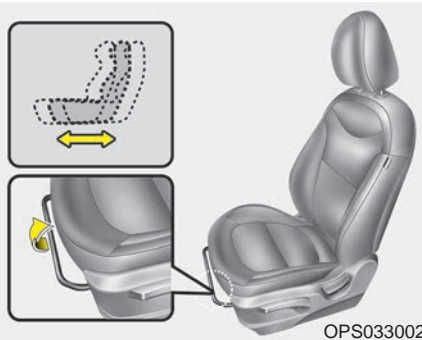

To move the seat forward or backward:

1. Pull the seat slide adjustment lever up and hold it.
2. Slide the seat to the position you desire.
3. Release the lever and make sure the seat is locked in place.

Adjust the seat before driving, and make sure the seat is locked securely by trying to move forward and backward without using the lever. If the seat moves, it is not locked properly.

### Seatback angle

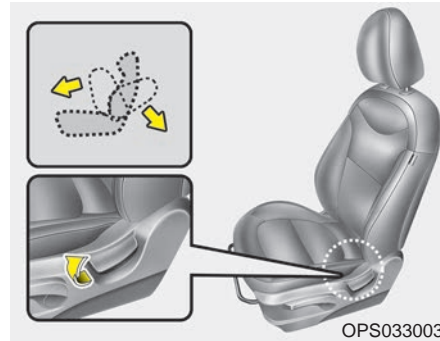

To recline the seatback:

1. Lean forward slightly and lift up the seatback recline lever.
2. Carefully lean back on the seat and adjust the seatback of the seat to the position you desire.
3. Release the lever and make sure the seatback is locked in place. (The lever **MUST** return to its original position for the seatback to lock.)

### Seat height (for driver's seat)

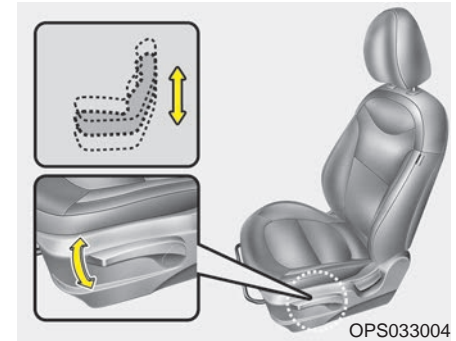

To change the height of the seat, push the lever upwards or downwards.

- To lower the seat cushion, push the lever down several times.
- To raise the seat cushion, pull the lever up several times.

### Front seat adjustment - power (if equipped)

The front seat can be adjusted by using the control switches located on the outside of the seat cushion. Before driving, adjust the seat to the proper position so you can easily control the steering wheel, pedals and switches on the instrument panel.

**⚠ WARNING - Unattended children**

**Do not leave children unattended in the vehicle. Children might operate features of the vehicle that could injure them.**

**⚠ CAUTION - Power seat adjustments**

*The power seating controls function by electronic motor. Excessive operation may cause damage to the electrical equipment.*

**⚠ CAUTION - Power Seating**

*Do not operate two or more power seat control switches at the same time. Doing so may damage the power seat motor or electrical components.*

When in operation, the power seat consumes a large amount of electrical power. To prevent unnecessary charging system drain, don't adjust the power seat longer than necessary while the engine is not running.

### Forward and backward

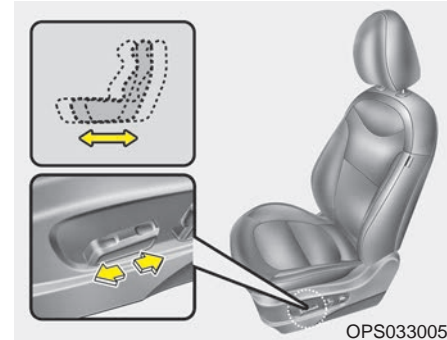

Push the control switch forward or backward to move the seat to the desired position. Release the switch once the seat reaches the desired position.

**Seatback angle**

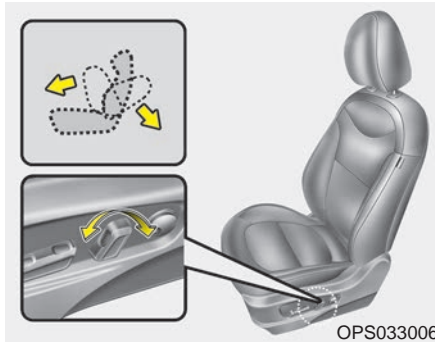

Push the control switch forward or backward to move the seatback to the desired angle. Release the switch once the seat reaches the desired position.

**Seat height (for driver's seat)**

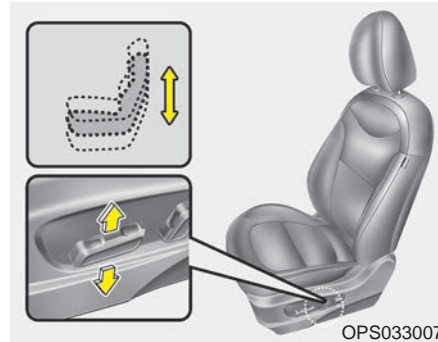

Pull the front portion of the control switch up to raise or press down to lower the front part of the seat cushion. Pull the rear portion of the control switch up to raise or press down to lower the rear part of the seat cushion. Release the switch once the seat reaches the desired position.

**Lumbar support (for driver's seat)**

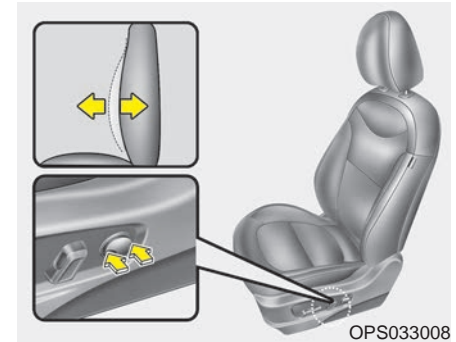

The depth of the lumbar support can be adjusted by pressing the button fore and after. If equipped, the location of the lumbar support can be adjusted up and down by pressing the button up and down.



### Headrest (for front seat)

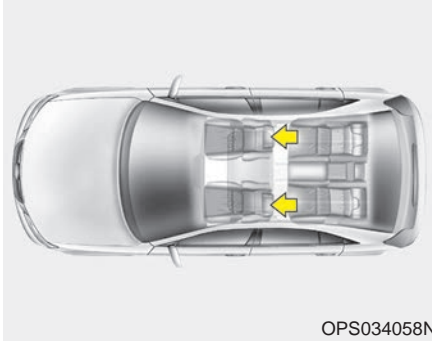

The driver's and front passenger's seats are equipped with a headrest for the occupant's safety and comfort. The headrest not only provides comfort for the driver and front passenger, but also helps protect the head and neck in the event of a rear collision.

For maximum effectiveness in case of an accident, the headrest should be adjusted so the middle of the headrest is at the same height of the center of gravity of an occupant's head. Generally, the center of gravity of most people's head is similar with the height of the top of their eyes. Also, adjust the headrest as close to your head as possible. For this reason, the use of a cushion that holds the body away from the seatback is not recommended.

#### **⚠ WARNING - Headrest removal/adjustment**

- **Do not operate the vehicle with the headrests removed. Headrests can provide critical neck and head support in a crash.**
- **Do not adjust the headrest height while the vehicle is in motion. Driver may lose control of the vehicle.**

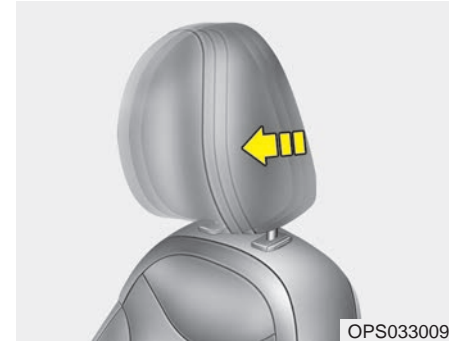

#### **Forward and rearward adjustment**

The headrest may be adjusted forward to 4 different positions by pulling the headrest forward to the desired detent. To adjust the headrest to its furthest rearward position, pull it fully forward to the farthest position and release it. Adjust the headrest so that it properly supports the head and neck.

#### **⚠ CAUTION**

***Excessive pulling or pushing may damage the headrest.***

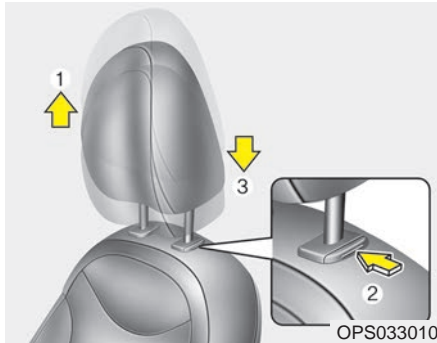

### Adjusting the height up and down

To raise the headrest, pull it up to the desired position (1). To lower the headrest, push and hold the release button (2) on the headrest support and lower the headrest to the desired position (3).

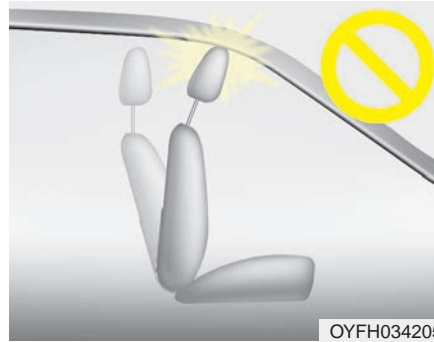

### \* NOTICE

If you recline the seatback towards the front with the headrest and seat cushion raised, the headrest may come in contact with the sunvisor or other parts of the vehicle.

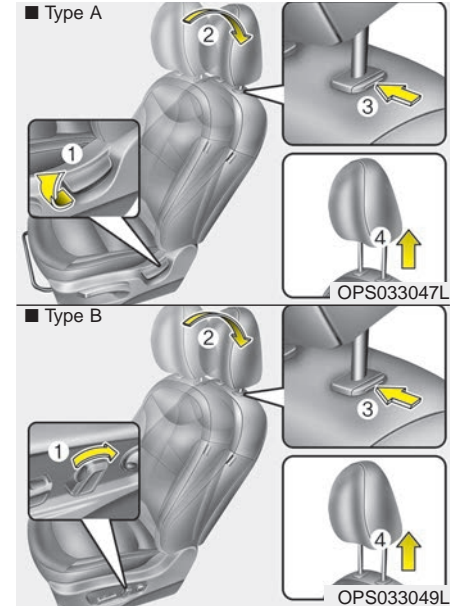

### Removal/Reinstall

To remove the headrest:

1. Recline the seatback(2) with the recline lever or switch(1).
2. Raise headrest as far as it can go.
3. Press the headrest release button (3) while pulling the headrest up (4).

**⚠ WARNING**

**NEVER allow anyone to ride in a seat with the headrest removed.**

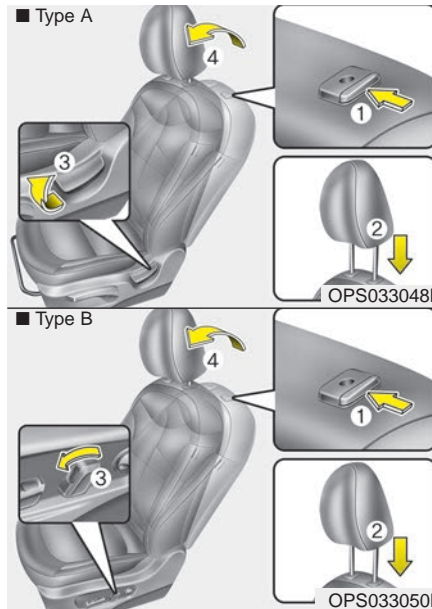

**⚠ WARNING - Headrest Reinstallation**

**To reduce the risk of injury to the head or neck, always make sure the headrest is locked into position and adjusted properly after reinstalling.**

To reinstall the headrest :

1. Put the headrest poles (2) into the holes while pressing the release button (1).
2. Recline the seatback(4) with the recline lever or switch(3)
3. Adjust the headrest to the appropriate height.

### Seatback pocket (if equipped)

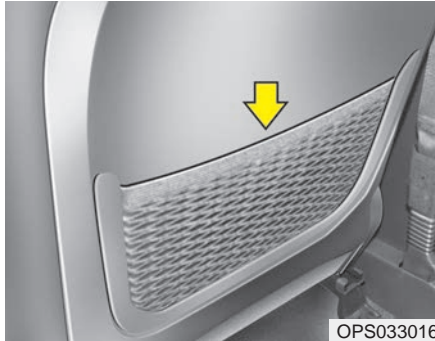

The seatback pocket is provided on the back of the front passenger's seatbacks.

**⚠ WARNING - Seatback pockets**

Do not put heavy or sharp objects in the seatback pocket. An occupant could contact such objects in a crash. Heavy objects in the front passenger seatback could also interfere with the airbag sensing system.

### Rear seat adjustment

#### *Folding the rear seat*

The rear seatbacks can be folded to facilitate carrying long items or to increase the luggage capacity of the vehicle.

**⚠ WARNING - Folded down seatback**

Never allow passengers sit on top of the folded down seatback while the vehicle is moving. This is not a proper seating position and no seat belts are available for use.

This could result in serious injury or death in case of an accident or sudden stop.

**⚠ WARNING - Objects**

Objects carried on the folded down seatback should not extend higher than the top of the front seatbacks. This could allow cargo to slide forward and cause injury or damage during sudden stops.

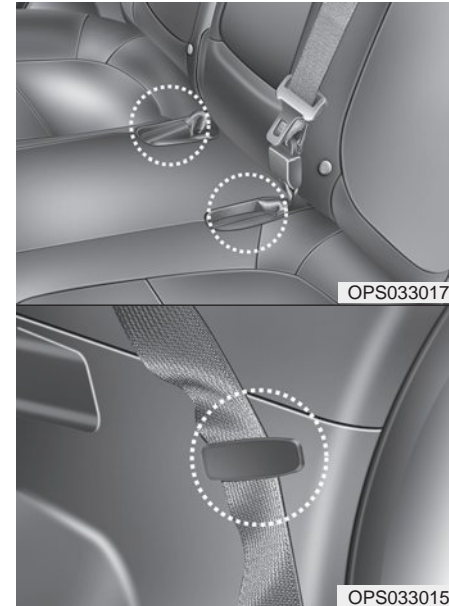

#### To fold down the rear seatback

1. Insert the rear seat belt buckle in the pocket (if equipped) between the rear seatback and cushion, and insert the rear seat belt webbing in the guide to prevent the seat belt from being damaged.

## Safety features of your vehicle

2. Set the front seatback to the upright position and if necessary, slide the front seat forward.
3. Lower the rear headrests to the lowest position.

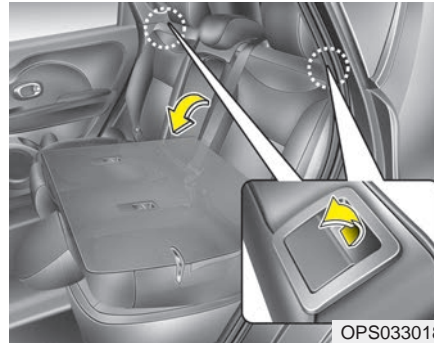

### **⚠ WARNING - Cargo**

**Do not place heavy objects in the rear seats, since they cannot be properly secured and may hit vehicle occupants in a frontal collision.**

4. Pull on the seatback folding lever, then fold the seat toward the front of the vehicle. When you return the seatback to its upright position, always be sure it has locked into position by pushing on the top of the seatback.
5. To use the rear seat, lift and pull the seatback backward by pulling on the folding lever.  
Pull the seatback firmly until it clicks into place.  
Make sure the seatback is locked in place.
6. Return the rear seat belt to the proper position.

Make sure the engine is off, the automatic transaxle is in P (Park) or the manual transaxle is in R (Reverse) or 1st, and the parking brake is securely applied whenever loading or unloading cargo. Failure to take these steps may allow the vehicle to move if the shift lever is inadvertently moved to another position.

### Headrest

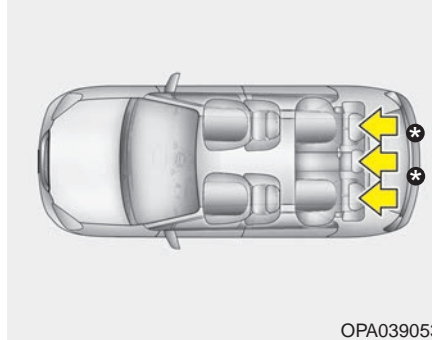

The rear seat(s) is equipped with headrests in all the seating positions for the occupant's safety and comfort. The headrest not only provides comfort for passengers, but also helps protect the head and neck in the event of a collision.

For maximum effectiveness in case of an accident, the headrest should be adjusted so the middle of the headrest is at the same height as the center of gravity of an occupant's head.

Generally, the center of gravity of most people's head is similar with the height of the top of their eyes.

Also adjust the headrest as close to your head as possible. For this reason, the use of a cushion that holds the body away from the seatback is not recommended.

**⚠ WARNING - Headrest removal/adjustment**

**Do not operate the vehicle with the headrests removed. Headrests can provide critical neck and head support in a crash.**

**Adjusting the height up and down**

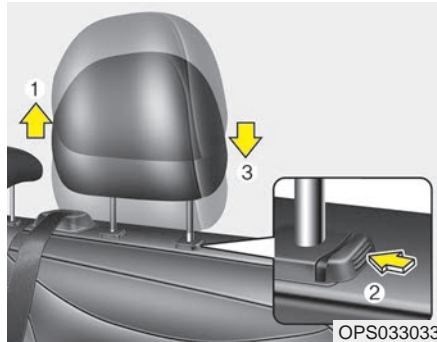

To raise the headrest :

1. Pull it up to the desired position (1).

To lower the headrest :

1. Push and hold the release button (2) on the headrest support
2. Lower the headrest to the desired position (3).

**Removal and installation**

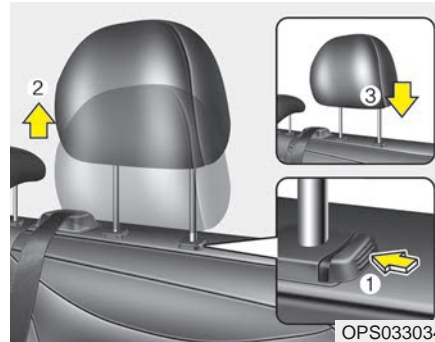

To remove the headrest :

1. Raise it as far as it can go then press the release button (1) while pulling the headrest up (2).

To reinstall the headrest :

1. Put the headrest poles (3) into the holes while pressing the release button (1).
2. Adjust it to the appropriate height.

Make sure the headrest locks in position after adjusting it to properly protect the occupants.

**⚠ WARNING - Headrest installation**  
After installing the headrest, make sure that it is installed in the right direction.  
A headrest installed reversely could increase whiplash injury during rear impact.

**Armrest**

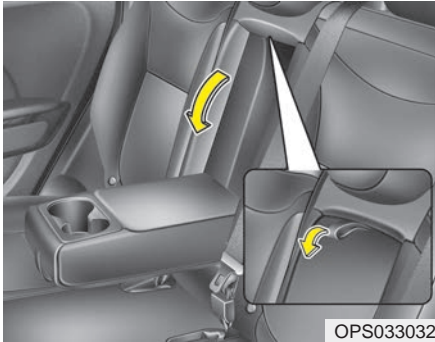

OPS033032

To use the armrest, pull it forward from the seatback.



## SEAT BELTS

### Seat belt restraint system

Seat belts are designed to bear upon the bony structure of the body, and should be worn low across the front of the pelvis, chest and shoulders, as applicable; wearing the lap section of the belt across the abdominal area must be avoided.

Seat belts should be adjusted as firmly as possible, consistent with comfort, to provide the protection for which they have been designed.

A slack belt will greatly reduce the protection afforded to the wearer.

Care should be taken to avoid contamination of the webbing with polishes, oils and chemicals, and particularly battery acid. Cleaning may safely be carried out using mild soap and water. The belt should be replaced if webbing becomes frayed, contaminated or damaged.

#### **WARNING - Shoulder Belt**

- **Never wear the shoulder belt under your arm or behind your back. An improperly positioned shoulder belt cannot protect the occupant in a crash.**
- **Always wear both the shoulder portion and lap portion of the lap/shoulder belt.**

#### **WARNING - Damaged seat belt**

**Replace the entire seat belt assembly if any part of the webbing or hardware is damaged as you can no longer be sure that a damaged seat belt will provide protection in a crash.**

- For maximum restraint system protection, the seat belts must always be used whenever the vehicle is moving. A properly positioned shoulder belt should be positioned midway over your shoulder across your collarbone.
- Never allow children to ride in the front passenger seat. See child restraint system section for further discussion.

- No modifications or additions should be made by the user which will either prevent the seat belt adjusting devices from operating to remove slack, or prevent the seat belt assembly from being adjusted to remove slack.
- When you fasten the seat belt, be careful not to latch the seat belt in buckles of other seat. It's very dangerous and you may not be protected by the seat belt properly.
- Do not unfasten the seat belt and do not fasten and unfasten the seat belt repeatedly while driving. This could result in loss of control, and an accident causing death, serious injury, or property damage.
- When fastening the seat belt, make sure that the seat belt does not pass over objects that are hard or can break easily.

**⚠ WARNING - Seat belt buckle**

**Do not allow foreign material (gum, crumbs, coins, etc.) to obstruct the seat belt buckle. This may prevent the seat belt from fastening securely.**

**Seat belt warning (for driver's seat)**



The driver's seat belt warning light and chime will activate pursuant to the following table when the ignition switch is in "ON" position.

Conditions		Warning Pattern	
Seat Belt	Vehicle Speed	Light-Blink	Chime-Sound
Unbuckled		6 seconds	
Buckled		6 seconds	None
Buckled → Unbuckled	Below 5 km/h (3 mph)	6 seconds	None
	5 km/h~ 10 km/h	6 seconds	
	Above 10 km/h (6 mph)	6 sec. on / 24 sec. off (11 times)	
Unbuckled	Above 10 km/h (6 mph)	6 seconds *1	
	↓ Below 5 km/h (3 mph)	↓ Stop *2	

\*1 Warning pattern repeats 11 times with an interval of 24 seconds. If the driver's seat belt is buckled, the light will stop within 6 seconds and chime will stop immediately.

\*2 The light will stop within 6 seconds and chime will stop immediately.

### Seat belt - Driver's 3-point system with emergency locking retractor

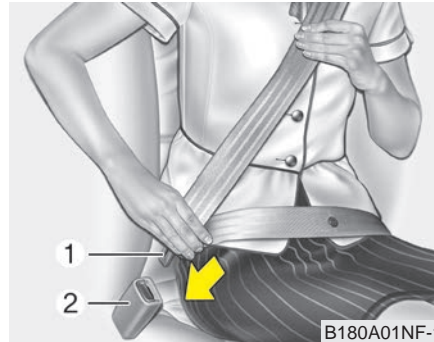

#### To fasten your seat belt:

To fasten your seat belt, pull it out of the retractor and insert the metal tab (1) into the buckle (2). There will be an audible "click" when the tab locks into the buckle.

The seat belt automatically adjusts to the proper length only after the lap belt portion is adjusted manually so that it fits snugly around your hips. If you lean forward in a slow, easy motion, the belt will extend and let you move around. If there is a sudden stop or impact, however, the belt will lock into position. It will also lock if you try to lean forward too quickly.

If you are not able to pull out the seat belt from the retractor, firmly pull the belt out and release it. Then you will be able to pull the belt out smoothly.

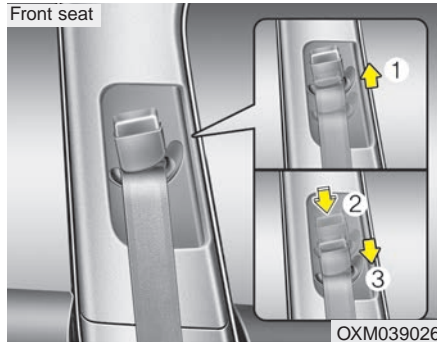

### Height adjustment

You can adjust the height of the shoulder belt anchor to one of the 3 positions for maximum comfort and safety.

The height of the adjusting seat belt should not be too close to your neck. The shoulder portion should be adjusted so that it lies across your chest and midway over your shoulder near the door and not your neck.

To adjust the height of the seat belt anchor, lower or raise the height adjuster into an appropriate position.

To raise the height adjuster, pull it up (1). To lower it, push it down (3) while pressing the height adjuster button (2).

Release the button to lock the anchor into position. Try sliding the height adjuster to make sure that it has locked into position.

**⚠ WARNING - Shoulder belt positioning**  
**Never position the shoulder belt across your neck or face.**

**⚠ WARNING - Seat belt replacement**  
**Replace your seat belts after being in an accident. Failure to replace seat belts after an accident could leave you with damaged seat belts that will not provide protection in the event of another collision.**

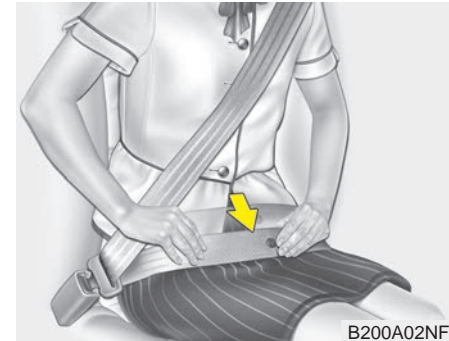

You should place the lap belt portion as low as possible and snugly across your hips, not on your waist. If the lap belt is located too high on your waist, it may increase the chance of injury in the event of a collision. Both arms should not be under or over the belt. Rather, one should be over and the other under, as shown in the illustration.

Never wear the seat belt under the arm that is near the door.

### ***Seat belts - Front passenger and rear seat 3-point system with combination locking retractor***

#### **To fasten your seat belt:**

Combination retractor type seat belts are installed in the rear seat positions to help accommodate the installation of child restraint systems. Although a combination retractor is also installed in the front passenger seat position, it is strongly recommended that children always be seated in the rear seat. NEVER place any infant restraint system in the front seat of the vehicle.

This type of seat belt combines the features of both an emergency locking retractor seat belt and an automatic locking retractor seat belt. To fasten your seat belt, pull it out of the retractor and insert the metal tab into the buckle. There will be an audible "click" when the tab locks into the buckle. When not securing a child restraint, the seat belt operates in the same way as the driver's seat belt (Emergency Locking Retractor Type).

It automatically adjusts to the proper length only after the lap belt portion of the seat belt is adjusted manually so that it fits snugly around your hips.

When the seat belt is fully extended from the retractor to allow the installation of a child restraint system, the seat belt operation changes to allow the belt to retract, but not to extend (Automatic Locking Retractor Type). Refer to "Using a child restraint system" in this section.

#### **\* NOTICE**

**Although the combination retractor provides the same level of protection for seated passengers in either emergency or automatic locking modes, have the seated passengers use the emergency locking feature for improved convenience. The automatic locking function is intended to facilitate child restraint installation. To convert from the automatic locking feature to the emergency locking operation mode, allow the unbuckled seat belt to fully retract.**

Do NOT fold down the left portion of the rear seat back when the rear center seat belt is buckled. ALWAYS UNBUCKLE the rear center seat belt before folding down the left portion of the rear seat back. If the rear center seat belt is buckled when the left portion of the rear seat back is folded down, distortion and damage to the top portion of the seat back and seat belt garnish may result, causing the seat back to lock into the folded down position.

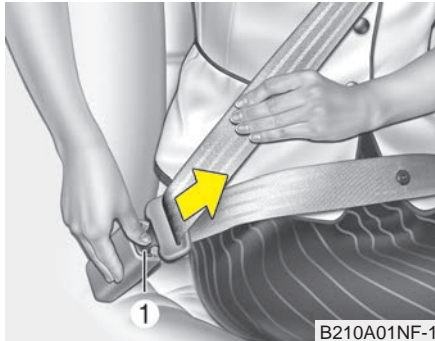

**To release the seat belt:**

The seat belt is released by pressing the release button (1) on the locking buckle. When it is released, the belt should automatically draw back into the retractor.

If this does not happen, check the belt to be sure it is not twisted, then try again.

**Stowing the rear seat belt**

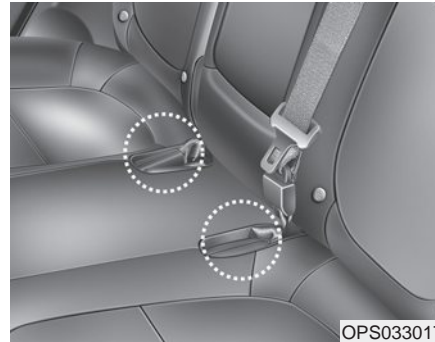

The rear seat belt buckles can be stowed in the pocket between the rear seatback and cushion when not in use.

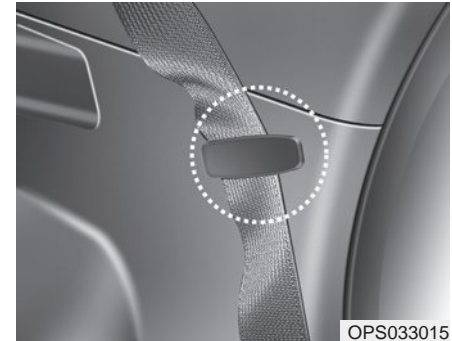

Routing the seat belt webbing through the rear seat belt guides will help keep the belts from being trapped behind or under the seats.

After inserting the seat belt, tighten the belt webbing by pulling it up.

**⚠ CAUTION - Seat belt guide**

*Remove the seat belt from the guides before using. If you pull on the seat belt when it is stored in the guides, it may damage the guides and/or belt webbing.*

### 3 Point rear center belt

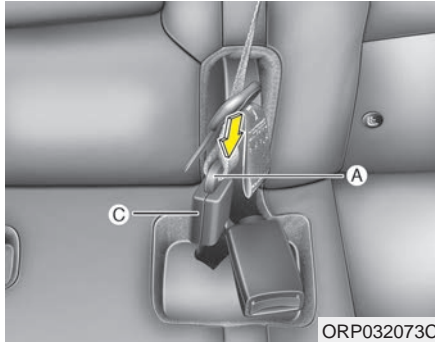

#### To fasten the rear center belt

1. Insert the mini tongue (A) into the open end of the anchor connector (C) until an audible “click” is heard, indicating the latch is locked. Make sure the belt is not twisted.

**⚠ WARNING - Rear center seat belt**  
Do not separate mini tongue and mini buckle even if there is not an occupant.  
If it is separated, It may hit the rear seat occupants in a collision or sudden stops.

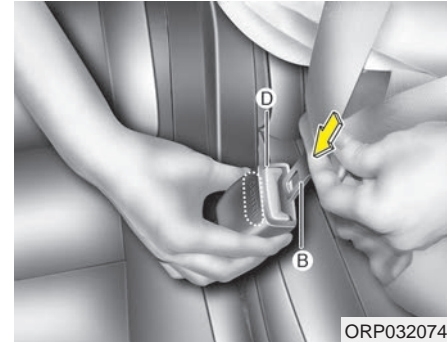

2. Pull the tongue plate (B) and insert the tongue plate (B) into the open end of the buckle (D) until an audible “click” is heard, indicating the latch is locked. Make sure the belt is not twisted.

When using the rear center seat belt, the buckle with the “CENTER” mark must be used.

There will be an audible “click” when the tab locks in the buckle. The seat belt automatically adjusts to the proper length only after the lap belt is adjusted manually so that it fits snugly around your hips, if you lean forward in a slow, easy motion, the belt will extend and let you move around. If there is a sudden stop or impact, the belt will lock into position. It will also lock if you try to lean forward too quickly.

When using the rear seat center belt, you must lock all tongue plates and buckles.

**To unfasten the rear center belt**

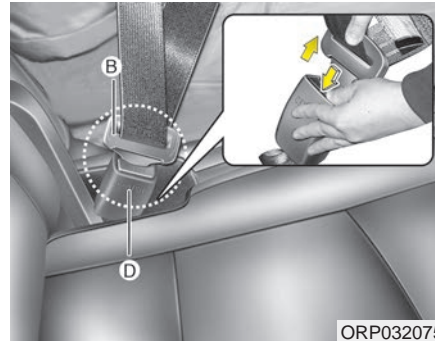

Press the release button on the buckle (D) and remove the tongue plate (B) from the buckle (D).

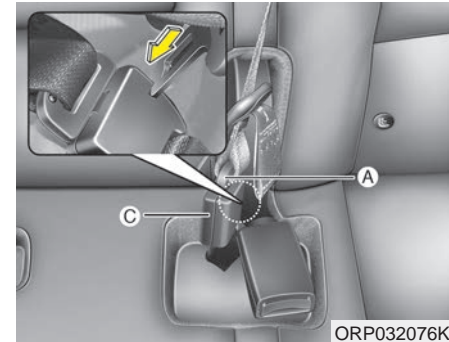

**When you fold the rear seatback**

To retract the rear center seatbelt, insert the tongue plate or similar small rigid device into the web release hole (C). Pull up on the seat belt web (A) and allow the webbing to retract automatically.



### Pre-tensioner seat belt



Your vehicle is equipped with driver's and front passenger's pre-tensioner seat belts (retractor pretensioner and EFD (Emergency Fastening Device)). The pre-tensioner seat belts may be activated, when a frontal collision is severe enough, together with the air bags.

When the vehicle stops suddenly, or if the occupant tries to lean forward too quickly, the seat belt retractor may lock into position. In certain frontal collisions, the pre-tensioner will activate and pull the seat belt into tighter contact against the occupant's body.

#### (1) Retractor Pretensioner

The purpose of the retractor pretensioner is to make sure that the shoulder belts fit in tightly against the occupant's upper body in certain frontal collisions.

#### (2) EFD (Emergency Fastening Device)

The purpose of the EFD is to make sure that the pelvis belts fit in tightly against the occupant's lower body in certain frontal collisions.

If the system senses excessive tension on the driver or passenger's seat belt when the pre-tensioner system activates, the load limiter inside the retractor pre-tensioner will release some of the pressure on the affected seat belt.

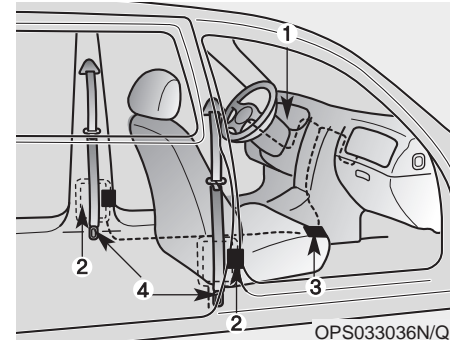

The seat belt pre-tensioner system consists mainly of the following components. Their locations are shown in the illustration:

1. SRS air bag warning light
2. Retractor pre-tensioner assembly
3. SRS control module
4. Emergency fastening device (EFD)

**\* NOTICE**

When the pre-tensioner seat belts are activated, a loud noise may be heard and fine dust, which may appear to be smoke, may be visible in the passenger compartment. These are normal operating conditions and are not hazardous.

- Both the driver's and front passenger's seat belt pre-tensioner system may be activated not only in certain frontal collision but also in certain side collision or rollover, if the vehicle is equipped with a side or curtain air bag.
- Because the sensor that activates the SRS air bag is connected with the pre-tensioner seat belt, the SRS air bag warning light  on the instrument panel will illuminate for approximately 6 seconds after the ignition switch has been turned to the ON position, and then it should turn off.

**⚠ WARNING - Skin irritation**  
**Wash all exposed skin areas thoroughly after an accident in which the pre-tensioner seat belts were activated. The fine dust from the pre-tensioner activation may cause skin irritation and should not be breathed for prolonged periods.**

If the pre-tensioner seat belt system are not working properly, this warning light will illuminate even if there is no malfunction of the SRS air bag. If the SRS air bag warning light does not illuminate when the ignition switch is turned ON, or if it remains illuminated after illuminating for approximately 6 seconds, or if it illuminates while the vehicle is being driven, have an authorized Kia Premium dealer inspect the pre-tensioner seat belt and SRS air bag system as soon as possible.

- Pre-tensioners are designed to operate only one time. After activation, pre-tensioner seat belts must be replaced. All seat belts, of any type, should always be replaced after they have been worn during a collision.
- Do not strike the pre-tensioner seat belt assemblies.

**⚠ WARNING - Hot pre-tensioner**

**Do not touch the pre-tensioner seat belt assemblies for several minutes after they have been activated. When the pre-tensioner seat belt mechanism fires during a collision the pre-tensioner becomes hot and can burn you.**

**Seat belt precautions**

*Infant or small child*

Child and/or infant seats must be properly placed and installed in the rear seat. For more information about the use of these restraints, refer to “Child restraint system” in this section.

**\* NOTICE**

Small children are best protected from injury in an accident when properly restrained in the rear seat by a child restraint system that meets the requirements of the safety standards of your country. Before buying any child restraint system, make sure that it has a label certifying that it meets safety standards of your country. The restraint must be appropriate for your child's height and weight. Check the label on the child restraint for this information. Refer to “Child restraint system” in this chapter.

### **Larger children**

Children who are too large for child restraint systems should always occupy the rear seat and use the available lap/shoulder belts. The lap portion should be fastened and snugged on the hips and as low as possible. Check if the belt fits periodically. A child's squirming could put the belt out of position. Children are given the most safety in the event of an accident when they are restrained by a proper restraint system in the rear seat. If a larger child (over age 12) must be seated in the front seat, the child should be securely restrained by the available lap/shoulder belt and the seat should be placed in the rearmost position. Children age 12 and under should be restrained securely in the rear seat. NEVER place a child age 12 and under in the front seat. NEVER place a rear facing child seat in the front seat of a vehicle.

If the shoulder belt portion slightly touches the child's neck or face, try placing the child closer to the center of the vehicle. If the shoulder belt still touches their face or neck they need to be returned to a child restraint system.

 **WARNING - Small children**

**Do not allow small children to ride in the vehicle without an appropriate child restraint system. If the shoulder belt comes in contact with your child's neck or face your child is too small to ride in the vehicle. In a crash the seat belt will inflict injury to your child's neck, throat and face.**

### **Restraint of pregnant women**

Pregnant women should wear lap/shoulder belt assemblies whenever possible according to specific recommendations by their doctors. The lap portion of the belt should be worn AS SECURELY AND LOW AS POSSIBLE.

 **WARNING - Pregnant women**

**Pregnant women must never place the lap portion of the seat belt above or on the abdomen where the fetus is located. The force of the seat belt during a collision will crush the fetus.**

### ***Injured person***

A seat belt should be used when an injured person is being transported. When this is necessary, you should consult a physician for recommendations.

### ***One person per belt***

Two people (including children) should never attempt to use a single seat belt. This could increase the severity of injuries in case of an accident.

### ***Do not lie down***

To reduce the chance of injuries in the event of an accident and to achieve maximum effectiveness of the restraint system, all passengers should be sitting up and the front and rear seats should be in an upright position when the vehicle is moving. A seat belt cannot provide proper protection if the person is lying down in the rear seat or if the front and rear seats are in a reclined position.

### **Care of seat belts**

Seat belt systems should never be disassembled or modified. In addition, care should be taken to assure that seat belts and belt hardware are not damaged by seat hinges, doors or other abuse.

#### **WARNING - Pinched seat belt**

**Make sure that the webbing and/or buckle does not get caught or pinched in the rear seat when returning the rear seatback to its upright position. A caught or pinched webbing/buckle may become damaged and could fail during a collision or sudden stop.**

***Periodic inspection***

All seat belts should be inspected periodically for wear or damage of any kind. Any damaged parts should be replaced as soon as possible.

***Keep belts clean and dry***

Seat belts should be kept clean and dry. If belts become dirty, they can be cleaned by using a mild soap solution and warm water. Bleach, dye, strong detergents or abrasives should not be used because they may damage and weaken the fabric.

***When to replace seat belts***

The entire in-use seat belt assembly or assemblies should be replaced if the vehicle has been involved in an accident. This should be done even if no damage is visible. Additional questions concerning seat belt operation should be directed to an authorized Kia dealer.

## CHILD RESTRAINT SYSTEM

Children riding in the vehicle should sit in the rear seat and must always be properly restrained to minimize the risk of injury in an accident, sudden stop or sudden maneuver. According to accident statistics, children are safer when properly restrained in the rear seats than in the front seat. Larger children not in a child restraint should use one of the seat belts provided.

You should be aware of the specific requirements in your country. Child and/or infant safety seats must be properly placed and installed in the rear seat. You must use a commercially available child restraint system that meets the requirements of the Safety Standards of your country.

Child restraint systems are designed to be secured in vehicle seats by the lap belt portion of a lap/shoulder belt, or by a tether anchor and/or LATCH anchors (if equipped).

Children could be injured or killed in a crash if their restraints are not properly secured. For small children and babies, a child seat or infant seat must be used. Before buying a particular child restraint system, make sure it fits your vehicle seat and seat belts, and fits your child.

Follow all the instructions provided by the manufacturer when installing the child restraint system.

### **WARNING - Restraint location**

**Never install a child or infant seat on the front passenger's seat. A child riding in the front passenger seat can be forcefully struck by an inflating airbag.**

### **WARNING- Hot child restraint**

**A child restraint system can become very hot if it is left in a closed vehicle on a sunny day. Be sure to check the seat cover, buckles and latches before placing a child in the restraint system.**

When the child restraint system is not in use, store it in the luggage area or fasten it with a seat belt so that it will not be thrown forward in case of a sudden stop or an accident.

**⚠ WARNING**

**- Holding children**

Never hold a child in your arms or lap when riding in a vehicle. The violent forces created during a crash will tear the child from your arms and throw the child against the car's interior. Always use a child restraint system which is appropriate for your child's height and weight.

**⚠ WARNING - Unattended Children**

Never leave children unattended in a vehicle. The car can heat up very quickly, resulting in injuries to the child in the vehicle.

**⚠ WARNING - Seat belt use**

Do not use one seat belt for two occupants at the same time. This will eliminate any safety benefit provided by the seat belt to the occupants.

After an accident, have an authorized Kia dealer check the child restraint system, seat belt, tether anchor and lower anchor.

**Using a child restraint system**

Rearward-facing child restraint system

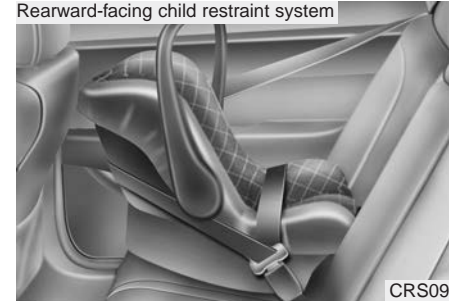

CRS09

Forward-facing child restraint system



OUN026150

For small children and babies, the use of a child seat or infant seat is required. The child seat or infant seat should be of appropriate size for the child and should be installed in accordance with the manufacturer's instructions.



For safety reasons, we recommend that the child restraint system be used in the rear seats.

Never place a rear-facing child restraint in the front passenger seat, because of the danger an inflating passenger-side air bag could impact the rear-facing child restraint and kill the child.

Since all passenger seat belts move freely under normal conditions and only lock under extreme or emergency conditions (emergency lock mode), you must manually change these seat belts to the auto lock mode to secure a child restraint.

If the seat belt does not operate as described in this section, have the system checked immediately by your authorized Kia dealer.

### **⚠ WARNING - Child seat installation**

- **Always follow the instructions provided by the child restraint system manufacturer. Child restraint system manufacturers know their products best.**
- **Failure to observe this manual's instructions regarding child restraint system and the instructions provided with the child restraint system could result in the improper installation of the child restraint system which may reduce the protection to your child in a crash or a sudden stop.**

### **\* NOTICE**

**If the vehicle headrest prevents proper installation of a child seat (as described in the child seat system manual), the headrest of the respective seating position shall be readjusted or entirely removed.**

### ***Placing a passenger seat belt into the auto lock mode***

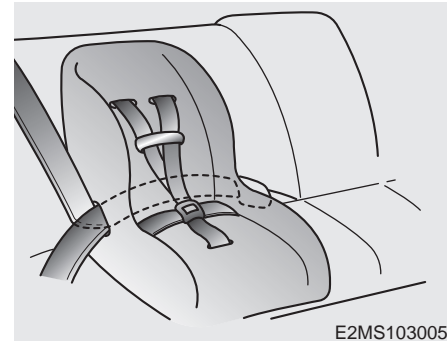

The auto lock mode will help prevent the normal movement of the child in the vehicle from causing the seat belt to loosen and compromise the child restraint system. To secure a child restraint system, use the following procedure.

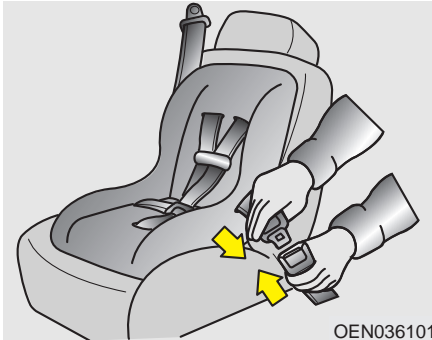

To install a child restraint system on the outboard or center rear seats, do the following:

1. Place the child restraint system in the seat and route the lap/shoulder belt around or through the restraint, following the restraint manufacturer's instructions. Be sure the seat belt webbing is not twisted.
2. Fasten the lap/shoulder belt latch into the buckle. Listen for the distinct "click" sound.

*Position the release button so that it is easy to access in case of an emergency.*

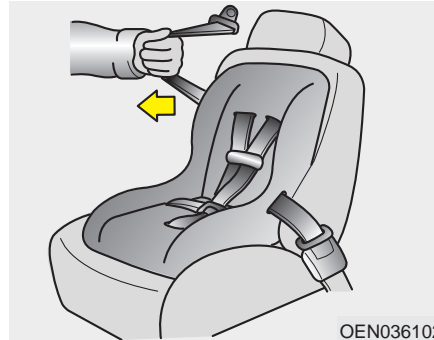

3. Pull the shoulder portion of the seat belt all the way out. When the shoulder portion of the seat belt is fully extended, it will shift the retractor to the "Auto Lock" (child restraint) mode.



4. Slowly allow the shoulder portion of the seat belt to retract and listen for an audible "clicking" or "ratcheting" sound. This indicates that the retractor is in the "Auto Lock" mode. If no distinct sound is heard, repeat steps 3 and 4.

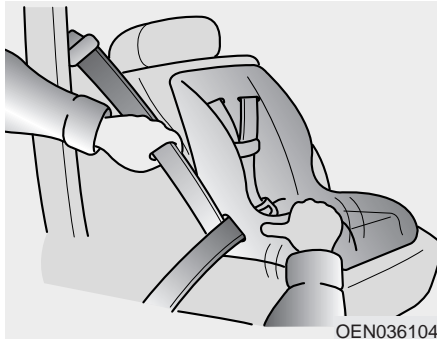

5. Remove as much slack from the belt as possible by pushing down on the child restraint system while feeding the shoulder belt back into the retractor.
6. Push and pull on the child restraint system to confirm that the seat belt is holding it firmly in place. If it is not, release the seat belt and repeat steps 2 through 6.
7. Double check that the retractor is in the “Auto Lock” mode by attempting to pull more of the seat belt out of the retractor. If you cannot, the retractor is in the “Auto Lock” mode.

The lap/shoulder belt automatically returns to the “emergency lock mode” whenever the belt is allowed to retract fully. Therefore, the preceding seven steps must be followed each time a child restraint is installed.

To remove the child restraint, press the release button on the buckle and then pull the lap/shoulder belt out of the restraint and allow the seat belt to retract fully.

**⚠ WARNING - Auto lock mode**

**Set the retractor to Automatic Lock mode when installing any child restraint system. If the retractor is not in the Automatic Locking mode, the child restraint can move when your vehicle turns or stops suddenly.**

**When the seat belt is allowed to retract to its fully stowed position, the retractor will automatically switch from the “Auto Lock” mode to the emergency lock mode for normal adult usage.**

**Securing a child restraint seat with tether anchor system**

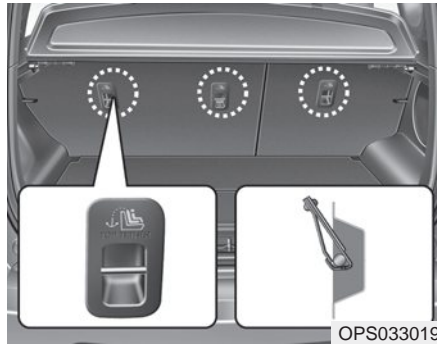

Child restraint hook holders are located on the back of the rear seatbacks.



This symbol indicates the position of the tether anchor.

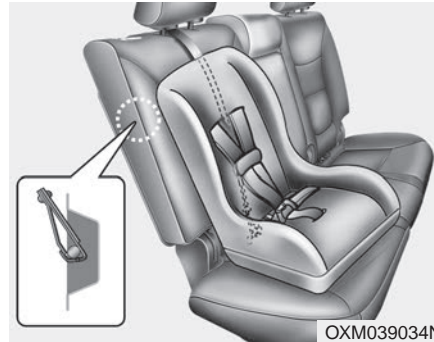

1. Route the child restraint seat strap over the seatback.

For vehicles with adjustable headrests, route the tether strap under the headrest and between the headrest posts, otherwise route the tether strap over the top of the seatback. In case of interference between the child restraint seat and the headrest remove the particular head restraint for better fitment of the child restraint seat.

2. Connect the tether strap hook to the appropriate child restraint hook holder and tighten to secure the child restraint seat.

**⚠ WARNING - Tether strap**  
 Never mount more than one child restraint to a single tether or to a single lower anchorage point. The increased load caused by multiple seats may cause the tethers or anchorage points to break.

Check that the child restraint system is secure by pushing and pulling it in different directions. Incorrectly fitted child restraints may swing, twist, tip or separate causing death or serious injury.

### ***Securing a child restraint seat with child seat lower anchor system***

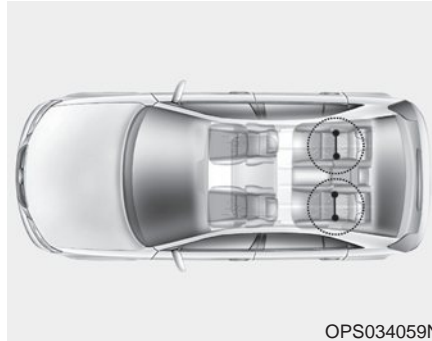

Some child seat manufacturers make child restraint seats that are labeled as LATCH or LATCH-compatible child restraint seats. LATCH stands for "Lower Anchors and Tethers for Children". These seats include two rigid or webbing mounted attachments that connect to two LATCH anchors at specific seating positions in your vehicle. This type of child restraint seat eliminates the need to use seat belts to attach the child seat in the rear seats.

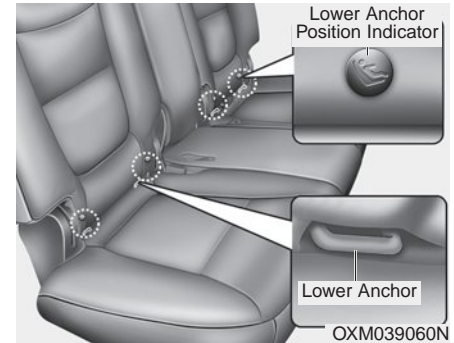

Child restraint symbols are located on the left and right 2nd row seat backs to indicate the position of the lower anchors for child restraints.

**⚠ WARNING - Unused rear seatbelts**

Always fasten the seatbelts behind the child restraint seat when they are not used to secure the child seat. Failure to do so may result in child strangulation.

Install the child restraint seat fully rearward against the seatback with the seatback reclined two positions from the most upright latched position.

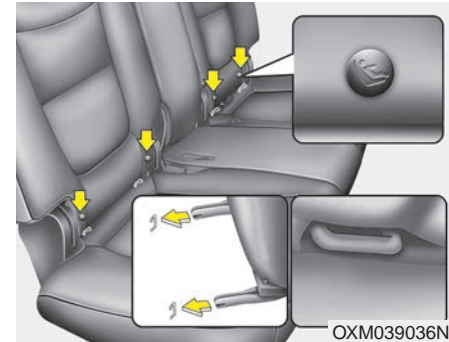

LATCH anchors have been provided in your vehicle. The LATCH anchors are located in the left and right outboard rear seating positions. Their locations are shown in the illustration. There is no LATCH anchor provided for the center rear seating position.

The LATCH anchors are located between the seatback and the seat cushion of the 2nd row seat left and right outboard seating positions.

Follow the child seat manufacturer's instructions to properly install child restraint seats with LATCH or LATCH-compatible attachments.

Once you have installed the LATCH child restraint, assure that the seat is properly attached to the LATCH and tether anchors.

Also, test the child restraint seat before you place the child in it. Tilt the seat from side to side. Also try to tug the seat forward. Check to see if the anchors hold the seat in place.

**⚠ WARNING - LATCH lower anchors**

**Never attempt to attach a LATCH equipped seat in the center seating position. LATCH lower anchors are only to be used with the left and right rear outboard seating positions. You may damage the anchors or the anchors may fail and break in a collision.**

## AIR BAG - ADVANCED SUPPLEMENTAL RESTRAINT SYSTEM

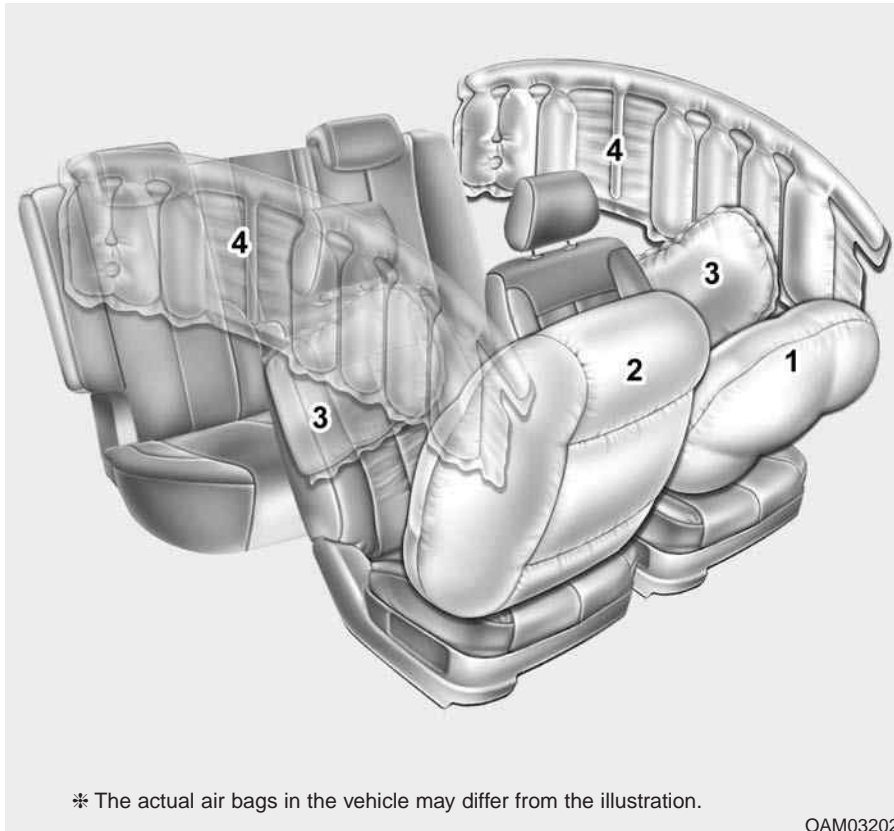

- (1) Driver's front air bag
- (2) Passenger's front air bag
- (3) Side air bag
- (4) Curtain air bag

Even in vehicles with air bags, you and your passengers must always wear the safety belts provided in order to minimize the risk and severity of injury in the event of a collision or rollover.

\* The actual air bags in the vehicle may differ from the illustration.

OAM032026



### How does the air bag system operate

- Air bags are activated (able to inflate if necessary) only when the ignition switch is turned to the ON or START position.
- The appropriate air bags inflate instantly in the event of a serious frontal collision or side collision in order to help protect the occupants from serious physical injury.
- There is no single speed at which the air bags will inflate.

Generally, air bags are designed to inflate based upon the severity of a collision and its direction. These two factors determine whether the sensors produce an electronic deployment/ inflation signal.

- Air bag deployment depends on a number of factors including vehicle speed, angles of impact and the density and stiffness of the vehicles or objects which your vehicle hits in the collision. The determining factors are not limited to those mentioned above.

- The front air bags will completely inflate and deflate in an instant.

It is virtually impossible for you to see the air bags inflate during an accident.

It is much more likely that you will simply see the deflated air bags hanging out of their storage compartments after the collision.

- In addition to inflating in serious side collisions, side and/or curtain air bags will inflate if the sensing system detects a rollover.
- When a rollover is detected, curtain air bags will remain inflated longer to help provide protection from ejection, especially when used in conjunction with the seat belts.

- In order to help provide protection, the air bags must inflate rapidly. The speed of the air bag inflation is a consequence of extremely short time in which to inflate the air bag between the occupant and the vehicle structures before the occupant impacts those structures. This speed of inflation reduces the risk of serious or life-threatening injuries and is thus a necessary part of the air bag design.

However, air bag inflation can also cause injuries which can include facial abrasions, bruises and broken bones because the inflation speed also causes the air bags to expand with a great deal of force.

- **There are even circumstances under which contact with the steering wheel or passenger air bag can cause fatal injuries, especially if the occupant is positioned excessively close to the steering wheel or passenger air bag.**

**⚠ WARNING**

**- Airbag inflation**

**Sit as far back as possible from the steering wheel while still maintaining comfortable control of your vehicle. A distance of at least 10" from your chest to the steering wheel is recommended. Failure to do so can result in airbag inflation injuries to the driver.**

***Noise and smoke***

When inflated, the air bags make a loud noise and leave smoke and powder in the air inside the vehicle. This is normal and is a result of the ignition of the air bag inflator. After the air bag inflates, you may feel substantial discomfort in breathing due to the contact of your chest with both the seat belt and the air bag, as well as from breathing the smoke and powder. **Open your doors and/or windows as soon as possible after impact in order to reduce discomfort and prevent prolonged exposure to the smoke and powder.**

Though smoke and powder are non-toxic, it may cause irritation to the skin (eyes, nose and throat, etc). If this is the case, wash and rinse with cold water immediately and consult a doctor if the symptom persists.

**⚠ WARNING**

**- Hot components**

**Do not touch the air bag storage area's internal components immediately after airbag inflation. The air bag related parts in the steering wheel, instrument panel and the roof rails above the front and rear doors are very hot. Hot components can result in burn injuries.**

**Do not install a child restraint on the front passenger's seat.**



Never place a rear-facing child restraint in the front passenger's seat. If the air bag deploys, it would impact the rear-facing child restraint, causing serious or fatal injury.

In addition, do not place front-facing child restraints in the front passenger's seat either. If the front passenger air bag inflates, it could cause serious or fatal injuries to the child.

### **⚠ WARNING - Air bag deployment**

**When children are seated in the rear outboard seats of a vehicle equipped with side and/or curtain air bags, install the child restraint system as far away from the door side as possible. Inflation of the side and/or curtain air bags could impact the child.**

### **Air bag warning light**



The purpose of air bag warning light in your instrument panel is to alert you of a potential problem with your air bag system, which could include your side and/or curtain air bags used for rollover protection.

When the ignition switch is turned ON, the warning light should illuminate for approximately 6 seconds, then go off. Have the system checked by an authorized Kia dealership if:

- The light does not turn on briefly when you turn the ignition ON.
- The light stays on after illuminating for approximately 6 seconds.
- The light comes on while the vehicle is in motion.
- The light blinks when the ignition switch is in ON position.

### SRS components and functions

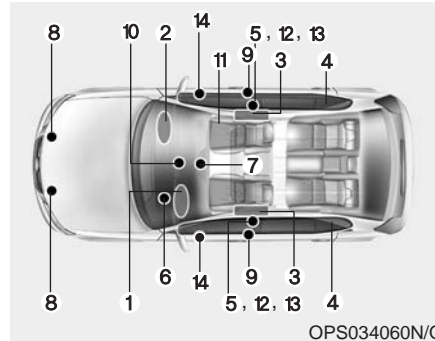

OPS034060N/Q

The SRS consists of the following components:

1. Driver's front air bag module
2. Passenger's front air bag module
3. Side air bag modules
4. Curtain air bag modules
5. Retractor pre-tensioner assemblies
6. Air bag warning light
7. SRS control module (SRSCM)/ Rollover sensor
8. Front impact sensors
9. Side impact sensors

10. PASSENGER "AIR BAG OFF" indicator (Front passenger's seat only)
11. Occupant detection system (Front passenger's seat only)
12. Driver's and front passenger's seat belt buckle sensors
13. Emergency fastening device (EFD)
14. Side pressure impact sensor

The SRSCM continually monitors all SRS components while the ignition switch is ON to determine if a crash impact is severe enough to require air bag deployment or pre-tensioner seat belt deployment.

## Safety features of your vehicle



If the air bag warning light illuminated for more than, 6 seconds after the ignition is turned on, or if it illuminates during vehicle operation, an SRS component may not be functioning properly and you should have your vehicle checked by an authorized Kia dealer.

If any of the following conditions occurs, this indicates a malfunction in the air bag system. Have an authorized Kia dealer inspect the air bag system as soon as possible.

- The light does not turn on briefly when you turn the ignition ON.
- The light stays on after illuminating for approximately 6 seconds.
- The light comes on while the vehicle is in motion.
- The light blinks when the ignition switch is in ON position.

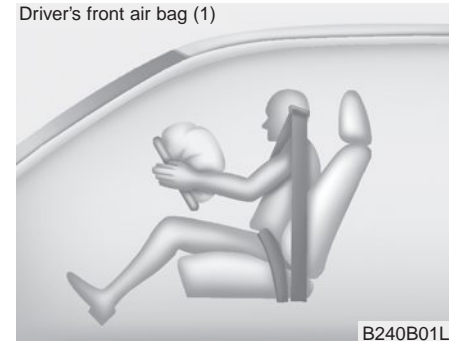

The front air bag modules are located both in the center of the steering wheel and in the front passenger's panel above the glove box. When the SRSCM detects a sufficiently severe impact to the front of the vehicle, it will automatically deploy the front air bags.

Driver's front air bag (2)

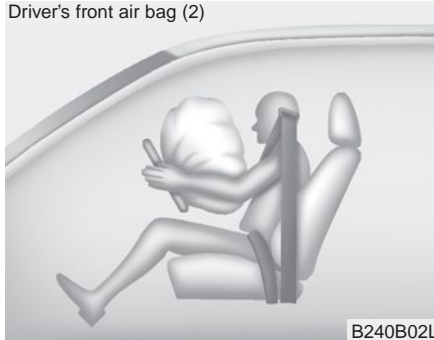

Upon deployment, tear seams molded directly into the pad covers will separate under pressure from the expansion of the air bags. Further opening of the covers then allows full inflation of the air bags.

Driver's front air bag (3)

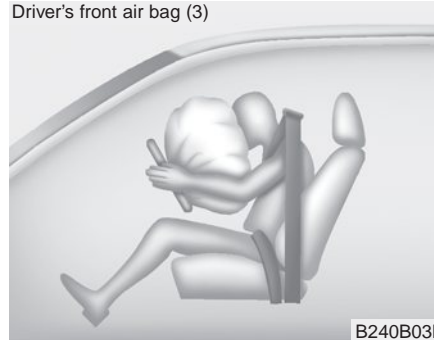

A fully inflated air bag, in combination with a properly worn seat belt, slows the driver's or the passenger's forward motion, reducing the risk of head and chest injury.

After complete inflation, the air bag immediately starts deflating, enabling the driver to maintain forward visibility and the ability to steer or operate other controls.

Passenger's front air bag



**⚠ WARNING**  
**- Air bag obstructions**

**Do not install or place any accessories on the steering wheel, instrument panel, or on the front passenger's panel above the glove box in a vehicle. Such objects may become dangerous projectiles if the air bag deploys.**

### **⚠ WARNING - Flying objects**

**Do not place any objects (an umbrella, bag, etc.) between the front door and the front seat. Such objects may become dangerous projectiles if the side airbag inflates.**

If an air bag deploys, there may be a loud noise followed by a fine dust released in the vehicle. These conditions are normal and are not hazardous - the air bags are packed in this fine powder. The dust generated during air bag deployment may cause skin or eye irritation as well as aggravate asthma for some persons. Always wash all exposed skin areas thoroughly with lukewarm water and a mild soap after an accident in which the air bags were deployed.

The SRS can function only when the ignition switch is in the ON position. If the SRS air bag warning light does not illuminate, or continuously remains on after illuminating for about 6 seconds when the ignition switch is turned to the ON position, or after the engine is started, comes on while driving, the SRS is not working properly. If this occurs, have your vehicle immediately inspected by an authorized Kia dealer.

### **\* NOTICE**

**Before you replace a fuse or disconnect a battery terminal, turn the ignition switch to the LOCK position and remove the ignition switch. Never remove or replace the air bag related fuse(s) when the ignition switch is in the ON position. Failure to observe this warning will cause the SRS air bag warning light to illuminate.**

### **Occupant Detection System (ODS)**

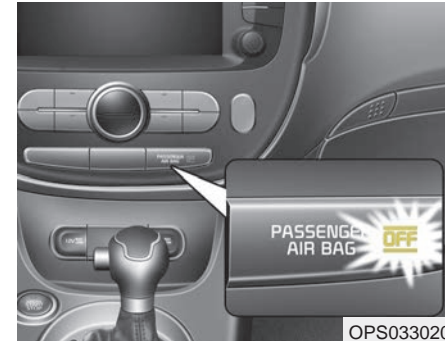

Your vehicle is equipped with an occupant detection system in the front passenger's seat.

The occupant detection system is designed to detect the presence of a properly-seated front passenger and determine if the passenger's front air bag should be enabled (may inflate) or not. Only the front passenger front air bag is controlled by the Occupant Detection System.

Do not put anything in front of the passenger air bag **OFF** indicator.

### ***Main components of the occupant detection system***

- A detection device located within the front passenger seat cushion.
- An electronic system which determines whether the passenger air bag systems should be activated or deactivated.
- A indicator light located on the instrument panel which illuminates the words PASSENGER AIR BAG “OFF” indicating the front passenger air bag system is deactivated.
- The instrument panel air bag warning light is interconnected with the occupant detection system.

If the front passenger seat is occupied by a person that the system determines to be of appropriate size, and he/she sits properly (sitting upright with the seatback in an upright position, centered on the seat cushion with their seat belt on, legs comfortably extended and their feet on the floor), the PASSENGER AIR BAG “OFF” indicator will turn off and the front passenger's air bag will be able to inflate, if necessary, in frontal crashes.

You will find the PASSENGER AIR BAG “OFF” indicator on the center facia panel. This system detects the conditions 1~4 in the following table and activates or deactivates the front passenger air bag based on these conditions.

Always be sure that you and all vehicle occupants are seated and restrained properly (sitting upright with the seat in an upright position, centered on the seat cushion, with the person's legs comfortably extended, feet on the floor, and wearing the safety belt properly) for the most effective protection by the air bag and the safety belt.

- The ODS (Occupant Detection System) may not function properly if the passenger takes actions which can defeat the detection system. These include:
  - (1) Failing to sit in an upright position.
  - (2) Leaning against the door or center console.
  - (3) Sitting towards the sides or the front of the seat.
  - (4) Putting legs on the dashboard or resting them on other locations which reduce the passenger weight on the front seat.
  - (5) Improperly wearing the safety belt.
  - (6) Reclining the seat back.
  - (7) Wearing a thick cloth like ski wear or hip protection wear.
  - (8) Put on the seat an additional thick cushion.



### **Condition and operation in the front passenger occupant detection system**

Condition detected by the occupant detection system	Indicator/Warning light		Devices
	"PASSENGER AIR BAG OFF" indicator light	SRS warning light	Front passenger air bag
1. Adult or child*1	Off	Off	Activated
2. Child restraint system*2	On	Off	Deactivated
3. Unoccupied	On	Off	Deactivated
4. There is a malfunction in the system	Off	On	Activated

\*1 : The ODS system uses a field to evaluate a person's size to determine whether the air bag should deploy. It is possible for a child to be detected and activate the ODS, thus allowing the air bag to deploy. To maximize safety, do not allow children to ride in the front passenger seat.

\*2 : Never install a child restraint system on the front passenger seat.

### **\* NOTICE**

**Do not modify or replace the front passenger seat. Don't place anything on or attach anything such as a blanket, front seat cover or after market seat heater to the front passenger seat. This can adversely affect the occupant detection system.**



### **WARNING - ODS System**

**Riding in an improper position adversely affects the Occupant Detection System and may result in the deactivation of the front passenger airbag. It is important for the driver to instruct the passenger as to the proper seating instructions as contained in this manual.**

**(Continued)**

(Continued)



- Never put a heavy load or an active electronic device on the front passenger seat or seatback pocket.

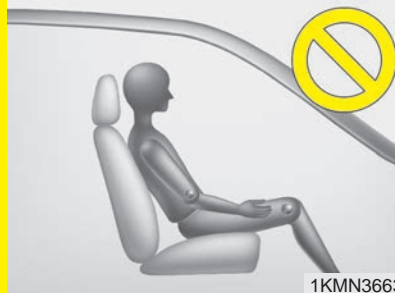

- Never sit with hips shifted towards the front of the seat.



- Never place feet on the dashboard.

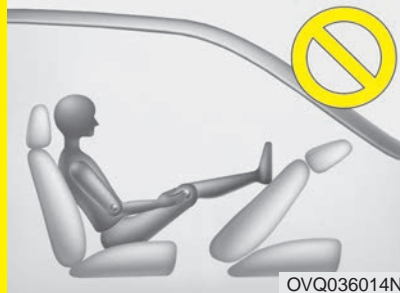

- Never place feet on the front passenger seatback.

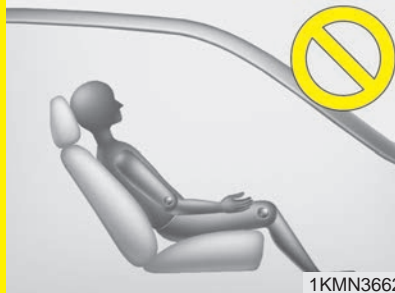

- Never excessively recline the front passenger seatback.



- Never lean on the door or center console.  
- Never sit on one side of the front passenger seat.

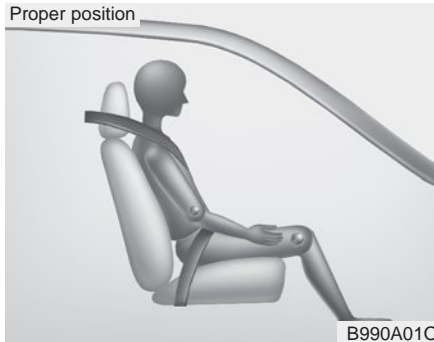

When an adult is seated in the front passenger seat, if the PASSENGER AIR BAG “OFF” indicator is on, turn the ignition switch to the LOCK position and ask the passenger to sit properly (sitting upright with the seat back in an upright position, centered on the seat cushion with their seat belt on, legs comfortably extended and their feet on the floor). Restart the engine and have the person remain in that position. This will allow the system to detect the person and to enable the passenger air bag.

If the PASSENGER AIR BAG “OFF” indicator is still on, ask the passenger to move to the rear seat.

### **⚠ WARNING - “AIR BAG OFF” light**

Do not allow an adult passenger to ride in the front seat when the PASSENGER AIR BAG “OFF” indicator is illuminated, because the air bag will not deploy in the event of a crash. The driver must instruct the passenger to reposition himself in the seat. Failure to properly position yourself may lead to air bag non-deployment resulting in air bag non-deployment in a collision. If the PASSENGER AIR BAG “OFF” indicator remains illuminated after the passenger repositions themselves properly and the car is restarted, it is recommended that passenger move to the rear seat because the passenger's front air bag will not deploy.

### **\* NOTICE**

The PASSENGER AIR BAG “OFF” indicator illuminates for about 4 seconds after the ignition switch is turned to the ON position or after the engine is started. If the front passenger seat is occupied, the occupant detection sensor will then classify the front passenger after several more seconds.

### **⚠ WARNING - ODS Interference**

- Do not place a heavy load or an active electronic device (ex. laptop computer, after market DMB/navigation/satellite audio, video game machine, MP3, etc.) in the front passenger seatback pocket or on the front passenger seat.
- Do not hang onto the front passenger seat.
- Do not hang any items such as seatback table on the front passenger seatback.

(Continued)

**(Continued)**

- Do not place feet on the front passenger seatback.
- Do not place any items under the front passenger seat.
- Do not place sharp objects on the front passenger seat. These may damage the occupant detection system, if they puncture the seat cushion.
- Do not spill any liquids on the seat.

Any of the above could interfere with the proper operation of the ODS sensor thereby increasing the risk of an injury in an accident.

**\* NOTICE**

Air bags can only be used once - have an authorized Kia dealer replace the air bag immediately after deployment.

Any child age 12 and under should ride in the rear seat. Children too large for child restraints should use the available lap/shoulder belts. No matter what type of crash, children of all ages are safer when restrained in the rear seat.

**\* NOTICE**

Do not modify or replace the front passenger seat. Don't place anything on or attach anything such as a blanket, front seat covers or after market seat heater to the front passenger seat. This can adversely affect the occupant detection system.

If the occupant detection system is not working properly, the SRS air bag warning light on the instrument panel will illuminate because the passenger's front air bag is connected with the occupant detection system. If there is a malfunction of the occupant detection system, the PASSENGER AIR BAG "OFF" indicator will not illuminate and the passenger's front air bag will inflate in frontal impact crashes even if there is no occupant in the front passenger's seat.

**Driver's and passenger's front air bag**

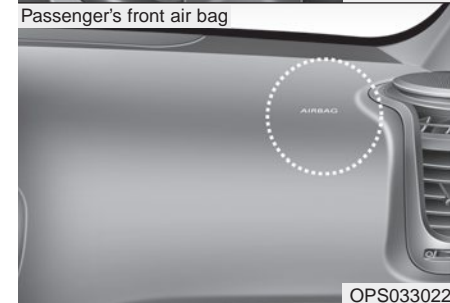

Your vehicle is equipped with an Advanced Supplemental Restraint (Air Bag) System and lap/shoulder belts at both the driver and passenger seating position.

The indication of the system's presence are the letters "AIR BAG" embossed on the air bag pad cover on the steering wheel and the passenger's side front panel pad above the glove box.

The SRS consists of air bags installed under the pad covers in the center of the steering wheel and the passenger's side front panel above the glove box.

The purpose of the SRS is to provide the vehicle's driver and/or the front passenger with additional protection than that offered by the seat belt system alone in case of a frontal impact of sufficient severity. The SRS uses sensors to gather information about the driver's and front passenger's seat belt usage and impact severity.

The seat belt buckle sensors determine if the driver and front passenger's seat belts are fastened.

 **CAUTION - Seat Track Sensor**

***Do not place any objects underneath the front seats as they could damage the seat track position sensor or interfere with the occupant detection system.***

These sensors provide the ability to control the SRS deployment based on whether or not the seat belts are fastened, and how severe the impact is.

The advanced SRS offers the ability to control the air bag inflation with two levels. A first stage level is provided for moderate-severity impacts. A second stage level is provided for more severe impacts.

The passenger's front air bag is designed to help reduce the injury of children sitting close to the instrument panel in low speed collisions. However, children are safer if they are restrained in the rear seat.

According to the impact severity and seat belt usage, the SRSCM (SRS Control Module) controls the air bag inflation. Failure to properly wear seat belts can increase the risk or severity of injury in an accident.

Additionally, your vehicle is equipped with an occupant detection system in the front passenger's seat. The occupant detection system detects the presence of a passenger in the front passenger's seat and will turn off the front passenger's air bag under certain conditions. For more detail, see "Occupant detection system" in this section.

**⚠ WARNING - Modification**

Modification to the seat structure can cause the air bag to deploy at a different level than should be provided.

Manufacturers are required by government regulations to provide a contact point concerning modifications to the vehicle for persons with disabilities, which modifications may affect the vehicle's advanced air bag system. However, Kia does not endorse nor will it support any changes to any part or structure of the vehicle that could affect the advanced air bag system, including the occupant detection system.

**⚠ WARNING - Replacement / Modifications**

The front passenger seat, dashboard or door should not be replaced except by an authorized Kia Premium dealer using original Kia parts designed for this vehicle and model. Any other such replacement or modification could adversely affect the operation of the occupant detection system and your advanced air bags.

Advanced air bags are combined with pre-tensioner seat belts to help provide enhanced occupant protection in frontal crashes. Front air bags are not intended to deploy in collisions in which sufficient protection can be provided by the pre-tensioner seat belt.

**⚠ WARNING - SRS Wiring**

Do not tamper with or disconnect SRS wiring or other components of the SRS system. Doing so could result in injury, due to accidental deployment of the air bags or by rendering the SRS inoperative.

Front air bags are not intended to deploy in side-impact, rear-impact or rollover crashes. In addition, front air bags will not deploy in frontal crashes below the deployment threshold.

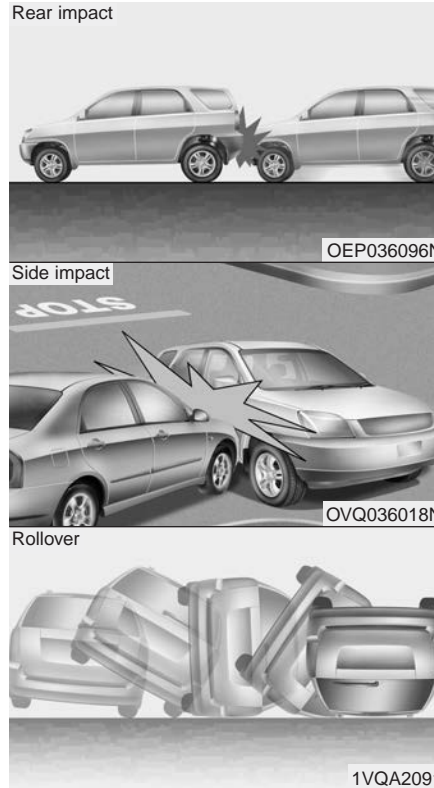

**Side air bag**

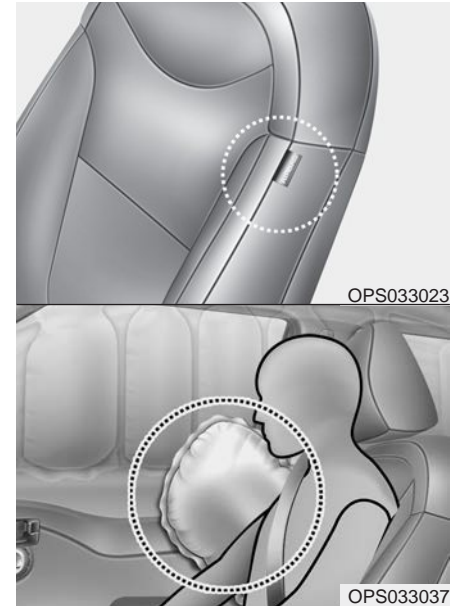

\* The actual air bags in the vehicle may differ from the illustration.

Your vehicle is equipped with a side air bag in each front seat. The purpose of the air bag is to provide the vehicle's driver and/or the front passenger with additional protection than that offered by the seat belt alone.

- The side air bags are designed to deploy during certain side-impact collisions, depending on the crash severity, angle, speed and point of impact.
- The side and/or curtain air bags do not only deploy on the side of the impact but also on the opposite side.
- The side and/or curtain air bags on both sides of the vehicle will deploy if a rollover or possible rollover is detected.
- The side air bags are not designed to deploy in all side impact or rollover situations.
- The side air bag is supplemental to the driver's and the passenger's seat belt systems and is not a substitute for them. Therefore your seat belts must be worn at all times while the vehicle is in motion.
- For best protection from the side air bag system and to avoid being injured by the deploying side air bag, both front seat occupants should sit in an upright position with the seat belt properly fastened. The driver's hands should be placed on the steering wheel at the 9:00 and 3:00 positions. The passenger's arms and hands should be placed on their laps.

**⚠ WARNING - Unexpected deployment**

**Avoid impact to the side impact airbag sensor when the ignition switch is ON to prevent unexpected deployment of the side impact air bag.**

**⚠ WARNING - Deployment**

**Do not install any accessories including seat covers, on the side or near the side impact air bag as this may affect the deployment of the side air bags.**

- If seat or seat cover is damaged, have the vehicle checked and repaired by an authorized Kia dealer. Inform the dealer that your vehicle is equipped with side air bags and an occupant detection system.

**⚠ WARNING - Flying objects**

**Do not place any objects (an umbrella, bag, etc.) between the front door and the front seat. Such objects may become dangerous projectiles if the side airbag inflates.**



### Curtain air bag

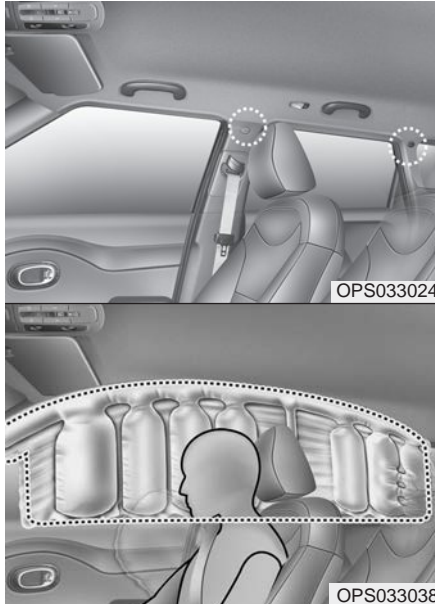

\* The actual air bags in the vehicle may differ from the illustration.

Curtain air bags are located along both sides of the roof rails above the front and rear doors.

They are designed to help protect occupants in certain side impacts and to help prevent them from ejecting out of the vehicle as a result of a rollover, especially when the seatbelts are also in use.

The curtain air bags are designed to deploy during certain side impact collisions, depending on the crash severity, angle, speed and point of impact.

The side and/or curtain air bags do not only deploy on the side of the impact but also on the opposite side.

Also, the curtain air bags on both sides of the vehicle will deploy in certain rollover situations.

The curtain air bags are not designed to deploy in all side impact or rollover situations.

Do not allow the passengers to lean their heads or bodies against the doors, put their arms on the doors, stretch their arms out of the window or place objects between the doors and passengers when they are seated on seats equipped with side impact and/or curtain air bags.

### \* NOTICE

Never try to open or repair any components of the side and curtain air bag system. This should only be done by an authorized Kia dealer.

**Why didn't my air bag go off in a collision? (Inflation and non-inflation conditions of the air bag)**

There are many types of accidents in which the air bag would not be expected to provide additional protection.

These include rear impacts, second or third collisions in multiple impact accidents, as well as low speed impacts.

*Air bag collision sensors*

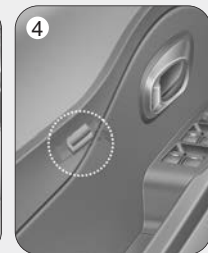
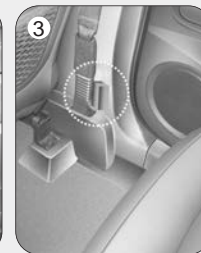
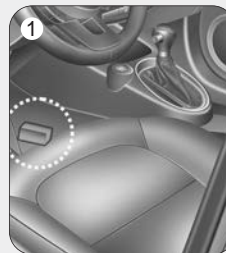

OPS033025N/OPS033026/OPS033027/OPS033028/OPS033029

- (1) SRS control module/Rollover sensor
- (2) Front impact sensor

- (3) Side impact sensor
- (4) Side pressure sensor

### **⚠ WARNING**

#### **- Air bag sensors**

- **Do not hit or allow any objects to impact the locations where air bags or sensors are installed.**

**This may cause unexpected air bag deployment, which could result in serious personal injury or death.**

- **If the installation location or angle of the sensors is altered in any way, the air bags may deploy when they should not or they may not deploy when they should.**

**Therefore, do not try to perform maintenance on or around the air bag sensors. Have the vehicle checked and repaired by an authorized Kia dealer.**

- Problems may arise if the sensor installation angles are changed due to the deformation of the front bumper, front end module, body or front doors and/or B pillar where side collision sensors are installed. Have the vehicle checked and repaired by an authorized Kia dealer.
- Installing bumper guards (or side step or running board) or replacing a bumper (or front door module) with non-genuine parts may adversely affect your vehicle's collision and air bag deployment performance.

### ***Air bag inflation conditions***



### **Front air bags**

Front air bags are designed to inflate in a frontal collision depending on the intensity, speed or angles of impact of the front collision.

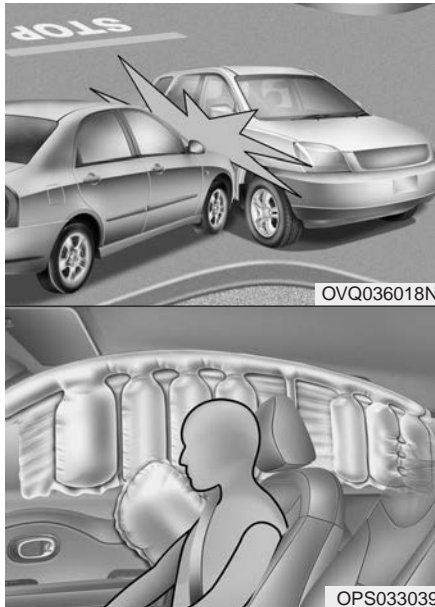

\* The actual air bags in the vehicle may differ from the illustration.

### Side air/or curtain air bags

Side air bags (side and/or curtain air bags) are designed to inflate when an impact is detected by side collision sensors depending on the strength, speed or angles of impact resulting from a side impact collision.

Also, the side and curtain air bags are designed to inflate when a rollover is detected by a rollover sensor.

Although the front air bags (driver's and front passenger's air bags) are designed to inflate in frontal collisions, they also may inflate in other types of collisions if the front impact sensors detect a sufficient frontal force in another type of impact. Side and curtain air bags are designed to inflate in certain side impact collisions. They may inflate in other type of collisions where a side force is detected by the sensors. Side air bag and/or curtain air bags may also inflate where rollover sensors indicate the possibility of a rollover occurring (even if none actually occurs) or in other situations, including when the vehicle is tilted while being towed. Even where side and/or curtain air bags would not provide impact protection in a rollover, however, they will deploy to prevent ejection of occupants, especially those who are restrained with seat belts.

If the vehicle chassis is impacted by bumps or objects on unimproved roads, the air bags may deploy. Drive carefully on unimproved roads or on surfaces not designed for vehicle traffic to prevent unintended air bag deployment.

### Air bag non-inflation conditions



- In certain low-speed collisions the air bags may not deploy. The air bags are designed not to deploy in such cases because they may not provide benefits beyond the protection of the seat belts in such collisions.

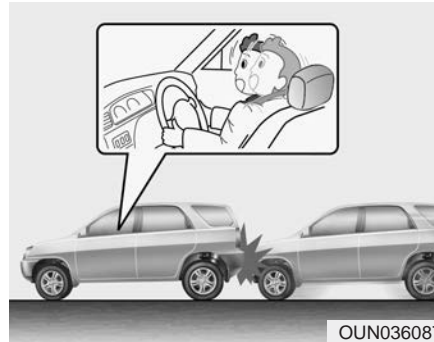

- Air bags are not designed to inflate in rear collisions, because occupants are moved backward by the force of the impact. In this case, inflated air bags would not be able to provide any additional benefit.



- Front air bags may not inflate in side impact collisions, because occupants move to the direction of the collision, and thus in side impacts, frontal air bag deployment would not provide additional occupant protection.

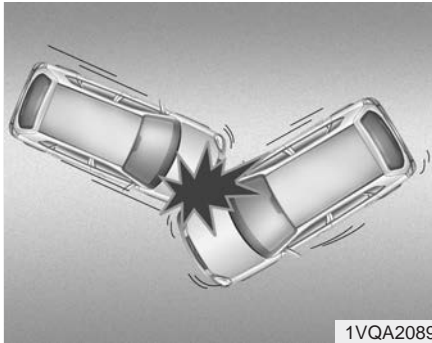

- In an angled collision, the force of impact may direct the occupants in a direction where the air bags would not be able to provide any additional benefit, and thus the sensors may not deploy any air bags.

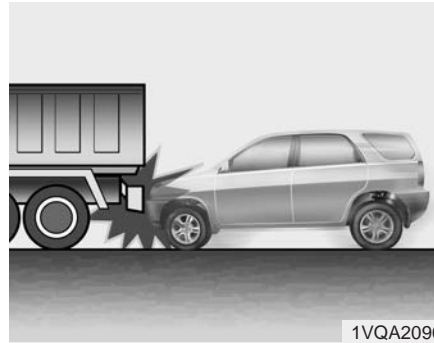

- Just before impact, drivers often brake heavily. Such heavy braking lowers the front portion of the vehicle causing it to “ride” under a vehicle with a higher ground clearance. Air bags may not inflate in this “under-ride” situation because deceleration forces that are detected by sensors may be significantly reduced by such “under-ride” collisions.

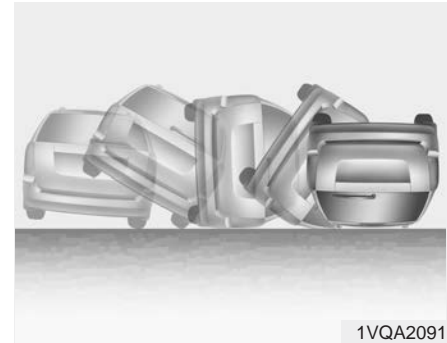

- Front air bags may not inflate in rollover accidents because front airbag deployment would not provide additional occupant protection.

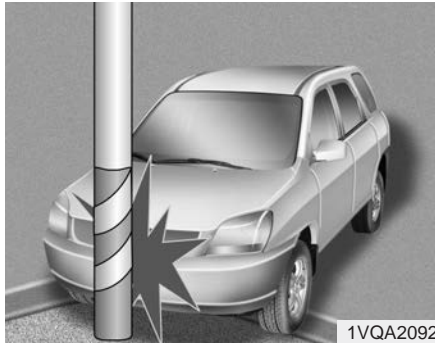

- Air bags may not inflate if the vehicle collides with objects such as utility poles or trees, where the point of impact is concentrated to one area and the full force of the impact is not delivered to the sensors.

### SRS Care

The SRS is virtually maintenance-free and so there are no parts you can safely service by yourself. If the SRS air bag warning light does not illuminate, or continuously remains on, have your vehicle immediately inspected by an authorized Kia dealer.

Any work on the SRS system, such as removing, installing, repairing, or any work on the steering wheel, the front passenger's panel, front seats and roof rails must be performed by an authorized Kia dealer. Improper handling of the SRS system may result in serious personal injury.

For cleaning the air bag pad covers, use only a soft, dry cloth or one which has been moistened with plain water. Solvents or cleaners could adversely affect the air bag covers and proper deployment of the system.

If components of the air bag system must be discarded, or if the vehicle must be scrapped, certain safety precautions must be observed. An authorized Kia dealer knows these precautions and can give you the necessary information. Failure to follow these precautions and procedures could increase the risk of personal injury.

**⚠ WARNING - Tampering with SRS**

Do not tamper with or disconnect SRS wiring, or other components of the SRS system. Doing so could result in the accidental inflation of the air bags or by rendering the SRS inoperative.

**⚠ WARNING - Towing Vehicle**

Always have the ignition off when your vehicle is being towed. The side air bags may inflate if the vehicle is tilted such as when being towed because of the rollover sensors in the vehicle.

**Adding equipment to or modifying your air bag-equipped vehicle**

If you modify your vehicle by changing your vehicle's frame, bumper system, front end or side sheet metal or ride height, this may affect the operation of your vehicle's air bag system.

**Air bag warning label**

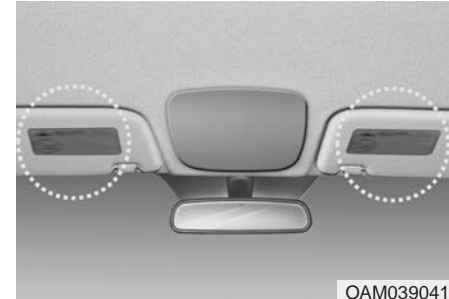

OAM039041

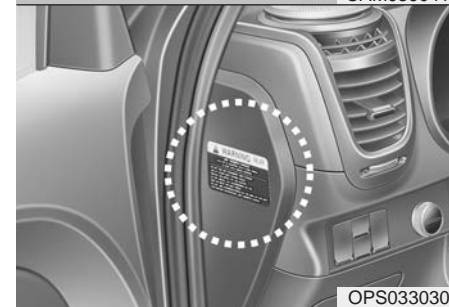

OPS033030

Air bag warning labels, some required by the Canada Motor Vehicle Safety Standards (CMVSS), are attached to the sunvisor to alert the driver and passengers of potential risks of the air bag system.



# Features of your vehicle

<b>Key</b> . . . . .	4-4	<b>Windows</b> . . . . .	4-26
• Record your key number . . . . .	4-4	• Power windows . . . . .	4-27
• Key operations . . . . .	4-4	<b>Hood</b> . . . . .	4-32
• Transmitter precautions . . . . .	4-6	• Opening the hood . . . . .	4-32
• Battery replacement . . . . .	4-7	• Closing the hood . . . . .	4-32
• Immobilizer system . . . . .	4-8	<b>Fuel filler lid</b> . . . . .	4-34
<b>Smart key</b> . . . . .	4-11	• Opening the fuel filler lid . . . . .	4-34
• Record your key number . . . . .	4-11	• Closing the fuel filler lid . . . . .	4-34
• Smart key function . . . . .	4-11	<b>Panoramic sunroof</b> . . . . .	4-37
• Loss of the smart key . . . . .	4-14	• Sunroof open warning . . . . .	4-38
• Smart key precautions . . . . .	4-15	• Sliding the sunroof . . . . .	4-38
• Smart key immobilizer system . . . . .	4-15	• Tilting the sunroof . . . . .	4-39
• Battery replacement . . . . .	4-17	• Sunshade . . . . .	4-40
<b>Door locks</b> . . . . .	4-19	• Resetting the sunroof . . . . .	4-41
• Operating door locks from outside the vehicle . . . . .	4-19	<b>Steering wheel</b> . . . . .	4-43
• Operating door locks from inside the vehicle . . . . .	4-20	• Electric power steering (EPS) . . . . .	4-43
• Impact sensing door unlock system . . . . .	4-22	• Tilt and telescopic steering . . . . .	4-44
• Auto door lock/unlock feature . . . . .	4-22	• Heated steering wheel . . . . .	4-45
• Speed sensing door lock system . . . . .	4-22	• Horn . . . . .	4-46
• Child-protector rear door lock . . . . .	4-23	• FLEX steer . . . . .	4-46
<b>Tailgate</b> . . . . .	4-24	<b>Mirrors</b> . . . . .	4-49
• Opening the tailgate . . . . .	4-24	• Inside rearview mirror . . . . .	4-49
• Closing the tailgate . . . . .	4-24	• Outside rearview mirror . . . . .	4-51
• Emergency tailgate safety release . . . . .	4-25		

<b>Instrument cluster</b> . . . . .	4-54	• <b>Lighting control</b> . . . . .	4-90
• <b>Instrument Cluster Control</b> . . . . .	4-55	• <b>High beam operation</b> . . . . .	4-91
• <b>LCD Display Control</b> . . . . .	4-55	• <b>Turn signals and lane change signals</b> . . . . .	4-92
• <b>Gauges</b> . . . . .	4-56	• <b>Front fog light</b> . . . . .	4-93
• <b>Transaxle Shift Indicator</b> . . . . .	4-60	<b>Wipers and Washers</b> . . . . .	4-94
<b>LCD Display</b> . . . . .	4-62	• <b>Windshield wiper/washer</b> . . . . .	4-94
• <b>LCD Modes</b> . . . . .	4-62	• <b>Rear window wiper/washer</b> . . . . .	4-94
• <b>Service Mode</b> . . . . .	4-63	• <b>Windshield wipers</b> . . . . .	4-94
• <b>User Settings Mode</b> . . . . .	4-64	• <b>Windshield washers</b> . . . . .	4-95
• <b>A/V Mode</b> . . . . .	4-66	• <b>Rear window wiper and washer switch</b> . . . . .	4-96
• <b>Turn By Turn Mode</b> . . . . .	4-66	<b>Interior light</b> . . . . .	4-97
• <b>Warning Messages</b> . . . . .	4-67	• <b>Interior lamp AUTO cut</b> . . . . .	4-97
<b>Trip computer</b> . . . . .	4-72	• <b>Map lamp</b> . . . . .	4-97
• <b>Overview</b> . . . . .	4-72	• <b>Room lamp</b> . . . . .	4-98
• <b>Trip A/B</b> . . . . .	4-73	• <b>Luggage room lamp</b> . . . . .	4-99
• <b>Fuel Economy</b> . . . . .	4-74	• <b>Portable lamp usage</b> . . . . .	4-99
<b>Warning and indicator lights</b> . . . . .	4-76	• <b>Glove box lamp</b> . . . . .	4-101
• <b>Warning lights</b> . . . . .	4-76	• <b>Vanity mirror lamp</b> . . . . .	4-101
• <b>Indicator Lights</b> . . . . .	4-83	<b>Defroster</b> . . . . .	4-102
<b>Rear camera display</b> . . . . .	4-88	• <b>Rear window defroster</b> . . . . .	4-102
<b>Lighting</b> . . . . .	4-89	<b>Manual climate control system</b> . . . . .	4-104
• <b>Headlamp escort</b> . . . . .	4-89	• <b>Heating and air conditioning</b> . . . . .	4-105
• <b>Battery saver function</b> . . . . .	4-89	• <b>System operation</b> . . . . .	4-110
• <b>Daytime running light</b> . . . . .	4-89	• <b>Climate control air filter</b> . . . . .	4-112

• Checking the amount of air conditioner refrigerant and compressor lubricant.....	4-113	• Rear seat warmer .....	4-138
<b>Automatic climate control system.....</b>	<b>4-114</b>	• Power outlet .....	4-138
• Automatic heating and air conditioning .....	4-115	• Clothes hanger.....	4-140
• Manual heating and air conditioning .....	4-116	• Floor mat anchor(s).....	4-141
• System operation.....	4-123	• Luggage net holder .....	4-142
• Climate control air filter.....	4-125	• Cargo area cover.....	4-142
• Checking the amount of air conditioner refrigerant and compressor lubricant.....	4-125	<b>Exterior features.....</b>	<b>4-145</b>
<b>Windshield defrosting and defogging.....</b>	<b>4-127</b>	• Mounting bracket for roof carrier.....	4-145
• Manual climate control system .....	4-127	<b>Audio system.....</b>	<b>4-147</b>
• Automatic climate control system .....	4-128	• Antenna .....	4-147
• Defogging logic.....	4-129	• Audio remote control.....	4-148
<b>Clean air .....</b>	<b>4-131</b>	• Aux and USB port.....	4-149
<b>Storage compartment.....</b>	<b>4-132</b>	• Speaker lights.....	4-150
• Center console storage .....	4-132		
• Glove box .....	4-132		
• Cool box .....	4-133		
• Sunglass holder .....	4-133		
• Luggage box.....	4-134		
<b>Interior features .....</b>	<b>4-135</b>		
• Cup holder .....	4-135		
• Sunvisor .....	4-136		
• Seat warmer.....	4-136		
• Seat air ventilation .....	4-138		

## KEY

### Record your key number



The key code number is stamped on the key code tag attached to the key set. Should you lose your keys, this number will enable an authorized Kia dealer to duplicate the keys easily. Remove the key code tag and store it in a safe place. Also, record the key code number and keep it in a safe and handy place, but not in the vehicle.

### Key operations

■ Type A



OED036001A

■ Type B

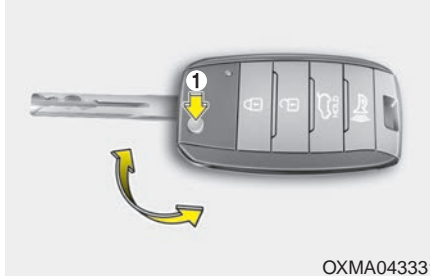

OXMA043331

- Used to start the engine.
- Used to lock and unlock the doors.

- To unfold the key, press the release button (1) then the key will unfold automatically. To fold the key, fold the key manually while pressing the release button (1).

### CAUTION

*Do not fold the key without pressing the release button. This may damage the key.*

### WARNING - Aftermarket key

**Use only Kia original parts for the ignition key in your vehicle. If an aftermarket key is used, the ignition switch may not return to ON after START. If this happens, the starter will continue to operate causing damage to the starter motor and possible fire due to excessive current in the wiring.**

**⚠ WARNING - Ignition key**

Never leave the keys in your vehicle with unsupervised children. Leaving children unattended in a vehicle with a manual ignition key or a smart key is dangerous. Children copy adults and they could place the key in the ignition switch or press the start button. The key would enable children to operate power windows or other controls, or even make the vehicle move, which could result in serious bodily injury or death. result in serious bodily injury or death.

**Door Lock (1)**

1. Close all doors, engine hood and tailgate.
2. Press the lock button(1).
3. All doors and tailgate will lock. The hazard warning lights will blink once.
4. If the lock button is pressed once more within 4 seconds, the hazard warning lights will blink and the horn will sound once.
5. Make sure that doors are locked by checking the door lock button inside or pulling the outside door handle.

**Door Unlock (2)**

1. Press the unlock button(2).
2. The driver's door will unlock. The hazard warning lights will blink two times.
3. Press the unlock button(2) twice within 4 seconds and all doors and tailgate will unlock. The hazard warning lights will blink two times.

**\* NOTICE**

You can activate or deactivate the Two Turn Unlock function. Refer to "User settings" in this chapter.

### ***Tailgate unlock (3)***

The tailgate is unlocked if the button is pressed for more than 1 second.

Also, once the tailgate is opened and then closed, the tailgate will be locked automatically.

### ***Panic (4)***

The horn sounds and hazard warning lights flash for about 30 seconds if this button is pressed for more than 1 second. To stop the horn and lights, press any button except the trunk button on the transmitter.

### **Transmitter precautions**

#### **\* NOTICE**

- The transmitter will not work if any of following occur:
  - The ignition key is in the ignition switch.
  - You exceed the operating distance limit (about 10 m [30 feet]).
  - The battery in the transmitter is weak.
  - Other vehicles or objects may be blocking the signal.
  - The weather is extremely cold.
  - The transmitter is close to a radio transmitter such as a radio substation or an airport which can interfere with normal operation of the transmitter.

(Continued)

(Continued)

- When the transmitter does not work correctly, open and close the door with the ignition key. If you have a problem with the transmitter, contact an authorized Kia dealer.
- If the transmitter is in close proximity to your mobile phone, the signal could be blocked by your mobile phones normal operational signals. This is especially important when the phone is active such as making and receiving calls, text messaging, and/or sending/receiving emails. Avoid placing the transmitter and your mobile phone in the same pants or jacket pocket and always try to maintain an adequate distance between the two devices.

**⚠ CAUTION**

*Keep the transmitter away from water or any liquid as it can become damaged and not function properly.*

**\* NOTICE**

If the keyless entry system is inoperative due to exposure to water or liquids, it will not be covered by your manufacturer's vehicle warranty.

**Battery replacement**

The transmitter uses a 3 volt lithium battery which will normally last for several years. When replacement is necessary, use the following procedure.

1. Insert a slim tool into the slot and gently pry open the transmitter center cover.
2. Replace the battery with a new battery (CR2032). When replacing the battery, make sure the battery is positioned battery.
3. Install the battery in the reverse order of removal.

For replacement transmitters, see an authorized Kia dealer for transmitter reprogramming.

- The transmitter is designed to give you years of trouble-free use, however it can malfunction if exposed to moisture or static electricity. If you are unsure how to use your transmitter or replace the battery, contact an authorized Kia dealer.
- Using the wrong battery can cause the transmitter to malfunction. Be sure to use the correct battery.
- To avoid damaging the transmitter, don't drop it, get it wet, or expose it to heat or sunlight.
-  An inappropriately disposed battery can be harmful to the environment and may cause human health. Dispose the battery according to your local law(s) or regulation.

 **CAUTION - Transmitter damage**

*Do not drop, wet or expose the keyless entry system transmitter to heat or sunlight or it will be damaged.*

 **IC WARNING**

**This device complies with Industry Canada licence-exempt RSS standard(s).**

**Operation is subject to the following two conditions: (1) this device may not cause interference, and (2) this device must accept any interference, including interference that may cause undesired operation of the device.**

### **Immobilizer system**

Your vehicle is equipped with an electronic engine immobilizer system to reduce the risk of unauthorized vehicle use.

Your immobilizer system is comprised of a small transponder in the ignition key and electronic devices inside the vehicle.

With the immobilizer system, whenever you insert your ignition key into the ignition switch and turn it to ON, it checks and determines and verifies if the ignition key is valid.

If the key is determined to be valid, the engine will start.

If the key is determined to be invalid, the engine will not start.

#### ***To activate the immobilizer system:***

Turn the ignition key to the OFF position. The immobilizer system activates automatically. Without a valid ignition key for your vehicle, the engine will not start.

#### ***To deactivate the immobilizer system:***

Insert the ignition key into the key cylinder and turn it to the ON position.

In order to prevent theft of your vehicle, do not leave spare keys anywhere in your vehicle. Your Immobilizer password is a customer unique password and should be kept confidential. Do not leave this number anywhere in your vehicle.



**\* NOTICE**

When starting the engine, do not use the key with other immobilizer keys around. Otherwise the engine may not start or may stop soon after it starts. Keep each key separate in order to avoid a starting malfunction.

Do not put metal accessories near the ignition switch.

Metal accessories may interrupt the transponder signal and may prevent the engine from being started.

**\* NOTICE**

If you need additional keys or lose your keys, contact an authorized Kia dealer.



**CAUTION - Immobilizer damage**

*Do not expose your immobilizer system to moisture, static electricity and rough handling. This may damage your immobilizer.*



**CAUTION - Immobilizer alterations**

*Do not change, alter or adjust the immobilizer system because it could cause the immobilizer system to malfunction.*

**This device complies with Industry Canada Standard RSS-210.**

Operation is subject to the following two conditions:

1. This device may not cause harmful interference, and
2. This device must accept any interference received, including interference that may cause undesired operation.

**\* NOTICE**

Changes or modifications not expressly approved by the party responsible for compliance could void the user's authority to operate the equipment. If the keyless entry system is inoperative due to changes or modifications not approved by the party responsible for compliance, it will not be covered by your manufacturer's vehicle warranty.

### **Limp home (override) procedure**

When you turn the ignition switch to the ON position, if the immobilizer indicator (  ) goes off after blinking 5 times, your transponder equipped in the ignition key is out of order. You cannot start the engine without the limp home procedure. To start the engine, you have to input your password by using the ignition switch. Your password is only available from an authorized Kia dealership. Contact an authorized dealer for more information.

The following procedure is how to input your password of “2345” as an example.

1. Turn the ignition switch to the ON position. The immobilizer indicator (  ) will blink 5 times and go off indicating the beginning of the limp home procedure.
2. Turn the ignition switch to the ACC position.

3. To enter the first digit (in this example “2”), turn the ignition switch to the ON and ACC position twice. Perform the same procedure for the next digits between 3 seconds and 10 seconds (for example, for “3”, turn the ignition ON and ACC 3 times).
4. If all of the digits have been input successfully, you have to start the engine within 30 seconds. If you attempt to start the engine after 30 seconds, the engine will not start and you will have to input your password again.

After performing the limp home procedure, you have to see an authorized Kia dealer immediately to inspect and repair your ignition key or immobilizer system.

## SMART KEY

### Record your key number



The key code number is stamped on the key code tag attached to the key set. Should you lose your keys, this number will enable an authorized Kia dealer to duplicate the keys easily. Remove the key code tag and store it in a safe place. Also, record the key code number and keep it in a safe and handy place, but not in the vehicle.

### **⚠ WARNING - Smart key**

**Never leave the smart key in your vehicle with unsupervised children. Leaving children unattended in a vehicle with a smart key is dangerous. Children copy adults and they could press the start button. The key would enable children to operate power windows or other controls, or even make the vehicle move, which could result in serious bodily injury or death. result in serious bodily injury or death.**

### Smart key function



OXMA043316

To remove the mechanical key, press and hold the release button (1) and remove the mechanical key (2).

To reinstall the mechanical key, put the key into the hole and push it until a click sound is heard.

With a smart key, you can lock or unlock a door (and Tailgate) and start the engine.

Refer to the following for more details.

### Door Lock

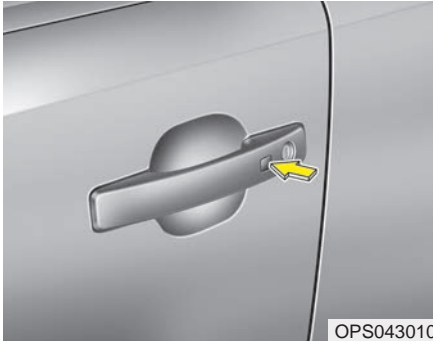

#### Using the door handle button

1. Carry the smart key.
2. Close all doors, engine hood and tailgate.
3. Press the button of the outside door handle.
4. The hazard warning lights will blink and the chime will sound once.
5. Make sure that doors are locked by pulling the outside door handle.

The button will only operate when the smart key is within 0.7~1m (28~40 in. ) from the outside door handle.

Even though you press the outside door handle button, the doors will not lock and the chime will sound for 3 seconds if any of following occur:

- The smart key is in the vehicle.
- The engine start/stop button is in ACC or ON position.
- Any door except the tailgate is open.



#### Using the button on the smart key

- 1 Close all doors, engine hood and tailgate.
2. Press the lock button(1).
3. The hazard warning lights will blink and the chime will sound once.
4. Make sure that doors are locked by pulling the outside door handle.

## **Unlocking**

### **Using the door handle button**

1. Carry the smart key.
2. Press the button of the driver's outside door handle.
3. The driver's door will unlock. The hazard warning lights will blink and the chime will sound two times.
4. Press the button twice within 4 seconds and all doors and the tailgate will unlock and the hazard warning lights will blink and the chime will sound two times.

- The button will only operate when the smart key is within 0.7~1m (28~40 in. ) from the outside door handle.
- When the smart key is recognized in the area of 0.7~1m (28~40 in.) from the front outside door handle, other people can also open the doors.
- After unlocking the driver's door or all doors, the door(s) will lock automatically unless the door is opened.

### **Using the button on the smart key**

1. Press the unlock button(2) of the smart key.
2. The driver's door will unlock. The hazard warning lights will blink and the chime will sound two times.
3. Press the unlock button(2) twice within 4 seconds and all doors and the tailgate will unlock. The hazard warning lights will blink and the chime will sound two times.

### **\* NOTICE**

After pressing the button, the doors will lock automatically unless any door is opened within 30 seconds.

### **\* NOTICE**

You can activate or deactivate the Two Turn Unlock function. Refer to "User settings" in this chapter.

### ***Tailgate unlocking***

#### **Using the tailgate handle button**

1. Carry the smart key.
2. Press the tailgate handle button.
3. When all doors are locked, the hazard warning lights will blink two times.

Once the tailgate is opened and then closed, the tailgate will lock automatically.

If you are within 0.7~1 m (28~40 in.) from the outside tailgate handle, with your smart key in possession, the tailgate will unlock and open when you press the tailgate handle switch.

#### **Using the button on the smart key**

1. Press the tailgate unlock button(3) for more than 1 second.
2. When all doors are locked, the hazard warning lights will blink two times.

### ***Panic***

1. Press the panic button(4) for more than 1 second.
2. The horn sounds and hazard warning light flash for about 30 seconds.

### ***Start-up***

You can start the engine without inserting the key. For detailed information refer to the “Engine start/stop button” in chapter 5.

### **Loss of the smart key**

A maximum of 2 smart keys can be registered to a single vehicle.

If you happen to lose your smart key, you will not be able to start the engine. You should immediately take the vehicle and remaining key to your authorized Kia dealer(tow the vehicle, if necessary) to protect it from potential theft.

### Smart key precautions

- The smart key will not work if any of the following occur:
  - The smart key is close to a radio transmitter such as a radio station or an airport which can interfere with normal operation of the smart key.
  - The smart key is near a mobile two way radio system or a cellular phone.
  - Another vehicle's smart key is being operated close to your vehicle.
- When the smart key does not work correctly, open and close the door with the mechanical key and contact an authorized Kia dealer.
- If the smart key is in close proximity to your cell phone or smart phone, the signal from the smart key could be blocked by normal operation of your cell phone or smart phone. This is especially important when the phone is active such as making a call, receiving calls, text messaging, and/or sending/receiving emails. Avoid placing the smart key and your cell phone or smart phone in the same pants or jacket pocket and maintain adequate distance between the two devices.



### CAUTION

***Keep the smart key away from water or any liquid as it can become damaged and not function properly.***

### \* NOTICE

**If the keyless entry system is inoperative due to exposure to water or liquids, it will not be covered by your manufacturer's vehicle warranty.**

### Smart key immobilizer system

Your vehicle is equipped with an electronic engine immobilizer system to reduce the risk of unauthorized vehicle use.

Your immobilizer system is comprised of a small transponder in the smart key and electronic devices inside the vehicle.

With the immobilizer system, whenever you turn the engine start/stop button to the ON position by pressing the button while carrying the smart key, it checks and determines and verifies if the smart key is valid or not.

If the key is determined to be valid, the engine will start.

If the key is determined to be invalid, the engine will not start.

#### *To deactivate the immobilizer system:*

Turn the engine start/stop button to the ON position by pressing the button while carrying the smart key.

#### *To activate the immobilizer system:*

Turn the engine start/stop button to the OFF position. The immobilizer system activates automatically. Without a valid smart key for your vehicle, the engine will not start.

In order to prevent theft of your vehicle, do not leave spare keys anywhere in your vehicle. Your Immobilizer password is a customer unique password and should be kept confidential. Do not leave this number anywhere in your vehicle.

### \* NOTICE

When starting the engine, do not use the key with other immobilizer keys around. Otherwise the engine may not start or may stop soon after it starts. Keep each key separate in order to avoid a starting malfunction.

Do not put metal accessories near the smart key.

The engine may not start because the metal accessories may interrupt the transponder signal from transmitting normally.

### \* NOTICE

If you need additional keys or lose your keys, contact an authorized Kia dealer.



**⚠ CAUTION - Immobilizer damage**

*Do not expose your immobilizer system to moisture, static electricity and rough handling. This may damage your immobilizer.*

**⚠ CAUTION - Immobilizer alterations**

*Do not change, alter or adjust the immobilizer system because it could cause the immobilizer system to malfunction.*

**This device complies with Industry Canada Standard RSS-210.**

Operation is subject to the following two conditions:

1. This device may not cause harmful interference, and
2. This device must accept any interference received, including interference that may cause undesired operation.

**\* NOTICE**

Changes or modifications not expressly approved by the party responsible for compliance could void the user's authority to operate the equipment. If the keyless entry system is inoperative due to changes or modifications not expressly approved by the party responsible for compliance, it will not be covered by your manufacturer's vehicle warranty.

**Battery replacement**

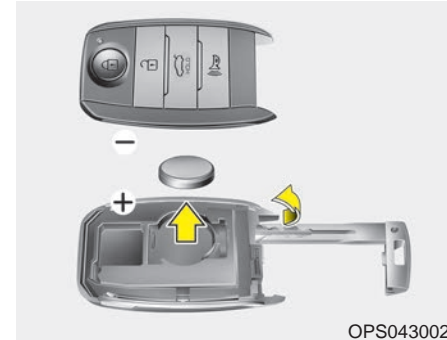

A smart key battery should last for several years, but if the smart key is not working properly, try replacing the battery with a new one. If you are unsure how to use your smart key or replace the battery, contact an authorized Kia dealer.

1. Remove the mechanical key.
2. Pry open the rear cover.
3. Replace the battery with a new battery (CR2032). When replacing the battery, make sure the battery position.

4. Install the battery in the reverse order of removal.
- The smart key is designed to give you years of trouble-free use, however it can malfunction if exposed to moisture or static electricity. If you are unsure how to use or replace the battery, contact an authorized Kia dealer.
  - Using the wrong battery can cause the smart key to malfunction. Be sure to use the correct battery.
  - To avoid damaging the smart key, don't drop it, get it wet, or expose it to heat or sunlight.
  -  An inappropriately disposed battery can be harmful to the environment and human health. Dispose the battery according to your local law(s) or regulation.

 **CAUTION - Smart key damage**

*Do not drop, get wet or expose the smart key to heat or sunlight, or it will be damaged.*

 **IC WARNING**

**This device complies with Industry Canada licence-exempt RSS standard(s).**

**Operation is subject to the following two conditions: (1) this device may not cause interference, and (2) this device must accept any interference that may cause undesired operation of the device.**

## DOOR LOCKS

### Operating door locks from outside the vehicle

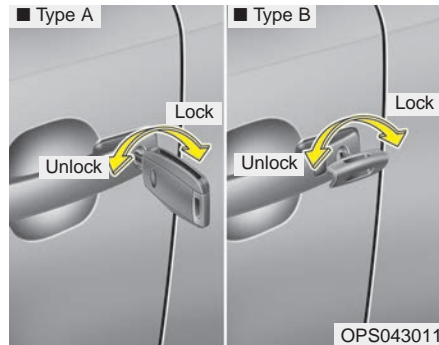

- Turn the key clockwise to lock and counterclockwise to unlock.
- If you lock the driver's door with a key
  - all vehicle doors will lock automatically. (for normal key)
  - only the driver's door will lock. (for folding key, smart key)

- From the driver's door
  - turn the key to the left once to unlock the door and once more within 4 seconds to unlock all doors. (for normal key).
  - turn the key to the left once to unlock the driver's door. (for folding key, smart key).
- Doors can also be locked and unlocked with the transmitter.
- Once the doors are unlocked, they may be opened by pulling the door handle.
- When closing the door, push the door by hand. Make sure the doors are closed securely.

### \* NOTICE

- In cold and wet climates, door lock and door mechanisms may not work properly due to freezing conditions.
- If the door is locked/unlocked multiple times in rapid succession with either the vehicle key or door lock switch, the system may stop operating temporarily in order to protect the circuit and prevent damage to system components.

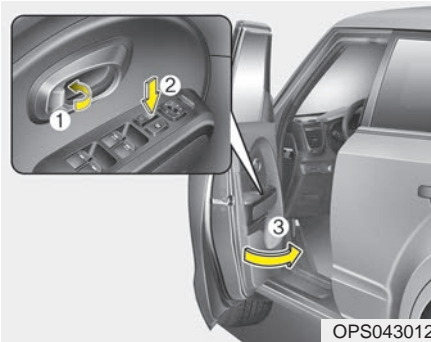

- To lock a door without the key, push the inside door lock button (1) or central door lock switch (2) to the “Lock” position and close the door (3).
- If you lock the door with the central door lock switch (2), all vehicle doors will lock automatically.

### \* NOTICE

Always remove the ignition key, engage the parking brake, close all windows and lock all doors when leaving your vehicle unattended.

### Operating door locks from inside the vehicle

*With the door lock button*

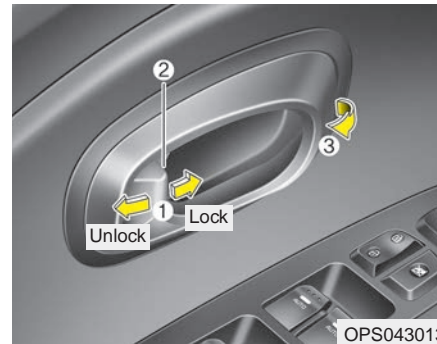

- To unlock a door, push the door lock button (1) to the “Unlock” position. The red mark (2) on the button will be visible.
- To lock a door, push the door lock button (1) to the “Lock” position. If the door is locked properly, the red mark (2) on the door lock button will not be visible.

- To open a door, pull the door handle (3) outward.
- If the inner door handle of the driver’s (or front passenger’s) door is pulled when the door lock button is in the lock position, the button will unlock and the door will open. (if equipped)
- Front doors cannot be locked if the ignition key is in the ignition switch and any front door is opened.

If a power door lock ever fails to function while you are in the vehicle, try one or more of the following techniques to exit:

- Operate the door unlock feature repeatedly (both electronic and manual) while simultaneously pulling on the door handle.
- Operate the other door locks and handles, front and rear.
- Lower a front window and use the key to unlock the door from outside.
- Move to the cargo area and open the tailgate.

**With central door lock switch**

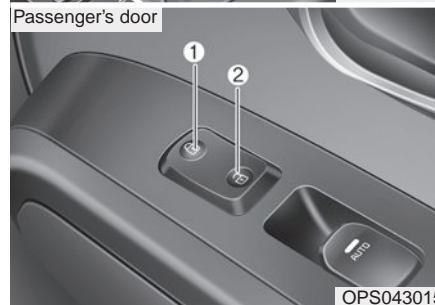
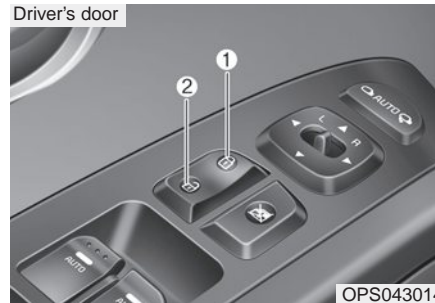

Operate by pressing the central door lock switch.

- When pressing the front portion (1) of the switch, all vehicle doors will lock.

- When pressing the rear portion (2) of the switch, all vehicle doors will unlock.
- If the key is in the ignition switch and any front door is opened, the doors will not lock even though the front portion (1) of the central door lock switch is pressed.

**⚠ WARNING - Doors**

The doors should always be fully closed and locked while the vehicle is in motion to prevent accidental opening of the door.

**⚠ WARNING**  
- Unattended children/animals

Never leave children or animals unattended in your vehicle. An enclosed vehicle can become extremely hot, causing death or severe injury to unattended children or animals who cannot escape the vehicle.

**Impact sensing door unlock system**

In the event of air bag deployment resulting from a vehicle impact, all doors will automatically unlock.

**Auto door lock/unlock feature (if equipped)**

- All doors will automatically lock when the transaxle shift lever is shifted out of P(Park).
- All doors will automatically unlock when the transaxle shift lever is shifted into P (Park).

**Speed sensing door lock system (if equipped)**

All doors will be automatically locked after the vehicle speed exceeds 15 km/h (9.3 mph). And all doors will be automatically unlocked when you turn the engine off or when you remove the ignition key.

**\* NOTICE**

You can select some auto door lock/unlock features in “User Settings” as follows;

- Speed sensing auto door lock
- Auto door unlock when the ignition key is removed from the ignition switch or engine is turned off.
- Auto door lock/unlock by shifting the shift lever out of P(Park) or into P(Park).

For more information, refer to “User Settings” in this chapter.

## Child-protector rear door lock

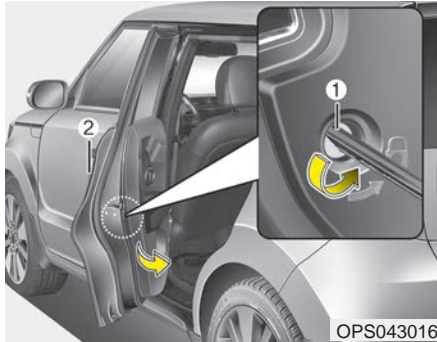

The child safety lock is provided to help prevent children from accidentally opening the rear doors from inside the vehicle. The rear door safety locks should be used whenever children are in the vehicle.

1. Open the rear door.
2. Push the child safety lock located on the rear edge of the door to the lock (  ) position. When the child safety lock is in the lock position, the rear door will not open even when the inner door handle is pulled.

3. Close the rear door.

To open the rear door, pull the outside door handle.

Even though the doors may be unlocked, the rear door will not open by pulling the inner door handle (1) until the rear door child safety lock is unlocked.

### **WARNING - Rear door locks**

**Use the rear door safety locks whenever children are in the vehicle. If a child accidentally opens the rear doors while the vehicle is motion, he can fall out.**

## TAILGATE

### Opening the tailgate



- The tailgate is locked or unlocked when all doors are locked or unlocked with the key, transmitter (or smart key) or central door lock switch.
- If unlocked, the tailgate can be opened by pressing the handle switch and then pulling the handle up.
- Only the tailgate is unlocked if the tailgate unlock button on the smart key is pressed (if equipped). Once the tailgate is opened and then closed, the tailgate is locked automatically.

### \* NOTICE

In cold and wet climates, door lock and door mechanisms may not work properly due to freezing conditions.

The tailgate swings upward. Make sure no objects or people are near the rear of the vehicle when opening the tailgate.

### ⚠ CAUTION - Tailgate lift

***Make certain that you close the tailgate before driving your vehicle. Possible damage may occur to the tailgate lift cylinders and attached hardware if the tailgate is not closed prior to driving.***

### Closing the tailgate



To close the tailgate, lower and push down the tailgate firmly. Make sure that the tailgate is securely latched.

Make sure your hands, feet and other parts of your body are safely out of the way before closing the tailgate.



**⚠ WARNING - Exhaust fumes**

Driving with the tailgate open is not advisable. Dangerous exhaust fumes can enter the passenger compartment. If you must drive with the tailgate opened, keep the air vents and all windows open so that additional outside air can enter.

**⚠ WARNING - Rear cargo area**

Occupants should never ride in the rear cargo area where no restraints are available. Occupants should always be properly restrained.

**Emergency tailgate safety release**

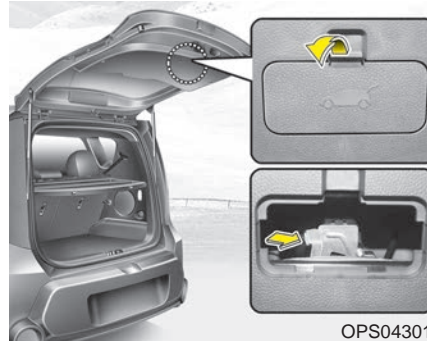

OPS043019

Your vehicle is equipped with an emergency tailgate safety release lever located on the bottom of the tailgate. When someone is inadvertently locked in the cargo area, the tailgate can be opened by pushing the release lever and pushing open the tailgate.

**⚠ WARNING**

- No one should be allowed to occupy the cargo area of the vehicle at any time. The cargo area is a very dangerous location in the event of a crash.
- Use the release lever for emergencies only. Use with extreme caution, especially while the vehicle is in motion.

## WINDOWS

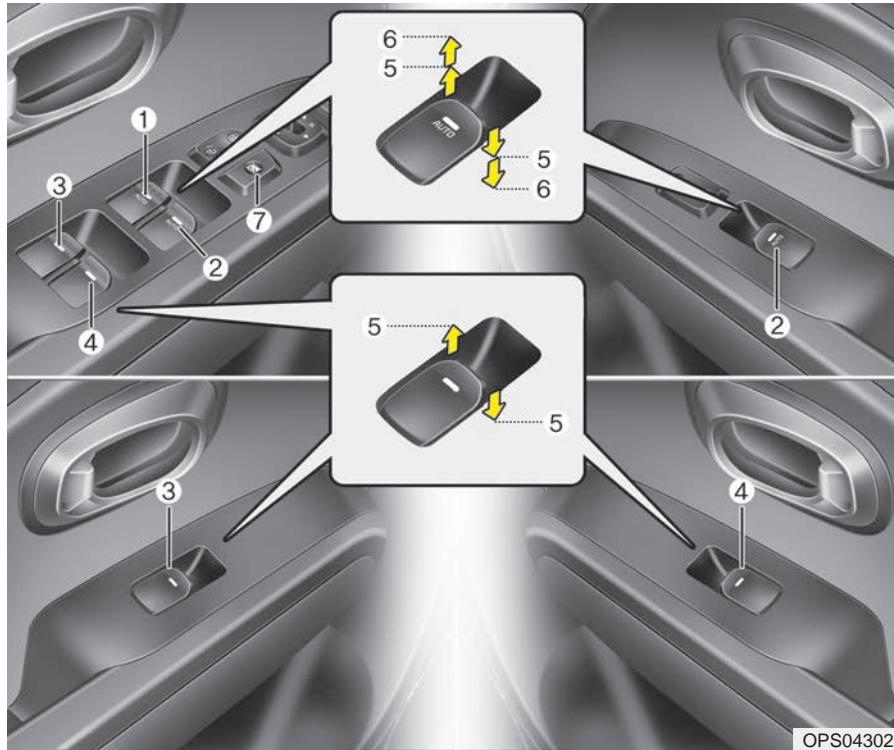

- (1) Driver's door power window switch
- (2) Front passenger's door power window switch
- (3) Rear door (left) power window switch
- (4) Rear door (right) power window switch
- (5) Window opening and closing
- (6) Automatic power window up/down
- (7) Power window lock switch

In cold and wet climates, power windows may not work properly due to freezing conditions.

## Power windows

The ignition switch must be in the ON position for power windows to operate. Each door has a power window switch that controls the door's window. The driver has a power window lock button which can block the operation of the rear passenger windows. The power windows can be operated for approximately 30 seconds after the ignition key is removed or turned to the ACC or LOCK position. However, if the front doors are opened, the power windows cannot be operated even within the 30 second period.

## \* NOTICE

While driving with the rear windows down or with the sunroof (if equipped) in an open (or partially open) position, your vehicle may demonstrate a wind buffeting or pulsation noise. This noise is a normal occurrence and can be reduced or eliminated by taking the following actions. If the noise occurs with one or both of the rear windows down, partially lower both front windows approximately one inch. If you experience the noise with the sunroof open, slightly reduce the size of the sunroof opening.

## Window opening and closing



OPS043021

The driver's door has a master power window switch that controls all the windows in the vehicle.

To open or close a window, press down or pull up the front portion of the corresponding switch to the first detent position (5).

### *Auto down window (if equipped)*



Pressing the power window switch momentarily to the second detent position (6) completely lowers the driver's window even when the switch is released. To stop the window at the desired position while the window is in operation, momentarily pull up the switch to the opposite direction of the window movement.

### *Auto up/down window (if equipped)*



Pressing or pulling up the power window switch momentarily to the second detent position (6) completely lowers or raises the window even when the switch is released. To stop the window at the desired position while the window is in operation, pull up or press down and release the switch.

If the power window does not operate normally, the automatic power window system must be reset as follows:

1. Turn the ignition switch to the ON position.
2. Close the driver's window and continue pulling up the driver's power window switch for at least 1 second after the window is completely closed.

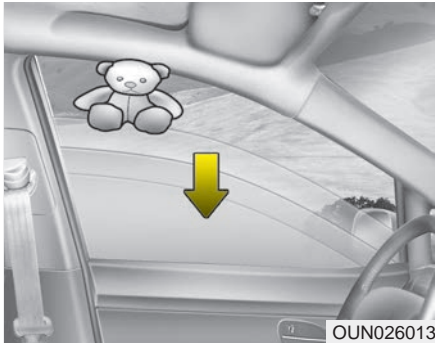

### Automatic reversal

If the upward movement of the window is blocked by an object or part of the body, the window will detect the resistance and will stop upward movement. The window will then lower approximately 30 cm (11.8 in.) to allow the object to be cleared.

The distance may vary based on the size or position of the window. If the window detects the resistance while the power window switch is pulled up continuously, the window will stop upward movement then lower approximately 2.5 cm (1 in.).

And if the power window switch is pulled up continuously again within 5 seconds after the window is lowered by the automatic window reversal feature, the automatic window reversal will not operate.

The automatic reverse feature for the driver's window is only active when the "auto up" feature is used by fully pulling up the switch. The automatic reverse feature will not operate if the window is raised using the halfway position on the power window switch.

### **▲ WARNING**

**Always check for obstructions before raising any window to avoid injuries or vehicle damage. If an object less than 0.16 in. (4 mm) in diameter is caught between the window glass and the upper window channel, the automatic reverse window may not detect the resistance and will not stop and reverse direction.**

### Power window lock button



- **When the power window lock switch is pressed :**
  - The driver's master control can operate all the power windows.
  - The front passenger's control can operate the front passenger's power window.
  - The rear passenger's control cannot operate the rear passenger's power window.
- The driver can disable the power window switches on the passenger doors by pressing the power window lock button located on the driver's door to the LOCK position (pressed).



### **CAUTION**

- Opening /closing Window

*To prevent possible damage to the power window system, do not open or close two windows or more at the same time. This will also ensure the longevity of the fuse.*

**⚠ WARNING**

**- Power windows**

**Do not allow children to play with the power windows. Keep the power window lock switch (on the driver's door) in the LOCK (pressed) position.**

Always double check to make sure all arms, hands, head and other obstructions are safely out of the way before closing a window.

## HOOD

### Opening the hood

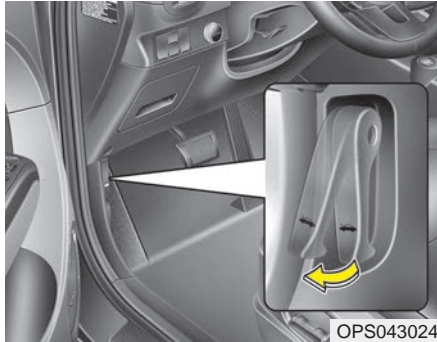

1. Pull the release lever to unlatch the hood. The hood should pop open slightly.

Open the hood after turning off the engine on a flat surface, shifting the shift lever to the P (Park) position for automatic transaxle and to the 1st (First) gear or R (Reverse) for manual transaxle, and setting the parking brake.

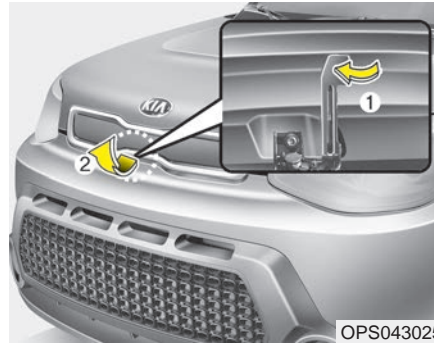

2. Go to the front of the vehicle, raise the hood slightly, pull the secondary latch (1) inside of the hood center and lift the hood (2).
3. Raise the hood. It will completely rise by itself after it has been raised about halfway.

### Closing the hood

1. Before closing the hood, check the following:
  - All filler caps in the engine compartment must be correctly installed.
2. Lower the hood halfway and push down to securely lock in place.

#### **⚠ WARNING**

**Before closing the hood, ensure that all obstructions are removed from the hood opening. Closing the hood with an obstruction present in the hood opening may result in severe personal injury.**



**⚠ WARNING - Fire risk**

Do not leave gloves, rags or any other combustible material in the engine compartment. Doing so may cause a heat-induced fire.

**⚠ WARNING - Unsecured engine hood**

Always double check to be sure that the hood is firmly latched before driving away. If it is not latched, the hood could fly open while the vehicle is being driven, causing a total loss of visibility, which might result in an accident.

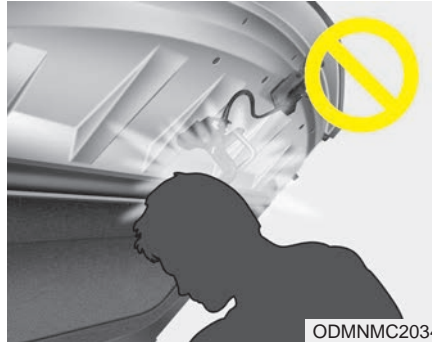

When you check the engine compartment, Take caution to avoid contacting your head with the safety hook which is located inside of the hood.

## FUEL FILLER LID

### Opening the fuel filler lid

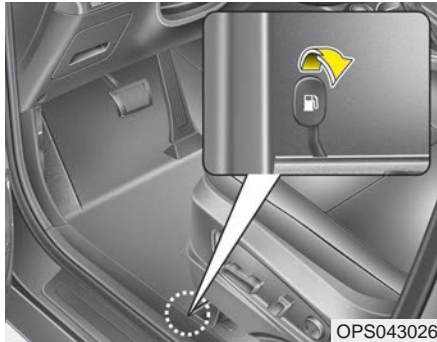

The fuel filler lid must be opened from inside the vehicle by pulling up the fuel filler lid opener.

If the fuel filler lid does not open because ice has formed around it, tap lightly or push on the lid to break the ice and release the lid. Do not pry on the lid. If necessary, spray around the lid with an approved de-icer fluid (do not use radiator anti-freeze) or move the vehicle to a warm place and allow the ice to melt.

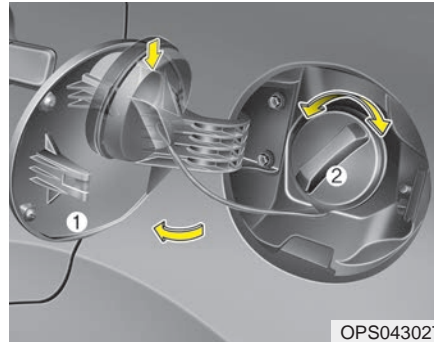

1. Stop the engine.
2. To open the fuel filler lid, push the fuel filler lid opener button.
3. Pull open the fuel filler lid (1).
4. To remove the cap, turn the fuel filler cap (2) counterclockwise.
5. Refuel as needed.

### Closing the fuel filler lid

1. To install the cap, turn it clockwise until it “clicks” once. This indicates that the cap is securely tightened.
2. Close the fuel filler lid and push it in lightly making sure that it is securely closed.

#### \* NOTICE

There may be an intermittent noise near the refueling hole while the engine is idling if the fuel cap is not closed securely. This occurs normally with the OBD system.

#### \* NOTICE

When refueling fully at an up hill, the fuel gauge may not point to the F position.

It is not a malfunction. If you move your vehicle to a level ground, the fuel gauge will move to the full position.

**⚠ WARNING - Refueling**

Always remove the fuel cap carefully and slowly. If the cap is venting fuel or if you hear a hissing sound, wait until the condition stops before completely removing the cap.

If pressurized fuel sprays out, it can cover your clothes or skin and subject you to the risk of fire and burns.

Always check that the fuel cap is installed securely to prevent fuel spillage in the event of an accident.

**\* NOTICE**

Tighten the cap until it clicks once, otherwise the fuel cap open warning indicator  light will illuminate

**⚠ WARNING**

- Fire/explosion risk

Read and follow all warnings posted at the gas station facility. Failure to follow all warnings will result in severe personal injury, severe burns or death due to fire or explosion.

**⚠ WARNING**

- Static electricity

- Before touching the fuel nozzle, you should eliminate potentially dangerous static electricity discharge by touching another metal part of the vehicle, a safe distance away from the fuel filler neck, nozzle, or other gas source.
- Do not get back into a vehicle once you have begun refueling since you can generate static electricity by touching, rubbing or sliding against any item or fabric (polyester, satin, nylon, etc.) capable of producing static electricity. Static electricity discharge can ignite fuel vapors resulting in rapid burning. If you must reenter the vehicle, you should once again eliminate potentially dangerous static electricity discharge by touching a metal part of the vehicle, away from the fuel filler neck, nozzle or other gasoline source.

**⚠ WARNING - Portable fuel container**

When using an approved portable fuel container, be sure to place the container on the ground prior to refueling. Static electricity discharge from the container can ignite fuel vapors causing a fire. Once refueling has begun, contact with the vehicle should be maintained until the filling is complete. Use only approved portable plastic fuel containers designed to carry and store gasoline.

**⚠ WARNING - Cell phone fires**

Do not use cellular phones while refueling. Electric current and/or electronic interference from cellular phones can potentially ignite fuel vapors causing a fire.

**⚠ WARNING - Smoking**

**DO NOT** use matches or a lighter and **DO NOT SMOKE** or leave a lit cigarette in your vehicle while at a gas station especially during refueling. Automotive fuel is highly flammable and can, when ignited, result in fire.

**⚠ WARNING - Refueling & Vehicle fires**

When refueling, always shut the engine off. Sparks produced by electrical components related to the engine can ignite fuel vapors causing a fire. Once refueling is complete, check to make sure the filler cap and filler door are securely closed, before starting the engine.

Make sure to refuel your vehicle according to the “Fuel requirements” suggested in chapter 1.

If the fuel filler cap requires replacement, use only a genuine Kia cap or the equivalent specified for your vehicle. An incorrect fuel filler cap can result in a serious malfunction of the fuel system or emission control system.

**⚠ CAUTION - Exterior paint**

*Do not spill fuel on the exterior surfaces of the vehicle. Any type of fuel spilled on painted surfaces may damage the paint.*

## PANORAMIC SUNROOF (IF EQUIPPED)



If your vehicle is equipped with a sunroof, you can slide or tilt your sunroof with the sunroof glass control lever located on the overhead console (1).

The sunroof can only be opened, closed, or tilted when the ignition switch is in the ON position.

### \* NOTICE

- In cold and wet climates, the sunroof may not work properly due to freezing conditions.
- After a vehicle is washed or in a rainstorm be sure to wipe off any water that is on the sunroof before operating it.

### ⚠ CAUTION

#### - Sunroof control

***Do not continue to pull or push the sunroof glass control lever after the sunroof is fully opened, closed, or tilted. Damage to the motor or system components could occur.***

### \* NOTICE

The sunroof cannot tilt when it is in the slide position but can be slid while in a tilt position.

### ⚠ WARNING - Roof cargo

**Do not operate the sun roof while using the roof rack to transport cargo. This may cause the cargo to come loose and distract the driver.**

### Sunroof open warning (if equipped)

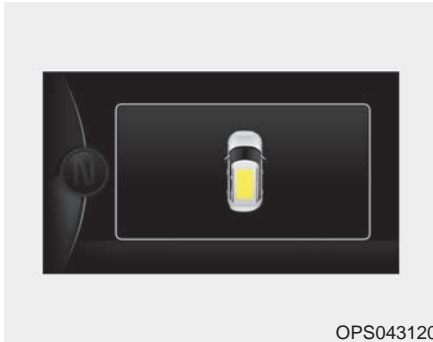

OPS043120

If the driver removes the ignition key (smart key: turns off the engine) when the sunroof is not fully closed, the warning chime will sound for a few seconds and a message will appear on the LCD display or warning indicator will illuminate.

Close the sunroof securely when leaving your vehicle.

### Sliding the sunroof



OPS043029

#### *When the sunshade is closed*

If you pull the sunroof control lever backward, both the sunshade and sunroof glass will slide all the way open. To stop the sunroof movement at any point, pull or push the sunroof glass control lever momentarily.

#### *When the sunshade is opened*

If you pull the sunroof glass control lever backward, the sunroof glass will slide all the way open. To stop the sunroof glass movement at any point, pull or push the sunroof control lever momentarily.

To close the sunroof glass pull (or push) the sunroof glass control lever downward (or forward).

When you push the sunroof glass control lever forward or pull it downward while the sunshade opened, the glass will be closed.

### Automatic reversal

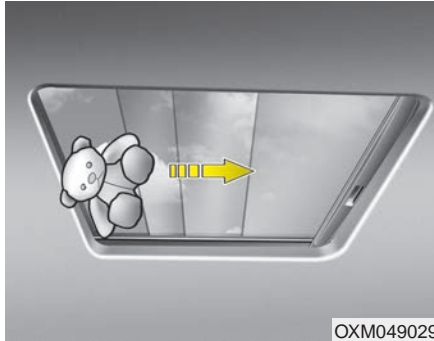

If an object or part of the body is detected while the sunroof is closing automatically, it will reverse the direction, and then stop.

The auto reverse function does not work if a tiny obstacle is between the sliding glass and the sunroof sash. You should always check that all passengers and objects are away from the sunroof before closing it.

### Tilting the sunroof



Before opening or closing the sunroof, open the sunshade (refer to the following page for instructions on how to use the sunshade).

To tilt up the sunroof

- Push the sunroof glass control lever upward.

\* When you push the sunroof glass control lever upward while the sunshade closed, the sunshade will be opened halfway and then glass will be tilt up.

To tilt down (or close) the sunroof

- Push the sunroof glass control lever forward or pull it downward

When you push the sunroof glass control lever forward or pull it downward while the sunshade opened, the glass will be tilt down.

Do not extend the face, neck, arms or body outside the sunroof while driving.

### **⚠ WARNING - Sunroof Operation**

When closing the sunroof, make sure there are no body parts in the movement range of the sliding roof. Parts of the body could become trapped or crushed.

### **⚠ CAUTION - Sunroof motor damage**

*If you try to open the sunroof when the temperature is below freezing or when the sunroof is covered with snow or ice, the glass or the motor could be damaged.*

### **⚠ CAUTION**

*Periodically remove any dirt that may accumulate on the guide rail to prevent damage to the sunroof.*

## Sunshade



### ***To open the sunshade***

Press the sunshade open button (1).  
To stop the sliding at any point, press the sunshade control switch momentarily.



***To close the sunshade when the sunroof glass is closed***

- Press the sunshade close button (2).

\* When you press the sunshade close button (2) with the sunroof glass opened

The sunshade will be closed halfway, then sunroof glass will be closed and then sunshade will be fully closed finally.

To stop the sliding at any point, press the sunshade control switch momentarily.

**\* NOTICE**

Wrinkles formed on the sunshade as material characteristic are normal.

 **CAUTION**

- Automatic sunroof shade

- ***Do not pull or push the sunshade by hand as such action may damage the sunshade or cause it to malfunction.***
- ***Close the sunroof when driving in dusty environments. Dust may cause a malfunction of the vehicle system.***

**Resetting the sunroof**

Whenever the vehicle battery is disconnected or discharged, you must reset your sunroof system as follows:

1. Turn the ignition switch to the ON position.
2. Close the sunshade and sunroof completely if opened.
3. Release the sunroof control lever.
4. Push the sunroof control lever forward in the direction of close (about 10 seconds) until the sunroof moves a little. Then, release the lever.

5. Push the sunroof control lever forward in the direction of close, until the sunroof operates as follows again:

The sunshade and sunroof glass slide open → The sunroof glass slide close → The sunshade close

Then, release the lever.

When this is complete, the sunroof system has been reset.

### **\* NOTICE**

**If you do not reset the sunroof, it may not work properly.**

## STEERING WHEEL

### Electric power steering (EPS)

The power steering uses a motor to assist you in steering the vehicle. If the engine is off or if the power steering system becomes inoperative, the vehicle may still be steered, but it will require increased steering effort.

The motor driven power steering is controlled by a power steering control unit which senses the steering wheel torque and vehicle speed to command the motor.

The steering becomes heavier as the vehicle's speed increases and becomes lighter as the vehicle's speed decreases for optimum steering control.

Should you notice any change in the effort required to steer during normal vehicle operation, have the power steering checked by an authorized Kia dealer.

- If the Electric Power Steering System does not operate normally, the warning light will illuminate on the instrument cluster. The steering wheel may require increased steering effort. Take your vehicle to an authorized Kia dealer and have the vehicle checked as soon as possible.
- When you operate the steering wheel in low temperature, noise may occur. If temperature rises, the noise will likely disappear. This is a normal condition.
- When the vehicle is stationary, when the steering wheel is turned all the way to the left or right continuously, the steering wheel becomes harder to turn. The power assist is limited to protect the motor from overheating.  
As time passes, the steering wheel return to its normal condition.

### \* NOTICE

The following symptoms may occur during normal vehicle operation:

- The EPS warning light does not illuminate.
- The steering gets heavy immediately after turning the ignition switch on. This happens as the system performs the EPS system diagnostics. When the diagnostics are completed, the steering wheel will return to its normal condition.
- A click noise may be heard from the EPS relay after the ignition switch is turned to the ON or LOCK (OFF) position.
- A motor noise may be heard when the vehicle is at a stop or at a low driving speed.

(Continued)

(Continued)

- If the Electric Power Steering System does not operate normally, the warning light will illuminate on the instrument cluster. The steering wheel may become difficult to control or operate abnormally. Take your vehicle to an authorized Kia dealer and have the vehicle checked as soon as possible.
- When you operate the steering wheel in low temperature, abnormal noise may occur. If temperature rises, the noise will likely disappear. This is a normal condition.
- When the charging system warning light comes on due to the low voltage (When the alternator or battery) does not operate normally or it malfunctions), the steering wheel may require increased steering effort.

### Tilt and telescopic steering

Tilt and telescopic steering allows you to adjust the steering wheel before you drive. You can also raise it to give your legs more room when you exit and enter the vehicle.

The steering wheel should be positioned so that it is comfortable for you to drive, while permitting you to see the instrument panel warning lights and gauges.

#### **⚠ WARNING - Steering wheel adjustment**

**Never adjust the angle and height of the steering wheel while driving. You may lose steering control.**

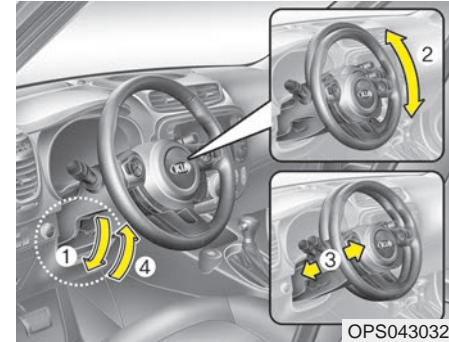

To change the steering wheel angle, pull down the lock-release lever (1), adjust the steering wheel to the desired angle (2) and height (3, if equipped) then pull up the lock-release lever to lock (4) the steering wheel in place. Be sure to adjust the steering wheel to the desired position before driving.

## Heated steering wheel (if equipped)

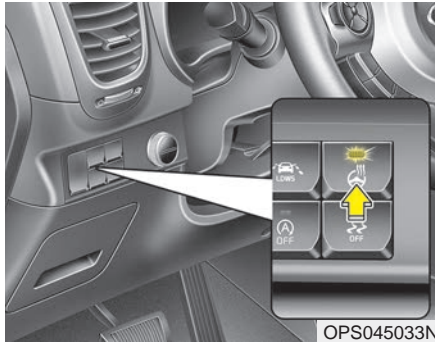

With the ignition switch in the ON position, pressing the heated steering wheel button warms the steering wheel. The indicator on the button will illuminate.

To turn the heated steering wheel off, press the button once again. The indicator on the button will turn off.

## \* NOTICE

The heated steering wheel will turn off automatically approximately 30 minutes after the heated steering wheel is turned on.

## ⚠ WARNING

If the steering wheel becomes too warm, turn the system off. The heated steering wheel may cause burns even at low temperatures, especially if used for long periods of time.

## ⚠ CAUTION

- *Do not install any grip to operate the steering wheel. This causes damage to the heated steering wheel system.*
- *When cleaning the heated steering wheel, do not use an organic solvent such as paint thinner, benzene, alcohol and gasoline. Doing so may damage the surface of the steering wheel.*
- *If the surface of steering wheel is damaged by sharp object, damage to the heated steering wheel components could occur.*

## Horn



To sound the horn, press the horn symbols on your steering wheel. Check the horn regularly to be sure it operates properly.

### \* NOTICE

To sound the horn, press the area indicated by the horn symbol on your steering wheel (see illustration). The horn will operate only when this area is pressed.

## FLEX STEER



The FLEX STEER controls steering effort based upon as driver's preference or road condition.

You can select the desired steering mode by pressing the FLEX STEER button.

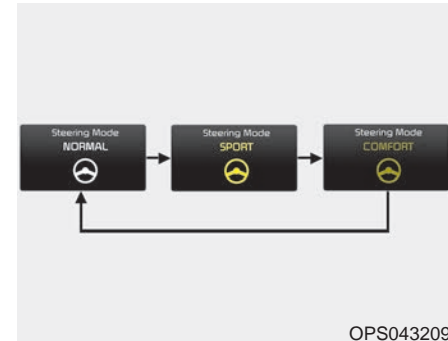

When the steering mode button is pressed, the selected steering mode will appear on the instrument cluster.

If the steering mode button is pressed within 4 seconds, the steering mode will change as shown above.

If the steering wheel mode button is not pressed for about 4 seconds, the LCD display will change to the previous screen (for Type B cluster).

**Normal mode**



The normal mode offers medium steering effort.

**Sport mode**



The steering wheel becomes heavier. The sport mode is usually used when driving on the highway.

**Comfort mode**



The steering wheel becomes lighter. The comfort mode is usually used when driving in the city or when parking the vehicle.

## Features of your vehicle

---

- For your safety, if you press the steering mode button while operating the steering wheel, but the steering effort will not change immediately. After operating the steering wheel, the steering effort will change automatically to the selected mode.
- Use caution when changing the steering mode while driving.
- When the electronic power steering is not operating properly, the flex steering wheel will not work.



## MIRRORS

### Inside rearview mirror

Adjust the rearview mirror so that the center view through the rear window is seen. Make this adjustment before you start driving.

Do not place objects in the rear seat or cargo area which would interfere with your vision through the rear window.

**⚠ WARNING**  
- Mirror adjustment

**Do not adjust the rearview mirror while the vehicle is moving. This could result in loss of control.**

**⚠ WARNING**

**Do not modify the inside mirror and don't install a wide mirror. It could result in injury, during an accident or deployment of the air bag.**

### *Day/night rearview mirror (if equipped)*

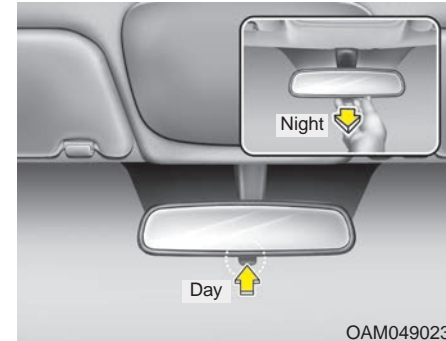

Make this adjustment before you start driving and while the day/night lever is in the day position.

Pull the day/night lever toward you to reduce the glare from the headlights of the vehicles behind you during night driving.

*Remember that you lose some rearview clarity in the night position.*

### **Electric chromic mirror (ECM) (if equipped)**

The electric rearview mirror automatically controls the glare from the headlights of the vehicles behind you in nighttime or low light driving conditions. The sensor mounted in the mirror senses the light level around the vehicle, and automatically controls the headlight glare from the vehicles behind you.

When the engine is running, the glare is automatically controlled by the sensor mounted in the rearview mirror.

Whenever the shift lever is shifted into reverse (R), the mirror will automatically go to the brightest setting in order to improve the drivers view behind the vehicle.

### **⚠ CAUTION - Cleaning mirror**

***When cleaning the mirror, use a paper towel or similar material dampened with glass cleaner. Do not spray glass cleaner directly on the mirror. It may cause the liquid cleaner to enter the mirror housing.***

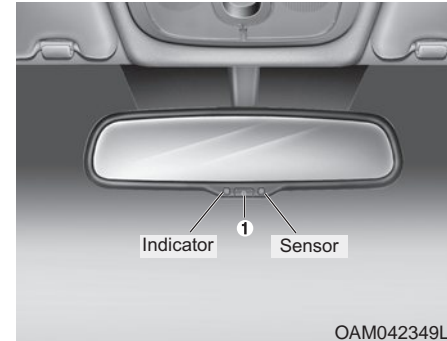

### **To operate the electric rearview mirror:**

- The mirror defaults to the ON position whenever the ignition switch is turned on.
- Press the ON/OFF button (1) to turn the automatic dimming function off. The mirror indicator light will turn off.

Press the ON/OFF button (1) to turn the automatic dimming function on. The mirror indicator light will illuminate.

## Outside rearview mirror

Be sure to adjust the mirror angles before driving.

Your vehicle is equipped with both left-hand and right-hand outside rearview mirrors. The mirrors can be adjusted remotely with the remote switch. The mirror heads can be folded back to prevent damage during an automatic vehicle wash or when passing through a narrow street.

The right outside rearview mirror is convex. Objects seen in the mirror are closer than they appear.

Use your interior rearview mirror or direct observation to determine the actual distance of following vehicles when changing lanes.



### CAUTION

#### - Rearview mirror

*Do not scrape ice off the mirror face; this may damage the surface of the glass. If ice should restrict the movement of the mirror, do not force the mirror for adjustment. To remove ice, use a deicer spray, or a sponge or soft cloth with very warm water.*

If the mirror is jammed with ice, do not adjust the mirror by force. Use an approved spray de-icer (not radiator antifreeze) to release the frozen mechanism or move the vehicle to a warm place and allow the ice to melt.



### WARNING

#### - Mirror adjustment

**Do not adjust or fold the outside rearview mirrors while the vehicle is moving. This could result in loss of control.**

### Remote control



#### Electric type

The electric remote control mirror switch allows you to adjust the position of the left and right outside rearview mirrors. To adjust the position of either mirror the ignition switch should be in the ACC position. Move the switch (1) to R or L to select the right side mirror or the left side mirror, then press a corresponding point on the mirror adjustment control to position the selected mirror up, down, left or right.

After the adjustment, put the switch into the neutral (center) position to prevent inadvertent adjustment.

#### CAUTION - Outside mirror

- *The mirrors stop moving when they reach the maximum adjusting angles, but the motor continues to operate while the switch is pressed.*

*Do not press the switch longer than necessary, the motor may be damaged.*

- *Do not attempt to adjust the outside rearview mirror by hand. Doing so may damage the parts.*

### Folding the outside rearview mirror

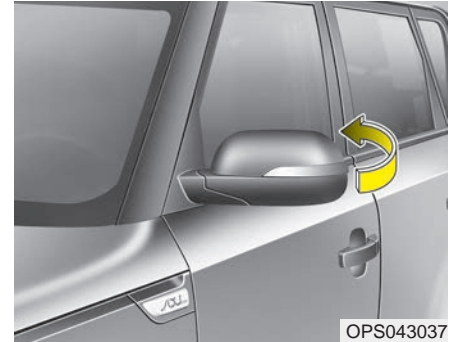

#### Manual type

To fold the outside rearview mirror, grasp the housing of the mirror and then fold it toward the rear of the vehicle.



### Electric type

The outside rearview mirror can be folded or unfolded by pressing the switch as below.

**Left (1)** : The mirror will unfold.

**Right (2)** : The mirror will fold.

### Center (AUTO, 3) :

The mirror will fold or unfold automatically as follows:

- Without smart key system
  - The mirror will fold or unfold when the door is locked or unlocked by the transmitter.
- With smart key system
  - The mirror will fold or unfold when the door is locked or unlocked by the smart key.
  - The mirror will fold or unfold when the door is locked or unlocked by the button on the outside door handle.
  - The mirror will unfold when you approach the vehicle (all doors closed and locked) with a smart key in possession. (if equipped)

### **⚠ CAUTION** - Electric type outside rearview mirror

*The electric type outside rearview mirror operates even though the ignition switch is in the OFF position. However, to prevent unnecessary battery discharge, do not adjust the mirrors longer than necessary while the engine is not running. In case it is an electric type outside rearview mirror, don't fold it by hand. It could cause motor failure.*

## INSTRUMENT CLUSTER

### ■ Type A



1. Tachometer
2. Speedometer
3. Engine coolant temperature gauge
4. Fuel gauge
5. LCD display
6. Warning and indicator lights (if equipped)
7. Turn signal indicator lights

### ■ Type B



\* The actual cluster in the vehicle may differ from the illustration.  
For more details, refer to the "Gauges" in this chapter.

## Instrument Cluster Control

### Adjusting Instrument Cluster Illumination

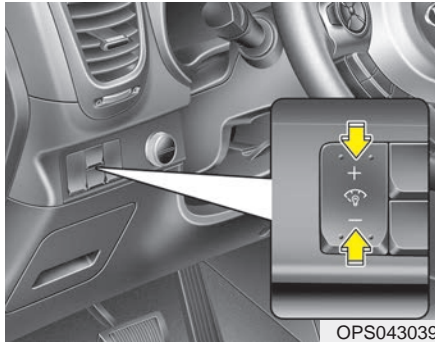

The brightness of the instrument panel illumination is changed by pressing the illumination control button ("+" or "-") when the ignition switch or Engine Start/Stop button is ON, or the tail lights are turned on.

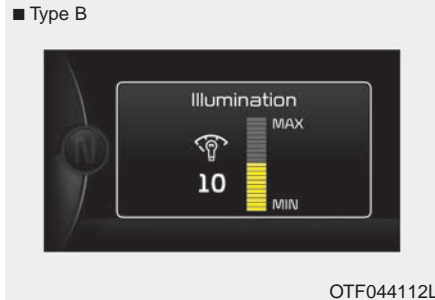

- If you hold the illumination control button ("+" or "-"), the brightness will be changed continuously.
- If the brightness reaches to the maximum or minimum level, an alarm will sound.

## LCD Display Control





The LCD display modes can be changed by using the control buttons on the steering wheel.

[For type A cluster]

- (1) TRIP : TRIP button for changing trip modes
- (2) RESET : RESET button for resetting items

[For type B cluster]

- (1)  : MODE button for changing modes or SELECT button for setting the selected item
- (2)  : MOVE button for changing items or RESET button for resetting the selected item

\* For the LCD modes, refer to “LCD Display” in this chapter.

### Gauges

#### Speedometer

■ Type A

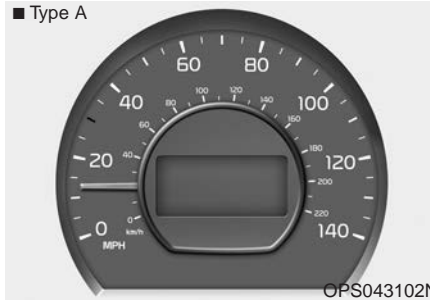

■ Type B



The speedometer indicates the speed of the vehicle and is calibrated in miles per hour (mph) and/or kilometers per hour (km/h).

### Tachometer

■ Type A



■ Type B



The tachometer indicates the approximate number of engine revolutions per minute (rpm).



Use the tachometer to select the correct shift points and to prevent lugging and/or over-revving the engine.



**CAUTION - Red zone**

*Do not operate the engine within the tachometer's RED ZONE. This may cause severe engine damage.*

**Engine Coolant Temperature Gauge**

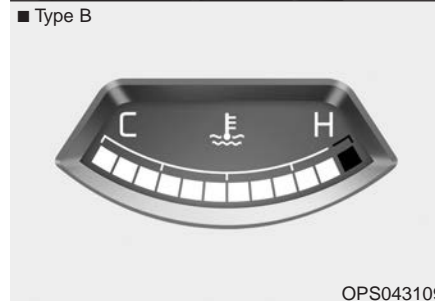
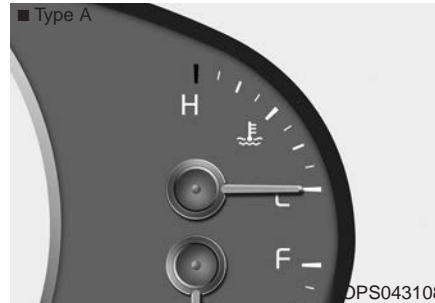

This gauge indicates the temperature of the engine coolant when the ignition switch or Engine Start/Stop button is ON.

If the gauge pointer moves beyond the normal range area toward the “H” position, it indicates overheating that may damage the engine.

Do not continue driving with an overheated engine. If your vehicle overheats, refer to “If the Engine Overheats” in chapter 6.



**WARNING - Hot radiator**

**Never remove the radiator cap when the engine is hot. The engine coolant is under pressure and could severely burn. Wait until the engine is cool before adding coolant to the reservoir.**

### Fuel Gauge

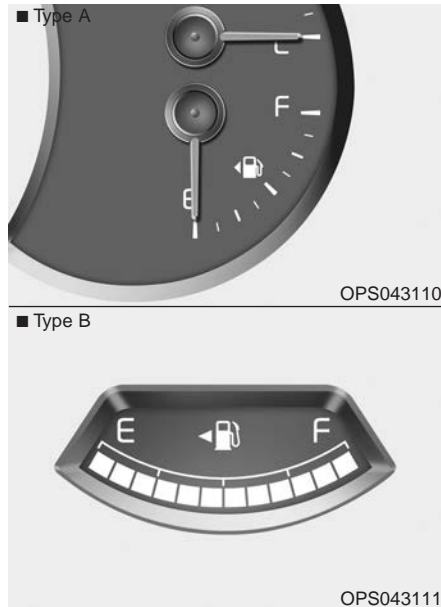

This gauge indicates the approximate amount of fuel remaining in the fuel tank.

### \* NOTICE

- The fuel tank capacity is given in chapter 8.
- The fuel gauge is supplemented by a low fuel warning light, which will illuminate when the fuel tank is nearly empty.
- On inclines or curves, the fuel gauge pointer may fluctuate or the low fuel warning light may come on earlier than usual due to the movement of fuel in the tank.

### \* NOTICE - Fuel gauge

Running out of fuel can expose vehicle occupants to danger. You must stop and obtain additional fuel as soon as possible after the warning light comes on or when the gauge indicator comes close to the "E (Empty)" level.



### CAUTION - Low fuel

*Avoid driving with an extremely low fuel level. Running out of fuel could cause the engine to misfire damaging the catalytic converter.*

### \* NOTICE

Fuel display may not be accurate if you are filling in sloping places.

### Odometer

■ Type A



OPS043113C

■ Type B

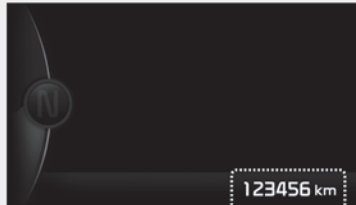

OPS043118C

The odometer Indicates the total distance that the vehicle has been driven and should be used to determine when periodic maintenance should be performed.

- Odometer range : 0 ~ 999999 miles or kilometers.

### Outside Temperature Gauge

■ Type A



OPS043114C

■ Type B

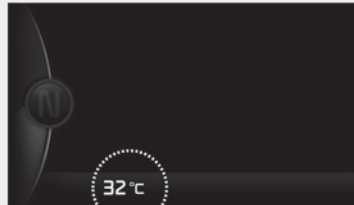

OPS043119C

This gauge indicates the current outside air temperatures by 1°C (1°F).

- Temperature range : -40°C ~ 60°C-  
(40°F ~ 140°F)

The outside temperature on the display may not change immediately like a general thermometer to prevent the driver from being inattentive.

To change the temperature unit (from °C to °F or from °F to °C)

- Type A Cluster

Change the trip modes to Distance To Empty mode and then press and hold the RESET button for 5 seconds and more.

- Type B Cluster

The temperature unit can be changed by using the "User Settings" mode of the LCD display

\* For more details, refer to "LCD Display" in this chapter.

### Transaxle Shift Indicator

#### Automatic Transaxle Shift Indicator

##### ■ Type A



OPS043115

##### ■ Type B

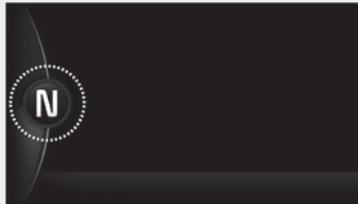

OTF044125L

This indicator displays which automatic transaxle shift lever is selected.

- Park : P
- Reverse : R
- Neutral : N
- Drive : D
- Sports Mode : 1, 2, 3, 4, 5, 6

### Manual Transaxle Shift Indicator (if equipped)

##### ■ Type A



OPS043116

##### ■ Type B

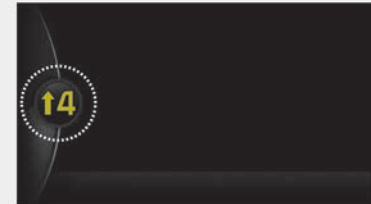

OTF044402

This indicator informs which gear is desired while driving to save fuel.

- Shifting up : ▲2, ▲3, ▲4, ▲5, ▲6
- Shifting down : ▼1, ▼2, ▼3, ▼4, ▼5







For example

- ▲3: Indicates that shifting up to the 3rd gear is desired (currently the shift lever is in the 2nd or 1st gear).
- ▼3: Indicates that shifting down to the 3rd gear is desired (currently the shift lever is in the 4th, 5th, or 6th gear).

When the system is not working properly, the indicator is not displayed.

## LCD DISPLAY (IF EQUIPPED)

### LCD Modes (for type B cluster)

Modes	Symbol	Explanation
Trip Computer		This mode displays driving information like the tripmeter, fuel economy, and so on. For more details, refer to "Trip Computer" in this chapter.
Turn By Turn (if equipped)		This mode displays the state of the navigation.
LDWS (if equipped)		This mode displays the state of the Lane Departure Warning System (LDWS). For more details, refer to "Lane Departure Warning System (LDWS)" in chapter 5.
A/V (if equipped)		This mode displays the state of the A/V system.
Service		This mode informs of service interval (mileage or days) and warning messages related to TPMS and so on.
Master warning		
User Settings		On this mode, you can change settings of the doors, lamps, and so on.

\* For controlling the LCD modes, refer to "LCD Display Control" in this chapter.

## Service Mode

### Service Interval

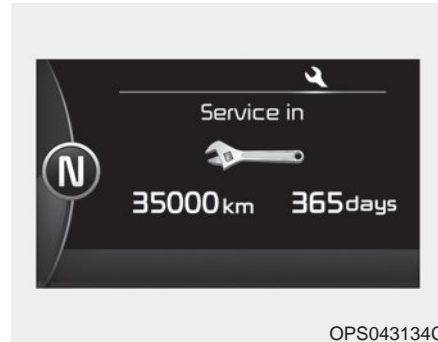

### Service in

It calculates and displays when you need a scheduled maintenance service (mileage or days).

If the remaining mileage or time reaches 1,500 km (900 mi.) or 30 days, "Service in" message is displayed for several seconds each time you set the ignition switch or Engine Start/Stop Button to the ON position.

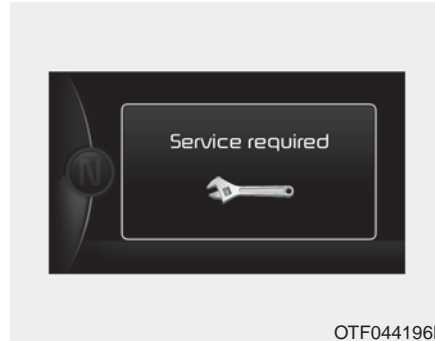

### Service required

If you do not have your vehicle serviced according to the already inputted service interval, "Service required" message is displayed for several seconds each time you set the ignition switch or Engine Start/Stop Button to the ON position (The mileage and time changes to "---").

To reset the service interval to the mileage and days you inputted before:

- Press the RESET button ▽ for more than 1 second.

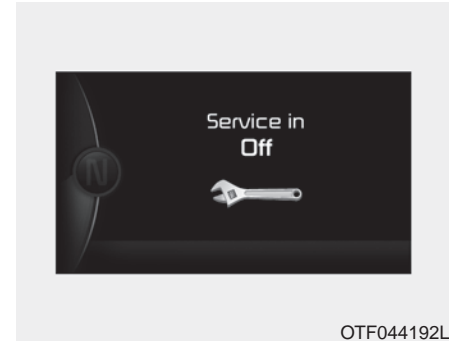

### Service in OFF

If the service interval is not set, "Service in OFF" message is displayed on the LCD display.

### \* NOTICE

If any of the following conditions occurs, the mileage and days may be incorrect.

- The battery cable is disconnected.
- The fuse switch is turned off.
- The battery is discharged.

### **Master Warning Mode (if equipped)**



- This warning light informs the driver the following situations
  - Service reminder (if equipped)
  - Forward collision warning system (FCWS) malfunction (if equipped)

The Master Warning Light illuminates when more than one of the above warning situations occur. At this time, the LCD Modes Icon will change from (P) to (▲).

If the warning situation is solved, the LCD Modes Icon will be changed back to its previous icon (P).

### **User Settings Mode**

#### **Description**

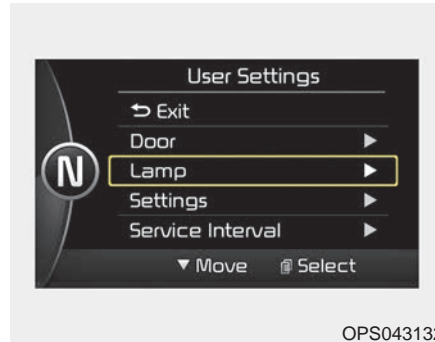

On this mode, you can change setting of the doors, lamps, and so on.

### **Door**

#### **Auto Door Lock (if equipped)**

- Off:  
The auto door lock operation will be deactivated.
- Speed (for manual transaxle)  
All doors will be automatically locked when the vehicle speed exceeds 15km/h (9.3mph).
- Shift Lever:  
All doors will be automatically locked if the automatic transaxle shift lever is shifted from the P (Park) position to the R (Reverse), N (Neutral), or D (Drive) position.

#### **Auto Door Unlock (if equipped)**

- Off:  
The auto door unlock operation will be canceled.
- Key Out or Power Off:  
All doors will be automatically unlocked when the ignition key is removed from ignition switch or Engine Start/Stop Button is set to the OFF position.



- **Shift Lever:**

All doors will be automatically unlocked if the automatic transaxle shift lever is shifted to the P (Park) position.

- **Two Press Unlock (if equipped)**

- **Off:**

The two press unlock function will be deactivated. Therefore, all doors will unlock if the door is unlocked.

- **On:**

The driver's door will unlock if the door is unlocked. When the door is unlocked again within 4 seconds, all doors will unlock.

- **Horn Feedback (if equipped)**

- **Off:**

The Horn feedback operation will be deactivated.

- **On:**

After locking the door by pressing the lock button on the transmitter, if you press the lock button again within 4 seconds, the warning sound will operate once to indicate that all doors are locked.

**Lamp**

- **One Touch Turn Lamp (if equipped)**

If this item is checked, the lane change signals will blink 3, 5 or 7 times when the turn signal lever is moved slightly.

- **Head Lamp Delay (if equipped)**

If this item is checked, the headlamp delay function will be activated.

**Settings**

- **Language**

Choose the language you prefer within the LCD.

- **Temperature Unit**

Convert the temperature unit from °C to °F or from °F to °C.

- **Welcome Sound**

If this item is checked, the welcome sound function will be activated.

**Fuel economy auto reset**

- **Auto Reset:**

The average fuel economy will reset automatically when refueling.

- **Manual Reset:**

The average fuel economy will not reset automatically whenever refueling.

For more details, refer to "Trip Computer" in this chapter.

- **Forward Collision Warning (if equipped)**

If this item is checked, forward collision warning function will be activated.

### Service Interval

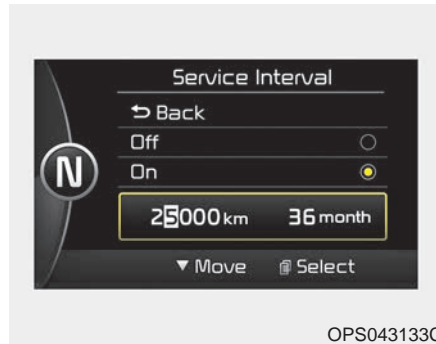

On this mode, you can activate the service interval function with mileage (mi. or km) and period (months).

### A/V Mode (if equipped)

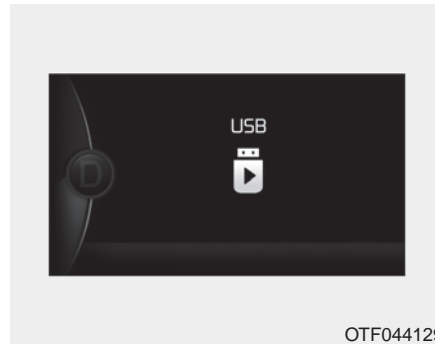

This mode displays the state of the A/V system.

### Turn By Turn Mode (if equipped)



This mode displays the state of the navigation.

## Warning Messages

**Shift to "P" position (for smart key system and automatic transaxle)**



- This warning message illuminates if you try to turn off the engine without the shift lever in P (Park) position.
- At this time, the Engine Start/Stop Button turns to the ACC position (If you press the Engine Start/Stop Button once more, it will turn to the ON position).

**Low Key Battery (for smart key system)**

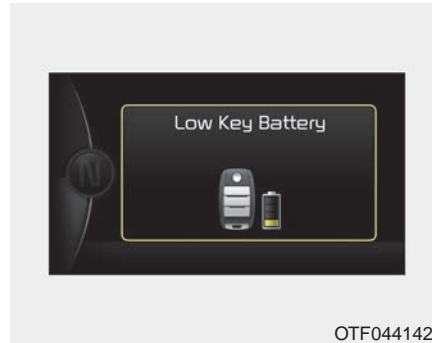

- This warning message illuminates if the battery of the smart key is discharged when the Engine Start/Stop Button changes to the OFF position.

**Press brake pedal to start engine (for smart key system and automatic transaxle)**

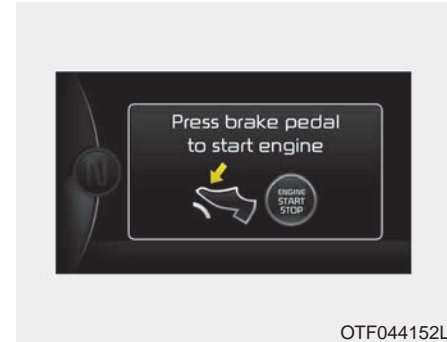

- This warning message illuminates if the Engine Start/Stop Button changes to the ACC position twice by pressing the button repeatedly without depressing the brake pedal.
- It means that you should depress the brake pedal to start the engine.

### **Press clutch pedal to start engine (for smart key system and manual transaxle)**



- This warning message illuminates if the Engine Start/Stop Button changes to the ACC position twice by pressing the button repeatedly without depressing the clutch pedal.
- It means that you should depress the clutch pedal to start the engine.

### **Key not in vehicle (for smart key system)**

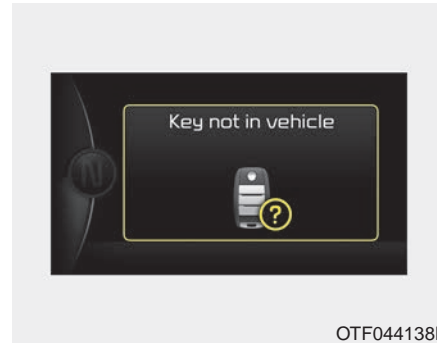

- This warning message illuminates if the smart key is not in the vehicle while the door is opened or closed with the ignition switch in the ACC position or engine is running.
- It means that you should always have the smart key with you.

### **Key not detected (for smart key system)**

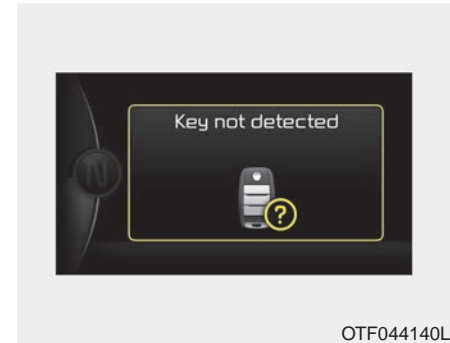

- This warning message illuminates if the smart key is not detected when you press the Engine Start/Stop Button.

**Press start button again  
(for smart key system)**



OTF044144L

- This warning message illuminates if you can not operate the Engine Start/Stop Button when there is a problem with the Engine Start/Stop Button system.
- It means that you could start the engine by pressing the Engine Start/ Stop Button once more.
- If the warning illuminates each time you press the Engine Start/Stop Button, have your vehicle inspected by an authorized Kia dealer.

**Press start button with smart key  
(for smart key system)**



OTF044146L

- This warning message illuminates if you press the Engine Start/Stop Button while the warning message "Key not detected" is illuminating.
- At this time, the immobilizer indicator light blinks.

**Check fuse "BRAKE SWITCH"  
(for smart key system and auto-  
matic transaxle)**



OTF044157L

- This warning message illuminates if the brake switch fuse is disconnected.
- It means that you should replace the fuse with a new one. If that is not possible, you can start the engine by pressing the Engine Start/Stop Button for 10 seconds in the ACC position.

### **Shift to "P" or "N" to start engine (for smart key system and auto- matic transaxle)**



- This warning message illuminates if you try to start the engine with the shift lever not in the P (Park) or N (Neutral) position.

### **\* NOTICE**

You can start the engine with the shift lever in the N (Neutral) position. But, for your safety, we recommend that you start the engine with the shift lever in the P (Park) position.

### **Door Open**

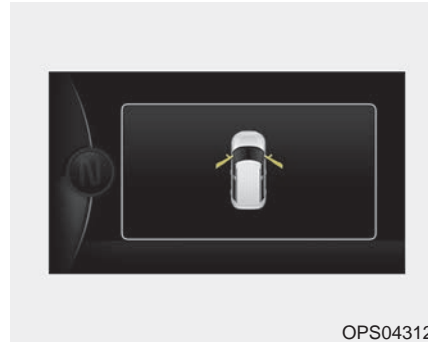

- It means that any door is open.

### **Tailgate Open**



- It means that the tailgate is open.

**Sunroof Open (if equipped)**



- The warning message illuminates if you turn off the engine when the sunroof is open.

**Turn on "FUSE SWITCH" (if equipped)**

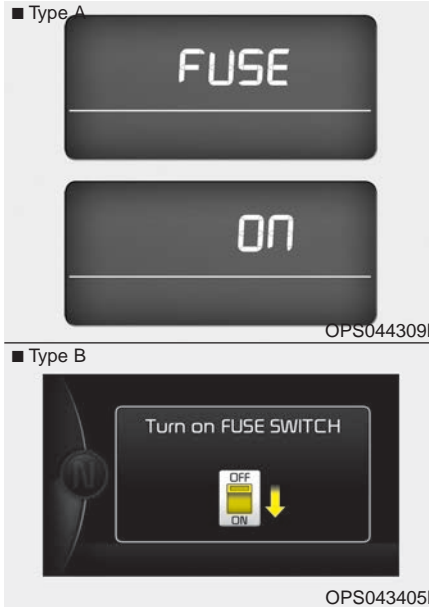

- This warning message illuminates if the fuse switch on the fuse box is OFF.

- The "FUSE" and "on" warning messages are displayed alternately. (for Type A)
- It means that you should turn the fuse switch on.

For more details, refer to "Fuses" in chapter 7.

*Low Washer Fluid (if equipped)*



- This warning message illuminates on the service reminder mode if the washer fluid level in the reservoir is nearly empty.
- It means that you should refill the washer fluid.

## TRIP COMPUTER

### Overview

#### Description

The trip computer is a microcomputer-controlled driver information system that displays information related to driving.

#### \* NOTICE

Some driving information stored in the trip computer (for example Average Vehicle Speed) resets if the battery is disconnected.

### *Trip Modes (for Type A cluster)*

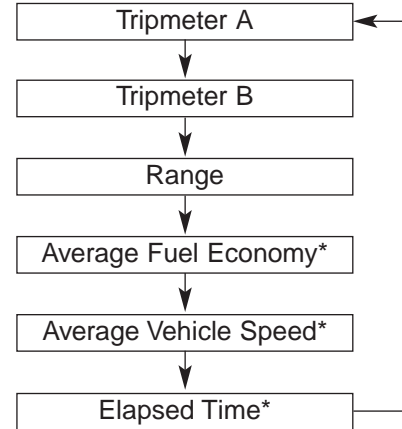

\* if equipped

To change the trip mode, press the TRIP button.



**Trip Modes (for Type B cluster)**

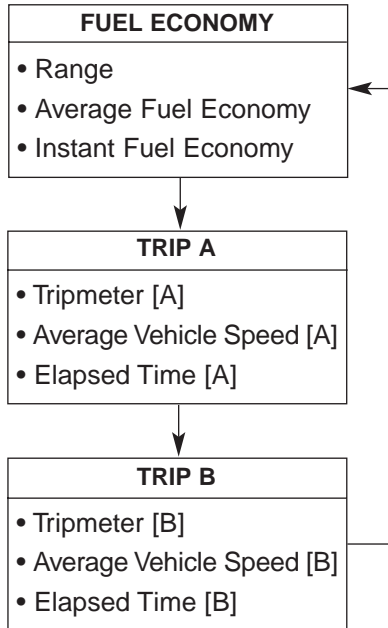

To change the trip mode, press the MOVE button ▽.

**Trip A/B**

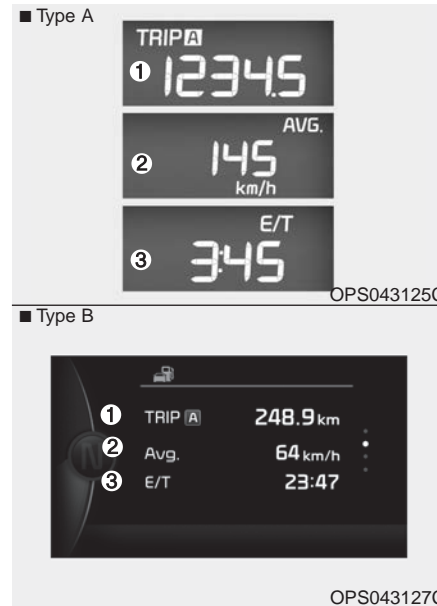

**Tripmeter (1)**

- The tripmeter is the total driving distance since the last tripmeter reset.
  - Distance range: 0.0 ~ 9999.9 mi. or km
- To reset the tripmeter, press the RESET/▽ button on the steering wheel for more than 1 second when the tripmeter is displayed.

**Average Vehicle Speed (2)**

- The average vehicle speed is calculated by the total driving distance and driving time since the last average vehicle speed reset.
  - Speed range: 160 MPH or 200 km/h
- To reset the average vehicle speed, press the RESET/▽ button on the steering wheel for more than 1 second when the average vehicle speed is displayed.

### \* NOTICE

- The average vehicle speed is not displayed if the driving distance is less than 50 meters (0.03 miles) or the driving time is less than 10 seconds since the ignition switch or Engine Start/Stop button is turned to ON.
- Even if the vehicle is not in motion, the average vehicle speed keeps going while the engine is running.

### Elapsed Time (3)

- The elapsed time is the total driving time since the last elapsed time reset.
  - Time range (hh:mm): 00:00 ~ 99:59
- To reset the elapsed time, press the RESET/▽ button on the steering wheel for more than 1 second when the elapsed time is displayed.

### \* NOTICE

Even if the vehicle is not in motion, the elapsed time keeps going while the engine is running.

## Fuel Economy

### Range (1)

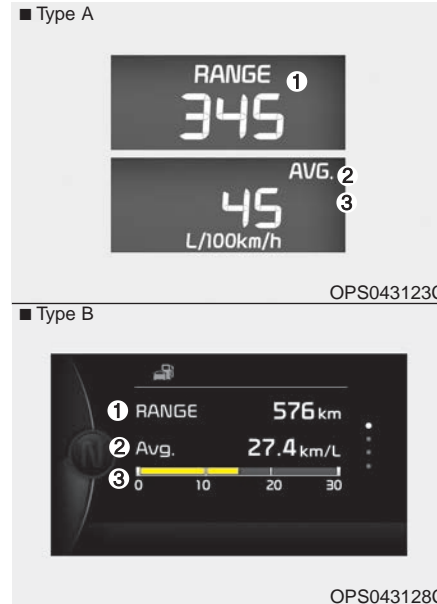

- The range to empty is the estimated distance the vehicle can be driven with the remaining fuel.
  - Distance range : 30 ~ 1999 mi or 50 ~ 1999 km.

- If the estimated distance is below 50 km (30 mi.), the trip computer will display “---” as distance to empty.
- If the vehicle is not on level ground or the battery power has been interrupted, the distance to empty function may not operate correctly.
- The distance to empty may differ from the actual driving distance as it is an estimate of the available driving distance.
- The trip computer may not register additional fuel if less than 1.6 gallons (6 liters ) of fuel are added to the vehicle.
- The fuel economy and distance to empty may vary significantly based on driving conditions, driving habits, and condition of the vehicle.

### ***Average Fuel Economy (2)***

- The average fuel economy is calculated by the total driving distance and fuel consumption since the last average fuel economy reset.
  - Fuel economy range: 0.0 ~ 99.9 MPG or L/100km
- The average fuel economy can be reset both manually and automatically.

#### **Manual reset**

To clear the average fuel economy manually, press the RESET/▽ button on the steering wheel for more than 1 second when the average fuel economy is displayed.

### **Automatic reset**

To make the average fuel economy be reset automatically whenever refueling, select the “Auto Reset” mode in User Setting menu of the LCD display (Refer to “LCD Display”).

Under “Auto Reset” mode, the average fuel economy will be cleared to zero (---) when the vehicle speed exceeds 1 km/h after refueling more than 1.6 gallons (6 liters).

### **\* NOTICE**

**The average fuel economy is not displayed for more accurate calculation if the vehicle does not drive more than 10 seconds or 0.03 miles (50 meters) since the ignition switch or Engine Start/Stop button is turned to ON.**

### ***Instant Fuel Economy (3)***

- This mode displays the instant fuel economy during the last few seconds when the vehicle speed is more than 10 km/h (6.2 MPH).
  - Fuel economy range: 0 ~ 99.9 MPG or L/100km

## WARNING AND INDICATOR LIGHTS

### Warning lights

#### \* NOTICE - Warning lights

Make sure that all warning lights are OFF after starting the engine. If any light is still ON, this indicates a situation that needs attention.

#### *Air bag Warning Light*



#### **This warning light illuminates:**

- Once you set the ignition switch or Engine Start/Stop Button to the ON position.
  - It illuminates for approximately 6 seconds and then goes off.
- When there is a malfunction with the SRS.

In this case, have your vehicle inspected by an authorized Kia dealer.

#### *Seat Belt Warning Light*



This warning light informs the driver that the seat belt is not fastened. For more details, refer to the “Seat Belts” in chapter 3.

### ***Parking Brake & Brake Fluid Warning Light***



#### **This warning light illuminates:**

- Once you set the ignition switch or Engine Start/Stop Button to the ON position.
  - It illuminates for approximately 3 seconds
  - It remains on if the parking brake is applied.
- When the parking brake is applied.
- When the brake fluid level in the reservoir is low.
  - If the warning light illuminates with the parking brake released, it indicates the brake fluid level in reservoir is low.

#### **If the brake fluid level in the reservoir is low:**

1. Drive carefully to the nearest safe location and stop your vehicle.
2. With the engine stopped, check the brake fluid level immediately and add fluid as required (For more details, refer to “Brake Fluid” in chapter 7).

Then check all brake components for fluid leaks. If any leaks in the brake system is still found, the warning light remains on, or the brakes do not operate properly, do not drive the vehicle.

In this case, have your vehicle towed to an authorized Kia dealer and inspected.

#### **Dual-diagonal braking system**

Your vehicle is equipped with dual-diagonal braking systems. This means you still have braking on two wheels even if one of the dual systems should fail.

With only one of the dual systems working, more than normal pedal travel and greater pedal pressure are required to stop the vehicle.

Also, the vehicle will not stop in as short a distance with only a portion of the brake system working.

If the brakes fail while you are driving, shift to a lower gear for additional engine braking and stop the vehicle as soon as it is safe to do so.

Driving the vehicle with a warning light ON is dangerous. If the Parking Brake & Brake Fluid Warning Light illuminates with the parking brake released, it indicates that the brake fluid level is low.

In this case, have your vehicle inspected by an authorized Kia dealer.

### ***Anti-lock Brake System (ABS) Warning Light***



#### **This warning light illuminates:**

- Once you set the ignition switch or Engine Start/Stop Button to the ON position.
  - It illuminates for approximately 3 seconds and then goes off.
- When there is a malfunction with the ABS (The normal braking system will still be operational without the assistance of the anti-lock brake system).

In this case, have your vehicle inspected by an authorized Kia dealer.

### ***Electronic Brake force Distribution (EBD) System Warning Light***



#### **These two warning lights illuminate at the same time while driving:**

- When the ABS and regular brake system may not work normally.

In this case, have your vehicle inspected by an authorized Kia dealer.

**⚠ WARNING - Electronic Brake force Distribution (EBD) System Warning Light**

When both ABS and Parking Brake & Brake Fluid Warning Lights are on, the brake system will not work normally and you may experience an unexpected and dangerous situation during sudden braking thereby increasing the risk of a crash or injury.

In this case, avoid high speed driving and abrupt braking. Have your vehicle inspected by an authorized Kia Premium dealer as soon as possible.

**\* NOTICE - Electronic Brake force Distribution (EBD) System Warning Light**

When the ABS Warning Light is on or both ABS and Parking Brake & Brake Fluid Warning Lights are on, the speedometer, odometer, or trip-meter may not work. Also, the EPS Warning Light may illuminate and the steering effort may increase or decrease.

In this case, have your vehicle inspected by an authorized Kia dealer as soon as possible.

***Electronic Power Steering (EPS) Warning Light (if equipped)***



**This warning light illuminates:**

- Once you set the ignition switch or Engine Start/Stop Button to the ON position.
  - It remains on until the engine is started.
- When there is a malfunction with the EPS.

In this case, have your vehicle inspected by an authorized Kia dealer.

### **Malfunction Indicator Lamp (MIL)**



#### **This warning light illuminates:**

- Once you set the ignition switch or Engine Start/Stop Button to the ON position.
  - It remains on until the engine is started.
- When there is a malfunction with the emission control system.

In this case, have your vehicle inspected by an authorized Kia dealer.

### **⚠ CAUTION - Malfunction Indicator Lamp (MIL)**

***Driving with the Malfunction Indicator Lamp (MIL) on may cause damage to the emission control systems which could effect drivability and/or fuel economy.***

### **⚠ CAUTION - Catalytic Converter Damage**

***If the Malfunction Indicator Lamp (MIL) illuminates, potential catalytic converter damage is possible which could result in loss of engine power.***

***In this case, have your vehicle inspected by an authorized Kia dealer as soon as possible.***

### **Charging System Warning Light**



#### **This warning light illuminates:**

- Once you set the ignition switch or Engine Start/Stop Button to the ON position.
  - It remains on until the engine is started.
- When there is a malfunction with either the alternator or electrical charging system.



**If there is a malfunction with either the alternator or electrical charging system:**

1. Drive carefully to the nearest safe location and stop your vehicle.
2. Turn the engine off and check the alternator drive belt for looseness or breakage.

If the belt is adjusted properly, there may be a problem in the electrical charging system.

In this case, have your vehicle inspected by an authorized Kia dealer as soon as possible.

### **Engine Oil Pressure Warning Light**



**This warning light illuminates:**

- Once you set the ignition switch or Engine Start/Stop Button to the ON position.
  - It remains on until the engine is started.
- When the engine oil pressure is low.

**If the engine oil pressure is low:**

1. Drive carefully to the nearest safe location and stop your vehicle.
2. Turn the engine off and check the engine oil level (For more details, refer to “Engine Oil” in section 7). If the level is low, add oil as required.
 

If the warning light remains on after adding oil or if oil is not available, have your vehicle inspected by an authorized Kia dealer as soon as possible.

### **⚠ CAUTION - Engine damage**

***If the engine does not stop immediately after the engine oil pressure warning light is illuminated and stays on while the engine is running, serious engine damage may result.***

- If the warning light stays on while the engine is running, it indicates that there may be serious engine damage or malfunction. In this case,
  1. Stop the vehicle as soon as it is safe to do so.
  2. Turn off the engine and check the oil level. If the oil level is low, fill the engine oil to the proper level.
  3. Start the engine again. If the warning light stays on after the engine is started, turn the engine off immediately. In this case, have your vehicle inspected by an authorized Kia Premium dealer.

### **Low Fuel Level Warning Light**



**This warning light illuminates:**  
When the fuel tank is nearly empty.

**If the fuel tank is nearly empty:**  
Add fuel as soon as possible.

 **CAUTION - Low Fuel Level**

*Driving with the Low Fuel Level warning light on or with the fuel level below “0 or E” can cause the engine to misfire and damage the catalytic converter (if equipped).*

### **Door Ajar Warning Light**



**This warning light illuminates:**  
When a door is not closed securely.

### **Tailgate Open Warning Light**



**This warning light illuminates:**  
When the tailgate is not closed securely.

### **Washer Fluid Warning Light (if equipped)**



**This warning light illuminates:**

- When the washer fluid level in the reservoir is nearly empty.

In this case, you should refill the washer fluid.

**Sunroof Open Warning Light (if equipped)**



**This warning light illuminates:**

When the sunroof is not closed securely.

**Fuel cap open warning indicator (if equipped)**



**This warning light illuminates:**

- When the fuel filler cap is not tightened securely.  
Always make sure that the fuel filler cap is tight.

**Forward collision warning (FCW) system OFF/warning indicator (if equipped)**



**This warning light illuminates:**

- When you deactivate this system in the User settings mode in LCD display.
- If this indicator illuminates with warning message in LCD display, there is a malfunction with the Forward collision warning system.  
In this case, have your vehicle inspected by an authorized Kia dealer.

**Indicator Lights**

**Electronic Stability Control (ESC) Indicator Light**



**This indicator light illuminates:**

- Once you set the ignition switch or Engine Start/Stop Button to the ON position.  
- It illuminates for approximately 3 seconds and then goes off.
- When there is a malfunction with the ESC system.

In this case, have your vehicle inspected by an authorized Kia dealer.

**This indicator light blinks:**

While the ESC is operating.

For more details, refer to “Electronic Stability Control (ESC)” in chapter 5.

### **Electronic Stability Control (ESC) OFF Indicator Light**



#### **This indicator light illuminates:**

- Once you set the ignition switch or Engine Start/Stop Button to the ON position.
  - It illuminates for approximately 3 seconds and then goes off.
- When you deactivate the ESC system by pressing the ESC OFF button.

For more details, refer to “Electronic Stability Control (ESC)” in chapter 5.

### **ECOMINDER® indicator Active ECO system**

**ECO**

#### **This indicator light illuminates:**

When the Active ECO button is pressed the ECOMINDER® indicator (green) will illuminate to show that the Active ECO is operating. For more detailed information, refer to "Active ECO" in chapter 5.

### **Immobilizer Indicator Light (Without Smart Key)**



#### **This indicator light illuminates:**

- When the vehicle detects the immobilizer in your key properly while the ignition switch is ON.
  - At this time, you can start the engine.
  - The indicator light goes off after starting the engine.

#### **This indicator light blinks:**

- When there is a malfunction with the immobilizer system.

In this case, have your vehicle inspected by an authorized Kia dealer.

**Immobilizer Indicator Light (With Smart Key)**



**This indicator light illuminates for up to 30 seconds:**

- When the vehicle detects the smart key in the vehicle properly while the Engine Start/Stop Button is ACC or ON.
  - At this time, you can start the engine.
  - The indicator light goes off after starting the engine.

**This indicator light blinks for a few seconds:**

- When the smart key is not in the vehicle.
  - At this time, you can not start the engine.

**This indicator light illuminates for 2 seconds and goes off:**

- When the vehicle can not detect the smart key which is in the vehicle while the Engine Start/Stop Button is ON.
 

In this case, have your vehicle inspected by an authorized Kia dealer.

**This indicator light blinks:**

- When the battery of the smart key is weak.
  - At this time, you can not start the engine. However, you can start the engine if you press the Engine Start/Stop Button with the smart key. (For more details, refer to “Starting the Engine” in section 5).
- When there is a malfunction with the immobilizer system.
 

In this case, have your vehicle inspected by an authorized Kia dealer.

**Turn Signal Indicator Light**



**This indicator light blinks:**

- When you turn the turn signal light on.

If any of the following occurs, there may be a malfunction with the turn signal system. In this case, have your vehicle inspected by an authorized Kia dealer.

- The indicator light does not blink but illuminates.
- The indicator light blinks more rapidly.
- The indicator light does not illuminate at all.

### *High Beam Indicator Light*



**This indicator light illuminates:**

- When the headlights are on and in the high beam position
- When the turn signal lever is pulled into the Flash-to-Pass position.

### *Light ON Indicator Light*



**This indicator light illuminates:**

- When the tail lights or headlights are on.

### *Front Fog Indicator Light (if equipped)*



**This indicator light illuminates:**

- When the front fog lights are on.

### *Cruise Indicator Light (if equipped)*

**CRUISE**

**This indicator light illuminates:**

- When the cruise control system is enabled.

For more details, refer to “Cruise Control System” in chapter 5.

***Cruise SET Indicator  
Light (if equipped)***

**SET**

**This indicator light illuminates:**

- When the cruise control speed is set.

For more details, refer to "Cruise Control System" in chapter 5.

***FLEX STEER indicator  
(if equipped)***

**SPORT    NORMAL    COMFORT**

**This indicator light illuminates:**

- When you press the FLEX STEER mode button.

For more details, refer to "FLEX STEER" in chapter 4.

## REAR CAMERA DISPLAY (IF EQUIPPED)

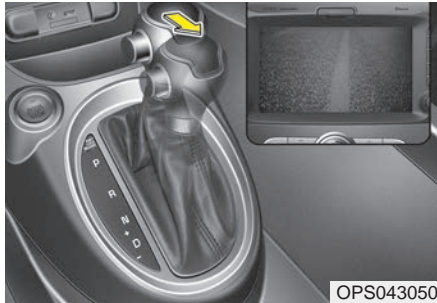

This system is a supplemental system that helps the driver by displaying objects behind the vehicle when backing up.

Always keep the camera lens clean. If lens is covered with foreign matter, the camera may not operate normally.

The rear camera display is not a safety device. It only serves to assist the driver in identifying objects directly behind the middle of the vehicle. The camera does NOT cover the complete area behind the vehicle. While the camera's display is generally accurate, objects can be much closer than they appear in the display screen and can be distorted in both size and proportion.

The rear camera display will activate when the back-up light is ON with the ignition switch ON and the shift lever in the R (Reverse) position.

### **⚠ WARNING - Backing up using camera**

**Never rely solely on the rear camera display when backing. You must always use methods of viewing the area behind you including looking over both shoulders as well as continuously checking all three rear view mirrors. Due to the difficulty of ensuring that the area behind you remains clear, always back slowly and stop immediately if you even suspect that a person, and especially a child, might be behind you.**



## LIGHTING

### Headlamp escort (if equipped)

If you turn the ignition switch to the ACC or OFF position with the headlights ON, the headlights remain on for about 5 minutes. However, if the driver's door is opened and closed, the headlights are turned off after 15 seconds.

The headlights can be turned off by pressing the lock button on the transmitter (or smart key) twice or turning the light switch to the OFF or Auto position. However, if you turn the light switch to the Auto position when it is dark outside, the headlights will not be turned off immediately.

### Battery saver function

- The purpose of this feature is to prevent the battery from being discharged. The system automatically turns off the parking lights when the driver removes the ignition key and opens the driver-side door (in that order).
- With this feature, the parking lights will turn off automatically if the driver parks on the side of the road at night.

If necessary, to keep the lights on when the ignition key is removed, perform the following:

- 1) Open the driver-side door.
- 2) Turn the parking lights OFF and ON again using the light switch on the steering column.

### Daytime running light

Daytime Running Lights (DRL) may help make it easier for others to see the front of your vehicle during the day. DRL can be helpful in many different driving conditions, and it is especially helpful after dawn and before sunset.

The DRL system turns OFF when:

1. The front fog light or headlight (low beam) switch is ON.
2. The engine is OFF.
3. The parking brake is applied.

## Lighting control



The light switch has a Headlight and a Parking light position.

To operate the lights, turn the knob at the end of the control lever to one of the following positions:

- (1) OFF position
- (2) Parking light position
- (3) Headlight position
- (4) Auto light position (if equipped)

## Parking light position ( 𠄎𠄎𠄎 )



When the light switch is in the parking light position (1st position), the tail, license and instrument panel lights will turn ON.

## Headlight position ( 𠄎𠄎 )



When the light switch is in the headlight position (2nd position), the head, tail, license and instrument panel lights will turn ON.

The ignition switch must be in the ON position to turn on the headlights.

### Auto light position (if equipped)

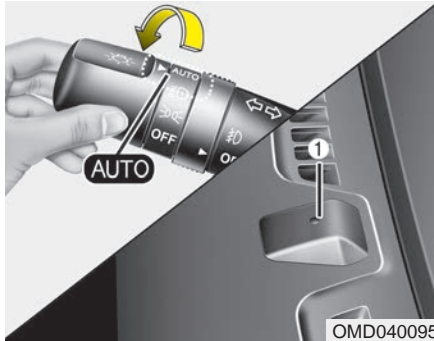

When the light switch is in the AUTO light position, the taillights and headlights will be turned ON or OFF automatically depending on the amount of light outside the vehicle.

- Never place anything over sensor (1) located on the instrument panel. This will ensure better auto-light system control.
- Don't clean the sensor using a window cleaner. The cleaner may leave a light film which could interfere with sensor operation.
- If your vehicle has window tint or other types of metallic coating on the front windshield, the Auto light system may not work properly.

### High beam operation



To turn on the high beam headlights, push the lever away from you. Pull it back for low beams.

The high beam indicator will light when the headlight high beams are switched on.

To prevent the battery from being discharged, do not leave the lights on for a prolonged time while the engine is not running.



OAM049043

To flash the headlights, pull the lever towards you. It will return to the normal (low beam) position when released. The headlight switch does not need to be on to use this flashing feature.

**⚠ WARNING - High beams**  
Do not use high beam when there are other vehicles. Using high beam could obstruct the other driver's vision.

### Turn signals and lane change signals

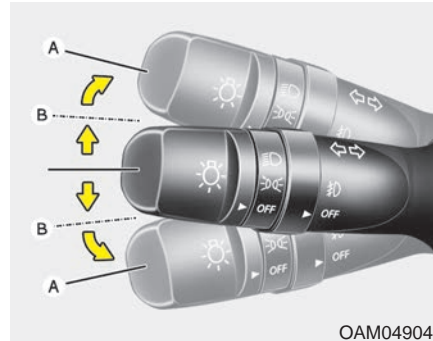

OAM049045

The ignition switch must be on for the turn signals to function. To turn on the turn signals, move the lever up or down (A). The green arrow indicators on the instrument panel indicate which turn signal is operating. They will self-cancel after a turn is completed. If the indicator continues to flash after a turn, manually return the lever to the OFF position.

To signal a lane change, move the turn signal lever slightly and hold it in position (B). The lever will return to the OFF position when released.

If an indicator stays on and does not flash or if it flashes abnormally, one of the turn signal bulbs may be burned out and will require replacement.

If an indicator flash is abnormally quick or slow, a bulb may be burned out or have a poor electrical connection in the circuit.

### ***One-touch lane change function***

To activate an one-touch lane change function, move the turn signal lever slightly and then release it. The lane change signals will blink 3, 5 or 7 times.

You can choose one-touch lane change blinking function in "One touch turn lamp" of "User setting". Refer to "User setting" in chapter 4.

### **\* NOTICE**

**If an indicator flash is abnormally quick or slow, the bulb may be burned out or have a poor electrical connection in the circuit.**

### **Front fog light (if equipped)**



OAM049046N

Fog lights are used to provide improved visibility when visibility is poor due to fog, rain or snow, etc. The fog lights will turn on when the fog light switch (1) is turned to the on position after the headlight is turned on.

To turn off the fog lights, turn the fog light switch (1) to the OFF position.

When in operation, the fog lights consume large amounts of vehicle electrical power. Only use the fog lights when visibility is poor.

## WIPERS AND WASHERS

### Windshield wiper/washer

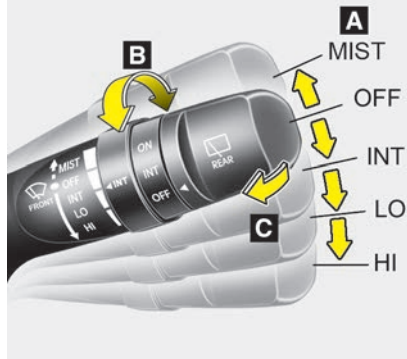

#### A : Wiper speed control

- MIST – Single wipe
- OFF – Off
- INT – Intermittent wipe
- LO – Low wiper speed
- HI – High wiper speed

#### B : Intermittent wipe time adjustment

#### C : Wash with brief wipes (front)

### Rear window wiper/washer (if equipped)

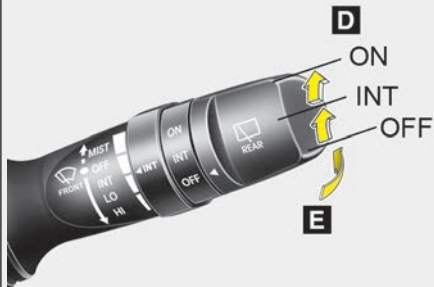

#### D : Rear wiper/washer control

- ON – Continuous wipe
- INT – Intermittent wipe (if equipped)
- OFF – Off

#### E : Wash with brief wipes (rear)

OAM049100N/OAM049048N

### Windshield wipers

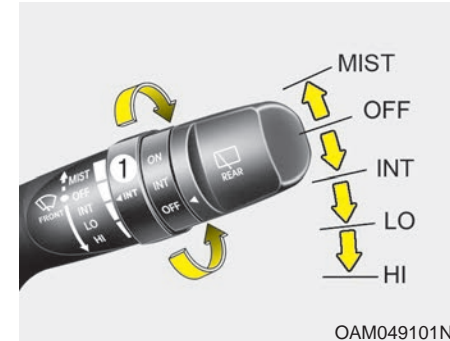

OAM049101N

Operates as follows when the ignition switch is turned ON.

**MIST** : For a single wiping cycle, push the lever upward and release it with the lever in the OFF position. The wipers will operate continuously if the lever is pushed upward and held.

**OFF** : Wiper is not in operation

**INT** : Wiper operates intermittently at the same wiping intervals. Use this mode in light rain or mist. To vary the speed setting, turn the speed control knob (1).

LO : Normal wiper speed  
 HI : Fast wiper speed

**\* NOTICE**

If there is heavy accumulation of snow or ice on the windshield, defrost the windshield for about 10 minutes, or until the snow and/or ice is removed before using the windshield wipers to ensure proper operation.

**Windshield washers**



In the OFF position, pull the lever gently toward you to spray washer fluid on the windshield and to run the wipers 1-3 cycles.

Use this function when the windshield is dirty.

The spray and wiper operation will continue until you release the lever.

If the washer does not work, check the washer fluid level. If the fluid level is not sufficient, you will need to add appropriate non-abrasive windshield washer fluid to the washer reservoir.

The reservoir filler neck is located in the front of the engine compartment on the passenger side.

**⚠ CAUTION - Washer pump**  
*To prevent possible damage to the washer pump, do not operate the washer when the fluid reservoir is empty.*

**⚠ WARNING - Obscured visibility**  
**Do not use the washer in freezing temperatures without first warming the windshield with the defrosters; the washer solution could freeze on the windshield and obscure your vision.**

**⚠ CAUTION**

**- Wipers & windshields**

- *To prevent possible damage to the wipers or windshield, do not operate the wipers when the windshield is dry.*
- *To prevent damage to the wiper blades, do not use gasoline, kerosene, paint thinner, or other solvents on or near them.*
- *To prevent damage to the wiper arms and other components, do not attempt to move the wipers manually.*

**Rear window wiper and washer switch (if equipped)**

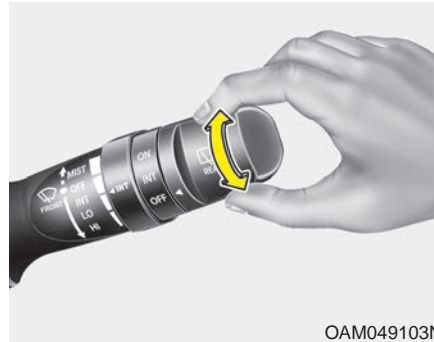

OAM049103N

The rear window wiper switch is located at the end of the wiper and washer switch lever. Turn the switch to the desired position to operate the rear wiper and washer.

ON - Normal wiper operation

INT - Intermittent wiper operation  
(if equipped)

OFF - Wiper is not in operation

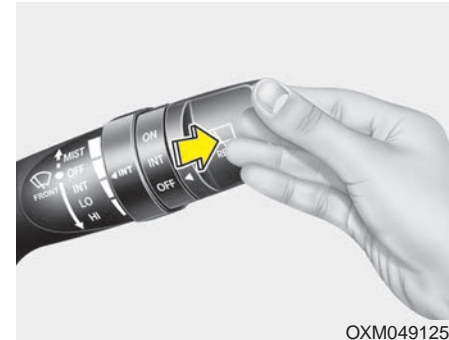

OXM049125

Push the lever away from you to spray rear washer fluid and to run the rear wipers 1~3 cycles. The spray and wiper operation will continue until you release the lever.



## INTERIOR LIGHT

Do not use the interior lights for extended periods when the engine is not running.

It may cause battery discharge.

**⚠ WARNING - Interior light**  
 Do not use the interior lights when driving in the dark. The glare from the interior lights may obstruct your view and cause an accident.

### Interior lamp AUTO cut

- When all entrances are closed, if you lock the vehicle by using the transmitter or the smart key, all interior lamp will be off after a few seconds.
- If you do not operate anything in the vehicle after turning off the engine, the lights will turn off after 20 minutes.

### Map lamp

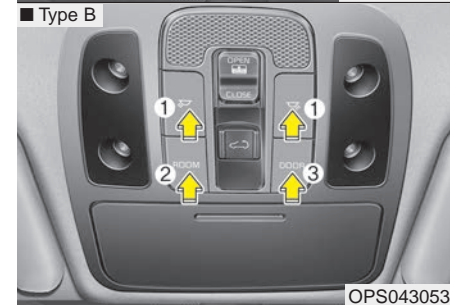

Press the lens (1) or button (1) to turn the map lamp on or off

## Features of your vehicle

- ROOM (2) :
  - The map lamp and room lamp stays on at all times.
  - To turn off the ROOM mode, press the ROOM button (2) once again (not pressed.)
- DOOR (3) :
  - The map lamp and room lamp comes on when a door is opened. The lamps go out after approximately 30 seconds.
  - The map lamp and room lamp comes on for approximately 30 seconds when doors are unlocked with a transmitter or smart key as long as the doors are not opened.
  - The map lamp and room lamp will stay on for approximately 20 minutes if a door is opened with the ignition switch in the ACC or LOCK/OFF position.
  - The map lamp and room lamp will stay on continuously if the door is opened with the ignition switch in the ON position.

- The map lamp and room lamp will go out immediately if the ignition switch is changed to the ON position or all doors are locked.
- To turn off the DOOR mode, press the DOOR button (3) once again (not pressed).

### \* NOTICE

- **When the lamp is turned on by pressing the lens (1), the lamp does not turn off even if the DOOR mode or ROOM mode is not selected (not pressed).**
- **If the ROOM button and DOOR button are pressed at the same time, the map lamp and room lamp will stay on at all times (ROOM mode will be selected).**

## Room lamp

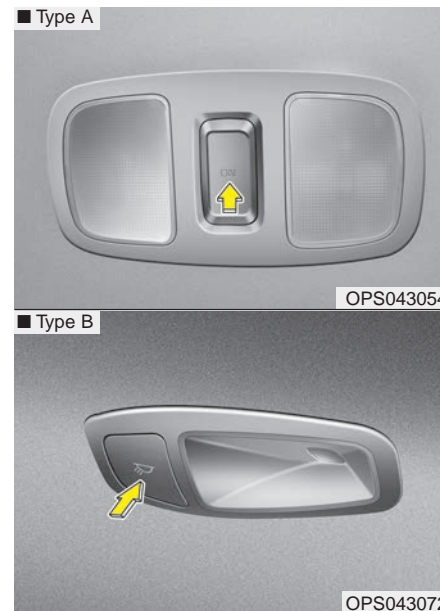

Press the button to turn the light on or off.

If the front map lamp turns on by the front map lamp switch, the room lamp will turn on.

## Luggage room lamp

### ■ Type A

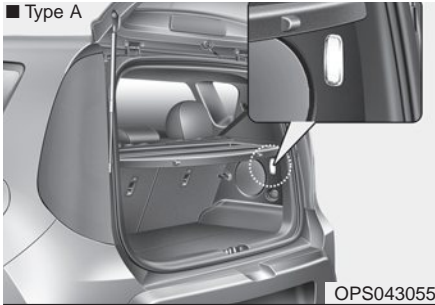

### ■ Type B

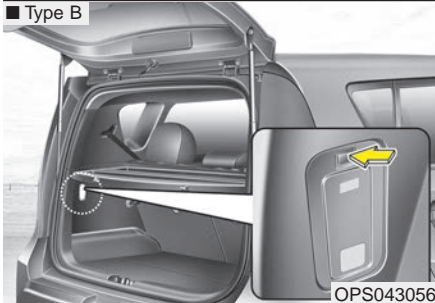

The luggage room lamp comes on when the tailgate is opened.

The lamp comes on as long as the tailgate is open. To prevent unnecessary charging system drain, close the tailgate securely after using the luggage room.

## Portable lamp usage (if equipped)

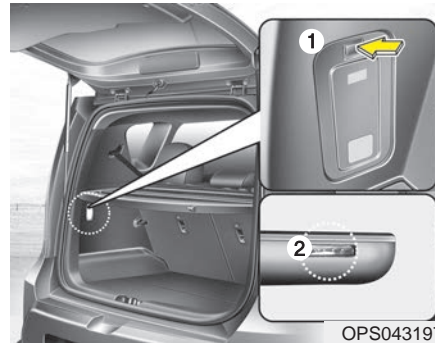

1. In-vehicle lamp, if necessary, after separation can be used as a portable.
2. Press push button (1).
3. Pull out the lamp holder.
4. Press the power switch (2).

\* If the portable lamp does not turn on, it means the portable lamp needs to be charged. Insert the lamp holder and then charge it again. The charge mode will be activated if the ignition switch (or engine start/stop button) is on position or engine is running.

**⚠ CAUTION - Portable lamp damage**

*You can use the regular batteries (Disposable batteries) but do not use the Non-rechargeable battery in charge mode. It may damage the vehicle.*

**\* NOTICE**

1. Remove the batteries when not in use for a long time.
2. Use the specified battery.
3. Do not place the lamp with water or moist places and liquid compounds. These can cause internal leakage of a battery.
4. When replacing the batteries, check the direction and insert. It will not be charged if installed reversely.
5. Do not mix the rechargeable batteries. It may not be charged normally.

If the portable lamp does not turn on anymore after charged, replace the rechargeable batteries.

**Battery replacement**

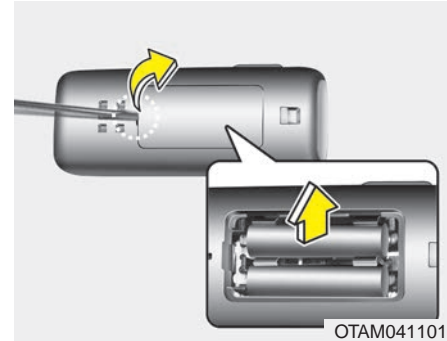

When replacement is necessary, use the following procedure.

1. Insert a slim tool into the slot and gently try open the battery cover.
2. Replace the batteries with new rechargeable batteries (AAA size). When replacing the batteries, make sure the position of batteries.
3. Close the cover carefully.

### Glove box lamp (if equipped)

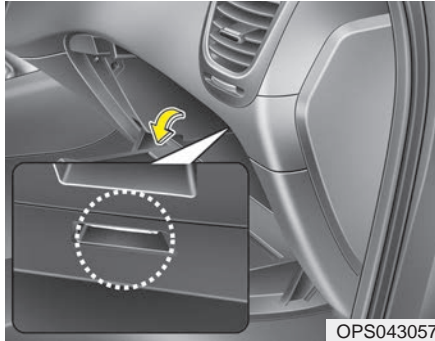

The glove box lamp comes on when the glove box is opened.

To prevent unnecessary charging system drain, close the glove box securely after using the glove box.

### Vanity mirror lamp (if equipped)

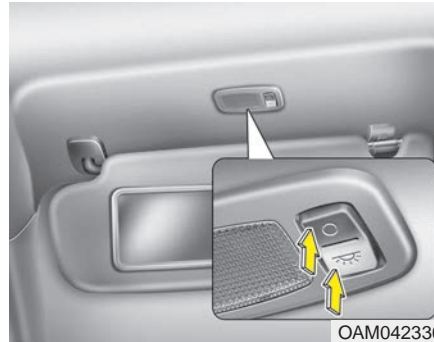

Pull the sunvisor downward and you can turn the vanity mirror lamp ON or OFF by pushing the button.

-  : To turn the lamp ON.
- O : To turn the lamp OFF.

To prevent unnecessary charging system drain, turn off the lamp by pushing the O button after using the lamp.

## DEFROSTER

### CAUTION - Conductors

*To prevent damage to the conductors bonded to the inside surface of the rear window, never use sharp instruments or window cleaners containing abrasives to clean the window.*

### \* NOTICE

If you want to defrost and defog the front windshield, refer to “Windshield defrosting and defogging” in this section.

### Rear window defroster

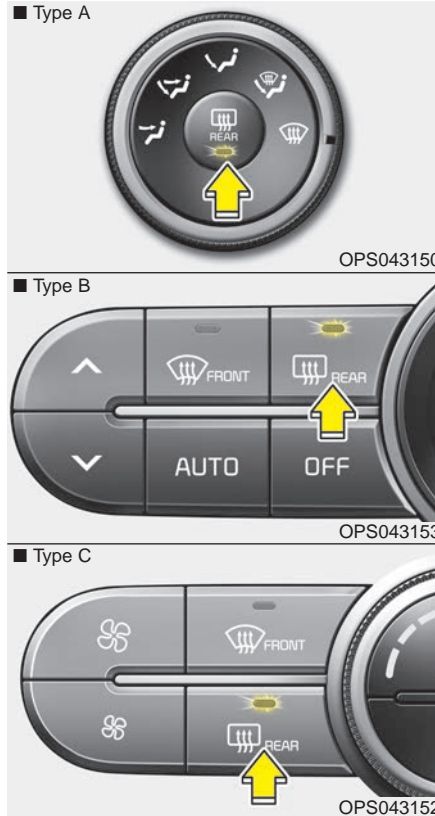

The defroster heats the window to remove frost, fog and thin ice from the rear window, while the engine is running.

To activate the rear window defroster, press the rear window defroster button located in the center facia switch panel.

The indicator on the rear window defroster button illuminates when the defroster is ON.

If there is heavy accumulation of snow on the rear window, brush it off before operating the rear defroster.

The rear window defroster automatically turns off after approximately 20 minutes or when the ignition switch is turned off. To turn off the defroster, press the rear window defroster button again.

***Outside rearview mirror defroster  
(if equipped)***

If your vehicle is equipped with the outside rearview mirror defrosters, they will operate at the same time you turn on the rear window defroster.

***Front wiper deicer (if equipped)***

The front wiper deicer will operate at the same time you turn on the front windshield defroster.

- To turn off the wiper deicer, press the front windshield defroster button again.
- The front wiper deicer automatically turns off after approximately 20 minutes or when the ignition switch is turned off.

## MANUAL CLIMATE CONTROL SYSTEM



1. Fan speed control knob
2. Air intake control button



3. Mode selection knob
4. Rear window defroster button

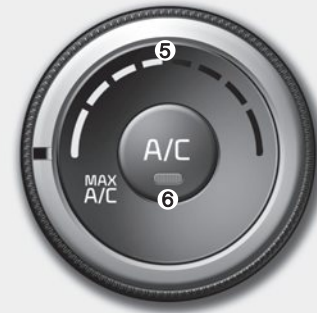



5. Temperature control knob
6. Air conditioning button (if equipped)

OPS043154



## Heating and air conditioning

1. Start the engine.
2. Set the mode to the desired position.  
For improving the effectiveness of heating and cooling;
  - Heating: 
  - Cooling: 
3. Set the temperature control to the desired position.
4. Set the air intake control to the outside (fresh) air position.
5. Set the fan speed control to the desired speed.
6. If air conditioning is desired, turn the air conditioning system (if equipped) on.

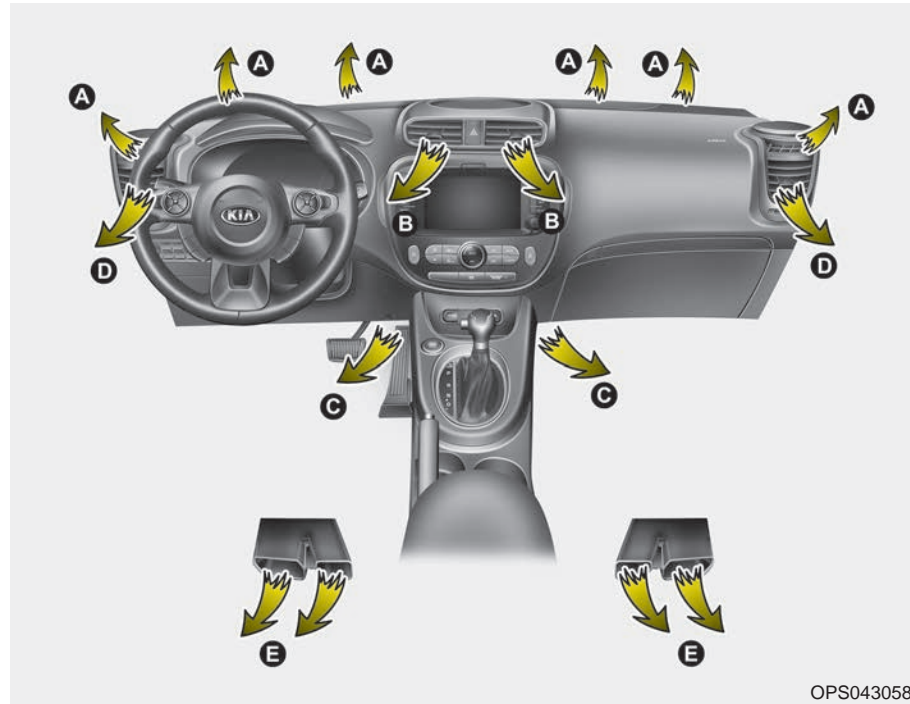

### Mode selection



The mode selection knob controls the direction of the air flow through the ventilation system.

Air can be directed to the floor, dashboard outlets, or windshield. Five symbols are used to represent.



#### **Vent mode (B, D)**

Air flow is directed toward the upper body and face. Additionally, each outlet can be controlled to direct the air discharged from the outlet.



#### **Vent-Floor mode (B, D, C, E)**

Air flow is directed towards the face and the floor.



#### **Floor mode (C, E, A, D)**

Most of the air flow is directed to the floor, with a small amount of the air being directed to the windshield and side window defrosters.



#### **Floor/Defrost mode (A, C, E, D)**

Most of the air flow is directed to the floor and the windshield with a small amount directed to the side window defrosters.



#### **Defrost mode (A, D)**

Most of the air flow is directed to the windshield with a small amount of air directed to the side window defrosters.

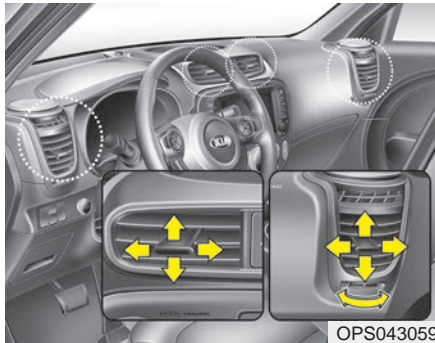

### Instrument panel vents

The outlet vents can be opened or closed separately using the thumb-wheel.

Also, you can adjust the direction of air delivery from these vents using the vent control lever as shown.

### Temperature control

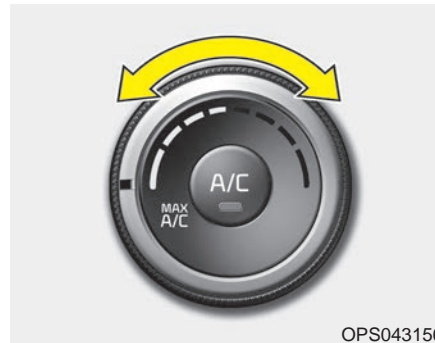

The temperature control knob allows you to control the temperature of the air flow from the ventilation system. To change the air temperature in the passenger compartment, turn the knob to the right position for warm air or left position for cooler air.

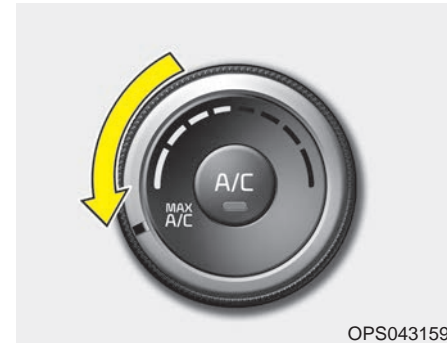

To operate the MAX A/C, turn the temperature knob to extreme left. Air flow is directed toward the upper body and face.

In this mode, the air conditioning and the recirculated air position will be selected automatically.

### Air intake control



The air intake control is used to select the outside (fresh) air position or recirculated air position.

To change the air intake control position, press the control button.

### Recirculated air position



With the recirculated air position selected, air from the passenger compartment will be drawn through the heating system and heated or cooled according to the function selected.

### \* NOTICE

- According to the outside temperature if the recirculation air position is on for a long time, the air intake position will automatically change to the outside (fresh) air position to ventilate the inside air.
- To cancel the automatic outside (fresh) air position, do the following.
  1. Turn the ignition switch to the ON position.
  2. Set the mode to the  position.
  3. While pressing the air conditioning button (A/C), press the air intake control button at least 5 times within 3 seconds.

### Outside (fresh) air position

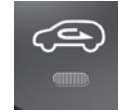

With the outside (fresh) air position selected, air enters the vehicle from outside and is heated or cooled according to the function selected.

Prolonged operation of the heater in the recirculated air position (without air conditioning selected) may cause fogging of the windshield and side windows and the air within the passenger compartment may become stale.

In addition, prolonged use of the air conditioning with the recirculated air position selected will result in excessively dry air in the passenger compartment.

**⚠ WARNING - Recirculated air**

Continuous use of the climate control system in the recirculated air position can cause drowsiness or sleepiness, and loss of vehicle control. Set the air intake control to the outside (fresh) air position as much as possible while driving.

**⚠ WARNING - Sleeping with AC on**

Do not sleep in a vehicle with the air conditioning or heating system on as this may cause serious harm or death due to a drop in the oxygen level and/or body temperature.

**⚠ WARNING - Reduced visibility**

Continued use of the climate control system in the recirculated air position may allow humidity to increase inside the vehicle which may fog the glass and obscure visibility.

***Sunroof inside air recirculation (if equipped)***

When the heater or air conditioning system is on with the sunroof opened, the outside (fresh) air position will be automatically selected. At this time, if you press the recirculated air position button, the recirculated air position will be selected but will change back to the outside (fresh) air position after 3 minutes.

When the sunroof is closed, the air intake position will return to the original position that was selected.

***Fan speed control***



The ignition switch must be in the ON position for fan operation.

The fan speed knob allows you to control the fan speed of the air flow from the ventilation system. To change the fan speed, turn the knob to the right for higher speed, or left for lower speed.

### To turn off the blowers



OPS043158

To turn off the blowers, turn the fan speed control knob to the "0" position.

### Air conditioning (if equipped)



OPS043161



Press the A/C button to turn the air conditioning system on (indicator light will illuminate). Press the button again to turn the air conditioning system off.

## System operation

### Ventilation

1. Set the mode to the  position.
2. Set the air intake control to the outside (fresh) air position.
3. Set the temperature control to the desired position.
4. Set the fan speed control to the desired speed.

### Heating

1. Set the mode to the  position.
2. Set the air intake control to the outside (fresh) air position.
3. Set the temperature control to the desired position.
4. Set the fan speed control to the desired speed.
5. If dehumidified heating is desired, turn the air conditioning system (if equipped) on.
  - If the windshield fogs up, set the mode to the  or  position.

**Operation Tips**

- To keep dust or unpleasant fumes from entering the vehicle through the ventilation system, temporarily set the air intake control to the recirculated air position. Be sure to return the control to the fresh air position when the irritation has passed to keep fresh air in the vehicle. This will help keep the driver alert and comfortable.
- Air for the heating/cooling system is drawn in through the grilles just ahead of the windshield. Care should be taken that these are not blocked by leaves, snow, ice or other obstructions.
- To prevent interior fog on the windshield, set the air intake control to the fresh air position and fan speed to the desired position, turn on the air conditioning system, and adjust the temperature control to desired temperature.

**Air conditioning (if equipped)**

All Kia Air Conditioning Systems are filled with R-134a refrigerant.

1. Start the engine. Press the air conditioning button.
  2. Set the mode to the  position.
  3. Set the air intake control to the outside air or recirculated air position.
  4. Adjust the fan speed control and temperature control to maintain maximum comfort.
- When maximum cooling is desired, set the temperature control to the extreme left position, set the mode control to the MAX A/C position, then set the fan speed control to the highest speed.

**CAUTION - Excessive A/C**

- *When using the air conditioning system, monitor the coolant closely while driving up hills or in heavy traffic when outside temperatures are high. Air conditioning system operation may cause overheating. Continue to use the blower fan but turn the air conditioning system off if the engine coolant temperature gauge indicates overheating.*
- *When opening the windows in humid weather air conditioning may create water droplets inside the vehicle. Since excessive water droplets may cause damage to electrical equipment, air conditioning should only be used with the windows closed.*

### Air conditioning system operation tips

- If the vehicle has been parked in direct sunlight during hot weather, open the windows for a short time to let the hot air inside the vehicle escape.
  - To help reduce moisture inside of the windows on rainy or humid days, decrease the humidity inside the vehicle by operating the air conditioning system.
  - During air conditioning system operation, you may occasionally notice a slight change in engine speed as the air conditioning compressor cycles. This is a normal system operation characteristic.
  - Use the air conditioning system every month only for a few minutes to ensure maximum system performance.
- When using the air conditioning system, you may notice clear water dripping (or even puddling) on the ground under the passenger side of the vehicle. This is a normal system operation characteristic.
  - Operating the air conditioning system in the recirculated air position provides maximum cooling, however, continual operation in this mode may cause the air inside the vehicle to become stale.
  - During cooling operation, you may occasionally notice a misty air flow because of rapid cooling and humid air intake. This is a normal system operation characteristic.

### Climate control air filter (if equipped)

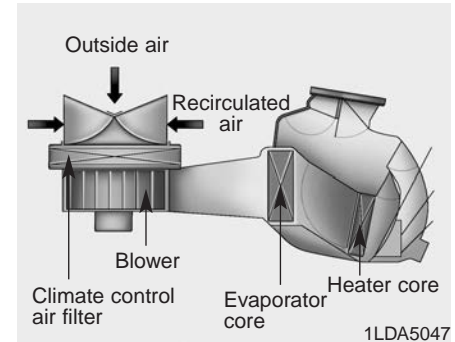

The climate control air filter installed behind the glove box filters the dust or other pollutants that come into the vehicle from the outside through the heating and air conditioning system. If dust or other pollutants accumulate in the filter over a period of time, the air flow from the air vents may decrease, resulting in moisture accumulation on the inside of the windshield even when the outside (fresh) air position is selected. If this happens, have the climate control air filter replaced by an authorized Kia dealer.



**\* NOTICE**

- Replace the filter every 15,000 miles or once a year.  
If the vehicle is being driven in severe conditions such as dusty or rough roads, more frequent air conditioner filter inspections and changes are required.
- When the air flow rate suddenly decreases, the system should be checked at an authorized Kia dealer.

**Checking the amount of air conditioner refrigerant and compressor lubricant**

When the amount of refrigerant is low, the performance of the air conditioning is reduced. Overfilling also has a negative impact on the air conditioning system.

Therefore, if abnormal operation is found, have the system inspected by an authorized Kia dealer.

**\* NOTICE**

It is important that the correct type and amount of oil and refrigerant is used. Otherwise, damage to the compressor and abnormal system operation may occur.

** WARNING**

The oil and refrigerant in your vehicle's air conditioning system is under very high pressure. If proper service procedures are not followed an explosion may result. To reduce the risk of serious injury or death, the air conditioning system in your vehicle should only be serviced by trained and certified technicians.

## AUTOMATIC CLIMATE CONTROL SYSTEM (IF EQUIPPED)

### ■ Type A

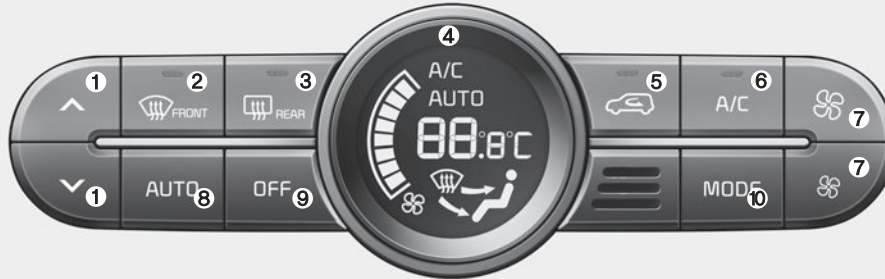

1. Temperature control button / knob
2. Front windshield defroster button
3. Rear windshield defroster button
4. Climate control display
5. Air intake control button
6. Air conditioning button (if equipped)
7. Fan speed control button
8. AUTO (automatic control) button
9. OFF button
10. Mode selection button
11. Climate control information screen selection button

### ■ Type B

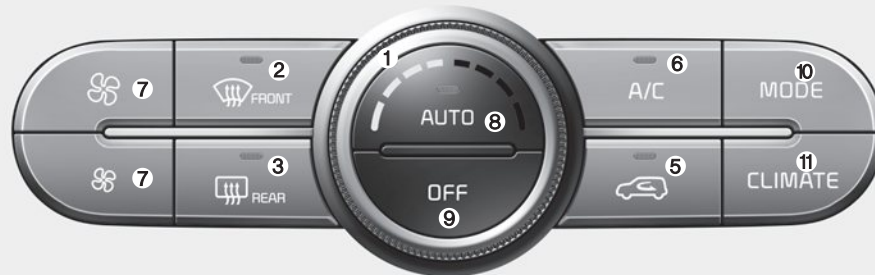

OPS043162/OPS043163

## Automatic heating and air conditioning

### ■ Type A

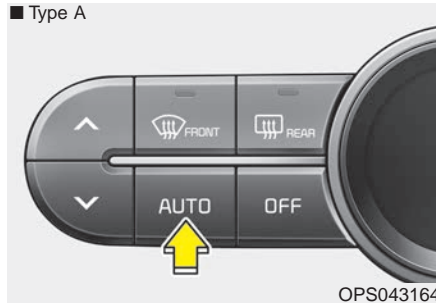

OPS043164

### ■ Type B

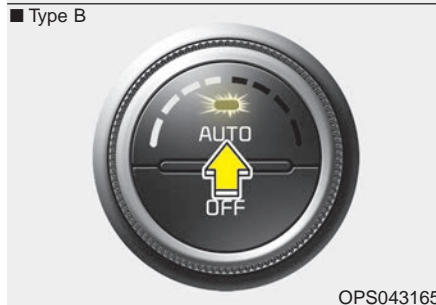

OPS043165

1. Push the AUTO button. It is indicated by AUTO on the display. The modes, fan speeds, air intake and air-conditioning will be controlled automatically by temperature setting.

### ■ Type A

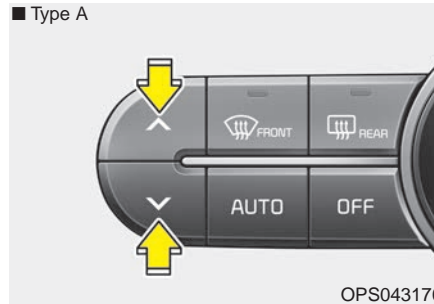

OPS043170

### ■ Type B

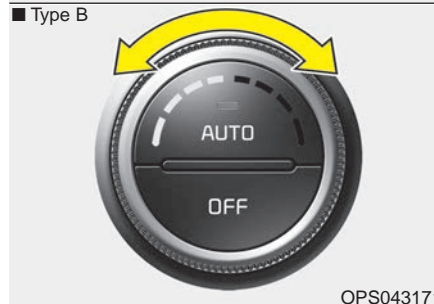

OPS043171

2. Push the temperature control button to set the desired temperature. (Type A)  
Turn the temperature control knob to set the desired temperature. (Type B)

## \* NOTICE

- To turn the automatic operation off, select any button or switch of the following:
  - Mode selection button
  - Air conditioning button
  - Front windshield defroster button (Press the button one more time to deselect the front windshield defroster function. The 'AUTO' sign will illuminate on the information display once again.)
  - Air intake control button
  - Fan speed control switch
 The selected function will be controlled manually while other functions operate automatically.
- Regardless of the temperature setting, when using automatic operation, the air conditioning system can automatically turn on to decrease the humidity inside the vehicle, even if the temperature is set to warm.

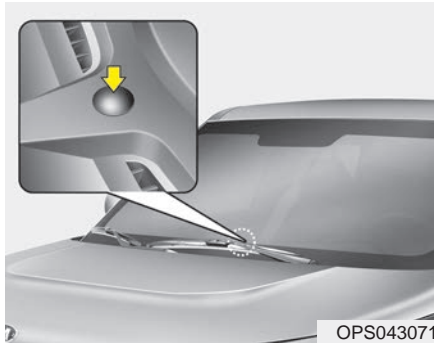

Never place anything over the sensor located on the instrument panel to ensure better control of the heating and cooling system.

### Manual heating and air conditioning

The heating and cooling system can be controlled manually by pushing buttons other than the AUTO button. In this case, the system works sequentially according to the order of buttons selected.

When pressing any button (or turning any knob) except AUTO button while automatic operation, the functions not selected will be controlled automatically.

1. Start the engine.
  2. Set the mode to the desired position.
  3. Set the temperature control to the desired position.
  4. Set the air intake control to the outside (fresh) air position.
  5. Set the fan speed control to the desired speed.
  6. If air conditioning is desired, turn the air conditioning system on.
- Press the AUTO button in order to convert to full automatic control of the system.

### Mode selection

■ Type A

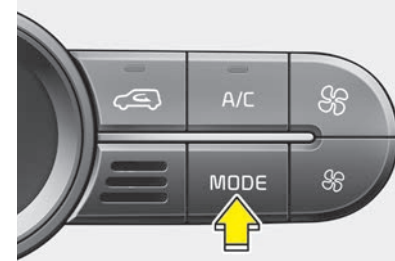

OPS043166

■ Type B

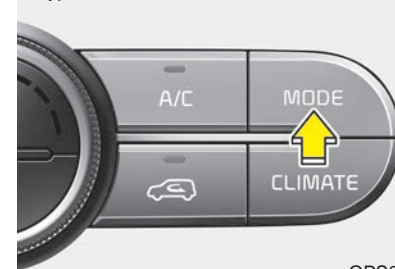

OPS043167

The mode selection button controls the direction of the air flow through the ventilation system.

Refer to the illustration in the “Manual climate control system”.

The air flow outlet port is converted as follows:



 **Vent mode (B, D)**

Air flow is directed toward the upper body and face. Additionally, each outlet can be controlled to direct the air discharged from the outlet.

 **Vent-Floor mode (B, D, C, E)**

Air flow is discharged towards the face and floor.

 **Floor mode (C, E, A, D)**

Most of the air flow is directed to the floor, with a small amount of the air being directed to the windshield and side window defroster.

 **Floor/Defrost mode (A, C, E, D)**

Most of the air flow is directed to the floor and the windshield with a small amount directed to the side window defrosters.



OPS043168

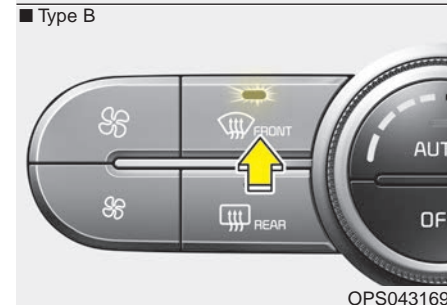

OPS043169

**Defrost mode (A, D)**

Most of the air flow is directed to the windshield with a small amount of air directed to the side window defrosters.

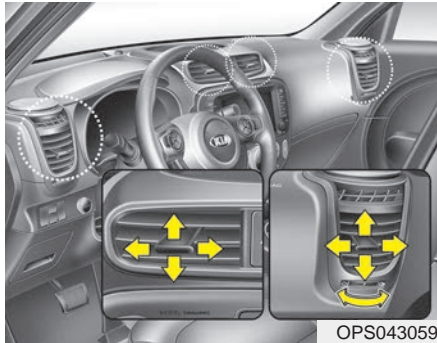

### Instrument panel vents

The outlet port can be opened or closed separately using the thumb-wheel.

Also, you can adjust the direction of air delivered from these vents using the vent control lever as shown.

### Temperature control

#### ■ Type A

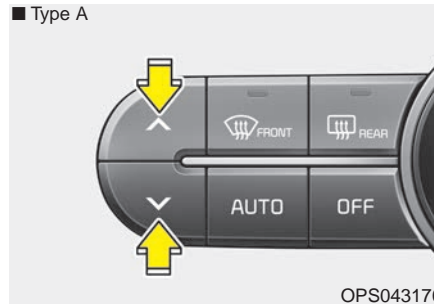

#### ■ Type B

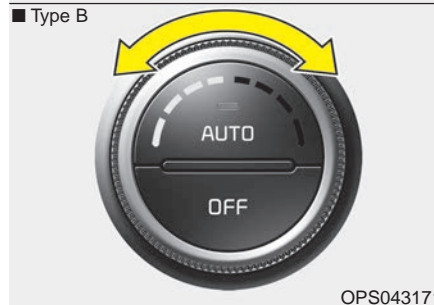

#### • Type A

The temperature will increase to the maximum (HI) by pushing the button (^).

The temperature will decrease to the minimum (Lo) by pushing the button (v).

When pushing the button, the temperature will increase or decrease by 0.5°C/1°F. When set to the lowest temperature setting, the air conditioning will operate continuously.

#### • Type B

The temperature will increase to the maximum (HI) by turning the knob to the right extremely.

The temperature will decrease to the minimum (Lo) by turning the knob to the left extremely.

When turning the knob, the temperature will increase or decrease by 0.5°C/1°F. When set to the lowest temperature setting, the air conditioning will operate continuously.

### Temperature scale conversion

If the battery has been discharged or disconnected, the temperature mode display will reset to Centigrade.

This is normal condition. You can switch the temperature scale as follows;

While pressing the AUTO button, press the OFF button for 3 seconds or more. The temperature scale will change from Centigrade to Fahrenheit, or from Fahrenheit to Centigrade.

The temperature unit (from °C to °F or from °F to °C) can be changed by using the “User Settings” mode of the LCD display.

### Air intake control



This is used to select outside (fresh) air position or recirculated air position.

To change the air intake control position, push the control button.

### Recirculated air position



The indicator light on the button illuminates when the recirculated air position is selected.

With the recirculated air position selected, air from passenger compartment will be drawn through the heating system and heated or cooled according to the function selected.

### \* NOTICE

- According to the outside temperature if the recirculation air position is on for a long time, the air intake position will automatically change to the outside (fresh) air position to ventilate the inside air.
- To cancel the automatic outside (fresh) air position, do the following.
  1. Turn the ignition switch to the ON position.
  2. Set the mode to the  position.
  3. While pressing the air conditioning button (A/C), press the air intake control button at least 5 times within 3 seconds.

### Outside (fresh) air position



The indicator light on the button does not illuminate when the outside (fresh) air position is selected.

With the outside (fresh) air position selected, air enters the vehicle from outside and is heated or cooled according to the function selected.

Prolonged operation of the heater in the recirculated air position (without air conditioning selected) may cause fogging of the windshield and side windows and the air within the passenger compartment may become stale.

In addition, prolonged use of the air conditioning with the recirculated air position selected will result in excessively dry air in the passenger compartment.

#### **⚠ WARNING - Recirculated air**

**Continuous use of the climate control system in the recirculated air position can cause drowsiness or sleepiness, and loss of vehicle control. Set the air intake control to the outside (fresh) air position as much as possible while driving.**

#### **⚠ WARNING - Reduced visibility**

**Continued climate control system operation in the recirculated air position may allow humidity to increase inside vehicle which may fog the glass and obscure visibility.**

#### **⚠ WARNING - Sleeping with AC on**

**Do not sleep in a vehicle with the air conditioning or heating system on as this may cause serious harm or death due to a drop in the oxygen level and/or body temperature.**



**Sunroof inside air recirculation (if equipped)**

When the heater or air conditioning system is on with the sunroof opened, the outside (fresh) air position will be automatically selected. At this time, if you press the recirculated air position button, the recirculated air position will be selected but will change back to the outside (fresh) air position after 3 minutes.

When the sunroof is closed, the air intake position will return to the original position that was selected.

**Fan speed control**

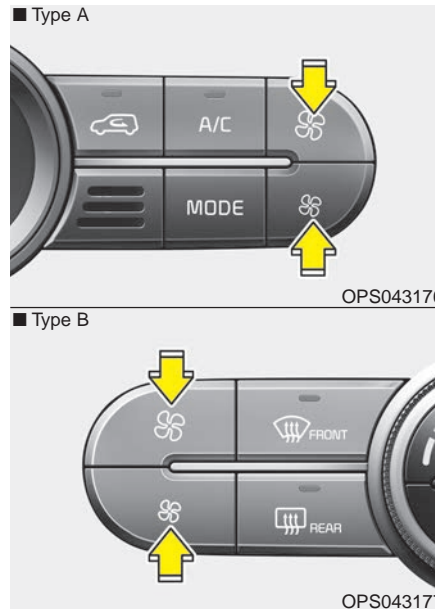

The fan speed can be set to the desired speed by pressing the fan speed control button.

To change the fan speed, press the button (♣) for higher speed, or push the button (♣) for lower speed. To turn the fan speed control off, press the OFF button and select outside (fresh) air position.

### Air conditioning

■ Type A



OPS043174

■ Type B



OPS043175

Push the A/C button to turn the air conditioning system on (indicator light will illuminate).

Push the button again to turn the air conditioning system off.

### Blower OFF

■ Type A



OPS043178

■ Type B



OPS043179

Push the OFF button to turn off the blower. However you can still operate the mode and air intake buttons as long as the ignition switch is in the position ON.

### Climate information screen selection (if equipped)

■ Type B



OPS043180



Press the climate information screen selection button to view climate information in full screen mode.

## System operation

### Ventilation

1. Set the mode to the  position.
2. Set the air intake control to the outside (fresh) air position.
3. Set the temperature control to the desired position.
4. Set the fan speed control to the desired speed.

### Heating

1. Set the mode to the  position.
  2. Set the air intake control to the outside (fresh) air position.
  3. Set the temperature control to the desired position.
  4. Set the fan speed control to the desired speed.
  5. If dehumidified heating is desired, turn the air conditioning system (if equipped) on.
- If the windshield fogs up, set the mode to the  or  position.

### Operation Tips

- To keep dust or unpleasant fumes from entering the vehicle through the ventilation system, temporarily set the air intake control to the recirculated air position. Be sure to return the control to the fresh air position when the irritation has passed to keep fresh air in the vehicle. This will help keep the driver alert and comfortable.
- Air for the heating/cooling system is drawn in through the grilles just ahead of the windshield. Care should be taken that these are not blocked by leaves, snow, ice or other obstructions.
- To prevent interior fog on the windshield, set the air intake control to the fresh air position and fan speed to the desired position, turn on the air conditioning system, and adjust the temperature control to desired temperature.

### Air conditioning (if equipped)

All Kia Air Conditioning Systems are filled with R-134a refrigerant.

1. Start the engine. Press the air conditioning button.
  2. Set the mode to the  position.
  3. Set the air intake control to the outside air or recirculated air position.
  4. Adjust the fan speed control and temperature control to maintain maximum comfort.
- When maximum cooling is desired, set the temperature control to the extreme left position, set the mode control to the MAX A/C position, then set the fan speed control to the highest speed.

### **CAUTION - Excessive A/C**

- *When using the air conditioning system, monitor the temperature gauge closely while driving up hills or in heavy traffic when outside temperatures are high. Air conditioning system operation may cause engine overheating. Continue to use the blower fan but turn the air conditioning system off if the temperature gauge indicates engine overheating.*
- *When opening the windows in humid weather air conditioning may create water droplets inside the vehicle. Since excessive water droplets may cause damage to electrical equipment, air conditioning should only be used with the windows closed.*

### **Air conditioning system operation tips**

- If the vehicle has been parked in direct sunlight during hot weather, open the windows for a short time to let the hot air inside the vehicle escape.
- To help reduce moisture inside of the windows on rainy or humid days, decrease the humidity inside the vehicle by operating the air conditioning system.
- During air conditioning system operation, you may occasionally notice a slight change in engine speed as the air conditioning compressor cycles. This is a normal system operation characteristic.
- Use the air conditioning system every month only for a few minutes to ensure maximum system performance.
- When using the air conditioning system, you may notice clear water dripping (or even puddling) on the ground under the passenger side of the vehicle. This is a normal system operation characteristic.
- Operating the air conditioning system in the recirculated air position provides maximum cooling, however, continual operation in this mode may cause the air inside the vehicle to become stale.
- During cooling operation, you may occasionally notice a misty air flow because of rapid cooling and humid air intake. This is a normal system operation characteristic.

### Climate control air filter (if equipped)

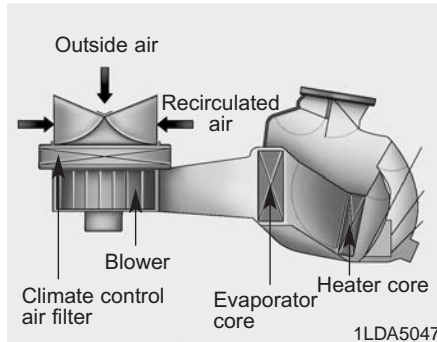

The climate control air filter installed behind the glove box filters the dust or other pollutants that come into the vehicle from the outside through the heating and air conditioning system. If dust or other pollutants accumulate in the filter over a period of time, the air flow from the air vents may decrease, resulting in moisture accumulation on the inside of the windshield even when the outside (fresh) air position is selected. If this happens, have the climate control air filter replaced by an authorized Kia dealer.

### \* NOTICE

- Replace the filter every 15,000 miles or once a year. If the vehicle is being driven in severe conditions such as dusty or rough roads, more frequent air conditioner filter inspections and changes are required.
- When the air flow rate suddenly decreases, the system should be checked at an authorized Kia dealer.

### Checking the amount of air conditioner refrigerant and compressor lubricant

When the amount of refrigerant is low, the performance of the air conditioning is reduced. Overfilling also has a negative impact on the air conditioning system.

Therefore, if abnormal operation is found, have the system inspected by an authorized Kia dealer.

### \* NOTICE



It is important that the correct type and amount of oil and refrigerant is used. Otherwise, damage to the compressor and abnormal system operation may occur.

**⚠ WARNING**

The oil and refrigerant in your vehicle's air conditioning system is under very high pressure. If proper service procedures are not followed an explosion may result. To reduce the risk of serious injury or death, the air conditioning system in your vehicle should only be serviced by trained and certified technicians.

## WINDSHIELD DEFROSTING AND DEFOGGING

### **⚠ WARNING - Windshield heating**



Do not use the  or  position during cooling operation in extremely humid weather. The difference between the temperature of the outside air and that of the windshield could cause the outer surface of the windshield to fog up, causing loss of visibility. In this case, set the mode selection knob or button to the  position and fan speed control knob or button to the lower speed.

- For maximum defrosting, set the temperature control to the extreme right/hot position and the fan speed control to the highest speed.
- If warm air to the floor is desired while defrosting or defogging, set the mode to the floor-defrost position.
- Before driving, clear all snow and ice from the windshield, rear window, outside rear view mirrors, and all side windows.
- Clear all snow and ice from the hood and air inlet in the cowl grille to improve heater and defroster efficiency and to reduce the probability of fogging up inside of the windshield.

### Manual climate control system

#### *To defog inside windshield*



1. Select any fan speed except “0” position.
2. Select desired temperature.
3. Select the  or  mode.
4. The outside (fresh) air and air conditioning will be selected automatically.

If the air conditioning and outside (fresh) air position are not selected automatically, press the corresponding button manually.

**To defrost outside windshield**



1. Set the fan speed to the highest (extreme right) position.
2. Set the temperature to the extreme hot position.
3. Select the  position.
4. The outside (fresh) air and air conditioning will be selected automatically.

**Automatic climate control system**

**To defog inside windshield**

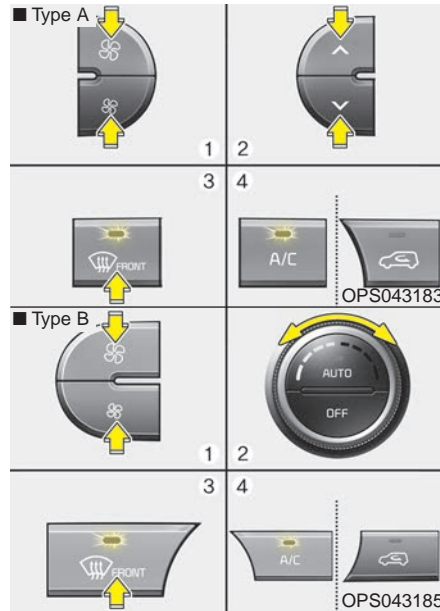

1. Set the fan speed to the desired position.
2. Select desired temperature.

3. Press the defrost button ()
4. The air-conditioning will be turned on according to the detected ambient temperature, outside (fresh) air position and higher fan speed will be selected automatically.

If the air-conditioning, outside (fresh) air position and higher fan speed are not selected automatically, adjust the corresponding button or knob manually.

If the  position is selected, with a low fan speed, a higher fan speed may be automatically selected.



**To defrost outside windshield**

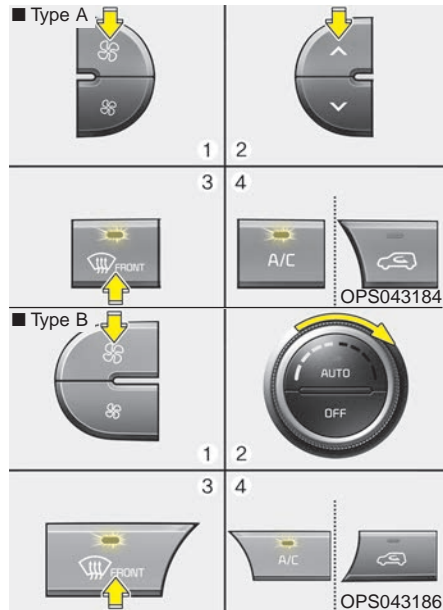



1. Set fan speed to the highest position.
2. Set temperature to the Maximum (HI).
3. Press the defrost button (  ).

4. The air-conditioning will be turned on according to the detected ambient temperature and outside (fresh) air position will be selected automatically.

If the  position is selected, with a low fan speed, a higher fan speed may be automatically selected.

**Defogging logic**

To reduce the possibility of fogging up the inside of the windshield, the air intake or air conditioning are controlled automatically according to certain conditions such as  or  position. To cancel or return to the defogging logic, do the following.

## Manual climate control system

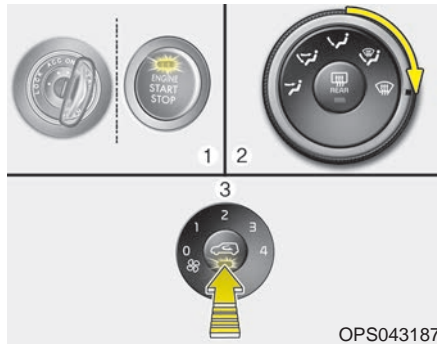

1. Turn the ignition switch to the ON position.
2. Turn the mode selection knob to the defrost position (☃).
3. Within 10 seconds after select the defrost position, press the air intake control button (👉) at least 5 times within 3 seconds.

The indicator on the air intake button blinks 3 times with 0.5 seconds of interval. It indicates that the defogging logic is canceled or returned to the programmed status.

If the battery has been discharged or disconnected, it will be reset to the defog logic status.

## Automatic climate control system

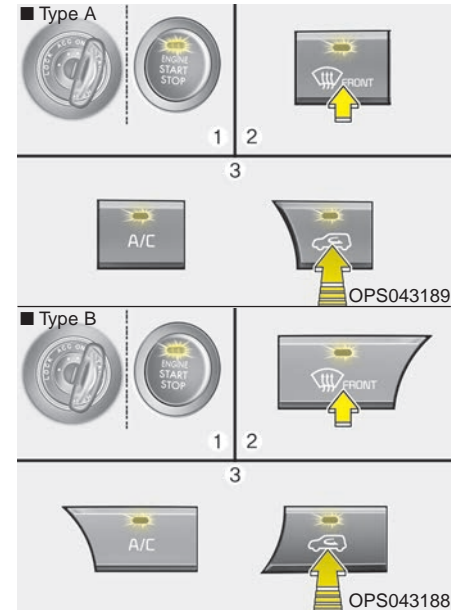

1. Turn the ignition switch to the ON position.
2. Press the defrost button (☃).

### CLEAN AIR (IF EQUIPPED)

3. While pressing the air conditioning button (A/C), press the air intake control button (☁️) at least 5 times within 3 seconds.

The indicator on the air intake button blinks 3 times with 0.5 seconds of interval. It indicates that the defogging logic is canceled or returned to the programmed status.

If the battery has been discharged or disconnected, it will be reset to the defog logic status.



When the ignition switch is in the ON position, the clean air function turns on automatically.

Also, the clean air function turns off automatically, when the ignition switch turns to the OFF position.

## STORAGE COMPARTMENT

These compartments can be used to store small items.

- To avoid possible theft, do not leave valuables in the storage compartment.
- Always keep the storage compartment covers closed while driving. Do not attempt to place so many items in the storage compartment that the storage compartment cover cannot close securely.

**⚠ WARNING - Flammable materials**

**Do not store, propane cylinders or other flammable/explosive materials in the vehicle. These items may catch fire and/or explode if the vehicle is exposed to hot temperatures for extended periods.**

### Center console storage

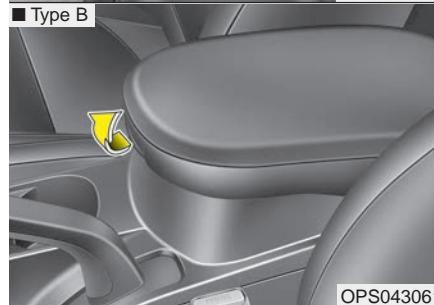
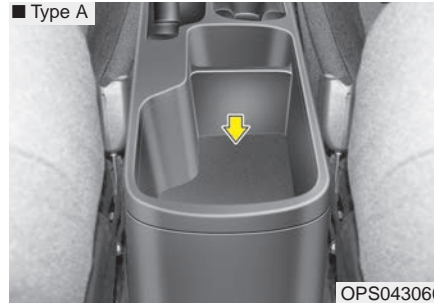

These compartments can be used to store small items required by the driver or front passenger.

To open the center console storage, pull up the lever. (Type B)

### Glove box

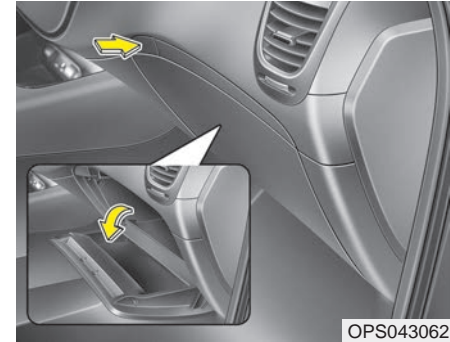

To open the glove box, push the button and the glove box will automatically open. Close the glove box after use.

Always keep the glove box closed while the vehicle is in operation.

**⚠ WARNING - Glove box**

**To reduce the risk of injury in an accident or sudden stop, always keep the glove box door closed while driving.**

### Cool box (if equipped)

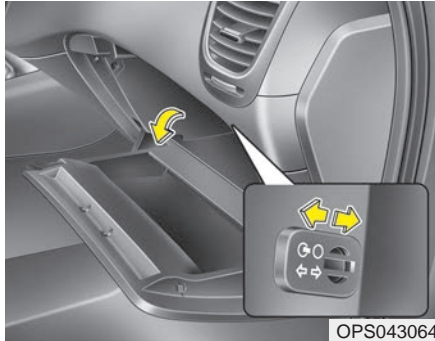

You can keep beverage cans or other items cool in the glove box.

1. Turn on the air conditioning.
2. Slide the open/close lever of the vent installed in the glove box to the open position.
3. When the cool box is not used, slide the lever to the closed position.

If some items in the cool box block the vent, the cooling effectiveness of the coolbox is reduced.

### \* NOTICE

Do not put perishable food in the cool box because it may not maintain the necessary consistent temperature to keep the food fresh.

### \* NOTICE

If the temperature control knob is in the warm or hot position, warm or hot air will flow into the glove box.

### Sunglass holder



To open the sunglasses holder, press the cover and the holder will slowly open. Place your sunglasses with the lenses facing out.

To close the sunglasses holder, push it up.

Do not place other items in the sunglasses holder.

**⚠ WARNING - Sunglass holder**

- Do not keep objects except sunglasses inside the sunglass holder. Such objects can be thrown from the holder in the event of a sudden stop or an accident, possibly injuring the passengers in the vehicle.
- Do not open the sunglass holder while the vehicle is moving. The rear view mirror of the vehicle can be blocked by an opened sunglass holder.

**Luggage box (if equipped)**

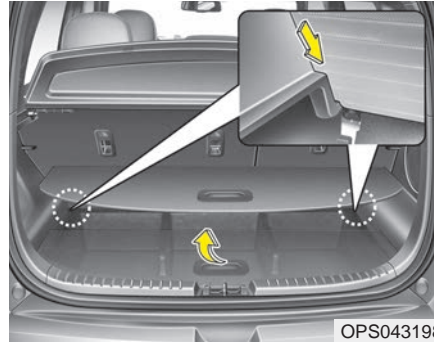

You can place a first aid kit, a reflector triangle, tools, etc. in the box for easy access.

## INTERIOR FEATURES

### Cup holder

#### **⚠ WARNING - Hot liquids**

Do not place uncovered cups with hot liquid in the cup holder while the vehicle is in motion. If the hot liquid spills, you burn yourself. Such a burn to the driver could lead to loss of control of the vehicle.

#### **⚠ CAUTION**

- *When cleaning spilled liquids, do not dry the cup holder at high temperature. This may damage the cup holder.*
- *When cleaning spilled liquids, do not dry the cup holder at high temperature. This may damage the cup holder.*

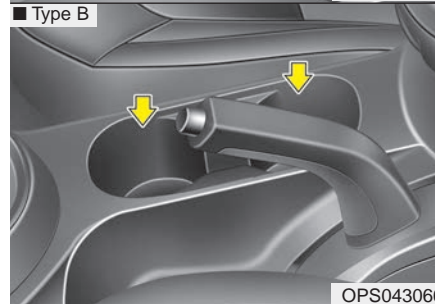
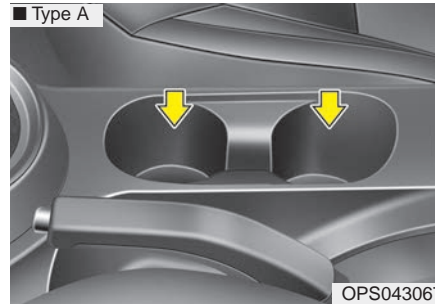

Cups or small beverage cans may be placed in the cup holders.

### Rear (if equipped)

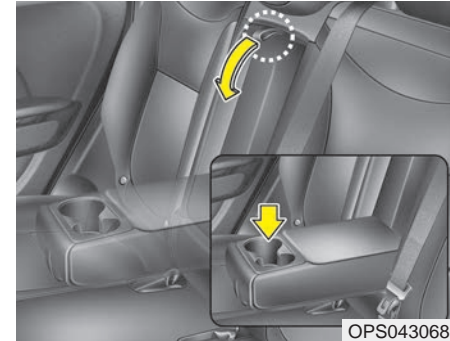

To use the cup holder, folding the center seat or pull down the armrest.

## Sunvisor

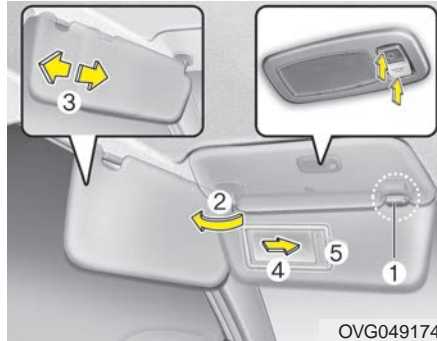

Use the sunvisor to shield direct light through the front or side windows.

To use the sunvisor, pull it downward.

To use the sunvisor for the side window, pull it downward, unsnap it from the bracket (1) and swing it to the side (2).

Adjust the sunvisor extension forward or backward (3). (if equipped)

To use the vanity mirror, pull down the visor and slide the mirror cover (4).

To use the vanity mirror lamp, switch it on. (if equipped)

The ticket holder (5, if equipped) is provided for holding a tollgate ticket.



### CAUTION - Vanity mirror lamp (if equipped)

*If you use the vanity mirror lamp, turn off the lamp before returning the sunvisor to its original position. It could result in battery discharge and possible sunvisor damage.*

## Seat warmer (if equipped)

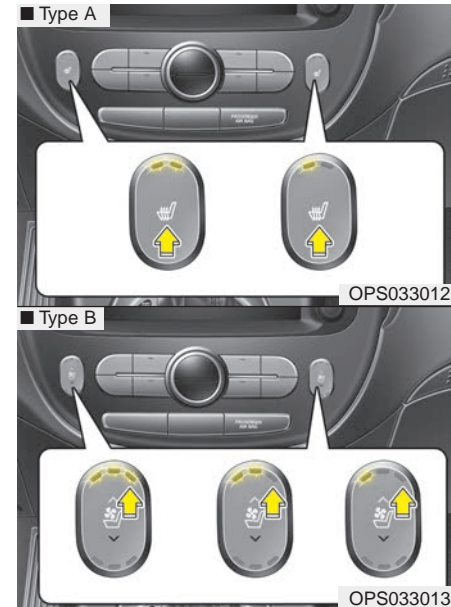

The seat warmer is provided to warm the front seats during cold weather. With the ignition switch in the ON position, push either of the switches to warm the driver's seat or the front passenger's seat.



During mild weather or under conditions where the operation of the seat warmer is not needed, keep the switches in the "OFF" position.

- Each time you press the switch, the temperature setting of the seat will change as follows :

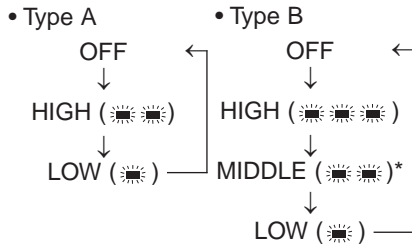

- The seat warmer defaults to the OFF position whenever the ignition switch is turned on.
- When pressing the switch for more than 1.5 seconds with the seat warmer operating, the seat warmer will turn OFF.

### \* NOTICE

With the seat warmer switch in the ON position, the heating system in the seat turns off or on automatically depending on the seat temperature.

### ⚠ CAUTION - Seat damage

- *When cleaning the seats, do not use an organic solvent such as paint thinner, benzene, alcohol and gasoline. Doing so may damage the surface of the heater or seats.*
- *To prevent overheating the seat warmer, do not place anything on the seats that insulates against heat, such as blankets, cushions or seat covers while the seat warmer is in operation.*
- *Do not place heavy or sharp objects on seats equipped with seat warmers. Damage to the seat warming components could occur.*

### \* NOTICE

Be careful not to spill liquid such as water or beverages on the seat. If you spill some liquid, wipe the seat with a dry towel. Before using the seat warmer, dry the seat completely.

### ⚠ WARNING - Seat heater burns

The seat warmer may cause burns, even at low temperatures, if used over a long period of time. Never allow passengers who may not be able to take care of themselves to be exposed to the risk of seat heater burns. These include:

1. Infants, children, elderly or disabled persons, or hospital outpatients
2. Persons with sensitive skin or those that burn easily
3. Fatigued individuals
4. Intoxicated individuals
5. Individuals taking medication that can cause drowsiness or sleepiness (sleeping pills, cold tablets, etc.)

### Seat air ventilation (if equipped)



The temperature setting of the seat changes according to the switch position.

- If you want to cool your seat cushion, press the switch (blue color).
- Each time you press the button, the airflow will change as follows:

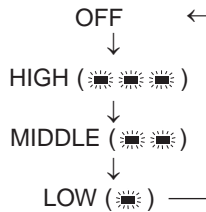

- When pressing the switch for more than 1.5 seconds with the seat air ventilation operating, the seat air ventilation will turn OFF.
- The seat air ventilation defaults to the OFF position whenever the ignition switch is turned on.

#### **⚠ CAUTION - Seat damage**

- *When cleaning the seats, do not use an organic solvent such as paint thinner, benzene, alcohol and gasoline. Doing so may damage the air ventilation seat.*
- *Do not place heavy or sharp objects on the seat. Those things may damage the air ventilation seat.*

#### **\* NOTICE**

Be careful not to spill liquid such as water or beverages on the seat. If you spill some liquid, wipe the seat with a dry towel. Before using the air ventilation seat, dry the seat completely.

### Rear seat warmer (if equipped)

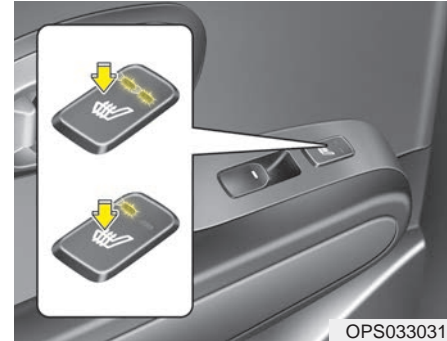

The seat warmer is provided to warm the rear outboard seats during cold weather. With the ignition switch in the ON position, push either of the switches to warm rear seats.

During mild weather or under conditions where the operation of the seat warmer is not needed, keep the switches in the "OFF" position.



- When pressing the switch for more than 1.5 seconds with the seat warmer operating, the seat warmer will turn OFF.
- The seat warmer defaults to the OFF position whenever the engine start/stop button (the ignition switch) is turned on.

### \* NOTICE

With the seat warmer switch in the ON position, the heating system in the seat turns off or on automatically depending on the seat temperature.

### CAUTION

#### - Seat damage

- *When cleaning the seats, do not use an organic solvent such as thinner, benzene, alcohol and gasoline. Doing so may damage the surface of the heater or seats.*
- *To prevent overheating the seat warmer, do not place anything on the seats that insulates against heat, such as blankets, cushions or seat covers while the seat warmer is in operation.*
- *Do not place heavy or sharp objects on seats equipped with seat warmers. Damage to the seat warming components could occur.*

### \* NOTICE

Be careful not to spill liquid such as water or beverages on the seat. If you spill some liquid, wipe the seat with a dry towel. Before using the seat warmer, dry the seat completely.

### WARNING - Seat heater burns

The seat warmer may cause burns, even at low temperatures, if used over a long period of time. Never allow passengers who may not be able to take care of themselves to be exposed to the risk of seat heater burns. These include:

1. Infants, children, elderly or disabled persons, or hospital outpatients
2. Persons with sensitive skin or those that burn easily
3. Fatigued individuals
4. Intoxicated individuals
5. Individuals taking medication that can cause drowsiness or sleepiness (sleeping pills, cold tablets, etc.)

### Power outlet (if equipped)

■ Front (Type A)

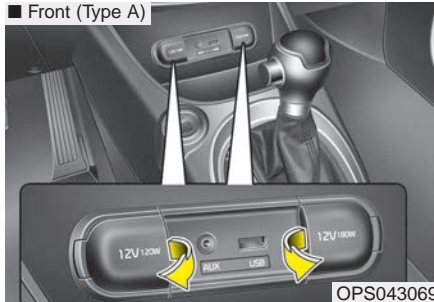

■ Rear (if equipped)

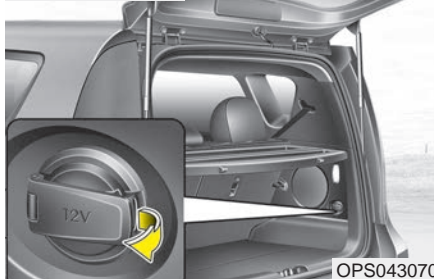

The power outlet is designed to provide power for mobile telephones or other devices designed to operate with vehicle electrical systems. The devices should draw less than 10 amps with the engine running.

- Use the power outlet only when the engine is running and remove the accessory plug after use. Using the accessory plug for prolonged periods of time with the engine off could cause the battery to discharge.
- Only use 12V electric accessories which are less than 10A(Driver's side) or 15A(Passenger's side) in electric capacity.
- Adjust the air-conditioner or heater to the lowest operating level when using the power outlet.
- Close the cover when not in use.
- Some electronic devices can cause electronic interference when plugged into a vehicle's power outlet. These devices may cause excessive audio static and malfunctions in other electronic systems or devices used in your vehicle.

### **⚠ WARNING - Electric shock**

**Do not put a finger or a foreign element (pin, etc.) into a power outlet and do not touch with a wet hand. You may get an electric shock.**

### Clothes hanger (if equipped)

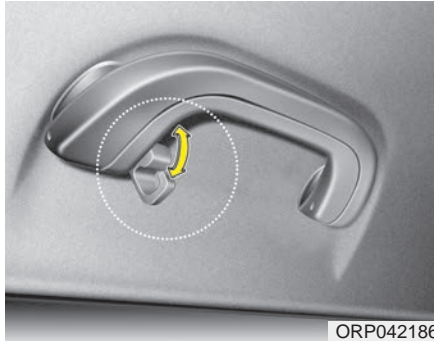

To use the hanger, pull down the upper portion of hanger.

Be careful when opening and closing the doors. Clothes, etc. may get caught between the door gap.

**⚠ CAUTION - Hanging clothing**

*Do not hang heavy clothes, since those may damage the hook.*

### Floor mat anchor(s)

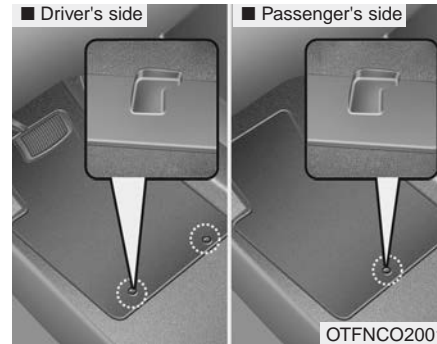

When using a floor mat on the floor carpet, make sure it attaches to the floor mat anchor(s) in your vehicle. This keeps the floor mat from sliding forward.

**⚠ WARNING - After market floor mat**

**Do not install aftermarket floor mats that are not capable of being securely attached to the vehicle's floor mat anchors. Unsecured floor mats can interfere with pedal operation.**

The following must be observed when installing ANY floormat to the vehicle.

- Ensure that the floormats are securely attached to the vehicle's floormat anchor(s) before driving the vehicle.
- Do not use ANY floormat that cannot be firmly attached to the vehicle's floormat anchors.
- Do not stack floormats on top of one another (e.g. all-weather rubber mat on top of a carpeted floormat). Only a single floormat should be installed in each position.

**IMPORTANT** - Your vehicle was manufactured with driver's side floormat anchors that are designed to securely hold the floormat in place. To avoid any interference with pedal operation, Kia recommends that only the Kia floormat designed for use in your vehicle be installed.

### Luggage net holder (if equipped)



To keep items from shifting in the cargo area, you can use the holders located in the cargo area to attach the luggage net.

If necessary, contact your authorized Kia dealer to obtain a luggage net.

### CAUTION

*To prevent damage to the vehicle, care should be taken when carrying fragile or bulky objects in the luggage compartment.*

### WARNING - Luggage net

- Always keep your face and body out of the luggage net recoil path and avoid using the luggage net when the straps have visible signs of wear or damage. The luggage net can snap and cause injuries.
- All cargo should be evenly distributed, properly secured and never piled higher than the seatback.

### Cargo area cover (if equipped)



Use the cargo area cover to hide items stored in the cargo area.

**Removal and installation**

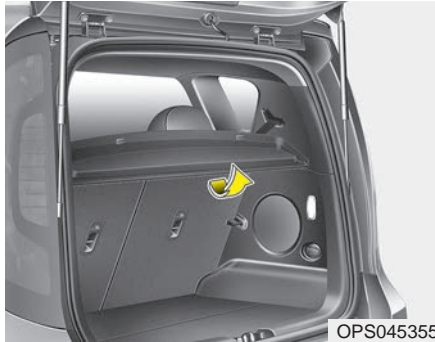

**To remove the cargo area cover:**

1. Fold the cargo area cover up in half.

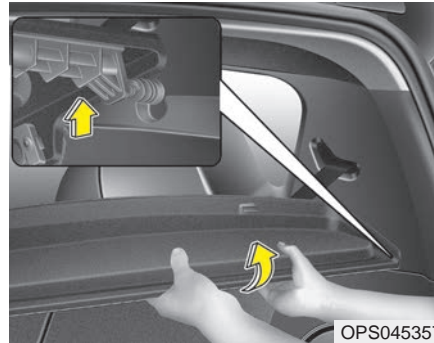

2. Firmly hold the folded part of the cover and lift it up.

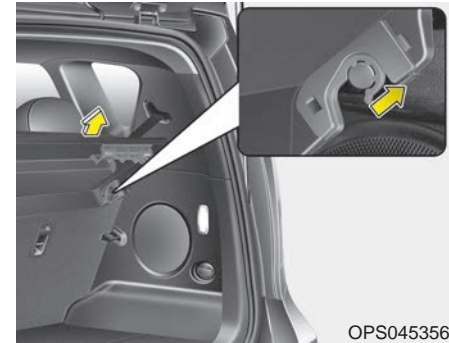

3. While lifting the cover up, hold the area near the front slots. Then, pull up the cover at approximately 45° angle.

**\* NOTICE**

Folded cover may block the rear view. Put the folded cover in the appropriate position.

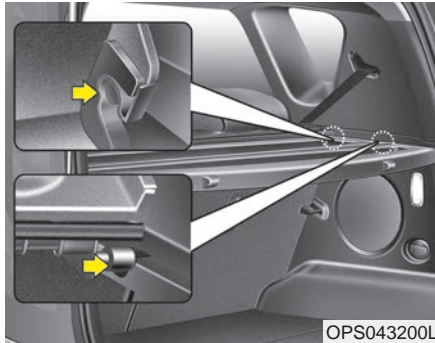

**To install the cargo area cover:**

To use the cargo area cover, insert the 4 edges into the slots.

**⚠ WARNING - Objects**

- Do not place objects on the cargo area cover. Such objects may be thrown about inside the vehicle and possibly injure vehicle occupants during an accident or when braking.
- All cargo should be evenly distributed, properly secured and never piled higher than the seatback.

**⚠ CAUTION - Luggage**

*Since the cargo area cover may be damaged or malformed, do not put luggage on it when it is used.*



## EXTERIOR FEATURES

### Mounting bracket for roof carrier (if equipped)

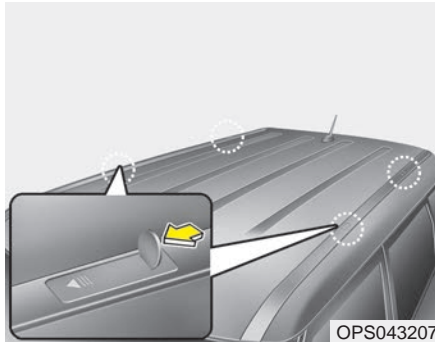

To install or remove a roof carrier, you can use the mounting bracket and cover on the roof.

When you install a roof carrier, do the following procedure.

1. Insert a slim tool (coin or flat blade driver) into the slot and slide the cover toward the arrow on the cover.

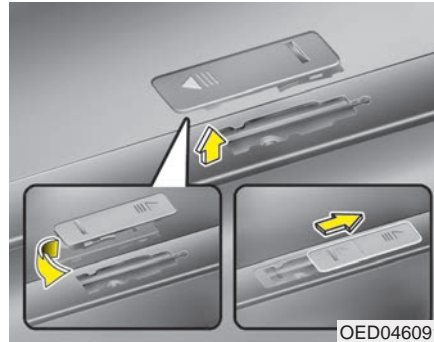

2. Rotate the cover half way and insert the cover on the roof hole as the illustration.

### \* NOTICE

To prevent losing the roof carrier cover, install the cover on the roof before you install the roof carrier.

3. After using the roof carrier, install the cover back on the roof in the reverse order.

### \* NOTICE

If the vehicle is equipped with a sunroof, be sure not to position cargo onto the roof in such a way that it could interfere with sunroof operation.

### ⚠ CAUTION - Loading roof rack

*When carrying cargo on the roof rack, take the necessary precautions to make sure the cargo does not damage the roof of the vehicle.*

- When carrying large objects on the roof, make sure they do not exceed the overall roof length or width.
- The vehicle center of gravity will be higher when items are loaded onto the roof. Avoid sudden starts, braking, sharp turns, abrupt maneuvers or high speeds that may result in loss of vehicle control or rollover resulting in an accident.
- To prevent damage or loss of cargo while driving, check frequently before or while driving to make sure the items on the roof are securely fastened.

**⚠ WARNING - Driving with roof load**

**Always drive slow and turn corners carefully when carrying items on the roof rack. The vehicle center of gravity will be higher when items are loaded onto the roof rack.**

## AUDIO SYSTEM

If you install aftermarket HID head lamps, your vehicle's audio and electronic devices may malfunction.

### Antenna (if equipped)

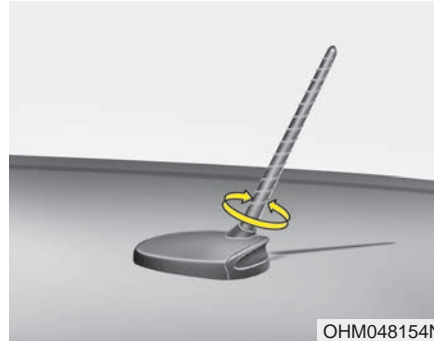

Your vehicle uses a roof antenna to receive AM or/and FM broadcast signals.

This antenna pole is removable. To remove the roof antenna pole, turn it counterclockwise. To install the roof antenna pole, turn it clockwise.



### **CAUTION - Antenna**

*Before entering a place with a low height clearance or a car wash, remove the antenna pole by rotating it counterclockwise. If not, the antenna may be damaged.*

- When reinstalling your roof antenna, it is important that it is fully tightened and adjusted to the upright position to ensure proper reception.
- When cargo is loaded on the roof rack, do not place the cargo near the antenna pole to ensure proper reception.

### Audio remote control (if equipped)



OPS043190

The steering wheel audio remote control button may be installed.

Do not operate the audio remote control buttons simultaneously.

### **⚠ WARNING**

**Driving while distracted can result in a loss of vehicle control that may lead to an accident, severe personal injury and death. The driver's primary responsibility is in the safe and legal operation of a vehicle, and use of any handheld devices, other equipment or vehicle systems which take the driver's eyes, attention and focus away from the safe operation of a vehicle or that are not permissible by law should never be used during operation of the vehicle.**

### **VOLUME (VOL+ / VOL-) (1)**

- Push the VOL + to increase volume.
- Push the VOL - to decrease volume.

### **SEEK/PRESET (∧ / ∨) (2)**

If the SEEK/PRESET button is pressed for more than 1 second, it will work as follows in each mode.

#### **RADIO mode**

It will function as the AUTO SEEK select button.

#### **USB mode**

It will function as the FF/REW button.

If the SEEK/PRESET button is pressed for less than 1 second, it will work as follows in each mode.

**RADIO mode**

It will function as the PRESET STATION select buttons.

**USB mode**

It will function as the FILE UP/DOWN button.

**MODE (3)**

Press the button to select Radio, USB or AUX.

Detailed information for audio control buttons is described in the following pages in this section.

**Aux and USB port (if equipped)**

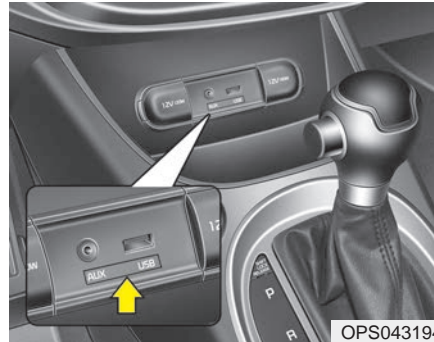

If your vehicle has an aux and/or USB(universal serial bus) port, you can use an aux port to connect audio devices and an USB port to plug in an USB.

When using a portable audio device connected to the power outlet, noise may occur during playback. If this happens, use the power source of the portable audio device.

### Speaker lights (if equipped)

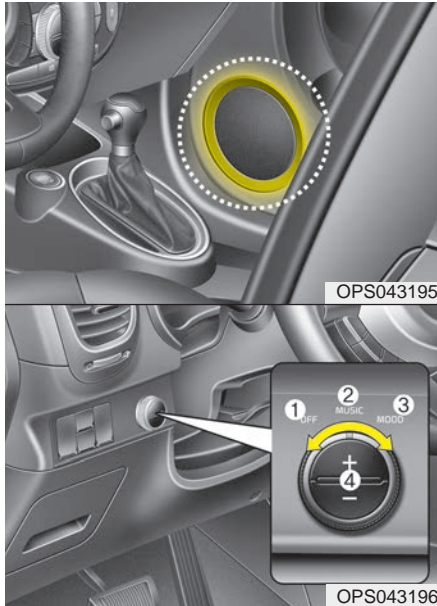

The speaker lights that lights around the front speaker is adjusted by turning the knob as follows.

1. OFF : The light turns off.

2. MUSIC :

The red light blinks according to the sound of the audio.

If the audio is not turned on, the light does not turn on.

3. MOOD :

The light color changes automatically at regular interval.

4. +/- :

When the lights are on, push the illumination button to adjust the light intensity.

If low lighting grade is selected, the intensity of light may be weak or may not illuminate according to the audio volume or selected condition.

The lighting around the front speaker may not illuminate when the sound of the audio is low.

Do not use the lights for extended periods when engine is not running. It may cause battery discharge.

### \* NOTICE

When the doors are opened, the lighting system will not operate.

## How vehicle audio works

### FM reception

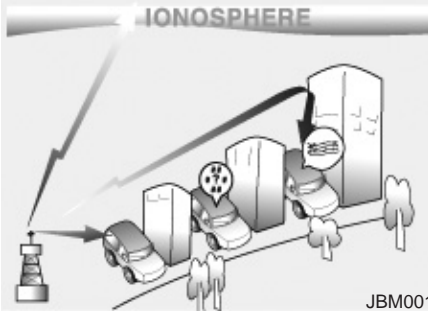

AM and FM radio signals are broadcast from transmitter towers located around your city. They are intercepted by the radio antenna on your vehicle. This signal is then processed by the radio and sent to your vehicle speakers.

However, in some cases the signal coming to your vehicle may not be strong and clear.

This can be due to factors, such as the distance from the radio station, closeness of other strong radio stations or the presence of buildings, bridges or other large obstructions in the area.

### AM reception

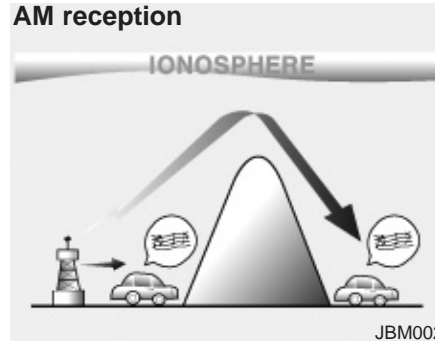

AM broadcasts can be received at greater distances than FM broadcasts. This is because AM radio waves are transmitted at low frequencies. These long distance, low frequency radio waves can follow the curvature of the earth rather than travelling straight. In addition, they curve around obstructions resulting in better signal coverage.

### FM radio station

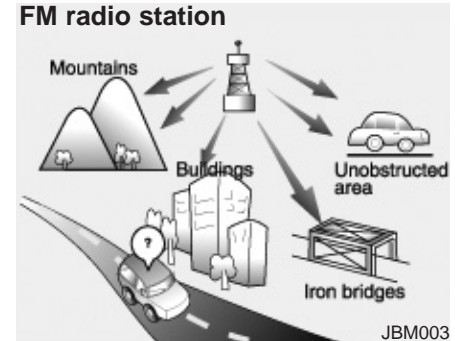

FM broadcasts are transmitted at high frequencies and do not bend to follow the earth's surface. Because of this, FM broadcasts generally begin to fade within short distances from the station. Also, FM signals are easily affected by buildings, mountains, and obstructions. This can lead to undesirable or unpleasant listening conditions which might lead you to believe a problem exists with your radio. The following conditions are normal and do not indicate radio trouble:

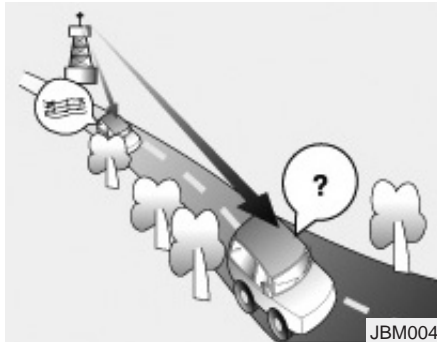

- **Fading** - As your vehicle moves away from the radio station, the signal will weaken and sound will begin to fade. When this occurs, we suggest that you select another stronger station.
- **Flutter/Static** - Weak FM signals or large obstructions between the transmitter and your radio can disturb the signal causing static or fluttering noises to occur. Reducing the treble level may lessen this effect until the disturbance clears.

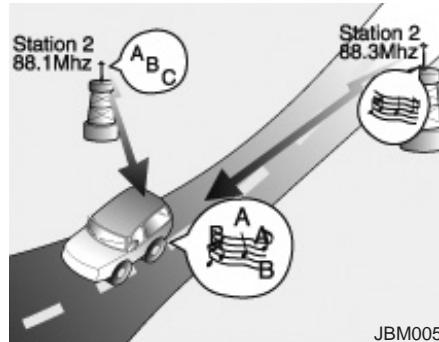

- **Station Swapping** - As an FM signal weakens, another more powerful signal near the same frequency may begin to play. This is because your radio is designed to lock onto the clearest signal. If this occurs, select another station with a stronger signal.
- **Multi-Path Cancellation** - Radio signals being received from several directions can cause distortion or fluttering. This can be caused by a direct and reflected signal from the same station, or by signals from two stations with close frequencies. If this occurs, select another station until the condition has passed.

### *Using a cellular phone or a two-way radio*

When a cellular phone is used inside the vehicle, noise may be produced from the audio system. This does not mean that something is wrong with the audio equipment. In such a case, try to operate mobile devices as far from the audio equipment as possible.

When using a communication system such as a cellular phone or a radio set inside the vehicle, a separate external antenna must be fitted. When a cellular phone or a radio set is used with an internal antenna alone, it may interfere with the vehicle's electrical system and adversely affect safe operation of the vehicle.



**⚠ WARNING - Cell phone use**

Do not use a cellular phone while driving. Stop at a safe location to use a cellular phone.

**⚠ WARNING - Driver Distraction**

- Do not stare at the screen while driving. Staring at the screen for prolonged periods of time could lead to traffic accidents.
- Using the phone while driving may lead to a lack of attention of traffic conditions and increase the likelihood of accidents. Use the phone feature after parking the vehicle.

**⚠ WARNING - Audio System**

Do not disassemble, assemble, or modify the audio system. Such acts could result in fire or electric shock.

**⚠ WARNING - Antenna**

Do not touch the antenna during thunder or lightning as such acts may lead to lightning induced electric shock.

**⚠ CAUTION**

*Refrain from use if the screen is blank or no sound can be hear as these signs may indicate product malfunction.*

- Adjust the volume to levels that allow the driver to hear sounds from outside of the vehicle. Driving in a state where external sounds cannot be heard may lead to accidents.
- Pay attention to the volume setting when turning the device on. A sudden output of extreme volume upon turning the device on could lead to hearing impairment. (Adjust the volume to a suitable levels before turning off the device.)
- Turn on the car ignition before using the audio system Do not operate the audio system for long periods of time with the ignition turned off as such operations may lead to battery discharge.
- In case of product malfunction, please contact your place of purchase or After Service center.
- Placing the audio system within an electromagnetic environment may result in noise interference.

 **CAUTION - LCD Monitor**

***Do not subject the device to severe shock or impact. Direct pressure onto the front side of the monitor may cause damage to the LCD or touch screen.***

 **CAUTION**

- ***When cleaning the device, make sure to turn off the audio system and use a dry and smooth cloth.***
- ***Never use tough materials, chemical cloths, or solvents (alcohol, benzene, thinners, etc.) as such materials may damage the device panel or cause color/quality deterioration.***
- ***Prevent caustic solutions such as perfume and cosmetic oil from contacting the dashboard because they may cause damage or discoloration.***

**USING THE USB DEVICE**

- To use an external USB device, make sure the device is not connected when starting up the vehicle. Connect the device after starting up.
- If you start the engine when the USB device is connected, it may damage the USB device. (USB flashdrives are very sensitive to electric shock.)
- If the engine is started up or turned off while the external USB device is connected, the external USB device may not work.
- The System may not play unauthenticated MP3 or WMA files.
  - 1) It can only play MP3 files with the compression rate between 8Kbps ~ 320Kbps.
  - 2) It can only play WMA music files with the compression rate between 8Kbps ~ 320Kbps.
- Take precautions for static electricity when connecting or disconnecting the external USB device.

(Continued)

(Continued)

- An encrypted MP3 PLAYER is not recognizable.
- Depending on the condition of the external USB device, the connected external USB device can be unrecognizable.
- When the formatted byte/sector setting of External USB device is not either 512BYTE or 2048BYTE, then the device will not be recognized.
- Use only a USB device formatted to FAT 12/16/32.
- USB devices without USB I/F authentication may not be recognizable.
- Make sure the USB connection terminal does not come in contact with the human body or other objects.
- If you repeatedly connect or disconnect the USB device in a short period of time, it may break the device.

(Continued)

(Continued)

- You may hear a strange noise when connecting or disconnecting a USB device.
- If you disconnect the external USB device during playback in USB mode, the external USB device can be damaged or may malfunction. Therefore, disconnect the external USB device when the audio is turned off or in another mode. (e.g, Radio)
- Depending on the type and capacity of the external USB device or the type of the files stored in the device, there is a difference in the time for recognition the device.
- Do not use the USB device for purposes other than playing music files.
- Playing videos through the USB is not supported.
- Use of USB accessories such as rechargers or heaters using USB I/F may lower performance or cause trouble.

(Continued)

(Continued)

- If you use devices such as a USB hub purchased separately, the vehicle's audio system may not recognize the USB device. In that case, connect the USB device directly to the multimedia terminal of the vehicle.
- If the USB device is divided by logical drives, only the music files on the highest-priority drive are recognized by car audio.
- Devices such as MP3 Player/ Cellular phone/Digital camera can be unrecognizable by standard USB I/F can be unrecognizable.
- Charging through the USB may not be supported in some mobile devices.
- USB HDD or USB types liable to connection failures due to vehicle vibrations are not supported. (i-stick type)
- Some non-standard USB devices (METAL COVER TYPE USB) can be unrecognizable.

(Continued)

(Continued)

- Some USB flash memory readers (such as CF, SD, micro SD, etc.) or external-HDD type devices can be unrecognizable.
- Music files protected by DRM (DIGITAL RIGHTS MANAGEMENT) are not recognizable.
- The data in the USB memory may be lost while using this audio. Always back up important data on a personal storage device.
- Please avoid using USB memory products which can be used as key chains or cellular phone accessories as they could cause damage to the USB jack. Please make certain only to use plug type connector products.



### USING iPod® DEVICE

iPhone® is a registered trademark of Apple inc.

- Some iPod® models may not support communication protocol and files may not properly play.

Supported iPod® models:

- iPhone® 3GS/4
  - iPod® touch 1st~4th generation
  - iPod® nano 1st~6th generation
  - iPod® classic
- The order of search or playback of songs in the iPod® can be different from the order searched in the audio system.
  - If the iPod® is disabled due to its own malfunction, reset the iPod®. (Reset: Refer to iPod® manual)
  - An iPod® may not operate normally on low battery.

(Continued)

(Continued)

- Some iPod® devices, such as the iPhone®, can be connected through the *Bluetooth®* Wireless Technology interface. The device must have audio *Bluetooth®* Wireless Technology capability (such as for stereo headphone *Bluetooth®* Wireless Technology ). The device can play, but it will not be controlled by the audio system.
- To use iPod® features within the audio, use the cable provided upon purchasing an iPod® device.
- Skipping or improper operation may occur depending on the characteristics of your iPod®/iPhone® device.
- If your iPhone® is connected to both the *Bluetooth®* Wireless Technology and USB, only support iPod® mode because the sound may not be properly played in *Bluetooth®* Audio Streaming. To use *Bluetooth®* Audio Streaming, disconnect iPod® cable with iPhone®.

(Continued)

(Continued)

- When connecting iPod® with the iPod® Power Cable, insert the connector to the multimedia socket completely. If not inserted completely, communications between iPod® and audio may be interrupted.
- When adjusting the sound effects of the iPod® and the audio system, the sound effects of both devices will overlap and might reduce or distort the quality of the sound.
- Deactivate (turn off) the equalizer function of an iPod® when adjusting the audio system's volume, and turn off the equalizer of the audio system when using the equalizer of an iPod®.
- When not using iPod® with car audio, detach the iPod® cable from iPod®. Otherwise, iPod® may remain in accessory mode, and may not work properly.
- Beside support 1M cable when purchasing iPod®/iPhone products, Long Cable cannot be recognized.

## **Bluetooth® Wireless Technology(if equipped)**

### ***Bluetooth® Wireless Technology***

The *Bluetooth®* word mark and logos are registered trademarks owned by Bluetooth SIG, Inc. and any use of such marks by Kia is under license.

A *Bluetooth®* enabled call phone is required to use *Bluetooth®* wireless technology.

### **⚠ WARNING**

**Driving while distracted can result in a loss of vehicle control that may lead to an accident, severe personal injury, and death. The driver's primary responsibility is in the safe and legal operation of a vehicle, and use of any handheld devices, other equipment, or vehicle systems which take the driver's eyes, attention and focus away from the safe operation of a vehicle or which are not permissible by law should never be used during operation of the vehicle.**

## **Before Using the *Bluetooth®* Wireless Technology Handsfree**

### ***What is Bluetooth® ?***

- *Bluetooth®* refers to a short-distance wireless networking technology which uses a 2.4GHz ~ 2.48GHz frequency to connect various devices within a certain distance.
- Supported within PCs, external devices, *Bluetooth®* phones, PDAs, various electronic devices, and automotive environments, *Bluetooth®* allows data to be transmitted at high speeds without having to use a connector cable.
- *Bluetooth®* Handsfree refers to a device which allows the user to conveniently make phone calls with *Bluetooth®* mobile phones through the audio system.
- *Bluetooth®* Handsfree may not be supported in some mobile phones. To learn more about mobile device compatibility, visit <http://www.kia.com/us/en/content/owners/bluetooth>.

### Precautions for Safe Driving

- Bluetooth® Handsfree is a feature that enables drivers to practice safe driving. Connecting the head unit with a Bluetooth® phone allows the user to conveniently make and receive calls and use contacts. Before using Bluetooth®, carefully read the contents of this user's manual.
- Excessive use or operations while driving may lead to negligent driving practices and result in accidents. Refrain from excessive operations while driving.
- Viewing the screen for prolonged periods of time is dangerous and may lead to accidents. When driving, view the screen only for short periods of time.

### When connecting a Bluetooth® Phone

- Before connecting the head unit with the mobile phone, check to see that the mobile phone supports Bluetooth® features.
  - Even if the phone supports Bluetooth®, the phone will not be found during device searches if the phone has been set to hidden state or the Bluetooth® power is turned off. Disable the hidden state or turn on the Bluetooth® power prior to searching/connecting with the Head unit.
  - If you do not want automatic connection with your Bluetooth® device, turn off the Bluetooth® feature within your mobile phone.
  - The Handsfree call volume and quality may differ depending on the mobile phone.
- Park the vehicle when connecting the head unit with the mobile phone.
  - Bluetooth® connection may become intermittently disconnected in some mobile phones. Follow these steps to try again.
    1. Within the mobile phone, turn the Bluetooth® function off/on and try again.
    2. Turn the mobile phone power Off/On and try again.
    3. Completely remove the mobile phone battery, reboot, and then again.
    4. Reboot the audio system and try again.
    5. Delete all paired devices, pair and try again.

## Voice Recognition

- When using the voice recognition feature, only commands listed within the user's manual are supported.
- Be aware that during the operation of the voice recognition system, pressing any key other than the  key terminate voice recognition mode.
- For superior voice recognition performance, position the microphone used for voice recognition above the head of the driver's seat and maintain a proper position when saying commands.
- Within the following situations, voice recognition may not function properly due to external sound.
  - When the windows and sunroof are open
  - When the blower AC/heater is set to high
  - When entering and passing through tunnels

(Continued)

(Continued)

- When driving on rugged and uneven roads
- During severe rain (heavy rains, windstorms)
- Phone related voice commands can be used only when a *Bluetooth*® Wireless Technology device is connected.
- When making calls by stating a name, the corresponding contact must be downloaded and stored within the audio system.
- After downloading the *Bluetooth*® Wireless Technology phone book, it takes some times to convert the phone book data into voice information. During this time, voice recognition may not properly operate.
- Pronounce the voice commands naturally and clearly as if in a normal conversation.

## Features of your vehicle

---

The Bluetooth and Voice Recognition Manual is provided in two versions due to software version differences. Before reading the manual, check the following.

Press the  key in FM Radio screen.

1. If you can find "FM <89.1>" on the screen,
  - ▶ (Go to 4-161 page)

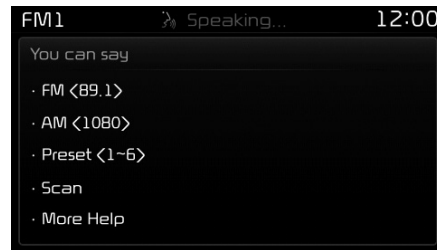
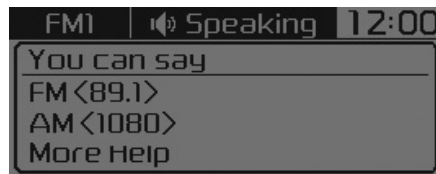

2. If you can find "FM <87.5~107.9>" on the screen,
  - ▶ (Go to 4-206 page)

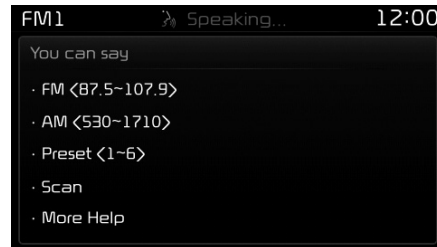
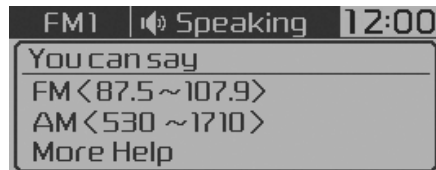



■ AUDIO : AM1A0B2AN, AM1A0B2KN



PS34001N

## SYSTEM CONTROLLERS AND FUNCTIONS

\* Display and settings may differ depending on the selected audio.

### Audio Head Unit



#### (1) RADIO

Changes to FM/AM/SiriusXM mode.

Each time the key is pressed, the mode is changed in order of FM1 → FM2 → AM → SAT1 → SAT2 → SAT3.

\* In Setup>Display, the radio pop up screen will be displayed when [Mode Pop up] is turned **On**.

When the pop up screen is displayed, use the **TUNE** knob or keys **1** ~ **6** to select the desired mode.

#### (2) MEDIA

Changes to USB(iPod®), AUX, My Music, BT Audio mode.

Each time the key is pressed, the mode is changed in order of USB(iPod®), AUX, My Music, BT Audio.

\* In Setup>Display, the media pop up screen will be displayed when [Mode Pop up] is turned **On**.

When the pop up screen is displayed, use the **TUNE** knob or keys **1** ~ **5** to select the desired mode.

#### (3) PHONE

Operates Phone Screen

\* When a phone is not connected, the connection screen is displayed.

#### (4) SETUP CLOCK

Briefly press the key (under 0.8 seconds) : Moves to the Display, Sound, Clock, Phone, System setting modes  
Press and hold the key (over 0.8 seconds) : Move to the Time setting screen

#### (5) SEEK TRACK

Radio Mode : Automatically searches for broadcast frequencies.

USB, iPod®, My Music modes

- Briefly press the key (under 0.8 seconds): Moves to next or previous song (file)

- Press and hold the key (over 0.8 seconds): Rewinds or fast-forwards the current song.

BT Audio mode : Moves to next or previous song(file)

\* The Play/Pause feature may operate differently depending on the mobile phone.

(6) PWR/VOL knob

- Power : Turns power On/Off by pressing the knob
- Volume : Sets volume by turning the knob left/right

(7) **1** ~ **6** (Preset)

Radio mode: Saves frequencies (channels) or receives saved frequencies (channels)

USB, iPod®, My Music mode

- **1 RPT** : Repeat
- **2 RDM** : Random

In the Radio, Media, Setup, and Menu pop up screen, the number menu is selected.



(8) **DISP**

Each time the button is pressed, it sets the screen Off → Screen On → Screen Off

- \* Audio operation is maintained and only the screen will be turned Off. In the screen Off state, press any key to turn the screen On again.

(9) **SCAN**

Radio mode

- Shortly press the key : Previews each broadcast for 5 seconds each.
- Press and hold the key (over 0.8 seconds): Previews the broadcasts saved in Preset **1** ~ **6** for 5 seconds each.

\* Press the **SCAN** key again to continue listening to the current frequency.

\* SAT Radio does not support the Preset scan feature.

USB, My Music mode

- Briefly press the key (under 0.8 seconds): Previews each song (file) for 10 seconds each.

\* Press the **SCAN** key again to continue listening to the current song (file).

(10) **MENU**

Displays menus for the current mode.

\* iPod List : Move to parent category

## Features of your vehicle

---

(11) 

Go to previous depth(no previous screen)

(12) 

Radio mode

- SiriusXM RADIO : Category Search
- USB mode : Folder Search

(13)  TUNE knob

AM/FM mode :

- Changes frequency by turning the knob left/right.

SiriusXM Radio Mode:

- Changes the station by turning the knob left/right. Press knob to select station.

USB, iPod®, My Music mode:

- Searches songs (files) by turning the knob left/right.

\* When the desired song is displayed, press the knob to play the song.

Moves focus in all selection menus and selects menus.

## SETUP

### Display Settings

Press the **SETUP** CLOCK key ▶ Select [Display] through **TUNE** knob or **1** key ▶ Select menu through **TUNE** knob

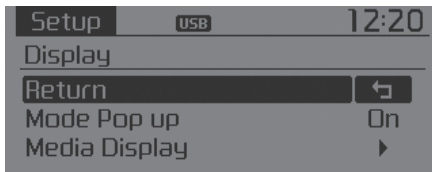

### Mode Pop up

[Mode Pop up] ▶ Changes **On**/**Off** selection mode

- During On state, press the **RADIO** or **MEDIA** key to display the mode change pop up screen.

### Media Display

When playing an MP3 file, select the desired display info from 'Folder/File' or 'Album/Artist/Song'.

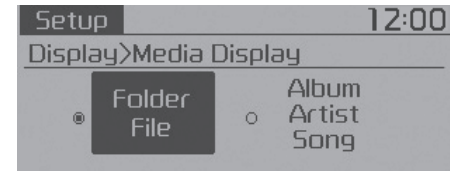

## SOUND SETTINGS

Press the **SETUP** clock key ▶ Select [Sound] through **TUNE** knob or **2** key ▶ Select menu through **TUNE** knob



### Tone

This menu allows you to set the Bass, Middle, Treble.

Select [Tone] ▶ Select menu through **TUNE** knob ▶ Turn **TUNE** knob left/right to set

- Bass, Middle, Treble : Selects the sound tone.
- Default : Restores default settings.
- \* Return : While adjusting values, pressing the **TUNE** knob will restore the parent menu.



### Position

This menu allows you to set the Fader, Balance.

Select [Position] ▶ Select menu through **TUNE** knob ▶ Turn **TUNE** knob left/right to set

- Fader, Balance : Selects the sound fader and balance.
- Default : Restores default settings.
- \* Return : While adjusting values, pressing the **TUNE** knob will restore the parent menu.

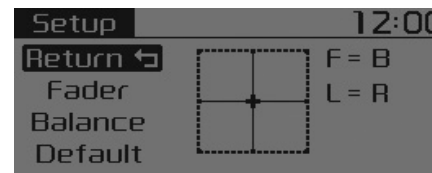

### Speed Dependent Volume Control

This feature will gradually increase the volume as speed increases to offset outside noise.

Select [Speed Dependent Vol.] ▶ Set [On/Off] of **TUNE** knob

### Voice Recognition Volume

Adjusts voice recognition volume.

Select [Voice Recognition Vol.] ▶ Set volume of **TUNE** knob



## CLOCK SETTINGS

Press the **SETUP** CLOCK key ▶ Select [Clock] through **TUNE** knob or **3** key ▶ Select menu through **TUNE** knob

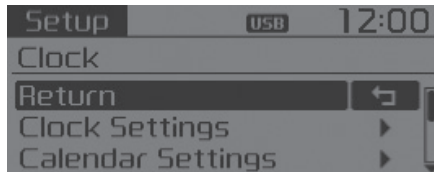

### **⚠ WARNING - Clock Setting Distraction**

Do not adjust the clock while driving. You may lose your steering control and cause severe personal injury or accidents.

## Sound Settings

This menu is used to set the time.

Select [Clock Settings] Set through **TUNE** knob ▶ Press **TUNE** knob

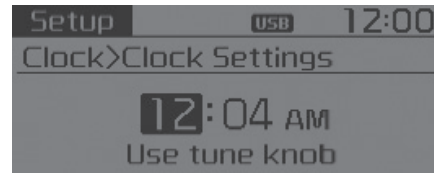

\* Adjust the number currently in focus to set the [hour] and press the tune knob to set the [minute] and [AM/PM].

## Calendar Settings

This menu is used to set the date.

Select [Calendar Settings] ▶ Set through **TUNE** knob ▶ Press **TUNE** knob

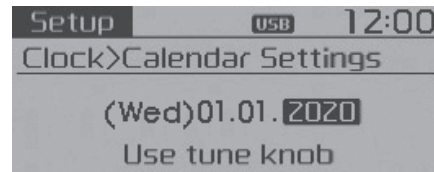

\* Adjust the number currently in focus to make the settings and press the tune knob to move to the next setting.

## Time Format

This function is used to set the 12/24 hour time format of the audio system. Select [Time Format] Set 12Hr / 24Hr through **TUNE** knob

## Clock Display when Power is OFF

Select [Clock Disp.(Pwr Off)] ▶ Set **On**/**Off** through **TUNE** knob

**On** : Displays time/date on screen

**Off** : Turn off.

## SYSTEM SETTINGS

Press the **SETUP** key ▶ Select [System] ▶ Select menu through **TUNE** knob

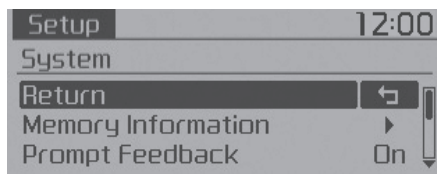

### Memory Information

Displays currently used memory and total system memory.

Select [Memory Information] ▶ OK

The currently used memory is displayed on the left side while the total system memory is displayed on the right side.



### Prompt Feedback

This feature is used to change voice command feedback between Normal and Expert modes.

Select [Prompt Feedback] ▶ Set through **TUNE** knob

- On : This mode is for beginner users and provides detailed instructions during voice command operation.

- Off : This mode is for expert users and omits some information during voice command operation. (When using Expert mode, guidance instructions can be heard through the [Help] or [Menu] commands.)

### Language

This menu is used to set the display and voice recognition language.

Select [Language] ▶ Set through **TUNE** knob

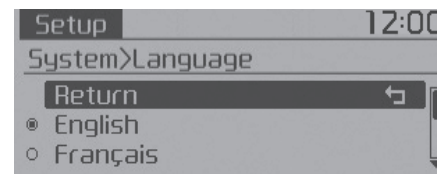

- \* The system will reboot after the language is changed.
- \* Language support by region
  - English, Francais, Espanol

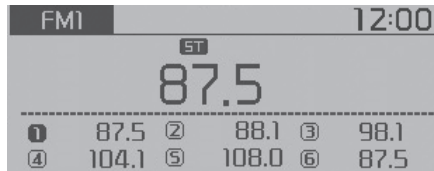

**RADIO : FM, AM or SiriusXM****SEEK**

Press the key

- Briefly pressing the key (under 0.8 seconds): Automatically searches for the next station.
- Pressing and holding the key (over 0.8 seconds): While holding the key, frequency changes without stopping. When the key is released, automatically searches for the next frequency from that point.

**Preset SEEK**

Press the ~ key

- Briefly pressing the key (under 0.8 seconds): Plays the frequency saved in the corresponding key.
- Pressing and holding the key (over 0.8 seconds): Pressing and holding the desired key from ~ will save the currently playing broadcast to the selected key and sound a BEEP.

**SCAN**

Press the key

- Briefly pressing the key (under 0.8 seconds): The broadcast frequency increases and previews each broadcast for 5 seconds each. After scanning all frequencies, returns and plays the current broadcast frequency.
- Pressing and holding the key (over 0.8 seconds): Previews the broadcasts saved in Preset ~ for 5 seconds each.

**Selecting through manual search**

Turn the TUNE knob left/right to adjust the frequency.

### MENU

Within **MENU** key are the A.Store (Auto Store) and Info functions.



#### 1 A.Store

Press the **MENU** key ▶ Set [A.Store] through **TUNE** knob or **1** key.

Saves broadcasts with superior reception to **1** ~ **6** keys. If no frequencies are received, then the most recently received frequency will be broadcast.

## SiriusXM® Satellite Radio information

### Satellite Radio channels:

Enjoy SiriusXM Satellite Radio with a 3-month trial subscription to the Sirius Select package. You'll get over 140 channels, including commercial-free music, plus all your favorite sports, exclusive talk, entertainment, and a selection of premium programming. For more information and a complete list of SiriusXM channels, visit [siriusxm.com](http://siriusxm.com) in the United States, [siriusxm.ca](http://siriusxm.ca) in Canada, or call SiriusXM at 1-888-539-7474.

### Satellite Radio reception factors:

To receive the satellite signal, your vehicle has been equipped with a satellite radio antenna located on the roof of your vehicle. The vehicle roof provides the best location for an unobstructed, open view of the sky, a requirement of a satellite radio system. Like AM/FM, there are several factors that can affect satellite radio reception performance:

- **Antenna obstructions:** For optimal reception performance, keep the antenna clear of snow and ice build-up and keep luggage and other material as far away from the antenna as possible.
- **Terrain:** Hills, mountains, tall buildings, bridges, tunnels, freeway overpasses, parking garages, dense tree foliage and thunderstorms can interfere with your reception.

### SiriusXM Satellite Radio service:

SiriusXM is a subscription-based satellite radio service that broadcasts music, sports, news and entertainment programming to radio receivers, which are available for installation in motor vehicles or factory installed, as well as for the home, portable and wireless devices, and through an Internet connection on personal computer.

Vehicles that are equipped with a factory installed SiriusXM Satellite Radio system include:

- Hardware and an introductory trial subscription term, which begins on the date of sale or lease of the vehicle.
- For a small upgrade fee, access to SiriusXM music channels, and other select channels over the Internet using any computer connected to the Internet (U.S. customers only).

For information on extended subscription terms, contact SiriusXM at 1-888-539-7474.

### NOTE:

**SiriusXM services require a subscription sold separately, or as a package, by Sirius XM Radio Inc. If you decide to continue service after your trial, the subscription plan you choose will automatically renew thereafter and you will be charged according to your chosen payment method at then-current rates. Fees and taxes apply. To cancel you must call SiriusXM at 1-866-635-2349. See SiriusXM Customer Agreement for complete terms at [www.siriusxm.com](http://www.siriusxm.com). SiriusXM U.S. satellite and data services are available only in the 48 contiguous USA, DC and PR (with coverage limitations). SiriusXM satellite service is also available in Canada; see [www.siriusxm.ca](http://www.siriusxm.ca). All fees and programming subject to change. Sirius, XM and all related marks and logos are trademarks of Sirius XM Radio Inc.**

## SiriusXM RADIO

### Using SiriusXM Satellite Radio

Your Kia vehicle is equipped with a 3-month trial subscription to SiriusXM so you have access to over 140 channels of music, information, and entertainment programming.

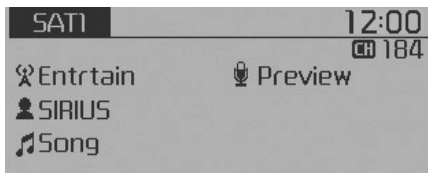

### Activation

In order to extend or reactivate your Sirius Select subscription, you will need to contact SiriusXM Customer Care at 1-800-643-2112. Have your 12-digit RID (Radio Identification Number) / ESN (Electronic Serial Number) ready. To retrieve the RID / ESN, turn on the radio, press the **RADIO** key, and tune to channel zero.

Please note that the vehicle will need to be turned on, in Sirius mode, and have an unobstructed view of the sky in order for the radio to receive the activation signal.

### SEEK

Press the **SEEK TRACK** key ▶

- Shortly pressing the key (under 0.8 seconds): select previous or next channel.
- Pressing and holding the key (over 0.8 seconds): continuously move to previous or next channel.

\* If the “Category” icon is displayed, channels are changed within the current category.



### SCAN

Press the **SCAN** key ▶

- Shortly pressing the key (under 0.8 seconds): Previews each broadcast for 10 seconds each
- \* Press the **SCAN** key again to continue listening to the current frequency
- \* If the “Category” icon is displayed, channels are changed within the current category.

### Category

Press the **CAT FOLDER** key ▶ Set through the **TUNE** knob

- The display will indicate the category menus, highlight the category that the current channel belongs to.
- In the Category List Mode, press the **CAT FOLDER** key to navigate category list.
- Press the tune knob to select the lowest channel in the highlighted category.
- \* If channel is selected by selecting category, then the “CATEGORY” icon is displayed at the top of the screen.

## Preset

Press the **RADIO** key ▶ **1** ~ **6**

- Briefly pressing the key (under 0.8 seconds): Plays the frequency saved in the corresponding key.
- Pressing and holding the key (over 0.8 seconds): Pressing and holding the desired key from **1** ~ **6** will save the current broadcast to the selected key and sound a BEEP.

## \* Troubleshooting

### 1. Antenna Error

If this message is displayed, the antenna or antenna cable is broken or unplugged. Please consult with your Kia dealership.

### 2. No Signal

If this message is displayed, it means that the antenna is covered and that the SiriusXM Satellite Radio signal is not available. Ensure the antenna is uncovered and has a clear view of the sky.

## Tune

- Rotate **TUNE** knob : Changes the channel number or scrolls category list.
- Press **TUNE** knob : Selects the menu.

## Menu

Select category menu through the **TUNE** knob ▶ Press the **MENU** key  
▶ Select [**Info**] through the **TUNE** knob or **RPT** key

## Info (Information)

Displays the Artist/Song info of the current song.

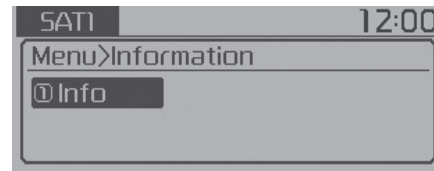

### BASIC METHOD OF USE : USB / iPod® / My Music

Press the **MEDIA** key to change the mode in order of USB(iPod®) → AUX → My Music → BT Audio.

The folder/file name is displayed on the screen.



<USB>



<My Music>

\* The USB music is automatically played when a USB is connected.

### Repeat

While song (file) is playing ▶ **1 RPT** (RPT) key

USB, iPod®, My Music mode: RPT on screen

- To repeat one song (press the key) : Repeats the current song.

USB mode: FLD.RPT on screen

- To repeat folder (pressing twice): repeats all files within the current folder.

\* Press the **1 RPT** key again to turn off repeat.

### Random

While song (file) is playing ▶ **2 RDM** (RDM) key

My Music mode: RDM on screen

- Random (press the key) : Plays all songs in random order.

USB mode: FLD.RDM on screen

- Folder Random (press the key) : Plays all files within the current folder in random order.

iPod® mode: ALL RDM on screen

- All Random (press the key) : Plays all files in random order.

USB : ALL RDM on screen

- All Random (pressing twice): Plays all files in random order.

\* Press the **2 RDM** key again to turn off random.

## Changing Song/File

While song (file) is playing ▶  
 key

- Shortly pressing the key : Plays the current song from the beginning.
- \* If the  key is pressed again within 2 second, the previous song is played.
- Pressing and holding the key (over 0.8 seconds): Rewinds the song.

While song (file) is playing ▶  
 key

- Shortly pressing the key : Plays the next song.
- Pressing and holding the key (over 0.8 seconds) : Fast forwards the song.

## Scan

While song (file) is playing ▶  key

- Shortly pressing the key : Scans all songs from the next song for 10 seconds each.
- \* Press the  key again to turn off.
- \* The SCAN function is not supported in iPod® mode.

## Folder Search : USB Mode

While file is playing ▶  (Folder Up) key

- Searches the next folder.



While file is playing ▶  (Folder Down) key

- Searches the parent folder.

\* If a folder is selected by pressing the  TUNE knob, the first file within the selected folder will be played.

\* In iPod® mode, moves to the Parent Folder.

## Searching Songs (File)

- Turning  TUNE knob : Searches for songs (files)
- Pressing  TUNE knob : Plays selected song (file).

### MENU : USB

Press the USB mode **MENU** key to set the Repeat, Folder Random, Folder Repeat, All Random, Information, and Copy features.



#### Repeat

Press the **MENU** key ▶ Set [**1**RPT] through the **TUNE** knob or **1 RPT** key to repeat the current song.

\* Press RPT again to turn off.

#### Folder Random

Press the **MENU** key ▶ Set [**2**F.RDM] through the **TUNE** knob or **2 RDM** key to randomly play songs within the current folder.

\* Press F.RDM again to turn off.

#### Folder Repeat

Press the **MENU** key ▶ Set [**3**F.RPT] through the **TUNE** knob or **3** key to repeat songs within the current folder.

\* Press F.RPT again to turn off.

#### All Random

Press the **MENU** key ▶ Set [**4**A.RDM] through the **TUNE** knob or **4** key to randomly play all songs within the USB.

\* Press A.RDM again to turn off.

#### Information

Press the **MENU** key ▶ Set [**5**Info] through the **TUNE** knob or **5** key to display information of the current song.

\* Press the **MENU** key to turn off info display.



## Copy

Press the **MENU** key ▶ Set [**6**Copy] through the **TUNE** knob or **6** key.

This is used to copy the current song into My Music. You can play the copied Music in My Music mode.

- \* If another key is pressed while copying is in progress, a pop up asking you whether to cancel copying is displayed.
- \* If another media is connected or inserted (USB, iPod®, AUX) while copying is in progress, copying is canceled.
- \* Music will not be played while copying is in progress.

## MENU : iPod®

In iPod® mode, press the **MENU** key to set the Repeat, Random, Information and Search features.

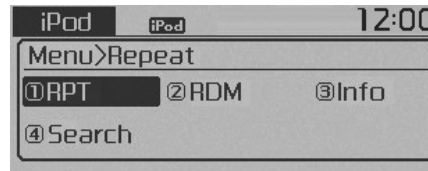

### Repeat

Press the **MENU** key ▶ Set [**1**RPT] through the **TUNE** knob or **1 RPT** key to repeat the current song.

- \* Press RPT again to turn repeat off.

### Random

Press the **MENU** key ▶ Set [**2**RDM] through the **TUNE** knob or **2 RDM** key.

Plays all songs within the currently playing category in random order.

- \* Press RDM again to turn off.

## Information

Press the **MENU** key ▶ Set [**3**Info] through the **TUNE** knob or **3** key.

Displays information of the current song.

- \* Press the **MENU** key to turn off info display.

## Search

Press the **MENU** key ▶ Set [**4**Search] through the **TUNE** knob or **4** key.

Displays iPod® category list.

- \* Searching iPod® category is **MENU** key pressed, move to parent category.

### MENU : My Music Mode

In My Music mode, press the **MENU** key to set the Repeat, Random, Information, Delete, Delete All, and Delete Selection features.



#### Repeat

Press the **MENU** key ▶ Set [**1**RPT] through the **TUNE** knob or **1 RPT** key.

Repeats the currently playing song.

\* Press RPT again to turn repeat off.

#### Random

Press the **MENU** key ▶ Set [**2**RDM] through the **TUNE** knob or **2 RDM** key.

Plays all songs in random order.

\* Press RDM again to turn random off.

#### Information

Press the **MENU** key ▶ Set [**3**Info] through the **TUNE** knob or **3** key.

Displays information of the current song.

\* Press the **MENU** key to turn off info display.

#### Delete

Press the **MENU** key ▶ Set [**4**Delete] through the **TUNE** knob or **4** key.

• Deletes currently playing file

In the play screen, pressing delete will delete the currently playing song.

• Deletes file from list



① Select the file you wish to delete by using the **TUNE** knob.

② Press the **MENU** key and select the delete menu to delete the selected file.

#### Delete All

Press the **MENU** key ▶ Set [**5**Del.All] through the **TUNE** knob or **5** key.  
Deletes all songs of My Music.

## Delete Selection

Press the **MENU** key ▶ Set [6]Del.Sel] through the **TUNE** knob or **6** key.

Songs within My Music are selected and deleted.

- ① Select the songs you wish to delete from the list.

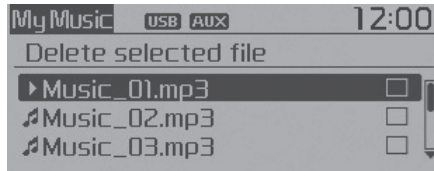

- ② After selecting, press **MENU** key and select the delete menu.



## My Music

- Even if memory is available, a maximum of 6,000 songs can be stored.
- The same song can be copied up to 1,000 times.
- Memory info can be checked in the System menu of Setup.

## AUX

AUX is used to play external MEDIA currently connected with the AUX terminal.

AUX mode will automatically start when an external device is connected with the AUX terminal.

If an external device is connected, you can also press the **MEDIA** key to change to AUX mode.



- \* AUX mode cannot be started unless there is an external device connected to the AUX terminal.

## AUX

Fully insert the AUX cable into the AUX terminal for use.

## **Bluetooth® Wireless Technology AUDIO (if equipped)**

### **What is Bluetooth® Wireless Technology?**

Bluetooth® Wireless Technology allows devices to be connected in a short distance, including hands-free devices, stereo headsets, wireless remote controllers, etc. For more information, visit the *Bluetooth®* Wireless Technology website at [www.Bluetooth.com](http://www.Bluetooth.com)

Before using *Bluetooth®* Wireless Technology audio features

- *Bluetooth®* Wireless Technology audio may not be supported depending on the compatibility of your *Bluetooth®* Wireless Technology mobile phone.
- In order to use *Bluetooth®* Wireless Technology audio, you must first pair and connect the *Bluetooth®* Wireless Technology mobile phone.
- The *Bluetooth®* word mark and logos are registered trademarks owned by Bluetooth SIG, Inc. and any use of such marks by Kia is under license. Other trademarks and trade names are those of their respective owners. A *Bluetooth®* enabled cell phone is required to use *Bluetooth®* Wireless Technology

### **⚠ WARNING**

**Driving while distracted can result in a loss of vehicle control that may lead to an accident, severe personal injury, and death. The driver's primary responsibility is in the safe and legal operation of a vehicle, and use of any handheld devices, other equipment, or vehicle systems which take the driver's eyes, attention and focus away from the safe operation of a vehicle or which are not permissible by law should never be used during operation of the vehicle.**

- *Bluetooth*<sup>®</sup> Wireless Technology audio can be used only when the [Audio Streaming] of Phone is turned .



### Starting *Bluetooth*<sup>®</sup> Wireless Technology Audio

- Press the **MEDIA** key to change the mode in order of USB→AUX→My Music→BT Audio.
- If BT Audio is selected, *Bluetooth*<sup>®</sup> Wireless Technology audio will start playing.
- \* Audio may not automatically start playing in some mobile phones.

### Using the *Bluetooth*<sup>®</sup> Wireless Technology audio features

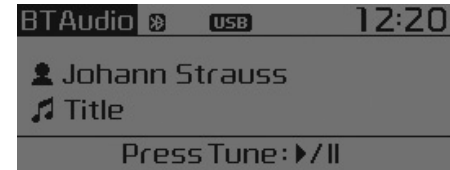
- Play / Stop  
Press the  TUNE knob to play and pause the current song.



- \* The title / artist info may not be supported in some mobile phone. When it is not supported, no title/no artist will be displayed.
- Previous / Next song  
Press  or  to play previous or next song.
- \* The previous song / next song / play / pause functions may not be supported in some mobile phones.



## PHONE(IF EQUIPPED)

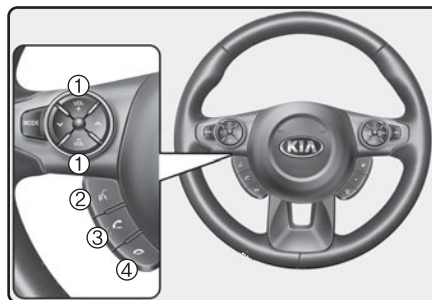

Before using the *Bluetooth*® Wireless Technology phone features

- In order to use *Bluetooth*® Wireless Technology phone, you must first pair and connect the *Bluetooth*® Wireless Technology mobile phone.
- If the mobile phone is not paired or connected, it is not possible to enter Phone mode. Once a phone is paired or connected, the guidance screen will be displayed.
- If Priority is set upon vehicle ignition (IGN/ACC ON), the *Bluetooth*® Wireless Technology phone will be automatically connected. Even if you are outside, the *Bluetooth*® Wireless Technology phone will be automatically connected once you are in the vicinity of the vehicle. If you do not want automatic *Bluetooth*® Wireless Technology phone connection, set the *Bluetooth*® Wireless Technology power to OFF.

### Making a call using the Steering-wheel mounted controls



- (1) VOLUME key : Raises or lowers speaker volume.
- (2)  key : Activates voice recognition.
- (3)  key : Places and transfers calls.
- (4)  key : Ends calls or cancels functions.

- Check call history and making call
  - Shortly press (less than 0.8 seconds) the  key on the steering remote controller.
  - The call history list will be displayed on the screen.
  - Press the  key again to connect a call to the selected number.
- Redialing the most recently called number
  - Press and hold (more than 0.8 seconds) the  key on the steering remote controller.
  - The most recently called number is redialed.
- \* If call history does not exist, a screen asking whether to download call history is displayed. (The download feature may not be supported in some mobile phones)

## **Bluetooth® Wireless Technology**

### **Pairing a Bluetooth® Wireless Technology Device (if equipped)**

#### ***What is Bluetooth® Wireless Technology Pairing?***

Pairing refers to the process of synchronizing your Bluetooth® Wireless Technology phone or device with the car audio system for connection. Pairing is necessary to connect and use the Bluetooth® Wireless Technology feature.

The Bluetooth® word mark and logos are registered trademarks owned by Bluetooth SIG, Inc. and any use of such marks by Kia is under license. Other trademarks and trade names are those of their respective owners. A Bluetooth® enabled cell phone is required to use Bluetooth® Wireless Technology

#### **⚠ WARNING**

Driving while distracted can result in a loss of vehicle control that may lead to an accident, severe personal injury, and death. The driver's primary responsibility is in the safe and legal operation of a vehicle, and use of any handheld devices, other equipment, or vehicle systems which take the driver's eyes, attention and focus away from the safe operation of a vehicle or which are not permissible by law should never be used during operation of the vehicle.

### Pairing **PHONE** key / key on the Steering Remote Controller

#### When No Devices have been Paired

1. Press the **PHONE** key or the  key on the steering remote controller. The following screen is displayed.

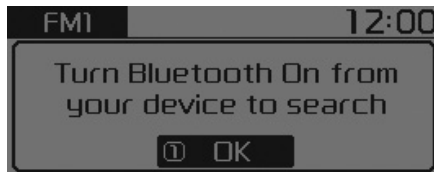

2. Select [OK] button to enter the Pair Phone screen.

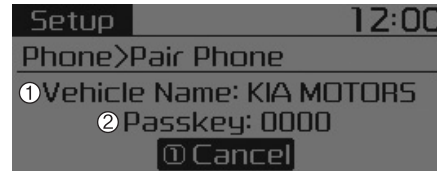

- 1) Vehicle Name : Name of device as shown when searching from your *Bluetooth*<sup>®</sup> Wireless Technology device
  - 2) Passkey : Passkey used to pair the device
3. From your *Bluetooth*<sup>®</sup> Wireless Technology device (i.e. Mobile Phone), search and select your car audio system.

[Non SSP supported device]  
(SSP: Secure Simple Pairing)

4. After a few moments, a screen is displayed where the passkey is entered. Enter the passkey "0000" to pair your *Bluetooth*<sup>®</sup> Wireless Technology device with the car audio system.

[SSP supported device]

4. After a few moments, a screen is displayed 6 digits passkey. Check the passkey on your *Bluetooth*<sup>®</sup> Wireless Technology device and confirm.



5. Once pairing is complete, the following screen is displayed.



During the pairing process, make sure that all connection requests on the phone are accepted for phonebook download and to allow acceptance of all future connection requests. " and "Visit <http://www.kia.com/us/en/content/owners/bluetooth> for additional information on pairing your Bluetooth-enabled mobile phone, and to view a phone compatibility list.



- If *Bluetooth*® Wireless Technology devices are paired but none are currently connected, pressing the **PHONE** key or the  key on the steering wheel displays the following screen. Select [Pair] button to pair a new device or select [Connect] to connect a previously paired device.

### Pairing through [PHONE] Setup

Press the **SETUP** **CLOCK** key ▶ Select [Phone] ▶ Select [Pair Phone] ▶ Select **TUNE** knob

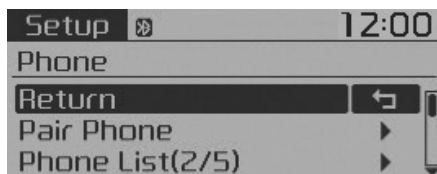

1. The following steps are the same as those described in the section "When No Devices have been Paired" on the previous page.

- *Bluetooth*® Wireless Technology features supported within the vehicle are as follows. Some features may not be supported depending on your *Bluetooth*® Wireless Technology device.
  - Outgoing/Incoming Handsfree calls
  - Operations during a call (Switch to Private, Switch to call waiting, MIC on/off)
  - Downloading Call History
  - Downloading Mobile Contacts
  - *Bluetooth*® Wireless Technology device auto connection
  - Bluetooth Audio Streaming
- Up to five *Bluetooth*® Wireless Technology devices can be paired to the Car Handsfree system.
- Only one *Bluetooth*® Wireless Technology device can be connected at a time.
- Other devices cannot be paired while a *Bluetooth*® Wireless Technology device is connected.
- Only *Bluetooth*® Wireless Technology Handsfree and Bluetooth audio related features are supported.
- Bluetooth related operations are possible only within devices that support Handsfree or audio features, such as a *Bluetooth*® Wireless Technology mobile phone or a Bluetooth audio device.
- If a connected *Bluetooth*® Wireless Technology device becomes disconnected due to being out of communication range, turning the device OFF, or a *Bluetooth*® Wireless Technology communication error, corresponding *Bluetooth*® Wireless Technology devices are automatically searched and reconnected.
- If the system becomes unstable due to communication errors between the car Handsfree and the *Bluetooth*® Wireless Technology device, reset the device by turning off and back on again. Upon resetting *Bluetooth*® Wireless Technology device, the system will be restored.

- After pairing is complete, a contacts download request is sent once to the mobile phone. Some mobile phones may require confirmation upon receiving a download request, ensure your mobile phone accepts the connection. Refer to your phones user's manual for additional information regarding phone pairing and connections.

### Connecting a Device

Press the **SETUP** CLOCK key ▶ Select [Phone] ▶ Select [Phone List]



- 1) Connected Phone : Device that is currently connected
- 2) Paired Phone : Device that is paired but not connected

From the paired phone list, select the device you want to connect and select [Connect].

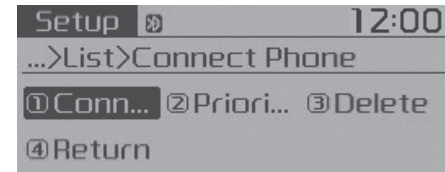

### Changing Priority

#### What is Priority?

It is possible to pair up to five *Bluetooth®* Wireless Technology devices with the car audio system. The "Change Priority" feature is used to set the connection priority of paired phones.

Press the **SETUP** CLOCK key ▶ Select [Phone] ▶ Select [Phone List]



From the paired phone list, select the phone you want to switch to the highest priority, then select [Change Priority] button from the Menu. The selected device will be changed to the highest priority.

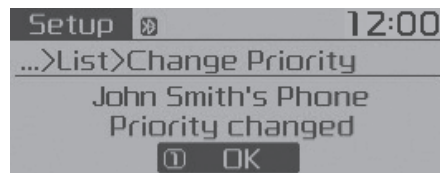
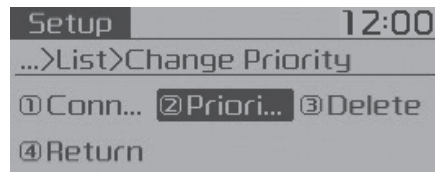

- Priority icon will be displayed when the selected phone is set as a priority phone.



### Disconnecting a Device

Press the **SETUP** CLOCK key ▶ Select [Phone] ▶ Select [Phone List]



From the paired phone list, select the currently connected device and select [Disconnect] button.



### Deleting a Device

Press the **SETUP** CLOCK key ▶ Select [Phone] ▶ Select [Phone List]



From the paired phone list, select the device you want to delete and select [Delete] button.

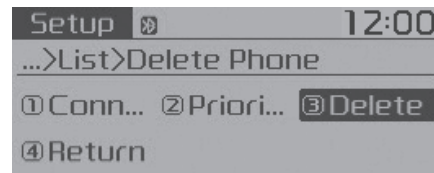

- When deleting the currently connected device, the device will automatically be disconnected to proceed with the deleting process.
- If a paired *Bluetooth*® Wireless Technology device is deleted, the device's call history and contacts data will also be deleted.
- To re-use a deleted device, you must pair the device again.

## USING *Bluetooth*<sup>®</sup> Wireless Technology(if equipped)

### Phone Menu Screen

#### *Phone Menus*

With a *Bluetooth*<sup>®</sup> Wireless Technology device connected, press the **PHONE** key to display the Phone menu screen.



- 1) Favorite : Up to 20 frequently used contacts saved for easy access.
- 2) Call History : Displays the call history list screen
- 3) Contacts : Displays the Contacts list screen
- 4) Setup : Displays Phone related settings.

- If you select the [Call History] button but there is no call history data, a prompt is displayed which asks to download call history data.
- If you select the [Contacts] button but there is no contacts data stored, a prompt is displayed which asks to download contacts data.
- This feature may not be supported in some mobile phones. For more information on download support, refer to your mobile phone user's manual.

### Answering Calls

#### *Answering a Call*

Answering a call with a *Bluetooth*<sup>®</sup> Wireless Technology device connected will display the following screen.

To accept the call, press  key on the steering wheel while the call is incoming.

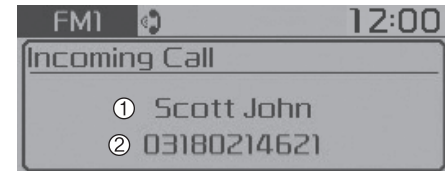

- 1) Caller : Displays the other caller's name when the incoming caller is saved within your contacts
- 2) Incoming Number : Displays the incoming number

**\* NOTICE**

- When an incoming call pop-up is displayed, most Audio and SETUP mode features are disabled. Only the call volume will operate.
- The telephone number may not be properly displayed in some mobile phones.

**Favorites**

Press the **PHONE** key ▶ Select [Favorites]



- 1) Saved favorite contact : Connects call upon selection
  - 2) To add favorite : Downloaded contacts be saved as favorite.
- To save Favorite, contacts should be downloaded.
  - Contact saved in Favorites will not be automatically updated if the contact has been updated in the phone. To update Favorites, delete the Favorite and create a new Favorite.

**Call History**

Press the **PHONE** key ▶ Select [Call History]



A list of incoming, outgoing and missed calls is displayed.

- Call history may not be saved in the call history list in some mobile phones.
- Calls received with hidden caller ID will not be saved in the call history list.
- Calling through the call history is not possible when there is no call history stored or a *Bluetooth*<sup>®</sup> Wireless Technology phone is not connected.
- Up to 50 received, dialed and missed calls are stored in Call History.
- Time of received/dialed calls and call time information are not stored in Call History.

### Contacts

Press the **PHONE** key ▶ Select [Contacts]

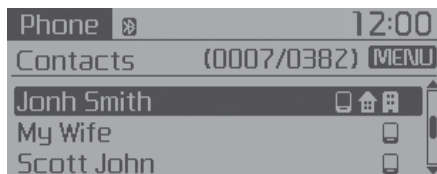

The list of saved phone book entries is displayed.

#### NOTE:

Find a contact in an alphabetical order, press the **MENU** key.

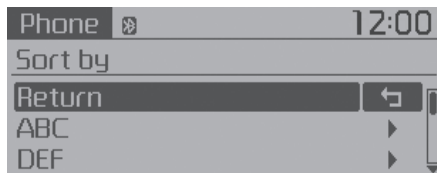

- Up to 1,000 contacts saved in your *Bluetooth*® Wireless Technology phone can be downloaded into the car contacts. Contacts that have been downloaded to the car cannot be edited or deleted on the phone.
- Mobile phone contacts are managed separately for each paired *Bluetooth*® Wireless Technology device (max 5 devices x 1,000 contacts each). Previously downloaded data is maintained even if the *Bluetooth*® Wireless Technology device has been disconnected. (However, the contacts and call history saved to the phone will be deleted if a paired phone is deleted.)
- It is possible to download contacts during Bluetooth streaming audio.
- When downloading contacts, the icon will be displayed within the status bar.
- It is not possible to begin downloading a contact list when the contact download feature has been turned off within the *Bluetooth*® Wireless Technology device. In addition, some devices may require device authorization upon attempting to download contacts. If downloading does not normally occur, check the *Bluetooth*® Wireless Technology device settings or the screen state.
- The contacts download feature may not be supported in some mobile phones. For more information of supported *Bluetooth*® devices and function support, refer to your phone's user manual.



## Bluetooth® Wireless Technology Setting

The *Bluetooth*® word mark and logos are registered trademarks owned by Bluetooth SIG, Inc. and any use of such marks by Kia is under license. Other trademarks and trade names are those of their respective owners. A *Bluetooth*® enabled cell phone is required to use *Bluetooth*® Wireless Technology.

### **⚠ WARNING**

**Driving while distracted can result in a loss of vehicle control that may lead to an accident, severe personal injury, and death. The driver's primary responsibility is in the safe and legal operation of a vehicle, and use of any handheld devices, other equipment, or vehicle systems which take the driver's eyes, attention and focus away from the safe operation of a vehicle or which are not permissible by law should never be used during operation of the vehicle.**

### Pairing a New Device

Press the **SETUP** **CLOCK** key ▶ Select [Phone] ▶ Select [Pair Phone]

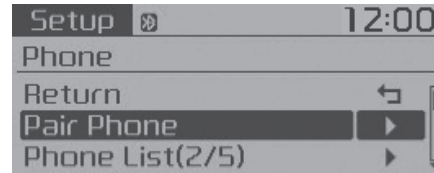

*Bluetooth*® Wireless Technology devices can be paired with the audio system.

For more information, refer to the "Pairing through Phone Setup" section within *Bluetooth*® Wireless Technology.

### Viewing Paired Phone List

Press the **SETUP** **CLOCK** key ▶ Select [Phone] ▶ Select [Phone List]

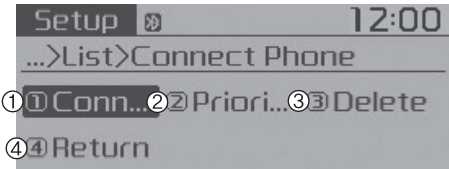

This feature is used to view mobile phones that have been paired with the audio system. Upon selecting a paired phone, the setup menu is displayed.

For more information, refer to the "Setting *Bluetooth*® Wireless Technology Connection" section within *Bluetooth*® Wireless Technology.

- 1) Connect/Disconnect Phone : Connect/ disconnects currently selected phone
- 2) Change Priority : Sets currently selected phone to highest connection priority
- 3) Delete : Deletes the currently selected phone
- 4) Return : Moves to the previous screen

- To learn more about whether your mobile phone supports contacts downloads, refer to your mobile phone user's manual.
- The contacts for only the connect-ed phone can be downloaded

### Downloading Contacts

Press the **SETUP** **CLOCK** key ▶ Select [Phone] ▶ Select [Contacts Download]



As the contacts are downloaded from the mobile phone, a download progress bar is displayed.

- Upon downloading phone contacts, the previous corresponding data is deleted.
- This feature may not be supported in some mobile phones.
- Voice Recognition may not operate while contacts are being downloaded.

### Outgoing Volume

Press the **SETUP** **CLOCK** key ▶ Select [Phone] ▶ Select [Outgoing Volume]

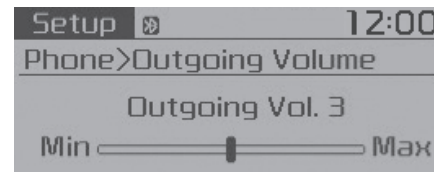

Use **TUNE** knob to adjust the outgoing volume level.

- While on a call, the volume can be changed by using the **SEEK** **TRACK** key.

### Turning Bluetooth System Off

Press the **SETUP**  
**CLOCK** key ▶ Select [Phone] ▶ Select [Bluetooth System Off]

Once *Bluetooth*® Wireless Technology is turned off, *Bluetooth*® Wireless Technology related features will not be supported within the audio system.



- To turn *Bluetooth*® Wireless Technology back on, go to **SETUP**  
**CLOCK** ▶ [Phone] and select “Yes”.

## VOICE RECOGNITION

### Using Voice Recognition

#### *Starting Voice Recognition*

Shortly press the  key on the steering wheel. Say a command

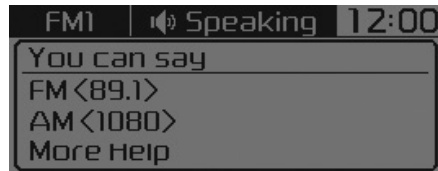

If prompt feedback is in [ON], then the system will say “Please say a command after the beep (BEEP)”

- If prompt feedback is in [OFF] mode, then the system will only say “(BEEP)”
- To change Prompt Feedback [On]/[Off], go to  ▶[System] ▶[Prompt Feedback]
- For proper recognition, say the command after the voice instruction and beep tone.

#### *Skipping Prompt Messages*

While prompt message is being stated ▶ Shortly press the  key on the steering remote controller

The prompt message is immediately ended and the beep tone will sound. After the “beep”, say the voice command.

#### *Re-starting Voice Recognition*

While system waits for a command ▶ Shortly press the  key on the steering remote controller

The command wait state is immediately ended and the beep tone will sound. After the “beep”, say the voice command.

## ENDING VOICE RECOGNITION

While Voice Recognition is operating  
▶ Press and hold the  key on the steering remote controller

- While using voice command, pressing any steering wheel control or a different key will end voice command.
- When the system is waiting for a voice command, say “cancel” or “end” to end voice command.
- When the system is waiting for a voice command, press and hold the  key on the steering wheel to end voice command.

## Voice Recognition and Phone Contact Tips:

The Kia Voice Recognition System may have difficulty understanding some accents or uncommon names. When using Voice Recognition to place a call, speak in a moderate tone, with clear pronunciation

To maximize the use of Voice Recognition, consider these guidelines when storing contacts:

- Do not store single-name entries (e.g., “Bob”, “Mom”, etc.). Instead, always use full names (including first and last names) for these contacts
- Do not use special characters (e.g., '@', '-', '\*', '&', etc.)
- Do not use abbreviations (i.e., use “Lieutenant” instead of “Lt.”) or acronyms (i.e., use “County Finance Department” instead of “C. F. D.”; Be sure to say the name exactly as it is entered in the contacts list

- Do not use acronyms (i.e., use “County Finance Department” instead of “CFD”).
- If a name is not recognized from the contact list, change it to a more descriptive name (e.g., use “Grandpa Joseph” instead of “Pa Joe”).

## Illustration on using voice commands

- Starting voice command.

Shortly pressing the  key (under 0.8 seconds):

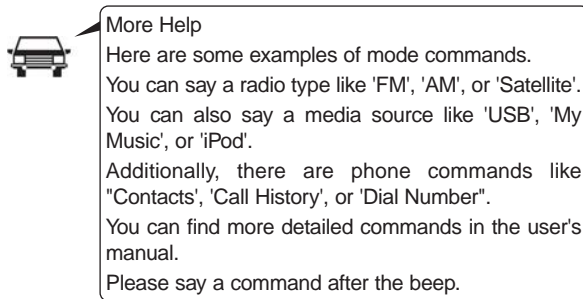

- Skipping Prompt Messages

Shortly pressing the  key (under 0.8 seconds):

Please say a... while guidance message is being stated

Shortly pressing the  key (under 0.8 seconds):

(BEEP)

More Help

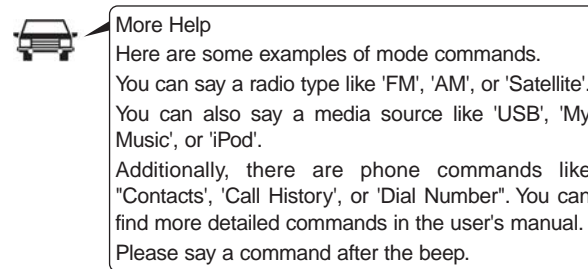

- Ending voice command.

Shortly pressing the  key (under 0.8 seconds):

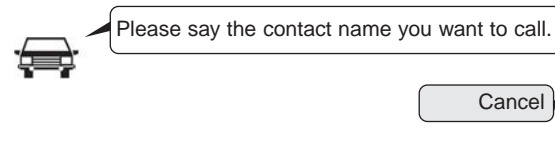
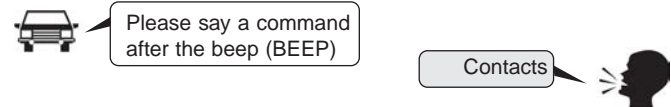

## Voice Command List

- Common Commands: These commands can be used in most operations. (However a few commands may not be available during certain operations)

Command	Function
More Help	Provides guidance on commands that can be used anywhere in the system.
Help	Provides guidance on commands that can be used within the current mode.
Call<Name>	Calls <Name> saved in Contacts Ex) Call "John Smith"
Call <Name> on Mobile	Calls <Name> to the number that is saved as "Mobile" in Contacts Ex) Call "John Smith" on Mobile
Call <Name> in Office	Calls <Name> to the number that is saved as "Office" in Contacts Ex) Call "John Smith" in Office
Call <Name> at Home	Calls <Name> to the number that is saved as "Home" in Contacts Ex) Call "John Smith" at Home
Call <Name> on Other	Calls <Name> to the number that is saved as "Other" in Contacts Ex) Call "John Smith" on Other
Phone	Provides guidance on Phone related commands. After saying this command, say "Favorites", "Call History", "Contacts" or "Dial Number" execute corresponding functions.
Favorites	Displays the Favorite screen.
Call History	Displays the Call History screen.

Command	Function
Contacts	Displays the Contacts screen. After saying this command, say the name of a contact saved in the Contacts to automatically connect the call.
Dial Number	Displays the Dial number screen. After saying this command, you can say the number that you want to call.
Redial	Connects the last dialed call number.
Tutorial	Provides guidance on how to use voice recognition and Bluetooth® connections
Radio	<ul style="list-style-type: none"> <li>• When listening to the radio, displays the next radio screen. (FM1→FM2→AM→SAT1→SAT2→SAT3→FM1)</li> <li>• When listening to a different mode, displays the most recently played radio screen.</li> <li>• When currently listening to the FM radio, maintains the current state.</li> <li>• When listening to a different mode, displays the most recently played FM screen.</li> </ul>
FM1(FM One)	Displays the FM1 screen.
FM2(FM Two)	Displays the FM2 screen.
AM	Displays the AM screen.

## Features of your vehicle

Command	Function
FM Preset 1~6	Plays the most recently played broadcast saved in FM Preset 1~6.
AM Preset 1~6	Plays the broadcast saved in AM Preset 1~6.
FM 87.5~107.9	Plays the FM broadcast of the corresponding frequency.
AM 530~1710	Plays the AM broadcast of the corresponding frequency.
SIRIUS (Satellite)	<ul style="list-style-type: none"> <li>• When currently listening to the SiriusXM®, maintains the current state.</li> <li>• When listening to a different mode, displays the most recently played SiriusXM® screen.</li> </ul>
SIRIUS (Satellite) 1~3	Displays the selected SiriusXM® screen.
SIRIUS Channel 0~223	Plays the selected SiriusXM® channel.
Media	Moves to the most recently played media screen.
USB	Plays USB music.
iPod®	Plays iPod® music.

Command	Function
My Music	Plays the music saved in My Music.
AUX (Auxiliary)	Plays the connected external device.
Bluetooth® Audio	Plays the music saved in connected Bluetooth® device.
Mute	Mutes the sound.
Cancel (Exit)	Ends voice command.



- FM/AM radio commands: Commands available during FM, AM radio operation.

Command	Function
Preset 1~6	Plays the broadcast station saved in Preset 1~6.
Scan	Scans receivable frequencies from the current broadcast and plays for 10 seconds each.
Preset Scan	Moves to the next preset from the current present and plays for 10 seconds each.
Information	Displays the information of the current broadcast. (This feature can be used when receiving RBDS broadcasts.)

- Satellite radio commands: Commands that can be used while listening to Satellite Radio.

Command	Function
Channel 0~223	Plays the selected Satellite Radio channel.
Scan	Scans receivable channels from the current broadcast and plays for 10 seconds each.
Preset 1~6	Plays the broadcast saved in Preset 1~6.
Information	Displays the information of the current broadcast.

## Features of your vehicle

---

- USB commands: Commands available during USB operation.

<b>Command</b>	<b>Function</b>
Random	Randomly plays the files within the current folder.
Random Off	Cancels random play to play files in sequential order.
Repeat	Repeats the current file.
Repeat Off	Cancels repeat play to play files in sequential order.
Information	Displays the information screen of the current file.
Next Folder	Play the first file in the next folder.
Previous Folder	Play the first file in the previous folder.

- iPod® Commands: Commands available during iPod® operation.

<b>Command</b>	<b>Function</b>
Random	Randomly plays the songs within the current category.
Random Off	Cancels random play to play songs in sequential order.
Repeat	Repeats the current song.
Repeat Off	Cancels repeat play to play songs in sequential order.

- My Music Commands: Commands available during My Music operation.

Command	Function
Random	Randomly plays all saved files.
Random Off	Cancel random play to play files in sequential order.
Repeat	Repeats the current file.
Repeat Off	Cancel repeat play to play files in sequential order.
Delete	Deletes the current file. You will bypass an additional confirmation process.

- *Bluetooth*<sup>®</sup> Wireless Technology Audio Commands: Commands available during *Bluetooth*<sup>®</sup> Wireless Technology audio streaming from mobile phone operation Command Operation.

Command	Function
Play	Plays the currently paused song.
Pause	Pauses the current song.

iPod® is a registered trademark of Apple Inc. iPod® mobile digital device sold separately. The Bluetooth® word mark and logos are registered trademarks owned by Bluetooth SIG, Inc. and any use of such marks by Kia is under license. SiriusXM services require a subscription sold separately, or as a package, by Sirius XM Radio Inc. If you decide to continue service after your trial, the subscription plan you choose will automatically renew thereafter and you will be charged according to your chosen payment method at then-current rates. Fees and taxes apply. To cancel you must call SiriusXM at 1-866-635-2349. See SiriusXM Customer Agreement for complete terms at [www.siriusxm.com](http://www.siriusxm.com). SiriusXM U.S. satellite and data services are available only in the 48 contiguous USA, DC and PR (with coverage limitations). SiriusXM satellite service is also available in Canada; see [www.siriusxm.ca](http://www.siriusxm.ca). All fees and programming subject to change. Sirius, XM and all related marks and logos are trademarks of Sirius XM Radio Inc. Android™ is a trademark of Google, Inc. BlackBerry is a registered trademark of Research In Motion Limited (RIM). All other marks, channel names and logos are the property of their respective owners. All rights reserved.

## IC

This device complies with Industry Canada's licence-exempt RSSs.

Operation is subject to the following two conditions:

- (1) This device may not cause interference; and
- (2) This device must accept any interference, including interference that may cause undesired operation of the device.

Le présent appareil est conforme aux CNR d'Industrie Canada applicables aux appareils radio exempts de licence. L'exploitation est autorisée aux deux conditions suivantes : (1) l'appareil ne doit pas produire de brouillage, et (2) l'utilisateur de l'appareil doit accepter tout brouillage radioélectrique subi, même si le brouillage est susceptible d'en compromettre le fonctionnement.

■ **AUDIO : AM1A0B2AN, AM1A0B2KN**



PS34001N

## SYSTEM CONTROLLERS AND FUNCTIONS

\* Display and settings may differ depending on the selected audio.

### Audio Head Unit



#### (1) RADIO

Changes to FM/AM/SiriusXM® mode. Each time the key is pressed, the mode is changed in order of FM1 → FM2 → AM → SAT1 → SAT2 → SAT3.

\* In Setup>Display, the radio pop up screen will be displayed when [Mode Pop up] is turned (On).

When the pop up screen is displayed, use the TUNE knob or keys 1 ~ 6 to select the desired mode.

#### (2) MEDIA

Changes to USB(iPod®), AUX, My Music, BT Audio mode.

Each time the key is pressed, the mode is changed in order of USB(iPod®), AUX, My Music, BT Audio.

\* In Setup>Display, the media pop up screen will be displayed when [Mode Pop up] is turned (On). When the pop up screen is displayed, use the TUNE knob or keys 1 ~ 5 to select the desired mode.

#### (3) PHONE

Operates Phone Screen

\* When a phone is not connected, the connection screen is displayed.

#### (4) SETUP CLOCK

Briefly press the key (under 0.8 seconds) : Moves to the Display, Sound, Clock, Phone, System setting modes  
Press and hold the key (over 0.8 seconds) : Move to the Time setting screen

#### (5) SEEK TRACK

Radio Mode : Automatically searches for broadcast frequencies.

USB, iPod®, My Music modes

- Briefly press the key (under 0.8 seconds): Moves to next or previous song (file)
- Press and hold the key (over 0.8 seconds): Rewinds or fast-forwards the current song.

BT Audio mode : Moves to next or previous song(file)

\* The Play/Pause feature may operate differently depending on the mobile phone.

### (6) PWR/VOL knob

- Power : Turns power On/Off by pressing the knob
- Volume : Sets volume by turning the knob left/right

### (7) **1** ~ **6** (Preset)

Radio mode: Saves frequencies (channels) or receives saved frequencies (channels)

USB, iPod®, My Music mode

- **1 RPT** : Repeat
- **2 RDM** : Random

In the Radio, Media, Setup, and Menu pop up screen, the number menu is selected.



### (8) **DISP**

Each time the button is pressed, it sets the screen Off → Screen On → Screen Off

- \* Audio operation is maintained and only the screen will be turned Off. In the screen Off state, press any key to turn the screen On again.

### (9) **SCAN**

Radio mode

- Shortly press the key : Previews each broadcast for 5 seconds each.
- Press and hold the key (over 0.8 seconds): Previews the broadcasts saved in Preset **1** ~ **6** for 5 seconds each.

\* Press the **SCAN** key again to continue listening to the current frequency.

\* SAT Radio does not support the Preset scan feature.

USB, My Music mode

- Briefly press the key (under 0.8 seconds): Previews each song (file) for 10 seconds each.

\* Press the **SCAN** key again to continue listening to the current song (file).

### (10) **MENU**

Displays menus for the current mode.

\* iPod List : Move to parent category



(11) **BACK**

Go to previous menu (no previous screen)

(12) **CAT FOLDER**

Radio mode

- SiriusXM® RADIO : Category Search
- USB mode : Folder Search

(13) **TUNE knob**

AM/FM mode :

- Changes frequency by turning the knob left/right.

SiriusXM® Radio Mode:

- Changes the station by turning the knob left/right. Press knob to select station.

USB, iPod®, My Music mode:

- Searches songs (files) by turning the knob left/right.

\* When the desired song is displayed, press the knob to play the song.

Moves focus in all selection menus and selects menus.

## SETUP

### Display Settings

Press the **SETUP** CLOCK key ▶ Select [Display] through **TUNE** knob or **1** key ▶ Select menu through **TUNE** knob



### Mode Pop up

[Mode Pop up] ▶ Changes **On**/**Off** selection mode

- During On state, press the **RADIO** or **MEDIA** key to display the mode change pop up screen.

### Media Display

When playing an MP3 file, select the desired display info from 'Folder/File' or 'Album/Artist/Song'.

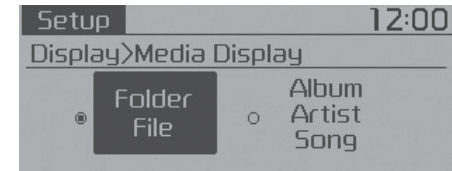

## SOUND SETTINGS

Press the **SETUP** clock key ▶ Select [Sound] through **TUNE** knob or **2** key ▶ Select menu through **TUNE** knob

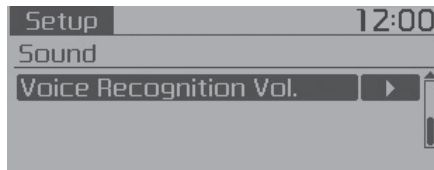
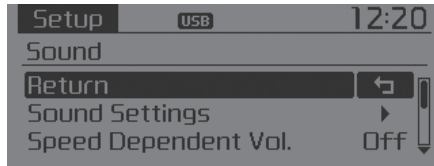

### Sound Settings

This menu allows you to set the 'Bass, Middle, Treble' and the Sound Fader and Balance.

Select [Sound Settings] ▶ Select menu through **TUNE** knob ▶ Turn **TUNE** knob left/right to set

- Bass, Middle, Treble : Selects the sound tone.
- Fader, Balance : Moves the sound fader and balance.
- Default : Restores default settings.

\* Back : While adjusting values, pressing the **TUNE** knob will restore the parent menu.

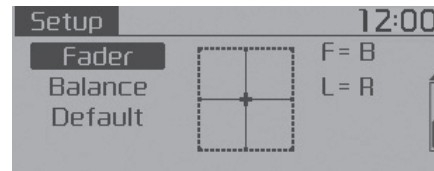

### Speed Dependent Volume Control

This feature will gradually increase the volume as speed increases to offset outside noise.

Select [Speed Dependent Vol.] ▶ Set [On/Off] of **TUNE** knob

### Voice Recognition Volume

Adjusts voice recognition volume.

Select [Voice Recognition Vol.] ▶ Set volume of **TUNE** knob



## CLOCK SETTINGS

Press the **SETUP** CLOCK key ▶ Select [Clock] through **TUNE** knob or **3** key ▶ Select menu through **TUNE** knob

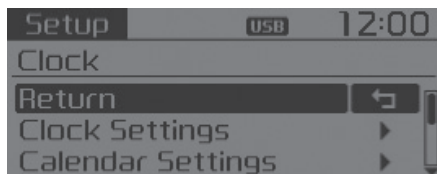

### **⚠ WARNING - Clock Setting Distraction**

Do not adjust the clock while driving. You may lose your steering control and cause severe personal injury or accidents.

## Sound Settings

This menu is used to set the time.

Select [Clock Settings] ▶ Set through **TUNE** knob ▶ Press **TUNE** knob

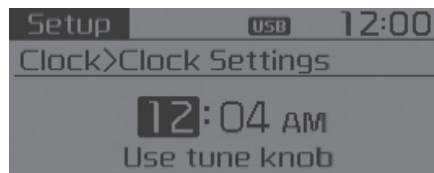

\* Adjust the number currently in focus to set the [hour] and press the tune knob to set the [minute] and [AM/PM].

## Calendar Settings

This menu is used to set the date (MM/DD/YYYY).

Select [Calendar Settings] ▶ Set through **TUNE** knob ▶ Press **TUNE** knob

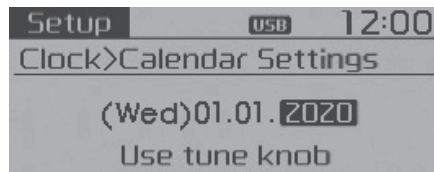

\* Adjust the number currently in focus to make the settings and press the tune knob to move to the next setting. (Set in order of Year/Month/Day)

## Time Format

This function is used to set the 12/24 hour time format of the audio system. Select [Time Format] Set 12Hr / 24Hr through **TUNE** knob

## Clock Display when Power is OFF

Select [Clock Disp.(Pwr Off)] ▶ Set **On**/**Off** through **TUNE** knob

**On** : Displays time/date on screen

**Off** : Turn off.

## SYSTEM SETTINGS

Press the **SETUP** key ▶ Select [System] ▶ Select menu through **TUNE** knob

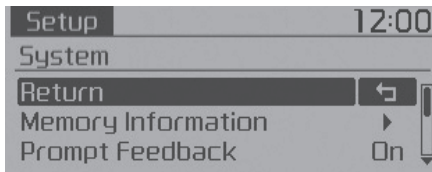

### Memory Information

Displays currently used memory and total system memory.

Select [Memory Information] ▶ OK

The currently used memory is displayed on the left side while the total system memory is displayed on the right side.



### Prompt Feedback

This feature is used to change voice command feedback between Normal and Expert modes.

Select [Prompt Feedback] ▶ Set through **TUNE** knob

- On : This mode is for beginner users and provides detailed instructions during voice command operation.

- Off : This mode is for expert users and omits some information during voice command operation. (When using Expert mode, guidance instructions can be heard through the [Help] or [Menu] commands.)

### Language

This menu is used to set the display and voice recognition language.

Select [Language] ▶ Set through **TUNE** knob

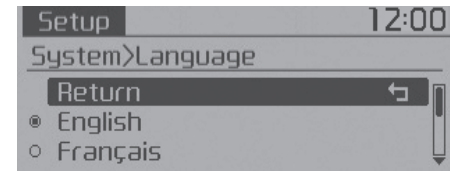

- \* The system will reboot after the language is changed.
- \* Language support by region
  - English, Francais, Espanol

### RADIO : FM, AM OR SIRIUS XM®

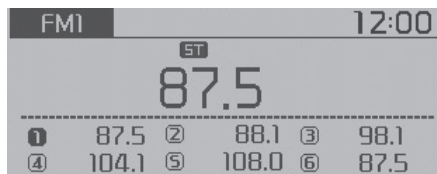



### SEEK

Press the  key

- Briefly pressing the key (under 0.8 seconds): Automatically searches for the next station.
- Pressing and holding the key (over 0.8 seconds): While holding the key, frequency changes without stopping. When the key is released, automatically searches for the next frequency from that point.



### Preset SEEK

Press the  ~  key

- Briefly pressing the key (under 0.8 seconds): Plays the frequency saved in the corresponding key.
- Pressing and holding the key (over 0.8 seconds): Pressing and holding the desired key from  ~  will save the currently playing broadcast to the selected key and sound a BEEP.

### SCAN

Press the  key

- Briefly pressing the key (under 0.8 seconds): The broadcast frequency increases and previews each broadcast for 5 seconds each. After scanning all frequencies, returns and plays the current broadcast frequency.
- Pressing and holding the key (over 0.8 seconds): Previews the broadcasts saved in Preset  ~  for 5 seconds each.

### Selecting through manual search

Turn the  TUNE knob left/right to adjust the frequency.

- FM : Changes by 200KHz
- AM : Changes by 10KHz

## MENU

Within **MENU** key are the A.Store (Auto Store) and Info functions.



### 1 A.Store

Press the **MENU** key ▶ Set [A.Store] through **TUNE** knob or **1** key.

Saves broadcasts with superior reception to **1** ~ **6** keys. If no frequencies are received, then the most recently received frequency will be broadcast.

## SiriusXM® Satellite Radio information

### Satellite Radio channels:

Enjoy SiriusXM Satellite Radio with a 3-month trial subscription to the Sirius Select package. You'll get over 140 channels, including commercial-free music, plus all your favorite sports, exclusive talk, entertainment, and a selection of premium programming. For more information and a complete list of SiriusXM channels, visit [siriusxm.com](http://siriusxm.com) in the United States, [siriusxm.ca](http://siriusxm.ca) in Canada, or call SiriusXM at 1-888-539-7474.

### Satellite Radio reception factors:

To receive the satellite signal, your vehicle has been equipped with a satellite radio antenna located on the roof of your vehicle. The vehicle roof provides the best location for an unobstructed, open view of the sky, a requirement of a satellite radio system. Like AM/FM, there are several factors that can affect satellite radio reception performance:

- Antenna obstructions: For optimal reception performance, keep the antenna clear of snow and ice build-up and keep luggage and other material as far away from the antenna as possible.

- Terrain: Hills, mountains, tall buildings, bridges, tunnels, freeway overpasses, parking garages, dense tree foliage and thunderstorms can interfere with your reception.

### SiriusXM Satellite Radio service:

SiriusXM is a subscription-based satellite radio service that broadcasts music, sports, news and entertainment programming to radio receivers, which are available for installation in motor vehicles or factory installed, as well as for the home, portable and wireless devices, and through an Internet connection on personal computer.

Vehicles that are equipped with a factory installed SiriusXM Satellite Radio system include:

- Hardware and an introductory trial subscription term, which begins on the date of sale or lease of the vehicle.
- For a small upgrade fee, access to SiriusXM music channels, and other select channels over the Internet using any computer connected to the Internet (U.S. customers only).

For information on extended subscription terms, contact SiriusXM at 1-888-539-7474.

### NOTE:

**SiriusXM services require a subscription sold separately, or as a package, by Sirius XM Radio Inc. If you decide to continue service after your trial, the subscription plan you choose will automatically renew thereafter and you will be charged according to your chosen payment method at then-current rates. Fees and taxes apply. To cancel you must call SiriusXM at 1-866-635-2349. See SiriusXM Customer Agreement for complete terms at [www.siriusxm.com](http://www.siriusxm.com). SiriusXM U.S. satellite and data services are available only in the 48 contiguous USA, DC and PR (with coverage limitations). SiriusXM satellite service is also available in Canada; see [www.siriusxm.ca](http://www.siriusxm.ca). All fees and programming subject to change. Sirius, XM and all related marks and logos are trademarks of Sirius XM Radio Inc. Sirius, XM and all related marks and logos are trademarks of Sirius XM Radio Inc.**



## SiriusXM RADIO

### Using SiriusXM Satellite Radio

Your Kia vehicle is equipped with a 3-month trial subscription to SiriusXM so you have access to over 140 channels of music, information, and entertainment programming.

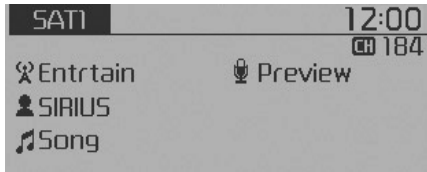

### Activation

In order to extend or reactivate your Sirius Select subscription, you will need to contact SiriusXM Customer Care at 1-800-643-2112. Have your 12-digit RID (Radio Identification Number) / ESN (Electronic Serial Number) ready. To retrieve the RID / ESN, turn on the radio, press the **RADIO** key, and tune to channel zero.

Please note that the vehicle will need to be turned on, in Sirius mode, and have an unobstructed view of the sky in order for the radio to receive the activation signal.

### SEEK

Press the **SEEK TRACK** key ▶

- Shortly pressing the key (under 0.8 seconds): select previous or next channel.
- Pressing and holding the key (over 0.8 seconds): continuously move to previous or next channel.
- \* If the “Category” icon is displayed, channels are changed within the current category.

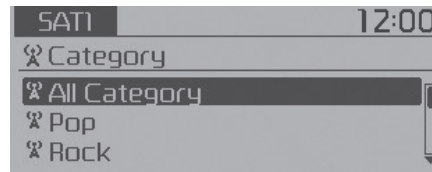

### SCAN

Press the **SCAN** key ▶

- Shortly pressing the key (under 0.8 seconds): Previews each broadcast for 10 seconds each
- \* Press the **SCAN** key again to continue listening to the current frequency
- \* If the “Category” icon is displayed, channels are changed within the current category.

### Category

Press the **CAT FOLDER** key ▶ Set through the **TUNE** knob

- The display will indicate the category menus, highlight the category that the current channel belongs to.
- In the Category List Mode, press the **CAT FOLDER** key to navigate category list.
- Press the tune knob to select the lowest channel in the highlighted category.
- \* If channel is selected by selecting category, then the “CATEGORY” icon is displayed at the top of the screen.

### Preset

Press the **RADIO** key ▶ **1** ~ **6**

- Briefly pressing the key (under 0.8 seconds): Plays the frequency saved in the corresponding key.
- Pressing and holding the key (over 0.8 seconds): Pressing and holding the desired key from **1** ~ **6** will save the current broadcast to the selected key and sound a BEEP.

### \* Troubleshooting

#### 1. Antenna Error

If this message is displayed, the antenna or antenna cable is broken or unplugged. Please consult with your Kia dealership.

#### 2. Acquiring Signal

If this message is displayed, it means that the antenna is covered and that the SIRIUS™ Satellite Radio signal is not available. Ensure the antenna is uncovered and has a clear view of the sky.

### Tune

- Rotate **TUNE** knob : Changes the channel number or scrolls category list.
- Press **TUNE** knob : Selects the menu.

### Menu

Select category menu through the **TUNE** knob ▶ Press the **MENU** key  
▶ Select [**Info**] through the **TUNE** knob or **1 RPT** key

### Info (Information)

Displays the Artist/Song info of the current song.

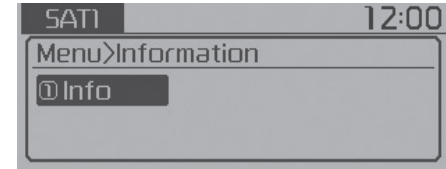

## BASIC METHOD OF USE : USB / iPod® / My Music

Press the **MEDIA** key to change the mod mode in order of USB(iPod®) → AUX → My Music → BT Audio.

The folder/file name is displayed on the screen.



<USB>



<My Music>

\* The USB music is automatically played when a USB is connected.

### Repeat

While song (file) is playing ▶ **1 RPT** (RPT) key

USB, iPod®, My Music mode: RPT on screen

- To repeat one song (press the key) : Repeats the current song.

USB mode: FLD.RPT on screen

- To repeat folder (pressing twice): repeats all files within the current folder.

\* Press the **1 RPT** key again to turn off repeat.

### Random

While song (file) is playing ▶ **2 RDM** (RDM) key

My Music mode: RDM on screen

- Random (press the key) : Plays all songs in random order.

USB mode: FLD.RDM on screen

- Folder Random (press the key) : Plays all files within the current folder in random order.

iPod® mode: ALL RDM on screen

- All Random (press the key) : Plays all files in random order.

USB : ALL RDM on screen

- All Random (pressing twice): Plays all files in random order.

\* Press the **2 RDM** key again to turn off random.

### Changing Song/File

While song (file) is playing ▶  
SEEK TRACK key

- Shortly pressing the key : Plays the current song from the beginning.
- \* If the SEEK TRACK key is pressed again within 2 second, the previous song is played.
- Pressing and holding the key (over 0.8 seconds): Rewinds the song.

While song (file) is playing ▶  
SEEK TRACK key

- Shortly pressing the key : Plays the next song.
- Pressing and holding the key (over 0.8 seconds) : Fast forwards the song.

### Scan

While song (file) is playing ▶ SCAN key

- Shortly pressing the key : Scans all songs from the next song for 10 seconds each.
- \* Press the SCAN key again to turn off.
- \* The SCAN function is not supported in iPod® mode.

### Folder Search : USB Mode

While file is playing ▶ CAT FOLDER key  
(Folder Up) key

- Searches the next folder.

While file is playing ▶ CAT FOLDER key  
(Folder Down) key

- Searches the parent folder.
- \* If a folder is selected by pressing the TUNE knob, the first file within the selected folder will be played.
- \* In iPod® mode, moves to the Parent Folder.

### Searching Songs (File)

- Turning TUNE knob : Searches for songs (files)
- Pressing TUNE knob : Plays selected song (file).

## MENU : USB

Press the USB mode **MENU** key to set the Repeat, Folder Random, Folder Repeat, All Random, Information, and Copy features.



### Repeat

Press the **MENU** key ▶ Set [**1**RPT] through the **TUNE** knob or **1 RPT** key to repeat the current song.

\* Press RPT again to turn off.

### Folder Random

Press the **MENU** key ▶ Set [**2**F.RDM] through the **TUNE** knob or **2 RDM** key to randomly play songs within the current folder.

\* Press F.RDM again to turn off.

### Folder Repeat

Press the **MENU** key ▶ Set [**3**F.RPT] through the **TUNE** knob or **3** key to repeat songs within the current folder.

\* Press F.RPT again to turn off.

### All Random

Press the **MENU** key ▶ Set [**4**A.RDM] through the **TUNE** knob or **4** key to randomly play all songs within the USB.

\* Press A.RDM again to turn off.

### Information

Press the **MENU** key ▶ Set [**5**Info] through the **TUNE** knob or **5** key to display information of the current song.

\* Press the **MENU** key to turn off info display.

### Copy

Press the **MENU** key ▶ Set [**6**Copy] through the **TUNE** knob or **6** key.

This is used to copy the current song into My Music. You can play the copied Music in My Music mode.

- \* If another key is pressed while copying is in progress, a pop up asking you whether to cancel copying is displayed.
- \* If another media is connected or inserted (USB, iPod®, AUX) while copying is in progress, copying is canceled.
- \* Music will not be played while copying is in progress.

### MENU : iPod®

In iPod® mode, press the **MENU** key to set the Repeat, Random, Information and Search features.

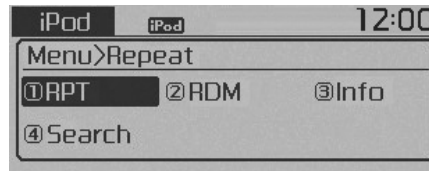

### Repeat

Press the **MENU** key ▶ Set [**1**RPT] through the **TUNE** knob or **1 RPT** key to repeat the current song.

- \* Press RPT again to turn repeat off.

### Random

Press the **MENU** key ▶ Set [**2**RDM] through the **TUNE** knob or **2 RDM** key.

Plays all songs within the currently playing category in random order.

- \* Press RDM again to turn off.

### Information

Press the **MENU** key ▶ Set [**3**Info] through the **TUNE** knob or **3** key.

Displays information of the current song.

- \* Press the **MENU** key to turn off info display.

### Search

Press the **MENU** key ▶ Set [**4**Search] through the **TUNE** knob or **4** key.

Displays iPod® category list.

- \* Searching iPod® category is **MENU** key pressed, move to parent category.

## MENU : My Music Mode

In My Music mode, press the **MENU** key to set the Repeat, Random, Information, Delete, Delete All, and Delete Selection features.



### Repeat

Press the **MENU** key ▶ Set [**1**RPT] through the **TUNE** knob or **1 RPT** key.

Repeats the currently playing song.

\* Press RPT again to turn repeat off.

### Random

Press the **MENU** key ▶ Set [**2**RDM] through the **TUNE** knob or **2 RDM** key.

Plays all songs in random order.

\* Press RDM again to turn random off.

### Information

Press the **MENU** key ▶ Set [**3**Info] through the **TUNE** knob or **3** key.

Displays information of the current song.

\* Press the **MENU** key to turn off info display.

### Delete

Press the **MENU** key ▶ Set [**4**Delete] through the **TUNE** knob or **4** key.

• Deletes currently playing file

In the play screen, pressing delete will delete the currently playing song.

• Deletes file from list



① Select the file you wish to delete by using the **TUNE** knob.

② Press the **MENU** key and select the delete menu to delete the selected file.

### Delete All

Press the **MENU** key ▶ Set [**5**Del.All] through the **TUNE** knob or **5** key.

Deletes all songs of My Music.

### Delete Selection

Press the **MENU** key ▶ Set [6]Del.Sel] through the **TUNE** knob or **6** key.

Songs within My Music are selected and deleted.

- ① Select the songs you wish to delete from the list.

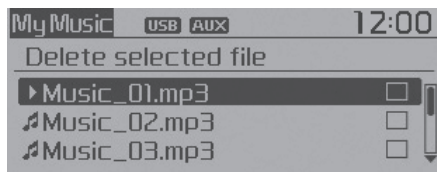

- ② After selecting, press **MENU** key and select the delete menu.



### My Music

- Even if memory is available, a maximum of 6,000 songs can be stored.
- The same song can be copied up to 1,000 times.
- Memory info can be checked in the System menu of Setup.

### AUX

AUX is used to play external MEDIA currently connected with the AUX terminal.

AUX mode will automatically start when an external device is connected with the AUX terminal.

If an external device is connected, you can also press the **MEDIA** key to change to AUX mode.



\* AUX mode cannot be started unless there is an external device connected to the AUX terminal.

### AUX

Fully insert the AUX cable into the AUX terminal for use.



## **Bluetooth® Wireless Technology AUDIO (if equipped)**

### **What is Bluetooth® Wireless Technology?**





Bluetooth® Wireless Technology allows devices to be connected in a short distance, including hands-free devices, stereo headsets, wireless remote controllers, etc. For more information, visit the *Bluetooth®* Wireless Technology website at [www.Bluetooth.com](http://www.Bluetooth.com)

Before using *Bluetooth®* Wireless Technology audio features

- *Bluetooth®* Wireless Technology audio may not be supported depending on the compatibility of your *Bluetooth®* Wireless Technology mobile phone.
- In order to use *Bluetooth®* Wireless Technology audio, you must first pair and connect the *Bluetooth®* Wireless Technology mobile phone.
- The *Bluetooth®* word mark and logos are registered trademarks owned by Bluetooth SIG, Inc. and any use of such marks by Kia is under license. Other trademarks and trade names are those of their respective owners. A *Bluetooth®* enabled cell phone is required to use *Bluetooth®* Wireless Technology

### **⚠ WARNING**

**Driving while distracted can result in a loss of vehicle control that may lead to an accident, severe personal injury, and death. The driver's primary responsibility is in the safe and legal operation of a vehicle, and use of any handheld devices, other equipment, or vehicle systems which take the driver's eyes, attention and focus away from the safe operation of a vehicle or which are not permissible by law should never be used during operation of the vehicle.**

- *Bluetooth*<sup>®</sup> Wireless Technology audio can be used only when the [Audio Streaming] of Phone is turned .
- \* Setting *Bluetooth*<sup>®</sup> Wireless Technology Audio Streaming : Press the  key ▶ Select [Phone] ▶ Select [Audio Streaming] through the  ▶ Set  / .



### Starting *Bluetooth*<sup>®</sup> Wireless Technology Audio

- Press the  key to change the mode in order of USB→AUX →My Music→BT Audio.
- If BT Audio is selected, *Bluetooth*<sup>®</sup> Wireless Technology audio will start playing.
- \* Audio may not automatically start playing in some mobile phones.

### Using the *Bluetooth*<sup>®</sup> Wireless Technology audio features

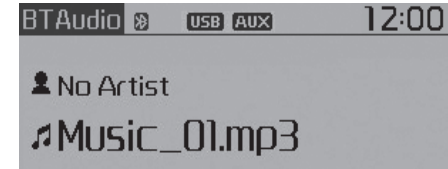
- Play / Stop  
Press the  TUNE knob to play and pause the current song.



- \* The title / artist info may not be supported in some mobile phone. When it is not supported, no title/no artist will be displayed.
- Previous / Next song  
Press  or  to play previous or next song.
- \* The previous song / next song / play / pause functions may not be supported in some mobile phones.

## PHONE(IF EQUIPPED)

Before using the *Bluetooth*® Wireless Technology phone features

- In order to use *Bluetooth*® Wireless Technology phone, you must first pair and connect the *Bluetooth*® Wireless Technology mobile phone.
- If the mobile phone is not paired or connected, it is not possible to enter Phone mode. Once a phone is paired or connected, the guidance screen will be displayed.
- If Priority is set upon vehicle ignition (IGN/ACC ON), the *Bluetooth*® Wireless Technology phone will be automatically connected. Even if you are outside, the *Bluetooth*® Wireless Technology phone will be automatically connected once you are in the vicinity of the vehicle. If you do not want automatic *Bluetooth*® Wireless Technology phone connection, set the *Bluetooth*® Wireless Technology power to OFF

## Making a call using the Steering-wheel mounted controls

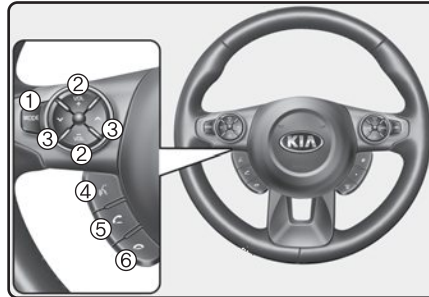



- (1) **MODE** button : Mode changes each time the button pressed.
- (2) **VOLUME** button : Raises or lowers speaker volume.
- (3) **▼ / ▲** button :

### RADIO mode

- Briefly press the key: Move to next or previous preset channel.
- Press and hold the key: Automatically searches for broadcast frequencies.

## USB, iPod, My Music Modes

- Briefly press the key: Move to next or previous song.
  - Press and hold the key: Rewinds or fast-forwards the current song.
- (4) **🗣️** button : Activates voice recognition.
  - (5) **📞** button : Places and transfers calls.
  - (6) **📞** button : Ends calls or cancels functions.

- Check call history and making call
  - ① Briefly press (under 0.8 seconds) the  key on the steering remote controller.
  - ② The call history list will be displayed on the screen.
  - ③ Press the  key again to connect a call to the selected number.
- Redialing the most recently called number
  - ① Press and hold (over 0.8 seconds) the  key on the steering remote controller.
  - ② The most recently called number is redialed.

### **Bluetooth® Wireless Technology**

#### **Pairing a Bluetooth® Wireless Technology Device(if equipped)**

##### *What is Bluetooth® Wireless Technology Pairing?*

Pairing refers to the process of synchronizing your *Bluetooth®* Wireless Technology phone or device with the car audio system for connection. Pairing is necessary to connect and use the *Bluetooth®* Wireless Technology feature.

The *Bluetooth®* word mark and logos are registered trademarks owned by Bluetooth SIG, Inc. and any use of such marks by Kia is under license. Other trademarks and trade names are those of their respective owners. A *Bluetooth®* enabled cell phone is required to use *Bluetooth®* Wireless Technology

#### **⚠ WARNING**

**Driving while distracted can result in a loss of vehicle control that may lead to an accident, severe personal injury, and death. The driver's primary responsibility is in the safe and legal operation of a vehicle, and use of any handheld devices, other equipment, or vehicle systems which take the driver's eyes, attention and focus away from the safe operation of a vehicle or which are not permissible by law should never be used during operation of the vehicle.**

## Pairing **PHONE** Key / Key on the Steering Remote Controller

### When No Devices have been Paired

1. Press the **PHONE** key or the  key on the steering remote controller.



2. Select [OK] button to enter the Pair Phone screen.

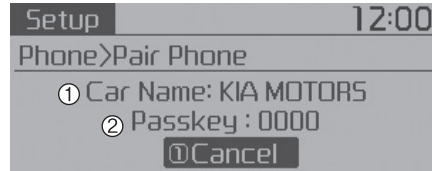

1) Car Name : Name of device as shown when searching from your *Bluetooth*<sup>®</sup> Wireless Technology device

2) Passkey : Passkey used to pair the device

3. From your *Bluetooth*<sup>®</sup> Wireless Technology device (i.e. Mobile Phone), search and select your car audio system.

[Non SSP supported device]  
(SSP: Secure Simple Pairing)

4. After a few moments, a screen is displayed where the passkey is entered. Enter the passkey "0000" to pair your *Bluetooth*<sup>®</sup> Wireless Technology device with the car audio system.

[SSP supported device]

4. After a few moments, a screen is displayed 6 digits passkey. Check the passkey on your *Bluetooth*<sup>®</sup> Wireless Technology device and confirm.





5. Once pairing is complete, the following screen is displayed.

## Features of your vehicle

---

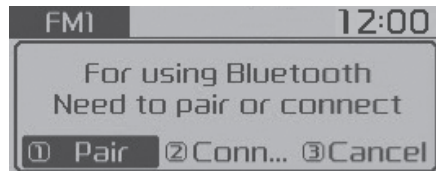
During the pairing process, make sure that all connection requests on the phone are accepted for phonebook download and to allow acceptance of all future connection requests. " and "Visit <http://www.kia.com/us/en/content/owners/bluetooth> for additional information on pairing your Bluetooth-enabled mobile phone, and to view a phone compatibility list.



- If *Bluetooth*® Wireless Technology devices are paired but none are currently connected, pressing the **PHONE** key or the  key on the steering wheel displays the following screen. Select [Pair] button to pair a new device or select [Connect] to connect a previously paired device.

## Pairing through [PHONE] Setup

Press the **SETUP** **CLOCK** key ▶ Select [Phone] ▶ Select [Pair Phone] ▶ Select **TUNE** knob

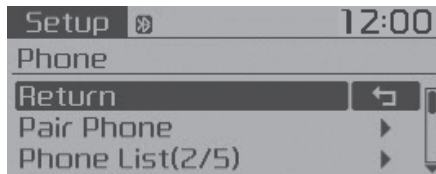

1. The following steps are the same as those described in the section "When No Devices have been Paired" on the previous page.

- *Bluetooth*® Wireless Technology features supported within the vehicle are as follows. Some features may not be supported depending on your *Bluetooth*® Wireless Technology device.
  - Outgoing/Incoming Handsfree calls
  - Operations during a call (Switch to Private, Switch to call waiting, MIC on/off)
  - Downloading Call History
  - Downloading Mobile Contacts
  - *Bluetooth*® Wireless Technology device auto connection
  - Bluetooth Audio Streaming
- Up to five *Bluetooth*® Wireless Technology devices can be paired to the Car Handsfree system.
- Only one *Bluetooth*® Wireless Technology device can be connected at a time.
- Other devices cannot be paired while a *Bluetooth*® Wireless Technology device is connected.
- Only *Bluetooth*® Wireless Technology Handsfree and Bluetooth audio related features are supported.
- Bluetooth related operations are possible only within devices that support Handsfree or audio features, such as a *Bluetooth*® Wireless Technology mobile phone or a Bluetooth audio device.
- If a connected *Bluetooth*® Wireless Technology device becomes disconnected due to being out of communication range, turning the device OFF, or a *Bluetooth*® Wireless Technology communication error, corresponding *Bluetooth*® Wireless Technology devices are automatically searched and reconnected.
- If the system becomes unstable due to communication errors between the car Handsfree and the *Bluetooth*® Wireless Technology device, reset the device by turning off and back on again. Upon resetting *Bluetooth*® Wireless Technology device, the system will be restored.

- After pairing is complete, a contacts download request is sent once to the mobile phone. Some mobile phones may require confirmation upon receiving a download request, ensure your mobile phone accepts the connection. Refer to your phones user's manual for additional information regarding phone pairing and connections.

### Connecting a Device

Press the **SETUP** CLOCK key ▶ Select [Phone] ▶ Select [Phone List]



- 1) Connected Phone : Device that is currently connected
- 2) Paired Phone : Device that is paired but not connected

From the paired phone list, select the device you want to connect and select [Connect].

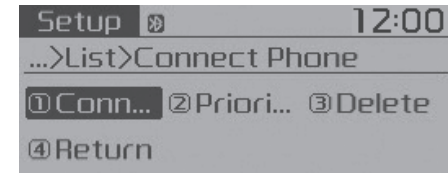



## Changing Priority

### What is Priority?

It is possible to pair up to five *Bluetooth®* Wireless Technology devices with the car audio system. The "Change Priority" feature is used to set the connection priority of paired phones.

Press the **SETUP** CLOCK key ▶ Select [Phone] ▶ Select [Phone List]



From the paired phone list, select the phone you want to switch to the highest priority, then select [Change Priority] button from the Menu. The selected device will be changed to the highest priority.

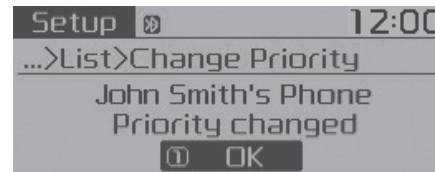
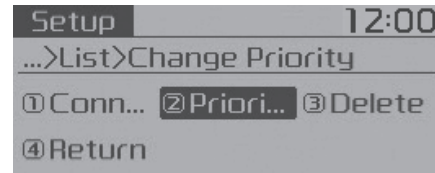

- Priority icon will be displayed when the selected phone is set as a priority phone.



### Disconnecting a Device

Press the **SETUP** CLOCK key ▶ Select [Phone] ▶ Select [Phone List]



From the paired phone list, select the currently connected device and select [Disconnect] button.



### Deleting a Device

Press the **SETUP** CLOCK key ▶ Select [Phone] ▶ Select [Phone List]



From the paired phone list, select the device you want to delete and select [Delete] button.

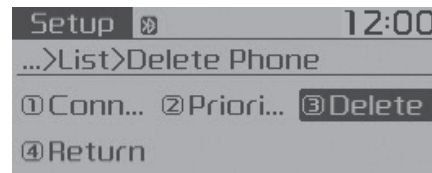

- When deleting the currently connected device, the device will automatically be disconnected to proceed with the deleting process.
- If a paired *Bluetooth*® Wireless Technology device is deleted, the device's call history and contacts data will also be deleted.
- To re-use a deleted device, you must pair the device again.

## USING *Bluetooth*® Wireless Technology(if equipped)

### Phone Menu Screen

#### *Phone Menus*

With a *Bluetooth*® Wireless Technology device connected, press the **PHONE** key to display the Phone menu screen.



- 1) Favorite : Up to 20 frequently used contacts saved for easy access.
- 2) Call History : Displays the call history list screen
- 3) Contacts : Displays the Contacts list screen
- 4) Setup : Displays Phone related settings.

- If you select the [Call History] button but there is no call history data, a prompt is displayed which asks to download call history data.
- If you select the [Contacts] button but there is no contacts data stored, a prompt is displayed which asks to download contacts data.
- This feature may not be supported in some mobile phones. For more information on download support, refer to your mobile phone user's manual.

### Answering Calls

#### *Answering a Call*

Answering a call with a *Bluetooth*® Wireless Technology device connected will display the following screen.

To accept the call, press  key on the steering wheel while the call is incoming.

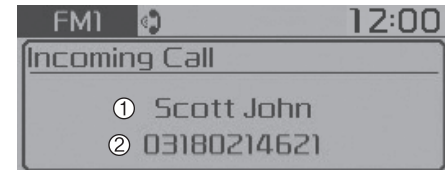

- 1) Caller : Displays the other caller's name when the incoming caller is saved within your contacts
- 2) Incoming Number : Displays the incoming number

- When an incoming call pop-up is displayed, most Audio and SETUP mode features are disabled. Only the call volume will operate.
- The telephone number may not be properly displayed in some mobile phones.
- When a call is answered with the mobile phone, the call mode will automatically revert to Private mode.

### Favorites

Press the **PHONE** key ▶ Select [Favorites]



- 1) Saved favorite contact : Connects call upon selection
  - 2) To add favorite : Downloaded contacts be saved as favorite.
- To save Favorite, contacts should be downloaded.
  - Contact saved in Favorites will not be automatically updated if the contact has been updated in the phone. To update Favorites, delete the Favorite and create a new Favorite.

### Call History

Press the **PHONE** key ▶ Select [Call History]



A list of incoming, outgoing and missed calls is displayed.

- Call history may not be saved in the call history list in some mobile phones.
- Calls received with hidden caller ID will not be saved in the call history list.
- Calling through the call history is not possible when there is no call history stored or a *Bluetooth*® Wireless Technology phone is not connected.
- Up to 50 received, dialed and missed calls are stored in Call History.
- Time of received/dialed calls and call time information are not stored in Call History.

## Contacts

Press the **PHONE** key ▶ Select [Contacts]

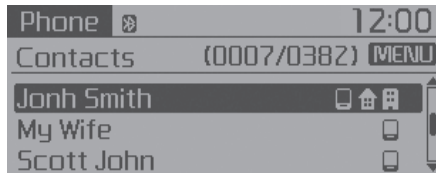

The list of saved phone book entries is displayed.

### NOTE:

Find a contact in an alphabetical order, press the **MENU** key.

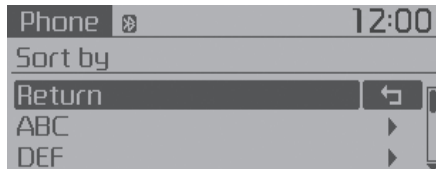

- Up to 1,000 contacts saved in your *Bluetooth*® Wireless Technology phone can be downloaded into the car contacts. Contacts that have been downloaded to the car cannot be edited or deleted on the phone.
- Mobile phone contacts are managed separately for each paired *Bluetooth*® Wireless Technology device (max 5 devices x 1,000 contacts each). Previously downloaded data is maintained even if the *Bluetooth*® Wireless Technology device has been disconnected. (However, the contacts and call history saved to the phone will be deleted if a paired phone is deleted.)
- It is possible to download contacts during Bluetooth streaming audio.
- When downloading contacts, the icon will be displayed within the status bar.
- It is not possible to begin downloading a contact list when the contact download feature has been turned off within the *Bluetooth*® Wireless Technology device. In addition, some devices may require device authorization upon attempting to download contacts. If downloading does not normally occur, check the *Bluetooth*® Wireless Technology device settings or the screen state.
- The contacts download feature may not be supported in some mobile phones. For more information of supported *Bluetooth*® devices and function support, refer to your phone's user manual.

## Bluetooth® Wireless Technology Setting

The *Bluetooth*® word mark and logos are registered trademarks owned by Bluetooth SIG, Inc. and any use of such marks by Kia is under license. Other trademarks and trade names are those of their respective owners. A *Bluetooth*® enabled cell phone is required to use *Bluetooth*® Wireless Technology.

### **⚠ WARNING**

**Driving while distracted can result in a loss of vehicle control that may lead to an accident, severe personal injury, and death. The driver's primary responsibility is in the safe and legal operation of a vehicle, and use of any handheld devices, other equipment, or vehicle systems which take the driver's eyes, attention and focus away from the safe operation of a vehicle or which are not permissible by law should never be used during operation of the vehicle.**

### Pairing a New Device

Press the **SETUP** CLOCK key ▶ Select [Phone] ▶ Select [Pair Phone]

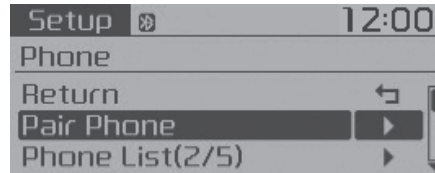

*Bluetooth*® Wireless Technology devices can be paired with the audio system.

For more information, refer to the “Pairing through Phone Setup” section within *Bluetooth*® Wireless Technology.

### Viewing Paired Phone List

Press the **SETUP** CLOCK key ▶ Select [Phone] ▶ Select [Phone List]

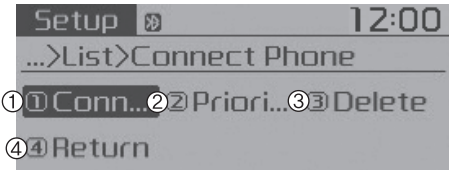

This feature is used to view mobile phones that have been paired with the audio system. Upon selecting a paired phone, the setup menu is displayed.

For more information, refer to the “Setting *Bluetooth*® Wireless Technology Connection” section within *Bluetooth*® Wireless Technology.

- 1) Connect/Disconnect Phone : Connect/ disconnects currently selected phone
- 2) Change Priority : Sets currently selected phone to highest connection priority
- 3) Delete : Deletes the currently selected phone
- 4) Return : Moves to the previous screen

- To learn more about whether your mobile phone supports contacts downloads, refer to your mobile phone user's manual.
- The contacts for only the connect-ed phone can be downloaded

### Downloading Contacts

Press the **SETUP** **CLOCK** key ▶ Select [Phone] ▶ Select [Contacts Download]



As the contacts are downloaded from the mobile phone, a download progress bar is displayed.

- Upon downloading phone contacts, the previous corresponding data is deleted.
- This feature may not be supported in some mobile phones.
- Voice Recognition may not operate while contacts are being downloaded.

### Outgoing Volume

Press the **SETUP** **CLOCK** key ▶ Select [Phone] ▶ Select [Outgoing Volume]

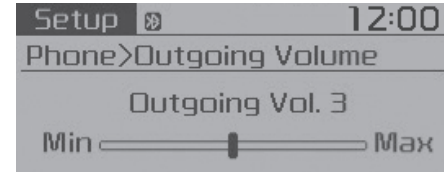

Use **TUNE** knob to adjust the outgoing volume level.

- While on a call, the volume can be changed by using the **SEEK** **TRACK** key.

### **Turning Bluetooth System Off**

Press the **SETUP**  
**CLOCK** key ▶ Select [Phone] ▶ Select [Bluetooth System Off]

Once *Bluetooth*® Wireless Technology is turned off, *Bluetooth*® Wireless Technology related features will not be supported within the audio system.

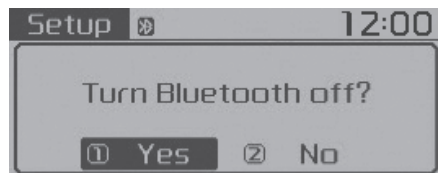
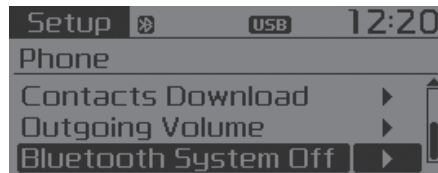

- To turn *Bluetooth*® Wireless Technology back on, go to **SETUP**  
**CLOCK** ▶ [Phone] and select “Yes”.



## VOICE RECOGNITION

### Using Voice Recognition

#### *Starting Voice Recognition*

Shortly press the  key on the steering wheel. Say a command



If prompt feedback is in [ON], then the system will say "Please say a command after the beep (BEEP)"

- If prompt feedback is in [OFF] mode, then the system will only say "(BEEP)"
- To change Prompt Feedback [On]/[Off], go to  ▶ [System] ▶ [Prompt Feedback]
- For proper recognition, say the command after the voice instruction and beep tone.

#### *Skipping Prompt Messages*

While prompt message is being stated ▶ Shortly press the  key on the steering remote controller

The prompt message is immediately ended and the beep tone will sound. After the "beep", say the voice command.

#### *Re-starting Voice Recognition*

While system waits for a command ▶ Shortly press the  key on the steering remote controller

The command wait state is immediately ended and the beep tone will sound. After the "beep", say the voice command.

### ENDING VOICE RECOGNITION

While Voice Recognition is operating  
▶ Press and hold the  key on the steering remote controller

- While using voice command, pressing any steering wheel control or a different key will end voice command.
- When the system is waiting for a voice command, say “cancel” or “end” to end voice command.
- When the system is waiting for a voice command, press and hold the  key on the steering wheel to end voice command.

### Voice Recognition and Phone Contact Tips:

The Kia Voice Recognition System may have difficulty understanding some accents or uncommon names. When using Voice Recognition to place a call, speak in a moderate tone, with clear pronunciation

To maximize the use of Voice Recognition, consider these guidelines when storing contacts:

- Do not store single-name entries (e.g., “Bob”, “Mom”, etc.). Instead, always use full names (including first and last names) for these contacts
- Do not use special characters (e.g., '@', '-', '\*', '&', etc.)
- Do not use abbreviations (i.e., use “Lieutenant” instead of “Lt.”) or acronyms (i.e., use “County Finance Department” instead of “C. F. D.”; Be sure to say the name exactly as it is entered in the contacts list

- Do not use acronyms (i.e., use “County Finance Department” instead of “CFD”).
- If a name is not recognized from the contact list, change it to a more descriptive name (e.g., use “Grandpa Joseph” instead of “Pa Joe”).

**Illustration on using voice commands**

• Starting voice command.

Shortly pressing the  key (under 0.8 seconds):

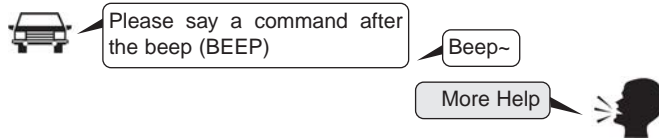



**More Help**  
 Here are some examples of mode commands. You can say a radio type like 'FM', 'AM', or 'Satellite'. You can also say a media source like 'USB', 'My Music', or 'iPod'. Additionally, there are phone commands like 'Contacts', 'Call History', or 'Dial Number'. You can find more detailed commands in the user's manual. Please say a command after the beep.

**More Help**  
 Here are some examples of mode commands. You can say a radio type like 'FM', 'AM', or 'Satellite'. You can also say a media source like 'USB', 'My Music', or 'iPod'. Additionally, there are phone commands like 'Contacts', 'Call History', or 'Dial Number'. You can find more detailed commands in the user's manual. Please say a command after the beep.

• Skipping Prompt Messages

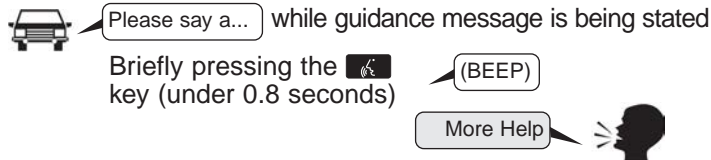
Briefly pressing the  key (under 0.8 seconds):



Briefly pressing the  key (under 0.8 seconds)

• End voice command.

Briefly pressing the  key (under 0.8 seconds):

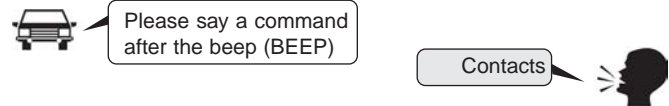

**Contacts.**  
 Please say the name of the contact you want to call.



**Beep Beep.. (end beep)**

### Voice Command List

- **Common Commands:** These commands can be used in most operations. (However a few commands may not be available during certain operations)

Command	Function
More Help	Provides guidance on commands that can be used anywhere in the system.
Help	Provides guidance on commands that can be used within the current mode.
Call<Name>	Calls <Name> saved in Contacts Ex) Call "John Smith"
Call <Name> on Mobile	Calls <Name> to the number that is saved as "Mobile" in Contacts Ex) Call "John Smith" on Mobile
Call <Name> in Office	Calls <Name> to the number that is saved as "Office" in Contacts Ex) Call "John Smith" in Office
Call <Name> at Home	Calls <Name> to the number that is saved as "Home" in Contacts Ex) Call "John Smith" at Home
Call <Name> on Other	Calls <Name> to the number that is saved as "Other" in Contacts Ex) Call "John Smith" on Other
Phone	Provides guidance on Phone related commands. After saying this command, say "Favorites", "Call History", "Contacts" or "Dial Number" execute corresponding functions.
Favorites	Display the Favorite screen.
Call History	Displays the Call History screen.

Command	Function
Contacts	Displays the Contacts screen. After saying this command, say the name of a contact saved in the Contacts to automatically connect the call.
Dial Number	Display the Dial number screen. After saying this command, you can say the number that you want to call.
Redial	Connects the most recently called number.
Tutorial	Provide guidance on how to use voice recognition and Bluetooth® connections
Radio	<ul style="list-style-type: none"> <li>• When listening to the radio, displays the next radio screen. (FM1→FM2→AM→SAT1→SAT2→SAT3→FM1)</li> <li>• When listening to a different mode, displays the most recently played radio screen.</li> <li>• When currently listening to the FM radio, maintains the current state.</li> <li>• When listening to a different mode, displays the most recently played FM screen.</li> </ul>
FM1(FM One)	Displays the FM1 screen.
FM2(FM Two)	Displays the FM2 screen.
AM	Displays the AM screen.

Command	Function
FM Preset 1~6	Plays the most recently played broadcast saved in FM Preset 1~6.
AM Preset 1~6	Plays the broadcast saved in AM Preset 1~6.
FM 87.5~107.9	Plays the FM broadcast of the corresponding frequency.
AM 530~1710	Plays the AM broadcast of the corresponding frequency.
SiriusXM® (Satellite)	<ul style="list-style-type: none"> <li>• When currently listening to the SiriusXM®, maintains the current state.</li> <li>• When listening to a different mode, displays the most recently played SiriusXM® screen.</li> </ul>
SiriusXM® (Satellite) 1~3	Displays the selected SiriusXM® screen.
SiriusXM® Channel 0~223	Plays the selected SiriusXM® channel.
Media	Moves to the most recently played media screen.
USB	Plays USB music.
iPod®	Plays iPod® music.

Command	Function
My Music	Plays the music saved in My Music.
AUX (Auxiliary)	Plays the connected external device.
Bluetooth® Audio	Plays the music saved in connected Bluetooth® device.
Please repeat	Repeats the most recent comment.
Mute	Mutes the sound.
Cancel (Exit)	Ends voice command.

## Features of your vehicle

---

- FM/AM radio commands: Commands available during FM, AM radio operation.

Command	Function
Preset 1~6	Plays the broadcast station saved in Preset 1~6.
Scan	Scans receivable frequencies from the current broadcast and plays for 10 seconds each.
Preset Scan	Moves to the next preset from the current present and plays for 10 seconds each.
Information	Displays the information of the current broadcast. (This feature can be used when receiving RBDS broadcasts.)

- Satellite radio commands: Commands that can be used while listening to Satellite Radio.

Command	Function
Channel 0~223	Plays the selected Satellite Radio channel.
Scan	Scans receivable channels from the current broadcast and plays for 10 seconds each.
Preset 1~6	Plays the broadcast saved in Preset 1~6.
Information	Displays the information of the current broadcast.

- USB commands: Commands available during USB operation.

Command	Function
Random	Randomly plays the files within the current folder.
Random Off	Cancels random play to play files in sequential order.
Repeat	Repeats the current file.
Repeat Off	Cancels repeat play to play files in sequential order.
Information	Displays the information screen of the current file.
Next Folder	Play the first file in the next folder.
Previous Folder	Play the first file in the previous folder.

- iPod® Commands: Commands available during iPod® operation.

Command	Function
Random	Randomly plays the songs within the current category.
Random Off	Cancels random play to play songs in sequential order.
Repeat	Repeats the current song.
Repeat Off	Cancels repeat play to play songs in sequential order.

## Features of your vehicle

---

- **My Music Commands:** Commands available during My Music operation.

<b>Command</b>	<b>Function</b>
Random	Randomly plays all saved files.
Random Off	Cancel random play to play files in sequential order.
Repeat	Repeats the current file.
Repeat Off	Cancel repeat play to play files in sequential order.
Delete	Deletes the current file. You will bypass an additional confirmation process.

- **Bluetooth® Wireless Technology Audio Commands:** Commands available during Bluetooth® Wireless Technology audio streaming from mobile phone operation Command Operation.

<b>Command</b>	<b>Function</b>
Play	Plays the currently paused song.
Pause	Pauses the current song.



iPod® is a registered trademark of Apple Inc. iPod® mobile digital device sold separately. The *Bluetooth*® word mark and logos are registered trademarks owned by Bluetooth SIG, Inc. and any use of such marks by Kia is under license. SiriusXM services require a subscription sold separately, or as a package, by Sirius XM Radio Inc. If you decide to continue service after your trial, the subscription plan you choose will automatically renew thereafter and you will be charged according to your chosen payment method at then-current rates. Fees and taxes apply. To cancel you must call SiriusXM at 1-866-635-2349. See SiriusXM Customer Agreement for complete terms at [www.siriusxm.com](http://www.siriusxm.com) SiriusXM U.S. satellite and data services are available only in the 48 contiguous USA, DC and PR (with coverage limitations). SiriusXM satellite service is also available in Canada; see [www.siriusxm.ca](http://www.siriusxm.ca) All fees and programming subject to change. Sirius, XM and all related marks and logos are trademarks of Sirius XM Radio Inc. Sirius, XM and all related marks and logos are trademarks of Sirius XM Radio Inc. Android™ is a trademark of Google, Inc. BlackBerry is a registered trademark of Research In Motion Limited (RIM). All other marks, channel names and logos are the property of their respective owners. All rights reserved.

### IC

This device complies with Industry Canada's licence-exempt RSSs.

Operation is subject to the following two conditions:

- (1) This device may not cause interference; and
- (2) This device must accept any interference, including interference that may cause undesired operation of the device.

Le présent appareil est conforme aux CNR d'Industrie Canada applicables aux appareils radio exempts de licence. L'exploitation est autorisée aux deux conditions suivantes : (1) l'appareil ne doit pas produire de brouillage, et (2) l'utilisateur de l'appareil doit accepter tout brouillage radioélectrique subi, même si le brouillage est susceptible d'en compromettre le fonctionnement.

# Driving your vehicle

• Be sure the exhaust system does not leak . . . . .	5-3	• Vehicle stability management (VSM) . . . . .	5-33
<b>Before driving . . . . .</b>	<b>5-4</b>	• Hill-start assist control (HAC) . . . . .	5-34
• Before entering vehicle . . . . .	5-4	• Good braking practices. . . . .	5-35
• Necessary inspections . . . . .	5-4	<b>Cruise control system. . . . .</b>	<b>5-37</b>
• Before starting . . . . .	5-5	• Cruise control switch . . . . .	5-38
<b>Key positions . . . . .</b>	<b>5-6</b>	• To set cruise control speed . . . . .	5-38
• Illuminated ignition switch . . . . .	5-6	• To increase cruise control set speed. . . . .	5-39
• Ignition switch position. . . . .	5-6	• To decrease the cruising speed . . . . .	5-39
• Starting the engine . . . . .	5-7	• To temporarily accelerate with the cruise control on . . . . .	5-39
<b>Engine start/stop button . . . . .</b>	<b>5-9</b>	• To cancel cruise control, do one of the following . . .	5-40
• Illuminated engine start/stop button . . . . .	5-9	• To resume cruising speed at more than approximately 20 mph (30 km/h) . . . . .	5-40
• Engine start/stop button position. . . . .	5-9	• To turn cruise control off, do one of the following. . .	5-41
• Starting the engine with a smart key . . . . .	5-11	<b>Active ECO system. . . . .</b>	<b>5-42</b>
<b>Manual transaxle . . . . .</b>	<b>5-14</b>	• Active ECO operation. . . . .	5-42
• Manual transaxle operation . . . . .	5-14	• When Active ECO is activated. . . . .	5-42
• Good driving practices . . . . .	5-16	• Limitation of Active ECO operation . . . . .	5-42
<b>Automatic transaxle . . . . .</b>	<b>5-17</b>	<b>ISG (Idle Stop and Go) system . . . . .</b>	<b>5-43</b>
• Automatic transaxle operation. . . . .	5-17	• Auto stop . . . . .	5-43
• Good driving practices . . . . .	5-22	• Auto start . . . . .	5-44
<b>Brake system. . . . .</b>	<b>5-23</b>	• Condition of ISG system operation . . . . .	5-45
• Power brakes . . . . .	5-23	• ISG system deactivation . . . . .	5-46
• Parking brake - Hand type. . . . .	5-25	• ISG system malfunction . . . . .	5-47
• Anti-lock brake system (ABS) . . . . .	5-27		
• Electronic stability control (ESC) . . . . .	5-29		

Lane departure warning system (LDWS) . . . . .	5-48
Foward collision warning system (FCWS) . . . . .	5-52
Economical operation . . . . .	5-56
Special driving conditions . . . . .	5-58
• Hazardous driving conditions . . . . .	5-58
• Reducing the risk of a rollover . . . . .	5-58
• Rocking the vehicle . . . . .	5-59
• Smooth cornering . . . . .	5-60
• Driving at night . . . . .	5-60
• Driving in the rain . . . . .	5-61
• Driving in flooded areas . . . . .	5-61
• Driving off-road . . . . .	5-62
• Highway driving . . . . .	5-62
Winter driving . . . . .	5-63
• Snowy or icy conditions . . . . .	5-63
• Use high quality ethylene glycol coolant . . . . .	5-64
• Check battery and cables . . . . .	5-64
• Change to "winter weight" oil if necessary . . . . .	5-64
• Check spark plugs and ignition system . . . . .	5-64
• To keep locks from freezing . . . . .	5-64
• Use approved window washer anti-freeze in system . . . . .	5-64
• Don't let your parking brake freeze . . . . .	5-65
• Don't let ice and snow accumulate underneath . . . . .	5-65
• Carry emergency equipment . . . . .	5-65
Trailer Towing . . . . .	5-65
Vehicle load limit . . . . .	5-66
• Tire and loading information label . . . . .	5-66
• Certification label . . . . .	5-70
Vehicle weight glossary . . . . .	5-71
• Base curb weight . . . . .	5-71
• Vehicle curb weight . . . . .	5-71
• Cargo weight . . . . .	5-71
• GAW (Gross axle weight) . . . . .	5-71
• GAWR (Gross axle weight rating) . . . . .	5-71
• GVW (Gross vehicle weight) . . . . .	5-71
• GVWR (Gross vehicle weight rating) . . . . .	5-71

E010000AUN-EU

**Be sure the exhaust system does not leak.**

The exhaust system should be checked whenever the vehicle is raised to change the oil or for any other purpose. If you hear a change in the sound of the exhaust or if you drive over something that strikes the underneath side of the vehicle, have the exhaust system checked as soon as possible by an authorized Kia dealer.

** WARNING - Engine exhaust**

Do not inhale exhaust fumes or leave your engine running in a enclosed area for a prolonged time. Exhaust fumes contain carbon monoxide, a colorless, odorless gas that can cause unconsciousness and death by asphyxiation.

** WARNING - Open tailgate**

Do not drive with the tailgate open. Poisonous exhaust gases can enter the passenger compartment. If you must drive with the tailgate open proceed as follows:

1. Close all windows.
2. Open side vents.
3. Set the air intake control at "Fresh", the air flow control at "Floor" or "Face" and the fan at the highest speed.

## BEFORE DRIVING

### Before entering vehicle

- Be sure that all windows, outside mirror(s), and outside lights are clean.
- Check the condition of the tires.
- Check under the vehicle for any sign of leaks.
- Be sure there are no obstacles behind you if you intend to back up.

### Necessary inspections

Fluid levels, such as engine oil, engine coolant, brake fluid, and washer fluid should be checked on a regular basis, at the exact interval depending on the fluid. Further details are provided in chapter 7, "Maintenance".

### WARNING

**Driving while distracted can result in a loss of vehicle control, that may lead to an accident, severe personal injury, and death. The driver's primary responsibility is in the safe and legal operation of a vehicle, and use of any handheld devices, other equipment, or vehicle systems which take the driver's eyes, attention and focus away from the safe operation of a vehicle or which are not permissible by law should never be used during operation of the vehicle.**

**Before starting**

- Close and lock all doors.
- Position the seat so that all controls are easily reached.
- Buckle your seat belt.
- Adjust the inside and outside rearview mirrors.
- Be sure that all lights work.
- Check all gauges.
- Check the operation of warning lights when the ignition switch is turned to the ON position.
- Release the parking brake and make sure the brake warning light goes out.

For safe operation, be sure you are familiar with your vehicle and its equipment.

**⚠ WARNING - Fire risk**

When you intend to park or stop the vehicle with the engine on, be careful not to depress the accelerator pedal for a long period of time. It may overheat the engine or exhaust system and cause fire.

**⚠ WARNING  
- Check surroundings**

Always check the surrounding areas near your vehicle for people, especially children, before putting a vehicle into D (Drive) or R (Reverse).

**⚠ WARNING - Loose objects**

Securely store items in your vehicle. When you make a sudden stop or turn the steering wheel rapidly, loose objects may drop on the floor and it could interfere with the operation of the foot pedals, possibly causing an accident.

**⚠ WARNING - Driving while intoxicated**

Do not drive while intoxicated. Drinking and driving is dangerous. Even a small amount of alcohol will affect your reflexes, perceptions and judgment.

Driving while under the influence of drugs is as dangerous as or more dangerous than driving drunk.

## KEY POSITIONS (IF EQUIPPED)

### Illuminated ignition switch



Whenever a front door is opened, the ignition switch will illuminate for your convenience, provided the ignition switch is not in the ON position. The light will go off immediately when the ignition switch is turned on. It will also go off after about 30 seconds when the door is closed.

### Ignition switch position

#### LOCK



The steering wheel locks to protect against theft (if equipped). The ignition key can be removed only in the LOCK position.

When turning the ignition switch to the LOCK position, push the key inward at the ACC position and turn the key toward the LOCK position.

#### ACC (Accessory)

The steering wheel is unlocked and electrical accessories are operative.

If difficulty is experienced turning the ignition switch to the ACC position, turn the key while turning the steering wheel right and left to release the tension.

#### ON

The warning lights can be checked before the engine is started. This is the normal running position after the engine is started.

*Do not leave the ignition switch ON if the engine is not running to prevent battery discharge.*



**START**

Turn the ignition switch to the START position to start the engine. The engine will crank until you release the key; then it returns to the ON position. The brake warning light can be checked in this position.

The anti-theft steering column lock (if equipped) is not a substitute for the parking brake. Before leaving the driver's seat, always make sure the shift lever is engaged in 1st gear for the manual transaxle or P (Park) for automatic transaxle, set the parking brake fully and shut the engine off. Unexpected and sudden vehicle movement may occur if these precautions are not taken.

 **WARNING - Ignition switch**

**Never turn the ignition switch to LOCK or ACC while the vehicle is moving. This would result in loss of directional control and braking function, which could cause an accident.**

**Starting the engine** **WARNING - Proper footwear**

**Always wear appropriate shoes when operating your vehicle. Unsuitable shoes (high heels, ski boots, sandals, etc.) may interfere with your ability to use the brake and accelerator pedals.**

1. Make sure the parking brake is applied.
2. **Manual Transaxle** - Depress the clutch pedal fully and shift the transaxle into Neutral. Keep the clutch pedal and brake pedal depressed while turning the ignition switch to the start position.

**Automatic Transaxle** - Place the transaxle shift lever in P (Park). Depress the brake pedal fully.

You can also start the engine when the shift lever is in the N (Neutral) position.

3. Turn the ignition switch to START and hold it there until the engine starts (a maximum of 10 seconds), then release the key.

*It should be started **without depressing the accelerator.***

4. Do not wait for the engine to warm up while the vehicle remains stationary.

Start driving at moderate engine speeds. (Steep accelerating and decelerating should be avoided.)

 **WARNING - Steering wheel**

Never reach for any controls through the steering wheel while the vehicle is in motion. The presence of your hand or arm in this area could cause a loss of vehicle control.

Do not engage the starter for more than 10 seconds. If the engine stalls or fails to start, wait 5 to 10 seconds before re-engaging the starter. Improper use of the starter may damage it.

 **CAUTION - Starter**

*If the engine stalls while you are in motion, do not attempt to move the shift lever to the P (Park) position. If traffic and road conditions permit, you may put the shift lever in the N (Neutral) position while the vehicle is still moving and turn the ignition switch to the START position in an attempt to restart the engine.*

## ENGINE START/STOP BUTTON (IF EQUIPPED)

### Illuminated ENGINE START/STOP button



Whenever the front door is opened, the ENGINE START/STOP button will illuminate for your convenience. The light will go off after about 30 seconds when the door is closed.

When all entrances are closed, if you lock the vehicle by using the transmitter or the smart key, the light will go off immediately.

### ENGINE START/STOP button position

#### OFF

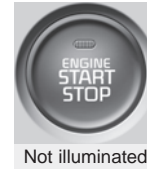

#### • With manual transaxle

To turn off the engine (START/RUN position) or vehicle power (ON position), stop the vehicle then press the engine start/stop button.

#### • With automatic transaxle

To turn off the engine (START/RUN position) or vehicle power (ON position), press the ENGINE START/STOP button with the shift lever in the P (Park) position. When you press the ENGINE START/STOP button without the shift lever in the P (Park) position, the ENGINE START/STOP button will not change to the OFF position but to the ACC position.

In an emergency situation while the vehicle is in motion, you are able to turn the engine off and to the ACC position by pressing the ENGINE START/STOP button for more than 2 seconds or 3 times successively within 3 seconds. If the vehicle is still moving, you can restart the engine without depressing the brake pedal by pressing the ENGINE START/STOP button with the shift lever in the N (Neutral) position.

### ACC(Accessory)

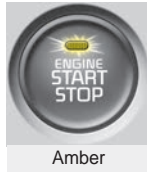

Amber

- **With manual transaxle**

Press the engine start/stop button when the button is in the OFF position without depressing the clutch pedal.

- **With automatic transaxle**

Press the ENGINE START/STOP button while it is in the OFF position without depressing the brake pedal.

If the ENGINE START/STOP button is in the ACC position for more than 1 hour, the button is turned off automatically to prevent battery discharge.

### ON



Redish orange

- **With manual transaxle**

Press the engine start/stop button when the button is in the ACC position without depressing the clutch pedal.

- **With automatic transaxle**

Press the ENGINE START/STOP button while it is in the ACC position without depressing the brake pedal.

The warning lights can be checked before the engine is started. Do not leave the ENGINE START/STOP button in the ON position for a long time. The battery may discharge, because the engine is not running.

### START/RUN



Not illuminated

- **With manual transaxle**

To start the engine, depress the clutch pedal and brake pedal, then press the engine start/stop button with the shift lever in the N (Neutral) position.

- **With automatic transaxle**

To start the engine, depress the brake pedal and press the ENGINE START/ STOP button with the shift lever in the P (Park) or the N (Neutral) position. For your safety, start the engine with the shift lever in the P (Park) position.

If you press the ENGINE START/STOP button without depressing the clutch pedal for manual transaxle vehicles or without depressing the brake pedal for automatic transaxle vehicles, the engine will not start and the ENGINE START/STOP button changes as follows:

OFF → ACC → ON → OFF or ACC

### \* NOTICE

If you leave the ENGINE START/STOP button in the ACC or ON position for a long time, the battery will discharge.

#### **WARNING** - Starting vehicle

**Never press the ENGINE START/STOP button while the vehicle is in motion except in an emergency. If the engine stops while the vehicle is in motion, this would result in loss of directional control and braking function, which could cause an accident.**

#### **WARNING** - Leaving the Vehicle

**To avoid unexpected or sudden vehicle movement, never leave your vehicle if the transmission is not locked in the P (Park) position and the parking brake is fully engaged. Before leaving the driver's seat, always make sure the shift lever is engaged in P (Park), set the parking brake fully and shut the engine off.**

### Starting the engine with a smart key (if equipped)

1. Carry the smart key or leave it inside the vehicle.
2. Make sure the parking brake is firmly applied
3. **Manual Transaxle** - Depress the clutch pedal fully and shift the transaxle into Neutral. Keep the clutch pedal and brake pedal depressed while starting the engine.

**Automatic transaxle** - Place the transaxle shift lever in P (Park). Depress the brake pedal fully.

*You can also start the engine when the shift lever is in the N (Neutral) position.*

4. Press the ENGINE START/STOP button while depressing the brake pedal.

*It should be started without depressing the accelerator.*

5. Do not wait for the engine to warm up while the vehicle remains stationary.

Start driving at moderate engine speeds. (Steep accelerating and decelerating should be avoided.)

- Even if the smart key is in the vehicle, if it is far away from you, the engine may not start.
- When the ENGINE START/STOP button is in the ACC position or above, if any door is opened, the system checks for the smart key. If the smart key is not in the vehicle, a message "key is not in the vehicle" will appear on the LCD display. And if all doors are closed, the chime will sound for 5 seconds. The indicator or warning will turn off while the vehicle is moving. Always have the smart key with you.



### **CAUTION - Starter**

*If the engine stalls while the vehicle is in motion, do not attempt to move the shift lever to the P (Park) position. If the traffic and road conditions permit, you may put the shift lever in the N (Neutral) position while the vehicle is still moving and press the ENGINE START/STOP button in an attempt to restart the engine.*



### **WARNING - Unintended vehicle movement**

**Never leave the smart key in the vehicle with children or vehicle occupants who are unfamiliar with the vehicle operation. Pushing the ENGINE START/STOP button while the smart key is in the vehicle may result in unintended engine activation and/or unintended vehicle movement.**



(Continued)

- When the stop lamp fuse is blown, you can't start the engine normally. Replace the fuse with a new one. If it is not possible, you can start the engine by pressing the ENGINE START/STOP button for 10 seconds while it is in the ACC position. The engine can start without depressing the brake pedal. But for your safety always depress the brake pedal before starting the engine.

Do not press the ENGINE START/STOP button for more than 10 seconds except when the stop lamp fuse is blown.

- If the battery is weak or the smart key does not work correctly, you can start the engine by pressing the engine start/stop button with the smart key.

The side with the lock button should contact the engine start/stop button directly.

When you press the engine start/stop button directly with the smart key, the smart key should contact the button at a right angle.

(Continued)

## MANUAL TRANSAXLE (IF EQUIPPED)

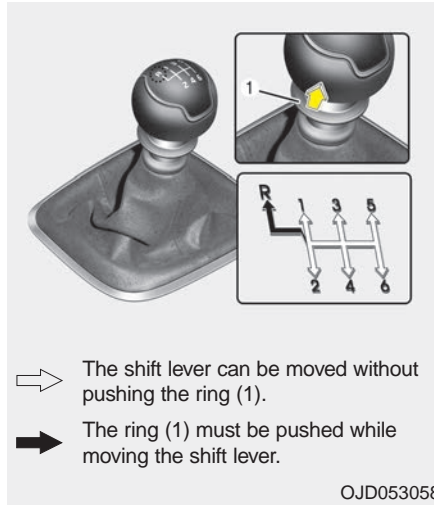

### Manual transaxle operation

- The manual transaxle has 6 forward gears.

This shift pattern is imprinted on the shift knob. The transaxle is fully synchronized in all forward gears so shifting to either a higher or a lower gear is easily accomplished.

- Press the clutch pedal down fully while shifting, then release it slowly.

If your vehicle is equipped with an ignition lock switch, the engine will not start when starting the engine without depressing the clutch pedal. (if equipped)

- The gearshift lever must be returned to the neutral position before shifting into R (Reverse).

The ring (1) located immediately below the shift knob must be pulled upward while moving the shift lever to the R (Reverse) position. (if equipped)

- *Make sure the vehicle is completely stopped before shifting into R (Reverse).*

*Never operate the engine with the tachometer (rpm) in the red zone.*

### **⚠ CAUTION - Downshifting**

***Do not downshift more than 2 gears or downshift the gear when the engine is running at high speed (5,000 RPM or higher). Such a downshifting may damage the engine.***



- During cold weather, shifting may be difficult until the transaxle lubricant has warmed up. This is normal and not harmful to the transaxle.
- If you've come to a complete stop and it's hard to shift into 1st or R (Reverse), put the shift lever in N (Neutral) position and release the clutch. Press the clutch pedal back down, and then shift into 1st or R (Reverse) gear position.

### CAUTION

- *To avoid premature clutch wear and damage, do not drive with your foot resting on the clutch pedal. Also, don't use the clutch to hold the vehicle stopped on an uphill grade, while waiting for a traffic light, etc.*
- *Do not use the shift lever as a handrest during driving, as this can result in premature wear of the transaxle shift forks.*

### WARNING

#### - Incline parking

**Before leaving the driver's seat, always set the parking brake fully and shut the engine off. Then make sure the transaxle is shifted into 1st gear when the vehicle is parked on a level or uphill grade, and shifted into R (Reverse) on a downhill grade. Unexpected and sudden vehicle movement can occur if these precautions are not followed in the order identified.**

### *Using the clutch*

The clutch should be pressed all the way to the floor before shifting, then released slowly. The clutch pedal should always be fully released while driving. Do not rest your foot on the clutch pedal while driving. This can cause unnecessary wear. Do not partially engage the clutch to hold the vehicle on an incline. This causes unnecessary wear. Use the foot brake or parking brake to hold the vehicle on an incline. Do not operate the clutch pedal rapidly and repeatedly.

### CAUTION

*When operating the clutch pedal, depress the clutch pedal down fully. If you don't depress the clutch pedal fully, the clutch may be damaged or noise may occur.*

### ***Downshifting***

When you must slow down in heavy traffic or while driving up steep hills, downshift before the engine starts to labor. Downshifting reduces the chance of stalling and gives better acceleration when you again need to increase your speed. When the vehicle is traveling down steep hills, downshifting helps maintain safe speed and prolongs brake life.

### **Good driving practices**

- Never take the vehicle out of gear and coast down a hill. This is extremely hazardous. Always leave the vehicle in gear.
  - Don't "ride" the brakes. This can cause them to overheat and malfunction. Instead, when you are driving down a long hill, slow down and shift to a lower gear. When you do this, engine braking will help slow down the vehicle.
  - Slow down before shifting to a lower gear. This will help avoid over-revving the engine, which can cause damage.
  - Slow down when you encounter cross winds. This gives you much better control of your vehicle.
  - Be sure the vehicle is completely stopped before you attempt to shift into reverse. The transaxle can be damaged if you do not. To shift into reverse, depress the clutch, move the shift lever to neutral, then shift to the reverse position.
- Exercise extreme caution when driving on a slippery surface. Be especially careful when braking, accelerating or shifting gears. On a slippery surface, an abrupt change in vehicle speed can cause the drive wheels to lose traction and the vehicle to go out of control.
  - Always buckle-up! In a collision, an unbelted occupant is significantly more likely to be seriously injured or killed than a properly belted occupant.
  - Avoid high speeds when cornering or turning. High speed cornering and turning increase the risk of vehicle rollover. Rollover accidents are violent and unpredictable.
  - Never exceed posted speed limits.

## AUTOMATIC TRANSAXLE (IF EQUIPPED)

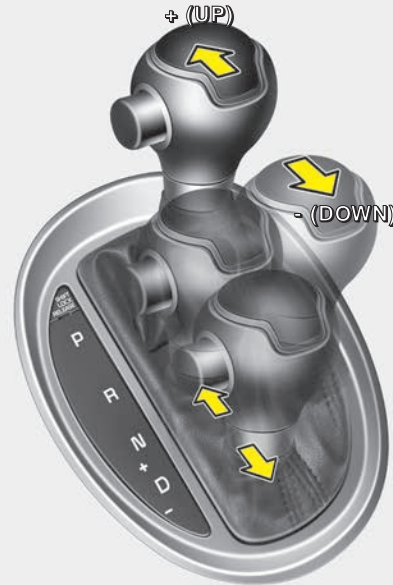
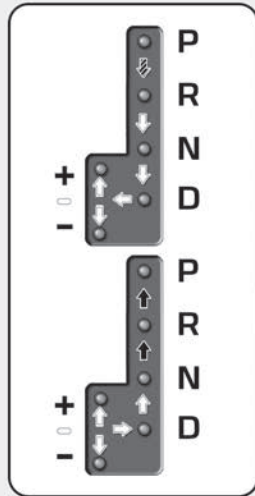

Depress the brake pedal and the lock release button when shifting.

(If the shift lock system is not equipped, it is not necessary to depress the brake pedal. However, it is recommended to depress the brake pedal to avoid inadvertent movement of the vehicle.)



Press the lock release button when shifting.



The shift lever can be shifted freely.

OPS053008

### Automatic transaxle operation

The automatic transaxle has 6 forward speeds and one reverse speed. The individual speeds are selected automatically, depending on the position of the shift lever.

### \* NOTICE

The first few shifts on a new vehicle, if the battery has been disconnected, may be somewhat abrupt. This is a normal condition, and the shifting sequence will adjust after shifts are cycled a few times by the TCM (Transaxle Control Module) or PCM (Powertrain Control Module).

For smooth operation, depress the brake pedal and the lock release button when shifting from N (Neutral) to a forward or reverse gear.

**⚠ WARNING - Leaving the Vehicle**

To avoid unexpected or sudden vehicle movement, never leave your vehicle if the transmission is not locked in the P (Park) position and the parking brake is fully engaged. Before leaving the driver's seat, always make sure the shift lever is engaged in P (Park), set the parking brake fully and shut the engine off.

**⚠ CAUTION - Transaxle**

*To avoid damage to your transaxle, do not accelerate the engine in R (Reverse) or any forward gear position with the brakes on. The transaxle may be damaged if you shift into P (Park) while the vehicle is in motion.*

When stopped on an incline, do not hold the vehicle with the engine power. Use the service brake or the parking brake.

**Transaxle ranges**

The indicator in the instrument cluster displays the shift lever position when the ignition switch is in the ON position.

**P (Park)**

Always come to a complete stop before shifting into P (Park). This position locks the transaxle and prevents the drive wheels from rotating.

Shifting into P (Park) while the vehicle is in motion will cause the drive wheels to lock which will cause you to lose control of the vehicle.

**R (Reverse)**

Use this position to drive the vehicle backward.

**⚠ CAUTION - Shifting**

*Always come to a complete stop before shifting into or out of R (Reverse); you may damage the transaxle if you shift into R (Reverse) while the vehicle is in motion, except when “Rocking the vehicle” explained in this section.*

**N (Neutral)**

The wheels and transaxle are not engaged. The vehicle will roll freely even on the slightest incline unless the parking brake or service brakes are applied.

**D (Drive)**

This is the normal forward driving position. The transaxle will automatically shift through a 6-gear sequence, providing the best fuel economy and power.

For extra power when passing another vehicle or climbing grades, depress the accelerator fully, at which time the transaxle will automatically downshift to the next lower gear.

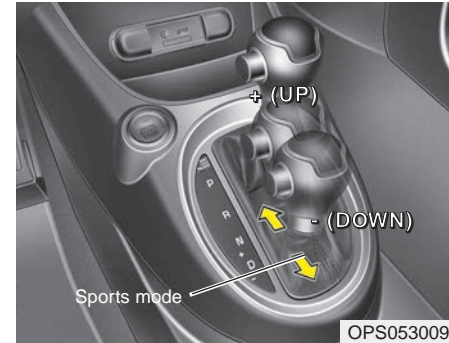
**Sports mode**

Whether the vehicle is stationary or in motion, sports mode is selected by pushing the shift lever from the D (Drive) position into the manual gate. To return to D (Drive) range operation, push the shift lever back into the main gate.

In sports mode, moving the shift lever backwards and forwards will allow you to make gearshifts rapidly. In contrast to a manual transaxle, the sports mode allows gearshifts with the accelerator pedal depressed.

Up (+) : Push the lever forward once to shift up one gear.

Down (-) : Pull the lever backwards once to shift down one gear.

- In sports mode, the driver must execute upshifts in accordance with road conditions, taking care to keep the engine speed below the red zone.
- In sports mode, only the 6 forward gears can be selected. To reverse or park the vehicle, move the shift lever to the R (Reverse) or P (Park) position as required.
- In sports mode, downshifts are made automatically when the vehicle slows down. When the vehicle stops, 1st gear is automatically selected.
- In sports mode, when the engine rpm approaches the red zone shift points are varied to upshift automatically.

(Continued)

(Continued)

- To maintain the required levels of vehicle performance and safety, the system may not execute certain gearshifts when the shift lever is operated.
- When driving on a slippery road, push the shift lever forward into the +(up) position. This causes the transaxle to shift into the 2nd gear which is better for smooth driving on a slippery road. Push the shift lever to the -(down) side to shift back to the 1st gear.

### ***Shift lock system***

For your safety, the automatic transaxle has a shift lock system which prevents shifting the transaxle from P (Park) into R (Reverse) unless the brake pedal is depressed.

To shift the transaxle from P (Park) into R (Reverse):

1. Depress and hold the brake pedal.
2. Start the engine or turn the ignition switch to the ON position.
3. Move the shift lever.

If the brake pedal is repeatedly depressed and released with the shift lever in the P (Park) position, a chattering noise near the shift lever may be heard. It is a normal condition.

**⚠ WARNING - Shifting from park**

Always fully depress the brake pedal before and while shifting out of the P (Park) position into another position to avoid inadvertent motion of the vehicle which could injure persons in or around the vehicle.

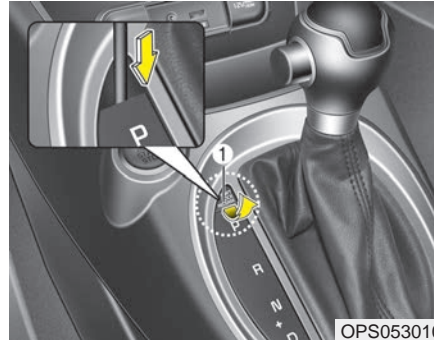
**Shift-lock override**

If the shift lever cannot be moved from the P (Park) position into R (Reverse) position with the brake pedal depressed, continue depressing the brake, then do the following:

1. Carefully remove the cap covering the shift-lock access hole (1).
2. Insert a screwdriver into the access hole and press down on the screwdriver.
3. Move the shift lever.
4. Have your vehicle inspected by an authorized Kia dealer immediately.

**Ignition key interlock system**

The ignition key cannot be removed unless the shift lever is in the P (Park) position. Even if the ignition switch is in the LOCK position, the key also cannot be removed.

If your vehicle is equipped with ENGINE START/STOP button, the button will not change to the OFF position unless the shift lever is in the P (Park) position.

### Good driving practices

- Never move the gear shift lever from P (Park) to any other position with the accelerator pedal depressed.
- Never move the gear shift lever into P (Park) when the vehicle is in motion.
- Slow down before shifting to a lower gear. Otherwise, the lower gear may not be engaged.
- Always use the parking brake. Do not depend on placing the transaxle in P (Park) to keep the vehicle from moving.
- Optimum vehicle performance and economy is obtained by smoothly depressing and releasing the accelerator pedal.

### *Moving up a steep grade from a standing start*

To move up a steep grade from a standing start, depress the brake pedal, shift the shift lever to D (Drive). Select the appropriate gear depending on load weight and steepness of the grade, and release the parking brake. Depress the accelerator gradually while releasing the service brakes.

**When accelerating from a stop on a steep hill, the vehicle may have a tendency to roll backwards. Shifting the shift lever into 2 (Second Gear) will help prevent the vehicle from rolling backwards.**



## BRAKE SYSTEM

### Power brakes

Your vehicle has power-assisted brakes that adjust automatically through normal usage.

In the event that the power-assisted brakes lose power because of a stalled engine or some other reason, you can still stop your vehicle by applying greater force to the brake pedal than you normally would. The stopping distance, however, will be longer.

When the engine is not running, the reserve brake power is partially depleted each time the brake pedal is applied. Do not pump the brake pedal when the power assist has been interrupted.

Pump the brake pedal only when necessary to maintain steering control on slippery surfaces.



#### **CAUTION - Brake Pedal**

***Do not drive with your foot resting on the brake pedal. This will create abnormally high brake temperatures which can cause excessive brake lining and pad wear.***



#### **WARNING - Steep hill braking**

**Avoid continuous application of the brakes when descending a long or steep hill by shifting to a lower gear. Continuous brake application will cause the brakes to overheat and could result in a temporary loss of braking performance.**

Wet brakes may impair the vehicle's ability to safely slow down; the vehicle may also pull to one side when the brakes are applied. Applying the brakes lightly will indicate whether they have been affected in this way. Always test your brakes in this fashion after driving through deep water. To dry the brakes, apply them lightly while maintaining a safe forward speed until brake performance returns to normal.

### *In the event of brake failure*

If service brakes fail to operate while the vehicle is in motion, you can make an emergency stop with the parking brake. The stopping distance, however, will be much greater than normal.

**⚠ WARNING - Parking brake**  
Applying the parking brake while the vehicle is moving at normal speeds can cause a sudden loss of control of the vehicle. If you must use the parking brake to stop the vehicle, use great caution in applying the brake.

### *Disc brakes wear indicator*

When your brake pads are worn and new pads are required, you will hear a high-pitched warning sound from your front brakes or rear brakes. You may hear this sound come and go or it may occur whenever you depress the brake pedal.

Please remember that some driving conditions or climates may cause a brake squeal when you first apply (or lightly apply) the brakes. This is normal and does not indicate a problem with your brakes.

Always replace the front or rear brake pads as pairs.

**⚠ WARNING - Brake wear**  
Do not ignore high pitched whining sounds from your brakes. If you ignore this audible warning, you will eventually lose braking performance, which could lead to a serious accident.

**⚠ CAUTION - Parking brake**  
*Driving with the parking brake applied will cause excessive brake pad (or lining) and brake rotor wear.*

## Parking brake - Hand type

### Applying the parking brake

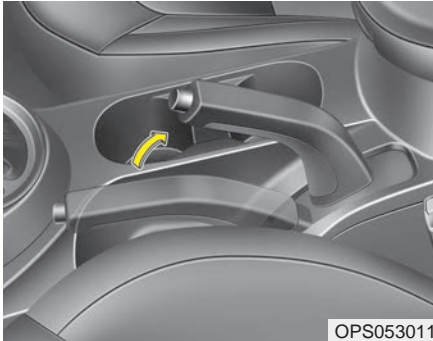

To engage the parking brake, first apply the foot brake and then without pressing the release button in, pull the parking brake lever up as far as possible.

In addition it is recommended that when parking the vehicle on a gradient, the shift lever should be positioned in the appropriate low gear on manual transaxle vehicles or in the P (Park) position for automatic transaxle vehicles.

**⚠ CAUTION-** Parking brake  
*Driving with the parking brake applied will cause excessive brake pad and brake rotor wear.*

### Releasing the parking brake

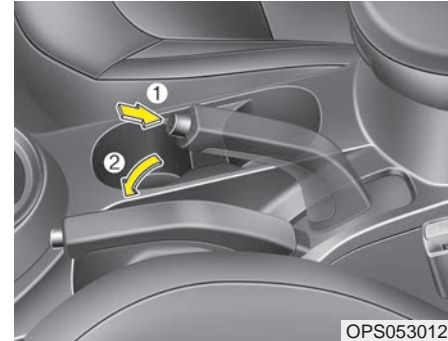

To release the parking brake, first apply the foot brake and pull up the parking brake lever slightly. Secondly press the release button (1) and lower the parking brake lever (2) while holding the button.

**⚠ WARNING - Parking Brake Use**

- **Never allow a passenger to touch the parking brake. If the parking brake is released unintentionally, serious injury may occur.**
- **All vehicles should always have the parking brake fully engaged when parked to avoid inadvertent movement of the car which can injure occupants or pedestrians.**



If at all possible, cease driving the vehicle immediately. If that is not possible, use extreme caution while operating the vehicle and only continue to drive the vehicle until you can reach a safe location or repair shop.

Check the brake warning light by turning the ignition switch ON (do not start the engine). This light will be illuminated when the parking brake is applied with the ignition switch in the START or ON position.

Before driving, be sure the parking brake is fully released and the brake warning light is off.

If the brake warning light remains on after the parking brake is released while the engine is running, there may be a malfunction in the brake system. Immediate attention is necessary.

### Anti-lock brake system (ABS)

ABS (or ESC) will not prevent accidents due to improper or dangerous driving maneuvers. Even though vehicle control is improved during emergency braking, always maintain a safe distance between you and objects ahead. Vehicle speeds should always be reduced during extreme road conditions. The vehicle should be driven at reduced speeds in the following circumstances:

- When driving on rough, gravel or snow-covered roads
- When driving with tire chains installed
- When driving on roads where the road surface is pitted or has different surface heights.

Driving in these conditions increase the stopping distance for your vehicle.

The ABS continuously senses the speed of the wheels. If the wheels are going to lock, the ABS system repeatedly modulates the hydraulic brake pressure to the wheels.

When you apply your brakes under conditions which may lock the wheels, you may hear a “tik-tik” sound from the brakes, or feel a corresponding sensation in the brake pedal. This is normal and it means your ABS is active.

In order to obtain the maximum benefit from your ABS in an emergency situation, do not attempt to modulate your brake pressure and do not try to pump your brakes. Press your brake pedal as hard as possible or as hard as the situation allows the ABS to control the force being delivered to the brakes.

### \* NOTICE

**A click sound may be heard in the engine compartment when the vehicle begins to move after the engine is started. These conditions are normal and indicate that the anti-lock brake system is functioning properly.**

- Even with the anti-lock brake system, your vehicle still requires sufficient stopping distance. Always maintain a safe distance from the vehicle in front of you.
- Always slow down when cornering. The anti-lock brake system cannot prevent accidents resulting from excessive speeds.
- On loose or uneven road surfaces, operation of the anti-lock brake system may result in a longer stopping distance than for vehicles equipped with a conventional brake system.



W-78

The ABS warning light will stay on for approximately 3 seconds after the ignition switch is ON. During that time, the ABS will go through self-diagnosis and the light will go off if everything is normal. If the light stays on, you may have a problem with your ABS. Contact an authorized Kia dealer as soon as possible.

- When you drive on a road having poor traction, such as an icy road, and have operated your brakes continuously, the ABS will be active continuously and the ABS warning light may illuminate. Pull your vehicle over to a safe place and stop the engine.
- Restart the engine. If the ABS warning light goes off, then your ABS system is normal. Otherwise, you may have a problem with the ABS. Contact an authorized Kia dealer as soon as possible.

### **\* NOTICE**

**When you jump start your vehicle because of a drained battery, the engine may not run as smoothly and the ABS warning light may turn on at the same time. This happens because of low battery voltage. It does not mean your ABS has malfunctioned.**

- **Do not pump your brakes!**
- **Have the battery recharged before driving the vehicle.**

## Electronic stability control (ESC)

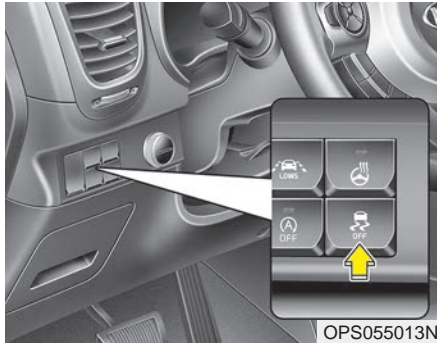

The Electronic Stability control (ESC) system is designed to stabilize the vehicle during cornering maneuvers. ESC checks where you are steering and where the vehicle is actually going. ESC applies the brakes on individual wheels and intervenes with the engine management system to stabilize the vehicle. Electronic stability control (ESC) will not prevent accidents. Excessive speed in turns, abrupt maneuvers and hydroplaning on wet surfaces can still result in serious accidents.

Only a safe and attentive driver can prevent accidents by avoiding maneuvers that cause the vehicle to lose traction. Even with ESC installed, always follow all the normal precautions for driving - including driving at safe speeds for the conditions.

The Electronic Stability Control (ESC) system is an electronic system designed to help the driver maintain vehicle control under adverse conditions. It is not a substitute for safe driving practices. Factors including speed, road conditions and driver steering input can all affect whether ESC will be effective in preventing a loss of control. It is still your responsibility to drive and corner at reasonable speeds and to leave a sufficient margin of safety.

When you apply your brakes under conditions which may lock the wheels, you may hear a “tik-tik” sound from the brakes, or feel a corresponding sensation in the brake pedal. This is normal and it means your ESC is active.

### \* NOTICE

A click sound may be heard in the engine compartment when the vehicle begins to move after the engine is started. These conditions are normal and indicate that the Electronic Stability Control System is functioning properly.

### \* NOTICE

For maximum protection, always wear your seat belt. No system, no matter how advanced, can compensate for all driver error and/or driving conditions. Always drive responsibly.

### **ESC operation**

#### **ESC ON condition**

-

- When the ignition is turned ON, ESC and ESC OFF indicator lights illuminate for approximately 3 seconds, then ESC is turned on.
- Press the ESC OFF button for at least half a second after turning the ignition ON to turn ESC off. (ESC OFF indicator will illuminate). To turn the ESC on, press the ESC OFF button (ESC OFF indicator light will go off).
- When starting the engine, you may hear a slight ticking sound. This is the ESC performing an automatic system self-check and does not indicate a problem.

### **When operating**



When the ESC is in operation, the ESC indicator light blinks.

- When the Electronic Stability Control is operating properly, you can feel a slight pulsation in the vehicle. This is only the effect of brake control and indicates nothing unusual.
- When moving out of the mud or driving on a slippery road, pressing the accelerator pedal may not cause the engine rpm (revolutions per minute) to increase.

### **ESC operation off**

#### **ESC OFF state**



This car has 2 kinds of ESC off states.



If the engine stops when ESC is off, ESC remains off. Upon restarting the engine, the ESC will automatically turn on again.





OPS053022

#### • ESC off state 1



To cancel ESC operation, press the ESC OFF button (ESC OFF ) shortly (ESC OFF indicator light (ESC OFF ) illuminates). At this state, the engine control function does not operate. It means the traction control function does not operate. Brake control function only operates.

If your vehicle is equipped with cluster type B, a message also will appear on the LCD display.



OPS053023

#### • ESC off state 2

To cancel ESC operation, press the ESC OFF button (ESC OFF ) for more than 3 seconds. ESC OFF indicator light (ESC OFF ) illuminates and ESC OFF warning chime will sound. At this state, the engine control function and brake control function do not operate. It means the car stability control function does not operate any more.

If your vehicle is equipped with cluster type B, a message also will appear on the LCD display.

#### ■ ESC indicator light



#### ■ ESC OFF indicator light



#### *Indicator light*

When ignition switch is turned to ON, the indicator light illuminates, then goes off if the ESC system is operating normally.

The ESC indicator light blinks whenever ESC is operating or illuminates when ESC fails to operate.

The ESC OFF indicator light comes on when the ESC is turned off with the button.

**⚠ CAUTION**

*Driving with varying tire or wheel sizes may cause the ESC system to malfunction. When replacing tires, make sure they are the same size as your original tires.*

**⚠ WARNING**

- Electronic stability control  
Drive carefully even though your vehicle has Electronic Stability Control. It can only assist you in maintaining control under certain circumstances.

**ESC OFF usage**

**When driving**

- ESC should be turned on for daily driving whenever possible.
- To turn ESC off while driving, press the ESC OFF button while driving on a flat road surface.

**⚠ WARNING - Operating ESC**

Never press the ESC OFF button while ESC is operating (ESC indicator light blinks).

If ESC is turned off while ESC is operating, the vehicle may slip out of control.

**\* NOTICE**

- When operating the vehicle on a dynamometer, ensure that the ESC is turned off (ESC OFF light illuminated). If the ESC is left on, it may prevent the vehicle speed from increasing, and result in false diagnosis.
- Turning the ESC off does not affect ABS or brake system operation.

## Vehicle stability management (VSM)

This system provides further enhancements to vehicle stability and steering responses when a vehicle is driving on a slippery road or a vehicle detects changes in coefficient of friction between right wheels and left wheels when braking.

### *VSM operation*

When the VSM is in operation, ESC indicator light (  ) blinks.

When the vehicle stability management is operating properly, you can feel a slight pulsation in the vehicle and/or abnormal steering responses (EPS). This is only the effect of brake and EPS control and indicates nothing unusual.

### The VSM does not operate when:

- Driving on bank road such as gradient or incline
- Driving in reverse
- ESC OFF indicator light (  ) remains on the instrument cluster
- EPS indicator light remains on the instrument cluster

### *VSM operation off*

If you press the ESC OFF button to turn off the ESC, the VSM will also cancel and the ESC OFF indicator light (  ) illuminates.

To turn on the VSM, press the button again. The ESC OFF indicator light goes out.

### *Malfunction indicator*

The VSM can be deactivated even if you don't cancel the VSM operation by pressing the ESC OFF button. It indicates that a malfunction has been detected somewhere in the Electric Power Steering system or VSM system. If the ESC indicator light (  ) or EPS warning light remains on, take your vehicle to an authorized Kia dealer and have the system checked.

### **\* NOTICE**

- **The VSM is designed to function above approximately 13 mph (22 km/h) on curves.**
- **The VSM is designed to function above approximately 6 mph (10 km/h) when a vehicle is braking on a split-mu road. The split-mu road is made of surfaces which have different friction forces.**

- The Vehicle Stability Management system is not a substitute for safe driving practices but a supplementary function only. It is the responsibility of the driver to always check the speed and the distance to the vehicle ahead. Always hold the steering wheel firmly while driving.
- Your vehicle is designed to activate according to the driver's intention, even with installed VSM. Always follow all the normal precautions for driving at safe speeds for the conditions – including driving in clement weather and on a slippery road.

### Hill-start assist control (HAC)

A vehicle has the tendency to roll back on a steep hill when it starts to go after stopping. The Hill-start Assist Control (HAC) prevents the vehicle from rolling back by applying the brakes automatically for about 2 seconds. The brakes are released when the accelerator pedal is depressed or after about 2 seconds.

The HAC is activated only for about 2 seconds, so when the vehicle is starting off always depress the accelerator pedal.

 **WARNING - Maintaining Brake Pressure on Incline**

**HAC does not replace the need to apply brakes while stopped on an incline. While stopped, make sure you maintain brake pressure sufficient to prevent your vehicle from rolling backward and causing an accident. Don't release the brake pedal until you are ready to accelerate forward.**

### Good braking practices

- Check to be sure the parking brake is not engaged and the parking brake indicator light is out before driving away.
- Driving through water may get the brakes wet. They can also get wet when the vehicle is washed. Wet brakes can be dangerous! Your vehicle will not stop as quickly if the brakes are wet. Wet brakes may cause the vehicle to pull to one side.

To dry the brakes, apply the brakes lightly until the braking action returns to normal, taking care to keep the vehicle under control at all times. If the braking action does not return to normal, stop as soon as it is safe to do so and call an authorized Kia dealer for assistance.

- Don't coast down hills with the vehicle out of gear. This is extremely hazardous. Keep the vehicle in gear at all times, use the brakes to slow down, then shift to a lower gear so that engine braking will help you maintain a safe speed.
- Don't "ride" the brake pedal. Resting your foot on the brake pedal while driving can be dangerous because the brakes might overheat and lose their effectiveness. It also increases the wear of the brake components.
- If a tire goes flat while you are driving, apply the brakes gently and keep the vehicle pointed straight ahead while you slow down. When you are moving slowly enough for it to be safe to do so, pull off the road and stop in a safe place.
- If your vehicle is equipped with an automatic transaxle, don't let your vehicle creep forward. To avoid creeping forward, keep your foot firmly on the brake pedal when the vehicle is stopped.
- Be cautious when parking on a hill. Firmly engage the parking brake and place the shift lever in P (automatic transaxle) or in first or reverse gear (manual transaxle). If your vehicle is facing downhill, turn the front wheels into the curb to help keep the vehicle from rolling. If your vehicle is facing uphill, turn the front wheels away from the curb to help keep the vehicle from rolling. If there is no curb or if it is required by other conditions to keep the vehicle from rolling, block the wheels.

- Under some conditions your parking brake can freeze in the engaged position. This is most likely to happen when there is an accumulation of snow or ice around or near the rear brakes or if the brakes are wet. If there is a risk that the parking brake may freeze, apply it only temporarily while you put the shift lever in P (automatic transaxle) or in first or reverse gear (manual transaxle) and block the rear wheels so the vehicle cannot roll. Then release the parking brake.
- Do not hold the vehicle on the upgrade with the accelerator pedal. This can cause the transaxle to overheat. Always use the brake pedal or parking brake.

## CRUISE CONTROL SYSTEM (IF EQUIPPED)



OPS053015

1. Cruise indicator
2. Cruise set indicator

The cruise control system allows you to program the vehicle to maintain a constant speed without pressing the accelerator pedal.

This system is designed to function above approximately 30 km/h (20 mph).

- If the cruise control is left on (CRUISE indicator light in the instrument cluster illuminated), the cruise control can be switched on accidentally. Keep the cruise control system off (CRUISE indicator light OFF) when the cruise control is not in use, to avoid inadvertently setting a speed.
- Use the cruise control system only when traveling on open highways in good weather.
- Do not use the cruise control driving in heavy or varying traffic, or on slippery (rainy, icy or snow-covered) or winding roads or over 6% up-hill or down-hill roads.

### **⚠ WARNING - Misuse of Cruise Control**

**Do not use cruise control if the traffic situation does not allow you to drive safely at a constant speed and with sufficient distance to the vehicle in front.**

### **\* NOTICE**

- During normal cruise control operation, when the SET switch is activated or reactivated after applying the brakes, the cruise control will energize after approximately 3 seconds. The delay is normal.
- To activate cruise control, depress the brake pedal at least once after turning the ignition switch to the ON position or starting the engine. This is to check if the brake switch which is important part to cancel cruise control is in normal condition.

### Cruise control switch



- CRUISE : Turns cruise control system on or off.
- CANCEL: Cancels cruise control operation.
- RES+: Resumes or increases cruise control speed.
- SET-: Sets or decreases cruise control speed.

### To set cruise control speed:



1. Press the CRUISE button on the steering wheel to turn the system on. The CRUISE indicator light in the instrument cluster will illuminate.
2. Accelerate to the desired speed, which must be more than 30 km/h (20 mph)

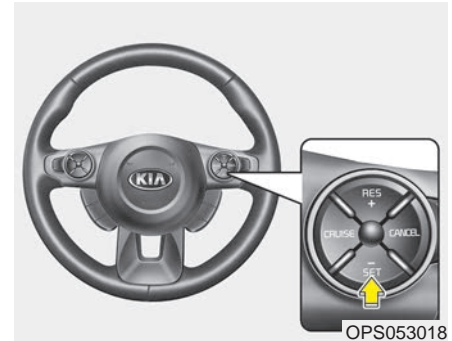

3. Push the SET - switch, and release it at the desired speed. The SET indicator light in the instrument cluster will illuminate. Release the accelerator pedal at the same time. The desired speed will automatically be maintained.

*On a steep grade, the vehicle may slow down or speed up slightly while going uphill or downhill.*

### \* NOTICE - Manual transaxle

For manual transaxle vehicles, you should depress the brake pedal at least once to set the cruise control after starting the engine.



**To increase cruise control set speed:**



Follow either of these procedures:

- Push the RES + switch and hold it. Your vehicle will accelerate. Release the lever at the speed you want.
- Push the RES + switch and release it immediately.

The cruising speed will increase by 2km/h (or 1 mph) each time you move the lever up (to RES+) in this manner.

**To decrease the cruising speed:**

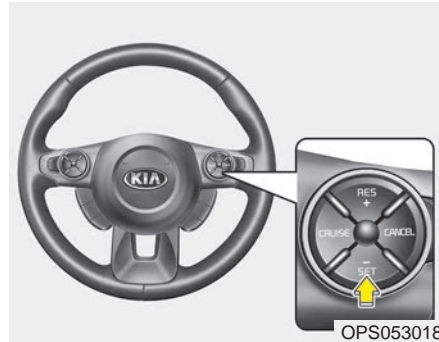

Follow either of these procedures:

- Push the SET - switch and hold it. Your vehicle will gradually slow down. Release the lever at the speed you want to maintain.
- Push the SET - switch and release it immediately.

The cruising speed will decrease by 2 km/h (1 mph) each time you move the lever down (to SET-) in this manner.

**To temporarily accelerate with the cruise control on:**

If you want to speed up temporarily when the cruise control is on, depress the accelerator pedal. Increased speed will not interfere with cruise control operation or change the set speed.

To return to the set speed, take your foot off the accelerator.

### To cancel cruise control, do one of the following:



- Press the brake pedal.
- Depress the clutch pedal if equipped with a manual transaxle.
- Shift into N (Neutral) with an automatic transaxle.
- Push the CANCEL switch located on the steering wheel.
- Decrease the vehicle speed lower than the memory speed by approximately 20 km/h (12 mph).
- Decrease the vehicle speed to less than approximately 25 km/h (15 mph).

*Each of these actions will cancel cruise control operation (the SET indicator light in the instrument cluster will go off), but it will not turn the system off. If you wish to resume cruise control operation, push the RES + switch located on your steering wheel. You will return to your previously preset speed.*

### To resume cruising speed at more than approximately 30 km/h (20 mph):



If any method other than the CRUISE button was used to cancel cruising speed and the system is still activated, the most recent set speed will automatically resume when the RES+ switch is pushed.

It will not resume, however, if the vehicle speed has dropped below approximately 30 km/h (20 mph).

**To turn cruise control off, do one of the following:**



- Press the CRUISE button (the CRUISE indicator light in the instrument cluster will go off).
- Turn the ignition off.

*Both of these actions cancel cruise control operation. If you want to resume cruise control operation, repeat the steps provided in "To set cruise control speed" on the previous page.*

## ACTIVE ECO SYSTEM (IF EQUIPPED)

### Active ECO operation

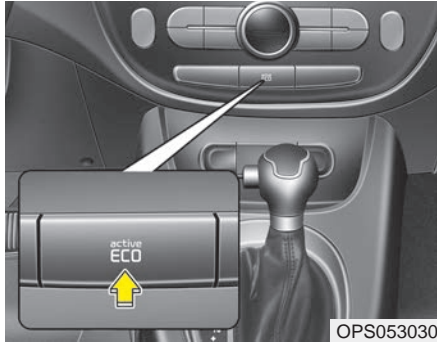

Active ECO helps improve fuel efficiency by controlling certain engine and transaxle system operating parameters. Fuel efficiency depends on the driver's driving habit and road condition.

- When the Active ECO button is pressed the ECO indicator (green) will illuminate to show that the Active ECO is operating.

- When the Active ECO is activated, it will remain on until the Active ECO button is pressed again. Active ECO does not turn off when the engine is restarted. To turn off Active ECO, press the Active ECO button again.
- If Active ECO is turned off, the system will return to normal mode.

### When Active ECO is activated:

- The acceleration may slightly be reduced even though you depress the accelerator fully.
- The air conditioner performance may be limited.
- The shift pattern of the automatic transaxle may change.
- The engine noise may get louder.

The above situations are normal conditions when the active eco system is activated to improve fuel efficiency.

### Limitation of Active ECO operation:

If the following conditions occur while Active ECO is operating, the system operation is limited even though there is no change in the ECO indicator.

- When the coolant temperature is low: The system will be limited until engine performance becomes normal.
- When driving up a hill: The system will be limited to gain power when driving uphill because the engine torque is restricted.
- When using sports mode: The system will be limited according to the shift location.
- When the accelerator pedal is deeply depressed for a few seconds: The system will be limited, judging that the driver wants to speed up.

## ISG (IDLE STOP AND GO) SYSTEM (IF EQUIPPED)

Your vehicle may be equipped with the ISG system, which reduces fuel consumption by automatically shutting down the engine, when the vehicle is at a standstill. (For example : red light, stop sign and traffic jam)

The engine starts automatically as soon as the starting conditions are met.

The ISG system is ON whenever the engine is running.

### \* NOTICE

When the engine automatically starts by the ISG system, some warning lights (ABS, ESC, ESC OFF, EPS or Parking brake warning light) may turn on for a few seconds.

This happens because of low battery voltage. It does not mean the system is malfunctioning.

### Auto stop

#### *To stop the engine in idle stop mode*

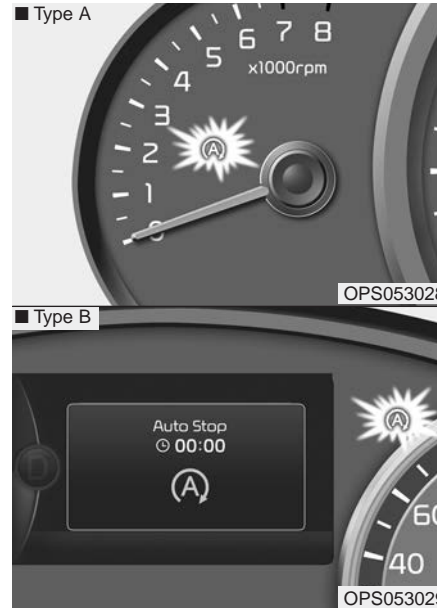

Stop the vehicle completely by pressing the brake pedal.

You must reach a speed of at least 5 mph (8 km/h) since last idle stop. The engine will stop and the green AUTO STOP indicator (A) on the instrument cluster will illuminate.

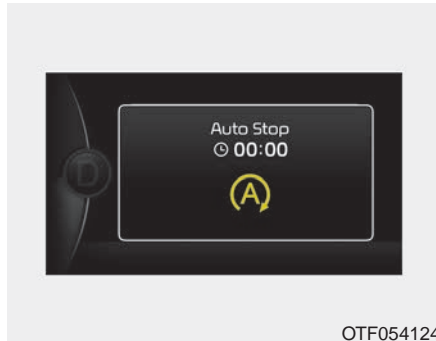

If your vehicle is equipped with cluster type B, a message "Auto Stop" also will appear on the LCD display.

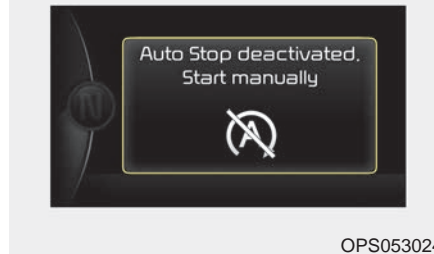
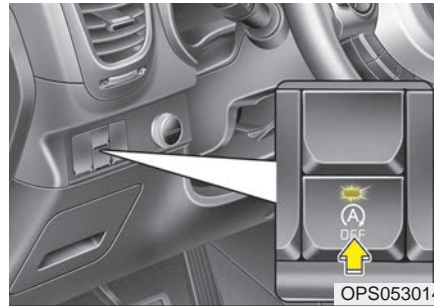

If you open the engine hood in auto stop mode, the ISG system will deactivate (the light on the ISG OFF button will illuminate). A message "Auto Stop Deactivated Start Manually" will appear on the LCD display. (if equipped)

Turn the engine on manually.

### Auto start

*To restart the engine from idle stop mode*

- Release the brake pedal.  
or
- Move the shift gear to the R (Reverse) position or the sports mode while depressing the brake pedal.

The engine will start and the green AUTO STOP indicator ((A)) on the instrument cluster will go out.

***The engine will also restart automatically without the driver's any actions if the following occurs:***

- When a certain amount of time has passed with the climate control system on.
- When the front defroster is on.
- The brake vacuum pressure is low.
- The battery charging status is low.
- The vehicle speed exceeds 1 MPH (1 km/h).
- The fan speed is in the highest position when the air conditioning is on.
- Engine is turned off by Auto Stop for a long time.
- If you unfasten the seat belt or open the driver's door while depressing the brake pedal.



The green AUTO STOP indicator (A) on the instrument cluster will blink for 5 seconds and a message "Auto Start" will appear on the LCD display (if equipped).

### **Condition of ISG system operation**

***The ISG system will operate under the following condition:***

- The driver's seat belt is fastened.
- The driver's door and engine hood are closed.
- The brake vacuum pressure is adequate.
- The battery is sufficiently charged.
- The outside temperature is more than -2°C (28.4°F).
- The outside temperature is under 32°C (89.6°F).
- The engine coolant temperature is not low.

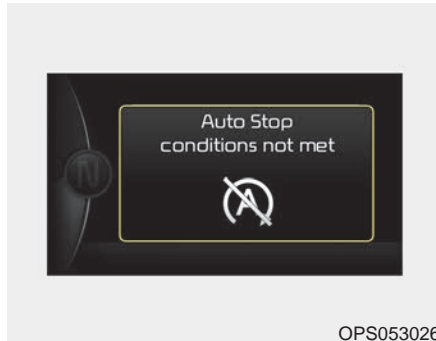

- If the ISG system does not meet the operation condition, the ISG system is deactivated. The light on the ISG OFF button will illuminate and a message “Auto Stop Conditions not met” will appear on the LCD display (if equipped).
- If the light or notice comes on continuously, please check the operation condition.

### ISG system deactivation

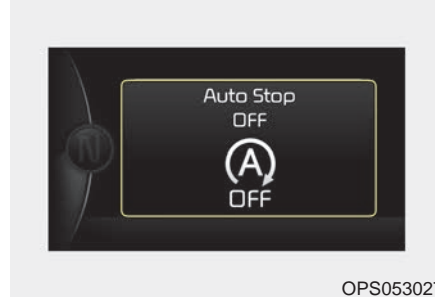
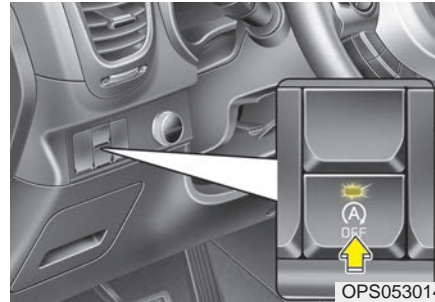

- If you want to deactivate the ISG system, press the ISG OFF button. The light on the ISG OFF button will illuminate and a message “Auto Stop off” will appear on the LCD display (if equipped).

- If you press the ISG OFF button again, the system will be activated and the light on the ISG OFF button will turn off.



## ISG system malfunction

*The system may not operate when:*

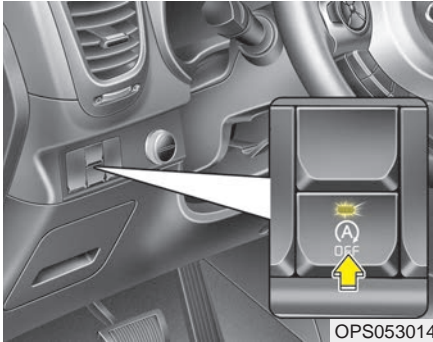

- If the ISG related sensors or system error occurs, the yellow AUTO STOP indicator (A) on the instrument cluster will stay on after blinking for 5 seconds and the light on the ISG OFF button will illuminate.

- If the ISG OFF button light is not turned off by pressing the ISG OFF button again or if the ISG system continuously does not work correctly, please contact an authorized Kia dealer as soon as possible.

**⚠ WARNING - Engine repair**  
 Turn the ignition switch to the **LOCK (OFF)** position or remove the key from the ignition completely before performing work on the vehicle in the engine area. Failure to do so could result in serious injuries due to sudden engine reactivation.

### \* NOTICE

If the AGM battery is reconnected or replaced, ISG function will not operate immediately.

If you want to use the ISG function, the battery sensor needs to be calibrated for approximately 4 hours with the ignition off and then, turn the engine on and off 2 or 3 times.

## LANE DEPARTURE WARNING SYSTEM (LDWS) (IF EQUIPPED)

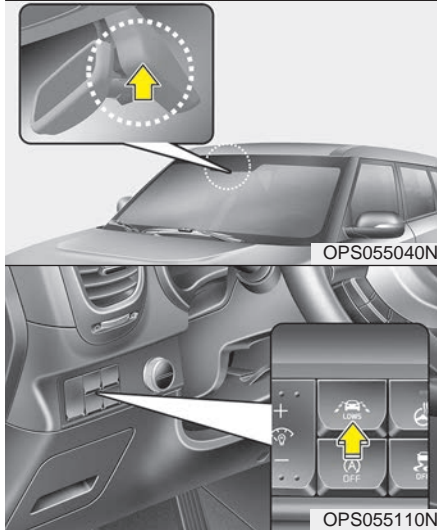
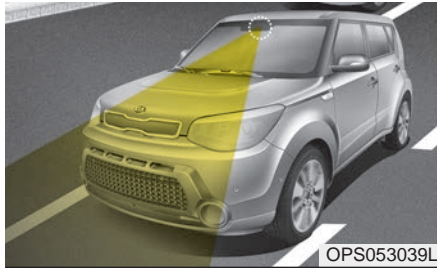

This system detects the lane with a sensor at the front windshield and notifies you if it detects that your vehicle leaves the lane.

### **⚠ WARNING - LDWS Alert**

**The LDWS is only intended to provide you with information regarding your vehicle's position on the roadway. Upon receiving an LDWS alert, you must take the necessary steps to maintain control of your vehicle. The LDWS does not provide any steering inputs into the vehicle for you. It can be dangerous to make a large sudden steering input in response to an alert, since that could result in loss of control.**

- The LDWS does not make the vehicle change lanes. It is the driver's responsibility to always check the road conditions.
- If the sensor cannot detect the lane or if the vehicle speed does not exceed 64 km/h (40 mph), the LDWS will not be able to notify you if the vehicle leaves the lane.
- If your vehicle has window tint or other types of coating on the front windshield, the LDWS may not work properly.
- Prevent damage to the LDWS sensor from water or any liquid.
- Do not remove the LDWS parts and avoid damaging the sensor by avoiding a strong impacts.
- Do not put objects that reflect light on the dash board.
- The operation of the LDWS can be affected by several factors (including environmental conditions). It is the responsibility of the driver to pay attention to the roadway and to maintain the vehicle in it's lane at all times.



OPS053068

To operate the LDWS, press the button with the engine start/stop button in the ON position. The indicator illuminates on the cluster. To cancel the LDWS, press the button again.

■ When the sensor detects the lane line



OPS053042L

■ When the sensor doesn't detect the lane line



OPS053043L

If the system detects that your vehicle is leaving the lane when the LDWS is operating and vehicle speed exceeds 64 km/h (40 mph), the warning operates as follows:

■ Left lane departure warning



OPS053044L

■ Right lane departure warning



OPS053045L

1. Visual warning

If you leave the lane, the lane you leave on the LCD display blinks yellow.

2. Auditory warning

If you leave the lane, the warning sound operates.



The color of symbol will change depend on the condition of LDWS system.

- White color : It means the sensor does not detect the lane line.
- Green color : It means the sensor detects the lane line.

### Warning indicator

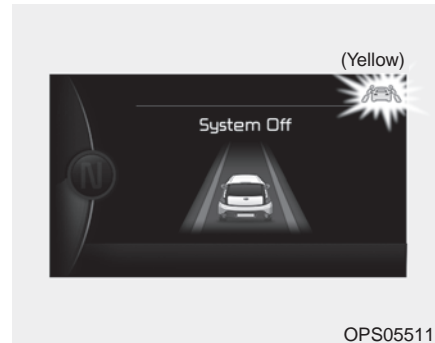

When the LDWS is not working properly, the warning light will illuminate and the warning message will come on for a few second.

Take your vehicle to an authorized Kia dealer and have the system checked.

### The LDWS does not operate when:

- The driver turns on the turn signal or the hazard warning flasher to change lane.
- Driving on the lane line.

### \* NOTICE

To change lanes, operate the turn signal switch then change the lane.

### **⚠ WARNING - LDWS Limitations**

**The Lane Departure Warning System is a supplemental system. Do not solely rely on the system but always pay attention and drive safely.**

**The LDWS may not warn you even if the vehicle leaves the lane, or may warn you even if the vehicle does not leave the lane when;**

- The lane is not visible due to snow, rain, stain, a puddle or other environmental conditions.
- The brightness of the outside changes suddenly such as tunnel enter/exit.
- The headlights are off at night or in a tunnel.
- The color of the lane marking from the road is difficult to distinguish.
- Driving on a steep grade or a curve.
- Light such as street light, sunlight or oncoming vehicle light reflects from water on the road.
- The lens or windshield is stained with foreign matter.
- The sensor cannot detect the lane because of fog, heavy rain or heavy snow.
- The surrounding of the inside rear view mirror temperature is high due to a direct ray of light.
- The lane is very wide or narrow.
- The lane line is damaged or indistinct.
- The windshield is fogged by humid air in the vehicle.
- The shadow is on the lane line by a median strip.
- The sensor cannot distinguish the lane from the road due to the dust/dirt.
- There is a mark similar to a lane line.
- There is a boundary structure.
- The distance from vehicle ahead is very short or the vehicle ahead drives hiding the lane line.
- The vehicle vibrates heavily due to road conditions.
- The lane number increases or decreases or the lane lines are crossing.
- Putting something on the dashboard.
- Driving with the sun in front of you.
- Driving in areas under construction.
- The lane line is more than two in either side (Left/Right)

**This device complies with Industry Canada licence-exempt RSS standard(s).**

Operation is subject to the following two conditions:

- (1) This device may not cause interference, and
- (2) This device must accept any interference, including interference that may cause undesired operation of the device.

## FORWARD COLLISION WARNING SYSTEM (FCWS) (IF EQUIPPED)

The Forward Collision Warning System helps avoid accidents by identifying critical situations early and warning the driver.

### FCWS Operation

#### *To operate:*

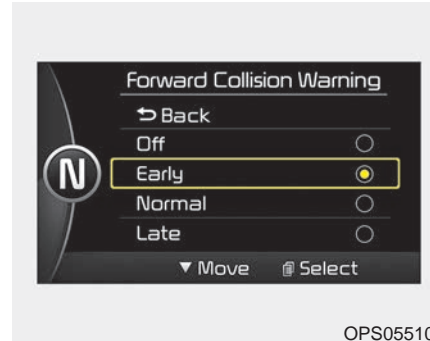

Go to the User Settings Mode (Driving Assist) and select FCW (Forward Collision Warning) on the LCD display.

Select [Off] to turn off the system or one of the three warnings timing level (Late/Normal/Early) to turn the system on and adjust the level of the forward collision warning timing.

The system will turn on and standby to activate. The system will activate when vehicle speed is above 16 km/h (10 mph) and below 177 km/h (110 mph).

FCWS will default ON when vehicle is restarted even though FCWS was turned off on User Settings Mode.

**Warning message**



OPS055107

A warning message and chime will be provided when rapidly approaching a slower moving, braking or stopped vehicle ahead. Immediately reduce your speed to prevent a collision.

**⚠ WARNING - Forward Collision Warning System**

The Forward Collision Warning System is a supplemental system to assist you and its effects may differ according to road and driving conditions. Do not solely rely on the system and always pay attention to prevent dangerous situations from occurring.

FCWS is a warning system and does not apply the brakes automatically in a near crash situation. FCWS may not provide a warning with enough time to help avoid a crash. FCWS does not detect pedestrians, animals, signs, construction or other objects. It is the responsibility of the driver to pay attention to the roadway to prevent collisions.

**FCWS malfunction message**

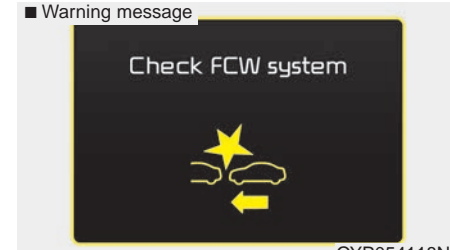

OYP054118N



OPS055109

When the FCWS is not working properly, the warning message will come on for a few second. After the message disappears, the master warning light will illuminate.

### System disabled

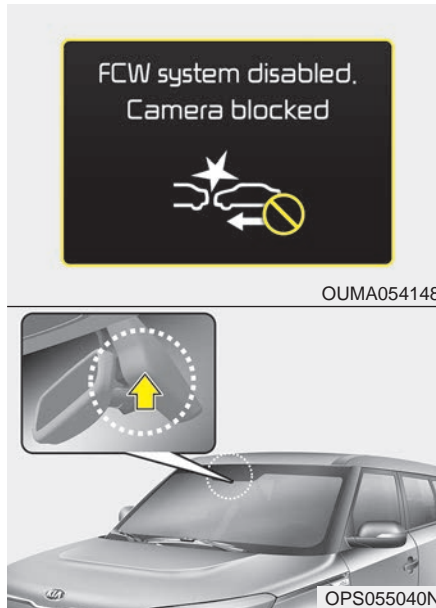

The message will appear when camera's field of view is covered by some objects. The system stops until the field of view is normal.

Check the windshield around the camera view area. If the system does not work normally even though camera's field of view is cleared, take your vehicle to an authorized Kia dealer and have the system checked.

### Limitations of the System

The Forward Collision Warning System may have limits to its ability to detect distance to the vehicle ahead due to road and traffic conditions.

The FCW could not detect vehicle or could detect objects as vehicles when :

- The camera lens is covered with dirt.
- There is heavy rain or heavy snow.
- Driving on a curve.
- Driving uphill or downhill.
- An object ahead is very narrow such as motorcycles or bicycles.
- A vehicle suddenly cut in on your lane.
- The front vehicle suddenly departs from the lane or it is hidden by other objects.
- A vehicle passes by at a higher rate of speed.



- An unusual shape vehicle is ahead such as a trailer, special access vehicles or a truck with unique shaped cargo.
  - The rear lamps of the vehicle ahead is missing, installed on an unusual place or installed unevenly.
  - The front vehicle has a separate lamp or LED lamp at the rear of the vehicle.
  - Pass through a tunnel where the difference of intensity of illumination is high.
  - Driving with the sun in front of you.
  - The approaching vehicle turns high beam on.
  - The vehicle violently vibrates due to road conditions.
  - The vehicle is tilted from a flat tire or being towed.
  - The vehicle ahead is not distinguishable due to multiple or repeated shape lamps.
  - The vehicle ahead is not distinguishable due to objects that can be mistaken for a vehicle.
- The surrounding environments such as shadow or markers on a road, etc. could be mistaken as a vehicle.

**This device complies with Industry Canada licence-exempt RSS standard(s).**

Operation is subject to the following two conditions:

- (1) This device may not cause interference, and
- (2) This device must accept any interference, including interference that may cause undesired operation of the device.

### ECONOMICAL OPERATION

Your vehicle's fuel economy depends mainly on your style of driving, where you drive and when you drive.

Each of these factors affects how many miles (kilometers) you can get from a gallon (liter) of fuel. To operate your vehicle as economically as possible, use the following driving suggestions to help save money in both fuel and repairs:

- Drive smoothly. Accelerate at a moderate rate. Don't make "jack-rabbit" starts or full-throttle shifts and maintain a steady cruising speed. Don't race between stoplights. Try to adjust your speed to the traffic so you don't have to change speeds unnecessarily. Avoid heavy traffic whenever possible. Always maintain a safe distance from other vehicles so you can avoid unnecessary braking. This also reduces brake wear.
- Drive at a moderate speed. The faster you drive, the more fuel your vehicle uses. Driving at a moderate speed, especially on the highway, is one of the most effective ways to reduce fuel consumption.
- Don't "ride" the brake or clutch pedal. This can increase fuel consumption and also increase wear on these components. In addition, driving with your foot resting on the brake pedal may cause the brakes to overheat, which reduces their effectiveness and may lead to more serious consequences.
- Take care of your tires. Keep them inflated to the recommended pressure. Incorrect inflation, either too much or too little, results in unnecessary tire wear. Check the tire pressures at least once a month.
- Be sure that the wheels are aligned correctly. Improper alignment can result from hitting curbs or driving too fast over irregular surfaces. Poor alignment causes faster tire wear and may also result in other problems as well as greater fuel consumption.
- Keep your vehicle in good condition. For better fuel economy and reduced maintenance costs, maintain your vehicle in accordance with the maintenance schedule in section 7. If you drive your vehicle in severe conditions, more frequent maintenance is required (see section 7 for details).
- Keep your vehicle clean. For maximum service, your vehicle should be kept clean and free of corrosive materials. It is especially important that mud, dirt, ice, etc. not be allowed to accumulate on the underside of the vehicle. This extra weight can result in increased fuel consumption and also contribute to corrosion.
- Travel lightly. Don't carry unnecessary weight in your vehicle. Weight reduces fuel economy.
- Don't let the engine idle longer than necessary. If you are waiting (and not in traffic), turn off your engine and restart only when you're ready to go.

- Remember, your vehicle does not require extended warm-up. After the engine has started, allow the engine to run for 10 to 20 seconds prior to placing the vehicle in gear. In very cold weather, however, give your engine a slightly longer warm-up period.
  - Don't "lug" or "over-rev" the engine. Lugging is driving too slowly in a very high gear resulting in engine bucking. If this happens, shift to a lower gear. Over-revving is racing the engine beyond its safe limit. This can be avoided by shifting at the recommended speed.
  - Use your air conditioning sparingly. The air conditioning system is operated by engine power so your fuel economy is reduced when you use it.
  - Open windows at high speeds can reduce fuel economy.
  - Fuel economy is less in crosswinds and headwinds. To help offset some of this loss, slow down when driving in these conditions.
- Keeping a vehicle in good operating condition is important both for economy and safety. Therefore, have an authorized Kia dealer perform scheduled inspections and maintenance.

 **WARNING - Engine off during motion**

**Never turn the engine off to coast down hills or anytime the vehicle is in motion. The power steering and power brakes will not function properly without the engine running. In addition, turning off the ignition while driving could engage the steering wheel lock resulting in loss of vehicle steering. Keep the engine on and downshift to an appropriate gear for engine braking effect.**

## SPECIAL DRIVING CONDITIONS

### Hazardous driving conditions

When hazardous driving conditions are encountered such as water, snow, ice, mud, sand, or similar hazards, follow these suggestions:

- Drive cautiously and allow extra distance for braking.
- Avoid sudden braking or steering.
- When braking with non-ABS brakes pump the brake pedal with a light up-and-down motion until the vehicle is stopped.

Do not pump the brake pedal on a vehicle equipped with ABS.

- If stalled in snow, mud, or sand, use second gear. Accelerate slowly to avoid spinning the drive wheels.
- Use sand, rock salt, or other non-slip material under the drive wheels to provide traction when stalled in ice, snow, or mud.

**⚠ WARNING - Downshifting**  
**Do not downshift with an automatic transaxle while driving on slippery surfaces. The sudden change in tire speed could cause the tires to skid and result in an accident.**

### Reducing the risk of a rollover

This multi-purpose passenger vehicle is defined as a Crossover Utility Vehicle (CUV). CUV's have higher ground clearance and a narrower track to make them capable of performing in a wide variety of off-road applications. Specific design characteristics give them a higher center of gravity than ordinary vehicles. An advantage of the higher ground clearance is a better view of the road, which allows you to anticipate problems. They are not designed for cornering at the same speeds as conventional passenger vehicles, any more than low-slung sports vehicles are designed to perform satisfactorily in off-road conditions. Due to this risk, driver and passengers are strongly recommended to buckle their seat belts. In a rollover crash, an unbelted person is more likely to die than a person wearing a seat belt. There are steps that a driver can make to reduce the risk of a rollover. If at all possible, avoid sharp turns or abrupt maneuvers, do not load your roof rack with heavy cargo, and never modify your vehicle in any way.

**⚠ WARNING - Replacement tires**

Always use the size and type of tires recommended in the tire section of the manual. Installation of variant tires can affect the safety and performance of your vehicle.

**Rocking the vehicle**

If it is necessary to rock the vehicle to free it from snow, sand, or mud, first turn the steering wheel right and left to clear the area around your front wheels. Then, shift back and forth between 1st (First) and R (Reverse) in vehicles equipped with a manual transaxle or R (Reverse) and any forward gear in vehicles equipped with an automatic transaxle. Do not race the engine, and spin the wheels as little as possible. If you are still stuck after a few tries, have the vehicle pulled out by a tow vehicle to avoid engine overheating and possible damage to the transaxle.

**⚠ WARNING - Sudden vehicle movement**

Do not attempt to rock the vehicle if people or objects are nearby. The vehicle may suddenly move forward or backwards as it becomes unstuck.

**⚠ CAUTION-** Vehicle rocking  
*Prolonged rocking may cause engine overheating, transaxle damage or failure, and tire damage.*

**⚠ CAUTION-** Spinning tires  
*Do not spin the wheels, especially at speeds more than 56 km/h (35 mph). Spinning the wheels at high speeds when the vehicle is stationary could cause a tire to overheat which could result in tire damage that may injure bystanders.*

The ESC system should be turned OFF prior to rocking the vehicle.

**⚠ WARNING**  
- Sudden vehicle movement  
Do not attempt to rock the vehicle if people or objects are nearby. The vehicle may suddenly move forward or backwards as it becomes unstuck.

### Smooth cornering



Avoid braking or gear changing in corners, especially when roads are wet. Ideally, corners should always be taken under gentle acceleration. If you follow these suggestions, tire wear will be held to a minimum.

### Driving at night



Because night driving presents more hazards than driving in the daylight, here are some important tips to remember:

- Slow down and keep more distance between you and other vehicles, as it may be more difficult to see at night, especially in areas where there may not be any street lights.

- Adjust your mirrors to reduce the glare from other driver's headlights.
- Keep your headlights clean and properly aimed. (On vehicles not equipped with the automatic headlight aiming feature.) Dirty or improperly aimed headlights will make it much more difficult to see at night.
- Avoid staring directly at the headlights of oncoming vehicles. You could be temporarily blinded, and it will take several seconds for your eyes to readjust to the darkness.

### Driving in the rain



Rain and wet roads can make driving dangerous, especially if you're not prepared for the slick pavement. Here are a few things to consider when driving in the rain:

- A heavy rainfall will make it harder to see and will increase the distance needed to stop your vehicle, so slow down.
- Keep your windshield wiping equipment in good shape. Replace your windshield wiper blades when they show signs of streaking or missing areas on the windshield.

- If your tires are not in good condition, making a quick stop on wet pavement can cause a skid and possibly lead to an accident. Be sure your tires are in good shape.
- Turn on your headlights to make it easier for others to see you.
- Driving too fast through large puddles can affect your brakes. If you must go through puddles, try to drive through them slowly.
- If you believe you may have gotten your brakes wet, apply them lightly while driving until normal braking operation returns.

### Driving in flooded areas

Avoid driving through flooded areas unless you are sure the water is no higher than the bottom of the wheel hub. Drive through any water slowly. Allow adequate stopping distance because brake performance may be affected.

After driving through water, dry the brakes by gently applying them several times while the vehicle is moving slowly.

### Driving off-road

Drive carefully off-road because your vehicle may be damaged by rocks or roots of trees. Become familiar with the off-road conditions where you are going to drive before you begin driving.

### Highway driving

#### *Tires*

Adjust the tire inflation pressures to specification. Low tire inflation pressures will result in overheating and possible failure of the tires.

Avoid using worn or damaged tires which may result in reduced traction or tire failure.

Never exceed the maximum tire inflation pressure shown on the tires.

**⚠ WARNING - Under/over inflated tires**

**Always check the tires for proper inflation before driving. Underinflated or overinflated tires can cause poor handling, loss of vehicle control, and sudden tire failure leading to accidents, injuries, and even death. For proper tire pressures, refer to "Tires and wheels" in section 8.**

**⚠ WARNING - Tire tread**

**Always check the tire tread before driving your vehicle. Worn-out tires can result in loss of vehicle control. Worn-out tires should be replaced as soon as possible. For further information and tread limits, refer to "Tires and wheels" in section 7.**

### *Fuel, engine coolant and engine oil*

High speed travel consumes more fuel than urban motoring. Do not forget to check both the engine coolant and engine oil.

### *Drive belt*

A loose or damaged drive belt may result in overheating of the engine.



## WINTER DRIVING



1VQA3005

Severe weather conditions in the winter result in greater wear and other problems. To minimize the problems of winter driving, you should follow these suggestions:

### Snowy or icy conditions

To drive your vehicle in deep snow, it may be necessary to use snow tires on your tires. If snow tires are needed, it is necessary to select tires equivalent in size and type of the original equipment tires. Failure to do so may adversely affect the safety and handling of your vehicle. Furthermore, speeding, rapid acceleration, sudden brake applications, and sharp turns are potentially very hazardous practices.

During deceleration, use engine braking to the fullest extent. Sudden brake applications on snowy or icy roads may cause skids to occur. You need to keep sufficient distance between the vehicle in operation in front of your vehicle. Also, apply the brake gently.

### Snow tires

If you mount snow tires on your vehicle, make sure they are radial tires of the same size and load range as the original tires. Mount snow tires on all four wheels to balance your vehicle's handling in all weather conditions. Keep in mind that the traction provided by snow tires on dry roads may not be as high as your vehicle's original equipment tires. You should drive cautiously even when the roads are clear. Check with the tire dealer for maximum speed recommendations.

*Do not install studded tires without first checking local, state and municipal regulations for possible restrictions against their use.*

#### **⚠ WARNING - Snow tire size**

**Snow tires should be equivalent in size and type to the vehicle's standard tires. Otherwise, the safety and handling of your vehicle may be adversely affected.**

### **Use high quality ethylene glycol coolant**

Your vehicle is delivered with high quality ethylene glycol coolant in the cooling system. It is the only type of coolant that should be used because it helps prevent corrosion in the cooling system, lubricates the water pump and prevents freezing. Be sure to replace or replenish your coolant in accordance with the maintenance schedule in section 7. Before winter, have your coolant tested to assure that its freezing point is sufficient for the temperatures anticipated during the winter.

### **Check battery and cables**

Winter puts additional burdens on the battery system. Visually inspect the battery and cables as described in section 7. The level of charge in your battery can be checked by an authorized Kia dealer or a service station.

### **Change to "winter weight" oil if necessary**

In some climates it is recommended that a lower viscosity "winter weight" oil be used during cold weather. See section 8 for recommendations. If you aren't sure what weight oil you should use, consult an authorized Kia dealer.

### **Check spark plugs and ignition system**

Inspect your spark plugs as described in section 7 and replace them if necessary. Also check all ignition wiring and components to be sure they are not cracked, worn or damaged in any way.

### **To keep locks from freezing**

To keep the locks from freezing, squirt an approved de-icer fluid or glycerine into the key opening. If a lock is covered with ice, squirt it with an approved de-icing fluid to remove the ice. If the lock is frozen internally, you may be able to thaw it out by using a heated key. Handle the heated key with care to avoid injury.

### **Use approved window washer anti-freeze in system**

To keep the water in the window washer system from freezing, add an approved window washer anti-freeze solution in accordance with instructions on the container. Window washer anti-freeze is available from an authorized Kia dealer and most auto parts outlets. Do not use engine coolant or other types of anti-freeze as these may damage the paint finish.

### **Don't let your parking brake freeze**

Under some conditions your parking brake can freeze in the engaged position. This is most likely to happen when there is an accumulation of snow or ice around or near the rear brakes or if the brakes are wet. If there is a risk the parking brake may freeze, apply it only temporarily while you put the gear shift lever in P (Park, automatic transaxle) or in first or reverse gear (manual transaxle) and block the rear wheels so the vehicle cannot roll. Then release the parking brake.

### **Don't let ice and snow accumulate underneath**

Under some conditions, snow and ice can build up under the fenders and interfere with the steering. When driving in severe winter conditions where this may happen, you should periodically check underneath the vehicle to be sure the movement of the front wheels and the steering components are not obstructed.

### **Carry emergency equipment**

Depending on the severity of the weather, you should carry appropriate emergency equipment. Some of the items you may want to carry include tow straps or chains, flashlight, emergency flares, sand, shovel, jumper cables, window scraper, gloves, ground cloth, coveralls, blanket, etc.

### **TRAILER TOWING**

**We do not recommend using this vehicle for trailer towing.**

## VEHICLE LOAD LIMIT

### Tire and loading information label

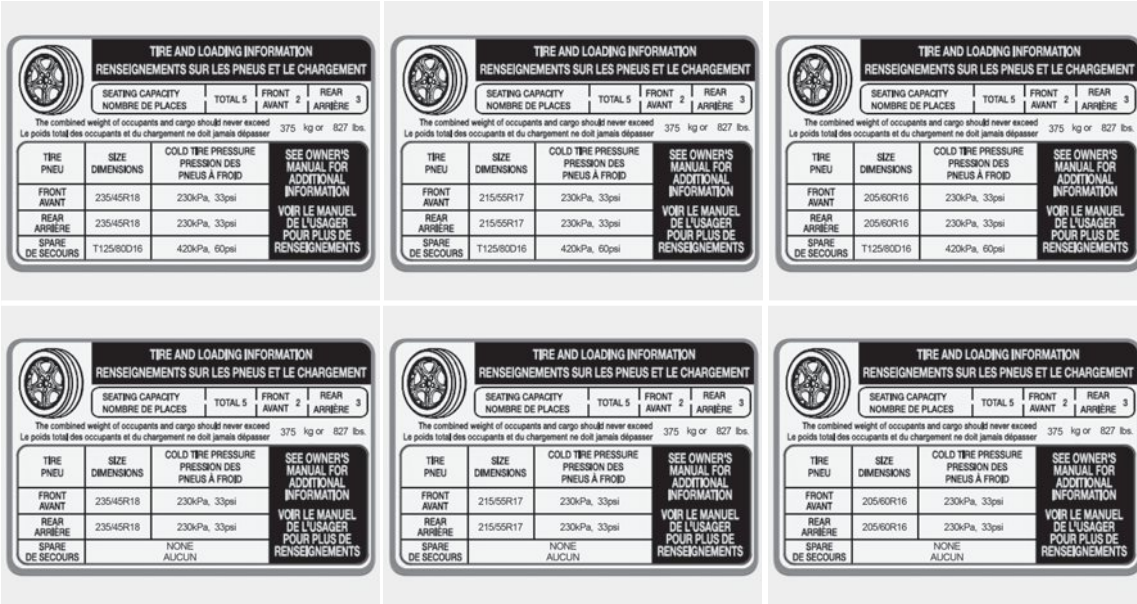

OPS053100N/OPS053104N/OPS053102N/OPS053101N/OPS053103N/OPS053105N

The label located on the driver's door sill gives the original tire size, cold tire pressures recommended for your vehicle, the number of people that can be in your vehicle and vehicle capacity weight.

***Vehicle capacity weight:***

375 kg (827 lbs.)

Vehicle capacity weight is the maximum combined weight of occupants and cargo. If your vehicle is equipped with a trailer, the combined weight includes the tongue load.

***Seating capacity:***

Total - 5 persons

(Front seat : 2 persons,  
Rear seat : 3 persons)

Seating capacity is the maximum number of occupants including a driver, your vehicle may carry.

However, the seating capacity may be reduced based upon the weight of all of the occupants, and the weight of the cargo being carried or towed.

Do not overload the vehicle as there is a limit to the total weight, or load limit including occupants and cargo, the vehicle can carry.

***Towing capacity:***

**We do not recommend using this vehicle for trailer towing.**

### ***Cargo capacity:***

The cargo capacity of your vehicle will increase or decrease depending on the weight and the number of occupants and the tongue load, if your vehicle is equipped with a trailer.

### ***Steps for determining correct load limit***

1. Locate the statement "The combined weight of occupants and cargo should never exceed XXX kg or XXX lbs." on your vehicle's placard.
2. Determine the combined weight of the driver and passengers that will be riding in your vehicle.
3. Subtract the combined weight of the driver and passengers from XXX kg or XXX lbs.
4. The resulting figure equals the available amount of cargo and luggage load capacity. For example, if the "XXX" amount equals 635 kg (1400 lbs.) and there will be five 68 kg (150 lbs.) passengers in your vehicle, the amount of available cargo and luggage load capacity is 295 kg (650 lbs).  
 $(635 - 340 (5 \times 68)) = 295 \text{ kg}$  or  
 $1400 - 750 (5 \times 150) = 650 \text{ lbs.}$

5. Determine the combined weight of luggage and cargo being loaded on the vehicle. That weight may not safely exceed the available cargo and luggage load capacity calculated in Step 4.
6. If your vehicle will be towing a trailer, load from your trailer will be transferred to your vehicle. Consult this manual to determine how this reduces the available cargo and luggage load capacity of your vehicle.

**Example 1**

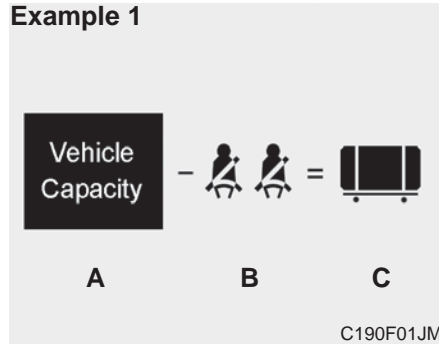

Item	Description	Total
A	Vehicle Capacity Weight	635 kg (1400 lbs)
B	Subtract Occupant Weight 68 kg (150 lbs) × 2	136 kg (300 lbs)
C	Available Cargo and Luggage weight	499 kg (1100 lbs)

**Example 2**

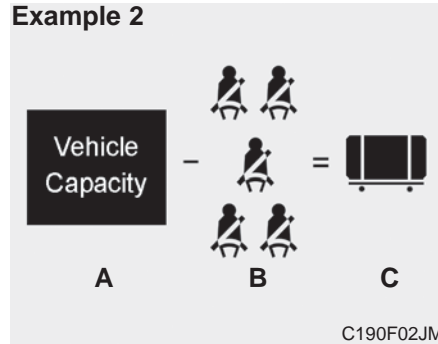

Item	Description	Total
A	Vehicle Capacity Weight	635 kg (1400 lbs)
B	Subtract Occupant Weight 68 kg (150 lbs) × 5	340 kg (750 lbs)
C	Available Cargo and Luggage weight	295 kg (650 lbs)

**Example 3**

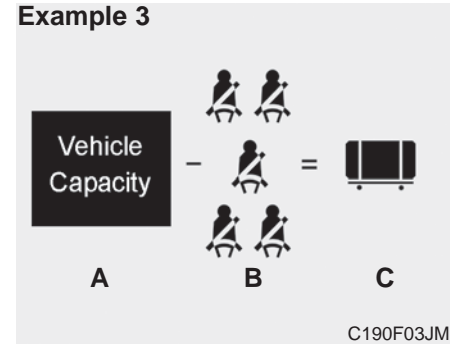

Item	Description	Total
A	Vehicle Capacity Weight	635 kg (1400 lbs)
B	Subtract Occupant Weight 78 kg (172 lbs) × 3	390 kg (860 lbs)
C	Available Cargo and Luggage weight	245 kg (540 lbs)

Refer to your vehicle's tire and loading information label for specific information about your vehicle's capacity weight and seating positions. The combined weight of the driver, passengers and cargo should never exceed your vehicle's capacity weight.

### Certification label

The certification label is located on the driver's door sill at the center pillar.

This label shows the maximum allowable weight of the fully loaded vehicle. This is called the GVWR (Gross Vehicle Weight Rating). The GVWR includes the weight of the vehicle, all occupants, fuel and cargo.

This label also tells you the maximum weight that can be supported by the front and rear axles, called Gross Axle Weight Rating (GAWR).

To find out the actual loads on your front and rear axles, you need to go to a weigh station and weigh your vehicle. Your dealer can help you with this. Be sure to spread out your load equally on both sides of the centerline.

**⚠ WARNING - Over loading**  
Never exceed the GVWR for your vehicle, the GAWR for either the front or rear axle and vehicle capacity weight. Exceeding these ratings can affect your vehicle's handling and braking ability.

The label will help you decide how much cargo and installed equipment your vehicle can carry.

If you carry items inside your vehicle - like suitcases, tools, packages, or anything else - they are moving as fast as the vehicle. If you have to stop or turn quickly, or if there is a crash, the items will keep going and can cause an injury if they strike the driver or a passenger.

**⚠ WARNING - Over loading**  
Do not overload your vehicle. Overloading your vehicle can cause heat buildup in your vehicle's tires and possible tire failure, increased stopping distances and poor vehicle handling all of which may result in a crash.

### \* NOTICE

Overloading your vehicle may cause damage. Repairs would not be covered by your warranty. Do not overload your vehicle.

**⚠ WARNING - Loose cargo**  
Do not travel with unsecured blunt objects in the passenger compartment of your vehicle (e.g. suit cases or unsecured child seats). These items may strike occupant during a sudden stop or crash.



## VEHICLE WEIGHT GLOSSARY

This section will guide you in the proper loading of your vehicle and/or trailer, to keep your loaded vehicle weight within its design rating capability, with or without a trailer. Properly loading your vehicle will provide maximum return of the vehicle design performance. Before loading your vehicle, familiarize yourself with the following terms for determining your vehicle's weight ratings, with or without a trailer, from the vehicle's specifications and the certification label:

### **Base curb weight**

This is the weight of the vehicle including a full tank of fuel and all standard equipment. It does not include passengers, cargo, or optional equipment.

### **Vehicle curb weight**

This is the weight of your new vehicle when you picked it up from your dealer plus any aftermarket equipment.

### **Cargo weight**

This figure includes all weight added to the Base Curb Weight, including cargo and optional equipment.

### **GAW (Gross axle weight)**

This is the total weight placed on each axle (front and rear) - including vehicle curb weight and all payload.

### **GAWR (Gross axle weight rating)**

This is the maximum allowable weight that can be carried by a single axle (front or rear). These numbers are shown on the certification label. The total load on each axle must never exceed its GAWR.

### **GVW (Gross vehicle weight)**

This is the Base Curb Weight plus actual Cargo Weight plus passengers.

### **GVWR (Gross vehicle weight rating)**

This is the maximum allowable weight of the fully loaded vehicle (including all options, equipment, passengers and cargo). The GVWR is shown on the certification label located on the driver's door sill.

# What to do in an emergency

- Road warning . . . . . 6-2
  - Hazard warning flasher . . . . . 6-2
- In case of an emergency while driving. . . . . 6-3
  - If the engine stalls at a crossroad or crossing. . . . . 6-3
  - If you have a flat tire while driving . . . . . 6-3
  - If the engine stalls while driving . . . . . 6-3
- If the engine will not start . . . . . 6-4
  - If engine doesn't turn over or turns over slowly . . . . 6-4
  - If engine turns over normally but does not start . . . . 6-4
- Emergency starting . . . . . 6-5
  - Jump starting. . . . . 6-5
  - Push-starting . . . . . 6-7
- If the engine overheats. . . . . 6-8
- If you have a flat tire (with Spare Tire) . . . . . 6-9
  - Jack and tools . . . . . 6-9
  - Removing and storing the spare tire . . . . . 6-10
  - Changing tires . . . . . 6-10
  - Use of temporary compact spare tire . . . . . 6-15
  - Jack label . . . . . 6-17

- If you have a flat tire (with Tire Mobility Kit) . . 6-18
  - Introduction . . . . . 6-18
  - Components of the Tire Mobility Kit . . . . . 6-20
  - Using the Tire Mobility Kit . . . . . 6-21
  - Distributing the sealant. . . . . 6-22
  - Checking the tire inflation pressure . . . . . 6-23
  - Notes on the safe use of the Tire Mobility Kit . . . . . 6-23
  - Technical Data . . . . . 6-24
- Towing . . . . . 6-25
  - Towing service . . . . . 6-25
  - Removable towing hook (front) . . . . . 6-26
  - Emergency towing. . . . . 6-27

## ROAD WARNING

### Hazard warning flasher

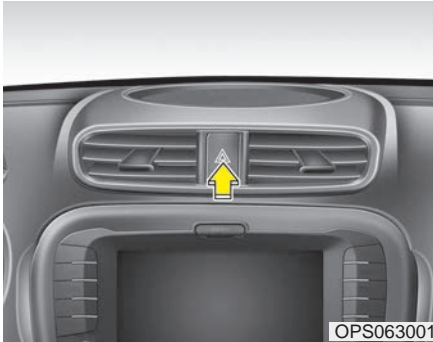

The hazard warning flasher serves as a warning to other drivers to exercise extreme caution when approaching, overtaking, or passing your vehicle.

It should be used whenever emergency repairs are being made or when the vehicle is stopped near the edge of a roadway.

Depress the flasher switch with the ignition switch in any position. The flasher switch is located in the center console switch panel. All turn signal lights will flash simultaneously.

- The hazard warning flasher operates whether your vehicle is running or not.
- The turn signals do not work when the hazard flasher is on.
- Care must be taken when using the hazard warning flasher while the vehicle is being towed.

## IN CASE OF AN EMERGENCY WHILE DRIVING

### If the engine stalls at a cross-road or crossing

If the engine stalls at a crossroad or crossing, set the shift lever in the N (Neutral) position and then push the vehicle to a safe place.

### If you have a flat tire while driving

If a tire goes flat while you are driving:

1. Take your foot off the accelerator pedal and let the vehicle slow down while driving straight ahead. Do not apply the brakes immediately or attempt to pull off the road as this may cause a loss of control. When the vehicle has slowed to such a speed that it is safe to do so, brake carefully and pull off the road. Drive off the road as far as possible and park on a firm level ground. If you are on a divided highway, do not park in the median area between the two traffic lanes.

2. When the vehicle is stopped, turn on your emergency hazard flashers, set the parking brake and put the transaxle in P (Park, automatic transaxle) or reverse (manual transaxle).
3. Have all passengers get out of the vehicle. Be sure they all get out on the side of the vehicle that is away from traffic.
4. When changing a flat tire, follow the instruction provided later in this section.

### If the engine stalls while driving

1. Reduce your speed gradually, keeping a straight line. Move cautiously off the road to a safe place.
2. Turn on your emergency flashers.
3. Try to start the engine again. If your vehicle will not start, contact an authorized Kia dealer or seek other qualified assistance.

### \* NOTICE

**If there was a check engine light and loss of power or stall and if safe to do so to wait at least 10 seconds to restart the vehicle after it stalls. This may reset the car so it will no longer run at low power (limp home) condition.**

## IF THE ENGINE WILL NOT START

### If engine doesn't turn over or turns over slowly

- 1.If your vehicle has an automatic transaxle, be sure the shift lever is in N (Neutral) or P (Park) and the emergency brake is set.
- 2.Check the battery connections to be sure they are clean and tight.
- 3.Turn on the interior light. If the light dims or goes out when you operate the starter, the battery is discharged.
- 4.Check the starter connections to be sure they are securely tightened.
- 5.Do not push or pull the vehicle to start it. See instructions for "Jump starting".

 **WARNING** - Push/pull start

**Do not push or pull the vehicle to start it. Push or pull starting may cause the catalytic converter to overload and create a fire hazard.**

### If engine turns over normally but does not start

- 1.Check the fuel level.
- 2.With the ignition switch in the LOCK position, check all connectors at the ignition coils and spark plugs. Reconnect any that may be disconnected or loose.
- 3.Check the fuel line in the engine compartment.
- 4.If the engine still does not start, call an authorized Kia dealer or seek other qualified assistance.

## EMERGENCY STARTING

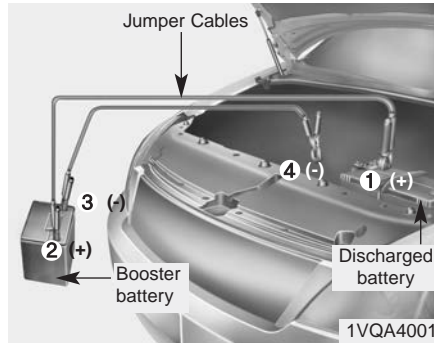

Connect cables in numerical order and disconnect in reverse order.

### Jump starting

Jump starting can be dangerous if done incorrectly. Therefore, to avoid harm to yourself or damage to your vehicle or battery, follow these jump starting procedures. If in doubt, we strongly recommend that you have a competent technician or towing service jump start your vehicle.

#### **⚠ CAUTION- 12 volt battery**

***Use only a 12-volt jumper system. You can damage a 12-volt starting motor, ignition system, and other electrical parts beyond repair by use of a 24-volt power supply (either two 12-volt batteries in series or a 24-volt motor generator set).***

#### **⚠ WARNING - Battery**

**Never attempt to check the electrolyte level of the battery as this may cause the battery to rupture or explode causing serious injury.**

#### **⚠ WARNING - Frozen batteries**

**Do not attempt to jump start the vehicle if the discharged battery is frozen or if the electrolyte level is low as the battery may rupture or explode.**

**⚠ WARNING - Battery**

**Keep all flames or sparks away from the battery. The battery produces hydrogen gas which will explode if exposed to flame or sparks.**

**⚠ WARNING - Sulfuric acid risk**

**When jump starting your vehicle be careful not to get acid on yourself, your clothing or on the vehicle. Automobile batteries contain sulfuric acid. This is poisonous and highly corrosive.**

***Jump starting procedure***

1. Make sure the booster battery is 12-volt and that its negative terminal is grounded.
2. If the booster battery is in another vehicle, do not allow the vehicles to come in contact.
3. Turn off all unnecessary electrical loads.
4. Connect the jumper cables in the exact sequence shown in the illustration. First connect one end of a jumper cable to the positive terminal of the discharged battery (1), then connect the other end to the positive terminal of the booster battery (2).

Proceed to connect one end of the other jumper cable to the negative terminal of the booster battery (3), then the other end to a solid, stationary, metallic point (for example, the engine lifting bracket) away from the battery (4). Do not connect it to or near any part that moves when the engine is cranked.

Do not allow the jumper cables to contact anything except the correct battery terminals or the correct ground. Do not lean over the battery when making connections.

**⚠ WARNING - Battery cables**

**Do not connect the jumper cable from the negative terminal of the booster battery to the negative terminal of the discharged battery. This can cause the discharged battery to overheat and crack, releasing battery acid.**

5. Start the engine of the vehicle with the booster battery and let it run at 2,000 rpm, then start the engine of the vehicle with the discharged battery.

*If the cause of your battery discharging is not apparent, you should have your vehicle checked by an authorized Kia dealer.*

## Push-starting

Vehicles equipped with automatic transaxle lock system cannot be push-started.

Follow the directions in this section for jump-starting.

**⚠ WARNING- Tow starting vehicle**

**Never tow a vehicle to start it because the sudden surge forward when the engine starts could cause a collision with the tow vehicle.**



## IF THE ENGINE OVERHEATS

If your temperature gauge indicates overheating, you experience a loss of power, or hear loud pinging or knocking, the engine will probably be too hot. If this happens, you should:

1. Pull off the road and stop as soon as it is safe to do so.
2. Place the shift lever in P (Park, automatic transaxle) or Neutral (manual transaxle) and set the parking brake. If the air conditioning is on, turn it off.
3. If engine coolant is running out under the vehicle or steam is coming out from underneath the hood, stop the engine. Do not open the hood until the coolant has stopped running or the steaming has stopped. If there is no visible loss of engine coolant and no steam, leave the engine running and check to be sure the engine cooling fan is operating. If the fan is not running, turn the engine off.

4. Check to see if the water pump drive belt is missing. If it is not missing, check to see that it is tight. If the drive belt seems to be satisfactory, check for coolant leaking from the radiator, hoses or under the vehicle. (If the air conditioning had been in use, it is normal for cold water to be draining from it when you stop).

**⚠ WARNING - Under the hood**

**While the engine is running, keep hair, hands and clothing away from moving parts such as the fan and drive belts to prevent injury.**

5. If the water pump drive belt is broken or engine coolant is leaking out, stop the engine immediately and call the nearest authorized Kia dealer for assistance.

**⚠ WARNING- Radiator cap**

**Do not remove the radiator cap when the engine is hot. This may result in coolant being blown out of the opening and cause serious burns.**

6. If you cannot find the cause of the overheating, wait until the engine temperature has returned to normal. Then, if coolant has been lost, carefully add coolant to the reservoir to bring the fluid level in the reservoir up to the halfway mark.
7. Proceed with caution, keeping alert for further signs of overheating. If overheating happens again, call an authorized Kia dealer for assistance.

Serious loss of coolant indicates there is a leak in the cooling system and this should be checked as soon as possible by an authorized Kia dealer.

## IF YOU HAVE A FLAT TIRE

### Jack and tools (if equipped)



The jack, jack handle, wheel lug nut wrench are stored in the luggage compartment.

Pull up the luggage box cover to reach this equipment.

- (1) Jack handle
- (2) Jack
- (3) Wheel lug nut wrench

### Jacking instructions

The jack is provided for emergency tire changing only.

To prevent the jack from “rattling” while the vehicle is in motion, store it properly.

Follow jacking instructions to reduce the possibility of personal injury.

#### **⚠ WARNING - Tire Jack**

**Do not place any portion of your body under a vehicle that is only supported by a jack since the vehicle can easily roll off the jack. Use vehicle support stands.**

- Always move the vehicle completely off the road and onto the shoulder before trying to change a tire. The jack should be used on a firm level ground. If you cannot find a firm, level place off the road, call a towing service company for assistance.
- Be sure to use the correct front and rear jacking positions on the vehicle; never use the bumpers or any other part of the vehicle for jack support.
- Do not allow anyone to remain in the vehicle while it is on the jack.
- Make sure any children present are in a secure place away from the road and from the vehicle to be raised with the jack.

#### **⚠ WARNING - Running vehicle on jack**

**Do not start or run the engine of the vehicle while the vehicle is on the jack as this may cause the vehicle to fall off the jack.**

### Removing and storing the spare tire (if equipped)

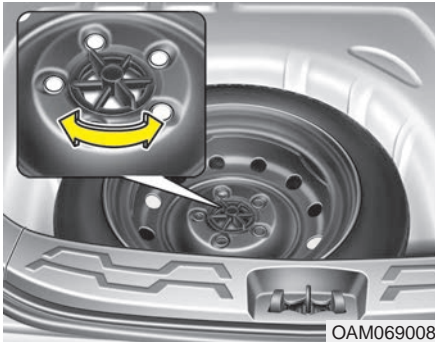

Turn the tire hold-down wing bolt counterclockwise.

Store the tire in the reverse order of removal.

To prevent the spare tire and tools from “rattling” while the vehicle is in motion, store them properly.

### Changing tires

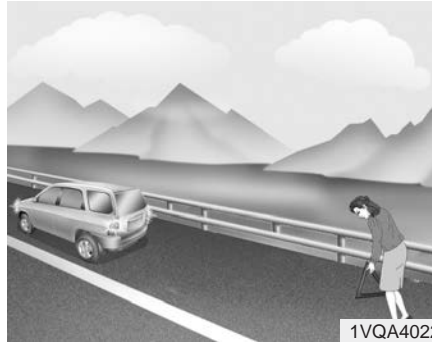

1. Park on a level surface and apply the parking brake firmly.
2. Place the transaxle shift lever in R (Reverse) with manual transaxle or P (Park) with automatic transaxle.
3. Activate the hazard warning flashers.



4. Remove the wheel lug nut wrench, jack, jack handle, and spare tire from the vehicle.
5. Block both the front and rear of the wheel that is diagonally opposite from the jack position.

**⚠ WARNING - Changing a tire**

- To prevent vehicle movement while changing a tire, always set the parking brake fully, and always block the wheel diagonally opposite the wheel being changed.
- We recommend that the wheels of the vehicle be blocked, and that no person remain in a vehicle that is being jacked.



6. Loosen the wheel lug nuts counter-clockwise one turn each, but do not remove any nut until the tire has been raised off the ground.

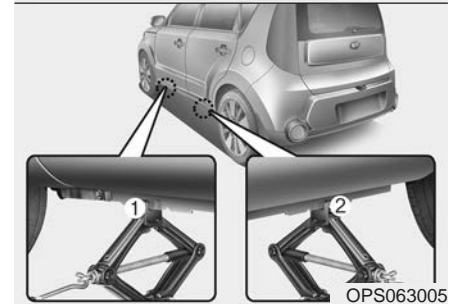
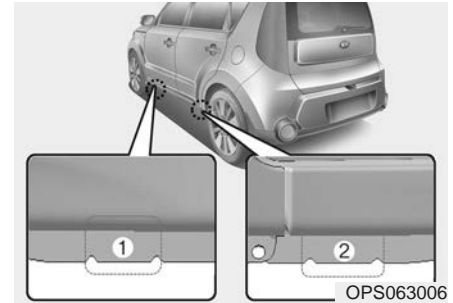

7. Place the jack at the front (1) or rear (2) jacking position closest to the tire you are changing. Place the jack at the designated locations under the frame.



**⚠ WARNING - Jack location**  
To reduce the possibility of injury, be sure to use only the jack provided with the vehicle in the correct jack position; never use any other part of the vehicle for jack support.

8. Insert the jack handle into the jack and turn it clockwise, raising the vehicle until the tire just clears the ground. This measurement is approximately 30 mm. (1 in).

Before removing the wheel lug nuts, make sure the vehicle is stable and that there is no chance for movement or slippage.

9. Loosen the wheel nuts and remove them with your fingers. Slide the wheel off the studs and lay it flat so it cannot roll away. To put the wheel on the hub, pick up the spare tire, line up the holes with the studs and slide the wheel onto them. If this is difficult, tip the wheel slightly and get the top hole in the wheel lined up with the top stud. Then jiggle the wheel back and forth until the wheel can slide over the other studs.

Wheels may have sharp edges. Handle them carefully to avoid possible severe injury. Before putting the wheel into place, be sure that there is nothing on the hub or wheel (such as mud, tar, gravel, etc.) that prevents the wheel from fitting solidly against the hub.

**⚠ WARNING - Installing a wheel**

**Make sure the wheel makes good contact with the hub when installed. If the contact of the mounting surface between the wheel and hub is not good, the wheel nuts could come loose and cause the loss of a wheel. Loss of a wheel may result in loss of control of the vehicle.**

10. To install the wheel, hold it on the studs, put the wheel nuts on the studs and tighten them finger tight. Jiggle the tire to be sure it is completely seated, then tighten the nuts as much as possible with your fingers again.
11. Insert the wrench into the jack and lower the vehicle to the ground by turning the wheel nut wrench counterclockwise.



Then position the wrench as shown in the drawing and tighten the wheel nuts. Be sure the socket is seated completely over the nut. Do not stand on the wrench handle or use an extension pipe over the wrench handle. Go around the wheel tightening every nut following the numerical sequence shown in the image until they are all tight. Then double-check each nut for tightness. After changing wheels, have an authorized Kia dealer tighten the wheel nuts to their proper torque as soon as possible.

**Wheel nut tightening torque:**

9~11 kg·m (65~79 lb·ft)

If you have a tire gauge, remove the valve cap and check the air pressure. If the pressure is lower than recommended, drive slowly to the nearest service station and inflate to the correct pressure. If it is too high, adjust it until it is correct. Always reinstall the valve cap after checking or adjusting the tire pressure. If the cap is not replaced, dust and dirt may get into the tire valve and air may leak from the tire. If you lose a valve cap, buy another and install it as soon as possible.

After you have changed the wheels, always secure the flat tire in its place and return the jack and tools to their proper storage locations.

 **CAUTION - Reusing lug nuts**

***Make certain during wheel removal that the same nuts that were removed are reinstalled - or, if replaced, that nuts with metric threads and the same chamfer configuration are used. Your vehicle has metric threads on the wheel studs and nuts. Installation of a non-metric thread nut on a metric stud will not secure the wheel to the hub properly and will damage the stud so that it must be replaced.***

Note that most lug nuts do not have metric threads. Be sure to use extreme care in checking for thread style before installing aftermarket lug nuts or wheels. If in doubt, consult an authorized Kia dealer.

 **WARNING - Wheel studs**  
**If the studs are damaged, they may lose their ability to retain the wheel. This could lead to the loss of the wheel and a collision.**

To prevent the jack, jack handle, wheel lug nut wrench and spare tire from rattling while the vehicle is in motion, store them properly.

Check the inflation pressures as soon as possible after installing the spare tire. Adjust it to the specified pressure, if necessary. Refer to "Tires and wheels" in chapter 8.

***Important - use of compact spare tire (if equipped)***

Your vehicle is equipped with a compact spare tire. This compact spare tire takes up less space than a regular-size tire. This tire is smaller than a conventional tire and is designed for temporary use only.

- You should drive carefully when the compact spare is in use. The compact spare should be replaced by the proper conventional tire and rim at the first opportunity.
- The operation of this vehicle is not recommended with more than one compact spare tire in use at the same time.

**⚠ WARNING - Spare tire**  
**Do not operate your vehicle on this compact spare at speeds over 80 km/h (50 mph). The compact spare tire is for emergency use only. The original tire should be repaired or replaced as soon as possible to avoid failure of the spare.**

The compact spare should be inflated to 420 kPa (60 psi).

**\* NOTICE**

**Check the inflation pressure after installing the spare tire. Adjust it to the specified pressure, as necessary.**

When using a compact spare tire, observe the following precautions:

- Under no circumstances should you exceed 80 km/h (50 mph); a higher speed could damage the tire.
- Ensure that you drive slowly enough for the road conditions to avoid all hazards. Any road hazard, such as a pothole or debris, could seriously damage the compact spare.
- Any continuous road use of this tire could result in tire failure, loss of vehicle control, and possible personal injury.
- Do not exceed the vehicle's maximum load rating or the load-carrying capacity shown on the sidewall of the compact spare tire.



## What to do in an emergency

---

- Avoid driving over obstacles. The compact spare tire diameter is smaller than the diameter of a conventional tire and reduces the ground clearance approximately 25 mm (1 inch), which could result in damage to the vehicle.
- Do not take this vehicle through an automatic vehicle wash while the compact spare tire is installed.
- Do not use the compact spare tire on any other vehicle because this tire has been designed especially for your vehicle.
- The compact spare tire's tread life is shorter than a regular tire. Inspect your compact spare tire regularly and replace worn compact spare tires with the same size and design, mounted on the same wheel.
- The compact spare tire should not be used on any other wheels, nor should standard tires, snow tires, wheel covers or trim rings be used with the compact spare wheel. If such use is attempted, damage to these items or other vehicle components may occur.
- Do not use more than one compact spare tire at a time.
- Do not tow a trailer while the compact spare tire is installed.

## Jack label

- Example
- Type A

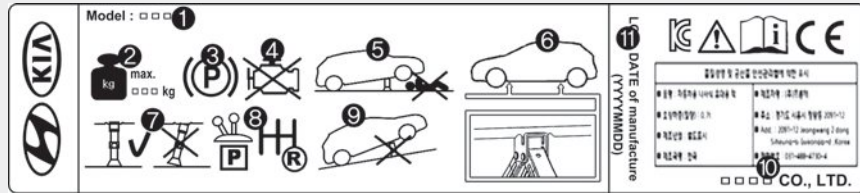

OHYK064001

- Type B



OHYK064002

\* The actual Jack label in the vehicle may differ from the illustration. For more detailed specifications, refer to the label attached to the jack.

1. Model Name
2. Maximum allowable load
3. When using the jack, set your parking brake.
4. When using the jack, stop the engine.
5. Do not get under a vehicle that is supported by a jack.
6. The designated locations under the frame
7. When supporting the vehicle, the base plate of jack must be vertical under the lifting point.
8. Shift into Reverse gear on vehicles with manual transmission or move the shift lever to the P position on vehicles with automatic transmission.
9. The jack should be used on firm level ground.
10. Jack manufacturer
11. Production date

## IF YOU HAVE A FLAT TIRE (TIRE MOBILITY KIT, IF EQUIPPED)

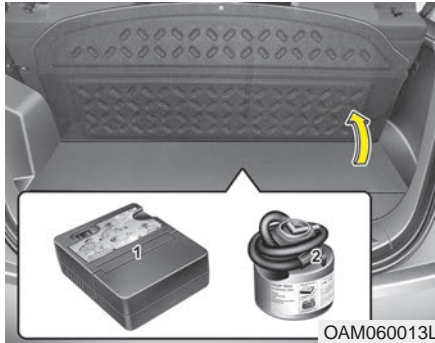

For safe operation, carefully read and follow the instructions in this manual before use.

- (1) Compressor
- (2) Sealant bottle

Tire Mobility Kit is a temporary fix to the tire and the tire should be inspected by an authorized Kia dealer as soon as possible.

### \* NOTICE

The Tire Mobility Kit sealing compound in the bottle is to be used for one tire only. For additional replacement sealant bottles, consult an authorized Kia dealer.

When two or more tires are flat, do not use the tire mobility kit because the supported one sealant of Tire Mobility Kit is only used for one flat tire.

**⚠ WARNING - Tire wall**  
Do not use the Tire Mobility Kit to repair punctures in the tire walls. This can result in an accident due to tire failure.

## Introduction



With the Tire Mobility Kit you stay mobile even after experiencing a tire puncture.

The system of compressor and sealing compound effectively and comfortably seals most punctures in a passenger car tire caused by nails or similar objects and reinflates the tire.

After you ensured that the tire is properly sealed you can drive cautiously on the tire (distance up to 200 km (120 miles)) at a max. speed of (80 km/h) in order to reach a service station or tire dealer for the tire replacement.

It is possible that some tires, especially with larger punctures or damage to the sidewall, cannot be sealed completely.

Air pressure loss in the tire may adversely affect tire performance.

For this reason, you should avoid abrupt steering or other driving maneuvers, especially if the vehicle is heavily loaded or if a trailer is in use.

The Tire Mobility Kit is not designed or intended as a permanent tire repair method and is to be used for one tire only.

This instruction shows you step by step how to temporarily seal the puncture simply and reliably.

Read the section "Notes on the safe use of the Tire Mobility Kit".

### **Notes on the suggested use of the Tire Mobility Kit**

- Park your car at the side of the road so that you can work with the Tire Mobility Kit away from moving traffic.
- To be sure your vehicle will not move, even when you're on fairly level ground, always set your parking brake.
- Only use the Tire Mobility Kit for sealing/inflation passenger car tires. Only punctured areas located within the tread region of the tire can be sealed using the tire mobility kit.
- Do not use on motorcycles, bicycles or any other type of tires.
- When the tire and wheel are damaged, do not use Tire Mobility Kit for your safety.
- Use of the Tire Mobility Kit may not be effective for tire damage larger than approximately 6 mm (0.24 in).  
Please contact the nearest Kia dealership if the tire cannot be made roadworthy with the Tire Mobility Kit.

- Do not use the Tire Mobility Kit if a tire is severely damaged by driving run flat or with insufficient air pressure.
- Do not remove any foreign objects such as nails or screws that have penetrated the tire.
- Provided the car is outdoors, leave the engine running. Otherwise operating the compressor may eventually drain the car battery.
- Never leave the Tire Mobility Kit unattended while it is being used.
- Do not leave the compressor running for more than 10 min. at a time or it may overheat.
- Do not use the Tire Mobility Kit if the ambient temperature is below -30°C (22°F).

## Components of the Tire Mobility Kit

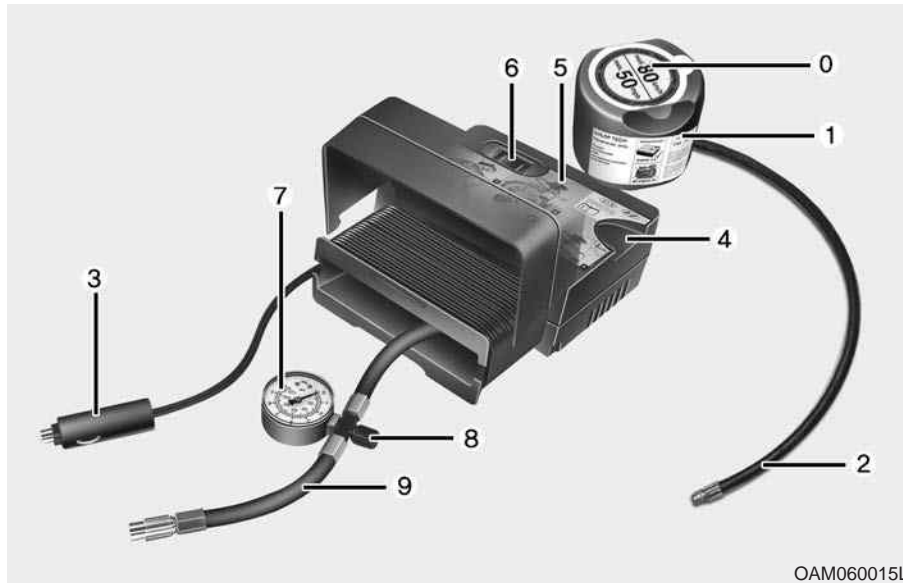

OAM060015L

0. Speed restriction label
1. Sealant bottle and label with speed restriction
2. Filling hose from sealant bottle to wheel
3. Connectors and cable for the power outlet direct connection
4. Holder for the sealant bottle
5. Compressor
6. On/off switch
7. Pressure gauge for displaying the tire inflation pressure
8. Screw cap for reducing tire inflation pressure

9. Hose to connect compressor and sealant bottle or compressor and wheel

Connectors, cable and connection hose are stored in the compressor housing.

**⚠ WARNING - Expired sealant**

Do not use the Tire sealant after the sealant has expired (i.e. pasted the expiration date on the sealant container). This can increase the risk of tire failure.

**⚠ WARNING - Sealant**

- Keep out of reach of children.
- Avoid contact with eyes.
- Do not swallow.

Strictly follow the specified sequence, otherwise the sealant may escape under high pressure.

## Using the Tire Mobility Kit

1. Detach the speed restriction label (0) from the sealant bottle (1), and place it in a highly visible place inside the vehicle such as on the steering wheel to remind the driver not to drive too fast.
2. Screw connection hose (9) onto the connector of the sealant bottle.
3. Ensure that screw cap (8) is closed.
4. Unscrew the valve cap from the valve of the defective wheel and screw filling hose (2) of the sealant bottle onto the valve.
5. Insert the sealant bottle into the housing (4) of the compressor so that the bottle is upright.



6. Ensure that the compressor is switched off, position 0.



7. Plug the compressor power cord into the front passenger side power outlet of the vehicle.

### \* NOTICE

Only use the front passenger side power outlet when connecting the power cord.

8. With the engine start/stop button position on or ignition switch position on, switch on the compressor and let it run for approximately 5~7 minutes to fill the sealant up to proper pressure. (refer to the Tire and Wheels, chapter 8). The inflation pressure of the tire after filling is unimportant and will be checked/corrected later.

Be careful not to overinflate the tire and stay away from the tire when filling it.

**⚠ WARNING - Tire pressure**  
Do not attempt to drive your vehicle if the tire pressure is below 200kpa (29 PSI). This could result in an accident due to sudden tire failure.

9. Switch off the compressor.  
10. Detach the hoses from the sealant bottle connector and from the tire valve.

Return the Tire Mobility Kit to its storage location in the vehicle.

**⚠ WARNING - Carbon monoxide**

Do not leave your vehicle running in a poorly ventilated area for extended periods of time. Carbon monoxide poisoning and suffocation can occur.

### Distributing the sealant

11. Immediately drive approximately 7~10km (4~6miles or, about 10min) to evenly distribute the sealant in the tire.

Do not exceed a speed of 80 km/h (50 mph). If possible, do not fall below a speed of 20 km/h (12 mph).

While driving, if you experience any unusual vibration, ride disturbance or noise, reduce your speed and drive with caution until you can safely pull off of the side of the road.

Call for road side service or towing.

When you use the Tire Mobility Kit, the tire pressure sensors and wheel may be stained by sealant.

Therefore, remove the tire pressure sensors and wheel stained by sealant and have it serviced by an authorized Kia dealer.

### Checking the tire inflation pressure

1. After driving approximately 7~10km (4~6miles or about 10min), stop at a safety location.
2. Connect connection hose (9) of the compressor directly to the tire valve.
3. Plug the compressor power cord into the vehicle power outlet.
4. Adjust the tire inflation pressure to the recommended tire inflation.

With the ignition switched on, proceed as follows.

- **To increase the inflation pressure** : Switch on the compressor, position I. To check the current inflation pressure setting, briefly switch off the compressor.

### \* NOTICE

The pressure gauge may show higher than actual reading when the compressor is running. To get an accurate tire pressure, the compressor needs to be turned off.

- **To reduce the inflation pressure**: Loosen the screw cap (8) on the compressor hose.



### CAUTION - Tire pressure sensor

*When you use the Tire Mobility Kit including sealant not approved by Kia, the tire pressure sensors may be damaged by sealant. The sealant on the tire pressure sensor and wheel should be removed when you replace the tire with a new one and inspect the tire pressure sensors in authorized dealer.*



### **Technical Data**

System voltage: DC 12 V

Working voltage: DC 10 - 15 V

Amperage rating: max. 15 A

Suitable for use at temperatures:

-30 ~ +70°C (-22 ~ +158°F)

Max. working pressure:

6 bar (87 psi)

Size

Compressor: 170 x 150 x 60 mm

(6.7 x 5.9 x 2.4 in.)

Sealant bottle: 85 x 70 ø mm

(3.3 x 2.8 ø in.)

Compressor weight:

0.8 kg (1.77 lbs)

Sealant volume:

200 ml (12.2 cu. in.)

## TOWING

### Towing service

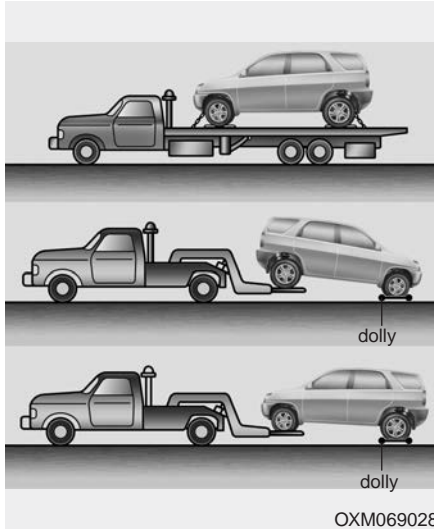

If emergency towing is necessary, we recommend having it done by an authorized Kia dealer or a commercial tow-truck service. Proper lifting and towing procedures are necessary to prevent damage to the vehicle. The use of wheel dollies or flatbed is recommended.

*For trailer towing guidelines information, refer to "Trailer towing" in chapter 5.*

It is acceptable to tow the vehicle with the rear wheels on the ground (without dollies) and the front wheels off the ground.

If any of the loaded wheels or suspension components are damaged or the vehicle is being towed with the front wheels on the ground, use a towing dolly under the front wheels.

When being towed by a commercial tow truck and wheel dollies are not used, the front of the vehicle should always be lifted, not the rear.

### **⚠ WARNING**

#### **- Side and curtain air bag**

**If your vehicle is equipped with side and curtain air bag, set the ignition switch to LOCK or ACC position when the vehicle is being towed.**

**The side and curtain air bag may deploy when the ignitions is ON, and the rollover sensor detects the situation as a rollover.**

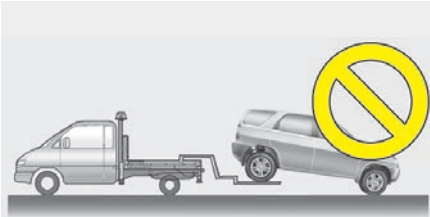

OUN046030

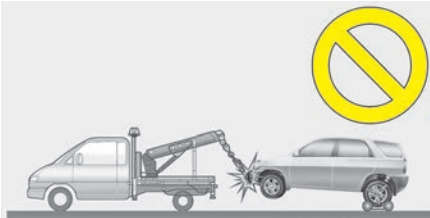

OCM054034

### **⚠ CAUTION - Towing**

- **Do not tow the vehicle backwards with the front wheels on the ground as this may cause damage to the vehicle.**
- **Do not tow with sling-type equipment. Use wheel lift or flatbed equipment.**

When towing your vehicle in an emergency without wheel dollies :

1. Set the ignition switch in the ACC position.
2. Place the transaxle shift lever in N (Neutral).
3. Release the parking brake.

### **⚠ CAUTION - Towing gear position**

***Failure to place the transaxle shift lever in N (Neutral) may cause internal damage to the transaxle.***

### **Removable towing hook (front) (if equipped)**

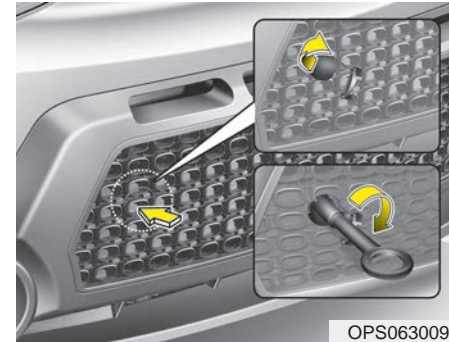

OPS063009

1. Remove the towing hook from the tool case.
2. Remove the hole cover pressing the lower part of the cover on the front bumper.

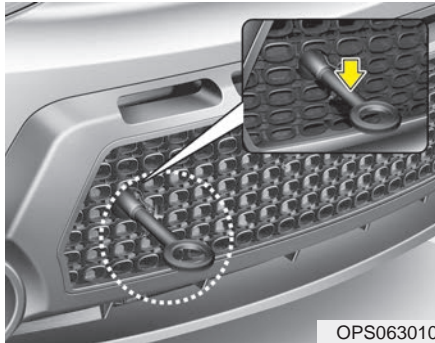

3. Install the towing hook by turning it clockwise into the hole until it is fully secured.
4. Remove the towing hook and install the cover after use.

## Emergency towing

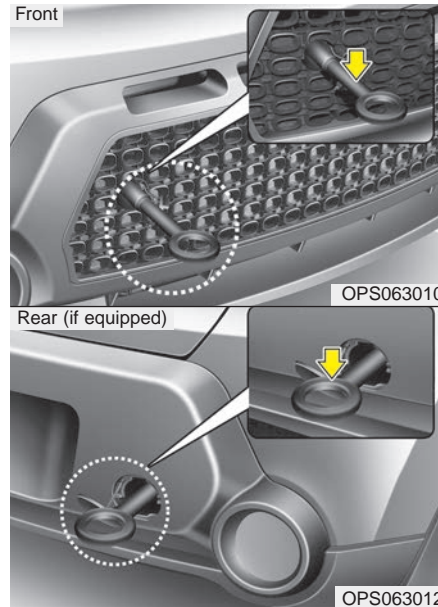

If towing is necessary, we recommend you to have it done by an authorized Kia dealer or a commercial tow truck service.

If towing service is not available in an emergency, your vehicle may be temporarily towed using a cable or chain secured to the emergency towing hook under the front (or rear) of the vehicle. Use extreme caution when towing the vehicle. A driver must be in the vehicle to steer it and operate the brakes.

Towing in this manner may be done only on hard-surfaced roads for a short distance and at low speeds. Also, the wheels, axles, power train, steering and brakes must all be in good condition.

- Do not use the tow hooks to pull a vehicle out of mud, sand or other conditions from which the vehicle cannot be driven out under its own power.
- Avoid towing a vehicle heavier than the vehicle doing the towing.
- The drivers of both vehicles should communicate with each other frequently.

## What to do in an emergency

- Attach a towing strap to the tow hook.
- Using a portion of the vehicle other than the tow hooks for towing may damage the body of your vehicle.
- Only use a cable or chain specifically intended for use in towing vehicles. Securely fasten the cable or chain to the towing hook provided.
- Before emergency towing, check that the hook is not broken or damaged.
- Fasten the towing cable or chain securely to the hook.
- Do not jerk the hook. Apply it steadily and with even force.
- To avoid damaging the hook, do not pull from the side or at a vertical angle. Always pull straight ahead.

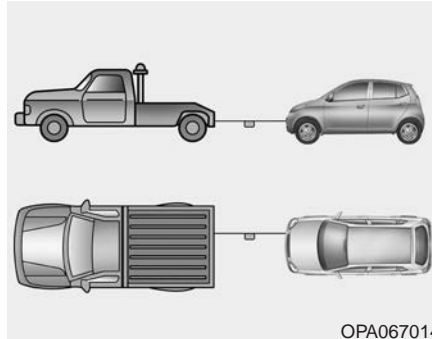

- Use a towing strap less than 5 m (16 feet) long. Attach a white or red cloth (about 30 cm (12 inches) wide) in the middle of the strap for easy visibility.
- Drive carefully so that the towing strap is not loose during towing.

### ***Emergency towing precautions***

- Turn the ignition switch to ACC so the steering wheel isn't locked.
- Place the transaxle shift lever in N (Neutral).
- Release the parking brake.
- Press the brake pedal with more force than usual since you will have reduced brake performance.
- More steering effort will be required because the power steering system will be disabled.
- If you are driving down a long hill, the brakes may overheat and brake performance will be reduced. Stop often and let the brakes cool off.
- If the car is being towed with all four wheels on the ground, it can be towed only from the front. Be sure that the transaxle is in neutral. Be sure the steering is unlocked by placing the ignition switch in the ACC position. A driver must be in the towed vehicle to operate the steering and brakes.

 **CAUTION - Automatic transaxle**

*To avoid serious damage to the automatic transaxle, limit the vehicle speed to 15 km/h (10 mph) and drive less than 1.5 km (1 mile) when towing.*

**\* NOTICE**

Before towing, check the automatic transaxle for fluid leaks under your vehicle. If the automatic transaxle fluid is leaking, a flatbed equipment or towing dolly must be used.

# Maintenance

Engine compartment . . . . .	7-3	• Filter replacement . . . . .	7-47
Maintenance services . . . . .	7-5	Wiper blades . . . . .	7-49
• Owner's responsibility . . . . .	7-5	• Blade inspection . . . . .	7-49
• Owner maintenance precautions . . . . .	7-6	• Blade replacement . . . . .	7-49
Owner maintenance . . . . .	7-7	Battery . . . . .	7-53
• Owner maintenance schedule . . . . .	7-7	• For best battery service . . . . .	7-53
Scheduled maintenance service . . . . .	7-9	• Battery recharging . . . . .	7-54
Explanation of scheduled maintenance items . . . . .	7-32	• Reset items . . . . .	7-55
Engine oil . . . . .	7-36	Tires and wheels . . . . .	7-56
• Checking the engine oil level . . . . .	7-36	• Tire care . . . . .	7-56
• Changing the engine oil and filter . . . . .	7-37	• Recommended cold tire inflation pressures . . . . .	7-56
Engine coolant . . . . .	7-38	• Checking tire inflation pressure . . . . .	7-57
• Checking the coolant level . . . . .	7-38	• Tire rotation . . . . .	7-58
• Changing the coolant . . . . .	7-40	• Wheel alignment and tire balance . . . . .	7-59
Brake/clutch fluid . . . . .	7-41	• Tire replacement . . . . .	7-60
• Checking the brake/clutch fluid level . . . . .	7-41	• Wheel replacement . . . . .	7-61
Washer fluid . . . . .	7-43	• Tire traction . . . . .	7-61
• Checking the washer fluid level . . . . .	7-43	• Tire maintenance . . . . .	7-61
Parking brake . . . . .	7-44	• Tire sidewall labeling . . . . .	7-62
• Checking the parking brake . . . . .	7-44	• Low aspect ratio tire . . . . .	7-69
Air cleaner . . . . .	7-45	Fuses . . . . .	7-71
• Filter replacement . . . . .	7-45	• Inner panel fuse replacement . . . . .	7-73
Climate control air filter . . . . .	7-47	• Engine compartment fuse replacement . . . . .	7-74
• Filter inspection . . . . .	7-47	• Fuse/relay panel description . . . . .	7-76

---

<b>Light bulbs</b> .....	<b>7-84</b>
• <b>Front light replacement</b> .....	<b>7-84</b>
• <b>Side repeater light bulb replacement</b> .....	<b>7-90</b>
• <b>Rear combination light bulb replacement</b> .....	<b>7-91</b>
• <b>High mounted stop light bulb replacement</b> .....	<b>7-93</b>
• <b>License plate light bulb replacement</b> .....	<b>7-94</b>
• <b>Interior light bulb replacement</b> .....	<b>7-95</b>
<b>Appearance care</b> .....	<b>7-96</b>
• <b>Exterior care</b> .....	<b>7-96</b>
• <b>Interior care</b> .....	<b>7-102</b>
<b>Emission control system</b> .....	<b>7-104</b>



## ENGINE COMPARTMENT

### ■ 1.6L GDI

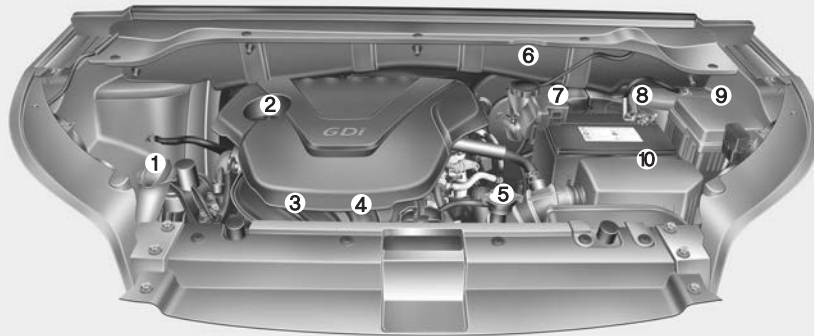

1. Windshield washer fluid reservoir
2. Engine oil filler cap
3. Engine oil dipstick
4. Engine coolant reservoir
5. Radiator cap
6. Brake fluid reservoir
7. Positive battery terminal
8. Negative battery terminal
9. Fuse box
10. Air cleaner

\* The actual engine compartment in the vehicle may differ from the illustration.

OPS073001

### ■ 2.0L GDI

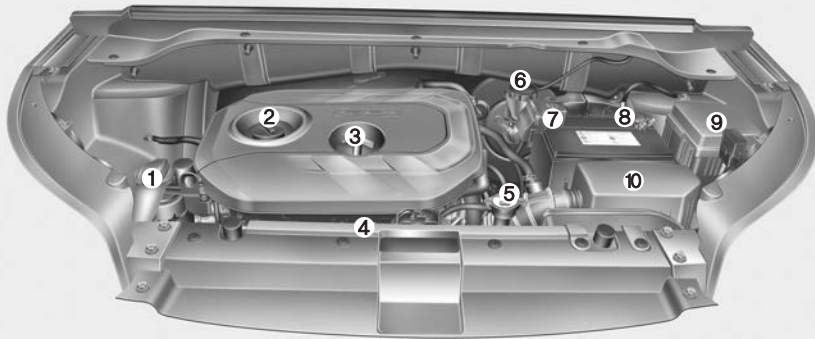

1. Engine coolant reservoir
  2. Engine oil filler cap
  3. Brake fluid reservoir
  4. Air cleaner
  5. Fuse box
  6. Positive battery terminal
  7. Negative battery terminal
  8. Windshield washer fluid reservoir
  9. Radiator cap
  10. Engine oil dipstick
- \* : if equipped

\* The actual engine room in the vehicle may differ from the illustration.

OPS073002

## MAINTENANCE SERVICES

You should exercise the utmost care to prevent damage to your vehicle and injury to yourself whenever performing any maintenance or inspection procedures.

Should you have any doubts concerning the inspection or servicing of your vehicle, we strongly recommend that you have an authorized Kia dealer perform this work.

An authorized Kia dealer has factory trained technicians and genuine Kia parts to service your vehicle properly. For expert advice and quality service, see an authorized Kia dealer.

Inadequate, incomplete or insufficient servicing may result in operational problems with your vehicle that could lead to vehicle damage, an accident, or personal injury.

### Owner's responsibility

#### \* NOTICE

**Maintenance Service and Record Retention are the owner's responsibility.**

**You should retain documents that show proper maintenance has been performed on your vehicle in accordance with the scheduled maintenance service charts shown on the following pages. You need this information to establish your compliance with the servicing and maintenance requirements of your vehicle warranties.**

**Detailed warranty information is provided in your Warranty & Consumer Information manual.**

Repairs and adjustments required as a result of improper maintenance or a lack of required maintenance are not covered.

We recommend you have your vehicle maintained and repaired by an authorized Kia dealer. An authorized Kia dealer meets Kia's high service quality standards and receives technical support from Kia in order to provide you with a high level of service satisfaction.

### **Owner maintenance precautions**

Improper or incomplete service may result in problems. This section gives instructions only for the maintenance items that are easy to perform.

As explained earlier in this section, several procedures can be done only by an authorized Kia dealer with special tools.

### **\* NOTICE**

Improper owner maintenance during the warranty period may affect warranty coverage. For details, read the separate **Warranty & Consumer Information** manual provided with the vehicle. If you're unsure about any servicing or maintenance procedure, have it done by an authorized Kia dealer.

### **⚠ WARNING - Maintenance work**

**Do not wear jewelry or loose clothing while working under the hood of your vehicle with the engine running. These can become entangled in moving parts, if you must run the engine while working under the hood, make certain that you remove all jewelry (especially rings, bracelets, watches, and necklaces) and all neckties, scarves, and similar loose clothing before getting near the engine or cooling fans.**

## OWNER MAINTENANCE

The following lists are vehicle checks and inspections that should be performed by the owner or an authorized Kia dealer at the frequencies indicated to help ensure safe, dependable operation of your vehicle.

Any adverse conditions should be brought to the attention of your dealer as soon as possible.

These Owner Maintenance Checks are generally not covered by warranties and you may be charged for labor, parts and lubricants used.

### Owner maintenance schedule

#### *When you stop for fuel:*

- Check the engine oil level.
- Check the coolant level in the coolant reservoir.
- Check the windshield washer fluid level.
- Look for low or under-inflated tires.

Check if the front of the radiator and condenser are clean and not blocked with leaves, dirt or insects etc. If any of the above parts are extremely dirty or you are not sure of their condition, take your vehicle to an authorized Kia dealer.

**⚠ WARNING - Hot coolant**  
**Be careful when checking your engine coolant level when the engine is hot. Scalding hot coolant and steam may blow out under pressure.**

#### *While operating your vehicle:*

- Note any changes in the sound of the exhaust or any smell of exhaust fumes in the vehicle.
- Check for vibrations in the steering wheel. Notice any increased steering effort or looseness in the steering wheel, or change in its straight-ahead position.
- Notice if your vehicle constantly turns slightly or “pulls” to one side when traveling on smooth, level road.
- When stopping, listen and check for unusual sounds, pulling to one side, increased brake pedal travel or “hard-to-push” brake pedal.
- If any slipping or changes in the operation of your transaxle occurs, check the transaxle fluid level.
- Check the automatic transaxle P (Park) function.
- Check the parking brake.
- Check for fluid leaks under your vehicle (water dripping from the air conditioning system during or after use is normal).

### ***At least monthly:***

- Check the coolant level in the engine coolant reservoir.
- Check the operation of all exterior lights, including the stoplights, turn signals and hazard warning flashers.
- Check the inflation pressures of all tires including the spare.

### ***At least twice a year (i.e., every Spring and Fall):***

- Check the radiator, heater and air conditioning hoses for leaks or damage.
- Check the windshield washer spray and wiper operation. Clean the wiper blades with clean cloth dampened with washer fluid.
- Check the headlight alignment.
- Check the muffler, exhaust pipes, shields and clamps.
- Check the lap/shoulder belts for wear and function.
- Check for worn tires and loose wheel lug nuts.

### ***At least once a year:***

- Clean the body and door drain holes.
- Lubricate the door hinges and checks, and hood hinges.
- Lubricate the door and hood locks and latches.
- Lubricate the door rubber weatherstrips.
- Check the air conditioning system.
- Inspect and lubricate the automatic transaxle linkage and controls.
- Clean the battery and terminals.
- Check the brake fluid level.

## SCHEDULED MAINTENANCE SERVICE

Follow the Normal Maintenance Schedule if the vehicle is usually operated where none of the following conditions apply. If any of the following conditions apply, follow the Maintenance Under Severe Usage Conditions.

- Repeated short distance driving.
- Driving in dusty conditions or sandy areas.
- Extensive use of brakes.
- Driving in areas where salt or other corrosive materials are being used.
- Driving on rough or muddy roads.
- Driving in mountainous areas.
- Extended periods of idling or low speed operation.
- Driving for a prolonged period in cold temperatures and/or extremely humid climates.
- More than 50% driving in heavy city traffic during hot weather above 32°C (90°F).

*If your vehicle is operated under the above conditions, you should inspect, replace or refill more frequently than the following Normal Maintenance Schedule. After 120 months or 240,000 km (150,000 miles) continue to follow the prescribed maintenance intervals.*

### **NORMAL MAINTENANCE SCHEDULE**

The following maintenance services must be performed to ensure good emission control and performance. Keep receipts for all vehicle emission services to protect your warranty. Where both mileage and time are shown, the frequency of service is determined by whichever occurs first.

- \*<sup>1</sup> Inspect "Water Pump" when replacing the drive belt or timing belt.
- \*<sup>2</sup> Fuel filter & Fuel tank air filter are considered to be maintenance free but periodic inspection is recommended for this maintenance schedule depends on fuel quality. If there are some important safety matters like fuel flow restriction, surging, loss of power, hard starting problem etc, replace the fuel filter immediately regardless of maintenance schedule and consult an authorized Kia dealer for details.
- \*<sup>3</sup> Inspect for excessive tappet noise and/or engine vibration and adjust if necessary.
- \*<sup>4</sup> The drive belt should be replaced when cracks occur or tension is reduced excessively.
- \*<sup>5</sup> When replacing coolant, use only a qualified coolant additive for your vehicle and never mix hard water in the coolant filled at the factory. An improper coolant mixture can result in serious malfunction or engine damage.
- \*<sup>6</sup> If TOP TIER Detergent Gasoline is not available, one bottle of additive is recommended. Additives are available from your authorized Kia dealer along with information on how to use them. Do not mix other additives.



**NORMAL MAINTENANCE SCHEDULE (CONT.)****12,000 km or 6 months**

- Inspect air cleaner filter
- Inspect air conditioning compressor, air conditioner refrigerant and performance (if equipped)
- Inspect cooling system \*1
- Inspect drive shaft and boots
- Inspect visually the following items.
  - 1) Battery condition
  - 2) Brake fluid / clutch(if equipped) fluid
  - 3) Fuel lines, hoses and connections
  - 4) Brake pedal and operation
  - 5) Chassis/body nuts and bolts
  - 6) Drum brake and linings (if equipped)
  - 7) Disc brakes and pads(if equipped)
  - 8) Exhaust pipe and muffler
  - 9) Front suspension ball joints
  - 10) Fuel tank, cap, lines and hoses
  - 11) Lubricate all locks and hinges
  - 12) Parking brakes
  - 13) Steering operation and linkage
  - 14) Suspension mounting bolts

(Continued)

(Continued)

- Replace engine oil and filter  
(Every 12,000 km or 12 months)
- Add fuel additive \*6  
(Every 12,000 km or 12 months)
- Rotate tires - including tire pressure and tread wear  
(Every 12,000 km or 12 months)

\* Inspect : Inspect and if necessary, adjust, correct, clean or replace.

## NORMAL MAINTENANCE SCHEDULE (CONT.)

### 24,000 km or 12 months

- Inspect air cleaner filter
- Inspect air conditioning compressor, air conditioner refrigerant and performance (if equipped)
- Inspect cooling system \*1
- Inspect drive shaft and boots
- Inspect visually the following items
  - 1) Battery condition
  - 2) Brake fluid / clutch(if equipped) fluid
  - 3) Fuel lines, hoses and connections
  - 4) Brake pedal and operation
  - 5) Chassis/body nuts and bolts
  - 6) Drum brake and linings (if equipped)
  - 7) Disc brakes and pads(if equipped)
  - 8) Exhaust pipe and muffler
  - 9) Front suspension ball joints
  - 10) Fuel tank, cap, lines and hoses
  - 11) Lubricate all locks and hinges
  - 12) Parking brakes
  - 13) Steering operation and linkage
  - 14) Suspension mounting bolts
- Replace climate control air filter (if equipped)
- Replace engine oil and filter  
(Every 12,000 km or 12 months)

(Continued)

(Continued)

- Add fuel additive \*6  
(Every 12,000 km or 12 months)
- Rotate tires - including tire pressure and tread wear  
(Every 12,000 km or 12 months)

\* Inspect : Inspect and if necessary, adjust, correct, clean or replace.

**NORMAL MAINTENANCE SCHEDULE (CONT.)****36,000 km or 18 months**

- Inspect air cleaner filter
- Inspect air conditioning compressor, air conditioner refrigerant and performance (if equipped)
- Inspect cooling system \*1
- Inspect drive shaft and boots
- Inspect visually the following items.
  - 1) Battery condition
  - 2) Brake fluid / clutch(if equipped) fluid
  - 3) Fuel lines, hoses and connections
  - 4) Brake pedal and operation
  - 5) Chassis/body nuts and bolts
  - 6) Drum brake and linings (if equipped)
  - 7) Disc brakes and pads(if equipped)
  - 8) Exhaust pipe and muffler
  - 9) Front suspension ball joints
  - 10) Fuel tank, cap, lines and hoses
  - 11) Lubricate all locks and hinges
  - 12) Parking brakes
  - 13) Steering operation and linkage
  - 14) Suspension mounting bolts

(Continued)

(Continued)

- Replace engine oil and filter  
(Every 12,000 km or 12 months)
- Add fuel additive \*6  
(Every 12,000 km or 12 months)
- Rotate tires - including tire pressure and tread wear  
(Every 12,000 km or 12 months)

\* Inspect : Inspect and if necessary, adjust, correct, clean or replace.

## NORMAL MAINTENANCE SCHEDULE (CONT.)

### 48,000 km or 24 months

- Inspect air conditioning compressor, air conditioner refrigerant and performance (if equipped)
- Inspect cooling system \*1
- Inspect drive shaft and boots
- Inspect fuel filter \*2
- Inspect fuel line, hoses and connection
- Inspect fuel tank air filter \*2
- Inspect manual transaxle fluid (if equipped)  
(Every 60,000 km or 48 months)
- Inspect vapor hose and fuel filler cap
- Inspect visually the following items
  - 1) Battery condition
  - 2) Brake fluid / clutch (if equipped) fluid
  - 3) Fuel lines, hoses and connections
  - 4) Brake pedal and operation
  - 5) Chassis/body nuts and bolts
  - 6) Drum brake and linings (if equipped)
  - 7) Disc brakes and pads (if equipped)
  - 8) Exhaust pipe and muffler
  - 9) Front suspension ball joints
  - 10) Fuel tank, cap, lines and hoses
  - 11) Lubricate all locks and hinges

(Continued)

(Continued)

- 12) Parking brakes
  - 13) Steering operation and linkage
  - 14) Suspension mounting bolts
- Replace air cleaner filter
  - Replace climate control air filter (if equipped)
  - Replace engine oil and filter  
(Every 12,000 km or 12 months)
  - Add fuel additive \*6  
(Every 12,000 km or 12 months)
  - Rotate tires - including tire pressure and tread wear  
(Every 12,000 km or 12 months)

\* Inspect : Inspect and if necessary, adjust, correct, clean or replace.

**NORMAL MAINTENANCE SCHEDULE (CONT.)****60,000 km or 30 months**

- Inspect air cleaner filter
- Inspect air conditioning compressor, air conditioner refrigerant and performance (if equipped)
- Inspect cooling system \*1
- Inspect drive shaft and boots
- Inspect visually the following items.
  - 1) Battery condition
  - 2) Brake fluid / clutch(if equipped) fluid
  - 3) Fuel lines, hoses and connections
  - 4) Brake pedal and operation
  - 5) Chassis/body nuts and bolts
  - 6) Drum brake and linings (if equipped)
  - 7) Disc brakes and pads(if equipped)
  - 8) Exhaust pipe and muffler
  - 9) Front suspension ball joints
  - 10) Fuel tank, cap, lines and hoses
  - 11) Lubricate all locks and hinges
  - 12) Parking brakes
  - 13) Steering operation and linkage
  - 14) Suspension mounting bolts

(Continued)

(Continued)

- Replace engine oil and filter  
(Every 12,000 km or 12 months)
- Add fuel additive \*6  
(Every 12,000 km or 12 months)
- Rotate tires - including tire pressure and tread wear  
(Every 12,000 km or 12 months)

\* Inspect : Inspect and if necessary, adjust, correct, clean or replace.

## NORMAL MAINTENANCE SCHEDULE (CONT.)

### 72,000 km or 36 months

- Inspect air cleaner filter
- Inspect air conditioning compressor, air conditioner refrigerant and performance (if equipped)
- Inspect cooling system \*1
- Inspect drive shaft and boots
- Inspect visually the following items
  - 1) Battery condition
  - 2) Brake fluid / clutch (if equipped) fluid
  - 3) Fuel lines, hoses and connections
  - 4) Brake pedal and operation
  - 5) Chassis/body nuts and bolts
  - 6) Drum brake and linings (if equipped)
  - 7) Disc brakes and pads (if equipped)
  - 8) Exhaust pipe and muffler
  - 9) Front suspension ball joints
  - 10) Fuel tank, cap, lines and hoses
  - 11) Lubricate all locks and hinges
  - 12) Parking brakes
  - 13) Steering operation and linkage
  - 14) Suspension mounting bolts

(Continued)

(Continued)

- Replace climate control air filter (if equipped)
- Replace engine oil and filter  
(Every 12,000 km or 12 months)
- Add fuel additive \*6 (Every 12,000 km or 12 months)
- Rotate tires - including tire pressure and tread wear  
(Every 12,000 km or 12 months)

\* Inspect : Inspect and if necessary, adjust, correct, clean or replace.

**NORMAL MAINTENANCE SCHEDULE (CONT.)****84,000 km or 42 months**

- Inspect air cleaner filter
- Inspect air conditioning compressor, air conditioner refrigerant and performance (if equipped)
- Inspect cooling system \*1
- Inspect drive shaft and boots
- Inspect visually the following items.
  - 1) Battery condition
  - 2) Brake fluid / clutch(if equipped) fluid
  - 3) Fuel lines, hoses and connections
  - 4) Brake pedal and operation
  - 5) Chassis/body nuts and bolts
  - 6) Drum brake and linings (if equipped)
  - 7) Disc brakes and pads(if equipped)
  - 8) Exhaust pipe and muffler
  - 9) Front suspension ball joints
  - 10) Fuel tank, cap, lines and hoses
  - 11) Lubricate all locks and hinges
  - 12) Parking brakes
  - 13) Steering operation and linkage
  - 14) Suspension mounting bolts

(Continued)

(Continued)

- Replace engine oil and filter  
(Every 12,000 km or 12 months)
- Add fuel additive \*6  
(Every 12,000 km or 12 months)
- Rotate tires - including tire pressure and tread wear  
(Every 12,000 km or 12 months)

\* Inspect : Inspect and if necessary, adjust, correct, clean or replace.

### NORMAL MAINTENANCE SCHEDULE (CONT.)

#### 96,000 km or 48 months

- Inspect air conditioning compressor, air conditioner refrigerant and performance (if equipped)
- Inspect cooling system \*1
- Inspect drive belt \*4  
(First, 96,000 km or 72 months  
after every 24,000 km or 24 months)
- Inspect drive shaft and boots
- Inspect fuel filter \*2
- Inspect fuel line, hoses and connection
- Inspect fuel tank air filter \*2
- Inspect vapor hose and fuel filler cap
- Inspect visually the following items
  - 1) Battery condition
  - 2) Brake fluid / clutch (if equipped) fluid
  - 3) Fuel lines, hoses and connections
  - 4) Brake pedal and operation
  - 5) Chassis/body nuts and bolts
  - 6) Drum brake and linings (if equipped)
  - 7) Disc brakes and pads (if equipped)

(Continued)

(Continued)

- 8) Exhaust pipe and muffler
- 9) Front suspension ball joints
- 10) Fuel tank, cap, lines and hoses
- 11) Lubricate all locks and hinges
- 12) Parking brakes
- 13) Steering operation and linkage
- 14) Suspension mounting bolts
- Replace air cleaner filter
- Replace climate control air filter (if equipped)
- Replace engine oil and filter  
(Every 12,000 km or 12 months)
- Add fuel additive \*6  
(Every 12,000 km or 12 months)
- Rotate tires - including tire pressure and tread wear  
(Every 12,000 km or 12 months)

\* Inspect : Inspect and if necessary, adjust, correct, clean or replace.



**NORMAL MAINTENANCE SCHEDULE (CONT.)****108,000 km or 54 months**

- Inspect air cleaner filter
- Inspect air conditioning compressor, air conditioner refrigerant and performance (if equipped)
- Inspect cooling system \*1
- Inspect drive shaft and boots
- Inspect visually the following items.
  - 1) Battery condition
  - 2) Brake fluid / clutch(if equipped) fluid
  - 3) Fuel lines, hoses and connections
  - 4) Brake pedal and operation
  - 5) Chassis/body nuts and bolts
  - 6) Drum brake and linings (if equipped)
  - 7) Disc brakes and pads(if equipped)
  - 8) Exhaust pipe and muffler
  - 9) Front suspension ball joints
  - 10) Fuel tank, cap, lines and hoses
  - 11) Lubricate all locks and hinges
  - 12) Parking brakes
  - 13) Steering operation and linkage
  - 14) Suspension mounting bolts

(Continued)

(Continued)

- Replace engine oil and filter  
(Every 12,000 km or 12 months)
- Add fuel additive \*6  
(Every 12,000 km or 12 months)
- Rotate tires - including tire pressure and tread wear  
(Every 12,000 km or 12 months)

\* Inspect : Inspect and if necessary, adjust, correct, clean or replace.

## NORMAL MAINTENANCE SCHEDULE (CONT.)

### 120,000 km or 60 months

- Inspect air cleaner filter
- Inspect air conditioning compressor, air conditioner refrigerant and performance (if equipped)
- Inspect cooling system \*1
- Inspect drive belt \*4  
(First 96,000 km or 72 months after every 24,000 km or 24 months)
- Inspect drive shaft and boots
- Inspect manual transaxle fluid (if equipped)  
(Every 60,000 km or 48 months)
- Inspect visually the following items
  - 1) Battery condition
  - 2) Brake fluid / clutch (if equipped) fluid
  - 3) Fuel lines, hoses and connections
  - 4) Brake pedal and operation
  - 5) Chassis/body nuts and bolts
  - 6) Drum brake and linings (if equipped)
  - 7) Disc brakes and pads (if equipped)

(Continued)

(Continued)

- 8) Exhaust pipe and muffler
- 9) Front suspension ball joints
- 10) Fuel tank, cap, lines and hoses
- 11) Lubricate all locks and hinges
- 12) Parking brakes
- 13) Steering operation and linkage
- 14) Suspension mounting bolts
- Replace climate control air filter (if equipped)
- Replace engine oil and filter  
(Every 12,000 km or 12 months)
- Add fuel additive \*6  
(Every 12,000 km or 12 months)
- Rotate tires - including tire pressure and tread wear  
(Every 12,000 km or 12 months)

\* Inspect : Inspect and if necessary, adjust, correct, clean or replace.

**NORMAL MAINTENANCE SCHEDULE (CONT.)****132,000 km or 66 months**

- Inspect air cleaner filter
- Inspect air conditioning compressor, air conditioner refrigerant and performance (if equipped)
- Inspect cooling system \*1
- Inspect drive shaft and boots
- Inspect visually the following items.
  - 1) Battery condition
  - 2) Brake fluid / clutch(if equipped) fluid
  - 3) Fuel lines, hoses and connections
  - 4) Brake pedal and operation
  - 5) Chassis/body nuts and bolts
  - 6) Drum brake and linings (if equipped)
  - 7) Disc brakes and pads(if equipped)
  - 8) Exhaust pipe and muffler
  - 9) Front suspension ball joints
  - 10) Fuel tank, cap, lines and hoses
  - 11) Lubricate all locks and hinges
  - 12) Parking brakes
  - 13) Steering operation and linkage
  - 14) Suspension mounting bolts

(Continued)

(Continued)

- Replace engine oil and filter  
(Every 12,000 km or 12 months)
- Add fuel additive \*6  
(Every 12,000 km or 12 months)
- Rotate tires - including tire pressure and tread wear  
(Every 12,000 km or 12 months)

\* Inspect : Inspect and if necessary, adjust, correct, clean or replace.

## NORMAL MAINTENANCE SCHEDULE (CONT.)

### 144,000 km or 72 months

- Inspect air conditioning compressor, air conditioner refrigerant and performance (if equipped)
- Inspect cooling system \*1
- Inspect drive belt \*4  
(First 96,000 km or 72 months after every 24,000 km or 24 months)
- Inspect drive shaft and boots
- Inspect fuel filter \*2
- Inspect fuel line, hoses and connection
- Inspect fuel tank air filter \*2
- Inspect valve clearance (Engine 1.6) \*3
- Inspect vapor hose and fuel filler cap
- Inspect visually the following items
  - 1) Battery condition
  - 2) Brake fluid / clutch (if equipped) fluid
  - 3) Fuel lines, hoses and connections
  - 4) Brake pedal and operation
  - 5) Chassis/body nuts and bolts
  - 6) Drum brake and linings (if equipped)
  - 7) Disc brakes and pads (if equipped)
  - 8) Exhaust pipe and muffler

(Continued)

(Continued)

- 9) Front suspension ball joints
  - 10) Fuel tank, cap, lines and hoses
  - 11) Lubricate all locks and hinges
  - 12) Parking brakes
  - 13) Steering operation and linkage
  - 14) Suspension mounting bolts
- Replace air cleaner filter
  - Replace climate control air filter (if equipped)
  - Replace engine oil and filter  
(Every 12,000 km or 12 months)
  - Add fuel additive \*6  
(Every 12,000 km or 12 months)
  - Rotate tires - including tire pressure and tread wear  
(Every 12,000 km or 12 months)

\* Inspect : Inspect and if necessary, adjust, correct, clean or replace.

**NORMAL MAINTENANCE SCHEDULE (CONT.)****156,000 km or 78 months**

- Inspect air cleaner filter
- Inspect air conditioning compressor, air conditioner refrigerant and performance (if equipped)
- Inspect cooling system \*1
- Inspect drive shaft and boots
- Inspect visually the following items.
  - 1) Battery condition
  - 2) Brake fluid / clutch(if equipped) fluid
  - 3) Fuel lines, hoses and connections
  - 4) Brake pedal and operation
  - 5) Chassis/body nuts and bolts
  - 6) Drum brake and linings (if equipped)
  - 7) Disc brakes and pads(if equipped)
  - 8) Exhaust pipe and muffler
  - 9) Front suspension ball joints
  - 10) Fuel tank, cap, lines and hoses
  - 11) Lubricate all locks and hinges
  - 12) Parking brakes
  - 13) Steering operation and linkage
  - 14) Suspension mounting bolts

(Continued)

(Continued)

- Replace engine oil and filter  
(Every 12,000 km or 12 months)
- Add fuel additive \*6  
(Every 12,000 km or 12 months)
- Rotate tires - including tire pressure and tread wear  
(Every 12,000 km or 12 months)

\* Inspect : Inspect and if necessary, adjust, correct, clean or replace.

## NORMAL MAINTENANCE SCHEDULE (CONT.)

### 168,000 km or 84 months

- Inspect air cleaner filter
- Inspect air conditioning compressor, air conditioner refrigerant and performance (if equipped)
- Inspect cooling system \*1
- Inspect drive belt \*4  
(First 96,000 km or 72 months after every 24,000 km or 24 months)
- Inspect drive shaft and boots
- Inspect manual transaxle fluid (if equipped)  
(Every 60,000 km or 48 months)
- Inspect visually the following items
  - 1) Battery condition
  - 2) Brake fluid / clutch (if equipped) fluid
  - 3) Fuel lines, hoses and connections
  - 4) Brake pedal and operation
  - 5) Chassis/body nuts and bolts
  - 6) Drum brake and linings (if equipped)
  - 7) Disc brakes and pads (if equipped)
  - 8) Exhaust pipe and muffler
  - 9) Front suspension ball joints
  - 10) Fuel tank, cap, lines and hoses

(Continued)

(Continued)

- 11) Lubricate all locks and hinges
  - 12) Parking brakes
  - 13) Steering operation and linkage
  - 14) Suspension mounting bolts
- Replace climate control air filter (if equipped)
  - Replace engine oil and filter  
(Every 12,000 km or 12 months)
  - Add fuel additive \*6  
(Every 12,000 km or 12 months)
  - Replace spark plugs (iridium coated),
  - Rotate tires - including tire pressure and tread wear  
(Every 12,000 km or 12 months)

\* Inspect : Inspect and if necessary, adjust, correct, clean or replace.

**NORMAL MAINTENANCE SCHEDULE (CONT.)****180,000 km or 90 months**

- Inspect air cleaner filter
- Inspect air conditioning compressor, air conditioner refrigerant and performance (if equipped)
- Inspect cooling system \*1
- Inspect drive shaft and boots
- Inspect visually the following items.
  - 1) Battery condition
  - 2) Brake fluid / clutch(if equipped) fluid
  - 3) Fuel lines, hoses and connections
  - 4) Brake pedal and operation
  - 5) Chassis/body nuts and bolts
  - 6) Drum brake and linings (if equipped)
  - 7) Disc brakes and pads(if equipped)
  - 8) Exhaust pipe and muffler
  - 9) Front suspension ball joints
  - 10) Fuel tank, cap, lines and hoses
  - 11) Lubricate all locks and hinges
  - 12) Parking brakes
  - 13) Steering operation and linkage
  - 14) Suspension mounting bolts

(Continued)

(Continued)

- Replace engine oil and filter  
(Every 12,000 km or 12 months)
- Add fuel additive \*6  
(Every 12,000 km or 12 months)
- Rotate tires - including tire pressure and tread wear  
(Every 12,000 km or 12 months)

\* Inspect : Inspect and if necessary, adjust, correct, clean or replace.

## NORMAL MAINTENANCE SCHEDULE (CONT.)

### 192,000 km or 96 months

- Inspect air conditioning compressor, air conditioner refrigerant and performance (if equipped)
- Inspect cooling system \*1
- Inspect drive belt \*4  
(First 96,000 km or 72 months after every 24,000 km or 24 months)
- Inspect drive shaft and boots
- Inspect fuel filter \*2
- Inspect fuel line, hoses and connection
- Inspect fuel tank air filter \*2
- Inspect vapor hose and fuel filler cap
- Inspect visually the following items
  - 1) Battery condition
  - 2) Brake fluid / clutch (if equipped) fluid
  - 3) Fuel lines, hoses and connections
  - 4) Brake pedal and operation
  - 5) Chassis/body nuts and bolts
  - 6) Drum brake and linings (if equipped)
  - 7) Disc brakes and pads (if equipped)
  - 8) Exhaust pipe and muffler
  - 9) Front suspension ball joints

(Continued)

(Continued)

- 10) Fuel tank, cap, lines and hoses
  - 11) Lubricate all locks and hinges
  - 12) Parking brakes
  - 13) Steering operation and linkage
  - 14) Suspension mounting bolts
- Replace air cleaner filter
  - Replace climate control air filter (if equipped)
  - Replace engine coolant\*5  
(First, 192,000 km or 120 months after every 48,000 km or 24 months)
  - Replace engine oil and filter  
(Every 12,000 km or 12 months)
  - Add fuel additive \*6 (Every 12,000 km or 12 months)
  - Rotate tires - including tire pressure and tread wear  
(Every 12,000 km or 12 months)

\* Inspect : Inspect and if necessary, adjust, correct, clean or replace.



**NORMAL MAINTENANCE SCHEDULE (CONT.)****204,000 km or 102 months**

- Inspect air cleaner filter
- Inspect air conditioning compressor, air conditioner refrigerant and performance (if equipped)
- Inspect cooling system \*1
- Inspect drive shaft and boots
- Inspect visually the following items.
  - 1) Battery condition
  - 2) Brake fluid / clutch(if equipped) fluid
  - 3) Fuel lines, hoses and connections
  - 4) Brake pedal and operation
  - 5) Chassis/body nuts and bolts
  - 6) Drum brake and linings (if equipped)
  - 7) Disc brakes and pads(if equipped)
  - 8) Exhaust pipe and muffler
  - 9) Front suspension ball joints
  - 10) Fuel tank, cap, lines and hoses
  - 11) Lubricate all locks and hinges
  - 12) Parking brakes
  - 13) Steering operation and linkage
  - 14) Suspension mounting bolts

(Continued)

(Continued)

- Replace engine oil and filter  
(Every 12,000 km or 12 months)
- Add fuel additive \*6  
(Every 12,000 km or 12 months)
- Rotate tires - including tire pressure and tread wear  
(Every 12,000 km or 12 months)

\* Inspect : Inspect and if necessary, adjust, correct, clean or replace.

## NORMAL MAINTENANCE SCHEDULE (CONT.)

### 216,000 km or 108 months

- Inspect air cleaner filter
- Inspect air conditioning compressor, air conditioner refrigerant and performance (if equipped)
- Inspect cooling system \*1
- Inspect drive belt \*4  
(First 96,000 km or 72 months after every 24,000 km or 24 months)
- Inspect drive shaft and boots
- Inspect visually the following items
  - 1) Battery condition
  - 2) Brake fluid / clutch (if equipped) fluid
  - 3) Fuel lines, hoses and connections
  - 4) Brake pedal and operation
  - 5) Chassis/body nuts and bolts
  - 6) Drum brake and linings (if equipped)
  - 7) Disc brakes and pads (if equipped)
  - 8) Exhaust pipe and muffler
  - 9) Front suspension ball joints
  - 10) Fuel tank, cap, lines and hoses
  - 11) Lubricate all locks and hinges
  - 12) Parking brakes
  - 13) Steering operation and linkage
  - 14) Suspension mounting bolts

(Continued)

(Continued)

- Replace climate control air filter (if equipped)
- Replace engine oil and filter  
(Every 12,000 km or 12 months)
- Add fuel additive \*6  
(Every 12,000 km or 12 months)
- Rotate tires - including tire pressure and tread wear  
(Every 12,000 km or 12 months)

\* Inspect : Inspect and if necessary, adjust, correct, clean or replace.

**NORMAL MAINTENANCE SCHEDULE (CONT.)****228,000 km or 114 months**

- Inspect air cleaner filter
- Inspect air conditioning compressor, air conditioner refrigerant and performance (if equipped)
- Inspect cooling system \*1
- Inspect drive shaft and boots
- Inspect visually the following items.
  - 1) Battery condition
  - 2) Brake fluid / clutch(if equipped) fluid
  - 3) Fuel lines, hoses and connections
  - 4) Brake pedal and operation
  - 5) Chassis/body nuts and bolts
  - 6) Drum brake and linings (if equipped)
  - 7) Disc brakes and pads(if equipped)
  - 8) Exhaust pipe and muffler
  - 9) Front suspension ball joints
  - 10) Fuel tank, cap, lines and hoses
  - 11) Lubricate all locks and hinges
  - 12) Parking brakes
  - 13) Steering operation and linkage
  - 14) Suspension mounting bolts

(Continued)

(Continued)

- Replace engine oil and filter  
(Every 12,000 km or 12 months)
- Add fuel additive \*6  
(Every 12,000 km or 12 months)
- Rotate tires - including tire pressure and tread wear  
(Every 12,000 km or 12 months)

\* Inspect : Inspect and if necessary, adjust, correct, clean or replace.

## NORMAL MAINTENANCE SCHEDULE (CONT.)

### 240,000 km or 120 months

- Inspect air conditioning compressor, air conditioner refrigerant and performance (if equipped)
- Inspect cooling system \*1
- Inspect drive belt \*4  
(First 96,000 km or 72 months after every 24,000 km or 24 months)
- Inspect drive shaft and boots
- Inspect fuel filter \*2
- Inspect fuel line, hoses and connection
- Inspect fuel tank air filter \*2
- Inspect manual transaxle fluid (if equipped)  
(Every 60,000 km or 48 months)
- Inspect vapor hose and fuel filler cap
- Inspect visually the following items
  - 1) Battery condition
  - 2) Brake fluid / clutch (if equipped) fluid
  - 3) Fuel lines, hoses and connections
  - 4) Brake pedal and operation
  - 5) Chassis/body nuts and bolts
  - 6) Drum brake and linings (if equipped)
  - 7) Disc brakes and pads (if equipped)

(Continued)

(Continued)

- 8) Exhaust pipe and muffler
  - 9) Front suspension ball joints
  - 10) Fuel tank, cap, lines and hoses
  - 11) Lubricate all locks and hinges
  - 12) Parking brakes
  - 13) Steering operation and linkage
  - 14) Suspension mounting bolts
- Replace air cleaner filter
  - Replace climate control air filter (if equipped)
  - Replace engine coolant \*5  
(First 192,000 km or 120 months after every 48,000 km or 24 months)
  - Replace engine oil and filter  
(Every 12,000 km or 12 months)
  - Add fuel additive \*6  
(Every 12,000 km or 12 months)
  - Rotate tires - including tire pressure and tread wear  
(Every 12,000 km or 12 months)

\* Inspect : Inspect and if necessary, adjust, correct, clean or replace.

### No check, No service required

- Automatic transaxle fluid (if equipped)

## MAINTENANCE UNDER SEVERE USAGE CONDITIONS

The following items must be serviced more frequently on cars normally used under severe driving conditions. Refer to the chart below for the appropriate maintenance intervals.

R : Replace    I : Inspect and, after inspection, clean, adjust, repair or replace if necessary

MAINTENANCE ITEM	MAINTENANCE OPERATION	MAINTENANCE INTERVALS	DRIVING CONDITION
ENGINE OIL AND FILTER	R	EVERY 6,000 km OR 6 months	A, B, C, D, E, F, G, H, I, J, K
AIR CLEANER FILTER	R	MORE FREQUENTLY	C, E
SPARK PLUGS	R	MORE FREQUENTLY	A, B, H, I, K
DISC BRAKE/ PADS, CALIPERS AND ROTORS	I	MORE FREQUENTLY	C, D, G, H
REAR BRAKE DRUMS/ LININGS, PARKING BRAKE	I	MORE FREQUENTLY	C, D, G, H
STEERING GEAR BOX, LINKAGE & BOOTS/ LOWER ARM BALL JOINT, UPPER ARM BALL JOINT	I	MORE FREQUENTLY	C, D, E, F, G, H, I
DRIVE SHAFTS AND BOOTS	I	EVERY 12,000 km OR 6 months	C, D, E, F, G, H
MANUAL TRANSAXLE OIL	R	EVERY 120,000 km	C, D, F, G, H, I, J
AUTOMATIC TRANSAXLE FLUID	R	EVERY 90,000 km	A, C, E, F, G, H, I
CLIMATE CONTROL AIR FILTER (FOR EVAPORATOR AND BLOWER UNIT)	R	MORE FREQUENTLY	C, E

### SEVERE DRIVING CONDITIONS

- A - Repeatedly driving short distance of less than 8 km in normal temperature or less than 16 km in freezing temperature
- B - Extensive engine idling or low speed driving for long distances
- C - Driving on rough, dusty, muddy, unpaved, graveled or salt-spread roads
- D - Driving in areas using salt or other corrosive materials or in very cold weather

- E - Driving in sandy areas
- F - Driving in heavy traffic area over 32°C (90°F)
- G - Driving on uphill, downhill, or mountain road
- H - Towing a Trailer, or using a camper, or roof rack
- I - Driving as a patrol car, taxi, other commercial use or vehicle towing
- J - Driving over 170 km/h
- K - Frequently driving in stop-and-go conditions

## **EXPLANATION OF SCHEDULED MAINTENANCE ITEMS**

### **Engine oil and filter**

The engine oil and filter should be changed at the intervals specified in the maintenance schedule. If the vehicle is being driven in severe conditions, more frequent oil and filter changes are required.

### **Drive belts**

Inspect all drive belts for evidence of cuts, cracks, excessive wear or oil saturation and replace if necessary. Drive belts should be checked periodically for proper tension and adjusted as necessary.

### **Fuel filter (cartridge)**

A clogged filter can limit the speed at which the vehicle may be driven, damage the emission system and cause multiple issues such as hard starting. If an excessive amount of foreign matter accumulates in the fuel tank, the filter may require replacement more frequently.

After installing a new filter, run the engine for several minutes, and check for leaks at the connections. Fuel filters should be installed by an authorized Kia dealer.

### **Fuel lines, fuel hoses and connections**

Check the fuel lines, fuel hoses and connections for leakage and damage. Have an authorized Kia dealer replace any damaged or leaking parts immediately.

### **Vapor hose and fuel filler cap**

The vapor hose and fuel filler cap should be inspected at those intervals specified in the maintenance schedule. Make sure that a new vapor hose or fuel filler cap is correctly replaced.

**Vacuum crankcase ventilation hoses (if equipped)**

Inspect the surface of hoses for evidence of heat and/or mechanical damage. Hard and brittle rubber, cracking, tears, cuts, abrasions, and excessive swelling indicate deterioration. Particular attention should be paid to examine those hose surfaces nearest to high heat sources, such as the exhaust manifold.

Inspect the hose routing to assure that the hoses do not come in contact with any heat source, sharp edges or moving components which might cause heat damage or mechanical wear. Inspect all hose connections, such as clamps and couplings, to make sure they are secure, and that no leaks are present. Hoses should be replaced immediately if there is any evidence of deterioration or damage.

**Air cleaner filter**

A Genuine Kia air cleaner filter is recommended when the filter is replaced.

**Spark plugs**

Make sure to install new spark plugs of the correct heat range.

**Valve clearance (if equipped)**

Inspect for excessive valve noise and/or engine vibration and adjust if necessary. An authorized Kia dealer should perform the operation.

**Cooling system**

Check the cooling system components, such as the radiator, coolant reservoir, hoses and connections for leakage and damage. Replace any damaged parts.

**Coolant**

The coolant should be changed at the intervals specified in the maintenance schedule.

### **Automatic transaxle fluid (if equipped)**

Automatic transaxle fluid should not be checked under normal usage conditions.

But in severe conditions, the fluid should be changed at an authorized Kia dealer in accordance to the scheduled maintenance at the beginning of this section.

#### **\* NOTICE**

Automatic transaxle fluid color is basically red.

As the vehicle is driven, the automatic transaxle fluid will begin to look darker.

It is the normal condition and you should not judge the need to replace the fluid based upon the changed color.

#### **CAUTION - Transaxle fluids**

*The use of a non-specified fluid could result in transaxle malfunction and failure.*

*Use only specified automatic transaxle fluid. (Refer to "Recommended lubricants and capacities" in section 8.)*

### **Manual transaxle fluid (if equipped)**

Inspect the manual transaxle fluid according to the maintenance schedule.

### **Brake hoses and lines**

Visually check for proper installation, chafing, cracks, deterioration and any leakage. Replace any deteriorated or damaged parts immediately.

### **Brake/clutch (if equipped) fluid**

Check the brake fluid level in the brake fluid reservoir. The level should be between "MIN" and "MAX" marks on the side of the reservoir. Use only hydraulic brake fluid conforming to DOT 3 or DOT 4 specification.

### **Parking brake**

Inspect the parking brake system including the parking brake lever (or pedal) and cables.



**Brake discs, pads, calipers and rotors**

Check the pads for excessive wear, discs for run out and wear, and calipers for fluid leakage.

For more information on checking the pads or lining wear limit, we recommend you to refer to the Kia website.

(<http://www.kiatechinfo.com>)

**Exhaust pipe and muffler**

Visually inspect the exhaust pipes, muffler and hangers for cracks, deterioration, or damage. Start the engine and listen carefully for any exhaust gas leakage. Tighten connections or replace parts as necessary.

**Suspension mounting bolts**

Check the suspension connections for looseness or damage. Retighten to the specified torque.

**Steering gear box, linkage & boots/lower arm ball joint**

With the vehicle stopped and engine off, check for excessive free-play in the steering wheel.

Check the linkage for bends or damage. Check the dust boots and ball joints for deterioration, cracks, or damage. Replace any damaged parts.

**Drive shafts and boots**

Check the drive shafts, boots and clamps for cracks, deterioration, or damage. Replace any damaged parts and, if necessary, repack the grease.

**Air conditioning refrigerant**

Check the air conditioning lines and connections for leakage and damage.

## ENGINE OIL

### Checking the engine oil level

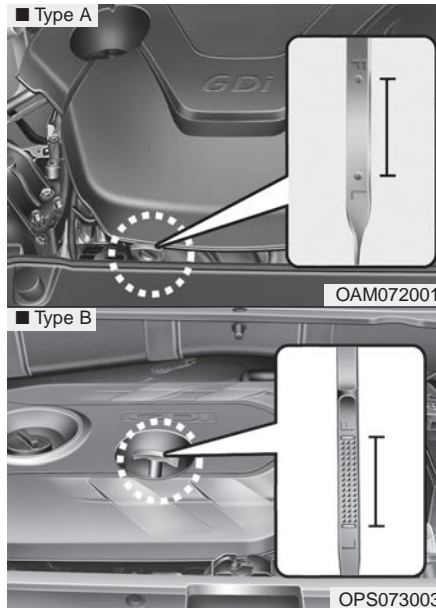

1. Be sure the vehicle is on level ground.
2. Start the engine and allow it to reach normal operating temperature.

3. Turn the engine off and wait for a few minutes (about 5 minutes) for the oil to return to the oil pan.
4. Pull the dipstick out, wipe it clean, and re-insert it fully.

**⚠ WARNING - Radiator hose**

**Be very careful not to touch the radiator hose when checking or adding the engine oil as it may be hot enough to burn you.**

5. Pull the dipstick out again and check the level. The level should be between F and L.

**⚠ CAUTION - Replacing engine oil**

- **Do not overfill the engine oil. It may damage the engine.**
- **Do not spill engine oil, when adding or changing engine oil. If you drop the engine oil on the engine room, wipe it off immediately.**

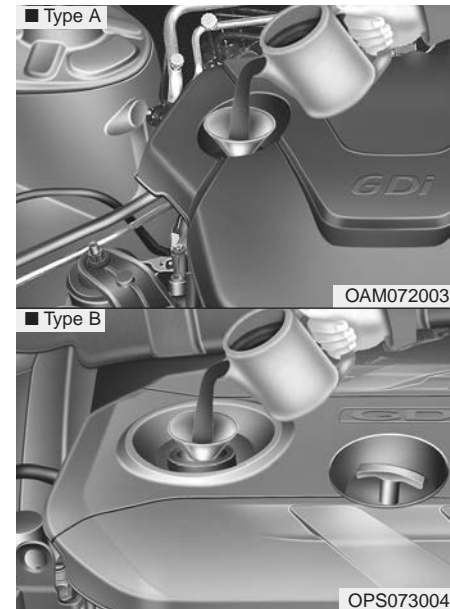

If it is near or at L, add enough oil to bring the level to F. **Do not overfill.**

**Use a funnel to help prevent oil from being spilled on engine components.**

*Use only the specified engine oil.  
(Refer to “Recommended lubricants  
and capacities” in chapter 8.)*

### **Changing the engine oil and filter**

Have engine oil and filter changed by an authorized Kia dealer according to the Maintenance Schedule at the beginning of this chapter.

** WARNING**

**Used engine oil may cause irritation or cancer of the skin if left in contact with the skin for prolonged periods of time. Always protect your skin by washing your hands thoroughly with soap and warm water as soon as possible after handling used oil.**

## ENGINE COOLANT

The high-pressure cooling system has a reservoir filled with year round antifreeze coolant. The reservoir is filled at the factory.

Check the antifreeze protection and coolant level at least once a year, at the beginning of the winter season, and before traveling to a colder climate.

### Checking the coolant level

#### CAUTION

*Never attempt to remove the radiator cap while the engine is operating or hot. Doing so might lead to cooling system and engine damage.*

Turn the engine off and wait until it cools down. Use extreme care when removing the radiator cap. Wrap a thick towel around it, and turn it counterclockwise slowly to the first stop. Step back while the pressure is released from the cooling system.

When you are sure all the pressure has been released, press down on the cap, using a thick towel, and continue turning counterclockwise to remove it.

#### WARNING - Cooling fan



Use caution when working near the blade of the cooling fan. The electric motor (cooling fan) is controlled by engine coolant temperature, refrigerant pressure and vehicle speed. It may sometimes operate even when the engine is not running.

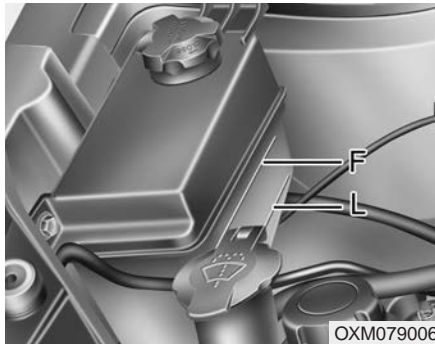

Check the condition and connections of all cooling system hoses and heater hoses. Replace any swollen or deteriorated hoses.

The coolant level should be filled between F and L marks on the side of the coolant reservoir when the engine is cool.

If the coolant level is low, add enough specified coolant to provide protection against freezing and corrosion. Bring the level to F, but do not overfill. If frequent additions are required, see an authorized Kia dealer for a cooling system inspection.

### **Recommended engine coolant**

- When adding coolant, use only deionized water or soft water for your vehicle and never mix hard water in the coolant filled at the factory. An improper coolant mixture can result in serious malfunction or engine damage.
- The engine in your vehicle has aluminum engine parts and must be protected by an ethylene-glycol with phosphate based coolant to prevent corrosion and freezing.
- DO NOT USE alcohol or methanol coolant or mix them with the specified coolant.
- Do not use a solution that contains more than 60% antifreeze or less than 35% antifreeze, which would reduce the effectiveness of the solution.

For mixture percentage, refer to the following table.

Ambient Temperature	Mixture Percentage (volume)	
	Antifreeze	Water
-15°C (5°F)	35	65
-25°C (-13°F)	40	60
-35°C (-31°F)	50	50
-45°C (-49°F)	60	40

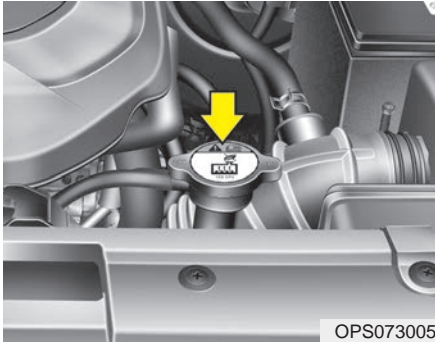

### Changing the coolant

Have the coolant changed by an authorized Kia dealer according to the Maintenance Schedule at the beginning of this chapter.

Put a thick cloth around the radiator cap before refilling the coolant in order to prevent the coolant from overflowing into engine parts such as the alternator.

#### **WARNING**



#### Radiator cap

**Do not remove the radiator cap when the engine and radiator are hot. Scalding hot coolant and steam may blow out under pressure which may result in serious injury.**

## BRAKE/CLUTCH FLUID

### Checking the brake/clutch\* fluid level

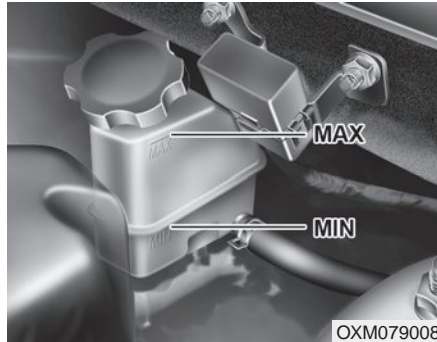

Check the fluid level in the reservoir periodically. The fluid level should be between MAX and MIN marks on the side of the reservoir.

Before removing the reservoir cap and adding brake/clutch\* fluid, clean the area around the reservoir cap thoroughly to prevent brake/clutch\* fluid contamination.

\* if equipped



#### **CAUTION - Proper fluid**

**Only use brake fluid in brake system. Small amounts of improper fluids (such as engine oil) can cause damage to the brake system.**

If the level is low, add fluid to the MAX level. The level will fall with accumulated mileage. This is a normal condition associated with the wear of the brake linings and/or clutch disc (if equipped). If the fluid level is excessively low, have the brake/clutch\* system checked by an authorized KIA dealer.

*Use only the specified brake/clutch\* fluid. (Refer to "Recommended lubricants and capacities" in chapter 8.)*

*Never mix different types of fluid.*

In the event the brake/clutch\* system requires frequent additions of fluid, the vehicle should be inspected by an authorized Kia dealer.

When changing and adding brake/clutch\* fluid, handle it carefully. Do not let it come in contact with your eyes. If brake/ clutch\* fluid should come in contact with your eyes, immediately flush them with a large quantity of fresh tap water. Have your eyes examined by a doctor as soon as possible.

 **CAUTION - Brake/clutch\*  
fluid**

***Do not allow brake/clutch\* fluid  
to contact the vehicle's body  
paint, as paint damage will  
result.***

Brake/clutch\* fluid, which has been exposed to open air for an extended time should never be used as its quality cannot be guaranteed. It should be disposed of properly.



## WASHER FLUID

### Checking the washer fluid level

■ Type A

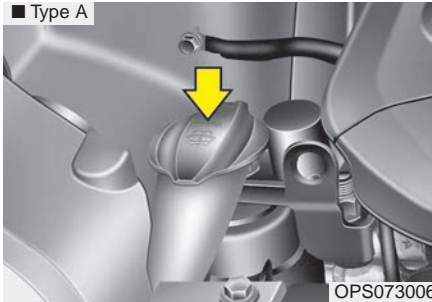

■ Type B

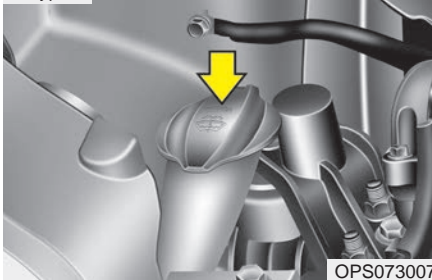

The reservoir is translucent so that you can check the level with a quick visual inspection.

Check the fluid level in the washer fluid reservoir and add fluid if necessary. Plain water may be used if washer fluid is not available. However, use washer solvent with antifreeze characteristics in cold climates to prevent freezing.

#### **⚠ WARNING - Flammable Fluid**

Do not allow the washer fluid to come in contact with open flames or sparks. The windshield washer fluid reservoir is flammable under certain circumstances. This can result in a fire.

#### **⚠ WARNING - Coolant**

- Do not use radiator coolant or antifreeze in the washer fluid reservoir.
- Radiator coolant can severely obscure visibility when sprayed on the windshield and may cause loss of vehicle control.

#### **⚠ WARNING - Windshield fluid**

Do not drink the windshield washer fluid. The windshield washer fluid is poisonous to humans and animals.

## PARKING BRAKE

### Checking the parking brake

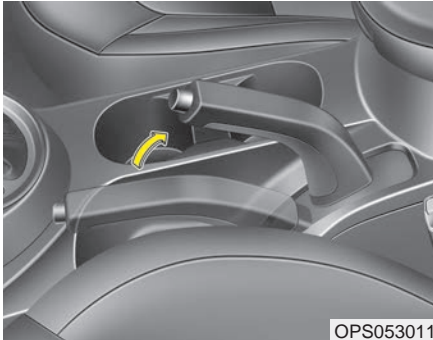

Check the stroke of the parking brake by counting the number of “clicks” heard while fully applying it from the released position. Also, the parking brake alone should securely hold the vehicle on a fairly steep grade. If the stroke is more or less than specified, have the parking brake adjusted by an authorized Kia dealer.

**Stroke : 6~8 “clicks” at a force of  
20 kg (44 lbs, 196 N).**

## AIR CLEANER

### Filter replacement



It must be replaced when necessary, and should not be washed. You can clean the filter when inspecting the air cleaner element. Clean the filter by using compressed air.

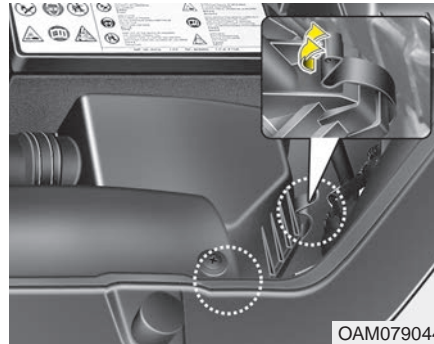

1. Loosen the air cleaner cover attaching clips and open the cover.

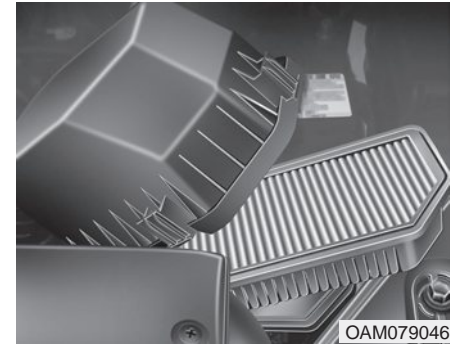

2. Wipe the inside of the air cleaner.  
3. Replace the air cleaner filter.  
4. Lock the cover with the cover attaching clips.

Replace the filter according to the Maintenance Schedule.

If the vehicle is operated in extremely dusty or sandy areas, replace the element more often than the usual recommended intervals. (Refer to “Maintenance under severe usage conditions” in this chapter.)

 **CAUTION**

**- Air filter maintenance**

- ***Do not drive with the air cleaner removed; this will result in excessive engine wear.***
- ***When removing the air cleaner filter, be careful that dust or dirt does not enter the air intake, or damage may result.***
- ***Use a Kia genuine part. Use of non-genuine parts could damage the air flow sensor.***

## CLIMATE CONTROL AIR FILTER (IF EQUIPPED)

### Filter inspection

The climate control air filter should be replaced according to the maintenance schedule. If the vehicle is operated in severely air-polluted cities or on dusty rough roads for a long period, it should be inspected more frequently and replaced earlier. When you replace the climate control air filter, replace it performing the following procedure, and be careful to avoid damaging other components.

### Filter replacement

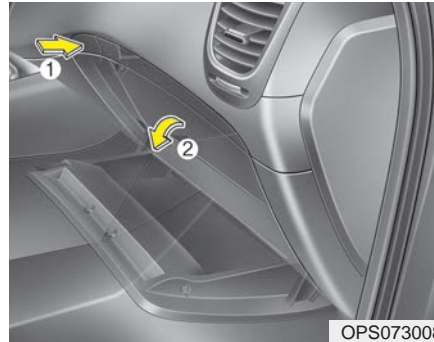

1. Open the glove box.



2. With the glove box open, remove the Air filter cover.

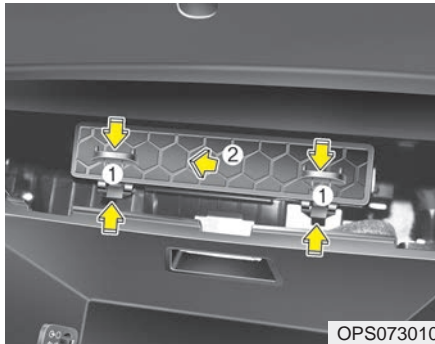

3. Remove the climate control air filter case by pulling out both sides of the cover.

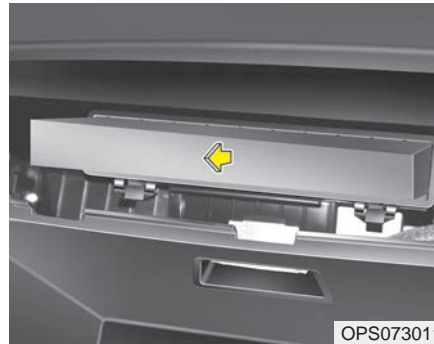

4. Replace the climate control air filter.  
5. Reassemble in the reverse order of disassembly.

When replacing the climate control air filter install it properly. Otherwise, the system may produce noise and the effectiveness of the filter may be reduced.

## WIPER BLADES

### Blade inspection

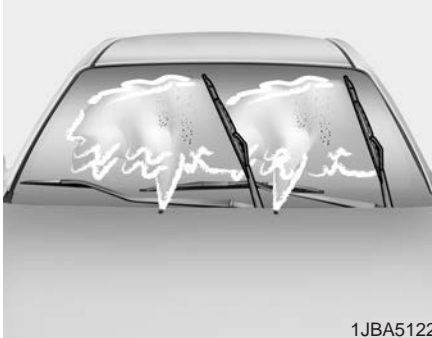

1JBA5122

Commercial hot waxes applied by automatic vehicle washes have been known to make the windshield difficult to clean.

Contamination of either the windshield or the wiper blades with foreign matter can reduce the effectiveness of the windshield wipers. Common sources of contamination are insects, tree sap, and hot wax treatments used by some commercial vehicle washes. If the blades are not wiping properly, clean both the window and the blades with a good cleaner or mild detergent, and rinse thoroughly with clean water.



### **CAUTION - Wiper blades**

***To prevent damage to the wiper blades, do not use gasoline, kerosene, paint thinner, or other solvents on or near them.***

### Blade replacement

When the wipers no longer clean adequately, the blades may be worn or cracked, and require replacement.

To prevent damage to the wiper arms or other components, do not attempt to move the wipers manually.

The use of a non-specified wiper blade could result in wiper malfunction and failure.

### Front windshield wiper blade



#### Type A

1. Raise the wiper arm and turn the wiper blade assembly to expose the plastic locking clip.

**⚠ CAUTION - Wiper arms**

*Do not allow the wiper arm to fall against the windshield, since it may chip or crack the windshield.*

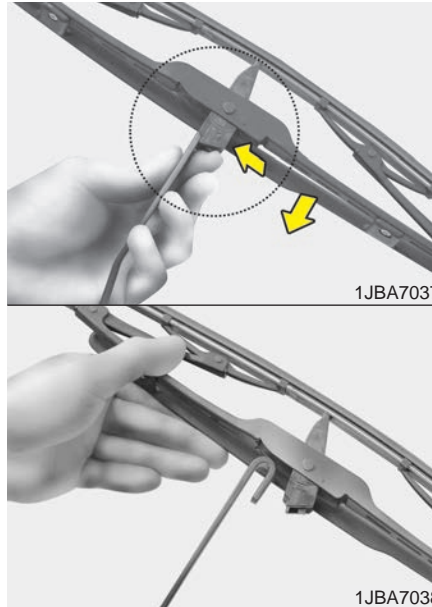

2. Compress the clip and slide the blade assembly downward.
3. Lift it off the arm.
4. Install the blade assembly in the reverse order of removal.



#### Type B

1. Raise the wiper arm.

**⚠ CAUTION - Wiper arms**

*Do not allow the wiper arm to fall against the windshield, since it may chip or crack the windshield.*



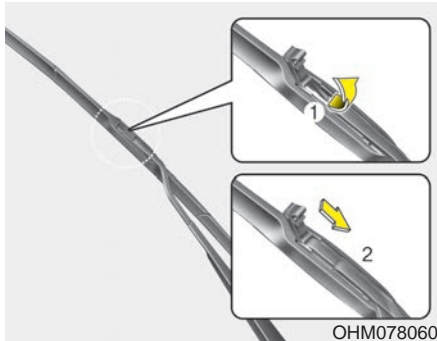

2. Lift up the wiper blade clip. Then pull down the blade assembly and remove it.

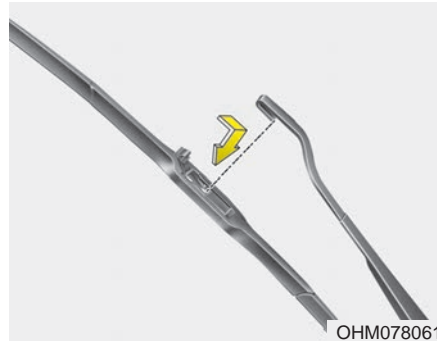

3. Install the new blade assembly in the reverse order of removal.

### Rear window wiper blade

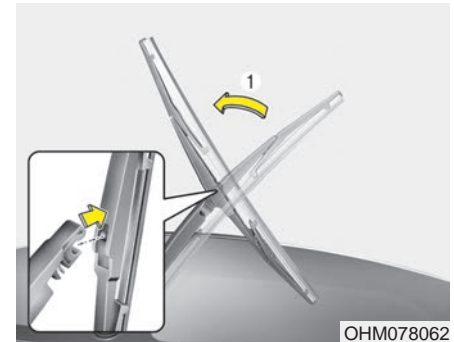

1. Raise the wiper arm and pull out the wiper blade assembly.

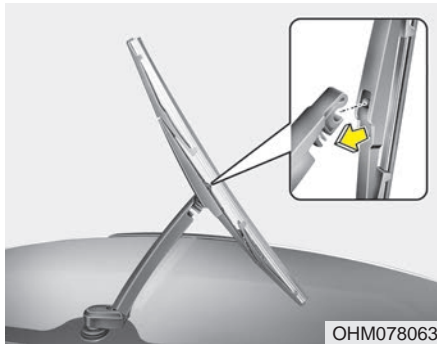

2. Install the new blade assembly by inserting the center part into the slot in the wiper arm until it clicks into place.
3. Make sure the blade assembly is installed firmly by trying to pull it slightly.

To prevent damage to the wiper arms or other components, have an authorized Kia dealer replace the wiper blade.

## BATTERY

### For best battery service

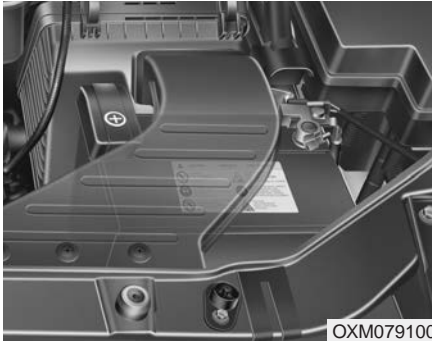

- Keep the battery securely mounted.
- Keep the battery top clean and dry.
- Keep the terminals and connections clean, tight, and coated with petroleum jelly or terminal grease.
- Rinse any spilled electrolyte from the battery immediately with a solution of water and baking soda.
- If the vehicle is not going to be used for an extended time, disconnect the battery cables.

#### **WARNING** - Risk of explosion



Keep lit cigarettes and all other flames or sparks away from the battery.



The battery contains hydrogen -- a highly combustible gas which will explode if it comes in contact with a flame or spark.

#### **WARNING** - Sulfuric acid in batteries



Keep batteries out of the reach of children because batteries contain highly corrosive **SULFURIC ACID** and electrolytes. Do not allow battery acid to contact your skin, eyes, clothing or paint finish.



Wear eye protection when charging or working near a battery. Always provide ventilation when working in an enclosed space.



Always read the following instructions carefully when handling a battery.



If any electrolyte gets into your eyes, flush your eyes with clean water for at least 15 minutes and get immediate medical attention.

If electrolyte gets on your skin, thoroughly wash the contacted area. If you feel pain or burning sensation, get medical attention immediately.



An inappropriately disposed battery can be harmful to the environment and human health. Dispose the battery according to your local law(s) or regulation.

**⚠ WARNING - Risk of electrocution**

**Never touch the electrical ignition system while the vehicle is running. This system works with high voltage which can "zap" you.**

**\* NOTICE**

**If you connect unauthorized electronic devices to the battery, the battery may be discharged. Never use unauthorized devices.**

**⚠ WARNING - Recharging battery**

**Never attempt to recharge the battery when the battery cables are connected.**

### Battery recharging

Your vehicle has a maintenance-free, calcium-based battery.

- If the battery becomes discharged in a short time (because, for example, the headlights or interior lights were left on while the vehicle was not in use), recharge it by slow charging (trickle) for 10 hours.
- If the battery gradually discharges because of high electric load while the vehicle is being used, recharge it at 20-30A for two hours.

When recharging the battery, observe the following precautions:

- The battery must be removed from the vehicle and placed in an area with good ventilation.
- Do not allow cigarettes, sparks, or flame near the battery.
- Watch the battery during charging, and stop or reduce the charging rate if the battery cells begin gassing (boiling) violently or if the temperature of the electrolyte of any cell exceeds 49°C (120°F).
- Wear eye protection when checking the battery during charging.
- Disconnect the battery charger in the following order.
  1. Turn off the battery charger main switch.
  2. Unhook the negative clamp from the negative battery terminal.
  3. Unhook the positive clamp from the positive battery terminal.
- Before performing maintenance or recharging the battery, turn off all accessories and stop the engine.
- The negative battery cable must be removed first and installed last when the battery is disconnected.

### **Reset items**

Items should be reset after the battery has been discharged or the battery has been disconnected.

- Auto up/down window (See chapter 4)
- Sunroof (See chapter 4)
- Trip computer (See chapter 4)
- Climate control system (See chapter 4)
- Clock (See chapter 4)
- Audio (See chapter 4)

## TIRES AND WHEELS

### Tire care

For proper maintenance, safety, and maximum fuel economy, you must always maintain recommended tire inflation pressures and stay within the load limits and weight distribution recommended for your vehicle.

### Recommended cold tire inflation pressures

All tire pressures (including the spare) should be checked when the tires are cold. "Cold Tires" means the vehicle has not been driven for at least three hours or driven less than 1.6 km (one mile).

Recommended pressures must be maintained for the best ride, vehicle handling, and minimum tire wear.

For recommended inflation pressure, refer to "Tire and wheels" in chapter 8.

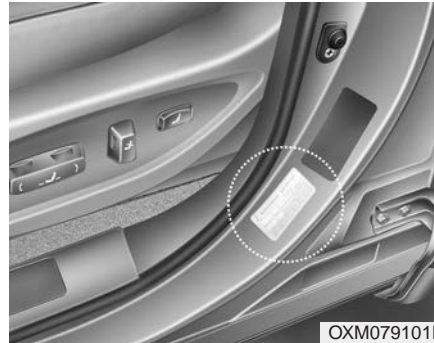

OXM079101L

All specifications (sizes and pressures) can be found on a label attached to the driver's side center pillar.

### **⚠ WARNING - Tire under inflation**

**Inflate your tire consistent with the instructions provided in this manual. Severe under inflation can lead to severe heat build-up, causing blowouts, tread separation and other tire failures that can result in the loss of vehicle control. This risk is much higher on hot days and when driving for long periods at high speeds.**

- Underinflation also results in excessive wear, poor handling and reduced fuel economy. Wheel deformation also is possible. Keep your tire pressures at the proper levels. If a tire frequently needs refilling, have it checked by an authorized Kia dealer.
- Overinflation produces a harsh ride, excessive wear at the center of the tire tread, and a greater possibility of damage from road hazards.
- Warm tires normally exceed recommended cold tire pressures by 28 to 41 kPa (4 to 6 psi). Do not release air from warm tires to adjust the pressure or the tires will be underinflated.
- Be sure to reinstall the tire inflation valve caps. Without the valve cap, dirt or moisture could get into the valve core and cause air leakage. If a valve cap is missing, install a new one as soon as possible.

Always observe the following:

- Check tire pressure when the tires are cold. (After vehicle has been parked for at least three hours or hasn't been driven more than 1.6 km (one mile) since startup.)
- Check the pressure of your spare tire each time you check the pressure of other tires.
- Never overload your vehicle. Be careful not to overload a vehicle luggage rack if your vehicle is equipped with one.

**⚠ WARNING - Tire inflation**  
**Overinflation or underinflation can reduce tire life, adversely affect vehicle handling, and lead to sudden tire failure. This could result in loss of vehicle control and potential injury.**

## Checking tire inflation pressure

Check your tires once a month or more.

Also, check the tire pressure of the spare tire.

### *How to check*

Use a good quality gauge to check tire pressure. You cannot tell if your tires are properly inflated simply by looking at them. Radial tires may look properly inflated even when they're underinflated.

Check the tire's inflation pressure when the tires are cold. - "Cold" means your vehicle has been sitting for at least three hours or driven no more than 1.6 km (1 mile).

Remove the valve cap from the tire valve stem. Press the tire gauge firmly onto the valve to get a pressure measurement. If the cold tire inflation pressure matches the recommended pressure on the tire and loading information label, no further adjustment is necessary. If the pressure is low, add air until you reach the recommended amount.

If you overfill the tire, release air by pushing on the metal stem in the center of the tire valve. Recheck the tire pressure with the tire gauge. Be sure to put the valve caps back on the valve stems. They help prevent leaks by keeping out dirt and moisture.

- Inspect your tires frequently for proper inflation as well as wear and damage. Always use a tire pressure gauge.
- Tires with too much or too little pressure wear unevenly causing poor handling, loss of vehicle control, and sudden tire failure leading to accidents, injuries, and even death. The recommended cold tire pressure for your vehicle can be found in this manual and on the tire label located on the driver's side center pillar.
- Remember to check the pressure of your spare tire. Kia recommends that you check the spare every time you check the pressure of the other tires on your vehicle.

### **Tire rotation**

To equalize tread wear, it is recommended that the tires be rotated every 12,000 km (7,500 miles) or sooner if irregular wear develops.

During rotation, check the tires for correct balance.

When rotating tires, check for uneven wear and damage. Abnormal wear is usually caused by incorrect tire pressure, improper wheel alignment, out-of-balance wheels, severe braking or severe cornering. Look for bumps or bulges in the tread or side of tire. Replace the tire if you find either of these conditions. Replace the tire if fabric or cord is visible. After rotation, be sure to bring the front and rear tire pressures to specification and check lug nut tightness.

Refer to "Tire and wheels" in chapter 8.



Without a spare tire

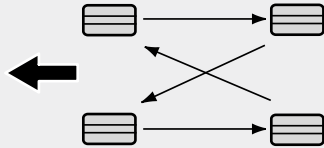

S2BLA790A

Directional tires (if equipped)

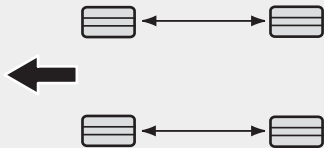

CBGQ0707A

*Disc brake pads should be inspected for wear whenever tires are rotated.*

Rotate radial tires that have an asymmetric tread pattern only from front to rear and not from right to left.

- Do not use the compact spare tire (if equipped) for tire rotation.

**⚠ WARNING - Mixing tires**  
**Do not mix bias ply and radial ply tires under any circumstances. This may cause unusual handling characteristics.**

### Wheel alignment and tire balance

The wheels on your vehicle were aligned and balanced carefully at the factory to give you the longest tire life and best overall performance.

In most cases, you will not need to have your wheels aligned again. However, if you notice unusual tire wear or your vehicle pulling one way or the other, the alignment may need to be reset.

If you notice your vehicle vibrating when driving on a smooth road, your wheels may need to be rebalanced.

**⚠ CAUTION - Wheel weight**  
*Improper wheel weights can damage your vehicle's aluminum wheels. Use only approved wheel weights.*

### Tire replacement



If the tire is worn evenly, a tread wear indicator will appear as a solid band across the tread. This shows there is less than 1.6 mm (1/16 inch) of tread left on the tire. Replace the tire when this happens.

Do not wait for the band to appear across the entire tread before replacing the tire.

The ABS works by comparing the speed of the wheels. The tire size affects wheel speed. When replacing tires, all 4 tires must use the same size originally supplied with the vehicle. Using tires of a different size can cause the ABS (Anti-lock Brake System) and ESC (Electronic Stability Control) to work irregularly.

### \* NOTICE

**We recommend that when replacing tires, use the same originally supplied with the vehicles. If not, that affects driving performance.**

### *Compact spare tire replacement*

A compact spare tire has a shorter tread life than a regular size tire. Replace it when you can see the tread wear indicator bars on the tire. The replacement compact spare tire should be the same size and design tire as the one provided with your new vehicle and should be mounted on the same compact spare tire wheel. The compact spare tire is not designed to be mounted on a regular size wheel, and the compact spare tire wheel is not designed for mounting a regular size tire.

## Wheel replacement

When replacing the metal wheels for any reason, make sure the new wheels are equivalent to the original factory units in diameter, rim width and offset.

A wheel that is not the correct size may adversely affect wheel and bearing life, braking and stopping abilities, handling characteristics, ground clearance, body-to-tire clearance, snow chain clearance, speedometer and odometer calibration, headlight aim and bumper height.



### **CAUTION - Wheels**

*Wheels that do not meet Kia's specifications may fit poorly and result in damage to the vehicle or unusual handling and poor vehicle control.*

## Tire traction

Tire traction can be reduced if you drive on worn tires, tires that are improperly inflated or on slippery road surfaces. Tires should be replaced when tread wear indicators appear. Slow down whenever there is rain, snow or ice on the road to reduce the possibility of losing control of the vehicle.

## Tire maintenance

In addition to proper inflation, correct wheel alignment helps to decrease tire wear. If you find a tire is worn unevenly, have your dealer check the wheel alignment.

When you have new tires installed, make sure they are balanced. This will increase vehicle ride comfort and tire life. Additionally, a tire should always be rebalanced if it is removed from the wheel.

## Tire sidewall labeling

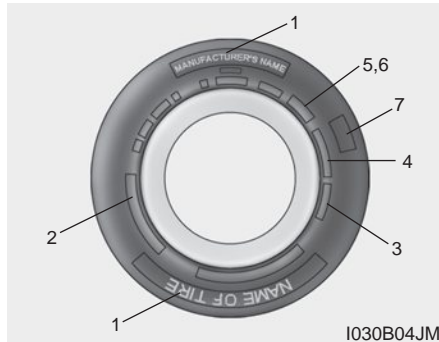

This information identifies and describes the fundamental characteristics of the tire and also provides the tire identification number (TIN) for safety standard certification. The TIN can be used to identify the tire in case of a recall.

### 1. *Manufacturer or brand name*

Manufacturer or Brand name is shown.

### 2. *Tire size designation*

A tire's sidewall is marked with a tire size designation. You will need this information when selecting replacement tires for your vehicle. The following explains what the letters and numbers in the tire size designation mean.

Example tire size designation:

(These numbers are provided as an example only; your tire size designator could vary depending on your vehicle.)

#### **P235/65R17 108T**

P - Applicable vehicle type (tires marked with the prefix "P" are intended for use on passenger vehicles or light trucks; however, not all tires have this marking).

235 - Tire width in millimeters.

65 - Aspect ratio. The tire's section height as a percentage of its width.

R - Tire construction code (Radial).

17 - Rim diameter in inches.

108 - Load Index, a numerical code associated with the maximum load the tire can carry.

T - Speed Rating Symbol. See the speed rating chart in this section for additional information.

### **Wheel size designation**

Wheels are also marked with important information that you need if you ever have to replace one. The following explains what the letters and numbers in the wheel size designation mean.

Example wheel size designation:

#### **7.0JX17**

7.0 - Rim width in inches.

J - Rim contour designation.

17 - Rim diameter in inches.

### Tire speed ratings

The chart below lists many of the different speed ratings currently being used for passenger vehicle tires. The speed rating is part of the tire size designation on the sidewall of the tire. This symbol corresponds to that tire's designed maximum safe operating speed.

Speed Rating Symbol	Maximum Speed
S	180 km/h (112 mph)
T	190 km/h (118 mph)
H	210 km/h (130 mph)
V	240 km/h (149 mph)
Z	240 km/h (Above 149 mph)

### 3. Checking tire life (TIN : Tire Identification Number)

Any tires that are over 6 years old, based on the manufacturing date, (including the spare tire) should be replaced by new ones. You can find the manufacturing date on the tire sidewall (possibly on the inside of the wheel), displaying the DOT Code. The DOT Code is a series of numbers on a tire consisting of numbers and English letters. The manufacturing date is designated by the last four digits (characters) of the DOT code.

#### DOT : XXXX XXXX OOOO

The front part of the DOT means a plant code number, tire size and tread pattern and the last four numbers indicate week and year manufactured.

For example:

DOT XXXX XXXX 1615 represents that the tire was produced in the 16th week of 2015.

**⚠ WARNING - Tire age**  
**Replace tires within the recommended time frame. Failure to replace tires as recommended can result in sudden tire failure, which could lead to a loss of control and an accident.**

### ***4. Tire ply composition and material***

The number of layers or plies of rubber-coated fabric in the tire. Tire manufacturers also must indicate the materials in the tire, which include steel, nylon, polyester, and others. The letter "R" means radial ply construction; the letter "D" means diagonal or bias ply construction; and the letter "B" means belted-bias ply construction.

### ***5. Maximum permissible inflation pressure***

This number is the greatest amount of air pressure that should be put in the tire. Do not exceed the maximum permissible inflation pressure. Refer to the Tire and Loading Information label for recommended inflation pressure.

### ***6. Maximum load rating***

This number indicates the maximum load in kilograms and pounds that can be carried by the tire. When replacing the tires on the vehicle, always use a tire that has the same load rating as the factory installed tire.

### ***7. Uniform tire quality grading***

Quality grades can be found where applicable on the tire sidewall between tread shoulder and maximum section width.

For example:

TREADWEAR 200  
TRACTION AA  
TEMPERATURE A

Tires degrade over time, even when they are not being used. Regardless of the remaining tread, we recommend that tires be replaced after approximately

six (6) years of normal service. Heat caused by hot climates or frequent high loading conditions can accelerate the aging process.

**Tread wear**

The tread wear grade is a comparative rating based on the wear rate of the tire when tested under controlled conditions on a specified government test course. For example, a tire graded 150 would wear one-and-a-half times ( $1\frac{1}{2}$ ) as well on the government course as a tire graded 100. The relative performance of tires depends upon the actual conditions of their use, however, and may depart significantly from the norm due to variations in driving habits, service practices and differences in road characteristics and climate.

These grades are molded on the side-walls of passenger vehicle tires. The tires available as standard or optional equipment on your vehicle may vary with respect to grade.

**Traction - AA, A, B & C**

The traction grades, from highest to lowest, are AA, A, B and C. Those grades represent the tire's ability to stop on wet pavement as measured under controlled conditions on specified government test surfaces of asphalt and concrete. A tire marked C may have poor traction performance.

The traction grade assigned to this tire is based on straight-ahead braking traction tests, and does not include acceleration, cornering, hydroplaning, or peak traction characteristics.

**Temperature -A, B & C**

The temperature grades are A (the highest), B and C representing the tire's resistance to the generation of heat and its ability to dissipate heat when tested under controlled conditions on a specified indoor laboratory test wheel.

Sustained high temperature can cause the material of the tire to degenerate and reduce tire life, and excessive temperature can lead to sudden tire failure. Grades B and A represent higher levels of performance on the laboratory test wheel than the minimum required by law.

### **Tire terminology and definitions**

**Air Pressure:** The amount of air inside the tire pressing outward on the tire. Air pressure is expressed in kilopascal (kPa) or pounds per square inch (psi).

**Accessory Weight:** This means the combined weight of optional accessories. Some examples of optional accessories are, automatic transaxle, power seats, and air conditioning.

**Aspect Ratio:** The relationship of a tire's height to its width.

**Belt:** A rubber coated layer of cords that is located between the plies and the tread. Cords may be made from steel or other reinforcing materials.

**Bead:** The tire bead contains steel wires wrapped by steel cords that hold the tire onto the rim.

**Bias Ply Tire:** A pneumatic tire in which the plies are laid at alternate angles less than 90 degrees to the centerline of the tread.

**Cold Tire Pressure:** The amount of air pressure in a tire, measured in pounds per square inch (psi) or kilopascals (kPa) before a tire has built up heat from driving.

**Curb Weight:** This means the weight of a motor vehicle with standard and optional equipment including the maximum capacity of fuel, oil and coolant, but without passengers and cargo.

**DOT Markings:** The DOT code includes the Tire Identification Number (TIN), an alphanumeric designator which can also identify the tire manufacturer, production plant, brand and date of production.

**GVWR:** Gross Vehicle Weight Rating

**GAWR FRT:** Gross Axle Weight Rating for the Front Axle.

**GAWR RR:** Gross Axle Weight Rating for the Rear axle.

**Intended Outboard Sidewall:** The side of an asymmetrical tire, that must always face outward when mounted on a vehicle.

**Kilopascal (kPa):** The metric unit for air pressure.

**Load Index:** An assigned number ranging from 1 to 279 that corresponds to the load carrying capacity of a tire.

**Maximum Inflation Pressure:** The maximum air pressure to which a cold tire may be inflated. The maximum air pressure is molded onto the sidewall.

**Maximum Load Rating:** The load rating for a tire at the maximum permissible inflation pressure for that tire.

**Maximum Loaded Vehicle Weight:** The sum of curb weight; accessory weight; vehicle capacity weight; and production options weight.

**Normal Occupant Weight:** The number of occupants a vehicle is designed to seat multiplied by 68 kg (150 pounds).



**Occupant Distribution:** Designated seating positions.

**Outward Facing Sidewall:** The side of an asymmetrical tire that has a particular side that faces outward when mounted on a vehicle. The outward facing sidewall bears white lettering or bears manufacturer, brand, and/or model name molding that is higher or deeper than the same moldings on the inner facing sidewall.

**Passenger (P-Metric) Tire:** A tire used on passenger cars and some light duty trucks and multipurpose vehicles.

**Recommended Inflation Pressure:** Vehicle manufacturer's recommended tire inflation pressure and shown on the tire placard.

**Radial Ply Tire:** A pneumatic tire in which the ply cords that extend to the beads are laid at 90 degrees to the centerline of the tread.

**Rim:** A metal support for a tire and upon which the tire beads are seated.

**Sidewall:** The portion of a tire between the tread and the bead.

**Speed Rating:** An alphanumeric code assigned to a tire indicating the maximum speed at which a tire can operate.

**Traction:** The friction between the tire and the road surface. The amount of grip provided.

**Tread:** The portion of a tire that comes into contact with the road.

**Treadwear Indicators:** Narrow bands, sometimes called "wear bars," that show across the tread of a tire when only 2/32 inch of tread remains.

**UTQGS:** Uniform Tire Quality Grading Standards, a tire information system that provides consumers with ratings for a tire's traction, temperature and treadwear. Ratings are determined by tire manufacturers using government testing procedures. The ratings are molded into the sidewall of the tire.

**Vehicle Capacity Weight:** The number of designated seating positions multiplied by 68 kg (150 lbs.) plus the rated cargo and luggage load.

**Vehicle Maximum Load on the Tire:** Load on an individual tire due to curb and accessory weight plus maximum occupant and cargo weight.

**Vehicle Normal Load on the Tire:** Load on an individual tire that is determined by distributing to each axle its share of the curb weight, accessory weight, and normal occupant weight and driving by 2.

**Vehicle Placard:** A label permanently attached to a vehicle showing the original equipment tire size and recommended inflation pressure.

### All season tires

Kia specifies all season tires on some models to provide good performance for use all year round, including snowy and icy road conditions. All season tires are identified by ALL SEASON and/or M+S (Mud and Snow) on the tire sidewall. Snow tires have better snow traction than all season tires and may be more appropriate in some areas.

### Summer tires

Kia specifies summer tires on some models to provide superior performance on dry roads. Summer tire performance is substantially reduced in snow and ice. Summer tires do not have the tire traction rating M+S (Mud and Snow) on the tire side wall. If you plan to operate your vehicle in snowy or icy conditions, Kia recommends the use of snow tires or all season tires on all four wheels.

### Snow tires

If you equip your vehicle with snow tires, they should be the same size and have the same load capacity as the original tires. Snow tires should be installed on all four wheels; otherwise, poor handling may result.

Snow tires should carry 28 kPa (4 psi) more air pressure than the pressure recommended for the standard tires on the tire label on the driver's side of the center pillar, or up to the maximum pressure shown on the tire sidewall, whichever is less.

Do not drive faster than 120 km/h (75 mph) when your vehicle is equipped with snow tires.

### Radial-ply tires

Radial-ply tires provide improved tread life, road hazard resistance and smoother high speed ride. The radial-ply tires used on this vehicle are of belted construction, and are selected to complement the ride and handling characteristics of your vehicle. Radial-ply tires have the same load carrying capacity, as bias-ply or bias belted tires of the same size, and use the same recommended inflation pressure. Mixing of radial-ply tires with bias-ply or bias belted tires is not recommended. Any combinations of radial-ply and bias-ply or bias belted tires when used on the same vehicle will seriously deteriorate vehicle handling. The best rule to follow is: Identical radial-ply tires should always be used as a set of four.

Longer wearing tires can be more susceptible to irregular tread wear. It is very important to follow the tire rotation interval shown in this section to achieve the tread life potential of these tires. Cuts and punctures in radial-ply tires are repairable only in the tread area, because of sidewall flexing. Consult your tire dealer for radial-ply tire repairs.

### **Low aspect ratio tire (if equipped)**

Low aspect ratio tires, whose aspect ratio is lower than 50, are provided for sporty looks.

Because the low aspect ratio tires are optimized for handling and braking, it may be more uncomfortable to ride in and there is more noise compare with normal tires.

### **CAUTION**

***Because the sidewall of the low aspect ratio tire is shorter than the normal, the wheel and tire of the low aspect ratio tire is easier to be damaged. So, follow the instructions below.***

- ***When driving on a rough road or off road, drive cautiously because tires and wheels may be damaged. And after driving, inspect tires and wheels.***
- ***When passing over a pothole, speed bump, manhole, or curb stone, drive slowly so that the tires and wheels are not damaged.***
- ***If the tire is impacted, we recommend that you inspect the tire condition or contact an authorized Kia dealer.***
- ***To prevent damage to the tire, inspect the tire condition and pressure every 3,000km.***

- It is not easy to recognize the tire damage with your own eyes. But if there is the slightest hint of tire damage, even though you cannot see the tire damage with your own eyes, have the tire checked or replaced because the tire damage may cause air leakage from the tire.
- If the tire is damaged by driving on a rough road, off road, pothole, manhole, or curb stone, it will not be covered by the warranty.

You can find out the tire information on the tire sidewall.

## FUSES

### ■ Blade type



Normal



Blown

### ■ Cartridge type



Normal



Blown

### ■ Multi fuse

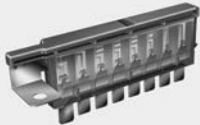

Normal

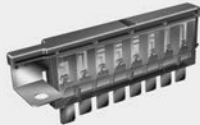

Blown



Normal



Blown

OLM079051N

A vehicle's electrical system is protected from electrical overload damage by fuses.

This vehicle has 2 (or 3) fuse panels, one located in the driver's side panel bolster, the other in the engine compartment near the battery.

If any of your vehicle's lights, accessories, or controls do not work, check the appropriate circuit fuse. If a fuse has blown, the element inside the fuse will melt.

If the electrical system does not work, first check the driver's side fuse panel.

Always replace a blown fuse with one of the same rating.

If the replacement fuse blows, this indicates an electrical problem. Avoid using the system involved and immediately consult an authorized Kia dealer.

*Three kinds of fuses are used: micro mini type for lower amperage rating, cartridge type, and multi fuse for higher amperage ratings.*

### **⚠ WARNING - Fuse replacement**

- **Never replace a fuse with anything but another fuse of the same rating.**
- **A higher capacity fuse could cause damage and possibly a fire.**
- **Never install a wire or aluminum foil instead of the proper fuse - even as a temporary repair. It may cause extensive wiring damage and a possible fire.**
- **When replacing a fuse, make sure the ignition is in the Off position and all electrical devices are off prior to separating the (-) terminal from the battery.**

Do not arbitrarily modify or add-on electric wiring to the vehicle.

 **CAUTION**

*Do not use a screwdriver or any other metal object to remove fuses because it may cause a short circuit and damage the system.*

**\* NOTICE**

The actual fuse/relay panel label may differ depending on equipment/options.

 **WARNING - Electrical Fire**

- Always ensure replacements fuses and relays are securely fastened when installed. Failure to do so can result in a vehicle fire.
- We recommend that you do not remove fuses, relays and terminals that are fastened with bolts or nuts. If they are not completely re-installed, such looseness may cause electrical arcing and a possible fire. If fuses, relays and terminals fastened with bolts or nuts need replacement, consult with an authorized Kia dealer.

 **CAUTION - Fuse fire**

- *When replacing a blown fuse or relay, make sure the new fuse or relay fits tightly into the clips. Failure to tightly install the fuse or relay may cause damage to the wiring and electric systems.*
- *Do not remove fuses, relays and terminals fastened with bolts or nuts. The fuses, relays and terminals may not be fastened correctly which may cause vehicle damage.*

 **CAUTION - Fuse Replacement**

*Do not input any other objects except fuses or relays into fuse/relay terminals such as a driver or wiring. It may cause contact failure and system malfunction.*

## Inner panel fuse replacement

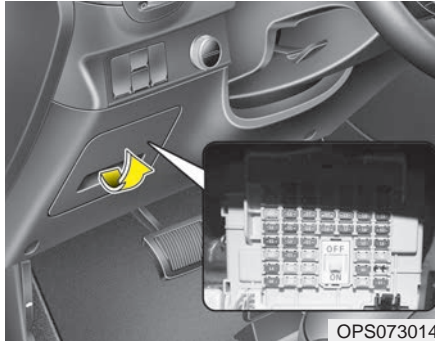

1. Turn the ignition switch and all other switches off.
2. Open the fuse panel cover.

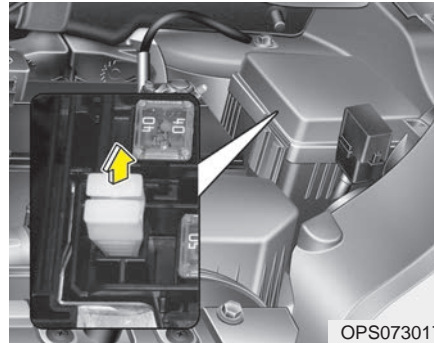

3. Pull the suspected fuse straight out. Use the fuse puller provided on the engine compartment fuse panel cover.
4. Check the removed fuse; replace it if it is blown.

*Spare fuses are provided in the engine compartment fuse panel.*

5. Push in a new fuse of the same rating, and make sure it fits tightly in the clips.

If it fits loosely, consult an authorized Kia dealer.

*If you do not have a spare, use a fuse of the same rating from a circuit you may not need for operating the vehicle, such as the power outlet fuse.*

If the headlights or other electrical components do not work and the fuses are OK, check the fuse panel in the engine compartment. If a fuse is blown, it must be replaced.

### Fuse switch

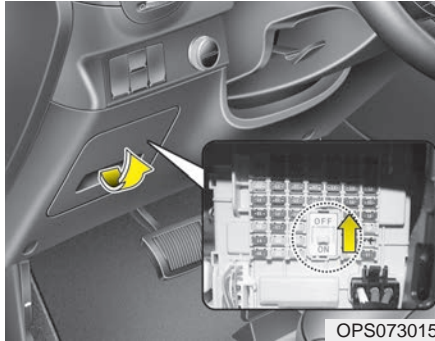

Always, put the fuse switch at the ON position.

If you move the switch to the OFF position, some items such as audio and digital clock must be reset and transmitter (or smart key) may not work properly.

### \* NOTICE

If you need to park your vehicle for prolonged periods more than 1 month, move the transportation fuse switch to the OFF position to prevent the battery being discharged.

### Engine compartment fuse replacement



1. Turn the ignition switch and all other switches off.
2. Remove the fuse panel cover by pressing the tab and pulling the cover up. When the blade type fuse is disconnected, remove it by using the clip designed for changing fuses located in the engine room fuse box. Upon removal, securely insert reserve fuse of equal quantity.



3. Check the removed fuse; replace it if it is blown. To remove or insert the fuse, use the fuse puller in the engine compartment fuse panel.
4. Push in a new fuse of the same rating, and make sure it fits tightly in the clips. If it fits loosely, consult an authorized Kia dealer.

**⚠ CAUTION - Fuse panel covers**

***After checking the fuse panel in the engine compartment, securely install the fuse panel cover with using cover locking sound. If not, electrical failures may occur from water contact.***

### Multi fuse

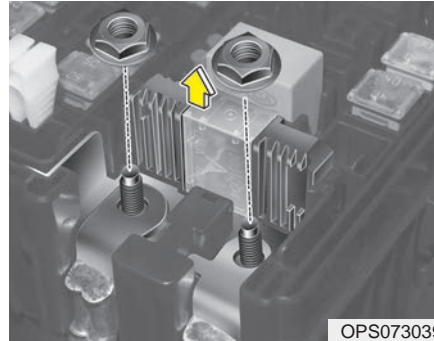

If the multi fuse is blown, it must be removed as follows:

1. Turn off the engine.
2. Disconnect the negative battery cable.
3. Remove the nuts shown in the picture above.
4. Replace the fuse with a new one of the same rating.
5. Reinstall in the reverse order of removal.

### \* NOTICE

If the multi fuse is blown, consult an authorized Kia dealer.

**⚠ CAUTION**

***Visually inspect the battery cap for secure closing. If the battery cap is not securely latched, the electrical system may be damaged due to moisture entering the system.***

### Fuse/relay panel description

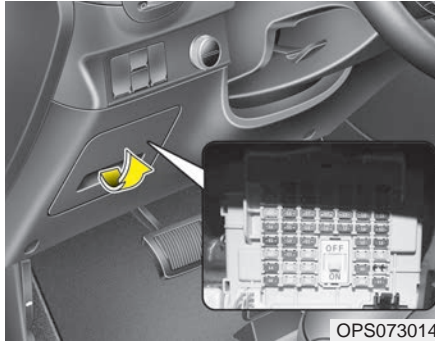

OPS073014

Inside the fuse/relay panel covers, you can find the fuse/relay label describing fuse/relay name and capacity.

#### \* NOTICE

Not all fuse panel descriptions in this manual may be applicable to your vehicle. It is accurate at the time of printing. When you inspect the fuse panel in your vehicle, refer to the fuse panel label.

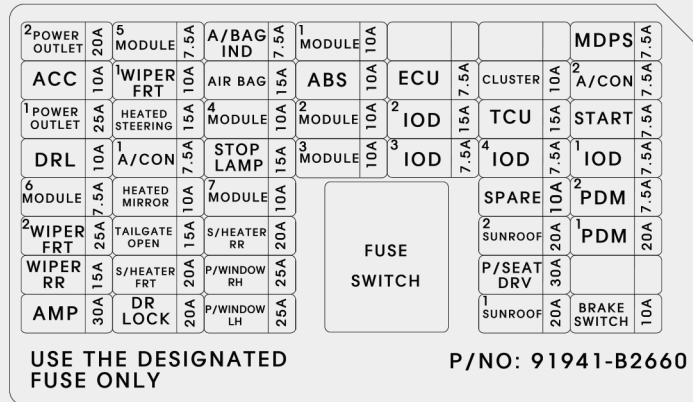

OPS075107

**Inner fuse panel**

Description	Fuse rating	Protected component
POWER OUTLET 2	20A	P_OUTLET
ACC	10A	O_S_MIRR_SW, AMP, AUDIO/UVO/AVN 4.0_HEAD UNIT, BCM, TMU, MOOD_LAMP_UNIT, SMK_UNIT, LDC_AMP(400W), LDC_AMP(200W)
POWER OUTLET 1	25A	C/LIGHT, REAR_P_OUTLET
DRL	10A	BCM(DAY_RUNNIG_LIGHT_LAMP_POWER)
MODULE 6	7.5A	SUNROOF_MOTOR, LUGGAGE_PORTABLE_LAMP(CHARGE_POWER), SEAT_EXTN_DRV(HEATED), REAR_SEAT(IGN2)
WIPER FRT 2	25A	FRONT_WIPER_MOTOR(POWER), FRONT_WIPER_RLY(LOW)
WIPER RR	15A	REAR_WIPER_MOTOR, MULTI_FUNCTION_SW(WIPER), REAR_WIPER_RLY, REAR_WIPER_RLY_COIL,
AMP	30A	AMP, LDC_AMP(400W)
MODULE 5	7.5A	BCM, SMK_UNIT
WIPER FRT 1	10A	MULTI_FUNCTION_SW(WIPER), BCM(WASHER_MOTOR_POWER),
HEATED STEERING	15A	STEERING_HEATED
A/CON 1	7.5A	AIR_CONTROL_UNIT(MANUAL, AUTO), IONIZER, PTC_RLY_COIL, BLOWER_RLY_COIL
HEATED MIRROR	10A	OUTSIDE_MIRROR(HEATED), ECU(ELEC. LOAD DEFROST), AIR_CONTROL_UNIT_MANUAL/AUTO(HEATED_SIGNAL)

## Maintenance

Description	Fuse rating	Protected component
TAILGATE OPEN	15A	T/GATE_OPEN_RLY(T/GATE_LATCH_MOTOR), T/GATE_OPEN_RLY_COIL
S/HEATER FRT	20A	FRONT_SEAT_EXTN(HEATED_POWER)
DR LOCK	20A	DOOR_LOCK_RLY, DOOR_LOCK_RLY_COIL, DOOR_UNLOCK_RLY_COIL, DEAD_LOCK_RLY, DEAD_LOCK_RLY_COIL
A/BAG IND	7.5A	CLUSTER
A/BAG	15A	ACU, WCS_ECU
MODULE 4	10A	I_S_MIRR_ECM, AUTO_HLLD_ECU, HLLD_SW, P_OUTLET_EXTN, AVN UNIT, AIR_CONTROL_UNIT(MANUAL, AUTO), OBD, LDC_AMP(200W, 400W), TMU, SEAT_EXTN, DRV, S_HEATER, REAR_SEAT_WARMER_SW
STOP LAMP	15A	HAZARD_SW(ESS_INDICATOR_POWER), STOP_SIGNAL_ELECTRONIC_MODULE
MODULE 7	10A	SPORTS_MODE_SW(ATM_SHIFT_LOCK_SOLENOID), KEY_LOCK_SOLENOID
S/HEATER RR	20A	REAR_SEAT(HEATED_POWER)
P/WDW RH	25A	FRONT_P/WINDOW_SW(POWER), P/WINDOW_SAFETY_ECU(POWER)
P/WDW LH	25A	FRONT_P/WINDOW_SW(POWER), P/WINDOW_SAFETY_ECU(POWER)
MODULE 1	10A	SPORTS_MODE_SW(ATM_SHIFT_LOCK_SOLENOID), BCM
ABS	10A	ABS/ESP_UNIT
MODULE 2	10A	LOWER_SW, CENTER_SW, STOP_LP_SW, WATER_FUEL_SNSR

Description	Fuse rating	Protected component
MODULE 3	10A	SMART_PARKING_ASSIST_SYSTEM_UNIT(SNSR), REAR_PARKING_ASSIST_SYSTEM_SNSR, TPMS_UNIT, LANE_DEPARTURE_WARNING_SYSTEM_UNIT, OIL_LEVEL_SNSR, HLLD_ACTR
ECU	7.5A	ENGINE_CONTROL_UNIT, AIR_FLOW_SNSR, START_RLY_COIL, SMK_UNIT, SMATRA_IMMOBILIZATION
IOD 2	15A	LDC_AMP(200W), AUDIO/UVO/AVN4.0_HEAD_UNIT, TMU
IOD 3	7.5A	OUTSIDE_MIRROR_FOLDING_RLY, OUTSIDE_MIRROR_FOLDING_RLY_COIL, OUTSIDE_MIRROR_UNFOLDING_RLY, OUTSIDE_MIRROR_UNFOLDING_RLY_COIL
CLUSTER	10A	CLUSTER
TCU	15A	SPEED_SNSR (MT), BACK_UP_LAMP_SW, OIL_PUMP_INVERTER, INHIBITOR, TRANSMISSION_CONTROL_UNIT
IOD 4	7.5A	OBDII(POWER), TPMS_UNIT(POWER), CLUSTER, AIR_CONTROL_UNIT(MANUAL, AUTO), BCM, REAR_PARKING_ASSIST_SYSTEM_BUZZER
SPARE	10A	-
SUNROOF 2	20A	SUNROOF_MOTOR(POWER)
P/SEAT DRV	30A	FRNT_SEAT_EXTN(POWER)
SUNROOF 1	20A	SUNROOF_MOTOR(POWER)
MDPS	7.5A	MDPS_UNIT
A/CON 2	7.5A	AIR_CONTROL_UNIT_MANUAL(MAX_BLOWER), AIR_CONTROL_UNIT_AUTO(BLOWER_MOTOR)
START	7.5A	E/R_FUSE & RELAY_BOX(RELAY - START / SUB START), PDM

## Maintenance

---

Description	Fuse rating	Protected component
IOD 1	7.5A	GLOVE_BOX_LAMP, DOOR_WARNING_SW, OVER_HEAD_CONSOLE_LAMP, PERSONAL_LAMP, SUNVISOR_LAMP, LUGGAGE_LAMP, PORTABLE_LAMP(DOOR)
PDM 2	7.5A	SMK_UNIT(BATT_CPU), SMATRA_IMMOBILIZATION(BATT)
PDM 1	20A	SMK_UNIT(POWER)
BRAKE SWITCH	10A	STOP_LAMP_SW(NORMAL_OPEN), SMK_UNIT

**Engine compartment fuse panel**

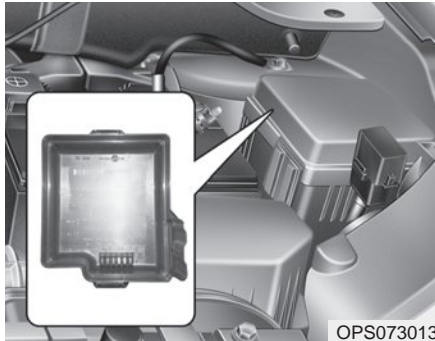

**\* NOTICE**

The actual fuse/relay panel label may differ from equipped items.

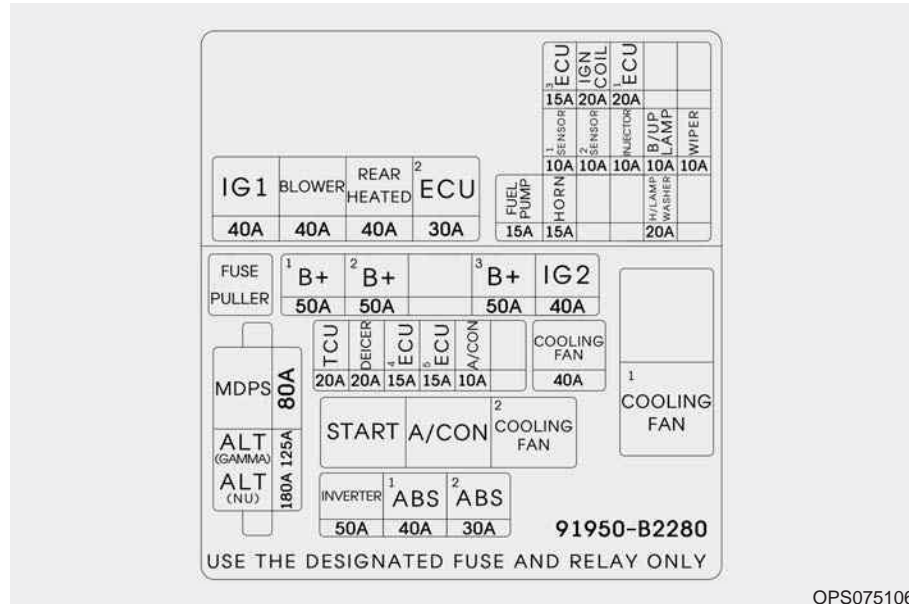

## Engine compartment fuse panel

Description	Fuse rating	Protected component
IG1	40A	IGN_SW(B1), BUTTON_START_RLY(IG1), BUTTON_START_RLY(ACC)
BLOWER	40A	BLOWER_RLY, BLOWER_MOTOR
REAR HEATED	40A	REAR_GLASS_HEATED_RLY
ECU 2	30A	MAIN_RLY, MAIN_RLY_COIL
ECU 3	15A	ECU(AFTER_AIN_RELAY)
IGN COIL	20A	IGNITION_COIL(POWER)
ECU 1	20A	ECU(AFTER_MAIN_RELAY)
SENSOR 1	10A	STOP_LAMP_SW(NORMAL_CLOSE), O2_SNSR, PURGE_CONTROL_SOLENOID_VALVE, OCV,
SENSOR 2	10A	CMP, COOLING_FAN_LOW_RLY_COIL
INJECTOR	10A	-
B/UP LAMP	10A	RR_COMBI_LAMP(BACK_UP_LAMP)
WIPER	10A	ECU(WIPER_SWITCH)
FUEL PUMP	15A	FUEL_PUMP_MOTOR
HORN	15A	HORN_RLY, HORN_RLY_COIL, HORN
H/LAMP WASHER	20A	HEAD_LAMP_WASHER_RLY, HEAD_LAMP_WASHER_RLY_COIL, HEAD_LAMP_WASHER_MOTOR



Description	Fuse rating	Protected component
B+ 1	50A	SMART_JUNCTION_BLOCK(B+1)
B+ 2	50A	SMART_JUNCTION_BLOCK(B+2)
B+ 3	50A	SMART_JUNCTION_BLOCK(B+3)
IG2	40A	IGN_SW(IG2), BUTTON_START_RLY(IG2), START_RLY
MDPS	80A	MDPS_UNIT
ALT (GAMMA)	125A	ALTERNATOR
ALT (NU)	180A	
TCU	20A	TRANSMISSION_CONTROL_UNIT
DEICER	20A	DEICER
ECU 4	15A	ECU(BATT_DIRECT)
ECU 5	15A	ECU(BATT_DIRECT)
A/CON	10A	A/CON_RLY
COOLING FAN	40A	COOLING_FAN_MOTOR, SUB_FUEL_PUMP, SUB_FUEL_VALVE
INVERTER	50A	OIL_PUMP_INVERTER
ABS 1	40A	ABS/ESP_UNIT(MOTOR)
ABS 2	30A	ABS/ESP_UNIT(SOLENOID)

## LIGHT BULBS

### **⚠ WARNING - Lights**

Prior to working on the light, firmly apply the parking brake, ensure that the ignition switch is turned to the **LOCK** position and turn off the lights to avoid sudden movement of the vehicle and burning your fingers or receiving an electric shock.

*Use only the bulbs of the specified wattage.*

### **⚠ CAUTION** - Light replacement

*Be sure to replace the burned-out bulb with one of the same wattage rating. Otherwise, it may cause damage to the fuse or electric wiring system.*

- If you don't have necessary tools, the correct bulbs and the expertise, consult an authorized Kia dealer. In many cases, it is difficult to replace vehicle light bulbs because other parts of the vehicle must be removed before you can get to the bulb. This is especially true if you have to remove the headlight assembly to get to the bulb(s).

Removing/installing the headlight assembly can result in damage to the vehicle.

- Do not install additional bulb or LED. If you install that, the lamp may not be operated properly and fuse box or electric wiring system may have problem.

### Headlight, position light, turn signal light, side marker light and front fog light bulb replacement

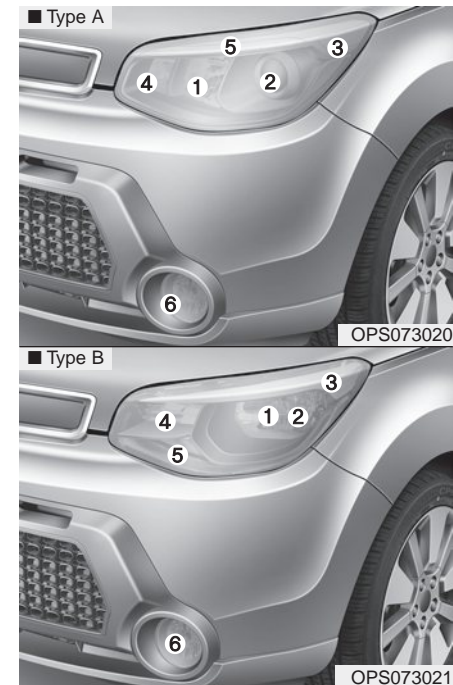

- (1) Headlight (High)
- (2) Headlight (Low)
- (3) Front side marker light
- (4) Front turn signal
- (5) Front position light
- (6) Front fog light (if equipped)

If the headlight aiming adjustment is necessary after the headlight assembly is reinstalled, consult an authorized Kia dealer.

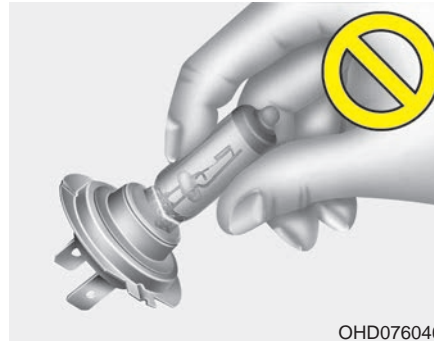

**⚠ WARNING - Halogen bulbs**

**Handle halogen bulbs with care.**

- **Halogen bulbs contain pressurized gas that will produce flying pieces of glass if broken.**

- Always handle them carefully, and avoid scratches and abrasions. If the bulbs are lit, avoid contact with liquids. Never touch the glass with bare hands. Residual oil may cause the bulb to overheat and burst when lit. A bulb should be operated only when installed in a headlight.
- If a bulb becomes damaged or cracked, replace it immediately and carefully dispose of it.
- Wear eye protection when changing a bulb. Allow the bulb to cool down before handling it.

### Headlight (HID type)

If the light bulb is not operating, have the vehicle checked by an authorized Kia dealer.

**⚠ WARNING - HID**  
Headlight low beam  
(if equipped)

Do not attempt to replace or inspect the low beam (XENON bulb) due to electric shock danger. If the low beam (XENON bulb) is not working, have your vehicle checked by an authorized Kia dealer.

### \* NOTICE

HID lamps have superior performance vs. halogen bulbs. HID lamps are estimated by the manufacturer to last twice as long or longer than halogen bulbs depending on their frequency of use. They will probably require replacement at some point in the life of the vehicle. Cycling the headlamps on and off more than typical use will shorten HID lamps life. HID lamps do not fail in the same manner as halogen incandescent lamps. If a headlamp goes out after a period of operation but will immediately relight when the headlamp switch is cycled it is likely the HID lamp needs to be replaced. HID lighting components are more complex than conventional halogen bulbs thus have higher replacement cost.

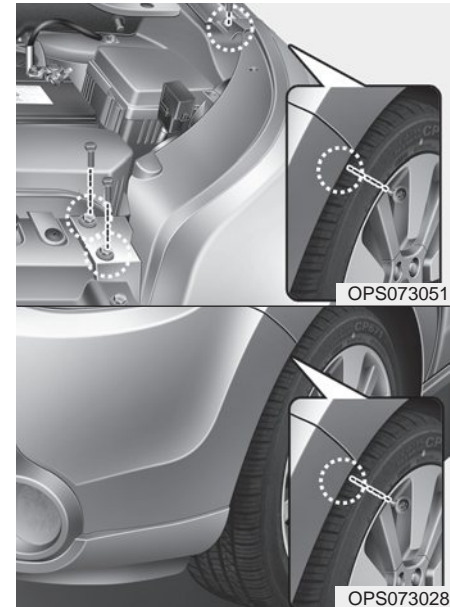

1. Turn off the engine and open the hood. Disconnect the negative battery cable.
2. Disconnect the power connector from the back of the headlight assembly.
3. Loosen the retaining bolts.

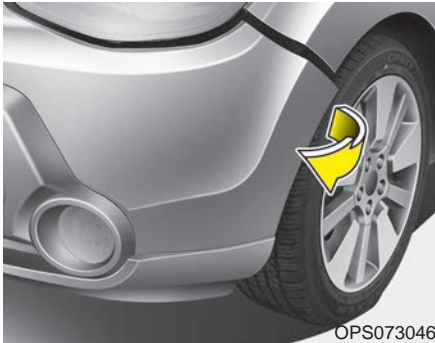

4. Pull out the end of the front bumper.
5. Remove the headlight assembly from the body of the vehicle.

If you can reach the bulb without removing the headlight assembly, you do not need to do step 3, 4 and 5.

### Headlight bulb (High)

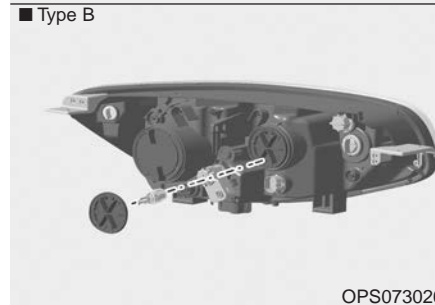
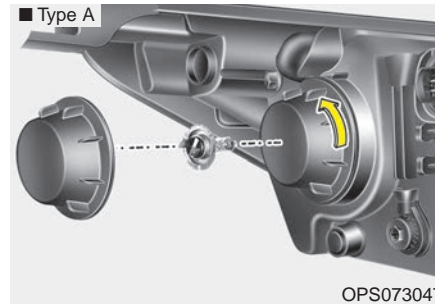

Follow the steps 1 to 5 from the previous page.

6. Remove the headlight bulb cover by turning it counterclockwise.
7. Disconnect the headlight bulb socket-connector.

8. Unsnap the headlight bulb retaining wire by depressing the end and pushing it upward.
9. Remove the bulb from the headlight assembly.
10. Install a new headlight bulb and snap the headlight bulb retaining wire into position by aligning the wire with the groove on the bulb.
11. Connect the headlight bulb socket connector.
12. Install the headlight bulb cover by turning it clockwise.
13. Connect the power connector to the back of the headlight assembly.
14. Reinstall the headlight assembly to the body of the vehicle.

## Headlight bulb (Low)

■ Type A

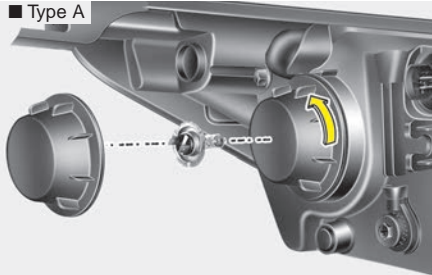

OPS073047

■ Type B

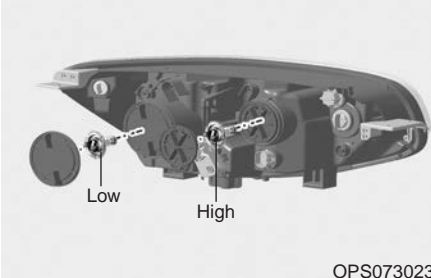

OPS073023

Follow the steps 1 to 5 from the previous page.

6. Remove the headlight bulb cover by turning it counterclockwise.

7. Remove the bulb from the assembly by turning it counterclockwise.

8. Insert a new bulb by inserting it into the housing and rotating it until it locks into place.

9. Install the headlight bulb cover by turning it clockwise.

## Front turn signal/position light

■ Type A

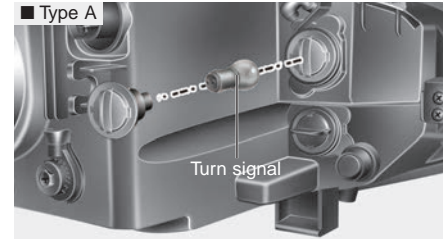

OPS073049

■ Type B

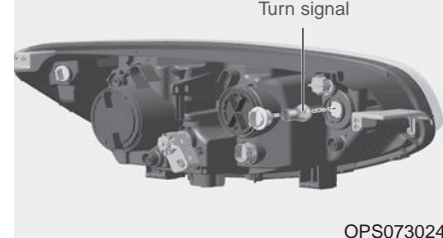

OPS073024

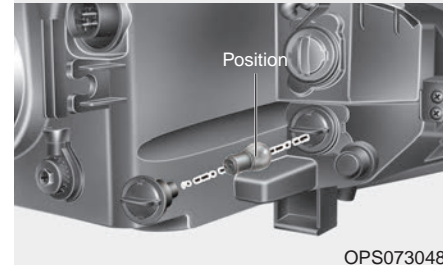

OPS073048

**Bulb type**

Follow the steps 1 to 5 from the previous page.

6. Remove the socket from the assembly by turning the socket counterclockwise until the tabs on the socket align with the slots on the assembly.
7. Remove the bulb from the socket by pressing it in and rotating it counterclockwise until the tabs on the bulb align with the slots in the socket.
8. Insert a new bulb by inserting it into the socket and rotating it until it locks into place.
9. Install the socket in the assembly by aligning the tabs on the socket with the slots in the assembly and turning the socket clockwise.
10. Reinstall the light assembly to the body of the vehicle.

**LED type**

If the light bulb is not operating, have the vehicle checked by an authorized Kia dealer.

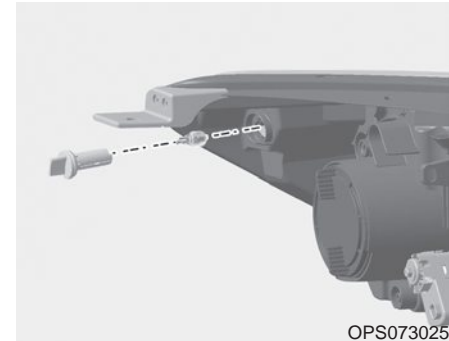
**Front side marker**

Follow the steps 1 to 5 from the previous page.

6. Remove the socket from the assembly by turning the socket counterclockwise until the tabs on the socket align with the slots on the assembly.
7. Pull the bulb out of the socket.
8. Insert a new bulb into the socket.
9. Install the socket into the assembly by aligning the tabs on the socket with the slots on the assembly and turning the socket clockwise.

**Front fog lamp bulbs  
(if equipped)**

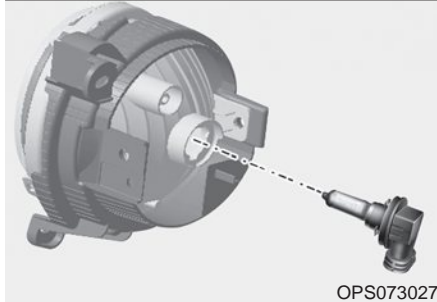
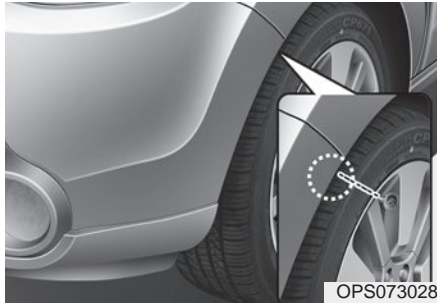

1. Remove the front bumper under cover.
2. Reach your hand into the back of the front bumper.

3. Disconnect the power connector from the socket.
4. Remove the bulb-socket from the housing by turning the socket counter clockwise until the tabs on the socket align with the slots on the housing.
5. Install the new bulb-socket into the housing by aligning the tabs on the socket with the slots in the housing. Push the socket into the housing and turn the socket clockwise.
6. Connect the power connector to the socket.
7. Reinstall the front bumper under cover.

**\* NOTICE**

**If the headlight aiming adjustment is necessary after the headlight assembly is reinstalled, consult an authorized Kia dealer.**

**Side repeater light bulb  
replacement (if equipped)**

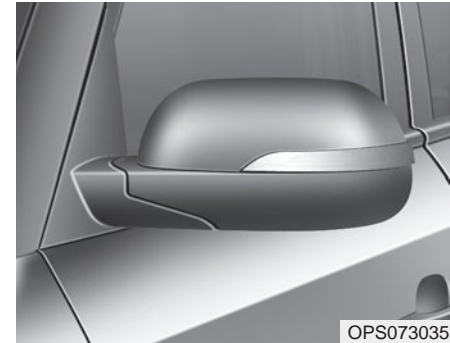

If the light bulb is not operating, have the vehicle checked by an authorized Kia dealer.



## Rear combination light bulb replacement

### ■ Type A

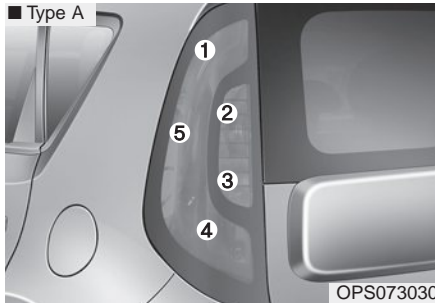

### ■ Type B

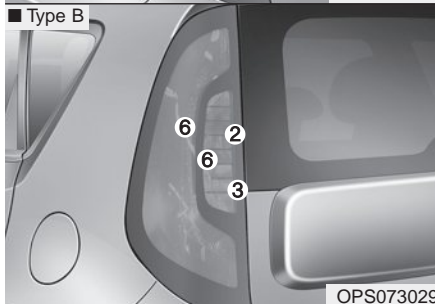

- (5) Tail light
- (6) Tail/Stop light and side marker (LED)

- (1) Tail light and side marker
- (2) Rear turn signal light
- (3) Back-up light
- (4) Stop and tail light

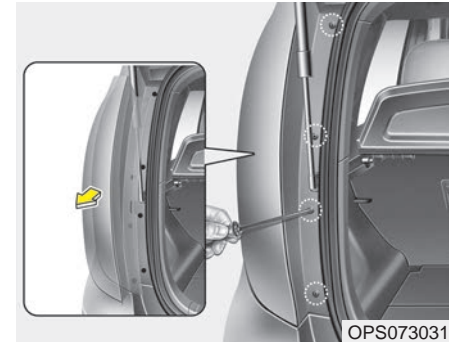

1. Open the tailgate.
2. Loosen the light assembly retaining screws with a philips head screwdriver.
3. Remove the rear combination light assembly from the body of the vehicle.

## Tail light and side marker, Turn signal light and Stop and tail light

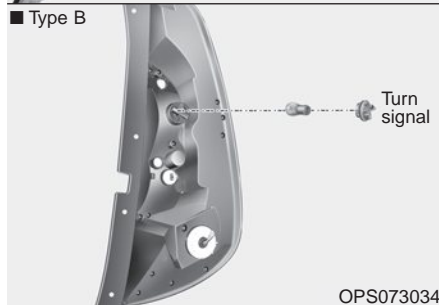
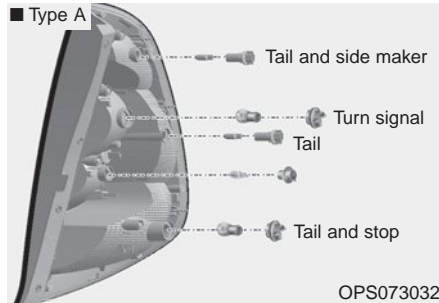

4. Remove the socket from the assembly by turning the socket counterclockwise until the tabs on the socket align with the slots on the assembly.

5. Remove the bulb from the socket by pressing it in and rotating it counterclockwise until the tabs on the bulb align with the slots in the socket.
6. Insert a new bulb by inserting it into the socket and rotating it until it locks into place.
7. Install the socket in the assembly by aligning the tabs on the socket with the slots in the assembly and turning the socket clockwise.
8. Reinstall the light assembly to the body of the vehicle.

## Back-up light

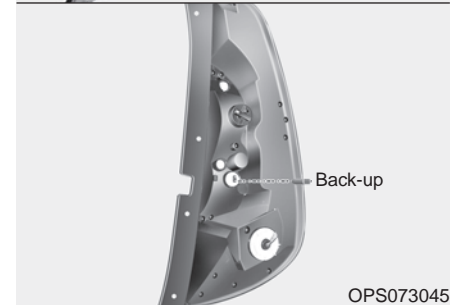
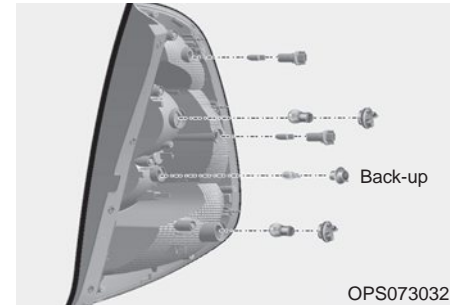

Follow the steps 1 to 3 from the previous page.

4. Remove the socket from the assembly by turning the socket counterclockwise until the tabs on the socket align with the slots on the assembly.

5. Pull the bulb out of the socket.
6. Insert a new bulb into the socket.
7. Install the socket into the assembly by aligning the tabs on the socket with the slots on the assembly and turning the socket clockwise.
8. Reinstall the light assembly to the body of the vehicle.

### High mounted stop light replacement

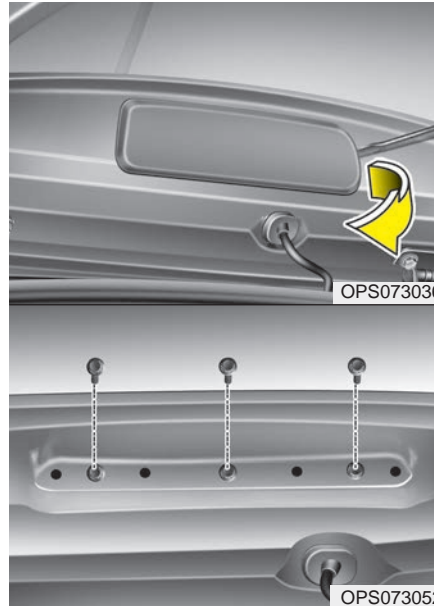

1. Open the tailgate.
2. Remove the cover.
3. Loosen the retaining bolts.

### Bulb type

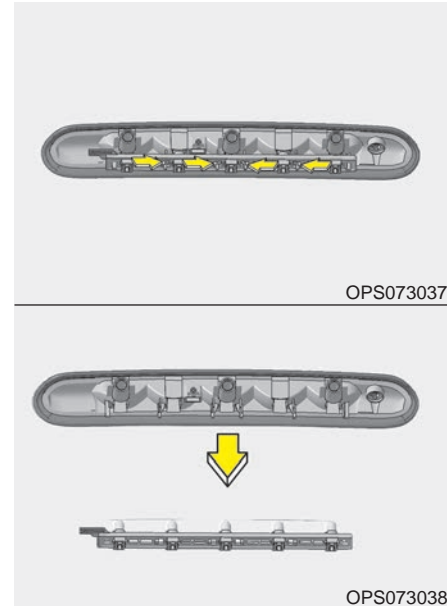

4. Pull out the module from the high mounted stop light assembly by pulling both clips.
5. Replace the bulbs by pulling it out.
6. Reinstall in the reverse order.

**LED type (if equipped)**

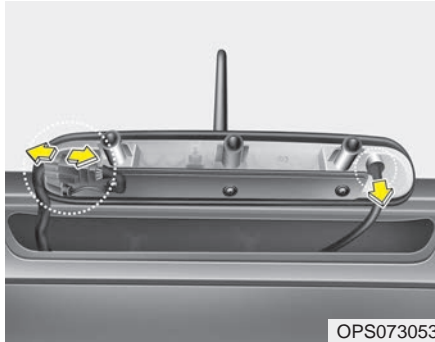

5. Replace the LED with new one.
6. Reinstall in the reverse order.

**License plate light bulb replacement**

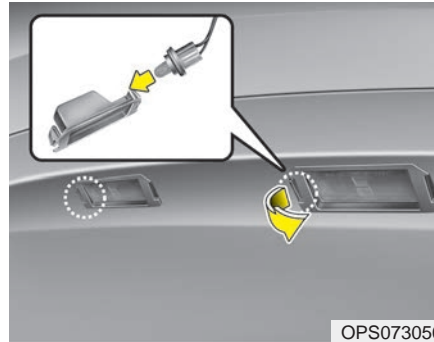

1. Remove the lens by pressing the tabs.
2. Remove the socket from the lens.
3. Remove the bulb by turning it counter clockwise.
4. Install a new bulb in the socket and install the socket to the lens.
5. Reinstall the lens securely.

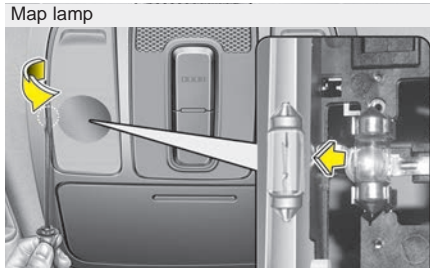

Map lamp



Room lamp

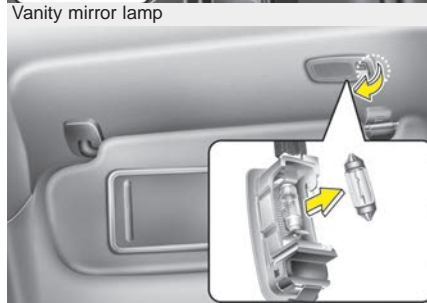
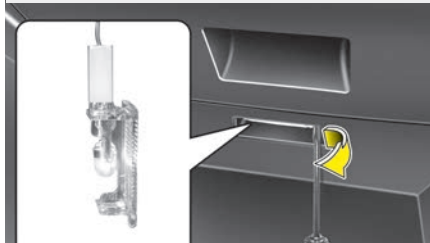

Vanity mirror lamp

OPS073041/OPS073042/OPS073043/  
OPS073044/OXM079041

## Interior light bulb replacement

1. Using a flat-blade screwdriver, gently pry the lens from the interior light housing.
2. Remove the bulb by pulling it straight out.

**⚠ WARNING - Interior lights**  
Prior to working on the Interior Lights, ensure that the "OFF" button is depressed to avoid burning your fingers or receiving an electric shock.

3. Install a new bulb in the socket.
4. Align the lens tabs with the interior light housing notches and snap the lens into place.

**⚠ CAUTION**  
*Be careful not to dirty or damage the lens, lens tab, and plastic housings.*

## APPEARANCE CARE

### Exterior care

#### *Exterior general caution*

It is very important to follow the label directions when using any chemical cleaner or polish. Read all warning and caution statements that appear on the label.

### *Finish maintenance*

#### **Washing**

To help protect your vehicle's finish from rust and deterioration, wash it thoroughly and frequently at least once a month with lukewarm or cold water.

If you use your vehicle for off-road driving, you should wash it after each off-road trip. Pay special attention to the removal of any accumulation of salt, dirt, mud, and other foreign materials. Make sure the drain holes in the lower edges of the doors and rocker panels are kept clear and clean.

Insects, tar, tree sap, bird droppings, industrial pollution and similar deposits can damage your vehicle's finish if not removed immediately.

Even prompt washing with plain water may not completely remove all these deposits. A mild soap, safe for use on painted surfaces, may be used.

After washing, rinse the vehicle thoroughly with lukewarm or cold water. Do not allow soap to dry on the finish.

After washing the vehicle, test the brakes while driving slowly to see if they have been affected by water. If braking performance is impaired, dry the brakes by applying them lightly while maintaining a slow forward speed.

#### **CAUTION**

- ***Do not use strong soap, chemical detergents or hot water, and do not wash the vehicle in direct sunlight or when the body of the vehicle is warm.***
- ***Be careful when washing the side windows of your vehicle. Especially, with high-pressure water. Water may leak through the windows and wet the interior.***
- ***To prevent damage to the plastic parts and lamps, do not clean with chemical solvents or strong detergents.***

### High-pressure washing

- When using high-pressure washers, make sure to maintain sufficient distance from the vehicle. Insufficient clearance or excessive pressure can lead to component damage or water penetration.
- Do not spray the camera, sensors or its surrounding area directly with a high pressure washer. Shock applied from high pressure water may cause the device to not operate normally.
- Do not bring the nozzle tip close to boots (rubber or plastic covers) or connectors as they may be damaged if they come into contact with high pressure water.

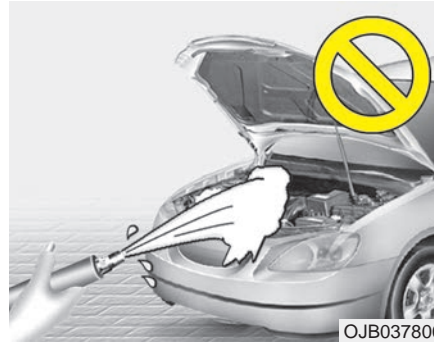

#### **⚠ CAUTION - Wetting engine**

- ***Water washing in the engine compartment including high pressure water washing may cause the failure of electrical circuits located in the engine compartment.***
- ***Never allow water or other liquids to come in contact with electrical/electronic components inside the vehicle as this may damage them.***

### Waxing

Wax the vehicle when water will no longer bead on the paint.

Always wash and dry the vehicle before waxing. Use a good quality liquid or paste wax, and follow the manufacturer's instructions. Wax all metal trim to protect it and to maintain its luster.

Removing oil, tar, and similar materials with a spot remover will usually strip the wax from the finish. Be sure to re-wax these areas even if the rest of the vehicle does not yet need waxing.

#### **\* NOTICE**

Do not apply wax on embossed unpainted unit, as it may tarnish the unit.

 **CAUTION - Drying vehicle**

- *Wiping dust or dirt off the body with a dry cloth will scratch the finish.*
- *Do not use steel wool, abrasive cleaners, acid detergents or strong detergents containing high alkaline or caustic agents on chrome-plated or anodized aluminum parts. This may result in damage to the protective coating and cause discoloration or paint deterioration.*

***Finish damage repair***

Deep scratches or stone chips in the painted surface must be repaired promptly. Exposed metal will quickly rust and may develop into a major repair expense.

**\* NOTICE**

If your vehicle is damaged and requires any metal repair or replacement, be sure the body shop applies anti-corrosion materials to the parts repaired or replaced.

***Bright-metal maintenance***

- To remove road tar and insects, use a tar remover, not a scraper or other sharp object.
- To protect the surfaces of bright-metal parts from corrosion, apply a coating of wax or chrome preservative and rub to a high luster.
- During winter weather or in coastal areas, cover the bright metal parts with a heavier coating of wax or preservative. If necessary, coat the parts with non-corrosive petroleum jelly or other protective compound.



### ***Underbody maintenance***

Corrosive materials used for ice and snow removal and dust control may collect on the underbody. If these materials are not removed, accelerated rusting can occur on underbody parts such as the fuel lines, frame, floor pan and exhaust system, even though they have been treated with rust protection.

Thoroughly flush the vehicle underbody and wheel openings with lukewarm or cold water once a month, after off-road driving and at the end of each winter. Pay special attention to these areas because it is difficult to see all the mud and dirt. It will do more harm than good to wet down the road grime without removing it. The lower edges of the doors, rocker panels, and frame members have drain holes that should not be allowed to clog with dirt; trapped water in these areas can cause rusting.

### ***Aluminum wheel maintenance***

The aluminum wheels are coated with a clear protective finish.

- Do not use any abrasive cleaner, polishing compound, solvent, or wire brushes on aluminum wheels. They may scratch or damage the finish.
- Clean the wheel when it has cooled.
- Use only a mild soap or neutral detergent, and rinse thoroughly with water. Also, be sure to clean the wheels after driving on salted roads. This helps prevent corrosion.
- Avoid washing the wheels with highspeed vehicle wash brushes.
- Do not use any alkaline or acid detergents. It may damage and corrode the aluminum wheels coated with a clear protective finish.

#### **⚠ WARNING**

**After washing the vehicle, test the brakes while driving slowly to see if they have been affected by water. If braking performance is impaired, dry the brakes by applying them lightly while maintaining a slow forward speed.**

### ***Corrosion protection***

#### **Protecting your vehicle from corrosion**

By using the most advanced design and construction practices to combat corrosion, we produce vehicles of the highest quality. However, this is only part of the job. To achieve the long-term corrosion resistance your vehicle can deliver, the owner's cooperation and assistance is also required.

#### **Common causes of corrosion**

The most common causes of corrosion on your vehicle are:

- Road salt, dirt and moisture that is allowed to accumulate underneath the vehicle.
- Removal of paint or protective coatings by stones, gravel, abrasion or minor scrapes and dents which leave unprotected metal exposed to corrosion.

### High-corrosion areas

If you live in an area where your vehicle is regularly exposed to corrosive materials, corrosion protection is particularly important. Some of the common causes of accelerated corrosion are road salts, dust control chemicals, ocean air and industrial pollution.

### Moisture breeds corrosion

Moisture creates the conditions in which corrosion is most likely to occur. For example, corrosion is accelerated by high humidity, particularly when temperatures are just above freezing. In such conditions, the corrosive material is kept in contact with the vehicle's surface by moisture that evaporates slowly.

Mud is particularly corrosive because it dries slowly and holds moisture in contact with the vehicle. Although the mud appears to be dry, it can still retain the moisture and promote corrosion.

High temperatures can also accelerate corrosion of parts that are not properly ventilated so the moisture can be dispersed. For all these reasons, it is particularly important to keep your vehicle clean and free of mud or accumulations of other materials. This applies not only to the visible surfaces but particularly to the underside of the vehicle.

### To help prevent corrosion

You can help prevent corrosion from beginning by observing the following:

### Keep your vehicle clean

The best way to prevent corrosion is to keep your vehicle clean and free of corrosive materials. Attention to the underside of the vehicle is particularly important.

- If you live in a high-corrosion area — where road salts are used, near the ocean, areas with industrial pollution, acid rain, etc.—, you should take extra care to prevent corrosion. In winter, hose off the underside of your vehicle at least once a month and be sure to clean the underside thoroughly when winter is over.
- When cleaning underneath the vehicle, give particular attention to the components under the fenders and other areas that are hidden from view. Do a thorough job; just dampening the accumulated mud rather than washing it away will accelerate corrosion rather than prevent it. Water under high pressure and steam are particularly effective in removing accumulated mud and corrosive materials.

- When cleaning lower door panels, rocker panels and frame members, be sure that drain holes are kept open so that moisture can escape and not be trapped inside to accelerate corrosion.

### **Keep your garage dry**

Don't park your vehicle in a damp, poorly ventilated garage. This creates a favorable environment for corrosion. This is particularly true if you wash your vehicle in the garage or drive it into the garage when it is still wet or covered with snow, ice or mud. Even a heated garage can contribute to corrosion unless it is well ventilated so moisture is dispersed.

### **Keep paint and trim in good condition**

Scratches or chips in the finish should be covered with "touch-up" paint as soon as possible to reduce the possibility of corrosion. If bare metal is showing through, the attention of a qualified body and paint shop is recommended.

**Bird droppings :** Bird droppings are highly corrosive and may damage painted surfaces in just a few hours. Always remove bird droppings as soon as possible.

### **Don't neglect the interior**

Moisture can collect under the floor mats and carpeting and cause corrosion. Check under the mats periodically to be sure the carpeting is dry. Use particular care if you carry fertilizers, cleaning materials or chemicals in the vehicle.

These should be carried only in proper containers and any spills or leaks should be cleaned up, flushed with clean water and thoroughly dried.

### Interior care

#### *Interior general precautions*

Prevent chemicals such as perfume, cosmetic oil, sun cream, hand cleaner, and air freshener from contacting the interior parts because they may cause damage or discoloration. If they do contact the interior parts, wipe them off immediately. If necessary, use a vinyl cleaner, see product instructions for correct usage.

#### **CAUTION - Electrical components**

***Never allow water or other liquids to come in contact with electrical/electronic components inside the vehicle as this may damage them.***

#### **CAUTION - Leather**

***When cleaning leather products (steering wheel, seats etc.), use neutral detergents or low alcohol content solutions. If you use high alcohol content solutions or acid/alkaline detergents, the color of the leather may fade or the surface may get stripped off.***

#### ***Cleaning the upholstery and interior trim***

##### **Vinyl**

Remove dust and loose dirt from vinyl with a whisk broom or vacuum cleaner. Clean vinyl surfaces with a vinyl cleaner.

##### **Fabric**

Remove dust and loose dirt from fabric with a whisk broom or vacuum cleaner. Clean with a mild soap solution recommended for upholstery or carpets. Remove fresh spots immediately with a fabric spot cleaner. If fresh spots do not receive immediate attention, the fabric can be stained and its color can be affected. Also, its fire-resistant properties can be reduced if the material is not properly maintained.

Using anything but recommended cleaners and procedures may affect the fabric's appearance and fire-resistant properties.

***Cleaning the lap/shoulder belt webbing***

Clean the belt webbing with any mild soap solution recommended for cleaning upholstery or carpet. Follow the instructions provided with the soap. Do not bleach or re-dye the webbing because this may weaken it.

***Cleaning the interior window glass***

If the interior glass surfaces of the vehicle become fogged (that is, covered with an oily, greasy or waxy film), they should be cleaned with a glass cleaner. Follow the directions on the glass cleaner container.

**CAUTION - Rear window**

***Do not scrape or scratch the inside of the rear window. This may result in damage of the rear window defroster grid.***

### EMISSION CONTROL SYSTEM

The emission control system of your vehicle is covered by a written limited warranty. Please see the warranty information contained in the Warranty & Maintenance booklet in your vehicle.

Your vehicle is equipped with an emission control system to meet all applicable emission regulations.

There are three emission control systems, as follows.

- (1) Crankcase emission control system
- (2) Evaporative emission control system
- (3) Exhaust emission control system

In order to assure the proper function of the emission control systems, it is recommended that you have your vehicle inspected and maintained by an authorized Kia dealer in accordance with the maintenance schedule in this manual.

#### Caution for the Inspection and Maintenance Test (With Electronic Stability Control (ESC) system)

- **To prevent the vehicle from misfiring during dynamometer testing, turn the Electronic Stability Control (ESC) system off by pressing the ESC switch.**
- **After dynamometer testing is completed, turn the ESC system back on by pressing the ESC switch again.**

#### 1. Crankcase emission control system

The positive crankcase ventilation system is employed to prevent air pollution caused by blow-by gases being emitted from the crankcase. This system supplies fresh filtered air to the crankcase through the air intake hose. Inside the crankcase, the fresh air mixes with blow-by gases, which then pass through the PCV valve into the induction system.

#### 2. Evaporative emission control (including ORVR: Onboard Refueling Vapor Recovery) system

The Evaporative Emission Control System is designed to prevent fuel vapors from escaping into the atmosphere.

(The ORVR system is designed to allow the vapors from the fuel tank to be loaded into a canister while refueling at the gas station, preventing the escape of fuel vapors into the atmosphere.)

### **Canister**

Fuel vapors generated inside the fuel tank are absorbed and stored in the onboard canister. When the engine is running, the fuel vapors absorbed in the canister are drawn into the surge tank through the purge control solenoid valve.

### **Purge Control Solenoid Valve (PCSV)**

The purge control solenoid valve is controlled by the Engine Control Module (ECM); when the engine coolant temperature is low during idling, the PCSV closes so that evaporated fuel is not taken into the engine. After the engine warms up during ordinary driving, the PCSV opens to introduce evaporated fuel to the engine.

### **3. Exhaust emission control system**

The Exhaust Emission Control System is a highly effective system which controls exhaust emissions while maintaining good vehicle performance.

#### **Vehicle modifications**

This vehicle should not be modified. Modification of your vehicle could affect its performance, safety or durability and may even violate governmental safety and emissions regulations.

In addition, damage or performance problems resulting from any modification may not be covered under warranty.

- If you use unauthorized electronic devices, it may cause the vehicle to operate abnormally, wire damage, battery discharge and fire. For your safety, do not use unauthorized electronic devices.

### **Engine exhaust gas precautions (carbon monoxide)**

- Carbon monoxide can be present with other exhaust fumes. Therefore, if you smell exhaust fumes of any kind inside your vehicle, have it inspected and repaired immediately. If you ever suspect exhaust fumes are coming into your vehicle, drive it only with all the windows fully open. Have your vehicle checked and repaired immediately.

#### **⚠ WARNING - Exhaust**

**Engine exhaust gases contain carbon monoxide (CO). Though colorless and odorless, it is dangerous and could be lethal if inhaled. Follow the instructions on this page to avoid CO poisoning.**

- Do not operate the engine in confined or closed areas (such as garages) any more than what is necessary to move the vehicle in or out of the area.
- When the vehicle is stopped in an open area for more than a short time with the engine running, adjust the ventilation system (as needed) to draw outside air into the vehicle.
- Never sit in a parked or stopped vehicle for any extended time with the engine running.
- When the engine stalls or fails to start, excessive attempts to restart the engine may cause damage to the emission control system.

### *Operating precautions for catalytic converters*

**⚠ WARNING**  
- Catalytic converter

**Keep away from the catalytic converter and exhaust system while the vehicle is running or immediately thereafter. The exhaust and catalytic systems are very hot and may burn you.**

**⚠ WARNING - Fire**

- Do not park, idle or drive the vehicle over or near flammable objects, such as grass, vegetation, paper, leaves, etc. A hot exhaust system can ignite flammable items under your vehicle.
- Also, do not remove the heat sink around the exhaust system, do not seal the bottom of the vehicle or do not coat the vehicle for corrosion control. It may present a fire risk under certain conditions.



Your vehicle is equipped with a catalytic converter emission control device.

Therefore, the following precautions must be observed:

- Use only UNLEADED FUEL for gasoline engines.
- Do not operate the vehicle when there are signs of engine malfunction, such as misfire or a noticeable loss of performance.
- Do not misuse or abuse the engine. Examples of misuse are coasting with the ignition off and descending steep grades in gear with the ignition off.
- Do not operate the engine at high idle speed for extended periods (5 minutes or more).
- Do not modify or tamper with any part of the engine or emission control system. All inspections and adjustments must be made by an authorized Kia dealer.
- Avoid driving with a extremely low fuel level. Running out of fuel could cause the engine to misfire, damaging the catalytic converter.

Failure to observe these precautions could result in damage to the catalytic converter and to your vehicle. Additionally, such actions could void your warranties.

## Specifications & Consumer information

Dimensions .....	8-2
Engine .....	8-2
Bulb wattage .....	8-3
Tires and wheels .....	8-4
Capacity/Weight .....	8-5
Air conditioning system .....	8-5
Recommended lubricants and capacities .....	8-6
• Recommended sae viscosity number .....	8-8
Vehicle identification number (VIN) .....	8-9
Tire specification and pressure label .....	8-10
Engine number .....	8-10

## DIMENSIONS

Item	mm (in)	
Overall length	4,140 (162.9)	
Overall width	1,800 (70.9)	
Overall height	1,600 (62.9) * <sup>1</sup> /1,615 (63.6) * <sup>2</sup>	
Front tread	205/60R16	1,576 (62.1)
	215/55R17	1,568 (61.7)
	235/45R18	1,560 (61.4)
Rear tread	205/60R16	1,588 (62.5)
	215/55R17	1,580 (62.2)
	235/45R18	1,573 (61.9)
Wheelbase	2,570 (101.2)	

\*<sup>1</sup> without roof rack

\*<sup>2</sup> with roof rack

## ENGINE



Item	1.6L	2.0L
Displacement cc (cu. in)	1,591 (97.1)	1,999 (121.9)
Bore x Stroke mm (in.)	77x85.44 (3.03x3.36)	81x97 (3.19x3.81)
Firing order	1-3-4-2	1-3-4-2
No. of cylinders	4. In-line	4. In-line

**BULB WATTAGE**

<b>Light Bulb</b>		<b>Wattage</b>	<b>Bulb type</b>	
Front	Headlamps (Low/High)	55/60	H13	
	Headlamps (Low)	55	H7SLL	
	Headlamps (Low)-HID type*	35	D3S	
	Headlamps (High)	55	H7LL	
	Front turn signal lamps	28	PY28/8W	
	Front position lamps	8 (Opt : LED)	PY28/8W (Opt : LED)	
	Front fog lamps*	35	H8L	
	Front side marker	5	W5W	
	Side Repeater lamps (Outside Mirror)*	LED	LED	
Rear	Bulb Type	Rear Stop/Tail lamps (Bottom)	28/8	P28/8W
		Rear tail lamps (Mid)	5	W5W
		Rear tail lamps & side marker (Top)	5	W5W
	LED Type	Rear Stop lamps	LED	LED
		Rear Tail lamps & side marker	LED	LED
	Rear turn signal lamps	27	PY27W	
	Back-up lamps	16	W16W	
	High mounted stop lamps	5 (Opt :LED*)	W5W (Opt : LED*)	
	License plate lamps	5	W5W	
Interior	Map lamps	8	FESTOON	
	Room lamps	8	FESTOON	
	Personal lamps	LED	LED	
	Vanity mirror lamps	5	FESTOON	
	Glove box lamps	5	FESTOON	
	Luggage lamp	8	FESTOON	

\* If equipped

## TIRES AND WHEELS

Item	Tire size	Wheel sizee	Inflation pressure bar kPa (psi)				Wheel lug nut torque Kg-m (lb-ft, N-m)
			Normal load (  + $\emptyset$ )		Maximum load (  +  )		
			Front	Rear	Front	Rear	
Full size tire	205/60R16	6.5JX16	230 (33)	230 (33)	230 (33)	230 (33)	
	215/55R17	6.5JX17					
	235/45R18	7.5JX18					
Compact spare tire (if equipped)	T125/80D16	4.0TX16	420 (60)	420 (60)	420 (60)	420 (60)	9~11 (65~79, 88~107)

### CAUTION

*When replacing tires, use the same size originally supplied with the vehicle.  
Using tires of a different size can damage the related parts or make it work irregularly.*

### \* NOTICE

We recommend that when replacing tires, use the same originally supplied with the vehicles.  
If not, that affects driving performance.

## CAPACITY/WEIGHT

Item	1.6 Engine		2.0 Engine	
	M/T	A/T	M/T	A/T
Gross vehicle weight kg (lbs.)	1,740 (3,836)	1,770 (3,902)	1,770 (3,902)	1,860 (4,100)
Luggage volume (SAE) l (cu ft)	Min : 686 (24.2) Max : 1,735 (61.3)			

Min : Behind rear seat to upper edge of the seat back.

Max : Behind front seat to roof.

## AIR CONDITIONING SYSTEM

Item	Weight of volume	Classification
Refrigerant	550g	R-134a
Compressor lubricant	110g	FD46XG (IDEMITSU)

We recommend that you contact an authorized Kia dealer for more details.

## RECOMMENDED LUBRICANTS AND CAPACITIES

To help achieve proper engine and powertrain performance and durability, use only lubricants of the proper quality. The correct lubricants also help promote engine efficiency that results in improved fuel economy.

These lubricants and fluids are recommended for use in your vehicle.

Lubricant		Volume	Classification
Engine oil <sup>*1 *2</sup> (drain and refill) recommended (or equivalent) 	1.6 Engine	3.6 l (3.80 US qt.)	API Service SM <sup>*3</sup> or above ILSAC GF-4 or above ACEA A5 or above
	2.0 Engine		
Manual transaxle fluid	1.6 Engine	1.8~1.9 l (1.9~2.0 US qt.)	SAE 70W API-GL 4 HK MTF 70W SPIRAX S6 GHME 70W GS MTF HD 70W
	2.0 Engine	1.7~1.8 l (1.8~1.9 US qt.)	
Automatic transaxle fluid	1.6 Engine	7.3 l (7.71 US qt.)	MICHANG ATF SP-IV SK ATF SP-IV NOCA ATF SP-IV Kia genuine ATF SP-IV
	2.0 Engine		

\*1 Refer to the recommended SAE viscosity numbers on the next page.

\*2 Engine oils labeled Energy Conserving Oil are now available. Along with other additional benefits, they contribute to fuel economy by reducing the amount of fuel necessary to overcome engine friction. Often, these improvements are difficult to measure in everyday driving, but in a year's time, they can offer significant cost and energy savings.

\*3 If the API service SM engine oil is not available in your country, you are able to use API service SL.

Lubricant		Volume		Classification
Coolant	1.6 Engine	M/T	5.1 l (5.39 US qt.)	Mixture of antifreeze and distilled water (Ethylene glycol base coolant for aluminum radiator)
		A/T	5.0 l (5.29 US qt.)	
	2.0 Engine	M/T	5.1 l (5.39 US qt.)	
		A/T	5.0 l (5.29 US qt.)	
Brake/Clutch fluid		0.7~0.8 l (0.7~0.8 US qt.)		FMVSS116 DOT-3 or DOT-4
Fuel		54 l (14.26 US gal.)		Refer to "Fuel requirements" in chapter 1



**Recommended SAE viscosity number**

Always be sure to clean the area around any filler plug, drain plug, or dipstick before checking or draining any lubricant. This is especially important in dusty or sandy areas and when the vehicle is used on unpaved roads. Cleaning the plug and dipstick areas will prevent dirt and grit from entering the engine and other mechanisms that could be damaged.

Engine oil viscosity (thickness) has an effect on fuel economy and cold weather operating (engine start and engine oil flowability). Lower viscosity engine oils can provide better fuel economy and cold weather performance, however, higher viscosity engine oils are required for satisfactory lubrication in hot weather.

Using oils of any viscosity other than those recommended could result in engine damage.

When choosing an oil, consider the range of temperature your vehicle will be operated in before the next oil change. Proceed to select the recommended oil viscosity from the chart.

Temperature Range for SAE Viscosity Numbers										
Temperature	°C	-30	-20	-10	0	10	20	30	40	50
	(°F)	-10	0	20	40	60	80	100	120	
Gasoline Engine Oil *1		10W-30								
		5W-20 (5W-30)								

1. For better fuel economy, it is recommended to use the engine oil of a viscosity grade SAE 5W-20 (API SM / ILSAC GF-4). However, if the engine oil is not available in your country, select the proper engine oil using the engine oil viscosity chart.



## VEHICLE IDENTIFICATION NUMBER (VIN)

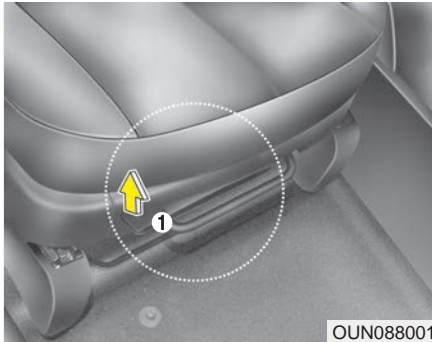

The vehicle identification number (VIN) is the number used in registering your vehicle and in all legal matters pertaining to its ownership, etc. The number is punched on the floor under the front passenger seat. To check the number, remove the cover (1).



The VIN is also on a plate attached to the top of the dashboard. The number on the plate can easily be seen through the windshield from outside.

## VEHICLE CERTIFICATION LABEL

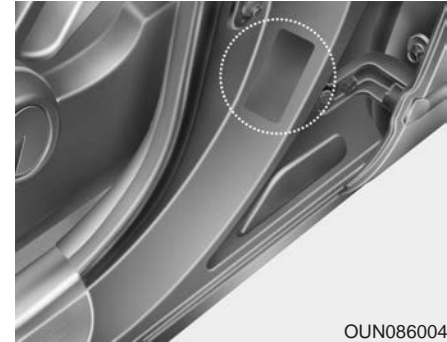

The vehicle certification label attached on the driver's side center pillar gives the vehicle identification number (VIN).

## TIRE SPECIFICATION AND PRESSURE LABEL

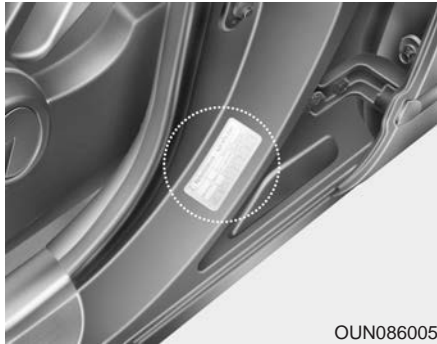

The tires supplied on your new vehicle are chosen to provide the best performance for normal driving.

The tire label located on the driver's side center pillar gives the tire pressures recommended for your vehicle.

## ENGINE NUMBER

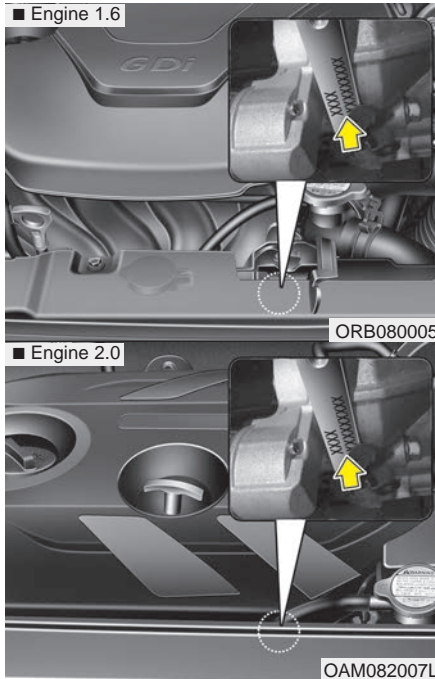

The engine number is stamped on the engine block as shown in the drawing.

# Index

## Index

### A

Active ECO system . . . . .	5-42
Active ECO operation . . . . .	5-42
Limitation of Active ECO operation . . . . .	5-42
When Active ECO is activated . . . . .	5-42
Air bag - advanced supplemental restraint system . . . . .	3-39
Adding equipment to or modifying your air bag-equipped vehicle . . . . .	3-63
Additional safety precautions . . . . .	3-63
Air bag warning label . . . . .	3-63
Air bag warning light . . . . .	3-42
Curtain air bag . . . . .	3-56
Do not installing a child restraint on a front passenger's seat . . . . .	3-42
Driver's and passenger's front air bag . . . . .	3-51
How does the air bag system operate . . . . .	3-40
Inflation and non-inflation conditions of the air bag . . . . .	3-57
Occupant Detection System (ODS) . . . . .	3-46
Side air bag . . . . .	3-54
SRS care . . . . .	3-62
SRS components and functions . . . . .	3-43
Air cleaner . . . . .	7-45
Filter replacement . . . . .	7-45
Air conditioning system . . . . .	8-5
Appearance care . . . . .	7-96
Exterior care . . . . .	7-96
Interior care . . . . .	7-102

Audio system . . . . .	4-147
Antenna . . . . .	4-147
Audio remote control . . . . .	4-148
Aux and USB port . . . . .	4-149
Speaker lights . . . . .	4-150
Automatic climate control system . . . . .	4-114
Automatic heating and air conditioning . . . . .	4-115
Checking the amount of air conditioner refrigerant and compressor lubricant . . . . .	4-125
Climate control air filter . . . . .	4-125
Manual heating and air conditioning . . . . .	4-116
System operation . . . . .	4-123
Automatic transaxle . . . . .	5-17
Automatic transaxle operation . . . . .	5-17
Good driving practices . . . . .	5-22

### B

Battery . . . . .	7-53
Battery recharging . . . . .	7-54
For best battery service . . . . .	7-53
Reset items . . . . .	7-55
Before driving . . . . .	5-4
Before entering vehicle . . . . .	5-4
Before starting . . . . .	5-5
Necessary inspections . . . . .	5-4
Brake system . . . . .	5-23
Anti-lock brake system (ABS) . . . . .	5-27

Electronic stability control (ESC) . . . . . 5-29  
 Good braking practices . . . . . 5-35  
 Hill-start assist control (HAC) . . . . . 5-34  
 Parking brake - Hand type . . . . . 5-25  
 Power brakes . . . . . 5-23  
 Vehicle stability management (VSM) . . . . . 5-33  
 Brake/clutch fluid . . . . . 7-41  
 Checking the brake/clutch fluid level . . . . . 7-41  
 Bulb wattage . . . . . 8-3

**C**

Capacity/Weight . . . . . 8-5  
 Child restraint system . . . . . 3-30  
 Lower anchor system . . . . . 3-36  
 Tether anchor system . . . . . 3-35  
 Using a child restraint system . . . . . 3-31  
 Clean air . . . . . 4-131  
 Climate control air filter . . . . . 7-47  
 Filter inspection . . . . . 7-47  
 Filter replacement . . . . . 7-47  
 Cruise control system . . . . . 5-37  
 Cruise control switch . . . . . 5-38  
 To cancel cruise control, do one of the following . . 5-40  
 To decrease the cruising speed . . . . . 5-39  
 To increase cruise control set speed . . . . . 5-39  
 To resume cruising speed at more than  
 approximately 20 mph (30 km/h) . . . . . 5-40

To set cruise control speed . . . . . 5-38  
 To temporarily accelerate with the cruise control on . . 5-39  
 To turn cruise control off, do one of the following . . 5-41

**D**

Defroster . . . . . 4-102  
 Rear window defroster . . . . . 4-102  
 Dimensions . . . . . 8-2  
 Door locks . . . . . 4-19  
 Auto door lock/unlock feature . . . . . 4-22  
 Child-protector rear door lock . . . . . 4-23  
 Impact sensing door unlock system . . . . . 4-22  
 Operating door locks from inside the vehicle . . . . 4-20  
 Operating door locks from outside the vehicle . . . . 4-19  
 Speed sensing door lock system . . . . . 4-22

**E**

Economical operation . . . . . 5-56  
 Emergency starting . . . . . 6-5  
 Jump starting . . . . . 6-5  
 Push-starting . . . . . 6-7  
 Emission control system . . . . . 7-104  
 Engine . . . . . 8-2  
 Engine compartment . . . . . 2-6,7-3  
 Engine coolant . . . . . 7-38  
 Changing the coolant . . . . . 7-40

## Index

Checking the coolant level . . . . .	7-38
Engine number . . . . .	8-10
Engine oil . . . . .	7-36
Changing the engine oil and filter . . . . .	7-37
Checking the engine oil level. . . . .	7-36
Engine start/stop button . . . . .	5-9
Engine start/stop button position . . . . .	5-9
Illuminated engine start/stop button. . . . .	5-9
Starting the engine with a smart key . . . . .	5-11
Explanation of scheduled maintenance items . . . . .	7-32
Exterior features . . . . .	4-145
Mounting bracket for roof carrier . . . . .	4-145
Exterior overview . . . . .	2-2

## F

Foward collision warning system (FCWS) . . . . .	5-52
Fuel filler lid . . . . .	4-34
Closing the fuel filler lid . . . . .	4-34
Opening the fuel filler lid. . . . .	4-34
Fuel requirements . . . . .	1-3
Do not use methanol . . . . .	1-4
Fuel Additives . . . . .	1-5
Gasoline containing alcohol and methanol . . . . .	1-3
Gasoline containing MMT. . . . .	1-4
Use of MTBE. . . . .	1-4
Fuses . . . . .	7-71
Engine compartment fuse replacement . . . . .	7-74

Inner panel fuse replacement . . . . .	7-73
Fuse/relay panel description. . . . .	7-76

## H

Hood . . . . .	4-32
Closing the hood . . . . .	4-32
Opening the hood . . . . .	4-32
How to use this manual . . . . .	1-2

## I

If the engine overheats . . . . .	6-8
If the engine will not start . . . . .	6-4
If engine doesn't turn over or turns over slowly . . . . .	6-4
If engine turns over normally but does not start . . . . .	6-4
If you have a flat tire (with Spare Tire) . . . . .	6-9
Changing tires . . . . .	6-10
Jack and tools. . . . .	6-9
Jack label . . . . .	6-17
Removing and storing the spare tire . . . . .	6-10
Use of temporary compact spare tire. . . . .	6-15
If you have a flat tire (with Tire Mobility Kit). . . . .	6-18
Checking the tire inflation pressure. . . . .	6-23
Components of the Tire Mobility Kit . . . . .	6-20
Distributing the sealant . . . . .	6-22
Introduction . . . . .	6-18
Notes on the safe use of the Tire Mobility Kit . . . . .	6-23

Technical Data . . . . .	6-24
Using the Tire Mobility Kit . . . . .	6-21
In case of an emergency while driving . . . . .	6-3
If the engine stalls at a crossroad or crossing . . . . .	6-3
If the engine stalls while driving . . . . .	6-3
If you have a flat tire while driving . . . . .	6-3
Instrument cluster . . . . .	4-54
Gauges . . . . .	4-56
Instrument Cluster Control . . . . .	4-55
LCD Display Control . . . . .	4-55
Transaxle Shift Indicator . . . . .	4-60
Instrument panel overview . . . . .	2-5
Interior features . . . . .	4-135
Cargo area cover . . . . .	4-142
Clothes hanger . . . . .	4-140
Cup holder . . . . .	4-135
Floor mat anchor(s) . . . . .	4-141
Luggage net holder . . . . .	4-142
Power outlet . . . . .	4-138
Rear seat warmer . . . . .	4-138
Seat air ventilation . . . . .	4-138
Seat warmer . . . . .	4-136
Sunvisor . . . . .	4-136
Interior light . . . . .	4-97
Glove box lamp . . . . .	4-101
Interior lamp AUTO cut . . . . .	4-97
Luggage room lamp . . . . .	4-99
Map lamp . . . . .	4-97

Portable lamp usage . . . . .	4-99
Room lamp . . . . .	4-98
Vanity mirror lamp . . . . .	4-101
Interior overview . . . . .	2-4
ISG (Idle Stop and Go) system . . . . .	5-43
Auto start . . . . .	5-44
Auto stop . . . . .	5-43
Condition of ISG system operation . . . . .	5-45
ISG system deactivation . . . . .	5-46
ISG system malfunction . . . . .	5-47

## K

Key . . . . .	4-4
Battery replacement . . . . .	4-7
Immobilizer system . . . . .	4-8
Key operations . . . . .	4-4
Record your key number . . . . .	4-4
Transmitter precautions . . . . .	4-6
Key positions . . . . .	5-6
Ignition switch position . . . . .	5-6
Illuminated ignition switch . . . . .	5-6
Starting the engine . . . . .	5-7

## L

Lane departure warning system (LDWS) . . . . .	5-48
LCD Display . . . . .	4-62



## Index

A/V Mode	4-66
LCD Modes	4-62
Service Mode	4-63
Turn By Turn Mode	4-66
User Settings Mode	4-64
Warning Messages	4-67
Light bulbs	7-84
Front light replacement	7-84
High mounted stop light bulb replacement	7-93
Interior light bulb replacement	7-95
License plate light bulb replacement	7-94
Rear combination light bulb replacement	7-91
Side repeater light bulb replacement	7-90
Lighting	4-89
Battery saver function	4-89
Daytime running light	4-89
Front fog light	4-93
Headlamp escort	4-89
High beam operation	4-91
Lighting control	4-90
Turn signals and lane change signals	4-92

## M

Maintenance services	7-5
Owner maintenance precautions	7-6
Owner's responsibility	7-5
Manual climate control system	4-104

Checking the amount of air conditioner refrigerant and compressor lubricant	4-113
Climate control air filter	4-112
Heating and air conditioning	4-105
System operation	4-110
Manual transaxle	5-14
Good driving practices	5-16
Manual transaxle operation	5-14
Mirrors	4-49
Inside rearview mirror	4-49
Outside rearview mirror	4-51

## O

Owner maintenance	7-7
Owner maintenance schedule	7-7

## P

Panoramic sunroof	4-37
Resetting the sunroof	4-41
Sliding the sunroof	4-38
Sunroof open warning	4-38
Sunshade	4-40
Tilting the sunroof	4-39
Parking brake	7-44
Checking the parking brake	7-44

**R**

Rear camera display . . . . . 4-88  
 Recommended lubricants and capacities . . . . . 8-6  
     Recommended sae viscosity number . . . . . 8-8  
 Road warning . . . . . 6-2  
     Hazard warning flasher . . . . . 6-2

**S**

Scheduled maintenance service . . . . . 7-9  
 Seat belts . . . . . 3-16  
     Care of seat belts . . . . . 3-28  
     Pre-tensioner seat belt . . . . . 3-24  
     Seat belt precautions . . . . . 3-26  
     Seat belt restraint system . . . . . 3-16  
 Seats . . . . . 3-2  
     Front seat adjustment - Manual . . . . . 3-5  
     Front seat adjustment - Power . . . . . 3-6  
     Rear seat adjustment . . . . . 3-11  
     Seatback pocket . . . . . 3-11  
 Smart key . . . . . 4-11  
     Battery replacement . . . . . 4-17  
     Loss of the smart key . . . . . 4-14  
     Record your key number . . . . . 4-11  
     Smart key function . . . . . 4-11  
     Smart key immobilizer system . . . . . 4-15  
     Smart key precautions . . . . . 4-15

Special driving conditions . . . . . 5-58  
     Driving at night . . . . . 5-60  
     Driving in flooded areas . . . . . 5-61  
     Driving in the rain . . . . . 5-61  
     Driving off-road . . . . . 5-52  
     Hazardous driving conditions . . . . . 5-58  
     Highway driving . . . . . 5-52  
     Reducing the risk of a rollover . . . . . 5-58  
     Rocking the vehicle . . . . . 5-59  
     Smooth cornering . . . . . 5-60  
 Steering wheel . . . . . 4-43  
     Electric power steering (EPS) . . . . . 4-43  
     FLEX steer . . . . . 4-46  
     Heated steering wheel . . . . . 4-45  
     Horn . . . . . 4-46  
     Tilt and telescopic steering . . . . . 4-44  
 Storage compartment . . . . . 4-132  
     Center console storage . . . . . 4-132  
     Cool box . . . . . 4-133  
     Glove box . . . . . 4-132  
     Luggage box . . . . . 4-134  
     Sunglass holder . . . . . 4-133

**T**

Tailgate . . . . . 4-24  
 Closing the tailgate. . . . . 4-24  
 Emergency tailgate safety release . . . . . 4-25  
 Opening the tailgate . . . . . 4-24  
 Tire specification and pressure label . . . . . 8-10  
 Tires and wheels . . . . . 7-56,8-4  
 Checking tire inflation pressure . . . . . 7-57  
 Low aspect ratio tire. . . . . 7-69  
 Recommended cold tire inflation pressures. . . . . 7-56  
 Tire care . . . . . 7-56  
 Tire maintenance . . . . . 7-61  
 Tire replacement. . . . . 7-60  
 Tire rotation . . . . . 7-58  
 Tire sidewall labeling . . . . . 7-62  
 Tire traction . . . . . 7-61  
 Wheel alignment and tire balance . . . . . 7-59  
 Wheel replacement. . . . . 7-61  
 Towing . . . . . 6-25  
 Emergency towing . . . . . 6-27  
 Removable towing hook (front) . . . . . 6-26  
 Towing service . . . . . 6-25  
 Trailer Towing. . . . . 5-61  
 Trip computer . . . . . 4-72  
 Fuel Economy . . . . . 4-74  
 Overview . . . . . 4-72  
 Trip A/B . . . . . 4-73

**V**

Vehicle Break-In Process . . . . . 1-6  
 Vehicle handling instructions . . . . . 1-5  
 Vehicle identification number (VIN) . . . . . 8-9  
 Vehicle load limit . . . . . 5-64  
 Certification label. . . . . 5-70  
 Tire and loading information label. . . . . 5-64  
 Vehicle weight glossary . . . . . 5-71  
 Base curb weight . . . . . 5-71  
 Cargo weight . . . . . 5-71  
 GAW (Gross axle weight) . . . . . 5-71  
 GAWR (Gross axle weight rating). . . . . 5-71  
 GVW (Gross vehicle weight). . . . . 5-71  
 GVWR (Gross vehicle weight rating) . . . . . 5-71  
 Vehicle curb weight . . . . . 5-71

**W**

Warning and indicator lights. . . . . 4-76  
 Indicator Lights . . . . . 4-83  
 Warning lights . . . . . 4-76  
 Washer fluid . . . . . 7-43  
 Checking the washer fluid level. . . . . 7-43  
 Windows . . . . . 4-26  
 Power windows . . . . . 4-27  
 Windshield defrosting and defogging. . . . . 4-127  
 Automatic climate control system . . . . . 4-128

---

Defogging logic . . . . .	4-129
Manual climate control system . . . . .	4-127
Winter driving . . . . .	5-63
Carry emergency equipment . . . . .	5-65
Change to "winter weight" oil if necessary . . . . .	5-64
Check battery and cables . . . . .	5-64
Check spark plugs and ignition system . . . . .	5-64
Don't let your parking brake freeze . . . . .	5-65
Don't let ice and snow accumulate underneath . . . . .	5-65
Snowy or icy conditions . . . . .	5-63
To keep locks from freezing . . . . .	5-64
Use approved window washer anti-freeze in system . . . . .	5-64
Use high quality ethylene glycol coolant . . . . .	5-64
Wiper blades . . . . .	7-49
Blade inspection . . . . .	7-49
Blade replacement . . . . .	7-49
Wipers and Washers . . . . .	4-94
Rear window wiper and washer switch . . . . .	4-96
Rear window wiper/washer . . . . .	4-94
Windshield washers . . . . .	4-95
Windshield wiper/washer . . . . .	4-94
Windshield wipers . . . . .	4-94