

KIA, THE COMPANY



Congratulations! Your selection of a Kia was a wise investment. It will give you years of driving pleasure. Now that you are the owner of a Kia vehicle, you'll probably be asked a lot of questions about your vehicle and the company like "What is a Kia?", "Who is Kia?", "What does 'Kia' mean?".

Here are some answers. First, Kia is the oldest car company in Korea. It is a company that has thousands of employees focused on building high-quality vehicles at affordable prices.

The first syllable, ***Ki***, in the word "Kia" means "to arise from to the world" or "to come up out of to the world." The second syllable, ***a***, means "Asia." So, the word ***Kia***, means "to arise from" or "to come up out of Asia to the world."

Drive safely and enjoy your Kia! ■

FOREWORD

Thank you for choosing a Kia vehicle.

When you require service, remember that your dealer knows your vehicle best. Your dealer has factory-trained technicians, recommended special tools, genuine Kia replacement parts and is dedicated to your complete satisfaction.

Because subsequent owners require this important information as well, this publication should remain with the vehicle if it is sold.

This manual will familiarize you with operational, maintenance and safety information about your new vehicle. It is supplemented by a Warranty and Consumer Information manual that provides important information on all warranties regarding your vehicle. We urge you to read these publications carefully and follow the recommendations to help assure enjoyable and safe operation of your new vehicle.

Kia offers a great variety of options, components and features for its various models.

Therefore, the equipment described in this manual, along with the various illustrations, may not all be applicable to your particular vehicle.

The information and specifications provided in this manual were accurate at the time of printing. Kia reserves the right to discontinue or change specifications or design at any time without notice and without incurring any obligation. If you have questions, always check with your Kia Dealer.

We assure you of our continuing interest in your motoring pleasure and satisfaction in your Kia vehicle.

© 2007 Kia Motors Corp.

All rights reserved. Reproduction by any means, electronic or mechanical, including photocopying, recording, or by any information storage and retrieval system or translation in whole or part is not permitted without written authorization from Kia Motors Corporation.

Printed in Korea

TABLE OF CONTENTS ■

Introduction	1
Your vehicle at a glance	2
Knowing your vehicle	3
Driving your vehicle	4
Driving tips	5
In case of an emergency	6
Maintenance	7
Specifications	8
Index	9

Introduction

1

How to use this manual / 1-2

Vehicle break-in process / 1-2

HOW TO USE THIS MANUAL

We want to help you get the greatest possible driving pleasure from your vehicle. Your Owner's Manual can assist you in many ways. We strongly recommend that you read the entire manual. Especially, in order to minimize the chance of death or injury, you must read the WARNING and CAUTION sections spread throughout the manual.

Illustrations complement the words in this manual to best explain how to enjoy your vehicle. By reading your manual, you learn about features, important safety information, and driving tips under various road conditions.

The general layout of the manual is provided in the Table of Contents. A good place to start is the index; it has an alphabetical listing of all information in your manual.

Sections: This manual has eight sections plus an index. Each section begins with a brief list of contents so you can tell at a glance if that section has the information you want.

You'll find various WARNING's, CAUTION's, and NOTICE's in this manual. These were prepared to enhance your personal safety. You should carefully read and follow ALL procedures and recommendations provided in these WARNING's, CAUTION's and NOTICE's.

WARNING

A WARNING indicates a situation in which serious bodily injury or death could result if the warning is ignored.

CAUTION

A CAUTION indicates a situation in which personal injury, perhaps severe, could result if the caution is ignored.

*** NOTICE**

A NOTICE indicates a situation in which damage to your vehicle could result if the notice is ignored.

VEHICLE BREAK-IN PROCESS

No special break-in period is needed. By following a few simple precautions for the first 1,000 km (600 miles) you may add to the performance, economy and life of your vehicle.

- Do not race the engine.
- Do not maintain a single speed for long periods of time, either fast or slow. Varying engine speed is needed to properly break-in the engine.
- Avoid hard stops, except in emergencies, to allow the brakes to seat properly.
- Avoid full-throttle starts.

Your vehicle at a glance

2

Interior overview / 2-2

Instrument panel overview / 2-3

Engine compartment / 2-4

INTERIOR OVERVIEW

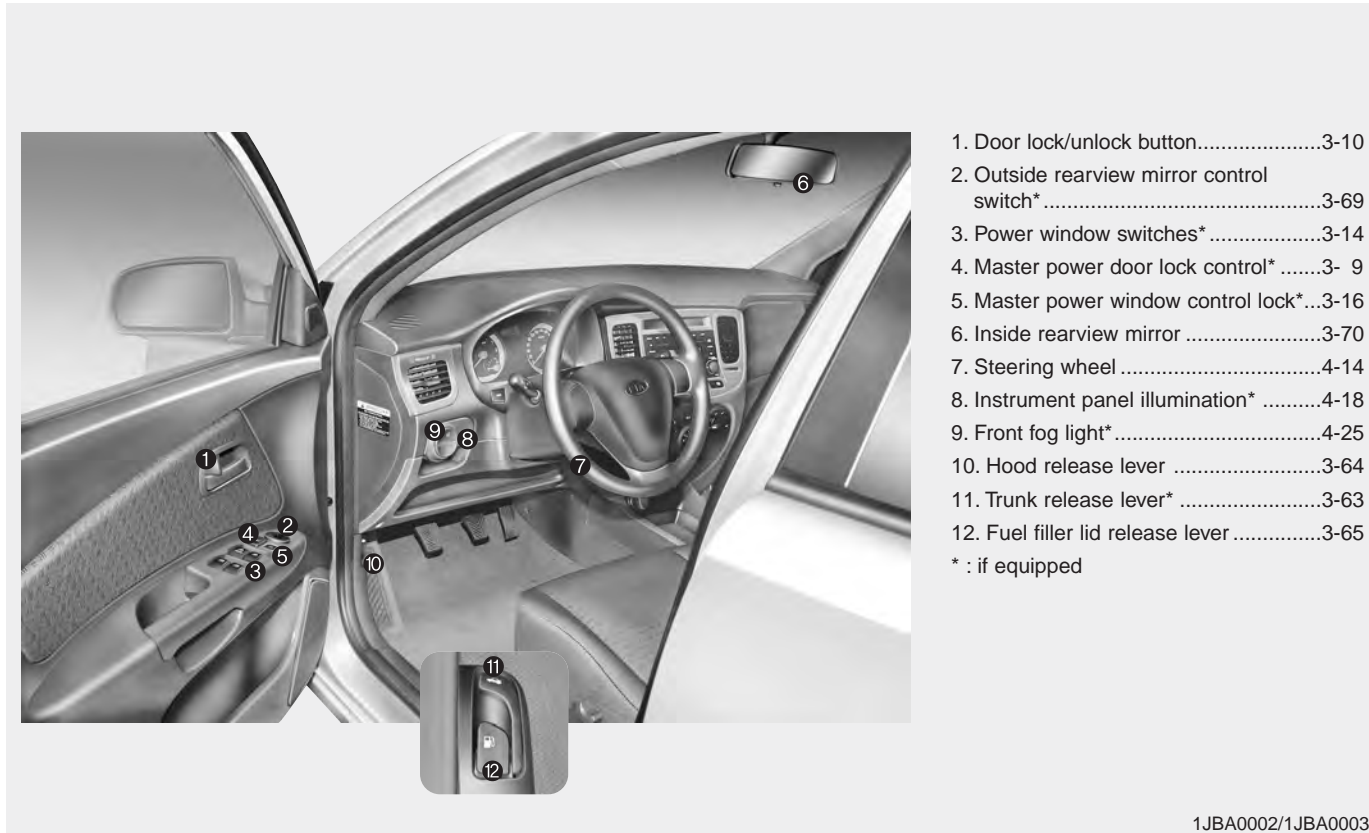

- 1. Door lock/unlock button.....3-10
 - 2. Outside rearview mirror control switch*3-69
 - 3. Power window switches*3-14
 - 4. Master power door lock control*3- 9
 - 5. Master power window control lock*...3-16
 - 6. Inside rearview mirror3-70
 - 7. Steering wheel4-14
 - 8. Instrument panel illumination*4-18
 - 9. Front fog light*4-25
 - 10. Hood release lever3-64
 - 11. Trunk release lever*3-63
 - 12. Fuel filler lid release lever3-65
- * : if equipped

1JBA0002/1JBA0003A

INSTRUMENT PANEL OVERVIEW



- 1. Driver's air bag3-49
 - 2. Light control / Turn signals4-23
 - 3. Instrument cluster4-16
 - 4. Wiper/Washer.....4-26
 - 5. Ignition switch.....4- 2
 - 6. Hazard.....4-29
 - 7. Rear window defroster4-29
 - 8. Climate control system.....4-30
 - 9. Shift lever4- 4
 - 10. Cigar lighter.....3-73
 - 11. Power socket.....3-75
 - 12. Passenger's air bag3-50
 - 13. Glove box3-72
 - 14. Multi box*3-72
 - 15. Audio controls*3-81
- * : if equipped

1JBN0003

ENGINE COMPARTMENT

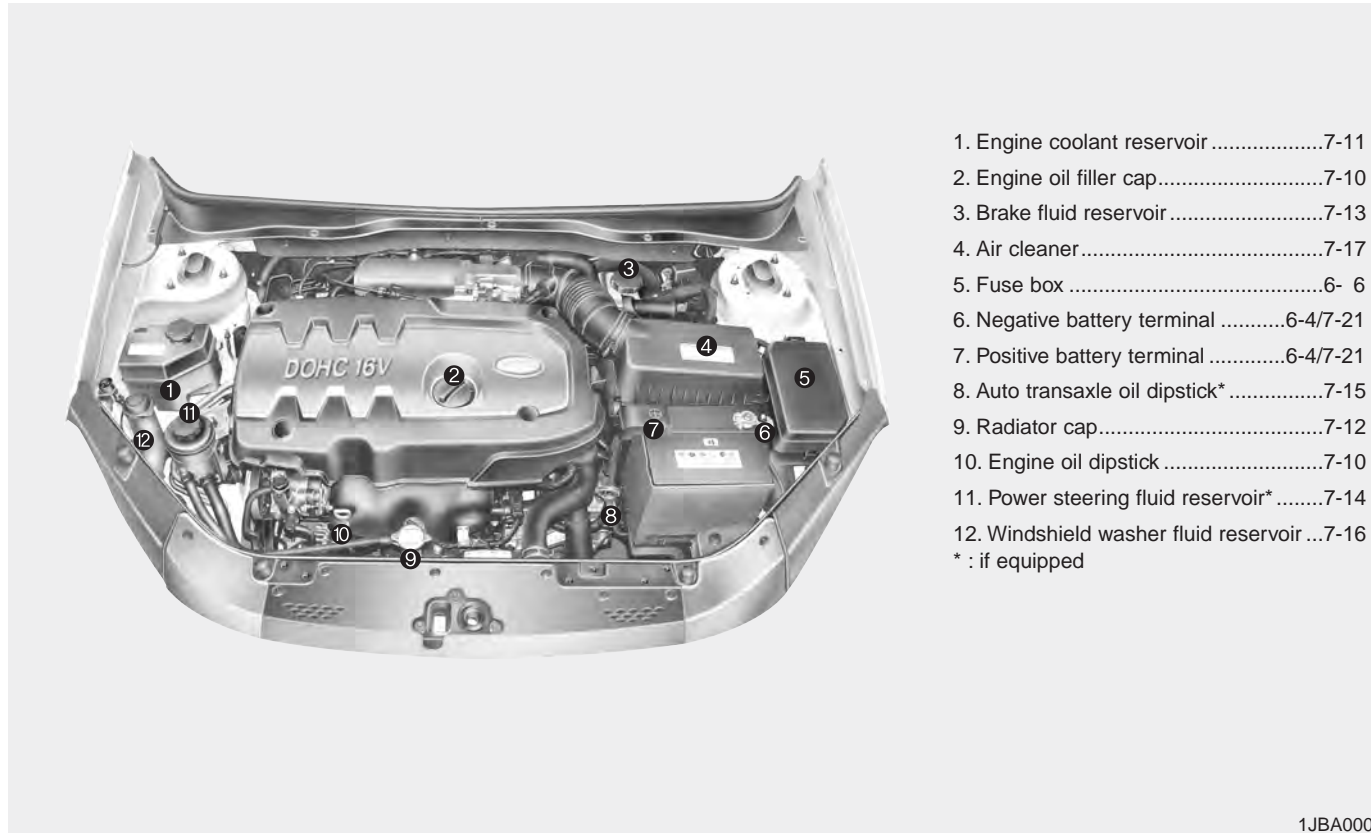

Keys / 3-2
Remote keyless entry / 3-3
Theft-alarm system / 3-5
Immobilizer system / 3-7
Door locks / 3-9
Windows / 3-14

Knowing your vehicle

3

Seat / 3-17
Safety belts / 3-27
Air bags-supplemental restraint system / 3-47
Trunk / 3-62
Hood / 3-64
Fuel filler lid / 3-65
Mirrors / 3-68
Interior lights / 3-71
Storage compartment / 3-72
Interior features / 3-73
Sunroof / 3-77
Luggage net / 3-79
Antenna / 3-80
Audio system / 3-81

KEYS



The key code number is stamped on the plate attached to the key set. Should you lose your keys, this number will enable an authorized Kia dealer to duplicate the keys easily. Remove the plate and store it in a safe place. Also, record the code number and keep it in a safe and handy place, but not in the vehicle. Use only Kia-approved key blanks.

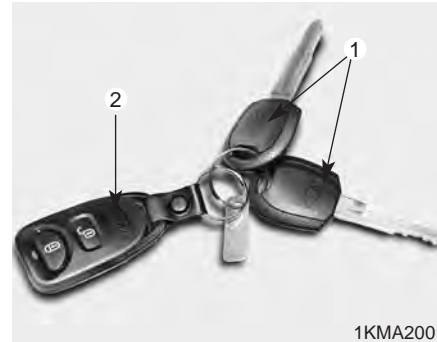

Key operations

- (1) Master key
Used to start the engine, lock and unlock the doors, and open the trunk (if equipped).
- (2) Transmitter (if equipped)
Used to lock and unlock the doors.

⚠ WARNING - Ignition key

Leaving children unattended in a vehicle with the ignition key is dangerous even if the key is not in the ignition. Children copy adults and they could place the key in the ignition. The ignition key would enable children to operate power windows or other controls, or even make the vehicle move, which could result in serious bodily injury or even death. Never leave the keys in your vehicle with unsupervised children.

⚠ CAUTION

Use only Kia original parts for the ignition key in your vehicle. If an aftermarket key is used, the ignition switch may not return to ON after START. If this happens, the starter will continue to operate causing damage to the starter motor and possible fire due to excessive current in the wiring.

REMOTE KEYLESS ENTRY (IF EQUIPPED)

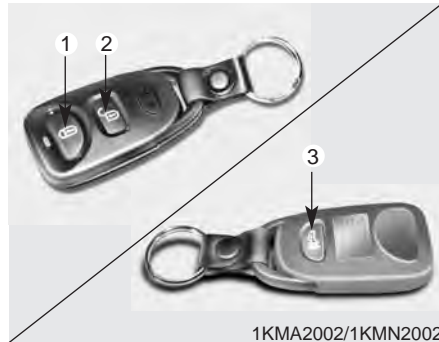

- ① Lock button
- ② Unlock button
- ③ Panic button

① Lock (🔒)

All doors are locked if the lock button is pressed.

② Unlock (🔓)

Driver's door is unlocked if the unlock button is pressed once. All doors are unlocked if the unlock button is pressed twice within 4 seconds.

After pressing this button, the doors will be locked automatically unless you open them within 30 seconds.

③ Panic (📢)

The horn sounds and hazard warning lights will flash for about 30 seconds if this button is pressed. To stop the horn and lights, press any button on the transmitter.

* NOTICE

The transmitter will not work if any of following occur:

- The ignition key is in ignition switch.
- You exceed the operating distance limit (about 10 m [30 feet]).
- The battery in the transmitter is weak.
- Other vehicles or objects may be blocking the signal.
- The weather is extremely cold.
- The transmitter is close to a radio transmitter such as a radio station or an airport which can interfere with normal operation of the transmitter.

When the transmitter does not work correctly, open and close the door with the ignition key. If you have a problem with the transmitter, contact an authorized Kia Dealer.

* NOTICE

Keep the transmitter away from water or any liquid. If the keyless entry system is inoperative due to exposure to water or liquids, it will not be covered by your manufacturer vehicle warranty.

Knowing your vehicle

Operational distance may vary depending upon the area the transmitter is used in. For example, if the vehicle is parked near police stations, government and public offices, broadcasting stations, military installations, airports, or transmitting towers, etc.

This device complies with Industry Canada Standard RSS-210. Operation is subject to the following two conditions:

1. This device may not cause interference, and
2. This device must accept any interference, including interference that may cause undesired operation of the device.

⚠ WARNING

Changes or modifications not expressly approved by the party responsible for compliance could void the user's authority to operate the equipment.

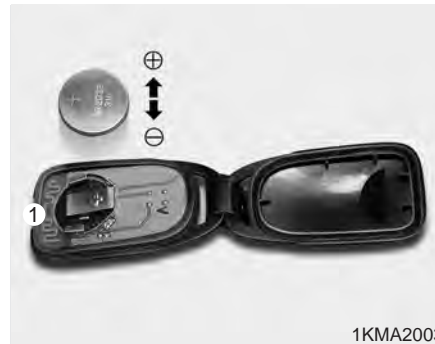

Battery replacement

Transmitter uses a 3 volt lithium battery which will normally last for several years. When replacement is necessary, use the following procedure.

1. Insert a slim tool into the slot and gently pry open the transmitter center cover (1).
2. Replace the battery with new one. When replacing the battery, make sure the battery positive "+" symbol faces up as indicated in the illustration.
3. Install the battery in the reverse order of removal.

*** NOTICE**

The keyless entry system transmitter is designed to give you years of trouble-free use, however it can malfunction if exposed to moisture or static electricity. If you are unsure how to use your transmitter or replace the battery, contact an authorized Kia dealer.

For replacement transmitters, see an Authorized Kia Dealer for reprogramming.

*** NOTICE**

- Using the wrong battery can cause the transmitter to malfunction. Be sure to use the correct battery.
- To avoid damaging the transmitter, don't drop it, get it wet, or expose it to heat or sunlight.

THEFT-ALARM SYSTEM (IF EQUIPPED)

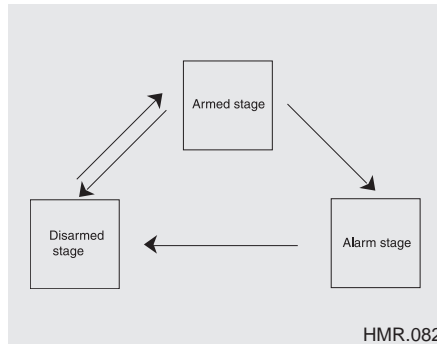

Theft alarm system will not operate when the ignition key is in the ignition switch.

If the lock button on the transmitter is pressed when the key is not in the ignition and any vehicle door or the trunk (if equipped) is open, then, the doors will lock but the theft alarm system will not activate. However, the theft alarm system will automatically activate when the open door(s) or trunk (if equipped) is closed and locked.

Armed stage

When the ignition switch is in the “LOCK” position, and key is not in the ignition, the system will be armed and the hazard lights will flash once when the following conditions are met:

- The hood, trunk (if equipped) and doors (including the rear hatch, if equipped) are all closed and locked with the transmitter.
- If a door or the trunk (if equipped) is not opened within approximately 30 seconds after unlocking with the transmitter, all doors will be locked again and theft alarm system armed.

* NOTICE

Do not arm the system until all passengers have left the vehicle. If the system is armed while a passenger(s) remains in the vehicle, the alarm may be activated when the remaining passenger(s) leaves the vehicle.

Alarm stage

The alarm will activate (horn will sound and lights flash) when:

- Any door is opened without using the transmitter or key.
- The trunk lid is opened without using the key. (if equipped)
- The engine hood is opened.

The alarm will sound ON for 27 seconds, then OFF for 10 seconds. This ON/OFF cycle will be repeated three times. During this time, the engine will not start.

* NOTICE

The engine will not start immediately while the theft-alarm system is armed or activated. You must disarm the theft-alarm system to start the engine.

Opening the trunk with the alarm armed (if equipped)

When the alarm is armed, the alarm will not sound if the trunk lid is opened with the key.

However, if the trunk lid is not opened completely within two seconds after unlocking with the key, the alarm will sound.

Also, if any of the doors or hood is opened while the trunk lid is open and the alarm armed, the alarm will sound.

Disarmed stage



If the following conditions are met, the alarm system will be deactivated and hazard flasher light will flash twice.

- When the doors are unlocked with the transmitter.

After depressing unlock button, you must open the doors within 30 seconds or all doors will automatically lock again and the theft-alarm system will be armed.

- When the doors are unlocked with the ignition key.
- When the ignition switch is in the "ON" position.

The alarm will be deactivated when:

- The lock (), unlock () button on the transmitter is pressed.
- The doors are unlocked with the ignition key.
- The ignition switch is in the "ON" position for 30 seconds or more.

* NOTICE

If the ignition key is in the ignition switch, the transmitter will not function. Avoid trying to start the engine with the alarm activated.

IMMOBILIZER SYSTEM (IF EQUIPPED)

Your vehicle is equipped with an electronic engine immobilizer system to reduce the risk of unauthorized vehicle use.

Your immobilizer system is comprised of a small transponder in the ignition key, and antenna coil in the key cylinder and Immobilizer Control Unit (or Smartra Unit).

With this system, whenever you insert your ignition key into the ignition switch and turn it to ON, the antenna coil in the ignition switch receives a signal from the transponder in the ignition key and then sends the signal to the ECU (Engine Control Unit).

The ECU checks the signal whether the ignition key is valid.

If the key is determined to be valid, the engine will start.

If the key is determined to be invalid, the engine will not start.

To deactivate the immobilizer system:

Insert the ignition key into the key cylinder and turn it to the ON position.

To activate the immobilizer system:

Turn the ignition key to the OFF position. The immobilizer system activates automatically. Without a valid ignition key for your vehicle, the engine will not start.

* NOTICE

When starting the engine, do not use the key with other immobilizer keys around. Otherwise the engine may not start or may stop soon after it starts. Keep each key separately not to have any malfunction after you receive your new vehicle.

Limp home (override) procedure

When you turn the ignition key to the ON position, if the IMMO indicator goes off after blinking 5 times, your transponder equipped in the ignition key is out of order. You cannot start the engine without the limp home procedure. To start the engine, you have to input your password by using the ignition switch.

The following procedure is how to input your password of "2345" as an example.

1. Turn the ignition key to the ON position. The IMMO indicator () will blink 5 times and go off indicating the beginning of the limp home procedure.
2. Turn the ignition key to the ACC position.
3. To enter the first digit (in this example "2"), turn the ignition key to the ON and ACC position twice. Perform the same procedure for the next digits between 3 seconds and 10 seconds (for example, for "3", turn the ignition ON and ACC 3 times).

4. If all of the digits have been input successfully, you have to start the engine within 30 seconds. If you attempt to start the engine after 30 seconds, the engine will not start and you will have to input your password again.

After performing the limp home procedure, you have to see an authorized Kia dealer immediately to inspect and repair your ignition key or immobilizer system.

* NOTICE

If you cannot start your engine in spite of limp home procedure, have your vehicle towed by an authorized Kia dealer for inspection and necessary repairs.

* NOTICE

The transponder in your ignition key is an important part of the immobilizer system. It is designed to give years of troublefree service, however you should avoid exposure to moisture, static electricity and rough handling. Immobilizer system malfunction could occur.

* NOTICE

Do not change, alter or adjust the immobilizer system because it could cause the immobilizer system to malfunction and should only be serviced by an authorized Kia dealer.

Malfunctions caused by improper alterations, adjustments or modifications to the immobilizer system are not covered by your vehicle manufacturer warranty.

This device complies with Industry Canada Standard RSS-210. Operation is subject to the following two conditions:

1. This device may not cause interference, and
2. This device must accept any interference, including interference that may cause undesired operation of the device.

WARNING

Changes or modifications not expressly approved by the party responsible for compliance could void the user's authority to operate the equipment.

DOOR LOCKS



Operating door locks from outside the vehicle

- Turn the key toward rear of vehicle to unlock and toward front of vehicle to lock.
- If you lock the driver's door with a key, all vehicle doors will lock automatically (if equipped).
- Turn the key to the right once to unlock the driver's door and to the right twice within 4 seconds to unlock all doors. (if equipped)
- If you lock the front passenger's door with a key, all vehicle doors will lock automatically.

- If your vehicle is equipped with a remote keyless entry system, all vehicle doors will unlock automatically when you unlock the front passenger's door with a key (if equipped).
- Doors can also be locked and unlocked with the transmitter (if equipped).
- Once the doors are unlocked, it may be opened by pulling the door handle.
- When closing the door, push the door firmly by the hand. Make sure that doors are closed securely.



To lock a door without the key, push down on the front portion of the inside door lock switch (1, if equipped) to the "LOCK" position and close the door (2).

* NOTICE

Always remove the ignition key, engage the parking brake, close all windows and lock all doors when leaving your vehicle unattended.

* NOTICE

If the door is locked/unlocked multiple times in rapid succession with either the vehicle key or door lock switch, the system may stop operating temporarily in order to protect the circuit and prevent damage to system components.

Knowing your vehicle

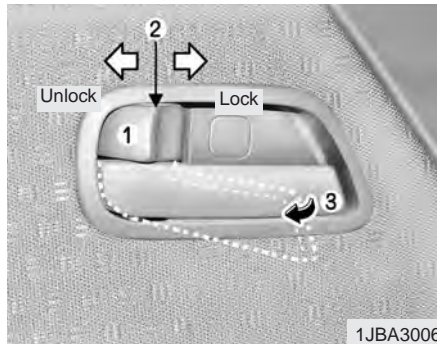

Operating door locks from inside the vehicle

With the door lock button

- To unlock a door, push the door lock button forward to the “Unlock” position (red mark on button visible).
- To lock a door, push the door lock button (1) forward to the “Lock” position. If the door is locked properly, the red mark (2) on the door lock button (1) will not be visible.
- To open a door, pull the door handle (3) outward.
- If the inner door handle of driver's side door is pulled when the door lock button is in lock position, the button is unlocked and door opens. (if equipped)

- Front doors cannot be locked if the ignition key is in the ignition switch and door is open.
- If you lock the front passenger's door with door lock button, all vehicle doors will lock automatically.

⚠ WARNING - Door lock malfunction

If a power door lock ever fails to function while you are in the vehicle, try one or more of the following techniques to exit:

- **Operate the door unlock feature repeatedly (both electronic and manual) while simultaneously pulling on the door handle.**
- **Operate the other door locks and handles, front and rear.**
- **Lower a front window and use the key to unlock the door from outside.**
- **Lower the rear seats (if equipped), move to the cargo area and open the trunk using the emergency release handle (if equipped).**



With central door lock switch (if equipped)

- When pushing down on the front portion (1) of the switch, all vehicle doors will lock.
- When pushing down on the rear portion (2) of the switch, all vehicle doors will unlock.
- However, if the key is in the ignition switch and any front door is open, the doors will not lock when the front portion of central door lock switch is pressed.

CAUTION - Doors

- *The doors should always be fully closed and locked while the vehicle is in motion to prevent accidental opening of the door. Locked doors will also discourage potential intruders when the vehicle stops or slows.*
- *Be careful when opening doors and watch for vehicles, motorcycles, bicycles or pedestrians approaching the vehicle in the path of the door. Opening a door when something is approaching can cause damage or injury.*

WARNING - Unlocked vehicles

Leaving your vehicle unlocked can invite theft or possible harm to you or others from someone hiding in your vehicle while you are gone. Always remove the ignition key, engage the parking brake, close all windows and lock all doors when leaving your vehicle unattended.

WARNING - Unattended children

An enclosed vehicle can become extremely hot, causing death or severe injury to unattended children or animals who cannot escape the vehicle. Furthermore, children might operate features of the vehicle that could injure them, or they could encounter other harm, possibly from someone gaining entry to the vehicle. Never leave children or animals unattended in your vehicle.

Impact sensing door unlock system (if equipped)

All doors will be automatically unlocked when the impact is delivered to impact sensors while the ignition switch is in the ON position.

However, if the impact causes damage to the vehicle electrical system or the mechanical door lock mechanisms, the impact sensing door unlock system may not operate.



Rear door child safety lock

The child safety lock is provided to help prevent children from accidentally opening the rear doors from inside the vehicle. The rear door safety locks should be used whenever children are in the vehicle.

1. Open the rear door.
2. Push the child safety lock located on the rear edge of the door to the "lock" position. When the child safety lock is in the "lock (⊕)" position, rear door will not open when the inner door handle is pulled inside the vehicle.
3. Close the rear door.
4. To open the rear door, pull the outside door handle.

Even though the doors may be unlocked, the rear door will not open by pulling the inner door handle (1) until rear door child safety lock is unlocked (⊖).

⚠ WARNING - Rear door locks

If children accidentally open the rear doors while the vehicle is in motion, they could fall out and be severely injured or killed. To prevent children from opening the rear doors from the inside, the rear door safety locks should be used whenever children are in the vehicle.

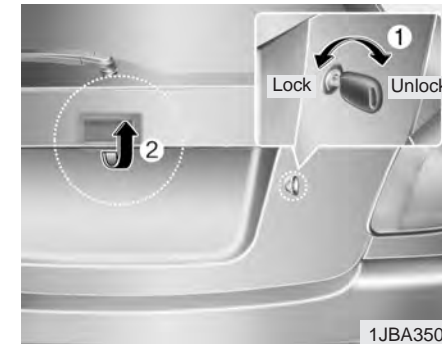

Rear hatch (if equipped)

Opening the rear hatch

- Rear hatch is locked or unlocked with a key.
- To open the rear hatch, insert the key into the lock, turn it to the unlock position (1) and pull up the rear hatch by pressing the handle (2).
- You can also lock/unlock the latch (but not release it) with the central door lock system (if equipped).
- If unlocked, the rear hatch can be opened by pressing the handle (2) and pulling the hatch up.

⚠ CAUTION - Rear hatch
The rear hatch swings upward. Make sure no objects or people are near the rear of the vehicle when opening the rear hatch.

⚠ WARNING - Exhaust fumes
If you drive with the rear hatch open, you will draw dangerous exhaust fumes into your vehicle which can cause serious injury or death to vehicle occupants.
If you must drive with the rear hatch open, keep the air vents and all windows open so that additional outside air comes into the vehicle.

⚠ WARNING - Rear cargo area
Occupants should never ride in the rear cargo area where no restraints are available. To avoid injury in the event of an accident or sudden stops, occupants should always be properly restrained.



Cargo area lamp (if equipped)

The cargo area lamp turns on when the rear hatch is opened. It remains on until the rear hatch is securely closed.

*** NOTICE**

Make sure to close the rear hatch securely. If it remains open while engine is not running, it may cause battery discharge because cargo area lamp remains on.

WINDOWS

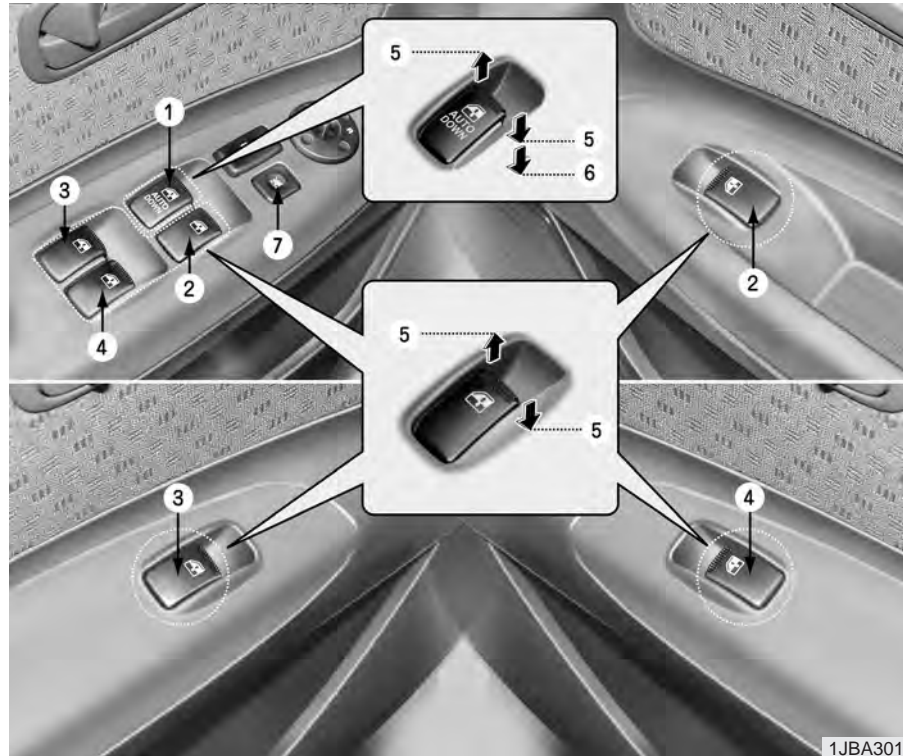

Power windows (if equipped)

- (1) Driver's door power window switch
- (2) Front passenger's door power window switch
- (3) Rear door (left) power window switch*
- (4) Rear door (right) power window switch*
- (5) Window opening and closing
- (6) Automatic power window down* (Driver's window)
- (7) Power window lock switch*

- **Power window timer***

The power windows can be operated for approximately 30 seconds after the ignition key is removed or turned to the ACC or LOCK position. If the front door is open, the window will not operate unless the ignition key is in the ON position.

* : if equipped

Power windows (if equipped)

The ignition switch must be in the ON position for power windows to operate. Each door has a power window switch that controls that door's window. However, the driver has a power window lock switch which can block the operation of passenger windows.

If you notice buffeting and pulsation (wind shock) with either side window open, you should open the opposite window slightly to reduce the condition.

*** NOTICE**

- To prevent the power window system from the possibility of damage, do not open or close two windows at the same time. This will also ensure the longevity of the fuse.
- Never try to operate the main switch on the driver's door and the individual door window switch in opposing directions at the same time. If this is done, the window will stop and cannot be opened or closed.



1JBA3011



1JBH2013

Window opening and closing

The driver's door has a master power window switch that controls all the windows in the vehicle. To open or close a window, press down (5) or pull up (5) the front portion of the corresponding switch.

Automatic power window down (driver's window, if equipped)

Depressing the power window switch momentarily to the second detent position (6) completely lowers the driver's window even when the switch is released. To stop the window at the desired position while the window is in operation, pull up the switch momentarily to the opposite direction of the window movement.



1JBA3013

**Power window lock switch
(if equipped)**

- The driver can disable the power window switches on all passenger doors by depressing the power window lock switch located on the driver's door to LOCK (pressed).
- **When the power window lock switch is ON, the driver's master control cannot operate the passenger door power windows either.**

CAUTION - Windows

- *Always double-check to make sure all arms, hands, heads and other obstructions are safely out of the way before closing a window. Serious injury could occur.*
- *Do not allow children to play with the power windows. Keep the driver's door power window lock switch in the LOCK position (depressed). Serious injury can result from unintentional window operation by a child.*
- *Never extend face or arms outside through the window opening while driving.*

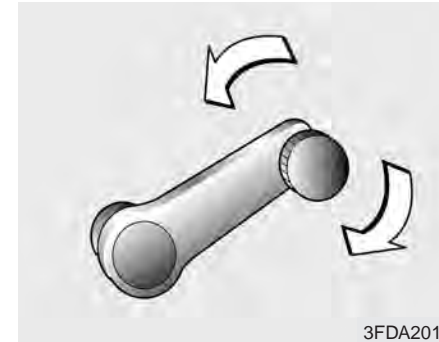

3FDA2015

Manual windows (if equipped)

Use the window crank to open and close each window.

SEAT

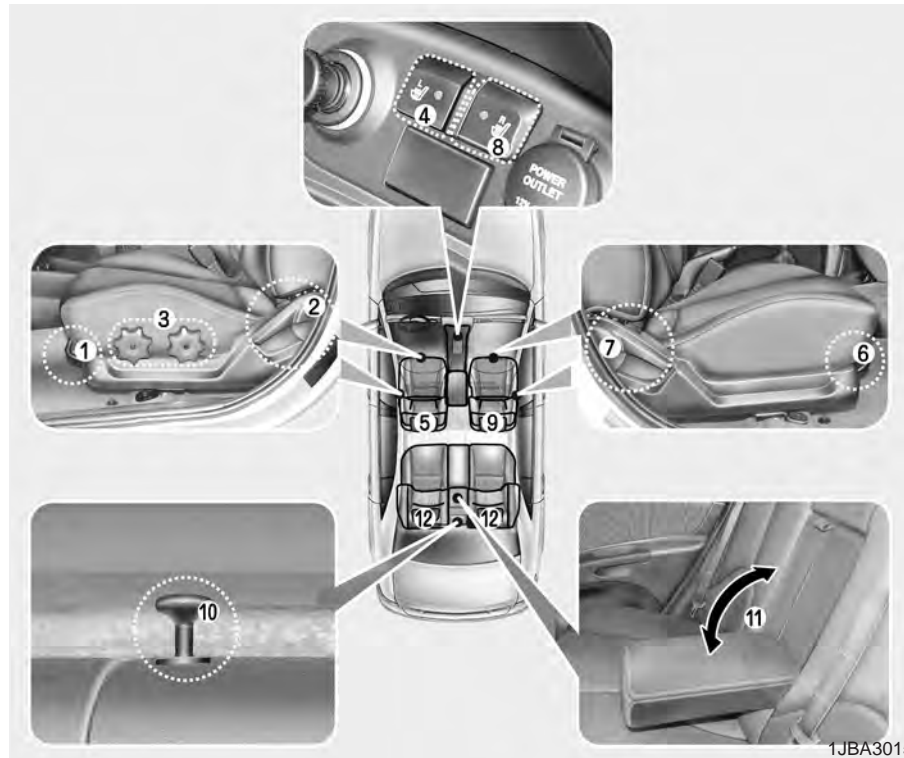

1JBA3015

Driver's seat

- (1) Seat adjustment, forward / backward
- (2) Seatback recliner
- (3) Seat front/rear height adjustment*
- (4) Seat heater switch*
- (5) Headrest adjustment

Front passenger seat

- (6) Seat adjustment, forward / backward
- (7) Seatback recliner
- (8) Seat heater switch*
- (9) Headrest adjustment

Rear seat

- (10) Split folding rear seat*
 - (11) Armrest*
 - (12) Headrest adjustment*
- * ; if equipped

⚠ WARNING - Loose objects
Loose objects in the driver's foot area could interfere with the operation of the foot pedals, possibly causing an accident. Loose objects might interfere with the seat slide mechanism. Do not place anything under the front seats.

⚠ WARNING

- Children should never be left unattended in the car.
- In order to avoid unnecessary air bag injuries including the possibility of severe injury or death, always sit as far back as possible by moving the seat far back, while still maintaining good vehicle control. Serious injury or death may be caused due to the deployment of the passenger's air bag.

⚠ WARNING - Driver's seat

- Never attempt to adjust seat while the vehicle is moving. This could result in loss of control, and an accident causing death, serious injury, or property damage.
- Do not allow anything to interfere with the normal position of the seatback. Storing items against a seatback or in any other way interfering with proper locking of a seatback could result in serious or fatal injury in a sudden stop or collision.
- Always drive and ride with your seatback upright and the lap portion of the safety belt, or lap belt, snug and low across the hips. This position puts your safety belts in the best position to protect you in case of an accident.
- In order to avoid unnecessary air bag injuries including the possibility of severe injury or death, always sit as far back as possible from the steering wheel so that your chest is away at least 10 inches (250 mm) away from the steering wheel.

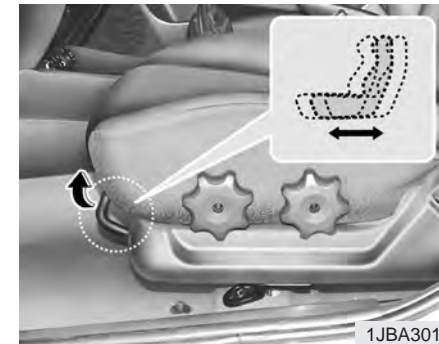

Front seat adjustment

Adjusting the seat forward and backward

To move the seat forward or backward:

1. Pull the seat slide adjustment lever under the front edge of the seat cushion up and hold it.
2. Slide the seat to the desired position.
3. Release the lever and make sure the seat is locked in place.

Adjust the seat before driving, and make sure the seat is locked securely by trying to move forward and backward without using the control knob. If the seat moves, it is not locked properly.

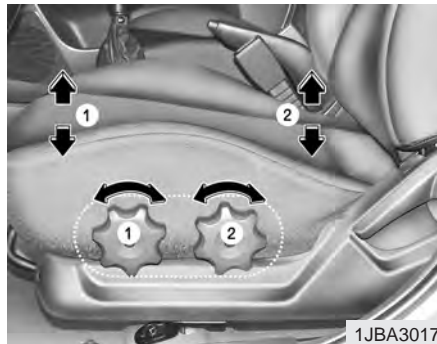

1JBA3017

Adjusting height of the driver's seat cushion (if equipped)

To change the height of the seat cushion, rotate the knob located on the outside of the seat cushion.

- To adjust the front height of the seat cushion, rotate the knob (1).
- To adjust the rear height of the seat cushion, rotate the knob (2).

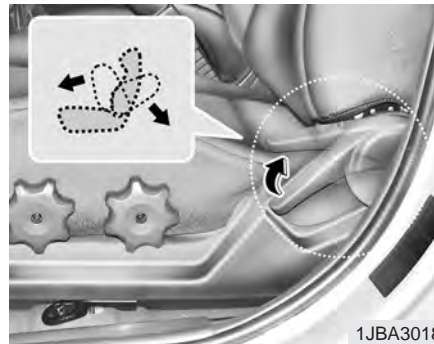

1JBA3018

Adjusting the seatback recliner

To recline the seatback:

1. Lean forward slightly and lift up on the seatback recline lever located on the outside of the seat, at the rear.
2. Carefully lean back on the seat and adjust the seatback to the desired position.
3. Release the lever and make sure the seatback is locked in place. (The lever MUST return to its original position for the seatback to lock.)

⚠ WARNING - Driver responsibility for front seat passenger

Driving or riding in a vehicle with a front seatback reclined could lead to serious or fatal injury in an accident. If a front seat is reclined during an accident, the occupant's hips may slide under the lap portion of the safety belt applying great force to the unprotected abdomen or neck. Serious or fatal internal injuries could result. Keep the seatbacks in a comfortably upright position whenever the vehicle is in motion.



Warming the front seat (if equipped)

The front seats can be electrically heated individually when the ignition switch is ON.

When you depress the seat warmer switch, a thermostat regulates seat temperature. To deactivate the heating system, depress the switch once again.

*** NOTICE**

- The seat warmer may not operate if ambient temperature is warm enough.
- If the seat warmer doesn't work when the ambient temperature is below 24°C (75°F), have the system checked by an authorized dealer.
- When cleaning the seats, do not use an organic solvent such as thinner, benzene, alcohol and gasoline. Doing so may damage the surface of the heater or seats.
- To prevent overheating the seat warmer, do not place blankets, cushions or seat covers on the seats while the seat warmer is in operation.
- Do not place heavy or sharp objects on seats equipped with seat warmers. Damage to the seat warming components could occur.

⚠ WARNING

Passengers should use extreme caution when using seat warmers due to the possibility of excess heating or burns. In particular, the following types of passengers should exercise extreme care:

1. Infants, children, elderly or handicapped persons, or hospital outpatients
2. Persons with sensitive skin or those that burn easily
3. Fatigued individuals
4. Intoxicated individuals
5. Individuals taking medication that can cause drowsiness or sleepiness (sleeping pills, cold tablets, etc.)

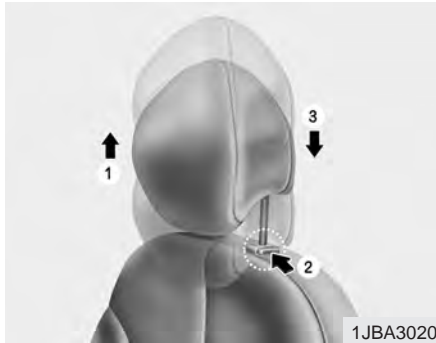

Headrest adjustment

Adjusting the height up and down

The headrest not only provides comfort for the driver and passengers, but also helps to protect the head and neck in the event of a collision.

To raise the headrest, pull it up to the desired position (1). To lower the headrest, push and hold the release button (2) on the headrest support and lower the headrest to the desired position (3). For best protection, adjust the headrest so its center is as high as your ears. Also adjust the headrest so its distance from the head is as wide as your fist.

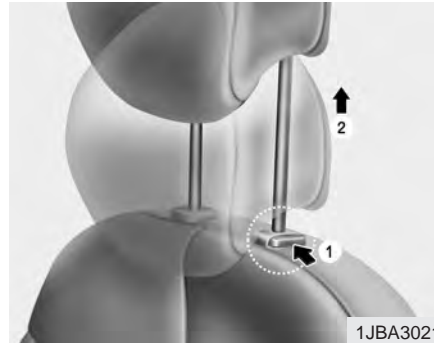

Removal

To remove the headrest, raise it as far as it can go then press the release lever (1) while pulling upward (2).

⚠ WARNING - Headrest positioning
To reduce the risk of head and neck injuries, each occupant headrest must be properly adjusted. Do not drive the vehicle with the headrest removed or improperly positioned.
Do not adjust the driver's headrest while driving, or else loss of control and an accident is possible.

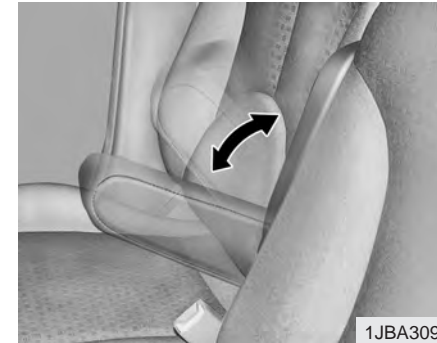

Armrest (if equipped)

To use the armrest, pull it forward from the seatback.

Rear seat

Split folding rear seat (if equipped)

The rear seatbacks fold forward to provide additional cargo space and to provide access to the cargo area.

- To fold the rear seatback(s) down, pull the lock release lever, then fold the seatback forward and down.
- To raise the seatback, lift and push it firmly until it clicks into place. If the seatback is locked into its upright position, red mark of knob becomes invisible.

- When you return the seatback to its upright position, reposition the rear safety belts so that they can be used by rear seat passengers.

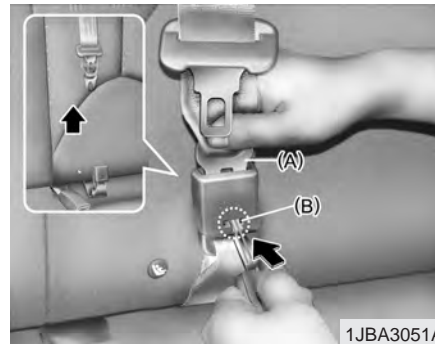

4 Door (if equipped)

1. Slide and upright the front seat to the forward position.
2. Lower the headrest to the lowest position.
3. To retract the rear center seatbelt, insert the key or similar small rigid device into the web release button (B) on the anchor connector. Pull up on the seat belt web (A) and allow the webbing to retract automatically. (4Door, if equipped)

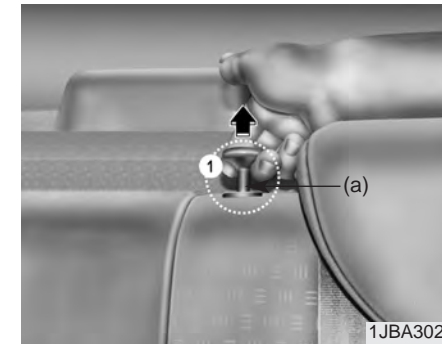

4. Pull the lock release lever (1). If the seatback is unlocked, red mark (a) of knob becomes visible.

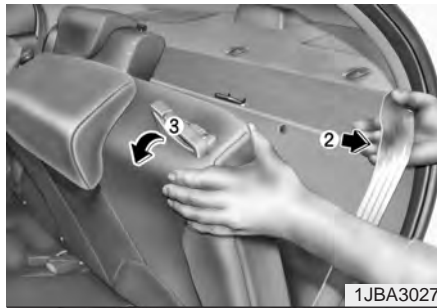

1JBA3027



1JBA3028

5. Move the rear lap/shoulder belt to the outside (2) so that they don't interfere with the seatback when lowering (3).
6. Fold the seatback forward and down firmly (4).

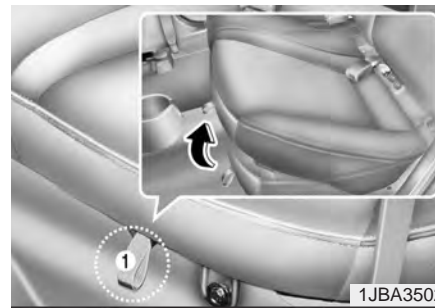

1JBA3502

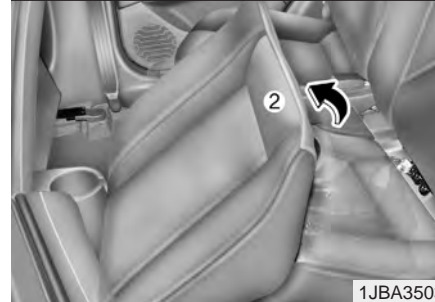

1JBA3503

5 Door (if equipped)

1. Set the front seatback to the upright position and slide the front seat forward.
2. Pull the seat cushion retaining strap (1) and lift the front of the seat cushion.
3. Lift the rear of seat cushion (2).

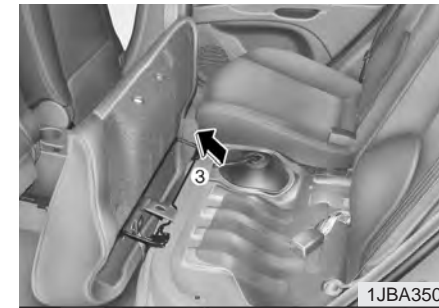

1JBA3504

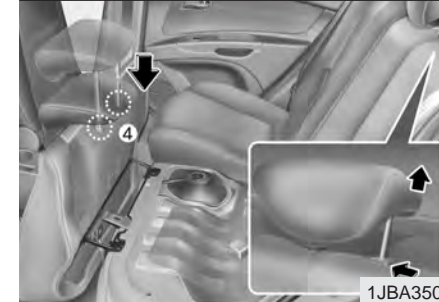

1JBA3505

4. Fold the seat cushion forward firmly into place (3).
5. Remove the headrest from the rear seatback and stow the headrest by inserting the headrest poles into the holes on the bottom of the seat cushion (4).

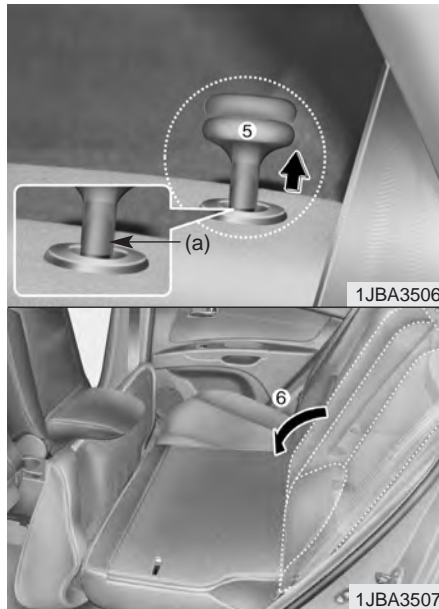

6. Pull up on the rear seatback lock release lever (5). If the seatback is unlocked, red mark (a) of knob becomes visible.
7. Fold the seatback forward and down firmly (6).

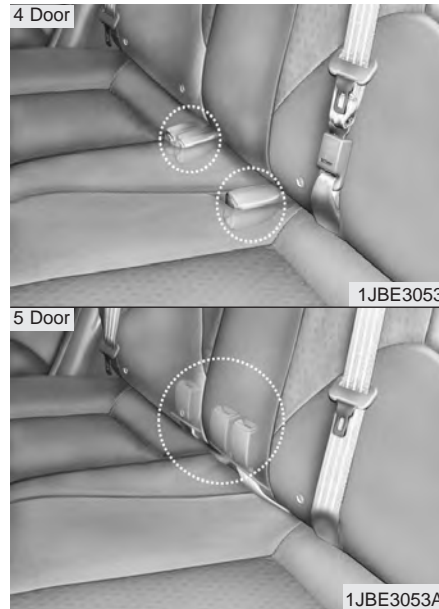

*** NOTICE - Damaging rear safety buckles**

When you fold the rear seatback or put luggage on the rear seat cushion, insert the buckle in the pocket between the rear seatback and cushion. Doing so can prevent the buckle from being damaged by the rear seatback or luggage.

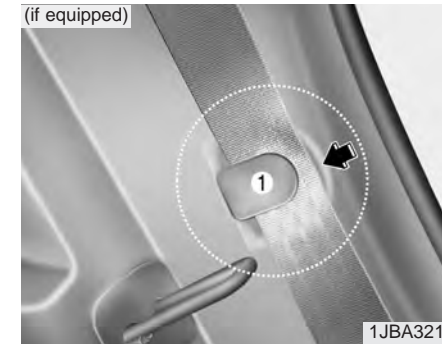

*** NOTICE - Rear safety belts**

Routing the safety belt webbing through the rear safety belt guides will help keep the belts from being trapped behind or under the seats. When returning the rear seatbacks to the upright position, remember to return the rear shoulder belts to their proper position.

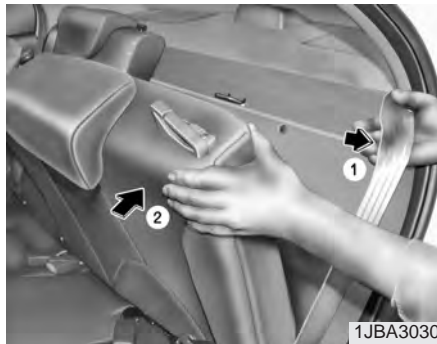

To unfold the rear seat:

1. Move the rear lap/shoulder belt (1, if equipped) to the side so that it is clear of the seatback.
2. Lift and push the seatback backward firmly until it clicks into place (2).
3. Move and push the headrest and the seat cushion downward firmly to the proper position (5 Door, if equipped).
4. Return the rear safety belt to the proper position.

CAUTION

- When returning the rear seatbacks to the upright position, remember to return the rear shoulder belts to their proper position.
- Do not remove the floor carpet in your vehicle. Emission control system components cause high exhaust temperatures under the floor.

WARNING - Cargo

Cargo should always be secured to prevent it from being thrown about the vehicle in a collision and causing injury to the vehicle occupants.

*** NOTICE**

If the seat belt is locked during the seatback folding, pull out and retract the seat belt to release it.

CAUTION

- Make sure the engine is off, the transaxle is in P and the parking brake is applied whenever loading or unloading cargo. Vehicle may move if shift lever is inadvertently moved to another position.
- Be careful when loading cargo through the rear passenger seats to prevent damage to the vehicle interior.
- When cargo is loaded through the rear passenger seats, ensure the cargo is properly secured to prevent it from moving while driving. Unsecured cargo in the passenger compartment can cause damage to the vehicle or injury to its occupants.



Armrest (if equipped)

The armrest is located in the center of the rear seat. Pull the armrest down from the seatback.

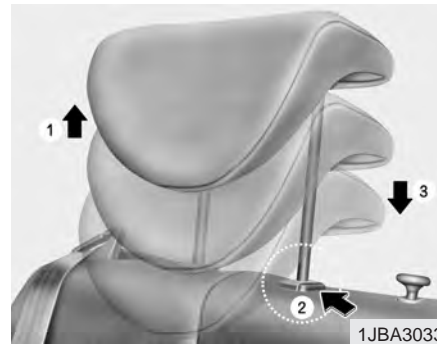

Headrest adjustment (if equipped)

Adjusting the height up and down

The headrest not only provides comfort for the driver and passengers, but also helps to protect the head and neck in the event of a collision.

To raise the headrest, pull it up to the desired position (1). To lower the headrest, push and hold the release button (2) on the headrest support and lower the headrest to the desired position (3). For best protection, adjust the headrest so its center is as high as your ears. Also adjust the headrest so its distance from the head is as wide as your fist.

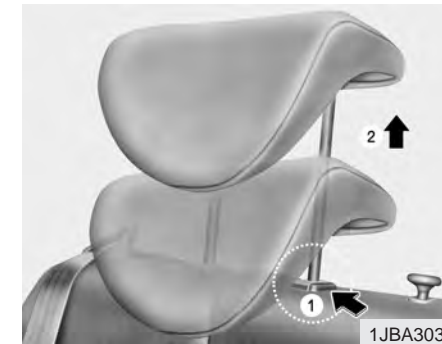

Removal

To remove the headrest, raise it as far as it can go then press the release lever (1) while pulling upward (2).

⚠ WARNING - Rear headrest
To reduce the risk of head and neck injuries to rear passengers, do not operate the vehicle with the rear headrest removed or improperly positioned.

SAFETY BELTS

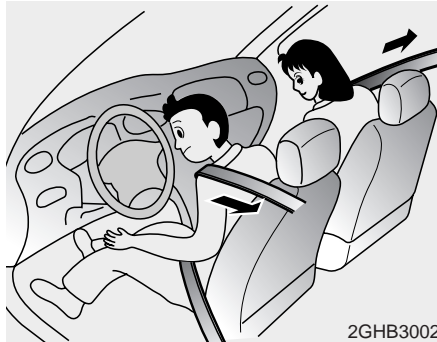

Pre-tensioner seat belt (if equipped)

Your vehicle is equipped with driver's and front passenger's pre-tensioner safety belts. The purpose of the pre-tensioner is to make sure that excess slack is taken up in certain frontal collisions. The pre-tensioner seat belts will activate together with the air bags, where the frontal collision is severe enough.

CAUTION

Both the driver's and front passenger's pre-tensioner seat belts will be activated in certain frontal collisions. The pre-tensioner seat belts can be activated, where the frontal collision is severe enough, together with the air bag. The pre-tensioners will be activated under these conditions even if there is no one on the seat at the time of the collision.

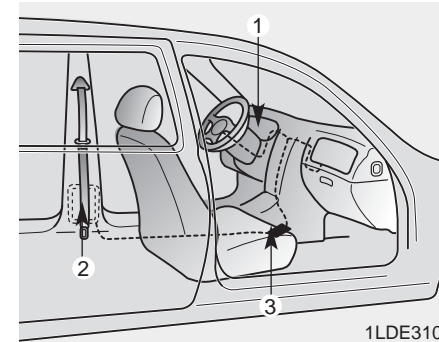

The seat belt pre-tensioner system consists mainly of the following components. Their locations are shown in the illustration.

- (1) SRS air bag warning light
- (2) Seatbelt pre-tensioner assembly
- (3) SRS air bag control module

⚠ WARNING - Safety belt adjustment

To obtain maximum benefit from a pre-tensioner seat belt:

- The safety belt must be worn correctly.
- The safety belt must be adjusted to the correct position.

⚠ CAUTION - Air bag/Pre-tensioner dust

When the air bags and pre-tensioners are activated, a loud noise may be heard and fine dust, which may appear to be smoke, may be visible in the passenger compartment. This dust is not toxic. The dust may cause skin irritation and should not be breathed for prolonged periods. Ventilate the vehicle after impact and wash your hands and face thoroughly after an accident.

⚠ WARNING - Air bag/pre-tensioner warning light

If the SRS air bag warning light does not illuminate when the ignition key is turned to "ON", or if it remains illuminated after approximately 6 seconds, or if it illuminates while the vehicle is being driven, please have an authorized Kia dealer inspect the pre-tensioner and air bag system as soon as possible.

⚠ CAUTION - Hot parts

The pre-tensioner assembly mechanism becomes hot during activation. Do not touch the pre-tensioner seat belt assembly for several minutes after they have been activated.

⚠ WARNING - Replacing used pre-tensioners

- Pre-tensioners are designed to operate once. After activation, pre-tensioner seat belts must be replaced. All seat belts, of any type, should always be replaced after they have been worn during a collision.
- Do not attempt to replace the pre-tensioners yourself. This must be done by an authorized Kia dealer.

⚠ WARNING - Damaging the pre-tensioners

- Do not hit or strike the pre-tensioner assemblies, especially with a tool or heavy object.
- Do not attempt to service or repair the pre-tensioners.

Safety belt restraint system

⚠ WARNING - Safety belts

To minimize the risk of serious or fatal injury in an accident, the driver and all passengers should use the appropriate safety restraints for their age and size. The presence of air bags does not change the need to be properly restrained by a safety belt or size-appropriate child restraint. In fact, air bags are designed to work the best when passengers are correctly restrained in the vehicle.

- Be sure you are familiar with the information in this section, including the information on infant and child restraints.
- Read the safety warnings on the sun visors of your vehicle also.

We strongly recommend that the driver and all passengers be properly restrained at all times by using the safety belts provided with the vehicle. Proper use of the safety belts decreases the risk of severe injury or death in accidents or sudden stops. In most states, and in Canada, the law requires their use.

All seats have lap/shoulder belts. Inertial locks in the safety belt retractors allow all of the lap/shoulder safety belts to remain unlocked during normal vehicle operation. This allows the occupants some freedom of movement and increased comfort while using the safety belts. If a force is applied to the vehicle, such as a strong stop, a sharp turn, or a collision, the safety belt retractors will automatically lock the safety belts.

Since the inertial locks do not require a collision in order to lock up, you may become aware of the safety belts locking while braking or going around sharp corners.

Always use the rear seat position(s) to install your child restraint(s).

⚠ WARNING - Child restraint in front seat

Never install a child restraint system in the front passenger position, as an inflating air bag could cause serious or fatal injury to a child in that position.

The rear safety belts use a special auto-lock feature designed to allow a child restraint to be used in these positions without an added locking clip. They normally lock only under extreme or emergency conditions (emergency lock mode). However they can be adjusted so that they remain fixed and locked when a child restraint system is placed in these positions. (Use this auto-lock mode only to secure a child restraint, never for passengers restrained by the safety belts.) Page 3-42 gives instructions on placing the safety belt in the auto lock mode. The drivers safety belt can only operate in the emergency lock mode.

Knowing your vehicle

Safety belts provide the best restraint when:

- The seatback is upright.
- The occupant is sitting upright (not slouched).
- The lap belt is snug across the hips.
- The shoulder belt is snug across the chest.
- The knees are straight forward.

⚠ WARNING - After a collision

- Lap/shoulder belt assemblies may be stretched or damaged when subjected to the stress and forces of a collision.
- The entire restraint system should be inspected following any collision. All belts, retractors, anchors and hardware damaged by a collision should be replaced before the vehicle is operated again.

⚠ WARNING - Cargo area (if equipped)

Passengers should never be allowed to ride in the cargo area of a vehicle. No safety belts are provided for the cargo area. Persons riding in the vehicle without a fastened safety belt are much more likely to suffer serious bodily injury or death during an accident.

⚠ WARNING - Twisted belts

A twisted or jammed safety belt cannot restrain you properly. If you cannot untwist or unjam the safety belt, have an authorized Kia dealer service it immediately. Never drive or ride with a twisted or jammed safety belt.

⚠ WARNING - Belt use

Safety belts must be used correctly to work properly in an accident. Each seating position in your vehicle has a specific safety belt assembly that includes a buckle and tongue designed to be used together.

(Continued)

(Continued)

Failure to heed these warnings and follow these instructions will increase the risk and severity of injuries and the likelihood of death in an accident.

- Use the shoulder portion of the safety belt on the outside shoulder only. Never wear the shoulder portion under the arm.
- Never swing the safety belt around your neck to fit over the inside shoulder.
- Never wear the shoulder portion of the safety belt across the neck or face.
- Wear the lap portion as low as possible. Be sure that the lap belt fits snugly around the hips. Never wear a lap portion of a lap/shoulder belt over your waist; it should always go over the stronger area of your hips.
- Never use a single safety belt for more than one person.
- The front seatbacks should always remain in a comfortable, upright position when the vehicle is moving.

⚠ WARNING - Safety belt care

- A damaged belt may not give you the protection you need in an accident.
- Inspect your safety belts periodically for excessive wear or damage. Pull out each belt fully and look for fraying, cuts, burns or other damage. Pull the safety belt out and let it retract a number of times. Make sure that the lap/shoulder belts return smoothly and easily into the retractor.
- Check the latches to make sure they latch and release without interference or delay.
- Never close the doors on any part of the lap or shoulder belt.
- Any belt not in good condition or in good working order should be promptly replaced.

⚡ CAUTION

Never close the doors on any part of the lap or shoulder belt. It can damage the safety belt or buckle which could increase the risk of injury in case of an accident.



1GQA2083

Safety belt warning light and chime

As a reminder to the driver and passenger, safety belt warning light will blink for approximately 6 seconds each time you turn the ignition switch ON.

If the driver's lap/shoulder belt is not fastened when the key is turned ON or if it is disconnected after the key is turned ON, the safety belt warning light will blink for approximately 6 seconds.

If the driver's lap/shoulder belt is not fastened when the key is turned ON or if it is disconnected after the key is turned ON, the safety belt warning chime will sound for approximately 6 seconds. (if equipped)

If the driver's lap/shoulder belt is not fastened within 30 seconds after the engine is started, the safety belt warning light and chime will activate for six seconds. This cycle will repeat 11 times with an interval of 24 seconds between cycles.

Knowing your vehicle



Lap/shoulder belt

To fasten the front lap/shoulder belt:

1. Grasp the buckle and tongue plate.
2. Slowly pull the lap/shoulder belt out from the retractor.



3. Insert the tongue plate (1) into the open end of the buckle (2) until an audible “click” is heard, indicating the belt is locked in the buckle.

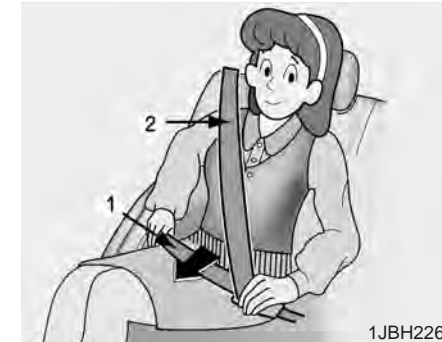

4. Position the lap portion (1) of the belt across your lap as **LOW ON THE HIPS** as possible to reduce the risk of sliding under it during an accident. Adjust the belt to a **SNUG FIT** by pulling up on the shoulder portion (2) of the safety belt. The belt retractor is designed to take up excess webbing automatically and to maintain tension on the belt. For your safety, do not put any excess slack into the safety belt at any location.

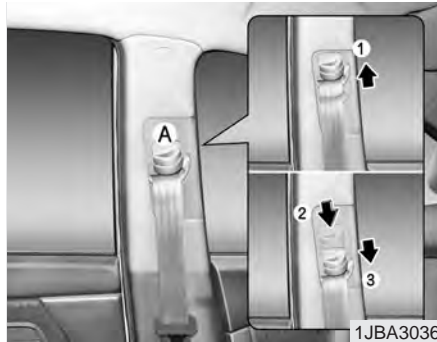

1JBA3036

- Adjust the shoulder anchor position to your size. To raise the anchor position, push the anchor up (1). To lower the anchor position, press (2) the button (A) and slide the anchor down (3). After adjustment, make sure the anchor is locked in position.

If the height of the adjusting seat belt is too near your neck, you will not be getting the most effective protection. The shoulder portion should be adjusted so that it lies across your chest and midway over your shoulder nearest the door and not your neck.

⚠ WARNING

- The height adjuster must be in the locked position when the vehicle is moving.
- The misadjustment of height of the shoulder belt could reduce the effectiveness of the seat belt in a crash.

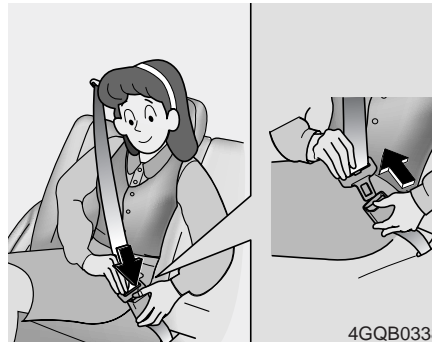

4GQB0338

To unfasten the front lap/shoulder belt:

Press the release button on the buckle and allow the belt to slowly retract.

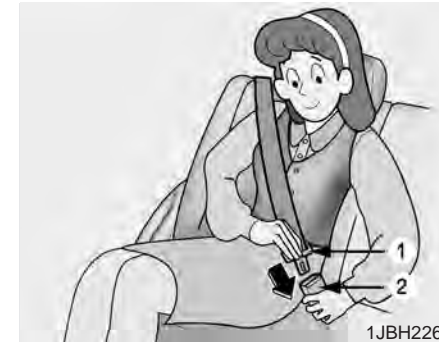

1JBH2263

Rear lap/shoulder belt

To fasten the rear lap/shoulder belt:

- Grasp the buckle and tongue plate.
- Slowly pull the lap/shoulder belt out.
- Insert the tongue plate (1) into the open end of the buckle (2) until an audible "click" is heard, indicating the belt is locked in the buckle.

Knowing your vehicle

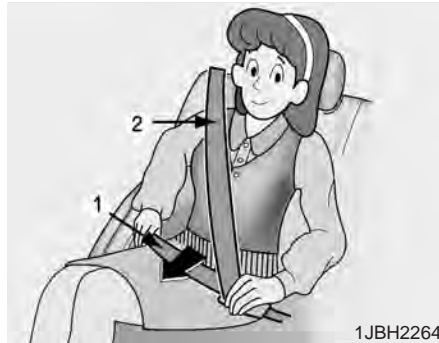

4. Position the lap portion (1) of the belt across your lap as **LOW ON THE HIPS** as possible to reduce the risk of sliding under it during an accident. Adjust the belt to a **SNUG FIT** by pulling up on the shoulder portion (2) of the safety belt. The belt retractor is designed to take up excess webbing automatically and to maintain tension on the belt. For your safety do not put any excess slack into the safety belt.

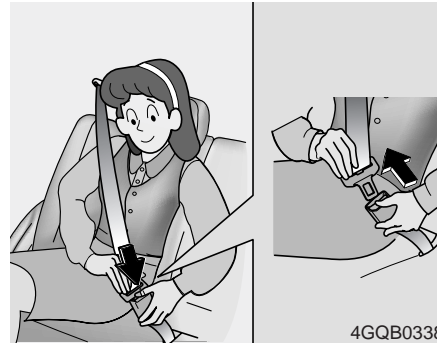

To unfasten:

Press the release button on the buckle and allow the belt to slowly retract.

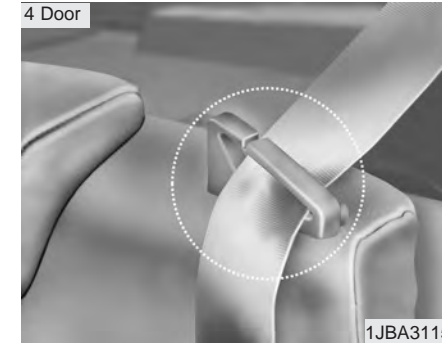

*** NOTICE**

When returning the rear seatbacks to the upright position, remember to return the rear shoulder belts to their proper position. Routing the safety belt webbing through the rear safety belt guides will help keep the belts from being trapped behind or under the seats.

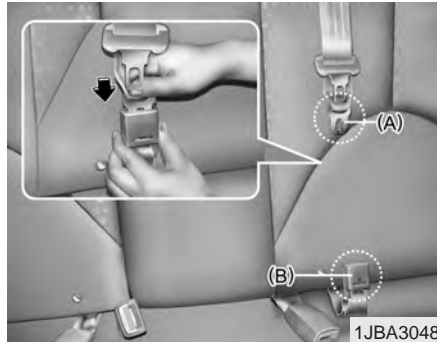

**3 Point rear center belt
(if equipped)**

To fasten the rear center belt

1. Insert the tongue plate (A) into the open end of the anchor connector (B) until an audible “click” is heard, indicating the latch is locked. Make sure the belt is not twisted.

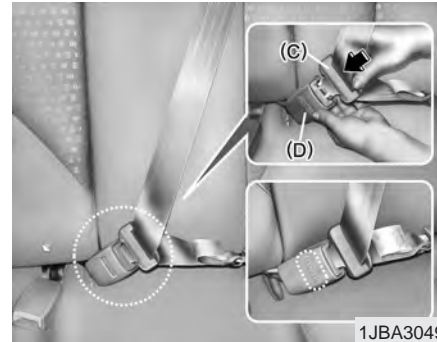

2. Pull the tongue plate (C) and insert the tongue plate (C) into the open end of the buckle (D) until an audible “click” is heard, indicating the latch is locked. Make sure the belt is not twisted.

There will be an audible “click” when the tab locks in the buckle. The seat belt automatically adjusts to the proper length only after the lap belt is adjusted manually so that it fits snugly around your hips, if you lean forward in a slow, easy motion, the belt will extend and let you move around. If there is a sudden stop or impact, the belt will lock into position. It will also lock if you try to lean forward too quickly.

⚠ WARNING

When using the rear seat center belt, you must lock all tongue plates and buckle/anchor connector. If any tongue plate or buckle/anchor connector is not locked, it will increase the chance of injury or death in the event of collision.

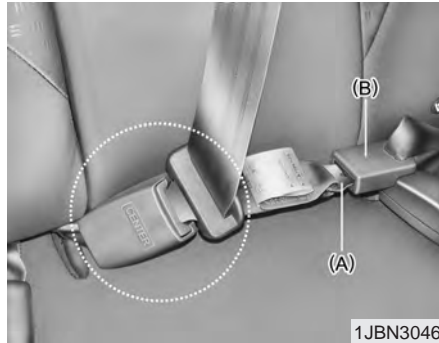

When using the rear center seat belt, the buckle with the “CENTER” mark must be used.

⚠ WARNING

- When using the rear center belt, you must lock all tongue plates and buckles prior to use. If any tongue plate or buckle is not locked, it will increase the chance of injury or death in the event of collision.
- The rear center seatbelt tongue plate (A) and anchor connector (B) should remain locked at all times. They should only be unlocked when folding the rear seatback down or when carrying an object in the rear seat that could cause damage to the seatbelt webbing or locking devices. In either case, lock the tongue plate (A) and anchor connector (B) immediately after unfolding the seatbacks or removing the object being transported.

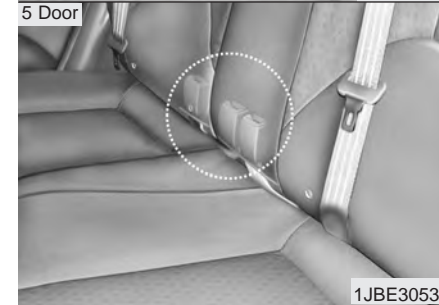
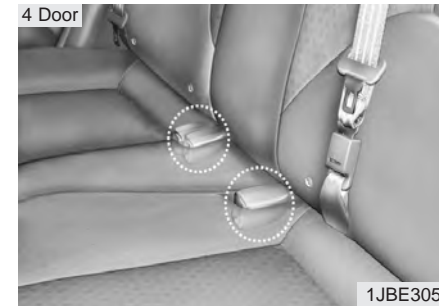

Stowing the rear safety belt

The rear safety belt buckles can be stowed in the pocket between the rear seatback and cushion when not in use.

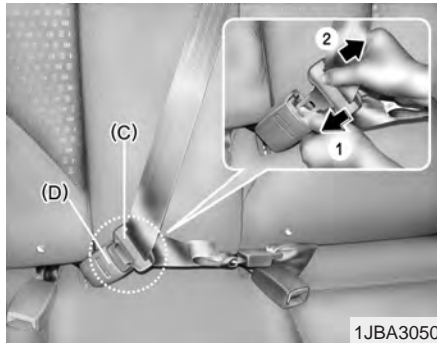

To unfasten the rear center belt

1. Press the release button on the buckle (D) and remove the tongue plate (C) from the buckle (D).

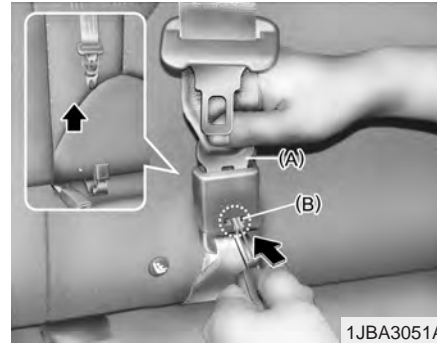

2. To retract the rear center seatbelt, insert the key or similar small rigid device into the web release button (B) on the anchor connector. Pull up on the seat belt web (A) and allow the webbing to retract automatically. (4Door, if equipped)

Proper use and care of the safety belt system

To ensure that the safety belts provide the maximum protection, please follow these instructions:

- Use the belts at all times - even on short trips.
- If the safety belt is twisted, straighten it prior to use.
- Keep sharp edges and damaging objects away from the belts.
- Periodically inspect belt webbing, anchors, buckles and all other parts for signs of wear and damage. Replace damaged, excessively worn or questionable parts immediately.
- To clean the belt webbing, use a mild soap solution recommended for cleaning upholstery or carpets. Follow the instructions provided with the soap.
- Do not make modifications or additions to the safety belt.
- After wearing a safety belt, make sure it fully retracts to the stowed position. Do not allow the belt to get caught in the door when you close it.

⚠ WARNING

Do not bleach or dye the webbing because this may weaken the webbing fibers and allow them to fail when loaded in a collision.

Restraint of pregnant women

Pregnant women should wear lap/shoulder belt assemblies whenever possible according to specific recommendations by their doctors. The lap portion of the belt should be worn AS SNUGLY AND LOW AS POSSIBLE.

⚠ WARNING - Pregnant women

Pregnant women must never place the lap portion of the safety belt over the area of the abdomen where the fetus is located or above the abdomen where the belt could crush the fetus during an impact.

Restraint of infants and small children

To increase their safety, infants and young children should always be restrained by a restraint system approved for their age and size.

Never allow a child to stand or kneel on the seat of a moving vehicle. Never allow a safety belt to be placed around both a child and an adult or around two children at the same time.

It is best for children to be seated in the rear seats.

Many companies manufacture child restraint systems (often called child seats) for infants and small children. An acceptable child restraint system must always satisfy Canadian Motor Vehicle Safety Standards. Make sure that any child-restraint system you use in your vehicle is labelled as complying with Federal Safety Standards.

The child-restraint system should be chosen to fit both the size of the child and the size of the vehicle seat. Be sure to follow any instructions provided by the child-restraint system manufacturer when installing the child-restraint system.

⚠ WARNING - Children on laps

Never hold a child on your lap or in your arms in a moving vehicle. Even a very strong person cannot hold onto a child in the event of even a minor collision.

⚠ CAUTION - Hot metal parts

Safety belts and seats can become hot in a vehicle that has been closed during warm/hot weather; they could burn a child. Check seats, seatbelt webbing and buckles before you place a child anywhere near them.

⚠ WARNING - Infants and young children

- Infants and young children are at much greater risk of serious injury or death in an accident or sudden stop if they are unrestrained or restrained improperly. Follow all instructions in this section and the instructions that came with an approved child safety system. The child restraint must be correctly installed in the vehicle, and the child must be correctly placed in the child restraint.
- All children under 12 are safest in the back seat.
- Never install a rear facing infant seat in the front passenger position. The baby will be injured or killed by the air bag if it deploys.
- Never allow a child to stand or kneel on the seat of a moving vehicle.

Restraint of larger children

As children grow, they may need to use new child-restraint systems, including larger child seats or booster seats, which are appropriate for their increased size.

A child who has outgrown available child-restraint systems should use the belts provided in the vehicle. When seated in the rear outboard seats, the child should be restrained by the lap/shoulder belt.

If the shoulder belt portion slightly touches the child's neck or face, try placing the child closer to the center of the vehicle. If the shoulder belt still touches their face or neck they need to be returned to a child restraint system. In addition, aftermarket devices are available from independent manufacturers which help pull the shoulder belt down and away from the child's face or neck.

⚠ WARNING - Shoulder belts on small children

- Never allow a shoulder belt to be in contact with a child's neck or face while the vehicle is in motion.
- If safety belts are not properly worn and adjusted, there is a risk of death or serious injury to such a child.

Child restraint system

For small children and babies, the use of a child seat or infant seat is strongly recommended and is required by law in almost all states. This child seat or infant seat should be of appropriate size for the child and should be installed in accordance with the manufacturer's instructions.

Children riding in the car should sit on the rear seat and must always be properly restrained to minimize the risk of injury in an accident, sudden stop or sudden maneuver. According to accident statistics, children are safer when properly restrained in the rear seats than in the front seat.

Children could be injured or killed in a crash if their restraints are not properly secured. For small children and babies, a child seat or infant seat must be used. Before buying a particular child restraint system, make sure it fits your car and seat belts, and fits your child. Follow all the instructions provided by the child seat manufacturer when installing the child restraint system.



⚠ WARNING - Child restraints

- A child restraint system must be placed in the rear seat. Never install a child or infant seat on the front passenger's seat. Should an accident occur and cause the passenger air bag to deploy, it could severely injure or kill an infant or child seated in the front seat.

(Continued)

(Continued)

- Since a safety belt or child restraint system can become very hot if it is in a closed vehicle, be sure to check the seat cover and buckles before placing a child there.
- When the child restraint system is not in use, store it in the trunk or fasten it with a safety belt so that it will not be thrown forward in the case of a sudden stop or an accident.
- Children who are too large to be in a child restraint should sit in the rear seat and be restrained with the available lap/shoulder belts.
- When using the vehicles lap/shoulder safety belts, always make sure that the shoulder belt portion is positioned midway over the shoulder, never across the neck or behind the back. The lap belt portion of the lap/shoulder belt must always be positioned as low as possible on the child's hips and as snug as possible.

(Continued)

(Continued)

- If the vehicle's safety belt will not properly fit the child, you must use an appropriate child restraint or booster seat in the rear.
- Never allow a child to stand up or kneel while the vehicle is moving.
- Never use an infant carrier or child seat that "hooks" over a seatback. It will not provide adequate protection in an accident.
- Never allow a child to be held while they are in a moving vehicle, as this could result in serious injury or death to the child in the event of an accident or sudden stop. Holding a child in a moving vehicle does not provide the child with any protection during an accident, even if the person holding the child is wearing a seat belt.

Installing a child restraint system

For safety reasons, we recommend that the child restraint system be used in the rear seats.

Never place a rear-facing child restraint in the front passenger seat, because of the danger that an inflating passenger side air bag could impact the rear-facing child restraint and kill the child.

Since all passenger safety belts move freely under normal conditions and only lock under extreme or emergency conditions (emergency lock mode), you must manually change these safety belts to the auto lock mode to secure a child restraint.

 WARNING - Child seat installation

- Before installing the child restraint system, read the instructions supplied by the child restraint system manufacturer.
- If the safety belt does not operate as described in this section, have the system checked immediately by your authorized Kia dealer.
- Failure to observe this manual's instructions regarding child restraint system and the instructions provided with the child restraint system could increase the chance and/or severity of injury or death in an accident.

Placing a passenger safety belt into the auto lock mode

The use of the auto lock mode will ensure that the normal movement of the child in the vehicle does not cause the safety belt to be pulled out and loosen the firmness of its hold on the child restraint system. To secure a child restraint system, use the following procedure.

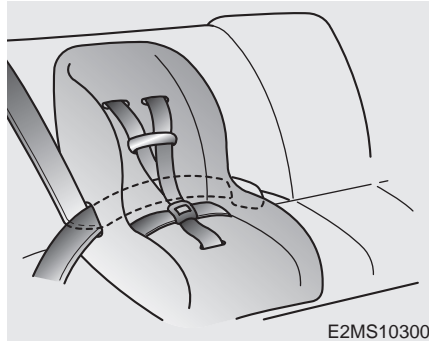

Installing a child restraint system by lap/shoulder belt

To install a child restraint system on the outboard or center rear seats, do the following:

1. Place the child restraint system in the seat and route the lap/shoulder belt around or through the restraint, following the restraint manufacturer's instructions. Be sure the safety belt webbing is not twisted.

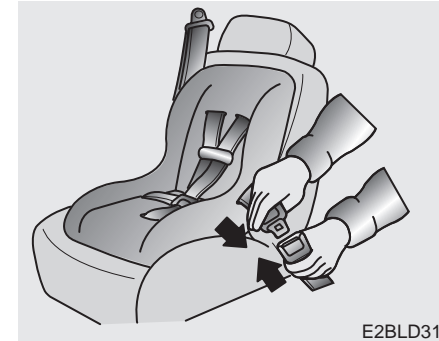

2. Fasten the lap/shoulder belt latch into the buckle. Listen for the distinct "click" sound.

Position the release button so that it is easy to access in case of an emergency.



3. Pull the shoulder portion of the safety belt all the way out. When the shoulder portion of the safety belt is fully extended, it will shift the retractor to the "Auto Lock" (child restraint) mode.



4. Slowly allow the shoulder portion of the safety belt to retract and listen for an audible "clicking" or "ratcheting" sound. This indicates that the retractor is in the "Auto Lock" mode. If no distinct sound is heard, repeat steps 3 and 4.

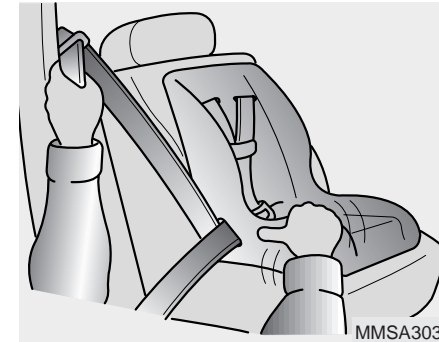

5. Remove as much slack from the belt as possible by pushing down on the child restraint system while feeding the shoulder belt back into the retractor.

6. Push and pull on the child restraint system to confirm that the safety belt is holding it firmly in place. If it is not, release the safety belt and repeat steps 2 through 6.

7. Double check that the retractor is in the "Auto Lock" mode by attempting to pull more of the safety belt out of the retractor. If you cannot, the retractor is in the "Auto Lock" mode.

To remove the child restraint, press the release button on the buckle and then pull the lap/shoulder belt out of the restraint and allow the safety belt to retract fully.

⚠ WARNING - Auto lock mode

The lap/shoulder belt automatically returns to the “emergency lock mode” whenever the belt is allowed to retract fully. Therefore, the preceding seven steps must be followed each time a child restraint is installed.

If the safety belt is not placed in the “Auto lock” mode, severe injury or death could occur to the child and/or other occupants in the vehicle in a collision, since the child restraint will not be effectively held in place.

When the safety belt is allowed to retract to its fully stowed position, the retractor will automatically switch from the “Auto Lock” mode to the emergency lock mode for normal adult usage.

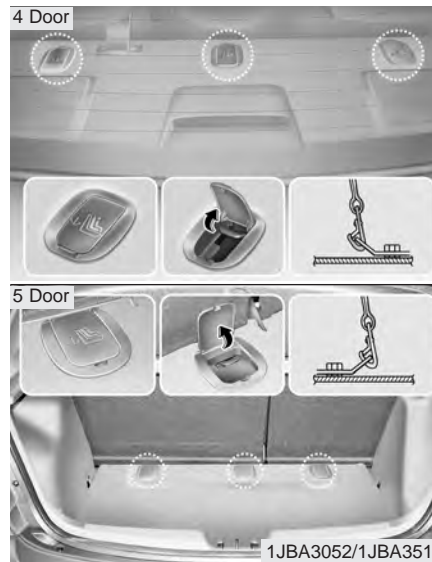

Securing a child restraint seat with “Tether Anchor” system (if equipped)

Child restraint hook holders are located on the shelf or floor behind the rear seats.

1. Open the tether anchor cover on the shelf or floor behind the rear seats.

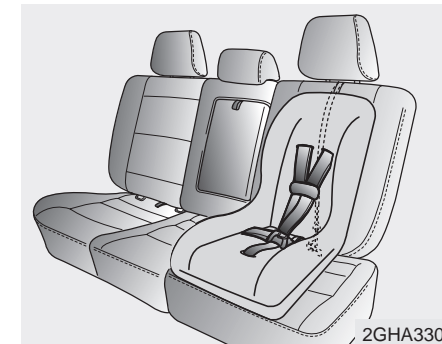

2. Route the child restraint seat strap over the seatback.
For vehicles with adjustable headrest, route the tether strap under the headrest and between the headrest posts, otherwise route the tether strap over the top of the seatback.
3. Connect the tether strap hook to the corresponding hook holder and tighten to secure the seat.

⚠ WARNING - Tether strap

If the tether strap is secured incorrectly, the child restraint seat may not be restrained properly in the event of a collision. Do not mount more than one child restraint seat to a tether anchorage, since the anchorage can then fail in a collision.

⚠ WARNING - Child restraint check

Check that the child restraint system is secured by pushing and pulling it in different directions. Incorrectly fitted child restraints may swing, twist, tip or come away causing death or injury.

⚠ WARNING - Child restraint anchorage

- Child restraint anchorages are designed to withstand only those loads imposed by correctly fitted child restraints. Under no circumstances are they to be used for adult seat belts or harnesses or for attaching other items or equipment to the vehicle.
- The tether strap may not work properly if attached somewhere other than the correct tether anchor.

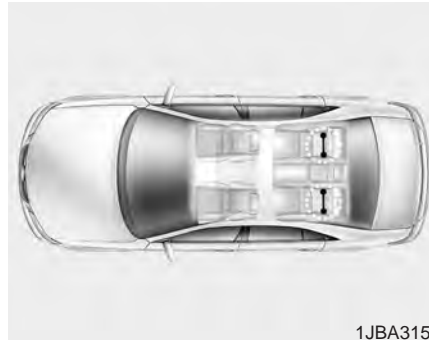

Child seat lower anchors

Some child seat manufacturers make child restraint seats that are labeled as International Standards Organization Fixed (ISOFIX) or ISOFIX-compatible child restraint seats. These seats include two rigid or webbing mounted attachments that connect to two ISOFIX anchors at specific seating positions in your vehicle. This type of child restraint seat eliminates the need to use seat belts to attach the child seat for in the rear seats.

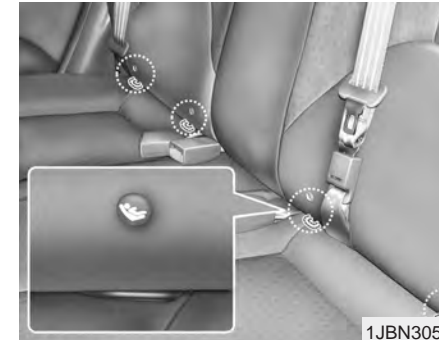

There is a child restraint symbol located on the lower portion of each side of the rear seatbacks. These symbols indicate the position of the lower anchors for child restraints so equipped.

⚠ WARNING

When using the vehicle's "ISOFIX" system to install a child restraint system in the rear seat, all unused vehicle rear seat belt metal latch plates or tabs must be latched securely in their seat belt buckles and the seat belt webbing must be retracted behind the child restraint to prevent the child from reaching and taking hold of unretracted seat belts. Unlatched metal latch plates or tabs may allow the child to reach the unretracted seat belts which may result in strangulation and a serious injury or death to the child in the child restraint.

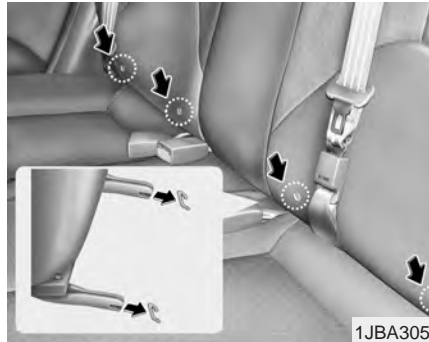

ISOFIX anchors have been provided in your vehicle. The ISOFIX anchors are located in the left and right outboard rear seating positions. Their locations are shown in the illustration. There is no ISOFIX anchor provided for the center rear seating position.

The ISOFIX anchors are located between the seatback and the seat cushion of the rear seat left and right outboard seating positions.

Follow the child seat manufacturer's instructions to properly install child restraint seats with ISOFIX or ISOFIX-compatible attachments.

Once you have installed the ISOFIX child restraint, assure that the seat is properly attached to the ISOFIX and tether anchors. Also, test the child restraint seat before you place the child in it. Tilt the seat from side to side. Also try to tug the seat forward. Check to see if the anchors hold the seat in place.

⚠ WARNING - ISOFIX Anchors

If the child restraint is not anchored properly, the risk of a child being seriously injured or killed in a collision greatly increases.

⚠ WARNING - ISOFIX lower anchors

ISOFIX lower anchors are only to be used with the left and right rear outboard seating positions. Never attempt to attach an ISOFIX equipped seat in the center seating position. You may damage the anchors or the anchors may fail and break in a collision.

AIR BAG - SUPPLEMENTAL RESTRAINT SYSTEM

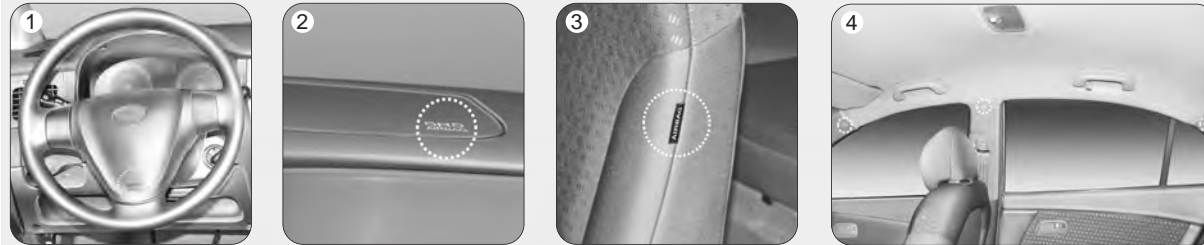

- (1) Driver's air bag
 - (2) Front passenger's air bag
 - (3) Side air bag*
 - (4) Curtain air bag*
 - (5) SRS Control Module
 - (6) Side impact sensor*
 - (7) Front impact sensor*
- * : if equipped

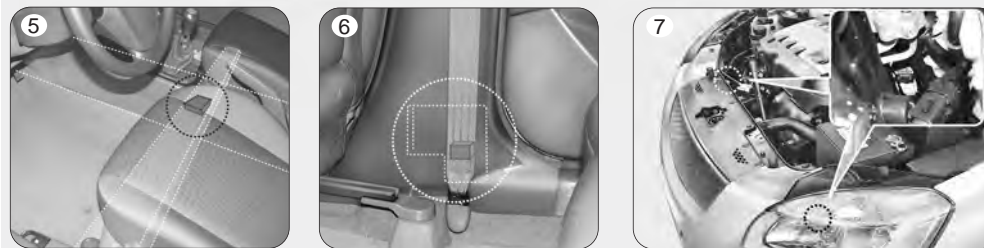

1JBC3511/1JBA3055/1JBA3056/1JBA3057/1JBA3059/1JBA3060/1JBA3061/1JBA3062/1LDN2168

What your air bag system does

Driver's air bag and front passenger's air bag are designed to supplement the protection offered by the safety belt in certain frontal collisions. Likewise, side air bag and curtain air bags are designed to supplement the protection offered by the safety belt in side collisions. Safety belts are designed to reduce the injury of the driver or passengers in case of light impact or collision. No safety belt or air bag system can completely eliminate injuries that may cause in collisions or impacts. To help reduce impact on driver or passengers in any collision, safety belts must be correctly worn.

What your air bag system does not do

The air bag system is designed to supplement the protection offered by the safety belt system. IT IS NOT A SUBSTITUTE FOR THE SAFETY BELT.

The importance of using safety belts

There are four very important reasons to use safety belts even with an air bag supplemental restraint system. They:

- help keep you in the proper position (away from the air bag) when it inflates.
- reduce the risk of harm in rollover, side impact (vehicles not equipped with side and curtain air bags) or rear impact collisions, because an air bag is not designed to inflate in such situations and even a side curtain air bag is designed to inflate only in certain side impact collisions.
- reduce the risk of harm in frontal or side collisions which are not severe enough to actuate the air bag supplemental restraint system.
- reduce the risk of being ejected from your vehicle.

Your vehicle's Supplemental Restraint System Control Module is equipped with a recording device that may record the use or status of the safety belt restraint system by the driver and front passenger in certain collisions.

WARNING - Air bags & safety belts

- Even in vehicles with air bags, you and your passengers must always wear the safety belts provided in order to minimize the risk and severity of injury in the event of a collision or rollover.
- Always wear your safety belt. It can help keep you away from the air bags during heavy braking just before a collision. It may also reduce the risk of occupant ejection.
- If occupants are not wearing safety belts or correctly seated, they cannot be fully protected, and thus face a greater risk of serious injury or death.

(Continued)

(Continued)

- **Driver's and front passenger's air bag are designed to inflate only in certain frontal collisions, and side and curtain air bags are designed to inflate in certain side impacts. Frontal air bags are not designed to provide protection in side impacts, rear impacts, rollovers, or less severe frontal collisions. They will not provide protection from later impacts in a multi-impact collision.**
 - **If your vehicle has been subjected to flood conditions (e.g. soaked carpeting/standing water on the floor of the vehicle, etc.) or if your vehicle has become flood damaged in any way, do not attempt to start the vehicle or put the key in the ignition. Have the vehicle towed to an authorized Kia dealer for inspection and necessary repairs.**
- Disregarding this precaution may cause an unexpected air bag deployment, which could result in serious personal injury or death.**

Air bag system components

The main components of your SRS are:

- To indicate that your vehicle is equipped with air bags, the corresponding air bag covers are marked with "SRS AIR BAG".
 - Driver's air bag
 - Passenger's air bag
 - Side air bag (if equipped)
 - Curtain air bag (if equipped)
- A diagnostic system that continually monitors the system operation.
- Air bag warning light to warn you of a possible problem with the system.
- Emergency power backup in case your car's electrical system is disconnected in a crash.

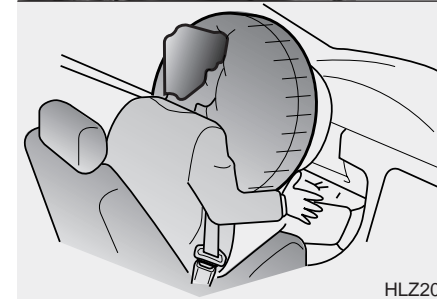

Driver's air bag

The driver's air bag is stored in the center of the steering wheel.

⚠ WARNING - Steering wheel

- You must always sit as far back from the steering wheel air bag as possible (chest at least 250 mm (10 inches) away from the steering wheel), while still maintaining a comfortable seating position for good vehicle control, in order to reduce the risk of injury or death in a collision.
- Never place objects over the air bag storage compartments or between the air bags and yourself. Due to the speed and force of the air bag inflation, such objects could hit your body at high speed and cause severe bodily injury and even death.
- Do not put stickers or ornaments on the steering wheel cover. These may interfere with the deployment of the air bag.

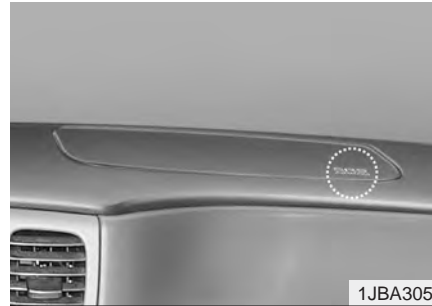

Front passenger's air bag

Front passenger's air bag is stored in the instrument panel on the glove box. Never put any objects or ornaments on the instrument panel.

⚠ WARNING

- The front seat passenger's air bag is much larger than the steering wheel air bag and inflates with considerably more force. It can seriously hurt or kill a passenger who is not in the proper position and wearing the safety belt properly. The front passengers should always move their seat as far back as practical and sit back in their seat.
- It is essential that the front passengers always wear their safety belts when vehicle is in motion, even when the vehicle is moving in a parking lot or up a driveway into garage.
- If the driver brakes the vehicle heavily in urgent situations, occupants will be thrown forward. If front passengers are not wearing the safety belts, they will be directly in front of the air bags when inflation occurs. In that situation, severe injury or death is possible.

(Continued)

(Continued)

- Never allow front passenger to put their hands, feet or face on or close to the instrument panel. In the event of air bag deployment, such a mispositioned occupant would be likely to suffer severe injury or death.
- Never allow children, pregnant women or weak persons to sit in the front passenger seat. They may be seriously injured by the air bag inflation when air bag deploys.
- Do not use child restraint systems on the front passenger's seat, as inflation may cause death or severe personal injury.
- Do not put objects or stickers on the instrument panel. Do not apply any accessory on the front windshield glass or do not install aftermarket mirrors or accessories on the factory installed rearview mirror. Any of these could may interfere with the deployment of air bag inflation or could hit your body at high speed and cause severe bodily injury and even death.



Side air bag (if equipped)

Side air bags are stored in the left side of the driver's seat and right side of the front passenger's seat.

If air bag inflation conditions are met (side collision), they will inflate.

⚠ WARNING - Seat covers, damage and modifications

- Do not use any accessory seat covers for a vehicle equipped with side air bags. Use of seat covers could interfere with side air bag deployment. If seat or seat cover is damaged, have the vehicle checked and repaired by an authorized Kia dealer. Inform them that your vehicle is equipped with side air bags and an occupant detection system.
- Do not make modifications or additions to the seats as they may cause the air bag system to malfunction resulting in severe personal injury or death.

Knowing your vehicle



Curtain air bag (if equipped)

Curtain air bags are located along both sides of the roof rails above the front and rear doors.

They are designed to help protect the heads of the front seat occupants and the rear outboard seat occupants in certain side impact collisions.

- The curtain air bag deployment occurs only on the side of the vehicle affected by the impact.
- The side air bags (side and/or curtain air bags) are not designed to deploy in collisions from the front or rear of the vehicle or in most rollover situations.
- The curtain air bags are designed to deploy only in certain side-impact collisions, depending on the crash severity, angle, speed and impact.

⚠ WARNING

- In order for side air bags (side and curtain air bags) to provide its best protection, both front seat occupants and both outboard rear occupants should sit in an upright position with the seat belts properly fastened. **Importantly, children should sit in a proper child restraint system in the rear seat.**

(Continued)

(Continued)

- When children are seated in the rear outboard seats, they must be seated in the proper child restraint system. Make sure to put the child restraint system as far away from the door side as possible, and secure the child restraint system in a locked position.
- Do not allow the passengers to lean their heads or bodies onto doors, put their arms on the doors, stretch their arms out of the window, or place objects between the doors and passengers when they are seated on seats equipped with side air bags.
- Never try to open or repair any components of the side curtain air bag system. This should only be done by an authorized Kia dealer.

Failure to follow the above mentioned instructions can result in injury or death to the vehicle occupants in an accident.

Why didn't my air bag go off in a collision?

(Inflation and non-inflation conditions of the air bag)

There are many types of accidents in which one or more of the air bags would not be expected to provide additional protection.

These include rear impacts, second or third collisions in multiple impact accidents, as well as low speed impacts. Just because your vehicle is damaged and even if it is totally unusable, don't be surprised that the air bags did not inflate.

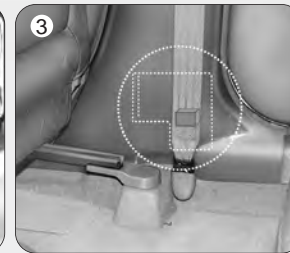
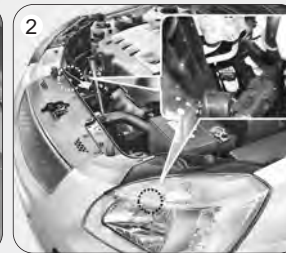

1JBA3512/1JBA3061/1JBA3060/1JBA3062

Air bag collision sensors

- (1) SRS control module
- (2) Front impact sensor (if equipped)

- (3) Side impact sensor (if equipped)

⚠ WARNING - Protecting air bag module and sensors

- Do not hit or allow any heavy objects to hit the locations where air bags or sensors are installed. This may cause damage and unexpected air bag deployment, which could result in severe personal injury or death.
- If the installation location or angle of the sensors is altered in any way, the air bags may deploy when they should not or they may not deploy when they should, causing severe injury or death. Therefore, do not try to perform maintenance on or around the air bag sensors. Have the vehicle checked and repaired by an authorized Kia dealer.

⚠ WARNING - Body changes

- Problems may arise if the sensor installation angles are changed due to the deformation of front bumper, body or B pillar where side collision sensors are installed. In the event of a collision, have the vehicle inspected by an authorized Kia dealer.
- Your vehicle has been designed to absorb impact and deploy the air bag(s) in certain collisions. Installing aftermarket bumper guards or replacing a bumper with non-genuine parts may adversely affect your vehicles collision and air bag deployment performance.



Air bag inflation condition

Front air bag

Front air bags (driver's and front passenger's air bags) are designed to inflate when the impact is delivered to front collision sensors depending on the intensity, speed or angles of impact of the front collision - generally from an area a little to the left to a little to the right of straight ahead.



Side air bags (if equipped)

Side air bags (side and/or curtain air bags) are designed to inflate when an impact is detected by side collision sensors depending on the strength, speed or angles of impact of side impact collision or rollover.

Although the front air bags (driver's and front passenger's air bags) are designed to inflate only in frontal collision, it may inflate in any collision if front impact sensors detect a sufficient impact. Side air bags (side and/or curtain air bags) are designed to inflate only in side impact collision, it may inflate in any collision if side impact sensors detect a sufficient impact.

If the vehicle chassis is impacted by bumps or objects on unimproved roads or sidewalks, air bags may deploy. Drive carefully on unimproved roads or on surfaces not designed for vehicle traffic to prevent unintended air bag deployment. To protect occupants, front air bags and pre-tensioner seat belts may deploy in certain side impact collisions.



Air bag non-inflation conditions

- In certain low-speed collisions the air bags may not deploy. The air bags are designed not to deploy in such cases because the risk of injuries which can be caused by the air bags exceeds the benefits they provide in protecting occupants.

Knowing your vehicle

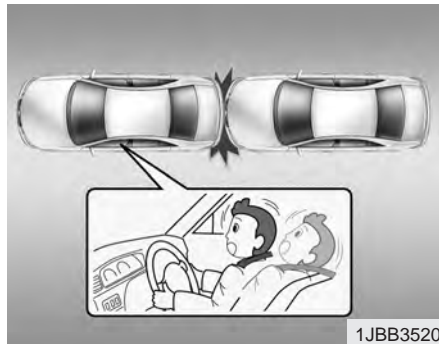

- Frontal air bags are not designed to inflate in rear collisions, because occupants are moved backward by the force of the impact. In this case, the air bags do not provide protection.



- Front air bags may not inflate in side impact collision, because occupants move to the direction of the collision, and thus in side impacts, frontal air bag deployment does not provide occupant protection.

However, side or curtain air bags may inflate depending on the intensity, vehicle speed and angles of impact.

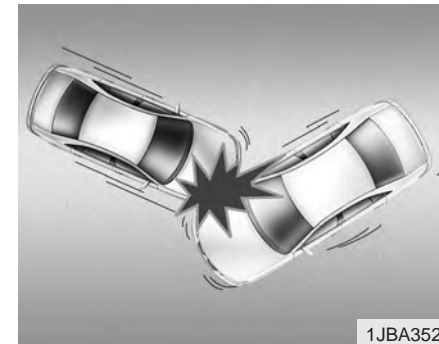

- In a slant or angled collision, the force of impact may direct the occupants in a direction between the front and side air bags, and thus the sensors may not deploy any air bags.

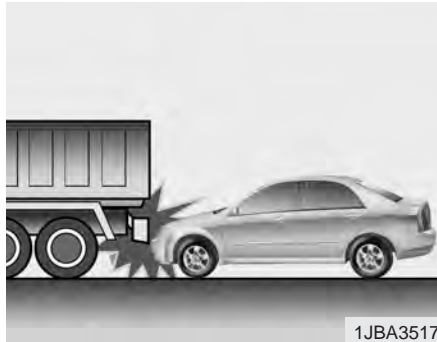

- Just before impact, drivers often brake heavily. Such heavy braking lowers the front portion of the vehicle causing it to “ride” under a vehicle with a higher ground clearance. Air bags may not inflate in this “under-ride” situation because deceleration forces that are detected by sensors may be significantly altered by such “under-ride” collisions.

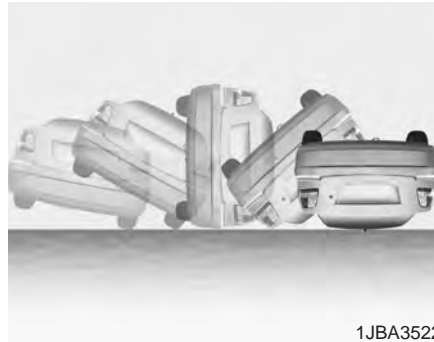

- Air bags may not inflate in rollover accidents because air bag deployment would not provide proper protection to the occupants. However, side air bags may inflate when the vehicle is rolled over by a side impact collision, if the vehicle is equipped with side air bags and curtain air bags.

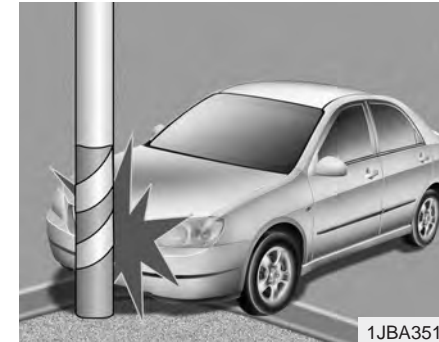

- Air bags may not inflate if the vehicle collides with objects such as utility poles or trees, where the point of impact is concentrated to one area and the full force of the impact is not transmitted to the sensors.

Air bag system operation

- Air bags only operate when the ignition switch is turned to the ON or START positions.
- Air bags inflate instantly in the event of serious frontal or side collision (if equipped with side air bag or curtain air bag) in order to help protect the occupants from serious physical injury.
- There is no single vehicle speed at which the air bags will inflate.
- Air bag deployment depends on a number of factors including vehicle speed, angles of impact and the density and stiffness of the vehicles or objects which your vehicle hits in the collision. However, factors are not limited to those mentioned above.
- The front air bags will completely inflate and deflate in an instant.
It is virtually impossible for you to see the air bags inflate during an accident. It is much more likely that you will simply see the deflated air bags hanging out of their storage compartments after the collision.

- In order to help provide protection in a severe collision, the air bags must inflate rapidly. The speed of air bag inflation is a consequence of the extremely short time in which a collision occurs and the need to get the air bag between the occupant and the vehicle structures before the occupant impacts those structures. This speed of inflation reduces the risk of serious or life-threatening injuries in a severe collision and is thus a necessary part of air bag design.
However, air bag inflation can also cause injuries which normally can include facial abrasions, bruises and broken bones, and sometimes more serious injuries because the inflation speed also causes the air bags to expand with a great deal of force.
- **There are even circumstances under which contact with the steering wheel air bag can cause fatal injuries, especially if the occupant is positioned excessively close to the steering wheel.**

WARNING - Seated positioning

- **To avoid severe personal injury or death caused by deploying air bags in a collision, the driver should sit as far back from the steering wheel air bag as possible (at least 250 mm (10 inches) away). The front passenger should always move their seat as far back as possible and sit back in their seat.**
- **Air bag inflates instantly in an event of collision, passengers may be injured by the air bag expansion force if they are not in proper position.**
- **Air bag inflation may cause injuries which normally include facial or bodily abrasions, injuries by the broken glasses or burns by the explosives.**

Noise and smoke

When the air bags inflate, they make a loud noise and they leave smoke and powder in the air inside of the vehicle. This is normal. After the air bag inflates, you may feel substantial discomfort in breathing due to the contact of your chest to both the safety belt and the air bag, as well as from breathing the smoke and powder. **We strongly urge you to open your doors and/or windows as soon as possible after impact in order to reduce discomfort and prevent prolonged exposure to the smoke and powder.**

Though the smoke and powder are non-toxic, it may cause irritation to the skin (eyes, nose and throat etc.). Wash and rinse with cold water immediately and consult a doctor if symptoms persist.

⚠ WARNING - Hot air bag parts

When the air bags deploy, the air bag related parts in steering wheel and/or instrument panel and/or in both sides of the roof rails above the front and rear doors are very hot. To prevent injury, do not touch the air bag storage area's internal components immediately after an air bag has inflated.



Installing a child restraint on a front passenger seat is extremely dangerous and should never be done.

Never place a rear-facing child restraint in the front passenger's seat. If the air bag deploys, it would impact the rear-facing child restraint, causing severe or fatal injuries.

In addition, do not place front-facing child restraint in the front passenger's seat either. If the front passenger air bag inflates, it may cause severe or fatal injuries to the child.

⚠ WARNING

- Never put child restraint in the front passenger seat. If the front passenger air bag inflates, it may cause severe or fatal injuries.
- When children are seated in the rear outboard seats in which curtain air bags are equipped, be sure to put the child restraint system as far away from the door side as possible, and secure the child restraint system to be locked in position.

Inflation of side or curtain air bag (if equipped) could cause severe injury or death due to the expansion impact.

**AIR
BAG**

Air bag warning light

The purpose of air bag warning light in your instrument panel is to alert you of a potential problem with your air bag - Supplemental Restraint System (SRS).

When the ignition switch is turned ON, the indicator light should blink or illuminate for approximately 6 seconds, then go off.

Have the system checked if:

- The light does not turn on briefly when you turn the ignition ON.
- The light stays on after the engine starts.
- The light comes on while the vehicle is in motion.

Air bag (Supplemental Restraint System) service

Your Supplemental Restraint System is virtually maintenance-free. There are no parts which you can service.

You must have the system serviced under the following circumstances:

- If an air bag ever inflates, the air bag must be replaced. Do not try to remove or discard the air bag by yourself. This must be done by an authorized Kia dealer.
- If the air bag warning indicator light alerts you to a problem, have the air bag system checked as soon as possible. Otherwise, your air bag system may be ineffective.

⚠ CAUTION - No modification
Do not modify any part of the air bag system. Modification could make the air bag system ineffective or could cause unnecessary deployment.

Repairing or scrapping the vehicle

- Repairing/replacing the steering wheel, instrument panel, center console headliner/pillar trim, or modifying vehicle sheet metal components could disable the air bag system. Have such repairs and maintenance performed by an authorized Kia dealer.
- Special care must be taken in scrapping or junking an air bag-equipped vehicle. Always refer such activities to a qualified professional.

⚠ WARNING - No maintenance or repair

- Do not work on the air bag system's components or wiring. This could cause the air bags to inflate inadvertently, possibly seriously injuring someone. Working on the system could also disable the system so that the air bags would not deploy in a collision.
- Any work on the air bag system, such as removing, installing, or repairing the steering wheel must be performed by a qualified Kia technician. Improper handling of the air bag system including the steering wheel may result in serious personal injury or death.

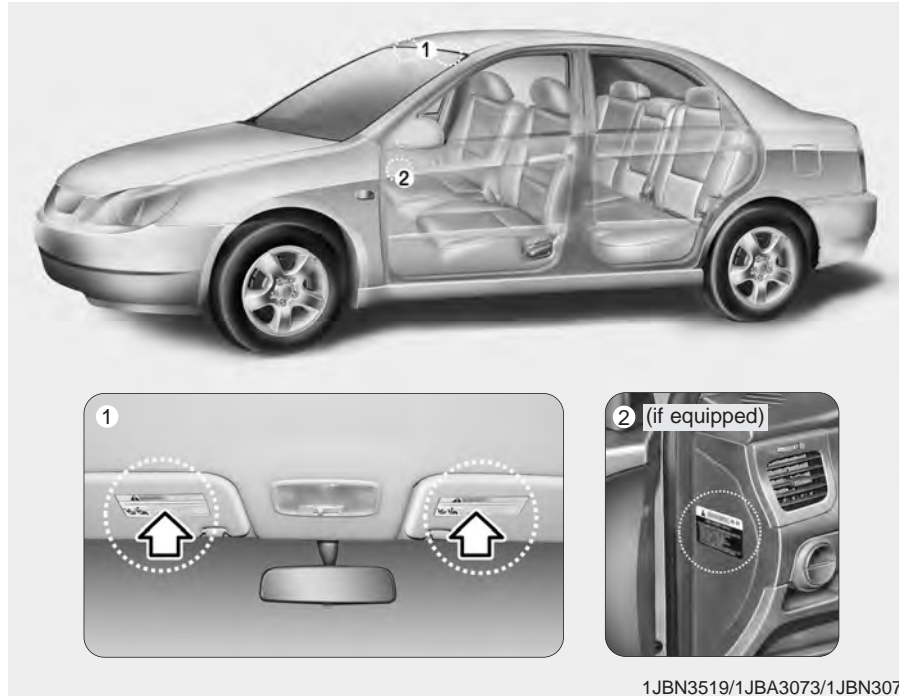

Air bag warning label

Air bag warning labels which are now required by the Canadian Motor Vehicle Safety Standard (CMVSS) are attached to alert driver and passengers of potential risk of air bag system.

Note that these government warnings focus on the risk to children, Kia also wants you to be aware of the risks which adults are exposed to. Those have been described in previous pages.

TRUNK (IF EQUIPPED)



Outside the vehicle

- To open the trunk, insert the key into the lock and turn it to the right (clockwise).
- To close the trunk, use both hands to push the trunk lid down. Check to see if the trunk is completely shut.

⚠ PROPOSITION 65 WARNING

Engine exhaust and a wide variety of automobile components and parts, including components found in the interior furnishings in a vehicle, contain or emit chemicals known to the State of California to cause cancer and birth defects and reproductive harm. In addition, certain fluids contained in vehicles and certain products of component wear contain or emit chemicals known to the State of California to cause cancer and birth defects or other reproductive harm.

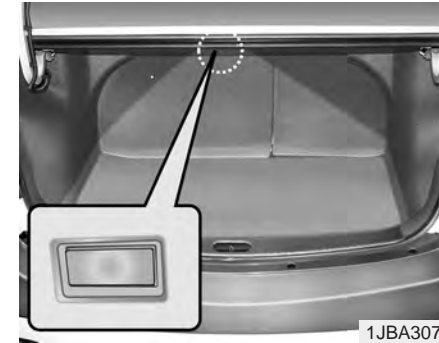

Trunk room lamp

Trunk room lamp turns on when the trunk is opened. It remains on until the trunk is securely closed.

*** NOTICE**

Make sure to close the trunk securely. If it remains open while engine is not running, it may cause battery discharge because trunk room lamp remains on.



Inside the vehicle

To open the trunk from inside the vehicle, pull the trunk lid release lever.

⚠ WARNING - Exhaust fumes

If you drive with the trunk lid open, you will draw dangerous exhaust fumes into your vehicle causing serious injury or death to vehicle occupants. Open trunk lids can also dangerously obscure rear view vision.

If you must drive with the trunk lid open, keep the air vents open so that additional outside air comes into the vehicle.



Emergency trunk safety release (if equipped)

Your vehicle is equipped with an emergency trunk release cable located inside the trunk. The lever glows in the dark when the trunk lid is closed. If someone is inadvertently locked in the trunk, pulling this handle will release the trunk latch mechanism and open the trunk.

⚠ WARNING

No one should be allowed to occupy the trunk of the vehicle at any time. If the trunk is partially or totally latched and the person is unable to get out, severe injury or death could occur due to lack of ventilation, exhaust fumes and rapid heat build-up, or because of exposure to cold weather conditions. The trunk is also a highly dangerous location in the event of a crash because it is not a protected occupant space but merely a part of the vehicle's crush zone.

⚠ CAUTION

- *If a person is locked in the trunk, they can pull the emergency release to open the trunk lid.*
- *We recommend that cars be kept locked and keys be kept out of the reach of children, and that parents teach their children about the dangers of playing in trunks.*

HOOD



Opening the hood:

1. Pull the release lever on the lower left side of the instrument panel to unlatch the hood. The hood should pop open slightly.



2. Go to the front of the vehicle, raise the hood slightly, pull the secondary latch (1) inside of the hood center and lift (2) the hood.



3. Lift the hood and hold it open with the support rod by inserting the free end of the rod into the slot (1).

CAUTION - Hot parts
Grasp the support rod in the area wrapped in rubber. The rubber will help prevent you from being burned by hot metal when the engine is hot.

Closing the hood

1. Before closing the hood, check the following:
 - All filler caps in engine compartment must be correctly installed.
 - Gloves, rags or any other combustible material must be removed from the engine compartment.
2. Secure the support rod in its clip.
3. Lower the hood to about 30 cm (12 inches) height and then let it drop to properly lock in place.
Make sure the hood is properly locked before driving.

CAUTION - Hood

- *Before closing the hood, make sure that all engine parts and tools have been removed from the engine area and that no one's hands are near the hood opening.*
- *Do not leave gloves, rags or any other combustible material in the engine compartment. Doing so may cause a heat-induced fire.*

FUEL FILLER LID

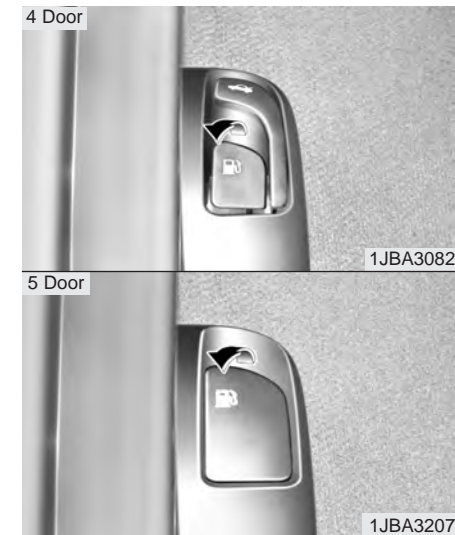

1. Stop the engine.
2. To open the fuel filler lid, pull the release lever.

CAUTION

To avoid injury from sharp edges, it is recommended that protective gloves be worn if there is a need to open the fuel filler door manually.

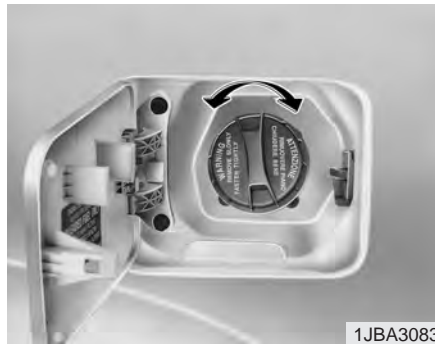

3. Pull the fuel filler lid out to open.
4. To remove the cap, turn the fuel tank cap counterclockwise.
5. Refuel as needed.
6. To install the cap, turn it clockwise until it "clicks". This indicates that the cap is securely tightened.
7. Close the fuel filler lid and push it lightly and make sure that it is securely closed.

⚠ WARNING - Refueling

If pressurized fuel sprays out, it can cover your clothes or skin and thus subject you to the risk of fire and burns. Always remove the fuel cap carefully and slowly. If the cap is venting fuel or if you hear a hissing sound, wait until the condition stops before completely removing the cap.

⚠ WARNING - Refueling dangers

Automotive fuels are flammable materials. When refueling, please note the following guidelines carefully. Failure to follow these guidelines may result in severe personal injury, severe burns or death by fire or explosion.

- Before refueling note the location of the Emergency Gasoline Shut-Off, if available, at the gas station facility.

(Continued)

(Continued)

- Before touching the fuel nozzle, you should eliminate potentially dangerous static electricity discharge by touching another metal part of the vehicle, a safe distance away from the fuel filler neck, nozzle, or other gas source.
- Do not get back into a vehicle once you have begun refueling since you can generate static electricity by touching, rubbing or sliding against any item or fabric (polyester, satin, nylon, etc.) capable of producing static electricity. Static electricity discharge can ignite fuel vapors resulting in rapid burning. If you must re-enter the vehicle, you should once again eliminate potentially dangerous static electricity discharge by touching a metal part of the vehicle, away from the fuel filler neck, nozzle or other gasoline source.
- When using a portable fuel container be sure to place the container on the ground prior to refueling.

(Continued)

(Continued)

Static electricity discharge from the container can ignite fuel vapors causing a fire. Once refueling has begun, contact with the vehicle should be maintained until the filling is complete.

Use only portable plastic fuel containers designed to carry and store gasoline.

- Do not use cellular phones while refueling. Electric current and/or electronic interference from cellular phones can potentially ignite fuel vapors causing a fire.
- When refueling, always shut the engine off. Sparks produced by electrical components related to the engine can ignite fuel vapors causing a fire. Once refueling is complete, check to make sure the filler cap and filler door are securely closed, before starting the engine.

(Continued)

(Continued)

- DO NOT use matches or a lighter and DO NOT SMOKE or leave a lit cigarette in your vehicle while at a gas station especially during refueling. Automotive fuel is highly flammable and can, when ignited, result in fire.
- If a fire breaks out during refueling, leave the vicinity of the vehicle, and immediately contact the manager of the gas station and then contact the local fire department or 911.

*** NOTICE**

- Make sure to refuel with unleaded fuel only.
- Check to make sure the fuel filler cap is securely closed after refueling. A loose fuel filler cap may cause the “Check fuel filler cap ()” light in the instrument panel to illuminate unnecessarily.
- If the fuel filler cap requires replacement, use only a genuine Kia cap or the equivalent specified for your vehicle. An incorrect fuel filler cap can result in a serious malfunction of the fuel system or emission control system.
- Do not spill fuel on the exterior surfaces of the vehicle. Any type of fuel spilled on painted surfaces may damage the paint.

MIRRORS

Outside rearview mirror

Be sure to adjust mirror angles before driving.

Your vehicle is equipped with both left-hand and right-hand outside rearview mirrors. The mirrors can be adjusted remotely with the control levers or remote switch, depending on the type of mirror control installed. The mirror heads can be folded back to prevent damage during an automatic car wash or when passing in a narrow street.

CAUTION

- *The right outside rearview mirror is convex. Objects seen in the mirror are closer than they appear.*
- *Use your interior rearview mirror or direct observation to determine the actual distance of following vehicles when changing lanes.*

*** NOTICE**

Do not scrape ice off the mirror face; this may damage the surface of the glass. If ice should restrict movement of the mirror, do not force the mirror for adjustment. To remove ice, use a deicer spray, or a sponge or soft cloth with very warm water.



Manual remote control (if equipped)

To adjust an outside mirror, move the control lever located at the forward inside area of the window frame.



**Electric remote control
(if equipped)**

The electric remote control mirror switch allows you to adjust the position of the left and right outside rearview mirrors. To adjust the position of either mirror, move the lever (1) to R or L to select the right side mirror or the left side mirror, then press a corresponding point (●) on the mirror adjustment control to position the selected mirror up, down, left or right.

After adjustment, put the lever into neutral position to prevent the inadvertent adjustment.

*** NOTICE**

- The mirrors stop moving when they reach the maximum adjusting angles, but the motor continues to operate while the switch is depressed. Do not depress the switch longer than necessary, the motor may be damaged.
- Do not attempt to adjust the outside rearview mirror by hands. Doing so may damage the parts.



**Folding the outside rearview
mirror**

To fold outside rearview mirror, grasp the housing of mirror and then fold it back, toward the rear of the vehicle.

Knowing your vehicle

Outside rearview mirror heater (if equipped)

The outside rearview mirror heater is automatically turned on when the rear window defroster is turned on. To heat the outside rearview mirror glass, push the button for the rear window defroster.

The rearview mirror heater (and rear window defroster) will not operate unless the engine is running.

The outside rearview mirror glass will be heated for defrosting or defogging and will give you improved rear vision in inclement weather conditions. Push the button again to turn the heater off. The outside rearview mirror heater automatically turns off after 20 minutes.

Day/night rearview mirror (if equipped)

Adjust the rearview mirror to center on the view through the rear window. Make this adjustment before you start driving.

CAUTION

Do not place objects in the rear seat or cargo area which would interfere with your vision out the rear window.

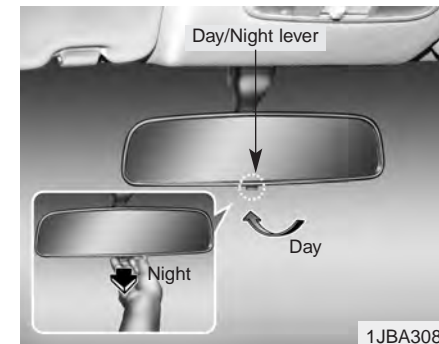

Make this adjustment before you start driving and while the day/night lever is in the day position.

Pull the day/night lever toward you to reduce glare from the headlights of vehicles behind you during night driving.

Remember that you lose some rearview clarity in the night position.

INTERIOR LIGHTS

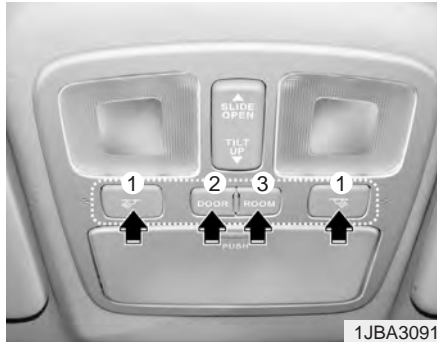

Map light (if equipped)

The lights are turned ON or OFF by pressing the corresponding switch.

(1) Map light

(2) DOOR

: The light turns on when a door is opened or when a door is unlocked by the transmitter (if equipped). Interior light goes out slowly after 30 seconds if the door is closed. However if the ignition switch is ON or all vehicle doors are locked when the door is closed, interior light will turn off even within 30 seconds.

(3) ROOM

: The light turns on and stays on even when the doors are all closed.

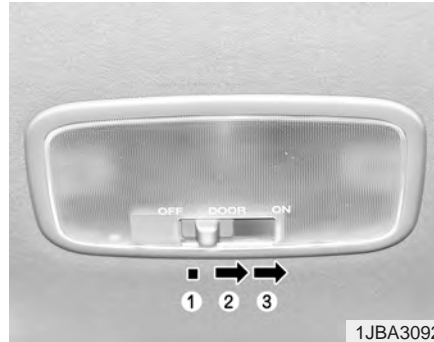

Dome light (if equipped)

(1) OFF

: The light stays off even when a door is open.

(2) DOOR

: The light turns on when a door is opened or when a door is unlocked by the transmitter (if equipped). Interior light goes out slowly after 30 seconds if the door is closed. However if the ignition switch is ON or all vehicle doors are locked when the door is closed, interior light will turn off even within 30 seconds.

(3) ON

: The light turns on and stays on even when the doors are all closed.

* NOTICE

Do not use the interior lights for extended periods when engine is not running. It may cause battery discharge.

STORAGE COMPARTMENT

* NOTICE

- To avoid possible theft, do not leave valuables in the storage compartment.
- Since stored items may move while driving, be sure to position them in the storage compartment so that they do not make noise or cause a potential safety hazard when the vehicle is moving.
- Always keep the storage compartment covers closed while driving. Do not attempt to place many items in the storage compartment that the storage compartment cover can not close securely.

⚠ WARNING - Flammable materials

Do not store cigarette lighters, propane cylinders, or other flammable/explosive materials in the vehicle. These items may catch fire and/or explode if the vehicle is exposed to hot temperatures for extended periods.

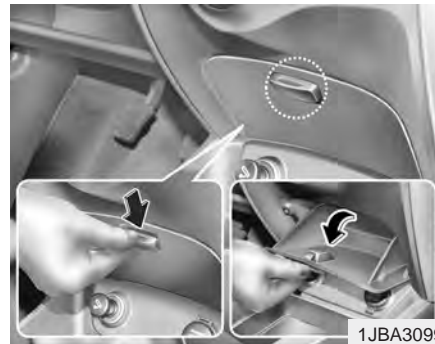

Multi box (if equipped)

To open the cover located above the cigarette lighter/power outlet, push the button and pull the cover down. It can be used for storing small items.

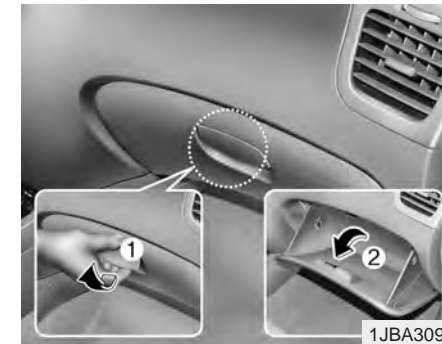

Glove box

To open the glove box, pull the handle (1) and the glove box will automatically open (2). Close the glove box after use.

⚠ CAUTION

To reduce the risk of injury in case of an accident or sudden stop, always keep the glove box door closed while driving.



1JBA3096

Sunglass holder (if equipped)

A sunglass storage compartment is provided on the overhead console. To open the sunglass holder, press the cover and the holder will slowly open. Place your sunglasses in the compartment door with the lenses facing out. Push to close.

* NOTICE

Make sure the sunglass holder is closed while driving.

CAUTION

Do not use the sunglass holder while driving. This could result in loss of control, and an accident causing serious injury or property damage.

INTERIOR FEATURES

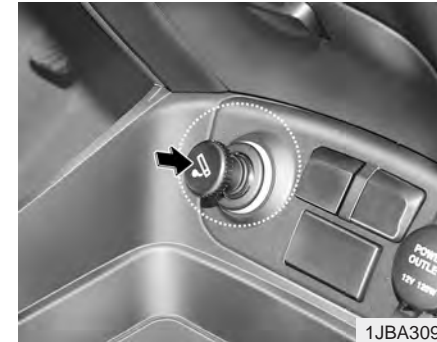

1JBA3097

Cigarette lighter

To operate the cigarette lighter, press it in and release it. When it is heated, it automatically pops out ready for use.

If the engine is not running, the ignition switch must be in the ACC position for the lighter to operate.

*** NOTICE**

- Do not hold the lighter in after it is already heated because it will over-heat.
- Only a genuine Kia lighter should be used in the cigarette lighter socket. The use of plug-in accessories (shavers, hand-held vacuums, and coffee pots, for example) may damage the socket or cause electrical failure.
- If the lighter does not pop out within 30 seconds, remove it to prevent over-heating.

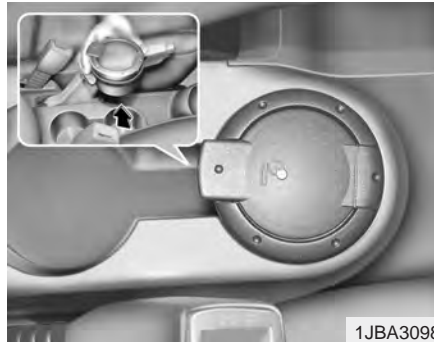

Ashtrays

To use the ashtray, open the cover.
To remove the ashtray to empty or clean it, pull it up and out.

⚠ WARNING - Ashtray use

- Do not use the vehicle's ashtrays as waste receptacles.
- Putting lit cigarettes or matches in an ashtray with other combustible materials may cause a fire.

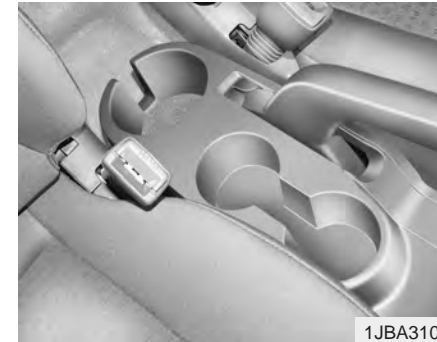

Cup holder

Cups or small beverage cans may be placed in the cup holders.

⚠ WARNING - Hot liquids

- Do not place uncovered cups of hot liquid in the cup holder while the vehicle is in motion. If the hot liquid spills, you could be burned. Such a burn to the driver could cause a loss of control of the vehicle.
- To reduce the risk of personal injury in the event of sudden stop or collision, do not place uncovered or insecure bottles, glasses, cans, etc., in the cup holder while the vehicle is in motion.

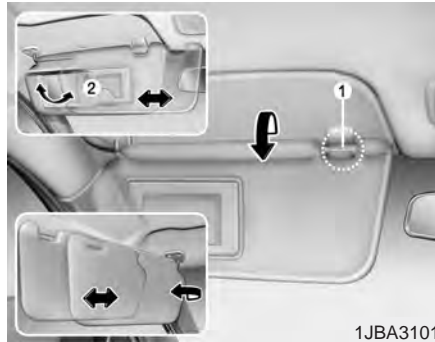

Sunvisor

Use the sunvisor to shield direct light through the front or side windows.

To use a sunvisor, pull it downward.

To use a sunvisor for a side window shade, pull it downward, unsnap it from the bracket (1) and swing it to the side.

To use the vanity mirror, pull down the visor and pull up the mirror cover (2, if equipped).

* NOTICE

- Close the vanity mirror cover securely and return the sunvisor to its original position after use.
- If the vanity mirror lamp is equipped and mirror cover is not closed securely, the lamp will stay on and could result in battery discharge and possible sunvisor damage.



Power socket (if equipped)

The power outlets are designed to provide power for mobile telephones or other devices designed to operate with vehicle electrical systems. The devices should draw less than 10 amps with the engine running.

*** NOTICE**

- Use the power outlet when the engine is running, and remove a plug from the power outlet after using the electric appliance. Using the power outlet excessively or while the engine is not running or leaving appliances plugged into the power outlet when not in use will cause battery discharge
- Only use the electric appliances which are less than 12V and 10A in electric capacity.
- Adjust the air-conditioner or heater to the lowest operation level when you have to use the power socket while using air-conditioner or heater.
- Close the cover when not in use.
- Some electronic devices can cause electronic interference when plugged into a vehicle's power outlet. These devices may cause excessive audio static and malfunctions in other electronic systems or devices used in your vehicle.



Digital clock (if equipped)

Whenever the battery terminals or memory fuse are disconnected, you must reset the time.

When the ignition switch is in the ACC or ON position, the clock buttons operates as follows:

• **HOUR:**

Pressing the “H” button with your finger, a pencil or similar object will advance the time displayed by one hour.

• **MINUTE:**

Pressing the “M” button with your finger, a pencil or similar object will advance the time displayed by one minute.

• **RESET:**

To clear away minutes, press the “R” button with your finger, a pencil or similar object. Then the clock will be set precisely on the hour.

For example, if the “R” button is pressed while the time is between 9:01 and 9:29, the display will be reset to 9:00.

9:01 ~ 9:29 ⇒ 9:00

9:30 ~ 9:59 ⇒ 10:00

SUNROOF (IF EQUIPPED)



1JBA3104

- (1) SLIDE OPEN (TILT DOWN) button
 (2) Tilt UP (slide close) BUTTON

If your vehicle is equipped with this feature, you can slide or tilt your sunroof with the sunroof control buttons located on the overhead console.

The sunroof can only be opened, closed, or tilted when the ignition switch is in the "ON" position.

* NOTICE

- Do not continue to press the sunroof control button(s) after the sunroof is in the fully open, closed, or tilt position(s). Damage to the motor or system components could occur.
- The sunroof cannot slide when it is in the tilt position nor can it be tilted while in an open or slide position.

Sliding the sunroof

Autoslide open

To use the autoslide feature, momentarily (less than 0.4 second) press the SLIDE OPEN button on the overhead console. The sunroof will slide all the way open. To stop the sunroof sliding at any point, press any sunroof control button.

Manual slide open

Press the SLIDE OPEN button on the overhead console and hold it until the sunroof is opened to the desired position.

Close

To close the sunroof, press the TILT UP button on the overhead console and hold it until the sunroof is closed.

Tilting the sunroof

Autotilt open

To use the autotilt feature, momentarily (less than 0.4 second) press the TILT UP button on the overhead console. The sunroof will tilt all the way open. To stop the sunroof tilting at any point, press any sunroof control button.

Manual tilt open

Press the TILT UP button on the overhead console and hold it until the sunroof is opened to the desired position.

Close

To close the sunroof, press the SLIDE OPEN button on the overhead console and hold it until the sunroof is closed.



Sunshade

The sunshade will be opened with the glass panel automatically when the glass panel is slid. You will have to close it manually if you want it closed.

* NOTICE

- Do not press any sunroof control button longer than necessary. Damage to the motor or system components could occur.
- Periodically remove any dirt that may accumulate on the guide rail.
- If you try to open the sunroof when the temperature is below freezing or when the sunroof is covered with snow or ice, the glass or the motor could be damaged.
- The sunroof is made to slide together with sunshade. Do not leave the sunshade closed while the sunroof is open.

⚠ WARNING

- Do not extend face or arms outside through the sunroof opening while driving.
- Make sure hand and face are safely out of the way before closing a sunroof.



In case of an emergency

If the sunroof does not open electrically:

1. Open the sunglass holder.
2. Remove the two (2) screws, and then remove the overhead console.

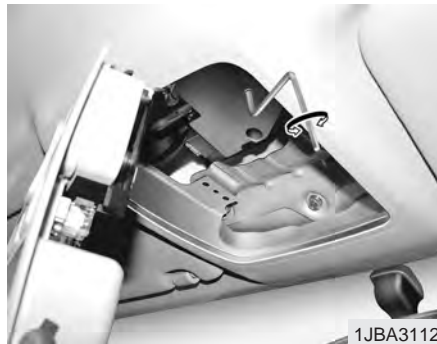

3. Insert the emergency handle (provided with the vehicle) and turn the handle clockwise to open or counterclockwise to close.

Resetting the sunroof

Whenever the vehicle battery is disconnected or discharged, or you use the emergency handle to operate the sunroof, you have to reset your sunroof system as follows:

1. Turn the ignition key to the ON position.
2. Set the sunroof to the maximum TILT-UP position using the corresponding sunroof switch.
3. Then, release it.
4. Press and hold the TILT UP button once again until the sunroof has returned to the original position of TILT UP after it is raised a little higher than the maximum TILT UP position. This may take several seconds.

When this is complete, the sunroof system is reset.

LUGGAGE NET (IF EQUIPPED)

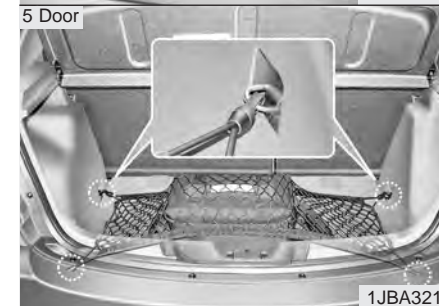

To keep items from shifting in the trunk, you can use the four rings located in the trunk to attach the cargo net.

*** NOTICE**

Do not put fragile, bulky or an excessive quantity of items into luggage net. They could be damaged.

⚠ WARNING

To avoid eye injury, **DO NOT** overstretch the netting.

ALWAYS keep face and body out of recoil path of the net, in case of strap.

DO NOT use the luggage net when strap has visible signs of wear or damage.

ANTENNA



Roof type antenna (if equipped)

If your vehicle has an audio system, an amplifying antenna is installed in your vehicle.

This antenna can be removed from the vehicle when you wash your vehicle.

*** NOTICE**

- Be sure to remove the antenna before washing the car in an automatic car wash or it may be damaged.
- When reinstalling your antenna, it is important that it is fully tightened to ensure proper reception.

AUDIO SYSTEM - HOW CAR AUDIO WORKS

FM reception

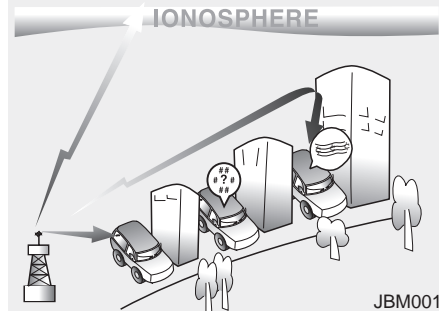

JBM001

AM and FM radio signals are broadcast from transmitter towers located around your city. They are intercepted by the radio antenna on your car. This signal is then received by the radio and sent to your car speakers.

When a strong radio signal has reached your vehicle, the precise engineering of your audio system ensures the best possible quality reproduction. However, in some cases the signal coming to your vehicle may not be strong and clear. This can be due to factors such as the distance from the radio station, closeness of other strong radio stations or the presence of buildings, bridges or other large obstructions in the area.

AM broadcasts can be received at greater distances than FM broadcasts.

AM(MW, LW) reception

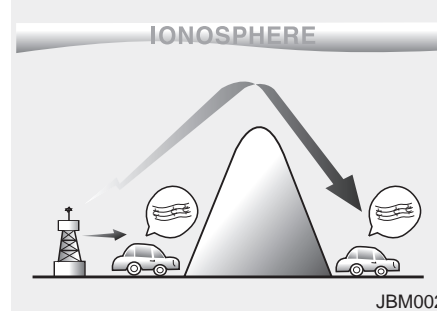

JBM002

This is because AM radio waves are transmitted at low frequencies. These long, low frequency radio waves can follow the curvature of the earth rather than travelling straight out into the atmosphere. In addition, they curve around obstructions so that they can provide better signal coverage.

FM radio station

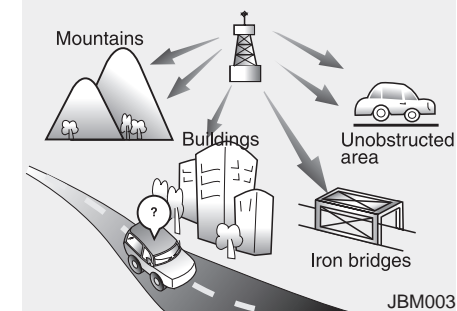

JBM003

FM broadcasts are transmitted at high frequencies and do not bend to follow the earth's surface. Because of this, FM broadcasts generally begin to fade at short distances from the station. Also, FM signals are easily affected by buildings, mountains, or other obstructions. These can result in certain listening conditions which might lead you to believe a problem exists with your radio. The following conditions are normal and do not indicate radio trouble:

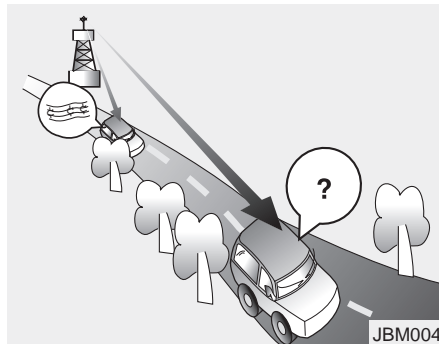

- Fading - As your car moves away from the radio station, the signal will weaken and sound will begin to fade. When this occurs, we suggest that you select another stronger station.
- Flutter/Static - Weak FM signals or large obstructions between the transmitter and your radio can disturb the signal causing static or fluttering noises to occur. Reducing the treble level may lessen this effect until the disturbance clears.

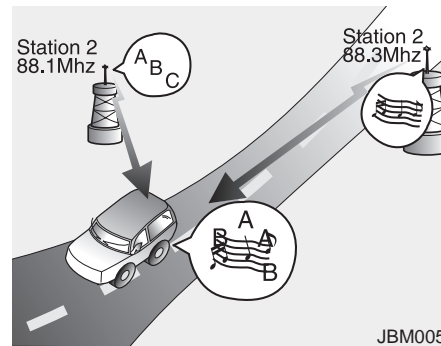

- Station Swapping - As a FM signal weakens, another more powerful signal near the same frequency may begin to play. This is because your radio is designed to lock onto the clearest signal. If this occurs, select another station with a stronger signal.
- Multi-Path Cancellation - Radio signals being received from several directions can cause distortion or fluttering. This can be caused by a direct and reflected signal from the same station, or by signals from two stations with close frequencies. If this occurs, select another station until the condition has passed.

Using a cellular phone or a two-way radio

When a cellular phone is used inside the vehicle, noise may be produced from the audio equipment. This does not mean that something is wrong with the audio equipment. In such a case, use the cellular phone at a place as far as possible from the audio equipment.

CAUTION

When using a communication system such a cellular phone or a radio set inside the vehicle, a separate external antenna must be fitted. When a cellular phone or a radio set is used with an internal antenna alone, it may interfere with the vehicle's electrical system and adversely affect safe operation of the vehicle.

WARNING

Don't use a cellular phone when you are driving. You must stop at a safe place to use a cellular phone.

Care of cassette tapes (if equipped)

- Because the thickness of a cassette tape with the total playback time of over 60 minutes (C-60) are too thin, we suggest that you do not use any of them to avoid having tapes being tangled.
- To achieve better sound quality, periodically clean the tape head using a cotton stick with colorless alcohol (once per month).
- If a tape is too loose, fasten it to reel by winding with objects like a pencil.
- Because dust or foreign objects on a cassette tape may damage the playback head, always store tapes in their cases when not in use.
- Make sure cassette tapes are kept away from magnetic devices (TV, stereo system, etc) in order to achieve better sound quality.
- Be certain that no objects or substances other than cassette tapes are inserted into the cassette tape player.
- Because tape media can be distorted when exposed to direct sunlight, Do not leave cassette tapes on the seats, dashboard or near the back windshield.

Care of disc (if equipped)

- If the temperature inside the car is too high, open the car windows for ventilation before using your car audio.
- It is illegal to copy and use MP3/WMA/AAC/WAVE files without permission. Use CDs that are created only by lawful means.
- Do not apply volatile agents such as benzene and thinner, normal cleaners and magnetic sprays made for analogue disc onto CDs.
- To prevent the disc surface from getting damaged. Hold and carry CDs by the edges or the edges of the center hole only.
- Clean the disc surface with a piece of soft cloth before playback (wipe it from the center to the outside edge.)
- Do not damage the disc surface or attach pieces of sticky tape or paper onto it.
- Make sure on undesirable matter other than CDs are inserted into the CD player (Do not insert more than one CD at a time).

- Keep CDs in their cases after use to protect them from scratches or dirt.
- Depending on the type of CD-R/CD-RW CDs, certain CDs may not operate normally according to manufacturing companies or making and recording methods. In such circumstances, if you still continue to use those CDs, they may cause the malfunction of your car audio system.

* NOTICE - Playing an Incompatible Copy-Protected Audio CD

Some copy-protected CDs, which do not comply with the international audio CD standards (Red Book), may not play on your car audio. Please note that if you try to play copy protected CDs and the CD player of your car audio is not performing to your expectation, this may be caused by those CDs and not a defect in the device itself. Please replace those CDs.

AUDIO SYSTEM - STEREO RADIO OPERATION (M445) (IF EQUIPPED)

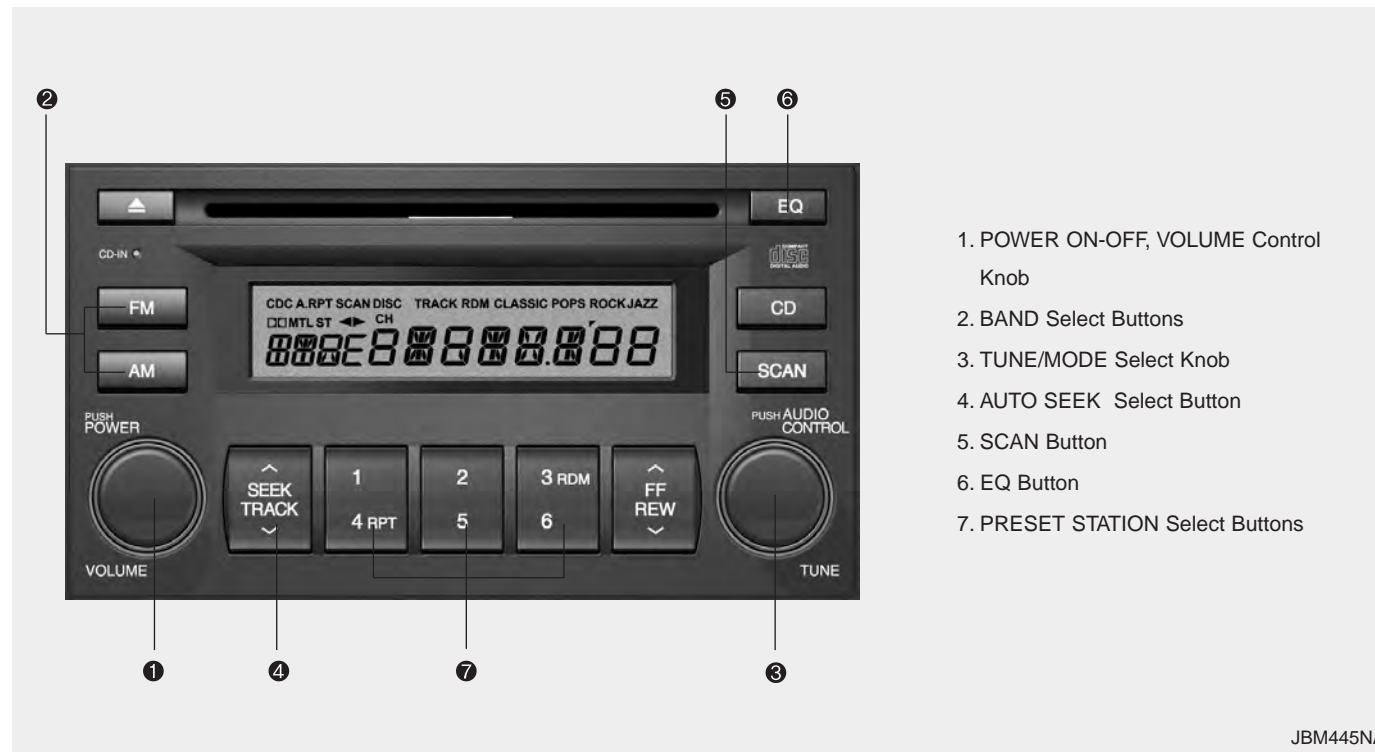

1. POWER ON-OFF Control Knob

The radio unit may be operated when the ignition key is in the "ACC" or "ON" position. Press the knob to switch the power on. The LCD shows the radio frequency in radio mode, and displays the CD track in CD mode. To switch the power off, press the knob again.

VOLUME Control

Rotate the knob clockwise to increase the volume and turn the knob counterclockwise to reduce the volume.

2. BAND Selector

FM Selection Button

Pressing the **FM** button changes the FM1 and FM2 bands.

AM Selection Button

Pressing the **AM** button selects the AM band. AM mode is displayed on LCD.

3. TUNE/MODE Select Knob

Rotate the knob clockwise to increase the frequency and turn the knob counterclockwise to reduce the frequency.

Mode Select Knob

Pressing the MODE knob changes the BASS, MIDDLE, TREBLE, FADER and BALANCE mode.

The mode selected is shown on the display.

After selecting the desired mode, rotate the mode select knob clockwise or counterclockwise to adjust.

BASS Control

To increase the BASS, rotate the knob clockwise, to decrease the BASS, rotate the knob counterclockwise.

MID Control

To increase the MID, rotate the knob clockwise, to decrease the MID, rotate the knob counterclockwise.

TREBLE Control

To increase the TREBLE, rotate the knob clockwise, to decrease the TREBLE, rotate the knob counterclockwise.

FAD (Fader Control)

Rotate the control knob clockwise to emphasize rear speaker sound (front speaker sound will be attenuated). When the control knob is turned counterclockwise, front speaker sound will be emphasized (rear speaker sound will be attenuated).

BALANCE Control

Rotate the knob clockwise to emphasize right speaker sound (left speaker sound will be attenuated). When the control knob is turned counterclockwise, left speaker sound will be emphasized (right speaker sound will be attenuated).

4. AUTO SEEK Select Button (Automatic Channel Selection)

Press the AUTO SEEK select button. When the \wedge side is pressed, the unit will automatically tune to the next higher frequency and when the \vee side is pressed, it will automatically tune to the next lower frequency.

5. SCAN Button

When you Press the button, frequency is changed and the next channel is received automatically.

To stay on a station, press the SCAN button again.

6. EQ Button

Press the EQ button to select the CLASSIC, POPS, ROCK, JAZZ and OFF MODE for the desired tone quality. Each press of the button changes the display as follows;



7. PRESET STATION Select Buttons

Six (6) stations for AM, FM1 and FM2 respectively can be preset in the electronic memory circuit.

HOW TO PRESET STATIONS

Six AM and twelve FM stations may be programmed into the memory of the radio. Then, by simply pressing the AM / FM select buttons and/or one of the six station select buttons, you may recall any of these stations instantly. To program the stations, follow these steps:

- Press AM/FM selector to set the band for AM, FM1 and FM2.
- Select the desired station to be stored by seek or manual tuning.
- Determine the preset station select button you wish to use to access that station.

- Press the station select button for more than two seconds. A select button indicator will show in the display indicating which select button you have depressed. The frequency display will flash after it has been stored into the memory. You should then release the button, and proceed to program the next desired station. A total of 18 stations can be programmed by selecting one AM and two FM station per button.
- When completed, any preset station may be recalled by selecting AM, FM1 or FM2 band and the appropriate station button.

CAUTION

- *Do not place beverages close to the audio system. The audio system mechanism may be damaged if you spill them.*
- *Do not strike or allow anything to impact the audio system, damage to the system mechanisms could occur.*

AUDIO SYSTEM - COMPACT DISC PLAYER OPERATION (M445) (IF EQUIPPED)

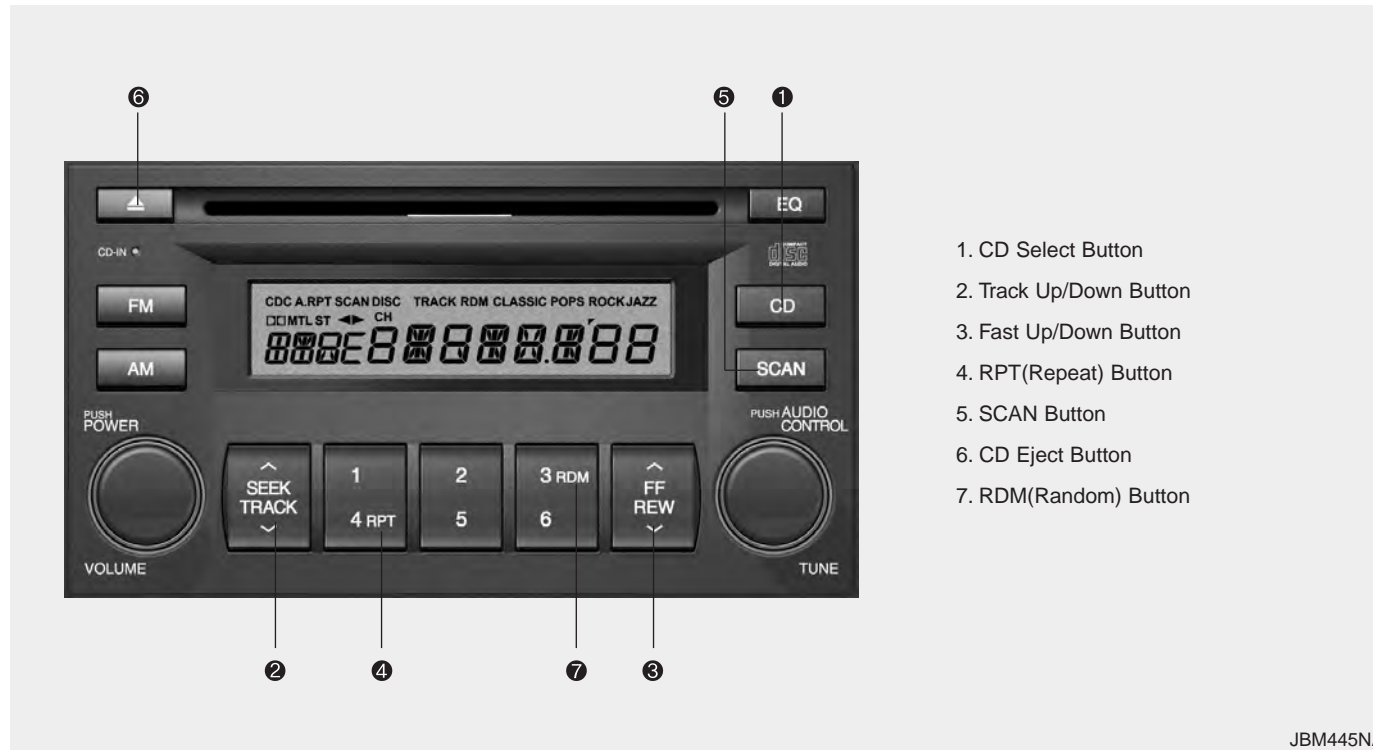

1. CD Select Button

- Insert the CD with the label facing upward.
- Insert the CD to start CD playback, during radio operation.
- When a disc is in the CD deck, if you press the CD button the CD player will begin playing even if the radio player is being used.
- The CD player can be used when the ignition switch is in either the "ON" or "ACC" position.

* NOTICE

- Do not stick paper or tape etc., on the label side or the recording side of any discs, as it may cause a malfunction.
- The unit cannot play a CD-R(Recordable CD) and CD-RW(Rewritable CD) that is not finalized.
Please refer to the manual of CD-R/CD-RW recorder or CD-R/CD-RW software for more information on finalization process.
- Depending on the recording status, some CD-Rs/CD-RWs may not be played on this unit.

2. TRACK UP/DOWN Button

- The desired track on the disc currently being played can be selected using the track number.
- Press \wedge button once to skip forward to the beginning of the next track. Press \vee within a second after playback begins to quickly move backward through a CD. If you press \vee after more than a second, it will take you to the beginning of the track you are now listening to.

3. FF/REW Button

If you want to fast forward or reverse through the compact disc track, push and hold the FF or REW button. When you release the button, the compact disc player will resume playing.

4. REPEAT (RPT) Button

- To repeat the track you are currently listening to, press the RPT button. To cancel, press it again.
- If you do not release RPT operation when the track ends, it will automatically be replayed. This process will be continued until you push the button again or turn the radio OFF then ON.

5. SCAN Button

- To playback the first 10 seconds of each track, press the SCAN button.
- Press the SCAN button again within 10 sec. when you have reached the desired track.

6. CD EJECT Button

When the  button is pressed with a CD loaded, the CD will eject.

Forcing to eject : To force to eject a CD, press this button for more than 3 seconds.

(Do this only when a CD is jammed and you can not eject it in the normal way - e.g.) in case that you have inserted 2 CDs by mistake)

7. RANDOM(RDM)

Press the RDM button to listen the tracks in random, rather than sequential, order. Press it again to cancel random play.

* NOTICE

- To assure proper operation of the unit, keep the vehicle interior temperature within a normal range by using the vehicle's air conditioning or heating system.
- When replacing the fuse, replace it with a fuse having the correct capacity.
- All stored bookmarks are all erased when the car battery is disconnected or power to the vehicle is lost. If this occurs, the bookmarks will have to be reset.
- This equipment is designed to be used only in a 12 volt DC battery system with negative ground.
- This unit is made of precision parts. Do not attempt to disassemble or adjust any parts.

(Continued)

(Continued)

- When driving your vehicle, be sure to keep the volume of the unit set low enough to allow you to hear sounds coming from the outside.
- Do not expose this equipment (including the speakers and CD) to water or excessive moisture.

CAUTION

- *Do not insert warped or poor quality discs into the CD player as damage to the unit may occur.*
- *Do not insert anything like coins into the player slot as damage to the unit may occur.*
- *Do not place beverages close to the audio system. The playback mechanism may be damaged if you spill them.*
- *Do not strike or allow anything to impact the audio system, damage to the system mechanisms could occur.*
- *Off-road or rough surface driving may cause the compact disc to skip. Do not use the compact disc when driving in such conditions as damage to the compact disc face could occur.*

(Continued)

(Continued)

- *Do not attempt to grab or pull the compact disc out while the disc is being pulled into the audio unit by the self-loading mechanism. Damage to the audio unit and compact disc could occur.*
- *Avoid using recorded compact discs in your audio unit. Original compact discs are recommended.*

AUDIO SYSTEM - STEREO RADIO OPERATION (M455) (IF EQUIPPED)



1. POWER ON-OFF Control Knob

- The radio unit may be operated when the ignition key is in the “ACC” or “ON” position. Press the button to switch the power on. The display shows the radio frequency in the radio mode, the tape direction indicator in the tape mode or CD/MP3 track in either the CD/MP3 mode. To switch the power off, press the button again.
- Push the FM/AM, TAPE or CD/MP3 to turn on that function without pushing Power ON-OFF control knob.

VOLUME Control

Rotate the knob clockwise to increase the volume and turn the knob counterclockwise to reduce the volume.

2. Adjustment Mode Select (AUDIO) Button

Pressing the AUDIO button changes the BASS, MIDDLE, TREBLE, FADER and BALANCE mode.

The mode selected is shown on the display.

After selecting the desired mode, rotate the mode select knob clockwise or counterclockwise to adjust.

BASS Control

To increase the bass, rotate the knob clockwise, to decrease the bass, rotate the knob counterclockwise.

MID Control

To increase the MID, rotate the knob clockwise, to decrease the MID, rotate the knob counterclockwise.

TREBLE Control

To increase the TREBLE, rotate the knob clockwise, to decrease the TREBLE, rotate the knob counterclockwise.

FAD (Fader Control)

Turn the control knob clockwise to emphasize rear speaker sound (front speaker sound will be attenuated). When the control knob is turned counterclockwise, front speaker sound will be emphasized (rear speaker sound will be attenuated).

BALANCE Control

Rotate the knob clockwise to emphasize right speaker sound. (Left speaker sound will be attenuated) When the control knob is turned counter clockwise, left speaker sound will be emphasized (Right speaker sound will be attenuated).

3. BAND Select Button

Pressing the FM/AM Button changes the AM, FM1 and FM2 bands. The mode selected is shown on the display.

4. SCAN Button

When you Press the button, frequency is changed and the next channel is received automatically.

To stay on a station, press the SCAN button again.

5. EQ Button

Press the EQ button to select the CLASSIC, POPS, ROCK, JAZZ and OFF MODE for the desired tone quality. Each press of the button changes the display as follows;

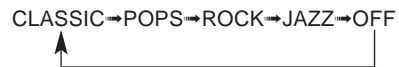

6. AUTO SEEK Select Button (Automatic Channel Selection)

Press the AUTO SEEK select button. When the \wedge side is pressed, the unit will automatically tune to the next higher frequency and when the \vee side is pressed, it will automatically tune to the next lower frequency.

7. TUNE (Manual) Select Knob

Rotate the knob clockwise to increase the frequency and turn the knob counter-clockwise to reduce the frequency.

8. PRESET STATION Select Buttons

Six (6) stations for AM, FM1 and FM2 respectively can be preset in the electronic memory circuit.

HOW TO PRESET STATIONS

Six AM and twelve FM1 stations may be programmed into the memory of the radio. Then, by simply pressing the band select button and/or one of the six station select buttons, you may recall any of these stations instantly. To program the stations, follow these steps:

- Press band selector to set the band for AM, FM1 and FM2.
- Select the desired station to be stored by seek or manual tuning.
- Determine the preset station select button you wish to use to access that station.

- Press the station select button for more than two seconds. Beep sound will be heard while depressing the button. You should then release the button, and proceed to program the next desired station. A total of 18 stations can be programmed by selecting one AM and two FM station per button.
- When completed, any preset station may be recalled by selecting AM, FM1 or FM2 band and the appropriate station button.

CAUTION

- *Do not place beverages close to the audio system. The playback mechanism may be damaged if you spill them.*
- *Do not strike or allow anything to impact the audio system, damage to the system mechanisms could occur.*

AUDIO SYSTEM - CASSETTE TAPE PLAYER OPERATION (M455) (IF EQUIPPED)

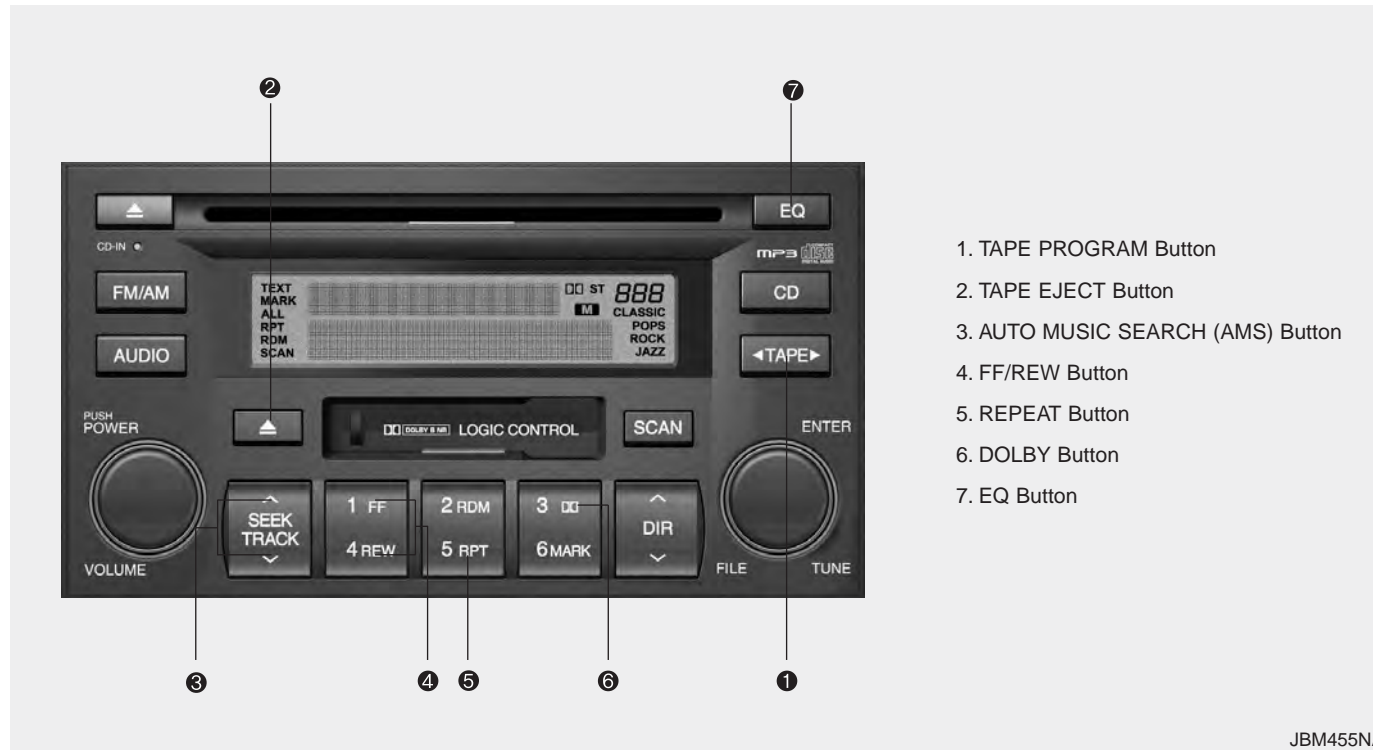



JBM455NA

1. TAPE PROGRAM Button



- This allows you to play the reverse side of the tape by merely depressing the program button. An arrow will appear in the display to show tape direction.
- Push the TAPE button to turn on that function without pushing power ON/OFF control knob.

2. TAPE EJECT Button

- When the  button is pressed with a cassette loaded, the cassette will eject.
- When the  button is pressed during FF/REW mode, the cassette will eject.

3. AUTO MUSIC SEARCH (AMS) Button

Press the button to find the starting point of each song in a prerecorded music tape. The quiet space between songs (must have at least 4 sec. gap) can be identified by the AUTO MUSIC SEARCH button.

- Pressing the  button will play the beginning of the next music segment.
- Pressing the  button will start replay at the beginning of the music just listened to.

4. FF/REW Button

- forward tape winding starts when the FF button is pressed during PLAY or REW mode.
- Tape PLAY starts when the FF button is pressed again during FF mode.
- Tape rewinding starts when the REW button is pressed during PLAY or FF mode.
- Tape PLAY starts when the REW button is pressed again during REW mode.

5. REPEAT Button

- To repeat the track you are currently listening to, press the RPT button. To cancel, press again.
- If you do not release RPT operation when the track ends, it will automatically be replayed. This process will be continued until you push the button again.

6. DOLBY Button

If you get background noise during tape PLAY, you can reduce this considerably by merely pressing the DOLBY button. If you want to cancel the DOLBY feature, press the button again.

7. EQ Button

Press the EQ button to select the CLASSIC, POPS, ROCK, JAZZ and OFF MODE for the desired tone quality. Each press of the button changes the display as follows;

CLASSIC→POPS→ROCK→JAZZ→OFF



*** NOTICE**

- To assure proper operation of the unit, keep the vehicle interior temperature within a normal range by using the vehicle's air conditioning or heating system.
- When replacing the fuse, replace it with a fuse having the correct capacity.
- The preset station frequencies are all erased when the car battery is disconnected. Therefore, all data will have to be set again if this should occur.
- Do not add any oil to the rotating parts. Keep magnets, screwdrivers and other metallic objects away from the tape mechanism and head.
- This equipment is designed to be used only in a 12 volt DC battery system with negative ground.
- This unit is made of precision parts. Do not attempt to disassemble or adjust any parts.

(Continued)

(Continued)

- When driving your vehicle, be sure to keep the volume of the unit set low enough to allow you to hear sounds coming from the outside.
- Do not expose this equipment (including the speakers and tape) to water or excessive moisture.

CAUTION

- *Do not insert anything like coins into the player slot as damage to the unit may occur.*
- *Do not place beverages close to the audio system. The playback mechanism may be damaged if you spill them.*
- *Do not strike or allow anything to impact the audio system, damage to the system mechanisms could occur.*

AUDIO SYSTEM - COMPACT DISC PLAYER (M455) (IF EQUIPPED)

Compatible with MP3/WMA/AAC/WAVE



1. AUDIO/MP3 CD Select Button
2. TRACK UP/DOWN Button
3. FF/REW Button
4. REPEAT (RPT) Button
5. RANDOM (RDM) Button
6. BOOKMARK (MARK) Button
7. SCROLL Button
8. EQ Button
9. CD EJECT Button
10. SCAN Button
11. FILE SEARCH Knob
(TUNE Select Knob)
12. DIRECTORY SEARCH Button

JBM455NA

1. AUDIO/MP3 CD Select Button

- Insert the CD with the label facing upward.
- Insert the CD to start CD playback, during radio operation or cassette tape playing.
- If you press the CD button while a disc is in the CD deck, the CD player will begin playing even if the radio or cassette player is being used.
- The CD player can be used when the ignition switch is in either the "ON" or "ACC" position.
- Push the CD button to turn on that function without pushing Power ON-OFF control knob.

* NOTICE

- Do not stick paper or tape etc., on the label side or the recording side of any discs, as it may cause a malfunction.
- The unit can play a multi-session CD-R (recordable CD) and CD-RW (rewritable CD) that consists of more than two sessions.
Please refer to the manual of CD-R/CD-RW recorder or CD-R/CD-RW software for more information on finalization process.

(Continued)

(Continued)

- Depending on the recording status, some CD-Rs/CD-RWs may not be played on this unit.

* NOTICE

Playback of MP3, AAC and WMA file formats are supported. Load to play time for these formats may be longer due to the compressed nature of these discs.

2. TRACK UP/DOWN Button

- The desired track on the disc currently being played can be selected using the track number.
- Press \wedge button once to skip forward to the beginning of the next track.
Press \vee within a second after playback begins to quickly move backward through a CD.
If you press \vee after more than a second, it will take you to the beginning of the file you are now listening to.

3. FF/REW Button

If you want to fast forward or reverse through the compact disc track, push and hold the FF or REW button.
When you release the button, the compact disc player will resume playing.

4. REPEAT (RPT) Button

- To repeat the track you are currently listening to, press the RPT button. To cancel, press it again.
- To repeat the music within selected folder, press the RPT button for more than 0.8 second. To cancel, press it again. (MP3 CD only)
- If you do not release RPT operation when the track ends, it will automatically be replayed.

This process will be continued until you push the button again or power ON/OFF.

5. RANDOM (RDM) Button

- Press the RDM button to listen to recorded tracks in random sequence. Press RDM again to cancel or turn the audio unit OFF then ON. The unit defaults to playing tracks in sequential order.
- To listen the music within the selected folder in random order, press the RDM button within a second. To cancel, press it again or power ON/OFF.(MP3 CD only)

6. BOOKMARK (MARK) Button

When the CD player unit is operating, the desired track on the disc can be bookmarked by using the MARK button.(MP3 CD only)

- Press the MARK button for more than 0.8 second to bookmark the desired track.

"M" will be displayed on the LCD and "MEMORY No." will display for approximately five seconds.

To play a bookmarked track, press the MARK button within 0.8 second and select the bookmarked track to play.

- To erase a bookmarked track, press the MARK button for more than 0.8 second. The unit will beep once when the bookmark is erased.

7. SCROLL Button

When the CD is playing, you can scroll through long file names by pressing the DOLBY button for approximately one second. The file name will appear on the LCD for about three seconds.

8. EQ Button

Press the EQ button to select the CLASSIC, POPS, ROCK, JAZZ and OFF MODE for the desired tone quality. Each press of the button changes the display as follows;

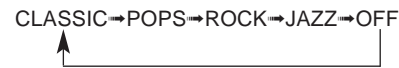

9. CD EJECT Button

When the  button is pressed with a CD loaded, the CD will eject.

Forcing to eject : To force to eject a CD, press this button for more than 3 seconds.

(Do this only when a CD is jammed and you can not eject it in the normal way - e.g.) in case that you have inserted 2 CDs by mistake)

10. SCAN Button

- To playback the first 10 seconds of each track, press the SCAN button more than 0.8 second.
- To playback the first 10 seconds of each track in the selected folder, press the SCAN button within 0.8 second. (MP3 CD only)
- Press the SCAN button again within 10 sec. when you have reached the desired track.



11. FILE SEARCH Knob (TUNE Select Knob)

- You can skip the track by turning the FILE SEARCH knob clockwise or counterclockwise.

After selecting the desired track, press the FILE SEARCH knob to playback the track.

If you do not press the FILE SEARCH knob within five seconds, the search will stop.

12. DIRECTORY SEARCH Button

- You can move through the folder by pushing the DIR button to up  and down .

After moving the desired folder, press the FILE SEARCH knob to playback the selected folder.

If you do not press the FILE SEARCH knob within five seconds, the search will stop.

*** NOTICE**

- To assure proper operation of the unit, keep the vehicle interior temperature within a normal range by using the vehicle's air conditioning or heating system.
- When replacing the fuse, replace it with a fuse having the correct capacity.
- All stored bookmarks are all erased when the car battery is disconnected or power to the vehicle is lost. If this occurs, the bookmarks will have to be reset.
- This equipment is designed to be used only in a 12 volt DC battery system with negative ground.
- This unit is made of precision parts. Do not attempt to disassemble or adjust any parts.
- When driving your vehicle, be sure to keep the volume of the unit set low enough to allow you to hear sounds coming from the outside.
- Do not expose this equipment (including the speakers and tape) to water or excessive moisture.

CAUTION

- *Do not insert warped or poor quality discs into the CD player as damage to the unit may occur.*
- *Do not insert anything like coins into the player slot as damage to the unit may occur.*
- *Do not place beverages close to the audio system. The playback mechanism may be damaged if you spill them.*
- *Do not strike or allow anything to impact the audio system, damage to the system mechanisms could occur.*
- *Off-road or rough surface driving may cause the compact disc to skip. Do not use the compact disc when driving in such conditions as damage to the compact disc face could occur.*

(Continued)

(Continued)

- *Do not attempt to grab or pull the compact disc out while the disc is being pulled into the audio unit by the self-loading mechanism. Damage to the audio unit and compact disc could occur.*
- *Avoid using recorded compact discs in your audio unit. Original compact discs are recommended.*

Ignition switch / 4-2
Starting the engine / 4-3
Manual transaxle / 4-4
Automatic transaxle / 4-6
Brake system / 4-9
Steering wheel / 4-14
Instrument cluster / 4-16
Gauges / 4-17

Driving your vehicle

4

Warnings and indicators / 4-19
Lighting / 4-23
Wipers and washers / 4-26
Defroster / 4-29
Hazard warning flasher / 4-29
Climate control system / 4-30
Windshield defrosting and defogging / 4-37

IGNITION SWITCH

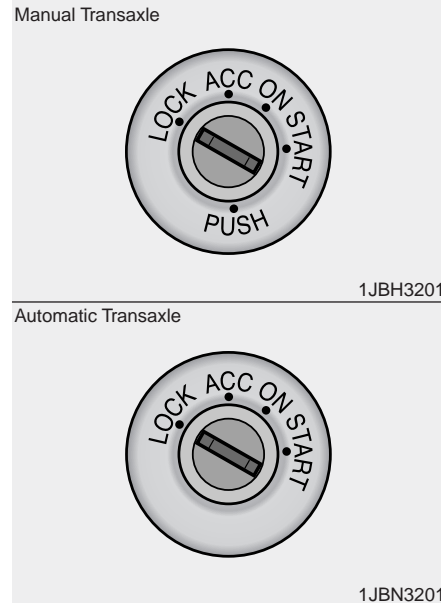

Ignition switch and anti-theft steering column lock

Ignition switch position

LOCK

The steering wheel locks to protect against theft. The ignition key can be removed only in the LOCK position. When turning the ignition switch to the LOCK position, push the key inward at the ACC position and turn the key toward the LOCK position (manual transaxle).

ACC (Accessory)

The steering wheel is unlocked and electrical accessories are operative.

ON

This is the normal running position after the engine is started. The warning lights can be checked before the engine is started.

Do not leave the ignition switch ON if the engine is not running to prevent battery discharge.

START

Turn the ignition key to the START position to start the engine. The engine will crank until you release the key; then it returns to the ON position. The brake warning lamp can be checked in this position.

*** NOTICE**

If it is difficult to turn the ignition key to the START position, turn the steering wheel right and left to release resistance and then turn the key.

Automatic transaxle

When turning the ignition switch to the LOCK position, the shift lever must be in the P (Park) position.

Illuminated ignition switch

Whenever a door is opened, the ignition switch will be illuminated for your convenience, provided the ignition switch is not in the ON position. The light will go off approximately 30 seconds after closing the door or when the ignition switch is turned on.

STARTING THE ENGINE

⚠ WARNING - Ignition key

- Never turn the ignition switch to LOCK or ACC while the vehicle is moving. This would result in loss of directional control and braking function, which could cause an accident or collision.
- Before leaving the driver's seat, always make sure the shift lever is engaged in 1st gear for manual transaxle or P (Park) for automatic transaxle. Then, set the parking brake fully and shut the engine off. Unexpected and sudden vehicle movement may occur if these precautions are not taken.
- Never reach for the ignition switch, or any other controls through the steering wheel while the vehicle is in motion. The presence of your hand or arm in this area could cause a loss of vehicle control, an accident and serious bodily injury or death.
- Do not place any movable objects around the driver's seat as they may move while driving, interfere with the driver and lead to an accident.

⚠ CAUTION

Always wear appropriate shoes when operating your vehicle. Unsuitable shoes (high heels, ski boots, etc.) may interfere with your ability to use the brake and accelerator pedal, and the clutch (if equipped).

1. Make sure the parking brake is applied.
2. **Manual Transaxle** - Depress the clutch pedal fully and shift the transaxle into Neutral. Keep the clutch pedal depressed while turning the ignition switch to the start position. The starter will not operate if the clutch pedal is not fully depressed.
Automatic Transaxle - Place the transaxle shift lever in P (Park). Depress the brake pedal fully.
You can also start the engine when the shift lever is in the N (Neutral) position.
3. Turn the ignition switch to START and hold it there until the engine starts (a maximum of 10 seconds), then release the key.
4. In extremely cold weather (below -18°C / 0°F) or after the vehicle has not been operated for several days, let the engine warm up without depressing the accelerator.

*Whether the engine is cold or warm, it should be started **without depressing the accelerator.***

⚠ CAUTION - Stall

If the engine stalls while you are in motion, do not attempt to move the shift lever to the P (Park) position. If traffic and road conditions permit, you may put the shift lever in the N (Neutral) position while the vehicle is still moving and turn the ignition switch to the START position in an attempt to restart the engine.

*** NOTICE**

Do not engage the starter for more than 10 seconds. If the engine stalls or fails to start, wait 5 to 10 seconds before re-engaging the starter. Excessive or improper use of the starter may damage it.

The starter will not operate if:

- **Manual Transaxle** - the clutch pedal is not fully depressed.
- **Automatic Transaxle** - the shift lever is NOT in the P (Park) or N (Neutral) position.

MANUAL TRANSAXLE (IF EQUIPPED)

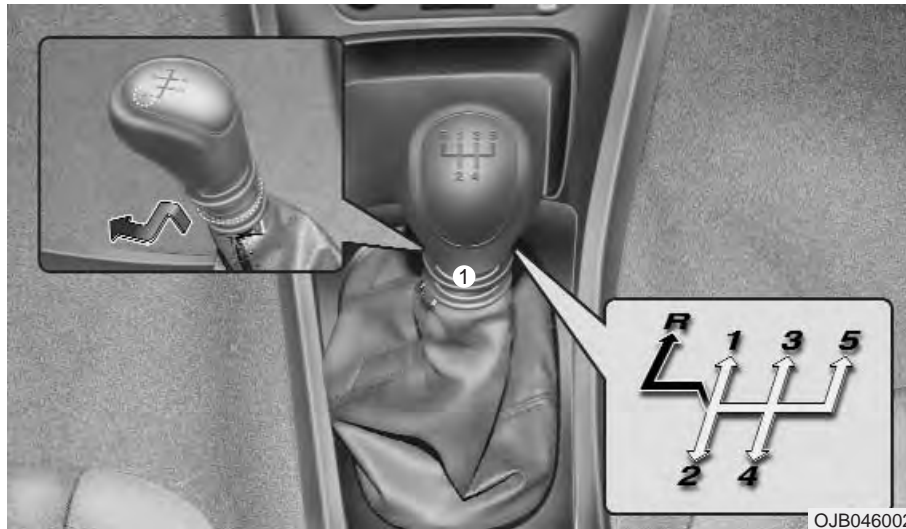

- ⇨ The shift lever can be moved without pulling the ring (1).
- ➡ The ring (1) must be pulled up while moving the shift lever.

Manual transaxle operation

The manual transaxle has five forward gears.

Press the clutch pedal down fully while shifting, then release it slowly.

The gearshift lever must be returned to the neutral position before shifting into R (Reverse). The ring located immediately below the shift knob must be pulled upward while moving the shift lever to the R position.

Make sure the vehicle is completely stopped before shifting into R (Reverse).

Never operate the engine with the tachometer (rpm) in the red zone.

* NOTICE

When downshifting from fifth gear to fourth gear, caution should be taken not to inadvertently press the gear shift lever sideways in such a manner that second gear is engaged. Such a drastic downshift may cause the engine speed to increase to the point that the tachometer will enter the red-zone. Such over-revving of the engine may possibly cause engine damage.

*** NOTICE**

To avoid premature clutch wear and damage, do not drive with your foot resting on the clutch pedal. Also, don't use the clutch to hold the vehicle stopped on an uphill grade, while waiting for a traffic light, etc..

⚠ WARNING - Manual transaxle

Before leaving the driver's seat, always set the parking brake fully and shut the engine off. Then make sure the transaxle is shifted into 1st gear when the vehicle is parked on a level or uphill grade, and shifted into R (Reverse) on a downhill grade. Unexpected and sudden vehicle movement can occur if these precautions are not followed in the order identified.

Downshifting

When you must slow down in heavy traffic or while driving up steep hills, downshift before the engine starts to labor. Downshifting reduces the chance of stalling and gives better acceleration when you again need to increase your speed. When the vehicle is traveling down steep hills, downshifting helps maintain safe speed and prolongs brake life.

AUTOMATIC TRANSAXLE (IF EQUIPPED)

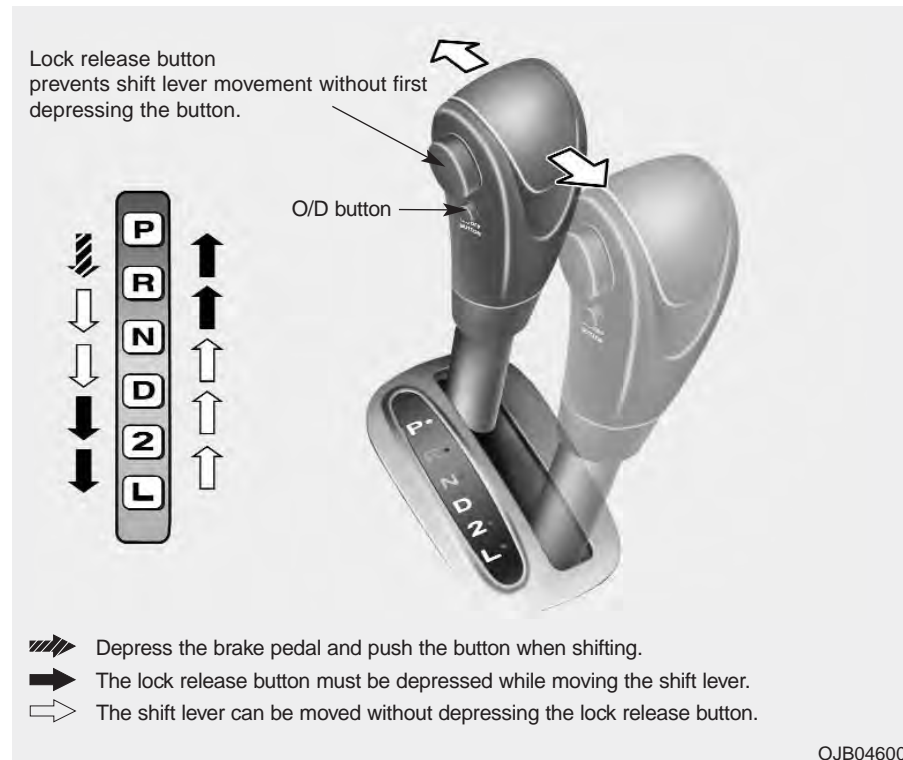

Automatic transaxle operation

All normal forward driving is done with the shift lever in the D (Drive) position. To move the shift lever from the P (Park) position, the brake pedal must be depressed and the lock release button must be pressed.

For smooth operation, depress the brake pedal when shifting from N (Neutral) to a forward or reverse gear.

⚠ WARNING - Automatic transaxle

Before leaving the driver's seat, always make sure the shift lever is in the P (PARK) position; then set the parking brake fully and shut the engine off. Unexpected and sudden vehicle movement can occur if these precautions are not followed in the order identified.

*** NOTICE**

- To avoid damage to your transaxle, do not accelerate the engine in R (Reverse) or any forward gear position with the brakes on.
- When stopped on an upgrade, do not hold the vehicle stationary with engine power. Use the service brake or the parking brake.

(Continued)

(Continued)

- Do not shift from N (Neutral) or P (Park) into D (Drive), or R (Reverse) when the engine is above idle speed.

Transaxle ranges

P (Park)

This position locks the transaxle and prevents the front wheels from rotating. Always come to a complete stop before shifting into this position.

WARNING

- Shifting into P (Park) while the vehicle is in motion will cause the drive wheels to lock which will cause you to lose control of the vehicle.
- Do not use the P (Park) position in place of the parking brake. Always make sure the shift lever is latched in the P (Park) position so that it cannot be moved unless the lock release button is pushed in, AND set the parking brake fully.

(Continued)

(Continued)

- Before leaving the driver's seat, always make sure the shift lever is in the P (Park) position. Set the parking brake fully, shut the engine off and take the key with you. Unexpected and sudden vehicle movement can occur if you do not follow these precautions in the order specified.
- Never leave a child unattended in a vehicle.

*** NOTICE**

The transaxle may be damaged if you shift into P (Park) while the vehicle is in motion.

R (Reverse)

Use this position to drive the vehicle backward.

*** NOTICE**

Always come to a complete stop before shifting into or out of R (Reverse); you may damage the transaxle if you shift into R while the vehicle is in motion.

N (Neutral)

With the gearshift in the N position, the wheels and transaxle are not locked. The vehicle will roll freely even on the slightest incline unless the parking brake or service brakes are applied.

D (Drive)

This is the normal forward driving position. The transaxle will automatically shift through a 4-gear sequence, providing the best fuel economy and power.

For extra power when passing another vehicle or climbing grades, depress the accelerator fully, at which time the transaxle will automatically downshift to the next lower gear.

Driving your vehicle

2 (Second Gear)

Use 2 (Second Gear) for more power when climbing hills and for increased braking when going down hills. This position also helps reduce wheel spin on slippery surfaces. When the shift lever is placed in 2 (Second Gear), the transaxle will automatically shift from first to second gear.

L (Low)

Move the shift lever to this position in hard pulling situations and for climbing steep grades.

CAUTION

Do not exceed the recommended maximum speeds in 2 (Second Gear) or L (Low). Operating the vehicle at speeds above the maximum recommended, for 2 (Second Gear) or L (Low) may cause excessive heat to develop which could result in damage to or failure of the automatic transaxle.



O/D (Over Drive) system (if equipped)

Pressing the O/D system button cancels and engages the overdrive system. When the O/D system is cancelled, the O/D OFF indicator illuminates and the transaxle gear range is limited to 1st through 3rd. The transaxle will not shift to 4th gear until the O/D system button is pressed again to release the switch.

When driving down a sloping road with the transaxle in O/D (4th), you can decrease the vehicle speed without using the brakes by pressing the O/D button.

When the ignition is switched OFF, O/D OFF mode is automatically cancelled.

O/D OFF Indicator (^{O/D} OFF)

This indicator light illuminates in the instrument panel when the O/D mode is cancelled.

Moving up a steep grade from a standing start

To move up a steep grade from a standing start, depress the brake pedal, shift the shift lever to D (Drive). Select the appropriate gear depending on load weight and steepness of the grade, and release the parking brake. Depress the accelerator gradually while releasing the service brakes.

Shift lock system

For your safety, the Automatic Transaxle has a shift lock system which prevents shifting the transaxle out of P (Park) unless the brake pedal is depressed.

To shift the transaxle out of P (Park):

1. Depress and hold the brake pedal.
2. Start the engine or turn the ignition to the ON position.
3. Depress the lock release button and move the shift lever.

If the brake pedal is repeatedly depressed and released with the shift lever in the P (Park) position, a chattering sound near the shift lever may be heard. This is a normal condition.

Ignition key interlock system

The ignition key cannot be removed unless the shift lever is in the P (Park) position. If the ignition switch is in any other position, the key cannot be removed.

BRAKE SYSTEM

Power brakes

Your vehicle has power-assisted brakes that adjust automatically through normal usage.

In the event that the power-assisted brakes lose power because of a stalled engine or some other reason, you can still stop your vehicle by applying greater force to the brake pedal than you normally would. The stopping distance, however, will be longer.

When the engine is not running, the reserve brake power is partially depleted each time the brake pedal is applied. Do not pump the brake pedal when the power assist has been interrupted.

Pump the brake pedal only when necessary to maintain steering control on slippery surfaces.

In the event of brake failure

If service brakes fail to operate while the vehicle is in motion, you can make an emergency stop with the parking brake. The stopping distance, however, will be much greater than normal.

⚠ WARNING - Parking brake
Pulling the parking brake while the vehicle is moving at normal speeds can cause a sudden loss of control of the vehicle. If you must use the parking brake to stop the vehicle, use great caution in applying the brake.

⚠ WARNING - Brakes

- Do not drive with your foot resting on the brake pedal. This will create abnormal high brake temperatures, excessive brake lining and pad wear, and increased stopping distances.
- When descending a long or steep hill, shift to a lower gear and avoid continuous application of the brakes. Continuous brake application will cause the brakes to overheat and could result in a temporary loss of braking performance.

(Continued)

(Continued)

- Wet brakes may result in the vehicle not slowing down at the usual rate and pulling to one side when the brakes are applied. After going through water, apply the brakes lightly to regain smooth braking performance.

Disc brakes wear indicator

Your vehicle has disc brakes.

When your brake pads are worn and it's time for new pads, you will hear a high-pitched warning sound from your front brakes or rear brakes (if equipped). You may hear this sound come and go or it may occur whenever you depress the brake pedal.

Please remember that some driving conditions or climates may cause a brake squeal when you first apply (or lightly apply) the brakes. This is normal and does not indicate a problem with your brakes.

*** NOTICE**

To avoid costly brake repairs, do not continue to drive with worn brake pads.

⚠ WARNING - Brake wear

This brake wear warning sound means your vehicle needs service. If you ignore this audible warning, you will eventually lose braking performance, which could lead to a serious accident.

⚠ CAUTION

Always replace brake pads as complete front or rear axle sets to ensure smooth brake performance.

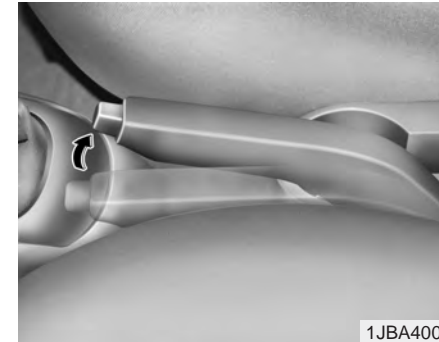

Parking brake

To apply the parking brake, pull the parking brake handle fully and firmly upward while applying the service brake.

⚠ CAUTION

Driving with the parking brake applied will cause excessive brake pad and brake rotor wear.

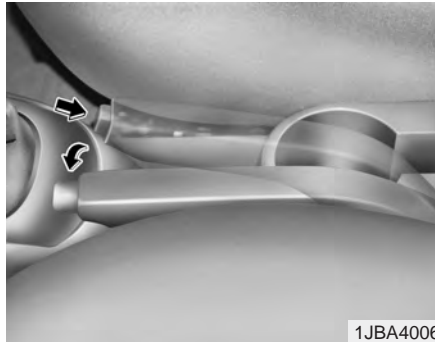

To release the parking brake, pull the handle up slightly and push the release button, then lower the handle to the released position while holding the button in.

⚠ WARNING - Parking brake

- To prevent unintentional movement when stopped and leaving the vehicle, do not use the gearshift lever in place of the parking brake. Set the parking brake AND make sure the gearshift lever is securely positioned in 1st (First) gear or R (Reverse) for manual transaxle equipped vehicles and in P (Park) for automatic transaxle equipped vehicles.
- **Never allow a person who is unfamiliar with the vehicle or children to touch the parking brake. If the parking brake is released unintentionally, serious injury may occur.**



Check the brake warning light by turning the ignition switch ON (do not start the engine). This light will be illuminated when the parking brake is applied with the ignition switch in the START or ON position.

Before driving, be sure the parking brake is fully released and the brake warning light is off.

If the brake warning light remains on after the parking brake is released, there may be a malfunction in the brake system. Immediate attention is necessary.

If at all possible, cease driving the vehicle immediately. If that is not possible, use extreme caution while operating the vehicle and only continue to drive the vehicle until you can reach a safe location or repair shop.

Parking on curbed streets

- When parking your vehicle on an uphill grade, park as close to the curb as possible and turn the front wheels away from the curb so that the front wheels will contact the curb if the vehicle moves backward.
- When parking your vehicle on a downhill grade, park as close to the curb as possible and turn the front wheels toward the curb so that the front wheels will contact the curb if the vehicle moves forward.

Anti-lock brake system (ABS) (if equipped)

WARNING - ABS Brakes

Your ABS is not a substitute for good driving judgement. You can still have an accident. In fact, your ABS will probably not be able to prevent an accident in the following driving conditions:

- **Dangerous driving, such as neglecting safety precautions, speeding, or driving too close to the vehicle in front of you.**
- **Driving at high speed in situations providing considerably less traction, such as wet conditions where hydroplaning could occur.**
- **Driving too fast on poor road surfaces. The ABS is designed to improve maximum braking effectiveness on typical highways and roads in good condition. On poor road surfaces, the ABS may actually reduce braking effectiveness.**

The ABS continuously senses the speed of the wheels. If the wheels are going to lock, the ABS repeatedly modulates the hydraulic brake pressure to the wheels.

When you apply your brakes under conditions which may lock the wheels, you may hear a “tik-tik” sound from the brakes, or feel a corresponding sensation in the brake pedal. This is normal and it means your ABS is active.

In order to obtain the maximum benefit from your ABS in an emergency situation, do not attempt to modulate your brake pressure and do not try to pump your brakes. Press your brake pedal as hard as possible or as hard as the situation warrants and allow the ABS to control the force being delivered to the brakes.

- Even with the anti-lock brake system, your vehicle still requires sufficient stopping distance. Always maintain a safe distance from the vehicle in front of you.
- Always slow down when cornering. The anti-lock brake system cannot prevent accidents resulting from excessive speeds.
- On loose or uneven road surfaces, operation of the anti-lock brake system may result in a longer stopping distance than for vehicles equipped with a conventional brake system.



*** NOTICE**

- If the ABS warning light is on and stays on, you may have a problem with the ABS. In this case, however, your regular brakes will work normally.
- The ABS warning light will stay on for approximately 3 seconds after the ignition switch is ON. During that time, the ABS will go through self-diagnosis and the light will go off if everything is normal. If the light stays on, you may have a problem with your ABS. Contact an authorized Kia dealer as soon as possible.

*** NOTICE**

- When you drive on a road having poor traction, such as an icy road, and operate your brakes continuously, the ABS will be active continuously and the ABS warning light may illuminate. Pull your car over to a safe place and stop the engine.
- Restart the engine. If the ABS warning light is off, then your ABS is normal. Otherwise, you may have a problem with the ABS. Contact an authorized Kia dealer as soon as possible.

*** NOTICE**

- When you jump start your vehicle because of a drained battery, the engine may not run as smoothly and the ABS warning light may turn on at the same time. This happens because of the low battery voltage. It does not mean your ABS is malfunctioning.
- Do not pump your brakes!
 - Have the battery recharged before driving the vehicle.

STEERING WHEEL

Power steering (if equipped)

Power steering uses energy from the engine to assist you in steering the vehicle. If the engine is off or if the power steering system becomes inoperative, the vehicle may still be steered, but it will require increased steering effort.

Should you notice any change in the effort required to steer during normal vehicle operation, have the power steering checked by an authorized Kia dealer.

* NOTICE

- Never hold the steering wheel against a stop (extreme right or left turn) for more than 5 seconds with the engine running. Holding the steering wheel for more than 5 seconds in either position may cause damage to the power steering pump.
- If the power steering drive belt breaks or if the power steering pump malfunctions, the steering effort will greatly increase.

* NOTICE

If the vehicle is parked for extended periods outside in cold weather (below -10 °C /14 °F), the power steering may require increased effort when the engine is first started. This is caused by increased fluid viscosity due to the cold weather and does not indicate a malfunction.

When this happens, increase the engine RPM by depressing the accelerator until the RPM reaches 1,500 rpm then release or let the engine idle for two or three minutes to warm up the fluid.

Tilt steering (if equipped)

A tilt steering wheel allows you to adjust the steering wheel before you drive. You can also raise it to the highest level to give your legs more room when you exit and enter the vehicle.

The steering wheel should be positioned so that it is comfortable for you to drive, while permitting you to see the instrument panel warning lights and gauges.

WARNING - Steering wheel

- Never adjust the angle of steering wheel while driving. You may lose your steering control and cause severe personal injury or accidents.
- After adjusting, push the steering wheel both up and down to be certain it is locked in position.

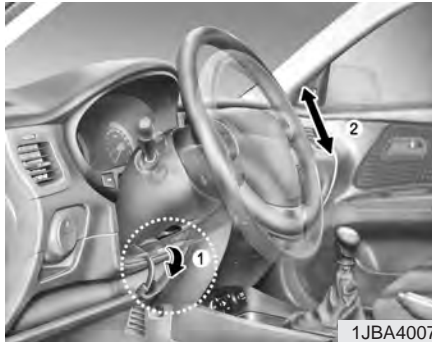

To change the steering wheel angle, pull down (1) the lock release lever, adjust the steering wheel to the desired angle (2), then pull up the lock-release lever to lock the steering wheel in place. Be sure to adjust the steering wheel to the desired position before driving.



Horn

To sound the horn, press the horn symbol on your steering wheel. Check the horn regularly to be sure it operates properly.

CAUTION - Horn

- *To sound the horn, press the area indicated by the horn symbol on your steering wheel (see illustration). The horn will operate only when this area is pressed.*
- *Do not strike the horn severely to operate it, or hit it with your fist. Do not press on the horn with a sharp-pointed object.*

INSTRUMENT CLUSTER

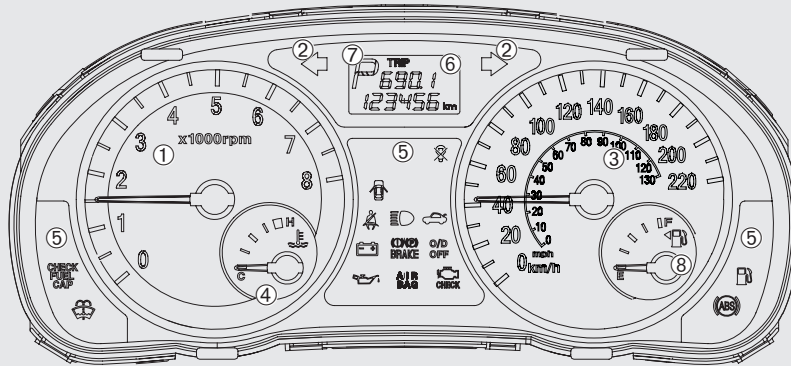

1. Tachometer
2. Turn signal indicators
3. Speedometer
4. Engine temperature gauge
5. Warning and indicator lights
6. Odometer / Tripmeter
7. Shift position indicator
(Automatic transaxle only)
8. Fuel gauge

7JBC4030

GAUGES

Speedometer

The speedometer indicates the forward speed of the vehicle.

Odometer

The odometer indicates the total distance the vehicle has been driven.



Tripmeter

You can choose the tripmeter A and tripmeter B by pressing the tripmeter mode button.

TRIP A: Tripmeter A (if equipped)

TRIP B: Tripmeter B (if equipped)

The tripmeter indicates the distance of individual trips selected by the driver. Tripmeter A and B can be reset to 0 by pressing the reset button for 1 second or more, and then releasing.

Tachometer

The tachometer indicates the approximate number of engine revolutions per minute (rpm).

Use the tachometer to select the correct shift points and to prevent lugging and/or over-revving the engine.

The tachometer pointer may move slightly when the ignition switch is in ACC or ON position with the engine OFF. This movement is normal and will not affect the accuracy of the tachometer once the engine is running.

* NOTICE

Do not operate the engine within the tachometer's RED ZONE.

This may cause severe engine damage.

Fuel gauge

The fuel gauge indicates the approximate amount of fuel remaining in the fuel tank.

Fuel tank capacity - 45 liters
(11.9 gallons)

The fuel gauge is supplemented by a low fuel warning light, which will illuminate when the fuel level has dropped to about 5.5~6.5 liters (1.5~1.7 gallons).

⚠ WARNING - Fuel gauge
Running out of fuel can expose vehicle occupants to danger, both in vehicle operation and by stopping in high neighborhoods.
You must stop and obtain additional fuel as soon as possible after the warning light comes on or when the gauge indicator comes close to the E level.

Engine temperature gauge

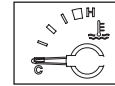

This gauge shows the temperature of the engine coolant when the ignition switch is ON.

Do not continue driving with an overheated engine. If your vehicle overheats, refer to "Overheating" in the Index.

* NOTICE

If the gauge pointer moves beyond the normal range area toward the "H" position, it indicates overheating that may damage the engine.



Instrument panel illumination (if equipped)

When the vehicle's parking lights or headlights are on, rotate the illumination control knob to adjust the instrument panel illumination intensity.

WARNINGS AND INDICATORS

Warning lights / audible indicators

Checking operation

All warning lights are checked by turning the ignition switch ON (do not start the engine). Any light that does not illuminate should be checked by an authorized Kia dealer.

After starting the engine, check to make sure that all warning lights are off. If any are still on, this indicates a situation that needs attention. When releasing the parking brake, the brake system warning light should go off. The fuel warning light will stay on if the fuel level is low.

Anti-lock brake system (ABS) warning light (if equipped)



This light illuminates if the key is turned to ON and goes off in approximately 3 seconds if the system is operating normally.

If the light stays on, you may have a problem with your ABS. Contact an authorized Kia dealer as soon as possible.

Electronic brake force distribution (EBD) system warning (if equipped)



If ABS and BRAKE warning lights illuminate at the same time while driving, your vehicle has a problem with ABS and EBD system.

In this case, your ABS and regular brake system may not work normally. Have the vehicle checked by an authorized Kia dealer as soon as possible.

⚠ WARNING - Brake indicators

If the both ABS and Brake warning lights are ON and stay ON, your vehicle's brake system will not work normally. You may experience an unexpected and dangerous situation during sudden braking. In this case, avoid high speed driving and abrupt braking. Have your vehicle checked by authorized Kia dealer as soon as possible.

Engine oil pressure warning



This warning light indicates the engine oil pressure is low.

If the warning light illuminates while driving:

1. Drive safely to the side of the road and stop.
2. With the engine off, check the engine oil level. If the level is low, add oil as required.

If the warning light remains on after adding oil or if oil is not available, call an authorized Kia dealer.

* NOTICE

If the engine is not stopped immediately, severe damage could result.

Charging system warning

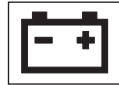

This warning light indicates a malfunction of either the generator or electrical charging system.

If the warning light comes on while the vehicle is in motion:

1. Drive to the nearest safe location.
2. With the engine off, check the generator drive belt for looseness or breakage.
3. If the belt is adjusted properly, a problem exists somewhere in the electrical charging system. Have an authorized Kia dealer correct the problem as soon as possible.

Safety belt warning



As a reminder to the driver and passenger, safety belt warning light will blink for approximately 6 seconds each time you turn the ignition switch ON.

If the driver's lap/shoulder belt is not fastened when the key is turned ON or if it is disconnected after the key is turned ON, the safety belt warning light will blink for approximately 6 seconds.

If the driver's lap/shoulder belt is not fastened within 30 seconds after the engine is started, the safety belt warning light will blink for 6 seconds. This cycle will repeat 11 times with an interval of 24 seconds between cycles.

If the system does not operate as described, see an authorized Kia dealer for assistance.

Shift pattern indicators (if equipped)

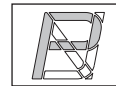

The individual indicators illuminate to show the automatic transaxle shift lever selection.

Immobilizer indicator (if equipped)



This light illuminates when the immobilizer key is inserted and turned to the ON position to start the engine.

If this light turns off or blinks when the ignition switch is in the ON position before starting the engine, have the system checked by an authorized Kia Dealer.

O/D OFF Indicator (if equipped)



This indicator comes on when the O/D system is deactivated.

Parking brake & brake fluid warning



Parking brake warning

This light is illuminated when the parking brake is applied with the ignition switch in the START or ON position. The warning light should go off when the parking brake is released.

Low brake fluid level warning

If the warning light remains on, it may indicate that the brake fluid level in the reservoir is low.

If the warning light remains on:

1. Drive carefully to the nearest safe location and stop your vehicle.
2. With the engine stopped, check the brake fluid level immediately and add fluid as required. Then check all brake components for fluid leaks.
3. Do not drive the vehicle if leaks are found, the warning light remains on or the brakes do not operate properly. Have it towed to any authorized Kia dealer for a brake system inspection and necessary repairs.

To check bulb operation, check whether the parking brake and brake fluid warning light illuminates when the ignition switch is in the ON position.

⚠ WARNING

Driving the vehicle with a brake warning light on is dangerous. If the brake warning light remains on, have the brakes checked and repaired immediately by an authorized Kia dealer.

Trunk lid open warning (if equipped)



This warning light activates when the trunk is not closed securely.

Door ajar warning



This warning light illuminates when a door is not closed securely.

Low washer fluid level warning indicator (if equipped)



This warning light indicates the washer fluid reservoir is near empty. Refill the washer fluid as soon as possible.

Low fuel level warning



This warning light indicates the fuel tank is nearly empty. The warning light will come on when the fuel level has dropped to about 5.5–6.5 liters (1.5–1.7 gallons). Refuel as soon as possible.

Headlight high beam indicator



This indicator illuminates when the headlights are on and in the high beam position or when the turn signal lever is pulled into the Flash-to-Pass position.

Air bag warning (if equipped)



This warning light will blink or illuminate for approximately 6 seconds each time you turn the ignition switch to the ON position.

If this indicator does not go out, or if it illuminates while the vehicle is being driven, see an authorized Kia dealer for immediate service.

Check fuel filler cap warning



This warning light indicates the fuel filler cap is not tight securely. Always make sure that the fuel filler cap is tight.

**Malfunction indicator
(if equipped)**



This indicator light is part of the Engine Control System which monitors various emission control system components. If this light illuminates while driving, it indicates that a potential problem has been detected somewhere in the emission control system.



Generally, your vehicle will continue to be drivable and will not need towing, but have the system checked by an authorized Kia dealer as soon as possible.

**Stop/Tail light failure
warning (if equipped)**



This light indicates a malfunction in the stop/tail light circuit, such as a burned out bulb. If this indicator comes on, check for a burned out stop/tail lamp, if the indicator is still on have the vehicle checked by an authorized Kia dealer for service.

CAUTION

- *Prolonged driving with the Emission Control System Malfunction Indicator Lamp () illuminated may cause damage to the emission control systems which could effect drivability and/or fuel economy.*
- *If the Emission Control System Malfunction Indicator Light () begins to flash ON and OFF, potential catalytic converter damage is possible which could result in loss of engine power. Have the Engine Control System inspected as soon as possible by an authorized Kia dealer.*

**Safety belt warning chime
(if equipped)**

If the driver's seat belt is not fastened when the ignition key is turned "ON" or if it is disconnected after the key is turn ON, the safety belt warning chime will sound for approximately 6 seconds.

If the driver's lap/shoulder belt is not fastened within 30 seconds after the engine is started, the safety belt warning chime will sound for 6 seconds. This cycle will repeat 11 times with an interval of 24 seconds between cycles.

**Door ajar warning chime
(if equipped)**

If a door is opened with the ignition switch ON, the warning chime will sound.

**Key reminder warning chime
(if equipped)**

If the driver's door is opened and the ignition key is left in the ignition switch in the LOCK or ACC position, the key reminder warning chime will sound. This is to prevent you from locking your keys in the vehicle.

LIGHTING

Battery saver function

- The purpose of this feature is to prevent the battery from being discharged. The system automatically turns off the headlights and parking lights when the driver removes the ignition key and opens the driver-side door.
- With this feature, the parklight will be turned off automatically if the driver parks on the side of road at night.

If necessary, to keep the lights on when the ignition key is removed, perform the following :

- 1) Open the driver-side door.
- 2) Turn the parking lights OFF and ON again using the light switch on the steering column.



Lighting control

The light switch has a headlight and a parking light position.

To operate the lights, turn the knob at the end of the control lever to one of the following positions:

- (1) OFF position
- (2) Parking light position
- (3) Headlight position



Parking light position (1st position)

When the light switch is in the parking light position (1st position), the tail, position, license and instrument panel lights are ON.



Headlight position (D01)

When the light switch is in the headlight position (2nd position) the head, tail, position, license and instrument panel lights are ON.



High - beam operation

To turn on the high beam headlights, push the lever away from you. Pull it back for low beams.

The high-beam indicator will light when the headlight high beams are switched on.

To prevent the battery from being discharged, do not leave the lights on for a prolonged time while the engine is not running.

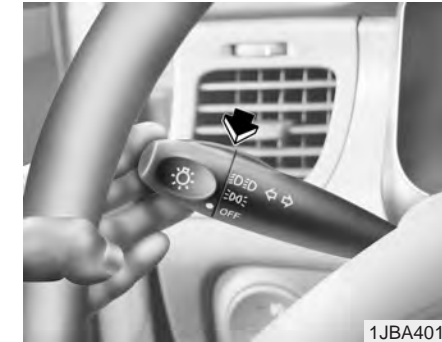

Flashing headlights

To flash the headlights, pull the lever towards you. It will return to the normal (low-beam) position when released. The headlight switch does not need to be on to use this flashing feature.

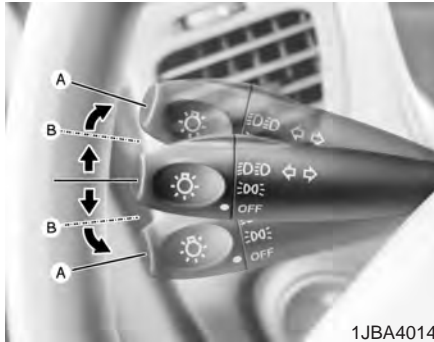

Turn signals (A)

The ignition switch must be on for the turn signals to function. To turn on the turn signals, move the lever up or down. Green arrow indicators on the instrument panel indicate which turn signal is operating. They will self-cancel after a turn is completed. If the indicator continues to flash after a turn, manually return the lever to the OFF position.

Lane change signals (B)

To signal a lane change, move the turn signal lever slightly and hold it in position. The lever will return to the OFF position when released.

If an indicator stays on and does not flash or if it flashes abnormally, one of the turn signal bulbs may be burned out and will require replacement.

*** NOTICE**

If an indicator flash is abnormally quick or slow, the bulb may be burned out or have a poor electrical connection in the circuit.

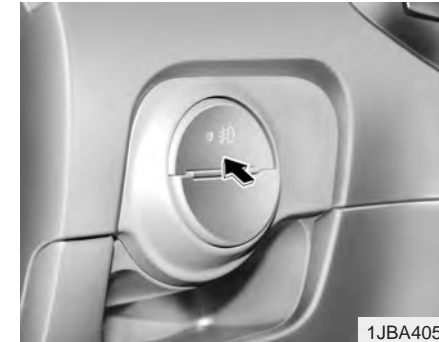

Front fog light (if equipped)

Fog lights are used to provide improved visibility and avoid accidents when visibility is poor due to fog, rain or snow etc. The fog lights will turn on when the fog light button is pressed after the headlight switch is turned on.

To turn off the fog lights, press the fog light button again.

*** NOTICE**

When in operation, the fog lights consume large amounts of vehicle electrical power. Only use the fog lights when visibility is poor. Unnecessary battery and generator drain could occur if the fog lights are used excessively.

**Daytime running light
(if equipped)**

Daytime Running Lights (DRL) can make it easier for others to see the front of your vehicle during the day. DRL can be helpful in many different driving conditions, and it is especially helpful after dawn and before sunset.

The DRL system will make your high-beam headlights turn OFF when:

1. The head light switch is ON.
2. The parking brake engaged.
3. Engine stops.

WIPERS AND WASHERS

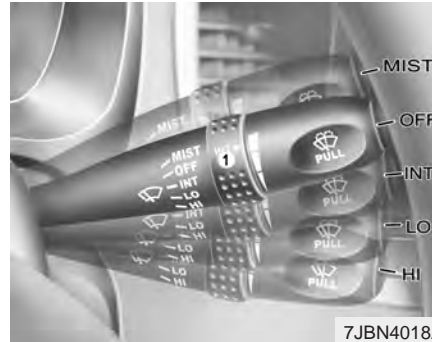

Windshield wipers

Operates as follows when the ignition switch is turned ON.

OFF : Wiper is not in operation

INT : Wiper operates intermittently at the same wiping intervals. Use this mode in a light rain or mist. To vary the speed setting, turn the speed control knob (1).

LO : Normal wiper speed

HI : Fast wiper speed

MIST : For a single wiping cycle, push the lever upward and release it with the lever in the OFF position. The wipers will operate continuously if the lever is pushed upward and held.

*** NOTICE**

Before using the windshield wipers when there is a heavy accumulation of snow or ice on the windshield, defrost the windshield for about 10 minutes, or until the snow or ice is removed. This will help ensure proper windshield wiper operation and will prevent damage to the wiper blades, wiper linkage, and wiper motor.



Variable intermittent wipers

Set the lever to the INT position and choose the desired wiper interval by turning the ring(1).



One - touch wiper

For a single wiping cycle, push the lever upward and release it with the lever in the OFF position.

The wipers will operate continuously if the lever is pushed upward and held.

*** NOTICE**

- To prevent possible damage to the wipers or windshield, do not operate the wipers when the windshield is dry.
- To prevent damage to the wiper blades, do not use gasoline, kerosene, paint thinner, or other solvents on or near them.
- To prevent damage to the wiper arms and other components, do not attempt to move the wipers manually.



Windshield washers

In the OFF position, pull the lever gently toward you to spray washer fluid on the windshield and to run the wipers 2-3 cycles.

Use this function when the windshield is dirty.

The spray and wiper operation will continue until you release the lever.

Driving your vehicle

If the washer does not work, check the washer fluid level. If the fluid level is not sufficient, you will need to add appropriate non-abrasive windshield washer fluid to the washer reservoir.

The reservoir filler neck is located in the front of the engine compartment on the passenger side.

* NOTICE

To prevent possible damage to the washer pump, do not operate the washer when the fluid reservoir is empty.

WARNING

Do not use the washer in freezing temperatures without first warming the windshield with the defrosters; the washer solution could freeze on contact with the windshield and obscure your vision.



7JBN4056

Rear window wiper and washer switch (if equipped)

The rear window wiper and washer switch is located at the end of the wiper and washer switch lever. Turn the switch to desired position to operate the rear wiper and washer.

 - Spraying washer fluid and wiping

ON - Normal wiper operation

OFF - Wiper is not in operation

DEFROSTER



The defroster heats the window to remove frost, fog and thin ice from the interior and exterior of the rear window, while engine is running.

* NOTICE

- To prevent damage to the conductors bonded to the inside surface of the rear window, never use sharp instruments or window cleaners containing abrasives to clean the window.
- To prevent the battery from being discharged, the rear window defroster will only operate when the engine is running.

(Continued)

(Continued)

- If you want to defrost and defog on the front windshield, refer to “Windshield Defrosting and Defogging” in this section.

To activate the rear window defroster, press the rear window defroster button located in the center console switch panel. The indicator on the rear window defroster button illuminates when the defroster is ON.

If there is heavy accumulation of snow on the rear window, brush it off before operating the rear defroster.

The rear window defroster automatically turns off after 20 minutes or when the ignition switch is turned off. To turn off the defroster, press the rear window defroster button again.

Outside mirror heater (if equipped)

There is no control button for the outside mirror heater; instead the outside mirror heater automatically turns on when the rear window defroster is turned on.

HAZARD WARNING FLASHER



The hazard warning flasher causes the rear tail lights and front turn signal lights to flash on and off, which serves as a warning to other drivers to exercise caution when approaching or passing your vehicle.

To activate the flasher, depress the hazard warning flasher switch. This switch operates in any ignition switch position.

To turn the flashers off, depress the switch again.

CLIMATE CONTROL SYSTEM (IF EQUIPPED)

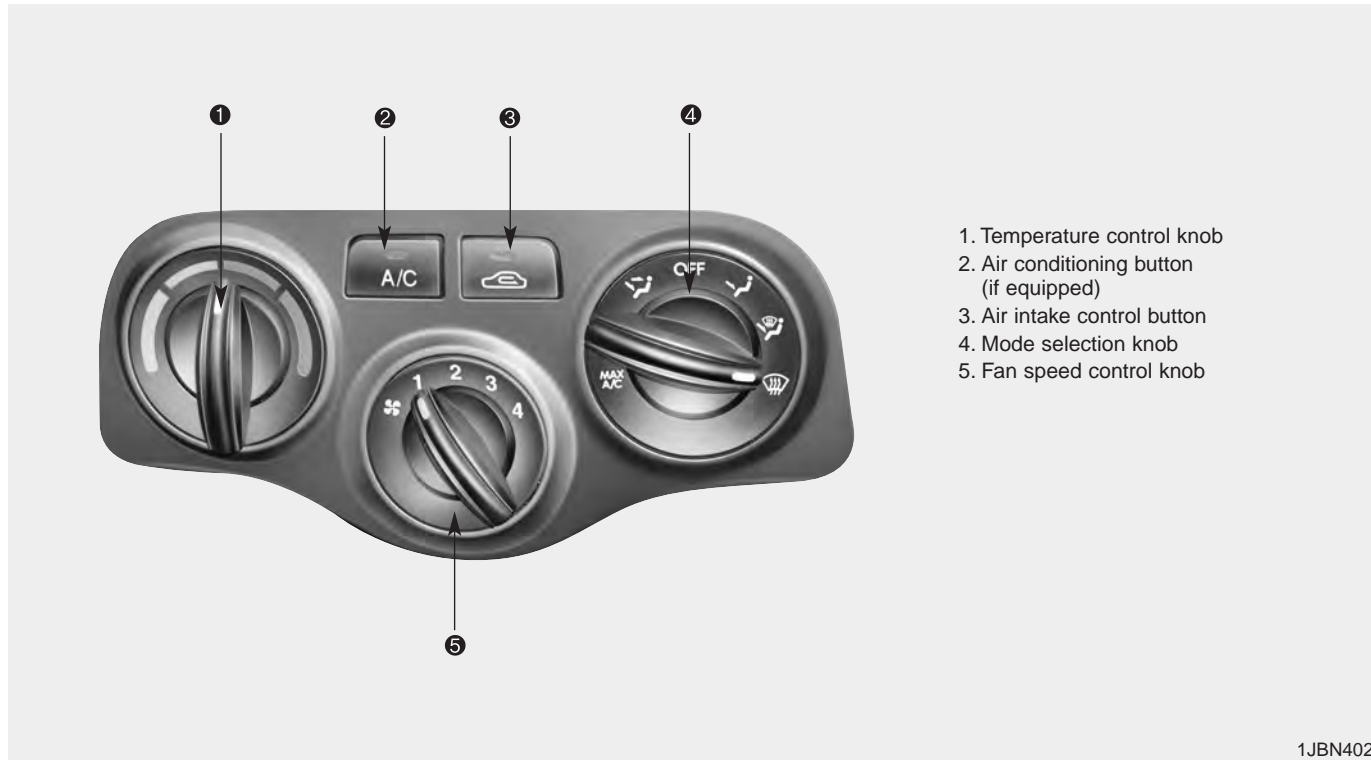



1JBN4024

Fan speed control knob

Four (4) adjustable fan speeds are provided which increase as the number increases. The ignition switch must be in the ON position for fan operation.

Setting the mode selection knob to the OFF position turns off the fan.

- 1 - Low speed
- 2 - Medium speed
- 3 - High speed
- 4 - Maximum speed



1JBN4025

Temperature control knob

The temperature control knob allows you to control the temperature of the air flowing from the ventilation system. To change the air temperature in the passenger compartment turn the knob to the right for warm and hot air or left for cooler air.



1JBN4026

Mode selection knob

The mode selection knob controls the direction of the air flow through the ventilation system.

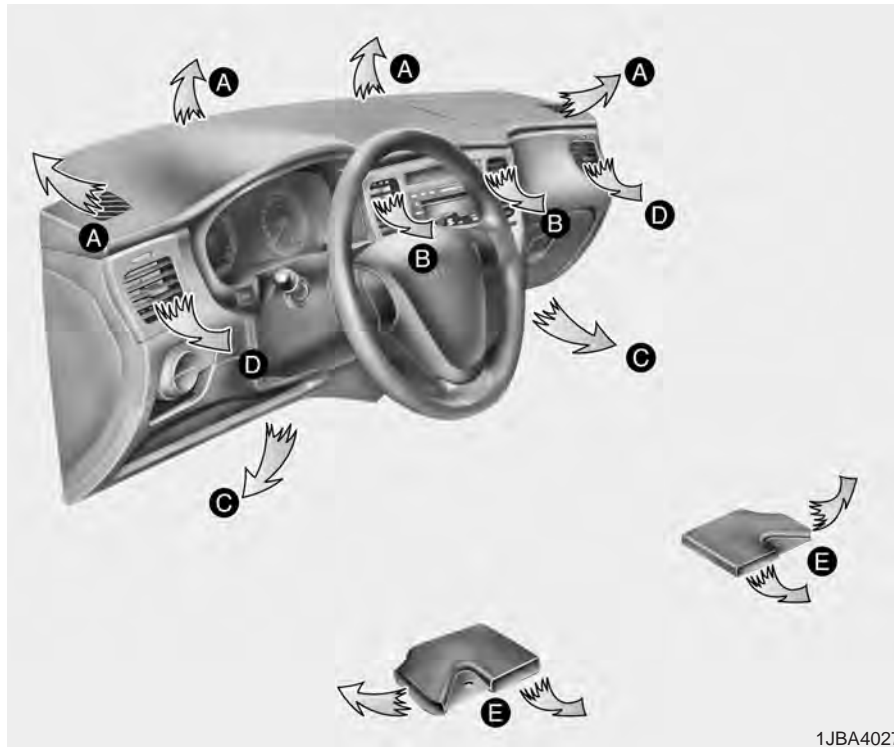

MAX/ A/C position

**MAX
A/C**

When you select the MAX A/C mode while the fan is on, the following system settings will be made automatically;

- the air conditioning system will be turned on.
- the recirculated air position will be selected.
- the face mode will be selected.

If you select MAX A/C mode, you will not be able to cancel the A/C system operation, or change the recirculated air mode position.

Set the fan speed control knob to the desired speed and rotate the temperature control knob to the extreme left position for maximum cooling.

(outlet port: B, D)

Face position



Air flow is directed toward the upper body and face. Additionally, each outlet can be controlled to direct the air discharged from the outlet. (outlet port: B, D)

Face - floor position



Air flow is directed towards the face and the floor. The air to the floor is warmer than the air to the face (except when the temperature control is set to the extreme cold position). (outlet port: B, C, E, D)

Floor position



Most of the air flow is directed to the floor, with a small amount of the air being directed to the windshield and side window defroster. (outlet port: C, E, A, D)

Floor - defrost position



Most of the air flow is directed to the floor and the windshield with a small amount directed to the side window defrosters. (outlet port: A, C, E, D)

Defrost position



Most of the air flow is directed to the windshield with a small amount of air directed to the side window defrosters. (outlet port: A, D)

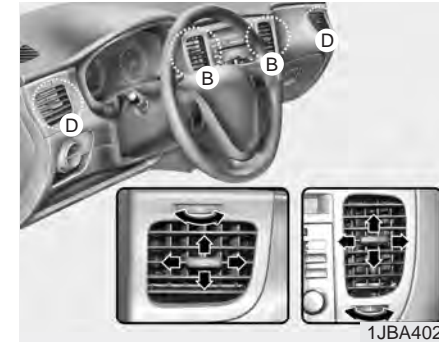

Instrument panel vents

If air flow control is not satisfactory, check the instrument panel vents. The outlet port (B, D) can be opened or closed separately using the thumbwheel.

Also, you can adjust the direction of air delivery from these vents using the vent control lever as shown.

The air from outlet port (D) flows at any mode. Close the ventilation outlets using the thumbwheel to block the air flow if you do not want the air.



Air intake control button

This is used to select outside (fresh) air position or recirculated air position. To change the air intake control position, push the control button.

Recirculated air position



The indicator light on the button is illuminated when the recirculated air position is selected.

With the recirculated air position selected, air from passenger compartment will be drawn through the heating system and heated or cooled according to the function selected.

Outside (fresh) air position



The indicator light on the button is not illuminated when the outside (fresh) air position is selected.

With the outside (fresh) air position selected, air enters the vehicle from outside and is heated or cooled according to the function selected.

*** NOTICE**

It should be noted that prolonged operation of the heating in recirculated air position will cause fogging of the windshield and side windows and the air within the passenger compartment will become stale.

In addition, prolonged use of the air conditioning with the “recirculated air position” selected, will result in excessively dry air in the passenger compartment.

⚠ WARNING

- Continued climate control system operation in the recirculated air position may allow humidity to increase inside vehicle which may fog the glass and obscure visibility.
- Do not sleep in a vehicle with air conditioning or heating system on. It may cause serious harm or death due to a drop in the oxygen level and/or body temperature.
- Continued climate control system operation in the recirculated air position can cause drowsiness or sleepiness, and loss of vehicle control. Set the air intake control to the outside (fresh) air position as much as possible while driving.



Air conditioning button (if equipped)



Push the A/C button to turn the air conditioning system on (indicator light will illuminate). Push the button again to turn the air conditioning system off.

System operation

Ventilation

1. Set the mode to the  position.
2. Set the air intake control to the outside (fresh) air position.
3. Set the temperature control to the desired position.
4. Set the fan speed control to the desired speed.

Heating

1. Set the mode to the  position.
 2. Set the air intake control to the outside (fresh) air position.
 3. Set the temperature control to the desired position.
 4. Set the fan speed control to the desired speed.
 5. If dehumidified heating is desired, turn the air conditioning system (if equipped) on.
- If the windshield fogs up, set the mode to the ,  position.

Air conditioning (if equipped)

All Kia Air Conditioning Systems are filled with environmentally friendly R-134a refrigerant which is not damaging to the ozone layer.

1. Start the engine. Push the air conditioning button.
2. Set the mode to the  position.
3. Set the air intake control to the outside air or recirculated air position.

4. Adjust the fan speed control and temperature control to maintain maximum comfort.
- When maximum cooling is desired, set the temperature control to the extreme left position, set the mode control to the MAX A/C position, then set the fan speed control to the highest speed.

* NOTICE

- When using the air conditioning system, monitor the temperature gauge closely while driving up hills or in heavy traffic when outside temperatures are high. Air conditioning system operation may cause engine overheating. Continue to use the blower fan but turn the air conditioning system off if the temperature gauge indicates engine overheating.
- When opening the windows in humid weather air conditioning may create water droplets inside the vehicle. Since excessive water droplets may cause damage to electrical equipment, air conditioning should only be run with the windows closed.

Air conditioning system operation tips

- If the vehicle has been parked in direct sunlight during hot weather, open the windows for a short time to let the hot air inside the vehicle escape.
- To help reduce moisture inside of windows on rainy or humid days, decrease the humidity inside the vehicle by operating the air conditioning system.
- During air conditioning system operation, you may occasionally notice a slight change in engine speed at idle as the air conditioning compressor cycles. This is a normal system operation characteristic.
- Use the air conditioning system every month if only for a few minutes to ensure maximum system performance.
- When using the air conditioning system, you may notice clear water dripping (or even puddling) on the ground under the passenger side of the vehicle. This is a normal system operation characteristic.

- The air conditioning system includes a function that automatically turns the air conditioning compressor off if engine coolant temperature approaches an over heating level. The air conditioning compressor operation will resume once engine coolant temperature returns to the normal range. Also, the air conditioning compressor is automatically turned off for a few seconds when the accelerator is fully depressed (wide open throttle).
- When operating the air conditioning system use the outside (fresh) air position.
- Operating the air conditioning system in the recirculated air position does provide maximum cooling, however, continual operation in this mode may cause the air inside the vehicle to become stale.

Checking the amount of air conditioner refrigerant and compressor lubricant

When the amount of refrigerant is low, the performance of the air conditioning is reduced. Overfilling also has a bad influence on the air conditioning system. Therefore, if abnormal operation is found, have the system inspected by an authorized Kia dealer.

CAUTION

The air conditioning system should be serviced by an authorized Kia dealer. Improper service may cause serious injury.

*** NOTICE**

When the performance of the air conditioning system is reduced it is important that the correct type and amount of oil and refrigerant is used. Otherwise, damage to the compressor and abnormal system operation may occur.

WINDSHIELD DEFROSTING AND DEFOGGING

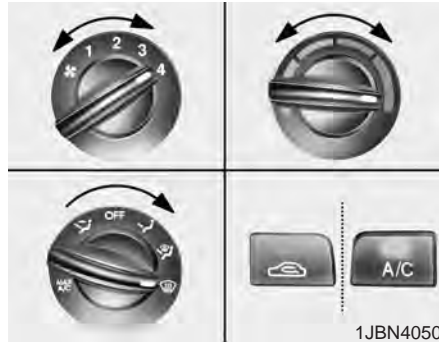

1JBN4050

Manual climate control system

To defog inside windshield

1. Select any fan speed.
2. Select desired temperature.
3. Select the or position.
4. The outside (fresh) air and air conditioning will be selected.

To reduce the probability of fogging up the inside of the windshield, the air intake control is set to the outside (fresh) air position automatically and the air conditioning will automatically operate if the mode is selected to the or position. If you don't want the air conditioning and the outside (fresh) air position, press the corresponding button to cancel the operation.

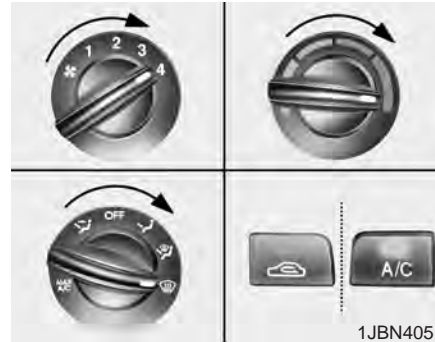

1JBN4051

To defrost outside windshield

1. Set the fan speed to the "3" or "4" position.
2. Set the temperature to the extreme hot position.
3. Select the position.
4. The outside (fresh) air and air conditioning will be selected.

To reduce the probability of fogging up the inside of the windshield, the air intake control is set to the outside (fresh) air position automatically and the air conditioning will automatically operate if the mode is selected to the or position. If you don't want the air conditioning and the outside (fresh) air position, press the corresponding button to cancel the operation.

CAUTION

Do not use the or position during cooling operation in extremely humid weather. The difference between the temperature of the outside air and that of the windshield could cause the outer surface of the windshield to fog up, causing loss of visibility. In this case, set the mode selection knob to the position and fan speed control knob to the lower speed.

- For maximum defrosting, set the temperature control to the extreme right/hot position and the fan speed control to the highest speed.
- If warm air to the floor is desired while defrosting or defogging, set the mode to the floor-defrost position.
- Before driving, clear all snow and ice from the windshield, rear window, outside rear view mirrors, and all side windows.
- Clear all snow and ice from the hood and air inlet in the cowl grill to improve heater and defroster efficiency and to reduce the probability of fogging up inside of the windshield.

Fuel requirements / 5-2
Emission control system / 5-2
Before driving / 5-4
Suggestions for economical operation / 5-5
Special driving conditions / 5-6
Trailer towing / 5-9
Overloading / 5-9
Label information / 5-10

FUEL REQUIREMENTS

Gasoline engine (unleaded)

Your new Kia vehicle is designed to use only unleaded fuel with a minimum Octane Rating of 87 Anti-Knock Index (AKI).

* NOTICE

NEVER USE LEADED FUEL. The use of leaded fuel is detrimental to the catalytic converter and will damage the engine control system's oxygen sensor and affect emission control.

Never add any fuel system cleaning agents to the fuel tank other than what Kia has specified. (Consult an Authorized Kia Dealer for details.)

Gasoline containing alcohol and methanol

Gasohol, a mixture of gasoline and ethanol (also known as grain alcohol), and gasoline or gasohol containing methanol (also known as wood alcohol) are being marketed along with or instead of leaded or unleaded gasoline.

Do not use gasohol containing more than 10% ethanol, and do not use gasoline or gasohol containing any methanol. Either of these fuels may cause drivability problems and damage to the fuel system.

Discontinue using gasohol of any kind if drivability problems occur.

Vehicle damage or driveability problems may not be covered by the manufacturer's warranty if they result from the use of:

1. Gasohol containing more than 10% ethanol.
2. Gasoline or gasohol containing methanol.
3. Leaded fuel or leaded gasohol.

* NOTICE

Never use gasohol which contains methanol. Discontinue use of any gasohol product which impairs drivability.

EMISSION CONTROL SYSTEM

The emission control system of your vehicle is covered by a written limited warranty. Please see the warranty information contained in the Warranty & Consumer Information Manual in your vehicle.

Vehicle modifications

This vehicle should not be modified. Modification of your Kia could affect its performance, safety or durability, may violate governmental safety and emissions regulations, and void the vehicle's warranty.

In addition, damage or performance problems resulting from any modification may not be covered under warranty.

Engine exhaust gas precautions (carbon monoxide)

WARNING - Exhaust

Engine exhaust gases contain carbon monoxide (CO). Though colorless and odorless, it is dangerous and could be lethal if inhaled. Follow the instructions following to avoid CO poisoning.

- Carbon monoxide can be present with other exhaust fumes. Therefore, if you smell exhaust fumes of any kind inside your vehicle, have it inspected and repaired immediately. If you ever suspect exhaust fumes are coming into your vehicle, drive it only with all the windows fully open. Have your vehicle checked and repaired immediately.
- Do not operate the engine in confined or closed areas (such as garages) any more than what is necessary to move the vehicle in or out of the area.
- When the vehicle is stopped in an open area for more than a short time with the engine running, adjust the ventilation system (as needed) to draw outside air into the vehicle.
- Never sit in a parked or stopped vehicle for any extended time with the engine running.
- When the engine stalls or fails to start, excessive attempts to re-start the engine may cause damage to the emission control system.

Operating precautions for catalytic converters

⚠ WARNING - Fire
A hot exhaust system can ignite flammable items under your vehicle. Do not park the vehicle over or near flammable objects, such as grass, vegetation, paper, leaves, etc..

Your vehicle is equipped with a catalytic converter emission control device.

Therefore, the following precautions must be observed:

- Use only UNLEADED FUEL for gasoline engine (unleaded).
- Do not operate the vehicle when there are signs of engine malfunction, such as misfire or a noticeable loss of performance.
- Do not misuse or abuse the engine. Examples of misuse are coasting with the ignition off and descending steep grades in gear with the ignition off.

- Do not operate the engine at high idle speed for extended periods (5 minutes or more).
- Do not modify or tamper with any part of the engine or emission control system. All inspections and adjustments must be made by an authorized Kia dealer.

Failure to observe these precautions could result in damage to the catalytic converter and to your vehicle. Additionally, such actions could void your warranties.

BEFORE DRIVING

Before entering vehicle:

- Be sure that all windows, outside mirror(s), and outside lights are clean.
- Check the condition of the tires.
- Check under the vehicle for any sign of leaks.
- Be sure there are no obstacles behind you if you intend to back up.

Necessary inspections

Fluid levels, such as engine oil, engine coolant, brake fluid, and washer fluid should be checked on a regular basis, with the exact interval depending on the fluid. Further details are provided in Section 7, Maintenance.

Before starting

- Close and lock all doors.
 - Position the seat so that all controls are easily reached.
 - Adjust the inside and outside rearview mirrors.
 - Be sure that all lights work.
 - Check all gauges.
 - Check the operation of warning lights when the ignition switch is turned to the ON position.
 - Release the parking brake and make sure the brake warning light goes out.
- For safe operation, be sure you are familiar with your vehicle and its equipment.

 **WARNING - Driving under the influence of alcohol or drugs**

Drinking and driving is dangerous. Drunk driving is the number one contributor to the highway death toll each year. Even a small amount of alcohol will affect your reflexes, perceptions and judgement. Driving while under the influence of drugs is as dangerous or more dangerous than driving drunk.

You are much more likely to have a serious accident if you drink or take drugs and drive.

If you are drinking or taking drugs, don't drive. Do not ride with a driver who has been drinking or taking drugs. Choose a designated driver or call a cab.

SUGGESTIONS FOR ECONOMICAL OPERATION

Your vehicle's fuel economy depends mainly on your style of driving, where you drive and when you drive.

Each of these factors affects how many kilometers (miles) you can get from a liter (gallon) of fuel. To operate your vehicle as economically as possible, use the following driving suggestions to help save money in both fuel and repairs:

- Avoid lengthy warm-up idling. Once the engine is running smoothly, begin driving. Remember, engine warm-up may take a little longer on cold days.
- Save fuel by accelerating slowly after stopping.
- Keep the engine in tune and follow the recommended periodic maintenance schedule. This will increase the life of all parts and lower your operating costs.
- Do not use the air conditioner unnecessarily.
- Slow down when driving on rough roads.
- For longer tire life and better fuel economy, always keep the tires inflated to the recommended pressures.

- Maintain a safe distance from other vehicles to avoid sudden stops. This will reduce wear on brake linings and pads. Driving in such a way will also save fuel because extra fuel is required to accelerate back to driving speed.
- Do not carry unnecessary weight in the vehicle.
- Do not rest your foot on the brake pedal while driving. This can cause needless wear, possible damage to the brakes, and poor fuel economy.
- Improper wheel alignment results in faster tire wear and lower fuel economy.
- Open windows at high speeds can reduce fuel economy.
- Fuel economy is less in crosswinds and headwinds. To help offset some of this loss, slow down when driving in these conditions.

Keeping a vehicle in good operating condition is important both for economy and safety. Therefore, have an authorized Kia dealer perform scheduled inspections and maintenance.

WARNING - Engine off during motion

Never turn the engine off to coast down hills or anytime the vehicle is in motion. The power steering and power brakes will not function properly without the engine running. Instead, keep the engine on and downshift to an appropriate gear for engine braking effect.

SPECIAL DRIVING CONDITIONS

Hazardous driving conditions

When hazardous driving conditions are encountered such as water, snow, ice, mud, sand, or similar hazards, follow these suggestions:

- Drive cautiously and allow extra distance for braking.
- Avoid sudden movements in braking or steering.
- When braking with non-ABS brakes pump the brake pedal with a light up-and-down motion until the vehicle is stopped.

CAUTION - ABS
Do not pump the brake pedal on a vehicle equipped with ABS.

- If stalled in snow, mud, or sand, use second gear. Accelerate slowly to avoid spinning the drive wheels.
- Use sand, rock salt, tire chains, or other non-slip material under the drive wheels to provide traction when stalled in ice, snow, or mud.

WARNING - Downshifting
Downshifting with an automatic transaxle, while driving on slippery surfaces can cause an accident. The sudden change in tire speed could cause the tires to skid. Be careful when downshifting on slippery surfaces.

Rocking the vehicle

If it is necessary to rock the vehicle to free it from snow, sand, or mud, first turn the steering wheel right and left to clear the area around your front wheels. Then, shift back and forth between 1 (First) and R (Reverse) in vehicles equipped with a manual transaxle or R (Reverse) and any forward gear in vehicles equipped with an automatic transaxle. Do not race the engine, and spin the wheels as little as possible. If you are still stuck after a few tries, have the vehicle pulled out by a tow vehicle to avoid engine overheating and possible damage to the transaxle.

*** NOTICE**
Prolonged rocking may cause engine over-heating, transaxle damage or failure, and tire damage.

WARNING - Spinning tires
Do not spin the wheels, especially at speeds more than 56 km/h (35 mph). Spinning the wheels at high speeds when the vehicle is stationary could cause a tire to overheat, explode and injure bystanders.

Driving at night

Because night driving presents more hazards than driving in the daylight, here are some important tips to remember:

- Slow down and keep more distance between you and other vehicles, as it may be more difficult to see at night, especially in areas where there may not be any street lights.
- Adjust your mirrors to reduce the glare from other driver's headlights.
- Keep your headlights clean and properly aimed on vehicles not equipped with the automatic headlight aiming feature. Dirty or improperly aimed headlights will make it much more difficult to see at night.
- Avoid staring directly at the headlights of oncoming vehicles. You could be temporarily blinded, and it will take several seconds for your eyes to readjust to the darkness.

Driving in the rain

Rain and wet roads can make driving dangerous, especially if you're not prepared for the slick pavement. Here are a few things to consider when driving in the rain:

- A heavy rainfall will make it harder to see and will increase the distance needed to stop your vehicle, so slow down.
- Keep your windshield wiping equipment in good shape. Replace your windshield wiper blades when they show signs of streaking or missing areas on the windshield.
- If your tires are not in good condition, making a quick stop on wet pavement can cause a skid and possibly lead to an accident. Be sure your tires are in good shape.
- Turn on your headlights to make it easier for others to see you.
- Driving too fast through large puddles can affect your brakes. If you must go through puddles, try to drive through them slowly.
- If you believe you may have gotten your brakes wet, apply them lightly while driving until normal braking operation returns.

Winter driving

- We recommend that you carry emergency equipment, including tire chains, a window scraper, windshield de-icer, a bag of sand or salt, flares, a small shovel and jumper cables.
- Make sure you have sufficient ethylene-glycol coolant in the radiator.
- Check the battery condition and cables. Cold temperatures reduce the output capability of any battery, so it must be in excellent condition to provide enough winter starting power.
- Make sure the engine oil viscosity is suitable for cold weather.
- Check the ignition system for loose connections and damage.
- Use antifreeze-formulated windshield washer fluid. (Do not use engine coolant antifreeze.)
- Do not use the parking brake if it might freeze. When parking, shift to 1 (First) or R (Reverse) with a manual transaxle or P (Park) with an automatic transaxle and block the rear wheels.

Driving tips

Snow tires

If you mount snow tires on your Kia, make sure they are radial tires of the same size and load range as the original tires. Mount snow tires on all four wheels to balance your vehicle's handling in all weather conditions. Keep in mind that the traction provided by snow tires on dry roads may not be as high as your vehicle's original equipment tires. You should drive cautiously even when the roads are clear. Check with the tire dealer for maximum speed recommendations.

⚠ WARNING - Snow tire size
Snow tires should be equivalent in size and type to the vehicle's standard tires. Otherwise, the safety and handling of your vehicle may be adversely affected.

Do not install studded tires without first checking local, state and municipal regulations for possible restrictions against their use.

Driving in flooded areas

Avoid driving through flooded areas unless you are sure the water is no higher than the bottom of the wheel hub. Drive through any water slowly. Allow adequate stopping distance because brake performance may be affected.

After driving through water, dry the brakes by gently applying them several times while the vehicle is moving slowly.

TRAILER TOWING

We do not recommend using this vehicle for trailer towing.

OVERLOADING

⚠ CAUTION - Vehicle weight
The gross axle weight rating (GAWR) and the gross vehicle weight rating (GVWR) for your vehicle are on the manufacturer's label attached to the driver's door. Exceeding these ratings can cause an accident or vehicle damage. You can calculate the weight of your load by weighing the items (and people) before putting them in the vehicle. Be careful not to overload your vehicle.

LABEL INFORMATION

There are several important labels and identification numbers located on your vehicle. The label locations are identified in the illustrations shown.

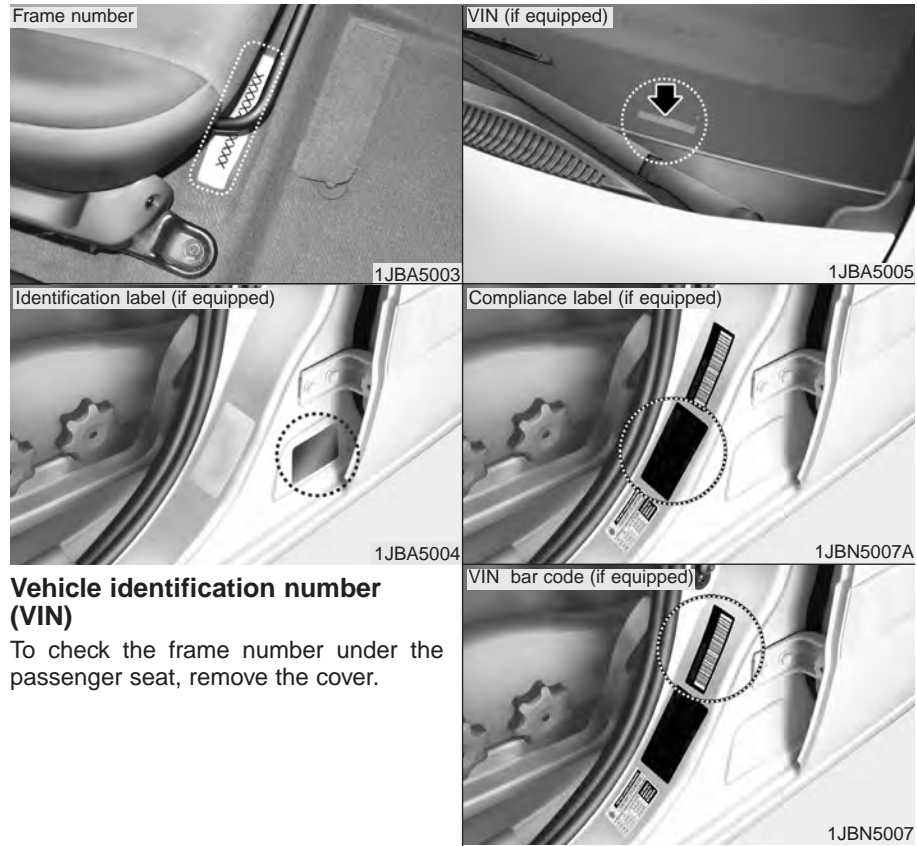

Vehicle identification number (VIN)

To check the frame number under the passenger seat, remove the cover.



1JBN5007B

Tire specification / pressure label



1JBA5109

Engine number

Road warning / 6-2
Overheating / 6-2
Emergency starting / 6-3
Electrical circuit protection / 6-6
Towing / 6-12
If you have a flat tire / 6-17

In case of an emergency

6

ROAD WARNING



Hazard warning flasher

The hazard warning flasher serves as a warning to other drivers to exercise extreme caution when approaching, overtaking, or passing your vehicle. It should be used whenever emergency repairs are being made or when the vehicle is stopped near the edge of a roadway.

Depress the flasher switch with the ignition switch in any position. The flasher switch is located in the center console switch panel. All turn signal lights will flash simultaneously.

- The hazard warning flasher operates whether your vehicle is running or not.
- The turn signals do not work when the hazard flasher is on.
- Care must be taken when using the hazard warning flasher while the vehicle is being towed.

OVERHEATING

If your temperature gauge indicates overheating, if you experience a loss of power, or if you hear a loud knocking or pinging noise, the engine has probably overheated. Should any of these symptoms occur, use the following procedure:

1. Turn on the hazard warning flasher, then drive to the nearest safe location and stop your vehicle; set the automatic transaxle in P (Park), or shift the manual transaxle to N (Neutral) and apply the parking brake.
2. Make sure the air conditioner is off.
3. If coolant or steam is boiling out of the radiator, stop the engine and call an authorized Kia dealer for assistance.

If coolant is not boiling out, allow the engine to idle and open the hood to permit the engine to cool gradually.

If the temperature does not go down with the engine idling, stop the engine and allow sufficient time for it to cool.

4. The coolant level should then be checked. If the level in the reservoir is low, look for leaks at the radiator hoses and connections, heater hoses and connections, radiator, and water pump. If you find a major leak or another problem that may have caused the engine to overheat, do not operate the engine until it has been corrected. Call an authorized Kia dealer for assistance. If you do not find a leak or other problem, carefully add coolant to the reservoir.

⚠ WARNING - Removing radiator cap

Do not remove the radiator cap when the engine and radiator are hot. Scalding hot coolant and steam may blow out under pressure. This could cause serious injury.

If the engine frequently overheats, have the cooling system checked and repaired by an authorized Kia dealer.

EMERGENCY STARTING

Jump starting

Jump starting can be dangerous if done incorrectly. Therefore, to avoid harm to yourself or damage to your vehicle or battery, follow the jump starting procedures. If in doubt, we strongly recommend that you have a competent technician or towing service jump start your vehicle.

* NOTICE

Use only a 12-volt jumper system. You can damage a 12-volt starting motor, ignition system, and other electrical parts beyond repair by use of a 24-volt power supply (either two 12-volt batteries in series or a 24-volt motor generator set).

⚠ WARNING - Battery

Never attempt to check the electrolyte level of the battery as this may cause the battery to rupture or explode causing serious injury.

⚠ WARNING - Battery

- Keep all flames or sparks away from the battery. The battery produces hydrogen gas which may explode if exposed to flame or sparks.
- Do not attempt to jump start the vehicle if the discharged battery is frozen or if the electrolyte level is low; the battery may rupture or explode.

Connecting jumper cables

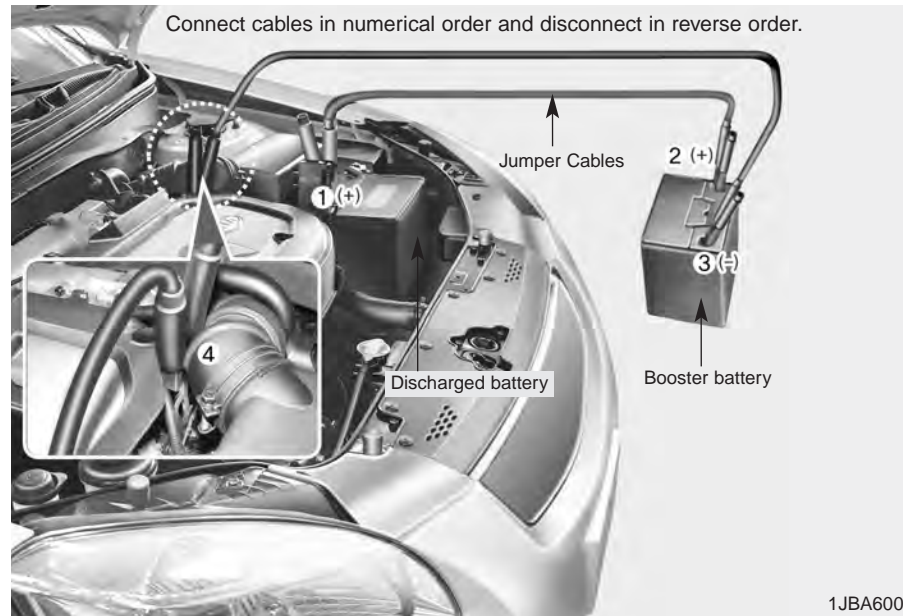

Jump starting procedure

1. Make sure the booster battery is 12-volt and that its negative terminal is grounded.
2. If the booster battery is in another vehicle, do not allow the vehicles to touch.
3. Turn off all unnecessary electrical loads.
4. Connect the jumper cables in the exact sequence shown in the previous illustration. First connect one end of a jumper cable to the positive terminal of the discharged battery (1), then connect the other end to the positive terminal on the booster battery (2).
5. Proceed to connect one end of the other jumper cable to the negative terminal of the booster battery (3), then the other end to a solid, stationary, metallic point (for example, the engine lifting bracket) away from the battery (4). Do not connect it to or near any part that moves when the engine is cranked. Do not connect the jumper cable from the negative terminal of the booster battery to the negative terminal of the discharged battery.

Do not allow the jumper cables to contact anything except the correct battery terminals or the correct ground. Do not lean over the battery when making connections.

⚡ CAUTION - Battery cables
Do not connect the jumper cable from the negative terminal of the booster battery to the negative terminal of the discharged battery. This can cause the discharged battery to overheat and crack, releasing battery acid.

6. Start the engine of the vehicle with the booster battery and let it run at 2,000 rpm, then start the engine of the vehicle with the discharged battery.

If the cause of your battery discharging is not apparent, you should have your vehicle checked by an authorized Kia dealer.

Push-starting

Your manual transaxle-equipped vehicle should not be push-started because it might damage the emission control system.

Vehicles equipped with automatic transaxle cannot be push-started.

Follow the directions in this section for jump-starting.

⚡ CAUTION
Never tow a vehicle to start it because the sudden surge forward when the engine starts could cause a collision with the tow vehicle.

ELECTRICAL CIRCUIT PROTECTION

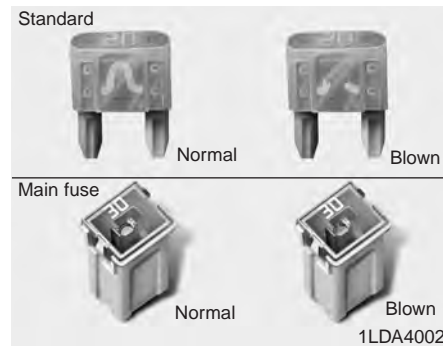

Fuses

A vehicle's electrical system is protected from electrical overload damage by fuses.

This vehicle has two fuse panels, one located in the driver's side panel bolster, the other in the engine compartment near the battery.

If any of your vehicle's lights, accessories, or controls do not work, check the appropriate circuit fuse. If a fuse has blown, the element inside the fuse will be melted.

If the electrical system does not work, first check the driver's side fuse panel.

Always replace a blown fuse with one of the same rating.

If the replacement fuse blows, this indicates an electrical problem. Avoid using the system involved and immediately consult an authorized Kia dealer.

Two kinds of fuses are used: standard for lower amperage rating and main for higher amperage ratings.

Fuse replacement

⚠ WARNING - Fuse replacement

- **Never replace a fuse with anything but another fuse of the same rating.**
- **A higher capacity fuse could cause damage through overheating and possibly a fire.**
- **Never install a wire instead of the proper fuse - even as a temporary repair. It may cause extensive wiring damage and possibly a fire.**

*** NOTICE**

Do not use a screwdriver or any other metal object to remove fuses because it may cause a short circuit and damage the system.

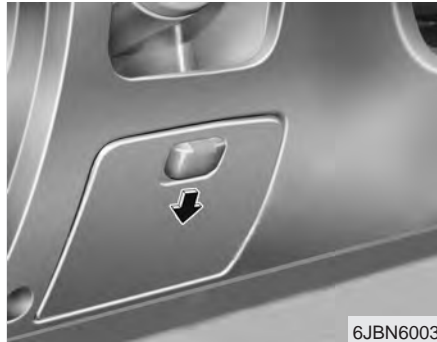

Driver-side panel bolster

1. Turn the ignition switch and all other switches off.
2. Open the cover.

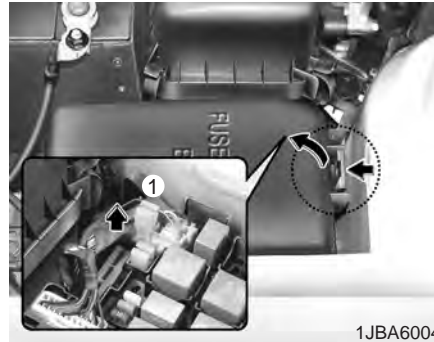

4. Pull the suspected fuse straight out. Use the removal tool (1) provided in the engine compartment fuse/relay box.
5. Check the removed fuse; replace it if it is blown.
Spare fuses are provided in the fuse panel in engine compartment.
6. Push in a new fuse of the same rating, and make sure it fits tightly in the clips. If it fits loosely, consult an authorized Kia dealer.

If you do not have a spare, use a fuse of the same rating from a circuit you may not need for operating the vehicle, such as the audio fuse.

If the headlights or other electrical components do not work and the fuses are OK, check the fuse block in the engine compartment. If a fuse is blown, it must be replaced.

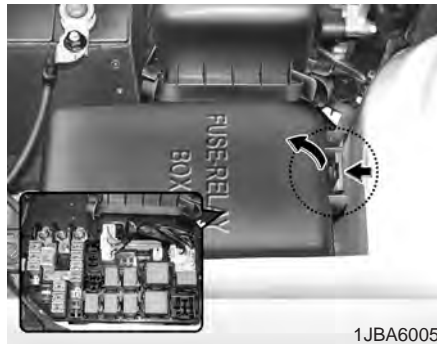

1JBA6005

Engine compartment

1. Turn the ignition switch and all other switches off.
 2. Remove the fuse box cover by pressing the taps and pulling up.
 3. Check the removed fuse; replace it if it is blown.
 4. Push in a new fuse of the same rating, and make sure it fits tightly in the clips.
- If it fits loosely, consult an authorized Kia dealer.

*** NOTICE**

After checking the fuse box in the engine compartment, securely install the fuse box cover. If not, electrical failures may occur from water leaking in.



1JBA6007

Main fuse

If the MAIN fuse is blown, it must be removed as follows:

1. Disconnect the negative battery cable.
2. Remove the screws shown in the picture above.
3. Replace the fuse with a new one of the same rating.
4. Reinstall in the reverse order of removal.

*** NOTICE**

If the MAIN fuse is blown, consult an authorized Kia dealer.

Fuse/Relay panel description

Inside the fuse/relay box covers, you can find the fuse/relay label describing fuse/relay name and capacity.

Engine compartment

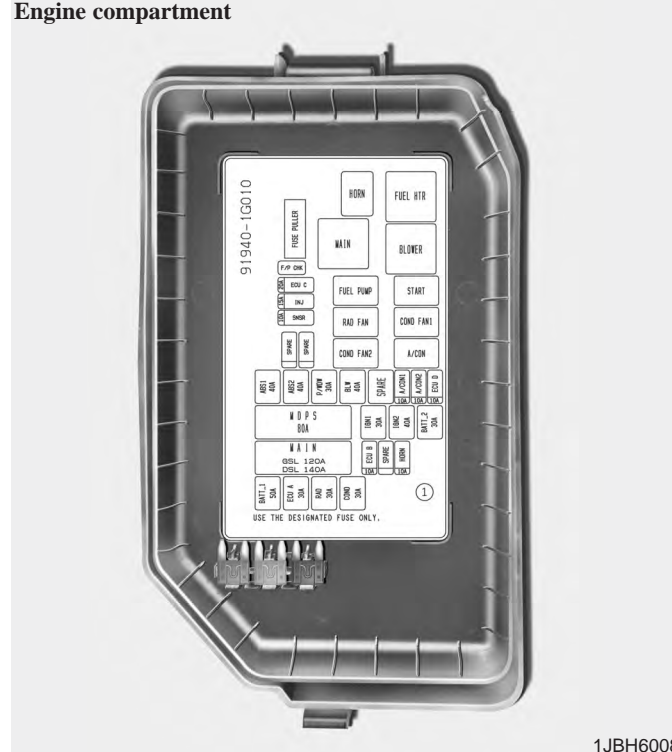

Engine compartment

Description	Fuse rating	Protected component
BATT_1	50A	Alternator, Battery
ECU A	30A	Engine control unit
RAD	30A	Radiator fan
COND	30A	Condenser fan
ECU B	10A	Engine control unit
SPARE	-	Spare fuse
HORN	10A	Horn
IGN1	30A	Ignition
IGN2	40A	Ignition
BATT_2	30A	Alternator, Battery
MAIN	125A	Alternator
MDPS	80A	Power steering wheel
ABS1	40A	ABS
ABS2	40A	ABS
P/WDW	30A	Power window
BLW	40A	Blower
SPARE	-	Spare fuse
A/CON1	10A	Air conditioner
A/CON2	10A	Air conditioner
ECU D	10A	Engine control unit
SNSR	10A	Sensors
INJ	15A	Injector
ECU C	20A	Engine control unit
SPARE	-	Spare fuse
SPARE	-	Spare fuse
HORN	-	Horn relay
MAIN	-	Main relay

In case of an emergency

Description	Fuse rating	Protected component
FUEL PUMP	-	Fuel pump relay
RAD FAN	-	Radiator fan relay
COND FAN2	-	Condenser fan relay
FUEL HTR	-	Fuel filter heater relay
BLOWER	-	Blower motor relay
START	-	Start motor relay
COND FAN1	-	Condenser fan relay
A/CON	-	Air conditioner relay

Driver-side knee bolster

1. RR WIPER	15A	1	2	3	4	5	6	7	8	9	10	11
2. H/LP(LH)	10A	12	13	14	15	16	17	18	19	20	2	
3. FR WIPER	25A	21	22	23	24	25	26	27	28	29	30	31
4. BLOWER	10A	32	33	34	35	36	37	38	39			
5. H/LP(RH)	10A											
6. S/ROOF	20A											
7. STOP LP	15A											
8. C/DR LOCK	20A											
9. IGN COIL	15A											
10. ABS	10A											
11. B/UP LP	10A											
12. SPARE	-											
13. C/LIGHTER	25A											
14. FOLD'G	10A											
15. HTD SEAT	20A											
16. AMP	25A											
17. FR FOG LP	10A											
18. SPARE	-											
19. ECU	10A											
20. CLUSTER	10A											
21. P/MDW RH	25A											
22. AUDIO	10A											
23. RR FOG LP	10A											
24. IGN	10A											
25. HTD GLASS	30A											
26. A/BAG	15A											
27. TCJ	10A											
28. SNFR	10A											
29. SPARE	-											
30. MULT B/UP	10A											
31. AUDIO	15A											
32. P/MDW LH	25A											
33. HTD MIRR	10A											
34. TAIL LP(LH)	10A											
35. TAIL LP(RH)	10A											
36. HAZARD	10A											
37. T/SIG LP	10A											
38. A/BAG IND	10A											
39. START	10A											

USE THE DESIGNATED FUSE ONLY.

1JBH6009

Driver-side knee bolster

Description	Fuse rating	Protected component
RR WIPER	15A	Rear wiper
H/LP(LH)	10A	Headlight (left)
FR WIPER	25A	Front wiper
BLOWER	10A	Blower
H/LP(RH)	10A	Headlight (right)
S/ROOF	20A	Sunroof
STOP LP	15A	Stop light
C/DR LOCK	20A	Central door lock
IGN COIL	15A	Ignition coil
ABS	10A	ABS
B/UP LP	10A	Back-up light
SPARE	-	Spare fuse
C/LIGHTER	25A	Cigar lighter
FOLD'G	10A	Outside rearview mirror folding
HTD SEAT	20A	Seat warmer
AMP	25A	Amplifier
FR FOG LP	10A	Front fog light
SPARE	-	Spare fuse
ECU	10A	Engine control unit
CLUSTER	10A	Cluster
P/WDW RH	25A	Power window (right)
AUDIO	10A	Audio
RR FOG LP	10A	Rear fog light
IGN	10A	Ignition

Description	Fuse rating	Protected component
HTD GLASS	30A	Rear window defroster
A/BAG	15A	Air bag
TCU	10A	Automatic transaxle control
SNSR	10A	Sensors
SPARE	-	Spare fuse
MULT B/UP	10A	Cluster, ETACS, A/C, Clock, Room lamp
AUDIO	15A	Audio
P/WDW LH	25A	Power window (left)
HTD MIRR	10A	Outside rearview mirror heater
TAIL LP(LH)	10A	Taillight (left)
TAIL LP(RH)	10A	Taillight (right)
HAZARD	10A	Hazard warning light
T/SIG LP	10A	Turn signal light
A/BAG IND	10A	Air bag warning
START	10A	Start motor

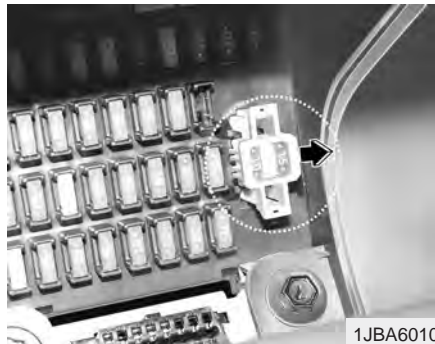

Memory fuse

Your vehicle is equipped with a memory fuse to prevent battery discharge if your vehicle is parked without being operated for prolonged periods. Use the following procedures before parking the vehicle for prolonged period.

1. Turn off the engine.
2. Turn off the headlights and tail lights.
3. Open the driver-side knee bolster cover and pull up the "MULT B/UP 10A / AUDIO 15A".

* NOTICE

- If the memory fuse is pulled up from the fuse panel, the warning chime, audio, clock and interior lamps, etc., will not operate. Some items must be reset after replacement.
- Even though the memory fuse is pulled up, the battery can still be discharged by operation of the headlights or other electrical devices.

TOWING

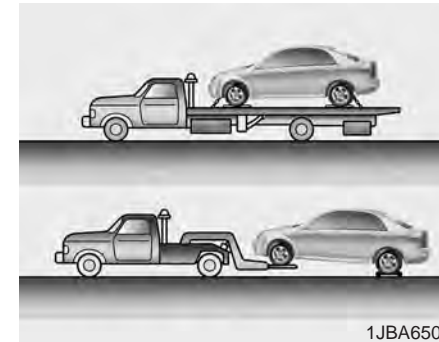

If emergency towing is necessary, we recommend having it done by an authorized Kia dealer or a commercial tow-truck service. Proper lifting and towing procedures are necessary to prevent damage to the vehicle. The use of wheel dollies or flatbed equipment is recommended.

For trailer towing guidelines information, refer to section 5 "Driving Tips".

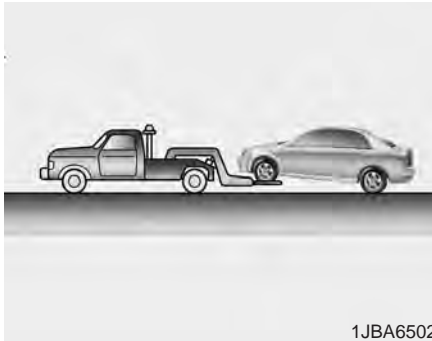

1JBA6502

It is acceptable to tow the vehicle with the rear wheels on the ground (without dollies) and the front wheels off the ground. When being towed by a commercial tow truck and wheel dollies are not used, the front of the vehicle should always be lifted, not the rear.



1JBA6503

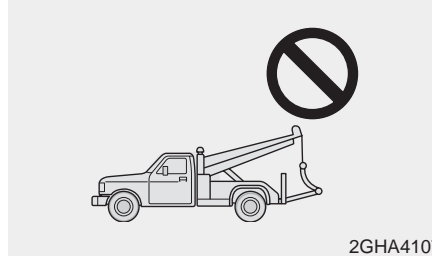

2GHA4107

*** NOTICE**

- Do not tow the vehicle backwards with the front wheels on the ground as this may cause damage to the vehicle.
- Do not tow with sling-type equipment. Use wheel lift or flatbed equipment.

When towing your vehicle in an emergency without wheel dollies :

1. Set the ignition switch in the ACC position.
2. Place the transaxle shift lever in N (Neutral).
3. Release the parking brake.

*** NOTICE**

Failure to place the transaxle shift lever in N (Neutral) may cause internal damage to the transaxle.

In case of an emergency

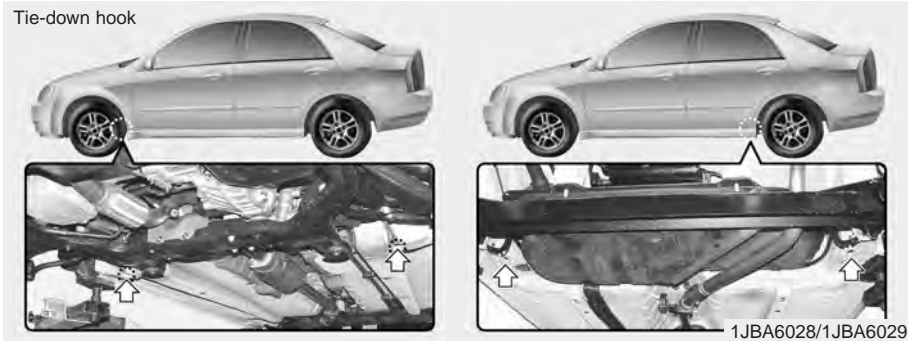

Tie-down hook (for flatbed towing)

CAUTION

Do not use the hooks under the front of the vehicle for towing purposes. These hooks are designed ONLY for transport tie-down. If the tie-down hooks are used for towing, the tie-down hooks will be damaged and this could lead to serious injury.



Front towing hook

1. Open the trunk lid or rear hatch, and remove the towing hook from the tool bag.
2. Remove the hole cover pressing the lower part of the cover on the front bumper (1).

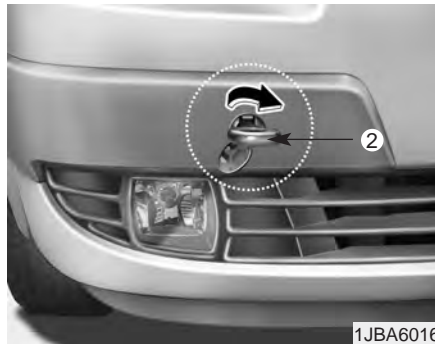

1JBA6016

3. Install the towing hook by turning it clockwise into the hole until it is fully secured (2).
4. Remove the towing hook and install the cover after use.

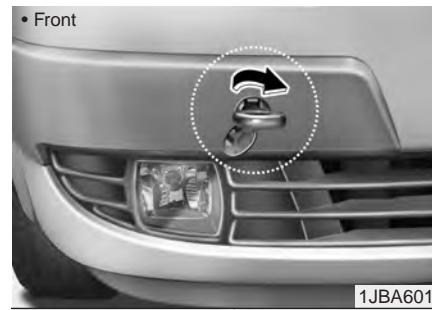

1JBA6016



1JBA6017

Towing with a vehicle other than a tow truck

If towing is necessary, we recommend you to have it done by an authorized Kia dealer or a commercial tow truck service.

If towing service is not available in an emergency, your vehicle may be temporarily towed using a cable or chain secured to the emergency towing hook under the front or rear of the vehicle. Use extreme caution when towing the vehicle. A driver must be in the vehicle to steer it and operate the brakes.

Towing in this manner may be done only on hard-surfaced roads for a short distance and at low speeds. Also, the wheels, axles, power train, steering and brakes must all be in good condition.

- Do not use the tow hooks to pull a vehicle out of mud, sand or other conditions from which the vehicle cannot be driven out under its own power.
- Avoid towing a vehicle heavier than the vehicle doing the towing.
- The drivers of both vehicles should communicate with each other frequently.

* NOTICE

- Attach a towing strap to the tow hook.
- Using a portion of the vehicle other than the tow hooks for towing may damage the body of your vehicle.
- Use only a cable or chain specifically intended for use in towing vehicles. Securely fasten the cable or chain to the towing hook provided.

In case of an emergency

- Before emergency towing, check that the hook is not broken or damaged.
- Fasten the towing cable or chain securely to the hook.
- Do not jerk the hook. Apply steady and even force.
- To avoid damaging the hook, do not pull from the side or at a vertical angle. Always pull straight ahead.

CAUTION

Use extreme caution when towing the vehicle.

- **Avoid sudden starts or erratic driving maneuvers which would place excessive stress on the emergency towing hook and towing cable or chain. The hook and towing cable or chain may break and cause serious injury or damage.**
- **If the towing vehicle does not move easily, do not forcibly continue the towing. Contact an authorized Kia dealer or a commercial tow truck service for assistance.**
- **Tow the vehicle as straight ahead as possible.**
- **Keep away from the vehicle during towing.**

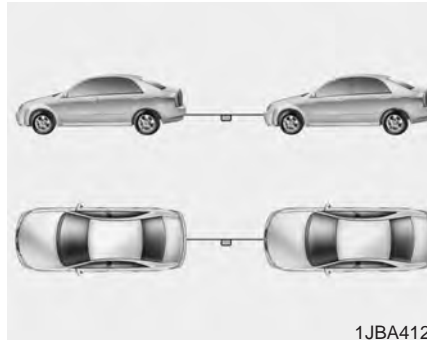

- Use a towing strap less than 5m (16 feet) long. Attach a white or red cloth (about 30cm (12 inches) wide) in the middle of the strap for easy visibility.
 - Drive carefully so that the towing strap is not loosened during towing.
- When your vehicle is being towed by another vehicle other than a tow truck (in case of an emergency)**
- Turn the ignition switch to ACC so the steering wheel isn't locked.
 - Place the transaxle shift lever in N (Neutral).
 - Release the parking brake.
 - Vehicles equipped with automatic transaxles should not exceed 45 km/h (28 mph) and should not be towed more than 80 km (50 miles).
 - Vehicles equipped with manual transaxle should not be towed in excess of 88 km/h (55 mph) and should not be towed more than 645 km (400 miles).
 - Press the brake pedal with more force than normal since you will have reduced brake performance.
 - More steering effort will be required because the power steering system will be disabled.
 - If you are driving down a long hill, the brakes may overheat and brake performance will be reduced. Stop often and let the brakes cool off.

IF YOU HAVE A FLAT TIRE

* NOTICE

To prevent internal damage to the transaxle, never tow your vehicle from the rear (backwards) with all four tires in contact with the surface.

Tips for towing a stuck vehicle

The following methods are effective when your vehicle is stuck in mud, sand or similar substances that prevent the vehicle from being driven out under its own power.

- Remove the soil and sand, etc. from the front and the back of the tires.
- Place a stone or wood under the tires.



The spare tire, jack, jack handle, front towing hook, wheel lug nut wrench are stored in the luggage compartment. Move the carpeting out of the way to reach this equipment.

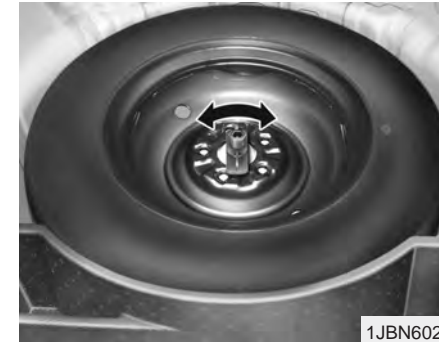

Removing the spare tire

Turn the tire hold-down wing bolt counterclockwise.

Store the tire in the reverse order of removal.

To prevent the spare tire and tools from "rattling" while the vehicle is in motion, store them properly.

Important - use of compact spare tire

your vehicle is equipped with a compact spare tire. This compact spare tire takes up less space than a regular-size tire. This tire is smaller than a conventional tire and is designed for temporary use only.

CAUTION

- *You should drive carefully when the compact spare is in use. The compact spare should be replaced by the proper conventional tire and rim at the first opportunity.*
- *The operation of this vehicle is not recommended with more than one compact spare tire in use at the same time.*

CAUTION

This spare tire should be used only for VERY short distances. Compact spares should NEVER be used for long drives or extended distances.

The compact spare should be inflated to 60 psi (420 kPa).

* NOTICE

Check the inflation pressure after installing the spare tire. Adjust it to the specified pressure, as necessary.

When using a compact spare tire, observe the following precautions:

- Under no circumstances should you exceed 80 km/h (50 mph); a higher speed could damage the tire.
- Ensure that you drive slowly enough for the road conditions to avoid all hazards. Any road hazard, such as a pothole or debris, could seriously damage the compact spare.
- Any continuous road use of this tire could result in tire failure, loss of vehicle control, and possible personal injury.
- Do not exceed the vehicle's maximum load rating or the load-carrying capacity shown on the sidewall of the compact spare tire.
- Avoid driving over obstacles. The compact spare tire diameter is smaller than the diameter of a conventional tire and reduces the ground clearance approximately 25 mm (1 inch), which could result in damage to the vehicle.

- Do not take this vehicle through an automatic car wash.
- Do not use tire chains on this tire. Because of the smaller size, a tire chain will not fit properly. This could damage the vehicle and result in loss of the chain.
- This tire should not be installed on the front axle if the vehicle must be driven in snow or on ice.
- Do not use the compact spare tire on any other vehicle because this tire has been designed especially for your vehicle.
- The compact spare tire's tread life is shorter than a regular tire. Inspect your compact spare tire regularly and replace worn compact spare tires with the same size and design, mounted on the same wheel.

Changing tires

Jacking instructions

The jack is provided for emergency tire changing only.

Follow jacking instructions to reduce the possibility of personal injury.

⚠ WARNING - Changing tires

- Never attempt vehicle repairs in the traffic lanes of a public road or highway.
- Always move the vehicle completely off the road and onto the shoulder before trying to change a tire. The jack should be used on level firm ground. If you cannot find a firm, level place off the road, call a towing service company for assistance.
- Be sure to use the correct front and rear jacking positions on the vehicle; never use the bumpers or any other part of the vehicle for jack support.

(Continued)

(Continued)

- The vehicle can easily roll off the jack causing serious injury or death. No person should place any portion of their body under a vehicle that is supported only by a jack ; use vehicle support stands.
- Do not start or run the engine while the vehicle is on the jack.
- Do not allow anyone to remain in the vehicle while it is on the jack.
- Make sure any children present are in a secure place away from the road and from the vehicle to be raised with the jack.

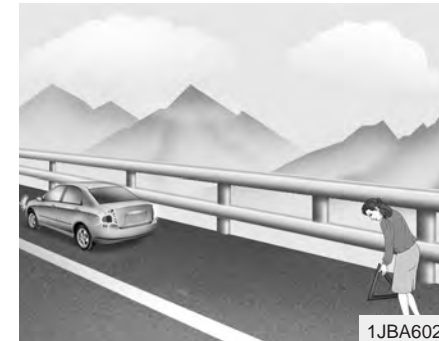

Tire replacement

1. Park on a level surface and apply the parking brake firmly.
2. Shift the shift lever into R (Reverse) with manual transaxle or P (Park) with automatic transaxle.
3. Activate the hazard warning flasher.

In case of an emergency



4. Remove the wheel lug nut wrench, jack, jack handle, and spare tire from the vehicle.
5. Block both the front and rear of the wheel that is diagonally opposite the jack position.

⚠ WARNING - Changing a tire

- To prevent vehicle movement while changing a tire, always set the parking brake fully, and always block the wheel diagonally opposite the wheel being changed.
- It is recommended that the wheels of the vehicle be chocked, and that no person should remain in a vehicle that is being jacked.



6. Wrap a piece of cloth around the tip of the screwdriver to avoid scratching. Insert a screwdriver into the notch of the wheel cover and pry gently to remove the wheel cover (if equipped).



7. Loosen the wheel lug nuts counterclockwise one turn each, but do not remove any nut until the tire has been raised off the ground.

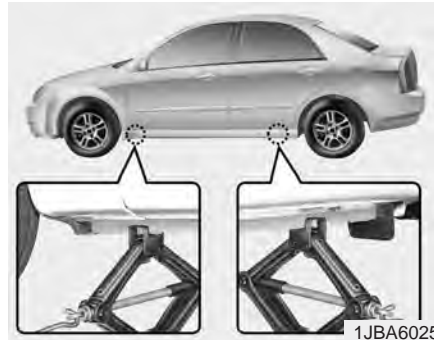

8. Place the jack at the front or rear jacking position closest to the tire you are changing. Place the jack at the designated locations under the frame. The jacking positions are plates welded to the frame with two tabs and a raised dot to index with the jack.

⚠ WARNING - Jack location
To reduce the possibility of injury, be sure to use only the jack provided with the vehicle and in the correct jack position; never use any other part of the vehicle for jack support.



9. Insert the jack handle into the jack and turn it clockwise, raising the vehicle until the tire just clears the ground. This measurement is approximately 30 mm (1.2 in). Before removing the wheel lug nuts, make sure the vehicle is stable and that there is no chance for movement or slippage.

10. Remove the wheel lug nuts by turning them counterclockwise, then remove the wheel.

11. Mount the spare tire into position and install the wheel lug nuts with the beveled edge inward.



12. Once the wheel lug nuts have been tightened, lower the vehicle fully to the ground and continue to tighten the lug nuts until they are fully secured. Tighten the wheel lug nuts firmly in a “X” pattern.

If you are unsure of the tightness of the wheel lug nuts, have them checked at the nearest service station. The specified tightening torque is 9~11 kg•m (65-79 lb•ft, 88-107 N•m). Improperly tightened wheel lug nuts could cause brake pedal vibration while braking.

CAUTION

Your vehicle has metric threads on the wheel studs and nuts. Make certain during wheel removal that the same nuts removed are reinstalled - or, if replaced, that nuts with metric threads and the same chamfer configuration are used.

Installation of a non-metric thread nut on a metric stud or vice-versa will not secure the wheel to the hub properly and will damage the stud so that it must be replaced.

Note that most lug nuts do not have metric threads. Be sure to use extreme care in checking for thread style before installing aftermarket lug nuts or wheels. If in doubt, consult an authorized Kia dealer.

WARNING - Wheel studs

If the studs are damaged or if non-metric nut is used on a metric stud or vice versa, they may lose their ability to retain the wheel. This could lead to the loss of the wheel in a collision resulting in severe injury or death.

To prevent the jack, jack handle, wheel lug nut wrench and spare tire from rattling while the vehicle is in motion, store them properly.

WARNING

Check the inflation pressures as soon as possible after installing the spare tire. Adjust it to the specified pressure, if necessary. Refer to Section 8, Specifications.

Maintenance services / 7-2
Maintenance schedule / 7-3
Owner maintenance / 7-7
Engine compartment / 7-9
Engine oil / 7-10
Engine cooling system / 7-11
Brake fluid / 7-13
Drive belts / 7-14
Power steering / 7-14
Automatic transaxle / 7-15
Lubricants and fluids / 7-16
Air cleaner / 7-17
Climate control air filter / 7-18
Wiper blades / 7-19
Battery / 7-21
Tires and wheels / 7-23

Maintenance

7

Lubricant specifications / 7-32
Exterior care / 7-33
Interior care / 7-35

MAINTENANCE SERVICES

You should exercise the utmost care to prevent damage to your vehicle and injury to yourself whenever performing any maintenance or inspection procedures.

Should you have any doubts concerning the inspection or servicing of your vehicle, we strongly recommend that you have an authorized Kia dealer perform this work.

An authorized Kia dealer has factory-trained technicians and genuine Kia parts to service your vehicle properly. For expert advice and quality service, see an authorized Kia dealer.

Inadequate, incomplete or insufficient servicing may result in operational problems with your vehicle that could lead to vehicle damage, an accident, or personal injury.

Owner's responsibility

Maintenance Service and Record Retention are the owner's responsibility.

You should retain documents that show proper maintenance has been performed on your vehicle in accordance with the scheduled maintenance service charts shown on the following pages. You need this information to establish your compliance with the servicing and maintenance requirements of your Kia warranties.

Detailed warranty information is provided in your Warranty & Consumer Information manual.

Repairs and adjustments required as a result of improper maintenance or a lack of required maintenance are not covered.

We strongly recommend that all vehicle maintenance be performed by an authorized Kia dealer using genuine Kia parts.

MAINTENANCE SCHEDULE

Engine control system

MAINTENANCE ITEM	MAINTENANCE INTERVALS	Kilometers or time in months, whichever comes first																
		× 1,000 km	8	16	24	32	40	48	56	64	72	80	88	96	104	112	120	128
		# Months	4	8	12	16	20	24	28	32	36	40	44	48	52	56	60	64
Engine oil & engine oil filter	(1)	Replace every 6,000 km or 6 months.																
Drive belts (tension)					I				I				I					I
Cooling system hoses & connections				I				I			I			I				I
Engine coolant	(1)	I	I	I	I	I	R	I	I	I	I	I	R	I	I	I	I	I
Fuel filter								R								R		
Fuel tank cap, lines, EVAP canister and hoses							I						I					
Fuel tank air filter				I			R			I			R					I
Air cleaner element	(2)	I	I	I	I	I	R	I	I	I	I	I	R	I	I	I	I	I
Ignition wires							I						I					
Spark plugs							R						R					
Idle speed				I			I			I			I					I
Engine timing belt													R					

Maintenance

MAINTENANCE SCHEDULE (CONTINUED)

Chassis and body

MAINTENANCE ITEM	MAINTENANCE INTERVALS	Kilometers or time in months, whichever comes first																
		x 1,000 km	8	16	24	32	40	48	56	64	72	80	88	96	104	112	120	128
		# Months	4	8	12	16	20	24	28	32	36	40	44	48	52	56	60	64
Air conditioner compressor operation & refrigerant amount (if equipped)																		
Exhaust pipes, heat shield & mountings																		
Front suspension ball joints																		
Brakes/clutch fluid (1)									R								R	
Front brake pads & discs (3)																		
Rear brake pads & discs/drums (3)																		
Parking brake																		
Brake lines & connections (including booster)																		
Manual transaxle oil (1)					R				R				R				R	
Clutch & brake pedal free play																		

MAINTENANCE SCHEDULE (CONTINUED)

Chassis and body (Continued)

MAINTENANCE ITEM	MAINTENANCE INTERVALS	Kilometers or time in months, whichever comes first																
		x 1,000 km	8	16	24	32	40	48	56	64	72	80	88	96	104	112	120	128
		# Months	4	8	12	16	20	24	28	32	36	40	44	48	52	56	60	64
Automatic transaxle fluid	(1)	I	I	I	R	I	I	I	R	I	I	I	R	I	I	I	R	
Chassis & underbody bolts & nuts		I	I	I	I	I	I	I	I	I	I	I	I	I	I	I	I	
Tire condition & inflation pressure		I	I	I	I	I	I	I	I	I	I	I	I	I	I	I	I	
Wheel alignment	(4)	Inspect when abnormal condition noted																
Tire rotation		Rotate the tires every 12,000 km																
Steering operation & linkage		I	I	I	I	I	I	I	I	I	I	I	I	I	I	I	I	
Power steering fluid & lines			I		I		I		I		I		I		I		I	
Driveshaft dust boots				I			I			I			I			I		
Seat belts, buckles & anchors		I	I	I	I	I	I	I	I	I	I	I	I	I	I	I	I	
Lock, hinges & hood latch		L	L	L	L	L	L	L	L	L	L	L	L	L	L	L	L	

Maintenance

Chart symbols:

I- Inspect these items and their related parts. If necessary, correct, clean, refill, adjust or replace.

R- Replace or change

L- Lubricate.

- (1) Refer to the lubricant and coolant specifications in the Owner's Manual.
- (2) More frequent maintenance is required if driving under dusty conditions.
- (3) More frequent maintenance is required if the vehicle is operated under any of the following conditions:
 - a. Short-distance driving.
 - b. Driving on dusty roads.
 - c. Extensive idling or slow-speed driving in stop-and-go traffic.
- (4) If necessary, rotate and balance the wheels.

* Note: Check the engine oil and coolant levels every week.

OWNER MAINTENANCE

Owner maintenance schedule

The following lists are vehicle checks and inspections that should be performed by the owner or an authorized Kia dealer at the frequencies indicated to help ensure safe, dependable operation of your vehicle.

Any adverse conditions should be brought to the attention of your dealer as soon as possible.

These Owner Maintenance Checks are generally not covered by warranties and you may be charged for labor, parts and lubricants used.

When you stop for fuel:

- Check the engine oil level.
- Check coolant level in coolant reservoir.

WARNING

Be careful when checking your engine coolant level when the engine is hot. Scalding hot coolant and steam may blow out under pressure. This could cause burns or other serious injury.

- Check the windshield washer fluid level.
- Look for low or under-inflated tires.

While operating your vehicle:

- Note any changes in the sound of the exhaust or any smell of exhaust fumes in the vehicle.
- Check for vibrations in the steering wheel. Notice any increased steering effort or looseness in the steering wheel, or change in its straight-ahead position.
- Notice if your vehicle constantly turns slightly or “pulls” to one side when traveling on smooth, level road.
- When stopping, listen and check for strange sounds, pulling to one side, increased brake pedal travel or “hard-to-push” brake pedal.
- If any slipping or changes in the operation of your transaxle occurs, check the transaxle fluid level.
- Check automatic transaxle P (Park) function.
- Check parking brake.
- Check for fluid leaks under your vehicle (water dripping from the air conditioning system during or after use is normal).

At least monthly:

- Check coolant level in the coolant recovery reservoir.
- Check the operation of all exterior lights, including the stoplights, turn signals and hazard warning flashers.
- Check the inflation pressures of all tires including the spare.

At least twice a year (i.e., every Spring and Fall) :

- Check radiator, heater and air conditioning hoses for leaks or damage.
- Check windshield washer spray and wiper operation. Clean wiper blades with clean cloth dampened with washer fluid.
- Check headlight alignment.
- Check muffler, exhaust pipes, shields and clamps.
- Check the lap/shoulder belts for wear and function.
- Check for worn tires and loose wheel lug nuts.

Maintenance

At least once a year :

- Clean body and door drain holes.
- Lubricate door hinges and checks, and hood hinges.
- Lubricate door and hood locks and latches.
- Lubricate door rubber weatherstrips.
- Check the air conditioning system before the warm weather season.
- Check the power steering fluid level.
- Inspect and lubricate automatic transaxle linkage and controls.
- Clean battery and terminals.
- Check the brake fluid level.

Owner maintenance precautions

Improper or incomplete service may result in problems. This section gives instructions only for the maintenance items that are easy to perform.

As explained earlier in this section, several procedures can be done only by an authorized Kia dealer with special tools.

Improper owner maintenance during the warranty period may affect warranty coverage. For details, read the separate Kia Warranty & Consumer Information Manual provided with the vehicle. If you're unsure about any servicing or maintenance procedure, have it done by an Authorized Kia Dealer.

WARNING - Maintenance work

- **Performing maintenance work on a vehicle can be dangerous. You can be seriously injured while performing some maintenance procedures. If you lack sufficient knowledge and experience or the proper tools and equipment to do the work, have it done by an Authorized Kia Dealer.**
- **Working under the hood with the engine running is dangerous. It becomes even more dangerous when you wear jewelry or loose clothing. These can become entangled in moving parts and result in injury. Always remove all loose or hanging clothing and all jewelry before working on the engine.**

ENGINE COMPARTMENT

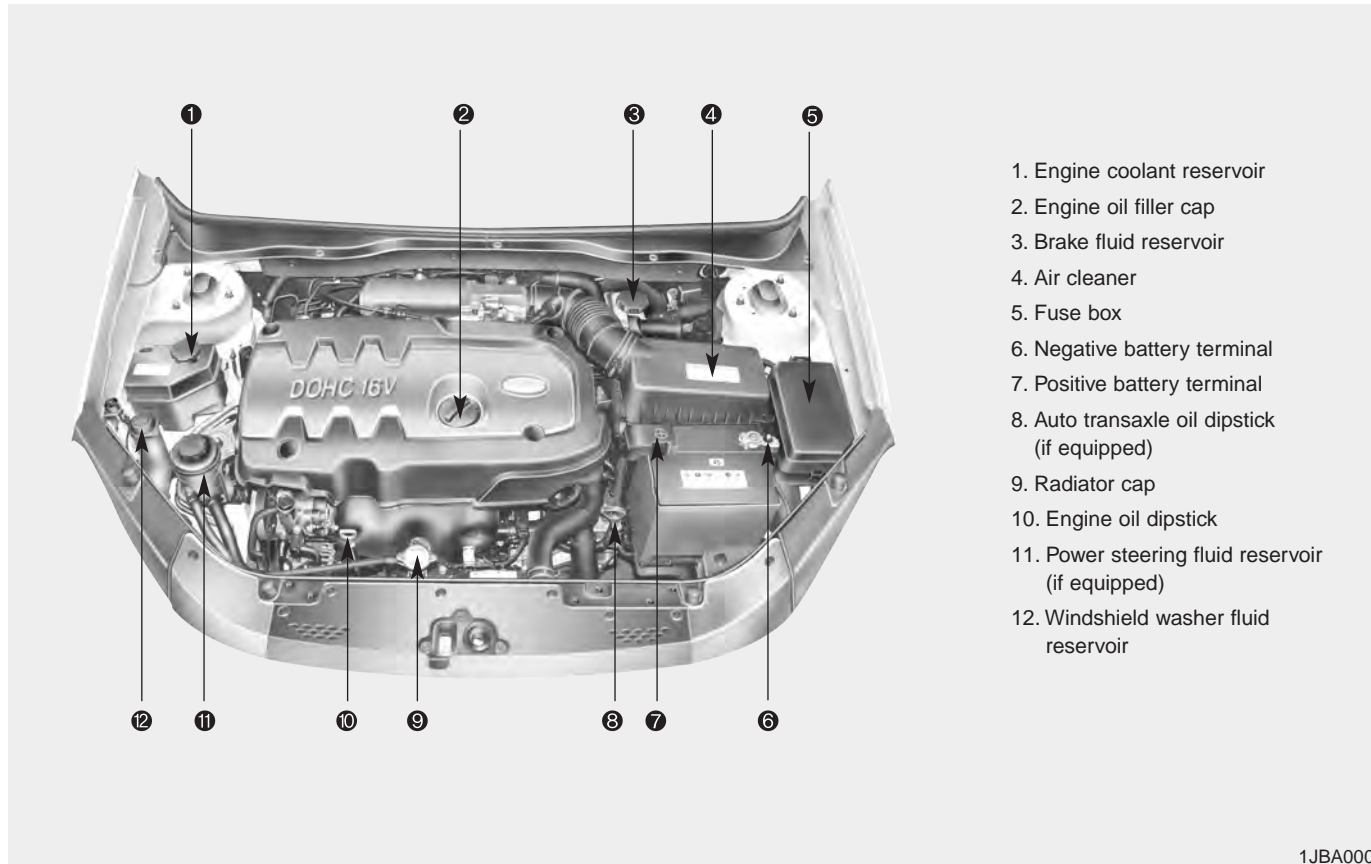

ENGINE OIL

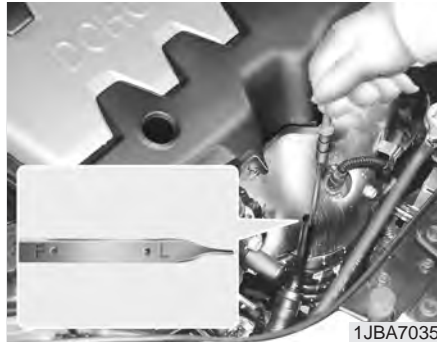

Checking the engine oil level

1. Be sure the vehicle is on level ground.
2. Start the engine and allow it to reach normal operating temperature.
3. Turn the engine off and wait for a few minutes (about 5 minutes) for the oil to return to the oil pan.
4. Pull the dipstick out, wipe it clean, and re-insert it fully.

⚠ WARNING - Radiator hose
Be very careful not to touch the radiator hose when checking or adding the engine oil as it may be hot enough to burn you.

5. Pull the dipstick out again and check the level. The level should be between F and L.



If it is near or at L, add enough oil to bring the level to F. **Do not overfill.**

Use only the specified engine oil. (Refer to "Recommended Lubricants" later in this section.)

Changing the engine oil and filter

Have engine oil and filter changed by an Authorized Kia Dealer according to the Maintenance Schedule at the beginning of this section.

ENGINE COOLING SYSTEM

The high-pressure cooling system has a reservoir filled with year-round antifreeze coolant. The reservoir is filled at the factory.

Check the antifreeze protection and coolant level at least once a year, at the beginning of the winter season, and before traveling to a colder climate.

Checking the coolant level

⚠ WARNING - Removing radiator cap

- Never attempt to remove the radiator cap while the engine is operating or hot. Doing so might lead to cooling system and engine damage and could result in serious personal injury from escaping hot coolant or steam.

(Continued)

(Continued)

- Turn the engine off and wait until it cools down. Use extreme care when removing the radiator cap. Wrap a thick towel around it, and turn it counterclockwise slowly to the first stop. Step back while the pressure is released from the cooling system. When you are sure all the pressure has been released, press down on the cap, using a thick towel, and continue turning counterclockwise to remove it.
- Even if the engine is not operating, do not remove the radiator cap or the drain plug while the engine and radiator are hot. Hot coolant and steam may still blow out under pressure, causing serious injury.



1JBA7002

Check the condition and connections of all cooling system hoses and heater hoses. Replace any swollen or deteriorated hoses.

The coolant level should be filled between F and L marks on the side of the coolant reservoir when the engine is cool.

If the coolant level is low, add enough specified coolant to provide protection against freezing and corrosion. Bring the level to F, but do not overfill. If frequent additions are required, see an authorized Kia dealer for a cooling system inspection.

Engine coolant

Have coolant changed by an authorized Kia dealer according to the Maintenance Schedule at the beginning of this section.

- Use only soft (de-mineralized) water in the coolant mixture.
- The engine in your vehicle has aluminum engine parts and must be protected by an ethylene-glycol-based coolant to prevent corrosion and freezing.
- DO NOT USE alcohol or methanol coolant or mix them with the specified coolant.
- Do not use a solution that contains more than 60% antifreeze or less than 35% antifreeze, which would reduce the effectiveness of the solution.

For mixture percentage, refer to the following table.

Ambient Temperature	Mixture Percentage (volume)	
	Coolant Solution	Water
-15°C (5°F)	35	65
-25°C (-13°F)	40	60
-35°C (-31°F)	50	50
-45°C (-49°F)	60	40



⚠ WARNING - Radiator cap
Do not remove the radiator cap when the engine and radiator are hot. Scalding hot coolant and steam may blow out under pressure causing serious injury.

BRAKE FLUID (IF EQUIPPED)

1JBA7004

Checking brake fluid level

Check the fluid level in the reservoir periodically. The fluid level should be between MAX and MIN marks on the side of the reservoir.

Before removing the reservoir cap and adding brake fluid, clean the area around the reservoir cap thoroughly to prevent brake fluid contamination.

If your vehicle is equipped with a manual transaxle, brake fluid is used as clutch fluid.

If the level is low, add fluid to the MAX level. The level will fall with accumulated mileage. This is a normal condition associated with the wear of the brake linings. If the fluid level is excessively low, have the brake system checked by an authorized Kia dealer.

Use only the specified brake fluid. (Refer to "Recommended Lubricants" later in this section.)

Never mix different types of fluid.

⚠ WARNING - Loss of brake fluid

In the event the brake system requires frequent additions of fluid, the vehicle should be inspected by an authorized Kia dealer.

⚠ WARNING - Brake fluid

When changing and adding brake fluid, handle it carefully. Do not let it come in contact with your eyes. If brake fluid should come in contact with your eyes, immediately flush them with a large quantity of fresh tap water. Have your eyes examined by a doctor as soon as possible.

*** NOTICE**

Do not allow brake fluid to contact the vehicle's body paint, as paint damage will result. Brake fluid, which has been exposed to open air for an extended time should never be used as its quality cannot be guaranteed. It should be thrown out. Don't put in the wrong kind of fluid. A few drops of mineral-based oil, such as engine oil, in your brake/clutch system can damage brake/clutch system parts.

DRIVE BELTS

Drive belts should be checked periodically for proper tension and adjusted if necessary. At the same time, belts should be examined for cracks, wear, fraying or other evidence of deterioration and replaced if necessary.

Belt routing should also be checked to be sure there is no interference between the belts and other parts of the engine. After a belt is replaced, the new belt should be adjusted again after two or three weeks to eliminate slack resulting from initial stretching after use.

Checking the compressor drive belt

Have the drive belts checked in accordance with the maintenance schedule.

POWER STEERING (IF EQUIPPED)

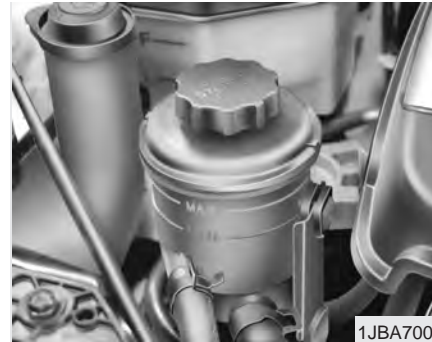

Checking the power steering fluid level

With the vehicle on level ground, check the fluid level in the power steering reservoir periodically. The fluid should be between MAX and MIN marks on the side of the reservoir at the normal temperature.

Before adding power steering fluid, thoroughly clean the area around the reservoir cap to prevent power steering fluid contamination.

If the level is low, add fluid to the MAX level.

In the event the power steering system requires frequent addition of fluid, the vehicle should be inspected by an authorized Kia dealer.

* NOTICE

- To avoid damage to the power steering pump, do not operate the vehicle for prolonged periods with a low power steering fluid level.
- Never start the engine when the reservoir tank is empty.
- When adding fluid, be careful that dirt does not get into the tank.
- Insufficient fluid can result in increased steering effort; excessive noise may also be present as the steering wheel is turned.
- The use of the non-specified fluid could reduce the effectiveness of the power steering wheel and cause damage to it.

Use only the specified power steering fluid. (Refer to "Recommended Lubricants" later in this section.)

Power steering hose

Check the hoses and hose connections for leaks or damage before driving the vehicle.

AUTOMATIC TRANSAXLE (IF EQUIPPED)

1JBA7006

Checking the automatic transaxle fluid level

The automatic transaxle fluid level should be checked regularly.

Keep the vehicle on the level ground with the parking brake applied and check the fluid level according to the following procedure.

1. Place the selector lever in N (Neutral) position and confirm the engine is running at normal idle speed.
2. After the transaxle is warmed up sufficiently (fluid temperature 158~176°F (70~80°C)), for example by 10 minutes usual driving, shift the selector lever through all positions then place the selector lever in N (Neutral) or P (Park) position.

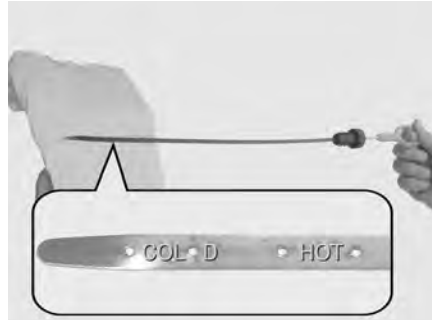

1LDA5009

3. Confirm that the fluid level is in "HOT" range on the level gauge. If the fluid level is lower, add the specified fluid from the fill hole. If the fluid level is higher, drain the fluid from the drain hole.
4. If the fluid level is checked in cold condition (fluid temperature 68~86°F (20~30°C) add the fluid to "COLD" line and then recheck the fluid level according to the above step 2.

⚠ WARNING - Transaxle fluid
The transaxle fluid level should be checked when the engine is at normal operating temperature. This means that the engine, radiator, radiator hose and exhaust system etc., are very hot. Exercise great care not to burn yourself during this procedure.

⚠ CAUTION

- *Low fluid level causes transaxle slippage. Overfilling can cause foaming, loss of fluid and transaxle malfunction.*
- *The use of a non-specified fluid could result in transaxle malfunction and failure.*

⚠ WARNING - Parking brake
To avoid sudden movement of the vehicle, apply parking brake and depress the brake pedal before moving the shift lever.

LUBRICANTS AND FLUIDS

* NOTICE

“COLD” scale is for reference only and should NOT be used to determine transaxle fluid level.

New automatic transaxle fluid should be red. The red dye is added so the assembly plant can identify it as automatic transaxle fluid and distinguish it from engine oil or antifreeze. The red dye, which is not an indicator of fluid quality, is not permanent. As the vehicle is driven, the automatic transaxle fluid will begin to look darker. The color may eventually appear light brown.

* NOTICE

Have an Authorized Kia dealer inspect or change the automatic transaxle fluid according to the Scheduled Maintenance at the beginning of this section.

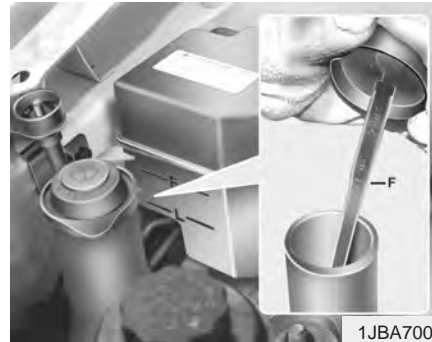

Checking the washer fluid level

The reservoir is translucent so that you can check the level with a quick visual inspection.

Check the fluid level in the washer fluid reservoir and add fluid if necessary. Plain water may be used if washer fluid is not available. However, use washer solvent with antifreeze characteristics in cold climates to prevent freezing.

⚠ WARNING - Coolant

- Do not use radiator coolant or antifreeze in the washer fluid reservoir.
- Radiator coolant can severely obscure visibility when sprayed on the windshield and may cause loss of vehicle control or damage to paint and body trim.
- Windshield washer fluid agents contain some amounts of alcohol and can be flammable under certain circumstances. Do not allow sparks or flame to contact the washer fluid or the washer fluid reservoir. Damage to the vehicle or it's occupants could occur.
- Windshield washer fluid is poisonous to humans and animals. Do not drink and avoid contacting windshield washer fluid. Serious injury or death could occur.

Body lubrication

All moving points of the body, such as door hinges, hood hinges, and locks, should be lubricated each time the engine oil is changed. Use a non-freezing lubricant on locks during cold weather.

Make sure the engine hood secondary latch keeps the hood from opening when the primary latch is released.

AIR CLEANER**Element cleaning**

This element may be air cleaned or replaced, depending on its condition. Unless it is very dirty, merely shake it to remove foreign particles. Each time this filter is inspected, wipe the inside of the air cleaner housing and cover with a damp cloth. If the vehicle is operated in extremely dusty or sandy areas, clean or replace this element more often than at the usual recommended intervals.

*** NOTICE**

Do not drive with the air cleaner removed; this will result in excessive engine wear.

CAUTION - Engine

Driving without an air cleaner encourages backfiring, which could cause a fire in the engine compartment.

CLIMATE CONTROL AIR FILTER (IF EQUIPPED)

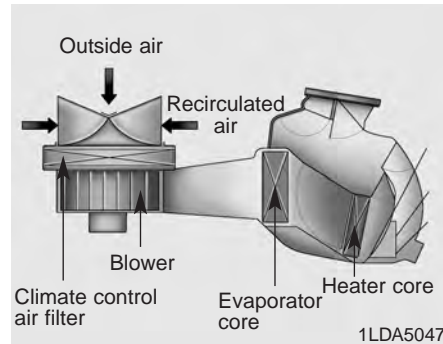

The climate control air filter should be replaced every 15,000 km (10,000 miles). If the vehicle is operated in the severely air-polluted cities or on dusty rough roads for a long period, it should be inspected more frequently and replaced earlier. When you try to replace the climate control air filter by owner maintenance, replace it performing the following procedure, and in this case, be careful to avoid damaging other components.

The climate control air filter installed behind the glove box filters the dust or other pollutants that come into the vehicle from the outside through the heating and air conditioning system. If dust or other pollutants accumulate in the filter over a period of time, the air flow from the air vents may decrease, resulting in moisture accumulation on the inside of the windshield even when the outside (fresh) air position is selected. If this happens, have the climate control air filter replaced by an authorized Kia dealer.

WIPER BLADES

Wiper blade maintenance

Commercial hot waxes applied by automatic car washes have been known to make the windshield difficult to clean.

Contamination of either the windshield or the wiper blades with foreign matter can reduce the effectiveness of the windshield wipers. Common sources of contamination are insects, tree sap, and hot wax treatments used by some commercial car washes. If the blades are not wiping properly, clean both the window and the blades with a good cleaner or mild detergent, and rinse thoroughly with clean water.

* NOTICE

To prevent damage to the wiper blades, do not use gasoline, kerosene, paint thinner, or other solvents on or near them.

Windshield wiper blade replacement

When the wipers no longer clean adequately, the blades may be worn or cracked, and require replacement.

* NOTICE

To prevent damage to the wiper arms or other components, do not attempt to move the wipers manually.

* NOTICE

The use of a non-specified wiper blade could result in wiper malfunction and failure.

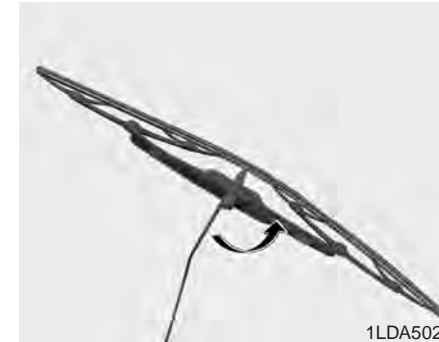

1. Raise the wiper arm and turn the wiper blade assembly to expose the plastic locking clip.

* NOTICE

Do not allow the wiper arm to fall against the windshield, since it may chip or crack the windshield.

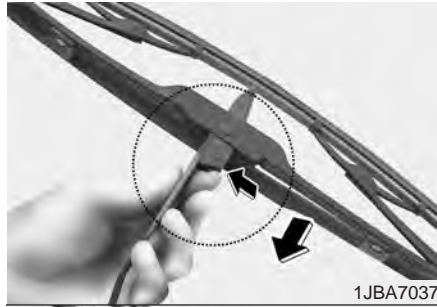

1JBA7037



1JBA7038

2. Compress the clip and slide the blade assembly downward.
3. Lift it off the arm.
4. Install the blade assembly in the reverse order of removal.

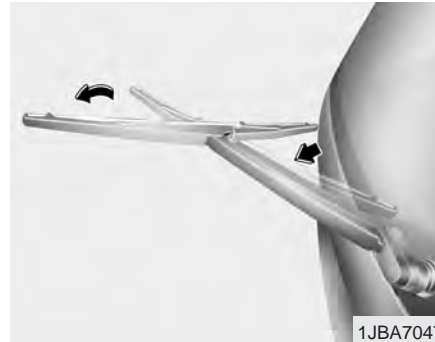

1JBA7047

Rear window wiper blade replacement (if equipped)

1. Raise the wiper arm and pull out the wiper blade assembly.

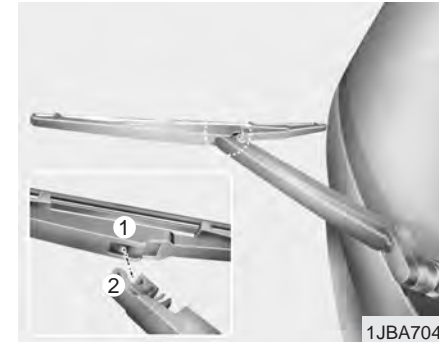

1JBA7048

2. Install the new blade assembly by inserting the center part (1) into the slot (2) in the wiper arm until it clicks into place.
3. Make sure the blade assembly is installed firmly by gently pulling on the blade.

BATTERY**⚠ WARNING - Battery dangers**

Always read the following instructions carefully when handling a battery.



Keep lighted cigarettes and all other flames or sparks away from the battery.



Hydrogen, which is a highly combustible gas, is always present in battery cells and may explode if ignited.



Keep batteries out of the reach of children because batteries contain highly corrosive **SULFURIC ACID**. Do not allow battery acid to contact your skin, eyes, clothing or paint finish.

(Continued)

(Continued)



If any electrolyte gets into your eyes, flush your eyes with clean water for at least 15 minutes and get immediate medical attention. If possible, continue to apply water with a sponge or cloth until medical attention is received.

If electrolyte gets on your skin, thoroughly wash the contacted area. If you feel a pain or a burning sensation, get medical attention immediately.



Wear eye protection when charging or working near a battery. Always provide ventilation when working in an enclosed space.

(Continued)

(Continued)

- When lifting a plastic-cased battery, excessive pressure on the case may cause battery acid to leak, resulting in personal injury. Lift with a battery carrier or with your hands on opposite corners.
- Never attempt to charge the battery when the battery cables are connected.
- The electrical ignition system works with high voltage. Never touch these components with the engine running or the ignition switched on.

Failure to follow the above warnings can result in serious bodily injury or death.



For best battery service :

- Keep the battery securely mounted.
- Keep the top of the battery clean and dry.
- Keep the terminals and connections clean, tight, and coated with petroleum jelly or terminal grease.
- Rinse any spilled electrolyte from the battery immediately with a solution of water and baking soda.
- If the vehicle is not going to be used for an extended time, disconnect the battery cables.

Battery recharging

Your vehicle has a maintenance-free, calcium-based battery.

- If the battery becomes discharged in a short time (because, for example, the headlights or interior lights were left on while the vehicle was not in use), recharge it by slow charging (trickle) for 10 hours.
- If the battery gradually discharges because of high electric load while the vehicle is being used, recharge it at 20-30A for two hours.

Items to be reset after the battery has been discharged or the battery has been disconnected.

- Clock (See Chapter 3)
- Audio (See Chapter 3)
- Sunroof (See Chapter 3)

⚠ WARNING - Recharging battery

When recharging the battery, observe the following precautions:

- **The battery must be removed from the vehicle and placed in an area with good ventilation.**

(Continued)

(Continued)

- **Do not allow cigarettes, sparks, or flame near the battery.**
- **Watch the battery during charging, and stop or reduce the charging rate if the battery cells begin gassing (boiling) violently or if the temperature of the electrolyte of any cell exceeds 49°C (120°F).**
- **Wear eye protection when checking the battery during charging.**
- **Disconnect the battery charger in the following order.**
 1. Turn off the battery charger main switch.
 2. Unhook the negative clamp from the negative battery terminal.
 3. Unhook the positive clamp from the positive battery terminal.

*** NOTICE**

- Before performing maintenance or recharging the battery, turn off all accessories and stop the engine.
- The negative battery cable must be removed first and installed last when the battery is disconnected.

TIRES AND WHEELS

Tire care

For proper maintenance, safety, and maximum fuel economy, you must always maintain recommended tire inflation pressures and stay within the load limits and weight distribution recommended for your vehicle.

Recommended cold tire inflation pressures

All tire pressures (including the spare) should be checked every day when the tires are cold. "Cold Tires" means the vehicle has not been driven for at least three hours or driven less than 1.6 km (one mile).

Recommended pressures must be maintained for the best ride, top vehicle handling, and minimum tire wear.



All specifications (sizes and pressures) can be found on a label attached to the vehicle.

⚠ WARNING - Tire underinflation

Severe underinflation (10 psi (70 kPa) or more) can lead to severe heat build-up, causing blowouts, tread separation and other tire failures that can result in the loss of vehicle control leading to severe injury or death. This risk is much higher on hot days and when driving for protracted periods at high speeds.

* NOTICE

- Underinflation also results in excessive wear, poor handling and reduced fuel economy. Wheel deformation also is possible. Keep your tire pressures at the proper levels. If a tire frequently needs refilling, have it checked by an authorized Kia dealer.
- Overinflation produces a harsh ride, excessive wear at the center of the tire tread, and a greater possibility of damage from road hazards.

*** NOTICE**

- Warm tires normally exceed recommended cold tire pressures by 28 to 41 kPa (4 to 6 psi). Do not release air from warm tires to adjust the pressure or the tires will be underinflated.
- Be sure to reinstall the tire inflation valve caps. Without the valve cap, dirt or moisture could get into the valve core and cause air leakage. If a valve cap is missing, install a new one as soon as possible.

⚠ WARNING - Tire Inflation
Overinflation or underinflation can reduce tire life, adversely affect vehicle handling, and lead to sudden tire failure. This could result in loss of vehicle control and potential injury.

⚡ CAUTION - Tire pressure

Always observe the following:

- *Check tire pressure when the tires are cold. (After vehicle has been parked for at least three hours or hasn't been driven more than 1.6 km (one mile) since startup.)*
- *Check the pressure of your spare tire each time you check the pressure of other tires.*
- *Never overload your vehicle. Be careful not to overload a vehicle luggage rack if your vehicle is equipped with one.*
- *Worn, old tires can cause accidents. If your tread is badly worn, or if your tires have been damaged, replace them.*

Checking tire inflation pressure

Check your tires once a month or more.

Also, check the tire pressure of the spare tire.

How to check

Use a good quality gage to check tire pressure. You can not tell if your tires are properly inflated simply by looking at them. Radial tires may look properly inflated even when they're underinflated.

Check the tire's inflation pressure when the tires are cold. - "Cold" means your vehicle has been sitting for at least three hours or driven no more than 1.6 km (1 mile).

Remove the valve cap from the tire valve stem. Press the tire gage firmly onto the valve to get a pressure measurement. If the cold tire inflation pressure matches the recommended pressure on the tire and loading information label, no further adjustment is necessary. If the pressure is low, add air until you reach the recommended amount.

If you overfill the tire, release air by pushing on the metal stem in the center of the tire valve. Recheck the tire pressure with the tire gage. Be sure to put the valve caps back on the valve stems. They help prevent leaks by keeping out dirt and moisture.

Tire rotation

To equalize tread wear, it is recommended that the tires be rotated every 12,000 km (7,500 miles) or sooner if irregular wear develops.

During rotation, check the tires for correct balance.

When rotating tires, check for uneven wear and damage. Abnormal wear is usually caused by incorrect tire pressure, improper wheel alignment, out-of-balance wheels, severe braking or severe cornering. Look for bumps or bulges in the tread or side of tire. Replace the tire if you find either of these conditions. Replace the tire if fabric or cord is visible. After rotation, be sure to bring the front and rear tire pressures to specification and check lug nut tightness.

Refer to Section 8, Specifications.

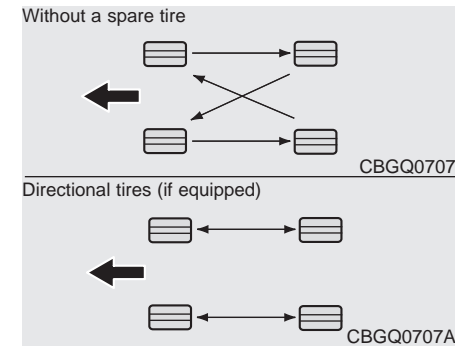

Disc brake pads should be inspected for wear whenever tires are rotated.

Rotate radial tires that have an asymmetric tread pattern only from front to rear and not from right to left.

⚠ WARNING

- Do not use the temporary spare tire for tire rotation
- Do not mix bias ply and radial ply tires under any circumstances. This may cause unusual handling characteristics that could result in death, severe injury, or property damage.



Tire replacement

If the tire is worn evenly, a tread wear indicator will appear as a solid band across the tread. This shows there is less than 1.6 mm (1/16 inch) of tread left on the tire. Replace the tire when this happens.

Do not wait for the band to appear across the entire tread before replacing the tire.

Compact spare tire replacement (if equipped)

A compact spare tire has a shorter tread life than a regular size tire. Replace it when you can see the tread wear indicator bars on the tire. The replacement compact spare tire should be the same size and design tire as the one provided with your new Kia and should be mounted on the same compact spare tire wheel. The compact spare tire is not designed to be mounted on a regular size wheel, and the compact spare tire wheel is not designed for mounting a regular size tire.

Wheel alignment and tire balance

The wheels on your vehicle were aligned and balanced carefully at the factory to give you the longest tire life and best overall performance.

In most cases, you will not need to have your wheels aligned again. However, if you notice unusual tire wear or your vehicle pulling one way or the other, the alignment may need to be reset.

If you notice your vehicle vibrating when driving on a smooth road, your wheels may need to be rebalanced.

* NOTICE

Improper wheel weights can damage your vehicle's aluminum wheels. Use only approved wheel weights.

⚠ WARNING - Replacing tires

- Driving on worn-out tires is very hazardous and will reduce braking effectiveness, steering accuracy, and traction.
- Your vehicle is equipped with tires designed to provide for safe ride and handling capability. Do not use a size and type of tire and wheel that is different from the one that is originally installed on your vehicle. It can affect the safety and performance of your vehicle, which could lead to handling failure or rollover and serious injury. When replacing the tires, be sure to equip all four tires with the tire and wheel of the same size, type, tread, brand and load-carrying capacity.

(Continued)

(Continued)

- If you nevertheless decide to equip your vehicle with any tire/wheel combination not recommended by Kia for off road driving, you should not use these tires for highway driving.
- The use of any other tire size or type may seriously affect ride, handling, ground clearance, stopping distance, body to tire clearance, snow tire clearance, and speedometer reliability.
 - It is best to replace all four tires at the same time. If that is not possible, or necessary, then replace the two front or two rear tires as a pair. Replacing just one tire can seriously affect your vehicle's handling.

Wheel replacement

When replacing the metal wheels for any reason, make sure the new wheels are equivalent to the original factory units in diameter, rim width and offset.

⚠ WARNING

A wheel that is not the correct size may adversely affect wheel and bearing life, braking and stopping abilities, handling characteristics, ground clearance, body-to-tire clearance, snow chain clearance, speedometer calibration, headlight aim and bumper height.

Tire maintenance

In addition to proper inflation, correct wheel alignment helps to decrease tire wear. If you find a tire is worn unevenly, have your dealer check the wheel alignment.

When you have new tires installed, make sure they are balanced. This will increase vehicle ride comfort and tire life. Additionally, a tire should always be rebalanced if it is removed from the wheel.

Tire traction

Tire traction can be reduced if you drive on worn tires, tires that are improperly inflated or on slippery road surfaces. Tires should be replaced when tread wear indicators appear. To reduce the possibility of losing control, slow down whenever there is rain, snow or ice on the road.

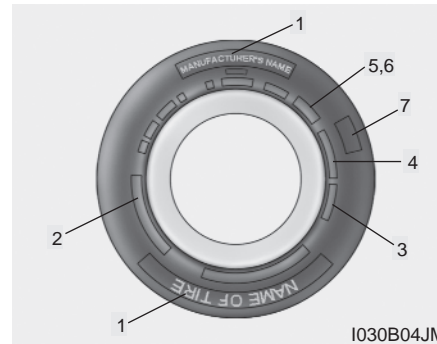

Tire sidewall labeling

Federal law requires tire manufacturers to place standardized information on the sidewall of all tires. This information identifies and describes the fundamental characteristics of the tire and also provides the tire identification number (TIN) for safety standard certification. The TIN can be used to identify the tire in case of a recall.

1. Manufacturer or brand name

Manufacturer or Brand name is shown.

2. Tire size designation

A tire's sidewall is marked with a tire size designation. You will need this information when selecting replacement tires for your car. The following explains what the letters and numbers in the tire size designation mean.

Example tire size designation:

(These numbers are provided as an example only; your tire size designator could vary depending on your vehicle.)

P185/65R14 86H

P - Applicable vehicle type (tires marked with the prefix "P" are intended for use on passenger cars or light trucks; however, not all tires have this marking).

185 - Tire width in millimeters.

65 - Aspect ratio. The tire's section height as a percentage of its width.

R - Tire construction code (Radial).

14 - Rim diameter in inches.

86 - Load Index, a numerical code associated with the maximum load the tire can carry.

H - Speed Rating Symbol. See the speed rating chart in this section for additional information.

Wheel size designation

Wheels are also marked with important information that you need if you ever have to replace one. The following explains what the letters and numbers in the wheel size designation mean.

Example wheel size designation:
5.5JX14

- 5.5 - Rim width in inches.
- J - Rim contour designation.
- 14 - Rim diameter in inches.

Tire speed ratings

The chart below lists many of the different speed ratings currently being used for passenger cars. The speed rating is part of the tire size designation on the sidewall of the tire. This symbol corresponds to that tire's designed maximum safe operating speed.

Speed Rating Symbol	Maximum Speed
S	180 km/h (112 mph)
T	190 km/h (118 mph)
H	210 km/h (130 mph)
V	240 km/h (149 mph)
Z	Above 240 km/h (149 mph)

3. Checking tire life (TIN : Tire Identification Number)

Any tires that are over 6 years, based on the manufacturing date, tire strength and performance, decline with age naturally (even unused spare tires). Therefore, the tires (including the spare tire) should be replaced by new ones. You can find the manufacturing date on the tire sidewall (possibly on the inside of the wheel), displaying the DOT Code. The DOT Code is a series of numbers on a tire consisting of numbers and English letters. The manufacturing date is designated by the last four digits (characters) of the DOT code.

DOT : XXXX XXXX OOOO

The front part of the DOT means a plant code number, tire size and tread pattern and the last four numbers indicate week and year manufactured.

For example:

DOT XXXX XXXX 1605 represents that the tire was produced in the 16th week of 2005.

⚠ WARNING

Tires degrade over time, even when they are not being used. Regardless of the remaining tread, it is recommended that tires generally be replaced after six (6) years of normal service. Heat caused by hot climates or frequent high loading conditions can accelerate the aging process. Failure to follow this warning can result in sudden tire failure, which could lead to a loss of control and an accident involving serious injury or death.

4. Tire ply composition and material

The number of layers or plies of rubber-coated fabric in the tire. Tire manufacturers also must indicate the materials in the tire, which include steel, nylon, polyester, and others. The letter "R" means radial ply construction; the letter "D" means diagonal or bias ply construction; and the letter "B" means belted-bias ply construction.

5. Maximum permissible inflation pressure

This number is the greatest amount of air pressure that should be put in the tire. Do not exceed the maximum permissible inflation pressure. Refer to the Tire and Loading Information label for recommended inflation pressure.

6. Maximum load rating

This number indicates the maximum load in kilograms and pounds that can be carried by the tire. When replacing the tires on the vehicle, always use a tire that has the same load rating as the factory installed tire.

7. Uniform tire quality grading

The following information relates to the tire grading system developed by the Canadian Motor Vehicle Safety Standard (CMVSS) for grading tires by tread wear, traction and temperature performance.

Tread wear

The tread wear grade is a comparative rating based on the wear rate of the tire when tested under controlled conditions on a specified government test course. For example, a tire graded 150 would wear one-and-a-half times as well on the government course as a tire graded 100.

The relative performance of tires depends upon the actual conditions of their use. However, performance may differ from the norm because of variations in driving habits, service practices and differences in road characteristics and climate.

These grades are molded on the side-walls of passenger vehicle tires. The tires available as standard or optional equipment on Kia vehicles may vary with respect to grade.

Traction - AA, A, B & C

The traction grades, from highest to lowest, are AA, A, B and C. The grades represent the tires ability to stop on wet pavement as measured under controlled conditions on specified government test surfaces of asphalt and concrete. A tire marked C may have poor traction performance.

Temperature -A, B & C

The temperature grades are A (the highest), B and C. The grades represent the tire's resistance to the generation of heat and its ability to dissipate heat when tested under controlled conditions on a specified indoor laboratory test wheel.

Sustained high temperature can cause the material of the tires to degenerate and reduce tires life, and excessive temperature can lead to sudden tires failure. Grades A and B represent higher levels of performance on the laboratory test wheel than the minimum required by the law.

⚠ WARNING - Tire temperature

The temperature grade for this tire is established for a tire that is properly inflated and not overloaded. Excessive speed, underinflation, or excessive loading, either separately or in combination, can cause heat build-up and possible sudden tire failure. This can cause loss of vehicle control and serious injury or death.

All season tires

Kia specifies all season tires on some models to provide good performance for use all year round, including snowy and icy road conditions. All season tires are identified by ALL SEASON and/or M+S (Mud and Snow) on the tire sidewall. Snow tires have better snow traction than all season tires and may be more appropriate in some areas.

Summer tires

Kia specifies summer tires on some models to provide superior performance on dry roads. Summer tire performance is substantially reduced in snow and ice. Summer tires do not have the tire traction rating M+S (Mud and Snow) on the tire side wall. If you plan to operate your vehicle in snowy or icy conditions. Kia recommends the use of snow tires or all season tires on all four wheels.

Snow tires

If you equip your car with snow tires, they should be the same size and have the same load capacity as the original tires. Snow tires should be installed on all four wheels; otherwise, poor handling may result.

Snow tires should carry 28 kPa (4 psi) more air pressure than the pressure recommended for the standard tires on the tire label on the driver's side of the center pillar, or up to the maximum pressure shown on the tire sidewall, whichever is less.

Do not drive faster than 120 km/h (75 mph) when your car is equipped with snow tires.

LUBRICANT SPECIFICATIONS

Recommended lubricants

To help achieve proper engine and powertrain performance and durability, use only lubricants of the proper quality. The correct lubricants also help promote engine efficiency that results in improved fuel economy.

Engine oils labeled Energy Conserving Oil are now available. Along with other additional benefits, they contribute to fuel economy by reducing the amount of fuel necessary to overcome engine friction. Often, these improvements are difficult to measure in everyday driving, but in a year's time, they can offer significant cost and energy savings.

These lubricants and fluids are recommended for use in your vehicle.

Lubricant	Classification
Engine oil *1	API Service SJ, SL or above, ILSAC GF-3 or above
Manual transaxle fluid	API Service GL-4 (SAE 75W-85, fill-for-life)
Automatic transaxle fluid	DIAMOND ATF SP-III, SK ATF SP-III
Power steering fluid	PSF-III
Brake/Clutch fluid	FMVSS116 DOT-3 or DOT-4

*1 Refer to the recommended SAE viscosity numbers.

Recommended SAE viscosity number

* NOTICE

Always be sure to clean the area around any filler plug, drain plug, or dipstick before checking or draining any lubricant. This is especially important in dusty or sandy areas and when the vehicle is used on unpaved roads. Cleaning the plug and dipstick areas will prevent dirt and grit from entering the engine and other mechanisms that could be damaged.

Engine oil viscosity (thickness) has an effect on fuel economy and cold weather operating (starting and oil flow). Lower viscosity engine oils can provide better fuel economy and cold weather performance, however, higher viscosity engine oils are required for satisfactory lubrication in hot weather. Using oils of any viscosity other than those recommended could result in engine damage.

When choosing an oil, consider the range of temperature your vehicle will be operated in before the next oil change. Proceed to select the recommended oil viscosity from the chart.

Temperature Range for SAE Viscosity Numbers										
Temperature	°C	-30	-20	-10	0	10	20	30	40	50
	(°F)	-10	0	20	40	60	80	100	120	
Engine Oil *1		10W-30								
		5W-20, 5W-30								

1. For better fuel economy, it is recommended to use the engine oil of a viscosity grade SAE 5W-20,5W-30 (API SJ, SL / ILSAC GF-3).

EXTERIOR CARE

Exterior general caution

It is very important to follow the label directions when using any chemical cleaner or polish. Read all warning and caution statements that appear on the label.

Finish maintenance

Washing

To help protect your vehicle's finish from rust and deterioration, wash it thoroughly and frequently at least once a month with lukewarm or cold water.

If you use your vehicle for off-road driving, you should wash it after each off-road trip. Pay special attention to the removal of any accumulation of salt, dirt, mud, and other foreign materials. Make sure the drain holes in the lower edges of the doors and rocker panels are kept clear and clean.

Insects, tar, tree sap, bird droppings, industrial pollution and similar deposits can damage your vehicle's finish if not removed immediately.

Even prompt washing with plain water may not completely remove all these deposits. A mild soap, safe for use on painted surfaces, may be used.

After washing, rinse the vehicle thoroughly with lukewarm or cold water. Do not allow soap to dry on the finish.

* NOTICE

Do not use strong soap, chemical detergents or hot water, and do not wash the vehicle in direct sunlight or when the body of the vehicle is warm.

⚠ WARNING - Wet brakes

After washing the vehicle, test the brakes while driving slowly to see if they have been affected by water. If braking performance is impaired, dry the brakes by applying them lightly while maintaining a slow forward speed.

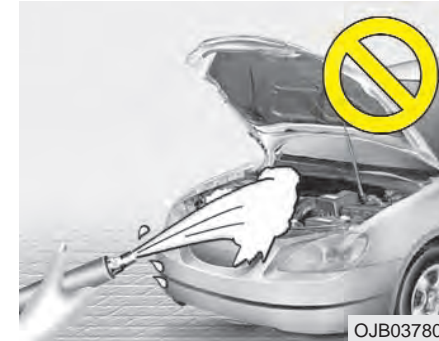

* NOTICE

- Water washing in the engine compartment including high pressure water washing may cause the failure of electrical circuits located in the engine compartment.
- Never allow water or other liquids to come in contact with electrical/electronic components inside the vehicle as this may damage them.

Waxing

Wax the vehicle when water will no longer bead on the paint.

Always wash and dry the vehicle before waxing. Use a good quality liquid or paste wax, and follow the manufacturer's instructions. Wax all metal trim to protect it and to maintain its luster.

Removing oil, tar, and similar materials with a spot remover will usually strip the wax from the finish. Be sure to re-wax these areas even if the rest of the vehicle does not yet need waxing.

*** NOTICE**

- **Wiping dust or dirt off the body with a dry cloth will scratch the finish.**
- **Do not use steel wool, abrasive cleaners, or strong detergents containing highly alkaline or caustic agents on chrome-plated or anodized aluminum parts. This may result in damage to the protective coating and cause discoloration or paint deterioration.**

Finish damage repair

Deep scratches or stone chips in the painted surface must be repaired promptly. Exposed metal will quickly rust and may develop into a major repair expense.

*** NOTICE**

If your vehicle is damaged and requires any metal repair or replacement, be sure the body shop applies anti-corrosion materials to the parts repaired or replaced.

Bright-metal maintenance

- To remove road tar and insects, use a tar remover, not a scraper or other sharp object.
- To protect the surfaces of bright-metal parts from corrosion, apply a coating of wax or chrome preservative and rub to a high luster.
- During winter weather or in coastal areas, cover the bright metal parts with a heavier coating of wax or preservative. If necessary, coat the parts with non-corrosive petroleum jelly or other protective compound.

Underbody maintenance

Corrosive materials used for ice and snow removal and dust control may collect on the underbody. If these materials are not removed, accelerated rusting can occur on underbody parts such as the fuel lines, frame, floor pan and exhaust system, even though they have been treated with rust protection.

Thoroughly flush the vehicle underbody and wheel openings with lukewarm or cold water once a month, after off-road driving and at the end of each winter. Pay special attention to these areas because it is difficult to see all the mud and dirt. It will do more harm than good to wet down the road grime without removing it. The lower edges of doors, rocker panels, and frame members have drain holes that should not be allowed to clog with dirt; trapped water in these areas can cause rusting.

⚠ WARNING

After washing the vehicle, test the brakes while driving slowly to see if they have been affected by water. If braking performance is impaired, dry the brakes by applying them lightly while maintaining a slow forward speed.

Aluminum wheel maintenance

The aluminum wheels are coated with a clear protective finish.

- Do not use any abrasive cleaner, polishing compound, solvent, or wire brushes on aluminum wheels. They may scratch or damage the finish.
- Use only a mild soap or neutral detergent, and rinse thoroughly with water. Also, be sure to clean the wheels after driving on salted roads. This helps prevent corrosion.
- Avoid washing the wheels with high-speed car wash brushes.
- Do not use any acid detergent. It may damage and corrode the aluminum wheels coated with a clear protective finish.

INTERIOR CARE**Interior general precautions**

Prevent caustic solutions such as perfume and cosmetic oil from contacting the dashboard because they may cause damage or discoloration. If they do contact the dashboard, wipe them off immediately. See the instructions that follow for the proper way to clean vinyl.

*** NOTICE**

Never allow water or other liquids to come in contact with electrical/electronic components inside the vehicle as this may damage them.

Cleaning the upholstery and interior trim***Vinyl***

Remove dust and loose dirt from vinyl with a whisk broom or vacuum cleaner. Clean vinyl surfaces with a vinyl cleaner.

Fabric

Remove dust and loose dirt from fabric with a whisk broom or vacuum cleaner. Clean with a mild soap solution recommended for upholstery or carpets. Remove fresh spots immediately with a fabric spot cleaner. If fresh spots do not receive immediate attention, the fabric can be stained and its color can be affected. Also, its fire-resistant properties can be reduced if the material is not properly maintained.

*** NOTICE**

Using anything but recommended cleaners and procedures may affect the fabric's appearance and fire-resistant properties.

Cleaning the lap/shoulder belt webbing

Clean the belt webbing with any mild soap solution recommended for cleaning upholstery or carpet. Follow the instructions provided with the soap. Do not bleach or re-dye the webbing because this may weaken it.

Cleaning the interior window glass

If the interior glass surfaces of the vehicle become fogged (that is, covered with an oily, greasy or waxy film), they should be cleaned with glass cleaner. Follow the directions on the glass cleaner container.

*** NOTICE**

Do not scrape or scratch the inside of the rear window. This may result in damage to the rear window defroster grid.

Specifications / 8-2

Specifications

SPECIFICATIONS

The specifications given here are for general information only. Although this information was accurate at the time of printing, Kia reserves the right to change its vehicles or their specifications without notice. Please check with an authorized Kia dealer for more precise and more up-to-date information.

Dimensions

mm (in)

Item	4 Door	5 Door
Overall length	4,240 (166.9)	4,015 (158.1)
Overall width	1,695 (66.7)	1,695 (66.7)
Overall height	1,470 (57.9)	1,470 (57.9)
Front tread	1,470/1,485 ^{*1} (57.9/58.5 ["])	1,470/1,485 ^{*1} (57.9/58.5 ["])
Rear tread	1,460/1,475 ^{*1} (57.5/58.1 ["])	1,460/1,475 ^{*1} (57.5/58.1 ["])
Wheelbase	2,500 (98.4)	2,500 (98.4)

*1 If P175/70R14 tires are equipped

Tires

Item		Recommended Cold Tire Inflation Pressure kPa (psi)	Wheel lug nut torque kg-m (lb-ft, N-m)
Tire	Wheel		
P175/70R14	5.0J x 14	210 (30)	9~11 (65~79, 88~107)
P185/65R14	5.5J x 14	220 (32)	9~11 (65~79, 88~107)
P195/55R15	5.5J x 15	210 (30)	9~11 (65~79, 88~107)
P205/45R16	6.5J x 16	220 (32)	9~11 (65~79, 88~107)
Compact spare tire			
T115/70D15		420 (60)	9~11 (65~79, 88~107)

Engine

Item	Gasoline Engine
BoreXStroke	76.5 mm X 87 mm (3.01 in X 3.43 in)
Displacement	1599 cc (97.6 cu.in)
Compression Ratio	10.0 ± 0.2

Weights

Refer to the label describing GVWR & GAWR weights attached to your vehicle.
(see page 5-10, Label information)

Electrical system

Size	Gasoline Engine	
Battery	12V / 55AH (20HR)	
Generator	13.5V / 90A	
Starter	12V-0.9kW	
Spark Plug	Gap	1.0 mm ~ 1.1 mm
	Spec.	BKR5ES-11, RC10YC4

Specifications

Light Bulbs

Light Bulb	Wattage	
	4 Door	5 Door
Headlights (Low/High)	55/60	55/60
Front turn signal lights	27	27
Position lights	5	5
Front fog lights (if equipped)	27	27
Front side mark light	5	5
Stop and tail lights	27/8	28/8
Rear turn signal lights	27	27
Back-up lights	18	18
High mounted stop light	18	18
License plate lights	5	5
Front map lamp	10	10
Center dome lamp	10	10
Trunk room (cargo area) lamp	5	5

Capacities

Lubricant	Volume	Classification
Engine oil ^{*1} (with filter change)	3.3 l (3.5 US qt.)	API service SJ, SL or above ILSAC GF-3 or above
Manual transaxle fluid	1.9 l (2.0 US qt.)	API service GL-4 SAE 75W-85 (fill-for-life)
Automatic transaxle fluid	6.1 l (6.5 US qt.)	DIAMOND ATF SP-III, SK ATF SP-III
Power steering	0.8 l (0.8 US qt.)	PSF-III
Coolant	5.5~5.8 l (5.8~6.1 US qt.)	Ethylene glycol base for aluminum radiator
Brake fluid	0.7~0.8 l (0.7~0.8 US qt.)	FMVSS116 DOT-3 or DOT-4
Fuel	45 l (11.9 US gal.)	Unleaded gasoline with AKI 87 or higher

*1 Refer to the recommended SAE viscosity numbers on the page 7-32.

Index

A

- Air bags-supplemental restraint system.....3-47
- Air cleaner7-17
- Antenna3-80
- Audio system3-81
- Automatic transaxle.....4-6, 7-15

B

- Battery.....7-21
- Before driving.....5-4
- Brake fluid7-13
- Brake system.....4-9

C

- Climate control air filter7-18
- Climate control system4-30

D

- Defroster4-29
- Door locks.....3-9
- Drive belts.....7-14

E

- Electrical circuit protection6-6
- Emergency starting6-3
- Emission control system.....5-2

- Engine compartment2-4, 7-9
- Engine cooling system.....7-11
- Engine oil.....7-10
- Exterior care.....7-33

F

- Fuel filler lid3-65
- Fuel requirements5-2

G

- Gauges4-17

H

- Hazard warning flasher.....4-29
- Hood.....3-64
- How to use this manual1-2

I

- If you have a flat tire6-17
- Ignition switch4-2
- Immobilizer system3-7
- Instrument cluster4-16
- Instrument panel overview2-3
- Interior care.....7-35
- Interior features.....3-73
- Interior lights3-71
- Interior overview2-2

K

Keys3-2

L

Label information5-10
 Lighting.....4-23
 Lubricant specifications.....7-32
 Lubricants and fluids7-16
 Luggage net3-79

M

Maintenance schedule.....7-3
 Maintenance services.....7-2
 Manual transaxle.....4-4
 Mirrors3-68

O

Overheating.....6-2
 Overloading5-9
 Owner maintenance7-7

P

Power steering7-14

R

Remote keyless entry.....3-3
 Road warning.....6-2

S

Safety belts.....3-27
 Seat.....3-17
 Special driving conditions5-6
 Specifications.....8-2
 Starting the engine4-3
 Steering wheel.....4-14
 Storage compartment3-72
 Suggestions for economical operation.....5-5
 Sunroof.....3-77

T

Theft-alarm system3-5
 Tires and wheels7-23
 Towing6-12
 Trailer towing5-9
 Trunk.....3-62

V

Vehicle break-in process1-2

W

Warnings and indicators4-19
 Windows3-14
 Windshield defrosting and defogging.....4-37
 Wiper blades7-19
 Wipers and washers4-26