

2006 VOLVO V70



This manual deals with the operation and care of your Volvo.

Welcome to the worldwide family of Volvo owners. We trust that you will enjoy many years of safe driving in your Volvo, an automobile designed with your safety and comfort in mind. To help ensure your satisfaction with this vehicle, we encourage you to familiarize yourself with the equipment descriptions, operating instructions and maintenance requirements/ recommendations in this manual. We also urge you and your passengers to wear seat belts at all times in this or any other automobile. And, of course, please do not operate a vehicle if you may be affected by alcohol, medication or any impairment that could hinder your ability to drive.

Your Volvo is designed to meet all applicable safety and emission standards, as evidenced by the certification labels attached to the driver's door opening and on the left wheel housing in the engine compartment

For further information please contact your retailer, or:

In the USA:

Volvo Cars of North America

Customer Care Center

P.O. Box 914

Rockleigh, New Jersey 07647-0914

800-458-1552

In Canada:

Volvo Cars of Canada Ltd.

National Customer Service

175 Gordon Baker Road

North York, Ontario M2H 2N7

800-663-8255

<http://www.volvocars.com>

Contents

Contents

[Chapter 1 - Safety](#)

[Chapter 2 - Instruments, switches and controls](#)

[Chapter 3 - Climate control system](#)

[Chapter 4 - Interior](#)

[Chapter 5 - Keys, Locks, Alarm](#)

[Chapter 6 - Starting and driving](#)

[Chapter 7 - Wheels and tires](#)

[Chapter 8 - Maintenance/Serviceing](#)

[Chapter 9 - Specifications](#)

[Chapter 10 - Audio systems](#)

[HomeLink® Universal Transceiver \(option\)](#)

[Index](#)

[Back Cover](#)

General information

Shiftlock

When your car is parked, the gear selector is locked in the (P)ark position. To release the selector from this position, turn the ignition key to position II (or start the engine), depress the brake pedal, press the button on the front of the gear selector knob and move the selector from (P)ark.

Keylock

This means that when you switch off the ignition, the gear selector must be in the (P)ark position before the key can be removed from the ignition switch.

Anti-lock Brake System (ABS)

The ABS system in your car performs a self-diagnostic test when the vehicle first reaches the speed of approximately 12 mph (20 km/h). The brake pedal will pulsate several times and a sound may be audible from the ABS control module. This is normal.

Fuel filler door

Press the button on the light switch panel (see [page 37](#)) when the car is at a standstill to unlock the fuel filler door. Please note that the fuel filler door will remain unlocked until the car begins to move forward. An audible click will be heard when the fuel filler door relocks.

Fuel filler cap

After refueling, close the fuel filler cap by turning it clockwise until it *clicks* into place. If this cap is not closed tightly or if the engine is running when the car is refueled, the Malfunction Indicator Lamp ("Check Engine" light) may indicate a fault.

WARNING! If your vehicle is involved in an accident, unseen damage may affect your vehicle's driveability and safety.

Important

Before you operate your car for the first time, please familiarize yourself with the new-engine oil consumption information on [page 159](#). You should also be familiar with the information in chapters one, two and four of this manual.

Information contained in the balance of the manual is extremely useful and should be read after operating the vehicle for the first time.

The manual is structured so that it can be used for reference. For this reason, it should be kept in the car for ready access. Do not export your Volvo to another country before investigating that country's applicable safety and exhaust emission requirements. In some cases it may be difficult or impossible to comply with these requirements. Modifications to the emission control system(s) may render your Volvo not certifiable for legal operation in the U.S., Canada and other countries.

All information, illustrations and specifications contained in this manual are based on the latest product information available at the time of publication. Please note that some vehicles may be equipped differently, depending on special legal requirements and that optional equipment described in this manual may not be available in all markets.

Volvo reserves the right to make model changes at any time, or to change specifications or design, without notice and without incurring obligation.

CALIFORNIA Proposition 65 Warning

WARNING! Engine exhaust, some of its constituents, and certain vehicle components contain or emit chemicals known to the state of California to cause cancer, and birth defects or other reproductive harm. In addition, certain fluids contained in vehicles and certain products of component wear contain or emit chemicals known to the State of California to cause cancer, and birth defects or other reproductive harm.

Volvo and the environment

Volvo is committed to the well being of our customers. As a natural part of this commitment, we care about the environment in which we all live. Caring for the environment means an everyday involvement in reducing our environmental impact.

Volvo's environmental activities are based on a holistic view, which means we consider the overall environmental impact of a product throughout its complete life cycle. In this context, design, production, product use, and recycling are all important considerations. In production, Volvo has partly or completely phased out several chemicals including freons, lead chromates, naphtanates, asbestos, mercury and cadmium; and reduced the amount of chemicals used in our plants 50% since 1991.

In use, Volvo was the first in the world to introduce into production a three-way catalytic converter with a Lambda sond, now called oxygen sensor, in 1976. The current version of this highly efficient system reduces emissions of harmful substances (CO, HC, NOx) from the exhaust pipe by approximately 95% and the search to eliminate the remaining emissions continues. Volvo is the only automobile manufacturer to offer CFC-free retrofit kits for the air conditioning system for all models as far back as the M/Y 1975 240. Advanced electronic engine controls, refined

purification systems and cleaner fuels are bringing us closer to our goal.

After Volvo cars and parts have fulfilled their use, recycling is the next critical step in completing the life cycle. The metal content is about 75% of the total weight of a car, which makes the car among the most recycled industrial products. In order to have efficient and well controlled recycling, many Volvo variants have printed dismantling manuals, indicating the weight and material of individual components. For Volvo, all homogeneous plastic parts weighing more than 1.7 oz. (50 grams) are marked with international symbols that indicate how the component is to be sorted for recycling.

In addition to continuous environmental refinement of conventional gasoline-powered internal combustion engines, Volvo is actively looking at advanced technology alternative-fuel vehicles. When you drive a Volvo, you become our partner in the work to lessen the car's impact on the environment.

To reduce your vehicle's environmental impact, you can:

- Maintain proper air pressure in your tires. Tests have shown decreased fuel economy with improperly inflated tires
- Follow the recommended maintenance schedule in your Warranty and Service Records Information booklet.
- Drive at a constant speed
- See an authorized Volvo retailer as soon as possible for inspection if the check engine (malfunction indicator) lamp illuminates, or stays on after the vehicle has started
- Properly dispose of any vehicle related waste such as used motor oil, used batteries, brake pads, etc.
- When cleaning your car, use Volvo's own car care products, all of which have systematically been adapted to the environment

PremAir®

On the surface of the radiator in the engine compartment, there is a special coating called PremAir®. PremAir® works as a catalytic converter, converting most of the ozone passing through the radiator into oxygen, thereby reducing harmful ground-level ozone. PremAir is a registered trademark of Engelhard Corporation.



[Top of Page](#)

2006 VOLVO V70

Chapter 1 - Safety

pg. 1 Safety

[Occupant safety](#) 2

[Seat belts](#) 3

[Supplemental Restraint System \(SRS\)](#) 5

[Front airbags](#) 6

[Occupant weight sensor \(OWS\)](#) 9

[Side impact \(SIPS\) airbags](#) 12

[Volvo Inflatable Curtain \(VIC\)](#) 13

[Inspecting SRS system components](#) 14

[Whiplash Protection System \(WHIPS\)](#) 15

[Child safety](#) 17

pg. 2 Seat belts

Volvo Concern for Safety

Safety is the Volvo cornerstone. Our concern dates back to 1927 when the first Volvo rolled off the production line. Three-point seat belts (a Volvo invention), safety cages, and energy-absorbing impact zones were designed into Volvo cars long before it was fashionable or required by government regulation. We will not compromise our commitment to safety. We continue to seek out new safety features and to refine those already in our cars. You can help. We would appreciate hearing your suggestions about improving automobile safety. We also want to know if you ever have a safety concern with your car. Call us in the U.S. at: 800-458-1552 or in Canada at: 800-663-8255.

Occupant safety

How safely you drive doesn't depend on how old you are but rather on:

- How well you see.
- Your ability to concentrate.
- How quickly you make decisions under stress to avoid an accident.

The tips listed below are suggestions to help you cope with the ever changing traffic environment.

- Never drink and drive.
- If you are taking any medication, consult your physician about its potential effects on your driving abilities.

- Take a driver-retraining course
- Have your eyes checked regularly
- Keep your windshield and headlights clean.
- Replace wiper blades when they start to leave streaks.
- Take into account the traffic, road, and weather conditions, particularly with regard to stopping distance.

Reporting Safety Defects in the U.S.

If you believe that your vehicle has a defect which could cause a crash or could cause injury or death, you should immediately inform the National Highway Traffic Safety Administration (NHTSA) in addition to notifying Volvo Cars of North America. If NHTSA receives similar complaints, it may open an investigation, and if it finds that a safety defect exists in a group of vehicles, it may order a recall and remedy campaign. However, NHTSA cannot become involved in individual problems between you, your retailer, or Volvo Cars of North America. To contact NHTSA, you may either call the Auto Safety Hotline toll-free at 1-800-424-9393 (or 202-366-0123 in Washington, D.C. area) or write to: NHTSA, U.S. Department of Transportation, Washington D.C. 20590. You can also obtain other information about motor vehicle safety from the Hotline. Volvo strongly recommends that if your vehicle is covered under a service campaign, safety or emission recall or similar action, it should be completed as soon as possible. Please check with your local retailer or Volvo Cars of North America, LLC. if your vehicle is covered under these conditions.

NHTSA can be reached at:

Internet : <http://www.nhtsa.dot.gov>

Telephone:

1-888-DASH-2-DOT (1-888-327-4236) (toll free)

1-800-424-9393 (toll free)

1-202-366-0123 (in Washington DC area)

pg. 3 Seat belts

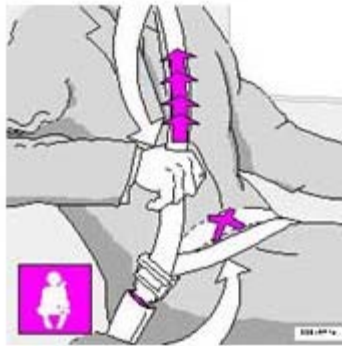

Adjusting the seat belt

Using seat belts

Volvo, the inventor of the three-point seat belt, urges you and all occupants of your vehicle to wear seat belts and ensure that children are properly restrained, using an infant, car, or booster seat determined by age, weight and height.

Volvo also believes no child should sit in the front seat of a vehicle. Most states and provinces make it mandatory for occupants of a vehicle to use seat belts.

Seat belt tensioners

The seat belts are equipped with tensioners that reduce slack in the belts. These tensioners are triggered in situations where the airbags deploy. The front seat belts also include a tension reducing device which, in the event of a collision, limits the peak forces exerted by the seat belt on the occupant.

Buckling a seat belt

Pull the belt out far enough to insert the latch plate into the receptacle until a distinct click is heard. The seat belt

retractor is normally "unlocked" and you can move freely, provided that the shoulder belt is not pulled out too far. The retractor will lock up as follows:

- if the belt is pulled out rapidly
- during braking and acceleration
- if the vehicle is leaning excessively
- when driving in turns

When wearing the seat belt remember:

- The belt should not be twisted or turned.
- The lap section of the belt must be positioned low on the hips (not pressing against the abdomen).
- Make sure that the shoulder belt is rolled up into its retractor and that the shoulder and lap belts are taut.

Unbuckling the seat belt

To remove the seat belt, press the red section on the seat belt receptacle. Before exiting the vehicle, check that the seat belt retracts fully after being unbuckled. If necessary, guide the belt back into the retractor slot.

Seat belt reminder

The seat belt reminder consists of an audible signal, an indicator light above the rearview mirror, and a symbol in the instrument panel that alert the driver and front seat passenger if their seat belts are not fastened.



Sample label on all seat belts with tensioners

Seat belt maintenance

Check periodically that the seat belts are in good condition. Use water and a mild detergent for cleaning. Check seat belt mechanism function as follows: attach the seat belt and pull rapidly on the strap.

WARNING!

- Never use a seat belt for more than one occupant.
- Never wear the shoulder portion of the belt under the arm, behind the back or otherwise out of position. Such use could cause injury in the event of an accident.
- Seat belts lose much of their strength when exposed to violent stretching and should be replaced after any collision, even if they appear to be undamaged.
- Never repair the belt yourself; have this work done by an authorized Volvo service technician only.
- Any device used to induce slack into the shoulder belt portion of the three-point belt system will have a detrimental effect on the amount of protection available to you in the event of a collision.
- The seat back should not be tilted too far back. The shoulder belt must be taut in order to function properly.
- Do not use child safety seats or child booster cushions/backrests in the front passenger's seat. We also recommend that children who have outgrown these devices sit in the rear seat with the seat belt properly fastened.

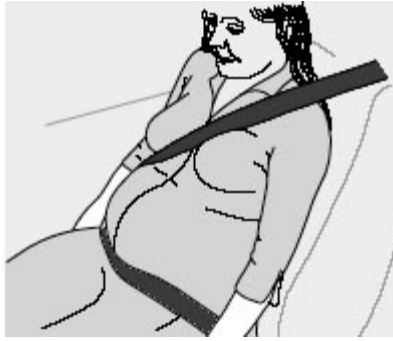

Seat belt use during pregnancy

Seat belt use during pregnancy

The seat belt should always be worn during pregnancy. But it is crucial that it be worn in the correct way. The diagonal section should wrap over the shoulder then be routed between the breasts and to the side of the belly. The lap section should lay flat over the thighs and as low as possible under the belly. It must never be allowed to ride upward. Remove all slack from the belt and insure that it fits close to the body without any twists. As a pregnancy progresses, pregnant drivers should adjust their seats and steering wheel such that they can easily maintain control of the vehicle as they drive (which means they must be able to easily operate the foot pedals and steering wheel). Within this context, they should strive to position the seat with as large a distance as possible between their belly and the steering wheel.

Child seats

Please refer to [page 21](#) for information on securing child seats with the seat belts.

pg. 5 Supplemental Restraint System (SRS)



SRS warning light

Supplemental Restraint System

As an enhancement to the three-point seat belts, your Volvo is equipped with a Supplemental Restraint System (SRS). Volvo's SRS consists of seat belt tensioners, front airbags, side impact airbags, the occupant weight sensor, and inflatable curtains. All of these systems are monitored by the SRS control module. An SRS warning light in the instrument panel (see the illustration above) illuminates when the ignition key is turned to position I, II, or III, and will normally go out after approximately 7 seconds if no faults are detected in the system.

Where applicable, a text message will also be displayed when the SRS warning light illuminates. If this warning symbol is not functioning properly, the general warning symbol  illuminates and a text message will be displayed.

WARNING!

- If the SRS warning light stays on after the engine has started or if it illuminates while you are driving, have the vehicle inspected by a trained and qualified Volvo service technician as soon as possible.
- Never try to repair any component or part of the SRS yourself. Any interference in the system could cause malfunction and serious injury. All work on these systems should be performed by an authorized Volvo service technician.

WARNING!

If your vehicle has been subjected to flood conditions (e.g. soaked carpeting/standing water on the floor of the vehicle) or if your vehicle has become flood-damaged in any way, do not attempt to start the vehicle or put the key in the ignition before disconnecting the battery (see below). This may cause airbag deployment which could result in personal injury. Have the vehicle towed to a trained and qualified Volvo service technician for repairs.

Automatic transmission:

Before attempting to tow the vehicle, use the following procedure to override the shiftlock system to move the gear selector to the neutral position:

- Switch off the ignition for at least 10 minutes and disconnect the battery
- Wait at least one minute.
- Insert the key in the ignition and turn it to position II.
- Press firmly on the brake pedal.
- Move the gear selector from (P)ark to the (N)eutral position.

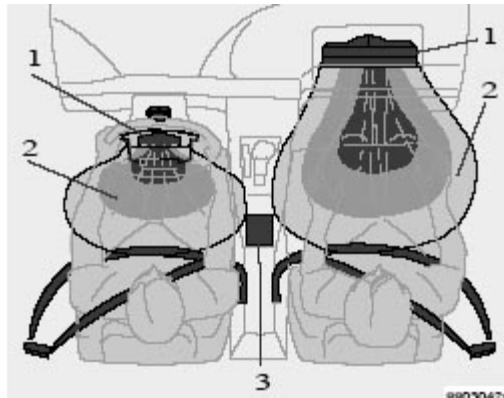

The front airbag system

The front airbags supplement the three-point seat belts. For these airbags to provide the protection intended, seat belts must be worn at all times.

The front airbag system includes gas generators (1) surrounded by the airbags (2) and a deceleration sensor (3) that activates the gas generators, causing the airbags to be inflated with nitrogen gas.

As the movement of the seats' occupants compresses the airbags, some of the gas is expelled at a controlled rate to provide better cushioning. Both seat belt tensioners also deploy, minimizing seat belt slack. The entire process, including inflation and deflation of the airbags, takes approximately one fifth of a second.

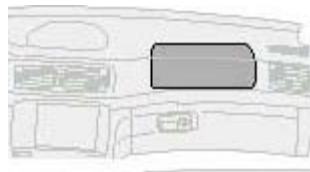

*Passenger's side airbag - above
glove compartment*

The location of the front airbags is indicated by "SRS AIRBAG" embossed on the steering wheel pad and above the glove compartment, and by decals on both sun visors and on the front and far right side of the dash.

- The driver's side front airbag is folded and located in the steering wheel hub.
- The passenger's side front airbag is folded behind a panel located above the glove compartment.

WARNING!

- The airbags in the vehicle are designed to be a SUPPLEMENT to-not a replacement for-the three-point seat belts. For maximum protection, wear seat belts at all times. Be aware that no system can prevent all possible injuries that may occur in an accident.
- Never drive a vehicle with a steering wheel-mounted airbag with your hands on the steering wheel pad/airbag housing.
- The front airbags are designed to help prevent serious injury. Deployment occurs very quickly and with considerable force. During normal deployment and depending on variables such as seating position, one may experience abrasions, bruises, swellings, or other injuries as a result from deployment of one or both of the airbags.
- When installing any accessory equipment, make sure that the front airbag system is not damaged. Any interference in the system could cause malfunction.

pg. 7 Front airbags

Front airbag deployment

- The front airbags are designed to deploy during certain frontal or front-angular collisions, impacts, or decelerations, depending on the crash severity, angle, speed and object impacted. The airbags may also deploy in certain non-frontal collisions where rapid deceleration occurs.
- The SRS sensors, which trigger the front airbags, are designed to react to both the impact of the collision and the inertial forces generated by it, and to determine if the intensity of the collision is sufficient for the seat belt tensioners and/or airbags to be deployed.

However, not all frontal collisions activate the front airbags.

- If the collision involves a nonrigid object (e.g., a snow drift or bush), or a rigid, fixed object at a low speed, the front airbags will not necessarily deploy.
- Front airbags do not normally deploy in a side impact collision, in a collision from the rear or in a rollover situation.
- The amount of damage to the bodywork does not reliably indicate if the airbags should have deployed or not.

NOTE:

- Deployment of front airbags occurs only one time during an accident. In a collision where deployment occurs, the airbags and seat belt tensioners activate. Some noise occurs and a small amount of powder is released. The release of the powder may appear as smoke-like matter. This is a normal characteristic and does not indicate fire.
- Volvo's dual-threshold, dual-stage front airbags use special sensors to control deployment. The point at which the airbag deploys is determined by whether or not the seat belt is being used, as well as the severity of the collision.
- Collisions can occur where only one of the airbags deploys. If the impact is less severe, but severe enough to present a clear injury risk, the dual-stage airbags are triggered at 70-80% of their total capacity. If the impact is more severe, the dual-stage airbags are triggered at full capacity.

Should you have questions about any component in the SRS system, please contact a trained and qualified Volvo service technician or Volvo Customer Support:

In the USA:

Volvo Cars of North America
Customer Care Center
P.O. Box 914

Rockleigh, New Jersey 07647-0914
800-458-1552
<http://www.volvocars.us>

In Canada:

Volvo Cars of Canada Ltd.
National Customer Service
175 Gordon Baker Road
North York, Ontario M2H 2N7
800-663-8255
<http://www.volvocanada.com>

WARNING!

- Do not use child safety seats or child booster cushions/backrests in the front passenger's seat. We also recommend that occupants under 4 feet 7 inches (140 cm) in height who have outgrown these devices sit in the rear seat with the seat belt fastened¹.
- Never drive with the airbags deployed. The fact that they hang out can impair the steering of your vehicle. Other safety systems can also be damaged.
- The smoke and dust formed when the airbags are deployed can cause skin and eye irritation in the event of prolonged exposure.

¹ See also the Occupant Weight Sensor information on [page 11](#).

pg. 8 Front airbags



Airbag decal on outside of both sun visors



SRS decal at far right of the passenger's dashboard



WARNING!

- Children must never be allowed in the front passenger's seat. Volvo recommends that ALL occupants (adults and children) shorter than 4 feet 7 inches (140 cm) be seated in the back seat of any vehicle with a passenger-side front airbag. See [page 21](#) for guidelines.
- Occupants in the front passenger's seat must never sit on the edge of the seat, sit leaning toward the instrument panel or otherwise sit out of position.
- The occupant's back must be as upright as comfort allows and be against the seat back with the seat belt properly fastened.
- Feet must be on the floor, e.g., not on the dash, seat or out of the window.

WARNING!

- No objects or accessory equipment, e.g. dashboard covers, may be placed on, attached to, or installed near the air bag hatch (the area above the glove compartment) or the area affected by airbag deployment (see the illustration on [page 6](#)).
- There should be no loose articles, e.g. coffee cups, on the floor, seat, or dashboard area.
- Never try to open the airbag cover on the steering wheel or the passenger's side dashboard. This should only be done by a trained and qualified Volvo service technician.

Failure to follow these instructions can result in injury to the vehicle occupants.

pg. 9 Occupant Weight Sensor (OWS)

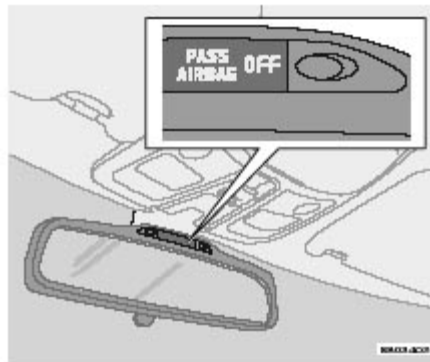

Occupant Weight Sensor (OWS) indicator light

Disabling the passenger's side front airbag

Volvo recommends that ALL occupants (adults and children) shorter than four feet seven inches (140 cm) be seated in the back seat of any vehicle with a front passenger side airbag, and be properly restrained for their size and weight. See also the child safety recommendations on [page 21](#).

The passenger's side front airbag is automatically enabled/disabled by the Occupant Weight Sensor (OWS), a system that monitors the weight of the person or object in the front passenger's seat. The system consists of a silicone-filled bag located under the padding in the front passenger's seat cushion, a control module located under this seat, and a seat belt tension sensor, located on the outboard side of the seat.

The OWS system continuously monitors the pressure on the front passenger's seat cushion and the tension applied to the seat belt. Based on this data, OWS assesses the weight of the occupant or object in the front passenger's seat. This information is transmitted to the SRS system control module, which enables or disables the passenger's side front airbag accordingly, as indicated in the table below.

If the system is functioning normally, the status of the front passenger's side airbag (enabled/disabled) will be shown by the OWS indicator light as explained in the table to the right. The OWS indicator light is separate and in addition to the SRS warning light in the instrument panel.

NOTE: When the ignition is switched on, the OWS indicator light will go on for up to 10 seconds while the system performs a self-diagnostic test and then go out.

However, if a fault is detected in the system:

- The OWS indicator light will stay on
- The SRS warning light (see [page 5](#)) will come on and stay on
- The message **PASS. AIRBAG OFF SERVICE URGENT** will be displayed in the information display.

Passenger's Seat occupancy status	OWS Indicator light status	Passenger's side front airbag status
Seat unoccupied/ person or object weighing less than approx. 15 lbs (7 kg) on seat	OWS indicator light PASS AIRBAG OFF is not lit	Passenger's side front airbag disabled
Seat occupied by a person or object weighing up to approx. 55-65 lbs (25-30 kg)	OWS indicator light PASS AIRBAG OFF lights up	Passenger's side front airbag disabled
Seat occupied by a person or object weighing more than approx. 55-65 lbs (25-30 kg)	OWS indicator light PASS AIRBAG OFF is not lit	Passenger's side front airbag enabled

(contd. on following page)

pg. 10 Occupant Weight Sensor (OWS)

WARNING!

If a fault in the system is detected and indicated as explained on the previous page, be aware that the passenger's

side front airbag will not deploy in the event of a collision.

In this case, the safety systems and Occupant Weight Sensor should be inspected by an authorized Volvo retailer as soon as possible.

Modifications

If you are considering modifying your vehicle in any way to accommodate a disability, for example by altering or adapting the driver's or front passenger's seat(s) and/or airbag systems, please contact Volvo at:

In the USA:

Volvo Cars of North America
Customer Care Center
P.O. Box 914
Rockleigh, New Jersey 07647-0914
800-458-1552

In Canada:

Volvo Cars of Canada Ltd.
National Customer Service
175 Gordon Baker Road
North York, Ontario M2H 2N7
800-663-8255

WARNING!

- No objects that add to the total weight on the seat should be placed on the front passenger's seat. If a child is seated in the front passenger's seat with any additional weight, this extra weight could cause the OWS system to enable the airbag, which might cause it to deploy in the event of a collision, thereby injuring the child.
- The seat belt should never be wrapped around an object on the front passenger's seat. This could interfere with the OWS system's function.
- The front passenger's seat belt should never be used in a way that exerts more pressure on the passenger than normal. This could increase the pressure exerted on the weight sensor by a child, and could result in the airbag being enabled, which might cause it to deploy in the event of a collision, thereby injuring the child.

WARNING!

- Never try to open, remove, or repair any components in the OWS system. This could result in system malfunction. Maintenance or repairs should only be carried out by an authorized Volvo service technician.
- The front passenger's seat should not be modified in any way. This could reduce pressure on the seat cushion, which might interfere with the OWS system's function.

pg. 11 Occupant Weight Sensor (OWS)

WARNING!

Keep the following points in mind with respect to the OWS system. Failure to follow these instructions could adversely affect the system's function and result in serious injury to the occupant of the front passenger's seat:

- The full weight of the front seat passenger should always be on the seat cushion. The passenger should never lift him/herself off the seat cushion using the armrest in the door or the center console, by pressing the feet on the floor, by sitting on the edge of the seat cushion, or by pressing against the backrest in a way that reduces pressure on the seat cushion. This could cause OWS to disable the front passenger's side airbag.
- Do not place any type of object on the front passenger's seat in such a way that jamming, pressing, or squeezing

occurs between the object and the front seat, other than as a direct result of the correct use of the ALR/ELR seat belt (see [page 21](#)).

- No objects should be placed under the front passenger's seat. This could interfere with the OWS system's function.

pg. 12 Side impact (SIPS) airbags



Location of the side impact (SIPS) airbag

Side impact airbags - front seats only

As an enhancement to the structural side impact protection built into your car, the car is also equipped with Side Impact Protection System (SIPS) airbags.

The SIPS airbag system is designed to help increase occupant protection in the event of certain side impact collisions. The SIPS airbags are designed to deploy only during certain side-impact collisions, depending on the crash severity, angle, speed and point of impact.

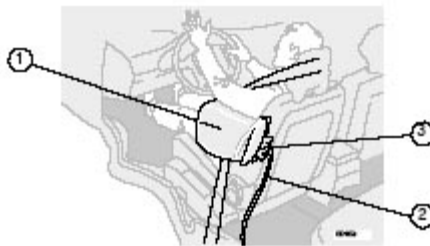

NOTE: SIPS airbag deployment (one airbag) occurs only on the side of the vehicle affected by the impact. The airbags are not designed to deploy in all side impact situations.

Components in the SIPS airbag system

This SIPS airbag system consists of a gas generator (1), the side airbag modules built into the outboard sides of both front seat backrests (2), and electronic sensors/wiring (3).

WARNING!

- The SIPS airbag system is a supplement to the structural Side Impact Protection System and the three-point seat belt system. It is not designed to deploy during collisions from the front or rear of the car or in rollover situations.
- The use of seat covers on the front seats may impede SIPS airbag deployment.
- No objects, accessory equipment or stickers may be placed on, attached to or installed near the SIPS airbag system or in the area affected by SIPS airbag deployment.
- Never try to open or repair any components of the SIPS airbag system. This should be done only by a trained and qualified Volvo service technician.

- In order for the SIPS airbag to provide its best protection, both front seat occupants should sit in an upright position with the seat belt properly fastened.
 - Failure to follow these instructions can result in injury to the occupants of the vehicle in the event of an accident.
-



[Contents](#) | [Top of Page](#)

2006
VOLVO
V70

Chapter 2 - Instruments, switches and controls

pg. 23 Instruments, switches and controls

<u>Interior</u>	<u>24</u>
<u>Exterior</u>	<u>25</u>
<u>Instruments</u>	<u>26</u>
<u>Instrument panel</u>	<u>27</u>
<u>Indicator and warning lights</u>	<u>28</u>
<u>Text information window</u>	<u>30</u>
<u>Switches in the center console</u>	<u>31</u>
<u>Trip computer</u>	<u>32</u>
<u>Cruise control</u>	<u>33</u>
<u>Lighting panel</u>	<u>35</u>
<u>Steering wheel adjustment/lock, Ignition switch</u>	<u>36</u>
<u>Left-side steering wheel lever</u>	<u>37</u>
<u>Right-side steering wheel lever</u>	<u>38</u>
<u>Tailgate wipers/washers, Water repellent glass</u>	<u>39</u>
<u>Warning flashers, heated mirrors/rear window, heated front seats</u>	<u>40</u>
<u>Parking brake, auxiliary socket/ashtrays</u>	<u>41</u>
<u>Electrically operated windows</u>	<u>42</u>
<u>Rearview/sideview mirrors</u>	<u>43</u>
<u>Power moonroof</u>	<u>44</u>
<u>Sun visor</u>	<u>45</u>

pg. 24 Interior

Electrically operated windows	42
Sideview mirror controls	43
Locking and unlocking the car	83
Alarm	84

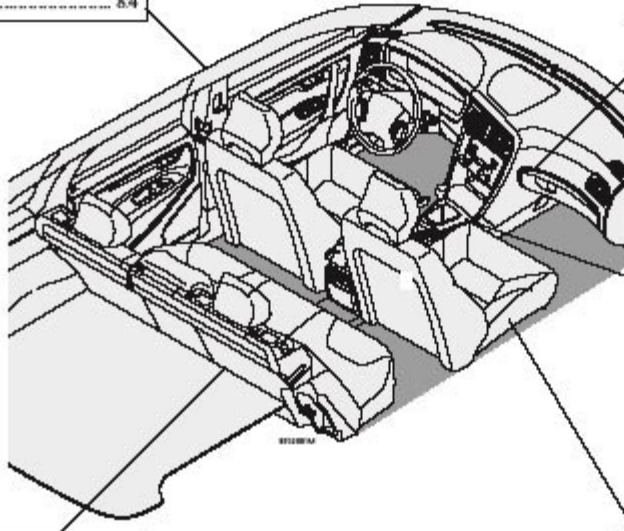

Glove compartment	61
-------------------------	----

Center console switches	31
Parking brake	41
Manual transmission.....	93
Automatic transmission	94

Adjusting head restraint.....	66
Integrated booster cushions	19
Folding rear seat	65
Child safety locks	86

Heated seats (option)	40
Power seat adjustment	58
Cleaning upholstery	151

pg. 25 Exterior

Moonroof (option)	44
Paint touch-up	148
Washing the car	149
Replacing a low beam	142
Replacing a high beam	142
Replacing a parking light	143
Replacing a front turn signal	143
Replacing a front fog light	144
Replacing a headlight wiper	164
Brake system	113
Tires	118
Wheels	118
Spare tire	131
Changing wheels	132
Fuel filler door	90
Refueling	90
Economical driving	101
Replacing a back-up light	145
Replacing a brake light.....	145
Replacing a tail light.....	145
Replacing a rear turn signal	145
Replacing a rear fog light	145
Replacing license plate lights	146

pg. 26 Instruments

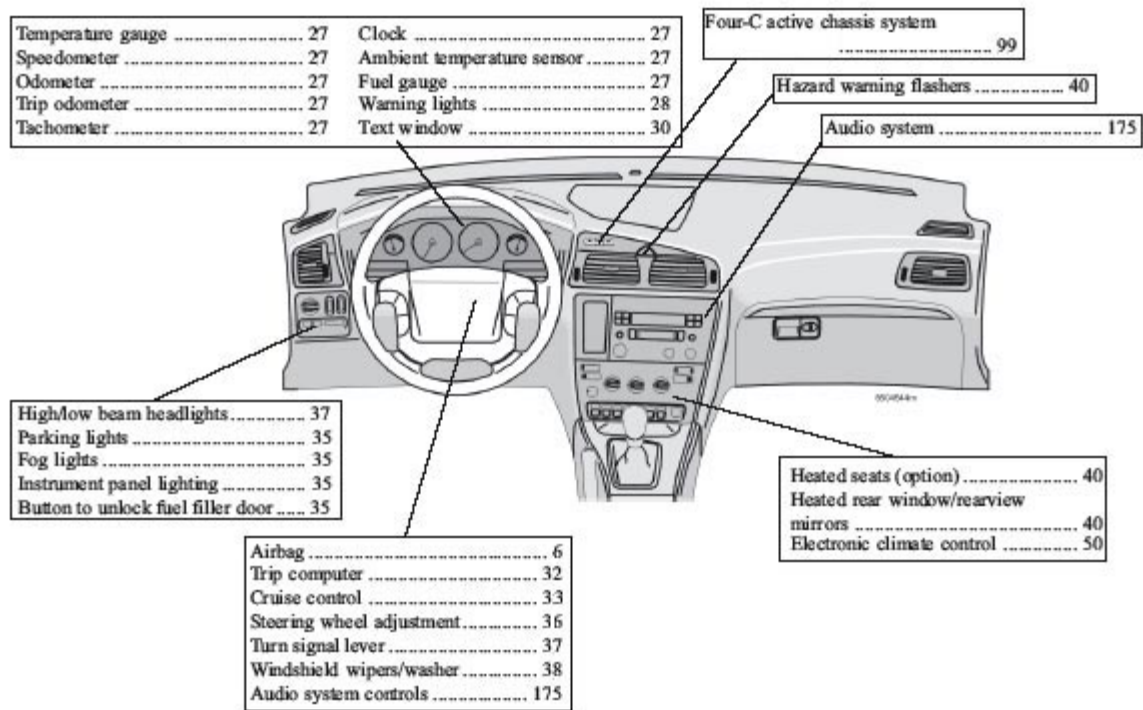

pg. 27 Instrument panel

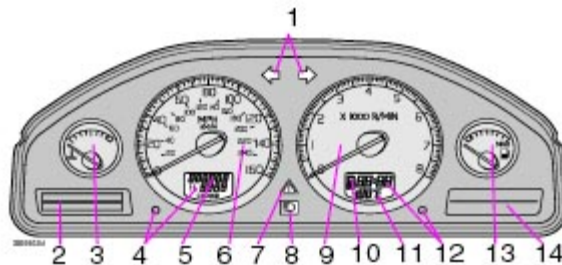

1 Turn signals

2 Text window

3 Temperature gauge

The pointer should be approximately midway on the gauge when driving.

Do not drive the car if the warning light is on. The text window will provide you with additional information.

If the engine temperature remains high, check coolant level - see [page 154](#).

4 Trip odometer/reset button

The trip odometer is used for measuring shorter distances. The last digit indicates 1/10 mile/kilometer. Press the button quickly to toggle between trip odometers 1 and 2. Hold in the button for more than 2 seconds to reset.

5 Odometer

6 Speedometer

7 General warning light (see [page 28](#)).

8 High beam indicator light

9 Tachometer

Indicates engine speed in thousands of rpm. Do not drive for long with the needle in the red section. The engine has an built-in function preventing too high engine speed. When this function operates, you may discern some pulsation, which is normal.

10 Gear and driving mode indicator

The currently selected driving mode is displayed here. If you use the Geartronic function on the automatic transmission, the currently selected gear will be displayed.

11 Ambient temperature indicator

This display indicates the air temperature outside your car. A "snowflake" symbol in the text window is displayed when the temperature is in the range of 23 - 36° F (-5 - +2° C).

Please note that this symbol does not indicate a fault with your car.

At low speeds or when the car is not moving, the temperature readings may be slightly higher than the actual ambient temperature.

12 Clock/reset button

Turn the button to adjust the clock.

13 Fuel gauge

The fuel tank holds approximately:

Front wheel drive, non-turbo models - 18.5 US gal. (70 liters)

All turbo models - 18 US gal. (68 liters)

When the warning light comes on there are approximately 1.8 US gal. (8 liters) of fuel remaining.

14 Indicator and warning lights

pg. 28 Indicator and warning lights

*The indicator and warning lights described on [pages 28 and 29](#) should never stay on when driving**

When the ignition key is turned, all of the warning lights in the lower right-hand side of the instrument panel should go on to test the function of the bulbs. If a light does not go off after the engine has started, the system indicated should be inspected.

NOTE: The parking brake reminder light will not go off until the parking brake has been fully released.

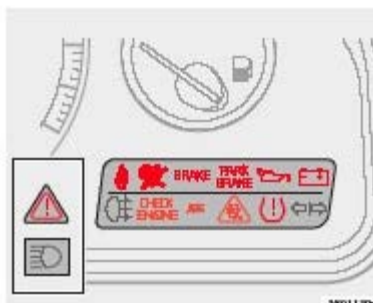

Warning lamp in the center of the instrument panel

This lamp lights up **red** or **yellow** depending on the severity of the fault that has been detected.

Red symbol - Stop the vehicle as soon as possible in a suitable location and read the message shown in the text window. The symbol and accompanying text will remain on until the fault has been corrected.

Yellow symbol - Follow the instructions shown in the text window. The text can be erased by pressing the READ button (see [page 30](#)), or will disappear automatically after two minutes.

NOTE: When the message "TIME FOR REGULAR SERVICE" is displayed, the text can be erased and the yellow symbol light can be turned off by pressing the READ button. The text will disappear and the symbol light will go out automatically after two minutes.

BRAKE

Brake failure warning light

If the light comes on while driving or braking, stop immediately, open the hood and check the brake fluid level in the reservoir. See [page 158](#) for the location of the reservoir.

Canadian models are equipped with this warning light: 



Oil pressure warning light

If the light comes on while driving, **stop the car and then stop the engine immediately and check the engine oil level.** R-models are also equipped with an oil level warning system. See [page 160](#). If the light stays on after restart, have the car towed to the nearest authorized Volvo retailer. After hard driving, the light may come on occasionally when the engine is idling. This is normal, provided it goes off when the engine speed is increased.

Parking Brake

Parking brake reminder light

This light will be on when the parking brake (hand brake) is applied. The parking brake lever is situated between the front seats.

Canadian models are equipped with this warning light: 



Generator warning light

If the light comes on while the engine is running, have the charging system checked.

* Rear fog light, if used, and trailer turn signal, if towing a trailer, will go on while driving.



Rear fog light

This light indicates that the rear fog light is on.

CHECK ENGINE

Malfunction indicator lamp

On-Board Diagnostic II (OBDII): As you drive, a computer called "OBDII" monitors your car's engine, transmission, electrical and emission systems. The CHECK ENGINE light will light up if the computer senses a condition that potentially may need correcting. When this happens, please have your car checked by a Volvo retailer as soon as possible.

A CHECK ENGINE light may have many causes. Sometimes, you may not notice a change in your car's behavior. Even so, an uncorrected condition could hurt fuel economy, emission cleanliness, and driveability. Extended driving without correcting the cause could even damage other components in your car.

Canadian models are equipped with this warning light: 

NOTE: If the fuel filler cap is not closed tightly or if the engine is running when the car is refueled, the Malfunction Indicator Lamp may indicate a fault. However, your vehicle's performance will not be affected. Use only Volvo original or approved fuel filler caps.



Anti-lock Brake System ABS

If the warning light comes on, there is a malfunction of the ABS system (the standard braking system will still function). The vehicle should be driven to a Volvo retailer for inspection. See [page 114](#) for additional information.



Stability Traction Control (STC) system (option), or Dynamic Stability and Traction Control (DSTC) system (option)

An indicator light will flash when STC or DSTC is actively working to stabilize the car. See [pages 115-116](#) for more detailed information.



Turn signal indicator - trailer (certain models)

If you are towing a trailer, this light will flash simultaneously with the turn signals on the trailer. If the light does not flash when signaling, neither the trailer's turn signals nor the car's turn signals are functioning.



Seat belt reminder

This symbol lights up to indicate that the driver has not fastened his/her seat belt.



Tire pressure warning light

See [page 123](#) for more information on this function.



Supplemental Restraint System (SRS)

If this light comes on while the car is being driven, or remains on for longer than approximately 10 seconds after the car has been started, the SRS system's diagnostic functions have detected a fault in a seat belt lock or tensioner, a front airbag, side impact airbag, and/or an inflatable curtain. Have the system(s) inspected by a trained and qualified Volvo service technician as soon as possible.

pg. 30 Text information window

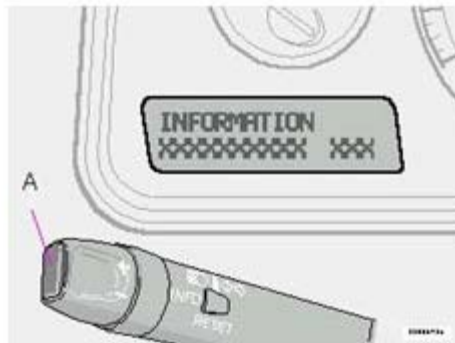

Messages in the text window

When a warning light in the instrument panel comes on, a message is also displayed in the text window. After you have read the message, you can erase it by pressing button A (see illustration above).

NOTE: Certain messages cannot be erased until the condition has been corrected.

Warning messages override text messages from any car feature that also uses the text window. A warning message must be acknowledged (erased) before you can access the feature of your choice. Press button A to erase the warning message.

Erased messages are stored in the system's memory until the required action has been taken. You can scroll through the stored messages by pressing button A. The text window can be cleared (the message will be returned to memory) by pressing button A again.

General messages

STOP SAFELY: Stop and switch off the engine - to help prevent serious risk of damage.

STOP ENGINE: Stop and switch off the engine - to help prevent serious risk of damage.

SERVICE URGENT: Take your car to a trained and qualified Volvo service technician for inspection immediately.

SEE MANUAL: Refer to your owner's manual. For additional information, please contact your Volvo retailer.

SERVICE REQUIRED: Take your car to a trained and qualified Volvo service technician for inspection as soon as possible (but preferably before the next scheduled maintenance service).

FIX NEXT SERVICE: Have the system affected inspected at the next scheduled maintenance service.

TIME FOR REGULAR SERVICE: This light will come on at 7,500 mile (12,000 km) intervals, after 750 hours of driving or after 12 months, whichever occurs first, to remind the driver that the service interval has been exceeded. The

light will stay on for 2 minutes after start until reset by the servicing retailer.

1) **OIL LEVEL LOW/FILL OIL*** Check the oil level and top up if necessary. See [page 160](#).

2) **OIL LEVEL LOW/STOP SAFELY*** Stop as soon as possible and switch off the engine, check the oil level and top up if necessary. See [page 160](#).

2) **OIL LEVEL LOW/STOP ENGINE*** Stop as soon as possible and switch off the engine, check the oil level and top up if necessary. See [page 160](#).

2) **OIL LEVEL LOW/SEE MANUAL*** Stop as soon as possible and switch off the engine, check the oil level and top up if necessary. See [page 160](#).

* These messages apply to R-models only.

1) Orange warning triangle, see [page 28](#).

2) Red warning triangle, see [page 28](#).

pg. 31 Switches in the center console

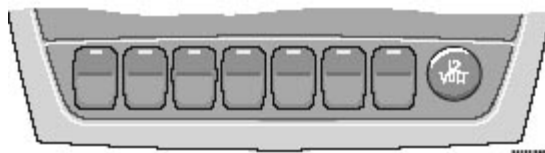

The positions of these buttons may vary, depending on the specifications of your car

Stability Traction Control (STC)*/ Dynamic Stability Traction Control (DSTC)**



Press this switch to turn the Spin Control (SC) function of the STC/DSTC system on or off. To help reduce the risk that the SC function is turned off inadvertently, the switch must be held in for at least half a second to disable this function.

See [pages 115-116](#) for more information. R-models only:

The Active Yaw Control function can also be deactivated. See [page 115](#) for more information.

WARNING!

Please be aware that the car's handling characteristics may be affected if the Spin Control/Active Yaw Control functions are switched off.



Disconnecting the alarm

This button is used to temporarily disconnect alarm sensors. See [page 85](#) for further information



Auxiliary socket

This 12 volt socket can be used to plug in certain accessories. The ignition key must be in position 1 (or higher) for the auxiliary socket to function. See also [page 41](#) for more information.



Front/rear park assist (option/accessory)

See [page 100](#) for more information on this function.

Four-C active chassis system: R models only

Please see [page 99](#) for information on adjusting the active chassis settings.



Power child locks (option)

See [page 86](#) for more information on this function.



Four-C active chassis system (option)

See [page 99](#) for information on this function.

* Standard on all models except R-models.

** Standard on R-models, optional on all other models.

pg. 32 Trip computer (option)

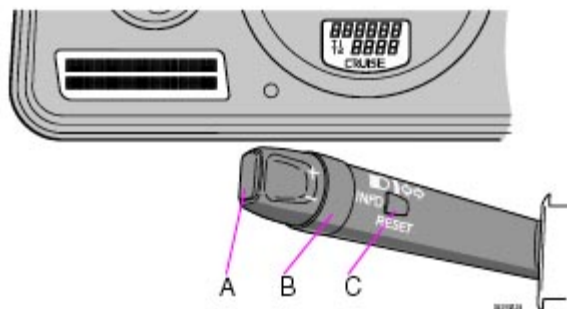

Trip computer

The trip computer stores information gathered from several systems in your car and has four menus that can be displayed in the text window.

- Driving distance on current fuel reserve
- Average fuel consumption
- Current fuel consumption
- Average speed
- Current speed in mph (Canadian models only)

NOTE: Warning messages from the car's monitoring systems will override the trip computer function. If a warning message is displayed in the text window while you are using the trip computer, you must acknowledge the message by pressing button A. Press button A again to return to the trip computer function.

Trip computer controls and functions

The four* trip computer functions can be accessed by twisting control B one step at a time in either direction. Twisting the control a fifth time** returns you to the original function.

The trip computer can be reset (current data will be erased from system memory) by pressing RESET (button C).

1. Driving distance on current fuel reserve

This function shows the approximate distance that can be driven on the fuel remaining in the tank. This calculation is based on average fuel consumption during the last 12 miles (20 km) of driving and the amount of fuel remaining in the tank when the reading was taken. When the driving distance on current fuel reserve is less than 12 miles (20 km), "----" will be displayed in the text window.

2. Average fuel consumption

This value indicates fuel consumption since the last time the trip computer was reset (by pressing RESET, button C). When the engine is switched off, information on fuel consumption is stored and remains in system memory until the RESET (button C) is pressed again.

3. Current fuel consumption

This value indicates the current fuel consumption, based on readings taken once per second. When the car is not moving, "----" will be displayed.

4. Average speed

This value indicates average speed since the last time the trip computer was reset (by pressing RESET, button C). When the engine is switched off, information on average speed is stored and remains in system memory until the RESET (button C) is pressed again.

5. Current speed in miles per hour (Canadian models only)

This function provides the driver with an instantaneous conversion of the car's current speed from km/h to mph.

NOTE: Trip computer readings may vary slightly depending on the circumference of the tires on the car.

*Five functions on Canadian models

**A sixth time on Canadian models



2006
VOLVO
V70

Chapter 3 - Climate control system

pg. 47 Climate control system

Ventilation 48

Climate control system - general information 49

Electronic Climate Control (ECC) 50

Manual climate control with air conditioning, A/C 54

pg. 48 Ventilation

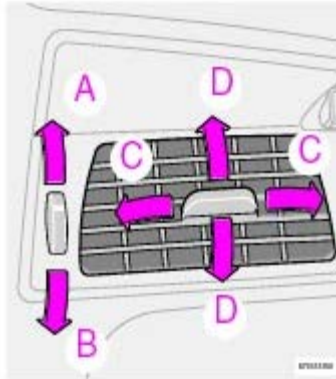

Air vents in dash

Air vents (dash)

A Open

B Closed

C Horizontal air flow

D Vertical air flow

Direct the outer air vents toward the side windows to demist.

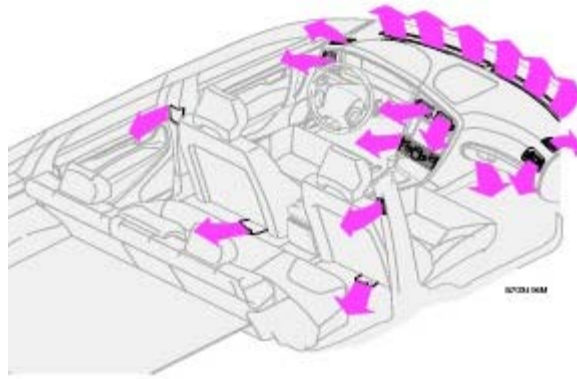

Air flow

The air that is drawn into the passenger compartment is distributed from 14 ventilation points.

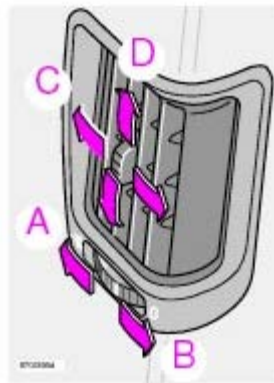

Air vents in door pillars

Air vents in door pillars

- A Open
- B Closed
- C Horizontal air flow
- D Vertical air flow

Direct the air vents toward the rear side windows to demist.

Direct the air vents toward the rear seat for the best heating/cooling effect.

pg. 49 Climate control system - general information

Condensation on the inside of the windows

Keeping the insides of the windows clean will help reduce the amount of condensation that forms on the windows. Use a commercial window cleaning agent to clean the windows.

Ice and snow

Always keep the air intake grille at the base of the windshield free of snow.

Cabin air filter

Replace the cabin air filter with a new one at the recommended intervals. Please refer to your Warranty and Service Records Information booklet, or consult your Volvo retailer for these intervals. The filter should be replaced more often when driving under dirty and dusty conditions. The filter cannot be cleaned and therefore should always be replaced with a new one.

Sensors

The sunlight sensor on the dashboard and passenger compartment temperature sensor in the ECC control panel should not be covered in any way as this could cause incorrect information to be sent to the ECC system.

Parking the car in warm weather

If your car has been parked in the sun in warm weather, opening the windows and moonroof (option) for several minutes before driving will help release the warm air from the passenger compartment. When the engine is running, close the windows and moonroof and use the recirculation function for several minutes to enable the air conditioning to cool the compartment as quickly as possible.

Windows and optional moonroof

The ECC system will function best if the windows and optional moonroof are closed. If you drive with the moonroof open, we recommend that you manually adjust the temperature and blower control (the LED in the AUTO switch should be off).

Acceleration

The air conditioning is momentarily disengaged during full-throttle acceleration.

Climate control maintenance

Special tools and equipment are required to maintain and carry out repairs on the climate system. Work of this type should only be done by a trained and qualified Volvo service technician.

Refrigerant

Volvo cares about the environment. The air conditioning system in your car contains a CFC-free refrigerant - R134a (HFC134a). This substance will not deplete the ozone layer. The system contains 2.2 lbs (1000 g) R134a and uses PAG oil.

Climate system blower

The climate system blower will be automatically switched off when the engine is not running (even if the ignition key is in position I or II) to avoid unnecessary battery drain. To activate the blower, turn the control to the desired setting.

Passenger compartment blower

Approximately 50 minutes after the ignition is turned off, the blower may come on automatically, and run for five minutes, to remove condensation in the A/C evaporator.

pg. 50 Electronic Climate Control (ECC)

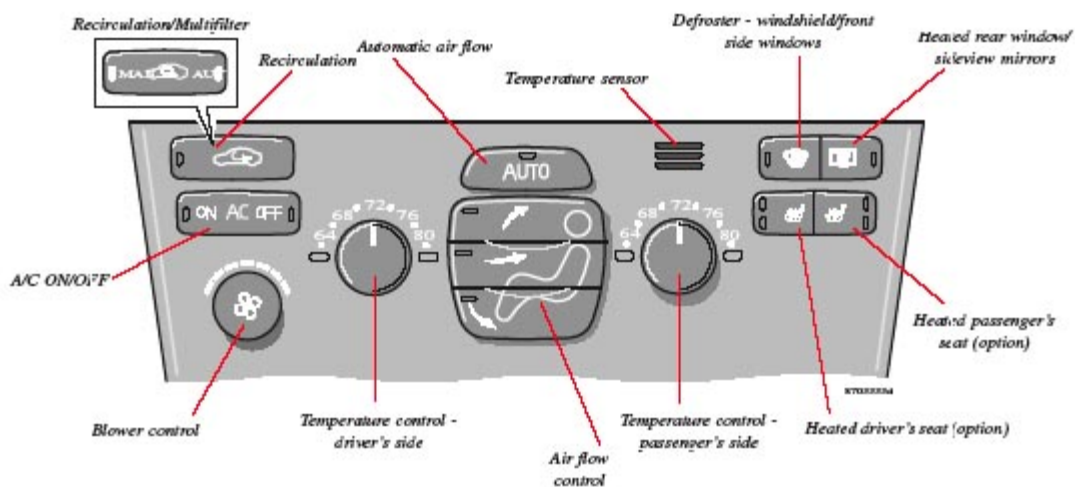



AUTO

This function automatically regulates the Electronic Climate Control system so that the selected temperatures are maintained. The blower, heating, air distribution (air flow) and air conditioning are controlled. If you prefer to manually set any of these functions, the remaining functions will still be controlled automatically. Pressing the AUTO button overrides any settings that were previously made manually.



Temperature

These controls are used to individually set the temperature for both sides of the passenger compartment. Please note that the compartment will not be heated or cooled faster by setting the temperature higher or lower than necessary. Set the control to the temperature you prefer.



Defroster

This function demists/de-ices the windshield and front side windows. The LED in the switch will light up to indicate that the defrost function is engaged. Blower speed increases automatically and the air in the passenger compartment is dehumidified. Recirculation will not function while defrost is engaged.

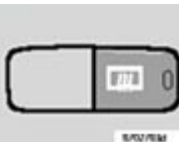

Heated rear window/sideview mirrors

This function demists/de-ices the rear window and sideview mirrors. The LED in the switch will light up to indicate that the heating function is engaged. See [page 40](#) for additional information on this function.

CAUTION:

Never use ice scrapers made of metal as they can easily scratch the mirror surface.



Recirculation (see also [page 55](#))

Press this switch to engage the recirculation function (air in the passenger compartment recirculates - no fresh air enters the compartment). The LED in the switch will light up to indicate that the function is engaged.

- Use this function if the outside air is contaminated with exhaust gases, smoke, etc or to heat/cool the car quickly.
- Recirculation should not be used for more than 15 minutes. *If your windows begin to fog or mist, make sure that the recirculation function is switched off.*
- Selecting Defroster automatically switches recirculation off.

Timer mode activation: (Cars with Interior Air Quality system have no timer mode) Press and hold the recirculation button for at least 3 seconds to activate a recirculation timer mode. The amber LED in the recirculation button will flash 5 times to show that the timer mode is being activated. In the timer mode, each time the recirculation button is pressed, the climate control system will recirculate the air in the passenger compartment for 5-12 minutes, depending on the outside air and then revert back to fresh air.

- **Timer mode deactivation:** Press and hold the recirculation button for at least 3 seconds. The amber LED in the recirculation button will illuminate steadily for 5 seconds to show a return to "normal" mode.
- In normal mode, when the recirculation button is pressed, the climate control system will recirculate the air in the passenger compartment until the recirculation button is pressed again.
- **Timer mode memory:** If the car is turned off while timer mode is active, timer mode will still be active when the car is restarted.



Heated front seats (option)

Please see [page 40](#) for more information on this function.



Press **AUTO** to automatically regulate air flow or press any combination of the controls shown in the illustration to manually adjust air flow. An LED in the switch will light up if an air flow control has been pressed.



Air conditioning ON/OFF

Press the switch to turn the air conditioning on or off. The "ON" or "OFF" LED will light up to indicate if the system is switched on or off. Other functions will still be regulated automatically (if the **AUTO** switch is on).

- The air conditioning functions only at temperatures above 32° F (0° C).
- While the **Defroster** function is selected, the air conditioning is temporarily activated to dehumidify the air, even if you have manually switched the air conditioning off. This will only function if the blower is *not* switched off.



Blower control

Turn the control clockwise to increase or counterclockwise to decrease the blower speed. Pressing the AUTO switch will automatically regulate blower speed and override manual adjustment.

NOTE: Turning the blower control counterclockwise as far as possible (an orange LED next to the control will light up) will turn both the blower and the air conditioning off.

pg. 53 Electronic Climate Control (ECC) with Interior Air Quality system (option)

Interior Air Quality system (option)

Some cars are equipped with a multifilter and air quality sensor. The filter separates gases and particles, thereby reducing the amounts of odors and contaminants entering the car. The air quality sensor detects increased levels of contaminants in the outside air. When the Air quality sensor detects contaminated outside air, the air intake closes and

the air inside the passenger compartment is recirculated, i.e. no outside air enters the car. The filter also cleans recirculated passenger compartment air. When the Air quality sensor is activated, the LED *AUT* comes on in

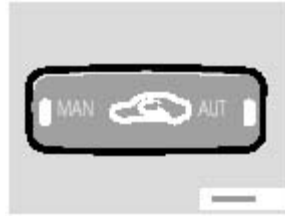

Operation:

Press  to activate the Air quality sensor (normal setting).

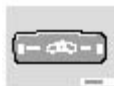
Or select one of three functions by pressing .

1. Press  : the LED *AUT* comes on. The Air quality sensor is now activated.

2. Press  : no LED is lighted. Recirculation not activated.

3. Press  : the LED *MAN* comes on. Recirculation is now activated.

You can switch between these three functions by repeatedly pressing .

Keep the following in mind:

- Make it a rule to have the air quality sensor activated at all times.
- Recirculation is limited in cold climates to avoid misting up.
- If misting occurs, you should deactivate the Air quality sensor.
- If the windows mist up, you can also use the windshield and side window defroster functions. See [page 51](#).
- The filter should be changed at the intervals listed in the Warranty and Service Records Information booklet. However, if the car is used in a severely contaminated environment, it may be necessary to change the filter more frequently.

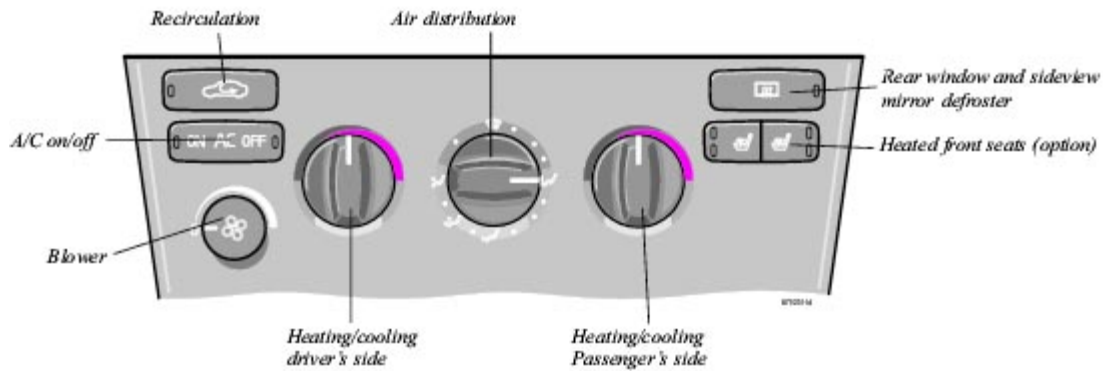

pg. 55 Manual climate control with air conditioning, A/C



A/C - ON/OFF

The air conditioning function is engaged by pressing ON and disengaged by pressing OFF. When you select Defroster , the air conditioning is automatically engaged if the fan is not set to position 0.



Heated front seats (option)

Please see [page 40](#) for more information on this function.



Heated rear window/sideview mirrors

This function demists/de-ices the rear window and sideview mirrors. The LED in the switch will light up to indicate that the heating function is engaged. See [page 40](#) for additional information on this function.

CAUTION:

Never use ice scrapers made of metal as they can easily scratch the mirror surface.



Recirculation

Recirculation can be used to shut out stale air, exhaust, etc. from the passenger compartment. The air in the passenger compartment is then recirculated, i. e. no air from outside the car is taken into the car when this function is activated. Recirculation (together with the air conditioning system) cools the passenger compartment more quickly in warm weather.

If you allow the air in the car to recirculate, there is a risk of icing and fogging, especially in winter. The timer function minimizes the risk of ice, misting and stale air.

Activate the timer function as follows:

- Press  for more than 3 seconds. The LED flashes for 5 seconds. The air recirculates in the car for 3-12

minutes depending on the outside temperature.

- The timer function is activated each time you press .

To switch off the timer function :

- Press  again for more than 3 seconds. The LED lights for 5 seconds to confirm your selection.

Recirculation is always disconnected when you select Defroster .



Blower

Blower speed can be increased or decreased by turning the knob. If the knob is set to 0, the air conditioning function is automatically disengaged.



Temperature





Turn the control to set the temperature for the driver's and passenger's sides of the car. For cooler air, the air conditioning function must be engaged.



Air distribution

Use the air distribution control positions (marked with dots) between the different symbols to fine-tune air distribution for the maximum comfort.

Air distribution

 Air through front and rear air vents.	When you want good cooling in warm weather.
 Defrost. Air is not recirculated in this position. Air conditioning is always connected. There is a certain amount of airflow to the air vents.	When you want to remove ice and fog from the windshield.
 Air to both floor and windows. There is a certain amount of airflow to the air vents.	When you want comfortable conditions and good demisting in cold weather!
 Air to floor. There is a certain amount of airflow to the air vents and the defroster vents for the windshield and side windows.	When you want to warm your feet.
 Air to floor and air vents.	In sunny weather with cool outside temperature.



[Contents](#) | [Top of Page](#)

2006
VOLVO
V70

Chapter 4 - Interior

pg. 57 Interior

Front seats (electrically operated)	58
Front seats (manually operated)	59
Storage compartments	61
Front storage compartments, coat hanger	63
Folding table in rear seat	64
Rear seat and cargo area	65
Cargo area	70
Securing cargo	71
Steel grid, cargo net	72
Nylon cargo net (XC70 with 3-section rear seat)	73
Cargo area cover, vanity mirrors	74
Spare tire	75
Auxiliary seat in cargo area, Extra handgrip - XC70	76
Interior lighting	77

pg. 58 Front seats

Electrically operated seats (option)

Operation

Driver's seat:

The seat can be adjusted if the ignition key is in position I, II or if the engine is running.

It can also be adjusted as follows **with the ignition off:**

- Within 10 minutes after the driver's door has been unlocked from the outside and has been opened and remains open.
- Within 40 seconds, if the driver's door has just been closed.
- Within 40 seconds, if the driver's door has not been opened after the ignition has been switched off.

Passenger's seat:

The seat can only be adjusted if the ignition key is in position I, II or if the engine is running.

Seat adjustment

Adjust the power seat(s) with the controls at the side of the seat as follows:

- 1 Front edge of seat (raise/lower)
- 2 Forward - rearward
- 3 Rear edge of seat (raise/lower)
- 4 Backrest tilt

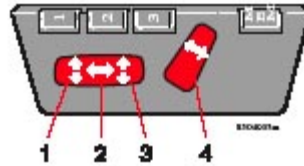

Power seat adjustment controls

NOTE: The power seats have an overload protector that activates if a seat is blocked by any object. If this occurs, switch off the ignition (key in position 0) and wait about 20 seconds before operating the seat again.

Emergency stop

If the seat accidentally begins to move, press any of the buttons to stop the seat.

NOTE: Please refer to the following page for information on programming the memory function in the driver's seat.

Remote keyless entry system and the driver's seat

The remote control transmitter also controls the position of the electrically operated driver's seat in the following way:

1. Adjust the seat to your preferences.
2. When you leave your vehicle, lock it using the remote control.

The position of the seat is now stored in the remote control.

Automatic seat adjustment

To move the seat to the position in which you left it:

1. Unlock the driver's door with the same remote control (the one used to lock the doors).
2. Open the driver's door within 2 minutes.

The driver's seat will automatically move to the position in which you left it.

NOTE:

- The seat will move to this position even if someone else has moved it to a different seating position and locked the car with a different remote control.
- This feature will work in the same way with all of the remote control transmitters (up to 3) that you use with your vehicle.
- This feature will not function if you lock your vehicle with the key.

WARNING!

- Because the driver's seat can be adjusted with the ignition off, children should never be left unattended in the car.
- Movement of the seat can be STOPPED at any time by pressing any button on the power seat control panel.
- Do not adjust the seat while driving. The seat should be adjusted so that the brake pedal can be depressed fully. In addition, position the seat as far rearward as comfort and control allow.
- The seat rails on the floor must not be obstructed in any way when the seat is in motion.



Programming the driver's seat memory (option)*

Three different seating and door mirror positions can be stored in the driver seat's memory.

The following example explains how button 1 can be programmed.

Buttons 2 and 3 can be programmed in the same way.

To program (store) a seat position in button 1:

1. Move the seat to the desired position using the seat adjustment controls (see the previous page).
2. Press and hold down the MEM (memory) button.
3. With the MEM button depressed, press button 1 briefly to store the seat's current position.

To move the seat to the position that it was in when button 1 was programmed:

Press and hold down button 1 until the seat stops moving.

As a safety precaution, the seat will stop automatically if the button is released before the seat has reached the preset position.

* This option is only available on the driver's seat.



Manually adjusted front seats

1. Front-rear adjustment: lift the bar and move the seat to the position of your choice.
2. Raise/lower the front edge of the seat cushion (option): use the control to pump the front edge of the cushion up or down.
3. Raise/lower seat height: pump the seat up or down
4. Lumbar support: turn the control for firmer or softer lumbar support.
5. Backrest tilt: turn the control to adjust the angle of the backrest.
6. Control panel for optional power seat (see [page 58](#) for more information).

WARNING!

- Do not adjust the seat while driving. The seat should be adjusted so that the brake pedal can be depressed fully. In addition, position the seat as far rearward as comfort and control allow.
- Check that the seat is securely locked into position after adjusting.

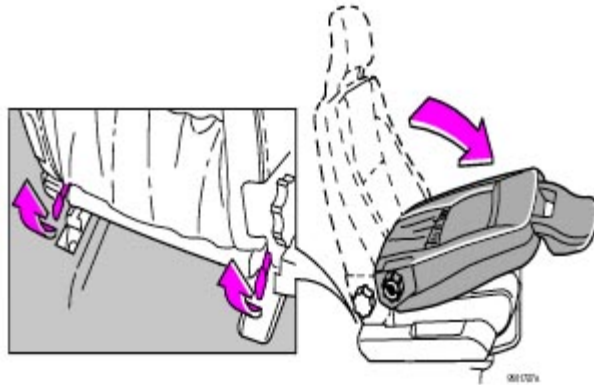

Folding front seat backrest

The passenger seat backrest can be folded down to the horizontal position for carrying long loads. To fold down the backrest:

- Move the seat as far rearward as possible
- Adjust the backrest tilt to the most upright position
- Lift the catches on the lower rear side of the backrest
- Without releasing the catches, push the backrest forward
- Move the seat as far forward as possible so that the head restraint slides under the glove compartment.

WARNING!

Cover sharp edges on the load to help prevent injury to occupants. Secure the load to help prevent shifting during sudden stops.

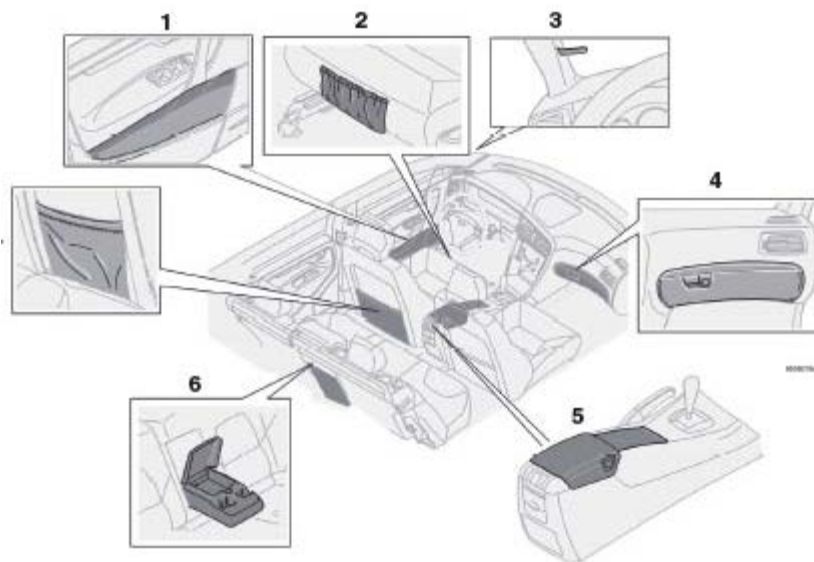

1. Storage compartment in door
2. Storage pocket in edge of front seat
3. Ticket clip
4. Glove compartment
5. Storage compartment and cup holders in center console (see the following page for more information)
6. Storage space and cupholders in rear seat armrest
7. Storage pocket in rear side of front seats§

WARNING!

Make sure that no hard, sharp or heavy objects lie on or in any of the storage places where they might cause injury during heavy braking.

pg. 62 Cup holders, Glove compartment

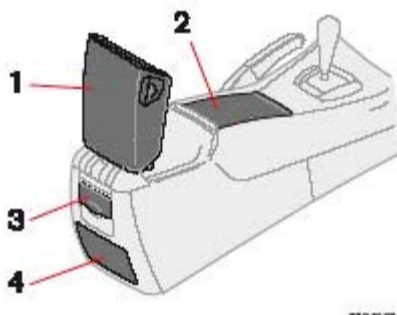

Storage compartments in the center console

1. Storage compartment cover

2. Front storage compartment

This storage space is fitted with a sliding cover (not on XC70 models)

3. 12-volt socket

4. Space for accessory ashtray

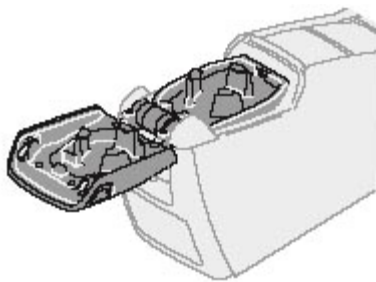

Cup holder for rear seat passengers

- To access the storage compartment, press the button on the left side of the armrest and fold the entire cover rearward.
- To open the rear seat cup holder, press the button on the right side of the armrest. Fold the upper section of the cover rearward.

The two sections of the cover can be closed separately.

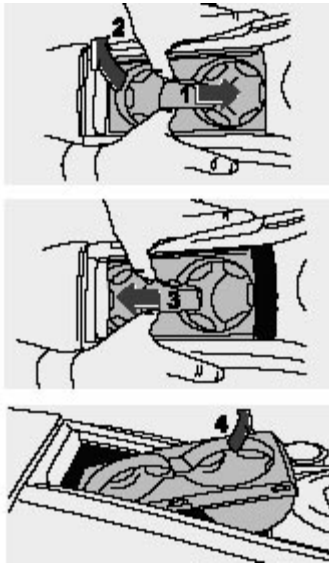

Removing the cup holder in the center console

Cup holders in the center console-V70 (option)

To remove the cup holders:

- Press the cup holder forward (1), while lifting the rear edge (2).
- Move the cup holder rearward (3), into the groove under the sliding cover.
- Angle the front edge of the cup holder upward (4) and lift it out.

Return the cup holder to the storage space in the reverse order.

Cup holders in the center console XC70 (option)

To remove the cup holders:

- Grasp the rear edge of the cup holder and press in the rear side to release the rear edge.
- Pull up the cup holder's rear edge and lift it out.

Return the cup holder to the storage space in the reverse order.

NOTE: Avoid pinching the parking brake gaiter.

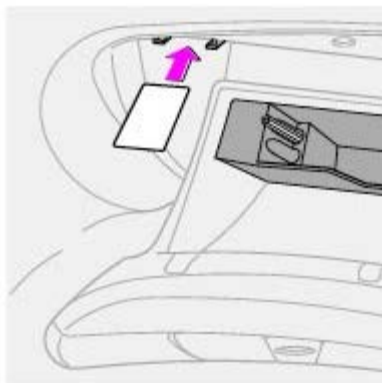

Storage in the glove compartment

The glove compartment has storage spaces designed specifically to hold credit cards, pens, and pencils.

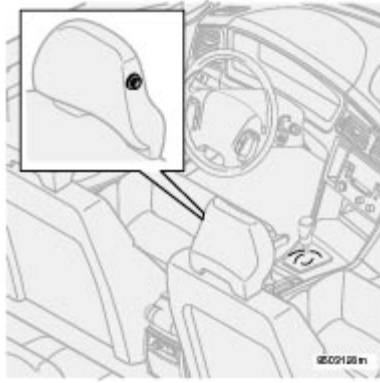

Coat hanger

Use the coat hanger for light jackets, etc.

pg. 64 Folding table in rear seat

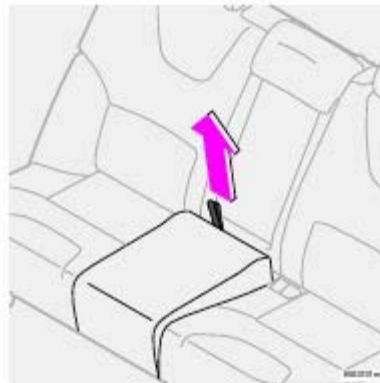

Folding Table (option)

Pull the tab and fold the table section forward.

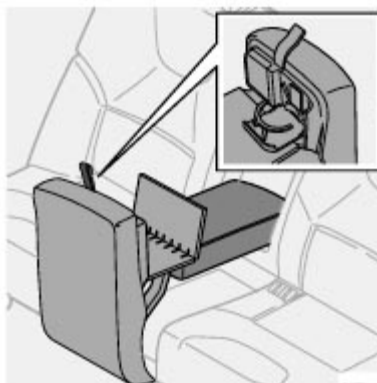

Fold the armrest in the backrest forward. Fold out the table so that it rests on the armrest. Press to release the cup holder. You do not have to fold the backrest forward, if you only want to use the cup holder.

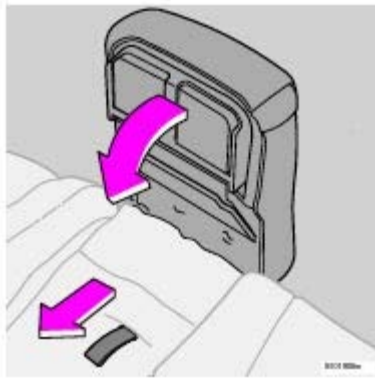

To close: Fold the table section upward into place. Fold the arm under the table inward being careful not to pinch your hand. Pull the release and fold the table section back in place.



[Contents](#) | [Top of Page](#)

2006
VOLVO
V70

Chapter 5 - Keys, Locks, Alarm

pg. 79 Keys, Locks, Alarm

[Keys, Immobilizer](#) 80

[Remote keyless entry system](#) 81

[Unlocking the tailgate, Central locking buttons](#) 83

[Alarm](#) 84

[Child safety locks - rear doors](#) 86

pg. 80 Keys, Immobilizer



Keys

Two types of keys are provided with your car; master keys and a service key. The master key, the remote control, and the central locking button may all be used to lock and unlock all of your car's locks.

The service key operates the driver's door and the ignition switch. It will also fit the tailgate lock cylinder on models outfitted with a factory installed third seat. The service key is intended to help deter unwanted entry into the glove compartment.

Turn the key once to unlock the driver's door and the fuel filler door.

Turn the key again (within 10 seconds) to unlock all doors and the tailgate.

One turn with the key towards lock in the drivers door locks all doors and tailgate.

Use the switch on the front door armrests to lock/unlock the car from the inside.

WARNING!

If the doors are locked while driving, this may hinder rapid access to the occupants of the car in the event of an accident. (Also see information on "Child safety locks").

NOTE: To help prevent accidentally locking the keys in the car, the central locking system is designed to unlock the doors immediately if the key is left in the ignition switch, the car is locked using the lock button on the door and the door is then closed. **A sound from the lock will be audible at this time.**

Please note that this function will not unlock the doors if the engine is running.

Immobilizer (start inhibitor)

Each of the keys supplied with your car contains a coded transmitter. The code in the key is transmitted to an antenna in the ignition switch where it is compared to the code stored in the start inhibitor module. The car will start only with a properly coded key.

Each key has a unique code, which your Volvo retailer uses if new keys are required. A maximum of six remote controls/keys can be programmed and used for one car.

If you misplace a key, take the other keys to an authorized Volvo retailer for reprogramming as an antitheft measure.

*This key operates only driver's door and ignition switch/steering wheel lock.

This device complies with part 15 of the FCC rules. Operation is subject to the following condition: (1) This device may not cause harmful interference, and (2) this device must accept any interference received, including interference that may cause undesired operation.

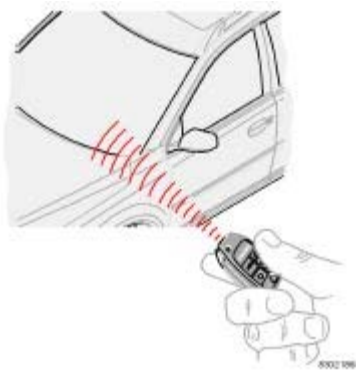

Remote keyless entry system

Your car is equipped with two coded remote control transmitters with integrated ignition keys called Key Integrated Remote (KIR). These transmitters use a radio frequency that will enable you to lock/unlock all doors and the tailgate from a distance of 10-15 feet (3-5 meters).

The transmitters will also activate or allow "keyless" entry into the passenger compartment or the tailgate. They will also activate or deactivate the vehicle's alarm system(s).

The car can also be locked/unlocked with the key.

If one of the transmitters is misplaced, contact your nearest authorized Volvo retailer for replacement.

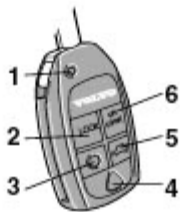

Buttons in remote control

*1 - Fold key in/out, 2 - Lock, 3 - Approach lighting
4 - "Panic" function *, 5 - Unlock tailgate, 6 - Unlock*

Using the remote control

Button 1: Press to extend the key. This button must also be pressed when the key is folded back into the slot in the side of the remote control unit.

Button 2 (Lock): Press once to lock all doors, and the tailgate.

Button 3 (Approach lighting): Press this button when approaching the car at night to light up the interior courtesy light, parking lights, license plate lights and the lights in the sideview mirrors.

Button 4 (Panic): See [page 84](#) for more information on this function.

Button 5 (Tailgate unlock): Press this button twice within 3 seconds to unlock the tailgate (without unlocking the other doors).

Button 6 (Unlock): Press this button once to unlock the driver's door only. Wait for at least 1 second and press the button again (within 10 seconds) to unlock all doors, and the tailgate.

NOTE:

- If the doors are unlocked with the remote, the locks will automatically reengage (re-lock) and the alarm will reset after 2 minutes unless a door has been opened.
- The lock/unlock and alarm features can also be utilized by using the keys.

FCC ID:LQNP2T-APU

This device complies with part 15 of the FCC rules. Operation is subject to the following conditions: (1) This device may not cause harmful interference, and (2) this device must accept any interference received, including interference that may cause undesired operation.

Canadian 2306104388

Model 504 2927 by Donnelly

Operation is subject to the following conditions: (1) this device may not cause interference, and (2) this device must accept any interference, including interference that may cause undesired operation of the device.

Canadian 2306104388A

Model 509 977 by Connaught Electronics

Operation is subject to the following conditions: (1) this device may not cause interference, and (2) this device must accept any interference, including interference that may cause undesired operation of the device.

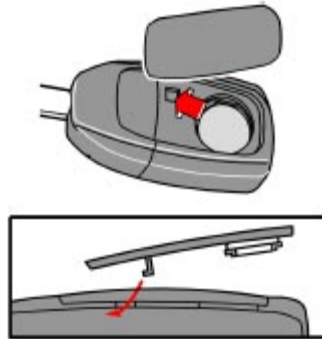

Remote keyless entry system - replacing batteries

If the range of the transmitter is noticeably reduced, this indicates that the battery is weak and should be replaced.

To replace the battery

- Remove the cover by carefully prying up its rear edge with a small screwdriver
- Replace the battery with a new 3-volt, CR 2032 battery. The battery should be inserted with the plus side upward. Avoid touching the contact surfaces of the battery with your fingers.
- Press the cover back into place. Ensure that the rubber seal seats correctly to help prevent moisture from entering the unit.

NOTE: The old battery should be disposed of properly at a recycling center or at your Volvo retailer.

WARNING!

Volvo does not recommend using the transmitter to lock the doors from inside the car. The alarm would be activated and would sound when one of the doors is opened. The doors must not be locked using the remote transmitter while the vehicle is occupied. In case of an accident, this may hinder rapid access to the occupants of the vehicle. The alarm will also sound.

Unlocking the tailgate

The tailgate lock is incorporated in the central locking system and is locked or unlocked when the driver's door is locked/unlocked.

The tailgate can be unlocked by:

- Pressing UNLOCK on the remote control twice.
- Using the central locking button on the driver's door.
- Pressing **twice** on the remote control's tailgate unlock button (see illustration on [page 81](#)).
- Relock the tailgate using the remote's "Lock" button.

Automatic relocking:

If you use the tailgate unlock button to unlock the tailgate without opening it, it will automatically relock after approximately 2 minutes.

NOTE: Please be aware that if the tailgate is unlocked using the tailgate unlock button, opened, and closed again, it will **remain unlocked** and the alarm will not be rearmed.

Press the lock button on the remote control to relock the tailgate and rearm the alarm.



Central locking buttons

Central locking buttons

These buttons (located on the both front door armrests) can be used to lock/unlock all doors and the tailgate and set the alarm.

The rear passenger doors can also be locked and unlocked with the individual lock buttons on each door.

pg. 84 Alarm

Alarm

The alarm is automatically armed whenever you lock your car. When armed, the alarm continuously monitors a number of points on the car. The following conditions will set off the alarm:

- The hood is forced open.
- The tailgate is forced open.
- A door is forced open.
- The ignition switch is tampered with.
- If there is movement in the passenger compartment (if the car is equipped with the optional movement sensor).
- The car is lifted or towed (if the car is equipped with the optional inclination sensor).
- The battery is disconnected (while the alarm is armed).

Arming the alarm

Press the LOCK button on the remote control, lock the car using the key in the driver's door or press the central lock button on one of the front doors with the door open. One long flash of the turn signals will confirm that the alarm is armed.

Disarming the alarm

Press the UNLOCK button on the remote control or unlock the doors with the key.

Turning off (stopping) the alarm

If the alarm is sounding, it can be stopped by pressing the UNLOCK button on the remote control or by unlocking the driver's door with the key.

Visual alarm signal

The visual alarm signal is given by flashing all turn signals and turning on the interior lighting for approximately 5 minutes.

Audible alarm signal

An audible alarm signal is given by a battery powered siren. One alarm cycle lasts for 25 seconds.

"Panic" button

In an emergency situation, this feature can be used to attract attention. Activate the "panic" function by pressing the red button on the remote control (see illustration on [page 81](#)) for at least 3 seconds or by pressing this button twice within 3 seconds. The turn signals will flash, the interior lights will go on and the car's horn will sound.

The function can be turned off by pressing any of the buttons on the remote control or will stop automatically after 25 seconds. When a button is pressed, there is a 5 second delay before the panic alarm is deactivated.

NOTE: This function will **NOT** unlock the car.

pg. 85 Alarm

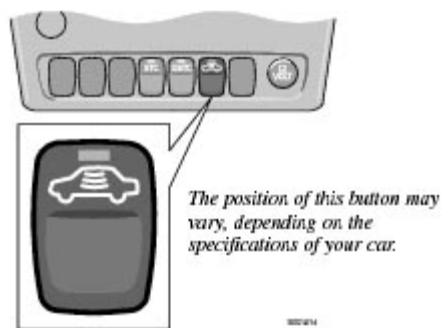

Temporarily turning off the inclination and movement alarm sensor(s) - accessory

This button will only be found in cars equipped with the accessory inclination and/or movement sensors.

FCC ID: MAYDA5823

This device complies with part 15 of the FCC rules. Operation is subject to the following conditions: (1) This device may not cause harmful interference, and (2) this device must accept any interference received, including interference that may cause undesired operation.

Canadian IC: 4405A-DA5823

Movement sensor DA5823 by Dynex

Operation is subject to the following conditions: (1) this device may not cause interference, and (2) this device must accept any interference, including interference that may cause undesired operation of the device.

In certain situations it may be desirable to turn off the inclination and movement alarm sensors if, for example, you drive your car onto a ferry where the rocking of the boat could trigger the alarm or if a pet is left in the car with the doors locked.

To temporarily turn off the inclination and movement alarm sensors from the alarm system:

From the time the ignition key is turned from the Drive position (position II) until you lock the car, you can press the button in the center console. The LED in the switch will light up and a message will be displayed in the text window

to indicate that the sensors are disconnected.

The car can then be locked in the usual way to set the alarm.

NOTE:

- This function will not turn off the vehicle's standard alarm.
- The optional sensors are automatically reconnected to the alarm system the next time the car is unlocked and then locked again.

LED alarm status signals

The status of the alarm system is indicated by the red LED at the top of the dash:

- LED off - the alarm is not armed
- LED flashes once per second - the alarm is armed
- LED flashes rapidly before the ignition is switched on - the alarm has been triggered
- **Fault in the alarm system:** If a fault has been detected in the alarm system, a message will be displayed in the text window. Contact a Volvo retailer.

Automatic re-lock/re-arm system

If the car is unlocked with the remote, the car will re-lock and the alarm will re-arm after 2 minutes unless a door or the tailgate has been opened.

pg. 86 Child safety locks - rear doors

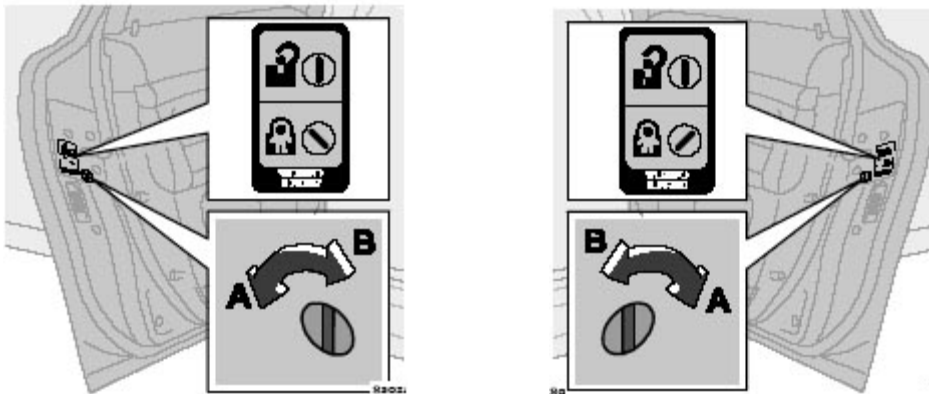

Child safety lock control in left rear door Child safety lock control in right rear door

Child safety locks - rear doors

The controls are located on the rear door jambs*. Use the ignition key or a screwdriver to adjust these controls.

A The door cannot be opened from the inside. Normal operation from the outside.

B The door lock functions normally.

* Vehicles equipped with the optional rear-facing auxiliary child seat in the cargo area also have a child safety lock on the underside of the tailgate. This lock is visible when the tailgate is open.

WARNING!

Remember, in the event of an accident, the rear seat passengers cannot open the doors from the inside with the buttons in position A.



Power child safety lock button

Power child safety locks (option)

To prevent the rear doors from being opened from the inside:

1. Turn the vehicle's ignition key to at least position 1.
2. Press the button shown above.

- Indicator light in the button ON: the doors cannot be opened from the inside. Normal operation from the outside.
- Indicator light in the button OFF: the doors can be opened from the inside.

NOTE: On vehicles equipped with the optional rear-facing auxiliary child seat in the cargo area, the child safety lock in the tailgate must be activated or deactivated manually.



2006
VOLVO
V70

Chapter 6 - Starting and driving

pg. 87 Starting and driving

Fuel requirements	88
Refueling	90
Starting the engine	91
Manual transmission	93
Automatic transmission (AW5)	94
Automatic transmission (Geartronic)	96
All Wheel Drive	98
Four-C active chassis system (option)	99
Front/rear park assist (option/accessory)	100
Driving economy, Handling	101
Points to remember	102
Roof racks/load carriers	103
Emergency towing	105
Vehicle towing information	106
Towing a trailer	107
Detachable trailer hitch	108
Jump starting	109
Winter driving	110
Long distance trips	111
Three-way catalytic converter	112
Brake system	113
Anti-lock brake system	114
STC/DSTC	115

Fuel requirements

Octane rating: Volvo engines are designed for optimum performance on unleaded premium gasoline with an octane rating AKI of 91, or above. AKI (ANTI KNOCK INDEX) is an average of the Research Octane Number, RON, and the Motor Octane Number, MON. $(RON + MON/2)$. The minimum octane requirement is AKI 87 (RON 91).

Deposit control gasoline (detergent additives)

Volvo recommends the use of detergent gasoline to control engine deposits. Detergent gasoline is effective in keeping injectors and intake valves clean. Consistent use of deposit control gasolines will help ensure good driveability and fuel economy. If you are not sure whether the gasoline contains deposit control additives, check with the service station operator.

Unleaded fuel

Each Volvo has a three-way catalytic converter and must use only unleaded gasoline. U.S. and Canadian regulations require that pumps delivering unleaded gasoline be labelled "UNLEADED". Only these pumps have nozzles which fit your car's filler inlet. It is unlawful to dispense leaded fuel into a vehicle labelled "unleaded gasoline only". Leaded gasoline damages the three-way catalytic converter and the heated oxygen sensor system. Repeated use of leaded gasoline will lessen the effectiveness of the emission control system and could result in loss of emission warranty coverage. State and local vehicle inspection programs will make detection of misfueling easier, possibly resulting in emission test failure for misfueled vehicles.

NOTE: Some U.S. and Canadian gasolines contain an octane enhancing additive called methyl-cyclopentadienyl manganese tricarbonyl (MMT). If such fuels are used, your Emission Control System performance may be affected, and the Check Engine light (malfunction indicator lamp) located on your instrument panel may light. If this occurs, please return your vehicle to an authorized Volvo retailer for service.

Gasoline containing alcohol and ethers "Oxygenated fuels"

Some fuel suppliers sell gasoline containing "oxygenates" which are usually alcohols or ethers. In some areas, state or local laws require that the service pump be marked indicating use of alcohols or ethers. However, there are areas in which the pumps are unmarked. If you are not sure whether there is alcohol or ethers in the gasoline you buy, check with the service station operator. To meet seasonal air quality standards, some areas require the use of "oxygenated" fuel.

Volvo allows the use of the following "oxygenated fuels; however, the octane ratings listed on this page must still be met.

Alcohol - Ethanol: Fuels containing up to 10% ethanol by volume may be used. Ethanol may also be referred to as Ethyl alcohol, or "Gasohol".

Ethers - MTBE: Fuels containing up to 15% MTBE may be used.

CAUTION! Do not use gasolines containing methanol (methyl alcohol, wood alcohol). This practice can result in vehicle performance deterioration and can damage critical parts in the fuel system. Such damage may not be covered under the New Vehicle Limited Warranty.

Carbon Monoxide - Important Warning

Carbon monoxide is a poisonous, colorless, and odorless gas. It is present in all exhaust gases. If you ever smell

exhaust fumes inside the vehicle, make sure the passenger compartment is ventilated, and immediately return the vehicle to your retailer for correction.

Fuel Formulations

Do not use gasoline that contains lead as a knock inhibitor, and do not use lead additives. Besides damaging the exhaust emission control systems on your car, lead has been strongly linked to certain forms of cancer. Many fuels contain benzene as a solvent. Unburned benzene has been strongly linked to certain forms of cancer. If you live in an area where you must fill your own gas tank, take precautions. These may include:

- standing upwind away from the filler nozzle while refueling
- refueling only at gas stations with vapor recovery systems that fully seal the mouth of the filler neck during refueling
- wear neoprene gloves while handling a fuel filler nozzle.

Use of Additives

With the exception of gas line antifreeze during winter months, do not add solvents, thickeners, or other store-bought additives to your car's fuel, cooling, or lubricating systems. Overuse may damage your engine, and some of these additives contain organically volatile chemicals. Do not needlessly expose yourself to these chemicals.

pg. 90 Refueling



Refueling

The fuel tank holds approximately:

Front wheel drive, non-turbo models - 18.5 US gal. (70 liters)

All turbo models - 18 US gal. (68 liters)

with sufficient volume left over to accommodate possible expansion of the fuel in hot weather. Be aware that the "usable" tank capacity will be somewhat less than the specified maximum. When the fuel level is low, such factors as ambient temperature, the fuel's "Reid vapor pressure" characteristics, and terrain can affect the fuel pump's ability to supply the engine with an adequate supply of fuel. Therefore, it is advisable to refuel as soon as possible when the needle nears the red zone, or when the fuel warning light comes on.

Fuel filler door

Press the button on the light switch panel (see illustration on [page 35](#)) when the car is at a standstill to unlock the fuel filler door. Please note that the fuel filler door will remain unlocked until the car begins to move forward. An audible click will be heard when the fuel filler door relocks.

If you intend to leave your car while it is being refueled, this feature enables you to lock the door/tailgate while leaving the fuel filler door unlocked.

You can also keep the car locked if you remain inside it during refueling. The central locking button does not lock the fuel filler door.

Be sure the fuel filler door is not obstructed and is completely closed after refueling.

Open the fuel filler cap slowly during hot weather conditions.

NOTE: During a transitional period, a small number of service stations may still have fuel nozzles that are not compatible with the fuel filler neck on cars equipped with the evaporative control system. Please refer to [page 153](#) for additional information.

WARNING!

Never carry a cell phone that is **switched on** while refueling your vehicle. If the phone rings, this may cause a spark that could ignite gasoline fumes, resulting in fire and injury.

CAUTION:

- Do not refuel with the engine running *. Turn the ignition off or to position I. If the ignition is on, an incorrect reading could occur in the fuel gauge.
- After refueling, close the fuel filler cap by turning it clockwise until it *clicks* into place *.
- Allow for fuel expansion by not overfilling the tank. Overfilling could also cause damage to the emission control systems.
- Avoid spilling gasoline when refueling. In addition to causing damage to the environment, gasolines containing alcohol can cause damage to painted surfaces, which may not be covered under the New Vehicle Limited Warranty.
- Do not use gasolines containing methanol (methyl alcohol, wood alcohol). This practice can result in vehicle performance deterioration and can damage critical parts in the fuel system. Such damage may not be covered under the New Vehicle Limited Warranty.

** If the fuel filler cap is not closed tightly or if the engine is running when the car is refueled, the Check Engine light (malfunction indicator lamp) may indicate a fault. However, your vehicle's performance will not be affected. Use only Volvo original or approved fuel filler caps.*

pg. 91 Starting the engine

Starting the engine

1. Fasten the seat belt.

WARNING!

Before starting, check that the seat, steering wheel and mirrors adjusted properly.
Make sure the brake pedal can be depressed completely. Adjust the seat if necessary. See [pages 58 and 59](#).

2. Apply the parking brake, if not already set. The gear selector (**automatic transmission**) is locked in the (P)ark position (**SHIFT-LOCK**).

Manual transmission: the clutch must be fully depressed.

3. **Without touching the accelerator pedal**, turn the ignition key* to the starting position. Allow the starter to operate for up to 10 seconds. Release the key as soon as the engine starts. If the engine fails to start, repeat this step.

For cold starts at altitudes above 6000 ft (1800 meters), depress the accelerator pedal halfway and turn the key to the starting position. Release the pedal slowly when the engine starts.

NOTE:

On certain models, when the car is started, idle speed may be noticeably higher than normal for a short period, depending on the temperature of the engine.

This has been done to help bring components in the emission control system to their normal operating temperature as quickly as possible, which enables them to function normally.

For cold starts at altitudes above 6000 ft (1800 meters), depress the accelerator pedal halfway and turn the key to the starting position. Release the pedal slowly when the engine starts.

4. To release the gear selector from the (P)ark position, the engine must be running (or the ignition key must be in

position II) and the brake pedal must be depressed. While keeping firm pressure on the brake pedal, release the parking brake.

5. Select the desired gear. The gear engages after a very slight delay which is especially noticeable when selecting R.

NOTE:

- Your car is equipped with a **KEYLOCK** system. When the engine is switched off, the gear selector must be in the **(P)**ark position before the key can be removed from the ignition switch.
- When starting in cold weather, the transmission may shift up at slightly higher engine speeds than normal until the automatic transmission fluid reaches normal operating temperature.

* Your car is equipped with an electronic start inhibitor (immobilizer). The keys you received with your car are specially coded. The code in the key is transmitted to an antenna in the ignition switch where it is compared to the code stored in the start inhibitor module. The car can only be started if a properly coded key is used.

If two of the keys to your car are close together, e.g., on the same key ring, when you try to start the car, this could cause interference in the immobilizer system and result in the car not starting. If this should occur, remove one of the keys from the key ring before trying to start the car again.

pg. 92 Starting the engine

CAUTION:

- The engine should be idling when you move the gear selector. Never accelerate until after you feel the transmission engage! Accelerating immediately after selecting a gear will cause harsh engagement and premature transmission wear.
- Selecting P or N when idling at a standstill for prolonged periods time will help prevent overheating of the automatic transmission fluid.
- Do not race a cold engine immediately after starting. Oil flow may not reach some lubrication points fast enough to prevent engine damage.

WARNING!

- Always place the gear selector in Park or in reverse on models with a manual transmission, and apply the parking brake before leaving the vehicle. Never leave the car unattended with the engine running.
- Always open garage doors fully before starting the engine inside a garage to ensure adequate ventilation. The exhaust gases contain carbon monoxide, which is invisible and odorless but very poisonous.
- An extra mat on the driver's floor can cause the accelerator pedal and the clutch to catch. Check that the movement of the accelerator pedal and clutch is not impeded. Not more than one protective floor covering may be used at one time.

pg. 93 Manual transmission



5-speed manual transmission

Depress the clutch pedal completely when changing gears*.

Remove your foot from the clutch pedal while driving. The shift pattern should be followed.

Overdrive (5th gear) should be used as often as possible to help improve fuel economy. This gear should be engaged at speeds above approx. 50 mph (80 km/h).

* Clutch interlock

The clutch must be fully depressed before you can start your car. If the clutch is not depressed, it will not be possible to start the engine.



6-speed manual transmission (option on certain models)

Fifth and sixth gears should be used as often as possible to help improve fuel economy.

WARNING!

An extra mat on the driver's floor can cause the accelerator pedal and/or the clutch pedal to catch. Check that the movement of these pedals is not impeded. Not more than one protective floor covering may be used at one time.



Engaging reverse gear

Never engage R while the car is moving.

CAUTION: Be careful that you do not inadvertently engage reverse while moving forward.

pg. 94 Automatic transmission AW5

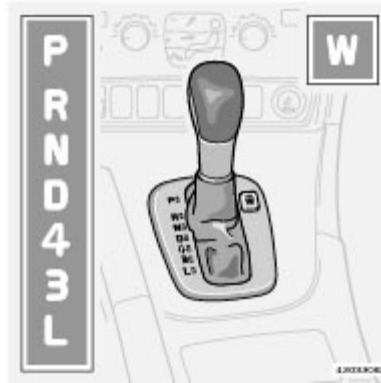

P (Park)

Use this position when starting the engine or parking the car.

Never use P while the car is in motion.

The parking brake should be set whenever the car is parked.

The gear selector is mechanically locked in the P position (SHIFTLOCK). To release the gear selector from this position, the engine must be running (or the ignition key must be in position II) and the brake pedal must be depressed.

WARNING!

Never leave the car unattended when the engine is running. If, by mistake, the gear selector is moved from P, the car may start moving.

R (Reverse)

Never engage R while the car is moving.

N (Neutral)

Neutral - no gear engaged. Use the parking brake.

D (Drive)

D is the normal driving position and should be used as often as possible to help improve fuel economy. The car should not be moving when shifting from R to the D position.

4 (Intermediate gear)

The transmission will shift automatically between gears 4, 3, 2 or 1 from this position. **The transmission cannot shift up to (D)rive from fourth gear.**

3 (Intermediate gear)

The transmission will shift automatically between gears 3, 2 and 1 from this position. **The transmission cannot shift up to fourth gear or (D)rive from third gear.**

L (Low gears)

The transmission is locked in gears 1 and 2 when the selector is in this position.

NOTE:

- Gears 4, 3, or L can be used if you are driving in a mountainous area, towing a trailer or to increase engine braking effect.
- The transmission has a built-in limiter designed to help prevent excessive engine speeds (high rpm) when gears 4, 3 or L are selected.

pg. 95 Automatic transmission AW5

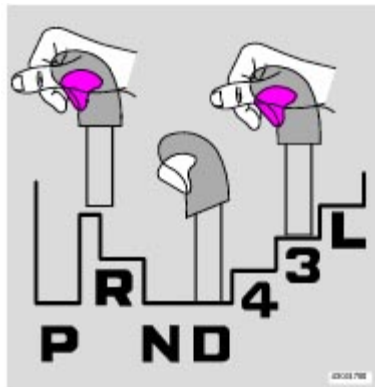

Automatic transmission - shift gate positions

The gear selector can be moved freely between N and D.

Depressing the button on the front of the gear selector knob enables you to move the gear selector to positions P, R, N, D, 4, 3 and L.



W Winter/Wet driving mode - enhanced vehicle traction

- Mode W will only function if the gear selector is in the (D)rive position.
- Press the button at the base of the gear selector to engage/disengage this driving mode (see illustration).
- An LED in the button will light up to indicate that **W** is engaged and this will also be displayed in the instrument panel (see [page 27](#)).
- This mode may be selected for starting/moving off on slippery roads.

NOTE: R-models are not equipped with this button.

Kickdown

Automatic shift to a lower gear (kickdown) is achieved by depressing the accelerator pedal fully and briskly. An upshift will occur when approaching the top speed for a particular gear or by releasing the accelerator pedal slightly. Kickdown can be used for maximum acceleration or when passing at highway speeds.

Cold starts

When driving before the engine has reached its normal operating temperature, the transmission will shift up at slightly higher engine speeds to heat the three-way catalytic converter as quickly as possible.

pg. 96 Automatic transmission (Geartronic)

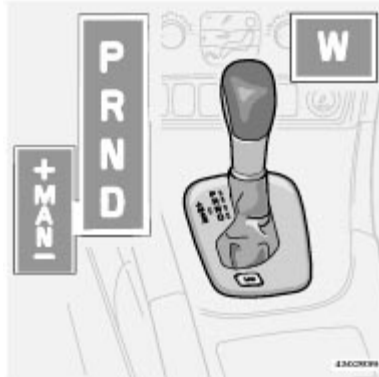

P (Park)

Use this position when starting the engine or parking the car.

Never use P while the car is in motion. The parking brake should be set whenever the car is parked.

The gear selector is mechanically locked in the P position (SHIFTLOCK). To release the gear selector from this position, the engine must be running (or the ignition key must be in position II) and the brake pedal must be depressed.

WARNING!

Never leave the car unattended when the engine is running. If, by mistake, the gear selector is moved from P, the car may start moving.

R (Reverse)

Never engage R while the car is moving forward.

N (Neutral)

Neutral - no gear engaged. Use the parking brake.

D (Drive)

D is the normal driving position and should be used as often as possible to help improve fuel economy. The car should not be moving when shifting from R to the D position.

Kickdown

Automatic shift to a lower gear (kickdown) is achieved by depressing the accelerator pedal fully and briskly. An upshift will occur when approaching the top speed for a particular gear or by releasing the accelerator pedal slightly.

Kickdown can be used for maximum acceleration or when passing at highway speeds. **Kickdown does not function**

when the transmission is in the manual shift (geartronic) mode (see next page).

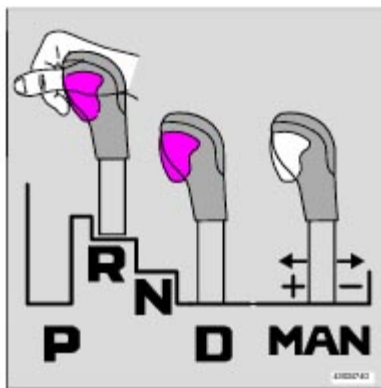

Shift gate positions

Automatic transmission - shift gate positions

You can move the gear selector freely between the (MAN)ual and (D)rive positions while driving.

Depress the button on the front of the gear selector knob to move between the R, N, D, and P positions.

Please see the following page for information on using the Geartronic manual shift mode.

pg. 97 Automatic transmission (Geartronic)

Manual shifting - Geartronic

You can move the gear selector freely between the (MAN)ual and (D)rive positions while driving. Gears 2, 3, and 4 have a "lock-up" function which reduces engine speed and helps save fuel.

The currently selected gear will be displayed in the instrument panel (see [page 27](#)).

- To access the (MAN)ual shifting position from (D)rive, pull the gear selector back slightly from D and move it to the left to MAN.
- To return to the (D)rive position from MAN, move the gear selector to the right and push it forward to the (D)rive position.

While driving

If you select the (MAN)ual position while driving, the gear that was being used in the (D)rive position will also initially be selected in (MAN)ual position.

- Move the gear selector forward (toward "+") to shift to a higher gear or rearward (toward "-") to shift to a lower gear.
- If you hold the gear selector toward "-", the transmission will downshift one gear and will utilize the braking power of the engine. If the current speed is too high for using a lower gear, the downshift will not occur until the speed has decreased enough to allow the lower gear to be used.
- If you slow down to a very low speed, the transmission will automatically shift down.
- When starting in the (MAN)ual position, 3rd gear is the highest gear that may be selected.

NOTE: Kickdown (see previous page) **does not function** when the transmission is in the manual shift (geartronic) mode. The gear selector must be in the D (Drive) position.

W Winter/Wet driving mode - enhanced vehicle traction

Please refer to the information on [page 95](#).



Sport mode (R-models only)

R-models are equipped with a (S)port button that can be used to engage/disengage the Sport shifting mode. An indicator light in the button will go on when Sport mode is engaged.

With Sport mode engaged, the transmission will shift up at higher rpm in first and second gears, and will also shift down at higher rpm for more immediate engine response during acceleration and deceleration.

pg. 98 All Wheel Drive - option

All Wheel Drive (AWD) - general information

Your Volvo can be equipped with permanent All Wheel Drive, which means that power is distributed automatically between the front and rear wheels. Under normal driving conditions, most of the engine's power is directed to the front wheels. However, if there is any tendency for the front wheels to spin, an electronically controlled coupling distributes power to the wheels that have the best traction.

Tire dimensions

Volvo recommends that you always drive on tires of the same brand, size, construction (radial), tread pattern, load-, speed-, traction-, temperature-, and treadwear rating. Never drive on mixed tires, except for brief periods when the temporary spare tire is in use.

Always use properly inflated tires of correct dimensions. Tire size and inflation pressures are shown on the tire inflation pressure placards, located on the driver's side B-pillar (the structural member at the side of the vehicle, at the rear of the driver's door opening), or on the inside of the fuel filler door on Canadian models.

Temporary Spare

The temporary spare tire is for temporary, low-speed, short-distance use only. Replace it with a full-sized tire as soon as possible. Do not drive on the temporary spare at speeds above 50 m.p.h. (80km/h) or for distances greater than 50 miles (80 km).

Never install snow chains on a temporary spare.

pg. 99 Four-C active chassis system (option)

Four-C

The FOUR-C (Continuously Controlled Chassis Concept) active chassis system, consisting of Comfort and Sport modes, is available as an option.

NOTE: The V70 R has a standard FOUR-C system consisting of Comfort, Sport, and Advanced sport modes. The buttons for controlling these driving modes are located in center instrument panel, above the ventilation system panel vents, see the illustration in the right column. These buttons can be pressed at any time to change driving modes. An indicator light in the selected button will come on to indicate the driving mode that is currently selected.

The Four-C system is based on a number of sensors that continuously monitor factors such as the car's lateral and vertical movements, speed, and movements of the wheels. The sensors receive data up to 500 times per second, which is used to provide extremely fast and precise adjustment of each shock absorber. The system adjusts the stiffness of the shock absorbers approximately 100 times per second.



Use the button in the center console to switch between the driving modes Comfort and Sport. This can be done at any time.

Comfort

The Comfort mode chassis setting offers the greatest amount of shock absorption and the softest ride. This mode is recommended for long-distance driving, or when driving in slippery conditions. The indicator light in the button will be off when this mode is selected. If Comfort mode was selected when the engine was switched off, this mode will still be active when the engine is restarted.

Sport

In this mode, shock absorption is stiffer to reduce the car's body sway during cornering and to provide more immediate steering response. The indicator light in the button will come on to indicate that Sport mode has been selected. If this setting was selected when the engine was switched off, Sport mode will still be active when the engine is restarted.

Advanced sport (V70 R only)

In this mode, movement of the shock absorbers is minimal, response from pressure on the throttle pedal is more direct, and body sway in curves or when cornering is sharply reduced. If Advanced sport mode was selected when the engine was switched off, Sport mode will be active when the engine is restarted.

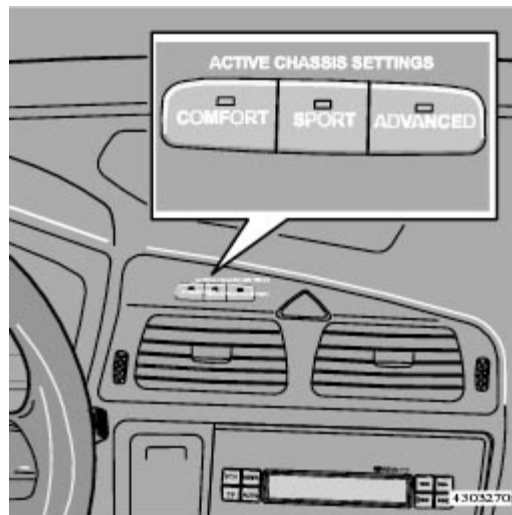

V70 R buttons on the dashboard

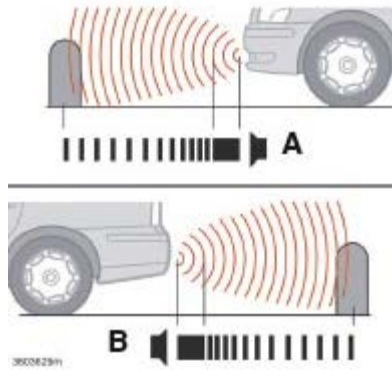

A - front (accessory as available), B - rear (option)

Front/rear park assist

The park assist system(s) are designed to assist you when driving into parking spaces, garages, etc. They utilize ultrasound sensors located in the bumpers to measure the distance to a vehicle or other object, or a person who may be close to the front or rear of the vehicle.

When is park assist active?

Front: the system is active from the time the engine is started until the car exceeds a speed of approximately 10 mph (15 km/h).

Rear: when the engine is running and reverse gear is selected.

NOTE:

- If the vehicle is equipped with front and rear park assist, both systems will either be activated or deactivated together. They cannot be used separately.
- The indicator light in the button (see the illustration on [page 31](#)) will light up to indicate that park assist system(s) are activated.

When park assist is actively working:

1. The audio system's volume will be reduced.
2. An intermittent signal will be audible from the speakers to indicate that you are approaching a person, object, parked vehicle, etc.

The signals begin when the distance between the bumper and the object is:

Rear: approximately 5 feet (1.5 meters)

Front: approximately 2.5 ft (0.8 meters)

3. At a distance of approximately 1 foot (30 cm), the signal will become constant.

Deactivating the system(s)

- Press the Park assist button on the center console (see [page 33](#)) to temporarily deactivate the system(s).
- The indicator light in the button will go out when the system(s) have been deactivated.
- If the vehicle is equipped with front and rear park assist, both systems will be deactivated by pressing the button.

NOTE:

It may be necessary to deactivate one or both of the park assist systems in certain cases.

- **Rear park assist:** towing a trailer, carrying bicycles in a rear-mounted carrier, etc, could trigger the rear park assist system's sensors.
- **Front park assist:** it may not be possible to combine auxiliary headlights and front park assist since these lights could trigger the system's sensors.

Faults in the system

If a fault should occur in the system, the LED in the button will be switched off and a message will be displayed in the text window.

Cleaning the sensors

For the system to function properly, the sensors in the front and/or rear bumpers should be kept clean. They can be cleaned with car washing detergent and a sponge.

WARNING!

These systems are designed to be a supplementary aid when parking the vehicle. They are not, however, intended to replace the driver's attention and judgement.

pg. 101 Driving economy, Handling

Economical driving conserves natural resources

Better driving economy may be obtained by thinking ahead, avoiding rapid starts and stops and adjusting the speed of your vehicle to immediate traffic conditions. Observe the following rules:

- Bring the engine to normal operating temperature as soon as possible by driving with a light foot on the accelerator pedal for the first few minutes of operation. A cold engine uses more fuel and is subject to increased wear.
- Whenever possible, avoid using the car for driving short distances. This does not allow the engine to reach normal operating temperature.
- Drive carefully and avoid rapid acceleration and hard braking.
- Do not exceed posted speed limits.
- Avoid carrying unnecessary items (extra load) in the car.
- Maintain correct tire pressure. Check tire pressure regularly (when tires are cold).
- Remove snow tires when threat of snow or ice has ended.
- Note that roof racks, ski racks, etc., increase air resistance and fuel consumption.
- Avoid using automatic transmission kickdown feature unless necessary.
- Avoid using the air conditioning when it is not required. When engaged, the A/C compressor places an additional load on the engine. However, at higher driving speeds, fuel consumption will be lower with the air conditioning on and the windows closed than with the air conditioning off and the windows open.
- Using the onboard trip computer's fuel consumption modes can help you learn how to drive more economically.

Other factors that decrease gas mileage are:

- Dirty air cleaner
- Dirty engine oil and clogged oil filter
- Dragging brakes
- Incorrect front end alignment

Some of the above mentioned items and others are checked at the standard Maintenance Service intervals.

NOTE: Vehicles equipped with automatic transmissions should use (D)rive as often as possible and avoid using "kick-down" to help improve fuel economy. Vehicles equipped with manual transmissions should use fifth gear at highway speeds. At other times, choose the highest gear that still allows smooth acceleration.

Handling, roadholding

Vehicle load, tire design and inflation pressure all affect vehicle handling. Therefore, check that the tires are inflated to the recommended pressure according to the vehicle load. See "Tire pressure" section. Loads should be distributed so that capacity weight or maximum permissible axle loads are not exceeded.

Speed-sensitive power steering

(Option on certain models)

With this feature, the steering is most responsive at lower speeds to make parking, driving in city traffic, etc., easier. The effect of the power steering diminishes as you accelerate for greater stability at highway speeds.

Weight distribution affects handling

At the specified curb weight your car has a tendency to understeer, which means that the steering wheel has to be turned more than might seem appropriate for the curvature of a bend. This ensures good stability and reduces the risk of rear wheel skid. Remember that these properties can alter with the vehicle load. The heavier the load on the rear of the vehicle (e.g., heavily loaded (max. 220 lbs, 100 kg) cargo area or when towing a trailer, the less the tendency to understeer.

pg. 102 Points to remember

Cooling system

The risk for engine overheating is greatest, especially in hot weather, when:

- Towing a trailer up steep inclines for prolonged periods at wide open throttle and low engine rpm.
- Stopping the engine suddenly after high speed driving (so-called "after-boiling" can occur).
- To avoid overheating, the following rules should be followed:

Do not drive for prolonged periods at engine speeds above 4500 rpm if you are towing a trailer in hilly terrain.

Reduce speed when towing a trailer up long, steep inclines. The risk of overheating can be reduced by switching off the air conditioning system for a short time.

Do not let the engine idle unnecessarily for prolonged periods.

Do not mount auxiliary lamps in front of the grill.

When the risk of overheating is imminent, or in the event of overheating (the temperature gauge goes repeatedly into, or stays continually in, the red section), the following precautions should be taken:

- Switch off the air conditioning system.
- Pull off the road, away from traffic, stop the car and put the gear selector into neutral.
- Switch the heater to full (maximum) position. Increase the engine speed to approx. 2000 rpm (twice idling speed) until the temperature begins to drop.

WARNING!

- Do not remove coolant expansion tank cap. The coolant will be extremely hot.

If necessary, see [page 154](#) for information on checking and topping-up the coolant level.

CAUTION: Drive slowly and carefully if going through standing water (i.e. flooded roadways, etc.). Damage to the engine could result if excess water is drawn in through the air intake system. Never drive the vehicle in water deeper than 1 foot (300 mm). See the flood warning on [page 5](#).

WARNING!

- **Driving with the tailgate open:** Driving with the tailgate open could mean that poisonous exhaust gases enter the passenger compartment.

If the tailgate must be kept open for any reason, proceed as follows:

- Close the windows.
- Set the ventilation system to air flow to floor, windshield and side windows and blower control to its highest setting.

- **Floor mats:** An extra mat on the driver's floor can cause the accelerator pedal to catch. Check that the movement

of the accelerator pedal is not impeded. Not more than one protective floor covering may be used at one time.

Electrical system

When replacing the battery or when carrying out work involving the electrical system, the following should be observed:

- A battery connection to the wrong terminal will damage the electrical system. Be sure to connect the positive battery cable to the positive battery terminal and the negative battery cable to the negative battery terminal.
- If booster batteries are used for starting, they must be properly connected to minimize the risk of the electrical system being damaged. For correct connection, see "Jump starting" section.
- Never disconnect the battery circuit (for example, to replace the battery) while the engine is running, as this may damage the generator. Always make sure that all the battery connections are properly cleaned and tightened.
- If any electrical welding work is performed on the vehicle, the battery's ground lead (negative cable) and all the connecting cables of the generator must be disconnected and the welder cables placed as near the welding points as possible.
- The radio must be turned off before the battery is disconnected.
- Switch off the ignition for at least 10 minutes before disconnecting the battery.

pg. 103 Roof racks/Load carriers

Load carriers (accessory)

Load carriers are available as Volvo accessories. Observe the following points when in use:

- To avoid damaging your car and to achieve maximum safety when driving, we recommend using the load carriers that Volvo has developed especially for your car.
- Volvo-approved removable roof racks are designed to carry the maximum allowable roof load for this vehicle: 220 lbs (100 kg). For Non-Volvo roof racks, check the manufacturer's weight limits for the rack.
- Never exceed the rack manufacturer's weight limits and never exceed the maximum rated roof load of 220 lbs (100 kg).
- Avoid single-point loads. Distribute loads evenly.
- Place heavier cargo at the bottom of the load.
- Anchor the cargo correctly with appropriate tie-down equipment.
- **Check periodically that the load carriers and load are properly secured.**
- Remember that the car's center of gravity and handling change when you carry a load on the roof.
- The car's wind resistance (and correspondingly, fuel consumption) will increase with the size of the load.
- Drive smoothly. Avoid rapid starts, fast cornering and hard braking.

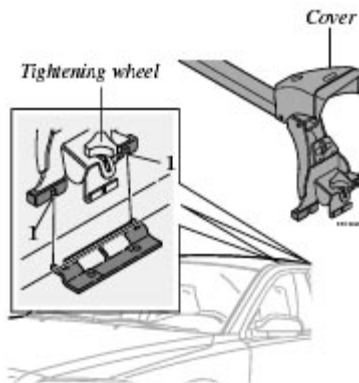

Load carrier attachment points

Attaching load carriers (models without rails)

The attachment brackets for the load carriers are located under the roof molding.

- 1 Make sure that the load carriers are placed in the right direction. See the mark on the decal under the cover.
- 2 Press the guide lugs into the holes (1).
- 3 Carefully lower the opposite side of the load carrier to the roof.
- 4 Loosen the tightening wheel slightly. Slide the hook on the load carrier attachment into the attachment bracket under the roof molding.
- 5 Turn the tightening wheel to secure the load carrier in the attachment bracket.
- 6 Repeat this procedure for the other load carrier attachments.
- 7 Check that the hooks on all four load carrier attachments are securely tightened in the respective attachment brackets on the roof of the car.
- 8 Press down the covers.

Check periodically that the load carriers and load are properly secured.

Reducing wind noise and improving fuel economy

To maximize fuel efficiency and minimize wind noise, Volvo recommends that load carriers be removed when not in use.

WARNING!

Loads carried on the vehicle's roof should not exceed 220 lbs (100 kg), including the weight of the load carriers and any other load carrying equipment (ski boxes, bicycle racks, etc). Excessive loads on the roof can adversely affect the handling and roadholding characteristics of the vehicle.

pg. 104 Load carriers (models with rails)

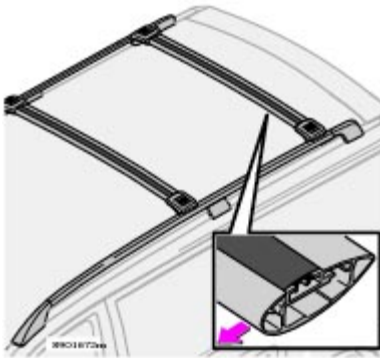

Position of load carriers

Make sure that the wing-shaped load carriers are installed on the roof rails with the rounded edge forward (see the inset illustration above). The load carriers are identical and can be placed anywhere along the roof rails.

Reducing wind noise and improving fuel economy

To maximize fuel efficiency and minimize wind noise, Volvo recommends that load carriers be removed when not in use.

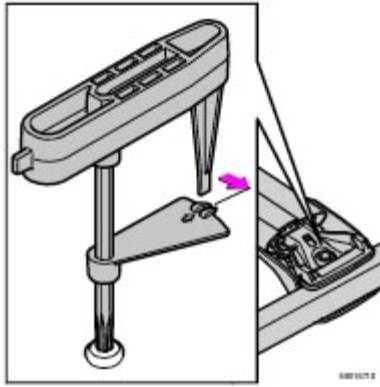

Fitting the load carriers (accessory)

Make sure that the load carrier is pressed firmly out against the roof rail. Screw the load carrier in place. Use the supplied torque wrench and tighten to the mark on the wrench (corresponding to 6 Nm). See illustration.

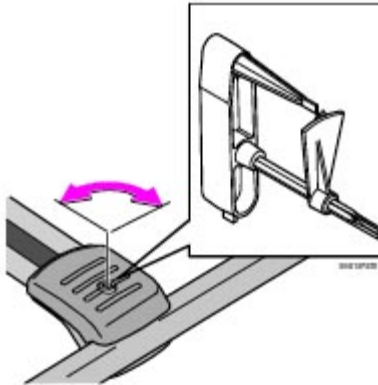

Load carrier cover

The car's ignition key or the stud on the edge of the supplied torque wrench can be used to undo or tighten the cover. Turn a quarter turn (90 degrees). See illustration.



2006
VOLVO
V70

Chapter 7 - Wheels and tires

pg.117 Wheels and tires

<u>General information</u>	<u>118</u>
<u>Tire inflation</u>	<u>120</u>
<u>Tire inflation pressure tables</u>	<u>122</u>
<u>Tire Pressure Monitoring System (TPMS)</u>	<u>123</u>
<u>Self supporting run flat tires</u>	<u>125</u>
<u>Tire designations</u>	<u>126</u>
<u>Glossary of tire terminology</u>	<u>127</u>
<u>Vehicle loading</u>	<u>128</u>
<u>Uniform Tire Quality Grading</u>	<u>129</u>
<u>Snow chains, snow tires, studded tires</u>	<u>130</u>
<u>Temporary spare</u>	<u>131</u>
<u>Changing a wheel</u>	<u>132</u>

pg. 118 Wheels and tires

General information

Your vehicle is equipped with tires according to the vehicle's tire information placard on the B-pillar (the structural member at the side of the vehicle, at the rear of the driver's door opening), or on the inside of the fuel filler door on Canadian models.

The tires have good road holding characteristics and offer good handling on dry and wet surfaces. It should be noted however that the tires have been developed to give these features on snow/ice-free surfaces.

Certain models are equipped with "all-season" tires, which provide a somewhat higher degree of road holding on slippery surfaces than tires without the "all-season" rating. However, for optimum road holding on icy or snow-covered roads, we recommend suitable winter tires on all four wheels.

When replacing tires, be sure that the new tires are the same size designation, type (radial) and preferably from the same manufacturer, on all four wheels. Otherwise there is a risk of altering the car's roadholding and handling characteristics.

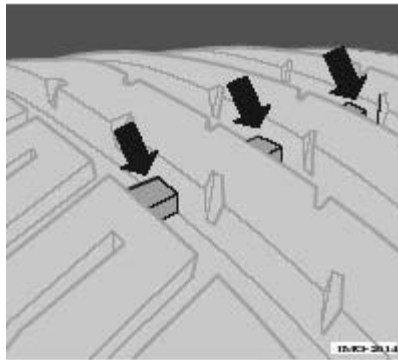

Tread wear indicator

Tread wear indicator

The tires have wear indicator strips running across or parallel to the tread. The letters TWI are printed on the side of the tire. When approximately 1/16" (1.6 mm) is left on the tread, these strips become visible and indicate that the tire should be replaced. Tires with less than 1/16" (1.6 mm) tread offer very poor traction.

When replacing worn tires, it is recommended that the tire be identical in type (radial) and size as the one being replaced. Using a tire of the same make (manufacturer) will prevent alteration of the driving characteristics of the vehicle.

New tires

Remember that tires are perishable goods. As of 2000, the manufacturing week and year will be indicated with 4 digits (e.g. 1502 means that the tire illustrated was manufactured during week 15 of 2002).

Storing wheels and tires

When storing complete wheels (tires mounted on rims), they should be suspended off the floor or placed on their sides on the floor. Tires not mounted on rims should be stored on their sides or standing upright, but should not be suspended.

CAUTION!

Tires should preferably be stored in a cool, dry, dark place, and should never be stored in close proximity to solvents, gasoline, oils, etc.

WARNING!

- The wheel and tire sizes for your Volvo are specified to meet stringent stability and handling requirements. Unapproved wheel/tire size combinations can negatively affect your vehicle's stability and handling. Approved tire sizes are shown in the Tire inflation pressure tables on [page 122](#).
- Any damage caused by installation of unapproved wheel/tire size combinations will not be covered by your new vehicle warranty. Volvo assumes no responsibility for death, injury, or expenses that may result from such installations.

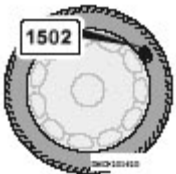

Tire age

Tires degrade over time, even when they are not being used, which can affect their reliability and roadholding characteristics. Therefore, all tires older than 6 years (including the spare tire and winter tires) should be inspected by a qualified technician, regardless of appearance or mileage. Heat caused by hot climates or frequent high loading conditions can accelerate the aging process.

A tire's age can be determined by the DOT stamp on the sidewall (see the illustration above).

A tire with e.g., visible cracks or discoloration should be replaced immediately.

Improving tire economy:

- Maintain correct tire pressure. See the tire pressure table on [page 122](#).
- Drive smoothly: avoid fast starts, hard braking and tire screeching.
- Tire wear increases with speed.
- Correct front wheel alignment is very important.
- Unbalanced wheels impair tire economy and driving comfort.
- Tires must maintain the same direction of rotation throughout their lifetime.
- When replacing tires, the tires with the most tread should be mounted on the rear wheels to reduce the chance of oversteer during hard braking.

Hitting curbs or potholes can damage the tires and/or wheels permanently.

pg. 120 Wheels and tires

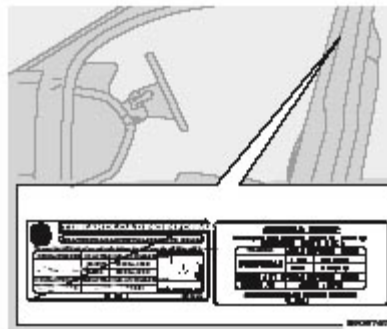

Tire inflation placards on U.S. models

Tire inflation

Check tire inflation pressure regularly.

A table listing the recommended inflation pressure for your vehicle can be found on [page 122](#). Tire inflation pressure placards are also located on the driver's side B-pillar (the structural member at the side of the vehicle, at the rear of the driver's door opening), or on the inside of the fuel filler door on Canadian models. These placards indicate the designation of the factory-mounted tires on your vehicle, as well as load limits and inflation pressure.

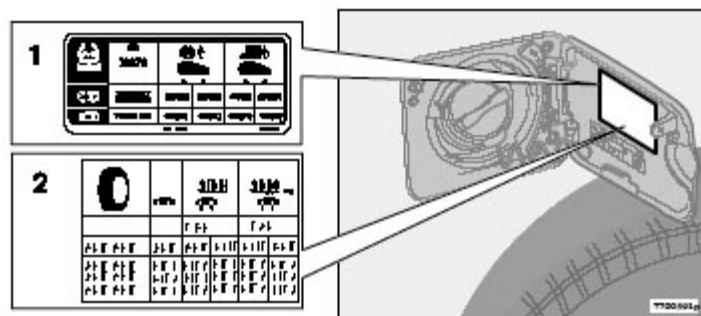

Tire inflation placard on Canadian models, 1. XC70, 2. V70

NOTE: The placards shown indicate inflation pressure for the tires installed on the car at the factory only.

- Use a tire gauge to check the tire inflation pressure, including the spare, at least once a month and before long trips. You are strongly urged to buy a reliable tire pressure gauge, as automatic service station gauges may be inaccurate.
- Use the recommended cold inflation pressure for optimum tire performance and wear.
- Under-inflation or over-inflation may cause uneven treadwear patterns.

When weather temperature changes occur, tire inflation pressures also change. A 10-degree temperature drop causes a corresponding drop of 1 psi (7 kPa) in inflation pressure. Check your tire pressures frequently and adjust them to the proper pressure, which can be found on the vehicle's tire information placard or certification label.

Checking tire pressure

Cold tires

Inflation pressure should be checked when the tires are cold.

The tires are considered to be cold when they have the same temperature as the surrounding (ambient) air.

This temperature is normally reached after the car has been parked for at least 3 hours.

pg. 121 Wheels and tires

After driving a distance of approximately 1 mile (1.6 km), the tires are considered to be hot. If you have to drive farther than this distance to pump your tire(s), check and record the tire pressure first and add the appropriate air pressure when you get to the pump.

If checking tire pressure when the tire is hot, never "bleed" or reduce air pressure. The tires are hot from driving and it is normal for pressures to increase above recommended cold pressures. A hot tire at or below recommended cold inflation pressure could be significantly under-inflated.

To check inflation pressure:

1. Remove the cap from the valve on one tire, then firmly press the tire gauge onto the valve.
2. Add air to reach the recommended air pressure
3. Replace the valve cap.
4. Repeat this procedure for each tire, including the spare.
5. Visually inspect the tires to make sure there are no nails or other objects embedded that could puncture the tire and cause an air leak.
6. Check the sidewalls to make sure there are no gouges, cuts, bulges or other irregularities.

NOTE:

- If you overfill the tire, release air by pushing on the metal stem in the center of the valve. Then recheck the pressure

with your tire gauge.

- Some spare tires require higher inflation pressure than the other tires. Consult the tire inflation table on [page 122](#) or see the inflation pressure placard.

pg. 122 Wheels and tires

Tire inflation pressure tables

Tire pressures recommended by Volvo for your vehicle. Refer to the tire inflation placard for information specific to the tires installed on your vehicle at the factory.

Cold tire pressure for vehicle loads up to 930 lbs (420 kg) ¹		
Tire size	Front, psi (kPa)	Rear, psi (kPa)
V70		
195/65R15	38 (260)	38 (260)
205/55R16	38 (260)	38 (260)
215/55R16	38 (260)	38 (260)
235/45R17	38 (260)	38 (260)
235/45R17 SSRFT ²	38 (260)	38 (260)
Temporary spare tire T125/80R17	61 (420)	61 (420)
V70 R		
235/45R17	39 (270)	39 (270)
Temporary spare tire T115/85R18	61 (420)	61 (420)
XC70		
215/65R16	38 (260) ³	38 (260)
215/60R17	38 (260) ³	38 (260)
Temporary spare tire T135/90R17	61 (420)	61 (420)

¹ These weights include the weight of all occupants of the car plus cargo.

² Self supporting run flat tires. See [page 119](#) for more information.

³ Canadian models: 35 psi (240 kPa).

Optional tire pressure. These inflation pressures may only be used when the vehicle is not fully loaded.

Optional cold tire pressure that may only be used for vehicle loads up to 495 lbs (225 kg).		
Tire size	Front, psi (kPa)	Rear, psi (kPa)
V70		
195/65R15	32 (220)	30 (210)
205/55R16	32 (220)	30 (210)
215/55R16	32 (220)	30 (210)
235/45R17	32 (220)	30 (210)
235/45R17 SSRFT	-	-

Temporary spare tire T125/80R17	61 (420)	61 (420)
V70 R		
235/45R17	35 (240)	35 (240)
Temporary spare tire T115/85R18	61 (420)	61 (420)
XC70		
215/65R16	30 (210) ⁴	30 (210) ⁴
215/60R17	30 (210) ⁴	30 (210) ⁴
Temporary spare tire T135/90R17	61 (420)	61 (420)

⁴ The optional tire pressure shown in this table may not be used on XC70s equipped with the Tire Pressure Monitoring System (option as available). Vehicles with this system must use the standard tire pressure listed in the table in the left column (38 psi/260 kPa).

pg. 123 Wheels and tires

Tire Pressure Monitoring System (TPMS) - option on certain U.S. models only

The tire pressure monitoring system uses sensors mounted in the tire valves to check inflation pressure levels. When the vehicle is moving at a speed of 20 mph (30 km/h) or faster, these sensors transmit inflation pressure data to a receiver located in the vehicle.

USA - FCC ID: MRXTG315AM04

This device complies with part 15 of the FCC rules. Operation is subject to the following conditions: (1) This device may not cause harmful interference, and (2) this device must accept any interference received, including interference that may cause undesired operation.

WARNING!

The TPMS system uses a radio frequency of 315 MHz. Accessory electrical equipment using the same frequency could interfere with TPMS and should not be installed in the vehicle. Please consult your Volvo retailer, a qualified Volvo service technician, or the accessory equipment's supplier for further information.

When low inflation pressure is detected, TPMS will light up the tire pressure warning light (ⓘ) (also referred to as a telltale) in the instrument panel, and will display a message in the text window. The wording of this message is determined by the degree of inflation pressure loss.

When the tire pressure monitoring system warning light is on, one or more of your tires is significantly under-inflated. You should stop and check your tires as soon as possible, and inflate them to the proper pressure as indicated on the vehicle's tire information placard.

Driving on a significantly under-inflated tire causes the tire to overheat and can lead to tire failure. Under-inflation also reduces fuel efficiency and tire tread life, and may affect the vehicle's handling and stopping ability. Each tire, including the spare, should be checked monthly when cold and set to the recommended inflation pressure as specified in the vehicle placard and owner's manual.

NOTE: If a fault occurs in TPMS, the tire pressure warning light will flash for approximately 1 minute and TIRE PRESS SYST SERVICE REQUIRED will be displayed.

Each tire, including the spare (if provided), should be checked monthly when cold and inflated to the inflation pressure recommended by the vehicle manufacturer on the vehicle placard or tire inflation pressure label. (If your vehicle has tires of a different size than the size indicated on the vehicle placard or tire inflation pressure label, you should consult the appropriate section of this owner's manual to determine the proper tire inflation pressure.) When the low tire pressure telltale is illuminated, one or more of your tires is significantly underinflated. You should stop and check your tires as soon as possible, and inflate them to the proper pressure. Driving on a significantly underinflated tire causes the tire to overheat and can lead to tire failure. Under-inflation also reduces fuel efficiency and tire tread life, and may affect the vehicle's handling and stopping ability. Your vehicle has also been equipped with a TPMS malfunction telltale to indicate when the system is not operating properly. When the malfunction telltale is illuminated, the system may not be able to detect or signal low tire pressure as intended. TPMS malfunctions may occur for a variety of reasons, including the installation of incompatible replacement tires on the vehicle. Always check the TPMS malfunction telltale after replacing one or more tires on your vehicle to ensure that the replacement tires are compatible with the TPMS.

NOTE: TPMS indicates low tire pressure but does not replace normal tire maintenance. For information on correct tire pressure, please refer to the table on [page 122](#), or consult your Volvo retailer.

Erasing warning messages

When a low tire pressure warning message has been displayed, and the tire pressure warning light has come on:

1. Use a tire pressure gauge to check the inflation pressure of all four tires.
2. Re-inflate the tire(s) to the correct pressure (consult the tire pressure placard or the table on [page 122](#)).
3. Drive the car for several minutes at a speed of 20 mph (30 km/h) or faster.

This will erase the warning text and the warning light will go out.

WARNING!

Incorrect inflation pressure could lead to tire failure, resulting in a loss of control of the vehicle.

(Contd. on following page)

pg. 124 Wheels and tires

Changing tires

Please note the following when changing or replacing the factory installed TPMS wheels/ tires on the vehicle:

- Only the factory-mounted wheels are equipped with TPMS sensors in the valves.
- If the vehicle is equipped with a temporary spare tire, this tire does not have a TPMS sensor.
- If winter wheels without TPMS sensors are mounted on the vehicle, TIRE PRESS SYST SERVICE REQUIRED will be displayed each time the vehicle is driven above 25 mph (40 km/h) for 10 minutes or more.
- Once TPMS sensors are properly installed, the warning message should not reappear.
- Volvo recommends that TPMS sensors be fitted on all wheels used on the vehicle. Volvo does not recommend moving sensors back and forth between sets of wheels.

CAUTION!

When inflating tires with TPMS valves, press the pump's mouthpiece straight onto the valve to help avoid bending or otherwise damaging the valve.

pg. 125 Wheels and tires

Self supporting run flat tires (option)

Certain models equipped with the Tire Pressure Monitoring System (TPMS) can also be equipped with self supporting

run flat tires.

Tires of this type have specially reinforced sidewalls that make it possible to continue driving in the event of a drop in inflation pressure. Tires of this type are mounted on special rims.

NOTE: Self supporting run flat tires are only available in conjunction with TPMS.

If a self supporting run flat tire should lose inflation pressure, the yellow TPMS warning symbol (ⓘ) in the instrument panel lights up to alert the driver, and a message will be shown in the text window in the instrument panel.

If this occurs, reduce vehicle speed to a maximum of 50 mph (80 km/h). The vehicle can be driven approximately 50 miles (80 km), or somewhat farther if the vehicle is not heavily loaded. The tire should be replaced as soon as possible.

Hard braking and sudden steering maneuvers should be avoided.

In certain cases, it may be difficult to see which self supporting run flat tire is defective. To determine which tire is damaged, check the inflation pressure of all four tires.

WARNING!

- Only specially trained persons should mount self supporting run flat tires.
- If self supporting run flat tires are mounted, the vehicle must be equipped with a Tire Pressure Monitoring System.
- After a low pressure warning has been displayed, do not exceed 50 mph (80 km/h).
- Avoid severe cornering and hard braking, and minimize the distance traveled before replacing the self supporting run flat tire.
- Self supporting run flat tires cannot be repaired. They must be replaced if damaged or punctured.

pg. 126 Wheels and tires

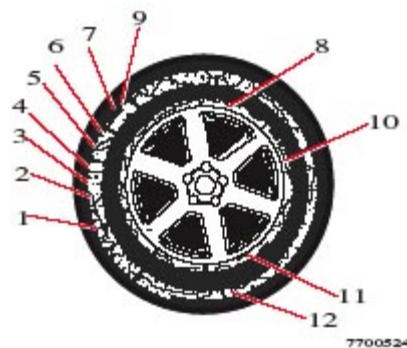

Tire designations

Federal law mandates that tire manufacturers place standardized information on the sidewall of all tires (see the illustration).

The following information is listed on the tire sidewall:

The tire designation (the following figures are examples of a tire designation):

1. 215: the width of the tire (in millimeters) from sidewall edge to sidewall edge. The larger the number, the wider the tire.

2. 65: The ratio of the tire's height to its width.
 3. R: Radial tire.
 4. 15: The diameter of the wheel rim (in inches).
 5. 95: The tire's load index. In this example, a load index of 95 equals a maximum load of 1521 lbs (690 kg).
 6. H: The tire's speed rating, or the maximum speed at which the tire is designed to be driven for extended periods of time, carrying a permissible load for the vehicle, and with correct inflation pressure. For example, H indicates a speed rating of 130 mph (210 km/h).
- NOTE:** This information may not appear on the tire because it is not required by law.
7. M+S or M/S = Mud and Snow, AT = All Terrain, AS = All Season
 8. U.S. DOT Tire Identification Number (TIN): This begins with the letters "DOT" and indicates that the tire meets all federal standards. The next two numbers or letters are the plant code where it was manufactured, the next two are the tire size code and the last four numbers represent the week and year the tire was built. For example, the numbers 317 mean the 31st week of 1997. After 2000 the numbers go to four digits. For example, 2501 means the 25th week of 2001. The numbers in between are marketing codes used at the manufacturer's discretion. This information helps a tire manufacturer identify a tire for safety recall purposes.
 9. Tire Ply Composition and Material Used: Indicates the number of plies indicates or the number of layers of rubber-coated fabric in the tire tread and sidewall. Tire manufacturers also must indicate the ply materials in the tire and the sidewall, which include steel, nylon, polyester, and others.
 10. Maximum Load: Indicates the maximum load in pounds and kilograms that can be carried by the tire. Refer to the vehicle's tire information placard or the safety certification label, located on the B-Pillar or the driver's door or on the inside of the fuel filler door on Canadian models, for the correct tire pressure for your vehicle.
 11. Treadwear, Traction, and Temperature grades: See [page 129](#) for more information.
 12. Maximum permissible inflation pressure: the greatest amount of air pressure that should ever be put in the tire. This limit is set by the tire manufacturer.

pg. 127 Wheels and tires

Glossary of tire terminology

The tire suppliers may have additional markings, notes or warnings such as standard load, radial tubeless, etc.

Glossary of tire terminology

- **Tire information placard:** A placard showing the OE (Original Equipment) tire sizes, recommended inflation pressure, and the maximum weight the vehicle can carry.
- **Tire Identification Number (TIN):** A number on the sidewall of each tire providing information about the tire brand and manufacturing plant, tire size and date of manufacturer.
- **Inflation pressure:** A measure of the amount of air in a tire.
- **Standard load:** A class of P-metric or Metric tires designed to carry a maximum load at 35 psi [37 psi (2.5 bar) for Metric tires]. Increasing the inflation pressure beyond this pressure will not increase the tires load carrying capability.
- **Extra load:** A class of P-metric or Metric tires designed to carry a heavier maximum load at 41 psi [43 psi (2.9 bar) for Metric tires]. Increasing the inflation pressure beyond this pressure will not increase the tires load carrying capability.
- **kPa:** Kilopascal, a metric unit of air pressure.

- **PSI:** Pounds per square inch, a standard unit of air pressure.
- **B-pillar:** The structural member at the side of the vehicle behind the front door.
- **Bead area of the tire:** Area of the tire next to the rim.
- **Sidewall of the tire:** Area between the bead area and the tread.
- **Tread area of the tire:** Area of the perimeter of the tire that contacts the road when mounted on the vehicle.
- **Rim:** The metal support (wheel) for a tire or a tire and tube assembly upon which the tire beads are seated.
- **Maximum load rating:** a figure indicating the maximum load in pounds and kilograms that can be carried by the tire. This rating is established by the tire manufacturer.
- **Maximum permissible inflation pressure:** the greatest amount of air pressure that should ever be put in the tire. This limit is set by the tire manufacturer.
- **Recommended tire inflation pressure:** inflation pressure, established by Volvo, which is based on the type of tires that are mounted on a vehicle at the factory. This inflation pressure is affected by the number of occupants in the car, the amount of cargo, and the speed at which the vehicle will be driven for a prolonged period. This information can be found on the tire inflation placard(s) located on the driver's side B-pillar or on the inside of the fuel filler door on Canadian models, and in the tire inflation table in this chapter.
- **Cold tires:** The tires are considered to be cold when they have the same temperature as the surrounding (ambient) air. This temperature is normally reached after the car has been parked for at least 3 hours.

pg. 128 Wheels and tires

Vehicle loading

Properly loading your vehicle will provide maximum return of vehicle design performance.

Before loading your vehicle, familiarize yourself with the following terms for determining your vehicle's weight ratings, with or without a trailer, from the vehicle's Federal/ Canadian Motor Vehicle Safety Standards (FMVSS/CMVSS) label, and the vehicle's tire information placard:

Curb weight

The weight of the vehicle including a full tank of fuel and all standard equipment. It does not include passengers, cargo, or optional equipment.

Capacity weight

All weight added to the curb weight, including cargo and optional equipment. When towing, trailer hitch tongue load is also part of cargo weight.

NOTE: For trailer towing information, please refer to the section "Towing a trailer" on [page 107](#).

Permissible axle weight

The maximum allowable weight that can be carried by a single axle (front or rear). These numbers are shown on the Federal/Canadian Motor Vehicle Safety Standards (FMVSS/ CMVSS) label. The total load on each axle must never exceed its maximum permissible weight.

Gross vehicle weight (GVW)

The vehicle's curb weight + cargo + passengers.

NOTE:

- The location of the various labels in your vehicle can be found on [page 160](#).
- A table listing important weight limits for your vehicle can be found on [page 166](#).

Steps for Determining Correct Load Limit

- (1) Locate the statement "the combined weight of occupants and cargo should never exceed XXX pounds" on your vehicle's placard.
- (2) Determine the combined weight of the driver and passengers that will be riding in your vehicle.
- (3) Subtract the combined weight of the driver and passengers from XXX kilograms or XXX pounds.
- (4) The resulting figure equals the available amount of cargo and luggage load capacity. For example, if the "XXX"

amount equals 1400 lbs. and there will be five 150 lb. passengers in your vehicle, the amount of available cargo and luggage load capacity is 650 lbs. (1400-750 (5 x 150) = 650 lbs.)

(5) Determine the combined weight of luggage and cargo being loaded on the vehicle. That weight may not safely exceed the available cargo and luggage load capacity calculated in Step 4.

(6) If your vehicle will be towing a trailer, load from your trailer will be transferred to your vehicle. Consult this manual¹ to determine how this reduces the available cargo and luggage load capacity of your vehicle.

WARNING!

- Exceeding the permissible axle weight, gross vehicle weight, or any other weight rating limits can cause tire overheating resulting in permanent deformation or catastrophic failure.

- Do not use replacement tires with lower load carrying capacities than the tires that were original equipment on the vehicle because this will lower the vehicle's GVW rating. Replacement tires with a higher limit than the originals do not increase the vehicle's GVW rating limitations.

¹ See "Towing a trailer" on [page 107](#).

pg. 129 Wheels and tires

Uniform tire quality grading

ALL PASSENGER VEHICLE TIRES MUST CONFORM TO FEDERAL SAFETY REQUIREMENTS IN ADDITION TO THESE GRADES>

Quality grades can be found, where applicable, on the tire sidewall between the tread shoulder and maximum section width. For example:

Treadwear 200 Traction AA Temperature A

TREADWEAR

The treadwear grade is a comparative rating based on the wear rate of the tire when tested under controlled conditions on a specified government test course. For example, a tire graded 150 would wear one and one half (1 1/2) times as well on the government course as a tire graded 100. The relative performance of tires depends upon the actual conditions of their use, however, and many depart significantly from the norm due to variation in driving habits, maintenance practices and differences in road characteristics and climate.

TRACTION

The traction grades, from highest to lowest, are AA, A, B, and C, as measured under controlled conditions on specified government test surfaces of asphalt and concrete. A tire marked C may have poor traction performance.

WARNING!

The traction grade assigned to this tire is based on braking (straight-ahead) traction tests and is not a measure of cornering (turning) traction.

TEMPERATURE

The temperature grades are AA (the highest), A, B, and C, representing the tire's resistance to the generation of heat and its ability to dissipate heat when tested under controlled conditions on a specified indoor laboratory test wheel. Sustained high temperature can cause the material of the tire to degenerate and reduce tire life, and excessive temperature can lead to sudden tire failure. The grade C corresponds to a minimum level of performance that all

passenger vehicle tires must meet under the Federal Motor Safety Standard No. 109. Grades B and A represent higher levels of performance on the laboratory test wheel than the minimum required by law.

WARNING!

The temperature grade for this tire is established for a tire that is properly inflated and not overloaded. Excessive speed, under-inflation, or excessive loading, either separately or in combination, can cause heat buildup and tire failure.

pg. 130 Wheels and tires

Snow chains, snow tires, studded tires

Snow chains

Snow chains can be used on your Volvo with the following restrictions:

- Snow chains should be installed on front wheels only. Use only Volvo approved snow chains.
- If accessory, aftermarket or "custom" tires and wheels are installed and are of a size different than the original tires and wheels, chains in some cases CANNOT be used. Sufficient clearances between chains and brakes, suspension and body components must be maintained.
- Some strap-on type chains will interfere with brake components and therefore CANNOT be used.
- All Wheel Drive models: Snow chains should only be installed on the front wheels. Only chains adapted for AWD models should be used.

Consult your Volvo retailer for additional snow chain information.

CAUTION:

- Check local regulations regarding the use of snow chains before installing.
- Always follow the chain manufacturer's installation instructions carefully. Install chains as tightly as possible and retighten periodically.
- Never exceed the chain manufacturer's specified maximum speed limit. (Under no circumstances should you exceed 31 mph (50 km/h)).
- Avoid bumps, holes or sharp turns when driving with snow chains.
- The handling of the vehicle can be adversely affected when driving with chains. Avoid fast or sharp turns as well as locked wheel braking.

Snow tires, studded tires¹

Tires for winter use:

- Owners who live in or regularly commute through areas with sustained periods of snow or icy driving conditions are strongly advised to fit suitable winter tires to help retain the highest degree of traction.
- It is important to install winter tires on all four wheels to help retain traction during cornering, braking, and accelerating. Failure to do so could reduce traction to an unsafe level or adversely affect handling.
- Do not mix tires of different design as this could also negatively affect overall tire road grip.
- Winter tires wear more quickly on dry roads in warm weather. They should be removed when the winter driving season has ended.
- Studded tires should be run-in 300-600 miles (500-1000 km) during which the car should be driven as smoothly as possible to give the studs the opportunity to seat properly in the tires. The tires should have the same rotational direction throughout their entire lifetime.

NOTE: Please consult state or provincial regulations restricting the use of studded winter tires before installing such

tires.

¹ Where permitted

pg. 131 Wheels and tires

Temporary Spare

The spare tire in your car is called a "Temporary Spare".

Recommended tire pressure (see the placard on the B-pillar or on the fuel filler door) should be maintained irrespective of which position on the car the temporary spare tire is used on.

In the event of damage to this tire, a new one can be purchased from your Volvo retailer.

WARNING!

Current legislation prohibits the use of the "Temporary Spare" tire other than as a temporary replacement for a punctured tire. It must be replaced as soon as possible by a standard tire. Road holding and handling may be affected with the "Temporary Spare" in use. Do not exceed 50 mph (80 km/h). Do not drive farther than 50 miles (80 km) on a temporary spare tire.

CAUTION:

The car must not be driven with wheels of different dimensions or with a spare tire other than the one that came with the car. The use of different size wheels can seriously damage your car's transmission.

pg. 132 Changing a wheel

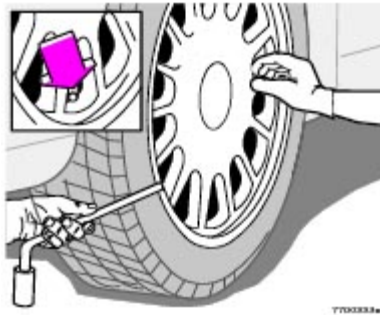

Insert flat end of lug wrench and turn/pull straight out

Changing a wheel

The spare wheel is located under the carpet on the cargo area floor. The jack and crank are secured in the wheel recess.

- Engage the parking brake.
- Put the gear selector in (P)ark (automatic) or in Reverse (manual).
- With the car still on the ground, use the lug wrench to loosen the wheel bolts 1/2 - 1 turn. Turn the bolts counterclockwise to loosen.
- Fold out the crank handle on the jack by pressing the knob on the handle downward. To attach the jack, refer to the illustration on the following page.

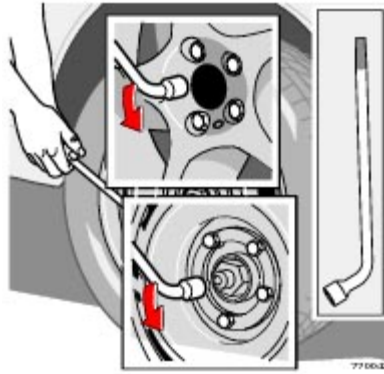

Loosen wheel bolts

There is a jack attachment located in the center on each side of the car. Position the jack on the bar in the attachment as shown in illustration above and crank while simultaneously guiding the base of the jack to the ground. **The base of the jack must be flat on a level, firm, non-slippery surface. Before raising the car, check that the jack is still correctly positioned in the attachment.**

WARNING!

The jack's attachment must engage the bar in the jack attachment (see inset illustration above). The car's weight must not rest on the jack attachment.

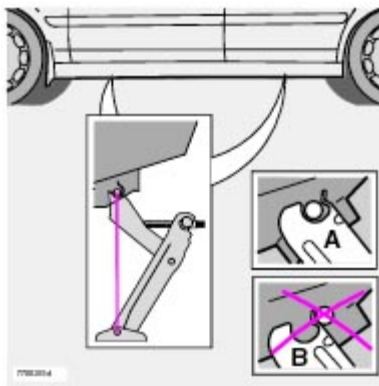

Attaching the jack

Raise the vehicle until both wheels on the side of the car where the jack is attached are lifted off the ground. Unscrew the wheel bolts completely and carefully remove the wheel so as not to damage the thread on the studs.

NOTE: To avoid excessive wear and the necessity of rebalancing, mark and reinstall wheels in the same location and position as before removal. To lessen the chance of imbalance, each wheel hub is equipped with a guide stud to ensure that a removed wheel can be reinstalled in its original position (as when changing over to winter tires/wheels).

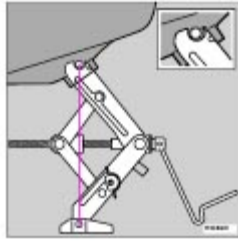

Jack for AWD models

CAUTION:

The car must not be driven with wheels of different dimensions or with a spare tire other than the one that came with the car. The use of different size wheels can seriously damage your car's transmission.

WARNING!

- The jack's attachment must engage the bar in the jack attachment (see inset illustration on the previous page). The car's weight must not rest on the jack attachment.
- Be sure the jack is on a firm, level, non-slippery surface.
- Never allow any part of your body to be extended under a car supported by a jack.
- Use the jack intended for the car when replacing a wheel. For any other job, use stands to support the side of the car being worked on.
- Apply the parking brake, select position P (automatic transmission) or Reverse gear (manual transmission).
- Block the wheels standing on the ground, use rigid wooden blocks or large stones.
- The jack should be kept well-greased.

Installing the wheel

Clean the contact surfaces on the wheel and hub. Lift the wheel and place it on the hub. Make sure that you align the wheel with the guide stud on the wheel hub prior to installation. Install the wheel bolts crosswise (see illustration) and tighten by turning lightly clockwise. Lower the vehicle to the ground and alternately tighten the bolts to 102 ft. lbs. (140 Nm). Install the wheel cap (where applicable).

CAUTION: Correct tightening torque on wheel bolts must be observed. The wheel bolts should never be greased or lubricated. The extended, chromed wheel bolts must not be used with steel rims, as they make it impossible to fit the hub caps.

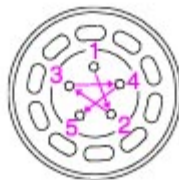

Correct tightening order for wheel bolts



[Contents](#) | [Top of Page](#)

2006
VOLVO
V70

Chapter 8 - Maintenance/Serviceing

pg. 135 Maintenance/Serviceing

Fuses 136

Replacing bulbs 141

Paint touch up 148

Washing the car 149

Cleaning the upholstery 151

Maintenance service, Warranty 152

Fuel/emissions systems 153

Drive belt, Coolant 154

Maintaining your car 155

Serviceing 157

Opening the hood, Engine compartment 158

Engine oil 159

Power steering/Brake fluid reservoirs 161

Replacing the battery 162

Battery maintenance 163

Replacing wiper blades 164

pg. 136 Fuses

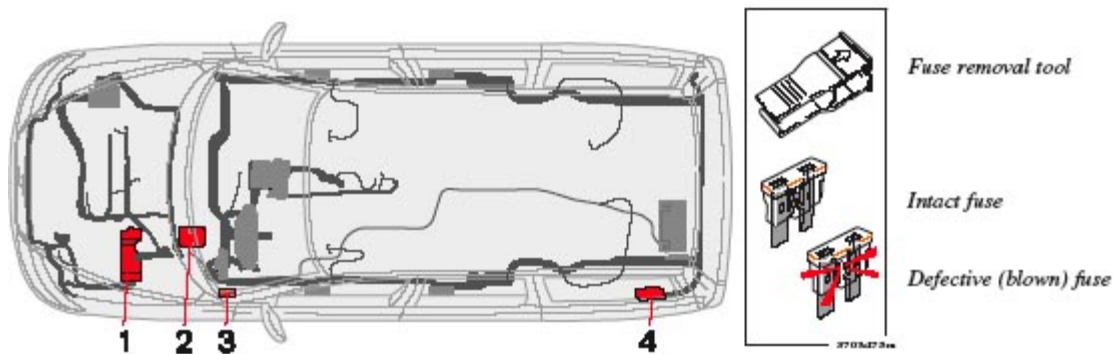

Replacing fuses

If an electrical component fails to function, it is possible that a fuse has blown due to a temporary circuit overload.

Fuses are located in four different places:

1. Relays/fuse box in the engine compartment
2. Fuse box in the passenger compartment, behind the plastic cover
3. Fuse box in the passenger compartment, on the edge of the dashboard
4. Fuse box in the cargo area

A label on the inside of each cover indicates the amperage and the electrical components that are connected to each fuse.

The easiest way to see if a fuse is blown is to remove it. Pull the fuse straight out. If a fuse is difficult to remove, you will find a special fuse removal tool in the passenger compartment fuse box. From the side, examine the curved metal wire to see if it is broken. If so, put in a new fuse of the **same color and amperage** (written on the fuse). Spare fuses are stored in the fuse box in the passenger compartment. If fuses burn out repeatedly, have the electrical system inspected by an authorized Volvo retailer.

WARNING!

Never use fuses with higher amperage than those stated on the following pages. Doing so could overload the car's electrical system.

pg. 137 Fuses in the engine compartment

Relays/fuses in the engine compartment

When replacing fuses, be sure to replace a blown fuse with a new one of the **same color and amperage** (written on the fuse). Fuse amperage is also indicated on the inside of the fuse box cover. Fuses in positions marked X are replacement fuses.

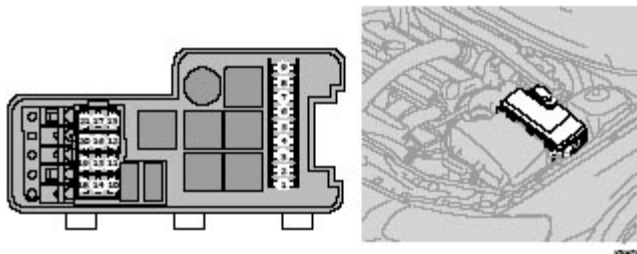

A - To open, press the plastic catches on the sides of the fuse box cover and lift

Ordinary fuses

Location

Amperage

1 ABS	30A
2 ABS	30A
3 -	
4 -	
5 Auxiliary lights (option)	20A
6 Starter motor relay	35A
7 Windshield wipers	25A
8 -	
9 Fuel pump	15A
10 Ignition coils, engine control module	20A
11 Throttle pedal sensor, A/C compressor, e-box fan	10A
12 Engine control module, fuel injectors, mass airflow sensor	15A
13 Throttle housing control module	10A
14 Heated oxygen sensor	20A
15 Crankcase ventilation heater, solenoid valves	10A
16 Driver's side low beam headlight.	20A
17 Passenger's side low beam headlight	20A
18 -	
19 Engine control module feed, engine relay	5A
20 Parking lights	15A
21 -	

pg. 138 Fuses in the passenger compartment

Fuse box on the edge of the dashboard

Fuses are located inside the access panel on the edge of the dashboard. When replacing a blown fuse, be sure to replace it with a new one of the **same color and amperage** (written on the fuse).

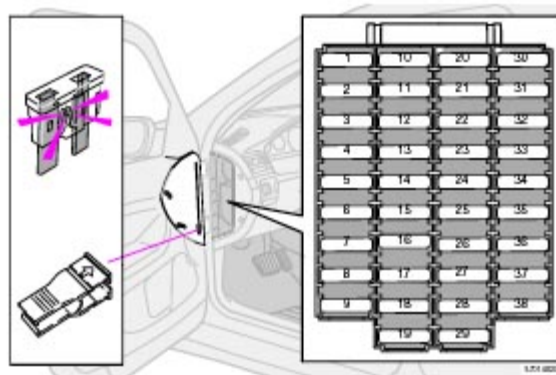

Location	Amperage
1 Power driver's seat (option)	25A
2 Power passenger's seat (option)	25A
3 Climate system blower	30A
4 Control module - front passenger's door	25A
5 Control module - driver's door	25A
6 Ceiling lighting, upper electrical control module	10A

7 Moon roof (option)	15A
8 Ignition switch, SRS system, engine control module, immobilizer, transmission control module (R-models)	7.5A
9 Onboard diagnostics, headlight switch, steering wheel angle sensor, steering wheel control module	5A
10 Audio system	20A
11 Audio system amplifier	30A
12 Navigation system display (option)	10A
13 -	
14 -	
15 -	
16 -	
17 -	
18 -	
19 -	
20 -	
21 -	
22 -	
23 -	
24 -	
25 -	
26 -	
27 -	
28 -	
29 -	
30 -	
31 -	
32 -	
33 -	
34 -	
35 -	
36 -	
37 -	
38 -	

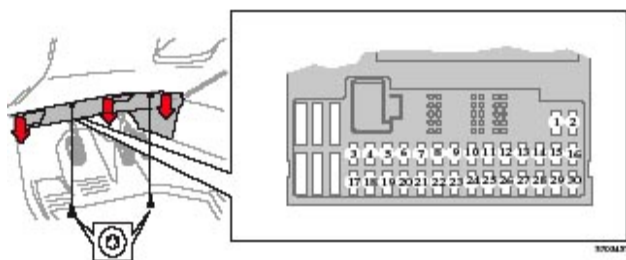

Fuse box in the passenger compartment, behind the plastic cover

Location	Amperage
1 Heated passenger's seat (option)	15A
2 Heated driver's seat (option)	15A
3 Horn	15A
4 -	
5 -	
6 -	
7 -	
8 Alarm siren	5A
9 Brake light switch feed	5A
10 Instrument panel, climate system, power driver's seat (option), Occupant Weight Sensor (US models only)	10A
11 12-volt sockets - front and rear seats	15A
12 -	
13 -	
14 Headlight wipers (V70 R)	15A
15 ABS, STC/DSTC	5A
16 Power steering, Bi-Xenon headlights (option)	10A
17 Driver's side front foglight (option)	7.5A
18 Passenger's side front foglight (option)	7.5A
19	-
20 -	
21 Transmission control module, reverse gear block (M66)	10A
22 Driver's side high beam	10A
23 Passenger's side high beam	10A
24 -	
25 -	
26 -	
27 -	
28 Power passenger's seat (option), audio system	5A
29 -	
30 -	

- 31 -
- 32 -
- 33 Vacuum pump 20A
- 34 Washer pump - headlight wipers (V70 R) 15A
- 35 -
- 36 -

pg. 140 Fuses in the cargo compartment

Fuses in the cargo area

The fuses in the cargo area are located behind the panel on the driver's side of the cargo compartment. When replacing a blown fuse, be sure to replace it with a new one of the **same color and amperage** (written on the fuse).

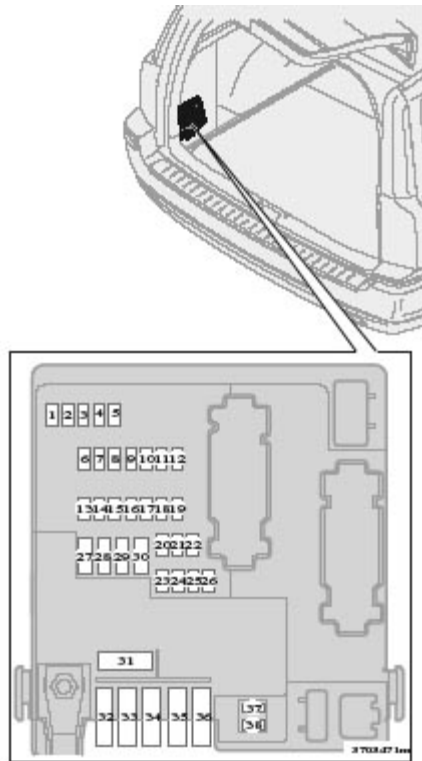

Ordinary fuses

Location	Amperage
1 Backup lights	10A
2 Parking lights, foglights, cargo area lighting, license plate lighting, brake lights	20A
3 Accessory control module	15A
4 -	
5 Rear Electronic Module	10A
6 CD-changer (option), Navigation system (option)	7.5A
7 Trailer wiring (30-feed)	15A
8 12-volt socket - cargo area	15A
9 Rear passenger's side door - power window cut-out function	20A
10 Rear driver's side door - power window, power window cut-out function	20A
11 -	

12 -	
13 -	
14 Subwoofer (option)	15A
15 -	
16 -	
17 Accessory audio	5A
18 -	
19 Tailgate wiper	15A
20 Trailer wiring (15-feed)	20A
21 -	
22 -	
23 All Wheel Drive	7.5A
24 Four-C chassis system (option)	15A
25 -	
26 Park assist (option)	5A
27 Main fuse: trailer wiring, Four-C, park assist, All Wheel Drive	30A
28 Central locking system	15A
29 Driver's side trailer lighting: parking lights, turn signal	25A
30 Passenger's side trailer lighting: parking light, brake light, fog light, turn signal	25A
31 Main fuse: fuses 37 and 38	40A
32 -	
33 -	
34 -	
35 -	
36 -	
37 Heated rear window	20A
38 Heated rear window	20A

pg. 141 Replacing bulbs

Replacing bulbs

When replacing bulbs, keep the following points in mind:

- Never touch the glass of bulbs with your fingers. Grease and oils from your fingers vaporize in the heat and will leave a deposit on the reflector, which will damage it.
- The optional Bi-Xenon headlight bulbs contain trace amounts of mercury. These bulbs should always be disposed of by an authorized Volvo retailer.
- Certain bulbs not listed here should only be replaced by an authorized Volvo service technician.

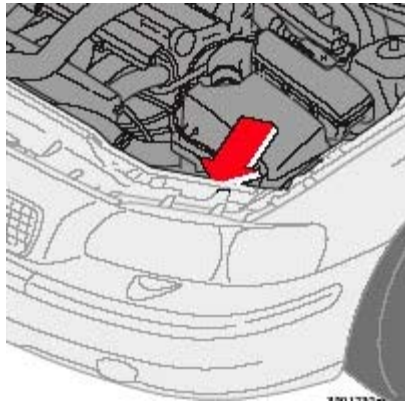

Replacing bulbs at the front of the vehicle

All front bulbs (except the optional front fog lights) are replaced from the engine compartment.

WARNING!

Bi-Xenon headlights (option) - due to the high voltage used by these headlights, these bulbs should only be replaced by an authorized Volvo service technician.

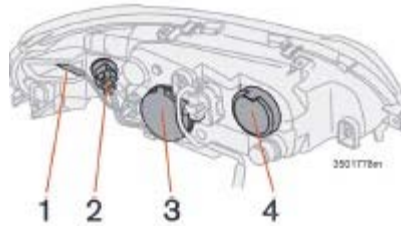

Location of the bulbs in the headlight housing *

1. Side marker light
2. Turn signal
3. Low beam headlight/Parking light
4. High beam headlight

Certain models may have a plastic tube that may hinder access to the bulbs. This tube can be broken off and discarded.

*Models with halogen headlights only

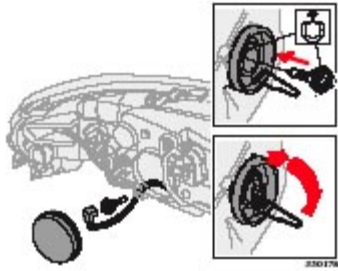

Low beam bulb

Low beam headlight

Removing the defective bulb:

1. Switch off the headlights and turn the ignition switch to position 0.
2. Remove the plastic cover.
3. Disconnect the wiring connector.
4. Loosen the retaining spring by first moving it to the right and then moving it outward and downward, out of the way.
5. Pull out the defective bulb.

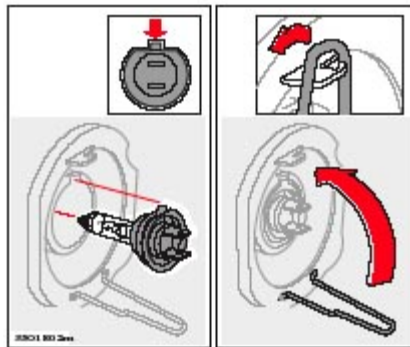

Installing the new bulb:

1. Insert the new bulb, without touching the glass, with the guide lug upward. The bulb will only seat properly in this position.
2. Move the retaining spring up and push it slightly to the left until it seats properly.
3. Reconnect the wiring connector.
4. Reinstall the plastic cover.

NOTE: If the vertical aim of your headlights needs to be adjusted for any reason (e.g., towing a trailer for extended periods), this should be done by an authorized Volvo retailer.

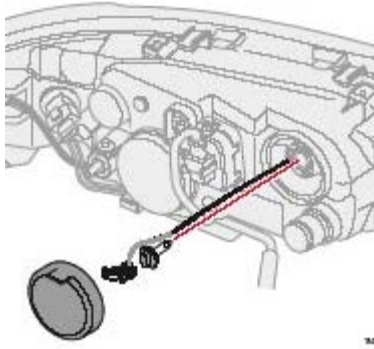

High beam bulb

High beam headlight

Removing the defective bulb:

1. Switch off the headlights and turn the ignition switch to position 0.
2. Remove the cover to access the bulb assembly.
3. Pull out the bulb.
4. Disconnect the wiring connector.
5. Twist the bulb counterclockwise, and pull it out of the holder.

Installing the new bulb:

1. Insert the new bulb into the holder. It can only be inserted in one way.
2. Reconnect the wiring connector.
3. Reinsert the bulb into its position in the headlight housing, with the wiring connector downward.
4. Press the cover back into place.

pg. 143 Replacing bulbs

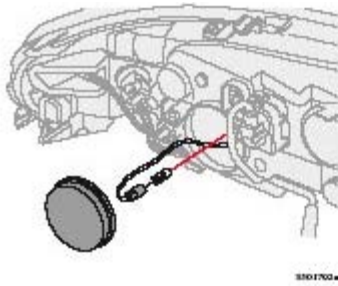

Parking light bulb

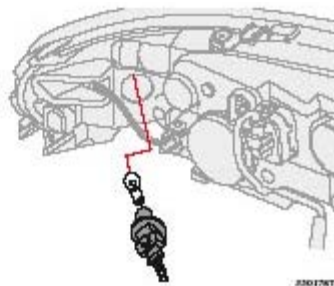

Turn signal, driver's side

Parking light

Removing the defective bulb:

1. Switch off the headlights and turn the ignition switch to position 0.
2. Remove the plastic cover of the low beam headlight assembly. Pull out the parking light holder.
3. Pull the bulb out of the holder.

Installing the new bulb:

1. Press a new bulb into the holder
2. Reinsert the bulb and holder into place.
3. Reinstall the plastic cover.

Turn signal, driver's side

Removing the defective bulb:

1. Switch off the headlights and turn the ignition switch to position 0.
2. Pull out the bulb holder by twisting it counterclockwise.
3. Remove the bulb from the holder by pressing it in and turning it counterclockwise.

Installing the new bulb:

1. Insert the new bulb into the holder by pressing it in and turning it clockwise.
2. Reinsert the bulb holder in the headlight housing and twist it clockwise until it seats properly.

Turn signal, passenger's side

Removing the defective bulb:

1. Switch off the headlights and turn the ignition switch to position 0.
2. Remove radiator pipe (1) from the box.
3. Remove filler pipe screw (2).

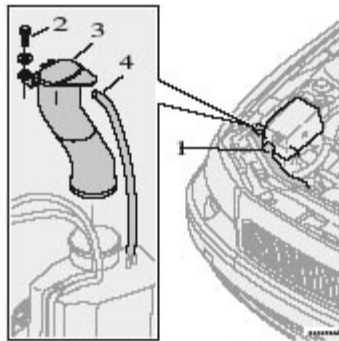

Turn signal, passenger's side

4. Pull the filler pipe (3) straight up.
5. Remove vent hose (4) from filler pipe.

Installing the new bulb:

1. Replace the bulb (same procedure as the driver's side bulb).
2. Ensure that the seal between the washer fluid reservoir and the filler pipe is correctly positioned.
3. Press the filler pipe (3) back into position.
4. Press the vent hose (4) into place on the filler pipe.
5. Reinstall and tighten the filler pipe screw (2) .
6. Reinstall the radiator pipe to the box (1).

pg. 144 Replacing bulbs

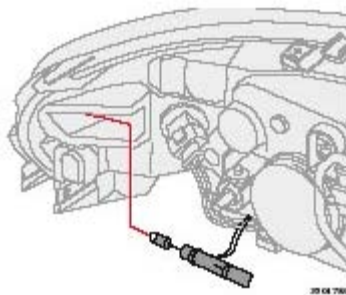

Side marker light

Side marker light

1. Turn the lamp holder counterclockwise and pull it out.
2. Pull out the defective bulb and insert a new one.
3. Reinsert the lamp holder and turn it clockwise until it seats properly.

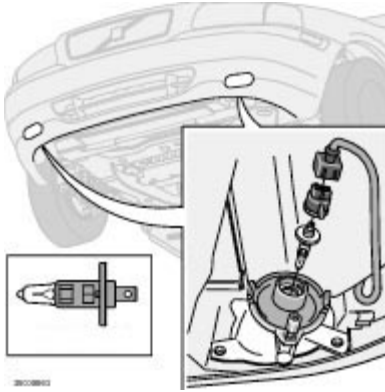

Front fog light

Front fog lights (option)

Removing the defective bulb:

1. Switch off the headlights and turn the ignition switch to position 0.
2. Turn the bulb holder slightly counterclockwise.
3. Pull out and remove the bulb.

Installing the new bulb:

1. Insert the new bulb (it can only be inserted in one position).
2. Reinsert the bulb holder and turn it clockwise. "TOP" must be upward.

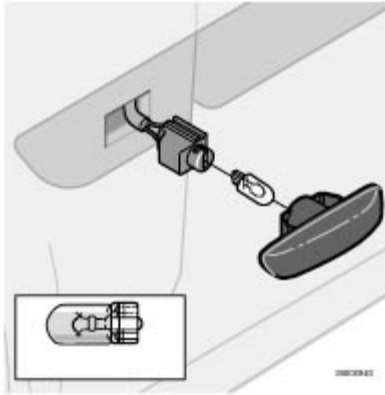

Side turn signal

Side turn signal

Removing the defective bulb:

1. Open the front door halfway.
2. From the inside of the fender, push the lamp housing and wiring out.
3. Turn the bulb holder 1/4 turn counterclockwise and pull it out from the lens.
4. Remove the bulb from the holder by pulling it straight out.

Installing the new bulb:

1. Press a new bulb into the holder.
2. Reinsert the bulb holder into the lens and turn it 1/4 turn clockwise.
3. Press the lens back into place in the fender.

Replacement of backup lights, rear parking lights and rear fog light

1. Switch off all lights and turn the ignition switch to position 0.
2. Open the access panel.
3. Twist the bulb holder counterclockwise and remove it.
4. Press the bulb inward, twist it counterclockwise and extract it.
5. Fit a new bulb.
6. Fit the bulb holder in place and twist it clockwise.
7. Refit the sound insulation and put the access panel back in place.

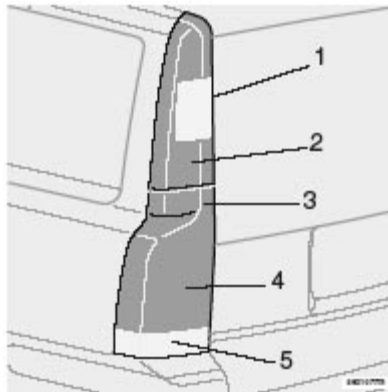

1. Rear turn signals
2. Brake light
3. Rear parking lights
4. Rear fog light (left side only) and rear parking lights
5. Backup light

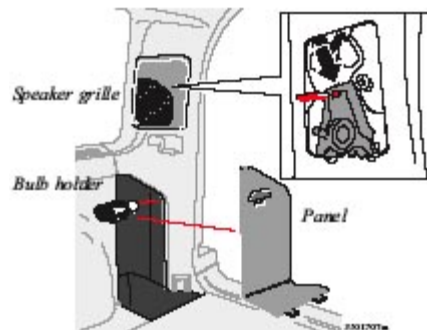

See table on [page 172](#).

Replacement of rear turn signal and brake light bulbs

1. Switch off all lights and turn the ignition switch to position 0.
2. Using a screwdriver, carefully pry off the speaker grille.
3. Pull out the red tab in the speaker.
4. Then press on the black pin above the extracted red tab and twist out the speaker.
5. Twist the bulb holder counterclockwise, and withdraw it.
6. Fit a new bulb.
7. Fit the bulb holder in place and twist it clockwise.
8. Refit the speaker and press in the red tab.
9. Press the speaker grille back into position.

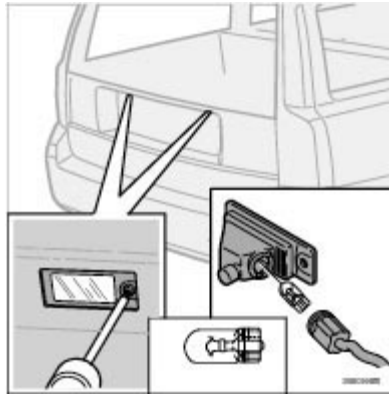

License plate lights

1. Switch off the ignition.
2. Loosen the screws with a Torx screwdriver.
3. Carefully pull out the lamp housing.
4. Turn the bulb holder counterclockwise and pull it out.
5. Pull out the defective bulb and insert a new one.
6. Reinsert the bulb holder into the housing and turn it clockwise.
7. Reinstall the housing and screw it in place.

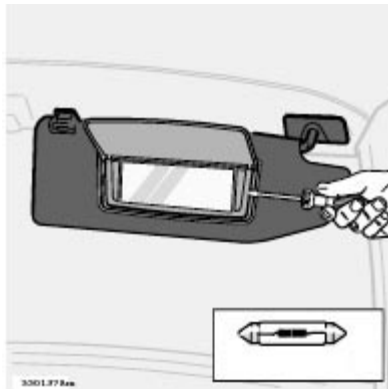

Vanity mirror lights

1. Carefully insert a screwdriver and pry out the lens.
2. Pry out the defective bulb and replace it.
3. Carefully press the lower edge of lens onto the four tabs and press the upper edge of the lens into place.



Front courtesy lights

These bulbs may be difficult for you to replace yourself. We recommend that you let an authorized Volvo retailer replace these bulbs if necessary.

pg. 147 Replacing bulbs

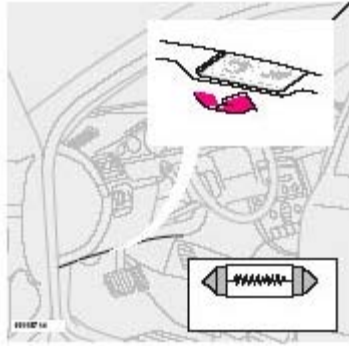

Door step courtesy lights

The door step courtesy lights are located under the dash on the driver's and passenger's sides. To replace a bulb:

1. Carefully insert a screwdriver and pry out the lens.
2. Replace the defective bulb.
3. Reinstall the lens.



Rear reading lights

These bulbs may be difficult for you to replace yourself. We recommend that you let an authorized Volvo retailer replace these bulbs if necessary.

NOTE: Other bulbs may be difficult for you to replace yourself. Let an authorized Volvo retailer replace these bulbs if necessary.

pg. 148 Paint touch up

Paint touch-up

Paint damage requires immediate attention to avoid rusting. Make it a habit to check the finish regularly - when washing the car for instance. Touch-up if necessary.

Paint repairs require special equipment and skill. Contact your Volvo retailer for any extensive damage.

Minor scratches can be repaired by using Volvo touch-up paint.

NOTE: When ordering touch-up paint from your Volvo retailer, use the paint code indicated on the model plate. The plate is located in the engine compartment.

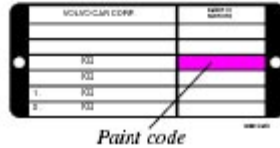

Minor stone chips and scratches

Material:

Primer - can

Paint - touch-up bottle

Brush

Masking tape

NOTE: When touching up the car, it should be clean and dry. The surface temperature should be above 60° F (15° C).

Minor scratches on the surface

If the stone chip has not penetrated down to the metal and an undamaged layer of paint remains, the touch-up paint can be applied as soon as the spot has been cleaned.



Deep scratches

1. Place a strip of masking tape over the damaged surface. Pull the tape off so that any loose flakes of paint adhere to it.

2. Thoroughly mix the primer and apply it with a small brush.

When the primer surface is dry, the paint can be applied using a brush. Mix the paint thoroughly; apply several thin paint coats and let dry after each application.

3. If there is a longer scratch, you may want to protect surrounding paint by masking it off.

pg. 149 Washing the car

Washing the car

- The car should be washed at regular intervals since dirt, dust, insects and tar spots adhere to the paint and may cause damage. It is particularly important to wash the car frequently in the wintertime to prevent corrosion, when salt has been used on the roads.
- When washing the car, do not expose it to direct sunlight. Use lukewarm water to soften the dirt before you wash with a sponge and plenty of water, to avoid scratching.
- **Bird droppings:** Remove from paintwork as soon as possible. Otherwise the finish may be permanently damaged.

- A detergent can be used to facilitate the softening of dirt and oil.
- A water-soluble grease solvent may be used in cases of sticky dirt. However, use a wash place equipped with a drainage separator.
 - Remove dirt from the drain holes in the doors and rocker panels.
 - Dry the car with a clean chamois.
 - Tar spots can be removed with kerosene or tar remover after the car has been washed.
 - A stiff-bristle brush and lukewarm soapy water can be used to clean the wiper blades. Frequent cleaning improves visibility considerably.
 - Wash off the dirt from the underside (wheel housings, fenders, etc.).
 - In areas of high industrial fallout, more frequent washing is recommended.
-

CAUTION:

During high pressure washing, the spray mouthpiece must never be closer to the vehicle than 13" (30 cm). Do not spray into the locks.

Special moonroof cautions:

- Always close the moonroof and sun shade before washing your vehicle.
 - Never use abrasive cleaning agents on the moonroof.
 - Never use wax on the rubber seals around the moonroof.
-

- When washing or steam cleaning the engine, avoid spraying water or steam directly on the electrical components or toward the rear side of the engine.
- After cleaning the engine, the spark plug wells should be inspected for water and blown dry if necessary.

Suitable detergents: Special car washing detergents should be used. Mix according to manufacturer's instructions.

Exterior plastic components

Cleaning exterior plastic components should be done with a cleaning agent specially designed for this purpose. Solvents or stain removers should not be used. Consult your Volvo retailer.

WARNING!

- When the car is driven immediately after being washed, apply the brakes several times in order to remove any moisture from the brake linings.
- Engine cleaning agents should not be used when the engine is warm. This constitutes a fire risk.

Water repellent glass (sideview mirrors/side windows) - option

- Do not apply wax, degreasing agents, etc. to this glass. This could damage the coating.
- Clean the glass surface with care to avoid scratching.

pg. 150 Washing the car

Automatic washing - simple and quick

- **We do NOT recommend washing your car in an automatic wash during the first six months (because the paint will not have hardened sufficiently).**
- An automatic wash is a simple and quick way to clean your car, but it is worth remembering that it may not be as thorough as when you yourself go over the car with sponge and water. Keeping the underbody clean is most important, especially in the winter. Some automatic washers do not have facilities for washing the underbody.
- Before driving into an automatic wash, make sure that side view mirrors, auxiliary lamps, etc, are secure, otherwise there is risk of the machine dislodging them.

Polishing and waxing

- Normally, polishing is not required during the first year after delivery. However, waxing may be beneficial.
 - Before applying polish or wax the car must be washed and dried. Tar spots can be removed with kerosene or tar remover. Difficult spots may require a fine rubbing compound.
 - After polishing, use liquid or paste wax.
 - Several commercially available products contain both polish and wax.
 - Waxing alone does not substitute for polishing of a dull surface.
 - A wide range of polymer-based car waxes can be purchased today. These waxes are easy to use and produce a long-lasting, high-gloss finish that protects the bodywork against oxidation, road dirt and fading.
 - Do not polish or wax your car in direct sunlight (the surface of the car should not be warmer than 113° F (45° C)).
-

CAUTION:

Volvo does not recommend the use of long-life or durable paint protection coatings, some of which may claim to prevent pitting, fading, oxidation, etc. These coatings have not been tested by Volvo for compatibility with your vehicle's clear coat. Some of them may cause the clear coat to soften, crack, or cloud. Damage caused by application of paint protection coatings may not be covered under your vehicle's paint warranty.

pg. 151 Cleaning the upholstery

Fabric

Clean with soapy water or a detergent. For more difficult spots caused by oil, ice cream, shoe polish, grease, etc., use a clothing/fabric stain remover. Consult your Volvo retailer.

Interior plastic components

Cleaning interior plastic components should be done with a cleaning agent specially designed for this purpose. Consult your Volvo retailer.

Alcantera™ suede-like material

Suede-like upholstery can be cleaned with a soft cloth and mild soap solution.

Leather care

Volvo's leather upholstery is manufactured with a protectant to repel soiling. Over time, sunlight, grease and dirt can break down the protection. Staining, cracking, scuffing, and fading can result.

Volvo offers an easy-to-use, non-greasy leather care kit formulated to clean and beautify your vehicle's leather, and to renew the protective qualities of its finish. The cleaner removes dirt and oil buildup. The light cream protectant restores a barrier against soil and sunlight.

Volvo also offers a special leather softener that should be applied after the cleaner and protectant. It leaves leather soft and smooth, and reduces friction between leather and other finishes in the vehicle.

Volvo recommends cleaning, protecting and conditioning your vehicle's leather two to four times a year. Ask your Volvo retailer about Leather Care Kit 951 0251 and Leather Softener 943 7429.

CAUTION!

- Under no circumstances should gasoline, naphtha or similar cleaning agents be used on the plastic or the leather since these can cause damage.
- Take extra care when removing stains such as ink or lipstick since the coloring can spread.
- Use solvents sparingly. Too much solvent can damage the seat padding.
- Start from the outside of the stain and work toward the center.

- Sharp objects (e.g. pencils or pens in a pocket) or velcro fasteners on clothing may damage the textile upholstery.
-

Cleaning the seat belts

Clean only with lukewarm water and mild soap solution.

Cleaning floor mats

The floor mats should be vacuumed or brushed clean regularly, especially during winter when they should be taken out for drying. Spots on textile mats can be removed with a mild detergent.

Bear in mind

- Take extra care when removing stains such as ink or lipstick since the coloring can spread.
- Use solvents sparingly. Too much solvent can damage the seat padding.
- Start from the outside of the stain and work toward the center.

pg. 152 Maintenance service, Warranty

Maintenance service

Volvo advises you to follow the service program outlined in the Warranty and Service Records Information booklet. This maintenance program contains inspections and services necessary for the proper function of your car. The maintenance services contain several checks which require special instruments and tools and therefore must be performed by a qualified technician. To keep your Volvo in top condition, specify time-tested and proven Genuine Volvo Parts and Accessories.

The Federal Clean Air Act - U.S.

The Federal Clean Air Act requires vehicle manufacturers to furnish written instructions to the ultimate purchaser to assure the proper servicing and function of the components that control emissions. These services, which are listed in the "Warranty and Service Records Information booklet," are not covered by the warranty. You will be required to pay for labor and material used.

Maintenance services

Your Volvo passed several major inspections before it was delivered to you, in accordance with Volvo specifications. The maintenance services outlined in the Warranty and Service Records Information booklet, many of which will positively affect your vehicle's emissions, should be performed as indicated. It is recommended that receipts for vehicle emission services be retained in case questions arise concerning maintenance.

Inspection and service should also be performed anytime a malfunction is observed or suspected.

Applicable warranties

In accordance with applicable U.S. and Canadian regulations, the following list of warranties is provided.

- New Car Limited Warranty
- Parts and Accessories Limited Warranty
- Corrosion Protection Limited Warranty
- Seat Belt and Supplemental Restraint Systems Limited Warranty
- Emission Design and Defect Warranty
- Emission Performance Warranty

These are the Federal warranties; other warranties are provided as required by state/provincial law. Refer to your separate Warranty and Service Records Information booklet for detailed information concerning each of the warranties.

Vehicle Event Data (Black Box)

Your vehicle's driving and safety systems employ computers that monitor, and share with each other, information about your vehicle's operation. One or more of these computers may store what they monitor, either during normal

vehicle operation or in a crash or near-crash event. Stored information may be read and used by:

- Volvo Car Corporation
 - service and repair facilities
 - law enforcement or government agencies
 - others who may assert a legal right to know, or who obtain your consent to know such information.
-



[Contents](#) | [Top of Page](#)

2006 VOLVO V70

Chapter 9 - Specifications

pg. 165 Specifications

[Label information](#) [166](#)

[Dimensions and weights](#) [167](#)

[Engine specifications](#) [169](#)

[Oil/fluid specifications and volumes](#) [170](#)

[Fuel system, Distributor ignition system, Suspension](#) [171](#)

[Electrical system](#) [172](#)

[Volvo On Call Roadside Assistance](#) [173](#)

pg. 166 Label information

1 Loads and Tire Pressures

(on inside of fuel filler door): Canadian models only.

2 Child safety latch label

3 Federal Motor Vehicle Safety Standards (FMVSS) specifications (USA) and Ministry of Transport (CMVSS) standards (Canada)

Your Volvo is designed to meet all applicable safety standards, as evidenced by the certification label on the facing side of the driver's door. For further information regarding these regulations, please consult your Volvo retailer.

4 Loads and Tire Pressures - U.S. models only

Certain models will only have one decal, depending on the specifications of the vehicle.

5 Vehicle Identification Number (VIN) *

The VIN plate is located on the top left surface of the dashboard. The VIN is also stamped on the right hand door pillar.

6 Model plate

Vehicle Identification Number (VIN). Codes for color and upholstery, etc. The plate is located in the engine compartment, on the inside of the left front fender.

7 Vehicle Emission Control Information

Your Volvo is designed to meet all applicable emission standards, as evidenced by the certification label on the underside of the hood. For further information regarding these regulations, please consult your Volvo retailer.

8 Vacuum hose routing

(underside of hood)

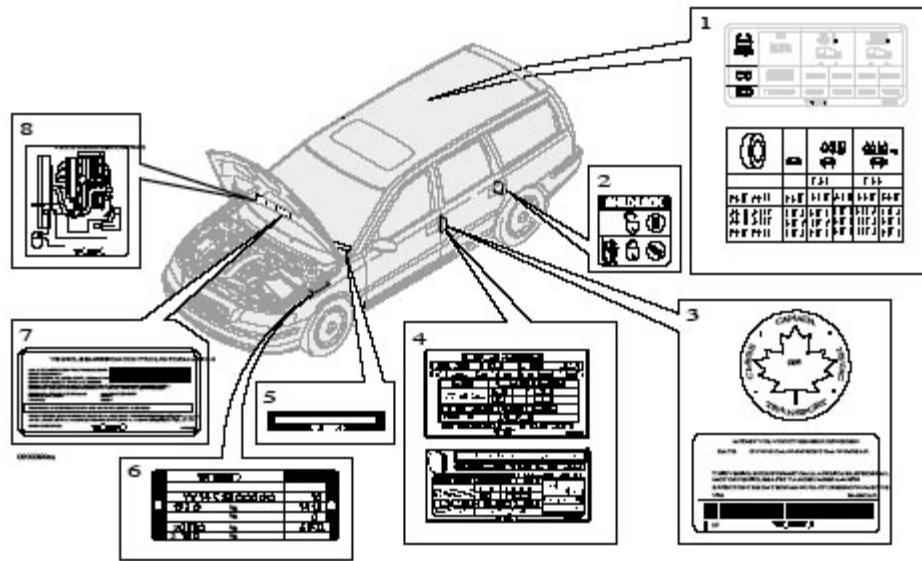

* The Vehicle Identification Number (VIN) should always be quoted in all correspondence concerning your vehicle with the retailer and when ordering parts.

All specifications are subject to change without prior notice.

pg. 167 Dimensions and weights

Dimensions

Length 185.4 in. (471 cm), XC70 -186.3 (473 cm)

Width 71 in. (180 cm), XC70 - 73.2 in. (186 cm)

Height 57.7 in. (147 cm), V70 AWD - 58.7 in. (149 cm)
XC70 - 61.5 in. 156 cm
V70R - 57.6 in (146 cm)

Wheelbase 108.5 in. (276 cm), XC70 - 108.8 in. (276 cm)

Track, front 61.5 in. (156 cm), XC70 - 63.4 in. (161 cm)
V70R - 61.3 in. (155 cm)

Track, rear 61.4 in. (156 cm), XC70 - 60.9 in. (155 cm)
V70R - 60.7 in. (154 cm)

Turning circle (between curbs) 35.8-39 ft. (10.9-11.9 m)

V70R 43.3 ft. (13.2 m) Cargo capacity - 17.1 cu. ft. (0.48 m³)¹
- 26.3 cu. ft. (0.74 m³)²
- 58.0 cu. ft. (1.64 m³)³

- 1) Rear seat backrest up, load height - upper edge of backrest
- 2) Rear seat backrest folded down, load height - upper edge of front seat backrests/lower edge of rear window
- 3) Rear seat backrest folded down, load height - head lining (ceiling)

All specifications are subject to change without prior notice.

pg. 168 Dimensions and weights

Weights	USA	Canada
Gross vehicle weight (GVW)*		
V70 man.	4630 lbs	2100 kg
V70 aut.	4690 lbs	2130 kg
V70 Turbo man.	4710 lbs	2140 kg
V70 Turbo aut.	4730 lbs	2150 kg
V70 AWD	4890 lbs	2220 kg
V70 AWD-R man.	4890 lbs	2220 kg
V70 AWD-R aut.	4890 lbs	2220 kg
XC70	4890 lbs	2220 kg
Capacity weight	930 lbs	420 kg
Curb weight		
V70	3410-3630 lbs	1555-1640 kg
V70 AWD	3710-3745 lbs	1680-1700 kg
V70 AWD-R	3810-3890 lbs	1750-1770 kg
XC70	3770-3800 lbs	1710-1725 kg
Permissible axle weight, front*		
V70 man.	2290 lbs	1040 kg
V70 aut.	2330 lbs	1060 kg
V70 Turbo man.	2320 lbs	1050 kg
V70 Turbo aut.	2360 lbs	1070 kg
V70 AWD	2400 lbs	1090 kg
V70 AWD-R man.	2380 lbs	1080 kg
V70 AWD-R aut.	2400 lbs	1090 kg
XC70	2490 lbs	1130 kg
Permissible axle weight, rear*		
V70, V70 Turbo	2470 lbs	1120 kg
V70 AWD	2580 lbs	1170 kg
V70 AWD-R	2580 lbs	1170 kg
XC70	2620 lbs	1190 kg
	USA	Canada
Max roof load	220 lbs	100 kg
Max trailer weight (w/o brakes)	1650 lbs	750 kg
Max trailer weight**		
- (with brakes, 2" ball)	3300 lbs	1500 kg
- (with brakes, 1 7/8" ball)	2000 lbs	900 kg
Max tongue weight ***	165 lbs	75 kg

WARNING!

When adding accessories, equipment, luggage and other cargo to your vehicle, the total loaded weight capacity of the vehicle must not be exceeded.

* The max permissible axle loads or the gross vehicle weight must not be exceeded.

** When driving for prolonged periods at temperatures above 86° F (30° C), the maximum recommended weight is 2000 lbs (900 kg).

***See also section "Trailer towing"

pg. 169 Engine specifications**Engine specifications****Designation: Volvo B 5254 T2**

Output	208 hp at 5000 rpm (154 kW/83 rps)
Max. torque	236 ft. lbs. at 1500-4500 rpm (320 Nm/25-75 rps)
Number of cylinders	5
Bore	3.27" (83 mm)
Stroke	3.67" (93.2 mm)
Displacement	2.5 liters
Compression ratio	9.0:1
Number of valves	20

Designation: Volvo B 5244 S

Output	165 hp at 6000 rpm (123 kW/100 rps)
Max. torque	166 ft. lbs. at 4500 rpm (225 Nm/75 rps)
Number of cylinders	5
Bore	3.27" (83 mm)
Stroke	3.54" (90 mm)
Displacement	2.4 liters
Compression ratio	10.3:1
Number of valves	20

Designation: Volvo B 5254 T4

Output	300 hp at 5500 rpm* (220 kW/92 rps)*
Max. torque	295 ft. lbs. at 1950-5250 rpm** (400 Nm/31-95 rps)**
Number of cylinders	5
Bore	3.27" (83 mm)
Stroke	3.67" (93.2 mm)
Displacement	2.5 liters
Compression ratio	8.5:1
Number of valves	20

* Automatic transmission: 300 hp at 6000 rpm, 220 kW at 100 rps

** Automatic transmission: 258 ft. lbs at 1850-6000 rpm, 350Nm at 32-100 rps

Charge air cooler (Intercooler)

Turbocharged engines employ a turbo-compressor to force air into the engine inlet manifold and a charge air cooler to cool the compressed inlet air. The resulting increase in air flow raises pressure in the intake manifold and increases engine power over that developed by a normally-aspirated engine. The charge air cooler (which resembles a radiator) is located between the turbo-compressor and inlet manifold.

pg. 170 Oil/fluid specifications and volumes

Engine Oil

Type: Engine oil must meet the minimum ILSAC specification GF-3, API SL, or ACEA A1/B1.

Volume: 5.8 qts (5.5 liters)

Volume between MIN and MAX on dipstick: 1.3 US qts (1.2 liters)

Manual transmission oil

Type: MTF 97309

M56 (five speed): 2.2 US qts. (2.1 liters)

M66 (6 speed): 2.1 US qts. (2.0 liters)

Automatic Transmission Fluid

Type: JWS 3309

AW5: 7.6 US qts (7.2 liters)

TF-80SC (V70 R): 7.4 US qts (7.0 liters)

Do not mix with other oils.

Cooling system

Type: Positive pressure, closed system. The thermostat begins to open at 194 °F (90 °C)

Coolant: Volvo original coolant/antifreeze

Power steering fluid

Volvo synthetic power steering fluid (Pentosin CHF 11S) P/N 1161529 or equivalent.

Volume: 0.95 US qts (0.9 liters)

Brake fluid

DOT 4+ boiling point >536°F(280°C), P/N 9437433

Volume: 0.64 US qts (0.6 liters)

Climate control system - refrigerant (R 134a)

Oil: PAG

Volume: 2.2 lbs (1,000 g) R134a

Fuel

Minimum octane requirement - AKI 87 (RON 91)

Fuel tank volume:

Front wheel drive, non-turbo models - 18.5 US gal. (70 liters)

All turbo models - 18 US gal. (68 liters)

Washer fluid reservoir

Volume: 6.8 US qts (6.4 liters) or 4.8 US qts (4.5 liters) on the V70 R.

All specifications are subject to change without prior notice.

pg. 171 Fuel system, Electronic ignition system, Suspension

Fuel system

The engine is equipped with a multiport fuel injection system.

Distributor ignition system

Firing order: 1-2-4-5-3

Electronic ignition setting: Not adjustable

Spark plugs: Champion RC8PYP 8 (or equivalent)

Spark plug gap: 0.028-0.032" (0.7-0.8 mm)

Tightening torque: 18.4 ft. lbs. (25 Nm)

WARNING!

The ignition system operates at very high voltages. Special safety precautions must be followed to prevent injury. Always turn the ignition off when:

- Replacing ignition components e.g. plugs, coil, etc.
- Do not touch any part of the ignition system while the engine is running. This may result in a shock and bodily injury.

Front suspension

Spring strut suspension with integrated shock absorbers and control arms linked to the support frame. Power-assisted rack and pinion steering. Safety type steering column. The alignment specifications apply to an unladen car but include fuel, coolant and spare wheel.

Rear suspension

Individual rear wheel suspension with longitudinal support arms, double link arms and track rods.

All specifications are subject to change without prior notice.

pg. 172 Electrical system

Electrical system

12 Volt, negative ground.

Voltage-controlled generator. Single-wire system with chassis and engine used as conductors. Grounded on chassis.

Battery

Voltage: 12 Volt, capacity: 600 A/115 min reserve capacity.

The battery contains corrosive and poisonous acids. It is of the utmost importance that old batteries are disposed of correctly. Your Volvo retailer can assist you in this matter.

Generator

Rated output: max. current: 140 A

Starter motor:

Output: 1.7 kW

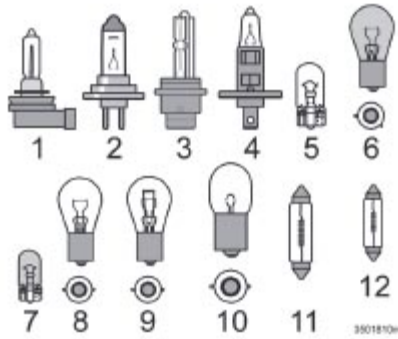

Bulbs

Bulb

Bulb	Type	Socket
1. High beam	65W H9	
2. Low beam	55W H11	
3. Bi-Xenon headlight (option)	35W D2R	
4. Front foglights	55W H1	
4. Front foglights (V70 R)	55W H3	
5. Front parking lights, front side marker lights, rear footwell lighting, license plate lighting	W5W	W2.1x9.5d
6. Front/rear turn signals	PY21W	BAU 15s
7. Side turn signals (amber)	WY5W	W2.1x9.5d
8. Brake lights, backup lights	P21W	BA15s
9. Rear foglight, parking light	P21/4W	BAZ15d
10. Rear parking light	R5W	BA15s
11. Front footwell lighting, cargo area Lighting	C5W	SV8.5
12. Vanity mirror	1.2W	SV5.5

WARNING!

Bi-Xenon headlights (option) - due to the high voltage used by these headlights, these bulbs should only be replaced by an authorized Volvo service technician.

All specifications are subject to change without prior notice.

pg. 173 On Call Roadside Assistance



Volvo On Call Roadside Assistance

Your new Volvo comes with a four-year On Call Roadside Assistance program. Additional information, features, and benefits are described in a separate information package in your glove compartment.

If you have misplaced your package, dial:

In the U.S.A.

1-800-63-VOLVO (1-800-638-6586)

In Canada:

1-800-263-0475



Technician certification

In addition to Volvo factory training, Volvo supports certification by the National Institute for Automotive Excellence (A.S.E.). Certified technicians have demonstrated a high degree of competence in specific areas. Besides passing exams, each technician must also have worked in the field for two or more years before a certificate is issued. These professional technicians are best able to analyze vehicle problems and perform the necessary service procedures to keep your Volvo at peak operating condition.

pg. 174 This page intentionally left blank



[Contents](#) | [Top of Page](#)

2006
VOLVO
V70

Chapter 10 - Audio systems

pg. 175 Audio systems

Introduction	176
Audio system HU-650 overview	177
Audio system HU-850 overview	178
Radio functions	179
RBDS functions	183
HU - 650 CD player	186
HU - 850 internal CD changer	187
External CD changer (option)	188
Dolby Surround Pro Logic II	189
Specifications	191
HomeLink®	192

pg. 176 Introduction

The audio system in your car is operated with the buttons and knobs in the system's front panel. Certain functions, such as adjusting the volume, changing radio stations or tracks on a CD, etc, can also be controlled with the optional steering wheel-mounted keypad.

The audio system is available in two versions:

HU-650

Features: AM/FM radio, single-disc CD player, 4x25W output, six speakers.

HU-850

Features: AM/FM radio, integrated 6-disc CD changer, 4x50W or 4x70W output plus 25W Dolby Pro Logic II, eleven speakers.

A subwoofer mounted under the floor in the cargo area is available as an option. Consult your Volvo retailer.

Compact disc care

- Keep the discs clean. Wipe them with a soft, clean, lint-free cloth, working from the center outwards. If necessary, dampen the cloth with a neutral soap solution. Dry thoroughly before using.

- Never use cleaning spray or antistatic liquid. Use only cleaners specifically made for CDs.
- Use discs of the correct size only (3.5" discs should never be used). The discs should conform to the norms EN60908 (IEC60908).
- Do not put tape or labels on the disc itself.
- Volvo does not recommend the use of plastic outer rings on the disc.
- Condensation may occur on discs/optical components of the changer in cold winter weather. The disc can be dried with a clean, lint-free cloth. Optical components in the CD changer may, however, take up to one hour to dry off.
- Never attempt to play a disc which is damaged in any way.
- When not in use, the discs should be stored in their covers. Avoid storing discs in excessive heat, direct sunlight or dusty locations.

pg. 177 Audio system HU-650 - overview

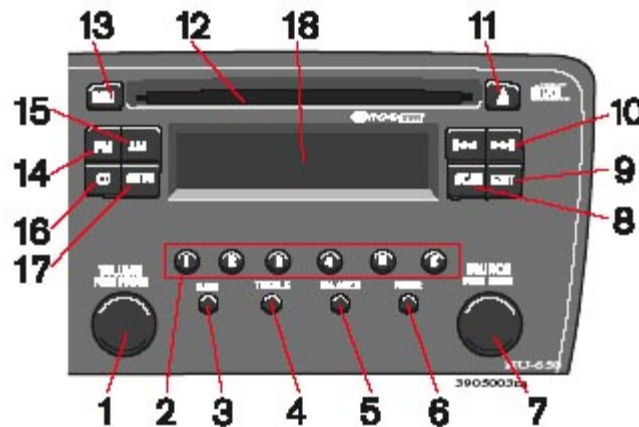

1. On/off - press
Volume - turn
2. Buttons for selecting stored radio stations/discs in optional CD changer
3. Bass (press to release control and turn to adjust)
4. Treble (press to release the control, and turn to adjust)
5. Balance (left/right) - press to release control and turn to adjust
6. Fader (front/rear) - press to release the control, and turn to adjust
7. Source/Menu
Press to open main menu
Turn to select FM, AM, CD, CD changer (option)
8. Scan function (automatically search for radio stations)
9. Exit (exit the menu)
10. Navigation buttons (seek/change radio station or CD track)
11. CD eject
12. CD slot

13. CD random play
14. FM (select FM1, FM2, FM3)
15. AM (select AM1 or AM2)
16. CD player
17. AUTO - automatically search for radio stations
18. Display

pg. 178 Audio system HU-850 - overview

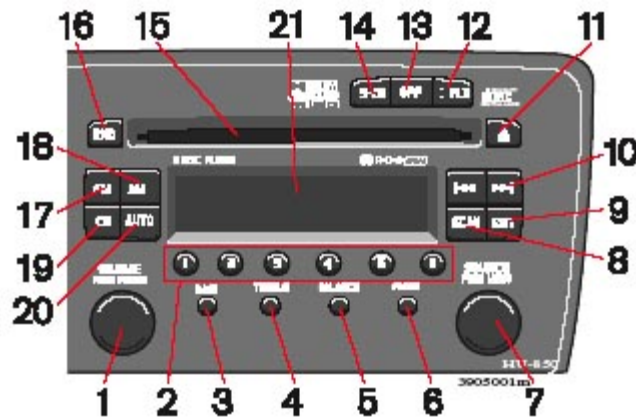

1. On/off - press
Volume - turn
2. Buttons for selecting stored radio stations/discs in optional CD changer
3. Bass (press to release control and turn to adjust)
4. Treble (press to release the control, and turn to adjust)
5. Balance (left/right) - press to release control and turn to adjust
6. Fader (front/rear) - press to release the control, and turn to adjust
7. Source/Menu
Press to open main menu
Turn to select FM, AM, CD, CD changer (option)
8. Scan function (automatically search for radio stations)
9. Exit (exit the menu)
10. Navigation buttons (seek/change radio station or CD track)
11. CD eject
12. Dolby Surround Pro Logic II

13. 2-channel stereo
14. 3-channel stereo
15. CD slot
16. CD random play
17. FM (select FM1, FM2, FM3)
18. AM (select AM1 or AM2)
19. CD player
20. AUTO - automatically search for radio stations
21. Display

pg. 179 Radio functions HU-650/HU-850



Switch on/off

Press the knob to switch on or turn off the radio.

Volume control

Turn the knob clockwise to increase volume. Volume control is electronic and does not have an end stop. If you have a key pad in the steering wheel, increase or decrease the volume with the + or - buttons.

Volume control - ALARM

If a CD is playing when the radio receives an alarm bulletin (available in certain areas only), the CD player enters pause mode. The bulletin is broadcast at the volume selected for this type of message.

After the bulletin has been completed, the audio system reverts to the originally selected sound source (radio or CD), which is played at the volume that was selected for that source.

If the bulletin volume is adjusted while the bulletin is being broadcast, this new volume is saved and used for subsequent bulletins.

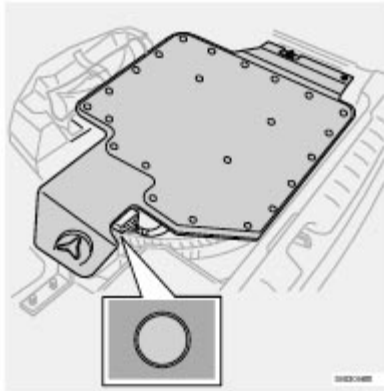

Volume control - Subwoofer

Turn the knob clockwise to increase volume.

Turn the knob counterclockwise to lower volume or switch off the subwoofer.

When the knob is in the middle, bass effect is "equalized".

pg. 180 Radio functions HU-650/HU-850

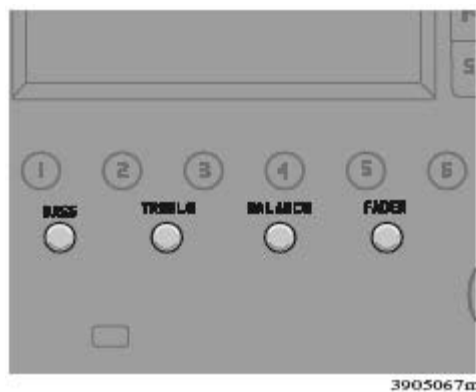

Sound settings

Bass

Adjust the bass by pressing the button to extend the control and turning it to the left (less bass) or to the right (more bass). A "detent" indicates "equalized" bass. Press the button back in when you have made the adjustment.

Treble

Adjust the treble by pressing the button to extend the control and turning it to the left (less treble), or to the right (more treble). A "detent" indicates "equalized" treble. Press the button back in when you have made the adjustment.

Fader - Balance front/rear

Adjust front/rear speaker balance by pressing the button to extend the control and turning it to the left (more sound from the rear speakers) or to the right (more sound from the front speakers). A "detent" indicates "equalized" balance. Press the button back in when you have made the adjustment.

Balance right/left

Adjust left/right speaker balance by pressing the button to extend the control, and turning it to the left (more sound from the left speakers) or to the right (more sound from the right speakers). A "detent" indicates "equalized" balance. Press the button back in when you have made the adjustment.

MID EQ level

This function is used to fine-tune the balance of sound in the speakers. To set the level:

1. Press SOURCE.
2. Turn the SOURCE knob, select ADVANCED MENU and press SOURCE.
3. Turn the SOURCE knob, select AUDIO SETTINGS and press SOURCE.
4. Turn the SOURCE knob, select MID EQ LEVEL and press SOURCE.
5. Turn the SOURCE knob, select the desired level and press SOURCE.
6. Press EXIT.



Selecting a sound source

The sound source (e.g. AM, FM, etc.) can be selected in two ways:

- Use the sound source buttons (see the center illustration above).
- Turn the SOURCE knob (see illustration above) to select a sound source (AM1, AM2, FM1, FM2, FM3, or CD). Press the knob to select the AM or FM band of your choice.

The sound source selected will be shown in the display.

pg. 181 Radio functions HU-650/HU-850





Scan

Press the SCAN button to start the station scan function. When a station is found, scanning stops for approximately 10 seconds, after which scanning will continue.

Press the SCAN or SOURCE button when a station has been found if you would like to listen to that station and to discontinue the scan function.

Station seek up/down

Press  or  to start the seek function. The radio seeks the next audible station and tunes it in. Repeat the procedure to continue the seek function.

Manual station search

Press  and hold it down. MAN will be shown in the display. The radio scans slowly in the selected direction and



will increase the scanning speed after a few seconds. Release the button when the desired frequency appears in the display.

The frequency can be fine-tuned by short presses on the keys.

The system will remain in manual search mode for 5 seconds after the button is released, after which it will return to seek mode.

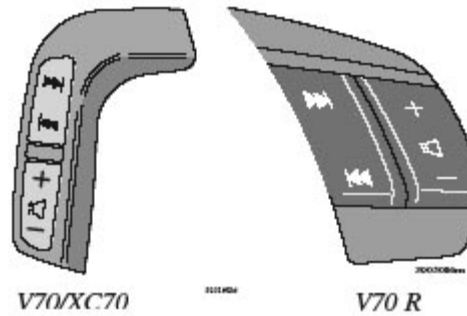

Steering wheel key pad (option)

If the vehicle is equipped with the key pad in the steering wheel press the right or left arrow to switch between preset stations.

pg. 182 Radio functions HU-650/HU-850

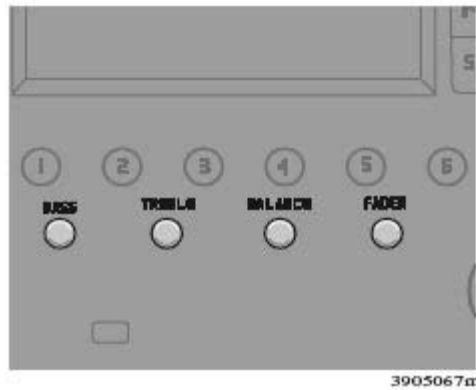

Storing stations

To store a selected station under one of the station setting buttons 1-6:

1. Tune to the desired station.
2. Press the button under which the station is to be stored and keep it depressed. The audio system sound will be interrupted for a few seconds and STORED will appear in the display. The station is now stored.

A total of 30 stations can be stored; 6 stations each in AM1, AM2, FM1, FM2, and FM3.



Storing stations automatically

This function automatically searches for and stores up to 10 strong AM or FM stations in a separate memory. If more than ten stations are found, the ten strongest ones are stored. This function is especially useful in areas in which you are not familiar with radio stations or their frequencies.

To use the AUTO function:

1. Select radio mode using the AM or FM buttons, or by turning the SOURCE knob.
2. Start the search by pressing AUTO for more than 2 seconds.
3. AUTO appears in the display and a number of stations with strong signals (max. 10) from the selected frequency band will be stored in the auto-store memory. If there are no stations with sufficient signal strength, NO STATION is displayed.

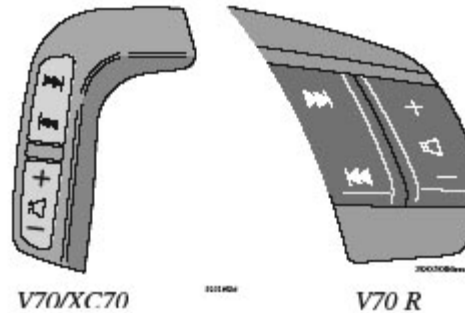

4. Press the AUTO button or the arrow keys on the optional steering wheel controls briefly to select the stored stations. When the radio is in auto-store mode, AUTO is shown in the display. AUTO disappears when you return to the normal radio mode.

Return to the normal radio mode by pressing the AM, FM, or EXIT button.

To return to the Auto-store mode, press the AUTO button briefly.



[Contents](#) | [Top of Page](#)

2006
VOLVO
V70

HomeLink® Universal Transceiver (option)

pg. 192 HomeLink® Universal Transceiver (option)

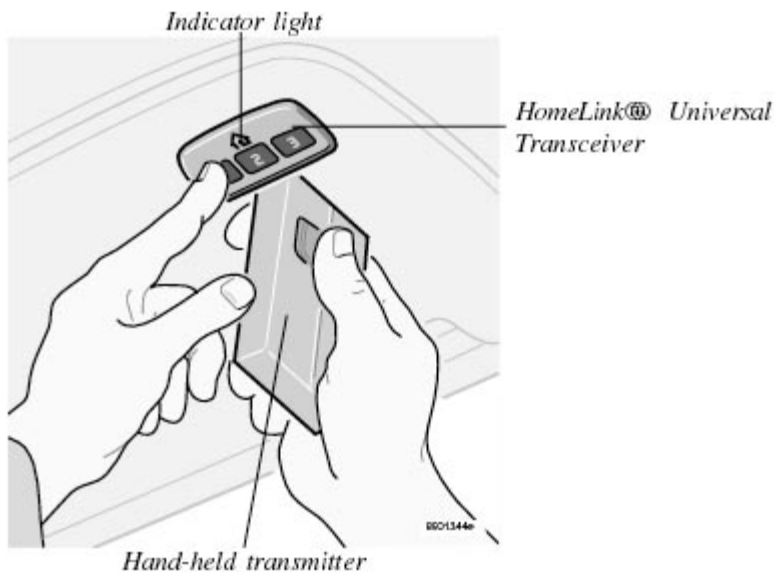

HomeLink® Universal Transceiver

HomeLink® is an advanced system that can be programmed to learn the codes of three different remote controlled-devices (e.g., garage door openers, remote lighting, entry door lock). HomeLink®'s sun visor-mounted transceiver, powered by your car's electrical system, may then be used in place of your hand-held remote controls.

NOTE: For your security, the HomeLink® Universal Transceiver is designed to **not** function if you lock your car from the *outside*.

Programming the transceiver

1. The ignition switch must be turned to the "accessory" position (II) before programming the HomeLink® Universal Transceiver.
2. Begin by erasing all 3 factory default channels. Hold down the two outside buttons (buttons 1 and 3 in the illustration) on the HomeLink® Universal Transceiver for about 20 seconds, until HomeLink®'s indicator light begins to flash. Then release the buttons.
3. Hold your hand-held transmitter (garage door opener, for example) 2 to 5 in. (5 to 12 cm) away from the HomeLink® surface, keeping the indicator light in view. For placement questions, contact HomeLink® toll-free 1-800-355-3515 (Internet: www.HomeLink.com).
4. Using two hands, push and hold both your hand-held transmitter's button and the transceiver button you wish to program. The indicator light will flash first slowly, then rapidly. Rapid flashing tells you the HomeLink® button has

been successfully programmed. Release both buttons.

5. If you are programming a rolling code-equipped device (e.g., garage door opener or entry door lock), refer to "Programming rolling codes" on the next page to complete the programming process.

Repeat steps 3 and 4 to program the other two transceiver buttons.

If, after several attempts, you are unable to successfully train the HomeLink® Universal Transceiver to learn your hand-held transmitter's signal, contact HomeLink® toll-free 1-800-355-3515 (Internet: www.HomeLink.com).

WARNING!

- If you use HomeLink® to open a garage door or gate, be sure no one is near the gate or door while it is in motion.
- Do not use the HomeLink® Universal Transceiver with any garage door opener that lacks safety "stop" and "reverse" features as required by federal safety standards. (This includes any garage door opener model manufactured before April 1, 1982) A garage door opener that cannot "detect" an object, signalling the door to "stop" and "reverse" does not meet current federal safety standards. Using a garage door opener without these features increases the risk of serious injury or death. For more information on this matter, call toll-free 1-800-355-3515 (Internet: www.HomeLink.com).

pg. 193 HomeLink® Universal Transceiver (option)

NOTE - Canadian residents:

During programming, your hand-held transmitter may automatically stop transmitting. To successfully train HomeLink®, continue to hold the HomeLink® button. At the same time, repeatedly press and hold your hand-held transmitter's button at *two-second intervals* until HomeLink® has learned your transmitter's code. The HomeLink® indicator light will flash first slowly, and then rapidly to indicate that the button has been successfully programmed.

Determining if your garage door uses a rolling code

Determine, in one of the following ways, if your garage door uses a rolling code system and is manufactured after 1996:

- Refer to the garage door opener owner's manual for verification.
- If your hand-held transmitter appears to program the HomeLink® Universal Transceiver but the programmed button does not activate the garage door, your garage door opener may have a rolling code.
- Press the programmed HomeLink® button. If the garage door opener has the rolling code feature, the HomeLink® indicator light flashes rapidly and then glows steadily after approximately 2 seconds.

To train a rolling code garage door opener, follow these instructions after programming the desired transceiver button according to "Programming the transceiver." The help of a second person may make training easier.

1. Locate the training button on the *garage door opener motor head unit*. The location and color of the training button may vary. If you encounter difficulty, refer to the garage door opener owner's manual or call toll-free 1-800-355-3515 (Internet: www.HomeLink.com).

2. Press the "training" button on the garage door opener motor head unit until the "training" light comes on.

3. Press and release the programmed HomeLink® button. Press and release the programmed HomeLink® button a *second* time to complete the training process. Some garage door openers may require you to do this procedure a *third* time to complete the training.

The programmed button on your HomeLink® Universal Transceiver should now operate your garage door opener. The

original hand-held transmitter can also be used, as desired, to operate the garage door.

The remaining two HomeLink® buttons can be programmed in the same way. In the event of any problems in programming the HomeLink® Universal Transceiver, call toll-free 1-800-355-3515 (Internet: www.HomeLink.com).

Operating the HomeLink® Universal Transceiver

Once programmed, the HomeLink® Universal Transceiver can be used in place of your hand-held transmitters.

To operate, the key must be turned to the "accessory" position (II) or the engine must be running. Press the programmed HomeLink® button to activate the garage door, driveway gate, security lighting, home security system, etc.

Your original hand-held transmitters may, of course, be used at any time.

Erasing programmed buttons

Individual buttons cannot be erased. To erase all three programmed buttons:

1. Turn the ignition key to the "accessory" position (II).
2. Hold down the two outside buttons on the HomeLink® Universal Transceiver for about 20 seconds, until HomeLink®'s indicator light begins to flash.
3. Release both buttons.

The HomeLink® buttons can be reprogrammed using the procedures described on the previous page.

(HomeLink® information continues on the next page)

pg. 194 HomeLink® Universal Transceiver (option)

Reprogramming a single HomeLink® button

1. Press and hold the desired HomeLink® button. **Do not release** the button until step 3 has been completed.
2. When the indicator light begins to flash slowly (after approximately 20 seconds), position your hand-held transmitter 2 to 5 in. (5 to 12 cm) away from the HomeLink® surface.
3. Press and hold the hand-held transmitter button. The HomeLink® indicator light will flash first slowly, then rapidly. When the indicator light flashes rapidly, release both buttons.

The previously programmed device has now been erased and the new device can be activated by pressing the HomeLink® button that has just been programmed. This procedure will not affect any other programmed HomeLink® buttons.

NOTE:

- Retain the original transmitter(s) for future programming procedures (e.g., if you purchase a new car).
- For your own security, erase all programmed buttons on the HomeLink® Universal Transceiver when you sell your car.
- Metallic sun protection films should not be used on any windows in a car equipped with HomeLink® Universal Transceiver. This could interfere with the transceiver's function.



**2006
VOLVO
V70**

INDEX

pg. 196 - 199 Index

A	
ABS	114
ABS - warning light	29
Active chassis system	99
Adjusting the steering wheel	36
Advanced chassis mode	99
Air conditioning	50 - 53
Air vents	48
Airbag - front	6-8
Alarm	84, 85
Alarm - "panic" function	84
All Wheel Drive	
- general information	98
Anti-lock Brake System (ABS)	114
Anti-lock Brake System - warning light	29
Antifreeze	110, 154
Approach lighting	80
Armrest (center) - 3-section rear seat	67
Ashtray	41
Audio systems	175
- CD player	186, 187
Automatic car washing	150
Automatic transmission	94, 95
- Cold starts	95
- Geartronic	96, 97
- Kickdown	95, 96
- Sport mode	97
Auxiliary 12 Volt socket in cargo area	70
Auxiliary seat	18, 76
Auxiliary socket	41
AWD	
- general information	98

B

Backrest (center) - 3-section rear seat	66
Backrests, rear - folding down	65
Battery	110, 172
- maintenance	163
- replacing	162
- ventilation hose	162
"Black box" (Vehicle Event Data)	152
Booster cushion	19, 20
Brake failure warning light	28
Brake fluid	
- reservoir	161
- specifications	170
Brake system	113
Bulbs (list)	172
Bulbs - replacing	141-147

C

Capacities (oils and fluids)	165, 170
Car washing	149
Cargo compartment cover	74
Cargo compartment lighting	70
Cargo eyelets	71
Cargo net	72
Catalytic converters - three-way	112
Center armrest - 3-section rear seat	67
Center backrest (3-section rear seat)	66
Center console - switches	31
Center seat head restraint	65
Central locking buttons	83
Chains (winter driving)	130
Changing a wheel	132
Chassis settings (R-models)	99
Child auxiliary seat	18
Child booster cushion	19, 20
Child Restraint Anchorages	22
Child safety	17-22
Child safety locks - rear doors	86
Child seat anchors, ISOFIX	22
Climate controls	50-56
Climate system - general information	49
Clock	27
Clutch interlock	93
Coat hanger	63
Cold weather driving	110

Combination filter	50, 53
Comfort chassis mode	99
Coolant	154
Cooling system - general information	102
Courtesy light	77
Courtesy lights (front) - replacing	146
Courtesy lights - exterior	80
Cruise control	33
Cup holders	63
D	
Detachable trailer hitch	108
Dimensions	167
Direction indicators	37
Direction indicators	30
Distributor ignition system	171
Dolby Surround Pro Logic II	189
Dome lighting	77
Door step courtesy lights - replacing	147
Doors and locks	80
Drive belt	154
Driving economy	101
Driving mode indicator	27
Driving mode W	95, 97, 110
Driving with tailgate open	102
Dynamic Stability Traction Control (DSTC)	115, 116
E	
Economical driving	101
Electric socket in cargo compartment	70
Electrical system	172
Electrical system - general information	102
Electrically operated moonroof	44
Electrically operated seats	58
Electrically operated sideview mirrors	43
Electrically operated windows	42
Electronic Brake Force Distribution	114
Electronic Climate Control (ECC)	50 - 53
Emergency towing	105, 106
Emergency warning flashers	40
Emission inspection readiness	156
Emissions systems	153
Engine - specifications	169
Engine - starting	91, 92
Engine compartment	158
Engine oil	110, 159-160., 170

Extension of cargo compartment	65
Exterior courtesy lights	80
Exterior features - overview	25
Extra seat	76
F	
Fog lights	35
Folding passenger's seat backrest	65
Folding front seat backrest	60
Folding table	64
Four-C active chassis system	31, 99
Front airbags	6 - 8
Front courtesy lights - replacing	146
Front fog lights	35
Front park assist (accessory)	100
Front reading lights	77
Front seat backrest - folding	60
Front seats - adjusting	58, 59
Front seats - heated	40
Front suspension	171
Fuel	88
Fuel filler cap	90
Fuel filler door	90
Fuel filler door, unlocking	35
Fuel formulations	89
Fuel gauge	27
Fuel requirements	88
Fuel system	153, 171
Fuel tank volume	170
Fuel/emissions systems	153
Fuses	136-140
G	
Gas cap	90
Gasoline	88
Gear indicator	27
Geartronic (automatic transmission)	96, 97
Generator	172
Generator warning light	28
Glossary of tire terminology	127
Glove compartment	63
H	
Hand brake	41
Handgrip - XC70	57, 76
Handling	101
Hazard warning flashers	40

Head restraint - center rear	66
Head restraint rear	65
Headlight flash	37
Headlight wiper blades - replacing	164
Headlights	35, 37
Heated front seats	40
Heated rear window	40
Heated sideview mirrors	40
Heating	50-53
High beam flash	37
High/low beam headlights	37
Hoisting the car	157
Holder for grocery bags	70
Home safe lighting	37
HomeLink®	192 -194
Hood - opening	158
HU-650 - overview	177
HU-850 - overview	178
I	
Ignition switch	36
Immobilizer (start inhibitor)	80, 91
Indicator lights	28, 29
Inflatable curtain (VIC)	13
Inspecting SRS system components	14
Instrument panel	27
Instrument panel lighting	35
Instruments	26
Integrated booster cushion	19
Interior Air Quality system	53
Interior features - overview	24
Interior lighting	77
ISOFIX child seat anchors	22
J	
Jack	75, 132
Jump starting	109
K	
Key - removing from ignition switch	91
Keyless entry system	81, 82
Keyless entry system - replacing batteries	82
Keylock	91
Keys	80
Kickdown	95, 96
L	
Label information	166

LATCH/ISOFIX anchors	22
License plate lights - replacing	146
Lifting the car	157
Lighting panel	35
Load carriers	103
Loading the vehicle	71
Locking and unlocking the car	80
Locking steering wheel	36
Long distance trip	111
Long loads	60
Low/high beam headlights	37
`	
M	
Maintaining your car	156
Maintenance, performed by owner	155
Maintenance service	152
Malfunction indicator lamp	29
Manual climate control with air conditioning	54-56
Manual front seat adjustment	59
Manual transmission	93
Mirrors	43
Mirrors, sideview - memory function	43
Moonroof	44
N	
Net - cargo	72
Nylon cargo net	72
O	
Occupant safety	2
Occupant Weight Sensor (OWS)	9-11
Octane rating	88
Odometer	29
Oil - engine	110, 159-160, 170
Oil -level (R-models)	160
Oil pressure warning light	28
On Call Roadside Assistance	173
Opening the hood	158
Owner maintenance	155
P	
Paint touch-up	148
Panel lighting	35
Panic function (alarm)	84
Park Assist	100
Parking brake	41
Parking brake reminder light	28

Parking lights	35
Passenger's seat backrest - folding	60
Polishing	150
Power moonroof	44
Power seats	58, 59
Power steering - speed sensitive	101
Power steering fluid	161
Power windows	42
On Call Roadside Assistance	183
R	
R-models, checking oil level	160
Radio	175
Rain sensor - windshield wipers	38
Reading lights - front/rear	77
Rear fog light	29, 35
Rear park assist	87, 100
Rear reading lights	77
Rear seat backrest	69
Rear window - heated	40
Rear-facing auxiliary seat	18, 76
Rearview mirror	43
Refrigerant	49
Refueling	90
Remote central locking system and sideview mirrors	43
Remote control - keyless entry system	81
Remote control - Homelink® Universal Transceiver	193
Remote keyless entry system	81
Remote keyless entry system - replacing batteries	82
Removing the seat cushion	69
Replacing bulbs	141-147
Replacing fuses	136
Replacing the battery	162
Replacing wiper blades	164
Reporting Safety Defects	2
Road assistance	173
Roadholding	101
Roadside Assistance	173
Roof load - maximum	168
Roof racks	103
Run flat tires	125
S	
Safety Defects - reporting	2
Safety locks - child	86
Seat belt reminder	3

Seat belts	3-5, 21
- use during pregnancy	4
Seat belts - cleaning	151
Seats - front	58, 59
Securing cargo	71
Self supporting run flat tires	125
Servicing	157
Shiftlock	91, 94, 96
Side impact airbag system (SIPS)	12
Side windows - laminated	39
Sideview mirrors	43
Sideview mirrors - heated	40
Sideview mirrors - memory function	43
Snow chains	130
Snow tires	130
Spare tire	75, 131
Spark plugs	171
Speed-sensitive power steering	101
Sport chassis mode	99
Sport mode (automatic transmission)	97
SRS	8
SRS system components - inspecting	14
SRS warning light	29
Stability Traction Control (STC)	115, 116
Start inhibitor (immobilizer)	80, 91
Starting the engine	91, 92
Steel grid	72
Steering wheel adjustment	36
Steering wheel lock	36
Stop and Store bag	68
Storage compartments	61, 62
Storage in the glove compartment	63
Storing wheels and tires	118
Studded tires	130
Subwoofer	75, 179
Supplemental Restraint System	5, 29
Suspension	171
Switches in center console	31
T	
Tachometer	27
Tailgate - driving when open	102
Tailgate - locking/unlocking	83
Tailgate wiper blade - replacing	164
Tailgate wiper/washer	39

Temperature gauge	27
Temporary spare tire	131
Text window	30
Three-way catalytic converters	112
Tire age	119
Tire changing	132
Tire designations	126
Tire inflation	120
Tire inflation pressure tables	122
Tire Pressure Monitoring System	123
Tire terminology	127
Tires	118-133
Tires - changing	132
Tool bag	75
Top tether anchorages	22
Touching up paint	148
Towing a trailer	107
Towing eyelet	105
Towing the car	105, 106
Trailer hitch	108
Trailer towing	107
Trailer weight - maximum	168
Transmission - automatic	94-99
Trip computer	32
Trip odometer	27
Turn signals	37
U	
Uniform Tire Quality Grading	129
Unlocking the fuel filler door	35
Unlocking the tailgate	83
Upholstery - cleaning	151
V	
Vehicle Event Data	152
Vehicle Identification Number (VIN)	166
Vehicle loading	71, 128
Ventilation	48
Ventilation hose, battery	162
Volvo Inflatable curtain (VIC)	13
Volumes (oils and fluids)	170
Volvo On Call Roadside Assistance	173
W	
Warning flashers	40
Warning light - center	28
Warning lights	28, 29

Warranty	152
Washer fluid reservoir	157, 170
Washer fluid solvent	110
Washing the car	149-151
Water repellent glass	39, 149
Waxing	150
Weight distribution	101
Wheels changing	132
Wheels and tires - storing	118
Whiplash Protection System (WHIPS)	15, 16
Windows - electrically operated	42
Windshield washer solvent	110
Windshield wiper blades - replacing	164
Windshield wipers/washers	38
Winter driving	110
Winter/Wet driving mode	95, 97, 110
Wiper blades - replacing	164



2006 VOLVO V70

Back Cover

Back Cover

Accessory Installation - Important Warning

- We strongly recommend that Volvo owners install only genuine, Volvo-approved accessories, and that accessory installations be performed only by the factory-trained technicians at your authorized Volvo retailer.
- Genuine Volvo accessories are tested to ensure compatibility with the performance, safety, and emission systems in your car. Additionally, your authorized Volvo retailer knows where accessories may and may not be safely installed in your Volvo. In all cases, please consult your authorized Volvo retailer before installing any accessory in or on your car.
- Accessories that have not been approved by Volvo may or may not be specifically tested for compatibility with your car. Additionally, an inexperienced installer may not be familiar with some of your car's systems.
- Any of your car's performance and safety systems could be adversely affected if you install accessories that Volvo has not tested, or if you allow accessories to be installed by someone unfamiliar with your car.
- Damage caused by unapproved or improperly installed accessories may not be covered by your new car warranty. See your Warranty and Service Records Information booklet for more warranty information. Volvo assumes no responsibility for death, injury, or expenses that may result from the installation of non-genuine accessories.

Driver Distraction

- Driver distraction results from driver activities that are not directly related to controlling the car in the driving environment. Your new Volvo is, or can be, equipped with many feature-rich entertainment and communication systems. These include hands-free cellular telephones, navigation systems, and multipurpose audio systems. You may also own other portable electronic devices for your own convenience. When used properly and safely, they enrich the driving experience. Improperly used, any of these could cause a distraction.
- For all of these systems, we want to provide the following warning that reflects the strong Volvo concern for your safety:
 - Never use these devices or any feature of your vehicle in a way that distracts you from the task of driving safely. Distraction can lead to a serious accident.
 - In addition to this general warning, we offer the following guidance regarding specific newer features that may be found in your vehicle:
 - Never use a hand-held cellular telephone while driving. Some jurisdictions prohibit cellular telephone use by a driver while the vehicle is moving.
 - If your car is equipped with a navigation system, set and make changes to your travel itinerary only with the vehicle parked.
 - Never program your audio system while the vehicle is moving. Program radio presets with the vehicle parked, and use your programmed presets to make radio use quicker and simpler.
 - Never use portable computers or personal digital assistants while the vehicle is moving.

A driver has a responsibility to do everything possible to ensure his or her own safety and the safety of passengers in

the vehicle and others sharing the roadway. Avoiding distractions is part of that responsibility.

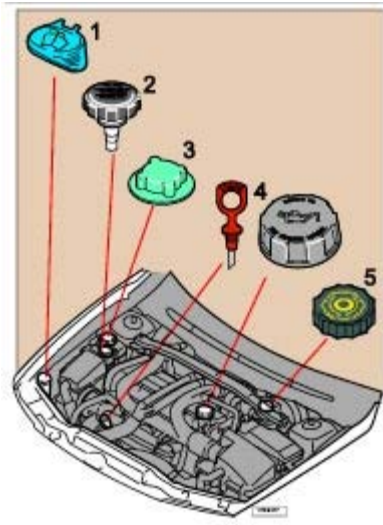

The following should be checked regularly: *

1 Washer fluid reservoir should be filled with water and solvent (wintertime: windshield washer anti-freeze). See [page 157](#).

2 Power steering - When cold, the level must not be above the COLD mark and when hot it must not be above the HOT mark. Top up if the level drops to the ADD mark with ATF fluid. See [page 161](#).

3 Coolant level should be between the expansion tank marks. Mixture: 50% anti-freeze and 50% water. See [page 154](#).

4 Engine oil level should be between the dipstick marks. The distance between the marks represents approx. 1.6 US qts (1.5 liters). See [page 159](#).

5 Brake fluid - check, without removing the cap, that the level is above the MIN mark. Use brake fluid DOT 4+. See [page 161](#).

* Engine oil should be checked each time the car is refuelled.

VOLVO

Volvo Car Corporation
S-40531 Gothenburg, Sweden

Octane rating, see [page 88](#).

Tire pressure, see label located on the inside of the fuel tank cover.

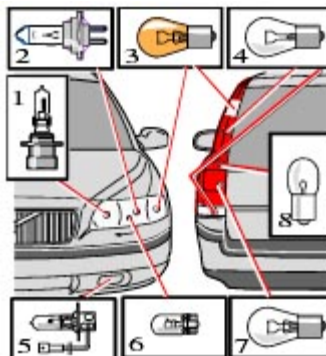



[Contents](#) | [Top of Page](#)