

# TABLE OF CONTENTS

1	<b>Before driving</b>	Adjusting and operating features such as door locks, mirrors, and steering column.
2	<b>When driving</b>	Driving, stopping and safe-driving information.
3	<b>Interior features</b>	Air conditioning and audio systems, as well as other interior features for a comfortable driving experience.
4	<b>Maintenance and care</b>	Cleaning and protecting your vehicle, performing do-it-yourself maintenance, and maintenance information.
5	<b>When trouble arises</b>	What to do if the vehicle needs to be towed, gets a flat tire, or is involved in an accident.
6	<b>Vehicle specifications</b>	Detailed vehicle information.
7	<b>For U.S. owners</b>	Reporting safety defects for U.S. owners
	<b>Index</b>	Alphabetical listing of information contained in this manual.

**1 Before driving**

**1-1. Key information ..... 24**  
 Keys ..... 24

**1-2. Opening, closing and locking the doors and trunk ..... 26**  
 Smart key system..... 26  
 Wireless remote control ..... 37  
 Doors..... 41  
 Trunk ..... 46

**1-3. Adjustable components (seats, mirrors, steering wheel) ..... 49**  
 Front seats ..... 49  
 Rear seats..... 51  
 Head restraints ..... 53  
 Seat belts ..... 55  
 Steering wheel ..... 63  
 Anti-glare inside rear view mirror..... 64  
 Outside rear view mirrors ..... 66

**1-4. Opening and closing the windows ..... 68**  
 Power windows ..... 68  
 Moon roof ..... 70

**1-5. Refueling ..... 73**  
 Opening the fuel tank cap .... 73

**1-6. Theft deterrent system ..... 77**  
 Engine immobilizer system ..... 77  
 Alarm ..... 79  
 Theft prevention labels (for U.S.A.) ..... 81

**1-7. Safety information ..... 82**  
 Correct driving posture ..... 82  
 SRS airbags ..... 84  
 Front passenger occupant classification system..... 96  
 Child restraint systems ..... 101  
 Installing child restraints .... 105

**2 When driving**

**2-1. Driving procedures..... 116**  
 Driving the vehicle ..... 116  
 Engine (ignition) switch (vehicles with smart key system) ..... 126  
 Engine (ignition) switch (vehicles without smart key system) ..... 130  
 Automatic transmission ..... 133  
 Manual transmission..... 137  
 Turn signal lever ..... 138  
 Parking brake ..... 139

**2-2. Instrument cluster ..... 141**  
 Gauges and meters ..... 141  
 Indicators and warning lights ..... 145  
 Multi-information display .... 149

<b>2-3. Operating the lights and wipers .....</b>	<b>152</b>
Headlight switch.....	152
Fog light switch .....	156
Windshield wipers and washer .....	157
<b>2-4. Using other driving systems .....</b>	<b>159</b>
Cruise control.....	159
Driving assist systems .....	162
<b>2-5. Driving information.....</b>	<b>165</b>
Cargo and luggage .....	165
Vehicle load limits .....	168
Winter driving tips .....	169
Trailer towing .....	173
Dinghy towing (automatic transmission) .....	181
Dinghy towing (manual transmission) .....	182

### 3 Interior features

<b>3-1. Using the air conditioning system and defogger.....</b>	<b>186</b>
Automatic air conditioning system .....	186
Manual air conditioning system .....	194
Rear window and outside rear view mirror defoggers .....	199

<b>3-2. Using the audio system ...</b>	<b>201</b>
Audio system types .....	201
Using the radio .....	204
Using the CD player .....	210
Playing MP3 and WMA discs .....	217
Optimal use of the audio system.....	225
Using the AUX adapter.....	228
Using the steering wheel audio switches.....	229
<b>3-3. Using the hands-free phone system (for cellular phone).....</b>	<b>232</b>
Hands-free phone system (for cellular phone) features (CD player with changer only) .....	232
Using the hands-free phone system (for cellular phone) .....	235
Making a phone call .....	244
Setting a cellular phone.....	248
Security and system setup .....	253
Using the phone book .....	257
<b>3-4. Using the interior lights... </b>	<b>264</b>
Interior lights list .....	264
• Interior light .....	265
• Personal lights.....	266

1

2

3

4

5

6

7

**3-5. Using the storage features ..... 267**  
 List of storage features..... 267  
 • Glove box ..... 268  
 • Console box ..... 268  
 • Cup holders..... 270  
 • Auxiliary boxes..... 272

**3-6. Other interior features ..... 275**  
 Sun visors ..... 275  
 Vanity mirrors ..... 276  
 Clock ..... 277  
 Ashtrays ..... 278  
 Power outlet ..... 279  
 Seat heaters ..... 281  
 Armrest..... 283  
 Rear sunshade ..... 284  
 Trunk storage extension  
 (vehicles with reclining  
 rear seat)..... 285  
 Floor mat ..... 286  
 Trunk features ..... 287  
 Garage door opener ..... 288  
 Compass ..... 293

**4 Maintenance and care**

**4-1. Maintenance and care ..... 298**  
 Cleaning and protecting  
 the vehicle exterior ..... 298  
 Cleaning and protecting  
 the vehicle interior ..... 300

**4-2. Maintenance ..... 303**  
 Maintenance  
 requirements ..... 303  
 General maintenance ..... 305  
 Emission inspection and  
 maintenance (I/M)  
 programs ..... 308

**4-3. Do-it-yourself  
 maintenance ..... 309**  
 Do-it-yourself service  
 precautions ..... 309  
 Hood ..... 313  
 Positioning the jack..... 314  
 Engine compartment ..... 316  
 Tires..... 334  
 Tire inflation pressure ..... 344  
 Wheels..... 348  
 Air conditioning filter ..... 350  
 Key battery ..... 353  
 Checking and replacing  
 fuses ..... 357  
 Light bulbs ..... 368

## 5 When trouble arises

<b>5-1. Essential information .....</b>	<b>374</b>
If your vehicle needs to be towed .....	374
If you think something is wrong .....	377
Fuel pump shut off system .....	378
Event data recorder .....	379
<b>5-2. Steps to take in an     emergency .....</b>	<b>381</b>
If a warning light turns on or a warning buzzer sounds... ..	381
If a warning message is displayed (vehicles with multi-information display) .....	391
If you have a flat tire.....	400
If the engine will not start ....	411
If the shift lever cannot be shifted from P (automatic transmission) .....	413
If you lose your keys .....	414
If the electronic key does not operate properly (vehicles with smart key system) .....	415
If the battery is discharged .....	417
If your vehicle overheats .....	421
If the vehicle becomes stuck .....	424

## 6 Vehicle specifications

<b>6-1. Specifications .....</b>	<b>428</b>
Maintenance data (fuel, oil level, etc.) .....	428
Fuel information.....	439
Tire information .....	442
<b>6-2. Customization.....</b>	<b>454</b>
Customizable features.....	454
<b>6-3. Initialization.....</b>	<b>458</b>
Items to initialize .....	458

## 7 For U.S. owners

Reporting safety defects for U.S. owners .....	460
---------------------------------------------------	-----

## Index

<b>Abbreviation list.....</b>	<b>462</b>
<b>Alphabetical index .....</b>	<b>463</b>
<b>What to do if... ..</b>	<b>473</b>

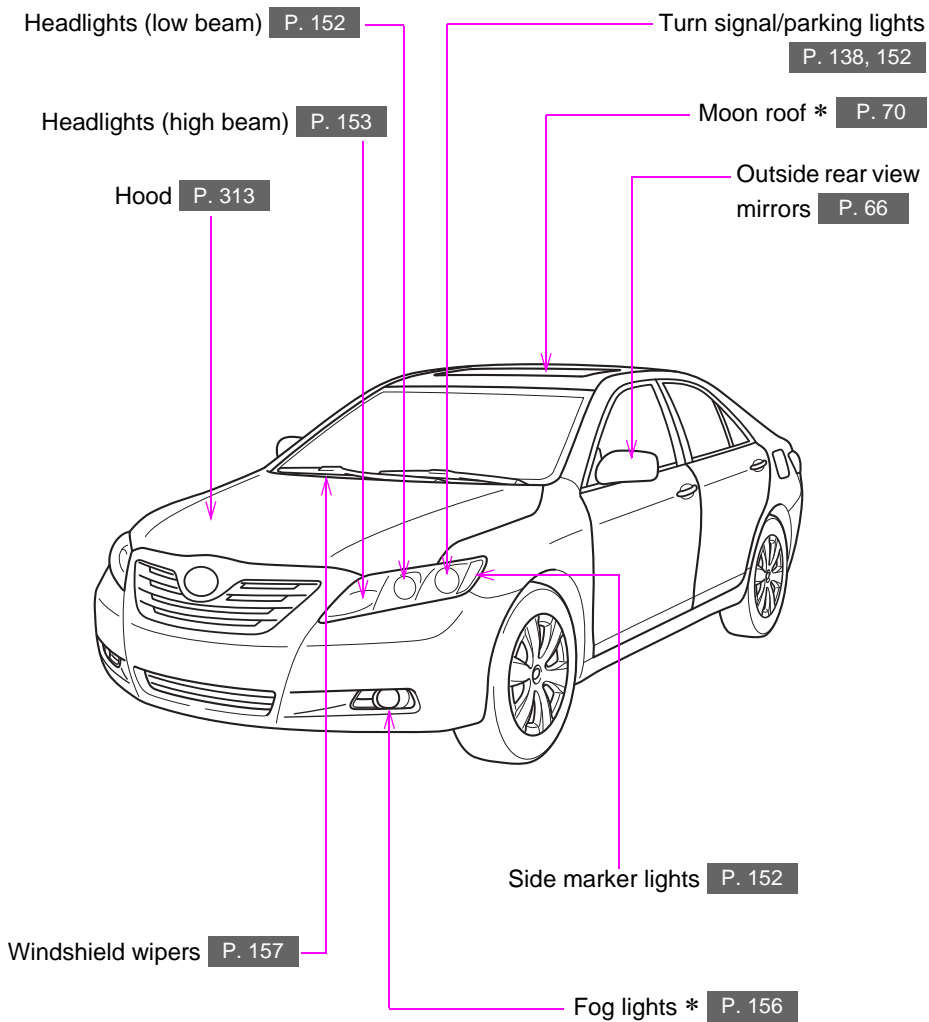

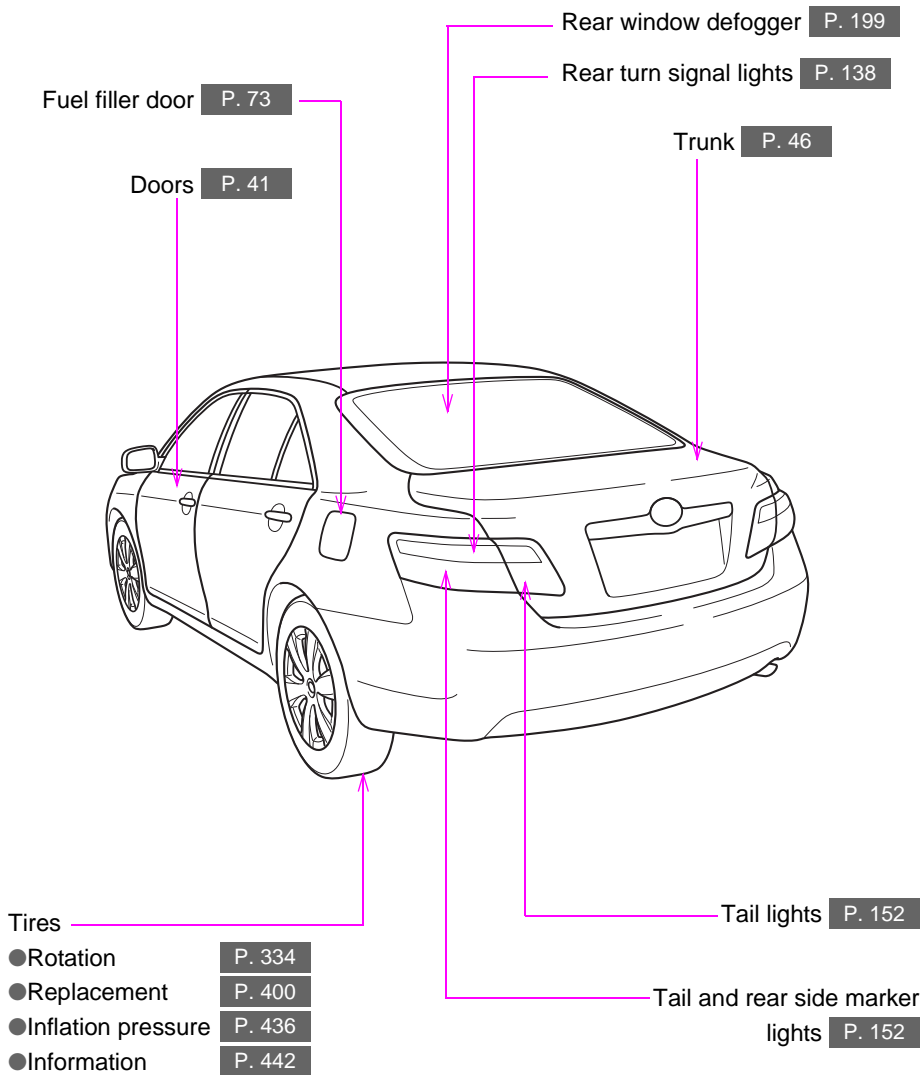

\*: If equipped

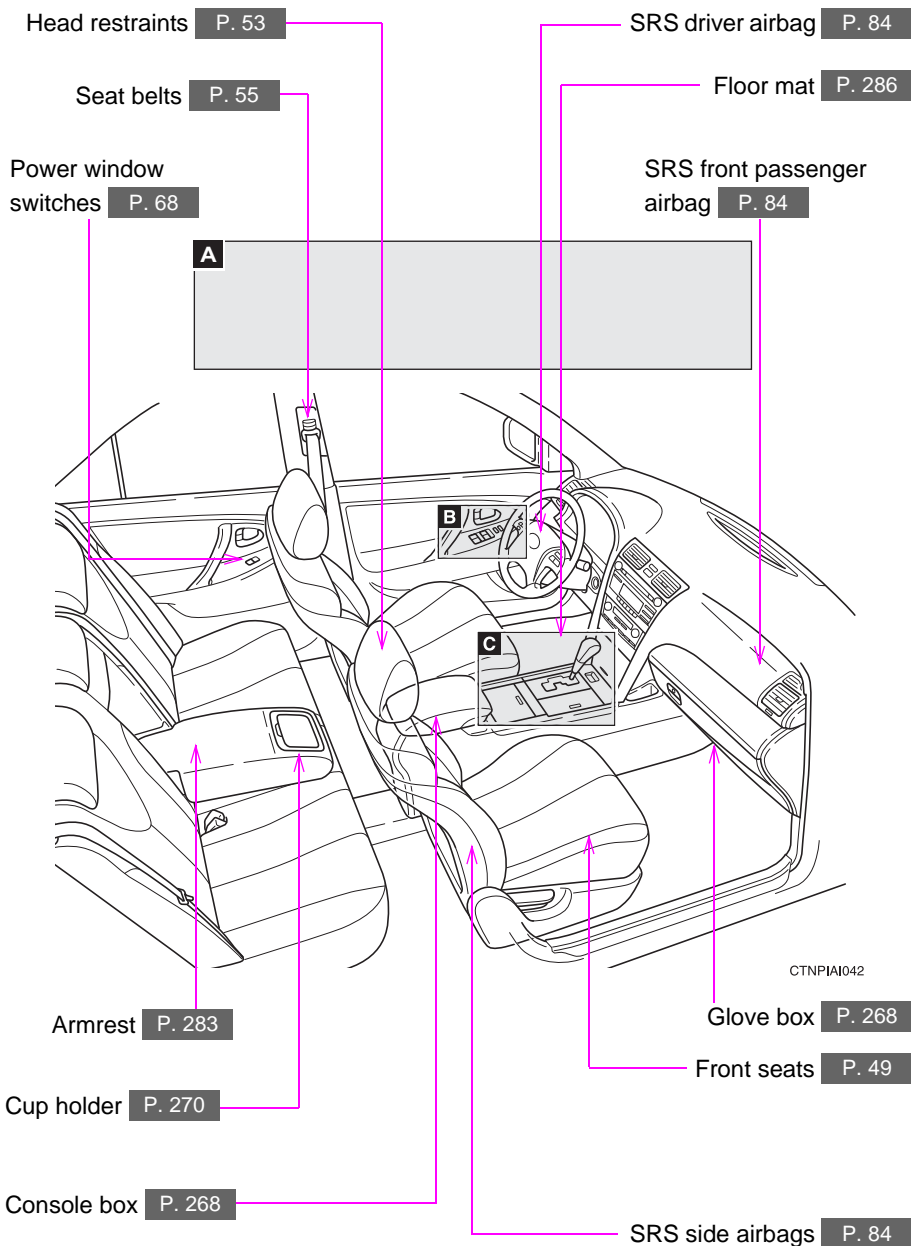

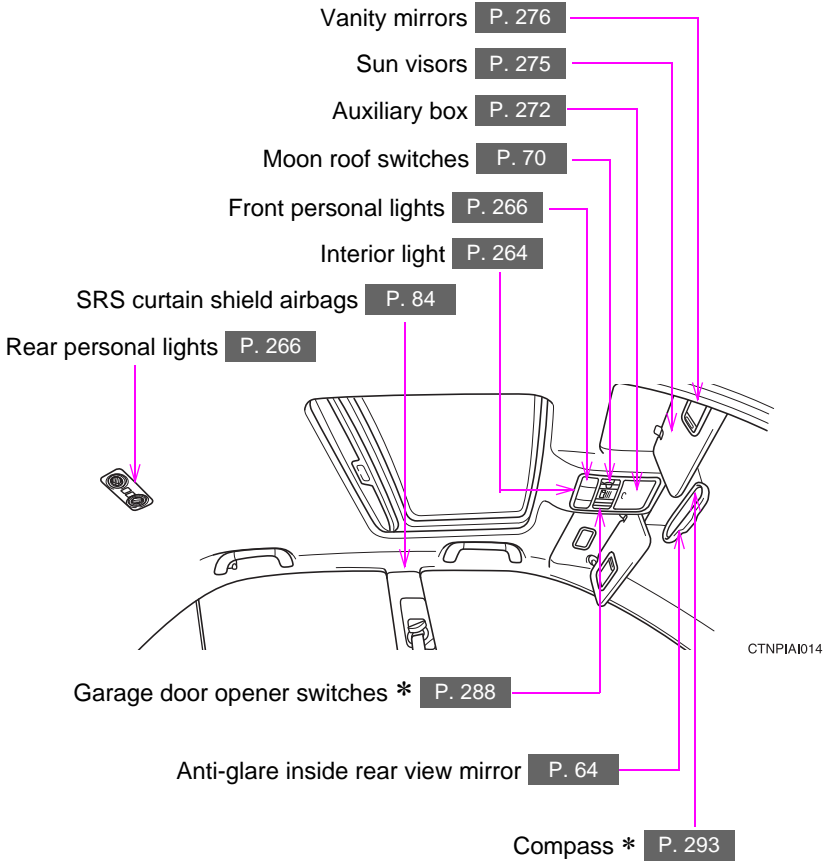

**A****► Vehicles with moon roof**

\*: If equipped

**A**

► **Vehicles without moon roof**

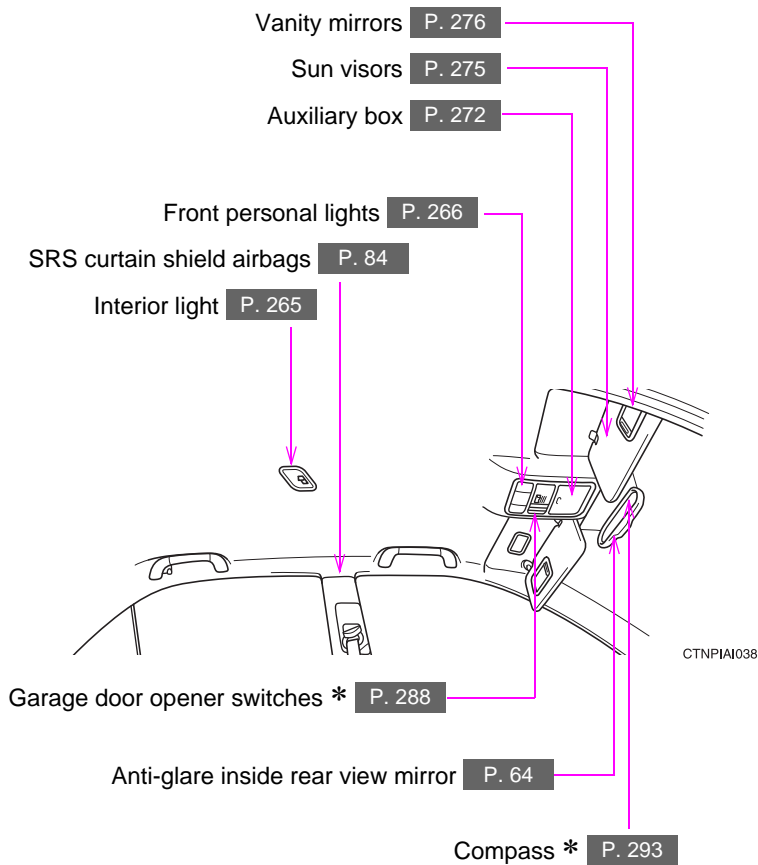

**B**

Inside door lock button P. 42

Door lock switch P. 41

Window lock switch P. 68

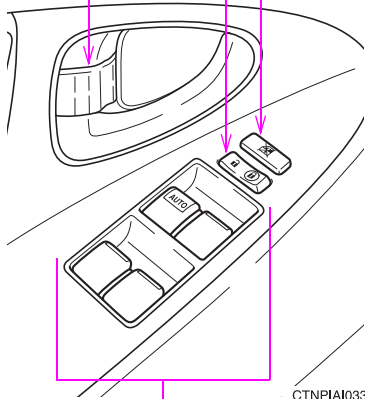

CTNPIA1033

Power window switches P. 68

\*: If equipped

**C**

► **Automatic transmission**

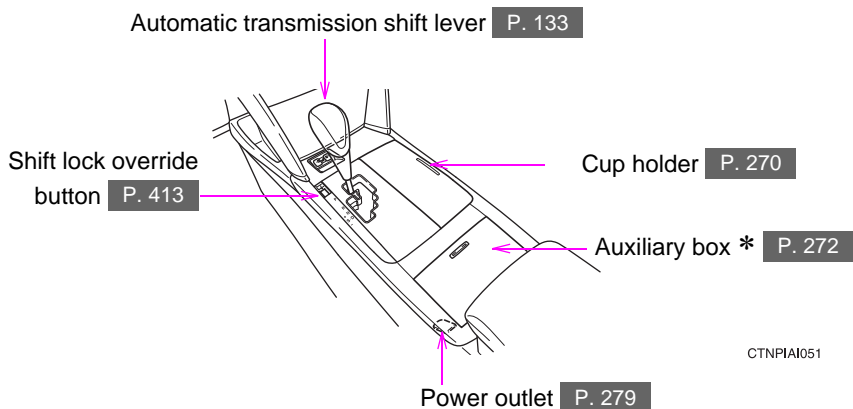

► **Manual transmission**

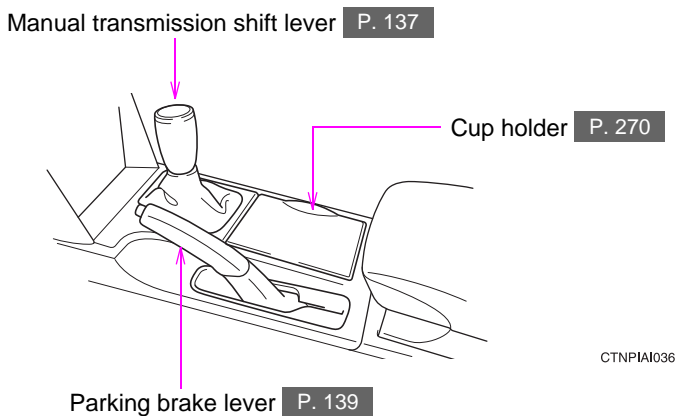

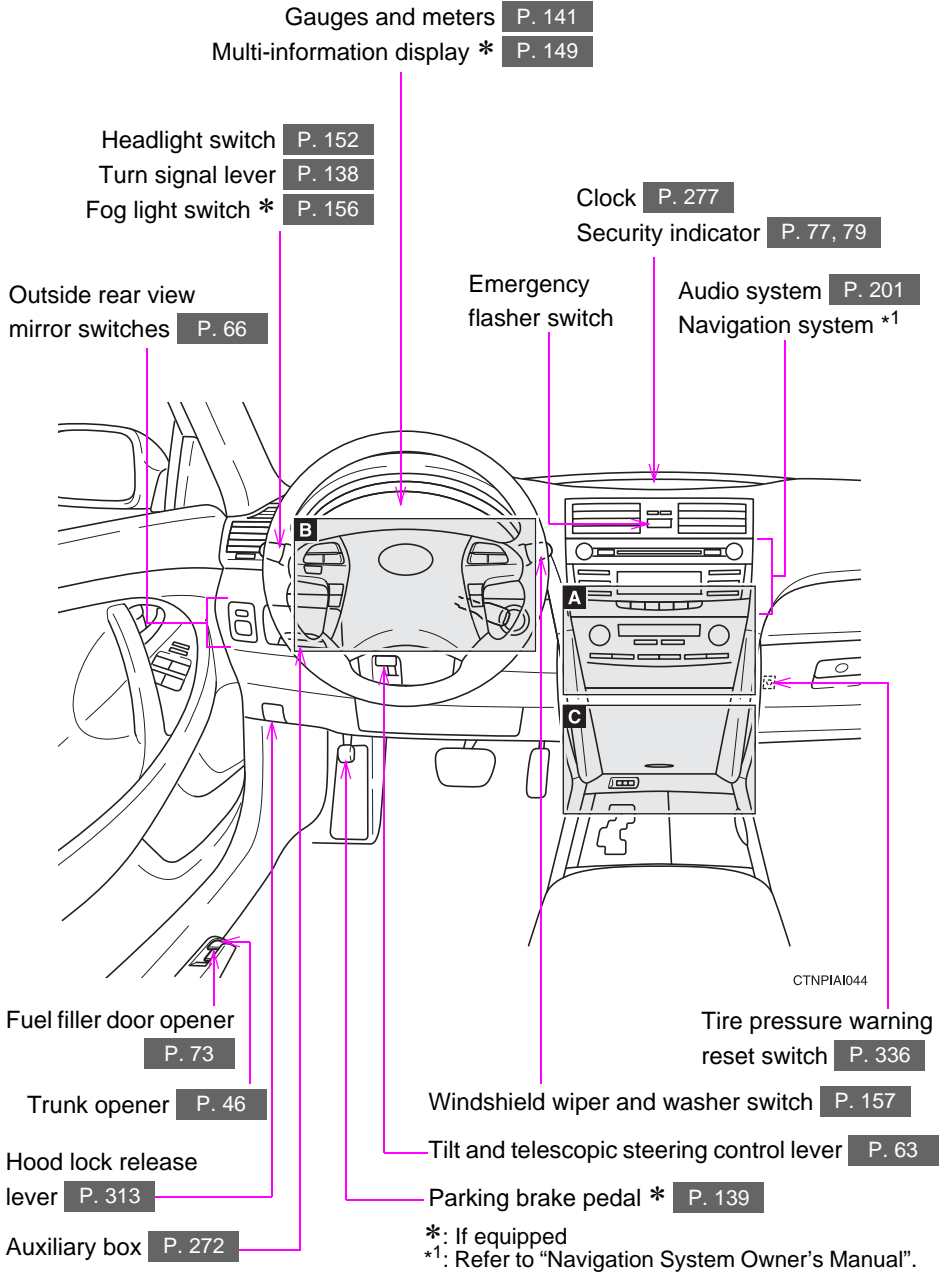

**A**

► **Automatic air conditioning system**

Air conditioning system **P. 186**

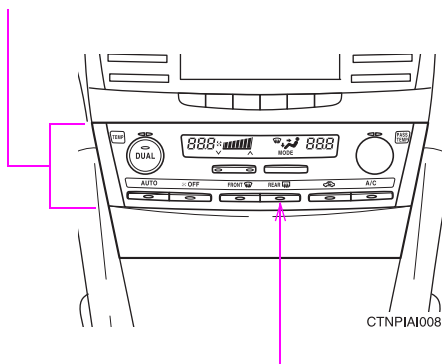

Rear window and outside rear view mirror defogger switch **P. 199**

► **Manual air conditioning system**

Air conditioning system **P. 194**

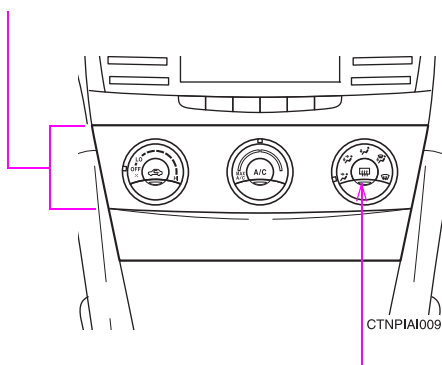

Rear window defogger switch **P. 199**

Outside rear view mirror defogger switch \* **P. 199**

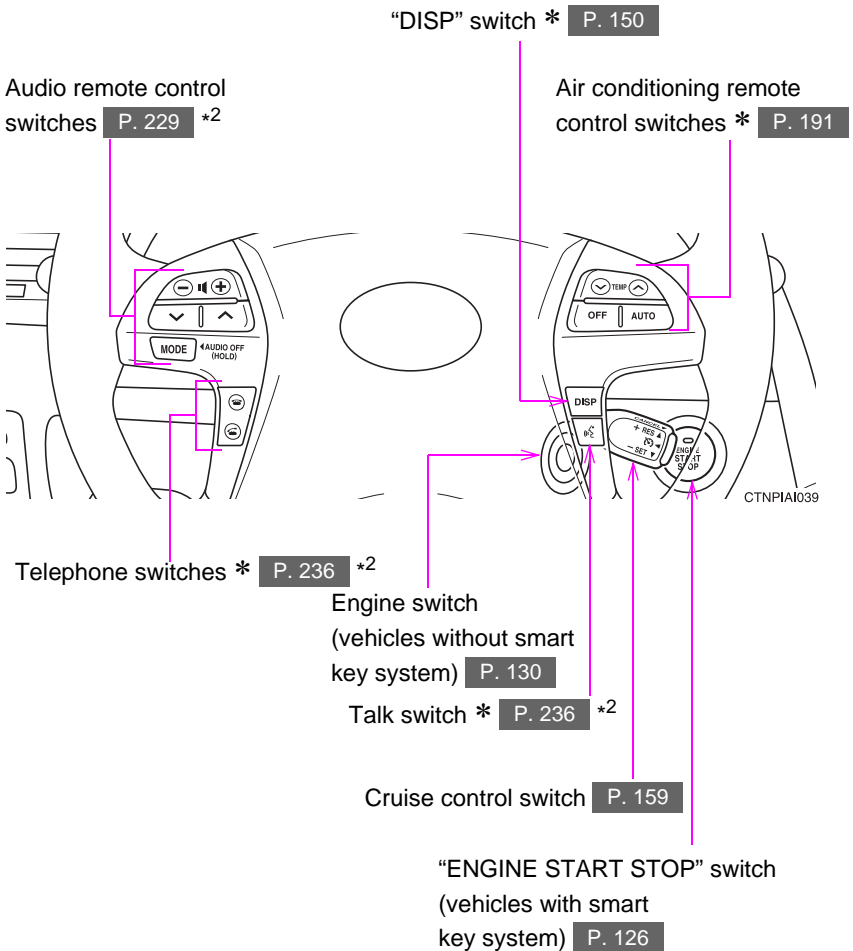
**B****► Type A**

\*: If equipped

\*2: For vehicles with a navigation system, refer to “Navigation System Owner’s Manual”.

**B**

► Type B

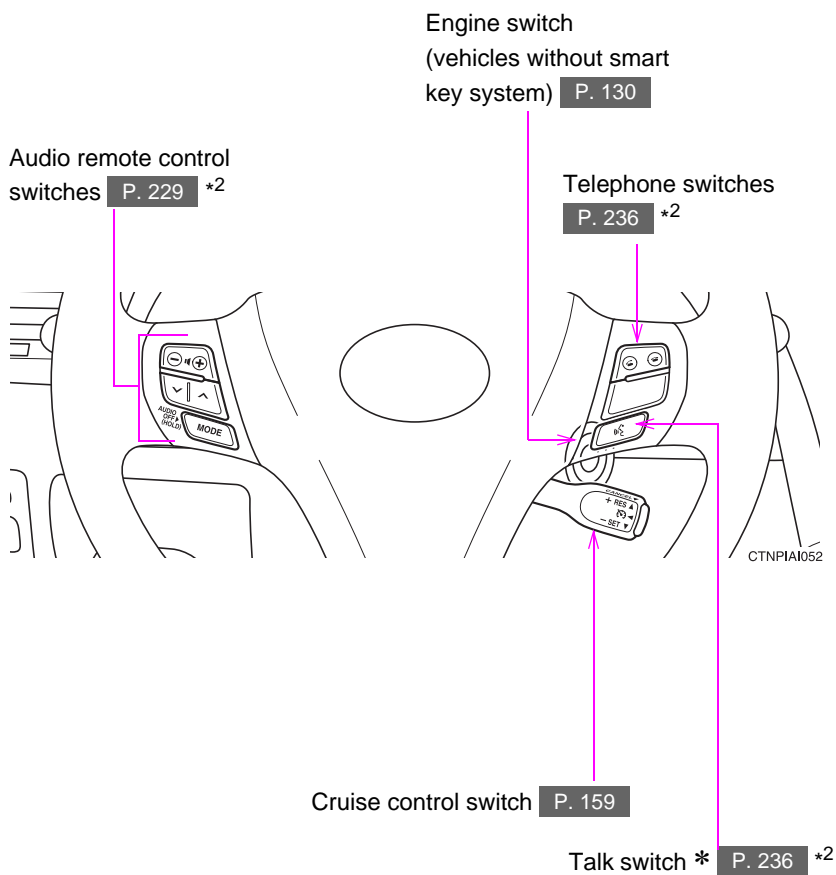



**C**

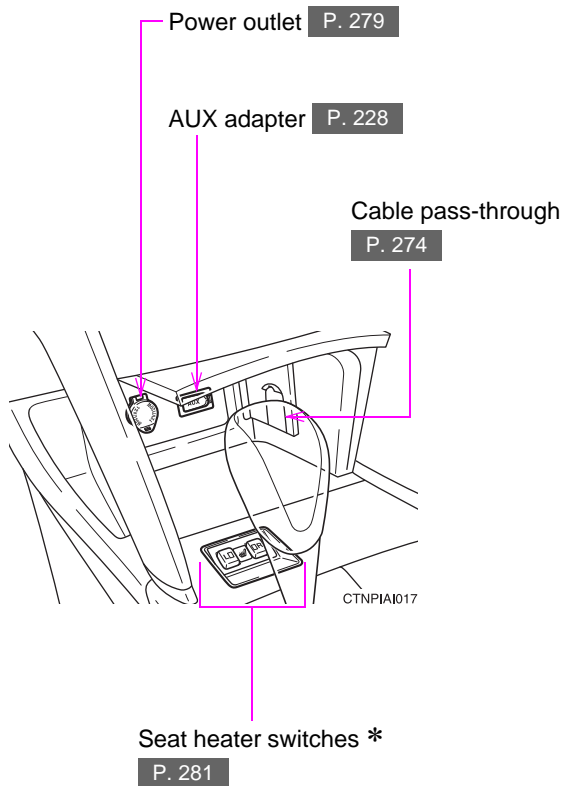

\*: If equipped

\*2: For vehicles with a navigation system, refer to "Navigation System Owner's Manual".

## For your information

### **Main Owners Manual**

Please note that this manual covers all models and all equipment, including options. Therefore, you may find some explanations for equipment not installed on your vehicle.

All specifications provided in this manual are current at the time of printing. However, because of the Toyota policy of continual product improvement, we reserve the right to make changes at any time without notice.

Depending on specifications, the vehicle shown in the illustrations may differ from your vehicle in terms of equipment.

### **Accessories, spare parts and modification of your Toyota**

A wide variety of non-genuine spare parts and accessories for Toyota vehicles are currently available on the market. You should know that these parts are not covered by Toyota warranty and that Toyota is not responsible for their performance, repair, or replacement, or for any damage they may cause to, or adverse effect they may have on, your Toyota vehicle.

This vehicle should not be modified with non-genuine Toyota products. Modification with non-genuine Toyota products could affect its performance, safety or durability, and may even violate governmental regulations. In addition, damage or performance problems resulting from the modification may not be covered under warranty.

### **Installation of a mobile two-way radio system**

As the installation of a mobile two-way radio system in your vehicle may affect electronic systems such as the multi-port fuel injection system/sequential multi-port fuel injection system, cruise control system, anti-lock brake system, SRS airbag system or seat belt pretensioner system, be sure to check with your Toyota dealer for precautionary measures or special instructions regarding installation.

## **Scraping of your Toyota**

The SRS airbag and seat belt pretensioner devices in your Toyota contain explosive chemicals. If the vehicle is scrapped with the airbags and seat belt pretensioners left as they are, this may cause an accident such as fire. Be sure to have the systems of the SRS airbag and seat belt pretensioner removed and disposed of by a qualified service shop or by your Toyota dealer before you scrap your vehicle.

## **Perchlorate Material**

Special handling may apply, See [www.dtsc.ca.gov/hazardouswaste/perchlorate](http://www.dtsc.ca.gov/hazardouswaste/perchlorate).

Your vehicle has components that may contain perchlorate. These components may include airbags, seat belt pretensioners, and wireless remote control batteries.



## CAUTION

### ■ **General precautions while driving**

**Driving under the influence:** Never drive your vehicle when under the influence of alcohol or drugs that have impaired your ability to operate your vehicle. Alcohol and certain drugs delay reaction time, impair judgment and reduce coordination, which could lead to an accident that will hurt or kill you, your occupants or others.

**Defensive driving:** Always drive defensively. Anticipate mistakes that other drivers or pedestrians might make and be ready to avoid accidents.

**Driver distraction:** Always give your full attention to driving. Anything that distracts the driver, such as adjusting controls, talking on a cellular phone or reading can result in a collision with resulting death or serious injury to you, your occupants or others.

### ■ **General precaution regarding children's safety**

Never leave children unattended in the vehicle, and never allow children to have or use the key.

Children may be able to start the vehicle or shift the vehicle into neutral. There is also a danger that children may injure themselves by playing with the cigarette lighter, the windows, or other features of the vehicle. In addition, heat build-up or extremely cold temperatures inside the vehicle can be fatal to children.



## Symbols used throughout this manual

### Cautions & Notices

#### CAUTION

This is a warning against anything which may cause death or injury to people if the warning is ignored. You are informed about what you must or must not do in order to reduce the risk of injury to yourself and others.

#### NOTICE

This is a warning against anything which may cause damage to the vehicle or its equipment if the warning is ignored. You are informed about what you must or must not do in order to avoid or reduce the risk of damage to your Toyota and its equipment.

### Safety symbol



Throughout this manual, you will also see the symbol of a circle with a slash through it. This means “Do not”, “Do not do this”, or “Do not let this happen”.

## Before driving

# 1

- |                                                                         |           |                                                      |           |
|-------------------------------------------------------------------------|-----------|------------------------------------------------------|-----------|
| <b>1-1. Key information.....</b>                                        | <b>24</b> | <b>1-4. Opening and closing the windows.....</b>     | <b>68</b> |
| Keys .....                                                              | 24        | Power windows .....                                  | 68        |
| <b>1-2. Opening, closing and locking the doors and trunk.....</b>       | <b>26</b> | Moon roof .....                                      | 70        |
| Smart key system .....                                                  | 26        | <b>1-5. Refueling.....</b>                           | <b>73</b> |
| Wireless remote control .....                                           | 37        | Opening the fuel tank cap .....                      | 73        |
| Doors .....                                                             | 41        | <b>1-6. Theft deterrent system ....</b>              | <b>77</b> |
| Trunk.....                                                              | 46        | Engine immobilizer system .....                      | 77        |
| <b>1-3. Adjustable components (seats, mirrors, steering wheel).....</b> | <b>49</b> | Alarm.....                                           | 79        |
| Front seats .....                                                       | 49        | Theft prevention labels (for U.S.A.) .....           | 81        |
| Rear seats.....                                                         | 51        | <b>1-7. Safety information .....</b>                 | <b>82</b> |
| Head restraints.....                                                    | 53        | Correct driving posture.....                         | 82        |
| Seat belts .....                                                        | 55        | SRS airbags.....                                     | 84        |
| Steering wheel .....                                                    | 63        | Front passenger occupant classification system ..... | 96        |
| Anti-glare inside rear view mirror .....                                | 64        | Child restraint systems.....                         | 101       |
| Outside rear view mirrors... ..                                         | 66        | Installing child restraints... ..                    | 105       |

# Keys

The following keys are provided with the vehicle.

► Vehicles with smart key system

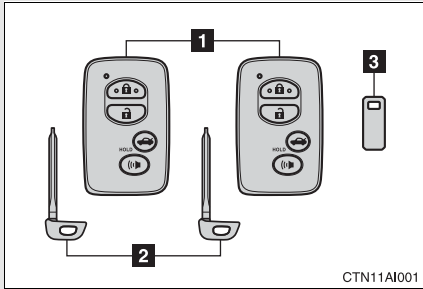

**1** Electronic keys

- Operating the smart key system (→P. 26)
- Operating the wireless remote control function (→P. 37)

**2** Mechanical keys

**3** Key number plate

► Vehicles without smart key system (type A)

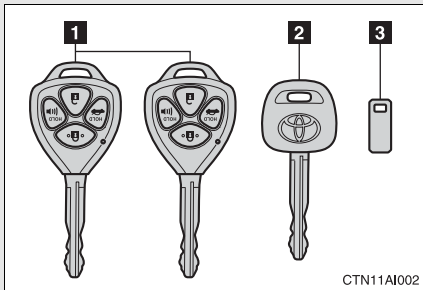

**1** Master keys

Operating the wireless remote control function (→P. 37)

**2** Valet key

**3** Key number plate

► Vehicles without smart key system (type B)

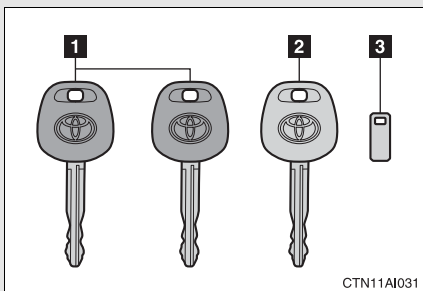

**1** Master keys

**2** Valet key

**3** Key number plate



## Using the mechanical key (vehicles with smart key system)

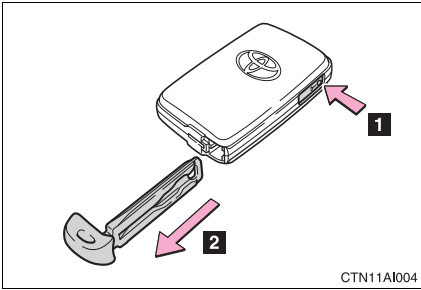

Take out the mechanical key.

After using the mechanical key, store it in the electronic key. Carry the mechanical key together with the electronic key. If the electronic key battery is depleted or the entry function does not operate properly, you will need the mechanical key. (→P. 415)

1

Before driving

### ■ When required to leave a key to the vehicle with a parking attendant

Lock the glove box and the trunk storage extension (if equipped) as circumstances demand. Set the luggage security system. (→P. 47, 268, 285)

Vehicles with smart key system: Remove the mechanical key for your own use and provide the attendant with the electronic key only.

Vehicles without smart key system: Carry the master key for your own use and leave the valet key only with the attendant.

### ■ Key number plate

Keep the plate in a safe place such as your wallet, not in the vehicle. In the event that a key is lost, a new key can be made by your Toyota dealer using the key number plate. (→P. 414)

### ⚠ NOTICE

#### ■ To prevent key damage

- Do not subject the keys to strong shocks, expose them to high temperatures by placing them in direct sunlight, or get them wet.
- Do not expose the keys to electromagnetic materials or attach any material that blocks electromagnetic waves to the key surface.
- Do not disassemble the electronic key.

## 1-2. Opening, closing and locking the doors and trunk Smart key system (if equipped)

The following operations can be performed simply by carrying the electronic key on your person, for example in your pocket.  
(The driver should always carry the electronic key.)

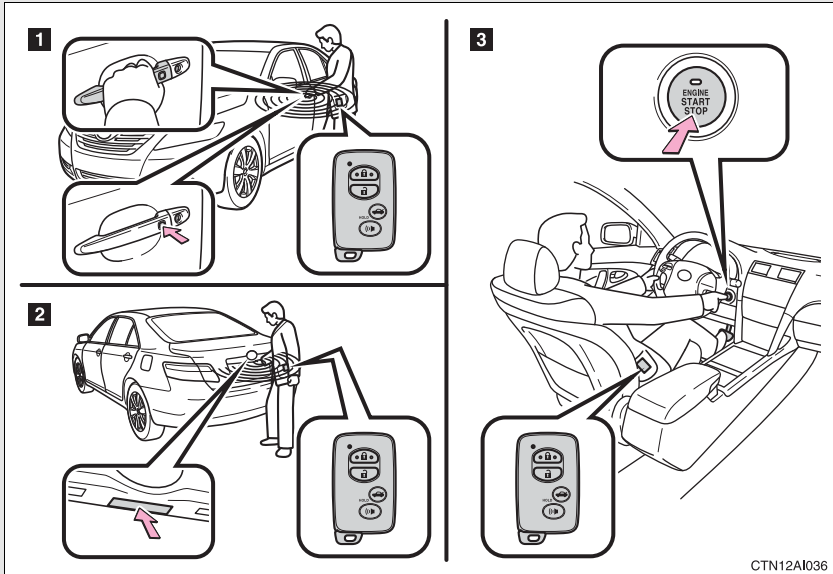

- 1** Locks and unlocks the doors (→P. 27)
- 2** Unlocks the trunk (→P. 27)
- 3** Starts the engine (→P. 126)

### Locking and unlocking the doors (front door handles only)

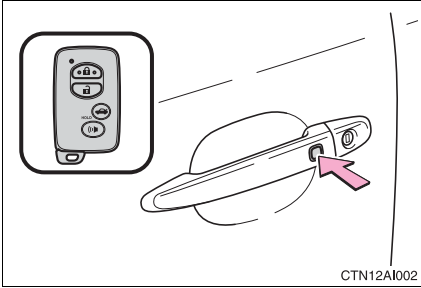

Press the lock button to lock the door.

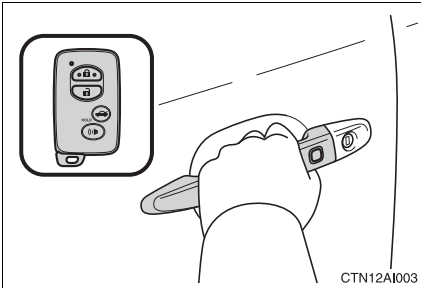

Grip the handle to unlock the door.

Make sure to touch the sensor on the back of the handle.

The door cannot be unlocked for 3 seconds after the door is locked.

### Unlocking the trunk

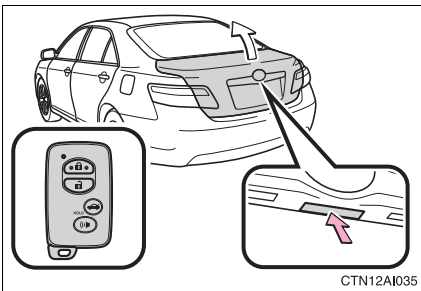

Press the button to unlock the trunk.

## Antenna location and effective range

### ■ Antenna location

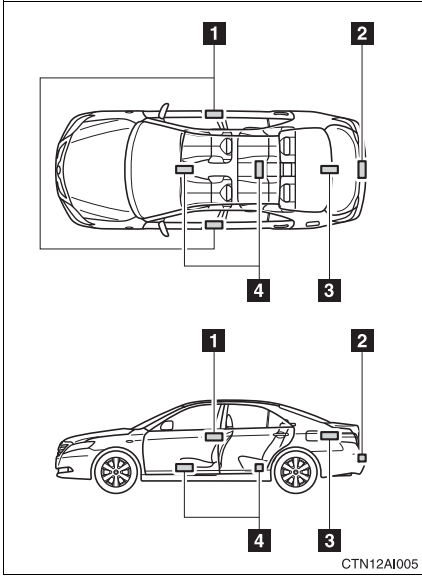

- 1** Antennas outside the cabin
- 2** Antenna outside the trunk
- 3** Antenna inside the trunk
- 4** Antennas inside the cabin

■ **Effective range (areas within which the electronic key is detected)**

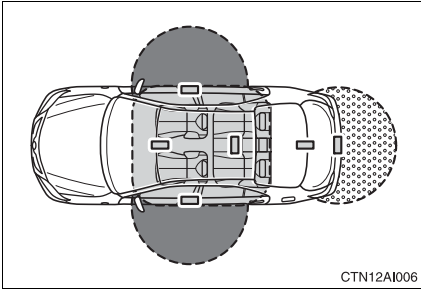

- When locking or unlocking the doors

The system can be operated when the electronic key is within about 2.3 ft. (0.7 m) of either of the outside front door handles. (Only the doors detecting the key can be operated.)

- When starting the engine or changing “ENGINE START STOP” switch modes

The system can be operated when the electronic key is inside the vehicle.

- When unlocking the trunk

The system can be operated when the electronic key is within about 2.3 ft. (0.7 m) of the trunk release button.

### ■ Operation signals

A buzzer sounds and the emergency flashers flash to indicate that the doors have been locked/unlocked. (Locked: Once; Unlocked: Twice)

### ■ Conditions affecting operation





The smart key system uses weak radio waves. In the following situations, the communication between the electronic key and the vehicle may be affected, preventing the smart key system and wireless remote control from operating properly. (Ways of coping: →P. 415)

- When the electronic key battery is depleted
- Near a TV tower, electric power plant, gas station, radio station, large display, airport or other facility that generates strong radio waves or electrical noise
- When carrying a portable radio, cellular phone, cordless phone or other wireless communication devices
- When the electronic key has come into contact with, or is covered by, a metallic object
- When multiple electronic keys are in the vicinity
- When carrying or using the electronic key together with the following devices that emit radio waves
  - Another vehicle's electronic key
  - A wireless key that emits radio waves
  - Personal computer
- If window tint with a metallic content or metallic objects are attached to the rear window



## ■ Switching the door unlock function

It is possible to set which doors the entry function unlocks.

**STEP 1** Turn the “ENGINE START STOP” switch OFF.

**STEP 2** When the indicator on the key surface is off, press and hold  ,  , or  for approximately 5 seconds while pressing the  button on the key.

The setting changes each time an operation is performed, as shown below. (When changing the setting continuously, release the buttons, wait for at least 5 seconds, and repeat step 2.)

Multi-information display	Unlocking doors	Beep
	Hold the driver's door handle to unlock only the driver's door.	Exterior: Beeps three times Interior: Pings once
	Hold the front passenger's door handle except the driver's door handle to unlock all doors	
	Hold the front passenger's door handle to unlock all doors	Exterior: Beeps twice Interior: Pings once

**STEP 3** Unlock the doors using the electronic key and open one of the doors.

If a door is not opened within 60 seconds after  is pressed, the doors will be locked again and the alarm will automatically be set. In case that the alarm is triggered, immediately stop the alarm. (→P. 79)

### ■ Battery-saving function

In the following circumstances, the entry function is disabled in order to prevent the vehicle and electronic key batteries from discharging.

- When the entry function has not been used for 2 weeks or more
- When the electronic key has been left within approximately 7 ft. (2 m) of the vehicle for 10 minutes or more

The system will resume operation when...

- The vehicle is locked using the door handle lock switch.
- The vehicle is locked/unlocked using the wireless remote control function. (→P. 37)
- The vehicle is locked/unlocked using the mechanical key. (→P. 415)

### ■ Electronic key battery depletion

- The standard battery life is 1 to 2 years. (The battery becomes depleted even if the electronic key is not used.) If the smart key system or the wireless remote control function does not operate, or the detection area becomes smaller, the battery may be depleted. Replace the battery when necessary. (→P. 353)
- To avoid serious deterioration, do not leave the electronic key within 3 ft. (1 m) of the following electrical appliances.
  - TVs
  - Personal computers
  - Recharging cellular phones or cordless phones
  - Table lamps

### ■ To operate the system properly

Make sure to carry the electronic key when operating the system. Do not get the electronic key too close to the vehicle when operating the system from the outside of the vehicle.

Depending on the position and holding condition of the electronic key, the key may not be detected correctly and the system may not operate properly. (The alarm may go off accidentally, or the door lock prevention may not function.)



### ■ Note for the smart key system

- Even when the electronic key is within the effective range (detection areas), the system may not operate properly in the following cases.
  - The electronic key is too close to the window or outside door handle, near the ground, or in a high place when the doors are locked or unlocked.
  - The electronic key is near the ground or in a high place, or too close to the rear bumper center when the trunk is unlocked.
  - The electronic key is on the instrument panel, package tray, floor, or in the auxiliary box of the driver's side instrument panel or glove box when the engine is started or "ENGINE START STOP" switch modes are changed.
- As long as the electronic key is within the effective range, the doors may be locked or unlocked by anyone.
- Even if the electronic key is not inside the vehicle, it may be possible to start the engine if the electronic key is near the window.
- The doors may unlock if a large amount of water splashes on the door handle, such as in the rain or in a car wash. (The doors will automatically be locked after approximately 60 seconds if the doors are not opened and closed.)
- Gripping the door handle when wearing a glove may not unlock the door.
- If the wireless remote control is used to lock the doors when the electronic key is near the vehicle, there is a possibility that the door may not be unlocked by the entry function. (Use the wireless remote control to unlock the doors.)

### ■ When the vehicle is not driven for extended periods

To prevent theft of the vehicle, do not leave the electronic key within 6 ft. (2 m) of the vehicle.

### ■ Security feature

If a door is not opened within approximately 60 seconds after the vehicle is unlocked, the security feature automatically locks the vehicle again.

### ■ Alarms and warning indicators

A combination of exterior and interior alarms as well as warning messages shown on the multi-information display are used to reduce the chance of vehicle theft and accidents resulting from erroneous operation. Take appropriate measures according to the warning message on the multi-information display. (→P. 391)

## 1-2. Opening, closing and locking the doors and trunk

The following table describes circumstances and correction procedures when only alarms are sounded.

Alarm	Situation	Correction procedure
Exterior alarm sounds once for 2 seconds	Tried to lock the doors using the entry function while the electronic key is still inside the passenger compartment	Retrieve the electronic key from the passenger compartment and lock the doors again.
	Closed the trunk while the electronic key is still inside the trunk and all doors are locked	Retrieve the electronic key from the trunk and close the trunk lid.
Exterior alarm sounds once for 10 seconds	Tried to lock the vehicle using the entry function while a door is open	Close all of the doors and lock the doors again.
Exterior alarm sounds once for 60 seconds	Tried to exit the vehicle with the electronic key and lock the doors without first turning the "ENGINE START STOP" switch OFF	Turn the "ENGINE START STOP" switch OFF and lock the doors again.
Interior alarm sounds continuously	Tried to open the door and exit the vehicle without shifting the shift lever to P	Shift the shift lever to P.
Interior alarm beeps repeatedly	Turned the "ENGINE START STOP" switch to ACCESSORY mode while the driver's door is open (Opened the driver's door when the "ENGINE START STOP" switch is in ACCESSORY mode.)	Turn the "ENGINE START STOP" switch OFF and close the driver's door.
	Turned the "ENGINE START STOP" switch OFF while the driver's door is open	Close the driver's door.

**■ If the smart key system does not operate properly**

- Locking and unlocking the doors and trunk: Use the mechanical key. (→P. 415)
- Starting the engine: →P. 416

**■ When the electronic key battery is fully depleted**

→P. 353

**■ Customization that can be configured at Toyota dealer**

It is possible to deactivate the smart key system, etc.  
(Customizable features →P. 454)

**■ Certification for the smart key system**

- ▶ For vehicles sold in the U.S.A.

FCC ID: NI4TMLF-3
-------------------

**NOTE:**

This device complies with Part 15 of the FCC Rules. Operation is subject to the following two conditions: (1) This device may not cause harmful interference, and (2) this device must accept any interference received, including interference that may cause undesired operation.

**NOTICE:**

This equipment has been tested and found to comply with the limits for a Class B digital device, pursuant to Part 15 of the FCC Rules. These limits are designed to provide reasonable protection against harmful interference in a residential installation. This equipment generates, uses and can radiate radio frequency energy and, if not installed and used in accordance with the instructions, may cause harmful interference to radio communications. However, there is no guarantee that interference will not occur in a particular installation. If this equipment does cause harmful interference to radio or television reception, which can be determined by turning the equipment off and on, the user is encouraged to try to correct the interference by one or more of the following measures:

- Reorient or relocate the receiving antenna.
- Increase the separation between the equipment and receiver.
- Connect the equipment into an outlet on a circuit different from that to which the receiver is connected.
- Consult the dealer or an experienced radio/TV technician for help.

**FCC WARNING:**

Changes or modifications not expressly approved by the party responsible for compliance could void the user's authority to operate the equipment.

► For vehicles sold in Canada

**NOTE:**

Operation is subject to the following two conditions: (1) This device may not cause interference, and (2) this device must accept any interference, including interference that may cause undesired operation of the device.

**⚠ CAUTION**

**■ Caution regarding interference with electronic devices**

- People with implanted pacemakers or cardiac defibrillators should maintain a reasonable distance between themselves and the smart key system antennas. (→P. 28)

The radio waves may affect the operation of such devices. If necessary, the entry function can be disabled. Ask your Toyota dealer for details, such as the frequency of radio waves and timing of emitting the radio waves. Then, consult your doctor to see if you should disable the entry function.

- User of any electrical medical device other than implanted pacemakers and implanted cardiac defibrillators should consult the manufacturer of the device for information about its operation under the influence of radio waves.

Radio waves could have unexpected effects on the operation of such medical devices.

Ask your Toyota dealer for details for disabling the entry function.

## 1-2. Opening, closing and locking the doors and trunk Wireless remote control (if equipped)

The wireless remote control can be used to lock and unlock the vehicle from outside the vehicle.

### ► Vehicles with smart key system

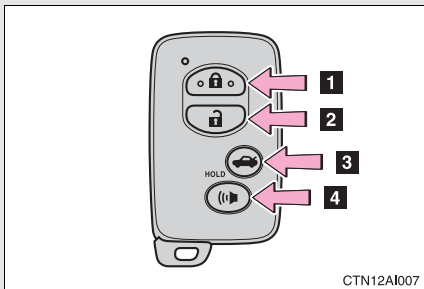

- 1 Locks all doors
- 2 Unlocks all doors
- 3 Unlocks the trunk (press and hold)
- 4 Sounds an alarm (press and hold)

### ► Vehicles without smart key system

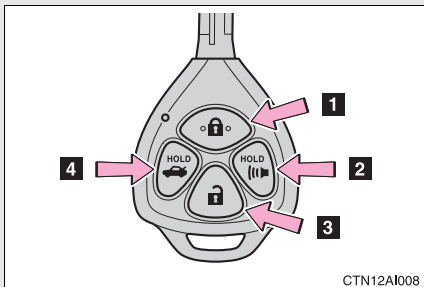

- 1 Locks all doors
- 2 Sounds an alarm (press and hold)
- 3 Unlocks all doors
- 4 Unlocks the trunk (press and hold)

### ■ 2-step unlocking function

When you press the  button, the driver's door is unlocked. Pressing the button again within 3 seconds unlocks the other doors.

### ■ Operation signals

Doors: A buzzer sounds and the emergency flashers flash to indicate that the doors have been locked/unlocked. (Locked: Once; Unlocked: Twice)

Trunk: A buzzer sounds to indicate that the trunk has been unlocked.

### ■ Door lock buzzer

If a door is not fully closed, a buzzer sounds continuously for 10 seconds if an attempt to lock the door is made. Fully close the door to stop the buzzer, and lock the vehicle once more.

### ■ Panic mode

#### ▶ Vehicles with smart key system



When  is pressed for longer than about one second, an alarm will sound intermittently and the vehicle lights will flash to deter any person from trying to break into or damage your vehicle.

To stop the alarm, press any button on the electronic key.

#### ▶ Vehicles without smart key system



When  is pressed for longer than about one second, an alarm will sound intermittently and the vehicle lights will flash to deter any person from trying to break into or damage your vehicle.

To stop the alarm, press any button on the wireless remote control.

### ■ Key battery depletion

#### ▶ Vehicles with smart key system

→P. 32

#### ▶ Vehicles without smart key system

The standard battery life is 1 to 2 years. (The battery becomes depleted even if the key is not used.) If the wireless remote control function does not operate, the battery may be depleted. Replace the battery when necessary. (→P. 353)

### ■ Security feature

If a door is not opened within approximately 60 seconds after the vehicle is unlocked, the security feature automatically locks the vehicle again.

### ■ When the electronic key battery is fully depleted (vehicles with smart key system)

→P. 353

### ■ Conditions affecting operation

▶ Vehicles with smart key system

→P. 30

▶ Vehicles without smart key system

The wireless remote control function may not operate normally in the following situations.

- Near a TV tower, radio station, electric power plant, airport or other facility that generates strong radio waves
- When carrying a portable radio, cellular phone or other wireless communication devices
- When multiple wireless keys are in the vicinity
- When the wireless key has come into contact with, or is covered by, a metallic object
- When a wireless key (that emits radio waves) is being used nearby
- When the wireless key has been left near an electrical appliance such as a personal computer

■ **Customization that can be configured at Toyota dealer**

Settings (e.g. trunk unlocking function) can be changed. (Customizable features →P. 454)

■ **Certification for wireless remote control**

▶ For vehicles sold in the U.S.A.

**NOTE:**

This device complies with Part 15 of the FCC Rules. Operation is subject to the following two conditions: (1) this device may not cause harmful interference, and (2) this device must accept any interference received, including interference that may cause undesired operation.

**NOTICE:**

This equipment has been tested and found to comply with the limits for a Class B digital device, pursuant to Part 15 of the FCC Rules. These limits are designed to provide reasonable protection against harmful interference in a residential installation. This equipment generates, uses and can radiate radio frequency energy and, if not installed and used in accordance with the instructions, may cause harmful interference to radio communications. However, there is no guarantee that interference will not occur in a particular installation. If this equipment does cause harmful interference to radio or television reception, which can be determined by turning the equipment off and on, the user is encouraged to try to correct the interference by one or more of the following measures:

- Reorient or relocate the receiving antenna.
- Increase the separation between the equipment and receiver.
- Connect the equipment into an outlet on a circuit different from that to which the receiver is connected.
- Consult the dealer or an experienced radio/TV technician for help.

**FCC WARNING:**

Changes or modifications not expressly approved by the party responsible for compliance could void the user's authority to operate the equipment.

▶ For vehicles sold in Canada

**NOTE:**

Operation is subject to the following two conditions: (1) this device may not cause interference, and (2) this device must accept any interference, including interference that may cause undesired operation of the device.



# 1-2. Opening, closing and locking the doors and trunk

## Doors

The vehicle can be locked and unlocked using the entry function, wireless remote control, key or door lock switch.

■ **Entry function (vehicles with smart key system)**

→P. 26

■ **Wireless remote control (if equipped)**

→P. 37

■ **Key**

▶ **Vehicles with smart key system**

The doors can also be locked and unlocked with the mechanical key. (→P. 415)

▶ **Vehicles without smart key system**

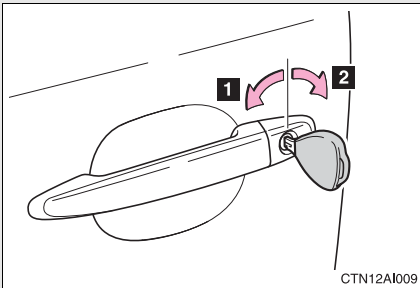

- 1 Locks all doors
- 2 Unlocks all doors

Turning the key unlocks the driver's door. Turning the key again unlocks the other doors.

■ **Door lock switch**

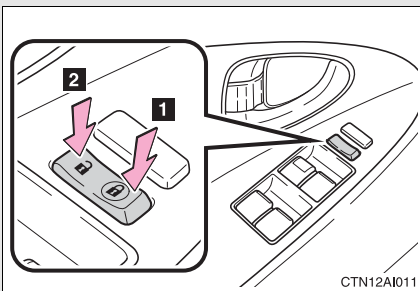

- 1 Locks all doors
- 2 Unlocks all doors

### ■ Inside lock button

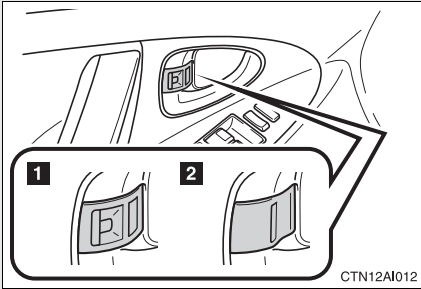

**1** Unlocks the door

**2** Locks the door

The front doors can be opened by pulling the inside handle even if the lock buttons are in the lock position.

### Locking the front doors from the outside without a key

#### ► Vehicles with smart key system

The door cannot be locked if the “ENGINE START STOP” switch is in ACCESSORY or IGNITION ON mode, or the electronic key is left inside the vehicle.

Depending on the position of the electronic key, the key may not be detected correctly and the door may be locked.

#### ► Vehicles without smart key system

The door cannot be locked if either of the front doors is open and the key is in the engine switch.

### Rear door child-protector lock

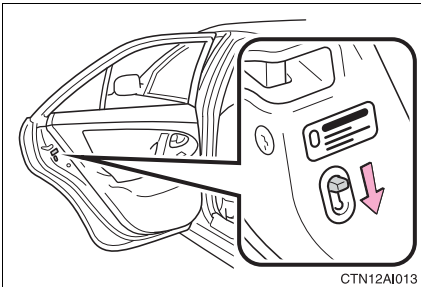

The door cannot be opened from inside the vehicle when the locks are set.

These locks can be set to prevent children from opening the rear doors. Push down on each rear door switch to lock both rear doors.

## Automatic door locking and unlocking systems

The following functions can be set or cancelled:

Function	Operation
Shift position linked door locking function *	Shifting the shift lever out of P locks all doors.
Shift position linked door unlocking function *	Shifting the shift lever to P unlocks all doors.
Speed linked door locking function	All doors are locked when the vehicle speed is approximately 12 mph (20 km/h) or higher.
Driver's door linked door unlocking function	<ul style="list-style-type: none"> <li>▶ Vehicles with smart key system All doors are unlocked when the driver's door is opened within 10 seconds after turning the "ENGINE START STOP" switch to ACCESSORY mode or OFF.</li> <li>▶ Vehicles without smart key system All doors are unlocked when the driver's door is opened within 10 seconds after turning the engine switch to "ACC" or "LOCK".</li> </ul>

\*: Vehicles with an automatic transmission only

## ■ Setting and canceling the functions

To switch between set and canceled, follow the procedure below:

**STEP 1** Vehicles with smart key system:

Close all the doors and switch the “ENGINE START STOP” switch to IGNITION ON mode. (Perform the step 2 within 10 seconds.)

Vehicles without smart key system:

Close all the doors and switch the engine switch to “ON” position. (Perform step 2 within 10 seconds.)

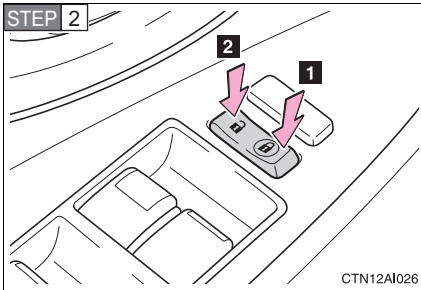

Shift the shift lever to P or N, and press and hold the driver's door lock switch (**1** or **2**) for approximately 5 seconds and then release.

The shift lever and switch positions corresponding to the desired function to be set or canceled are shown as follows.

Function	Shift lever position	Switch position
Shift position linked door locking function*	P	<b>1</b>
Shift position linked door unlocking function*		<b>2</b>
Speed linked door locking function	N	<b>1</b>
Driver's door linked door unlocking function		<b>2</b>

\*: Vehicles with an automatic transmission only

When the setting or canceling operation is complete, all doors are locked and then unlocked.

**■ Customization that can be configured at Toyota dealer**

Settings (e.g. unlocking function using a key) can be changed. (Customizable features →P. 454)

**⚠ CAUTION****■ To prevent an accident**

Observe the following precautions while driving the vehicle.

Failing to do so may result in a door opening and an occupant falling out, resulting in death or serious injury.

- Always use a seat belt.
- Always lock the doors.
- Ensure that all doors are properly closed.
- Do not pull the inside handle of either of the front doors while driving.
- Set the rear door child protector locks when children are seated in the rear seat.

## 1-2. Opening, closing and locking the doors and trunk

### Trunk

The trunk can be opened using the key, trunk opener, entry function or wireless remote control.

#### ■ Entry function (vehicles with smart key system)

→P. 26

#### ■ Wireless remote control (if equipped)

→P. 37

#### ■ Key

##### ▶ Vehicles with smart key system

The trunk can be opened using the mechanical key. (→P. 415)

##### ▶ Vehicles without smart key system

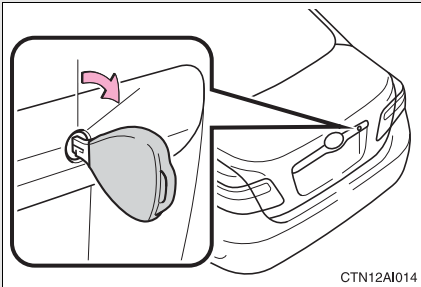

Turn the master key clockwise to release the trunk lid.

#### ■ Trunk opener

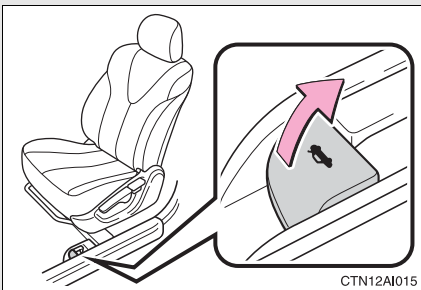

Release the trunk lid.

## Luggage security system

To protect luggage stored in the trunk against theft, do the following procedure.

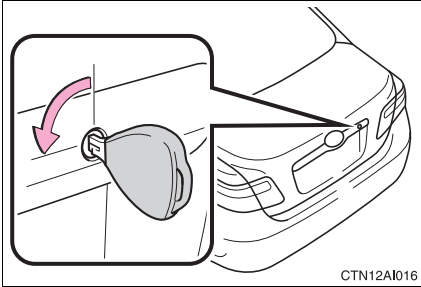

Turn the master key (vehicles without smart key system) or mechanical key (vehicles with smart key system) counterclockwise to lock the trunk opener feature.

The trunk lid cannot be opened even with the wireless remote control or the entry function.

1

Before driving

## Internal trunk release lever

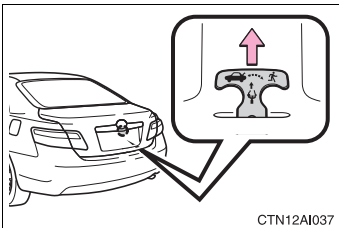

The trunk lid can be opened by pulling down on the glow-in-the-dark lever located on the inside of trunk lid.

The lever will continue to glow for some time after the trunk lid is closed.

## Trunk light

The trunk light turns on when the trunk is opened.

 CAUTION

■ **Caution while driving**

Keep the trunk lid closed.

This not only keeps personal belongings from being thrown out, but also prevents exhaust gases from entering the vehicle.

■ **When children are in the vehicle**

Never leave children unattended in the vehicle as they may lock themselves in the vehicle or trunk, which could cause the child to overheat or suffocate, resulting in death or serious injury.



# 1-3. Adjustable components (seats, mirrors, steering wheel)

## Front seats

### ► Power seat

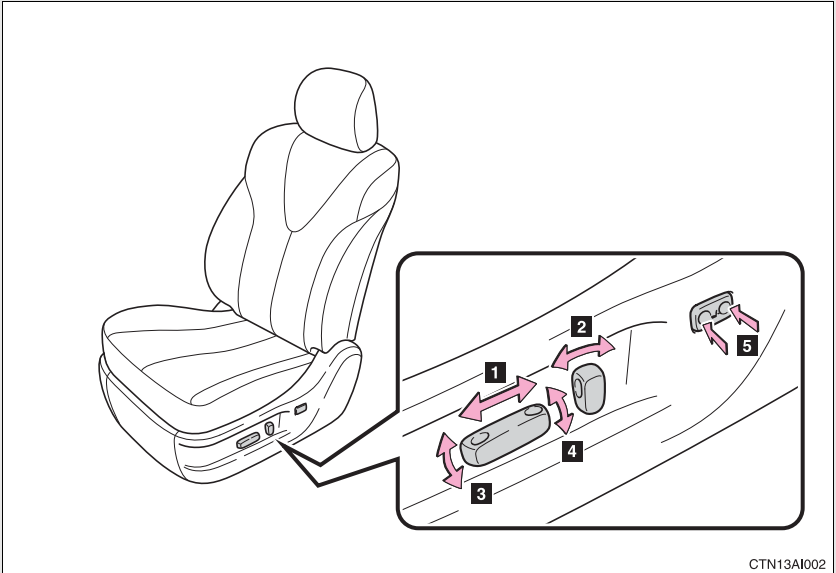

- 1** Seat position switch
- 2** Seatback angle switch
- 3** Seat cushion (front) angle switch (driver's side only)
- 4** Vertical height adjustment switch (driver's side only)
- 5** Lumbar support switch (driver's side only)

► Manual seat

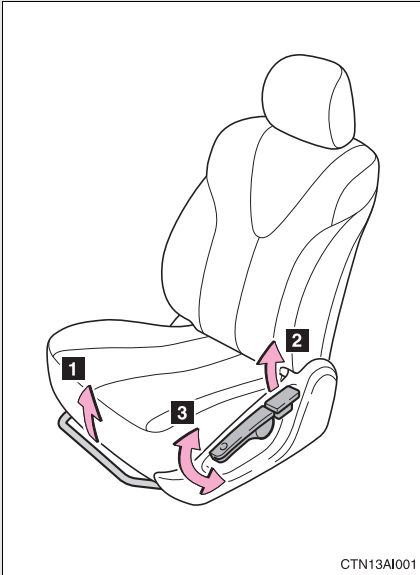

- 1** Seat position adjustment lever
- 2** Seatback angle adjustment lever
- 3** Vertical height adjustment lever (driver's side only)

**! CAUTION**

**■ Seat adjustment**

- Do not recline the seat more than necessary when the vehicle is in motion to reduce the risk of sliding under the lap belt.  
If the seat is too reclined, the lap belt may slide past the hips and apply restraint forces directly to the abdomen or your neck may contact the shoulder belt, increasing the risk of death or serious injury in the event of an accident.
- Manual seat only: After adjusting the seat, make sure that the seat is locked in position.

## Rear seats

### ■ Adjusting the rear seat (if equipped)

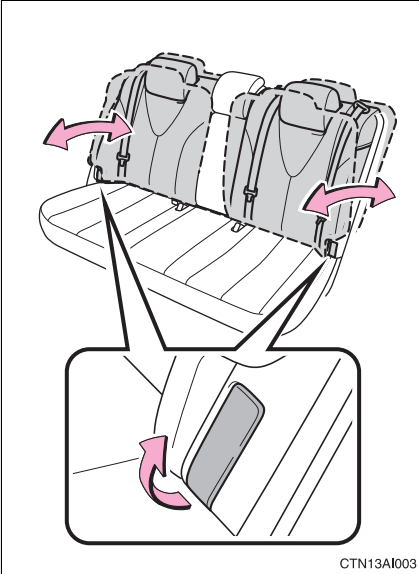

Pull up the seatback angle adjustment lever until the lock is completely released.

### ■ Folding down rear seatbacks (if equipped)

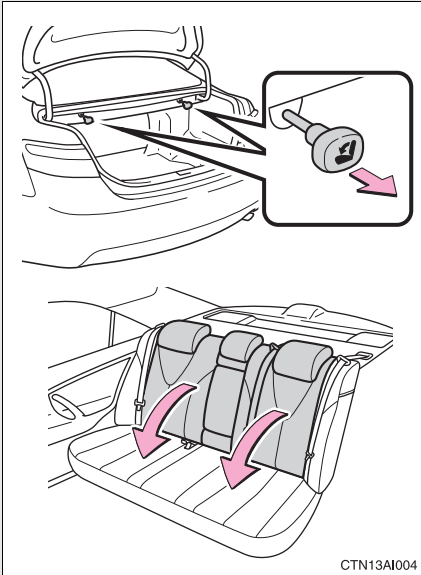

Pull the seatback lever in the trunk for the seatback you wish to fold down.

### ⚠ CAUTION

#### ■ After returning the seatback to the upright position

Observe the following precautions. Failure to do so may result in death or serious injury.

- Make sure the seatback is securely locked by pressing forward and rearward on the top of the seatback.
- Check that the seat belts are not twisted or caught in the seatback.

### ⚠ NOTICE

#### ■ When right seatback is folded down

Make sure the luggage loaded in the enlarged trunk will not damage the webbing of the rear center seat belt.

# 1-3. Adjustable components (seats, mirrors, steering wheel)

## Head restraints

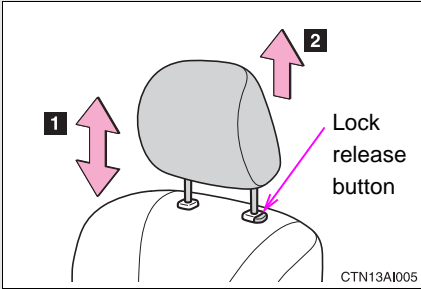

### 1 Vertical adjustment

Push and hold the lock release button when lowering the head restraint.

### 2 Removal

Pull the head restraint up while pressing the lock release button.

1

Before driving

### ■ Adjusting the height of the head restraints

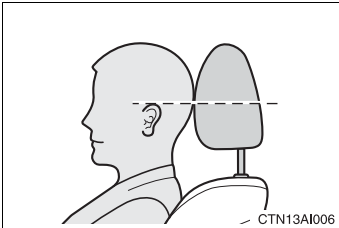

Make sure that the head restraints are adjusted so that the center of the head restraint is closest to the top of your ears.

### ■ Adjusting the rear center seat head restraint

Always raise the head restraint one level from the stowed position when using.

 CAUTION

■ **Head restraint precautions**

Observe the following precautions regarding the head restraints. Failure to do so may result in death or serious injury.

- Use the head restraints designed for each respective seat.
- Adjust the head restraints to the correct position at all times.
- After adjusting the head restraints, push down on them and make sure they are locked in position.
- Do not drive with the head restraints removed.

**Make sure that all occupants are wearing their seat belts before driving the vehicle.**

■ **Correct use of the seat belts**

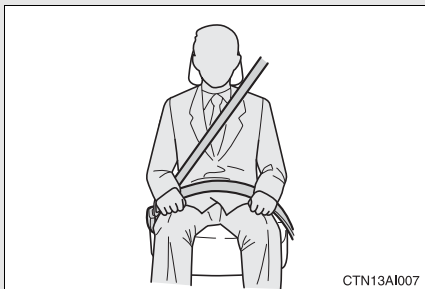

- Extend the shoulder belt so that it comes fully over the shoulder, but does not come into contact with the neck or slide off the shoulder.
- Position the lap belt as low as possible over the hips.
- Adjust the position of the seatback. Sit up straight and well back in the seat.
- Do not twist the seat belt.

■ **Fastening and releasing the seat belt**

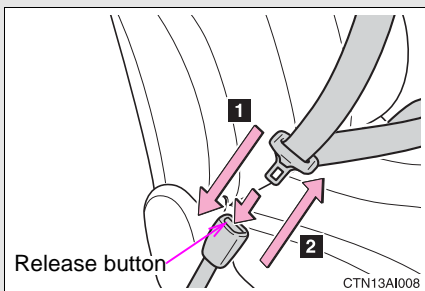

- 1** Fastening the belt  
Push the tab into the buckle until a clicking sound is heard.
- 2** Releasing the belt  
Press the release button.

### ■ Adjusting the height of the belt (front seats)

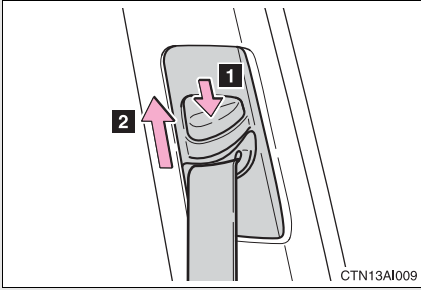

**1** Down

**2** Up

Move the height adjuster up and down as needed until you hear a click.

### Seat belt comfort guide (outside rear seat)

If the shoulder belt sits close to a person's neck, use the seat belt comfort guide.

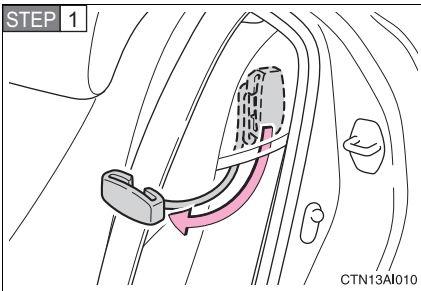

Pull out the comfort guide from the pocket.

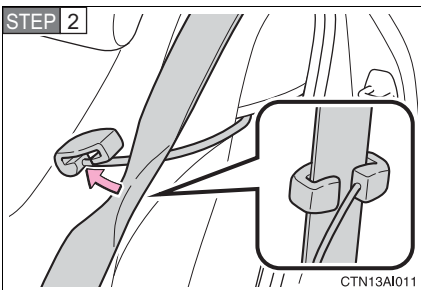

Slide the belt past the slot of the guide.

The elastic cord must be behind the seat belt.



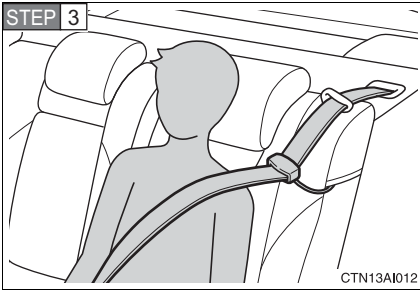

Buckle, position and release the seat belt.

### Seat belt pretensioners (front seats)

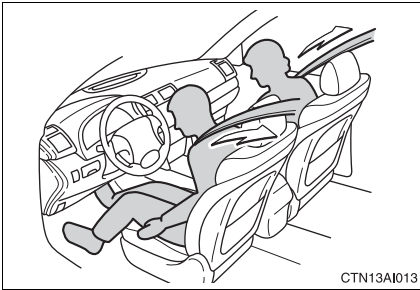

The pretensioner helps the seat belt to quickly restrain the occupant by retracting the seat belt when the vehicle is subjected to certain types of severe frontal collision.

The pretensioner may not activate in the event of a minor frontal impact, a side impact or a rear impact.

■ **Emergency locking retractor (ELR)**

The retractor will lock the belt during a sudden stop or on impact. It may also lock if you lean forward too quickly. A slow, easy motion will allow the belt to extend so that you can move around fully.

■ **Automatic locking retractor (ALR)**

When a passenger's shoulder belt is completely extended and then retracted even slightly, the belt is locked in that position and cannot be extended. This feature is used to hold the child restraint system (CRS) firmly. To free the belt again, fully retract the belt and then pull the belt out once more. (→P. 105)

■ **Pregnant women**

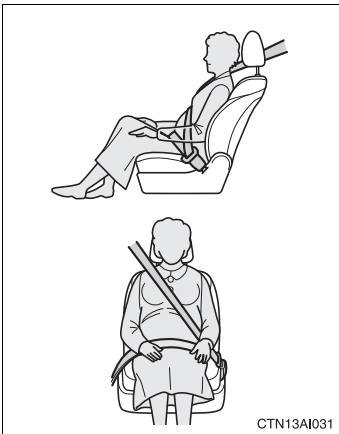

Obtain medical advice and wear the seat belt in the proper way. (→P. 55)

Women who are pregnant should position the lap belt as low as possible over the hips in the same manner as other occupants. Extend the shoulder belt completely over the shoulder and position the belt across the chest. Avoid belt contact over the rounding of the abdominal area.

If the seat belt is not worn properly, not only a pregnant woman, but also the fetus could suffer death or serious injury as a result of sudden braking or a collision.

■ **People suffering illness**

Obtain medical advice and wear the seat belt in the proper way.

■ **Child seat belt usage**

The seat belts of your vehicle were principally designed for persons of adult size.

- Use a child restraint system appropriate for the child, until the child becomes large enough to properly wear the vehicle's seat belt. (→P. 101)
- When the child becomes large enough to properly wear the vehicle's seat belt, follow the instructions on P. 55 regarding seat belt usage.

■ **Replacing the belt after the pretensioner has been activated**

The seat belts cannot be used after a pretensioner has been activated. After an accident, have the pretensioners inspected by your Toyota dealer. Make sure the pretensioners are replaced if they have been activated.

■ **Seat belt extender**

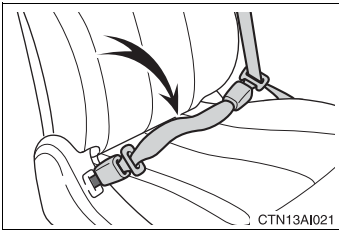

If your seat belts cannot be fastened securely because they are not long enough, a personalized seat belt extender is available from your Toyota dealer free of charge.

■ **Rear seat belt**

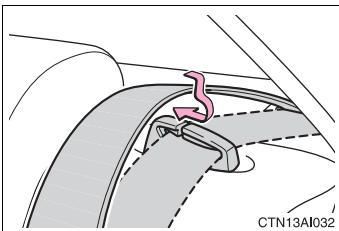

Use the seat belt after passing it through the guide if the seat belt comes free from the guide.

 **CAUTION**

■ **Wearing a seat belt**

Observe the following precautions to reduce the risk of injury in the event of sudden braking or an accident.

Failing to do so may cause death or severe injury.

- Ensure that all passengers wear a seat belt.
- Always wear a seat belt properly.
- Each seat belt should be used by one person only. Do not use a seat belt for more than one person at once, including children.
- Toyota recommends that children be seated in the rear seat and always use a seat belt and/or an appropriate child restraint system.
- Do not recline the seat any more than necessary to achieve a proper seating position. The seat belt is most effective when the occupants are sitting up straight and well back in the seats.
- Do not wear the shoulder belt under your arm.
- Always wear your seat belt low and snug across your hips.

■ **Seat belt pretensioners**

Do not place anything, such as a cushion, on the front passenger's seat. Doing so will disperse the passenger's weight, which prevents the sensor from detecting the passenger's weight properly. As a result, the seat belt pretensioner for the front passenger's seat may not activate in the event of a collision.

 **CAUTION****■ Seat belt damage and wear**

- Do not damage the seat belts by allowing the belt, plate, or buckle to be jammed in the door.
- Inspect the seat belt system periodically. Check for cuts, fraying, and loose parts. Do not use a damaged seat belt until it is replaced. Damaged seat belts cannot protect an occupant from death or serious injury.
- Ensure that the belt and tab are locked and the belt is not twisted. If the seat belt does not function correctly, immediately contact your Toyota dealer.
- Replace the seat assembly, including the belts, if your vehicle has been involved in a serious accident, even if there is no obvious damage.
- Do not attempt to install, remove, modify, disassemble or dispose of the seat belts. Have any necessary repairs carried out by your Toyota dealer. Inappropriate handling of the pretensioner may prevent it from operating properly resulting in death or serious injury.
- Always make sure the shoulder belt passes through the guide when using the seat belt. Failure to properly position the belt may reduce the amount of protection in an accident and could lead to serious injuries in a collision or sudden stop.
- Always make sure that the seat belt is not twisted, does not get caught in the guide or the seatback and is arranged in the proper position.

**■ Using a seat belt comfort guide**

- Make sure the belt is not twisted and that it lies flat. The elastic cord must be behind the belt and the guide must be on the front.
- To reduce the chance of injury in case of an accident or a sudden stop while driving, remove and store the comfort guide in its pocket when it is not in use.
- Always make sure the shoulder belt is positioned across the center of the shoulder. The belt should be kept away from the neck, and should not fall off the shoulder.  
Failure to observe these precautions could reduce the effectiveness of the seat belt in an accident, causing death or serious injury.

 CAUTION

■ **Using a seat belt extender**

- Do not wear the seat belt extender if you can fasten the seat belt without the extender.
- Do not use the seat belt extender when installing a child restraint system because the belt will not securely hold the child restraint system, increasing the risk of death or injury in the event of a collision.
- The personalized extender may not be safe on another vehicle, when used by another person, or at a different seating position other than the one originally intended.

 NOTICE

■ **When using a seat belt extender**

When releasing the seat belt, press on the buckle release button on the extender, not on the seat belt.

This helps prevent damage to the vehicle interior and the extender itself.

## 1-3. Adjustable components (seats, mirrors, steering wheel)

### Steering wheel

The steering wheel can be adjusted to a comfortable position.

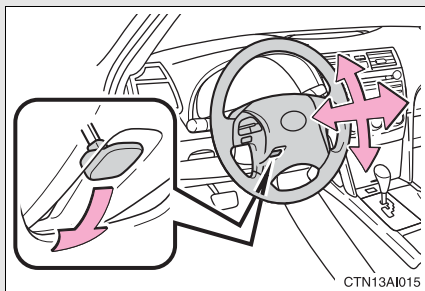

**STEP 1** Hold the steering wheel and press the lever down.

**STEP 2** Adjust to the ideal position by moving the steering wheel horizontally and vertically.

**STEP 3** Pull the lever up.

#### CAUTION

##### ■ Caution while driving

Do not adjust the steering wheel while driving.

Doing so may cause the driver to mishandle the vehicle and cause an accident, resulting in death or serious injury.

##### ■ After adjusting the steering wheel

Make sure that the steering wheel is securely locked.

Otherwise, the steering wheel may move suddenly, possibly causing an accident and resulting in death or serious injury.

## 1-3. Adjustable components (seats, mirrors, steering wheel)

### Anti-glare inside rear view mirror

Glare from the headlights of vehicles behind can be reduced by using the following functions.

#### ► Manual anti-glare inside rear view mirror

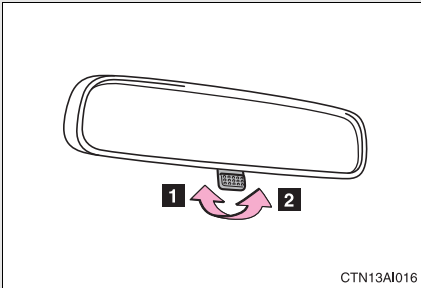

**1** Normal position

**2** Anti-glare position

#### ► Auto anti-glare inside rear view mirror

In automatic mode, sensors are used to detect the headlights of vehicles behind and the reflected light is automatically reduced.

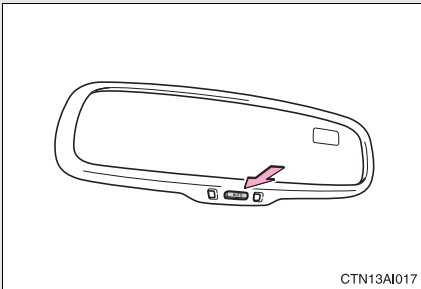

Turns automatic mode on/off

The indicator comes on when automatic mode is turned on.

Vehicles with smart key system:

The mirror will revert to the automatic mode each time the "ENGINE START STOP" switch is turned to IGNITION ON mode.

Vehicles without smart key system:

The mirror will revert to the automatic mode each time the engine switch is turned to "ON" position.



■ **To prevent sensor error**

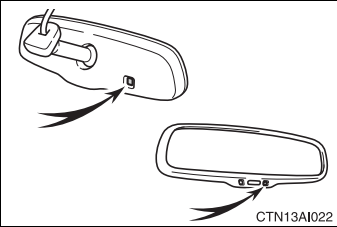

To ensure that the sensors operate properly, do not touch or cover them.

1

Before driving

**! CAUTION**

■ **Caution while driving**

Do not adjust the position of the mirror while driving.

Doing so may lead to mishandling of the vehicle and an accident, resulting in death or serious injury.

# 1-3. Adjustable components (seats, mirrors, steering wheel)

## Outside rear view mirrors

**Mirror angle can be adjusted using the switch.**

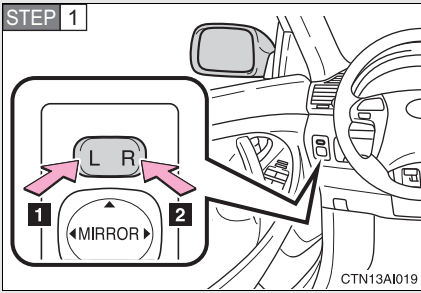

Select a mirror to adjust.

- 1 Left
- 2 Right

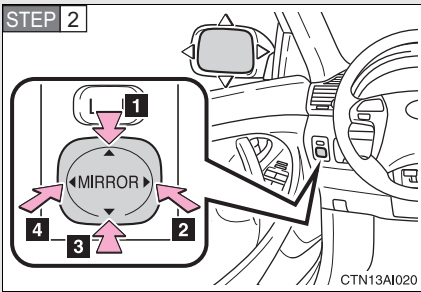

Adjust the mirror.

- 1 Up
- 2 Right
- 3 Down
- 4 Left

### ■ Mirror angle can be adjusted when

- ▶ Vehicles with smart key system  
The "ENGINE START STOP" switch is in ACCESSORY or IGNITION ON mode.
- ▶ Vehicles without smart key system  
The engine switch is in "ACC" or "ON" position.

### ■ When the mirrors are fogged up (vehicles with mirror defoggers)

Turn on the mirror defoggers to defog the mirrors. (→P. 199)

 CAUTION

■ **When driving the vehicle**

Observe the following precautions while driving.

Failing to do so may result in loss of control of the vehicle and cause an accident, resulting in death or serious injury.

- Do not adjust the mirrors while driving.
- Both the driver and passenger side mirrors must be properly adjusted before driving.

■ **When the mirror defoggers are operating (if equipped)**

Do not touch the surface of the mirror, as it may be hot.

## 1-4. Opening and closing the windows

### Power windows

The power windows can be opened and closed using the following switches.

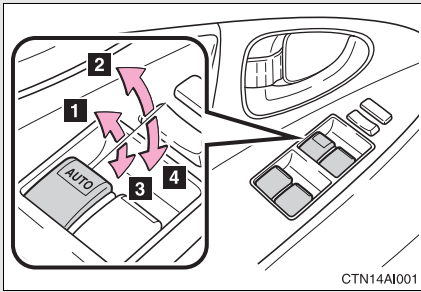

- 1** Close
- 2** One-touch close (driver's window on some models only)\*
- 3** Opening
- 4** One-touch open (driver's window only)\*

\*: Pressing the switch in the opposite direction will stop window travel partway.

### Lock switch

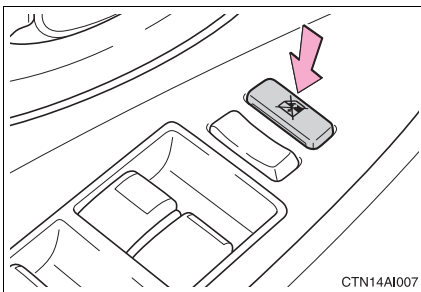

Press the switch down to lock passenger window switches.

Use this switch to prevent children from accidentally opening or closing a passenger window.

### ■ The power windows can be operated when

- ▶ Vehicles with smart key system  
The “ENGINE START STOP” switch is in IGNITION ON mode.
- ▶ Vehicles without smart key system  
The engine switch is in “ON” position.

### ■ Operating the power windows after turning the engine OFF

- ▶ Vehicles with smart key system  
The power windows can be operated for approximately 45 seconds after the “ENGINE START STOP” switch is turned to ACCESSORY mode or turned OFF. They cannot, however, be operated once either front door is opened.
- ▶ Vehicles without smart key system  
The power windows can be operated for approximately 45 seconds after the engine switch is turned to “ACC” or “LOCK” position. They cannot, however, be operated once either front door is opened.

### ■ Jam protection function (vehicles with one-touch closing operation)

If an object becomes caught between the window and the window frame, window travel is stopped and the window is opened slightly.

## CAUTION

### ■ Closing the windows

Observe the following precautions.  
Failing to do so may result in death or serious injury.

- Check to make sure that all passengers do not have any part of their body in a position where it could be caught when a window is being operated.
- Do not allow children to operate the power windows.  
Closing a power window on someone can cause serious injury, and in some instances, even death.

### ■ Jam protection function (vehicles with one-touch closing operation)

- Never try jamming any part of your body to activate the jam protection function intentionally.
- The jam protection function may not work if something gets caught just before the window fully closes.

## 1-4. Opening and closing the windows Moon roof (if equipped)

Use the overhead switches to open, close, and tilt the moon roof up and down.

### ■ Opening and closing

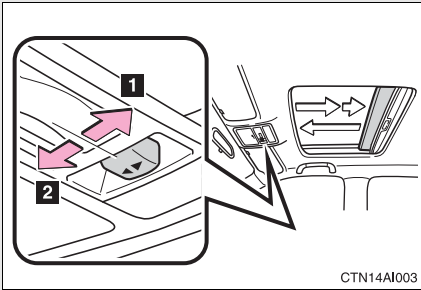

#### 1 Open

The moon roof stops slightly before the fully open position. Push the switch again to fully open.

#### 2 Close

Push the switch in either direction to stop the moon roof part-way.

### ■ Tilt up and down

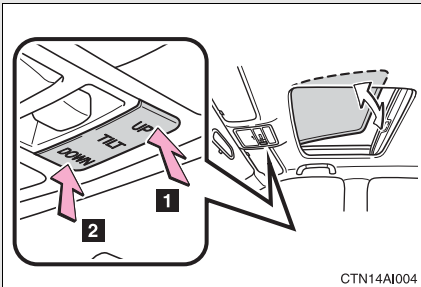

#### 1 Tilt up

#### 2 Tilt down

Push the switch in either direction to stop the moon roof part-way.

---

**■ The moon roof can be operated when****▶ Vehicles with smart key system**

The “ENGINE START STOP” switch is in IGNITION ON mode.

**▶ Vehicles without smart key system**

The engine switch is in “ON” position.

**■ Operating the moon roof after turning the engine OFF****▶ Vehicles with smart key system**

The moon roof can be operated for approximately 45 seconds after the “ENGINE START STOP” switch is turned to ACCESSORY mode or turned OFF. They cannot, however, be operated once either front door is opened.

**▶ Vehicles without smart key system**

The moon roof can be operated for approximately 45 seconds after the engine switch is turned to “ACC” or “LOCK” position. It cannot, however, be operated once either front door is opened.

**■ Jam protection function**

If an object is detected between the moon roof and the frame while closing or tilting down, travel is stopped and the moon roof opens slightly.

**■ To reduce wind noise**

Drive with the moon roof opened to slightly before the fully open position as driving with the moon roof opened fully will cause wind noise.

**■ Sunshade**

The sunshade can be opened and closed manually. However, the sunshade will open automatically when the moon roof is opened.

**■ Moon roof open reminder function****▶ Vehicles with smart key system**

An alarm will sound when the driver’s door is opened with the moon roof not fully closed and the “ENGINE START STOP” switch OFF.

**▶ Vehicles without smart key system**

An alarm will sound when the driver’s door is opened with the moon roof not fully closed and the engine switch OFF.

 **CAUTION**

■ **Opening the moon roof**

Observe the following precautions.

Failing to do so may cause death or serious injury.

- Do not allow any passengers to put their hands or heads outside the vehicle while it is moving.
- Do not sit on top of the moon roof.

■ **Closing the moon roof**

Observe the following precautions.

Failing to do so may result in death or serious injury.

- Check to make sure that all passengers do not have any part of their bodies in a position where they could be caught when the moon roof is being operated.
- Do not allow children to operate the moon roof.  
Closing the moon roof on someone can cause death or serious injury.

■ **Jam protection function**

- Never try jamming any part of your body to activate the jam protection function intentionally.
- The jam protection function may not work if something gets caught just before the moon roof fully closes.



# Opening the fuel tank cap

**Perform the following steps to open the fuel tank cap.**

■ **Before refueling the vehicle**

▶ Vehicles with smart key system

Turn the “ENGINE START STOP” switch OFF and ensure that all the doors and windows are closed.

▶ Vehicles without smart key system

Turn the engine switch OFF and ensure that all the doors and windows are closed.

■ **Opening the fuel tank cap**

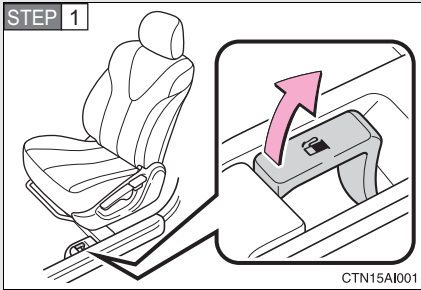

Open the fuel filler door.

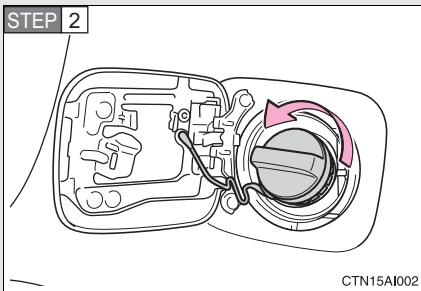

Turn the fuel tank cap slowly to open.

STEP 3

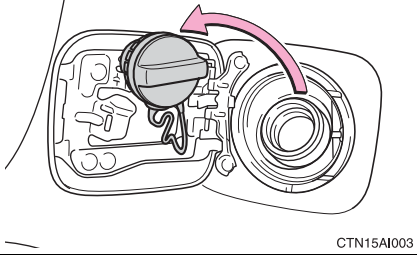

Hang the fuel tank cap on the back of the fuel filler door.

### Closing the fuel tank cap

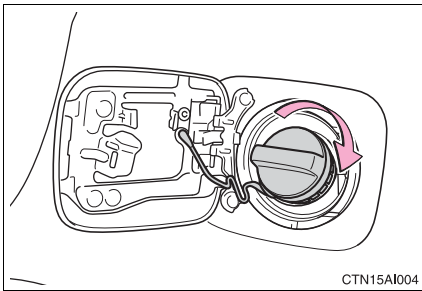

When replacing the fuel tank cap, turn it until a clicking sound is heard.

After releasing your hand, the cap will turn slightly to the opposite direction.

### ■ Fuel type

Unleaded gasoline (87 Octane rating [Research Octane Number 91] or higher)

### ■ Fuel tank capacity

18.5 gal. (70 L, 15.4 Imp. gal.)

 **CAUTION****■ Refueling the vehicle**

Observe the following precautions while refueling the vehicle.  
Failure to do so may result in death or serious injury.

- Touch the vehicle or some other metal surface to discharge any static electricity.  
Sparks resulting from discharging static electricity may cause the fuel vapors to ignite.
- Always hold the grips on the fuel tank cap and turn it slowly to remove it.  
A whooshing sound may be heard when the fuel tank cap is loosened.  
Wait until the sound cannot be heard before fully removing the cap.  
In hot weather, pressurized fuel may spray out of the filler neck and cause injury.
- Do not allow anyone that has not discharged static electricity from their bodies to come close to an open fuel tank.
- Do not inhale vaporized fuel.  
Fuel contains substances that are harmful if inhaled.
- Do not smoke while refueling the vehicle.  
Doing so may cause the fuel to ignite and cause a fire.
- Do not return to the vehicle or touch any person or object that is statically charged.  
This may cause static electricity to build up, resulting in a possible ignition hazard.

**■ When replacing the fuel cap**

Do not use anything but a genuine Toyota fuel tank cap designed for your vehicle. Doing so may cause a fire or other incident which may result in death or serious injury.



**NOTICE**

**■ Refueling**

Do not spill fuel during refueling.

Doing so may damage the vehicle, such as causing the exhaust systems to operate abnormally or damaging fuel system components or the vehicle's painted surface.

## 1-6. Theft deterrent system Engine immobilizer system

The vehicle's keys have built-in transponder chips that prevent the engine from starting if the key has not been previously registered in the vehicle's on-board computer.

Never leave the keys inside the vehicle when you leave the vehicle.

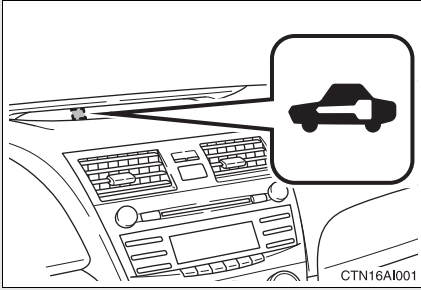

Vehicles with smart key system: The indicator light flashes after the "ENGINE START STOP" switch has been turned OFF to indicate that the system is operating.

Vehicles without smart key system: The indicator light flashes after the key has been removed from the engine switch to indicate that the system is operating.

1

Before driving

### ■ System maintenance

The vehicle has a maintenance-free type of engine immobilizer system.

### ■ Conditions that may cause the system to malfunction

- If the key is in contact with a metallic object
- If the key is in close proximity to or touching a key to the security system (key with a built-in transponder chip) of another vehicle

■ **Certifications for the engine immobilizer system (for vehicles sold in U.S.A.)**

- ▶ Vehicles with smart key system

FCC ID: NI4TMIMB-1

- ▶ Vehicles without smart key system

FCC ID: MOZRI-20BTY (Made in Japan)

FCC ID: MOZRI-21BTY (Made in Canada)

This device complies with Part 15 of the FCC Rules. Operation is subject to the following two conditions: (1) This device may not cause harmful interference, and (2) this device must accept any interference received, including interference that may cause undesired operation.

■ **Certifications for the engine immobilizer system (for vehicles sold in Canada)**

This device complies with RSS-210 of Industry Canada.

Operation is subject to the following two conditions: (1) This device may not cause interference, and (2) this device must accept any interference, including interference that may cause undesired operation of the device.

 **CAUTION**

Changes or modifications not expressly approved by the party responsible for compliance could void the user's authority to operate the equipment.

 **NOTICE**

■ **To prevent damage to the key**

Do not modify, remove or disable the engine immobilizer system. If any unauthorized changes or modifications are made, the proper operation of the system cannot be guaranteed.

## 1-6. Theft deterrent system Alarm (if equipped)

**The system sounds the alarm and flashes lights when forcible entry is detected.**

### ■ Triggering of the alarm

The alarm is triggered in the following situations.

- A locked door or trunk is unlocked or opened without the key, wireless remote control or entry function of the smart key system.
- The hood is opened while the vehicle is locked.
- The battery is reconnected.

### ■ Setting the alarm system

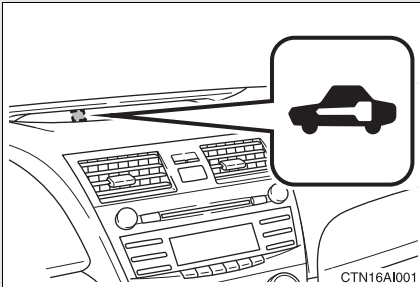

Close the doors, trunk and hood, and lock all doors. The system will be set automatically after 30 seconds.

The indicator light changes from being on to flashing when the system is set.

### ■ Deactivating or stopping the alarm

Do one of the following to deactivate or stop the alarm.

- Unlock the doors or trunk.
- Start the engine.

■ **Items to check before locking the vehicle**

To prevent unexpected triggering of the alarm and vehicle theft, make sure of the following.

- Nobody is in the vehicle.
- The windows and moon roof are closed before the alarm is set.
- No valuables or other personal items are left in the vehicle.

■ **Triggering of the alarm**

The alarm may be triggered in the following situations.  
(Stopping the alarm deactivates the system.)

- A person inside the vehicle opens a door, the trunk or hood.
- The battery is recharged or replaced when the vehicle is locked.

■ **When the battery is disconnected**

Be sure to deactivate the alarm system.

If the battery is discharged before deactivating the alarm system, the alarm may be triggered when the battery is reconnected.



# Theft prevention labels (for U.S.A.)

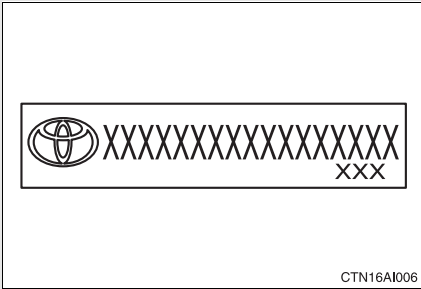

These labels are attached to the vehicle to reduce vehicle theft by facilitating the tracing and recovery of parts from stolen vehicles. Do not remove under penalty of law.

## Correct driving posture

Drive in a good posture as follows:

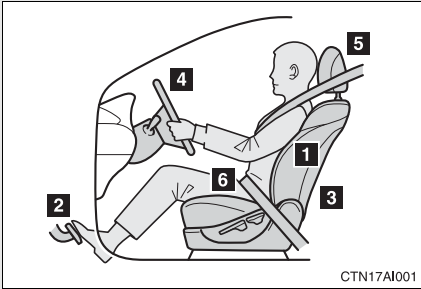

- 1** Sit upright and well back in the seat. (→P. 49)
- 2** Adjust the position of the seat forward or backward to ensure the pedals can be reached and easily depressed to the extent required. (→P. 49)
- 3** Adjust the seatback so that the controls are easily operable.
- 4** Adjust the tilt and telescopic positions of the steering wheel downward so the air-bag is facing your chest. (→P. 63)
- 5** Lock the head restraint in place with the center of the head restraint closest to the top of your ears. (→P. 53)
- 6** Wear the seat belt correctly. (→P. 55)

 **CAUTION****■ While driving**

- Do not adjust the position of the driver's seat while driving. Doing so could cause the driver to lose control of the vehicle.
- Do not place a cushion between the driver or passenger and the seatback. A cushion may prevent correct posture from being achieved, and reduce the effectiveness of the seat belt and head restraint, increasing the risk of death or serious injury to the driver or passenger.
- Do not place anything under the front seats. Objects placed under the front seats may become jammed in the seat tracks and stop the seat from locking in place. This may lead to an accident. The adjustment mechanism may also be damaged.

**■ Adjusting the seat position**

- Take care when adjusting the seat position to ensure that other passengers are not injured by the moving seat.
- Do not put your hands under the seat or near the moving parts to avoid injury. Fingers or hands may become jammed in the seat mechanism.

## SRS airbags

The SRS airbags inflate when the vehicle is subjected to certain types of severe impacts that may cause significant injury to the occupants. They work together with the seat belts to help reduce the risk of death or serious injury.

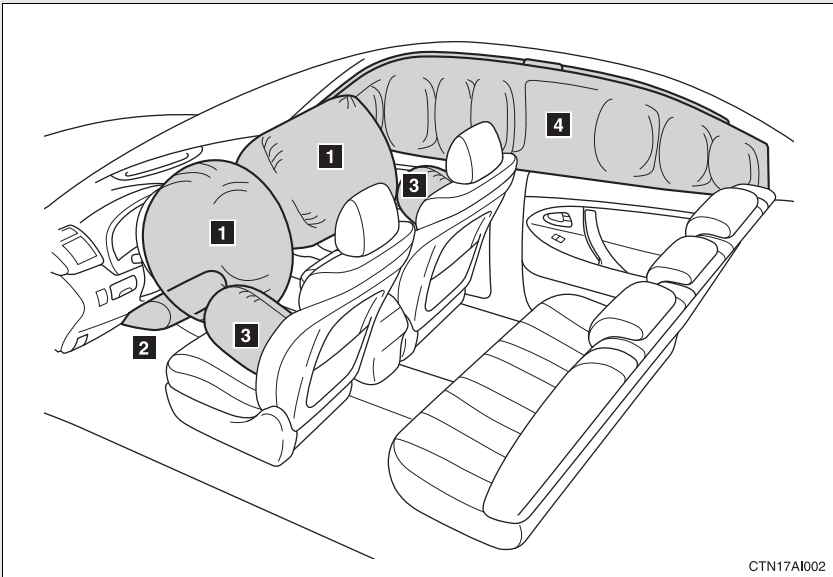

CTN17A1002

### ► Front airbags

#### **1** Driver airbag/front passenger airbag

Can help protect the head and chest of the driver and front passenger from impact with interior components.

#### **2** Driver knee airbag

Can help protect the knees of the driver.

### ► Side and curtain shield airbags

#### **3** Side airbags

Can help protect the torso of the front seat occupants.

#### **4** Curtain shield airbags

Can help protect primarily the head of occupants in the outer seats.

## Airbag system components

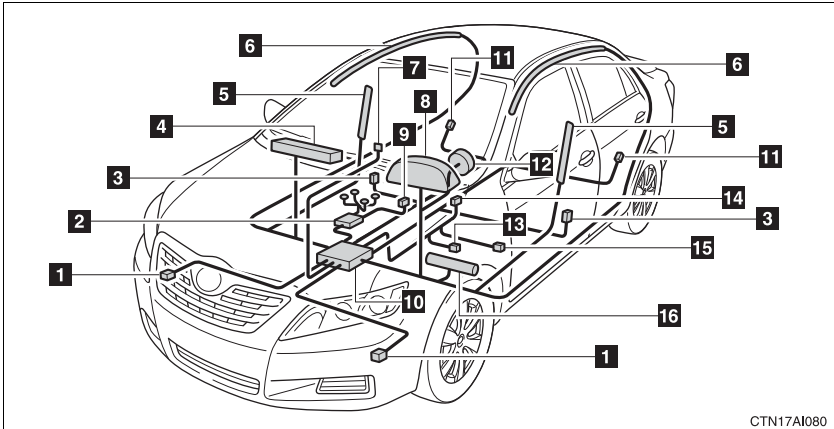

CTN17A1080

- |                                                          |                                                            |
|----------------------------------------------------------|------------------------------------------------------------|
| <b>1</b> Front airbag sensors                            | <b>10</b> Airbag sensor assembly                           |
| <b>2</b> Occupant detection system (ECU and sensors)     | <b>11</b> Curtain shield airbag sensors                    |
| <b>3</b> Side and curtain shield airbag sensors          | <b>12</b> Driver airbag                                    |
| <b>4</b> Front passenger airbag                          | <b>13</b> Driver's seat position sensor (with power seat)  |
| <b>5</b> Side airbags                                    | <b>14</b> Driver's seat belt buckle switch                 |
| <b>6</b> Curtain shield airbags                          | <b>15</b> Driver's seat position sensor (with manual seat) |
| <b>7</b> "AIR BAG ON" and "AIR BAG OFF" indicator lights | <b>16</b> Knee airbag                                      |
| <b>8</b> SRS warning light                               |                                                            |
| <b>9</b> Front passenger's seat belt buckle switch       |                                                            |

Your vehicle is equipped with ADVANCED AIRBAGS designed based on US motor vehicle safety standards (FMVSS208). The airbag system controls airbag deployment power for the driver and front passenger. The driver airbag system consists of the driver seat's position sensor etc. The front passenger's airbag system consists of the front passenger occupant classification sensor etc.

1

Before driving

The main SRS airbag system components are shown above. The SRS airbag system is controlled by the airbag sensor assembly. The airbag sensor assembly consists of a safing sensor and an airbag sensor.

In certain types of severe frontal or side impacts, the SRS airbag system triggers the airbag inflators. A chemical reaction in the inflators quickly fills the airbags with non-toxic gas to help restrain the motion of the occupants.

### ■ SRS warning light

This warning light system monitors the airbag sensor assembly, front airbag sensors, side and curtain shield airbag sensors, curtain shield airbag sensors, driver's seat position sensor, driver's seat belt buckle switch, front passenger occupant classification system, "AIR BAG ON" indicator light, "AIR BAG OFF" indicator light, front passenger's seat belt buckle switch, seat belt pretensioner assemblies, inflators, interconnecting wiring and power sources. (→P. 382)

### ■ If the SRS airbags deploy (inflate)

- Bruising and slight abrasions may result from contact with a deploying (inflating) SRS airbag.
- A loud noise and white powder will be emitted.
- Parts of the airbag module (steering wheel hub, airbag cover and inflator) as well as the front seats, and parts of the front and rear pillars and roof side rail, may be hot for several minutes. The airbag itself may also be hot.
- The front windshield may crack.

### ■ Operating conditions (front airbags)

- The SRS front airbags will deploy if the severity of the frontal impact is above the designed threshold level, comparable to an approximate 15 mph (25 km/h) collision when the vehicle impacts straight into a fixed barrier that does not move or deform.

However, this threshold velocity will be considerably higher if the vehicle strikes an object, such as a parked vehicle or sign pole, which can move or deform on impact, or if the vehicle is involved in an underride collision (e.g. a collision in which the front of the vehicle "underrides", or goes under, the bed of a truck, etc.).

- It is possible that in some collisions where the forward deceleration of the vehicle is very close to the designed threshold level, the SRS front airbags and the seat belt pretensioners may not activate together.
- The SRS front passenger airbag will not activate if there is no passenger sitting in the front passenger seat. However, the front passenger airbag may deploy if luggage is put in the seat, or the seat belt is fastened, even if the seat is unoccupied. (→P. 96)

■ **Operating conditions (side airbags and curtain shield airbags)**

- The SRS side airbags and curtain shield airbags are designed to inflate when the passenger compartment is subjected to a severe impact from the side.
- The SRS side airbag on the passenger seat will not activate if there is no passenger sitting in the front passenger seat. However, the side airbag on the passenger seat may deploy if luggage is put in the seat, even if the seat is unoccupied. (→P. 96)

■ **Conditions under which the SRS airbags may deploy (inflate), other than a collision**

The SRS front airbags may also deploy if a serious impact occurs to the underside of your vehicle. Some examples are shown in the illustration.

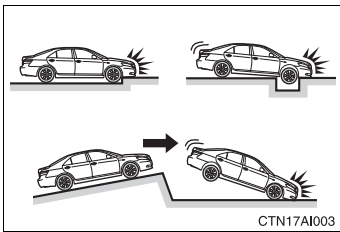

- Hitting a curb, edge of pavement or hard surface
- Falling into or jumping over a deep hole
- Landing hard or vehicle falling

■ **Types of collisions that may not deploy the SRS airbag (front airbags)**

The SRS front airbags are generally not designed to inflate if the vehicle is involved in a side or rear collision, if it rolls over, or if it is involved in a low-speed frontal collision. But, whenever a collision of any type causes sufficient forward deceleration of the vehicle, deployment of the SRS front airbags may occur.

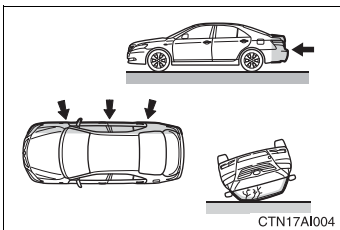

- Collision from the side
- Collision from the rear
- Vehicle rollover



### ■ Types of collisions that may not deploy the SRS airbag (side airbags and curtain shield airbags)

The SRS side airbags and curtain shield airbag system may not activate if the vehicle is subjected to a collision from the side at certain angles, or a collision to the side of the vehicle body other than the passenger compartment.

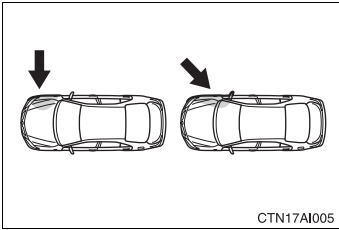

CTN17AI005

- Collision from the side to the vehicle body other than the passenger compartment
- Collision from the side at an angle

The SRS side airbags and curtain shield airbags are not generally designed to inflate if the vehicle is involved in a frontal or rear collision, if it rolls over, or if it is involved in a low-speed side collision.

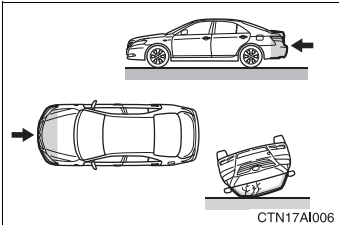

CTN17AI006

- Collision from the front
- Collision from the rear
- Vehicle rollover

### ■ When to contact your Toyota dealer

In the following cases, contact your Toyota dealer as soon as possible. Do not disconnect the battery cables before contacting your Toyota dealer.

- Any of the SRS airbags have been inflated.

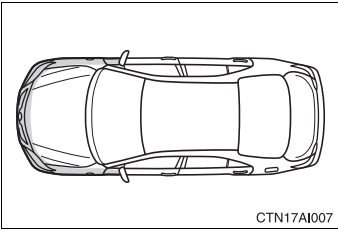

- The front of the vehicle is damaged or deformed, or was involved in an accident that was not severe enough to cause the SRS airbags to inflate.

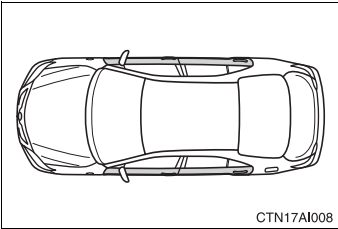

- A portion of a door is damaged or deformed, or the vehicle was involved in an accident that was not severe enough to cause the SRS side airbags and curtain shield airbags to inflate.

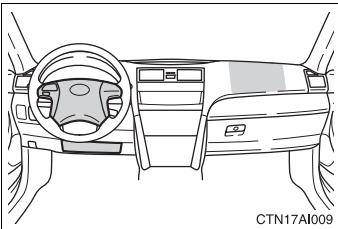

- The pad section of the steering wheel or dashboard near the front passenger airbag cover or lower portion of the instrument panel is scratched, cracked, or otherwise damaged.

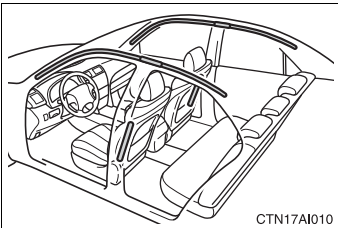

- The surface of the seats with the side airbag is scratched, cracked, or otherwise damaged.
- The portion of the front pillars, rear pillars or roof side rail garnishes (padding) containing the curtain shield airbags inside is scratched, cracked or otherwise damaged.

 CAUTION**■ SRS airbag precautions**

Observe the following precautions regarding the airbags.  
Failure to do so may cause death or serious injury.

- The driver and all passengers in the vehicle must wear their seat belts properly.

The SRS airbags are supplemental devices to be used with the seat belts.

- The SRS driver airbag deploys with considerable force, and can cause death or serious injury especially if the driver is very close to the airbag. The National Highway Traffic Safety Administration (“NHTSA”) advises:

Since the risk zone for the driver’s airbag is the first 2 - 3 in. (50 - 75 mm) of inflation, placing yourself 10 in. (250 mm) from your driver airbag provides you with a clear margin of safety. This distance is measured from the center of the steering wheel to your breastbone. If you sit less than 10 in. (250 mm) away now, you can change your driving position in several ways:

- Move your seat to the rear as far as you can while still reaching the pedals comfortably.
- Slightly recline the back of the seat.  
Although vehicle designs vary, many drivers can achieve the 10 in. (250 mm) distance, even with the driver seat all the way forward, simply by reclining the back of the seat somewhat. If reclining the back of your seat makes it hard to see the road, raise yourself by using a firm, non-slippery cushion, or raise the seat if your vehicle has that feature.
- If your steering wheel is adjustable, tilt it downward. This points the airbag toward your chest instead of your head and neck.

The seat should be adjusted as recommended by NHTSA above, while still maintaining control of the foot pedals, steering wheel, and your view of the instrument panel controls.

**! CAUTION**

**■ SRS airbag precautions**

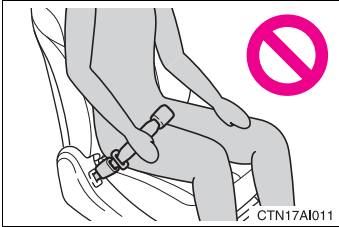

● If the seat belt extender has been connected to the driver's seat belt buckle but the seat belt extender has not also been fastened to the latch plate of the driver's seat belt, the SRS driver's airbag system will judge that the driver is wearing the seat belt even though the seat belt has not been connected. In this case, the driver's airbag may not activate correctly in a collision, resulting in death or serious injury in the event of collision. Be sure to wear the seat belt with the seat belt extender.

● The SRS front passenger airbag also deploys with considerable force, and can cause death or serious injury especially if the front passenger is very close to the airbag. The front passenger seat should be as far from the airbag as possible with the seatback adjusted, so the front passenger sits upright.

● Improperly seated and/or restrained infants and children can be killed or seriously injured by a deploying airbag. An infant or child who is too small to use a seat belt should be properly secured using a child restraint system. Toyota strongly recommends that all infants and children be placed in the rear seats of the vehicle and properly restrained. The rear seats are the safest for infants and children. (→P. 101)

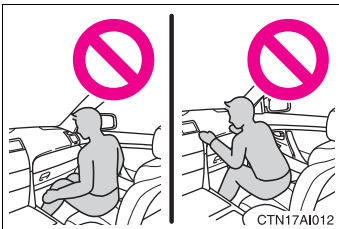

● Do not sit on the edge of the seat or lean against the dashboard.

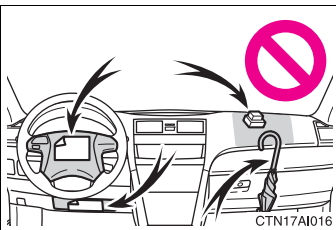
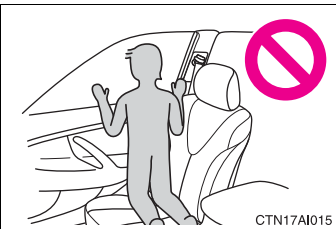
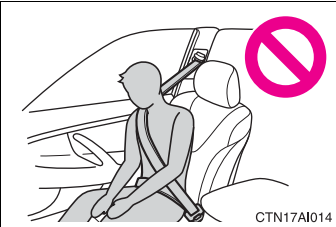
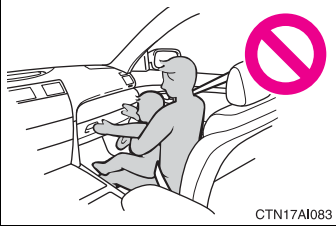
**CAUTION****SRS airbag precautions**

- Do not allow a child to sit on the knees of a front passenger while the vehicle is moving.
- Do not drive the vehicle while the driver or passenger has items resting on their knees.
- Do not lean against the door, the roof side rail or the front, side and rear pillars.
- Do not allow anyone to kneel on the passenger seat toward the door or put their head or hands outside the vehicle.
- Do not attach anything to or lean anything against areas such as the dashboard, steering wheel pad or lower portion of the instrument panel. These items can become projectiles when SRS driver, front passenger and knee airbags deploy.

**! CAUTION**

**■ SRS airbag precautions**

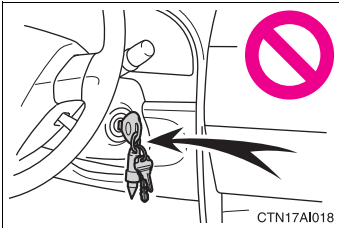
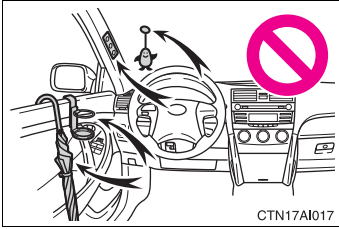

- Do not attach anything to areas such as the door, windshield glass, side door glass, front and rear pillars, roof side rail or assist grip.
  - Do not hang coat hangers or other hard objects on the coat hooks. All of these items could become projectiles and seriously injure or kill you, should the SRS curtain shield airbag deploy.
  - Vehicles without smart key system: Do not attach any heavy, sharp or hard objects such as keys or accessories to the key. The objects may restrict the SRS knee airbag inflation or be thrust into the driver's seat area by the force of the deploying airbag, thus causing a danger.
- If a vinyl cover is put on the area where the SRS knee airbag will deploy, be sure to remove it.
  - Do not use seat accessories which cover the parts where the SRS side airbags inflate as they may interfere with inflation of the airbags.
  - Do not strike or apply significant levels of force to the area of the SRS airbag components (→P. 85).  
Doing so can cause the SRS airbags to malfunction.
  - Do not touch any of the component parts immediately after the SRS airbags have deployed (inflated) as they may be hot.

 **CAUTION****■ SRS airbag precautions**

- If breathing becomes difficult after the SRS airbag has deployed, open a door or window to allow fresh air in, or leave the vehicle if it is safe to do so. Wash off any residue as soon as possible to prevent skin irritation.
- If the areas where the SRS airbags are stored, such as the steering wheel pad and front and rear pillars garnishes, are damaged or cracked, have them replaced by your Toyota dealer.

**■ Modification and disposal of SRS airbag system components**

Do not dispose of your vehicle or perform any of the following modifications without consulting your Toyota dealer.

The SRS airbags may malfunction or deploy (inflate) accidentally, causing death or serious injury.

- Installation, removal, disassembly and repair of the SRS airbags.
- Repairs, modifications, removal or replacement of the steering wheel, instrument panel, dashboard, seats or seat upholstery, front, side and rear pillars or roof side rail.
- Repairs or modifications of the front fender, front bumper, or side of the occupant compartment.
- Installation of snow plows, winches, etc. to the front grille (bull bars, kangaroo bar etc.).
- Modifications to the vehicle's suspension system.
- Installation of electronic devices such as mobile two-way radios or CD players.
- Modifications to your vehicle for a person with a physical disability.

## Front passenger occupant classification system

Your vehicle is equipped with a front passenger occupant classification system. This system detects the conditions of the front passenger seat and activates or deactivates the devices for the front passenger.

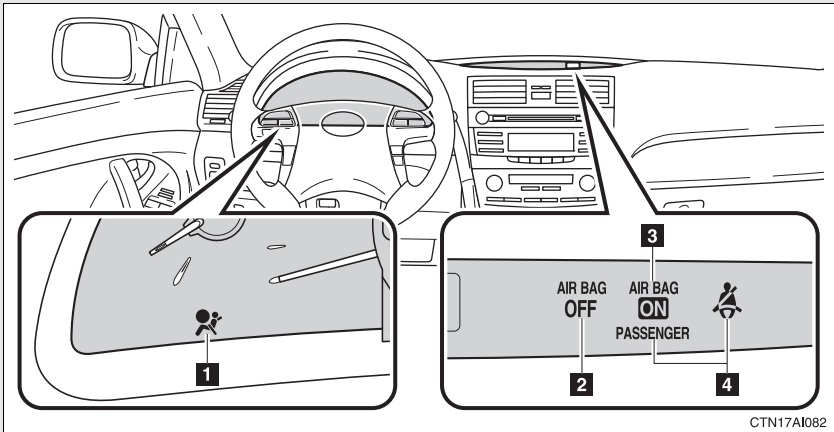

- 1** SRS warning light
- 2** “AIR BAG OFF” indicator light
- 3** “AIR BAG ON” indicator light
- 4** Front passenger's seat belt reminder light



### Conditions and operation of the front passenger occupant classification system

#### ■ Adult\*1

Indicator/ warning light	“AIR BAG ON” and “AIR BAG OFF” indicator lights	“AIR BAG ON”
	SRS warning light	Off
	Front passenger’s seat belt reminder light	Flashing*2
Devices	Front passenger airbag	Activated
	Side airbag on the front passenger seats	
	Curtain shield airbag in the front passenger side	
	Front passenger’s seat belt pretensioner	

1

Before driving

#### ■ Child\*3 or child restraint system\*4

Indicator/ warning light	“AIR BAG ON” and “AIR BAG OFF” indicator lights	“AIR BAG OFF”*5
	SRS warning light	Off
	Front passenger’s seat belt reminder light	Flashing*2
Devices	Front passenger airbag	Deactivated
	Side airbag on the front passenger seats	
	Curtain shield airbag in the front passenger side	Activated
	Front passenger’s seat belt pretensioner	

■ **Unoccupied**

Indicator/ warning light	“AIR BAG ON” and “AIR BAG OFF” indicator lights	Not illuminated
	SRS warning light	Off
	Front passenger’s seat belt reminder light	
Devices	Front passenger airbag	Deactivated
	Side airbag on the front passenger seats	
	Curtain shield airbag in the front passenger side	Activated
	Front passenger’s seat belt pretensioner	Deactivated

■ **There is a malfunction in the system**

Indicator/ warning light	“AIR BAG ON” and “AIR BAG OFF” indicator lights	“AIR BAG OFF”
	SRS warning light	On
	Front passenger’s seat belt reminder light	Off
Devices	Front passenger airbag	Deactivated
	Side airbag on the front passenger seats	
	Curtain shield airbag in the front passenger side	Activated
	Front passenger’s seat belt pretensioner	

\*1: The system judges a person of adult size as an adult. When a smaller adult sits in the front passenger seat, the system may recognize him/her as a child depending on his/her physique and posture.

\*2: In the event the front passenger does not wear a seat belt.

\*3: When a larger child who has outgrown a child restraint system sits in the front passenger seat, the system may recognize him/her as an adult depending on his/her physique or posture.

- \*4: Never install a rear-facing child restraint system on the front passenger seat. A forward-facing child restraint system should only be installed on the front passenger seat when it is unavoidable. (→P. 101)
- \*5: In case the indicator is not illuminated, consult this manual as for installing the child restraint system properly. (→P. 105)

 **CAUTION****■ Front passenger occupant classification system precautions**

Observe the following precautions regarding the front passenger occupant classification system.

Failure to do so may cause death or serious injury.

- Wear the seat belt properly.
- Make sure the front passenger's seat belt tab has not been left inserted into the buckle before someone sits in the front passenger seat.
- Make sure the "AIR BAG OFF" indicator light is not illuminated when using the seat belt extender for the front passenger seat. If the "AIR BAG OFF" indicator light is illuminated, disconnect the extender tongue from the seat belt buckle, then reconnect the seat belt. Reconnect the seat belt extender after making sure the "AIR BAG ON" indicator light is illuminated. If you use the seat belt extender while the "AIR BAG OFF" indicator light is illuminated, the front passenger airbag, side airbag on the front passenger side airbag may not activate correctly, which could cause death or serious injury in the event of collision.
- Do not put weight on the front passenger seat by putting your hands or feet on the front passenger seat seatback from the rear passenger seat.
- Do not let a rear passenger lift the front passenger seat with their feet or press on the seatback with their legs.
- Do not put objects under the front passenger seat.

 CAUTION

■ **Front passenger occupant classification system precautions**

- Do not recline the front passenger seatback so far that it touches a rear seat. This may cause the “AIR BAG OFF” indicator light to be illuminated, which indicates that the passenger’s airbags will not deploy in the event of a severe accident. If the seatback touches the rear seat, return the seatback to a position where it does not touch the rear seat. Keep the front passenger seatback as upright as possible when the vehicle is moving. Reclining the seatback excessively may lessen the effectiveness of the seat belt system.
- If an adult sits in the front passenger seat, the “AIR BAG ON” indicator light is illuminated. If the “AIR BAG OFF” indicator is illuminated, ask the passenger to sit up straight, well back in the seat, feet on the floor, and with the seat belt worn correctly. If the “AIR BAG OFF” indicator still remain illuminated, either ask the passenger to move to the rear seat, or if that is not possible, move the front passenger seat fully rearward.
- When it is unavoidable to install the forward-facing child restraint system on the front passenger seat, install the child restraint system on the front passenger seat in the proper order. (→P. 105)
- Do not modify or remove the front seats.
- Do not kick the front passenger seat or subject it to severe impact. Otherwise, the SRS warning light may come on to indicate a malfunction of the detection system. In this case, contact your Toyota dealer immediately.
- Child restraint systems installed on the rear seat should not contact the front seatbacks.
- Do not use a seat accessory, such as a cushion or seat cover, that covers the seat cushion surface.
- Do not modify or replace the upholstery of the front seat.

## Child restraint systems

**A child restraint system for a small child or baby must be properly restrained on the seat with the lap portion of the lap/shoulder belt.**

**The laws of all 50 states of U.S.A. and Canada now require the use of child restraint systems.**

### Points to remember

Studies have shown that installing a child restraint system on a rear seat is much safer than installing one to the front passenger seat.

- Choose a child restraint system appropriate to the age and size of the child.
- For installation details, follow the instructions provided with the child restraint system.

General installation instructions are provided in this manual.

(→P. 105)

## Types of child restraints

Child restraint systems are classified into the following 3 types according to the age and size of the child.

### ► Infant seat

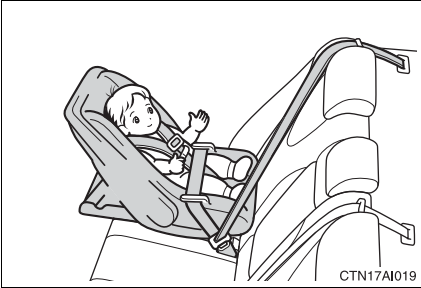

### ► Convertible seat

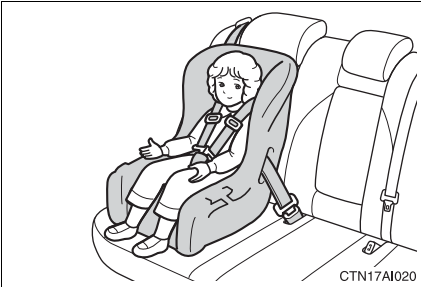

### ► Booster seat

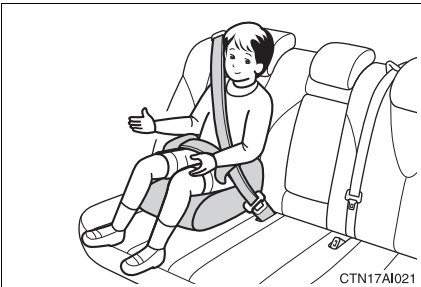

**■ When the child restraint system is not in use**

Leave the child restraint system properly secured on the seat. Do not store the restraint loosely on a passenger seat or in the trunk.

**■ Selecting an appropriate child restraint system**

Get an appropriate child restraint system for the child. If a child is too large for a child restraint system, sit the child on a rear seat and use the vehicle's seat belt. (→P. 55)

**⚠ CAUTION****■ Child restraint precautions**

- For effective protection in automobile accidents and sudden stops, a child must be properly restrained, using a seat belt or child restraint system depending on the age and size of the child. Holding a child in your arms is not a substitute for a child restraint system. In an accident, the child can be crushed against the windshield, or between you and the vehicle's interior.
- Toyota strongly urges the use of a proper child restraint system that conforms to the size of the child, installed on the rear seat. According to accident statistics, the child is safer when properly restrained in the rear seat than in the front seat.

 CAUTION

■ **Child restraint precautions**

- Never install a rear-facing child restraint system on the front passenger seat even if the “AIR BAG OFF” indicator light is illuminated. In the event of an accident, the force of the rapid inflation of the front passenger airbag can cause death or serious injury to the child if the rear-facing child restraint system is installed on the front passenger seat.
- A forward-facing child restraint system should be installed on the front passenger seat only when it is unavoidable. Always move the seat as far back as possible even if the “AIR BAG OFF” indicator light is illuminated, because the front passenger airbag could inflate with considerable speed and force. Otherwise, the child may be killed or seriously injured.
- Do not use the seat belt extender when installing a child restraint system on the front or rear passenger seat. If installing a child restraint system with the seat belt extender connected to the seat belt, the seat belt will not securely hold the child restraint system, which could cause death or serious injury to the child or other passengers in the event of collision.
- Do not allow the child to lean his/her head or any part of his/her body against the door or the area of the seat, front and rear pillars or roof side rail from which the side airbags or curtain shield airbags deploy even if the child is seated in the child restraint system. It is dangerous if the side airbags and curtain shield airbags inflate, and the impact could cause death or serious injury to the child.
- Make sure you have complied with all installation instructions provided by the child restraint manufacturer and that the system is properly secured. If it is not secured properly, it may cause death or serious injury to the child in the event of a sudden stop or accident.



## Installing child restraints

**Follow the child restraint system manufacturer's instructions. Firmly secure child restraints to the rear seats using a seat belt or a child restraint lower anchorage. Attach the top strap when installing a child restraint.**



Seat belts equipped with a child restraint locking mechanism (ALR/ELR belts except driver's seat belt) (→P. 55)

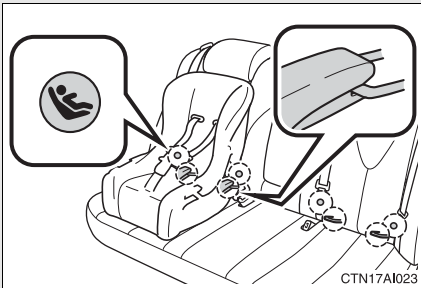

Child restraint lower anchorages

Lower anchorages are provided for the outside rear seats. (Buttons displaying the location of the anchorages are attached to the seats.)

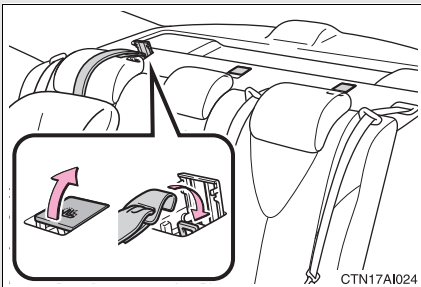

Anchor bracket (for top strap)

Anchor brackets are provided for all rear seats.

**Installing child restraints using a seat belt (child restraint lock function belt)**

**■ Rear facing child seat — Infant seat/convertible seat**

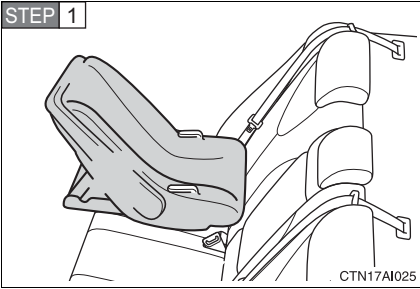

Place the child seat on the rear seat facing the rear of the vehicle.

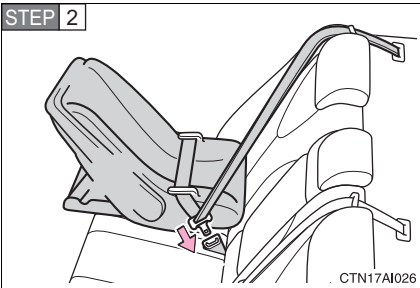

Run the seat belt through the child seat and insert the plate into the buckle. Make sure that the belt is not twisted.

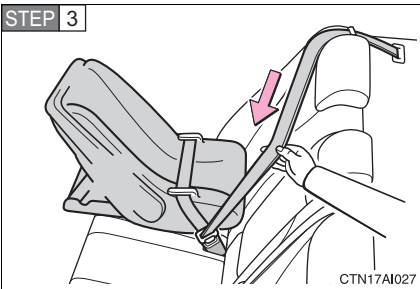

Fully extend the shoulder belt and then allow it to retract slightly in order to activate the ALR lock mode.

Lock mode allows the seat belt to retract only.

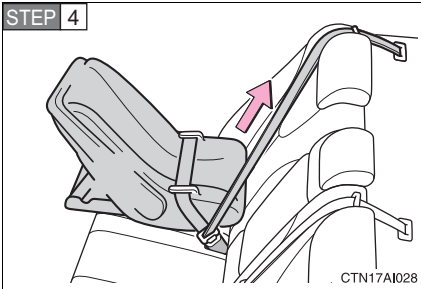

While pushing the child seat down into the rear seat, allow the shoulder belt to retract until the child seat is securely in place.

After the shoulder belt has retracted to a point where there is no slack in the belt, pull the belt to check that it cannot be extended.

### ■ Forward facing — Convertible seat

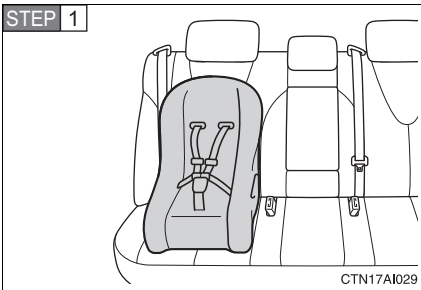

Place the child seat on the seat facing the front of the vehicle.

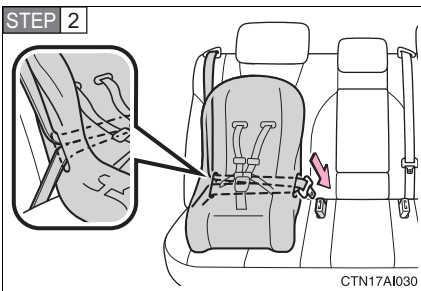

Run the seat belt through the child seat and insert the plate into the buckle. Make sure that the belt is not twisted.

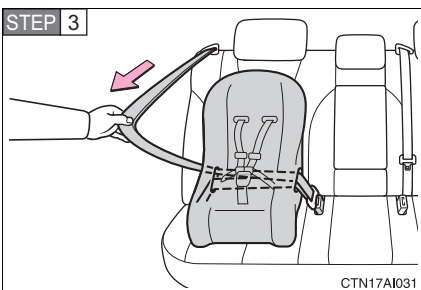

Fully extend the shoulder strap and then allow it to retract slightly into the ALR lock mode.

Lock mode allows the seat belt to retract only.

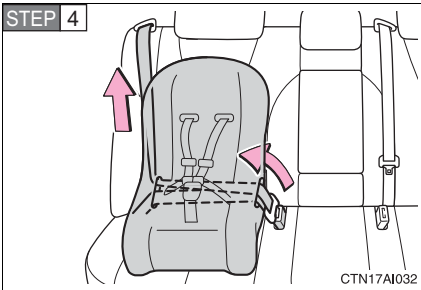

While pushing the child seat into the rear seat, allow the shoulder belt to retract until the child seat is securely in place.

After the shoulder belt has retracted to a point where there is no slack in the belt, pull the belt to check that it cannot be extended.

### ■ Booster seat

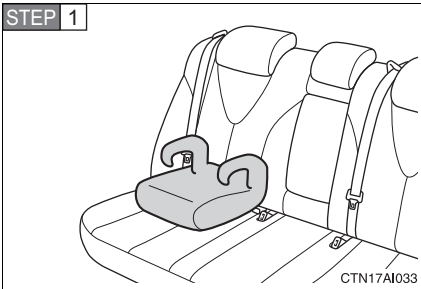

Place the booster seat on the seat facing the front of the vehicle.

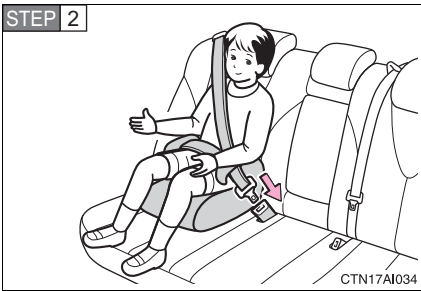

Sit the child in the booster seat. Fit the seat belt to the booster seat according to the manufacturer's instructions and insert the plate into the buckle. Make sure that the belt is not twisted.

Check that the shoulder belt is correctly positioned over the child's shoulder, and that the lap belt is as low as possible.

(→P. 55)

## Removing a child restraint installed with a seat belt

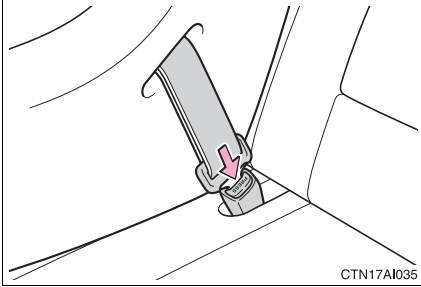

Push the buckle release button and fully retract the seat belt.

1

Before driving

## Installation with child restraint lower anchorages

**STEP 1** Vehicles with reclining type rear seat: Adjust the seatback to the most upright position.

► Type A

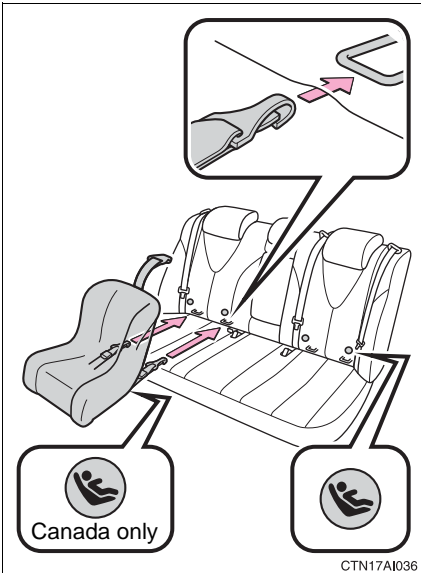

**STEP 2** Widen the gap between the seat cushion and seatback slightly.

**STEP 3** Latch the hooks of the lower straps onto the anchors.

If the child restraint has a top strap, the top strap should be latched onto the anchors.

For owners in Canada:  
A symbol on a child restraint system indicates the presence of a lower connector system.

► Type B

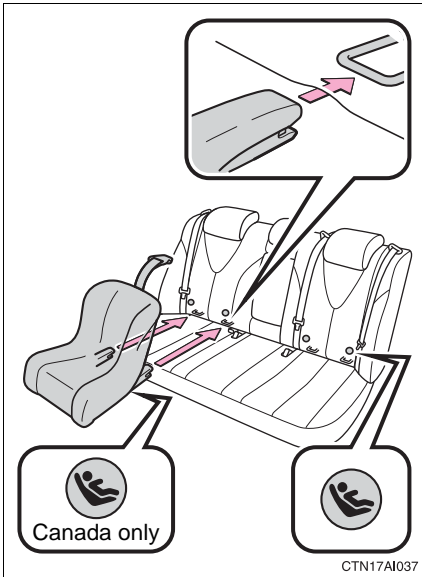

**STEP 2** Widen the gap between the seat cushion and seatback slightly.

**STEP 3** Latch the buckles onto the anchors.

If the child restraint has a top strap, the top strap should be latched onto the anchors.

For owners in Canada:

A symbol on a child restraint system indicates the presence of a lower connector system.

## Child restraint systems with a top strap

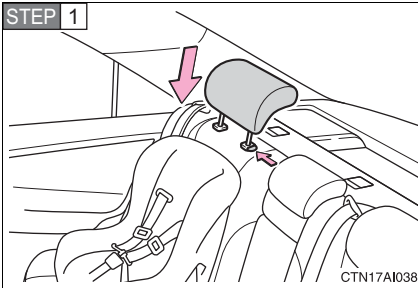

Secure the child restraint using the seat belt lower anchors, and lock the head restraint in place at the lowest position.

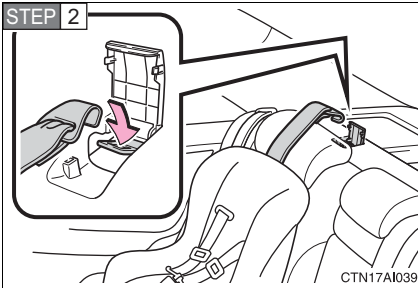

Open the anchor bracket cover, latch the hook onto the anchor bracket and tighten the top strap.

Make sure the top strap is securely latched.

### ■ Laws and regulations pertaining to anchorages

Anchorage conform to FMVSS225 or CMVSS210.2.

Child restraint systems conforming to FMVSS213 or CMVSS213 specifications can be used.

This vehicle is designed to conform to the SAE J1819.

**! CAUTION**

**■ When installing a booster seat**

Do not fully extend the shoulder belt to prevent the belt from going to ALR lock mode: (→P. 58)

- ALR mode causes the belt to tighten only which could cause injury or discomfort to the child.
- Do not allow the child to play with the seat belt or the child could be killed or seriously injured.

**■ When installing a child restraint system**

Follow the directions given in the child restraint system installation manual and fix the child restraint system securely in place.

If the child restraint system is not correctly fixed in place, the child may be seriously injured or even killed in the event of sudden braking or an accident.

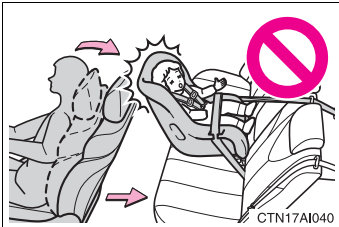

- If the driver's seat interferes with the child restraint system and prevents it from being attached correctly, attach the child restraint system to the right-hand rear seat.

- Adjust the front passenger seat so that it does not interfere with the child restraint system.

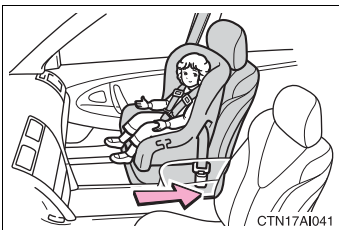

- Only put a forward-facing or booster child seat on the front seat when unavoidable. When installing a forward-facing or booster child seat on the front passenger seat, move the seat as far back as possible even if the "AIR BAG OFF" indicator light is illuminated. Failing to do so may result in death or serious injury if the airbags deploy (inflate).



 **CAUTION****■ When installing a child restraint system**

- Vehicles with reclining type rear seat: When installing a child restraint system in the rear center position, adjust both seatbacks to the most upright position. Otherwise, the child restraint system cannot be securely restrained and this may cause death or serious injuries in a collision.
- When a booster seat is installed, always ensure that the shoulder belt is positioned across the center of the child's shoulder. The belt should be kept away from the child's neck, but not so that it could fall off the child's shoulder. Failing to do so may result in death or serious injury in the event of an accident or sudden braking.
- Ensure that the belt and tab are securely locked and the seat belt is not twisted.
- Push and pull the child seat in different directions to be sure it is secure.
- Follow all installation instructions provided by the child restraint system manufacturer.

**■ Do not use a seat belt extender**

If a seat belt extender is used when installing a child restraint system, the seat belt will not securely hold the child restraint system, which could cause death or serious injury to the child or other passengers in the event of a collision.

**■ To correctly attach a child restraint system to the anchorages**

When using the lower anchorages, be sure that there are no foreign objects around the anchorages and that the seat belt is not caught behind the child restraint. Make sure the child restraint system is securely attached, or it may cause death or serious injury to the child in the event of a sudden stop or accident.



<b>2-1. Driving procedures .....</b>	<b>116</b>	<b>2-4. Using other driving systems .....</b>	<b>159</b>
Driving the vehicle.....	116	Cruise control .....	159
Engine (ignition) switch (vehicles with smart key system) .....	126	Driving assist systems .....	162
Engine (ignition) switch (vehicles without smart key system).....	130	<b>2-5. Driving information .....</b>	<b>165</b>
Automatic transmission....	133	Cargo and luggage .....	165
Manual transmission .....	137	Vehicle load limits .....	168
Turn signal lever .....	138	Winter driving tips .....	169
Parking brake.....	139	Trailer towing .....	173
<b>2-2. Instrument cluster.....</b>	<b>141</b>	Dinghy towing (automatic transmission) .....	181
Gauges and meters .....	141	Dinghy towing (manual transmission) ...	182
Indicators and warning lights .....	145		
Multi-information display.....	149		
<b>2-3. Operating the lights and     wipers .....</b>	<b>152</b>		
Headlight switch.....	152		
Fog light switch .....	156		
Windshield wipers and washer .....	157		

## 2-1. Driving procedures

# Driving the vehicle

The following procedures should be observed to ensure safe driving.

### ■ Starting the engine

→P. 126, 130

### ■ Driving

#### ▶ Automatic transmission

**STEP 1** With the brake pedal depressed, shift the shift lever to D. (→P. 133)

**STEP 2** Release the parking brake. (→P. 139)

**STEP 3** Gradually release the brake pedal and gently depress the accelerator pedal to accelerate the vehicle.

#### ▶ Manual transmission

**STEP 1** With the clutch pedal fully depressed, shift the shift lever to 1. (→P. 137)

**STEP 2** Release the parking brake. (→P. 139)

**STEP 3** Gradually release the clutch pedal. At the same time, gently depress the accelerator pedal to accelerate the vehicle.

### ■ Stopping

#### ▶ Automatic transmission

**STEP 1** With the shift lever in D, depress the brake pedal.

**STEP 2** If necessary, set the parking brake.

When the vehicle is stopped for an extended period of time, shift the shift lever to P or N. (→P. 133)

#### ▶ Manual transmission

**STEP 1** With the clutch pedal fully depressed, depress the brake pedal.

**STEP 2** If necessary, set the parking brake.

When the vehicle is stopped for an extended period of time, shift the shift lever to N. (→P. 137)

## ■ Parking the vehicle

### ▶ Automatic transmission

**STEP 1** With the shift lever in D, depress the brake pedal.

**STEP 2** Set the parking brake. (→P. 139)

**STEP 3** Shift the shift lever to P. (→P. 133)

When parking on a hill, if necessary, block the wheels.

**STEP 4** Vehicles with smart key system:

Turn the “ENGINE START STOP” switch OFF and stop the engine.

Vehicles without smart key system:

Turn the engine switch to “LOCK” position and stop the engine.

**STEP 5** Lock the door, making sure that you have the key on your person.

### ▶ Manual transmission

**STEP 1** With the clutch pedal fully depressed, depress the brake pedal.

**STEP 2** Set the parking brake. (→P. 139)

**STEP 3** Shift the shift lever to N. (→P. 137)

When parking on a hill, shift the shift lever to 1 or R. If necessary, block the wheels.

**STEP 4** Turn the engine switch to “LOCK” position and stop the engine.

**STEP 5** Lock the door, making sure that you have the key on your person.

## Starting on a steep uphill

### ► Automatic transmission

**STEP 1** Firmly set the parking brake and shift the shift lever to D.

**STEP 2** Gently depress the accelerator pedal.

**STEP 3** Release the parking brake.

### ► Manual transmission

**STEP 1** With the parking brake firmly set and the clutch pedal fully depressed, shift the shift lever to 1.

**STEP 2** Lightly depress the accelerator pedal at the same time as gradually releasing the clutch pedal.

**STEP 3** Release the parking brake.

---

## ■ Driving in the rain

- Drive carefully when it is raining, because visibility will be reduced, the windows may become fogged-up, and the road will be slippery.
- Drive carefully when it starts to rain, because the road surface will be especially slippery.
- Refrain from high speeds when driving on an expressway in the rain, because there may be a layer of water between the tires and the road surface, preventing the steering and brakes from operating properly.

## ■ Breaking in your new Toyota

To extend the life of the vehicle, the following precautions are recommended to observe:

- For the first 186 miles (300 km):
  - Avoid sudden stops.
- For the first 994 miles (1600 km):
  - Do not drive at extremely high speeds.
  - Avoid sudden acceleration.
  - Do not drive continuously in the low gears.
  - Do not drive at a constant speed for extended periods.

### ■ Drum-in-disc type parking brake system

Your vehicle has a drum-in-disc type parking brake system. This type of brake system needs bedding-down of the brake shoes periodically or whenever the parking brake shoes and/or drum are replaced. Have your Toyota dealer perform the bedding down.

### ■ Operating your vehicle in a foreign country

Comply with the relevant vehicle registration laws and confirm the availability of the correct fuel. (→P. 430)

### ■ Normal characteristics after turning off the engine

Approximately five hours after the engine is turned off, you may hear sound coming from under the vehicle for several minutes. This is because the fuel evaporation leakage check is performed. It does not indicate a malfunction.

## CAUTION

### ■ When starting the vehicle

Vehicles with automatic transmission: Always keep your foot on the brake pedal while stopped with the engine running. This prevents the vehicle from creeping.

### ■ When driving the vehicle

- Do not drive if you are unfamiliar with the location of the brake and accelerator pedals to avoid depressing the wrong pedal.
  - Accidentally depressing the accelerator pedal instead of the brake pedal will result in sudden acceleration that may lead to an accident that could result in death or serious injury.
  - When backing up, you may twist your body around, leading to a difficulty in operating the pedals. Make sure to operate the pedals properly.
  - Make sure to keep a correct driving posture even when moving the vehicle only slightly, allowing you to depress the brake and accelerator pedals properly.
  - Depress the brake pedal using your right foot. Depressing the brake pedal using your left foot may delay response in an emergency, resulting in an accident.

 CAUTION

- Do not drive the vehicle over or stop the vehicle near flammable materials. The exhaust system and exhaust gases can be extremely hot. This may cause a fire if there is any flammable material nearby.
- Vehicles with automatic transmission: Do not let the vehicle roll backwards while the shift lever is in a driving position, or roll forward while the shift lever is in R. Doing so may cause the engine to stall or lead to poor brake and steering performance, resulting in an accident or damage to the vehicle.
- If the smell of exhaust is noticed inside the vehicle, open the windows and check that the trunk is closed. Large amounts of exhaust in the vehicle can cause driver drowsiness and an accident, resulting in death or a serious health hazard. Have the vehicle inspected by your Toyota dealer immediately.
- Do not under any circumstances shift the shift lever to P or R (automatic transmission vehicles) or R (manual transmission vehicles) while the vehicle is moving. Doing so can cause significant damage to the transmission system and may result in a loss of vehicle control.
- Do not shift the shift lever to N while the vehicle is moving. Doing so may cause insufficient engine braking and lead to an accident.
- Do not turn the engine off while driving. The power steering and brake booster systems will not operate properly if the engine is not running.
- Use engine braking (downshift) to maintain a safe speed when driving down a steep hill. Using the brakes continuously may cause the brakes to overheat and lose effectiveness. (→P. 134)



 **CAUTION**

- When stopped on an inclined surface, use the brake pedal and parking brake to prevent the vehicle from rolling backward or forward and causing an accident.
- Do not adjust the position of the steering wheel, the seat, or the inside or outside rear view mirrors while driving.  
Doing so may result in a loss of vehicle control that can cause accidents that may result in death or serious injury.
- Always check that all passengers' arms, heads or other parts of their bodies are not outside the vehicle, as this may result in death or serious injury.
- Do not drive in excess of the speed limit. Even if the legal speed limit permits it, do not drive over 85 mph (140 km/h) unless your vehicle has high-speed capability tires. Driving over 85 mph (140 km/h) may result in tire failure, loss of control and possible injury. Be sure to consult a tire dealer to determine whether the tires on your vehicle are high-speed capability tires or not before driving at such speeds.

**■ When driving on slippery road surfaces**

- Sudden braking, acceleration and steering may cause tire slippage and reduce your ability to control the vehicle, resulting in an accident.
- Sudden changes in engine speed, such as engine braking caused by up-shifting or down-shifting, may cause the vehicle to skid, resulting in an accident.
- After driving through a puddle, lightly depress the brake pedal to make sure that the brakes are functioning properly. Wet brake pads may prevent the brakes from functioning properly. If the brakes on only one side are wet and not functioning properly, steering control may be affected, resulting in an accident.

**■ When shifting the shift lever**

Vehicles with an automatic transmission: Be careful not to shift the shift lever with the accelerator pedal depressed.

This may lead to unexpected rapid acceleration of the vehicle that may cause an accident and result in death or serious injury.

 CAUTION

■ **When the vehicle is stopped**

- Do not race the engine.

If the vehicle is in any gear other than P (automatic transmission only) or N the vehicle may accelerate suddenly and unexpectedly, and may cause an accident.

- Do not leave the vehicle with the engine running for a long time.

If such a situation cannot be avoided, park the vehicle in an open space and check that exhaust fumes do not enter the vehicle interior.

- Vehicles with an automatic transmission: Always keep a foot on the brake pedal while the engine is running to prevent an accident caused by the vehicle moving.

■ **When the vehicle is parked**

- Do not leave glasses, cigarette lighters, spray cans, or soft drink cans in the vehicle when it is in the sun.

Doing so may result in the following.

- Gas may leak from a cigarette lighter or spray can, and may lead to a fire.
- The temperature inside the vehicle may cause the plastic lenses and plastic material of eye glasses to deform or crack.
- Soft drink cans may fracture, causing the contents to spray over the interior of the vehicle, and may also cause a short circuit in the vehicle's electrical components.

- Always apply the parking brake, shift the shift lever to P (automatic transmission only), stop the engine and lock the vehicle.

Do not leave the vehicle unattended while the engine is running.

- Do not touch the exhaust pipe while the engine is running or immediately after turning the engine off.

Doing so may cause burns.

- Do not leave the engine running in an area with snow build-up, or where it is snowing. If snowbanks build up around the vehicle while the engine is running, exhaust gases may collect and enter the vehicle. This may lead to death or a serious health hazard.

 **CAUTION**
**Exhaust gases**

Exhaust gases include harmful carbon monoxide (CO) that is colorless and odorless. Inhaling exhaust gases may lead to death or a serious health hazard.

- If the vehicle is in a poorly ventilated area, stop the engine. In a closed area, such as a garage, exhaust gases may collect and enter the vehicle. This may lead to death or a serious health hazard.
- The exhaust should be checked occasionally. If there is a hole or crack caused by corrosion, damage to a joint or abnormal exhaust noise, be sure to have the vehicle inspected and repaired by your Toyota dealer. Failure to do so may allow exhaust gases to enter the vehicle, resulting in death or a serious health hazard.

**When taking a nap in the vehicle**

Always turn the engine off. Otherwise, you may accidentally move the shift lever or depress the accelerator pedal, which could cause an accident or fire due to engine overheating. Additionally, if the vehicle is parked in a poorly ventilated area, exhaust gases may collect and enter the vehicle, leading to death or a serious health hazard.

**When braking the vehicle**

- When the brakes are wet, drive more cautiously.  
Braking distance increases when the brakes are wet, and may cause one side of the vehicle to brake differently than the other side. Also the parking brake may not securely hold the vehicle.
- If the power brake assist function does not operate, do not follow other vehicles closely and avoid downhills or sharp turns that require braking. In this case, braking is still possible, but it will require more force on the pedal than usual. Braking distance may also increase.
- Do not pump the brake pedal if the engine stalls.  
Each push on the pedal uses up the reserve for the power-assisted brakes.
- The brake system consists of 2 individual hydraulic systems: If one of the systems fails, the other will still operate. In this case, the brake pedal should be depressed more firmly than usual and braking distance becomes longer.  
Do not drive your vehicle with only a single brake system. Have your brakes fixed immediately.

 NOTICE

■ **When driving the vehicle**

▶ Manual transmission

- Do not shift gears unless the clutch pedal is fully depressed. After shifting, do not release the clutch abruptly. Doing so may damage the clutch, transmission and gears.
- Do not rest your foot on the clutch pedal while driving. Doing so may cause clutch trouble.
- Do not use any gears other than the first gear when starting off and moving forward. Doing so may damage the clutch.
- Do not use the clutch to hold the vehicle when stopping on an uphill grade. Doing so may damage the clutch.
- Do not shift into reverse when the vehicle is still moving. Doing so may damage the clutch, transmission and gears.

▶ Automatic transmission

Do not use the accelerator pedal or depress the accelerator and brake pedals together to hold the vehicle on a hill.

■ **When parking the vehicle**

Vehicles with an automatic transmission: Always put the shift lever in P. Failure to do so may cause the vehicle to move or the vehicle may accelerate suddenly if the accelerator pedal is accidentally depressed.

■ **Avoiding damage to vehicle parts**

- Do not turn the steering wheel fully in either direction and hold it there for a long time. Doing so may damage the power steering motor.
- When driving over bumps in the road, drive as slowly as possible to avoid damaging the wheels, underside of the vehicle, etc.

 NOTICE

■ **If you hear a squealing or scraping noise (brake pad wear limit indicators)**

Have the brake pads checked and replaced by your Toyota dealer as soon as possible.

Rotor damage can result if the pads are not replaced when needed.

It is dangerous to drive the vehicle when the wear limits of the brake pads and/or that of the brake discs are exceeded.

■ **If you get a flat tire while driving**

A flat or damaged tire may cause the following situations. Hold the steering wheel firmly and gradually press the brake pedal to slow down the vehicle.

- It may be difficult to control your vehicle.
- The vehicle will make abnormal sounds.
- The vehicle will behave abnormally.

Replace a flat tire with a new one. (→P. 403)

■ **When encountering flooded roads**

Do not drive on a road that has flooded after heavy rain etc. Doing so may cause the following serious damage to the vehicle.

- Engine stalling
- Short in electrical components
- Engine damage caused by water immersion

In the event that you drive on a flooded road and the vehicle is flooded, be sure to have your Toyota dealer check the following.

- Brake function
- Changes in quantity and quality of engine oil, and transaxle fluid etc.
- Lubricant condition for the bearings and suspension joints (where possible) and the function of all joints, bearings, etc.

## 2-1. Driving procedures

### Engine (ignition) switch (vehicles with smart key system)

Modes can be switched by pressing the “ENGINE START STOP” switch when carrying the electronic key on your person. (The engine can be started in any mode by operating the “ENGINE START STOP” switch at the same time as depressing the brake pedal.)

#### ■ Starting the engine

**STEP 1** Check that the parking brake is set.

**STEP 2** Check that the shift lever is set in P.

**STEP 3** Sit in the driver’s seat and firmly depress the brake pedal.

The “ENGINE START STOP” switch indicator turns green. If the indicator does not turn green, the engine cannot be started.

**STEP 4**

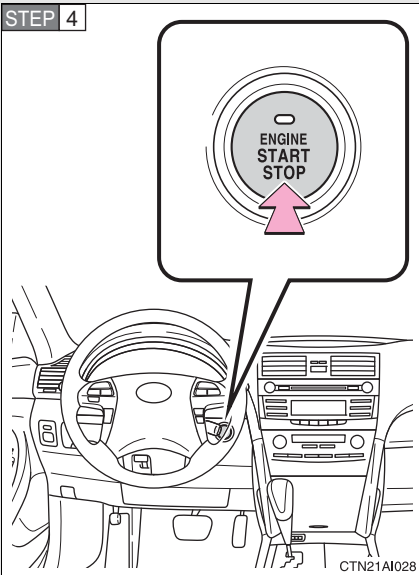

Press the “ENGINE START STOP” switch.

The engine will crank until it starts or for up to 25 seconds, whichever is less. If you press and hold the “ENGINE START STOP” switch, the engine will keep cranking for about 30 seconds maximum.

Continue depressing the brake pedal until the engine is completely started.

## ■ Changing “ENGINE START STOP” switch mode

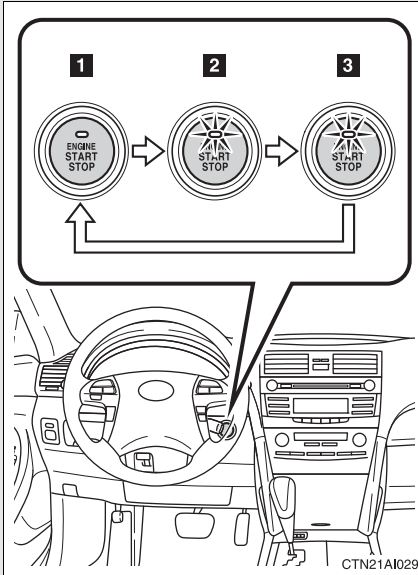

### 1 OFF\*

Emergency flashers can be used.

### 2 ACCESSORY mode

Some electrical components such as the audio system can be used.

The “ENGINE START STOP” switch indicator turns amber.

### 3 IGNITION ON mode

All electrical components can be used.

The “ENGINE START STOP” switch indicator turns amber.

\*: The engine cannot be turned off unless the shift lever is in P.

### ■ Steering lock release

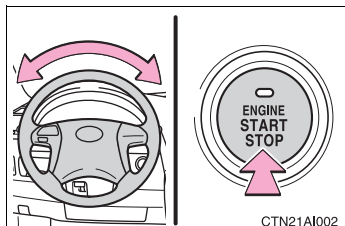

Make sure that the steering wheel lock is released.

To release the steering wheel lock, gently turn the wheel left or right while pressing the “ENGINE START STOP” switch.

If the steering wheel lock does not release, the “ENGINE START STOP” switch indicator will flash green.

### ■ If the engine does not start

The engine immobilizer system may not have been deactivated. (→P. 77)

### ■ When the “ENGINE START STOP” switch indicator flashes in amber

The system may be malfunctioning. Have the vehicle inspected by your Toyota dealer immediately.

### ■ Auto power OFF function

If the vehicle is left in ACCESSORY mode for more than an hour with the shift lever in P, the “ENGINE START STOP” switch will automatically turn OFF.

### ■ Key battery depletion

→P. 32

### ■ When the electronic key battery is discharged

→P. 353

### ■ Conditions affecting operation

→P. 30

### ■ Note for the entry function

→P. 33



 **CAUTION****■ When starting the engine**

Always start the engine while sitting in the driver's seat. Do not depress the accelerator pedal while starting the engine under any circumstances. Doing so may cause an accident resulting in death or serious injury.

**■ Caution when driving**

Do not touch the "ENGINE START STOP" switch while driving. Pressing and holding the "ENGINE START STOP" switch will stop the engine, which may lead to an unexpected accident.

 **NOTICE****■ To prevent battery discharge**

Do not leave the "ENGINE START STOP" switch in ACCESSORY or IGNITION ON mode for long periods without the engine running.

**■ When starting the engine**

- Do not race a cold engine.
- If the engine becomes difficult to start or stalls frequently, have the engine checked immediately.

### ■ Starting the engine

#### ▶ Automatic transmission

- STEP 1** Check that the parking brake is set.
- STEP 2** Check that the shift lever is set in P.
- STEP 3** Sit in the driver's seat and firmly depress the brake pedal.
- STEP 4** Turn the engine switch to the "START" position and start the engine.

#### ▶ Manual transmission

- STEP 1** Check that the parking brake is set.
- STEP 2** Check that the shift lever is set in N.
- STEP 3** Firmly depress the clutch pedal.
- STEP 4** Turn the engine switch to the "START" position and start the engine.

### ■ Changing engine switch mode

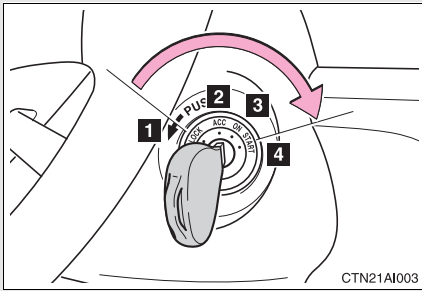

#### 1 "LOCK"

The steering wheel is locked and the key can be removed.

#### 2 "ACC"

Some electrical components such as the audio system can be used.

#### 3 "ON"

All electrical components can be used.

#### 4 "START"

For starting the engine.

### ■ Turning the key from “ACC” to “LOCK”

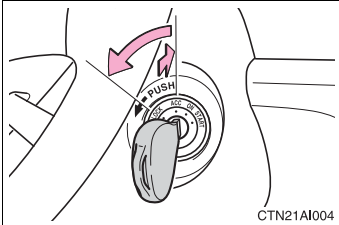

**STEP 1** Shift the shift lever to N (manual transmission) or P (automatic transmission). (→P. 133, 137)

**STEP 2** Push in the key and turn to the “LOCK” position.

### ■ Steering lock release

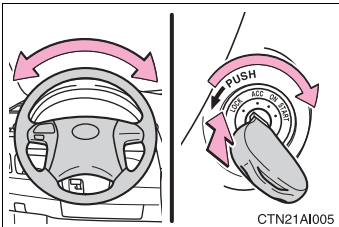

When starting the engine, the engine switch may seem stuck in the “LOCK” position. To free it, turn the key while turning the steering wheel slightly in either direction.

### ■ If the engine does not start

The engine immobilizer system may not have been deactivated. (→P. 77)

### ■ Key reminder function

A buzzer sounds if the driver’s door is opened while the key is in the “LOCK” position to remind you to remove the key.

## ▲ CAUTION

### ■ When starting the engine

Always start the engine while sitting in the driver's seat. Do not depress the accelerator while starting the engine under any circumstances.

Doing so may cause an accident resulting in death or serious injury.

### ■ Caution when driving

Do not turn the engine switch to the “LOCK” position while driving. If, in an emergency, you must turn the engine off while the vehicle is moving, turn the key only to the “ACC” position.

 NOTICE

■ **To prevent battery discharge**

Do not leave the key in the “ACC” or “ON” position for long periods if the engine is not running.

■ **When starting the engine**

- Do not crank for more than 30 seconds at a time. This may overheat the starter and wiring systems.
- Do not race a cold engine.
- If the engine becomes difficult to start or stalls frequently, have the engine checked immediately.

Select a shift position appropriate for the driving conditions.

■ Shifting the shift lever

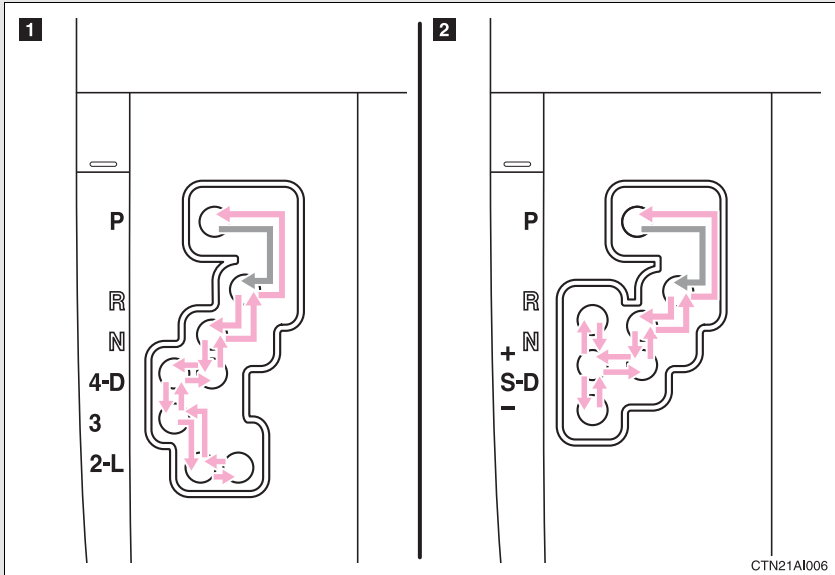

← Vehicles with smart key system:  
While the “ENGINE START STOP” switch is in IGNITION ON mode, depress the brake pedal and move the shift lever.

Vehicles without smart key system:  
While the engine switch is in “ON” position, depress the brake pedal and move the shift lever.

1 Standard type

2 Multi-mode type

### ■ Shift position uses

Shift position	Function	
	Standard type	Multi-mode type
P	Parking the vehicle or starting the engine	
R	Reversing	
N	Neutral	
D	Normal driving <sup>*1</sup>	
S		S mode driving <sup>*2</sup> (→P. 135)
4	Position for engine braking	
3,2	Position for more powerful engine braking	
L	Position for maximum engine braking	

\*1: To improve fuel consumption and reduce noises, set the shift lever in the D position for normal driving.

\*2: Selecting shift ranges using S mode restricts the upper limit of the possible gear ranges, controls engine braking forces, and prevents unnecessary upshifting.

## Changing shift ranges in S mode (multi-mode type)

Shift the shift lever to the S position and operate the shift lever.

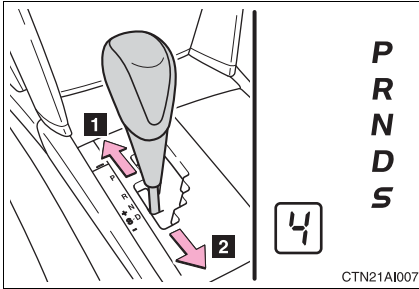

- 1** Upshifting
- 2** Downshifting

### ■ Shift ranges and their functions

Shift range	Function
6	A gear between 1 and 6 is automatically selected according to vehicle speed and driving conditions
5	A gear between 1 and 5 is automatically selected according to vehicle speed and driving conditions.
4	A gear between 1 and 4 is automatically selected according to vehicle speed and driving conditions.
3	A gear between 1 and 3 is automatically selected according to vehicle speed and driving conditions.
2	A gear between 1 and 2 is automatically selected according to vehicle speed and driving conditions.
1	Setting the gear at 1.

A lower shift range will provide greater engine braking forces than a higher shift range.

### ■ Downshifting restrictions

#### ▶ Standard type

The shift lever cannot be downshifted if the following speeds are exceeded.

mph (km/h)

Downshifting	Maximum speed
4→3	76 (141)
3→2	48 (89)
2→L	21 (40)

#### ▶ Multi-mode type

To help ensure safety and driving performance, downshifting operation may sometimes be restricted. In some circumstances, downshifting may not be possible even when the shift lever is operated. (The warning buzzer will sound twice.)

### ■ When driving with the cruise control system

Engine braking will not occur when downshifting from D or 6 to 4. (→P. 159)

### ■ If the shift lever cannot be shifted from P

→P. 413

### ■ If the “S” indicator does not come on even after shifting the shift lever to S (multi-mode type)

This may indicate a malfunction in the automatic transmission system. Have the vehicle inspected by your Toyota dealer immediately.

(In this situation, the vehicle will operate as if the shift lever is in D.)

### ■ AI-SHIFT

The AI-SHIFT automatically shifts the gear to the optimal position according to the driver performance and driving conditions.

The AI-SHIFT automatically operates when the shift lever is in the D position. (Shifting the shift lever to the S position cancels the function.)



■ **Shifting the shift lever**

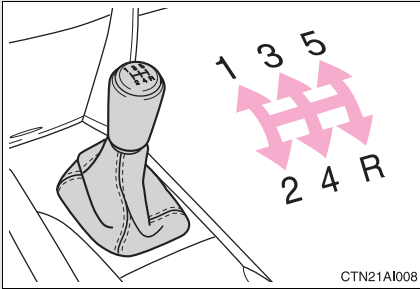

Fully depress the clutch pedal before operating the shift lever, and then release the clutch pedal slowly.

■ **Maximum allowable speeds**

Observe the following maximum allowable speeds in each gear when maximum acceleration is necessary.

mph (km/h)

Shift position	Maximum speed
1	33 (54)
2	59 (95)
3	90 (146)
4	124 (200)

## 2-1. Driving procedures

### Turn signal lever

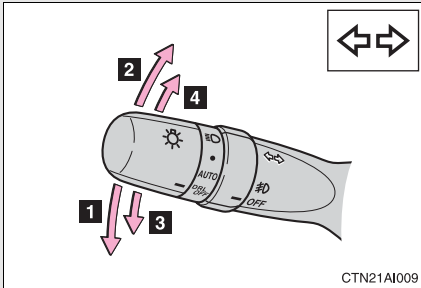

**1** Left turn

**2** Right turn

**3** Move and hold the lever partway to signal a lane change.

The left hand signal will flash until you release the lever.

**4** Move and hold the lever partway to signal a lane change.

The right hand signal will flash until you release the lever.

#### ■ Turn signals can be operated when

▶ Vehicles with smart key system

The "ENGINE START STOP" switch is in ON mode.

▶ Vehicles without smart key system

The engine switch is in "ON" position.

#### ■ If the indicators flash faster than usual

Check that a light bulb in the front or rear turn signal lights has not burned out.

## 2-1. Driving procedures

### Parking brake

#### ▶ Manual transmission

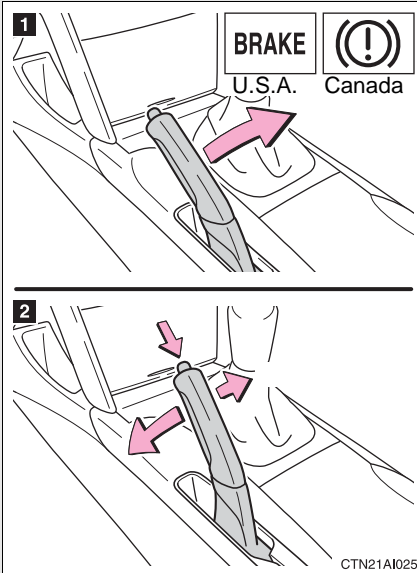

#### 1 Sets the parking brake

Fully set the parking brake while depressing the brake pedal.

#### 2 Releases the parking brake

Slightly raise the lever and lower it completely while pressing the button.

#### ▶ Automatic transmission

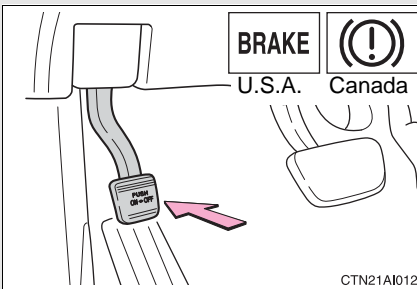

#### Sets the parking brake\*

(Depressing the pedal again releases the parking brake.)

\*: Fully depress the parking brake pedal with your left foot while depressing the brake pedal with your right foot.

 NOTICE

■ **Before driving**

Fully release the parking brake.

Driving the vehicle with the parking brake set will lead to brake components overheating, which may affect braking performance and increase brake wear.

## 2-2. Instrument cluster Gauges and meters

### ► Vehicles with multi-information display

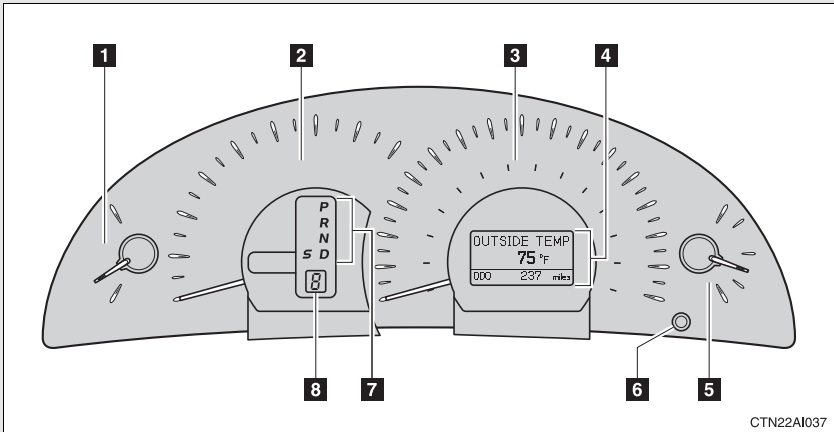

### ► Vehicles with smart key system

The following gauges, meters and displays illuminate when the “ENGINE START STOP” switch is in IGNITION ON mode.

### ► Vehicles without smart key system

The following gauges, meters and displays illuminate when the engine switch is in “ON” position.

#### **1** Engine coolant temperature gauge

Displays the engine coolant temperature.

#### **2** Tachometer

Displays the engine speed in revolutions per minute.

#### **3** Speedometer

Displays the vehicle speed.

#### **4** Multi-information display

→P. 149

#### **5** Fuel gauge

Displays the quantity of fuel remaining in the tank.

**6** Odometer/trip meter/instrument panel light control and trip meter reset button

Switches between odometer and trip meter displays. Pressing and holding the button will reset the trip meter when the trip meter is being displayed. To adjust the brightness of the instrument panel light, turn the button. (→P. 144)

**7** Automatic transmission shift position indicator lights

→P. 133

**8** Automatic transmission shift range display (if equipped)

→P. 133

► Vehicles without multi-information display

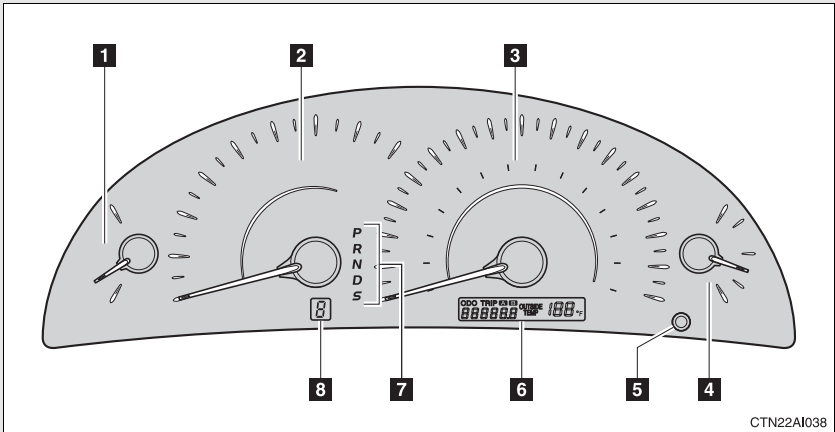

The following gauges, meters and displays illuminate when the engine switch is in “ON” position.

- 1** Engine coolant temperature gauge  
Displays the engine coolant temperature.
- 2** Tachometer  
Displays the engine speed in revolutions per minute.
- 3** Speedometer  
Displays the vehicle speed.
- 4** Fuel gauge  
Displays the quantity of fuel remaining in the tank.
- 5** Odometer/trip meter/instrument panel light control and trip meter reset button  
Switches between odometer and trip meter displays. Pressing and holding the button will reset the trip meter when the trip meter is being displayed. To adjust the brightness of the instrument panel light, turn the button. (→P. 144)

**6** Odometer, trip meter and outside temperature display

Odometer: Displays the total distance the vehicle has been driven.

Trip meter: Displays the distance the vehicle has been driven since the meter was last reset. Trip meters A and B can be used to record and display different distances independently.

Outside temperature: Displays the outside temperature.

**7** Automatic transmission shift position indicator lights

→P. 133

**8** Automatic transmission shift range display (if equipped)

→P. 133

### Instrument panel light control

The brightness of the instrument panel lights can be adjusted.

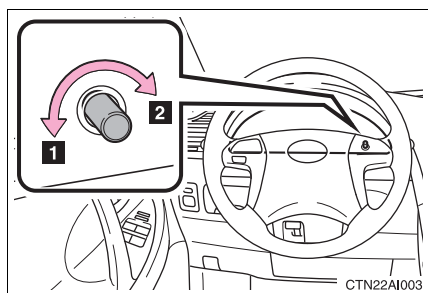

**1** Darker

**2** Brighter

When the headlight switch is turned to on, the brightness will be reduced slightly unless the control dial is turned fully clockwise.

### NOTICE

**■ To prevent damage to the engine and its components**

- Do not let the indicator needle of the tachometer enter the red zone, which indicates the maximum engine speed.
- The engine may be overheating if the engine coolant temperature gauge is in the red zone (H). In this case, immediately stop the vehicle in a safe place, and check the engine after it has cooled completely. (→P. 421)



# Indicators and warning lights

The indicator and warning lights on the instrument cluster and center panel inform the driver of the status of the vehicle's various systems.

► Instrument cluster (vehicles with multi-information display)

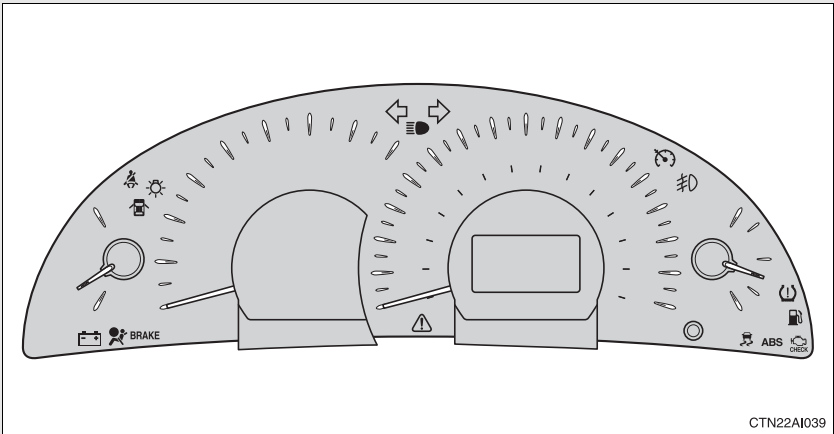

► Instrument cluster (vehicles without multi-information display)

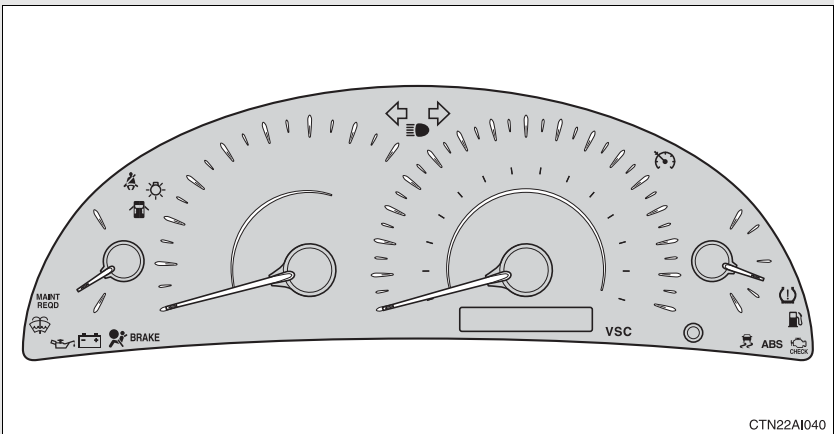

► Center panel

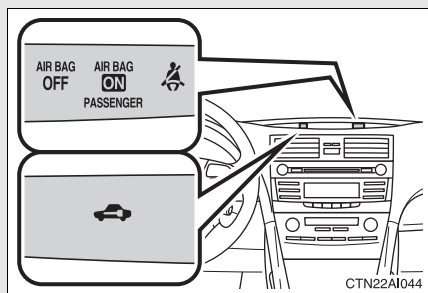

## ■ Indicators

The indicators inform the driver of the operating state of the vehicle's various systems.



Turn signal indicator  
(→P. 138)



Headlight high beam indicator (→P. 153)



<sup>\*</sup> Slip indicator  
(→P. 162)



(if equipped)

Engine immobilizer/theft deterrent system indicator (→P. 77, 79)



(U.S.A.)

Headlight indicator  
(→P. 152)



(CANADA)

Tail light indicator  
(→P. 152)



(if equipped)

Front fog light indicator  
(→P. 156)



<sup>\*</sup> SRS airbag on-off indicator (→P. 96)



Cruise control indicator  
(→P. 159)

## ■ Warning lights

Warning lights inform the driver of malfunctions in any of the vehicle's systems. (→P. 381)

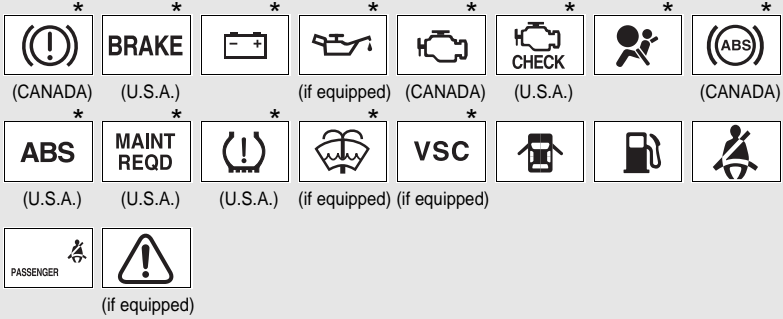

\*: These lights turn on when the “ENGINE START STOP” switch is turned to IGNITION ON mode (vehicles with smart key system) or the engine switch is turned to “ON” position (vehicles without smart key system) to indicate that a system check is being performed. They will turn off after the engine is started, or after a few seconds. There may be a malfunction in a system if a light does not come on, or if the lights do not turn off. Have the vehicle inspected by your Toyota dealer for details.

## ⚠ CAUTION

### ■ If a safety system warning light does not come on

Should a safety system light such as the ABS or the SRS airbag warning light not come on when you start the engine, this could mean that these systems are not available to help protect you in an accident, which could result in death or serious injury. Have the vehicle inspected by your Toyota dealer immediately if this occurs.

## Multi-information display (if equipped)

The multi-information display presents the driver with a variety of driving-related data, including the outside temperature.

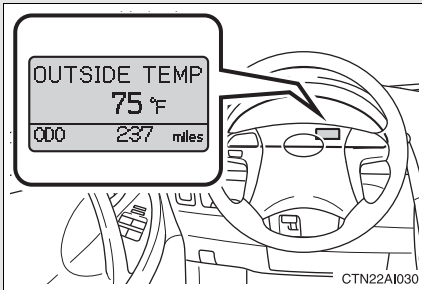

- Outside temperature display (→P. 150)

Indicates the outside temperature.

- Trip information (→P. 150)

Displays driving range, fuel consumption and other cruising-related information.

- Warning messages (→P. 391)

Automatically displayed when a malfunction occurs in one of the vehicle's systems.

- Odometer and trip meter display

Odometer: Displays the total distance the vehicle has been driven.

Trip meter: Displays the distance the vehicle has been driven since the meter was last reset. Trip meters A and B can be used to record and display different distances independently.

## Switch the display

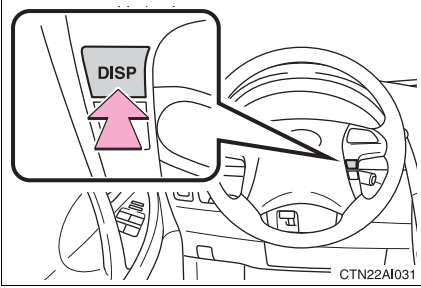

Display items can be switched by pressing the “DISP” button.

The display will return to the outside temperature display when the “DISP” button is pressed and held.

### ● Outside temperature

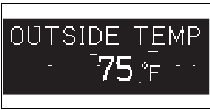

Displays the outside air temperature.

The temperature range that can be displayed is from -40°F (-40°C) to 122°F (50°C).

### ● Cruising range



Displays the estimated maximum distance that can be driven with the quantity of fuel remaining.

- This distance is computed based on your average fuel consumption. As a result, the actual distance that can be driven may differ from that displayed.
- When only a small amount of fuel is added to the tank, the display may not be updated.

### ● Average fuel consumption after refueling

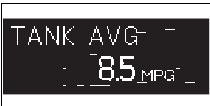

Displays the average fuel consumption since the vehicles was last refueled.

- Driving distance



Displays the driving distance since the engine was started.

- Average vehicle speed

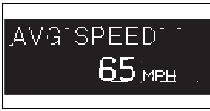

Displays the average vehicle speed since the engine was started.

- Cruise information off



Displays the odometer and trip meters only.

- Zoom display of odometer and trip meter

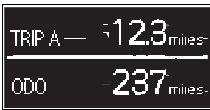

Displays the odometer and one of the trip meters simultaneously.

 NOTICE

**■ The multi-information display at low temperatures**

Allow the interior of the vehicle to warm up before using the liquid crystal information display. At extremely low temperatures, the information display monitor may respond slowly, and display changes may be delayed.

## Headlight switch

The headlights can be operated manually or automatically.

► For U.S.A.

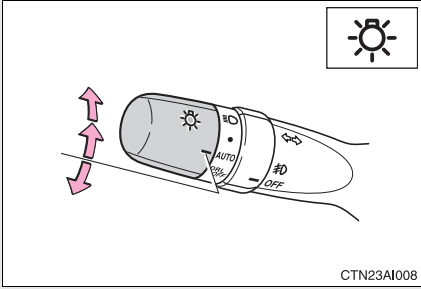

**AUTO** The headlights and parking lights turn on and off automatically.

● The side marker, parking, tail, license plate and instrument panel lights turn on.

 The headlights and all lights listed above turn on.

**DRL OFF** Daytime running light system is off.

► For Canada

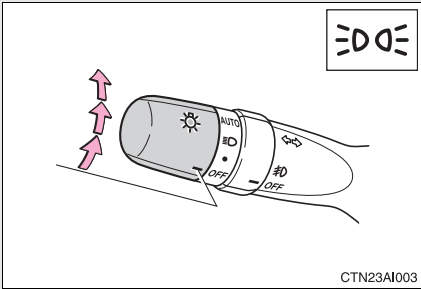

● The side marker, parking, tail, license plate and instrument panel lights turn on.

 The headlights and all lights listed above turn on.

**AUTO** The headlights and parking lights turn on and off automatically.



## Turning on the high beam headlights

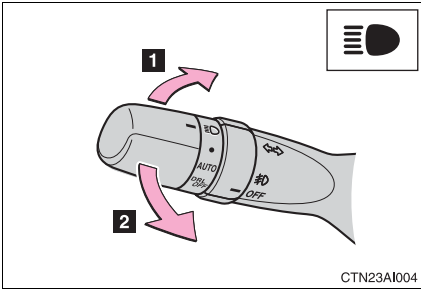

**1** With the headlights on, push the lever forward to turn on the high beams.

Pull the lever back to the center position to turn the high beams off.

**2** Pull the lever toward you to turn on the high beams.

Release the lever to turn them off. You can flash the high beams with the headlights on or off.

■ **The headlights can be operated automatically when**

- ▶ Vehicles with smart key system

The “ENGINE START STOP” switch is in IGNITION ON mode.

- ▶ Vehicles without smart key system

The engine switch is in “ON” position.

■ **Daytime running light system**

To make your vehicle more visible to other drivers, the headlights turn on automatically (at a reduced intensity) whenever the engine is started and the parking brake is released. Daytime running lights are not designed for use at night.

For U.S.A.: Daytime running lights can be turned off by operating the switch.

■ **Headlight control sensor**

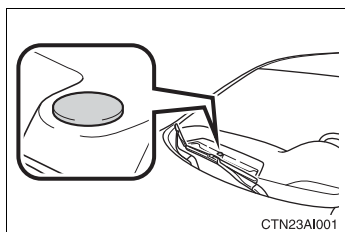



The sensor may not function properly if an object is placed on the sensor, or anything that blocks the sensor is affixed to the windshield.

Doing so interferes with the sensor detecting the level of ambient light and may cause the automatic headlight system to malfunction.

### ■ Automatic light off system

#### ▶ Vehicles with smart key system



- When the headlights are on: The headlights and tail lights turn off 30 seconds after all doors are closed with the “ENGINE START STOP” switch OFF. (The lights turn off immediately if the  on the key is pressed after all doors are locked.)
- When only the tail lights are on: The tail lights turn off automatically if the “ENGINE START STOP” switch is turned OFF and the driver’s door is opened.

To turn the lights on again, turn the “ENGINE START STOP” switch to IGNITION ON mode, or turn the headlight switch off and then back to the  or  position.

If any of the doors or trunk lid is kept open, the lights automatically turn off after 20 minutes.

#### ▶ Vehicles without smart key system

- When the headlights are on: The headlights and tail lights turn off 30 seconds after all doors are closed with the engine switch OFF. (The lights turn off immediately if the  on the key is pressed after all doors are locked.)
- When only the tail lights are on: The tail lights turn off automatically if the engine switch is turned OFF and the driver’s door is opened.

To turn the lights on again, turn the engine switch to “ON” position, or turn the headlight switch off and then back to the  or  position.

If any of the doors or trunk lid is kept open, the lights automatically turn off after 20 minutes.

### ■ Customization that can be configured at Toyota dealer

Settings (e.g. Light sensor sensitivity) can be changed. (Customizable features →P. 454)

#### NOTICE

#### ■ To prevent battery discharge

Do not leave the lights on longer than necessary when the engine is not running.

## 2-3. Operating the lights and wipers

### Fog light switch (if equipped)

The fog lights improve visibility in difficult driving conditions, such as in rain or fog. They can be turned on only when the headlights are on low beam.

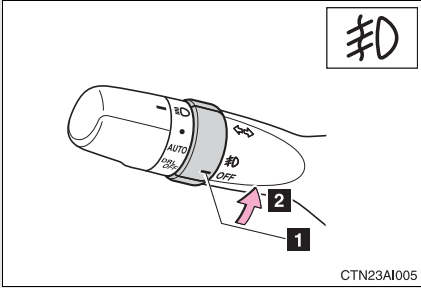

- 1** Off
- 2** Front fog lights on

## 2-3. Operating the lights and wipers Windshield wipers and washer

**Wiper intervals can be adjusted for intermittent operation (when “INT” is selected).**

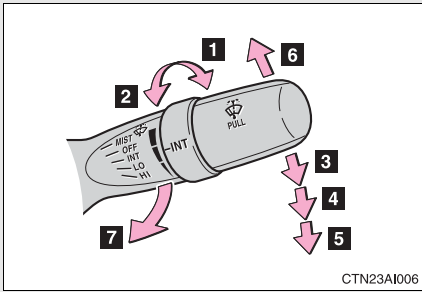

- 1** Intermittent windshield wiper interval adjustment (increase)
- 2** Intermittent windshield wiper interval adjustment (decrease)
- 3** Intermittent windshield wiper operation
- 4** Low speed windshield wiper operation
- 5** High speed windshield wiper operation
- 6** Temporary operation
- 7** Wash/wipe operation

Wipers operate automatically.

### ■ The windshield wiper and washers can be operated when

- ▶ Vehicles with smart key system

The “ENGINE START STOP” switch is in IGNITION ON mode.

- ▶ Vehicles without smart key system

The engine switch is in “ON” position.

### ■ If no windshield washer fluid sprays

Check that the washer nozzles are not blocked and if there is washer fluid in the windshield washer fluid reservoir.

 NOTICE

■ **When the windshield is dry**

Do not use the wipers, as they may damage the windshield.

■ **When there is no washer fluid spray from the nozzle**

Damage to the washer fluid pump may be caused if the lever is pulled toward you and held continually.

■ **When a nozzle becomes blocked**

Do not try to clear it with a pin or other object. The nozzle will be damaged.

## 2-4. Using other driving systems

### Cruise control

Use cruise control to maintain a set speed without using the accelerator.

#### ■ Set the vehicle speed

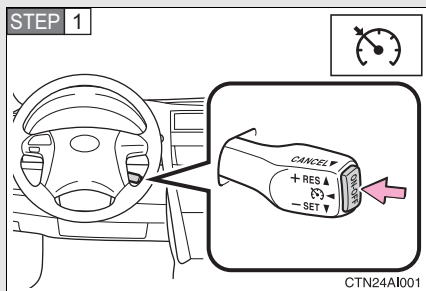

Press the “ON-OFF” button to activate the cruise control.

Press the button once more to deactivate the cruise control.

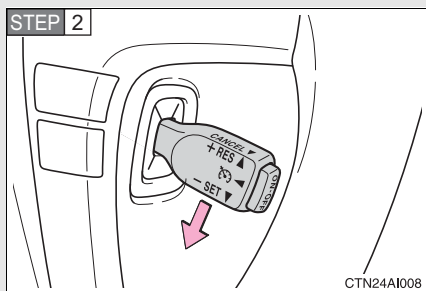

Accelerate or decelerate to the desired speed and push the lever down to set the cruise control speed.

#### ■ Adjusting the speed setting

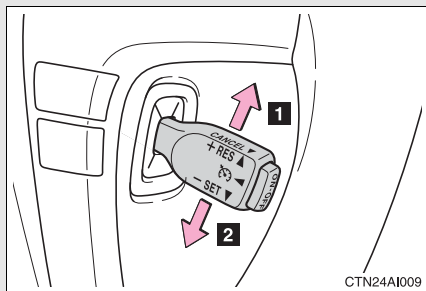

**1** Increase speed

**2** Decrease speed

Hold the lever until the desired speed setting is obtained.

Fine adjustment of the set speed can be made by lightly pushing the lever up or down and releasing it.

### ■ Canceling and resuming regular acceleration

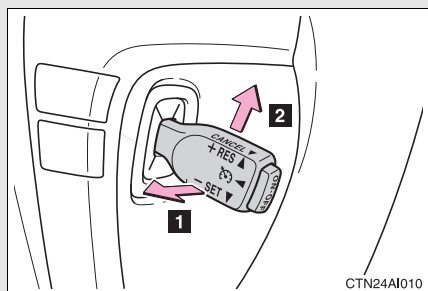

#### 1 Cancel

Pull the lever towards you to cancel cruise control.

The speed setting is also canceled when the brakes are applied or the clutch pedal (manual transmission) is depressed.

#### 2 Resume

To resume cruise control and return to the set speed, push the lever up.

### ■ Fine adjustment of the set speed

Adjustment of the set speed by approximately 1.0 mph (1.6 km/h) can be made by lightly pressing the lever up or down and releasing it.

### ■ Cruise control can be set when

- Automatic transmission:  
The shift lever is in D or 4 (standard type), or in D, 4, 5 or 6 range of S (multi-mode type).
- Vehicle speed is above 25 mph (40 km/h).

### ■ Accelerating

The vehicle can be accelerated normally.



### ■ Automatic cruise control cancellation

The set speed is automatically canceled in any of the following situations.

- Actual vehicle speed falls more than 10 mph (16 km/h) below the preset vehicle speed.  
At this time, the memorized set speed is not retained.
- Actual vehicle speed is below 25 mph (40 km/h).
- VSC is activated.

### ■ If the cruise control indicator light flashes

Press the “ON-OFF” button once to deactivate the system, and then press the button again to reactivate the system.

If the cruise control speed cannot be set or if the cruise control cancels immediately after being activated, there may be a malfunction in the cruise control system. Contact your Toyota dealer and have your Toyota inspected.

## CAUTION

### ■ To avoid operating the cruise control by mistake

Keep the “ON-OFF” button off when not in use.

### ■ Situations unsuitable for cruise control

Do not use cruise control in any of the following situations.

Doing so may result in control of the vehicle being lost and could cause serious or fatal accident.

- In heavy traffic
- On roads with sharp bends
- On winding roads
- On slippery roads, such as those covered with rain, ice or snow
- On steep hills

## 2-4. Using other driving systems

### Driving assist systems

To help enhance driving safety and performance, the following systems operate automatically in response to various driving situations. Be aware, however, that these systems are supplementary and should not be relied upon too heavily when operating the vehicle.

#### ■ ABS (Anti-lock Brake System)

Restrains the vehicle from slipping when driving on slick road surfaces or in the event of sudden braking.

#### ■ Brake assist

Generates an increased level of braking force after the brake pedal is depressed, when the system detects a panic stop situation.

#### ■ VSC (Vehicle Stability Control) (if equipped)

Helps the driver to control skidding when swerving suddenly or turning on slippery road surfaces.

#### ■ TRAC (Traction Control) (if equipped)

Maintains drive power and prevents the front wheels from spinning when starting the vehicle or accelerating on slippery roads.

### When VSC and TRAC are operating

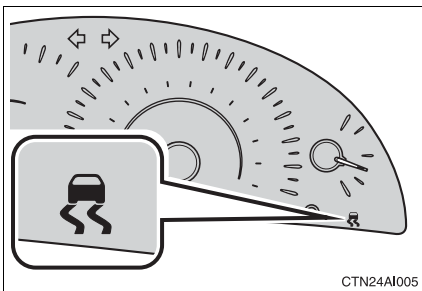

If the vehicle is in danger of slipping or the front wheels spin, the indicator flashes to indicate that VSC/TRAC have been engaged.

A buzzer (intermittent) sounds to indicate that VSC is operating.

### ■ Sounds and vibrations caused by ABS, brake assist, VSC and TRAC

- A sound may be heard from the engine compartment when the engine is started or just after the vehicle begins to move. This sound does not indicate that a malfunction has occurred in any of these systems.
- Any of the following conditions may occur when the above systems are operating. None of these indicates that a malfunction has occurred.
  - Vibrations may be felt through the vehicle body and steering.
  - A motor sound may be heard after the vehicle comes to a stop.
  - The brake pedal may pulsate slightly after ABS is activated.
  - The brake pedal may move down slightly after ABS is activated.

### CAUTION

#### ■ ABS does not operate effectively when

- Tires with inadequate gripping ability are used (such as excessively worn tires on a snow covered road).
- The vehicle hydroplanes while driving at high speed on the wet or slick road.

#### ■ Stopping distance when ABS is operating on the wet or slick roads

ABS is not designed to shorten the vehicle's stopping distance. Always maintain a safe distance from the vehicle in front of you in the following situations.

- When driving on dirt, gravel or snow-covered roads
- When driving with tire chains
- When driving over bumps in the road
- When driving over roads with potholes or uneven roads

#### ■ TRAC may not operate effectively when

Directional control and power may not be achievable while driving on slippery road surfaces, even if the TRAC system is operating.  
Do not drive the vehicle in conditions where stability and power may be lost.

 **CAUTION**

■ **When VSC is activated**

The slip indicator light flashes and a warning buzzer sounds. Always drive carefully. Reckless driving may cause an accident. Exercise particular care when the indicator light flashes and a buzzer sounds.

■ **Replacing tires**

Make sure that all tires are of the same size, brand, tread pattern and total load capacity. In addition, make sure that the tires are inflated to the recommended tire pressure level.

The ABS and VSC system will not function correctly if different tires are fitted on the vehicle.

Contact your Toyota dealer for further information when replacing tires or wheels.

■ **Handling of tires and suspension**

Using tires with any kind of problem or modifying the suspension will affect the driving assist systems, and may cause the system to malfunction.

## 2-5. Driving information

# Cargo and luggage

**Take notice of the following information about storage precautions, cargo capacity and load.**

- Stow cargo and luggage in the trunk whenever possible.
- Be sure all items are secured in place.
- Be careful to keep the vehicle level. Placing the weight as far forward as possible helps maintain vehicle balance.
- For better fuel economy, do not carry unnecessary weight.

### Capacity and distribution

Cargo capacity depends on the total weight of the occupants.

(Cargo capacity) = (Total load capacity) - (Total weight of occupants)

#### **Steps for Determining Correct Load Limit —**

- (1) Locate the statement “The combined weight of occupants and cargo should never exceed XXX kg or XXX lbs.” on your vehicle’s placard.
- (2) Determine the combined weight of the driver and passengers that will be riding in your vehicle.
- (3) Subtract the combined weight of the driver and passengers from XXX kg or XXX lbs.
- (4) The resulting figure equals the available amount of cargo and luggage load capacity.

For example, if the XXX amount equals 1400 lbs. and there will be five 150 lb passengers in your vehicle, the amount of available cargo and luggage load capacity is 650 lbs. (1400 - 750 (150 × 5) = 650 lbs.)

- (5) Determine the combined weight of luggage and cargo being loaded on the vehicle. That weight may not safely exceed the available cargo and luggage load capacity calculated in Step 4.

- (6) If your vehicle will be towing a trailer, load from your trailer will be transferred to your vehicle. Consult this manual to determine how this reduces the available cargo and luggage load capacity of your vehicle. (→P. 173)

### Example on your vehicle

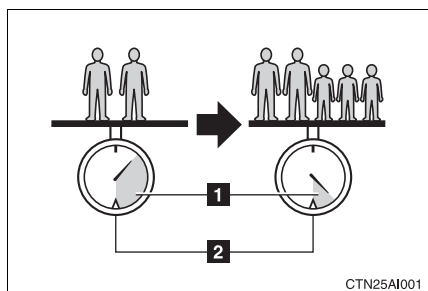

- 1** Cargo capacity
- 2** Total load capacity

When 2 people with the combined weight of 366 lb. (166 kg) are riding in your vehicle, which has a total load capacity of 900 lb. (410 kg), the available amount of cargo and luggage load capacity will be as follows:

$$900 \text{ lb.} - 366 \text{ lb.} = 534 \text{ lb.} \quad (410 \text{ kg} - 166 \text{ kg} = 244 \text{ kg})$$

In this condition, if 3 more passengers with the combined weight of 388 lb. (176 kg) get on, the available cargo and luggage load will be reduced as follows:

$$534 \text{ lb.} - 388 \text{ lb.} = 146 \text{ lb.} \quad (244 \text{ kg} - 176 \text{ kg} = 68 \text{ kg})$$

As shown in the above example, if the number of occupants increases, the cargo and luggage load will be reduced by an amount that equals the increased weight due to the additional occupants. In other words, if an increase in the number of occupants causes an excess of the total load capacity (combined weight of occupants plus cargo and luggage load), you must reduce the cargo and luggage on your vehicle.

 CAUTION**■ Storage precautions**

- Vehicles with fold-down type rear seat: To prevent cargo and luggage from sliding forward during braking, do not stack anything in the enlarged trunk. Keep cargo and luggage low, as close to the floor as possible.
- Vehicles with fold-down type rear seat: Never allow anyone to ride in the enlarged trunk. It is not designed for passengers. They should ride in their seats with their seat belts properly fastened. Otherwise, they are much more likely to suffer death or serious bodily injury, in the event of sudden braking or a collision.
- Do not place anything on the package tray behind the rear seatback. Such items may be thrown about and possibly injure people in the vehicle during sudden braking or in an accident.
- Do not drive with objects on top of the instrument panel. They may interfere with the driver's field of view or move during sharp acceleration or turning, thus impairing the driver's control of the vehicle. In an accident they may injure the vehicle occupants.
- Secure all items in the occupant compartment, as they may shift and injure someone during an accident or sudden braking.

**■ Capacity and distribution**

- Do not exceed the maximum axle weight rating or the total vehicle weight rating.
- Even if the total load of occupant's weight and the cargo load is less than the total load capacity, do not apply the load unevenly. Improper loading may cause deterioration of steering or braking control which may cause death or serious injury.

## 2-5. Driving information

### Vehicle load limits

**Vehicle load limits include total load capacity, seating capacity, towing capacity and cargo capacity.**

■ **Total load capacity: 900 lb. (410 kg)**

Total load capacity means the combined weight of occupants, cargo and luggage.

■ **Seating capacity: 5 occupants (Front 2, Rear 3)**

Seating capacity means the maximum number of occupants whose estimated average weight is 150 lb. (68 kg) per person.

■ **Towing capacity: 1000 lb. (453 kg)**

■ **Cargo capacity**

Cargo capacity may increase or decrease depending on the weight and the number of occupants.

---

■ **Total load capacity and seating capacity**

These details are also described on the tire and loading information label. (→P. 344)

 **CAUTION**

■ **Overloading the vehicle**

Do not overload the vehicle.

It may not only cause damage to the tires, but also degrade steering and braking ability, resulting in an accident.



**Carry out the necessary preparations and inspections before driving the vehicle in winter. Always drive the vehicle in a manner appropriate to the prevailing weather conditions.**

■ **Pre-winter preparations**

- Use fluids that are appropriate to the prevailing outside temperatures.
  - Engine oil
  - Engine coolant
  - Washer fluid
- Have a service technician inspect the level and specific gravity of battery electrolyte.
- Have the vehicle fitted with four snow tires or purchase a set of tire chains for the front tires.

Ensure that all tires are the same size and brand, and that chains match the size of the tires.

■ **Before driving the vehicle**

Perform the following according to the driving conditions.

- Do not try to forcibly open a window or move a wiper that is frozen. Pour warm water over the frozen area to melt the ice. Wipe away the water immediately to prevent it from freezing.
- To ensure proper operation of the climate control system fan, remove any snow that has accumulated on the air inlet vents in front of the windshield.
- Remove any ice that has accumulated on the vehicle chassis.
- Periodically check for and remove any excess ice or snow that may have accumulated in the wheel well or on the brakes.

### ■ When driving the vehicle

Accelerate the vehicle slowly and drive at a reduced speed suitable to road conditions.

### ■ When parking the vehicle

Park the vehicle and move the shift lever to P (automatic transmission) or R (manual transmission) without setting the parking brake. The parking brake may freeze up, preventing it from being released.

## Selecting tire chains

Use the correct tire chain size when mounting the snow chains. Chain size is regulated for each tire size.

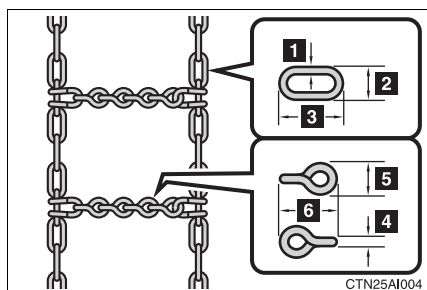

Side chain:

- 1 0.12 in. (3 mm) in diameter
- 2 0.39 in. (10 mm) in width
- 3 1.18 in. (30 mm) in length

Cross chain:

- 4 0.16 in. (4 mm) in diameter
- 5 0.55 in. (14 mm) in width
- 6 0.98 in. (25 mm) in length

## Regulations on the use of snow chains

- Regulations regarding the use of tire chains vary according to location and type of road. Always check local regulations before installing chains.
- Install the chains on the front tires.
- Retighten the chains after driving 1/4 - 1/2 mile (0.5 - 1.0 km).

### ■ Tire chains

Observe the following precautions when installing and removing chains.

- Install and remove tire chains in a safe location.
- Install tire chains on the front tires only. Do not install tire chains on rear tires.
- Install tire chains following the instructions provided in the accompanying manual.

### CAUTION

#### ■ Driving with snow tires

Observe the following precautions to reduce the risk of accidents.

Failing to do so may result in a loss of vehicle control and cause death or serious injury.

- Use tires of the size specified for your vehicle.
- Maintain the recommended level of air pressure.
- Do not drive in excess of 75 mph (120 km/h), regardless of the type of snow tires being used.
- Use snow tires on all, not just some wheels.

#### ■ Driving with tire chains

Observe the following precautions to reduce the risk of accidents.

Failing to do so may result in the vehicle being unable to be driven safely, and may cause death or serious injury.

- Do not drive in excess of the speed limit specified for the tire chains being used or 30 mph (50 km/h), whichever is lower.
- Avoid driving on bumpy road surfaces or over potholes.
- Avoid sudden turns and braking, as use of chains may adversely affect vehicle handling.
- Slow down sufficiently before entering a curve to ensure that vehicle control is maintained.

 NOTICE

■ **Repairing or replacing snow tires**

Request repairs of and obtain replacement snow tires from Toyota dealers or legitimate tire retailers.

This is because the removal and attachment of snow tires affects the operation of the tire pressure warning valves and transmitters.

■ **Fitting tire chains**

The tire pressure warning valves and transmitters may not function correctly when tire chains are fitted.

## Trailer towing

Your vehicle is designed primarily as a passenger carrying vehicle. Towing a trailer will have an adverse effect on handling, performance, braking, durability, and fuel consumption. For your safety and the safety of others, do not overload the vehicle or trailer.

Toyota warranties do not apply to damage or malfunction caused by towing a trailer for commercial purposes.

### ■ Weight limits

Confirm that the total trailer weight, gross vehicle weight, gross axle weight and trailer tongue load are all within the limits.

### ■ Gross vehicle weight

The gross vehicle weight must not exceed the Gross Vehicle Weight Rating (GVWR) indicated on the Certification Label. The gross vehicle weight is the sum weight of the unloaded vehicle, driver, passengers, luggage, hitch and trailer tongue load. Also included is the weight of any special equipment installed on your vehicle.

### ■ Gross axle weight

The load on either the front or rear axle resulting from distribution of the gross vehicle weight on both axles must not exceed the Gross Axle Weight Rating (GAWR) listed on the Certification Label.

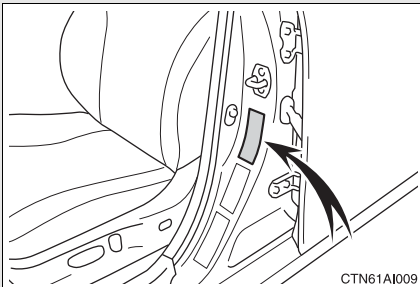

Certification label

### ■ Trailer tongue load

The trailer cargo load should be distributed so that the tongue load is 9 to 11% of the total trailer weight, not exceeding the maximum 100 lb. (45 kg). (Tongue load / Total trailer weight x 100 = 9 to 11%)

The total trailer weight and tongue load can be measured with platform scales found at highway weighing stations, building supply companies, trucking companies, junk yards, etc.

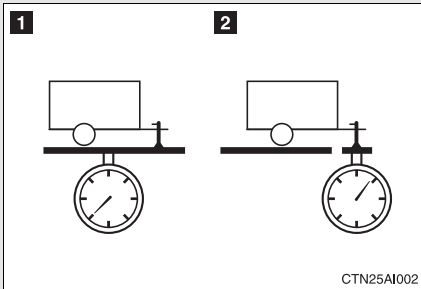

1 Total trailer weight

2 Tongue load

## Towing a trailer

Contact your Toyota dealer for further information about additional requirements such as a towing kits, etc.

## Hitch

Trailer hitch assemblies have different weight capacities established by the hitch manufacturer. Even though the vehicle may be rated for towing a higher weight, the operator must never exceed the maximum weight rating specified for the trailer hitch.

---

### ■ Before towing

- Ensure that your vehicle's tires are properly inflated. (→P. 344)
- Trailer tires should be inflated according to the trailer manufacturer's recommendation.
- All trailer lights must work in order to be legal.
- Confirm all lights work each time you connect them.
- Check that your vehicle remains level when a loaded or unloaded trailer is hitched. Do not drive if the vehicle is not level, and check for improper tongue load, overloading, worn suspension, or other possible causes.
- Make sure the trailer cargo is securely loaded.
- Check that your rear view mirrors conform to any federal, state/provincial or local regulations. If they do not, install rear view mirrors appropriate for towing purposes.

### ■ Break-in schedule

Toyota recommends that you do not use a new vehicle or a vehicle with any new power train components (engine, transmission, differential, wheel bearings, etc.) to tow a trailer for the first 500 miles (800 km) of driving.

### ■ Maintenance

- If you tow a trailer, your vehicle will require more frequent maintenance due to the additional load. (See “Scheduled Maintenance Guide” or “Owner's Manual Supplement”.)
- Retighten the fixing bolts of the towing ball and bracket after approximately 600 miles (1000 km) of trailer towing.

 **CAUTION**

■ **To avoid accident or injury**

- The total trailer weight (trailer weight plus the weight of cargo) must not exceed 1000 lb. (453 kg).
- Do not exceed the trailer hitch assembly weight, gross vehicle weight, gross axle weight and trailer tongue load capacities.
- Never load more weight in the back than in the front of the trailer. About 60% of the load should be in the front half of the trailer, and the remaining 40% in the rear.

■ **Hitches**

- If you wish to install a trailer hitch, contact your Toyota dealer.
- Use only a hitch that conforms to the total trailer weight requirement.
- Follow the directions supplied by the hitch manufacturer.
- Lubricate the hitch ball with a light coat of grease.
- Remove the trailer hitch whenever you are not towing a trailer. After removing the hitch, seal any mounting hole in the vehicle body to prevent entry of any substances into the vehicle.

■ **When towing a trailer**

- Never tap into your vehicle's hydraulic system, as this will lower the vehicle's braking effectiveness.
- Never tow a trailer without using a safety chain securely attached to both the trailer and the vehicle. If damage occurs to the coupling unit or hitch ball, there is danger of the trailer wandering into another lane.



 NOTICE**■ When installing a trailer hitch**

- Use only the position recommended by your Toyota dealer. Do not install the trailer hitch on the bumper; this may cause body damage.
- Do not use axle-mounted hitches, as they can cause damage to the axle housing, wheel bearings, wheels or tires.

**■ Brakes**

Toyota recommends trailers with brakes that conform to all applicable federal and state/provincial regulations.

**■ Safety chain**

A safety chain must always be used between the towing vehicle and the trailer. Leave sufficient slack in the chain for turns. The chain should cross under the trailer tongue to prevent the tongue from dropping to the ground in the case that it becomes damaged or separated. For the correct safety chain installation procedure, ask your Toyota dealer.

**■ Do not directly splice trailer lights**

Directly splicing trailer lights may damage your vehicle's electrical system and cause a malfunction.

**Trailer towing tips**

Your vehicle will handle differently when towing a trailer. The 3 main causes of vehicle-trailer accidents are driver error, excessive speed and improper trailer loading. Keep the following in mind when towing.

- Before starting out, check the trailer lights and the vehicle-trailer connections. Recheck after driving a short distance.
- Practice turning, stopping and reversing with the trailer attached in an area away from traffic until you become accustomed to the feel of the vehicle.

- Reversing with a trailer attached is difficult and requires practice. Grip the bottom of the steering wheel and move your hand to the left to move the trailer to the left. Move your hand to the right to move the trailer to right. (This is generally opposite to reversing without a trailer attached.) Avoid sharp or prolonged turning. Have someone guide you when reversing to reduce the risk of an accident.
- As stopping distance is increased when towing a trailer, vehicle-to-vehicle distance should be increased. For each 10 mph (16 km/h) of speed, allow at least one vehicle and trailer length.
- Avoid sudden braking as you may skid, resulting in jackknifing and loss of control. This is especially true on wet or slippery surfaces.
- Avoid jerky starts or sudden acceleration.
- Avoid jerky steering and sharp turns, and slow down before making turns.
- Note that when making a turn, the trailer wheels will be closer than the vehicle wheels to the inside of the turn. Compensate by making a larger than normal turning radius.
- Crosswinds and rough roads will adversely affect handling of your vehicle and trailer, causing sway. Periodically check the rear to prepare for being passed by large trucks or buses, which may cause your vehicle and trailer to sway. If swaying occurs, firmly grip the steering wheel, reduce speed immediately but gradually, and steer straight ahead. Never increase speed. If you make no extreme correction with the steering or brakes, your vehicle and trailer will stabilize.
- Take care when passing other vehicles. Passing requires considerable distance. After passing a vehicle, do not forget the length of your trailer, and be sure you have plenty of room before changing lanes.

- In order to maintain efficient engine braking and electrical charging performance, do not use overdrive (automatic transmission) or the 5th gear (manual transmission).
- Due to the added load of the trailer, your vehicle's engine may overheat on hot days (at temperatures over 85°F [30°C]) when driving up a long or steep grade. If the engine coolant temperature gauge indicates overheating, immediately turn off the air conditioning (if in use), pull your vehicle off the road and stop in a safe spot. (→P. 421)
- Always place wheel blocks under both the vehicle and the trailer wheels when parking. Apply the parking brake firmly, and put the transmission in P (automatic transmission) or in first or R (manual transmission). Avoid parking on a slope, but if unavoidable, do so only after performing the following:

**STEP 1** Apply the brakes and keep them applied.

**STEP 2** Have someone place wheel blocks under both the vehicle and trailer wheels.

**STEP 3** When the wheel blocks are in place, release the brakes slowly until the blocks absorb the load.

**STEP 4** Apply the parking brake firmly.

**STEP 5** Shift into first or R (manual transmission) or P (automatic transmission) and turn off the engine.

- When restarting after parking on a slope:

**STEP 1** With the transmission in the P position (automatic transmission) or the clutch pedal (manual transmission) depressed, start the engine. On vehicles with an automatic transmission, be sure to keep the brake pedal pressed.

**STEP 2** Shift into a forward gear. If reversing, shift into the R position.

**STEP 3** Release the parking brake (also brake pedal on vehicles with automatic transmission), and slowly pull or back away from the wheel blocks. Stop and apply the brakes.

**STEP 4** Have someone retrieve the blocks.

 CAUTION

■ **To avoid an accident**

- Do not exceed 45 mph (72 km/h) or posted towing speed limit, whichever is lower. As instability (swaying) of the towing vehicle-trailer combination increases as speed increases, exceeding 45 mph (72 km/h) may cause loss of control.
- Slow down and downshift before descending steep or long downhill grades. Do not make sudden downshifts.
- Avoid holding the brake pedal down too long or applying the brakes too frequently. This could cause the brakes to overheat and result in reduced braking efficiency.

## Dinghy towing (automatic transmission)

Your vehicle is not designed to be dinghy towed (with 4 wheels on the ground) behind a motor home.

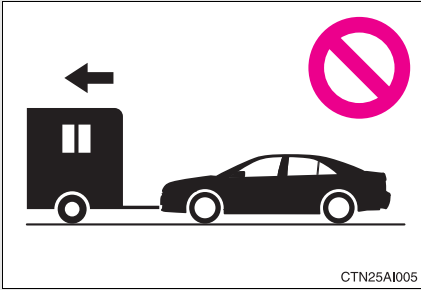

### NOTICE

**■ To avoid serious damage to your vehicle**

Do not tow your vehicle with four wheels on the ground.

## Dinghy towing (manual transmission)

Your vehicle can be dinghy towed in a forward direction (with 4 wheels on the ground) behind a motor home.

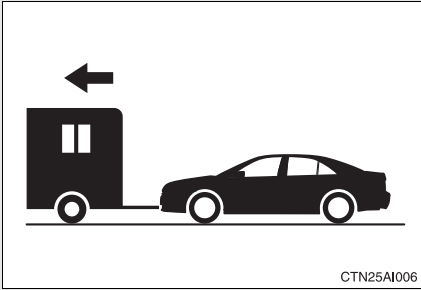

### Towing your vehicle with 4 wheels on the ground

To prevent damage to your vehicle, perform the following procedures before towing.

**STEP 1** Shift the shift lever to neutral.

**STEP 2** Switch to “ACC” position. (→P. 130)

Ensure that the audio system and other powered devices have been turned off.

**STEP 3** Release the parking brake.

After towing, leave the engine in idle for at least 3 minutes before driving the vehicle.

### ■ Necessary equipment and accessories

Specialized equipment and accessories are required for dinghy towing. Contact the service branch of the motor home manufacturer regarding recommended equipment.

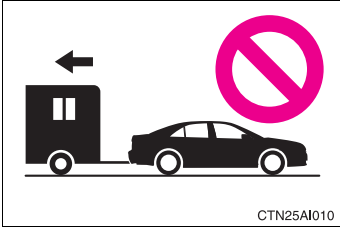
 NOTICE**■ Dinghy towing direction**

Do not tow the vehicle backwards.  
Doing so may cause serious damage.

**■ To prevent the steering from locking**

Ensure the engine switch is in “ACC” position.

---

<b>3-1. Using the air conditioning system and defogger...</b>	<b>186</b>
Automatic air conditioning system .....	186
Manual air conditioning system .....	194
Rear window and outside rear view mirror defoggers .....	199
<b>3-2. Using the audio system .....</b>	<b>201</b>
Audio system types .....	201
Using the radio .....	204
Using the CD player .....	210
Playing MP3 and WMA discs .....	217
Optimal use of the audio system .....	225
Using the AUX adapter ....	228
Using the steering wheel audio switches .....	229



## Interior features

# 3

- 3-3. Using the hands-free phone system (for cellular phone) ..... 232**
- Hands-free phone system (for cellular phone) features (CD player with changer only) ..... 232
  - Using the hands-free phone system (for cellular phone) ..... 235
  - Making a phone call ..... 244
  - Setting a cellular phone ... 248
  - Security and system setup ..... 253
  - Using the phone book ..... 257
- 3-4. Using the interior lights ..... 264**
- Interior lights list ..... 264
    - Interior light ..... 265
    - Personal lights ..... 266
- 3-5. Using the storage features ..... 267**
- List of storage features .... 267
    - Glove box ..... 268
    - Console box ..... 268
    - Cup holders ..... 270
    - Auxiliary boxes ..... 272
- 3-6. Other interior features ..... 275**
- Sun visors ..... 275
  - Vanity mirrors ..... 276
  - Clock ..... 277
  - Ashtrays ..... 278
  - Power outlet ..... 279
  - Seat heaters ..... 281
  - Armrest ..... 283
  - Rear sunshade ..... 284
  - Trunk storage extension (vehicles with reclining rear seat) ..... 285
  - Floor mat ..... 286
  - Trunk features ..... 287
  - Garage door opener ..... 288
  - Compass ..... 293

## 3-1. Using the air conditioning system and defogger Automatic air conditioning system

**Air outlets are automatically selected and fan speed is automatically adjusted according to the temperature setting.**

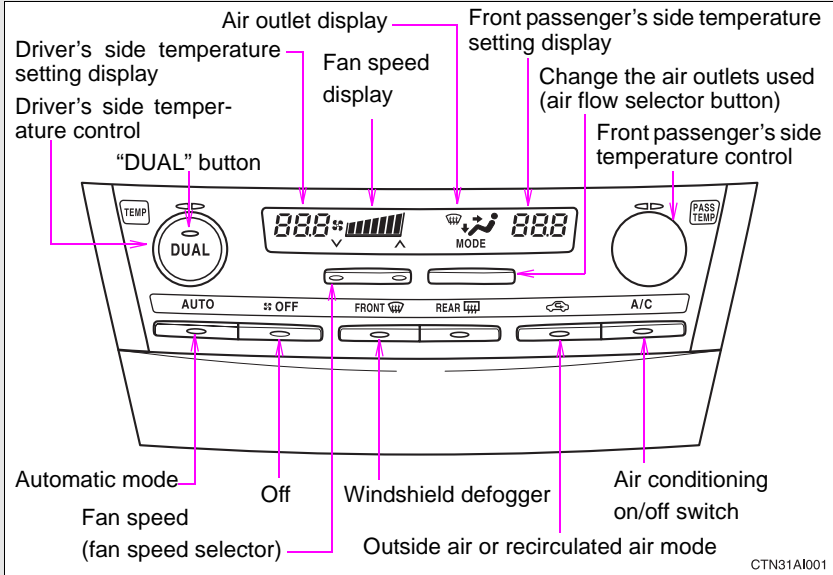

### Using the automatic mode

**STEP 1** Press .

The air conditioning system will begin to operate. Air outlets and fan speed are automatically adjusted according to the temperature setting.



**STEP 2** Turning  to the right increases the temperature and



turning  to the left decreases the temperature on the driver's side.

The temperature for the driver and passenger seats can be set separately. (→P. 187)

## Adjusting the settings

### ■ Adjusting the temperature setting

Turning  to the right increases the temperature and turning  to the left decreases the temperature on the driver's side.

Turn  to the right (increase) or  to the left (decrease) on the passenger's side to separately adjust the temperature for the passenger's and driver's side (dual mode). Press  to return the driver's and passenger's side temperatures to the same setting (simultaneous mode).

The air conditioning system switches between dual and simultaneous mode each time  is pressed.

### ■ Adjusting the fan speed

Press “^” (increase) or “v” (decrease) on the fan speed selector.

The fan speed is shown on the display. (7 levels)

Press  to turn the fan off.

### ■ Changing the air outlets

Press the air flow selector button.

The air outlets switch each time the button is pressed. The air flow shown on the display indicates the following.

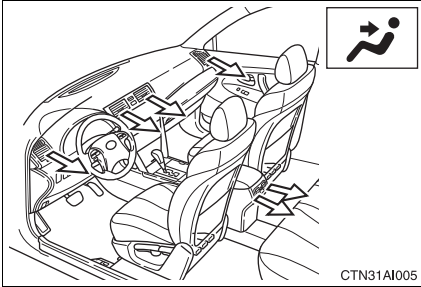

Air flows to the upper body.

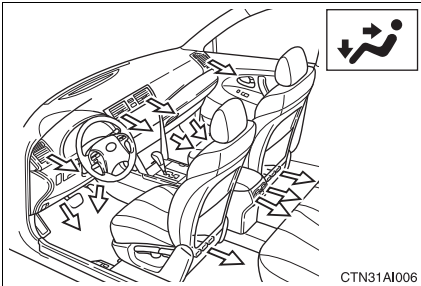

Air flows to the upper body and feet.

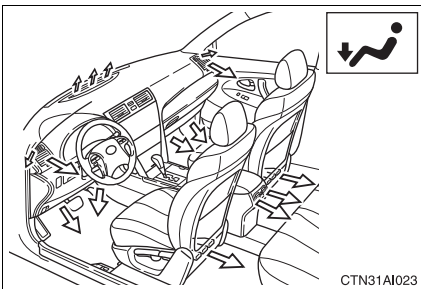

Air flows to the feet.

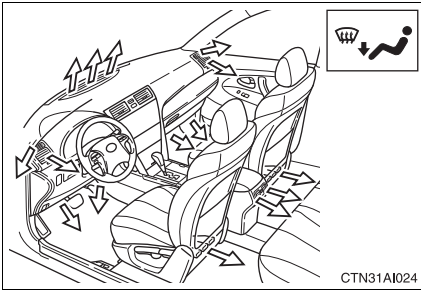

Air flows to the feet and the windshield defogger operates.

Recirculated air mode will automatically switch to outside air mode.

### ■ Switching between outside air and recirculated air modes

Press  .

The mode switches between outside air mode (indicator off) and recirculated air mode (indicator on) modes each time the button is pressed.

## Defogging the windshield

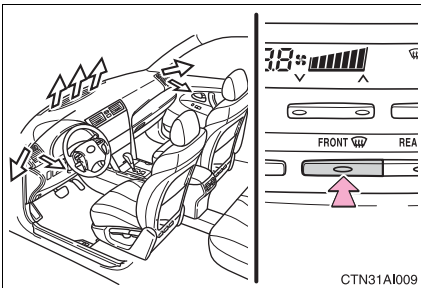

### Defogging

The air conditioning system control operates automatically.

Recirculated air mode will automatically switch to outside air mode. It is not possible to return to recirculated air mode when the switch is on.

## Adjusting the position of and opening and closing the air outlets

### ► Center outlets

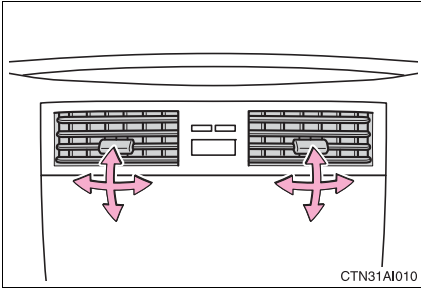

Direct air flow to the left or right, up or down.

### ► Right and left side outlets

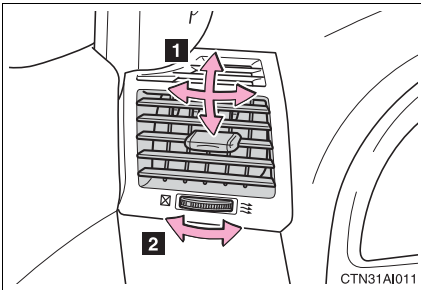

**1** Direct air flow to the left or right, up or down.

**2** Turn the knob right to open the vent and left to close the vent.

### ► Rear outlets

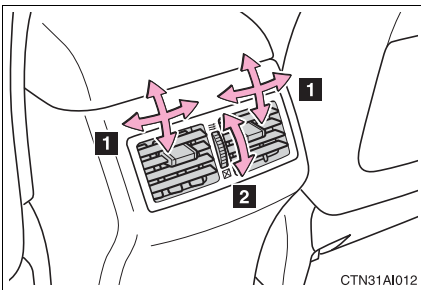

**1** Direct air flow to the left or right, up or down.

**2** Turn the knob up to open the vent and down to close the vent.

## Steering wheel switches

Some air conditioning features can be controlled using the switches on the steering wheel.

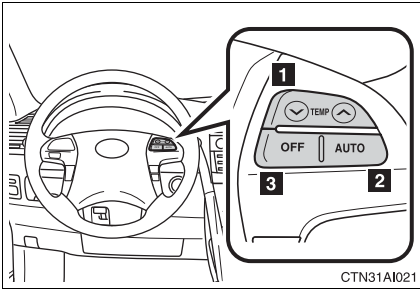

### 1 Temperature selector

“DUAL” button indicator on: Individual setting on the driver's side only.

“DUAL” button indicator off: Simultaneous setting on the driver's and front passenger's sides.

### 2 Automatic mode

### 3 Off

## ■ Using the automatic mode

**STEP 1** Press  .

The air conditioning system will begin to operate. Air outlets and fan speed are automatically adjusted according to the temperature setting. (→P. 186)

**STEP 2** Press “^” to increase the temperature and “v” to decrease the temperature on the  switch.

The temperature for the driver and passenger seat can be set separately. (→P. 187)

## ■ Adjusting the temperature setting

Press “^” to increase the temperature and “v” to decrease the temperature on the  switch.

## ■ Turning off the air conditioning system

Press  .

---

### ■ Using the automatic mode

Fan speed is adjusted automatically in accordance with the temperature setting and ambient conditions. As a result, the following may occur.

- The system may switch automatically to recirculated air mode when the coolest temperature setting is selected in summer.
- Immediately after  is pressed, the fan may stop for a while until warm or cool air is ready to flow.
- Cool air may flow to the area around the upper body when the heater is on.

### ■ Using the system in recirculated air mode

The windows will fog up more easily if the recirculated air mode is used for an extended period.

### ■ Window defogger feature

Recirculated air mode may automatically switch to outside air mode in situations where the windows need to be defogged.

### ■ When outside air temperature approaches 32°F (0°C)

The air conditioning system may not operate even when  is pressed.

### ■ When the indicator light on flashes

Press  and turn off the air conditioning system before turning it on once more. There may be a problem in the air conditioning system if the indicator light continues to flash. Turn the air conditioning system off and have it inspected by your Toyota dealer.

### ■ Windshield air flow button

When any of the following conditions occurs, the indicator light on the button may flash and a motor sound may be heard. This does not indicate a malfunction.

- The “ENGINE START STOP” switch is in ON mode (vehicles with smart key system) or engine switch is in “ON” position (vehicles without smart key system) after the battery is reconnected.
- Engine starting and stopping is repeated at short intervals.
- The engine is started with the low voltage battery.



### ■ Plasmacluster™\*

This air conditioning system adopts plasmacluster technology, which helps to keep good air quality in the cabin by emitting positive and negative ions through the driver's side vent.

A slight noise may be heard during operation. This is not a malfunction.

Also, static electricity may be discharged near the driver's side vent due to the high voltage used to operate the system.

To clean the driver's side vent, turn the system off and wipe the vent using a soft cloth.

\*: Plasmacluster technology is manufactured under license from SHARP Corporation. "Plasmacluster™" is a trademark of the SHARP Corporation.

### CAUTION

#### ■ To prevent the windshield from fogging up

Do not use  during cool air operation in extremely humid weather. The difference between the temperature of the outside air and that of the windshield can cause the outer surface of the windshield to fog up, blocking your vision.

#### ■ Plasmacluster™

Do not disassemble or repair the system because it contains high voltage parts. Call your Toyota dealer if the system needs repair.

### NOTICE

#### ■ To prevent battery discharge

Do not leave the automatic air conditioning system on longer than necessary when the engine is stopped.

#### ■ To prevent damage to the Plasmacluster™

Do not insert anything into the driver's side vent, attach anything to it, or use sprays around the driver's side vent. These things may cause the system not to work properly.

## 3-1. Using the air conditioning system and defogger

### Manual air conditioning system

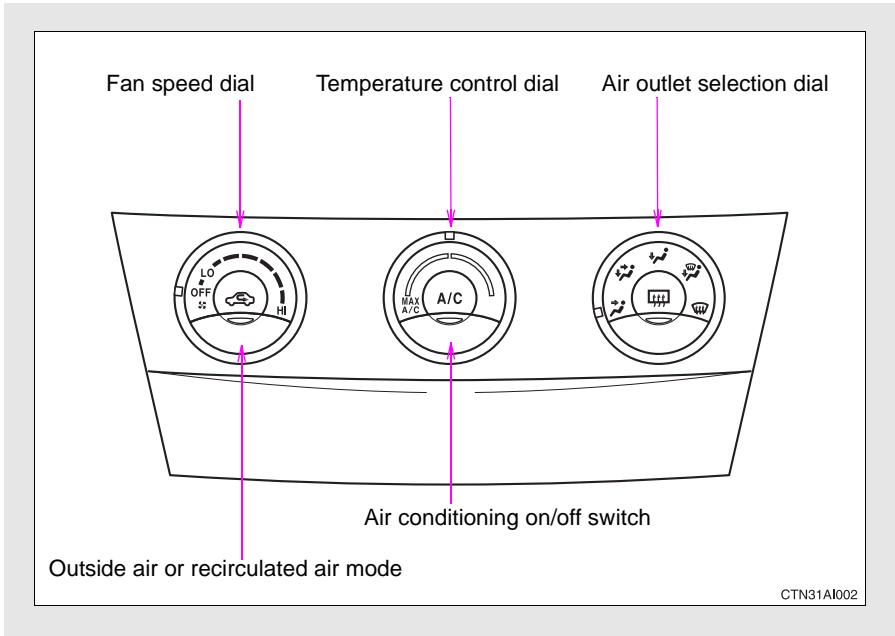

### Adjusting the settings

#### ■ Adjusting the temperature setting

Turn the temperature control dial clockwise (warm) or counterclockwise (cool).

If  is not pressed, the system will blow ambient temperature air or heated air.

For quick cooling, turn the temperature selector knob to the “MAX A/C” position. The air conditioning will automatically turn on and the air intake selector will be set to RECIRCULATE.

#### ■ Adjusting the fan speed

Turn the fan speed dial clockwise (increase) or counterclockwise (decrease).

Set the dial to “OFF” to turn the fan off.

### ■ Selecting the air outlets

Set the air outlet selection dial to an appropriate position.

The positions between the air outlet selections shown below can also be selected for more detailed adjustment.

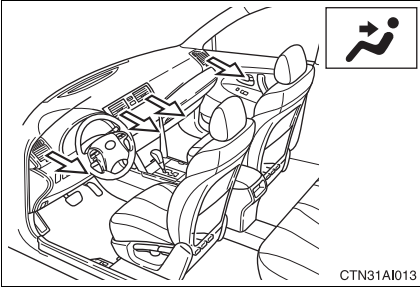

Air flows to the upper body.

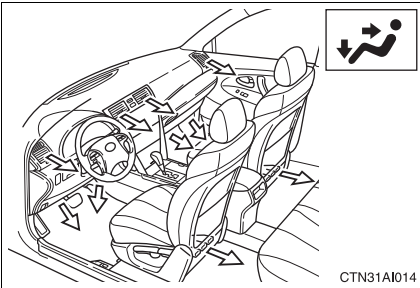

Air flows to the upper body and feet.

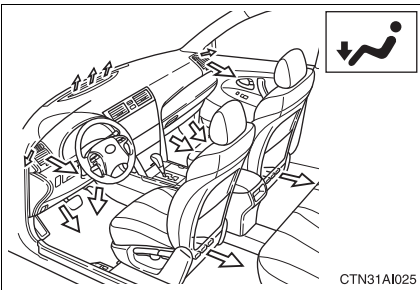

Air flows to the feet.

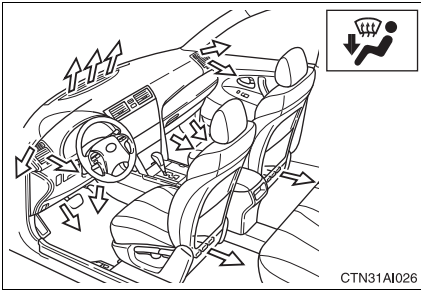

Air flows to the feet and the windshield defogger operates.

The air intake is automatically switched to outside air mode. It is not possible to return to recirculated air mode when the switch is on.

Pressing  to turn the air conditioning on clears the windshield and side windows faster.

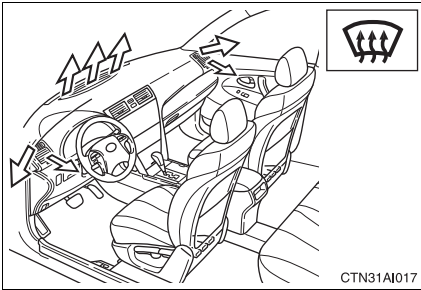

Air flows to the windshield and side windows.

The air intake is automatically switched to outside air mode.

Pressing  to turn the air conditioning on clears the windshield and side windows faster.

### ■ Switching between outside air and recirculated air modes

Press  .

The mode switches between outside air mode (indicator off) and recirculated air mode (indicator on) modes each time the button is pressed.

## Adjusting the position of and opening and closing the air outlets

### ► Center outlets

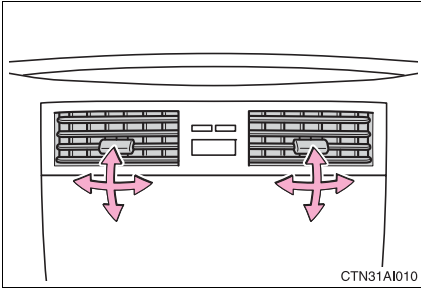

Direct air flow to the left or right, up or down.

### ► Right and left side outlets

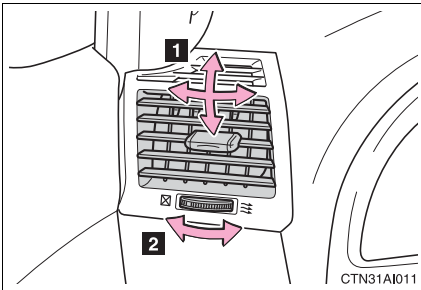

**1** Direct air flow to the left or right, up or down.

**2** Turn the knob right to open the vent and left to close the vent.

■ **Using the system in recirculated air mode**

The windows will fog up more easily if the recirculated air mode is used for an extended period.

■ **Window defogger feature**

In order to prevent the windows from fogging up, recirculated air mode may automatically switch to outside air mode if the ambient temperature drops. This feature can be cancelled by pushing and holding the air intake mode switch for longer than 2 seconds. The feature will be reactivated when the engine switch is turned to “ACC” or “LOCK” position.

■ **When outside air temperature approaches 32°F (0°C)**

The air conditioning system may not operate even when  is pressed.

■ **When the indicator light on  flashes**

Press  and turn off the air conditioning system before turning it on once more. There may be a problem in the air conditioning system if the indicator light continues to flash. Turn the air conditioning system off and have it inspected by your Toyota dealer.

 **CAUTION**

■ **To prevent the windshield from fogging up**

Do not set the air outlet selection dial to  during cool air operation in extremely humid weather. The difference between the temperature of the outside air and that of the windshield can cause the outer surface of the windshield to fog up, blocking your vision.

 **NOTICE**

■ **To prevent battery discharge**

Do not leave the air conditioning system on longer than necessary when the engine is stopped.

## 3-1. Using the air conditioning system and defogger Rear window and outside rear view mirror defoggers

### Clear the rear window using the defogger.

#### ► Vehicles with automatic air conditioning system

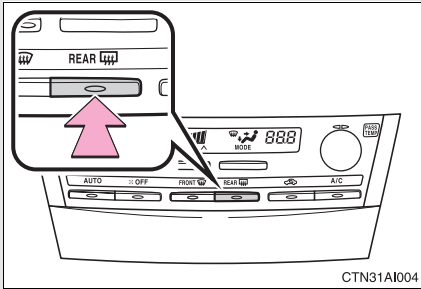

#### On/off

The defoggers will automatically turn off the operation time. The operation time is between 15 minutes and 1 hour depending on the ambient temperature and vehicle speed.

#### ► Vehicles with manual air conditioning system

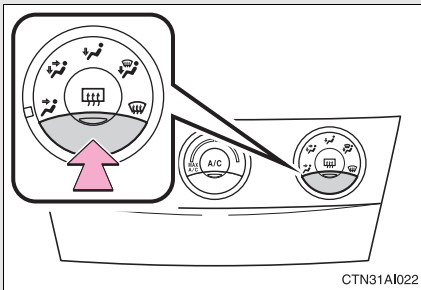

#### On/off

The defoggers will automatically turn off the operation time. The operation time is between 15 minutes and 1 hour depending on the ambient temperature and vehicle speed.

### ■ Outside rear view mirror defoggers (if equipped)

Turning the rear window defogger on will turn the outside rear view mirror defoggers on.

### ■ With manual air conditioning controls only

When any of the following conditions occurs, the indicator light on the switch may flash and a motor sound may be heard. This does not indicate a malfunction.

- The engine switch is in "ON" position after the battery is reconnected.
- Engine starting and stopping is repeated at short intervals.
- The engine is started with the low voltage battery.

 CAUTION

■ **Outside rear view mirror defoggers (if equipped)**

The surfaces of the outside rear view mirrors become hot. Do not touch them to prevent from burning yourself.



## 3-2. Using the audio system

### Audio system types

Owners of models equipped with a navigation system should refer to the “Navigation System Owner's Manual”.

#### ► CD player and AM/FM radio

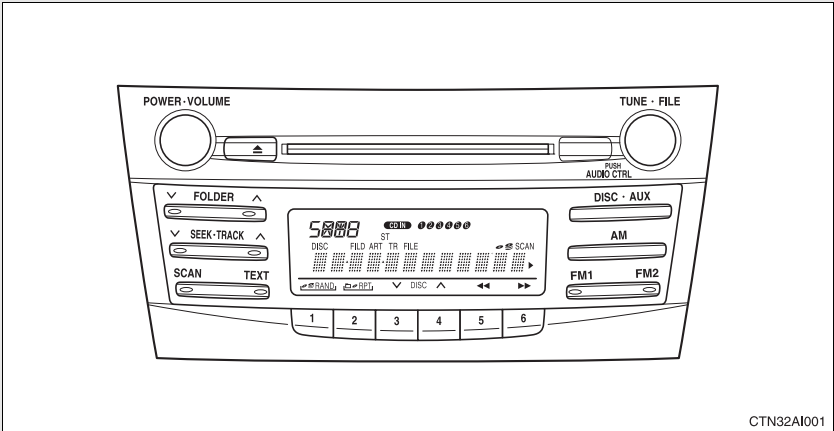

#### ► CD player with changer and AM/FM radio

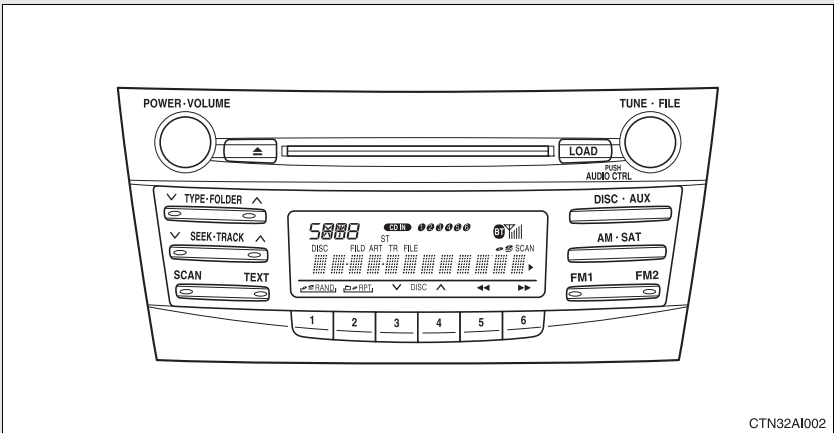

Title	Page
Using the radio	P. 204
Using the CD player	P. 210
Playing MP3 and WMA discs	P. 217
Optimal use of the audio system	P. 225
Using the AUX adapter	P. 228
Using the steering wheel audio switches	P. 229

### ■ Using cellular phones

Interference may be heard through the audio system's speakers if a cellular phone is being used inside or close to the vehicle while the audio system is operating.

### CAUTION

#### ■ For vehicles sold in U.S.A. and Canada

##### ● Part 15 of the FCC Rules

FCC Warning:

Any unauthorized changes or modifications to this equipment will void the user's authority to operate this device.

##### ● Laser products

- Do not take this unit apart or attempt to make any changes yourself.

This is an intricate unit that uses a laser pickup to retrieve information from the surface of compact discs. The laser is carefully shielded so that its rays remain inside the cabinet. Therefore, never try to disassemble the player or alter any of its parts since you may be exposed to laser rays and dangerous voltages.

- This product utilizes a laser.

Use of controls or adjustments or performance of procedures other than those specified herein may result in hazardous radiation exposure.



**NOTICE**

■ **To prevent battery discharge**

Do not leave the audio system on longer than necessary with the engine off.



■ **To avoid damaging the audio system**

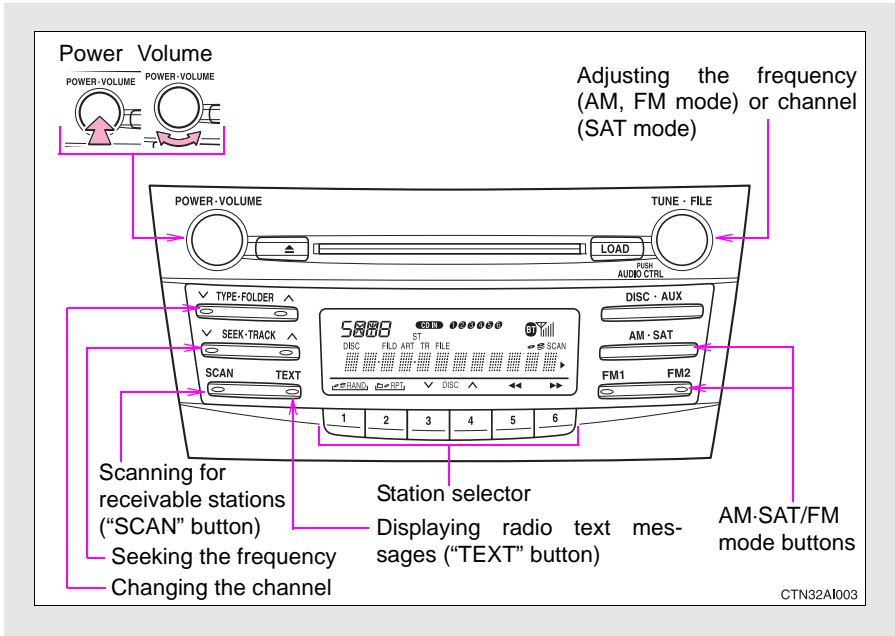

Take care not to spill drinks or other fluids over the audio system.

## 3-2. Using the audio system Using the radio



### Setting station presets (excluding XM<sup>®</sup> Satellite Radio)

**STEP 1** Search for desired stations by turning  or pressing "∧" or "∨" on .

**STEP 2** Press and hold the button (from  to ) the station is to be set to until you hear a beep.

### Scanning radio stations (excluding XM<sup>®</sup> Satellite Radio)

#### ■ Scanning the preset radio stations

**STEP 1** Press and hold the "SCAN" button until you hear a beep.  
Preset stations will be played for 5 seconds each.

**STEP 2** When the desired station is reached, press the "SCAN" button once again.

### ■ Scanning all radio stations within range

**STEP 1** Press the “SCAN” button.

All stations with reception will be played for 5 seconds each.

**STEP 2** When the desired station is reached, press the “SCAN” button once again.

## XM<sup>®</sup> Satellite Radio (if equipped)

### ■ Receiving XM<sup>®</sup> Satellite Radio

**STEP 1** Press and hold  until SAT shows in the display.



The display changes as follows each time  is pressed.

AM → SAT1 → SAT2 → SAT3

**STEP 2** Turn  to select the desired channel from all categories

or press  $\wedge$  or  $\vee$  on  to select the desired channel in the current category.

### ■ Setting XM<sup>®</sup> Satellite Radio channel presets

Select the desired channel. Press the button (from  to ) the channel is to be set to until you hear a beep.

### ■ Changing the channel category

Press  $\wedge$  or  $\vee$  on .

### ■ Scanning XM<sup>®</sup> Satellite Radio channels

- Scanning channels in the current category

**STEP 1** Press the “SCAN” button.

**STEP 2** When the desired channel is reached, press the “SCAN” button again.

- Scanning preset channels

**STEP 1** Press and hold the “SCAN” button until you hear a beep.

**STEP 2** When the desired channel is reached, press the “SCAN” button again.

### ■ Displaying text information

Press the “TEXT” button.

The display will show up to 10 characters.

The display changes as follows each time the button is pressed.

- CH NAME
- TITLE (SONG/PROGRAM TITLE)
- NAME (ARTIST NAME/FEATURE)
- CH NUMBER

### ■ When the battery is disconnected

Station presets are erased.

### ■ Reception sensitivity

Maintaining perfect radio reception at all times is difficult due to the continually changing position of the antenna, differences in signal strength and surrounding objects, such as trains, transmitters, etc.

### ■ XM<sup>®</sup> Satellite Radio

An XM<sup>®</sup> Satellite Radio is a tuner designed exclusively to receive broadcasts provided under a separate subscription. Availability is limited to the 48 contiguous states and 10 Canadian provinces.

#### ● XM<sup>®</sup> subscriptions

For detailed information about XM<sup>®</sup> Satellite Radio or to subscribe:  
U.S.A. —

Visit on the web at [www.xmradio.com](http://www.xmradio.com) or call 1-800-967-2346.

Canada —

Visit on the web at [www.xmradio.ca](http://www.xmradio.ca) or call 1-877-438-9677.

#### ● Radio ID

You will need the radio ID when activating XM<sup>®</sup> service or reporting a

problem. Select "CH000" using , and the receiver's 8-character ID number will appear.

#### ● Satellite tuner

The tuner supports only Audio Services (Music and Talk) and the accompanying Text Information of XM<sup>®</sup> satellite radio.

\*: Terms and services provided by XM<sup>®</sup> Satellite Radio are subject to change without notice.

### ■ If XM<sup>®</sup> Satellite Radio does not operate normally

If a problem occurs with the XM<sup>®</sup> tuner, a message will appear on the display. Refer to the table below to identify the problem, and take the suggested corrective action.

ANTENNA	The XM <sup>®</sup> antenna is not connected. Check whether the XM <sup>®</sup> antenna cable is attached securely.
	There is a short-circuit in the antenna or the surrounding antenna cable. See a Toyota certified dealer.
UPDATING	You have not subscribed to XM <sup>®</sup> Satellite Radio. The radio is being updated with the latest encryption code. Contact XM <sup>®</sup> Satellite Radio for subscription information. When a contract is canceled, you can choose the "CH000" and all free-to-air channels.
	The premium channel you selected is not authorized. Wait for about 2 seconds until the radio returns to the previous channel or "CH001". If it does not change automatically, select another channel. If you want to listen to the premium channel, contact XM <sup>®</sup> Satellite Radio.
NO SIGNAL	The XM <sup>®</sup> signal is too weak at the current location. Wait until your vehicle reaches a location with a stronger signal.
LOADING	The unit is acquiring audio or program information. Wait until the unit has received the information.
OFF AIR	The channel you selected is not broadcasting any programming. Select another channel.
-----	There is no song/program title or artist name/feature associated with the channel at this time. No action needed.



---	The channel you selected is no longer available. Wait for about 2 seconds until the radio returns to the previous channel or "CH001". If it does not change automatically, select another channel.
-----	----------------------------------------------------------------------------------------------------------------------------------------------------------------------------------------------------

Contact the XM<sup>®</sup> Listener Care Center at 1-800-967-2346 (U.S.A.) or 1-877-438-9677 (Canada)

### ■ Certifications for the radio tuner

This equipment has been tested and found to comply with the limits for a class B digital device, pursuant to Part 15 of the FCC Rules. These limits are designed to provide reasonable protection against harmful interference in a residential installation. This equipment generates, uses and can radiate radio frequency energy and, if not installed and used in accordance with the instructions, may cause harmful interference to radio communications. However, there is no guarantee that interference will not occur in a particular installation.

If this equipment does cause harmful interference to radio or television reception, which can be determined by turning the equipment off and on, the user is encouraged to try to correct the interference by trying one or more of the following:

- Reorienting or relocating the receiving antenna.
- Increasing the separation between the equipment and receiver.
- Connecting the equipment into an outlet on a circuit different from that to which the receiver is connected.
- Consulting the dealer or an experienced radio/TV technician for help.

## 3-2. Using the audio system Using the CD player

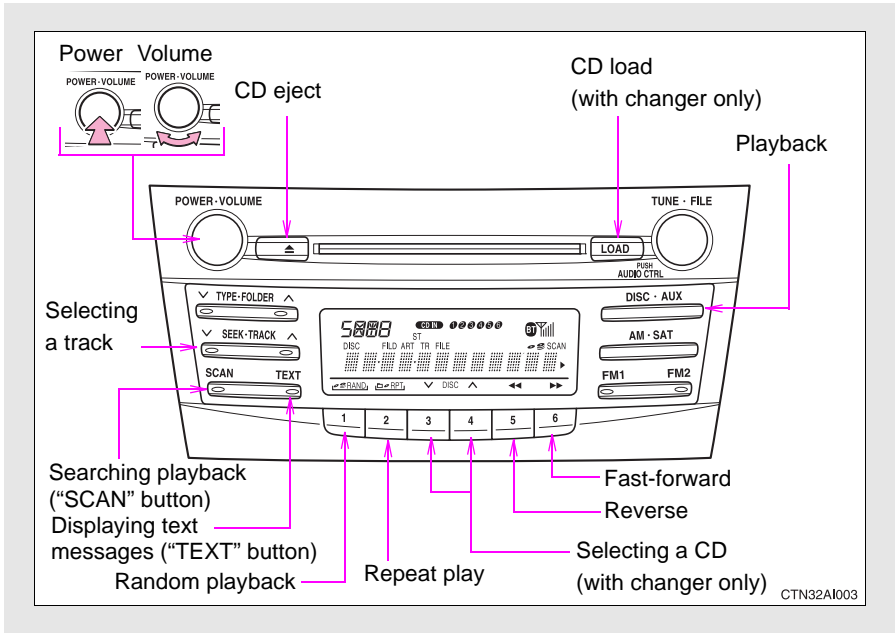

### Loading CDs

#### ■ Loading a CD (CD player without changer)

Insert a CD.

#### ■ Loading a CD (CD player with changer)

**STEP 1** Press **LOAD**.

**STEP 2** Insert a CD when the indicator on the slot turns from amber to green.

### ■ Loading multiple CDs (CD player with changer only)

**STEP 1** Press and hold  until you hear a beep.

**STEP 2** Insert a CD when the indicator on the slot turns from amber to green.

The indicator on the slot turns to amber when the CD is inserted.

**STEP 3** Insert the next CD when the indicator on the slot turns from amber to green again.

Repeat the procedure for the remaining CDs.



To stop the operation, press .

## Ejecting CDs

### ■ Ejecting a CD (CD player without changer)

Press  and remove the CD.

### ■ Ejecting a CD (CD player with changer)

**STEP 1** To select the CD to be ejected, press  (∨) or  (∧).

The number of the CD selected is shown on the display.

**STEP 2** Press  and remove the CD.

### ■ Ejecting all the CDs (CD player with changer only)

Press and hold  until you hear a beep, and then remove the CDs.

## Selecting a track

Press “∧” to move up or “∨” to move down using  until the desired track number is displayed.

### Fast-forwarding and reversing tracks

To fast-forward or reverse, press and hold “^” or “v” on .

### Scanning tracks

**STEP 1** Press the “SCAN” button.

The first ten seconds of each track will be played.

**STEP 2** Press the switch again when the desired track is reached.

### Selecting a CD (CD player with changer only)

#### ■ To select a CD to play

To select the desired CD, press  (v) or  (^).

#### ■ To scan loaded CDs

**STEP 1** Press and hold the “SCAN” button until you hear a beep.

The first ten seconds of the first track on each CD will be played.

**STEP 2** Press the switch again when the desired CD is reached.

### Repeat play

#### ■ To repeat a track

Press  (RPT).

#### ■ To repeat all of the tracks on a CD (CD player with changer only)

Press and hold  (RPT) until you hear a beep.

### Random playback

#### ■ Current CD

Press  (RAND).

Tracks are played in a random order until the button is pressed once more.

### ■ All CDs (CD player with changer only)

Press and hold  (RAND) until you hear a beep.

Tracks on all loaded CDs are played in a random order until the button is pressed once more.

## Switching the display

Press the “TEXT” button.

Each time the switch is pressed, the display changes in the order of Track no./Elapsed time→CD title→Track name.

### ■ Display

Up to 12 characters can be displayed at a time.



If there are 13 characters or more, pressing and holding the “TEXT” button for 1 second or more will display the remaining characters.

A maximum of 24 characters can be displayed.

If the “TEXT” button is pressed for 1 second or more again or has not been pressed for 6 seconds or more, the display will return to the first 12 characters.

Depending on the contents recorded, the characters may not be displayed properly or may not be displayed at all.

### ■ Canceling random and repeat playback

Press  (RAND),  (RPT) or the “SCAN” button again.

### ■ Error messages

“ERROR”: This indicates a problem either with the CD or inside the player. The CD may be dirty, damaged or inserted up-side down.

“WAIT”: Operation has stopped due to a high temperature inside the player. Wait for a while and then press . Contact your Toyota dealer if the CD still cannot be played back.

### ■ Discs that can be used

Discs with the marks shown below can be used.  
Playback may not be possible depending on the recording format or disc features, or due to scratches, dirt or deterioration.



CDs with copy-protect features may not be used.

### ■ CD player protection feature

To protect the internal components, playback is automatically stopped when a problem is detected while the CD player is being used.

### ■ If CDs are left inside the CD player or in the ejected position for extended periods

CDs may be damaged and may not play properly.

### ■ Lens cleaners

Do not use lens cleaners. Doing so may damage the CD player.

 NOTICE

**■ CDs and adapters that cannot be used**

Do not use the following types of CDs or 3 in. (8 cm) CD adapters or Dual Discs.

Doing so may damage the CD player and/or the CD insert/eject function.

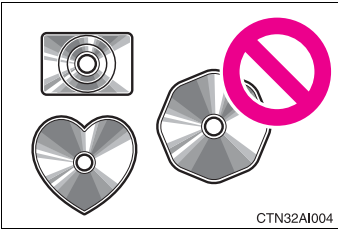

- CD player with changer and AM/FM radio: CDs that have a diameter that is not 4.7 in. (12 cm)

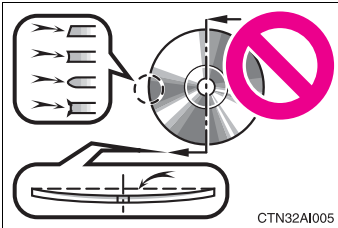

- Low-quality and deformed CDs

 NOTICE

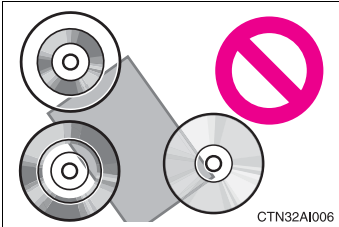

- CDs with a transparent or translucent recording area

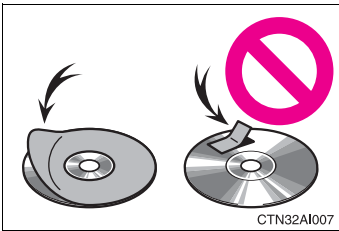

- CDs that have had tape, stickers or CD-R labels attached to them, or that have had the label peeled off

**■ CD player precautions**

Failure to follow the precautions below may result in serious damage to the CDs or the player itself.

- Do not insert anything other than CDs into the CD slot.
- Do not apply oil to the CD player.
- Store CDs away from direct sunlight.
- Never try to disassemble any part of the CD player.

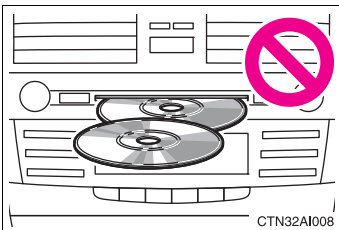

- Do not insert more than one CD at a time.



### 3-2. Using the audio system

## Playing MP3 and WMA discs

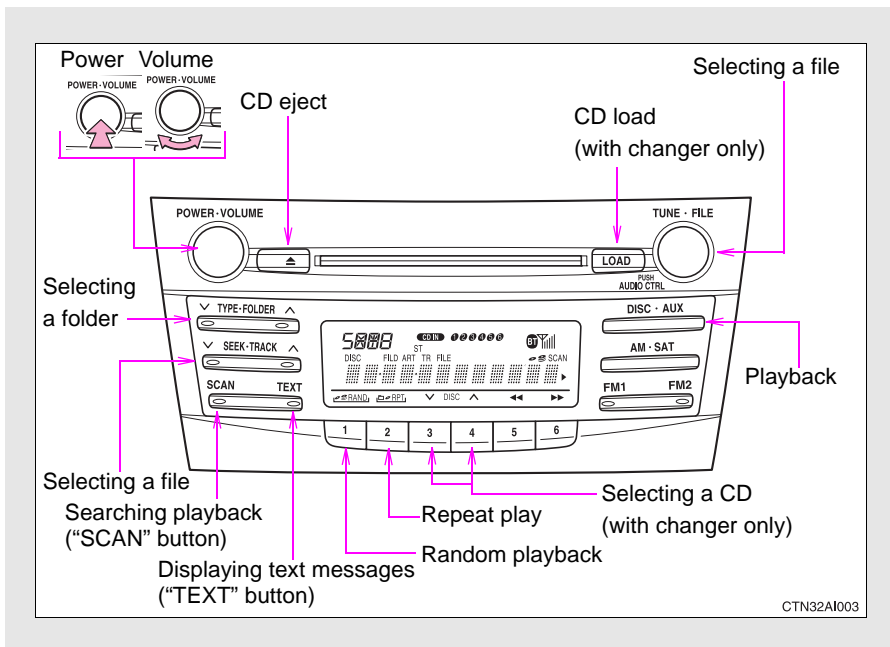

### Loading and ejecting MP3 and WMA discs

→P. 210

### Selecting a CD (CD player with changer only)

→P. 212

## Selecting and scanning a folder



### ■ Selecting folders one at a time

Press “^” or “v” on  or  to select the desired folder.

### ■ Selecting the desired folder by cueing the first file of each folder



Press and hold the “SCAN” button until you hear a beep. When the desired folder is reached, press the “SCAN” button once again.

### ■ Returning to the first folder

Press and hold “v” on  or  until you hear a beep.

## Selecting and scanning files

### ■ Selecting one file at a time

Turn  or press “^” or “v” on  or  to select the desired file.

### ■ Selecting the desired file by cueing the files in the folder

Press the “SCAN” button.

When the desired file is reached, press the “SCAN” button once again.

## Fast-forwarding and reversing files

To fast-forward or reverse, press and hold “^” or “v” on .

## Repeat play

### ■ To repeat a file

Press  (RPT).

### ■ To repeat all of the files in a folder

Press and hold  (RPT) until you hear a beep.

## Random playback

### ■ To play files from a particular folder in random order

Press  (RAND).

### ■ To play all of the files on a disc in random order

Press and hold  (RAND) until you hear a beep.

## Switching the display

Press the “TEXT” button.

Each time the switch is pressed, the display changes in the order of Folder no./File no./Elapsed time→Folder name→File name→Album title (MP3 only)→Track title→Artist name.

■ **Display**

→P. 213

■ **Canceling random and repeat playback**

→P. 213

■ **Error messages**

“ERROR”: This indicates a problem either with the CD or inside the player. The CD may be dirty, damaged or inserted up-side down.

“WAIT”: Operation has stopped due to a high temperature inside the player. Wait for a while and then press . Contact your Toyota dealer if the CD still cannot be played.

“NO MUSIC”: This indicates that the MP3/WMA file is not included in the CD.

■ **Discs that can be used**

→P. 214

■ **CD player protection feature**

→P. 214

■ **If CDs are left inside the CD player or in the ejected position for extended periods**

→P. 214

■ **Lens cleaners**

→P. 214

## ■ MP3 and WMA files

MP3 (MPEG Audio LAYER3) is a standard audio compression format.

Files can be compressed to approximately 1/10 of their original size by using MP3 compression.

WMA (Windows Media <sup>TM</sup> Audio) is a Microsoft audio compression format.

This format compresses audio data to a size smaller than that of the MP3 format.

There is a limit to the MP3 and WMA file standards and to the media/formats recorded by them that can be used.

### ● MP3 file compatibility

- Compatible standards  
MP3 (MPEG1 LAYER3, MPEG2 LSF LAYER3)
- Compatible sampling frequencies  
MPEG1 LAYER3: 32, 44.1, 48 (kHz)  
MPEG2 LSF LAYER3: 16, 22.05, 24 (kHz)
- Compatible bit rates  
MPEG1 LAYER3: 64, 80, 96, 112, 128, 160, 192, 224, 256, 320 (kbps)  
MPEG2 LSF LAYER3: 64, 80, 96, 112, 128, 144, 160 (kbps)  
\* Compatible with VBR
- Compatible channel modes: stereo, joint stereo, dual channel and monaural

### ● WMA file compatibility

- Compatible standards  
WMA Ver. 7, 8, 9
- Compatible sampling frequencies  
32, 44.1, 48 (kHz)
- Compatible bit rates  
Ver. 7, 8: CBR 48, 64, 80, 96, 128, 160, 192 (kbps)  
Ver. 9: CBR 48, 64, 80, 96, 128, 160, 192, 256, 320 (kbps)  
\* Only compatible with 2-channel playback

### ● Compatible media

Media that can be used for MP3 and WMA playback are CD-Rs and CD-RWs.

Playback in some instances may not be possible, depending on the status of the CD-R or CD-RW. Playback may not be possible or the audio may jump if the disc is scratched or marked with fingerprints.

### ● Compatible disc formats

The following disc formats can be used.

- Disc formats: CD-ROM Mode 1 and Mode 2  
CD-ROM XA Mode 2, Form 1 and Form 2
- File formats: ISO9660 Level 1, Level 2, (Romeo, Joliet)  
MP3 and WMA files written in any format other than those listed above may not play correctly, and their file names and folder names may not be displayed correctly.

Items related to standards and limitations are as follows.

- Maximum directory hierarchy: 8 levels
- Maximum length of folder names/file names: 32 characters
- Maximum number of folders: 192 (including the root)
- Maximum number of files per disc: 255

### ● File names

The only files that can be recognized as MP3/WMA and played are those with the extension .mp3 or .wma.

### ● Multi-sessions

As the audio system is compatible with multi-sessions, it is possible to play discs that contain MP3 and WMA files. However, only the first session can be played.

### ● ID3 and WMA tags

ID3 tags can be added to MP3 files, making it possible to record the track title and artist name, etc.

The system is compatible with ID3 Ver. 1.0, 1.1, and Ver. 2.2, 2.3 ID3 tags. (The number of characters is based on ID3 Ver. 1.0 and 1.1.)

WMA tags can be added to WMA files, making it possible to record the track title and artist name in the same way as with ID3 tags.

### ● MP3 and WMA playback

When a disc containing MP3 or WMA files is inserted, all files on the disc are first checked. Once the file check is finished, the first MP3 or WMA file is played. To make the file check finish more quickly, we recommend you do not write in any files other than MP3 or WMA files or create any unnecessary folders.

If the discs contain a mixture of music data and MP3 or WMA format data, only music data can be played.

### ● Extensions

If the file extensions .mp3 and .wma are used for files other than MP3 and WMA files, they will be mistakenly recognized and played as MP3 and WMA files. This may result in large amounts of interference and damage to the speakers.

### ● Playback

- To play MP3 files with steady sound quality, we recommend a fixed bit rate of 128 kbps and a sampling frequency of 44.1 kHz.
- CD-R or CD-RW playback may not be possible in some instances, depending on the characteristics of the disc.
- There is a wide variety of freeware and other encoding software for MP3 and WMA files on the market, and depending on the status of the encoding and the file format, poor sound quality or noise at the start of playback may result. In some cases, playback may not be possible at all.
- When files other than MP3 or WMA files are recorded on a disc, it may take more time to recognize the disc. In some cases, playback may not be possible at all.
- Microsoft, Windows, and Windows Media are the registered trademarks of Microsoft Corporation in the U.S. and other countries.

 NOTICE

■ **CDs and adapters that cannot be used (→P. 215)**

■ **CD player precautions (→P. 216)**



## Optimal use of the audio system

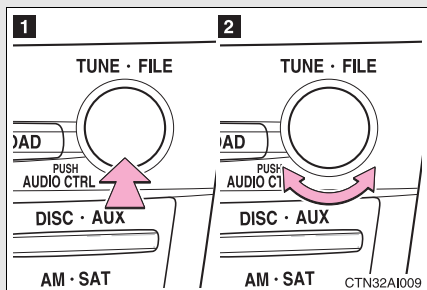

1 Displays the current mode

2 Changes the following settings

- Sound quality and volume balance (→P. 226)

The sound quality and balance setting can be changed to produce the best sound.

- Automatic Sound Levelizer on/off (→P. 226)

### Using the AUDIO CONTROL function

#### ■ Changing sound quality modes

Pressing  selects the mode to be changed in the following order.

“BAS”→“MID” (CD player with changer)→“TRE”→“FAD”→“BAL”→“ASL”

## ■ Adjusting sound quality

Turning  adjusts the level.

Mode displayed	Sound quality mode	Level	Turn to the left	Turn to the right
BAS	Bass*	-5 to 5	Low	High
MID	Mid-range* (CD player with changer)	-5 to 5		
TRE	Treble*	-5 to 5		
FAD	Front/rear volume balance	F7 to R7	Shifts to rear	Shifts to front
BAL	Left/right volume balance	L7 to R7	Shifts to left	Shifts to right

\*: The sound quality level is adjusted individually in each radio mode or CD mode.

## ■ Adjusting the Automatic Sound Levelizer (ASL)

### ▶ CD player without changer

When “ASL” is selected, turning  to the right changes the “ASL” level in the order of “LOW”, “MID” and “HIGH”.

Turning  to the left turns “ASL” off.

ASL automatically adjusts the volume and tone quality according to vehicle speed.

► CD player with changer

When “ASL” is selected, turning  to the right turns “ASL” on,

and turning  to the left turns “ASL” off.

“ASL” automatically adjusts the volume and tone quality according to the noise level as you drive your vehicle.

■ **Trademark owned by SRS Labs, Inc. (CD player without changer only)**



The audio systems utilize SRS FOCUS<sup>®</sup> and SRS TruBass<sup>®</sup> audio enhancement technologies, under license from SRS Labs, Inc., in all modes except AM radio mode.

FOCUS, TruBass, SRS and  symbols are trademarks of SRS Labs, Inc.

FOCUS and TruBass technologies are incorporated under license from SRS Labs, Inc.

## 3-2. Using the audio system

### Using the AUX adapter

This adapter can be used to connect a portable audio device and listen to it through the vehicle's speakers.

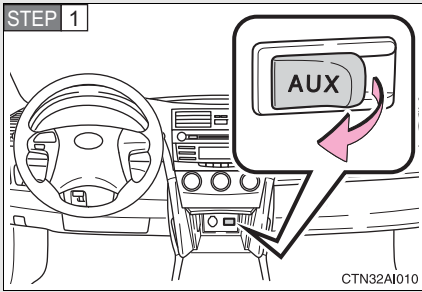

Connect the portable audio device.

**STEP 2** Press  .

#### ■ Operating portable audio devices connected to the audio system

The volume can be adjusted using the vehicle's audio controls. All other adjustments must be made on the portable audio device itself.

#### ■ When using a portable audio device connected to the power outlet

Noise may occur during playback. Use the power source of the portable audio device.

#### ■ Cable pass-through

Connected cables can be passed through the hole in the auxiliary box to the front passenger's side of the auxiliary box. (→P. 274)

## 3-2. Using the audio system

### Using the steering wheel audio switches (if equipped)

Some audio features can be controlled using the switches on the steering wheel.

#### ► Type A

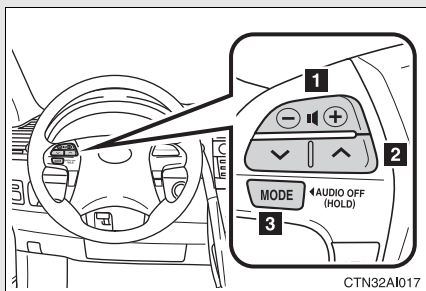

- 1 Volume (volume control switch)
- 2 Radio: Select radio stations  
CD: Select tracks, files (MP3 and WMA) and discs ("v ^" switch)
- 3 Power on, select audio source ("MODE" switch)

#### ► Type B

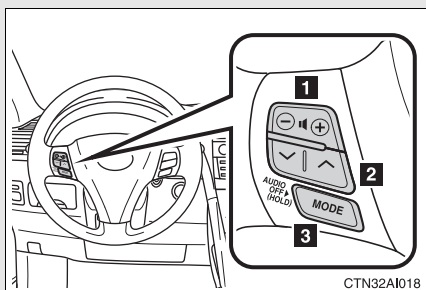

- 1 Volume (volume control switch)
- 2 Radio: Select radio stations  
CD: Select tracks, files (MP3 and WMA) and discs ("v ^" switch)
- 3 Power on, select audio source ("MODE" switch)

### Turning on the power

Press the "MODE" switch when the audio system is turned off.

The audio system can be turned off by holding the switch down until you hear a beep.

### Changing the audio source

Press the “MODE” switch when the audio system is turned on. The audio source changes as follows each time the switch is pressed.

CD player without changer:

FM1→FM2→CD→AUX→AM

CD player with changer:

FM1→FM2→CD changer→AUX→AM→SAT1→SAT2→SAT3

### Adjusting the volume

Press “+” on the volume control switch to increase the volume and “-” to decrease the volume.

Press and hold the switch to continue increasing or decreasing the volume.

### Selecting a radio station

**STEP 1** Press the “MODE” switch to select the radio mode.

**STEP 2** Press the “∨ ∧” switch to select a preset station.

To scan for receivable stations, press and hold the switch until you hear a beep.

### Selecting a track/file

**STEP 1** Press the “MODE” switch to select the CD mode.

**STEP 2** Press the “∨ ∧” switch to select the desired track/file.

### Selecting a folder (CD player without changer only)

**STEP 1** Press the “MODE” switch to select the CD mode.

**STEP 2** Press and hold the “∨ ∧” switch until you hear a beep.

**Selecting a disc in the CD player (CD player with changer only)**

**STEP 1** Press the “MODE” switch to select the CD mode.

**STEP 2** Press and hold the “ $\vee \wedge$ ” switch until you hear a beep.

 **CAUTION**

**■ To reduce the risk of an accident**

Exercise care when operating the audio switches on the steering wheel.

### 3-3. Using the hands-free phone system (for cellular phone)

Hands-free phone system (for cellular phone) features (CD player with changer only)

**This system supports Bluetooth<sup>®</sup>, which allows you to make or receive calls without using cables to connect a cellular phone and the system, and without operating the cellular phone.**

**Owners of models equipped with a navigation system should refer to the “Navigation System Owner’s Manual”.**

Title	Page
Using the hands-free phone system	P. 235
Making a phone call	P. 244
Setting a cellular phone	P. 248
Security and system setup	P. 253
Using the phone book	P. 257

#### ■ Conditions affecting operation

The hands-free phone system may not operate normally in the following situations:

- The cellular phone is turned off, or located outside the service area.
- The cellular phone has a low battery.
- The cellular phone is not connected to the system.
- The cellular phone is behind the seat or in the glove box, or metal material covers or touches the phone.

#### ■ When transferring ownership of the vehicle

Be sure to initialize the system to prevent personal data from being improperly accessed.

#### ■ Required profiles for the cellular phone

- HFP (Hands Free Profile) Ver. 1.0
- OPP (Object Push Profile) Ver. 1.1



■ Trademark owned by Bluetooth SIG. Inc.



■ Certification for the hands-free phone system

FCC ID: HYQBTAU01A  
 IC ID: 1551A-BTAU01A  
 MADE IN JAPAN

**NOTE:**

This device complies with Part 15 of the FCC Rules and RSS-210 of industry Canada. Operation is subject to the following two conditions: (1) This device may not cause harmful interference, and (2) This device must accept any interference received, including interference that may cause undesired operation.

**NOTICE:**

This equipment has been tested and found to comply with the limits for a Class B digital device, pursuant to Part 15 of the FCC Rules. These limits are designed to provide reasonable protection against harmful interference in a residential installation. This equipment generates, uses and can radiate radio frequency energy and, if not installed and used in accordance with the instructions, may cause harmful interference to radio communications. However, there is no guarantee that interference will not occur in a particular installation. If this equipment does cause harmful interference to radio or television reception, which can be determined by turning the equipment off and on, the user is encouraged to try to correct the interference by one or more of the following measures:

- Reorient or relocate the receiving antenna.
- Increase the separation between the equipment and receiver.
- Connect the equipment into an outlet on a circuit different from that to which the receiver is connected.
- Consult the dealer or an experienced radio/TV technician for help.

**FCC WARNING:**

Changes or modifications in construction not expressly approved by the party responsible for compliance could void the user's authority to operate the equipment.

**CAUTION:**

**Radio Frequency Radiation Exposure**

This equipment complies with FCC radiation exposure limits set forth for uncontrolled equipment and meets the FCC radio frequency (RF) Exposure Guidelines in Supplement C to OET65. This equipment has very low levels of RF energy that it deemed to comply without maximum permissive exposure evaluation (MPE). But it is desirable that it should be installed and operated with at least 20 cm and more between the radiator and person's body (excluding extremities: hands, wrists, feet and legs).

**Co-location:**

This transmitter must not be co-located or operated in conjunction with any other antenna or transmitter.

 **CAUTION**

 **Caution while driving**

Do not use a cellular phone, or connect the Bluetooth® phone.

 **NOTICE**

 **To prevent damage to a cellular phone**

Do not leave a cellular phone in the vehicle. The temperature inside may become high resulting in damage to the phone.

### 3-3. Using the hands-free phone system (for cellular phone) Using the hands-free phone system (for cellular phone)

#### ■ Audio unit

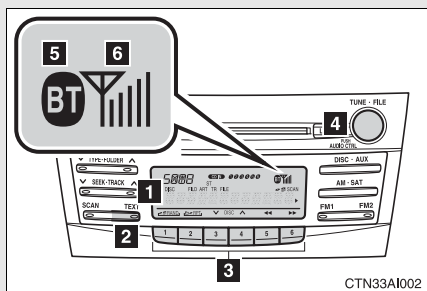

- 1 Displays such items as message, name, and phone number

Lower-case characters and special characters, such as an umlaut, cannot be displayed.

- 2 Press and hold: Displays information that is too long to be displayed at one time on the screen
- 3 Selects speed dials
- 4 Selects items such as menu or number  
Turn: Selects an item  
Press: Inputs the selected item
- 5 Displays Bluetooth® connection condition

If BT is not displayed, the hands-free phone system cannot be used.

- 6 Displays the reception level

■ **Steering wheel**

► **Type A**

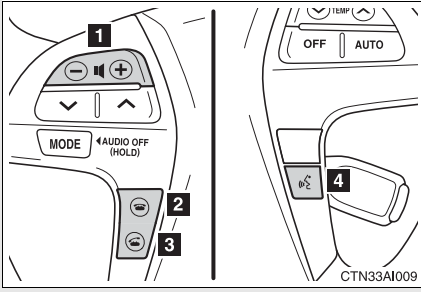

**1** Volume

The voice guidance volume cannot be adjusted by using this button.

**2** Hands-free phone system off/ends a call/refuses a call (on-hook switch)

**3** Hands-free phone system on/starts a call (off-hook switch)

**4** Press: Voice command system on  
Press and hold: Voice command system off (talk switch)

► Type B

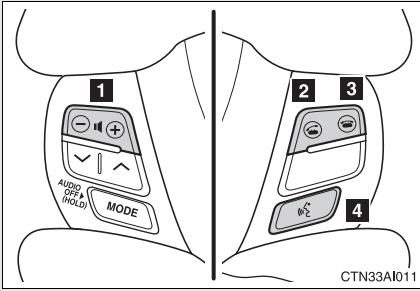

**1** Volume

The voice guidance volume cannot be adjusted by using this button.

**2** Hands-free phone system on/starts a call (off-hook switch)

**3** Hands-free phone system off/ends a call/refuses a call (on-hook switch)

**4** Press: Voice command system on  
Press and hold: Voice command system off (talk switch)

■ Microphone

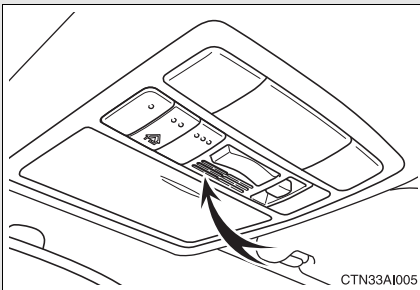

## Operating the system by using a voice command

By following voice guidance instructions output from the speaker, voice commands can be given to allow for operation of the hands-free phone system without checking the display or operating  .

### ■ Operation procedure when using a voice command

Press the talk switch and say the command for a desired function.  
(→P. 240)

### ■ Auxiliary commands when using a voice command

The following auxiliary commands can be used when operating the system using a voice command:

Cancel: Exits the hands-free phone system

Repeat: Repeats the previous voice guidance instruction

Go back: Returns to the previous procedure

Help: Reads aloud the function summary if a help comment is registered for the selected function

## Using the hands-free phone system for the first time

Before using the hands-free phone system, it is necessary to register a cellular phone in the system. The phone registration mode will be entered automatically when starting the system with no cellular phone registered. Follow the procedure below to register a cellular phone:

**STEP 1** Press the off-hook switch or the talk switch.

The introductory guidance and phone name registration instructions are heard.

**STEP 2** Register a phone name by either of the following methods.

- a. Select "Record Name" by using  , and say a name to be registered.
- b. Press the talk switch and say a name to be registered.

A voice guidance instruction to confirm the input is heard.

**STEP 3** Select "Confirm" by using a voice command or  .

A passkey is displayed and heard, and a voice guidance instruction for inputting the passkey into the cellular phone is heard.

**STEP 4** Input the passkey into the cellular phone.

Refer to the manual that comes with the cellular phone for the operation of the phone.

Guidance for registration completion is heard.

<b>Menu list of the hands-free phone system</b>
-------------------------------------------------

■ Normal operation

First menu	Second menu	Third menu	Operation detail
Callback	-	-	Dialing a number stored in the incoming call history memory
Redial	-	-	Dialing a number stored in the outgoing call history memory
Dial by number	-	-	Dialing by inputting a number
Dial by name	-	-	Dialing by inputting a name registered in the phone book
Phonebook	Add Entry	-	Adding a new number
	Change Name	-	Changing a name in the phone book
	Delete Entry	-	Deleting the phone book data
	Delete Speed Dial (Del Spd Dial)	-	Deleting a registered speed dial
	List Names	-	Listing the phone book data
	Set Speed Dial (Speed Dial)	-	Registering a speed dial



First menu	Second menu	Third menu	Operation detail
Setup	Security	Set PIN	Setting a PIN code
		Phonebook Lock	Locking the phone book
		Phonebook Unlock	Unlocking the phone book
	Phone Setup	Pair Phone	Registering the cellular phone to be used
		Change Name	Changing a registered name of a cellular phone
		Delete	Deleting a registered cellular phone
		List phones	Listing the registered cellular phones
		Select phone	Selecting a cellular phone to be used
		Set Passkey	Changing the passkey
	System Setup	Guidance Volume (Guidance Vol)	Setting voice guidance volume
Initialize		Initialization	

■ Using a short cut key

First menu	Second menu	Operation detail
Dial "XXX (name)"	-	Dialing a number registered in the phone book
Phone book add entry	-	Adding a new number
Phone book change name	-	Changing the name of a phone number in the phone book
Phone book delete entry	-	Deleting phone book data
Phone book set speed dial	-	Registering a speed dial
Phone book delete speed dial	-	Deleting a speed dial
Phonebook	Phonebook Unlock	Unlocking the phone book
	Phonebook Lock	Locking the phone book

■ **Automatic adjustment of volume**

When vehicle speed is 50 mph (80 km/h) or more, the volume automatically increases. The volume returns to the previous volume setting when vehicle speed drops to 43 mph (70 km/h) or less.

■ **When using a voice command**

For numbers, say a combination of single digits from zero to nine, # (pound), \* (star), and + (plus).

Say a command correctly and clearly.

■ **The system may not recognize your voice in the following situations:**

- When driving on a rough road
- When driving at high speeds
- When air is blowing out of the vents onto the microphone
- When the air conditioning fan emits a loud noise

■ **The following cannot be performed while driving:**

- Operating the system with 
- Registering a cellular phone to the system

■ **Changing the passkey**

→P. 251

## Making a phone call

### ■ Making a phone call

- Dialing by inputting a number  
“Dial by number”
- Dialing by inputting a name  
“Dial by name”
- Speed dialing
- Dialing a number stored in the outgoing history memory  
“Redial”
- Dialing a number stored in the incoming history memory  
“Call back”

### ■ Receiving a phone call

- Answering the phone
- Refusing the call

### ■ Transferring a call

### ■ Using the call history memory

- Dialing
- Storing data in the phone book
- Deleting

## Dialing by inputting a number

- STEP 1** Press the talk switch and say “Dial by number”.
- STEP 2** Press the talk switch and say the phone number.
- STEP 3** Dial by one of the following methods:
- a. Press the off-hook switch.
  - b. Press the talk switch and say “Dial”.

- c. Select “Dial” by using



## Dialing by inputting a name

**STEP 1** Press the talk switch and say “Dial by name”.

**STEP 2** Select a registered name to be input by either of the following methods:

- a. Press the talk switch and say a registered name.
- b. Press the talk switch and say “List names”. Press the talk switch while the desired name is being read aloud.

**STEP 3** Dial by one of the following methods:

- a. Press the off-hook switch.
- b. Press the talk switch and say “Dial”.
- c. Select “Dial” by using .

## Speed dialing

**STEP 1** Press the off-hook switch.

**STEP 2** Press the preset button in which the desired number is registered.

**STEP 3** Press the off-hook switch.

## When receiving a phone call

### ■ Answering the phone

Press the off-hook switch.

### ■ Refusing the call

Press the on-hook switch.

### Transferring a call

A call can be transferred between the cellular phone and system while dialing, receiving a call, or during a call. Use one of the following methods:

- a. Operate the cellular phone.  
Refer to the manual that comes with the cellular phone for the operation of the phone.
- b. Press the off-hook switch\*<sup>1</sup>.
- c. Press the talk switch and say “Call Transfer”\*<sup>2</sup>.

\*<sup>1</sup>: This operation can be performed only when transferring a call from the cellular phone to the system during a call.

\*<sup>2</sup>: While the vehicle is in motion, a call cannot be transferred from the system to the cellular phone.

### Using the call history memory

Follow the procedure below to use a number stored in the call history memory:

**STEP 1** Press the talk switch and say “Redial” (when using a number stored in the outgoing call history memory) or “Call back” (when using a number stored in the incoming call history memory).

**STEP 2** Select the number by either of the following methods:

- a. Say “Previous” or “Go back” until the desired number is displayed.

- b. Select the desired number by using



The following operations can be performed:

Dialing: Press the off-hook switch or select “Dial” by using a voice command or  .

Storing the number in the phone book: Select “Store” by using a voice command or  .

Deleting: Select “Delete” by using a voice command or  .

### ■ Call history

Up to 5 numbers can be stored in each of the outgoing and incoming call history memories.

### ■ When talking on the phone

- Do not talk simultaneously with the other party.
- Keep the volume of the received voice down. Otherwise, voice echo will increase.

### 3-3. Using the hands-free phone system (for cellular phone)

## Setting a cellular phone

Registering a cellular phone in the hands-free phone system allows the system to function. The following functions can be used for registered cellular phones:

#### ■ Functions and operation procedures

To enter the menu for each function, follow the steps below by

using a voice command or  :

- Registering a cellular phone
  1. "Setup" → 2. "Phone Setup" → 3. "Pair Phone"
- Selecting the cellular phone to be used
  1. "Setup" → 2. "Phone Setup" → 3. "Select Phone"
- Changing a registered name
  1. "Setup" → 2. "Phone Setup" → 3. "Change Name"
- Listing the registered cellular phones
  1. "Setup" → 2. "Phone Setup" → 3. "List Phones"
- Deleting a cellular phone
  1. "Setup" → 2. "Phone Setup" → 3. "Delete"
- Changing the passkey
  1. "Setup" → 2. "Phone Setup" → 3. "Set Passkey"

### Registering a cellular phone

Select "Pair Phone" by using a voice command or , and do the procedure for registering a cellular phone. (→P. 239)



**Selecting the cellular phone to be used**

**STEP 1** Select “Select Phone” by using a voice command or  .

► Pattern A

**STEP 2** Select the cellular phone to be used by either of the following methods, and select “Confirm” by using a voice command or



- a. Press the talk switch and say the desired phone name.
- b. Press the talk switch and say “List phones”. While the name of the desired cellular phone is being read aloud, press the talk switch.

► Pattern B

**STEP 2** Select the cellular phone to be used by using  .

**Changing a registered name**

**STEP 1** Select “Change Name” by using a voice command or  .

**STEP 2** Select the name of the cellular phone to be changed by either of the following methods:

- a. Press the talk switch and say the desired phone name, and select “Confirm” by using a voice command or  .
- b. Press the talk switch and say “List phones”. While the desired phone name is being read aloud, press the talk switch.

- c. Select the desired phone name by using  .

3 Interior features

**STEP 3** Press the talk switch or select “Record Name” by using



, and say a new name.

**STEP 4** Select “Confirm” by using a voice command or



.

### Listing the registered cellular phones

Selecting “List Phones” by using a voice command or  causes the list of registered cellular phones to be read aloud. When listing is complete, the system returns to “Phone Setup”.

Pressing the talk switch while the name of a cellular phone is being read selects the cellular phone, and the following functions will be available:

- Selecting a cellular phone: “Select Phone”
- Changing a registered name: “Change Name”
- Deleting a cellular phone: “Delete”

## Deleting a cellular phone

**STEP 1** Select “Delete” by using a voice command or  .

### ► Pattern A

**STEP 2** Select the cellular phone to be deleted by either of the following methods and select “Confirm” by using a voice command

or  :

- Press the talk switch and say the name of the desired cellular phone.
- Press the talk switch and say “List phones”. While the name of the desired cellular phone is being read aloud, press the talk switch.

### ► Pattern B

**STEP 2** Select the desired cellular phone to be deleted by using

 .

## Changing the passkey

**STEP 1** Select “Set Passkey” by using a voice command or  .

### ► Pattern A

**STEP 2** Press the talk switch, say a 4 to 8-digit number, and select

“Confirm” by using a voice command or  .

► Pattern B

**STEP 2** Select a 4 to 8-digit number by using  .

The number should be input 1 digit at a time.

**STEP 3** When the entire number to be registered as a passkey has

been input, press  once again.

---

■ **The number of cellular phones that can be registered**

Up to 6 cellular phones can be registered in the system.

## 3-3. Using the hands-free phone system (for cellular phone) Security and system setup

To enter the menu of each setting, follow the steps below:

### ■ Security setting items and operation procedure

- Setting or changing the PIN (Personal Identification Number)
  1. "Setup" → 2. "Security" → 3. "Set PIN"
- Locking the phone book
  1. "Setup" → 2. "Security" → 3. "Phonebook Lock"
- Unlocking the phone book
  1. "Setup" → 2. "Security" → 3. "Phonebook Unlock"

### ■ System setup items and operation procedure

- Setting voice guidance volume
  1. "Setup" → 2. "System Setup" → 3. "Guidance Vol"
- Initialization
  1. "Setup" → 2. "System Setup" → 3. "Initialize"





can only be used for system setup operation.

## Setting or changing the PIN

### ■ Setting a PIN

**STEP 1** Select "Set PIN" by using a voice command or .

**STEP 2** Enter a PIN by using a voice command or .

When using , input the code 1 digit at a time.

### ■ Changing the PIN

**STEP 1** Select “Set PIN” by using a voice command or  .

**STEP 2** Enter the registered PIN by using a voice command or  .

**STEP 3** Enter a new PIN by using a voice command or  .

When using  , input the code 1 digit at a time.

### Locking or unlocking the phone book

**STEP 1** Select “Phonebook lock (Phbk Lock)” or “Phonebook unlock (Phbk Unlock)” by using a voice command or  .

**STEP 2** Input the PIN by either of the following methods and select “Confirm” by using a voice command or  :

a. Press the talk switch and say the registered PIN.

b. Input a new PIN by using  .

## Setting voice guidance volume

**STEP 1** Select “Guidance Vol” by using  .

**STEP 2** Change the voice guidance volume.

To decrease the volume: Turn  counterclockwise.

To increase the volume: Turn  clockwise.

## Initialization

**STEP 1** Select “Initialize” and then “Confirm” by using  .

**STEP 2** Select “Confirm” by using  .

#### ■ Initialization

- The following data in the system can be initialized:
  - Phone book
  - Outgoing and incoming call history
  - Speed dials
  - Registered cellular phone data
  - Security code
- Once the initialization has been completed, the data cannot be restored to its original state.

#### ■ When the phone book is locked

The following functions cannot be used:

- Dialing by inputting a name
- Speed dialing
- Dialing a number stored in the call history memory
- Using the phone book



### 3-3. Using the hands-free phone system (for cellular phone)

## Using the phone book

To enter the menu of each setting, follow the steps below:

- Adding a new phone number
  1. "Phonebook" → 2. "Add Entry"
- Setting speed dial
  1. "Phonebook" → 2. "Set Speed Dial (Speed Dial)"
- Changing a registered name
  1. "Phonebook" → 2. "Change Name"
- Deleting registered data
  1. "Phonebook" → 2. "Delete Entry"
- Deleting speed dial
  1. "Phonebook" → 2. "Delete Speed Dial (Del Spd Dial)"
- Listing the registered data
  1. "Phonebook" → 2. "List Names"

### Adding a new phone number

The following methods can be used to add a new phone number:

- Inputting a phone number by using a voice command
- Transferring data from the cellular phone
- Inputting a phone number by using  TUNE FILE
- Selecting a phone number from outgoing or incoming call history

## ■ Adding procedure

**STEP 1** Select “Add Entry” by using a voice command or  .

**STEP 2** Use one of the following methods to input a telephone number:

▶ Inputting a telephone number by using a voice command

STEP2-1 Select “By Voice” by using a voice command or

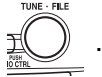

STEP2-2 Press the talk switch, say the desired number, and select “Confirm” by using a voice command.

▶ Transferring data from the cellular phone

STEP2-1 Select “By Phone” and then “Confirm” by using a

voice command or  .

STEP2-2 Transfer the data from the cellular phone.

Refer to the manual that comes with the cellular phone for the details of transferring data.

STEP2-3 Select the data to be registered by either of the following methods:

a. Say “Previous” or “Next” until the desired data is displayed, and select “Confirm” by using a voice command.

b. Select the desired data by using  .

► Inputting a phone number by using 

STEP2-1 Select “Manual Input” by using .

STEP2-2 Input a phone number by using , and press

 once again.

Input the phone number 1 digit at a time.

► Selecting a phone number from outgoing or incoming call history

STEP2-1 Select “Call History” by using a voice command or

.

STEP2-2 Select “Outgoing” or “Incoming” by using a voice

command or .

STEP2-3 Select the data to be registered by either of the following methods:

a. Say “Previous” or “Go back” until the desired data is displayed, and select “Confirm” by using a voice command.

b. Select the desired data by using .

**STEP 3** Select the name to be registered by either of the following methods, and select “Confirm” by using a voice command or

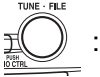

a. Press the talk switch and say the desired name.

b. Select “Record Name” by using , and say the desired name.

**STEP 4** Select “Confirm” by using a voice command or .

In **STEP 3**, selecting “Set Speed Dial (Speed Dial)” instead of “Confirm” registers the newly added phone number as a speed dial.

## Setting speed dials

**STEP 1** Select “Set Speed Dial (Speed Dial)” by using a voice command or





**STEP 2** Select the data to be registered as a speed dial by either of the following methods:

a. Press the talk switch, say desired number, and select “Con-

firm” by using a voice command or .

b. Press the talk switch, and say “List names”. While the desired name is being read aloud, press the talk switch,

and select “Confirm” by using a voice command or .

c. Select the desired data by using .

**STEP 3** Select the desired preset button, and register the data into speed dial by either of the following methods:

a. Press the desired preset button, and select “Confirm” by

using a voice command or  .

b. Press and hold the desired preset button.

### Changing a registered name

**STEP 1** Select “Change Name” by using a voice command or  .

**STEP 2** Select the name to be changed by either of the following methods.

a. Press the talk switch, say desired name, and select “Con-

firm” by using a voice command or  .

b. Press the talk switch, and say “List names”. While the desired name is being read aloud, press the talk switch,

and select “Confirm” by using a voice command or  .

c. Select the desired name by using  .

**STEP 3** Select “Record Name” with  or the talk switch.

**STEP 4** Say a new name, and select “Confirm” by using a voice command or  .

## Deleting registered data

**STEP 1** Select “Delete Entry” by using a voice command or  .

### ► Pattern A

**STEP 2** Select the data to be deleted by either of the following methods, and select “Confirm” by using a voice command or



- Press the talk switch, and say the name of the desired phone number to be deleted.
- Press the talk switch, say “List phones”. While the name of the desired phone number is being read aloud, press the talk switch.

### ► Pattern B

**STEP 2** Select the data to be deleted by using  .

## Deleting speed dials

**STEP 1** Select “Delete Speed Dial (Del Spd Dial)” by using a voice

command or  .

**STEP 2** Press the preset button in which the desired speed dial is registered, and select “Confirm” by using a voice command or



### **Listing the registered data**

Selecting “List names” by using a voice command causes a list of the registered data to be read aloud.

When listing is complete, the system returns to “Phonebook”.

Pressing the talk switch while the desired data is being read aloud selects the data, and the following function will be available.

- Dialing: “Dial”
- Changing a registered name: “Change Name”
- Deleting an entry: “Delete Entry”
- Setting a speed dial: “Set Speed Dial (Speed Dial)”

---

#### **■ Limitation of number of digits**

A phone number that exceeds 24 digits cannot be registered.

### 3-4. Using the interior lights

## Interior lights list

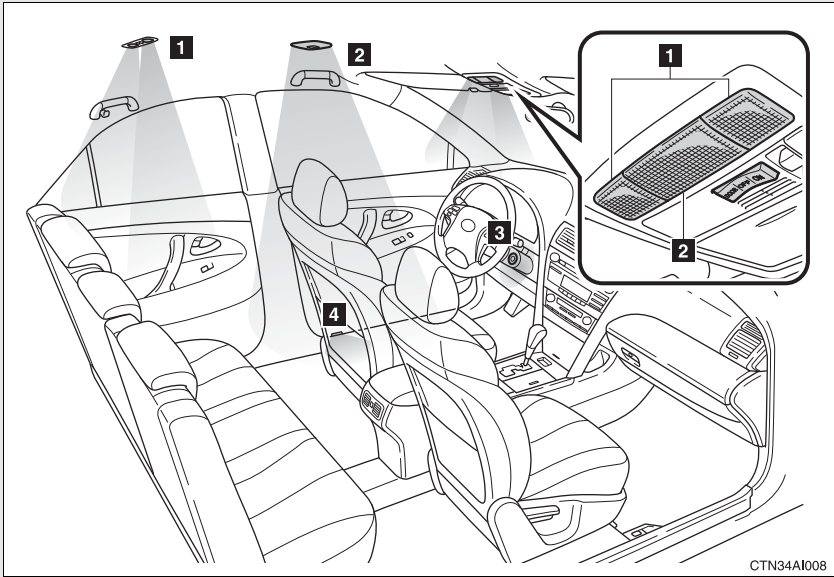

- 1** Personal lights (→P. 266)
- 2** Interior light (→P. 265)
- 3** Engine switch light (vehicles without smart key system)
- 4** Front door courtesy light



### ■ Illuminated entry system

The interior light (with the switch in the “DOOR” position) and engine switch light (vehicles without smart key system) automatically turn on/off according to “ENGINE START STOP” switch mode (vehicles with smart key system) or engine switch position (vehicles without smart key system), the presence of the electronic key (vehicles with smart key system), whether the doors are locked/unlocked and whether the doors are open/closed.

### ■ To prevent the battery from being discharged

If the interior light and engine switch light (vehicles without smart key system) remain on when the door is not fully closed and the interior light switch is in the “DOOR” position, the lights will go off automatically after 20 minutes.

### ■ Customization that can be configured at Toyota dealer

Settings (e.g. The time elapsed before lights turn off) can be changed.  
(Customizable features →P. 454)

## Interior light

### ▶ Vehicles without moon roof

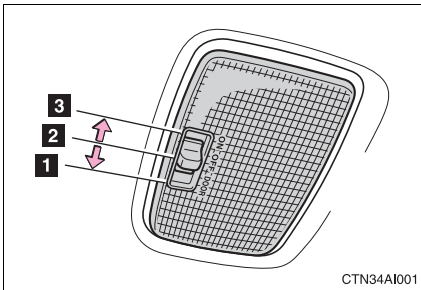

- 1 Door position
- 2 Off
- 3 On

► Vehicles with moon roof

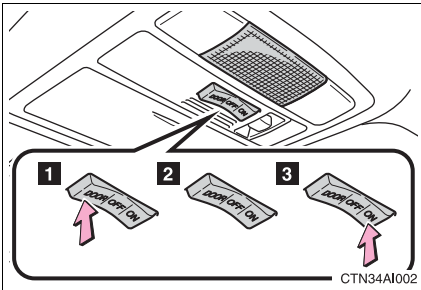

- 1 Door position
- 2 Off
- 3 On

**Personal lights**

► Front

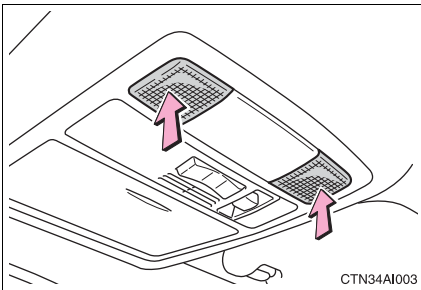

On/off

► Rear (vehicles with moon roof)

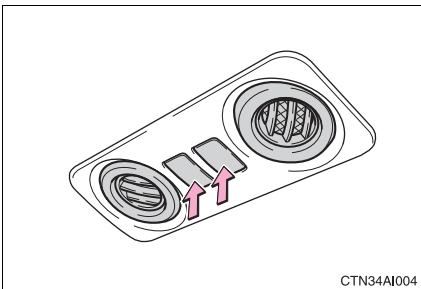

On/off

When either of the rear side doors is opened, the light on that side turns on automatically. Closing the rear side doors will turn the lights off.

## 3-5. Using the storage features

### List of storage features

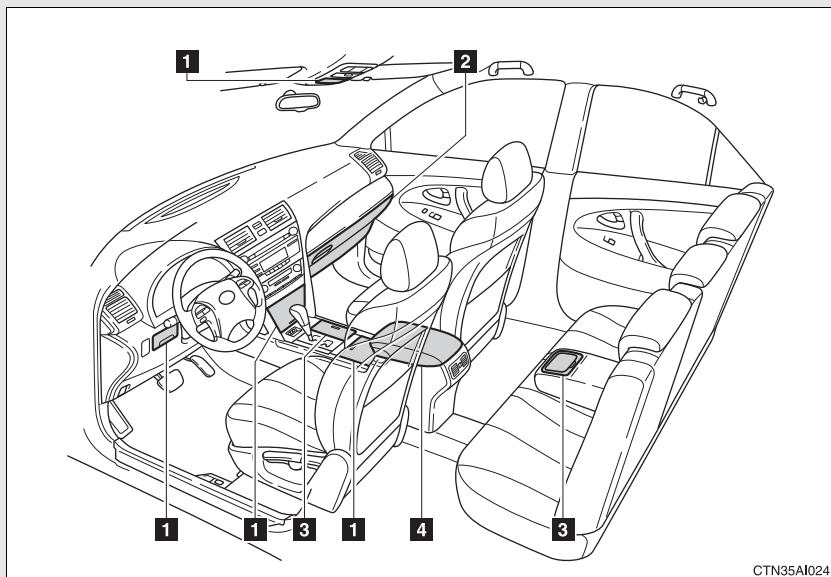

**1** Auxiliary boxes

**2** Glove box

**3** Cup holders

**4** Console box

## Glove box

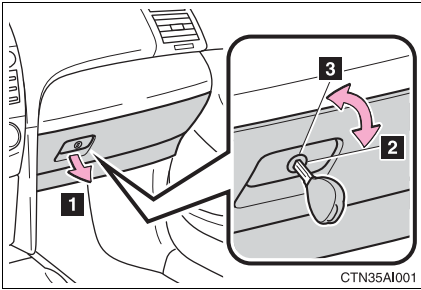

- 1** Open (pull the lever)
- 2** Lock with the master key (vehicles without smart key system) or mechanical key (vehicles with smart key system)
- 3** Unlock with the master key (vehicles without smart key system) or mechanical key (vehicles with smart key system)

## ■ Glove box light

The glove box light turns on when the tail lights are turned on.

## ! CAUTION

### ■ Caution while driving

Keep the glove box closed.

Injuries may result in the event of an accident or sudden braking.

## Console box

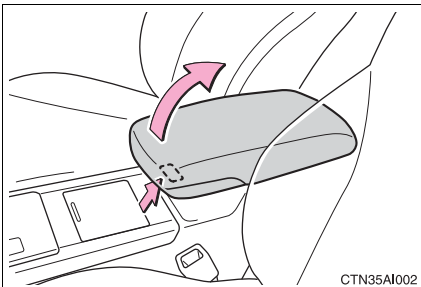

Lift the lid while pulling the lever.

### ■ When using the console box lid as an armrest (if equipped)

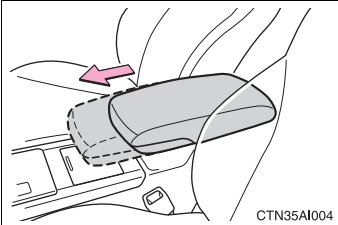

If necessary, the console box lid can slide forward. Pull the lid forward by grasping the front of the lid.

### ■ Tray in the rear console box

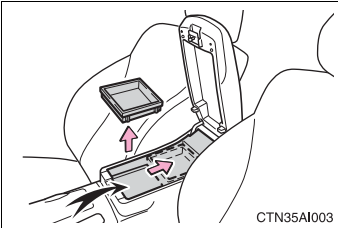

The tray slides forward/backward and can be removed.

## ⚠ CAUTION

### ■ Caution while driving

Keep the console box closed.  
Injuries may result in the event of an accident or sudden braking.

## Cup holders

### ► Manual transmission

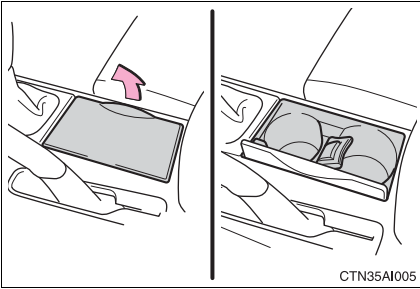

Lift the lid.

### ► Automatic transmission (type A)

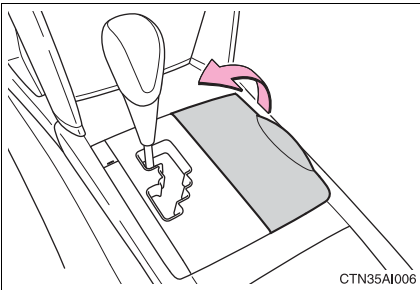

Lift the lid.

### ► Automatic transmission (type B)

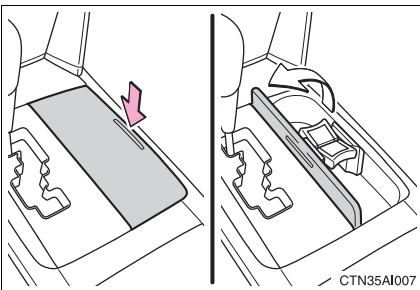

To open, press down and release the right side of the cup holder lid.

► Rear (type A)

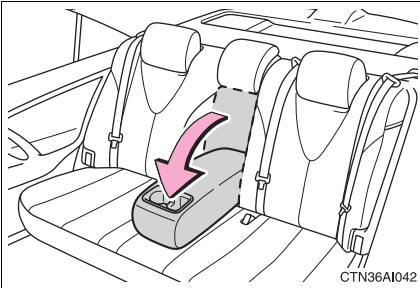

Pull the armrest down.

► Rear (type B)

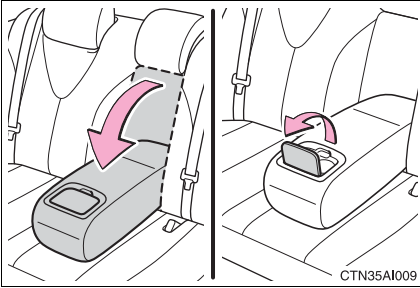

Pull the armrest down and lift the lid.

■ Using the cup holder (front) to store small items (automatic transmission)

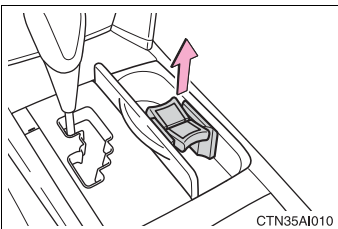

Remove the holder.

**! CAUTION****■ Items unsuitable for the cup holder**

Do not place anything other than cups or aluminum cans in the cup holders. Other items may be thrown out of the holders in the event of an accident or sudden braking and cause injury. If possible, cover hot drinks to prevent burns.

**■ When not in use**

Keep the cup holders closed.  
Injuries may result in the event of an accident or sudden braking.

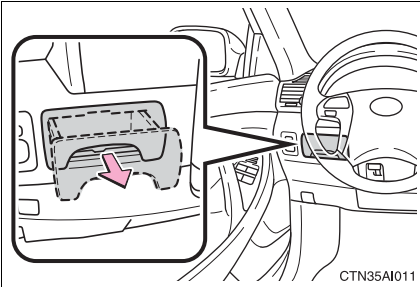
**Auxiliary boxes****► Driver's side instrument panel**

Pull the handle.



► Overhead console

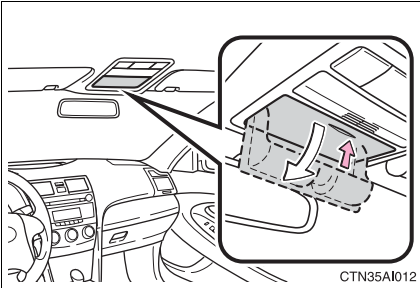

Push the lid.

► Front console

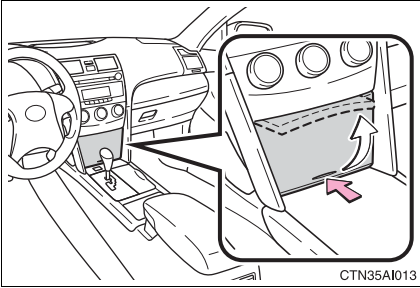

Push the lid.

► Center console (if equipped)

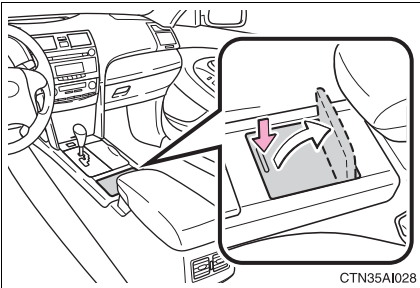

Push the lid.

### ■ Cable pass-through

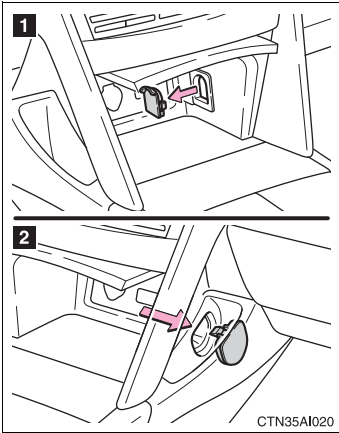

The auxiliary box of the front console is provided with a hole that allows cables to be passed into the cabin from the power outlet and AUX adapter inside.

- 1** Remove the lid.
- 2** Push out and remove the outer lid.

### ⚠ CAUTION

#### ■ Caution while driving

Keep the auxiliary boxes closed.  
Injuries may result in the event of an accident or sudden braking.

#### ■ Items that should not be left in the overhead console

Do not leave glasses or lighters in the console.  
If the interior of the vehicle becomes hot, lighters may explode and glasses may warp or become cracked.

## Sun visors

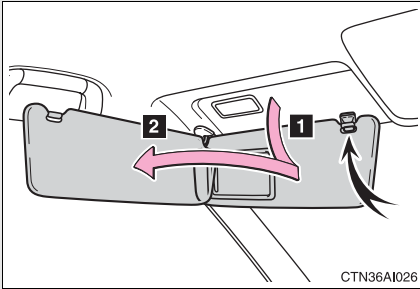

**1** Forward position:  
Flip down.

**2** Side position:  
Flip down, unhook, and  
swing to the side.

### 3-6. Other interior features

## Vanity mirrors

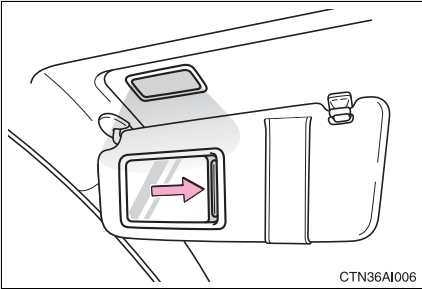

Slide the cover.

The light turns on when the cover is opened. (if equipped)

## Clock

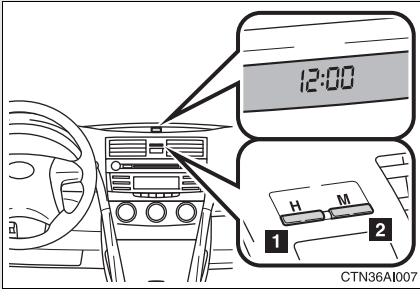

- 1** Adjusts the hour.
- 2** Adjusts the minutes.

### ■ The clock is displayed when

- ▶ Vehicles with smart key system

The “ENGINE START STOP” switch is in ACCESSORY or IGNITION ON mode.

- ▶ Vehicles without smart key system

The engine switch is in “ACC” or “ON” position.

### 3-6. Other interior features

## Ashtrays (if equipped)

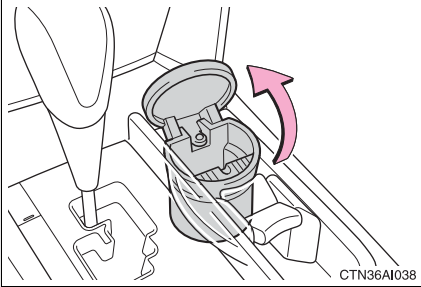

An ashtray can be installed in a cup holder. (→P. 270)

### **!** CAUTION

#### ■ When not in use

Keep the ashtray closed.

Injuries may result in the event of an accident or sudden braking.

#### ■ To prevent fire

- Fully extinguish matches and cigarettes before putting them in the ashtray, then make sure the ashtray is fully closed.
- Do not place paper or any other type of flammable object in the ashtray.

## Power outlet

The power outlet can be used for 12 V accessories that run on less than 10 A.

### ► Type A

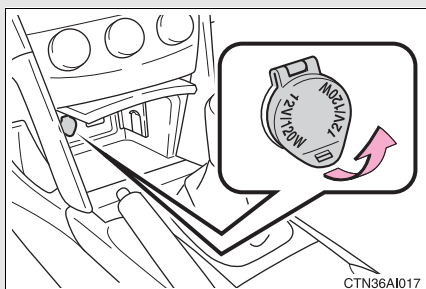

### ► Type B

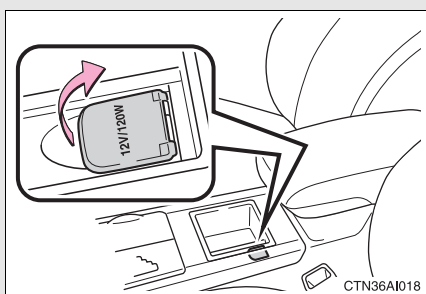

### ► Type C

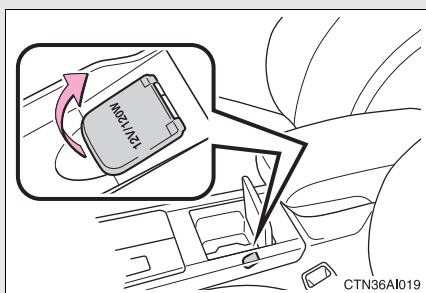

---

■ **The power outlet can be used when**

- ▶ Vehicles with smart key system

The “ENGINE START STOP” switch is in ACCESSORY or IGNITION ON mode.

- ▶ Vehicles without smart key system

The engine switch is in “ACC” or “ON” position.

■ **Cable pass-through**

Connected cables can be passed through the hole in the auxiliary box to the front passenger’s side of the auxiliary box. (→P. 274)

 **NOTICE**

■ **To avoid damaging the power outlet**

Close the power outlet lid when the power outlet is not in use.

Foreign objects or liquids that enter the power outlet may cause a short circuit.

■ **To prevent the fuse from being blown**

Do not use an accessory that uses more than 12 V 10 A.

■ **To prevent the battery from being discharged**

Do not use the power outlet longer than necessary when the engine is not running.



## Seat heaters (if equipped)

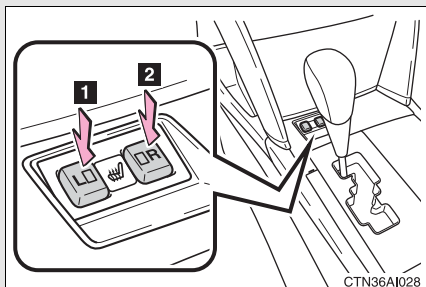

**1** Heats the left front seat

**2** Heats the right front seat

The indicator light comes on.

### ■ The seat heaters can be used when

▶ Vehicles with smart key system

The “ENGINE START STOP” switch is in IGNITION ON mode.

▶ Vehicles without smart key system

The engine switch is in “ON” position.

### ■ When not in use

Turn the seat heater off. The indicator light turns off.

## ⚠ CAUTION

### ■ Burns

● Use caution when seating the following persons in a seat with the seat heater on to avoid the possibility of burns:

- Babies, small children, the elderly, the sick and the disabled
- Persons with sensitive skin
- Persons who are fatigued
- Persons who have taken alcohol or drugs that induce sleep (sleeping drugs, cold remedies, etc.)

● Do not cover the seat with anything when using the seat heater. Using the seat heater with a blanket or cushion increases the temperature of the seat and may lead to overheating.



**NOTICE**

■ **To prevent seat heater damage**

Do not put unevenly weighted objects on the seat and do not stick sharp objects (needles, nails, etc.) into the seat.

■ **To prevent battery discharge**

Turn the switches off when the engine is not running.

## Armrest

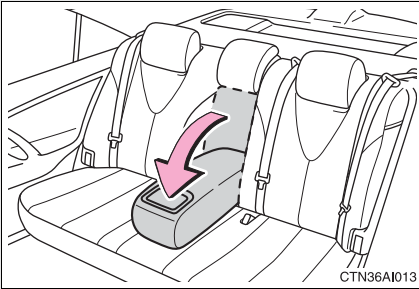

Pull the armrest down for use.

 **NOTICE**

**■ To prevent damage to the armrest**

Do not place too much strain on the armrest.

### 3-6. Other interior features

## Rear sunshade (if equipped)

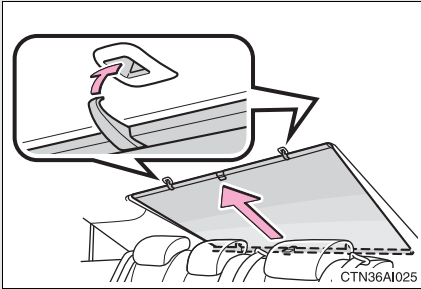

Pull the tab of the shade and hook it on using the anchors. To lower the shade, pull the tab slightly to unhook the shade, and lower it slowly.

#### CAUTION

##### ■ When the rear sunshade is being raised or lowered

Do not place fingers or other objects in the fastener section or in the opening. They may get caught, causing injury.

#### NOTICE

##### ■ To ensure normal operation of the sunshade

Observe the following precautions.

- Do not place anything where it may hinder the opening/closing of the shade.
- Do not place anything on the shade.

### 3-6. Other interior features

## Trunk storage extension (vehicles with reclining rear seat)

Long objects can be loaded in the vehicle by utilizing the trunk space and rear seat area.

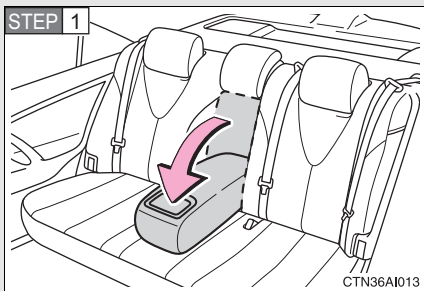

Pull down the armrest.

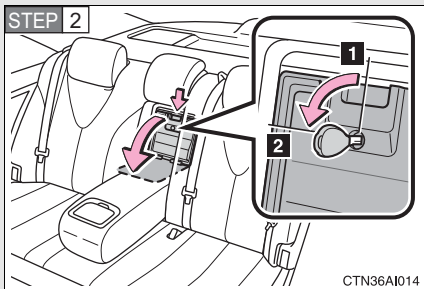

Open the armrest door.

The armrest door can be locked and unlocked using the mechanical key (vehicles with smart key system) or master key (vehicles without smart key system).

- 1 Lock
- 2 Unlock

### CAUTION

#### ■ When not in use

Ensure that the armrest door is closed.

In the event of sudden braking, items stored in the trunk may be thrown forward into the cabin, resulting in injury.

## Floor mat

**Securely place a mat that matches the size of the space on the carpet.**

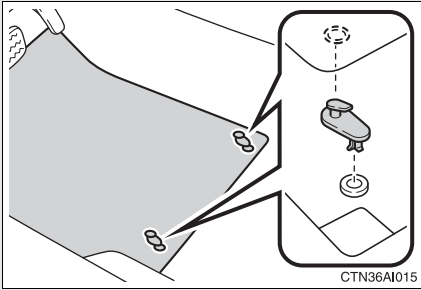

Secure the driver's floor mat using the hooks provided.

### **⚠ CAUTION**

#### **■ When inserting the floor mat**

Observe the following precautions.

Failure to do so may result in the floor mat slipping and interfering with the movement of the pedals during driving, resulting in an accident.

- Make sure the floor mat is properly placed on the vehicle carpet and the correct side faces upward.
- Do not place floor mats on the top of existing mats.

## Trunk features

### ■ Storage box

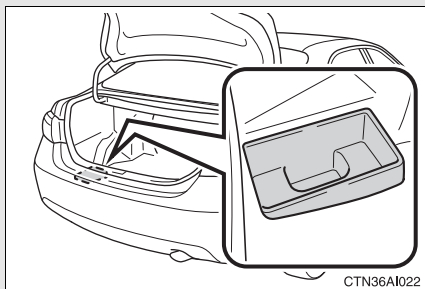

### ■ Grocery bag hooks

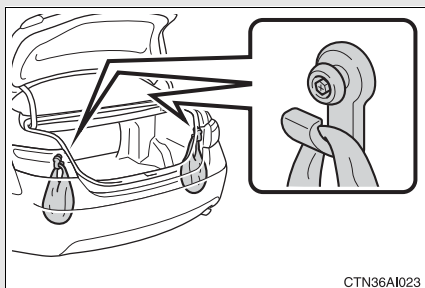

### ■ Cargo net

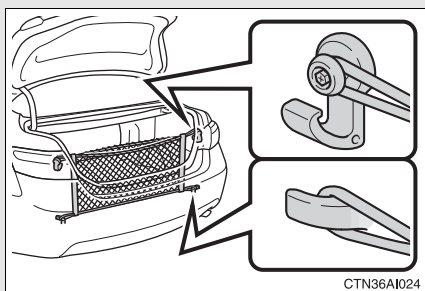

### ⚠ NOTICE

#### ■ To prevent damage to the cargo net hooks

Avoid hanging things other than a cargo net on them.

### 3-6. Other interior features

## Garage door opener (if equipped)

The garage door opener can be programmed to operate garage doors, gates, entry doors, door locks, home lighting systems, and security systems, and other devices.

The garage door opener (HomeLink® Universal Transceiver) is manufactured under license from HomeLink®.

### Programming HomeLink® (for U.S. owners)

The HomeLink® compatible transceiver in your vehicle has 3 buttons which can be programmed to operate 3 different devices. Refer to the programming method below appropriate for the device.

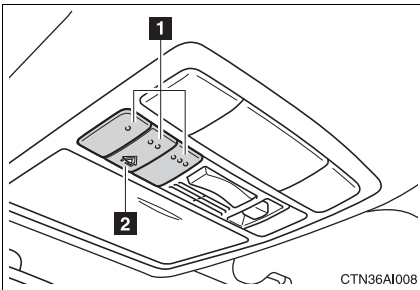

- 1 Buttons
- 2 Indicator

### ■ Programming HomeLink®

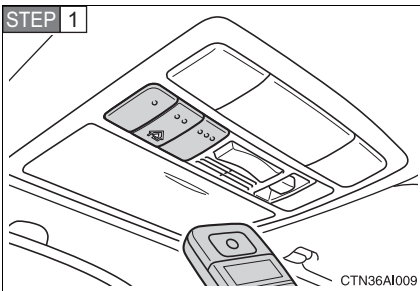

Point the remote control for the device 1 to 3 in. (25 to 75 mm) from the HomeLink® control buttons.

Keep the indicator light on HomeLink® in view while programming.



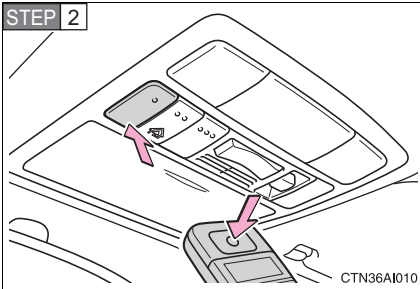

Press and hold down one of the buttons on HomeLink<sup>®</sup> and the button on the transmitter. When the indicator light on HomeLink<sup>®</sup> changes from a slow to a rapid flash after 20 seconds, you can release both buttons.

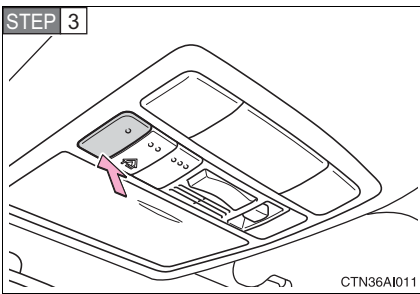

Test the operation of HomeLink<sup>®</sup> by pressing the newly programmed button.

If programming a garage door opener, check to see if the garage door opens and closes. If the garage door does not operate, see if your garage transmitter is of the Rolling Code type. Press and hold the programmed HomeLink<sup>®</sup> button. The garage door has the rolling code feature if the indicator light (on HomeLink<sup>®</sup>) flashes rapidly for 2 seconds and then remains lit. If your transmitter is of the Rolling Code type, proceed to the heading "Programming a rolling code system".

**STEP 4** Repeat the steps above to program another device for each of the remaining HomeLink<sup>®</sup> buttons.

### ■ Programming a Rolling Code system (for U.S. owners)

If your device is Rolling Code equipped, follow the steps under the heading “Programming HomeLink®” before proceeding with the steps listed below.

**STEP 1** Locate the training button on the ceiling-mounted garage door opener motor. The exact location and color of the button may vary by brand of garage door opener.

Refer to the operation manual supplied with the garage door opener for the location of the training button.

**STEP 2** Press the training button.

**STEP 3** Press and release the vehicle’s programmed HomeLink® button twice. The garage door may open.

If the garage door opens, the programming process is complete. If the door does not open, press and release the button a third time. This third press and release will complete the programming process by opening the garage door.

The ceiling-mounted garage door opener motor should now recognize the HomeLink® transceiver and operate the garage door.

**STEP 4** Repeat the steps above to program another rolling code system for any of the remaining HomeLink® buttons.

### ■ Programming an entry gate (for U.S. owners)/Programming all devices in the Canadian market

**STEP 1** Place your transmitter 1 to 3 in. (25 to 75 mm) away from the surface of HomeLink®.

Keep the indicator light on HomeLink® in view while programming.

**STEP 2** Press and hold the selected HomeLink® button.

**STEP 3** Repeatedly press and release (cycle) the device’s remote control button for two seconds each until step 4 is complete.

**STEP 4** When the indicator light on the HomeLink® compatible transceiver starts to flash rapidly, release the buttons.

**STEP 5** Test the operation of HomeLink<sup>®</sup> by pressing the newly programmed button. Check to see if the gate/device operates correctly.

**STEP 6** Repeat the steps above to program another device for each of the remaining HomeLink<sup>®</sup> buttons.

### ■ Programming other devices

To program other devices such as home security systems, home door locks or lighting, contact your authorized Toyota dealer for assistance.

### ■ Reprogramming a button

The individual HomeLink<sup>®</sup> buttons cannot be erased but can be reprogrammed. To reprogram a button, follow the “Programming” instructions.

## Operating HomeLink<sup>®</sup>

Press the appropriate HomeLink<sup>®</sup> button. The HomeLink<sup>®</sup> indicator light on the HomeLink<sup>®</sup> transceiver should turn on.

HomeLink<sup>®</sup> continues to send a signal for up to 20 seconds as long as the button is pressed.

## Erasing the entire HomeLink<sup>®</sup> memory (all three programs)

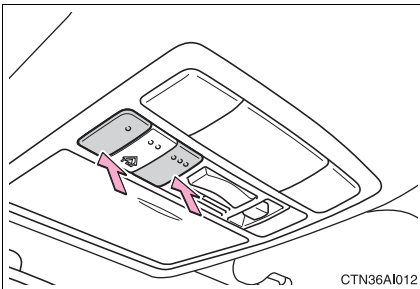

Press and hold down the 2 outside buttons for 20 seconds until the indicator light flashes.

If you sell your vehicle, be sure to erase the programs stored in the HomeLink<sup>®</sup> memory.

---

■ **Before programming**

- Install a new battery in the transmitter.
- The battery side of the transmitter must be pointed away from HomeLink®.

■ **Certification for the garage door opener**

This device complies with Part 15 of the FCC Rules and with RSS-210 of the IC Rules.

Operation is subject to the following two conditions: (1) This device may not cause harmful interference, and (2) this device must accept any interference received, including interference that may cause undesired operation.

**WARNING:** This transmitter has been tested and complies with FCC and IC rules. Changes or modifications not expressly approved by the party responsible for compliance could void the user's authority to operate the device.

 **CAUTION**

■ **When programming a garage door or other remote control device**

The garage door may operate, so ensure people and objects are out of danger to prevent potential harm.

■ **Conforming to federal safety standards**

Do not use the HomeLink® compatible transceiver with any garage door opener or device that lacks safety stop and reverse features as required by federal safety standards.

This includes any garage door that cannot detect an obstruction object. A door or device without these features increases the risk of death or serious injury.

### 3-6. Other interior features

## Compass (if equipped)

The compass on the inside rear view mirror indicates the direction in which the vehicle is heading.

#### ■ Operation

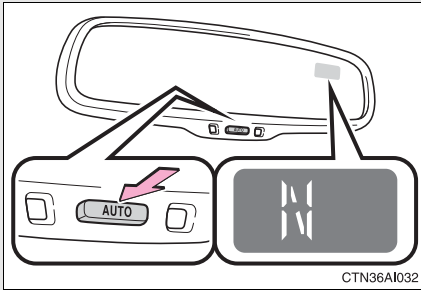

To turn the compass on or off, press and hold "AUTO" for 3 seconds.

#### ■ Displays and directions

Display	Direction
N	North
NE	Northeast
E	East
SE	Southeast
S	South
SW	Southwest
W	West
NW	Northwest

## Calibrating the compass

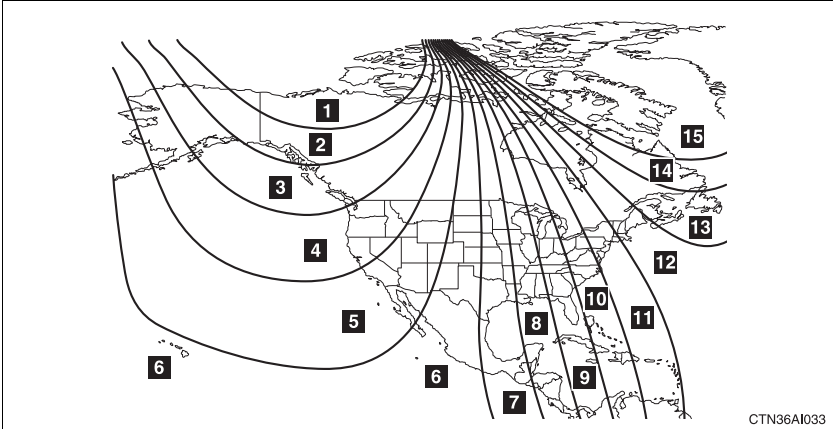

The direction display deviates from the true direction determined by the earth's magnetic field. The amount of deviation varies according to the geographic position of the vehicle.

If you cross over a map boundary shown in the illustration, the compass will deviate.

To obtain higher precision or perfect calibration, refer to the following.

### ■ Deviation calibration

**STEP 1** Stop the vehicle in a place where it is safe to drive in a circle.

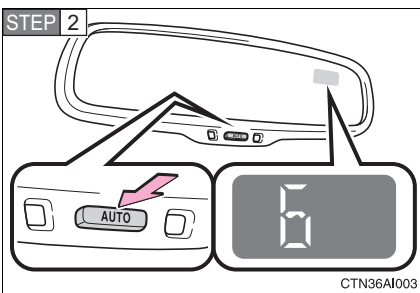

Press and hold "AUTO" for 6 seconds.

A number (1 to 15) appears on the compass display.

**STEP 3** Press "AUTO" and, referring to the map above, select the number of the zone where you are.

If the direction is displayed several seconds after adjustment, the calibration is complete.

## ■ Circling calibration

**STEP 1** Stop the vehicle in a place where it is safe to drive in a circle.

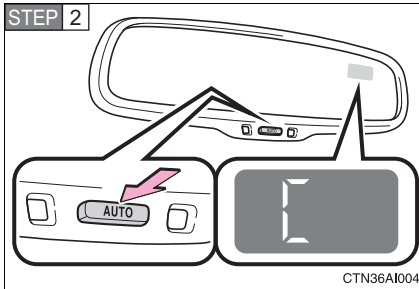

Press and hold “AUTO” for 9 seconds.

C appears on the compass display.

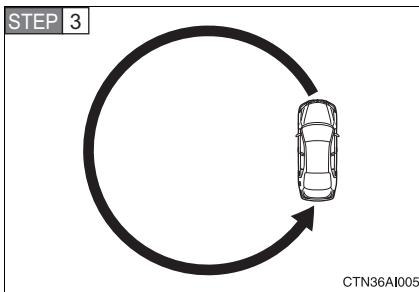

Drive the vehicle at 5 mph (8 km/h) or less in a circle until a direction is displayed.

If there is not enough space to drive in a circle, drive around the block until the direction is displayed.

## ■ Conditions unfavorable for correct operation

The compass may not show the correct direction in the following situations:

- The vehicle is stopped immediately after turning.
- The vehicle is on an inclined surface.
- The vehicle is in a place where the earth's magnetic field is subject to interference by artificial magnetic fields (underground car park/parking lot, under a steel tower, between buildings, roof car park/parking lot, near an intersection, near a large vehicle, etc.).
- The vehicle has become magnetized.  
(There is a magnet or metal object near the anti-glare inside rear view mirror.)
- The battery has been disconnected.
- A door is open.

 CAUTION

■ **While driving the vehicle**

Do not adjust the display. Be sure to adjust the display only when the vehicle is stopped.

■ **When doing the circling calibration**

Be sure to secure a wide space, and watch out for people and vehicles in the neighborhood. Do not violate any local traffic rules while performing circling calibration.

 NOTICE

■ **To avoid compass malfunctions**

Do not place magnets or any metal objects near the anti-glare inside rear view mirror.

Doing this may cause a malfunction of the compass sensor.

■ **To ensure normal operation of the compass**

- Do not perform circling calibration of the compass in a place where the earth's magnetic field is subject to interference by artificial magnetic fields.
- During calibration, do not operate electric systems (moon roof, power windows, etc.) as they may interfere with the calibration.



## Maintenance and care

# 4

<b>4-1. Maintenance and care .....</b>	<b>298</b>	<b>4-3. Do-it-yourself maintenance .....</b>	<b>309</b>
Cleaning and protecting the vehicle exterior.....	298	Do-it-yourself service precautions .....	309
Cleaning and protecting the vehicle interior.....	300	Hood .....	313
<b>4-2. Maintenance .....</b>	<b>303</b>	Positioning the jack .....	314
Maintenance requirements.....	303	Engine compartment.....	316
General maintenance.....	305	Tires .....	334
Emission inspection and maintenance (I/M) programs.....	308	Tire inflation pressure .....	344
		Wheels .....	348
		Air conditioning filter.....	350
		Key battery .....	353
		Checking and replacing fuses .....	357
		Light bulbs.....	368

## Cleaning and protecting the vehicle exterior

**Perform the following to protect the vehicle and maintain it in prime condition.**

- Working from top to bottom, liberally apply water to the vehicle body, wheel wells and underside of the vehicle to remove any dirt and dust.

Wash the vehicle body using a sponge or soft cloth, such as a chamois.

- For hard-to-remove marks, use car wash soap and rinse thoroughly with water.
- Wipe away any water.
- Wax the vehicle when the waterproof coating deteriorates.

If water does not bead on a clean surface, apply wax when the vehicle body is cool.

---

### ■ Automatic car washes

Brushes used in automatic car washes may scratch the vehicle surface and harm your vehicle's paint.

### ■ High pressure car washes

- Do not allow the nozzles of the car wash to come within close proximity of the windows.
- Before car wash, check that the fuel filler door on your vehicle is closed properly.

### ■ Aluminum wheels

Remove any dirt immediately by using a neutral detergent. Do not use hard brushes or abrasive cleaners. Do not use strong or harsh chemical cleaners. Use the same mild detergent and wax as used on the paint.

### ■ Bumpers and side moldings

Do not scrub with abrasive cleaners.

### ■ To prevent deterioration and body corrosion

- Wash the vehicle immediately in the following cases:
  - After driving near the sea coast
  - After driving on salted roads
  - If you see coal tar or tree sap on the paint surface
  - If you see dead insects or insect droppings on the paint
  - After driving in an area contaminated with soot, oily smoke, mine dust, iron powder or chemical substances
  - If the vehicle becomes heavily soiled in dust or mud
  - If liquids such as benzene and gasoline are spilled on the paint surface
- If the paint is chipped or scratched, have it repaired immediately.

#### CAUTION

##### ■ Caution about the exhaust pipe

Exhaust gasses cause the exhaust pipe to become quite hot.

When washing the vehicle, be careful not to touch the pipe until it has cooled sufficiently, as touching a hot exhaust pipe can cause burns.

#### NOTICE

##### ■ To protect your vehicle's painted surfaces

Do not use organic cleaners such as benzene or gasoline.

##### ■ Cleaning the exterior lights

- Wash carefully. Do not use organic substances or scrub with a hard brush. This may damage the surfaces of the lights.
- Do not apply wax on the surfaces of the lights. Wax may cause damage to the lenses.

## Cleaning and protecting the vehicle interior

**The following procedures will help protect your vehicle's interior and keep it in top condition:**

### ■ **Protecting the vehicle interior**

Remove dirt and dust using a vacuum cleaner. Wipe dirty surfaces with a cloth dampened with lukewarm water.

### ■ **Cleaning the leather areas**

- Remove dirt and dust using a vacuum cleaner.
- Wipe any excess dirt and dust with a soft cloth dampened with diluted detergent.

Use a diluted water solution of approximately 5% neutral wool detergent.

- Wring out any excess water from the cloth and thoroughly wipe off all remaining traces of detergent.
- Wipe the surface with a dry, soft cloth to remove any remaining moisture. Allow the leather to dry in a shaded ventilated area.

### ■ **Synthetic leather areas**

- Remove loose dirt using a vacuum cleaner.
- Apply a mild soap solution to the synthetic leather.
- Allow the solution to soak in for a few minutes. Remove the dirt and wipe off the solution with a clean, damp cloth.

### ■ Cleaning the inside of the rear window

Do not use glass cleaner to clean the rear window, as this may cause damage to the rear window defogger heater wires or antenna. Use a cloth dampened with lukewarm water to gently wipe the window clean. Wipe the window in strokes running parallel to the heater wires or antenna.

### ■ Caring for leather areas

Toyota recommends cleaning the interior of the vehicle at least twice a year to maintain the quality of the vehicle's interior.

### ■ Shampooing the carpets

There are several commercial foaming-type cleaners available. Use a sponge or brush to apply the foam. Rub in overlapping circles. Do not apply water. Excellent results are obtained by keeping the carpet as dry as possible.

### ■ Seat belts

Clean with mild soap and lukewarm water using a cloth or sponge. Also check the belts periodically for excessive wear, fraying or cuts.

## CAUTION

### ■ Water in the vehicle

- Be careful not to splash or spill liquid on the floor.
- Do not get any of the SRS components or wiring in the vehicle interior wet. (→P. 85)

Electrical malfunction may cause the airbags to deploy or not function properly, resulting in death or severe injury.

 NOTICE

■ **Cleaning detergents**

Do not use organic substances such as benzene or gasoline, acidic or alkaline solutions, dye, bleach or other detergent. Doing so may discolor the vehicle interior or cause streaks or damage to painted surfaces.

■ **Preventing damage to leather surfaces**

Observe the following precautions to avoid damage to and deterioration of leather surfaces.

- Remove any dust or dirt on leather surfaces immediately.
- Do not expose the vehicle to direct sunlight for extended periods of time. Park the vehicle in the shade, especially during summer.
- Do not place items made of vinyl, plastic, or that contain wax, on the upholstery, as they may stick to the leather surface if the vehicle interior heats up significantly.

■ **Water on the floor**

Do not wash the vehicle floor with water.

Vehicle systems such as the audio system may be damaged if water comes into contact with electrical components under the floor of the vehicle, and may also cause the body to rust.

■ **Cleaning the inside of the rear window**

Be careful not to scratch or damage the heater wires or antenna.

## Maintenance requirements

**To ensure safe and economical driving, day-to-day care and regular maintenance is essential. It is the owner's responsibility to perform regular checks. Toyota recommends the following maintenance.**

### ■ General maintenance

Should be performed on a daily basis. This can be done by yourself or by a Toyota dealer.

### ■ Scheduled maintenance

Should be performed at specified intervals according to the maintenance schedule.

For details about maintenance items and schedules, refer to the "Scheduled Maintenance Guide" or "Owner's Manual Supplement".

### ■ Do-it-yourself maintenance

You can perform some maintenance procedures yourself. Please be aware that do-it-yourself maintenance may affect warranty coverage.

The use of Toyota Repair Manuals is recommended.

For details about warranty coverage, see the separate "Owner's Warranty Information Booklet", "Owner's Manual Supplement".

---

### ■ Repair and replacement

It is recommended that genuine Toyota parts be used for repair to ensure performance of each system. If non-Toyota parts are used in replacement or if a repair shop other than a Toyota dealer performs repairs, confirm the warranty coverage.

■ **Allow inspection and repairs to be performed by a Toyota dealer**

- Toyota technicians are well-trained specialists and are kept up to date with the latest service information. They are well informed about the operations of all systems on your vehicle.
- Keep a copy of the repair order. It proves that the maintenance that has been performed is under warranty coverage. If any problem should arise while your vehicle is under warranty, your Toyota dealer will promptly take care of it.

 **CAUTION**

■ **Warning in handling of battery**

- Engine exhaust, some of its constituents, and a wide variety of automobile components contain or emit chemicals known to the State of California to cause cancer and birth defects and other reproductive harm. Work in a well ventilated area.
- Oils, fuels and fluids contained in vehicles as well as waste produced by component wear contain or emit chemicals known to the State of California to cause cancer and birth defects or other reproductive harm. Avoid exposure and wash any affected area immediately.
- Battery posts, terminals and related accessories contain lead and lead compounds which are known to cause brain damage. Wash your hands after handling. (→P. 330)



## General maintenance

Listed below are the general maintenance items that should be performed at the intervals specified in the “Owner's Warranty Information Booklet” or “Owner's Manual Supplement/Scheduled Maintenance Guide”. It is recommended that any problem you notice should be brought to the attention of your Toyota dealer or qualified service shop for advice.

<b>Engine compartment</b>
---------------------------

Items	Check points
Battery	Check the connections. (→P. 330)
Brake fluid	At the correct level? (→P. 327)
Engine coolant	At the correct level? (→P. 325)
Engine oil	At the correct level? (→P. 319)
Exhaust system	No fumes or strange sounds?
Power steering fluid	At the correct level? (→P. 328)
Radiator/condenser/hoses	Not blocked with foreign matter? (→P. 326)
Washer fluid	At the correct level? (→P. 333)

<b>Vehicle interior</b>
-------------------------

Items	Check points
Accelerator pedal	<ul style="list-style-type: none"> <li>• Moves smoothly (without uneven pedal effort or catching)?</li> </ul>
Automatic transmission “Park” mechanism	<ul style="list-style-type: none"> <li>• Can the vehicle be held securely on an incline with the shift lever in P?</li> </ul>
Brake pedal	<ul style="list-style-type: none"> <li>• Moves smoothly?</li> <li>• Does it have appropriate clearance and correct amount of free play?</li> </ul>
Brakes	<ul style="list-style-type: none"> <li>• Not pull to one side when applied?</li> <li>• Loss of brake effectiveness?</li> <li>• Spongy feeling brake pedal?</li> <li>• Pedal almost touches floor?</li> </ul>
Head restraints	<ul style="list-style-type: none"> <li>• Move smoothly and lock securely?</li> </ul>
Indicators/buzzers	<ul style="list-style-type: none"> <li>• Function properly?</li> </ul>
Lights	<ul style="list-style-type: none"> <li>• Do all the lights come on?</li> </ul>
Parking brake	<ul style="list-style-type: none"> <li>• Moves smoothly?</li> <li>• Can hold the vehicle securely on an incline?</li> </ul>
Seat belts	<ul style="list-style-type: none"> <li>• Does the seat belt system operate smoothly?</li> <li>• Are the belts undamaged?</li> </ul>
Seats	<ul style="list-style-type: none"> <li>• Do the seat controls operate properly?</li> </ul>
Steering wheel	<ul style="list-style-type: none"> <li>• Moves smoothly?</li> <li>• Has correct free play?</li> <li>• No strange noises?</li> </ul>

## Vehicle exterior

Items	Check points
Door/trunk	<ul style="list-style-type: none"> <li>• Operate smoothly?</li> </ul>
Engine hood	<ul style="list-style-type: none"> <li>• The lock system works properly?</li> </ul>
Fluid leaks	<ul style="list-style-type: none"> <li>• Is there any leakage after parking?</li> </ul>
Tires	<ul style="list-style-type: none"> <li>• Inflation pressure is correct?</li> <li>• Tire surfaces not worn or damaged?</li> <li>• Tires rotated according to the maintenance schedule?</li> <li>• Wheel nuts are not loose?</li> </ul>

### CAUTION

#### ■ If the engine is running

Turn the engine off and ensure that there is adequate ventilation before performing maintenance checks.

**Some states have vehicle emission inspection programs which include OBD (On Board Diagnostics) checks. The OBD system monitors the operation of the emission control system.**

■ **If the electronic engine control system warning light comes on**

The OBD system determines that a problem exists somewhere in the emission control system. Your vehicle may not pass the I/M test and may need to be repaired. Contact your Toyota dealer to service the vehicle.

■ **Your vehicle may not pass the I/M test:**

- When the battery is disconnected or discharged

Readiness codes that are set during ordinary driving are erased.

Also, depending on your driving habits, the readiness codes may not be completely set.

- When the fuel tank cap is loose

The electronic engine control system warning light comes on as a temporary malfunction and your vehicle may not pass the I/M test.

■ **When the electronic engine control system warning light goes off after several driving trips**

The error code in the OBD system will not be cleared unless the vehicle is driven 40 or more times.

■ **If your vehicle does not pass the I/M test**

Contact your Toyota dealer to prepare the vehicle for re-testing.

## Do-it-yourself service precautions

**If you perform maintenance yourself, be sure to follow the correct procedures as given in these sections.**

Items	Parts and tools
Battery condition (→P. 330)	<ul style="list-style-type: none"> <li>• Warm water</li> <li>• Baking soda</li> <li>• Grease</li> <li>• Conventional wrench (for terminal clamp bolts)</li> </ul>
Brake fluid level (→P. 327)	<ul style="list-style-type: none"> <li>• FMVSS No.116 DOT 3 or SAE J1703 brake fluid</li> <li>• Rag or paper towel</li> <li>• Funnel (used only for adding brake fluid)</li> </ul>
Engine coolant level (→P. 325)	<ul style="list-style-type: none"> <li>• “Toyota Super Long Life Coolant” or similar high quality ethylene glycol based non-silicate, non-amine, non-nitrite and non-borate coolant with long-life hybrid organic acid technology. For the U.S.A.: “Toyota Super Long Life Coolant” is pre-mixed with 50% coolant and 50% deionized water. For Canada: “Toyota Super Long Life Coolant” is pre-mixed with 55% coolant and 45% deionized water.</li> <li>• Funnel (used only for adding engine coolant)</li> </ul>
Engine oil level (→P. 319)	<ul style="list-style-type: none"> <li>• “Toyota Genuine Motor Oil” or equivalent</li> <li>• Rag or paper towel, funnel (used only for adding oil)</li> </ul>

Items	Parts and tools
Fuses (→P. 357)	<ul style="list-style-type: none"> <li>• Fuse with same amperage rating as original</li> </ul>
Power steering fluid level (→P. 328)	<ul style="list-style-type: none"> <li>• Automatic transmission fluid DEXRON® II or III</li> <li>• Rag or paper towel</li> <li>• Funnel (used only for adding power steering fluid)</li> </ul>
Radiator and condenser (→P. 326)	—
Tire inflation pressure (→P. 344)	<ul style="list-style-type: none"> <li>• Tire pressure gauge</li> <li>• Compressed air source</li> </ul>
Washer fluid (→P. 333)	<ul style="list-style-type: none"> <li>• Water washer fluid containing antifreeze (for winter use)</li> <li>• Funnel</li> </ul>

 **CAUTION**

The engine compartment contains many mechanisms and fluids that may move suddenly, become hot, or become electrically energized. To avoid death or serious injury observe the following precautions.

■ **When working on the engine compartment**

- Keep hands, clothing, and tools away from the moving fan and engine drive belt.
- Be careful not to touch the engine, radiator, exhaust manifold, etc. right after driving as they may be hot. Oil and other fluids may also be hot.
- Do not leave anything that may burn easily, such as paper or rags, in the engine compartment.
- Do not smoke, cause sparks or expose an open flame to fuel or the battery. Fuel and battery fumes are flammable.
- Be extremely cautious when working on the battery. It contains poisonous and corrosive sulfuric acid.
- Take care because brake fluid can harm your hands or eyes and damage painted surfaces.  
If fluid gets on your hands or in your eyes, flush the affected area with clean water immediately.

If you still experience discomfort, see a doctor.

■ **When working near the electric cooling fans or radiator grille**

Vehicles with smart key system: Be sure the “ENGINE START STOP” switch is OFF. With the “ENGINE START STOP” switch in IGNITION ON mode, the electric cooling fans may automatically start to run if the air conditioning is on and/or the coolant temperature is high. (→P. 326)

Vehicles without smart key system: Be sure the engine switch is OFF. With the engine switch in “ON” position, the electric cooling fans may automatically start to run if the air conditioning is on and/or the coolant temperature is high. (→P. 326)

■ **Safety glasses**

Wear safety glasses to prevent flying or falling material, fluid spray, etc. from getting in the eyes.

 NOTICE

■ **If you remove the air cleaner**

Driving with the air cleaner removed may cause excessive engine wear due to dirt in the air. Also, a backfire could cause a fire in the engine compartment.



## 4-3. Do-it-yourself maintenance

### Hood

**Release the lock from the inside of the vehicle to open the hood.**

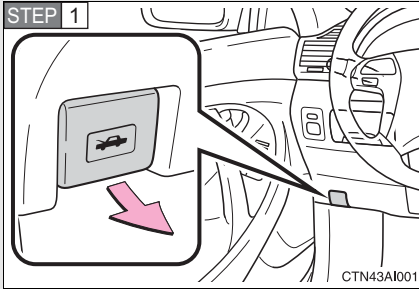

Pull the hood release lever.

The hood will pop up slightly.

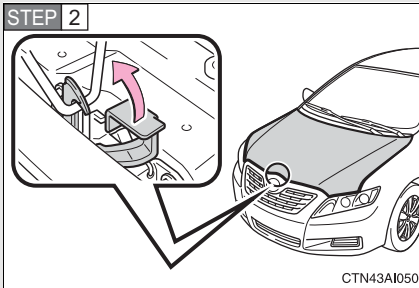

Lift the hood catch and lift the hood.

#### CAUTION

##### ■ Pre-driving check

Check that the hood is fully closed and locked.

If the hood is not locked properly, it may open while the vehicle is in motion and cause an accident, which may result in death or serious injury.

## 4-3. Do-it-yourself maintenance

### Positioning the jack

**When raising your vehicle with the jack, position the jack correctly. Improper placement may damage your vehicle or cause injury.**

#### ■ Front

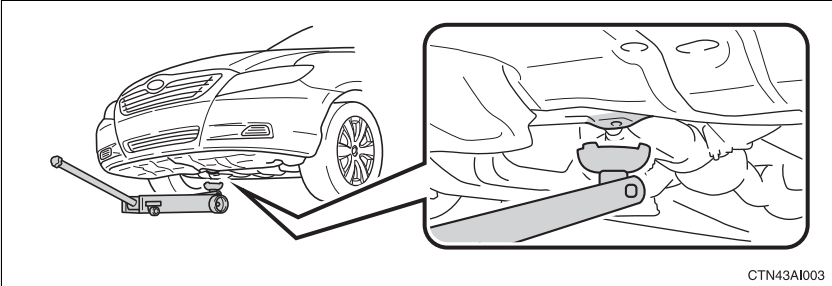

#### ■ Rear

##### ▶ 2.4 L 4-cylinder (2AZ-FE) engine

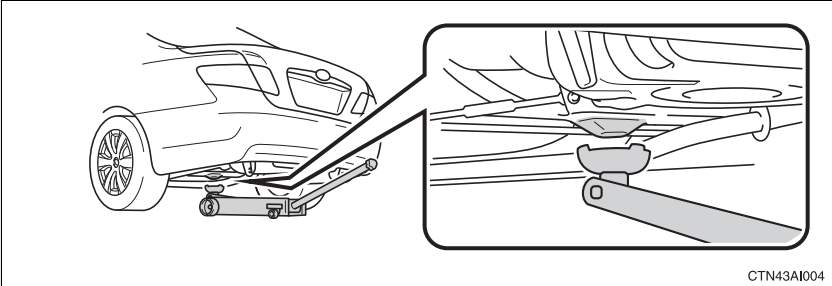

##### ▶ 3.5 L V6 (2GR-FE) engine

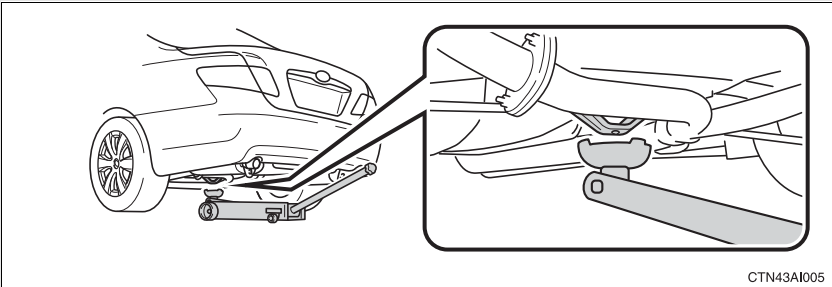

 **CAUTION****■ When raising your vehicle**

Make sure to observe the following to reduce the possibility of death or serious injury.

- Do not put any part of your body or get underneath the vehicle supported only by the jack.  
Always use automotive jack stands on a solid, level surface.
- Do not start the engine while the vehicle is supported by the jack.
- Stop the vehicle on level firm ground, firmly set the parking brake and put the shift lever in P (automatic transmission) or R (manual transmission).
- Make sure to set the jack properly at the jack point.  
Raising the vehicle with an improperly positioned jack will damage the vehicle and may cause the vehicle to fall off the jack.
- Do not raise the vehicle while someone is in the vehicle.
- When raising the vehicle, do not place any objects on top of or underneath the jack.

## 4-3. Do-it-yourself maintenance

### Engine compartment

#### ► 2.4 L 4-cylinder (2AZ-FE) engine

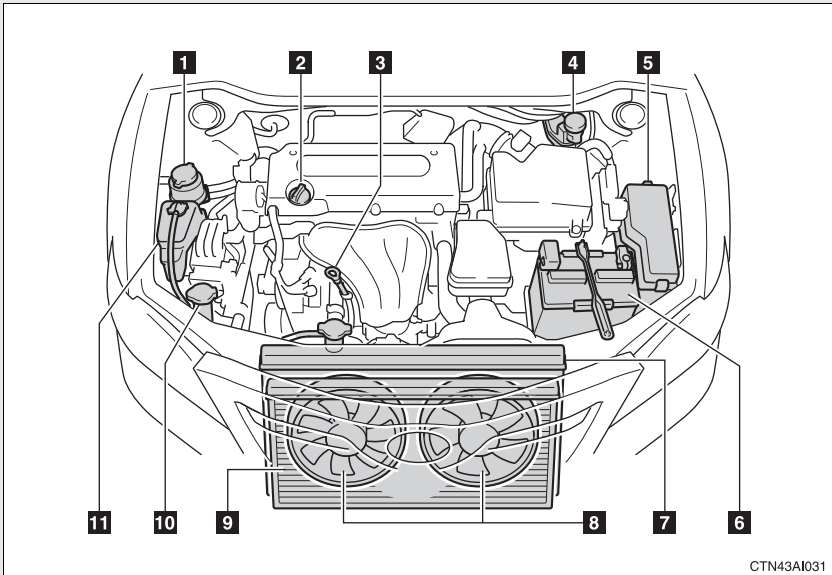

CTN43AI031

- |                                                   |                                              |
|---------------------------------------------------|----------------------------------------------|
| <b>1</b> Power steering fluid reservoir (→P. 328) | <b>5</b> Fuse box (→P. 357)                  |
| <b>2</b> Engine oil filler cap (→P. 320)          | <b>6</b> Battery (→P. 330)                   |
| <b>3</b> Engine oil level dipstick (→P. 319)      | <b>7</b> Radiator (→P. 326)                  |
| <b>4</b> Brake fluid reservoir (→P. 327)          | <b>8</b> Electric cooling fans               |
|                                                   | <b>9</b> Condenser (→P. 326)                 |
|                                                   | <b>10</b> Washer fluid tank (→P. 333)        |
|                                                   | <b>11</b> Engine coolant reservoir (→P. 325) |

## ▶ 3.5 L V6 (2GR-FE) engine

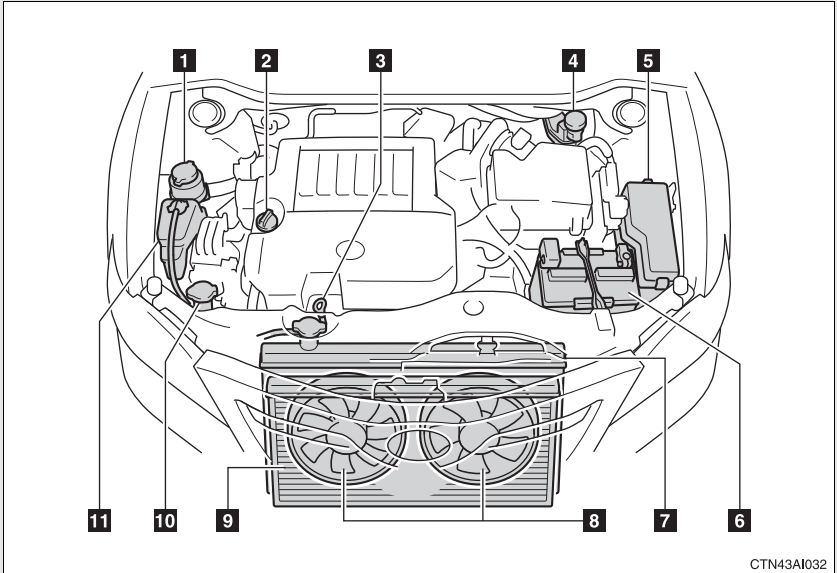

CTN43AI032

- |                                                   |                                              |
|---------------------------------------------------|----------------------------------------------|
| <b>1</b> Power steering fluid reservoir (→P. 328) | <b>5</b> Fuse box (→P. 357)                  |
| <b>2</b> Engine oil filler cap (→P. 320)          | <b>6</b> Battery (→P. 330)                   |
| <b>3</b> Engine oil level dipstick (→P. 319)      | <b>7</b> Radiator (→P. 326)                  |
| <b>4</b> Brake fluid reservoir (→P. 327)          | <b>8</b> Electric cooling fans               |
|                                                   | <b>9</b> Condenser (→P. 326)                 |
|                                                   | <b>10</b> Washer fluid tank (→P. 333)        |
|                                                   | <b>11</b> Engine coolant reservoir (→P. 325) |

### Engine compartment cover (3.5 L V6 [2GR-FE] engine only)

#### ■ Removing the engine compartment cover

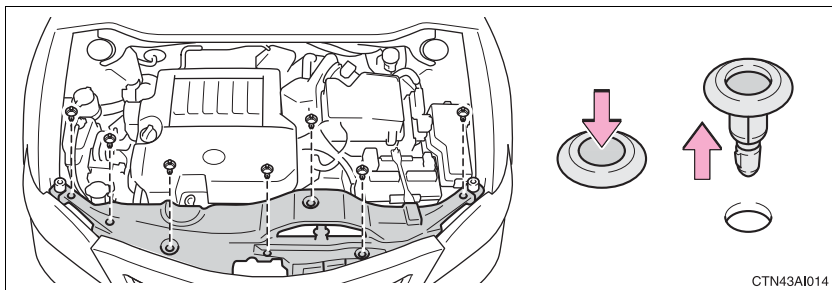

#### ■ Installing the clips

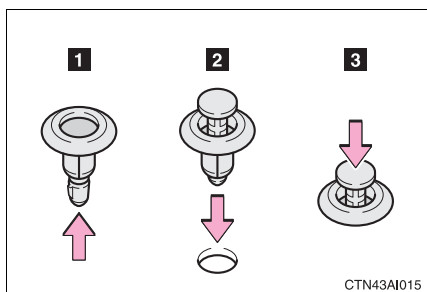

## Engine oil

With the engine at operating temperature and turned off, check the oil level on the dipstick.

### ■ Checking the engine oil

**STEP 1** Park the vehicle on level ground. After turning off the engine, wait a few minutes for the oil to drain back into the bottom of the engine.

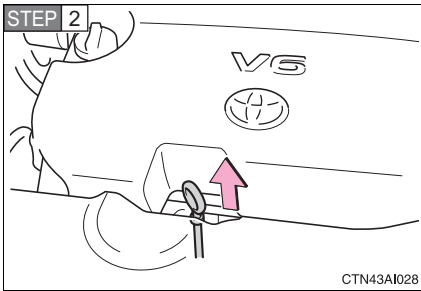

Hold a rag under the end and pull the dipstick out.

**STEP 3** Wipe the dipstick clean.

**STEP 4** Reinsert the dipstick fully.

**STEP 5** Holding a rag under the end, pull the dipstick out and check the oil level.

**STEP 6** Wipe the dipstick and reinsert it fully.

▶ 2.4 L 4-cylinder (2AZ-FE) engine

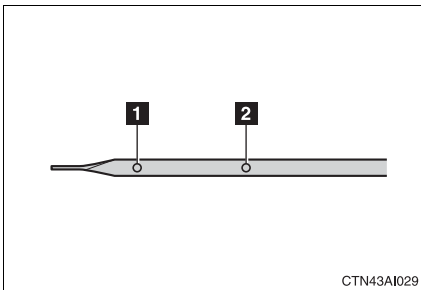

**1** Low

**2** Full

▶ 3.5 L V6 (2GR-FE) engine

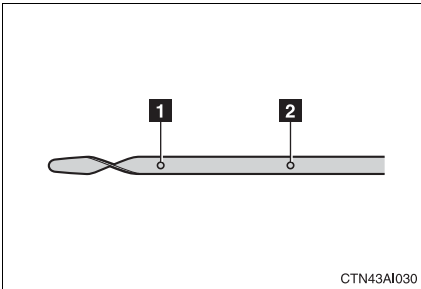

- 1 Low
- 2 Full

■ Adding engine oil

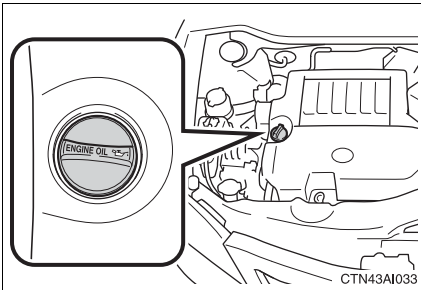

If the oil level is below or near the low level mark, add engine oil of the same type as already in the engine.

Make sure to check the oil type and prepare the items needed before adding oil.

Oil grade	ILSAC multigrade engine oil
Items	Clean funnel

**STEP 1** Remove the oil filler cap.

**STEP 2** Add engine oil slowly, checking the dipstick.



**STEP 3** Install the filler cap, turning it clockwise.

The approximate quantity of oil needed to raise the level between low and full on the dipstick is indicated as follows:

▶ 2.4 L 4-cylinder (2AZ-FE) engine

1.2 qt. (1.1 L, 1.0 Imp. qt.)

▶ 3.5 L V6 (2GR-FE) engine

1.6 qt. (1.5 L, 1.3 Imp. qt.)

### ■ Recommended viscosity

▶ 2.4 L 4-cylinder (2AZ-FE) engine

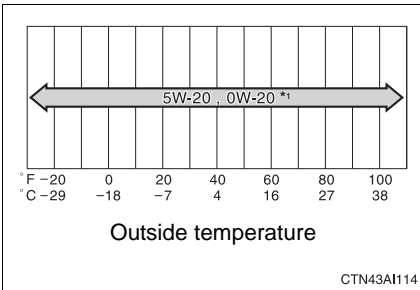

5W-20 or 0W-20

\*1: SAE 5W-20 or 0W-20 motor oil may be used. However, SAE 0W-20 is the best choice for fuel economy, and good starting in cold weather.

▶ 3.5 L V6 (2GR-FE) engine

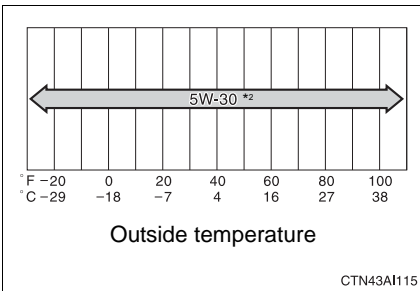

SAE 5W-30 is the best choice for good fuel economy, and good starting in cold weather.

\*2: If SAE 5W-30 oil is not available, SAE 10W-30 oil may be used. However, it should be replaced with SAE 5W-30 at the next oil change.

■ **How to read oil container labels**

Some oil containers are labeled with ILSAC certification marks that help you to select the proper oil.



CTN43AI008

### ■ Engine oil consumption

- The amount of engine oil consumed depends on the oil viscosity, the quality of the oil and the way the vehicle is driven.
- More oil is consumed under driving conditions such as high speeds and frequent acceleration and deceleration.
- A new engine consumes more oil.
- When judging the amount of oil consumption, keep in mind that the oil may have become diluted, making it difficult to judge the true level accurately.
- Oil consumption: Max. 1.1 qt./600 miles, 0.9 Imp.qt./600 miles (1.0 L per 1000 km)
- If you consume more than 1.1 qt. (1.0 L, 0.9 Imp.qt.) every 600 miles (1000 km), contact your Toyota dealer.

### ■ Changing the engine oil (U.S.A. only)

To reset the oil change system, follow the procedure below:

1. Turn the “ENGINE START STOP” switch or engine switch OFF with the trip meter A reading shown. (→P. 149)
2. While pressing the trip meter reset button (→P. 141), turn the “ENGINE START STOP” switch or engine switch ON.
  - ▶ Without multi-information display
3. Continue to press and hold the knob until the trip meter displays 000000.
  - ▶ With multi-information display
3. Continue to press and hold the knob until “COMPLETE” appears on the multi-information display.

 **CAUTION**

■ **Used engine oil**

- Used engine oil contains potentially harmful contaminants which may cause skin disorders such as inflammation or skin cancer, so care should be taken to avoid prolonged and repeated contact. To remove used engine oil from your skin, wash thoroughly with soap and water.
- Dispose of used oil and filters only in a safe and acceptable manner. Do not dispose of used oil and filters in household trash, in sewers or onto the ground. Call your Toyota dealer, service station or auto parts store for information concerning recycling or disposal.
- Do not leave used engine oil within the reach of children.

 **NOTICE**

■ **To prevent serious engine damage**

Check the oil level on a regular basis.

■ **When replacing the engine oil**

- Be careful not to spill engine oil on the vehicle components.
- Avoid overfilling, as the engine could be damaged.
- Check the oil level on the dipstick every time you refill the vehicle.
- Be sure the engine oil filler cap is properly tightened.

## Engine coolant

The coolant level is satisfactory if it is between the “F” and “L” lines on the reservoir when the engine is cold.

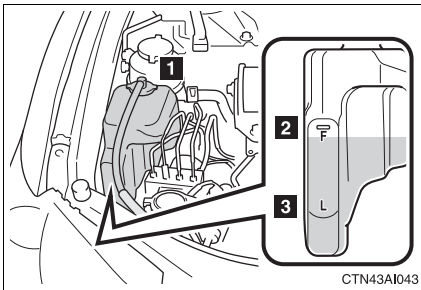

**1** Reservoir cap

**2** FULL

**3** LOW

If the level is on or below the “L” line, add coolant up to the “F” line.  
(→P. 421)

### ■ If the coolant level drops within a short time after replenishing

Visually check the radiator, hoses, engine coolant filler cap, radiator cap, drain cock and water pump.

If you cannot find a leak, have your Toyota dealer test the cap and check for leaks in the cooling system.

### ■ Coolant selection

Only use “Toyota Super Long Life Coolant” or similar high quality ethylene glycol based non-silicate, non-amine, non-nitrite, and non-borate coolant with long-life hybrid organic acid technology.

U.S.A.: “Toyota Super Long Life Coolant” is a mixture of 50% coolant and 50% deionized water. (Enabled: -31°F [-35°C])

Canada: “Toyota Super Long Life Coolant” is a mixture of 55% coolant and 45% deionized water. (Enabled: -44°F [-42°C])

For more details about engine coolant, contact your Toyota dealer.

## ⚠ CAUTION

### ■ When the engine is hot

Do not remove the coolant reservoir cap.

The cooling system may be under pressure and may spray hot coolant if the cap is removed, causing burns or other injuries.

 NOTICE

■ **When adding engine coolant**

Coolant is neither plain water nor straight antifreeze. The correct mixture of water and antifreeze must be used to provide proper lubrication, corrosion protection and cooling. Be sure to read the antifreeze or coolant label.

■ **If you spill coolant**

Be sure to wash it off with water to prevent damage to parts or paint.

**Radiator and condenser**

Check the radiator and condenser and remove any foreign objects. If any of the above parts are extremely dirty or you are not sure of their condition, have your vehicle checked by your Toyota dealer.

 CAUTION

■ **When the engine is hot**

Do not touch the radiator or condenser, as they may be hot and may cause burns.

## Brake fluid

### ■ Checking fluid level

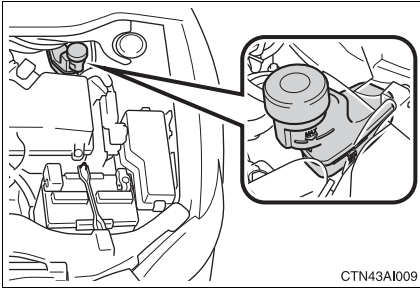

The brake fluid level should be between the “MAX” and “MIN” lines on the tank.

Make sure to check the fluid type and prepare the necessary items.

### ■ Adding fluid

Fluid type	FMVSS No.116 DOT 3 or SAE J1703 brake fluid
Items	Clean funnel

### ■ Brake fluid can absorb moisture from the air

Excess moisture in the fluid can cause a dangerous loss of braking efficiency. Use only newly opened brake fluid.

## ⚠ CAUTION

### ■ When filling the reservoir

Take care because brake fluid can harm your hands or eyes and damage painted surfaces.

If fluid gets in your eyes, flush your eyes with clean water immediately.

If you still experience discomfort, see a doctor.

 NOTICE

**■ If the fluid level is low or high**

It is normal for the brake fluid level to go down slightly as the brake pads wear or when the fluid level in the accumulator is high.

If the reservoir needs frequent refilling, it may indicate a serious problem.

**Power steering fluid**

**■ Fluid level**

The fluid level should be within the appropriate range.

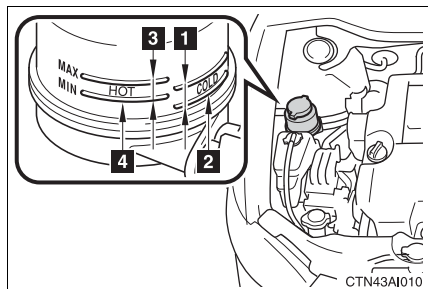

- 1** Full (when cold)
- 2** Add fluid (when cold)
- 3** Full (when hot)
- 4** Add fluid (when hot)

**Hot:** Vehicle has been driven around 50 mph (80 km/h) for 20 minutes, or slightly longer in cold temperatures. (Fluid temperature, 140°F - 175°F [60°C - 80°C])

**Cold:** Engine has not been run for about 5 hours. (Room temperature, 50°F - 85°F [10°C - 30°C])



## ■ Checking the fluid level

Make sure to check the fluid type and prepare the necessary items.

Fluid type	Automatic transmission fluid DEXRON <sup>®</sup> II or III
Items	Rag or paper towel and funnel (only for adding fluid)

**STEP 1** Clean all dirt off the reservoir.

**STEP 2** Remove the reservoir cap by turning it counterclockwise and wipe the dipstick clean.

**STEP 3** Reinstall the reservoir cap.

**STEP 4** Remove the reservoir cap again and look at the fluid level.

### CAUTION

#### ■ Checking the fluid level

Take care, as the reservoir may be hot.

### NOTICE

#### ■ When adding fluid

Avoid overfilling, or the power steering may be damaged.

#### ■ After replacing the reservoir cap

Check the steering box case, vane pump and hose connections for leaks or damage.

## Battery

Check the battery as follows.

### ■ Battery exterior

Make sure that the battery terminals are not corroded and that there are no loose connections, cracks, or loose clamps.

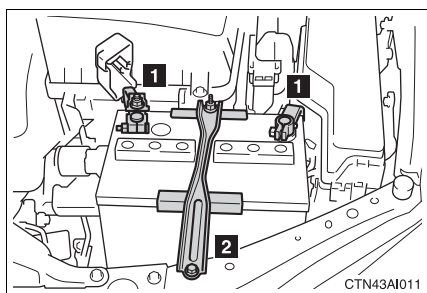

- 1** Terminals
- 2** Hold-down clamp

### ■ Checking battery fluid

Check the battery condition using the indicator color.

#### ▶ Type A

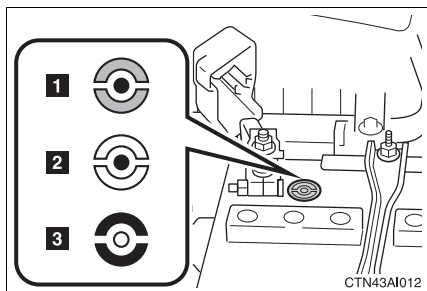

- 1** Blue: Good condition
- 2** White: Charging is necessary. Have the vehicle inspected by your Toyota dealer.
- 3** Red: Not working properly, have the battery checked by your Toyota dealer.

## ▶ Type B

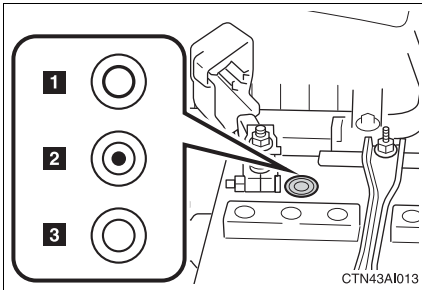

- 1 Green: Good condition
- 2 Dark: Charging is necessary. Have the vehicle inspected by your Toyota dealer.
- 3 Clear or light yellow: Not working properly, have the battery checked by your Toyota dealer.

## ■ Before recharging

When recharging, the battery produces hydrogen gas which is flammable and explosive. Therefore, before recharging:

- If recharging with the battery installed on the vehicle, be sure to disconnect the ground cable.
- Make sure the power switch on the charger is off when connecting and disconnecting the charger cables to the battery.

## ■ After recharging the battery (vehicles with smart key system)

The engine may not start. Follow the procedure below to initialize the system.

1. Shift the shift lever to P.
2. Open and close any of the doors.
3. Restart the engine.

 **CAUTION**

■ **Chemicals in the battery**

A battery contains poisonous and corrosive sulfuric acid and may produce hydrogen gas which is flammable and explosive. To reduce the risk of death or serious injury, take the following precautions while working on or near the battery:

- Do not cause sparks by touching the battery terminals with tools.
- Do not smoke or light a match near the battery.
- Avoid contact with eyes, skin and clothes.
- Never inhale or swallow electrolyte.
- Wear protective safety glasses when working near the battery.
- Keep children away from the battery.

■ **Where to safely charge the battery**

Always charge the battery in an open area. Do not charge the battery in a garage or closed room where there is not sufficient ventilation.

■ **How to recharge the battery**

Only perform a slow charge (5 A or less). The battery may explode if charged at a quicker rate.

■ **Emergency measures regarding electrolyte**

- If electrolyte gets in your eyes  
Flush your eyes with clean water for at least 15 minutes and get immediate medical attention. If possible, continue to apply water with a sponge or cloth while traveling to the nearest medical facility.
- If electrolyte gets on your skin  
Wash the affected area thoroughly. If you feel pain or burning, get medical attention immediately.
- If electrolyte gets on your clothes  
It can soak through clothing on to your skin. Immediately take off the clothing and follow the procedure above if necessary.
- If you accidentally swallow electrolyte  
Drink a large quantity of water or milk. Follow with milk of magnesia, beaten raw egg or vegetable oil. Get emergency medical attention immediately.

 NOTICE

■ **When recharging the battery**

Never recharge the battery while the engine is running. Also, be sure all accessories are turned off.

**Washer fluid**

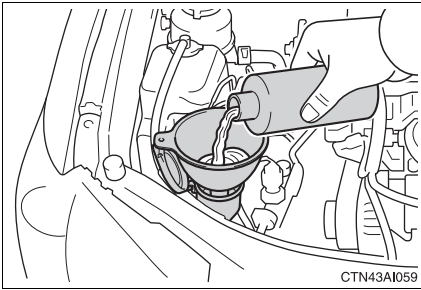

Add washer fluid in the following situations.

- Any washer does not work.
- The low washer fluid warning light comes on. (if equipped)
- The warning message appears on the multi-information display. (if equipped)

 CAUTION

■ **When refilling the washer fluid**

Do not refill the washer fluid when the engine is hot or running, as the washer fluid contains alcohol and may catch fire if spilled on the engine etc.

 NOTICE

■ **Do not use any fluid other than washer fluid**

Do not use soapy water or engine antifreeze instead of washer fluid. Doing so may cause streaking on the vehicle's painted surfaces.

■ **Diluting washer fluid**

Dilute washer fluid with water as necessary. Refer to the freezing temperatures listed on the washer fluid tank.

**Replace the tires when the treadwear indicators show.**

■ **Checking tires**

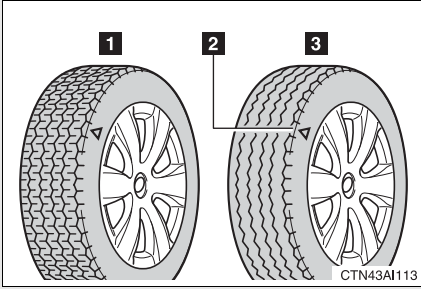

- 1** New tread
- 2** Treadwear indicator
- 3** Worn tread

The location of treadwear indicators is shown by the “TWI” or “△” marks, etc., molded on the sidewall of each tire.

Check spare tire condition and inflation pressure if not rotated.

■ **Tire rotation**

- ▶ Vehicles with a spare tire of different wheel type from the installed tires

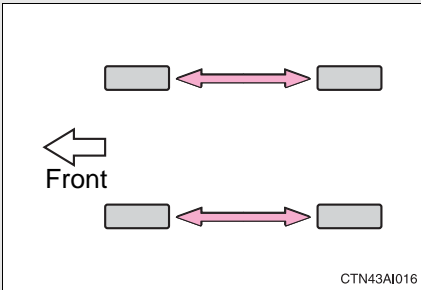

Rotate the tires in the order shown.

To equalize tire wear and extend tire life, Toyota recommends that tire rotation is carried out at the same interval as tire inspection.

- ▶ Vehicles with a spare tire of the same wheel type as the installed tires

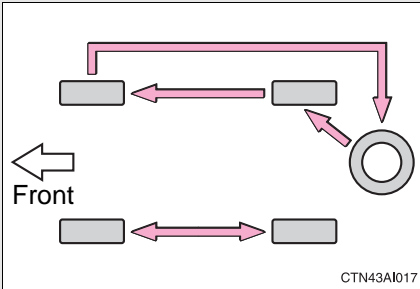

Rotate the tires in the order shown.

To equalize tire wear and extend tire life, Toyota recommends that tire rotation is carried out at the same interval as tire inspection.

### ■ The tire pressure warning system

Your Toyota is equipped with a tire pressure warning system that uses tire pressure warning valves and transmitters to detect low tire inflation pressure before serious problems arise. (→P. 384)

Vehicles with compact spare tire: The compact spare tire is not equipped with the tire pressure warning valve and transmitters.

### Installing tire pressure warning valves and transmitters

When replacing tires or wheels, tire pressure warning valves and transmitters must also be installed.

When new tire pressure warning valves and transmitters are installed, new tire pressure warning valve and transmitter ID codes must be registered in the tire pressure warning computer and the tire pressure warning system must be initialized. Have tire pressure warning valve and transmitter ID codes registered by your Toyota dealer. (→P. 337)

### Initializing the tire pressure warning system

■ **The tire pressure warning system must be initialized in the following circumstances:**

- When changing the tire inflation pressure by changing traveling speed or load weight, etc.
- When changing the tire size.

When the tire pressure warning system is initialized, the current tire inflation pressure is set as the pressure benchmark.

■ **How to initialize the tire pressure warning system**

**STEP 1** Park the vehicle in a safe place and turn the “ENGINE START STOP” switch or the engine switch OFF.

While the vehicle is moving, initialization is not performed.

**STEP 2** Adjust the tire inflation pressure to the specified cold tire inflation pressure level. (→P. 436)

Make sure to adjust the tire pressure to the specified cold tire inflation pressure level. The tire pressure warning system will operate based on this pressure level.

**STEP 3** Turn the “ENGINE START STOP” switch to IGNITION ON mode (vehicles with smart key system) or engine switch to “ON” position (vehicles without smart key system).



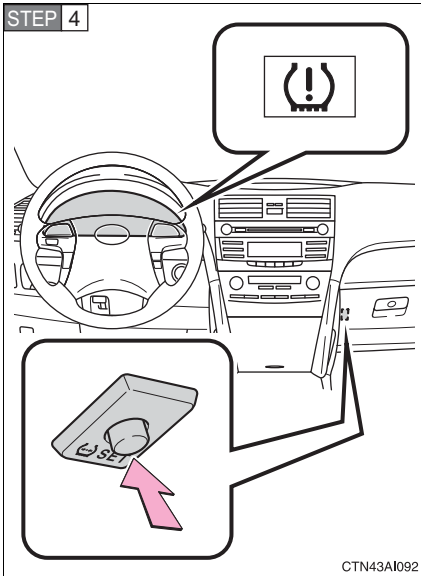

Press and hold the tire pressure warning reset switch until the tire pressure warning light blinks slowly 3 times.

**STEP 5** Vehicles with smart key system: Wait for a few minutes with the IGNITION ON mode, and then turn the “ENGINE START STOP” switch OFF.

Vehicles without smart key system: Wait for a few minutes with the engine switch in “ON” position, and then turn the engine switch to “LOCK” position.

### Registering ID codes

The tire pressure warning valve and transmitter is equipped with a unique ID code. When replacing a tire pressure warning valve and transmitter, it is necessary to register the ID code of tire pressure warning valve and transmitter. Have the ID code registered by your Toyota dealer.

### ■ **When to replace your vehicle's tires**

Tires should be replaced if:

- You have tire damage such as cuts, splits, cracks deep enough to expose the fabric or bulges indicating internal damage
- A tire goes flat repeatedly or cannot be properly repaired due to the size or location of a cut or other damage

If you are not sure, consult with your Toyota dealer.

### ■ **Replacing tires and wheels**

If the ID code of the tire pressure warning valve and transmitter is not registered, the tire pressure warning system will not work properly. After about 20 minutes, the tire pressure warning light comes on after blinking for 1 minute to indicate a system malfunction.

### ■ **Tire life**

Any tire over 6 years old must be checked by a qualified technician even if it has seldom or never been used or damage is not obvious.

### ■ **If the tread wears down 0.16 in. (4 mm) or more on snow tires**

The effectiveness of snow tires is lost.

### ■ **If you press the tire pressure warning reset switch accidentally**

If initialization is performed, adjust the tire inflation pressure to the specified level and initialize the tire pressure warning system again.

**■ When the initialization of the tire pressure warning system has failed**

Initialization can be completed in a few minutes. However, in the following cases, the settings has not been recorded and the system will not operate properly. If repeated attempts to record tire inflation pressure settings are unsuccessful, have the vehicle inspected by your Toyota dealer.

- When operating the tire pressure warning reset switch, the tire pressure warning light does not flash 3 times.
- After driving for a certain period of time since the initialization has been completed, the warning light comes on after blinking for 1 minute.

**■ Routine tire inflation pressure checks**

The tire pressure warning system does not replace routine tire inflation pressure checks. Make sure to check tire inflation pressure as part of your routine of daily vehicle checks.

**■ Maximum load of tire**

Check that the maximum load of the replaced tire is greater than 1/2 of the Gross Axle Weight Ratings (GAWR) of either the front axle or the rear axle, whichever is greater.

For the maximum load of the tire, see the load limit at maximum cold tire inflation pressure mentioned on the sidewall of the tire, and for the Gross Axle Weight Ratings (GAWR), see the Certification Label. (→P. 344, 442).

## ■ Tire types

### 1 Summer tires

Summer tires are high-speed performance tires best suited to highway driving under dry conditions. Since summer tires do not have the same traction performance as snow tires, summer tires are inadequate for driving on snow-covered or icy roads. For driving on snow-covered roads or icy roads, the use of snow tires is recommended. When installing snow tires, be sure to replace all four tires.

### 2 All season tires

All season tires are designed to provide better traction in snow and to be adequate for driving in most winter conditions, as well as for use year round. All season tires, however, do not have adequate traction performance compared with snow tires in heavy or loose snow. Also, all season tires fall short in acceleration and handling performance compared with summer tires in highway driving.

### 3 Snow tires

For driving on snow-covered roads or icy roads, we recommend using snow tires. If you need snow tires, select tires of the same size, construction and load capacity as the originally installed tires. Since your vehicle has radial tires as original equipment, make sure your snow tires also have radial construction. Do not install studded tires without first checking local regulations for possible restrictions. Snow tires should be installed on all wheels. (→P. 169)

## ■ Initializing the tire pressure warning system

Initialize the tires with the tire inflation pressure adjusted to the specified level.

## ■ Tire pressure warning system certification

► For vehicles sold in the U.S.A.

This device complies with Part 15 of the FCC Rules. Operation is subject to the following two conditions: (1) This device may not cause harmful interference, and (2) this device must accept any interference received, including interference that may cause undesired operation.

### NOTICE:

This equipment has been tested and found to comply with the limits for a Class B digital device, pursuant to Part 15 of the FCC Rules. These limits are designed to provide reasonable protection against harmful interference in a residential installation. This equipment generates, uses and can radiate radio frequency energy and, if not installed and used in accordance with the instructions, may cause harmful interference to radio communications. However, there is no guarantee that interference will not occur in a particular installation. If this equipment does cause harmful interference to radio or television reception, which can be determined by turning the equipment off and on, the user is encouraged to try to correct the interference by one or more of the following measures:

- Reorient or relocate the receiving antenna.
- Increase the separation between the equipment and receiver.
- Connect the equipment into an outlet on a circuit different from that to which the receiver is connected.
- Consult the dealer or an experienced radio/TV technician for help.

### FCC WARNING:

Changes or modifications not expressly approved by the party responsible for compliance could void the user's authority to operate the equipment.

► For vehicles sold in Canada

Operation is subject to the following two conditions: (1) this device may not cause interference, and (2) this device must accept any interference, including interference that may cause undesired operation of the device.

 **CAUTION**

■ **When inspecting or replacing tires**

Observe the following precautions to prevent accidents.

Failure to do so may cause damage to parts of the drive train, as well as dangerous handling characteristics, which may lead to fatal accidents or injury.

- Do not mix tires of different makes, models, tread patterns or tread-wear.
- Do not use tire sizes other than those recommended by Toyota.
- Do not mix radial, bias-belted, or bias-ply tires.
- Do not mix summer, all season and winter tires.
- Do not use tires that have been used on another vehicle.  
Do not use tires if you do not know how they were used previously.

■ **When initializing the tire pressure warning system**

Do not press the tire pressure warning reset switch without first adjusting the tire inflation pressure to the specified level. Otherwise, the tire pressure warning light may not come on even if the tire inflation pressure is low, or it may come on when the tire inflation pressure is actually normal.

 NOTICE**■ Repairing or replacing tires, wheels and tire pressure warning valves and transmitters**

When removing or fitting the wheels, tires or the tire pressure warning valves and transmitters, contact your Toyota dealer as the tire pressure warning valves and transmitters may be damaged if not handled correctly.

**■ To avoid damaging the tire pressure warning valves and transmitters**

Do not use liquid sealants on flat tires.

**■ Driving on rough roads**

Take particular care when driving on roads with loose surfaces or pot-holes.

These conditions may cause losses in tire air pressure, reducing the cushioning ability of the tires. In addition driving on rough roads may cause damage to the tires themselves, as well as the vehicle's wheels and body.

**■ If tire inflation pressures become low while driving**

Do not continue driving, or your tires and/or wheels may be ruined.

## 4-3. Do-it-yourself maintenance

### Tire inflation pressure

#### ■ Tire inflation pressure

The recommended cold tire inflation pressure and tire size is displayed on the tire and loading information label. (→P. 436)

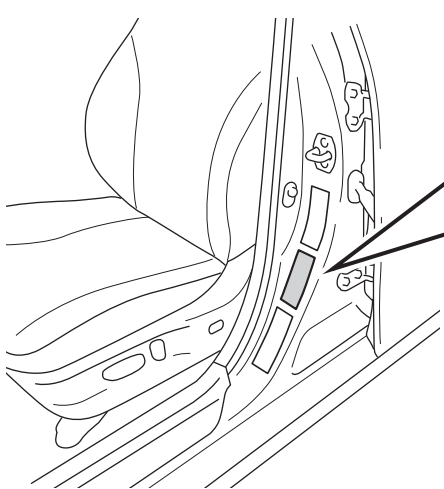

**► Type A**

TIRE AND LOADING INFORMATION RENSEIGNEMENTS RELATIFS AUX PNEUS ET À LA CHARGE DU VÉHICULE			INFORMATION SUR LES PNEUS ET LE CHARGEMENT RENSEIGNEMENTS RELATIFS AUX PNEUS ET À LA CHARGE DU VÉHICULE		
SEATING CAPACITY: TOTAL: 1 FRONT: 1 REAR: 1 The combined weight of occupants and cargo should never exceed 1000 kg or 2200 lb.			NOMBRE DE PLACES ASSIÈGES: TOTAL: 1 AVANT: 1 ARRIÈRE: 1 Le poids total des occupants et du chargement ne doit jamais être supérieur à 1000 kg ou 2200 lb.		
TIRE	SIZE	COLD TIRE PRESSURE	PNEUS	DIMENSION	PRESSION DE GONFLAGE À FROID
FRONT	PXXXXRXX	XXXkPa, XX PSI	AVANT	PXXXXRXX	XXXkPa, XX PSI
REAR	PXXXXRXX	XXXkPa, XX PSI	ARRIÈRE	PXXXXRXX	XXXkPa, XX PSI
Spare	PXXXXRXX	XXXkPa, XX PSI	SECOURS	PXXXXRXX	XXXkPa, XX PSI
SEE OWNER'S MANUAL FOR ADDITIONAL INFORMATION			VOIR LE MANUEL DU PROPRIÉTAIRE POUR PLUS AMPLES RENSEIGNEMENTS		

**► Type B**

TIRE AND LOADING INFORMATION RENSEIGNEMENTS RELATIFS AUX PNEUS ET À LA CHARGE DU VÉHICULE			INFORMATION SUR LES PNEUS ET LE CHARGEMENT RENSEIGNEMENTS RELATIFS AUX PNEUS ET À LA CHARGE DU VÉHICULE		
SEATING CAPACITY: TOTAL: 1 FRONT: 1 REAR: 1 The combined weight of occupants and cargo should never exceed 1000 kg or 2200 lb.			NOMBRE DE PLACES ASSIÈGES: TOTAL: 1 AVANT: 1 ARRIÈRE: 1 Le poids total des occupants et du chargement ne doit jamais être supérieur à 1000 kg ou 2200 lb.		
TIRE	SIZE	COLD TIRE PRESSURE	PNEUS	DIMENSION	PRESSION DE GONFLAGE À FROID
FRONT	PXXXXRXX	XXX kPa, XX PSI	AVANT	PXXXXRXX	XXX kPa, XX PSI
REAR	PXXXXRXX	XXX kPa, XX PSI	ARRIÈRE	PXXXXRXX	XXX kPa, XX PSI
Spare	PXXXXRXX	XXX kPa, XX PSI	SECOURS	PXXXXRXX	XXX kPa, XX PSI
SEE OWNER'S MANUAL FOR ADDITIONAL INFORMATION			VOIR LE MANUEL DU PROPRIÉTAIRE POUR PLUS AMPLES RENSEIGNEMENTS		

CTN43A112



### ■ Inspection and adjustment procedure

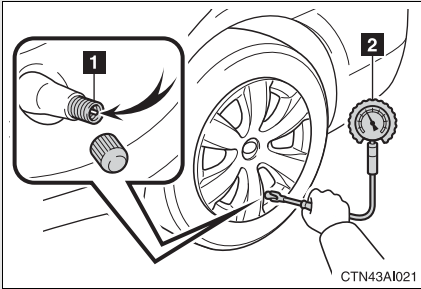

- 1 Tire valve
- 2 Tire pressure gauge

**STEP 1** Remove the tire valve cap.

**STEP 2** Press the tip of the tire pressure gauge onto the tire valve.

**STEP 3** Read the pressure using the graduations of the gauge.

**STEP 4** If the tire inflation pressure is not at the recommended level adjust the pressure.

If you add too much air, press the center of the valve to lower.

**STEP 5** After completing the tire inflation pressure measurement and adjustment, apply soapy water to the valve and check for leakage.

**STEP 6** Reinstall the tire valve cap.

### ■ Tire inflation pressure check interval

You should check tire inflation pressure every two weeks, or at least once a month.

Do not forget to check the spare.

### ■ **Effects of incorrect tire inflation pressure**

Driving with incorrect tire inflation pressure may result in the following:

- Reduced fuel efficiency
- Reduced driving comfort and tire life
- Reduced safety
- Damage to the drive train

If a tire needs frequent refilling, have it checked by your Toyota dealer.

### ■ **Instructions for checking tire inflation pressure**

When checking tire inflation pressure, observe the following:

- Check only when the tires are cold.  
If your vehicle has been parked for at least 3 hours and has not been driven for more than 1 mile or 1.5 km, you will get an accurate cold tire inflation pressure reading.
- Always use a tire pressure gauge.  
The appearance of the tire can be misleading. In addition, tire inflation pressures that are even just a few pounds off can degrade ride and handling.
- Do not bleed or reduce tire inflation pressure after driving. It is normal for the tire inflation pressure to be higher after driving.
- Never exceed the vehicle capacity weight.  
Passengers and luggage weight should be placed so that the vehicle is balanced.

 CAUTION**■ Proper inflation is critical to save tire performance**

Keep your tires properly inflated. Otherwise, the following conditions may occur and result in an accident causing death or serious injury.

- Excessive wear
- Uneven wear
- Poor handling
- Possibility of blowouts resulting from overheated tires
- Poor sealing of the tire bead
- Wheel deformation and/or tire separation
- A greater possibility of tire damage from road hazards

 NOTICE**■ When inspecting and adjusting tire inflation pressure**

Be sure to reinstall the tire valve caps.

Without the valve caps, dirt or moisture could get into the valve and cause air leakage, which could result in an accident. If the caps have been lost, replace them as soon as possible.

## Wheels

**If a wheel is bent, cracked or heavily corroded, it should be replaced. Otherwise, the tire may separate from the wheel or cause loss of handling control.**

### ■ Wheel selection

When replacing wheels, care should be taken to ensure that they are equivalent to those removed in load capacity, diameter, rim width, and offset.

Replacement wheels are available at your Toyota dealer.

Toyota does not recommend using:

- Wheels of different sizes or types
- Used wheels
- Bent wheels that have been straightened

### ■ Aluminum wheel precautions

- Use only Toyota wheel nuts and wrenches designed for use with your aluminum wheels.
- When rotating, repairing or changing your tires, check that the wheel nuts are still tight after driving 1000 miles (1600 km).
- Be careful not to damage the aluminum wheels when using tire chains.
- Use only Toyota genuine balance weights or equivalent and use a plastic or rubber hammer when balancing your wheels.

---

### ■ When replacing wheels

The wheels of your Toyota are equipped with tire pressure warning valves and transmitters that allow the tire pressure warning system to provide advanced warning in the event of a loss in tire inflation pressure. Whenever wheels are replaced, the tire pressure warning valves and transmitters must be switched over from the old wheels. (→P. 336)

 **CAUTION****■ When replacing wheels**

- Do not use wheels that are a different size from those recommended in the Owner's Manual, as this may result in loss of handling control.
- Never use an inner tube in a leaking wheel which is designed for a tubeless tire. Doing so may result in an accident, causing serious injury or death.

 **NOTICE****■ Replacing tire pressure warning valves and transmitters**

- Because tire repair or replacement may affect the tire pressure warning valves and transmitters, make sure to have tires serviced by your Toyota dealer or other qualified service shop. In addition, make sure to purchase your tire pressure warning valves and transmitters at your Toyota dealer.
- Ensure that only genuine Toyota wheels are used on your vehicle. Tire pressure warning valves and transmitters may not work properly with non-genuine wheels.

## 4-3. Do-it-yourself maintenance

### Air conditioning filter

The air conditioning filter must be cleaned or changed regularly to maintain air conditioning efficiency.

#### ■ Removal method

**STEP 1** Vehicles with smart key system: Turn the “ENGINE START STOP” switch OFF.

Vehicles without smart key system: Turn the engine switch OFF.

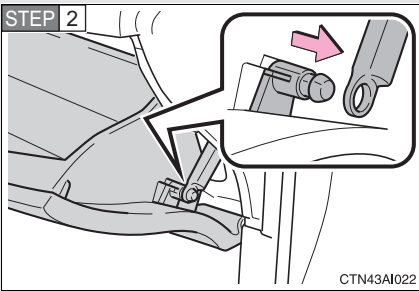

Open the glove box. Slide off the damper.

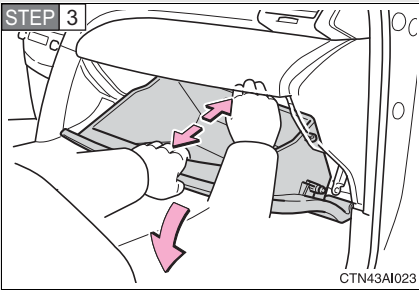

Apply pressure to the glove box as shown to disconnect the claws.

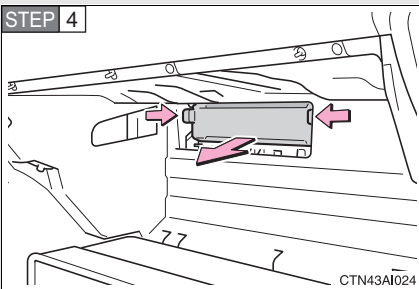

Remove the filter cover.

### ■ Cleaning method

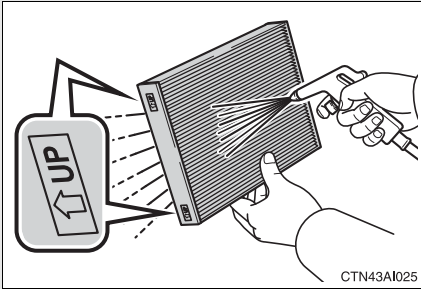

If the filter is dirty, clean by blowing compressed air through the filter from the downward side.

Hold the air gun 2 in. (5 cm) from the filter and blow for approximately 2 minutes at 72 psi (500 kPa, 5.0 kgf/cm<sup>2</sup> or bar).

If it is not available, have the filter cleaned by your Toyota dealer.

### ■ Replacement method

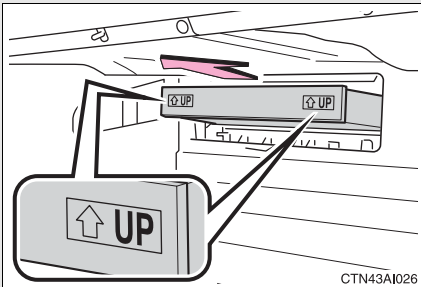

Remove the air conditioning filter and replace it with a new one.

The “↑UP” marks shown on the filter should be pointing up.

### ■ Checking interval

Inspect, clean and replace the air conditioning filter according to the maintenance schedule. In dusty areas or areas with heavy traffic flow, more frequent cleaning or early replacement may be required. (For scheduled maintenance information, please refer to the “Scheduled Maintenance Guide” or “Owner’s Manual Supplement”.)

### ■ If air flow from the vents decreases dramatically

The filter may be clogged. Check the filter and replace if necessary.



## NOTICE

### ■ To prevent damage to the system

- When using the air conditioning system, make sure that a filter is always installed.
- When cleaning the filter, do not clean the filter with water.



## Key battery

**Replace the battery with a new one if it is discharged.**

■ **You will need the following items:**

- Flathead screwdriver (To prevent damage to the key, cover the tip of the screwdriver with rag.)
- Small Phillips-head screwdriver
- Lithium battery CR1632 (vehicles with smart key system), or CR2016 (vehicles without smart key system)

■ **Replacing the battery (vehicles with smart key system)**

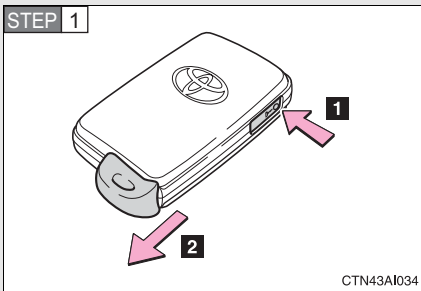

Take out the mechanical key.

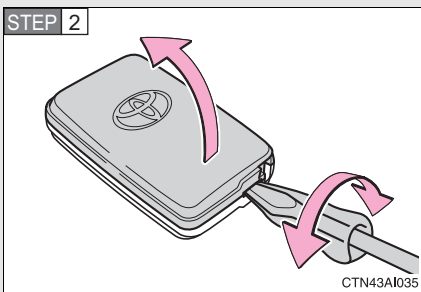

Remove the cover.

STEP 3

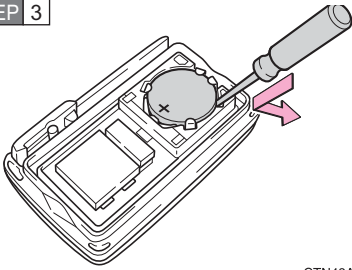

CTN43AI036

Remove the depleted battery.

Insert a new battery with the "+" terminal facing up.

■ Replacing the battery (vehicles without smart key system)

STEP 1

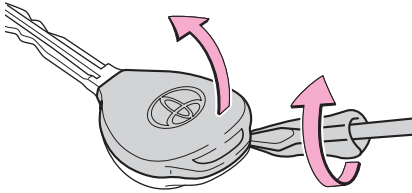

CTN43AI037

Remove the cover.

STEP 2

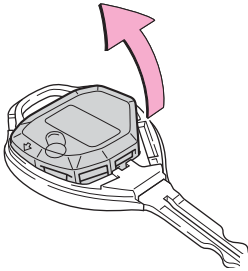

CTN43AI038

Remove the module.

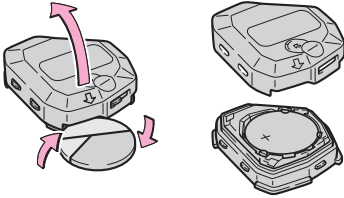
**STEP 3**

CTN43AI039

Open the case cover using a coin protected with tape etc. and remove the depleted battery.

Insert a new battery with the “+” terminal facing up.

### ■ If the key battery is discharged

The following symptoms may occur.

- The smart key system and wireless remote control will not function properly.
- The operational range is reduced.

### ■ Use a CR1632 (vehicles with smart key system), or CR2016 (vehicles without smart key system) lithium battery

- Batteries can be purchased at your Toyota dealer, jewelers, or camera stores.
- Replace only with the same or equivalent type recommended by your Toyota dealer.
- Dispose of used batteries according to the local laws.

### ⚠ CAUTION

#### ■ Removed battery and other parts

Keep away from children.

These parts are small and if swallowed by a child they can cause choking.

 NOTICE

■ **For normal operation after replacing the battery**

Observe the following precautions to prevent accidents.

- Always work with dry hands.  
Moisture may cause the battery to rust.
- Do not touch or move any other components inside the remote control.
- Do not bend either of the battery terminals.

## 4-3. Do-it-yourself maintenance

### Checking and replacing fuses

**If any of the electrical components do not operate, a fuse may have blown. If this happens, check and replace the fuses as necessary.**

**STEP 1** Vehicles with smart key system: Turn the “ENGINE START STOP” switch OFF.

Vehicles without smart key system: Turn the engine switch OFF.

**STEP 2** Open the fuse box cover.

#### ► Engine compartment

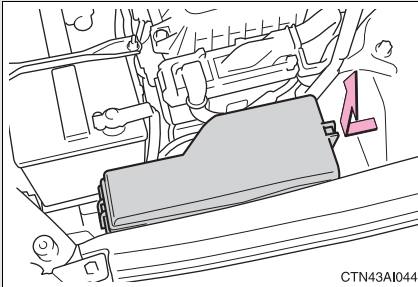

Push the tab in and lift the lid off.

#### ► Under the driver's side instrument panel

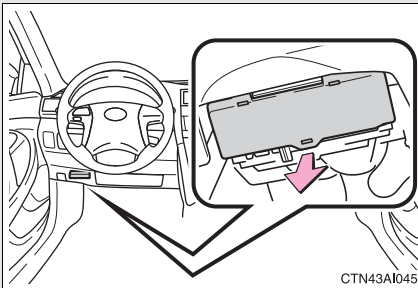

Remove the lid.

**STEP 3** After a system failure, see “Fuse layout and amperage ratings” (→P. 360) for details about which fuse to check.

**STEP 4**

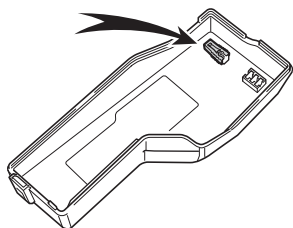

CTN43AI046

Remove the fuse with the pull-out tool.

**STEP 5** Check if the fuse has blown.

► Type A

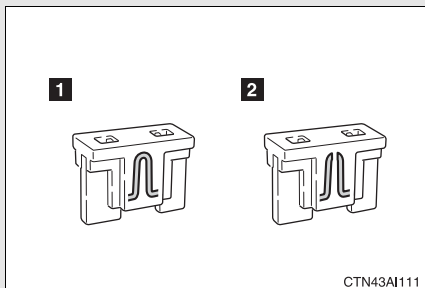

CTN43AI111

**1** Normal fuse

**2** Blown fuse

Replace it with one of an appropriate amperage rating. The amperage rating can be found on the fuse box lid.

► Type B

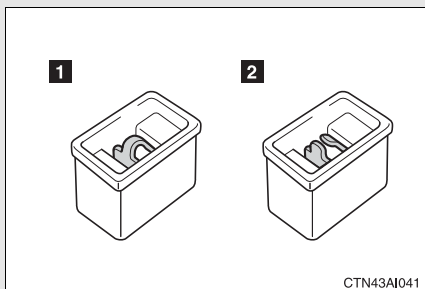

CTN43AI041

**1** Normal fuse

**2** Blown fuse

Replace it with one of an appropriate amperage rating. The amperage rating can be found on the fuse box lid.

► Type C

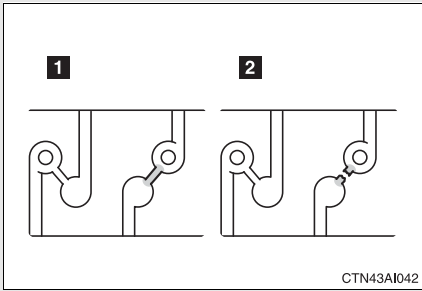

**1** Normal fuse

**2** Blown fuse

Contact your Toyota dealer.

## Fuse layout and amperage ratings

### ■ Engine compartment

#### ► Fuse box cover

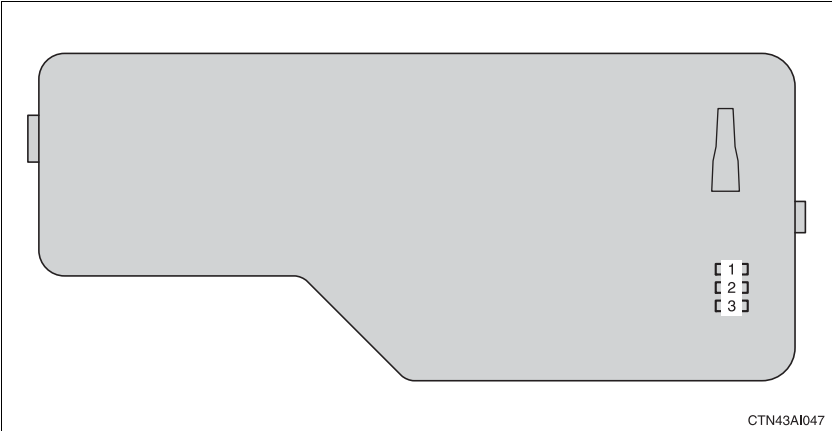

CTN43AI047

#### ► Fuse block

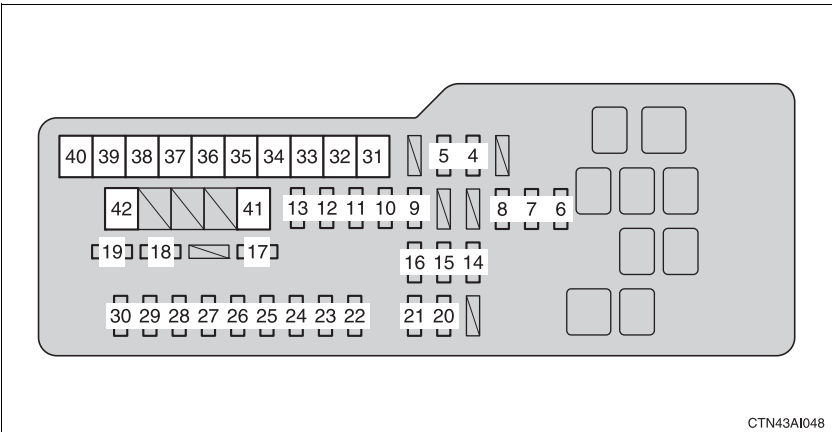

CTN43AI048

	Fuse	Ampere	Circuit
1	SPARE	30 A	Spare fuse
2	SPARE	15 A	Spare fuse
3	SPARE	10 A	Spare fuse



Fuse		Ampere	Circuit
4	RR FOG	10 A	No circuit
5	FR DEF	15 A	No circuit
6	AM2	7.5 A	Starting system
7	ALT-S	7.5 A	Charging system
8	MAYDAY/TEL	7.5 A	No circuit
9	E-ACM	10 A	No circuit
10	ETCS	10 A	Electronic throttle control system
11	HAZ	15 A	Turn signal lights
12	IG2	20 A	Multipoint fuel injection system/ sequential multipoint fuel injection system, starting system, "GAUGE NO.2" and "IGN" fuses
13	STR LOCK	20 A	Steering lock system
14	DOME	10 A	Gauges and meters, vanity lights, trunk light, engine switch light, door courtesy lights, interior light, per- sonal lights, clock, smart key sys- tem
15	ECU-B NO.1	10 A	Wireless remote control system, front passenger occupant classifi- cation system, main body ECU, vehicle stability control system
16	RADIO NO.1	15 A	Audio system, navigation system
17	DOOR NO.1	25 A	Main body ECU
18	AMP	25 A	Audio system
19	EFI MAIN	30 A	Multipoint fuel injection system/ sequential multipoint fuel injection system, electronic throttle control system, "EFI NO.2", and "EFI NO.3" fuses

Fuse		Ampere	Circuit
20	EFI NO.3	10 A	Multiport fuel injection system/ sequential multiport fuel injection system
21	EFI NO.2	15 A	Multiport fuel injection system/ sequential multiport fuel injection system
22	S-HORN	7.5 A	Horn
23	A/F	20 A	Multiport fuel injection system/ sequential multiport fuel injection system
24	MPX-B	10 A	Gauges and meters
25	EFI NO.1	10 A	Theft deterrent system, smart key system, multiport fuel injection sys- tem/sequential multiport fuel injec- tion system, electronic throttle control system
26	HORN	10 A	Horns
27	H-LP(RL)	15 A	Right-hand headlight (low beam)
28	H-LP(LL)	15 A	Left-hand headlight (low beam)
29	H-LP(RH)	15 A	Right-hand headlight (high beam)
30	H-LP(LH)	15 A	Left-hand headlight (high beam)
31	HTR	50 A	Air conditioning system
32	ABS NO.1	50 A	Anti-lock brake system, vehicle sta- bility control system, traction con- trol system, brake assist system
33	FAN MAIN	50 A	Electric cooling fans
34	ABS NO.2	30 A	Anti-lock brake system, vehicle sta- bility control system, traction con- trol system, brake assist system
35	RR DEF	50 A	Rear window defogger, "MIR HTR" fuse
36	RR PWR SEAT	30 A	No circuit

Fuse		Ampere	Circuit
37	H-LP CLN	30 A	No circuit
38	CDS FAN	40 A	Electric cooling fans
39	RDI FAN	40 A	Electric cooling fans
40	MSB	30 A	No circuit
41	ALT	120 A	“RR FOG”, “FR DEF”, “HTR”, “ABS NO.1”, “FAN MAIN”, “ABS NO.2”, “RR DEF”, “RR PWR SEAT”, “H-LP CLN”, “CDS FAN”, “RDI FAN” and “MSB” fuses
42	ST/AM2	30 A	Starting system

### ■ Under the instrument panel

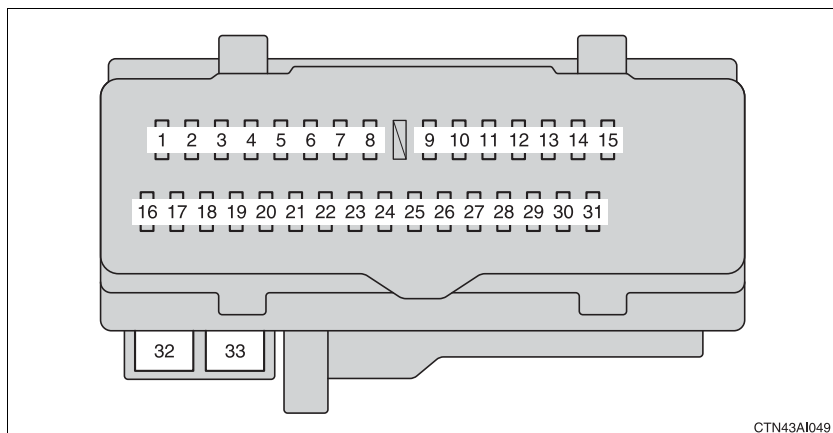

Fuse		Ampere	Circuit
1	RR DOOR RH	25 A	Rear right power window
2	RR DOOR LH	25 A	Rear left power window
3	FUEL OPN	7.5 A	No circuit
4	FR FOG	15 A	Front fog lights
5	OBD	7.5 A	On-board diagnosis system
6	ECU-B NO.2	7.5 A	No circuit
7	STOP	10 A	Stop lights, high mounted stop-light, shift lock control system, multiport fuel injection system/sequential multiport fuel injection system, main body ECU, anti-lock brake system, vehicle stability control system, traction control system, brake assist system, electronic throttle control system
8	TI&TE	30 A	No circuit
9	AM1	7.5 A	Starting system, multiport fuel injection system/sequential multiport fuel injection system

Fuse		Ampere	Circuit
10	A/C	7.5 A	Air conditioning system
11	PWR	25 A	Power windows
12	DOOR NO.2	25 A	Main body ECU
13	S/ROOF	30 A	Electric moon roof
14	TAIL	15 A	Front side marker lights, tail lights, rear side marker lights, license plate lights, front turn signal/parking lights
15	PANEL	7.5 A	Navigation system, seat heaters, emergency flashers, air conditioning system, audio system, clock, glove box light, instrument panel lights, steering switches
16	ECU IG NO.1	10 A	Main body ECU, electric moon roof, tire pressure warning system, electric cooling fans, auto anti-glare inside rear view mirror
17	ECU IG NO.2	7.5 A	Anti-lock brake system, vehicle stability control system, traction control system, brake assist system, shift lock control system, automatic transmission, cruise control system
18	A/C NO.2	10 A	Air conditioning system, rear window defogger
19	WASH	10 A	Windshield wipers and washer
20	S-HTR	20 A	Seat heaters
21	GAUGE NO.1	10 A	Emergency flashers, back-up lights, charging system
22	WIP	25 A	Windshield wipers and washer
23	H-LP LVL	7.5 A	No circuit

Fuse		Ampere	Circuit
24	INJ	15 A	Multiport fuel injection system/ sequential multiport fuel injection system, starting system
25	IGN	10 A	Multiport fuel injection system/ sequential multiport fuel injection system, theft deterrent system, SRS airbag system, steering lock system, front passenger occupant classification system, smart key system, electronic throttle control system
26	GAUGE NO.2	7.5 A	Gauges and meters, multi-informa- tion display, clock
27	ECU-ACC	7.5 A	Clock, main body ECU, shift lock control system, outside rear view mirror, smart key system
28	CIG	20 A	Power outlet
29	PWR OUTLET	20 A	Power outlet
30	RADIO NO.2	7.5 A	Audio system, navigation system
31	MIR HTR	10 A	Outside rear view mirror defoggers
32	POWER	30 A	Power windows
33	P/SEAT	30 A	Power seats

#### ■ After a fuse is replaced

- If the lights do not turn on even after the fuse has been replaced, a bulb may need replacing. (→P. 368)
- If the replaced fuse blows again, have the vehicle inspected by your Toyota dealer.

#### ■ If there is an overload in the circuits

The fuses are designed to blow before the entire wiring harness is damaged.

 **CAUTION****■ To prevent system breakdowns and vehicle fire**

Observe the following precautions.

Failing to do so may cause damage, and possibly a fire or injury.

- Never use a fuse of a higher amperage rating than indicated, or use any other object in place of a fuse.
- Always use a genuine Toyota fuse or equivalent.  
Never replace a fuse with a wire, even as a temporary fix.  
This can cause extensive damage or even fire.
- Do not modify the fuse or the fuse box.

 **NOTICE****■ Before replacing fuses**

Have the cause of electrical overload determined and repaired by your Toyota dealer, as soon as possible.

## Light bulbs

You may replace the following bulbs yourself. The difficulty level of replacement varies depending on the bulb. If necessary bulb replacement seems difficult to perform, contact your Toyota dealer.

For more information about replacing other light bulbs, contact your Toyota dealer.

### ■ Prepare a replacement light bulb.

Check the wattage of the light bulb being replaced. (→P. 438)

### ■ Remove the engine compartment cover. (3.5 L V6 [2GR-FE] engine only)

→P. 318

### ■ Bulb locations

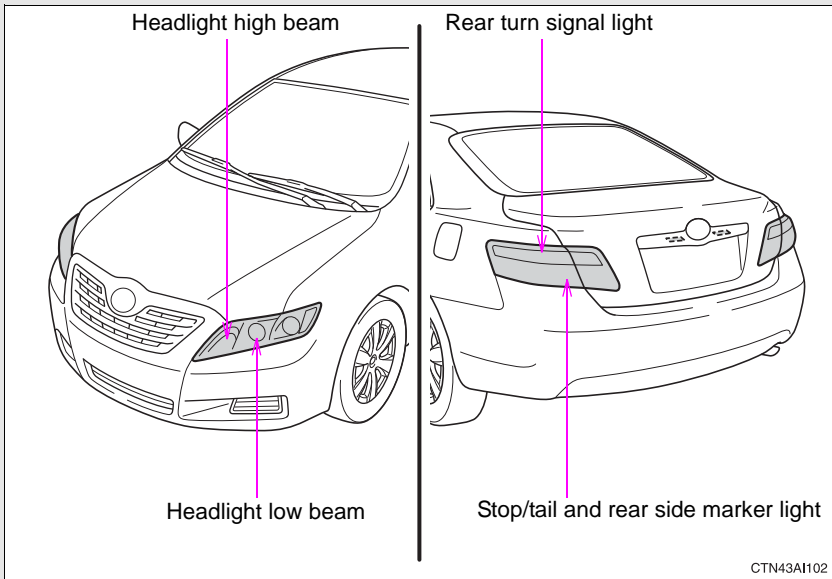



## Replacing light bulbs

### ■ Headlight

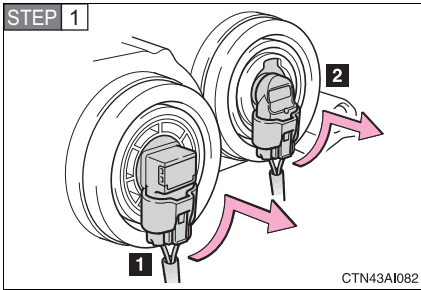

Turn the bulb base counterclockwise.

**1** Headlight (low beam)

**2** Headlight (high beam)

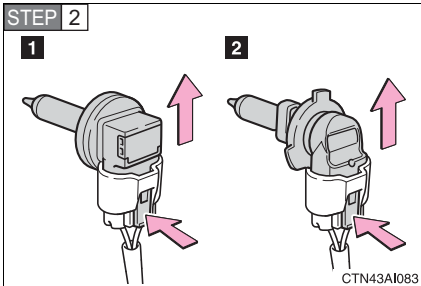

Unplug the connector while depressing the lock release.

**1** Headlight (low beam)

**2** Headlight (high beam)

### ■ Rear turn signal, stop/tail and rear side marker lights

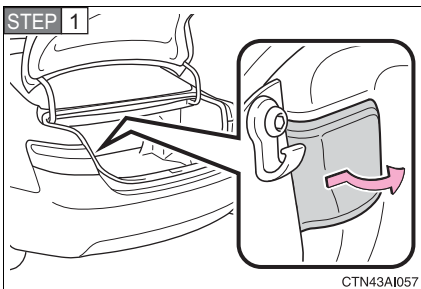

Open the trunk lid and remove the cover.

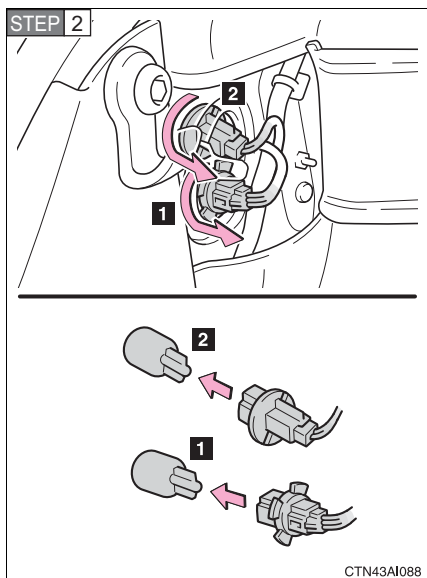

Turn the bulb bases counter-clockwise and remove them.

- 1** Rear turn signal light
- 2** Stop/tail and rear side marker light

■ **Lights other than the above**

If any of the lights listed below has burnt out, have it replaced by your Toyota dealer.

- Front fog lights
- Front turn signal/parking lights
- High mounted stoplight
- Front side marker lights
- Tail lights
- Back-up lights
- License plate lights

### ■ Condensation build-up on the inside of the lens

Contact your Toyota dealer for more information in the following situations. Temporary condensation build-up on the inside of the headlight lens does not indicate a malfunction.

- Large drops of water have built up on the inside of the lens.
- Water has built up inside the headlight.

### ■ LED high mounted stoplight

The high mounted stoplight consists of a number of LEDs. If any of the LEDs burn out, take your vehicle to your Toyota dealer to have the light replaced.

## CAUTION

### ■ Replacing light bulbs

- Turn off the headlights. Do not attempt to replace the bulb immediately after turning off the headlights.  
The bulbs become very hot and may cause burns.
- Do not touch the glass portion of the light bulb with bare hands. Hold the bulb by the plastic or metal portion.  
If the bulb is scratched or dropped it may blow out or crack.
- Fully install light bulbs and any parts used to secure them. Failing to do so may result in heat damage, fire, or water entering the headlight unit. This may damage the headlights or cause condensation to build up on the lens.

### ■ To prevent damage or fire

Make sure bulbs are fully seated and locked.



## When trouble arises

# 5

- |                                         |            |                                                                                        |            |
|-----------------------------------------|------------|----------------------------------------------------------------------------------------|------------|
| <b>5-1. Essential information ....</b>  | <b>374</b> | <b>5-2. Steps to take in an emergency .....</b>                                        | <b>381</b> |
| If your vehicle needs to be towed ..... | 374        | If a warning light turns on or a warning buzzer sounds... ..                           | 381        |
| If you think something is wrong .....   | 377        | If a warning message is displayed (vehicles with multi-information display) .....      | 391        |
| Fuel pump shut off system .....         | 378        | If you have a flat tire.....                                                           | 400        |
| Event data recorder .....               | 379        | If the engine will not start.....                                                      | 411        |
|                                         |            | If the shift lever cannot be shifted from P (automatic transmission) .....             | 413        |
|                                         |            | If you lose your keys .....                                                            | 414        |
|                                         |            | If the electronic key does not operate properly (vehicles with smart key system) ..... | 415        |
|                                         |            | If the battery is discharged .....                                                     | 417        |
|                                         |            | If your vehicle overheats .....                                                        | 421        |
|                                         |            | If the vehicle becomes stuck .....                                                     | 424        |

## If your vehicle needs to be towed

**If towing is necessary, we recommend having your vehicle towed by your Toyota dealer or a commercial towing service, using a lift-type truck or a flat bed truck.**

**Use a safety chain system for all towing, and abide by all state/provincial and local laws.**

**If towing from the front, the vehicle's rear wheels and axles must be in good condition. (→P. 375)**

**If they are damaged, use a towing dolly or flat bed truck.**

### **Before towing**

The following may indicate a problem with your transmission. Contact your Toyota dealer before towing.

- The engine is running, but the vehicle will not move.
- The vehicle makes an abnormal sound.

## Towing with a sling-type truck

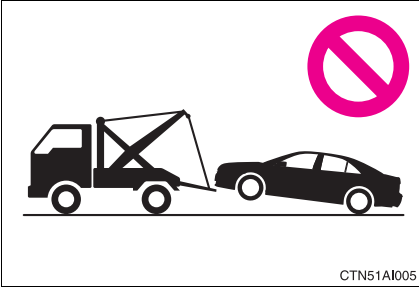

### NOTICE

#### ■ To prevent body damage

Do not tow with a sling-type truck, either from the front or rear.

## Towing with a wheel-lift type truck from the front

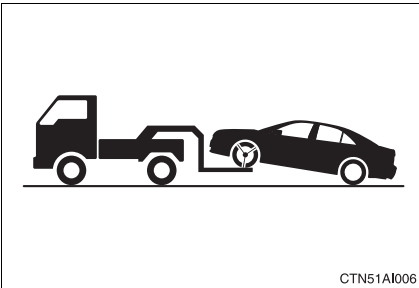

Release the parking brake.

### NOTICE

#### ■ To prevent damaging the vehicle

When raising the vehicle, ensure adequate ground clearance for towing at the opposite end of the raised vehicle. Without adequate clearance, the vehicle could be damaged while being towed.

### Towing with a wheel-lift type truck from the rear

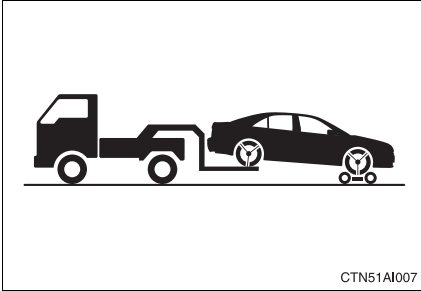

Automatic transmission: Use a towing dolly under the front wheels.

Manual transmissions: We recommend to use a towing dolly under the front wheels.

When not using a towing dolly, turn the engine switch to “ACC” position and shift the shift lever to N.

#### NOTICE

##### **■ To prevent causing serious damage to the transmission (automatic transmission)**

Never tow this vehicle from the rear with the front wheels on the ground.

##### **■ To prevent damaging the vehicle (manual transmission)**

Do not tow the vehicle when the engine switch is in “LOCK” position or key removed.

The steering lock mechanism is not strong enough to hold the front wheel straight.

### Using a flat bed truck

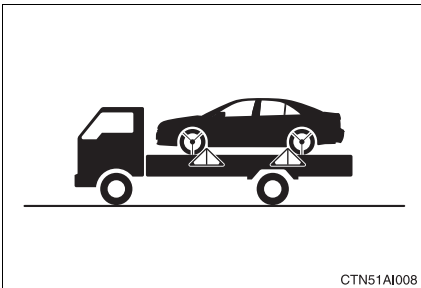

If you use chains or cables to tie down your vehicle, the angles shaded in black must be 45°.

Do not overly tighten the tie downs or the vehicle may be damaged.



## If you think something is wrong

**If you notice any of the following symptoms, your vehicle probably needs adjustment or repair. Contact your Toyota dealer as soon as possible.**

### ■ Visible symptoms

- Fluid leaks under the vehicle  
(Water dripping from the air conditioning after use is normal.)
- Flat-looking tires or uneven tire wear
- Engine coolant temperature gauge needle continually points higher than normal

### ■ Audible symptoms

- Changes in exhaust sound
- Excessive tire squeal when cornering
- Strange noises related to the suspension system
- Pinging or other noises related to the engine

### ■ Operational symptoms

- Engine missing, stumbling or running rough
- Appreciable loss of power
- Vehicle pulls heavily to one side when braking
- Vehicle pulls heavily to one side when driving on a level road
- Loss of brake effectiveness, spongy feeling, pedal almost touches the floor

## 5-1. Essential information

### Fuel pump shut off system

**To minimize the risk of fuel leakage when the engine stalls or an air-bag inflates upon collision, the fuel pump shut off system stops supplying fuel to the engine.**

Follow the procedure below to restart the engine after the system is activated.

▶ Vehicles with smart key system

**STEP 1** Turn the “ENGINE START STOP” switch OFF.

**STEP 2** Restart the engine.

▶ Vehicles without smart key system

**STEP 1** Turn the engine switch to “ACC” or “LOCK” position.

**STEP 2** Restart the engine.



#### NOTICE

■ **Before starting the engine**

Inspect the ground under the vehicle.

If you find that fuel has leaked on to the ground, the fuel system has been damaged and is in need of repair. Do not restart the engine.

**Your vehicle has computers that monitor and control certain aspects of your vehicle. These computers assist in driving and maintaining optimal vehicle performance.**

Besides storing data useful for troubleshooting, there is an event data recorder (EDR) that records data in a crash or a near car crash event.

### **In a crash or a near car crash event**

The SRS airbag sensor assembly contains the EDR. In a crash or a near car crash event, this device may record some or all of the following information:

- Engine speed
- Whether the brake pedal was applied or not
- Vehicle speed
- To what extent the accelerator pedal was depressed
- Position of the transmission shift lever
- Whether the driver and front passenger wore seat belts or not
- Driver's seat position
- SRS airbag deployment data
- SRS airbag system diagnostic data
- Front passenger's occupant classification

The information above is intended to be used for the purpose of improving vehicle safety performance. Unlike general data recorders, the EDR does not record sound data such as conversation between passengers.

### **Disclosure of the data**

Toyota will not disclose the data recorded in an EDR to a third party except when:

- An agreement from the vehicle's owner (or the leasing company for a leased vehicle) is obtained
- Officially requested by the police or other authorities
- Used as a defense for Toyota in a law suit
- Ordered by a court law

However, if necessary Toyota will:

- Use the data for research on Toyota vehicle safety performance
- Disclose the data to a third party for research purposes without disclosing details of the vehicle owner, and only when it is deemed necessary
- Disclose summarized data cleared of vehicle identification information to a non-Toyota organization for research purposes



## 5-2. Steps to take in an emergency

### If a warning light turns on or a warning buzzer sounds...

**Calmly perform the following actions if any of the warning lights turn on or flash. If a light turns on or flashes, but then turns off, this does not necessarily indicate a malfunction in the system.**

**Stop the vehicle immediately. Continuing to drive the vehicle may be dangerous.**



The following warning indicates a possible problem in the brake system. Immediately stop the vehicle in a safe place and contact your Toyota dealer.

Warning light	Warning light/Details
 (U.S.A.)	<b>Brake system warning light (warning buzzer)*</b> <ul style="list-style-type: none"><li>• Low brake fluid</li><li>• Malfunction in the brake system</li></ul> This light also comes on when the parking brake is not released. If the light turns off after the parking brake is fully released the system is operating normally.
 (Canada)	

\*: Parking brake engaged warning buzzer: The buzzer sounds to indicate that the parking brake is still engaged (with the vehicle having reached a speed of 3 mph [5 km/h]).



**Stop the vehicle immediately.**

The following warning indicates the possibility of damage to the vehicle that may lead to an accident. Immediately stop the vehicle in a safe place and contact your Toyota dealer.

Warning light	Warning light/Details
	<p><b>Charging system warning light</b> Indicates a malfunction in the vehicle's charging system.</p>
	<p><b>Low engine oil pressure warning light (vehicles without multi-information display)</b> Indicates that the engine oil pressure is too low.</p>

**Have the vehicle inspected immediately.**

Failing to investigate the cause of the following warnings may lead to the system operating abnormally and possibly cause an accident. Have the vehicle inspected by your Toyota dealer immediately.

Warning light	Warning light/Details
 (U.S.A.)  (Canada)	<p><b>Malfunction indicator lamp</b> Indicates a malfunction in:</p> <ul style="list-style-type: none"> <li>• The electronic engine control system;</li> <li>• The electronic throttle control system; or</li> <li>• The electronic automatic transmission control system.</li> </ul>
	<p><b>SRS warning light</b> Indicates a malfunction in:</p> <ul style="list-style-type: none"> <li>• The SRS airbag system;</li> <li>• The front passenger occupant classification system; or</li> <li>• The seat belt pretensioner system.</li> </ul>

Warning light	Warning light/Details
<div style="border: 1px solid black; padding: 5px; width: fit-content; margin-bottom: 5px;">ABS</div> (U.S.A.) <div style="border: 1px solid black; border-radius: 50%; padding: 5px; width: fit-content; margin-top: 5px;">(ABS)</div> (Canada)	<p><b>ABS warning light</b></p> <p>Indicates a malfunction in:</p> <ul style="list-style-type: none"> <li>• ABS; or</li> <li>• The brake assist system.</li> </ul>
<div style="border: 1px solid black; padding: 5px; width: fit-content; margin: 0 auto;">VSC</div>	<p><b>Vehicle stability control system and traction control system warning light (if equipped)</b></p> <p>Indicates a malfunction in the VSC system or TRAC system.</p>

### ■ If the malfunction indicator lamp comes on while driving





First check the following:

- Is the fuel tank empty?  
If it is, fill the fuel tank immediately.
- Is the fuel tank cap loose?  
If it is, tighten it securely.



The malfunction indicator lamp will go off after taking several driving trips. If the malfunction indicator lamp does not go off even after several trips, contact your Toyota dealer as soon as possible.

**Follow the correction procedures.**

After taking the specified steps to correct the suspected problem, check that the warning light turns off.

Warning light	Warning light/Details	Correction procedure
	<b>Open door warning light (warning buzzer)*<sup>1</sup></b> Indicates that a door or the trunk is not fully closed.	Check that all doors and the trunk are closed.
	<b>Low fuel level warning light</b> Indicates that remaining fuel is about 2.8 gal. (10.5 L, 2.3 Imp. gal.) or less	Refuel the vehicle.
	<b>Driver's seat belt reminder light (warning buzzer)*<sup>2</sup></b> Warns the driver to fasten his/her seat belt.	Fasten the seat belt.
 (On the center panel)	<b>Front passenger's seat belt reminder light (warning buzzer)*<sup>2</sup></b> Warns the front passenger to fasten his or her seat belt.	Fasten the seat belt.
	<b>Low windshield washer fluid warning light (vehicles without multi-information display)</b> Low level of washer fluid	Fill the tank.



Warning light	Warning light/Details	Correction procedure
 (U.S.A.)	<b>Engine oil replacement reminder light (vehicles without multi-information display)</b>	
	Illuminates for about 3 seconds and then flashes for about 15 seconds approximately 4500 miles (7200 km) after the engine oil is changed: Indicates that the engine oil is scheduled to be changed.	Check the engine oil, and change if necessary.
	Comes on and remains on if the distance driven exceeds 5000 miles (8000 km): Indicates that the engine oil should be changed.	Check and change the engine oil.
 (U.S.A.)	<b>Tire pressure warning light</b>	
	When the light comes on: Low tire inflation pressure.	Adjust the tire inflation pressure.
	When the light comes on after blinking for 1 minute: Malfunction in the tire pressure warning system.	Have the system checked by your Toyota dealer.
	<b>Master warning light (vehicles with multi-information display)</b> A buzzer sounds and the warning light comes on and flashes to indicate that the master warning system has detected a malfunction.	→P. 391

### \*1: Open door warning buzzer:

The open door warning buzzer sounds to alert the driver that one or more of the doors is not fully closed (with the vehicle having reached a speed of 3 mph [5 km/h]).

### \*2: Driver's and front passenger's seat belt reminders:

The driver's and front passenger's seat belts reminder sound to alert the driver and front passenger that his or her seat belt is not fastened. The buzzer sounds intermittently for 10 seconds after the vehicle has reached a speed of at least 12 mph (20 km/h). Then, if the seat belt is still unfastened, the buzzer will sound at a different tone for 20 more seconds.

---

#### ■ Key reminder buzzer (vehicles without smart key system)

The buzzer indicates that the key has not been removed with the engine off and the driver's door opened.

#### ■ Open moon roof reminder buzzer (if equipped)

The buzzer indicates that the moon roof is not fully closed with the engine off and the driver's door opened.

#### ■ Front passenger detection sensor and passenger seat belt reminder

- If luggage is placed on the front passenger seat, the front passenger detection sensor may cause the warning light to flash, even if a passenger is not sitting in the seat.
- If a cushion is placed on the seat, the sensor may not detect a passenger, and the warning light may not operate properly.

#### ■ Changing the engine oil (U.S.A. only)

Make sure to reset the oil change system. (→P. 323)

#### ■ When the tire pressure warning light comes on

Check the tire inflation pressure and adjust to the appropriate level. Pressing the tire pressure warning reset switch does not turn off the tire pressure warning light.

#### ■ The tire pressure warning light may turn on due to natural causes

The tire pressure warning light may turn on due to natural causes such as natural air leaks or tire inflation pressure changes caused by temperature. In this case, adjusting the tire inflation pressure will turn off the warning light (after a few minutes).

### ■ When a tire is replaced with a spare tire

#### ▶ Vehicles with a compact spare tire

The compact spare tire is not equipped with the tire pressure warning valve and transmitter. If a tire goes flat, the tire pressure warning light will not turn off even though the flat tire is replaced with the spare tire. Replace the spare tire with the repaired tire and adjust the proper tire inflation pressure. The tire pressure warning light will turn off after a few minutes.

#### ▶ Vehicles with a full-size spare tire

The spare tire is also equipped with the tire pressure warning valve and transmitter. The tire pressure warning light will turn on if the tire inflation pressure of the spare tire is low. If a tire goes flat, even though the flat tire is replaced with the spare tire, the tire pressure warning light does not turn off. Replace the spare tire with the repaired tire and adjust the proper tire inflation pressure. The tire pressure warning light will turn off after a few minutes.

### ■ If the tire pressure warning system is inoperative

The tire pressure warning system may become inoperative in the following conditions:

(When the condition becomes normal, the system will work properly.)

- If tires not equipped with tire pressure warning valves and transmitters are used.
- If the ID code on the tire pressure warning valves and transmitters is not registered in the tire pressure warning computer.
- If electronic devices or facilities using similar radio wave frequencies are nearby.
- If a large metallic object which can interfere with signal reception is put in the trunk
- If a radio set at similar frequencies is in use in the vehicle.
- If a window tint that affects the radio wave signals is installed
- If there is a lot of snow or ice on the vehicle, in particular around the wheels or wheel housings.
- If non-genuine Toyota wheels are used. (Even if you use Toyota wheels, the tire pressure warning system may not work properly with some types of tires.)

- If tire chains are used
- If the spare tire is in a location subject to poor radio wave signal reception
- If the tire inflation pressure is 73 psi (500 kPa, 5.1 kgf/cm<sup>2</sup> or bar) or higher.

■ **If the tire pressure warning light comes on after blinking frequently for 1 minute**

If the tire pressure warning light comes on after blinking frequently for 1 minute when the “ENGINE START STOP” switch or engine switch is turned ON, have it checked by your Toyota dealer.

■ **Customization that can be configured at Toyota dealer**

The vehicle speed linked seat belt reminder buzzer can be disabled. (Customizable features →P. 454) However, Toyota recommends that the seat belt reminder buzzer be operational to alert the driver and front passenger that the seat belts are not fastened.

 **CAUTION**

■ **If the tire pressure warning light comes on**

Be sure to observe the following precautions. Failure to do so could cause loss of vehicle control and result in death or serious injury.

- Stop your vehicle in a safe place as soon as possible. Adjust the tire inflation pressure immediately.
- If the tire pressure warning light comes on even after tire inflation pressure adjustment, it is probable that you have a flat tire. Check the tires. If the tire is flat, change to the spare tire and have the flat tire repaired by the nearest Toyota dealer.
- Avoid abrupt maneuvering and braking. If the vehicle tires deteriorate, you could lose control of the steering wheel or the brakes.

■ **If a blowout or sudden air leakage should occur**

The tire pressure warning system may not activate immediately.

 **CAUTION****■ Maintenance of the tires**

Each tire, including the spare (if provided), should be checked monthly when cold and inflated to the inflation pressure recommended by the vehicle manufacturer on the vehicle placard or tire inflation pressure label (tire and load information label). (If your vehicle has tires of a different size than the size indicated on the vehicle placard or tire inflation pressure label [tire and load information label], you should determine the proper tire inflation pressure for those tires.)

As an added safety feature, your vehicle has been equipped with a tire pressure monitoring system (TPMS-tire pressure warning system) that illuminates a low tire pressure telltale (tire pressure warning light) when one or more of your tires is significantly under-inflated. Accordingly, when the low tire pressure telltale (tire pressure warning light) illuminates, you should stop and check your tires as soon as possible, and inflate them to the proper pressure. Driving on a significantly under-inflated tire causes the tire to overheat and can lead to tire failure. Under-inflation also reduces fuel efficiency and tire tread life, and may affect the vehicle's handling and stopping ability.

Please note that the TPMS (tire pressure warning system) is not a substitute for proper tire maintenance, and it is the driver's responsibility to maintain correct tire pressure, even if under-inflation has not reached the level to trigger illumination of the TPMS low tire pressure telltale (tire pressure warning light).

 CAUTION

Your vehicle has also been equipped with a TPMS (tire pressure warning system) malfunction indicator to indicate when the system is not operating properly. The TPMS (tire pressure warning system) malfunction indicator is combined with the low tire pressure telltale (tire pressure warning light). When the system detects a malfunction, the telltale will flash for approximately one minute and then remain continuously illuminated. This sequence will continue upon subsequent vehicle start-ups as long as the malfunction exists. When the malfunction indicator is illuminated, the system may not be able to detect or signal low tire pressure as intended.

TPMS (tire pressure warning system) malfunctions may occur for a variety of reasons, including the installation of replacement or alternate tires or wheels on the vehicle that prevent the TPMS (tire pressure warning system) from functioning properly. Always check the TPMS (tire pressure warning system) malfunction telltale after replacing one or more tires or wheels on your vehicle to ensure that the replacement or alternate tires and wheels allow the TPMS (tire pressure warning system) to continue to function properly.

 NOTICE

■ **Precaution when installing a different tire**

When a tire of a different specification or maker is installed, the tire pressure warning system may not operate properly.

## 5-2. Steps to take in an emergency

If a warning message is displayed (vehicles with multi-information display)

**If a warning is shown on the multi-information display, stay calm and perform the following actions:**

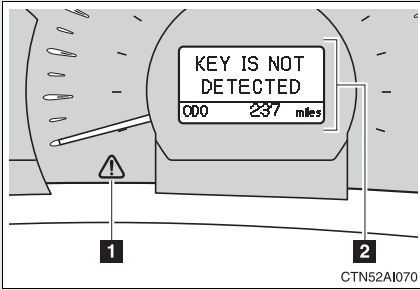

### **1** Master warning light

The master warning light also comes on or flashes in order to indicate that a message is currently being displayed on the multi-information display.

### **2** Multi-information display

If any of the warning lights turns on again after performing the following actions, contact your Toyota dealer.

**Stop the vehicle immediately.**

- The following warning indicates the possibility of damage to the vehicle that may lead to an accident. Immediately stop the vehicle in a safe place and contact your Toyota dealer.

Warning message	Details
<p data-bbox="106 475 314 578">LOW ENGINE OIL PRESSURE</p> 	<p data-bbox="366 493 886 521"><b>Indicates an abnormal engine oil pressure.</b></p> <p data-bbox="380 526 634 553">A buzzer also sounds.</p> <p data-bbox="380 558 898 618">The warning light may turn on if the engine oil pressure is too low.</p>



- The following warning indicates the possibility of damage to the vehicle that may lead to an accident. Immediately stop the vehicle in a safe place and allow the engine to cool.

Warning message	Details
<p data-bbox="106 893 314 995">WATER TEMP</p> 	<p data-bbox="366 927 940 987"><b>Indicates that the engine coolant temperature is too high.</b></p> <p data-bbox="380 992 634 1019">A buzzer also sounds.</p>





### Have the vehicle inspected immediately.



Failing to investigate the cause of the following warnings may lead to the system operating abnormally and possibly cause an accident. Have the vehicle inspected by your Toyota dealer immediately.



Warning message	Details
<div data-bbox="133 475 345 581" style="background-color: black; color: white; padding: 5px; text-align: center;">CHECK S/T LOCK</div> <div data-bbox="189 589 283 651" style="text-align: center;">  </div> <p data-bbox="124 657 352 716">(vehicles with smart key system)</p>	<p data-bbox="396 544 976 602"><b>Indicates a malfunction in the steering lock system.</b></p> <p data-bbox="412 609 663 634">A buzzer also sounds.</p>
<div data-bbox="133 747 345 852" style="background-color: black; color: white; padding: 5px; text-align: center;">CHECK VSC SYSTEM</div> <div data-bbox="189 860 283 922" style="text-align: center;">  </div>	<p data-bbox="396 782 948 841"><b>Indicates a malfunction in the TRAC and VSC systems (if equipped).</b></p> <p data-bbox="412 847 663 873">A buzzer also sounds.</p>

<b>Follow the correction procedures.</b>
------------------------------------------

After taking the specified steps to correct the suspected problem, check that the warning light turns off.

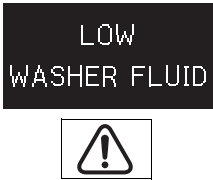
Warning message	Details	Correction procedure
	<p><b>Indicates that one or more of the doors is not fully closed.</b></p> <p>A buzzer sounds to indicate that one or more of the doors is not fully closed (with the vehicle having reached a speed of 3 mph [5 km/h]).</p>	<p>Make sure that all of the doors are closed.</p>
	<p><b>Indicates that the hood is not fully closed.</b></p> <p>A buzzer sounds to indicate that hood is not fully closed (with the vehicle having reached a speed of 3 mph [5 km/h]).</p>	<p>Close the hood.</p>

Warning message	Details	Correction procedure
	<p><b>Indicates that the trunk is not fully closed.</b></p> <p>A buzzer sounds to indicate that the trunk is not fully closed (with the vehicle having reached a speed of 3 mph [5 km/h]).</p>	<p>Close the trunk.</p>
	<p><b>Indicates that the moon roof is not fully closed (with the “ENGINE START STOP” switch OFF [vehicles with smart key system] or the engine switch OFF [vehicles without smart key system], and the driver's door open).</b></p> <p>A buzzer also sounds.</p>	<p>Close the moon roof.</p>
	<p><b>Indicates that the parking brake is still engaged with the vehicle having reached a speed of more than 3 mph (5 km/h).</b></p> <p>A buzzer also sounds.</p>	<p>Release the parking brake.</p>
	<p><b>Indicates that the washer fluid level is low.</b></p> <p>A buzzer also sounds.</p>	<p>Add washer fluid.</p>





Warning message	Details	Correction procedure
<div data-bbox="102 350 314 456" style="background-color: black; color: white; padding: 5px; text-align: center;"> <b>MAINT REQ SOON</b> </div> <div data-bbox="157 464 253 526" style="text-align: center;">  </div> <p data-bbox="131 532 278 561">(U.S.A. only)</p>	<p data-bbox="362 253 632 375"><b>Indicates that the engine oil is scheduled to be changed.</b> A buzzer also sounds.</p> <p data-bbox="362 396 632 646"><b>Comes on approximately 4500 miles (7200 km) after the engine oil is changed. (The indicator will not work properly unless the oil maintenance data has been reset).</b></p>	<p data-bbox="671 404 910 493">Check the engine oil, and change if necessary.</p>
<div data-bbox="102 745 314 850" style="background-color: black; color: white; padding: 5px; text-align: center;"> <b>MAINT REQ</b> </div> <div data-bbox="157 859 253 920" style="text-align: center;">  </div> <p data-bbox="131 927 278 956">(U.S.A. only)</p>	<p data-bbox="362 667 632 789"><b>Indicates that the engine oil should be changed.</b> A buzzer also sounds.</p> <p data-bbox="362 810 632 1027"><b>Comes on approximately 5000 miles (8000 km) after the engine oil is changed (and the oil maintenance data has been reset).</b></p>	<p data-bbox="671 818 929 875">Check and change the engine oil.</p>

■ **Changing the engine oil (U.S.A. only)**







Make sure to reset the oil change system. (→P. 323)



**Follow the correction procedures (vehicles with smart key system).**

After taking the specified steps to correct the suspected problem, check that the warning light turns off.

Interior buzzer	Exterior buzzer	Warning message	Details	Correction procedure
Once	—	 <p>(Comes on for 8 seconds)</p> 	Indicates that the electronic key is not present when the “ENGINE START STOP” switch is pressed.	Confirm the location of the electronic key.
Once	3 times	 	Indicates that a door other than the driver’s door has been opened and closed with the “ENGINE START STOP” switch in any mode other than OFF and the electronic key outside of the detection area.	Confirm the location of the electronic key.

## 5-2. Steps to take in an emergency

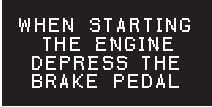
Interior buzzer	Exterior buzzer	Warning message	Details	Correction procedure
Once	3 times	 <p>KEY IS NOT DETECTED</p> 	Indicates that the driver's door has been opened or closed with the shift lever in P, the "ENGINE START STOP" switch in any mode other than OFF and the electronic key outside of the detection area.	Turn the "ENGINE START STOP" switch OFF or confirm the location of the electronic key.
Once	Continuous	 <p>KEY IS NOT DETECTED</p> <p>SHIFT TO P RANGE</p> <p>(Displayed alternately)</p> 	Indicates that the driver's door has been opened or closed (with the shift lever not in P, the "ENGINE START STOP" switch in any mode other than OFF and the electronic key outside of the detection area).	<ul style="list-style-type: none"> <li>• Shift the shift lever to P.</li> <li>• Confirm the location of the electronic key.</li> </ul>
Once	—	 <p>LOW KEY BATTERY</p> 	Indicates that the key battery is low.	Replace the battery. (→P. 353)

Interior buzzer	Exterior buzzer	Warning message	Details	Correction procedure
Once	—		Indicates that a door has been opened or closed and the “ENGINE START STOP” switch has been turned twice to ACCESSORY mode from OFF.	Press the “ENGINE START STOP” switch while depressing the brake pedal.
Once	—	 	Indicates that the steering lock has not released within 3 seconds of pressing the “ENGINE START STOP” switch.	Press the “ENGINE START STOP” switch again while turning the steering wheel with the brake pedal depressed.

## 5-2. Steps to take in an emergency If you have a flat tire

**Remove the flat tire and replace it with the spare provided.**

### ■ Before jacking up the vehicle

- Stop the vehicle on a hard, flat surface.
- Set the parking brake.
- Shift the shift lever to P (automatic transmission) or R (manual transmission).
- Stop the engine.
- Turn on the emergency flashers.

### ■ Location of the spare tire, jack and tools

#### ▶ Vehicles with a compact spare tire

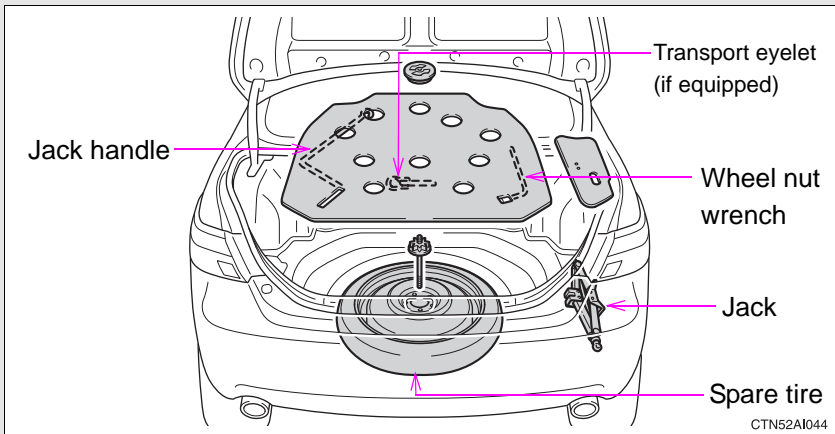



► Vehicles with a full-size spare tire

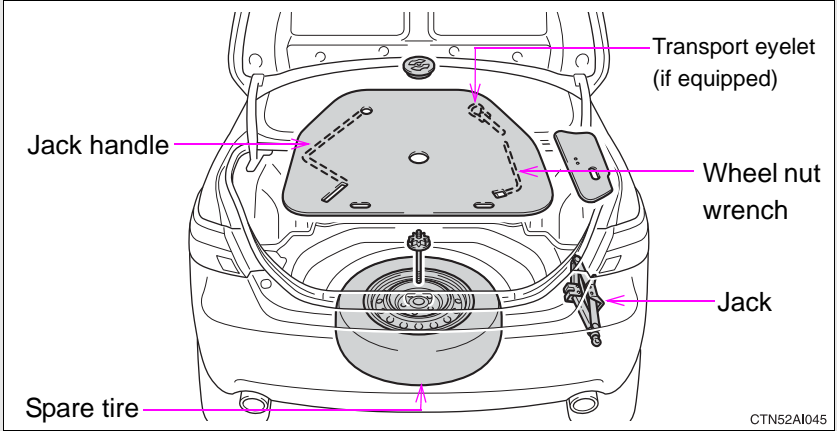

**Taking out the jack and spare tire**

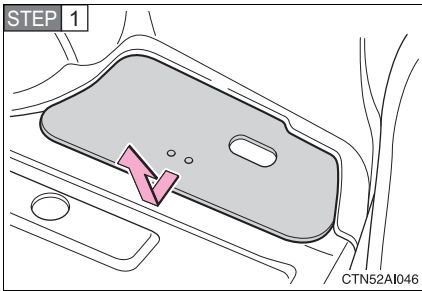

Remove the jack cover.

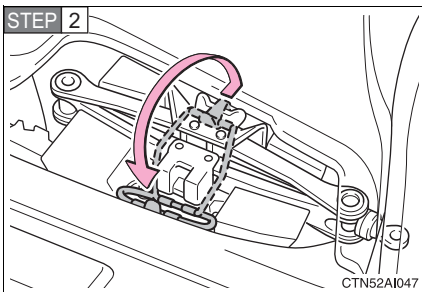

Remove the hook.

## Taking out the spare tire

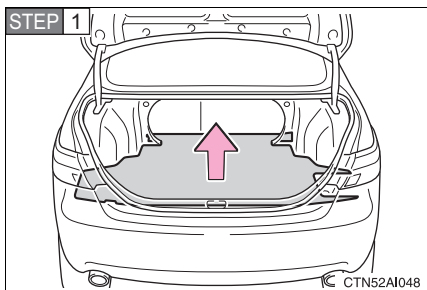

Remove the luggage floor cover.

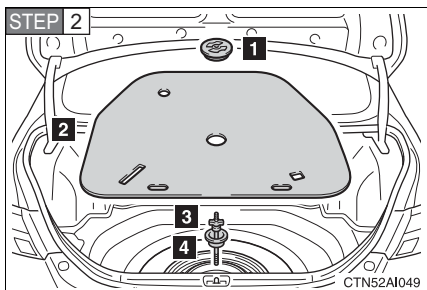

- 1 Loosen the nut and remove it.
- 2 Remove the spare tire cover.
- 3 Loosen the bolt and remove it.
- 4 Remove the spacer (with aluminum wheels).

## Replacing a flat tire

STEP 1

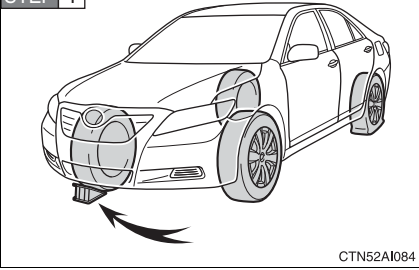

Chock the tires.

Flat tire		Wheel chock positions
Front	Left-hand side	Behind the rear right-hand side tire
	Right-hand side	Behind the rear left-hand side tire
Rear	Left-hand side	In front of the front right-hand side tire
	Right-hand side	In front of the front left-hand side tire

STEP 2

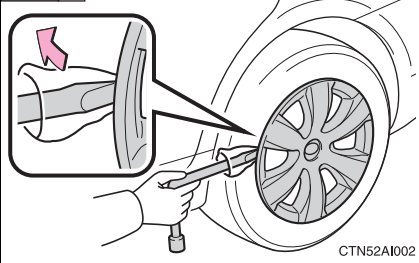

Vehicles with a steel wheel, remove the wheel ornament using the wrench.

To protect the wheel ornament, place a rag between the wrench and the wheel ornament, as shown in the illustration.

## 5-2. Steps to take in an emergency

STEP 3

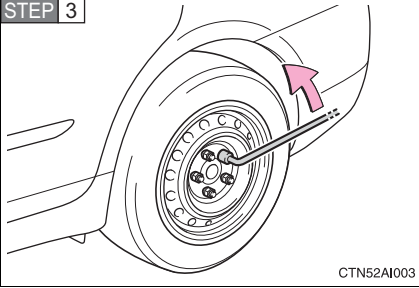

Slightly loosen the wheel nuts (one turn).

STEP 4

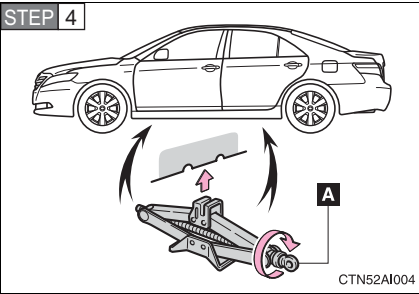

Turn the tire jack portion "A" by hand until the notch of the jack is in contact with the jack point.

STEP 5

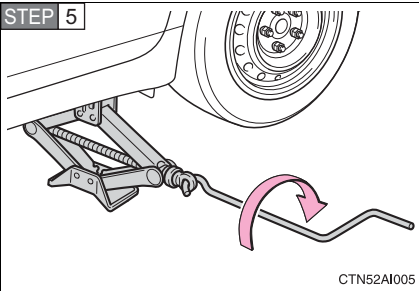

Raise the vehicle until the tire is slightly raised off the ground.

STEP 6

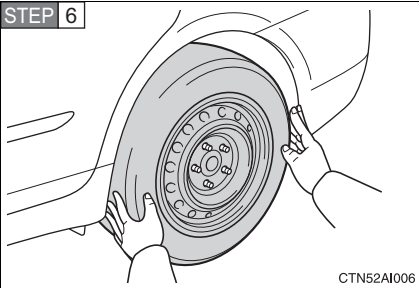

Remove all the wheel nuts and the tire.

When resting the tire on the ground, place the tire so that the wheel design faces up to avoid scratching the wheel surface.

## Installing the tire

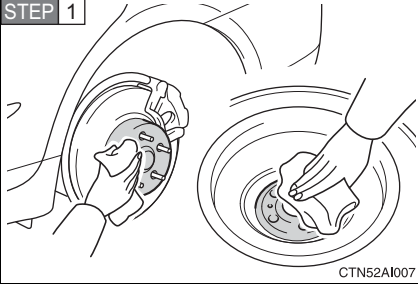

Remove any dirt or foreign matter from the wheel contact surface.

If foreign matter is on the wheel contact surface, the wheel nuts may loosen while the vehicle is in motion, and the tire may come off the vehicle.

**STEP 2** Install the tire and loosely tighten each wheel nut by hand by approximately the same amount.

### ► Replacing a steel wheel with a steel wheel

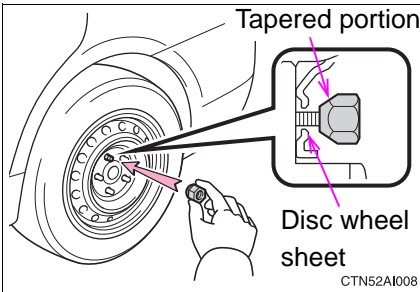

Tighten the nuts until the tapered portion comes into loose contact with the disc wheel sheet.

### ► Replacing an aluminum wheel with a steel wheel

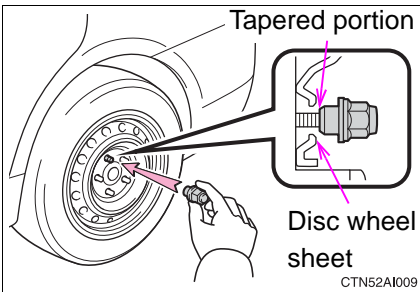

Tighten the nuts until the tapered portion comes into loose contact with the disc wheel sheet.

► Replacing an aluminum wheel with an aluminum wheel

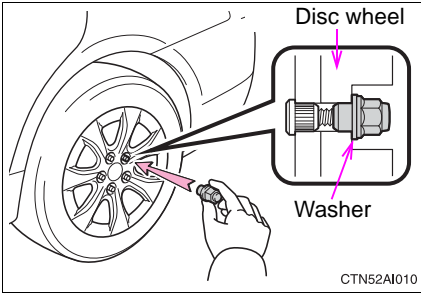

Turn the nuts until the washers come into contact with the disc wheel.

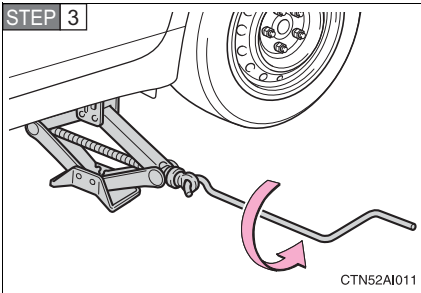

Lower the vehicle.

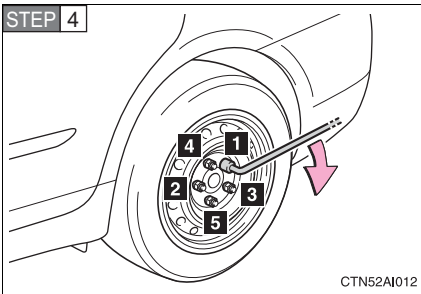

Firmly tighten each nut two or three times in the order shown in the illustration.

**Tightening torque:**  
76 ft•lb (103 N•m, 10.5 kgf•m)

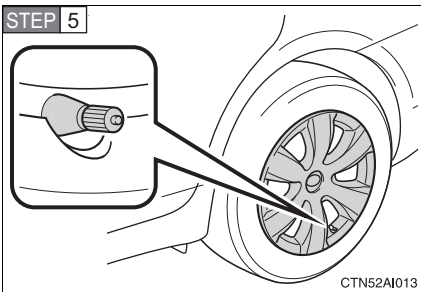

For vehicles with a steel wheel, reinstall the wheel ornament.

Align the cutout of the wheel ornament with the valve stem as shown.

**STEP 6** Stow the flat tire, tire jack and all tools.

### ■ The compact spare tire

- The compact spare tire is identified by the label “TEMPORARY USE ONLY” on the tire sidewall.  
Use the compact spare tire temporarily only in an emergency.
- Make sure to check the tire pressure of the compact spare tire. (→P. 436)

### ■ If you have a flat front tire on a road covered with snow or ice

Install the compact spare tire on the rear of the vehicle. Perform the following steps and fit tire chains to the front tires.

**STEP 1** Replace a rear tire with the compact spare tire.

**STEP 2** Replace the flat front tire with the tire removed from the rear of the vehicle.

**STEP 3** Fit tire chains to the front tires.

### ■ After completing the tire change (U.S.A. only)

The tire pressure warning system must be reset. (→P. 336)

### ■ When using the compact spare tire

As the compact spare tire is not equipped with the tire pressure warning valve and transmitter, low inflation pressure of the spare tire will not be warned. Also, if you replace the compact spare tire after the tire pressure warning light comes on, the light remains on.

### ■ Jack point guide

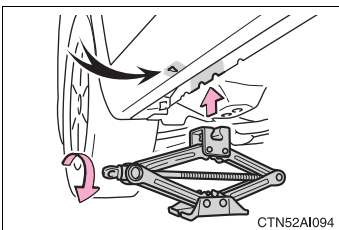

The jack point guides are located under the rocker panel. They indicate the jack point positions.

 **CAUTION**

■ **Using the tire jack**

Improper use of the tire jack may lead to death or injuries due to the vehicle suddenly falling off the jack.

- Do not use the tire jack for any purpose other than replacing tires or installing and removing tire chains.
- Only use the tire jack that comes with this vehicle for replacing a flat tire.  
Do not use it on other vehicles, and do not use other tire jacks for replacing tires on this vehicle.
- Always check that the tire jack is securely set to the jack point.
- Do not put any part of your body under the vehicle while it is supported by a jack.
- Do not start or run the engine while your vehicle is supported by the jack.
- Do not raise the vehicle while someone is in it.
- When raising the vehicle, do not put an object on or under the jack.
- Do not raise the vehicle to a height greater than that required to replace the tire.
- Use a jack stand if it is necessary to get under the vehicle.

Take particular care when lowering the vehicle to ensure that no one working on or near the vehicle will be injured.

■ **Replacing a flat tire**

Observe the following precautions to reduce the risk of death or serious injury.

- Never use oil or grease on the wheel bolts or wheel nuts.  
The oil or grease can cause the wheel nuts to loosen, causing a serious accident.  
Remove any oil or grease on the wheel bolts or wheel nuts.
- Have the wheel nuts tightened with a torque wrench to 76 ft•lbf (103 N•m, 10.5 kg•m) as soon as possible after changing wheels.  
Failure to follow these precautions could cause the nuts to loosen and the wheel may fall off, which could lead to an accident causing death or serious injury.



 **CAUTION****■ When using the compact spare tire**

- Remember that your compact spare tire is specifically designed for use with your vehicle. Do not use your compact spare tire on another vehicle.
- Do not use two compact spare tires simultaneously.
- Replace the compact spare tire with a standard tire as soon as possible.
- Avoid sudden acceleration, deceleration and braking, as well as sharp cornering.

**■ Speed limit when using the compact spare tire**

Do not drive at speeds in excess of 50 mph (80 km/h) when a compact spare tire is installed on the vehicle.

The compact spare tire is not designed for driving at high speeds. Failing to observe this precaution may lead to an accident causing death or serious injury.

**■ When the compact spare tire is attached**

The vehicle speed may not be correctly detected, and the following systems may not operate correctly:

- ABS & Brake assist
- VSC
- TRAC
- Navigation system

 NOTICE

■ **Do not drive the vehicle with a flat tire.**

Do not continue driving with a flat tire.

Driving even a short distance with a flat tire can damage the tire and the wheel beyond repair.

■ **Be careful when driving over bumps with the compact spare tire installed on the vehicle.**

The vehicle becomes lower when driving with the compact spare tire compared to when driving with standard tires. Be careful when driving over uneven road surfaces.

■ **Driving with tire chains and the compact spare tire**

Do not fit tire chains to the compact spare tire.

Tire chains may damage the vehicle body and adversely affect driving performance.

■ **When replacing the tires**

When removing or fitting the wheels, tires or the tire pressure warning valve and transmitter, contact your Toyota dealer as the tire pressure warning valve and transmitter may be damaged if not handled correctly.

■ **To avoid damaging the tire pressure warning valves and transmitters**

Do not use liquid sealants on flat tires.

## 5-2. Steps to take in an emergency If the engine will not start

**If the engine still does not start after following the correct starting procedure (→P. 126, 130) or releasing the steering lock (→P. 128, 131), confirm the following points.**

■ **The engine will not start even when the starter motor operates normally.**

One of the following may be the cause of the problem.

- There may not be sufficient fuel in the vehicle's tank.  
Refuel the vehicle.
- The engine may be flooded.  
Try to restart the engine once more following correct starting procedures. (→P. 126, 130)
- There may be a malfunction in the engine immobilizer system.  
(→P. 77)

■ **The starter motor turns over slowly, the interior lights and headlights are dim, or the horn does not sound or sounds at a low volume.**

One of the following may be the cause of the problem.

- The battery may be discharged. (→P. 417)
- The battery terminal connections may be loose or corroded.

■ **The starter motor does not turn over (vehicles with smart key system).**

The engine starting system may be malfunctioning due to an electrical problem such as an open circuit or a blown fuse. However, an interim measure is available to start the engine.  
(→P. 412)

■ **The starter motor does not turn over, the interior lights and headlights do not turn on, or the horn does not sound.**

One of the following may be the cause of the problem.

- One or both of the battery terminals may be disconnected.
- The battery may be discharged. (→P. 417)
- There may be a malfunction in the steering lock system (vehicles with smart key system).

Contact your Toyota dealer if the problem cannot be repaired, or if repair procedures are unknown.

**Emergency start function (vehicles with smart key system)**

When the engine does not start, the following steps can be used as an interim measure to start the engine if the “ENGINE START STOP” switch is functioning normally.

**STEP 1** Set the parking brake.

**STEP 2** Shift the shift lever to P.

**STEP 3** Set the “ENGINE START STOP” switch to ACCESSORY mode.

**STEP 4** Press and hold the “ENGINE START STOP” switch for about 15 seconds while depressing the brake pedal firmly.

Even if the engine can be started using the above steps, the system may be malfunctioning. Have the vehicle checked by your Toyota dealer.

## 5-2. Steps to take in an emergency

If the shift lever cannot be shifted from P (automatic transmission)

**If the shift lever cannot be shifted with your foot on the brake, there may be a problem with the shift lock system (a system to prevent accidental operation of the shift lever). Have the vehicle inspected by your Toyota dealer.**

**The following steps may be used as an emergency measure to ensure that the shift lever can be shifted.**

**STEP 1** Set the parking brake.

**STEP 2** Vehicles with smart key system: Turn the “ENGINE START STOP” switch to the ACCESSORY mode.

Vehicles without smart key system: Turn the engine switch to the “ACC” position.

**STEP 3** Depress the brake pedal.

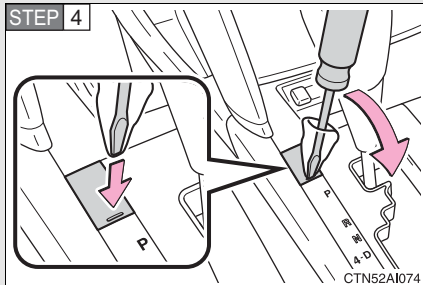

Pry the cover up with a flat-head screwdriver or equivalent.

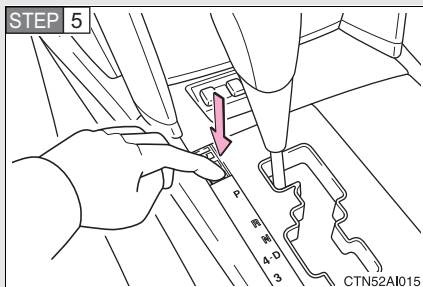

Press the shift lock override button.

The shift lever can be shifted while the button is pressed.

## If you lose your keys

**New genuine keys can be made by your Toyota dealer. For vehicles with the smart key system, bring the other key and the key number stamped on the key number plate. For vehicles without the smart key system, bring a master key and the key number stamped on the key number plate.**

## 5-2. Steps to take in an emergency

If the electronic key does not operate properly (vehicles with smart key system)

If communication between the electronic key and the vehicle is interrupted (→P. 30) or the electronic key cannot be used because the battery is depleted, the smart key system and wireless remote control cannot be used. In such cases, the doors and trunk can be opened or the engine can be started by following the procedure below.

### Locking and unlocking the doors and opening the trunk with the mechanical key

#### ► Doors

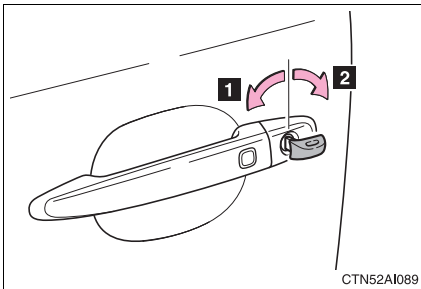

- 1 Locks all doors
- 2 Unlocks all doors

Turning the key rearward unlocks the driver's door. Turning the key once again unlocks the other doors.

#### ► Trunk

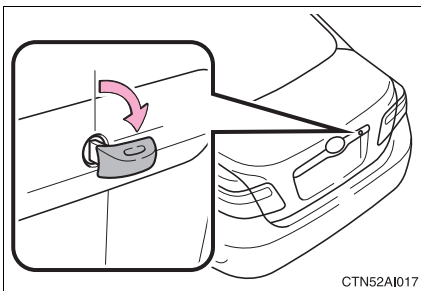

Turn the mechanical key clockwise to open.

## Changing “ENGINE START STOP” switch modes and starting the engine

**STEP 1** Shift the shift lever to P and apply the brakes.

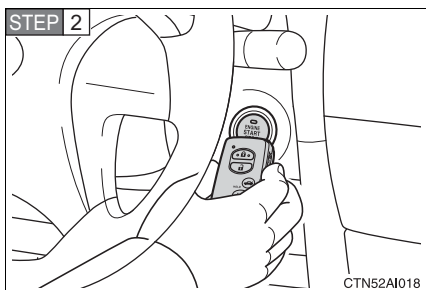

Touch the Toyota emblem side of the electronic key to the “ENGINE START STOP” switch.

An alarm will sound to indicate that the start function cannot detect the electronic key that is touched to the “ENGINE START STOP” switch if any of the doors is opened and closed while the key is touched to the switch.

**STEP 3** To change “ENGINE START STOP” switch modes: Within 5 seconds of the buzzer sounding, release the brake pedal and press the “ENGINE START STOP” switch. Modes can be changed each time the switch is pressed. (→P. 127)

To start the engine: Press the “ENGINE START STOP” switch within 5 seconds after the buzzer sounds, keeping the brake pedal depressed.

In the event that the “ENGINE START STOP” switch still cannot be operated, contact your Toyota dealer.

### ■ Stopping the engine

Shift the shift lever to P and press the “ENGINE START STOP” switch as you normally do when stopping the engine.

### ■ Replacing the key battery

As the above procedure is a temporary measure, it is recommended that the electronic key battery be replaced immediately when the battery is depleted. (→P. 353)



## 5-2. Steps to take in an emergency If the battery is discharged

The following procedures may be used to start the engine if the vehicle's battery is discharged.

You can call your Toyota dealer or qualified repair shop.

If you have a set of jumper (or booster) cables and a second vehicle with a 12-volt battery, you can jump start your Toyota following the steps below.

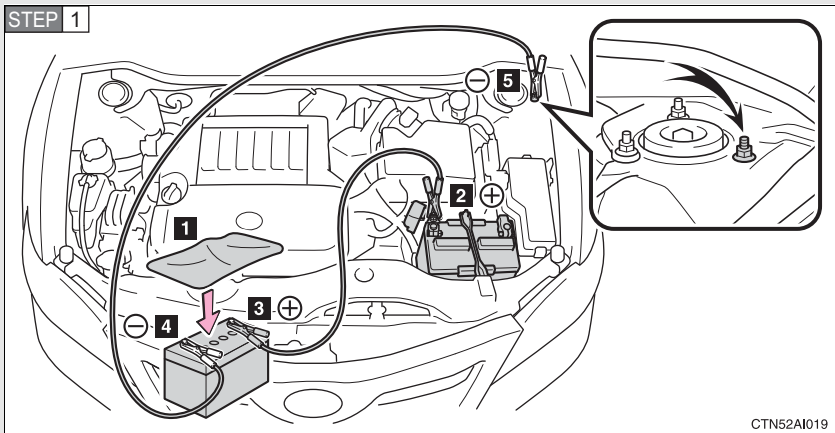

### Connecting the jumper cables

- 1** If required, remove all vent plugs from the booster battery. Lay a cloth over the open vents on the booster battery. (This helps reduce the explosion hazard, personal injuries and burns.)
- 2** Positive (+) battery terminal on your vehicle
- 3** Positive (+) battery terminal on the second vehicle
- 4** Negative (-) battery terminal on the second vehicle
- 5** Connect the jumper cable to ground on your vehicle as shown in the illustration.

**STEP 2** Start the engine of the second vehicle. Increase the engine speed slightly and maintain at that level for approximately 5 minutes to recharge the battery of your vehicle.

**STEP 3** Vehicles with smart key system — Open and close any of the doors with the “ENGINE START STOP” switch OFF.

**STEP 4** Maintain the engine speed of the second vehicle, and turn the “ENGINE START STOP” switch to IGNITION ON mode (vehicles with smart key system) or turn the engine switch to “ON” position (vehicles without smart key system), then start the vehicle's engine.

**STEP 5** Once the vehicle's engine has started, remove the jumper cables in the exact reverse order in which they were connected.

Once the engine starts, have the vehicle checked at your Toyota dealer as soon as possible.

---

### ■ Avoiding a discharged battery

- Turn off the headlights and the audio system while the engine is turned off.
- Turn off any unnecessary electrical components when the vehicle is running at a low speed for an extended period, such as in heavy traffic, etc.

### ■ When the battery is removed or discharged

The tire pressure warning system must be initialized.  
(→P. 336)

 **CAUTION****■ Avoiding battery fires or explosions**

Observe the following precautions to prevent accidentally igniting the flammable gas that may be emitted from the battery.

- Make sure the jumper cable is connected to the correct terminal and that it is not unintentionally in contact with any part other than the intended terminal.
- Do not allow the jumper cables to come into contact with the “+” and “-” terminals.
- Do not smoke, use matches, cigarette lighters or allow open flame near the battery.

**■ Battery precautions**

The battery contains poisonous and corrosive acidic electrolyte, while related parts contain lead and lead compounds. Observe the following precautions when handling the battery.

- When working with the battery, always wear safety glasses and take care not to allow any battery fluids (acid) to come into contact with skin, clothing or the vehicle body.
- Do not lean over the battery.
- In the event that battery fluid comes into contact with the skin or eyes, immediately wash the affected area with water and seek medical attention. Place a wet sponge or cloth over the affected area until medical attention can be received.
- Always wash your hands after handling the battery support, terminals, and other battery-related parts.
- Do not allow children near the battery.

 NOTICE

■ **To prevent damage to the vehicle**

Do not pull- or push-start the vehicle, because the catalytic converter may overheat and become a fire hazard.

■ **When handling jumper cables**

Be careful that the jumper cables do not become tangled in the cooling fans or any of the belts when connecting or disconnecting them.

## 5-2. Steps to take in an emergency If your vehicle overheats

### If your engine overheats:

**STEP 1** Stop the vehicle in a safe place and turn off the air conditioning system.

**STEP 2** Check to see if steam is coming out from under the hood.

If you see steam:

Stop the engine and carefully lift the hood.

If you do not see steam:

Leave the engine running and carefully lift the hood.

**STEP 3** 3.5 L V6 (2GR-FE) engine only: Remove the engine compartment cover. (→P. 318)

**STEP 4** Check to see if the cooling fans are operating.

If the fans are operating:

Wait until the temperature of the engine (shown on the instrument cluster) begins to fall and then stop the engine.

If the fans are not operating:

Stop the engine and call your Toyota dealer.

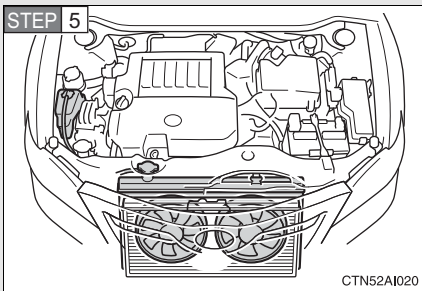

After the engine has cooled down sufficiently, check the engine coolant level and inspect the radiator core (radiator) for any leaks.

STEP 6

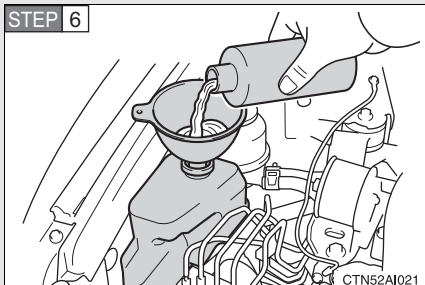

Add engine coolant if necessary.

Water can be used in an emergency if engine coolant is unavailable. (→P. 433)

Have the vehicle checked at the nearest Toyota dealer as soon as possible.

### ■ Overheating

If you observe the following, your vehicle may be overheating.

- The engine coolant temperature gauge enters the red zone or a loss of power is experienced.
- Steam is coming from under the hood.

### ⚠ CAUTION

#### ■ To prevent an accident or injury when inspecting under the hood of your vehicle

- Keep hands and clothing away from the fan and other belts while the engine is running.
- Do not loosen the coolant reservoir cap while the engine and radiator are hot.  
Serious injury, such as burns, may result from hot coolant and steam released under pressure.

**NOTICE****■ When adding engine coolant**

Wait until the engine has cooled down before adding engine coolant.

When adding coolant, do so slowly. Adding cool coolant to a hot engine too quickly can cause damage to the engine.

## 5-2. Steps to take in an emergency If the vehicle becomes stuck

**Carry out the following procedures if the tires spin or the vehicle becomes stuck in mud, dirt, or snow.**

- STEP 1** Stop the engine. Set the parking brake and put the shift lever in P (automatic transmission) or N (manual transmission).
- STEP 2** Remove the mud, snow, or sand from around the stuck tire.
- STEP 3** Place wood, stones or some other material to help provide traction under the tires.
- STEP 4** Restart the engine.
- STEP 5** Shift the shift lever to the D or R position (automatic transmission) or 1 or R position (manual transmission) and carefully apply the accelerator to free the vehicle.

### ■ Emergency hooks (if equipped)

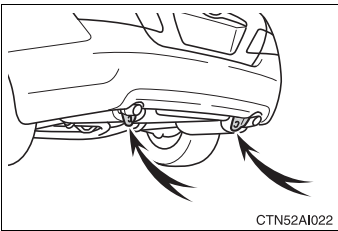

When your vehicle becomes stuck and cannot move, the emergency hooks are used for another vehicle to pull your vehicle out in an emergency. Your vehicle is not designed to tow another vehicle.



 **CAUTION****■ When attempting to free a stuck vehicle**

If you choose to rock the vehicle back and forth to free it, make sure the surrounding area is clear, to avoid striking other vehicles, objects or persons. The vehicle may also lunge forward or lunge back suddenly as it becomes free. Use extreme caution.

**■ When shifting the shift lever**

For vehicles with an automatic transmission, be careful not to shift the shift lever with the accelerator pedal depressed.

This may lead to unexpected rapid acceleration of the vehicle that may cause an accident and result in death or serious injury.

 **NOTICE****■ To avoid damaging the transmission and other components**

- Avoid spinning the wheels and do not rev the engine.
- If the vehicle remains stuck after trying these procedures, the vehicle may require towing to be freed.



## Vehicle specifications

# 6

<b>6-1. Specifications.....</b>	<b>428</b>
Maintenance data (fuel, oil level, etc.) .....	428
Fuel information .....	439
Tire information .....	442
<b>6-2. Customization .....</b>	<b>454</b>
Customizable features .....	454
<b>6-3. Initialization .....</b>	<b>458</b>
Items to initialize .....	458

## 6-1. Specifications

### Maintenance data (fuel, oil level, etc.)

#### Dimensions and weights

Overall length	189.2 in. (4805 mm)	
Overall width	71.7 in. (1820 mm)	
Overall height* <sup>1</sup>	57.7 in. (1465 mm) <sup>*2</sup> 57.9 in. (1470 mm) <sup>*3</sup>	
Wheelbase	109.3 in. (2775 mm)	
Tread	Front	62.0 in. (1575 mm)
	Rear	61.6 in. (1565 mm)
Vehicle capacity weight (Occupants + luggage)	900 lb. (410 kg)	
Towing capacity (trailer weight + cargo weight)	1000 lb. (453 kg)	

\*1: Unladen vehicles

\*2: P215/55R17 tires

\*3: P215/60R16 tires

#### Vehicle identification

##### ■ Vehicle identification number

The vehicle identification number (VIN) is the legal identifier for your vehicle. This is the primary identification number for your Toyota. It is used in registering the ownership of your vehicle.

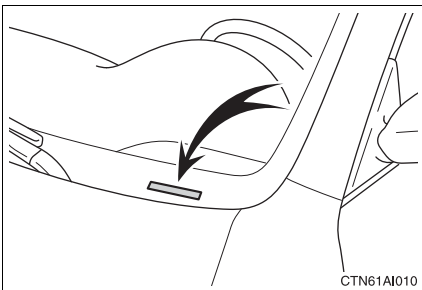

This number is stamped on the top left of the instrument panel.

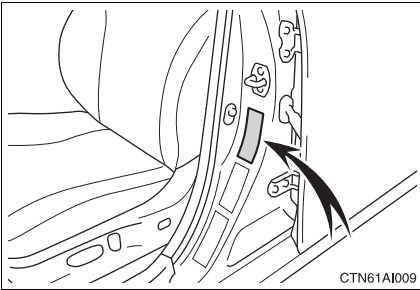

This number is also on the certification label on the driver's side center pillar.

### ■ Engine number

The engine number is stamped on the engine block as shown.

#### ▶ 2.4 L 4-cylinder (2AZ-FE) engine

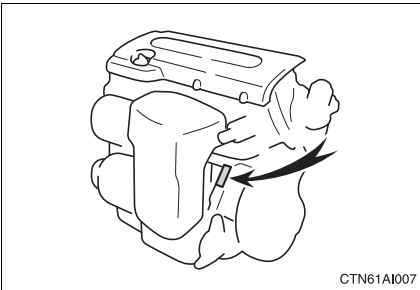

#### ▶ 3.5 L V6 (2GR-FE) engine

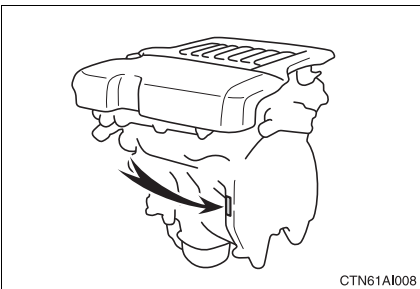

**Engine**

Model	2AZ-FE	2GR-FE
Type	4 cylinder in line, 4 cycle, gasoline	6 cylinder V type, 4 cycle, gasoline
Bore and stroke	3.48 × 3.78 in. (88.5 × 96.0 mm)	3.70 × 3.27 in. (94.0 × 83.0 mm)
Displacement	144.1 cu.in. (2362 cm <sup>3</sup> )	210.9 cu.in. (3456 cm <sup>3</sup> )
Drive belt tension	Automatic adjustment	
Valve clearance (engine cold)		Automatic adjustment
Intake	0.007 — 0.011 in. (0.19 — 0.29 mm)	
Exhaust	0.015 — 0.019 in. (0.38 — 0.48 mm)	

**Fuel**

Fuel type	Unleaded gasoline only
Octane rating	87 (Research Octane Number 91) or higher
Fuel tank capacity	18.5 gal. (70 L, 15.4 Imp.gal.)

## Lubrication system

<p>Oil capacity (drain and refill)</p> <p>With filter</p> <p>Without filter</p>	<ul style="list-style-type: none"> <li>▶ 2.4 L 4-cylinder (2AZ-FE) engine 4.5 qt. (4.3 L, 3.8 Imp.qt.)</li> <li>▶ 3.5 L V6 (2GR-FE) engine 6.4 qt. (6.1 L, 5.4 Imp.qt.)</li> <li>▶ 2.4 L 4-cylinder (2AZ-FE) engine 4.3 qt. (4.1 L, 3.6 Imp.qt.)</li> <li>▶ 3.5 L V6 (2GR-FE) engine 6.0 qt. (5.7 L, 5.0 Imp.qt.)</li> </ul>
<p>Oil grade</p>	<p>ILSAC multi-grade engine oil</p>
<p>Recommended oil viscosity</p>	<p>Use Toyota approved "Toyota Genuine Motor Oil" or equivalent to satisfy the grade and viscosity shown below.</p> <ul style="list-style-type: none"> <li>▶ 2.4 L 4-cylinder (2AZ-FE) engine</li> </ul> <div data-bbox="501 813 926 1105" style="border: 1px solid black; padding: 10px; margin-bottom: 20px;"> <p style="text-align: center;">5W-20, 0W-20 +1</p> <p style="text-align: center;">Outside temperature</p> <p style="text-align: right; font-size: small;">CTN43AH114</p> </div> <ul style="list-style-type: none"> <li>▶ 3.5 L V6 (2GR-FE) engine</li> </ul> <div data-bbox="501 1162 926 1455" style="border: 1px solid black; padding: 10px;"> <p style="text-align: center;">5W-30 +2</p> <p style="text-align: center;">Outside temperature</p> <p style="text-align: right; font-size: small;">CTN43AH115</p> </div>

\*1: 0W-20 is the oil that provides the optimal level of fuel efficiency.

\*2: 5W-30 is the oil that provides the optimal level of fuel efficiency.

#### Oil viscosity

- The 5W portion of the oil viscosity rating indicates the characteristic of the oil which allows cold startability. Oils with a lower value before the W allow for easier starting of the engine in cold weather.
- The 30 in 5W-30 indicates the oil viscosity when the oil is at its operating temperature. An oil with a higher viscosity may be better suited if the vehicle is operated at high speeds, or under extreme load conditions.



## Cooling system

Capacity (Reference)	<ul style="list-style-type: none"> <li>▶ 2.4 L 4-cylinder (2AZ-FE) engine 6.6 qt. (6.2 L, 5.5 Imp.qt.)</li> <li>▶ 3.5 L V6 (2GR-FE) engine 9.5qt. (9.0 L, 7.9 Imp.qt.)</li> </ul>
Coolant type	<p>Use either of the following.</p> <ul style="list-style-type: none"> <li>• “Toyota Super Long Life Coolant”</li> <li>• Similar high-quality ethylene glycol-based non-silicate, non-amine, non-nitrite, and non-borate coolant with long-life hybrid organic acid technology</li> </ul> <p>Do not use plain water alone.</p>

## Ignition system

Spark plug Make	<ul style="list-style-type: none"> <li>▶ 2.4 L 4-cylinder (2AZ-FE) engine DENSO SK20R11 NGK IFR6A11</li> <li>▶ 3.5 L V6 (2GR-FE) engine DENSO FK20HR11</li> </ul>
Gap	0.043 in. (1.1 mm)



### NOTICE

#### ■ Iridium-tipped spark plugs

Use only iridium-tipped spark plugs. Do not adjust spark plug gap.

**Electrical system**

Battery	
Open voltage at 68°F (20°C):	12.6 — 12.8 V Fully charged 12.2 — 12.4 V Half charged 11.8 — 12.0 V Discharged (Voltage checked 20 minutes after the engine and all the lights turned off)
Charging rates	5 A max.

**Manual transaxle**

Gear oil capacity (Reference)	2.6 qt. (2.5 L, 2.2 Imp.qt.)
Gear oil type	API GL-4 or 5
Recommended gear oil viscosity	SAE 75W-90

**Automatic transaxle**

Fluid capacity (drain and refill)	2.4 L 4-cylinder (2AZ-FE) engine: 3.7 qt. (3.5 L, 3.1 Imp.qt.)
Fluid capacity	3.5 L V6 (2GR-FE) engine: 6.76 qt. (6.4 L, 5.63 Imp.qt.)*
Fluid type	Toyota Genuine ATF WS

\*: The fluid capacity is a reference quantity. If replacement is necessary, contact your Toyota dealer.

 NOTICE

**Automatic transmission fluid type**

Using automatic transmission fluid other than “Toyota Genuine ATF WS” may cause deterioration in shift quality, locking up of your transmission accompanied by vibration, and ultimately damage the transmission of your vehicle.

**Clutch**

Pedal free play	0.2 — 0.6 in. (5 — 15 mm)
Fluid type	SAE J1703 or FMVSS No.116 DOT 3

**Brakes**

Pedal clearance <sup>*1</sup>	<ul style="list-style-type: none"> <li>▶ Automatic transmission 2.4 in. (61 mm)</li> <li>▶ Manual transmission 2.5 in. (63 mm)</li> </ul>
Pedal free play	0.04 — 0.24 in. (1 — 6 mm)
Brake pad wear limit	0.04 in. (1.0 mm)
Parking brake lever travel <sup>*2</sup>	7 — 9 clicks
Parking brake pedal travel <sup>*3</sup>	7 — 10 clicks
Fluid type	SAE J1703 or FMVSS No.116 DOT 3

<sup>\*1</sup>: Minimum pedal clearance when depressed with a force of 112 lbf (500 N, 51 kgf) while the engine is running

<sup>\*2</sup>: Parking brake lever travel when pulled up with a force of 44 lbf (200 N, 20 kgf)

<sup>\*3</sup>: Parking brake pedal travel when depressed with a force of 67 lbf (300 N, 31 kgf).

## Steering

Free play	Less than 1.2 in. (30 mm)
Power steering fluid type	Automatic transmission fluid DEXRON® II or III

## Tires and wheels

### ► 3.5 L V6 (2GR-FE) engine with 16-inch tires

Tire size	P215/60R16 94V, T155/70D17 110M
Tire inflation pressure (Recommended cold tire inflation pressure)	<p>Driving under normal conditions            Front: 30 psi (210 kPa, 2.1 kgf/cm<sup>2</sup> or bar)*            Rear: 30 psi (210 kPa, 2.1 kgf/cm<sup>2</sup> or bar)*            Spare:</p> <ul style="list-style-type: none"> <li>► Full-size spare tire 30 psi (210 kPa, 2.1 kgf/cm or bar)</li> <li>► Compact spare tire 60 psi (420 kPa, 4.2 kgf/cm or bar)</li> </ul> <p>*: When driving at high speeds above 100 mph (160 km/h), in countries where such speeds are permitted by law, add 5 psi (30 kPa, 0.3 kgf/cm<sup>2</sup> or bar) to the front tires and rear tires. Never exceed the maximum cold tire inflation pressure indicated on the tire sidewall.</p>
Wheel size	16 × 6 1/2 J or 16 × 6 1/2 JJ, 17 × 4 T (compact spare)
Wheel nut torque	76 ft•lbf (103 N•m, 10.5 kgf•m)

## ► Others

Tire size	P215/60R16 94V, P215/55R17 93V, T155/70D17 110M
Tire inflation pressure (Recommended cold tire inflation pressure)	<p>Driving under normal conditions            Front: 32 psi (220 kPa, 2.2 kgf/cm<sup>2</sup> or bar)*            Rear: 32 psi (220 kPa, 2.2 kgf/cm<sup>2</sup> or bar)*            Spare:</p> <ul style="list-style-type: none"> <li>► Full-size spare tire 32 psi (220 kPa, 2.2 kgf/cm or bar)</li> <li>► Compact spare tire 60 psi (420 kPa, 4.2 kgf/cm or bar)</li> </ul> <p>*: When driving at high speeds above 100 mph (160 km/h), in countries where such speeds are permitted by law, add 3 psi (20 kPa, 0.2 kgf/cm<sup>2</sup> or bar) to the front tires and rear tires. Never exceed the maximum cold tire inflation pressure indicated on the tire sidewall.</p>
Wheel size	16 × 6 1/2 J or 16 × 6 1/2 JJ, 17 × 7 J, 17 × 4 T (compact spare)
Wheel nut torque	76 ft•lbf (103 N•m, 10.5 kgf•m)

<b>Light bulbs</b>
--------------------

	Light Bulbs	Bulb No.	W	Type
Exterior	Headlights Low beam	—	55	A
	High beam	9005	60	B
	Front side marker lights	—	5	C
	Front turn signal/parking lights	3457NAK	27/8	D
	Rear turn signal lights	—	21	D
	Stop/tail and rear side marker lights	7443	21/5	C
	Tail lights Type A	—	5	C
	Type B	194	3.8	C
	License plate lights	—	5	C
Interior	Back-up lights	921	16	C
	Front fog lights (if equipped)	—	55	A
	Personal lights Front	—	5	C
	Rear	—	8	C
	Interior light	—	8	E
	Door courtesy lights	168	5	C
	Vanity lights	—	8	C
Glove box light	—	1.2	C	
Trunk light	—	3.8	C	

A: H11 halogen bulbs

B: HB3 halogen bulbs

C: Wedge base bulbs (clear)

D: Wedge base bulbs (amber)

E: Double end bulbs

**You must only use unleaded gasoline in your vehicle.**

**Unleaded gasoline with an Octane Rating of 87 (Research Octane Number 91) or higher is required for optimum engine performance.**

At minimum, the gasoline you use should meet the specifications of ASTM D4814 in the U.S.A. and CGSB3.5-M93 in Canada.

---

■ **Fuel tank opening for unleaded gasoline**

To help prevent incorrect fueling, your Toyota has a fuel tank opening that only accommodates the special nozzle on unleaded fuel pumps.

■ **If your engine knocks**

- Consult your Toyota dealer.
- You may occasionally notice light knocking for a short time while accelerating or driving uphill. This is normal and there is no need for concern.

■ **Gasoline quality**

In very few cases, driveability problems may be caused by the brand of gasoline you are using. If driveability problems persist, try changing the brand of gasoline. If this does not correct the problem, consult your Toyota dealer.

■ **Gasoline quality standards**

- Automotive manufacturers in the U.S., the Europe and Japan have developed a specification for fuel quality called World-Wide Fuel Charter (WWFC) that is expected to be applied worldwide.
- The WWFC consists of four categories that are based on required emission levels. In the U.S., category 4 has been adopted.
- The WWFC improves air quality by lowering emissions in vehicle fleets, and improves customer satisfaction through better performance.

■ **Toyota recommends the use of gasoline containing detergent additives**

- Toyota recommends the use of gasoline that contains detergent additives to avoid build-up of engine deposits.
- All gasoline sold in the U.S. contains detergent additives to clean and/or keep clean intake systems.

■ **Toyota recommends the use of cleaner burning gasoline**

Cleaner burning gasoline, including reformulated gasoline that contains oxygenates such as ethanol or MTBE (Methyl Tertiary Butyl Ether) is available in many areas.

Toyota recommends the use of cleaner burning gasoline and appropriately blended reformulated gasoline. These types of gasoline provide excellent vehicle performance, reduce vehicle emissions and improve air quality.

■ **Toyota does not recommend blended gasoline**

- Toyota allows the use of oxygenate blended gasoline where the oxygenate content is up to 10% ethanol or 15% MTBE.
- If you use gasohol in your Toyota, be sure that it has an octane rating no lower than 87.
- Toyota does not recommend the use of gasoline containing methanol.

■ **Toyota does not recommend gasoline containing MMT**

Some gasoline contains octane enhancing additive called MMT (Methylcyclopentadienyl Manganese Tricarbonyl).

Toyota does not recommend the use of gasoline that contains MMT. If fuel containing MMT is used, your emission control system may be adversely affected.

The malfunction indicator lamp on the instrument cluster may come on. If this happens, contact your Toyota dealer for service.



 NOTICE**■ Notice on gasoline quality**

- Do not use leaded gasoline.

Leaded gasoline can cause damage to your vehicle's catalytic converters causing the emission control system to malfunction.

- Do not use gasohol other than that stated here.

Other gasohol may cause fuel system damage or vehicle performance problems.

**■ Fuel-related poor driveability**

If after using a different type of fuel, poor driveability is encountered (poor hot starting, vaporization, engine knocking, etc.), discontinue the use of that type of fuel.

**■ When refueling with gasohol**

Take care not to spill gasohol. It can damage your vehicle's paint.

# 6-1. Specifications

## Tire information

### Typical tire symbols

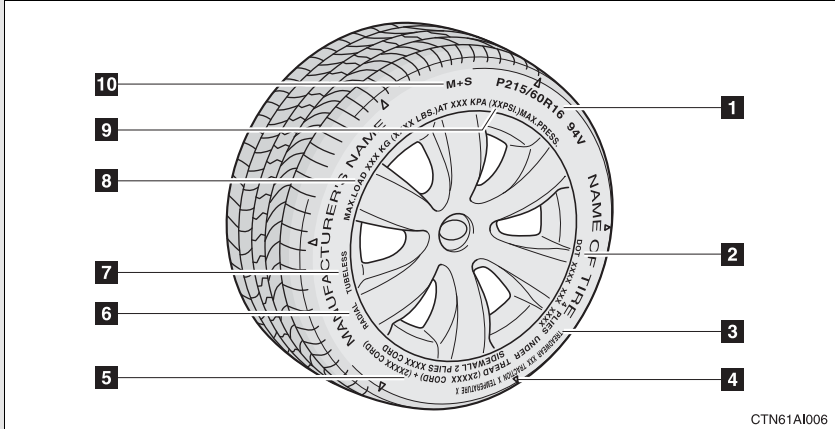

CTN61AI006

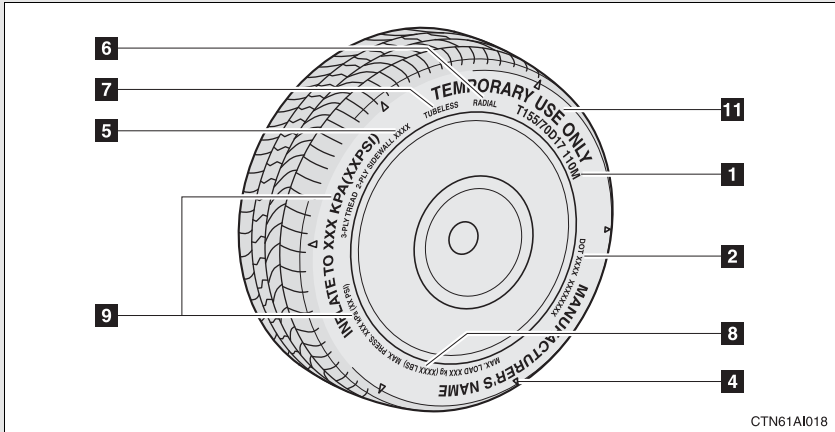

CTN61AI018

- 1** Tire size (→P. 445)
- 2** DOT and Tire Identification Number (TIN) (→P. 444)
- 3** Uniform tire quality grading  
For details, see “Uniform Tire Quality Grading” that follows.
- 4** Location of treadwear indicators (→P. 334)

**5** Tire ply composition and materials

Plies are layers of rubber-coated parallel cords. Cords are the strands which form the plies in a tire.

**6** Radial tires or bias-ply tires

A radial tire has RADIAL on the sidewall. A tire not marked RADIAL is a bias-ply tire.

**7** TUBELESS or TUBE TYPE

A tubeless tire does not have a tube and air is directly filled in the tire. A tube type tire has a tube inside the tire and the tube maintains the air pressure.

**8** Load limit at maximum cold tire inflation pressure (→P. 339)**9** Maximum cold tire inflation pressure (→P. 436)

This means the pressure to which a tire may be inflated.

**10** Summer tires or all season tires (→P. 340)

An all season tire has "M+S" on the sidewall. A tire not marked "M+S" is a summer tire.

**11** "TEMPORARY USE ONLY" (→P. 407)

A compact spare tire is identified by the phrase "TEMPORARY USE ONLY" molded into its sidewall. This tire is designed for temporary emergency use only.

**Typical DOT and Tire Identification Number (TIN)**

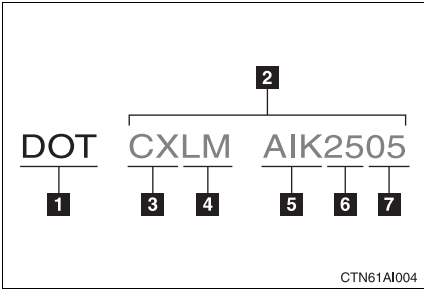

- 1** DOT symbol\*
- 2** Tire Identification Number (TIN)
- 3** Tire manufacturer's identification mark
- 4** Tire size code
- 5** Manufacturer's optional tire type code (3 or 4 letters)
- 6** Manufacturing week
- 7** Manufacturing year

\*: The DOT symbol certifies that the tire conforms to applicable Federal Motor Vehicle Safety Standards.

## Tire size

### ■ Typical tire size information

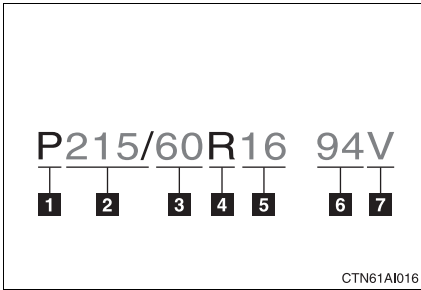

The illustration indicates typical tire size.

- 1** Tire use  
(P = Passenger car,  
T = Temporary use)
- 2** Section width (millimeters)
- 3** Aspect ratio  
(tire height to section width)
- 4** Tire construction code  
(R = Radial, D = Diagonal)
- 5** Wheel diameter (inches)
- 6** Load index (2 or 3 digits)
- 7** Speed symbol  
(alphabet with one letter)

### ■ Tire dimensions

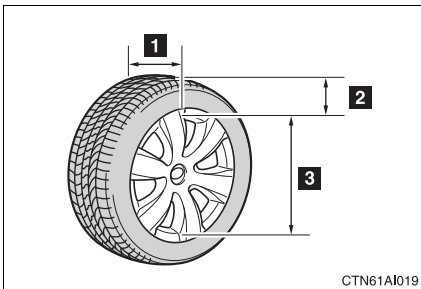

- 1** Section width
- 2** Tire height
- 3** Wheel diameter

## Tire section names

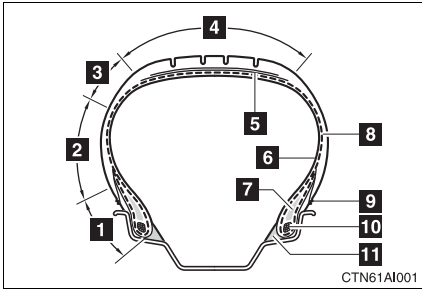

- 1 Bead
- 2 Sidewall
- 3 Shoulder
- 4 Tread
- 5 Belt
- 6 Inner liner
- 7 Reinforcing rubber
- 8 Carcass
- 9 Rim lines
- 10 Bead wires
- 11 Chafer

## Uniform Tire Quality Grading

This information has been prepared in accordance with regulations issued by the National Highway Traffic Safety Administration of the U.S.A. Department of Transportation.

It provides the purchasers and/or prospective purchasers of Toyota vehicles with information on uniform tire quality grading.

Your Toyota dealer will help answer any questions you may have as you read this information.

### ■ DOT quality grades

All passenger vehicle tires must conform to Federal Safety Requirements in addition to these grades. Quality grades can be found where applicable on the tire sidewall between tread shoulder and maximum section width.

For example: Treadwear 200 Traction AA Temperature A

## ■ Treadwear

The treadwear grade is a comparative rating based on the wear rate of the tire when tested under controlled conditions on a specified government test course.

For example, a tire graded 150 would wear one and a half (1.5) times as well on the government course as a tire graded 100.

The relative performance of tires depends upon the actual conditions of their use, however, and may depart significantly from the norm due to variations in driving habits, service practices and differences in road characteristics and climate.

## ■ Traction AA, A, B, C

The traction grades, from highest to lowest, are AA, A, B and C, and they represent the tire's ability to stop on wet pavement as measured under controlled conditions on specified government test surfaces of asphalt and concrete.

A tire marked C may have poor traction performance.

Warning: The traction grade assigned to this tire is based on braking (straight ahead) traction tests and does not include cornering (turning) traction.

## ■ Temperature A, B, C

The temperature grades are A (the highest), B, and C, representing the tire's resistance to the generation of heat and its ability to dissipate heat when tested under controlled conditions on a specified indoor laboratory test wheel.

Sustained high temperature can cause the material of the tire to degenerate and reduce tire life, and excessive temperature can lead to sudden tire failure.

Grade C corresponds to a level of performance which all passenger car tires must meet under the Federal Motor Vehicle Safety Standard No. 109.

Grades B and A represent higher levels of performance on the laboratory test wheel than the minimum required by law.

Warning: The temperature grades of a tire assume that it is properly inflated and not overloaded.

Excessive speed, underinflation, or excessive loading, either separately or in combination, can cause heat buildup and possible tire failure.

### Glossary of tire terminology

Tire related term	Meaning
Cold tire inflation pressure	Tire pressure when the vehicle has been parked for three hours or more, or has not been driven more than 1 mile or 1.5 km under that condition
Maximum inflation pressure	The maximum cold inflated pressure to which a tire may be inflated, shown on the sidewall of the tire
Recommended inflation pressure	Cold tire inflation pressure recommended by a manufacturer
Accessory weight	The combined weight (in excess of those standard items which may be replaced) of automatic transmission, power steering, power brakes, power windows, power seats, radio and heater, to the extent that these items are available as factory-installed equipment (whether installed or not)
Curb weight	The weight of a motor vehicle with standard equipment, including the maximum capacity of fuel, oil and coolant, and if so equipped, air conditioning and additional weight optional engine
Maximum loaded vehicle weight	The sum of: (a) Curb weight (b) Accessory weight (c) Vehicle capacity weight (d) Production options weight



Tire related term	Meaning
Normal occupant weight	150 lb. (68 kg) times the number of occupants specified in the second column of Table 1* that follows
Occupant distribution	Distribution of occupants in a vehicle as specified in the third column of Table 1* below
Production options weight	The combined weight of installed regular production options weighing over 5 lb. (2.3 kg) in excess of the standard items which they replace, not previously considered in curb weight or accessory weight, including heavy duty brakes, ride levelers, roof rack, heavy duty battery, and special trim
Rim	A metal support for a tire or a tire and tube assembly upon which the tire beads are seated
Rim diameter (Wheel diameter)	Nominal diameter of the bead seat
Rim size designation	Rim diameter and width
Rim type designation	The industry manufacturer's designation for a rim by style or code
Rim width	Nominal distance between rim flanges
Vehicle capacity weight (Total load capacity)	The rated cargo and luggage load plus 150 lb. (68 kg) times the vehicle's designated seating capacity
Vehicle maximum load on the tire	The load on an individual tire that is determined by distributing to each axle its share of the maximum loaded vehicle weight, and dividing by two
Vehicle normal load on the tire	The load on an individual tire that is determined by distributing to each axle its share of curb weight, accessory weight, and normal occupant weight (distributed in accordance with Table 1* below), and dividing by two

Tire related term	Meaning
Weather side	The surface area of the rim not covered by the inflated tire
Bead	The part of the tire that is made of steel wires, wrapped or reinforced by ply cords and that is shaped to fit the rim
Bead separation	A breakdown of the bond between components in the bead
Bias ply tire	A pneumatic tire in which the ply cords that extend to the beads are laid at alternate angles substantially less than 90 degrees to the centerline of the tread
Carcass	The tire structure, except tread and sidewall rubber which, when inflated, bears the load
Chunking	The breaking away of pieces of the tread or sidewall
Cord	The strands forming the plies in the tire
Cord separation	The parting of cords from adjacent rubber compounds
Cracking	Any parting within the tread, sidewall, or innerliner of the tire extending to cord material
CT	A pneumatic tire with an inverted flange tire and rim system in which the rim is designed with rim flanges pointed radially inward and the tire is designed to fit on the underside of the rim in a manner that encloses the rim flanges inside the air cavity of the tire
Extra load tire	A tire designed to operate at higher loads and at higher inflation pressures than the corresponding standard tire
Groove	The space between two adjacent tread ribs
Innerliner	The layer(s) forming the inside surface of a tubeless tire that contains the inflating medium within the tire

Tire related term	Meaning
Innerliner separation	The parting of the innerliner from cord material in the carcass
Intended outboard sidewall	(a) The sidewall that contains a whitewall, bears white lettering, or bears manufacturer, brand, and/or model name molding that is higher or deeper than the same molding on the other sidewall of the tire, or (b) The outward facing sidewall of an asymmetrical tire that has a particular side that must always face outward when mounted on a vehicle
Light truck (LT) tire	A tire designated by its manufacturer as primarily intended for use on lightweight trucks or multipurpose passenger vehicles
Load rating	The maximum load that a tire is rated to carry for a given inflation pressure
Maximum load rating	The load rating for a tire at the maximum permissible inflation pressure for that tire
Maximum permissible inflation pressure	The maximum cold inflation pressure to which a tire may be inflated
Measuring rim	The rim on which a tire is fitted for physical dimension requirements
Open splice	Any parting at any junction of tread, sidewall, or innerliner that extends to cord material
Outer diameter	The overall diameter of an inflated new tire
Overall width	The linear distance between the exteriors of the sidewalls of an inflated tire, including elevations due to labeling, decorations, or protective bands or ribs
Passenger car tire	A tire intended for use on passenger cars, multipurpose passenger vehicles, and trucks, that have a gross vehicle weight rating (GVWR) of 10,000 lb. or less.

Tire related term	Meaning
Ply	A layer of rubber-coated parallel cords
Ply separation	A parting of rubber compound between adjacent plies
Pneumatic tire	A mechanical device made of rubber, chemicals, fabric and steel or other materials, that, when mounted on an automotive wheel, provides the traction and contains the gas or fluid that sustains the load
Radial ply tire	A pneumatic tire in which the ply cords that extend to the beads are laid at substantially 90 degrees to the centerline of the tread
Reinforced tire	A tire designed to operate at higher loads and at higher inflation pressures than the corresponding standard tire
Section width	The linear distance between the exteriors of the sidewalls of an inflated tire, excluding elevations due to labeling, decoration, or protective bands
Sidewall	That portion of a tire between the tread and bead
Sidewall separation	The parting of the rubber compound from the cord material in the sidewall
Snow tire	A tire that attains a traction index equal to or greater than 110, compared to the ASTM-E 1136 Standard Reference Test Tire, when using the snow traction test as described in ASTM F-1805-00, Standard Test Method for Signal Wheel Driving Traction in a Straight Line on Snow-and Ice-Covered Surfaces, and which is marked with an Alpine Symbol (  ) on at least one sidewall
Test rim	The rim on which a tire is fitted for testing, and may be any rim listed as appropriate for use with that tire

Tire related term	Meaning
Tread	That portion of a tire that comes into contact with the road
Tread rib	A tread section running circumferentially around a tire
Tread separation	Pulling away of the tread from the tire carcass
Treadwear indicators (TWI)	The projections within the principal grooves designed to give a visual indication of the degrees of wear of the tread
Wheel-holding fixture	The fixture used to hold the wheel and tire assembly securely during testing

\*: Table 1 — Occupant loading and distribution for vehicle normal load for various designated seating capacities

Designated seating capacity, Number of occupants	Vehicle normal load, Number of occupants	Occupant distribution in a normally loaded vehicle
2 through 4	2	2 in front
5 through 10	3	2 in front, 1 in second seat
11 through 15	5	2 in front, 1 in second seat, 1 in third seat, 1 in fourth seat
16 through 20	7	2 in front, 2 in second seat, 2 in third seat, 1 in fourth seat

## Customizable features

**Your vehicle includes a variety of electronic features that can be personalized to your preferences. Programming these preferences requires specialized equipment and may be performed by your Toyota dealer.**

Some function settings are changed simultaneously with other functions being customized. Contact your Toyota dealer.

Item	Function	Default setting	Customized setting
Smart key system (→P. 26)	Smart key system	On	Off
	Operation signal (Emergency flashers)	On	Off
	Operation signal (Buzzer)	On	Off

Item	Function	Default setting	Customized setting
Wireless remote control (→P. 37)	Wireless remote control	On	Off
	Unlocking operation	Driver's door unlocked in one step, all doors unlocked in two steps	All doors unlocked in one step.
	Automatic door lock function to be activated if door is not opened after being unlocked	On	Off
	Time elapsed before automatic door lock function is activated if door is not opened after being unlocked	60 seconds	30 seconds
			120 seconds
	Operation signal (Emergency flashers)	On	Off
	Operation signal (Buzzer)	On	Off
	Door lock buzzer	On	Off
	Panic function	On	Off
	Trunk unlocking function	On	Off
	Trunk unlocking operation	Press and hold	Press twice
One short press			

Item	Function	Default setting	Customized setting
Door lock (→P. 41)	Unlocking using a key	Driver's door unlocked in one step, all doors unlocked in two steps	All doors unlocked in one step.
	Speed-detecting automatic door lock function	Off	On
	Opening driver's door unlocks all doors	Off	On
	Shifting gears to P unlocks all doors. (automatic transmission)	On	Off
	Shifting gears to position other than P locks all doors. (automatic transmission)	On	Off
Automatic light control system (→P. 152)	Light sensor sensitivity	Level 3	Level 1 to 5
	Time elapsed before headlights automatically turn off after doors are closed	30 seconds	0 seconds
			60 seconds
			90 seconds
Lights (→P. 152)	Daytime running light system (U.S.A. only)	On	Off



Item	Function	Default setting	Customized setting
Illumination (→P. 264)	Time elapsed before lights turn off	15 seconds	7.5 seconds 30 seconds
	Operation when the doors are unlocked	On	Off
	Vehicles with smart key system: Operation after the "ENGINE START STOP" switch turned OFF Vehicles without smart key system: Operation after the engine switch turned to "LOCK" position	On	Off
Seat belt reminder (→P. 384)	Vehicle speed linked seat belt reminder buzzer	On	Off

## 6-3. Initialization

### Items to initialize

**The following items must be initialized for normal system operation in cases such as after the battery is reconnected, or maintenance is performed on the vehicle.**

Item	When to initialize	Reference
Engine oil maintenance data (U.S.A. only)	After changing engine oil	P. 323
Tire pressure warning system	<ul style="list-style-type: none"><li>• When changing the tire inflation pressure by changing traveling speed or load weight, etc.</li><li>• When changing the tire size.</li></ul>	P. 336

**For U.S. owners**

**7**

Reporting safety defects for  
U.S. owners ..... 460

## Reporting safety defects for U.S. owners

If you believe that your vehicle has a defect which could cause a crash or could cause injury or death, you should immediately inform the National Highway Traffic Safety Administration (NHTSA) in addition to notifying Toyota Motor Sales, U.S.A., Inc. (Toll-free: 1-800-331-4331).

If NHTSA receives similar complaints, it may open an investigation, and if it finds that a safety defect exists in a group of vehicles, it may order a recall and remedy campaign. However, NHTSA cannot become involved in individual problems between you, your dealer, or Toyota Motor Sales, U.S.A., Inc.

To contact NHTSA, you may call the Vehicle Safety Hotline toll-free at 1-888-327-4236 (TTY: 1-800-424-9153); go to <http://www.safercar.gov>; or write to: Administrator, NHTSA, 1200 New Jersey Ave, S.E., Washington, DC 20590. You can also obtain other information about motor vehicle safety from <http://www.safercar.gov>.

## Index

Abbreviation list .....	462
Alphabetical index .....	463
What to do if... .....	473

For details of equipment related to the navigation system, such as the audio system, refer to the “Navigation System Owner’s Manual”.

## Abbreviation/Acronym list

ABBREVIATIONS	MEANING
A/C	Air Conditioner
ABS	Anti-Lock Brake System
ACC	Accessory
ALR	Automatic Locking Retractor
CAL	Calibration
CRS	Child Restraint System
DISP	Display
ECU	Electronic Control Unit
EDR	Event data recorder
ELR	Emergency Locking Retractor
GAWR	Gross Axle Weight Ratings
GVWR	Gross Vehicle Weight Rating
I/M	Emission inspection and maintenance
LED	Light Emitting Diode
MMT	Methylcyclopentadiency Manganese Tricarbonyl
M + S	Mud and Snow
MTBE	Methyl Tertiary Butyl Ether
OBD	On Board Diagnostics
SRS	Supplemental Restraint System
TIN	Tire Identification Number
TPMS	Tire Pressure Warning System
TRAC	Traction Control
VIN	Vehicle Identification Number
VSC	Vehicle Stability Control

**A**

**A/C** ..... 186, 194

**ABS**..... 162

**Air conditioning filter**..... 350

**Air conditioning system**

- Air conditioning filter ..... 350
- Automatic air conditioning system..... 186
- Manual air conditioning system..... 194
- Steering wheel air conditioning switch..... 191

**Airbags**

- Airbag operating conditions.... 87
- Airbag precautions for your child..... 91
- Airbag warning light..... 382
- Curtain shield airbag operating conditions..... 88
- Curtain shield airbag precautions ..... 91
- Front passenger occupant classification system ..... 96
- General airbag precautions .... 91
- Locations of airbags ..... 84
- Modification and disposal of airbags ..... 95
- Proper driving posture ..... 82, 91
- Side airbag operating conditions..... 88
- Side airbag precautions..... 91
- SRS airbags ..... 84

**Alarm**..... 79

**Antenna**..... 207

**Anti-lock brake system**..... 162

**Armrest** ..... 283

**Ashtray**..... 278

**Audio input** ..... 228

**Audio system**

- Antenna ..... 207
- Audio input ..... 228
- AUX adapter ..... 228
- CD player/changer ..... 210
- MP3/WMA disc..... 217

- Optimal use .....225
- Portable music player.....228
- Radio.....204
- Steering wheel audio switch.....229
- Type .....201

**Automatic air conditioning system** .....186

**Automatic light control system** .....152

**Automatic transmission** .....133

- Automatic transmission ..... 133
- If the shift lever cannot be shifted from P .....413
- S mode .....135

**AUX adapter** .....228

**Auxiliary boxes** .....272

**B**

**Back-up lights**

- Wattage .....438

**Battery**

- Checking .....330
- If the vehicle has discharged battery .....417
- Preparing and checking before winter .....169

**Bluetooth®** .....232

**Brake**

- Fluid .....327
- Parking brake .....139

**Brake assist**.....162

**Break-in tips** .....118

**C**

**Care**

Exterior .....298  
 Interior .....300  
 Seat belts .....301

**Cargo capacity .....165**

**Cargo net .....287**

**CD changer .....210**

**CD player .....210**

**Chains .....169**

**Child restraint system**

Booster seats, definition .....101  
 Booster seats, installation .....105  
 Convertible seats,  
 definition .....101  
 Convertible seats,  
 installation .....105  
 Front passenger occupant  
 classification system .....96  
 Infant seats, definition .....101  
 Infant seats, installation .....105  
 Installing CRS with lower  
 anchorages .....109  
 Installing CRS with  
 seat belts .....106  
 Installing CRS with top  
 straps .....111

**Child safety**

Airbag precautions .....91  
 Battery precautions .....332, 419  
 Child restraint system .....101  
 Child-protectors .....42  
 How your child should wear  
 the seat belt .....59  
 Installing child restraints .....105  
 Moon roof precautions .....72  
 Power window lock switch .....68  
 Power window precautions .....69  
 Removed key battery  
 precautions .....355  
 Seat belt comfort guide .....56  
 Seat belt extender  
 precautions .....62  
 Seat belt precautions .....60

Seat heater precautions .....281  
 Trunk precautions .....48

**Child-protectors .....42**

**Cleaning**

Exterior .....298  
 Interior .....300  
 Seat belts .....301

**Clock .....277**

**Compass .....293**

**Condenser .....326**

**Console box .....268**

**Cooling system**

Engine overheating .....421

**Cruise control .....159**

**Cup holder .....270**

**Curtain shield airbags .....84**

**Customizable features .....454**



**D**

- Daytime running light system** ..... 154
- Defogger**
  - Rear window..... 199
  - Side mirror..... 199
- Dimension**..... 428
- Dinghy towing** ..... 181,182
- Display**
  - Trip information ..... 149
  - Warning message ..... 391
- Do-it-yourself maintenance**.... 309
- Door courtesy light**
  - Door courtesy light ..... 264
  - Wattage..... 438
- Doors**
  - Door glasses ..... 68
  - Door lock ..... 26, 37, 41
  - Side mirrors..... 66
- Driver's seat belt reminder light** ..... 384
- Driving**
  - Break-in tips ..... 118
  - Correct posture..... 82
  - Procedures..... 116
  - Winter driving tips..... 169

**E**

- Electronic key**
  - If your electronic key battery is discharged ..... 415
- Emergency, in case of**
  - If a warning light turns on ..... 381
  - If a warning message is displayed..... 391
  - If the electronic key does not operate properly..... 415
  - If the engine will not start..... 411
  - If the shift lever cannot be shifted from P..... 413
  - If the vehicle has discharged battery..... 417
  - If the warning buzzer sounds ..... 381
  - If you have a flat tire ..... 400

- If you lose your keys .....414
- If you think something is wrong.....377
- If your vehicle becomes stuck .....424
- If your vehicle needs to be towed .....374
- If your vehicle overheats .....421
- Engine**
  - Compartment .....316
  - Engine switch.....126, 130
  - Hood.....313
  - How to start the engine .....126, 130
  - Identification number.....428
  - If the engine will not start .....411
  - Ignition switch.....126, 130
  - Overheating.....421
- Engine compartment cover**....318
- Engine coolant**
  - Capacity .....433
  - Checking .....325
  - Preparing and checking before winter ..... 169
- Engine coolant temperature gauge**.....141
- Engine immobilizer system**.....77
- Engine oil**
  - Capacity .....431
  - Checking .....319
  - Preparing and checking before winter .....169
- Engine oil maintenance data** .....323
- Engine switch light** .....264
- Event data recorder** .....379

<b>F</b>	<b>Floor mat.....</b>	<b>286</b>
	<b>Fluid</b>	
	Brake.....	327
	Power steering fluid.....	328
	Washer.....	333
	<b>Fog lights</b>	
	Switch.....	156
	Wattage.....	438
	<b>Front fog lights</b>	
	Switch.....	156
	Wattage.....	438
	<b>Front passenger occupant classification system .....</b>	<b>96</b>
	<b>Front passenger's seat belt reminder light.....</b>	<b>384</b>
	<b>Front seats</b>	
	Adjustment .....	49
	<b>Front side marker lights</b>	
	Wattage.....	438
	<b>Front turn signal lights</b>	
	Wattage.....	438
	<b>Fuel</b>	
	Capacity .....	430
	Fuel gauge .....	141
	Fuel pump shut off system....	378
	Gas station information .....	476
	Information .....	439
	Refueling .....	73
	Type .....	430
	<b>Fuel door.....</b>	<b>73</b>
	<b>Fuel filler door .....</b>	<b>73</b>
	<b>Fuel pump shut off system .....</b>	<b>378</b>
	<b>Fuses.....</b>	<b>357</b>

<b>G</b>	<b>Garage door opener .....</b>	<b>288</b>
	<b>Gas station information .....</b>	<b>476</b>
	<b>Gauges.....</b>	<b>141</b>
	<b>Glove box .....</b>	<b>268</b>
	<b>Glove box light.....</b>	<b>268</b>
	<b>Grocery bag hooks .....</b>	<b>287</b>

<b>H</b>	<b>Hands-free phone system (for cellular phone) .....</b>	<b>232</b>
	<b>Head restraints</b>	
	Adjusting .....	53
	<b>Headlights</b>	
	Replacing light bulbs .....	368
	Switch.....	152
	Wattage.....	438
	<b>Heaters</b>	
	Seat heater.....	281
	Side mirror.....	199
	<b>Hood.....</b>	<b>313</b>
	<b>Hooks</b>	
	Grocery bag hooks .....	287
<b>I</b>	<b>I/M test.....</b>	<b>308</b>
	<b>Identification number</b>	
	Engine .....	428
	Vehicle.....	428
	<b>Ignition switch .....</b>	<b>127, 130</b>
	<b>Illuminated entry system .....</b>	<b>265</b>
	<b>Indicator lights .....</b>	<b>145</b>
	<b>Initialization</b>	
	Items to initialize.....	458
	<b>Inside rear view mirror.....</b>	<b>64</b>
	<b>Interior lights</b>	
	Interior lights.....	264
	Switch.....	265
	Wattage.....	438

<b>J</b>	<b>Jack</b>	
	Positioning the jack .....	314
	Replacing the wheel.....	400
	<b>Jack handle .....</b>	<b>400</b>
<b>K</b>	<b>Keyless entry.....</b>	<b>37</b>
	<b>Keys</b>	
	Electronic key.....	24
	Engine switch .....	127, 130
	If you lose your keys .....	414
	If your electronic key battery is discharged .....	415
	Ignition switch.....	127, 130
	Key number.....	24
	Keyless entry.....	37
	Keys .....	24
	Mechanical key .....	24
	Wireless remote control key....	37
<b>L</b>	<b>License plate lights</b>	
	Wattage.....	438
	<b>Light bulbs</b>	
	Replacing .....	368
	Wattage.....	438
	<b>Lights</b>	
	Door courtesy lights .....	264
	Fog light switch .....	156
	Headlights switch .....	152
	Interior light switch .....	265
	Personal light switch .....	266
	Replacing light bulbs.....	368
	Turn signal lever.....	138
	Vanity lights.....	276
	Wattage.....	438
	<b>Load capacity.....</b>	<b>168</b>
	<b>Lock steering column.....</b>	<b>128, 131</b>

**M**

**Maintenance**  
 Do-it-yourself  
     maintenance .....309  
 General maintenance.....305  
 Maintenance data.....428  
 Maintenance requirements...303

**Manual air conditioning system ..... 194**

**Manual transmission**  
 Manual transmission ..... 137

**Meter**  
 Instrument panel light  
     control..... 144  
 Meters ..... 141

**Mirrors**  
 Inside rear view mirror.....64  
 Side mirror heater ..... 199  
 Side mirrors.....66  
 Vanity mirrors .....276

**Moon roof .....70**

**MP3 disc .....217**

**Multi-information display ..... 149**

**O**

**Odometer ..... 141, 149**

**Oil**  
 Engine oil ..... 319

**Opener**  
 Fuel filler door ..... 73  
 Hood .....313  
 Trunk.....46

**Outside rear view mirrors**  
 Adjusting and folding.....66

**Outside temperature display ..... 141, 149**

**Overheating, Engine ..... 421**

<b>P</b>	<b>Parking brake</b> .....	<b>139</b>
	<b>Parking lights</b>	
	Switch .....	152
	Wattage .....	438
	<b>Personal lights</b>	
	Switch .....	266
	Wattage .....	438
	<b>Power outlet</b> .....	<b>279</b>
	<b>Power steering fluid</b> .....	<b>328</b>
	<b>Power windows</b> .....	<b>68</b>

<b>R</b>	<b>Radiator</b> .....	<b>326</b>
	<b>Radio</b> .....	<b>204</b>
	<b>Rear side marker lights</b>	
	Replacing light bulb .....	368
	Switch .....	152
	Wattage .....	438
	<b>Rear seats</b>	
	Adjustment .....	51
	Folding down .....	52
	<b>Rear sunshade</b> .....	<b>284</b>
	<b>Rear turn signal lights</b>	
	Replacing light bulbs .....	368
	Wattage .....	438
	<b>Rear view mirror</b>	
	Compass .....	293
	<b>Rear window defogger</b> .....	<b>199</b>
	<b>Replacing</b>	
	Fuses .....	357
	Key battery .....	353
	Light bulbs .....	368
	Tires .....	400
	<b>Reporting safety defects for</b>	
	<b>U.S.A. owners</b> .....	<b>460</b>

**S**

**Seat belts**

- Adjusting the seat belt ..... 55
- Automatic Locking
  - Retractor ..... 58
- Child restraint system
  - installation ..... 105
- Cleaning and maintaining
  - the seat belts ..... 301
- Emergency Locking
  - Retractor ..... 58
- How to wear your seat belt ..... 55
- How your child should wear
  - the seat belt ..... 59
- Pregnant women, proper seat
  - belt use ..... 58
- Reminder light ..... 384
- Seat belt extenders ..... 59
- Seat belt pretensioners ..... 57

**Seat heaters ..... 281**

**Seating capacity ..... 168**

**Seats**

- Adjustment ..... 49, 51
- Adjustment precautions ..... 50
- Child seats/child restraint
  - system installation ..... 105
- Cleaning ..... 300
- Head restraint ..... 53
- Properly sitting in the seat ..... 82
- Rear seat folding down ..... 52
- Seat heaters ..... 281

**Service reminder**

- indicators ..... 145**

**Shift lever**

- Automatic transmission ..... 133
- If the shift lever cannot
  - be shifted from P ..... 413
- Manual transmission ..... 137

**Shift lock system ..... 413**

**Side airbags ..... 84**

**Side marker lights**

- Replacing light bulbs ..... 368
- Switch ..... 152
- Wattage ..... 438

**Side mirror**

- Adjusting ..... 66

**Smart key system**

- Entry function ..... 26
- Starting the engine ..... 127

**Spare tire**

- Inflation pressure ..... 344
- Spare tire ..... 400

**Spark plug ..... 433**

**Specifications ..... 428**

**Speedometer ..... 141**

**Steering**

- Column lock release ..... 128, 131

**Steering wheel**

- Adjustment ..... 63
- Air conditioning system
  - switches ..... 191
- Audio switches ..... 229

**Stop lights**

- Replacing light bulbs ..... 368
- Wattage ..... 438

**Storage box ..... 287**

**Storage feature ..... 267**

**Storage precautions ..... 165**

**Stuck**

- If your vehicle becomes
  - stuck ..... 424

**Sun visors ..... 275**

**Sunshade**

- Rear ..... 284
- Roof ..... 71

**Switch**

- Engine switch ..... 127, 130
- Fog light switch ..... 156
- Ignition switch ..... 127, 130
- Light switches ..... 152
- Power door lock switch ..... 41
- Power window switch ..... 68
- Window lock switch ..... 68
- Wiper and washer switch ..... 157

**T**

**Tachometer** ..... 141

**Tail lights**

    Replacing light bulbs ..... 368

    Switch ..... 152

    Wattage ..... 438

**Theft deterrent system**

    Alarm ..... 79

    Engine immobilizer system ..... 77

**Theft prevention labels** ..... 81

**Tire inflation pressure** ..... 344

**Tire information**

    Glossary ..... 448

    Size ..... 445

    Tire identification number ..... 444

    Uniform tire quality grading ... 446

**Tires**

    Chains ..... 169

    Checking ..... 334

    If you have a flat tire ..... 400

    Inflation pressure ..... 344

    Inflation pressure sensor ..... 336

    Replacing ..... 400

    Rotating tires ..... 334

    Size ..... 436

    Snow tires ..... 169

    Spare tire ..... 400

**Tools** ..... 400

**Total load capacity** ..... 168

**Towing**

    Dinghy towing ..... 181, 182

    Trailer towing ..... 173

**TRAC** ..... 162

**Traction control** ..... 162

**Trip information** ..... 149

**Trip meter** ..... 141, 149

**Trunk**

    Extending a space ..... 285

    Opener ..... 46

**Trunk light**

    Trunk light ..... 47

    Wattage ..... 438

**Turn signal lights**

    Replacing light bulbs ..... 368

    Switch ..... 138

    Wattage ..... 438

**V**

**Vanity lights**

- Vanity lights .....276
- Wattage .....438

**Vanity mirrors.....276**

**Vehicle identification**

- number .....428

**Vehicle stability control.....162**

**VSC.....162**

**W**

**Warning buzzers**

- Brake system .....381
- Downshifting.....136
- Open door .....384
- Seat belt reminder.....384

**Warning lights**

- Anti-lock brake system .....382
- Brake assist system .....382
- Brake system .....381
- Charging system .....382
- Engine oil maintenance.....384
- Engine oil pressure .....382
- Low fuel level .....384
- Low tire pressure warning  
light .....384
- Malfunction indicator lamp ....382
- Master warning light .....384
- Open door .....384
- Pretensioners .....382
- Seat belt reminder light .....384
- SRS airbags .....382
- Traction control .....382
- Vehicle stability control.....382
- Washer fluid .....384

**Warning messages**

- Engine coolant  
temperature .....392
- Engine oil maintenance.....394
- Engine oil pressure .....392
- Hood .....394
- Moon roof.....394
- Open door .....394
- Parking brake.....394
- Smart key system .....397
- Steering lock .....393
- Traction control .....393
- Trunk.....394
- Vehicle stability control .....393
- Washer fluid .....394

**Washer**

- Checking .....333
- Preparing and checking  
before winter.....169
- Switch .....157

**Washing and waxing .....298**

**Weight**

- Cargo capacity .....165
- Load limits .....168
- Weight.....428

**Wheels .....348**

**Window glasses .....68**

**Window lock switch.....68**

**Windows**

- Power windows .....68
- Rear window defogger .....199
- Washer.....157

**Windshield wipers .....157**

**Wireless remote control key**

- Replacing the battery .....353
- Wireless remote control .....37

**WMA disc.....217**



What to do if...

What to do if...

A tire punctures	P. 400	If you have a flat tire
The engine does not start	P. 411	If the engine will not start
	P. 77	Engine immobilizer system
	P. 417	If the battery is discharged
	P. 415	If the electronic key does not operate properly
The shift lever cannot be moved out	P. 413	If the shift lever cannot be shifted from P
The engine coolant temperature gauge enters the red zone	P. 421	If your vehicle overheats
Steam can be seen coming from under the hood		
The key is lost	P. 414	If you lose your keys
The battery runs out	P. 417	If the battery is discharged
The doors cannot be locked	P. 41	Doors
The horn begins to sound	P. 79	Alarm
The vehicle is stuck in mud or sand	P. 424	If the vehicle becomes stuck



■ Warning lights



Brake system warning light

or



P. 381



Charging system warning light

P. 382



Low engine oil pressure warning light

P. 382



Malfunction indicator lamp

or



P. 382



SRS warning light

P. 382



ABS warning light

or



P. 382



Engine oil replacement reminder light

P. 384



Tire pressure warning light

P. 384



Low windshield washer fluid level warning light

P. 384



Vehicle stability control system and traction control system warning light

P. 382



Open door warning light

P. 384



Low fuel level warning light

P. 384



Driver's seat belt reminder light

P. 384



Front passenger's seat belt reminder light

P. 384



Master warning light

P. 384

The warning message is displayed

P. 391

If a warning message is displayed

## GAS STATION INFORMATION

**Auxiliary catch lever**  
P. 313

**Trunk opener**  
P. 46

**Fuel filler door**  
P. 73

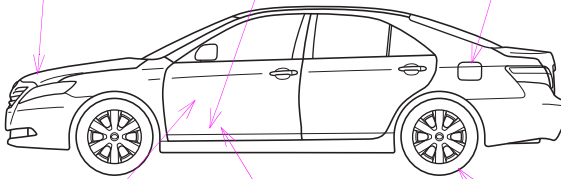

CTNPIA1020

**Hood lock release lever**  
P. 313

**Fuel filler door opener**  
P. 73

**Tire inflation pressure**  
P. 436

<b>Fuel tank capacity</b>		18.5 gal. (70 L, 15.4 Imp.gal.)	
<b>Fuel type</b>		Unleaded gasoline only P. 74, 430	
<b>Cold tire inflation pressure</b>		P. 436	
<b>Engine oil capacity (Drain and refill)</b>	2.4 L 4-cylinder (2AZ-FE) engine	With filter	qt. (L, Imp.qt) 4.5 (4.3, 3.8)
		Without filter	4.3 (4.1, 3.6)
	3.5 L V6 (2GR-FE) engine	With filter	6.4 (6.1, 5.4)
		Without filter	6.0 (5.7, 5.0)
<b>Engine oil type</b>		Toyota Genuine Motor Oil or equivalent Oil grade: ILSAC multigrade engine oil P. 431  Recommended oil viscosity: SAE 5W-20 or 0W-20 (2.4 L 4-cylinder [2AZ-FE] engine) SAE 5W-30 (3.5 L V6 [2GR-FE] engine)	