



Customer Experience Center  
1-800-331-4331

# HIGHLANDER

## 2009 Quick Reference Guide

# 2009 Highlander

This *Quick Reference Guide* is a summary of basic vehicle operations. It contains brief descriptions of fundamental operations so you can locate and use the vehicle's main equipment quickly and easily.

The *Quick Reference Guide* is not intended as a substitute for the *Owner's Manual* located in your vehicle's glove box. We strongly encourage you to review the *Owner's Manual* and supplementary manuals so you will have a better understanding of your vehicle's capabilities and limitations.

Your dealership and the entire staff of Toyota Motor Sales, U.S.A., Inc. wish you many years of satisfied driving in your new Highlander.

## ! A word about safe vehicle operations

This *Quick Reference Guide* is not a full description of Highlander operations. Every Highlander owner should review the *Owner's Manual* that accompanies this vehicle.

Pay special attention to the boxed information highlighted in color throughout the *Owner's Manual*. Each box contains safe operating instructions to help you avoid injury or equipment malfunction.

All information in this *Quick Reference Guide* is current at the time of printing. Toyota reserves the right to make changes at any time without notice.

## Seatbelts-Shoulder belt anchor

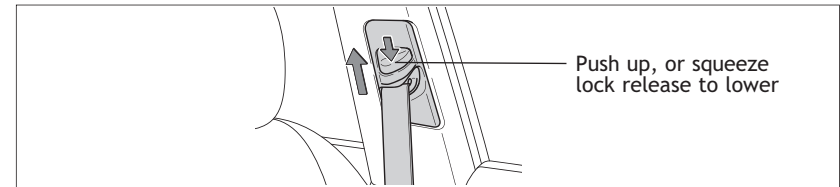

## Doors-Child safety locks

Rear door

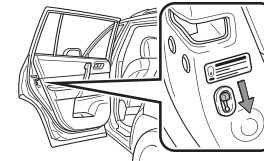

Moving the lever to "LOCK" will allow the door to be opened only from the outside.

## Spare tire & tools

Tool location

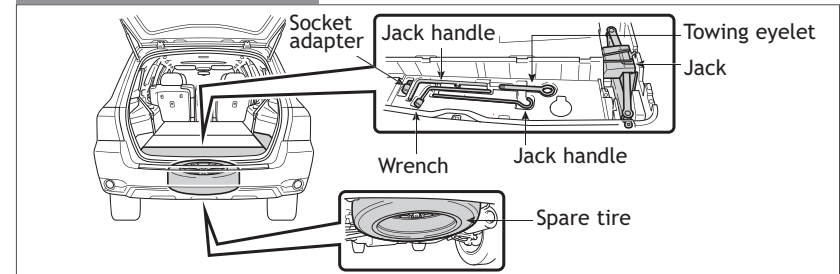

Removing the spare tire

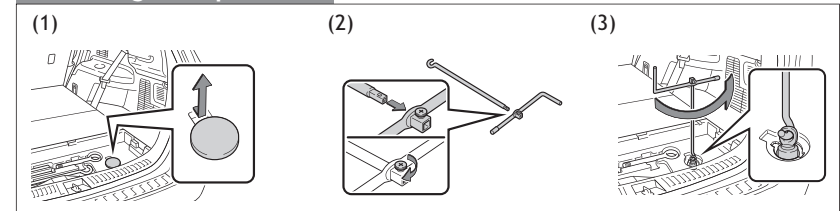

- (1) Remove the cover under the center deck board to find the spare tire clamp bolt.
- (2) Assemble the jack handle.
- (3) Put the socket adapter on the spare tire clamp bolt. Loosen the bolt by turning it counterclockwise with the jack handle.

Refer to the *Owner's Manual* for tire changing and jack positioning procedures.

# INDEX

## OVERVIEW

Engine maintenance	9
Fuel tank door release and cap	8
Hood release	8
Indicator symbols	4-5
Instrument cluster	4
Instrument panel	2-3
<b>Keyless entry<sup>1</sup></b>	<b>6</b>
Light control-Instrument panel	9
<b>Smart Key system<sup>1,2</sup></b>	<b>7</b>

## FEATURES/OPERATIONS

Air Conditioning/Heating	20-22
Audio	24-25
<b>Auto lock functions<sup>1</sup></b>	<b>11</b>
Automatic Transmission	10
Clock	22
Cruise control	23
Cup holders	27
Door locks	11
Door-Power back	12
Downhill Assist Control system (DAC)	26
Garage door opener (HomeLink <sup>®</sup> ) <sup>3</sup>	23
Hill-start Assist Control (HAC)	27
<b>Lights<sup>1</sup> &amp; turn signals</b>	<b>16</b>
Moonroof	12
<b>Multi-information display<sup>2</sup></b>	<b>18</b>
Parking brake	11
Power outlets-12V DC	17
Power outlets-115V AC	17
Rear seat entertainment system	26
Seat adjustments-Front	13
Seat adjustments-Rear	13
Seat heaters	22
Seats-Folding down second row seats	15
Seats-Head restraints	14
Seats-Removing Center-Stow <sup>™</sup> second row seat	14
Seats-Stowing third row seats	14
Steering lock release	11
Steering wheel controls	25
Telephone controls (Bluetooth <sup>®</sup> )	19
Tilt and telescopic steering wheel	12
Windows-Power	18
Windshield wipers & washers	15

## SAFETY AND

## EMERGENCY FEATURES

Doors-Child safety locks	29
Seatbelts	28
Seatbelts-Shoulder belt anchor	29
Spare tire & tools	29
Tire Pressure Monitoring (warning) System	28

<sup>1</sup> Visit your Toyota dealer for information on customizing this feature.

<sup>2</sup> Programmable by customer. Refer to the Owner's Manual for instructions and more information.

<sup>3</sup> HomeLink<sup>®</sup> is a registered trademark of Johnson Controls, Inc.

# OVERVIEW

## Instrument panel

### Steering wheel controls (if equipped)

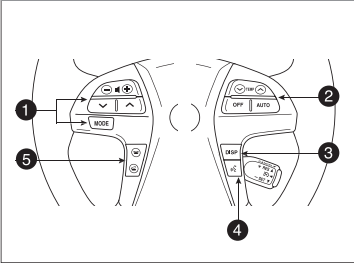

### Automatic Air Conditioning

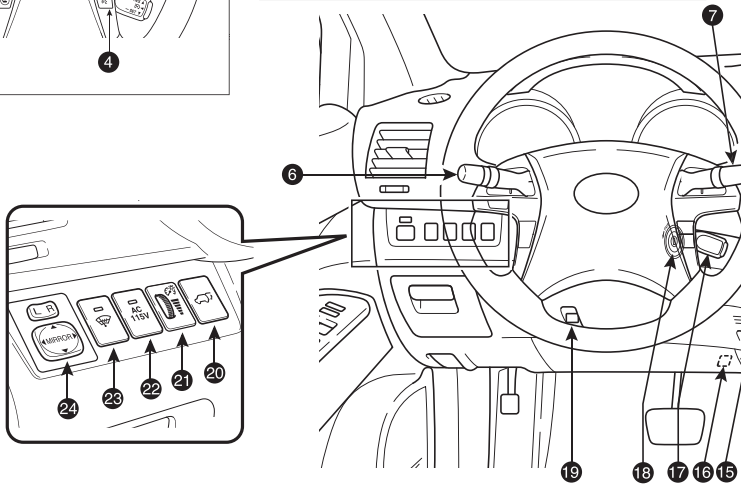
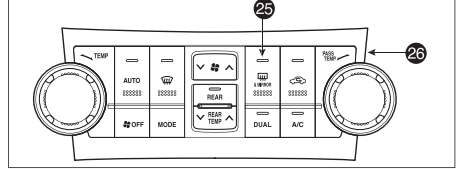

- 1 Steering wheel audio controls<sup>1</sup>
- 2 Steering wheel climate controls<sup>1</sup>
- 3 Multi-information display button<sup>1</sup>
- 4 Voice command button<sup>1</sup>
- 5 Telephone controls<sup>1,2</sup>
- 6 Headlight and turn signal controls/Headlight, turn signal and front fog light controls<sup>1</sup>
- 7 Wiper and washer controls
- 8 Multi-information display<sup>1</sup>
- 9 Audio system or navigation system-integrated audio system<sup>1,2</sup>
- 10 Theft deterrent system/Engine immobilizer indicator<sup>1</sup>
- 11 Emergency flasher button
- 12 "AIR BAG ON" and "AIR BAG OFF" indicator and front passenger seatbelt reminder lights
- 13 Power back door main switch<sup>1</sup>
- 14 "ENGINE START STOP" button (Smart Key)<sup>1</sup>
- 15 VSC/TRAC OFF switch

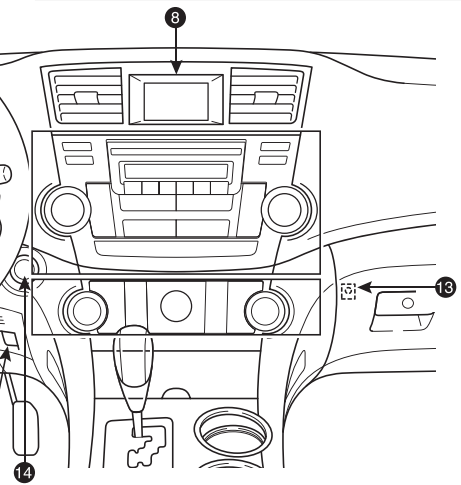
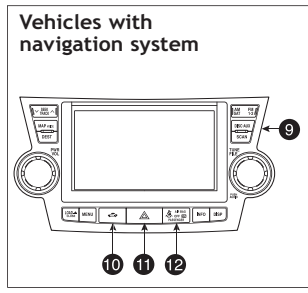
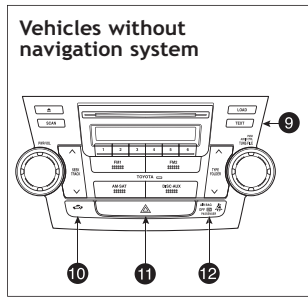
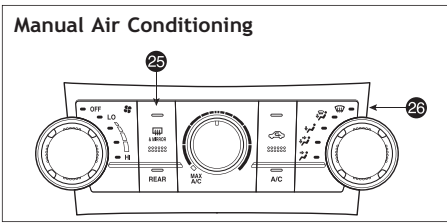

- 16 Tire Pressure Monitoring (warning) System
- 17 Cruise control
- 18 Ignition (standard key)
- 19 Tilt and telescopic steering lock release
- 20 Power back door button<sup>1</sup>
- 21 Instrument panel light control
- 22 115V AC Power outlet ON/OFF switch<sup>1</sup>
- 23 Windshield wiper de-icer switch<sup>1</sup>
- 24 Power rearview mirror control
- 25 Outside rearview mirror<sup>1</sup>/Rear window defogger button
- 26 Air Conditioning controls

<sup>1</sup> If equipped

<sup>2</sup> For vehicles with a navigation system, refer to the “Navigation System Owner’s Manual.”

## Instrument cluster

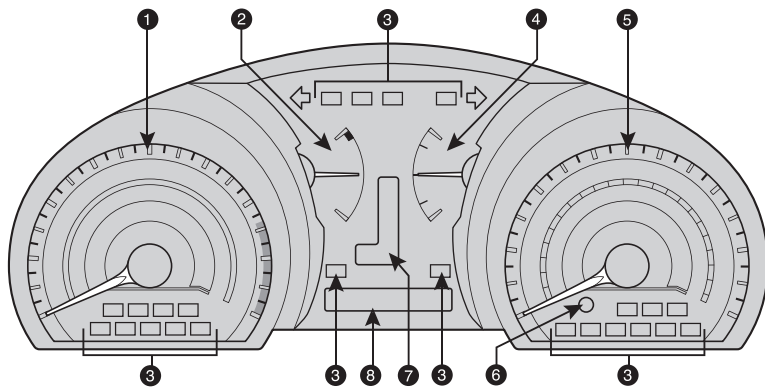















- ❶ Tachometer
- ❷ Engine coolant temperature
- ❸ Service indicator and reminder
- ❹ Fuel gauge
- ❺ Speedometer
- ❻ Trip meter reset knob
- ❼ Automatic Transmission shift position indicator
- ❽ Odometer and two trip meters/Automatic Transmission shift range display

## Indicator symbols

For details, refer to “Indicators and warning lights,” Section 2-2, 2009 *Owner’s Manual*.

<b>BRAKE</b>	Brake system warning <sup>1</sup>
	Driver seatbelt reminder (alarm will sound if speed is over 12 mph)
PASSENGER	Front passenger seatbelt reminder (alarm will sound if speed is over 12 mph)
	Charging system warning <sup>1</sup>
<b>AIR BAG</b> OFF ON	Front passenger occupant classification or front passenger airbag ON/OFF indicator <sup>1</sup>
	Low engine oil pressure warning <sup>1</sup>
CHECK	Malfunction/Check Engine indicator <sup>1</sup>

<sup>1</sup> If indicator does not turn off within a few seconds of starting engine, there may be a malfunction. Have vehicle inspected by your Toyota dealer.

<b>MAINT REQD</b>	Engine oil replacement reminder <sup>1</sup>
	Low fuel level warning
	Open door warning
	Airbag SRS warning <sup>1</sup>
	Master warning
<b>A/T OIL TEMP</b>	Automatic Transmission fluid temperature warning <sup>1</sup>
	Low Tire Pressure Warning <sup>1</sup>
	Electric power steering system warning <sup>1</sup>
	Low windshield washer fluid level warning <sup>1</sup>
	Theft deterrent/Engine immobilizer system indicator
	Headlight low/high beam indicator
	Turn signal indicator
	Tail light indicator
	Front fog light indicator
	Slip indicator/Hill-start Assist Control indicator/Downhill Assist Control indicator <sup>1</sup>
	Vehicle Stability Control OFF indicator <sup>1</sup>
<b>SNOW</b>	SNOW indicator
<b>CRUISE</b>	Cruise control indicator <sup>2</sup>
	Downhill Assist Control indicator <sup>1</sup>
<b>ABS</b>	Anti-lock Brake System warning <sup>1</sup>
<b>TRAC OFF</b>	Traction control OFF indicator <sup>1</sup>

<sup>2</sup> If this light flashes, refer to "Cruise control," Section 2-4, 2009 Owner's Manual.

## Keyless entry

### Locking operation

Without Smart Key system



With power back door



Without power back door

With Smart Key system



Push



### Unlocking operation

Without Smart Key system



With power back door

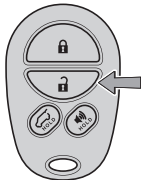

Without power back door

With Smart Key system



Push ONCE: Driver door  
TWICE: All doors



**NOTE:** If a door is not opened within 30 seconds of unlocking, all doors will relock for safety.

### Glass hatch operation (if equipped)

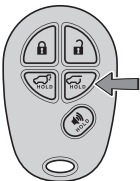

With power back door



Without power back door

Push and hold



### Power back door operation (if equipped)

Without Smart Key system



With Smart Key system



Push and hold



### Panic button



Push and hold





## Smart Key system (if equipped)

### Start function

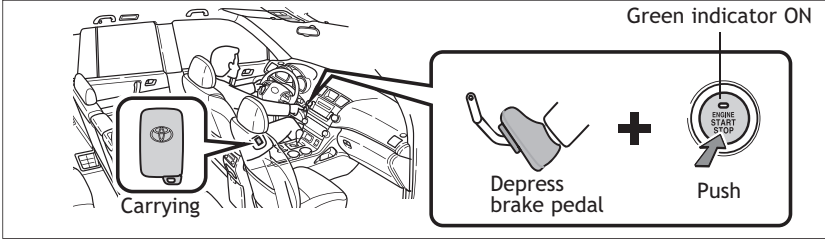

**NOTE:** Gear shift lever must be in Park and brake pedal depressed.

### Power (without starting engine)

Without depressing the brake pedal, pressing the “ENGINE START STOP” switch will change the operation mode in succession from:

**ACC**

Accessories such as the radio will operate.

**ON**

Power ON; the engine not running.

**OFF**

All systems OFF.

### Locking operation

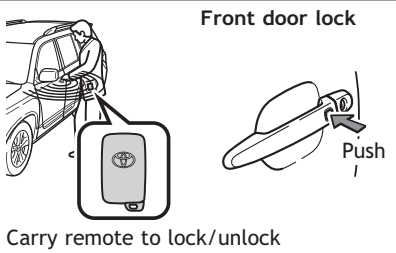

### Unlocking operation

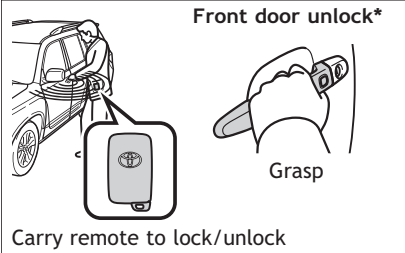

### Glass hatch unlock

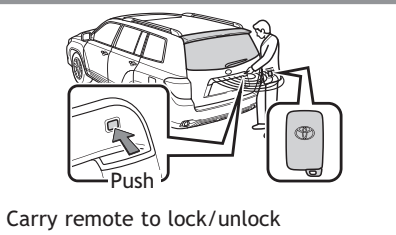

### Back door lock/unlock

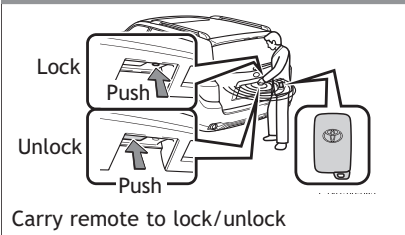

\* Driver door unlocking function can be programmed to unlock driver door only, or all doors. Grasping passenger door handle will unlock all doors.

**NOTE:** Doors may also be locked/unlocked using remote.

## Fuel tank door release and cap

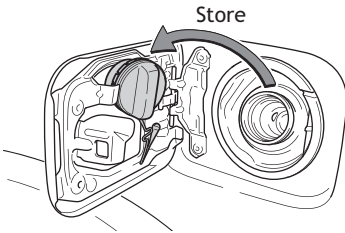
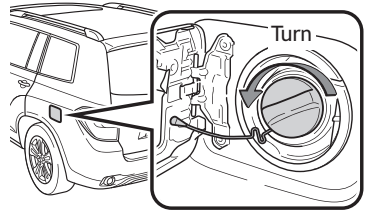
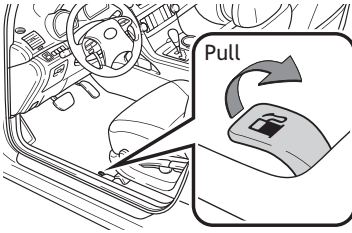

**NOTE:** Tighten until one click is heard. If the cap is not tightened enough, Check Engine “” indicator may illuminate.

## Hood release

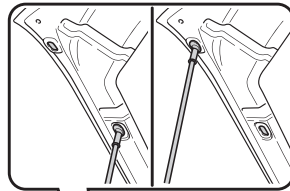
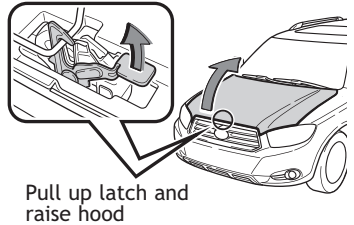
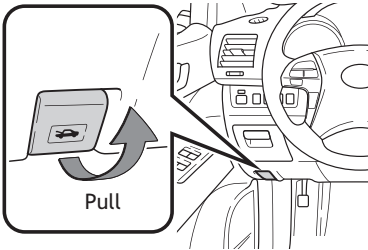

## Light control-Instrument panel

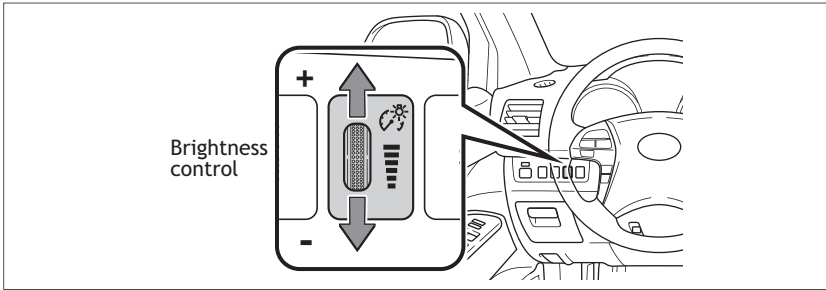

## Engine maintenance

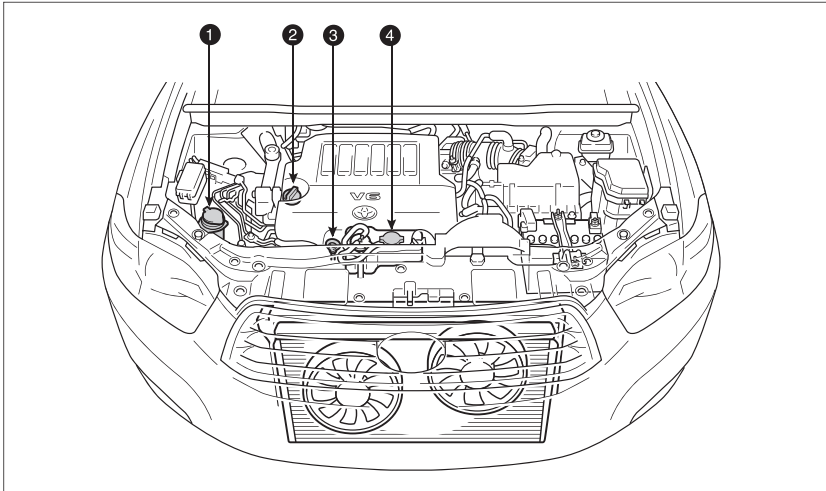

- 1 Windshield washer fluid tank
- 2 Engine oil filler cap
- 3 Engine oil level dipstick
- 4 Engine coolant reservoir

**Note:** Regularly scheduled maintenance, including oil changes, will help extend the life of your vehicle and maintain performance. Please refer to the “Owner’s Warranty Information Booklet,” “Scheduled Maintenance Guide” or “Owner’s Manual Supplement.”

# FEATURES/OPERATIONS

## Automatic Transmission

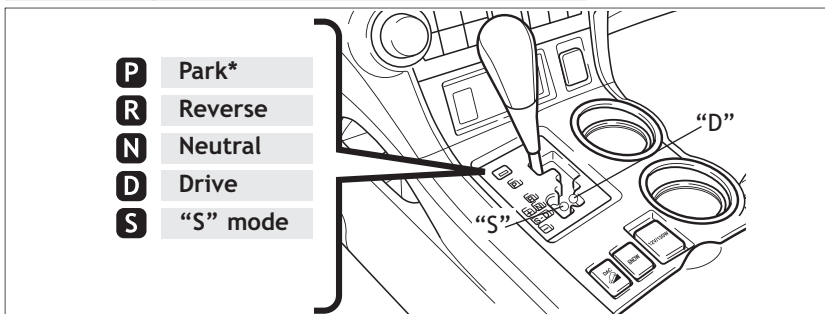

\* The ignition switch must be "ON" and the brake pedal depressed to shift from Park.

### "S" (Sequential) mode

Shift the shift lever to "S" position from "D" position.

#### Floor shift type:

- + : Upshift (push and release)
- : Downshift (pull and release)

Downshifting increases power going uphill, or provides engine braking downhill. For best fuel economy during normal driving conditions, always drive with the shift lever in the "D" position.

## Snow mode

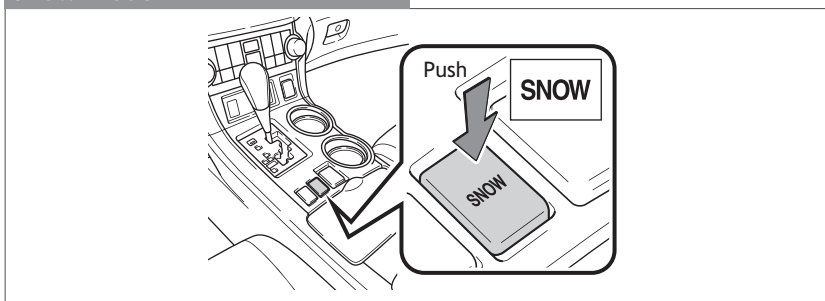

The snow mode prevents sudden acceleration on slippery surfaces. Use in snowy or icy road conditions.

## Auto lock functions

Automatic door locks can be programmed to operate in two different modes, or turned OFF.

- Doors lock when shifting from Park.
- Doors unlock when shifting into Park.

Refer to the *Owner's Manual* for more details.

## Steering lock release

Smart Key system

Without Smart Key system

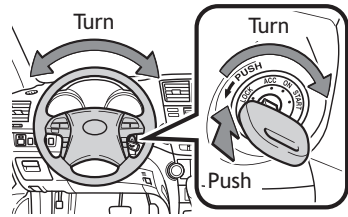
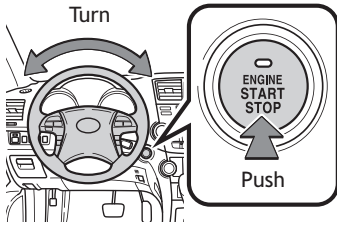

## Door locks

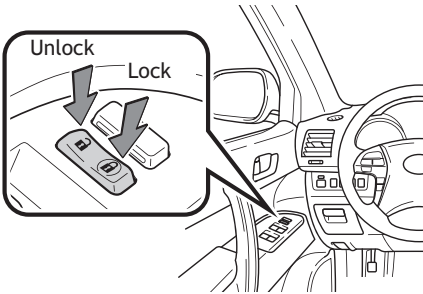

## Parking brake

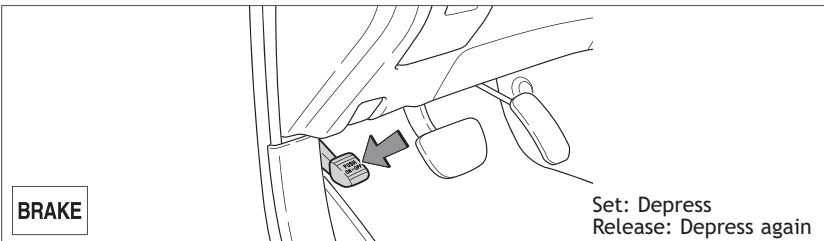

## Tilt and telescopic steering wheel

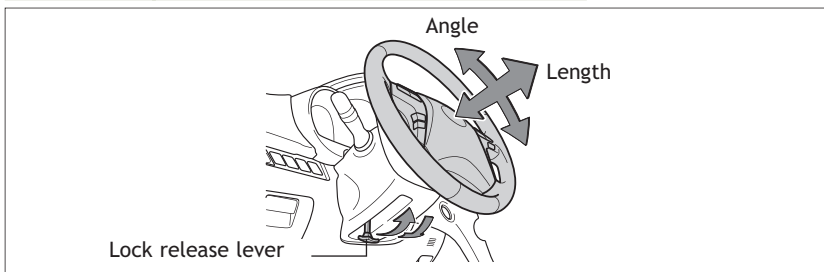

Hold wheel, push lever down, set angle and length, and return lever.

**Note:** Do not attempt to adjust while the vehicle is in motion.

## Moonroof (if equipped)

### Sliding operation

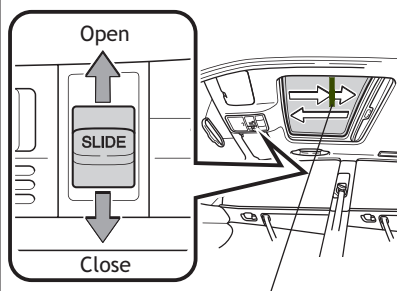

Recommended driving position to minimize wind noise.

### Tilting operation

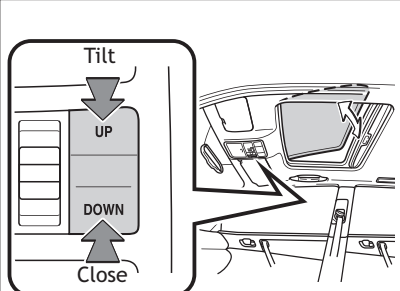

## Door-Power back (if equipped)

### Instrument panel

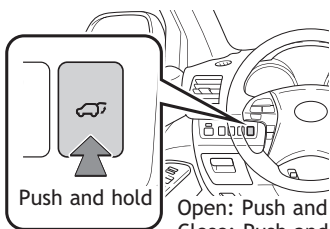

Open: Push and hold  
Close: Push and hold again

### Back door (close only)

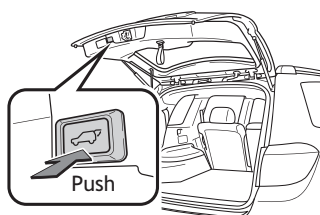

**NOTE:** If battery is disconnected, the power back door needs to be reinitialized. Refer to the *Owner's Manual* for more details.

## Seat adjustments-Front

### Manual seat

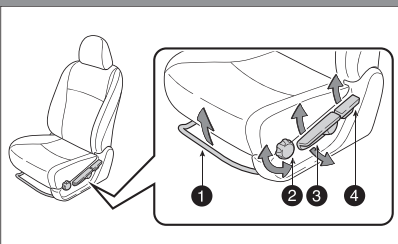

### Power seat

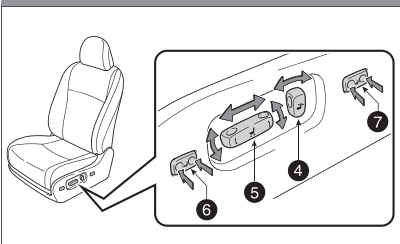

- 1 Seat position (forward/backward)
- 2 Seat cushion angle
- 3 Height crank (driver side only)
- 4 Seatback angle
- 5 Seat position, cushion angle and height
- 6 Driver seat leg support (if equipped)
- 7 Lumbar support (driver side only)

## Seat adjustments-Rear

### Second row seat

#### Without third seat

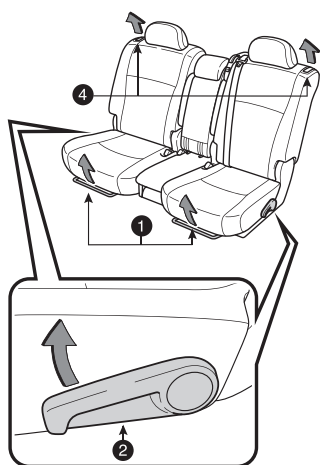

#### With third seat

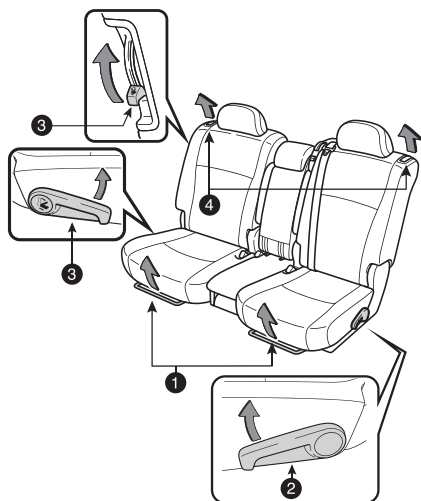

- 1 Seat position (forward/backward)
- 2 Seatback angle
- 3 Third seat access lever
- 4 Seatback release

Refer to the *Owner's Manual* for more details.

## Seats-Head restraints

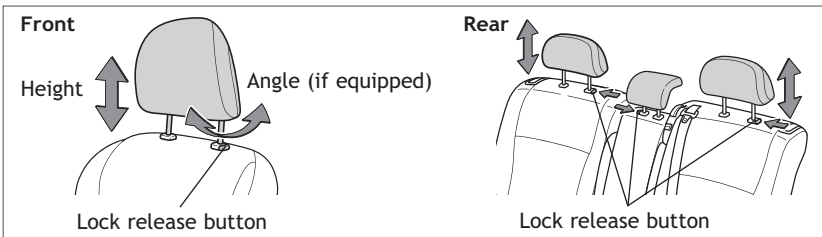

## Seats-Removing Center-Stow™ second row seat

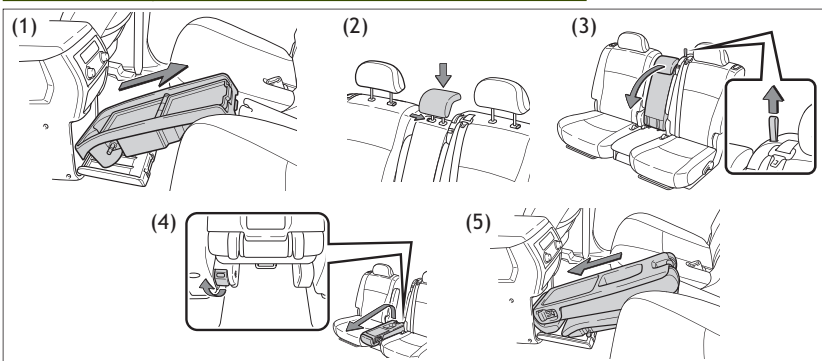

- (1) Remove the second row console from the front center console box.
- (2) Lower the center head restraint.
- (3) Pull the strap, then fold down the seatback.
- (4) Pull the lever behind the second center seat and lift the rear of the seat to remove.
- (5) Stow the seat in the front center console box.

**NOTE:** The second-row console can now be installed between the second row seats.

## Seats-Stowing third row seats (if equipped)

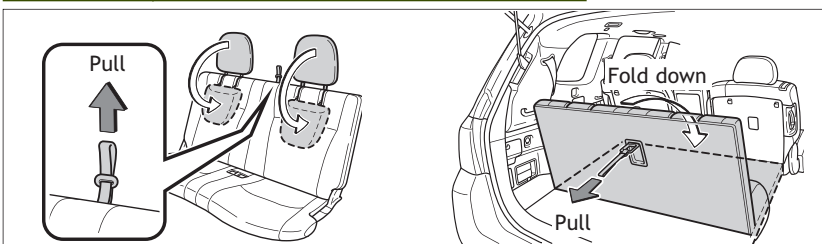

Refer to the *Owner's Manual* for more details.



## Seats-Folding down second row seats (if equipped)

From outside

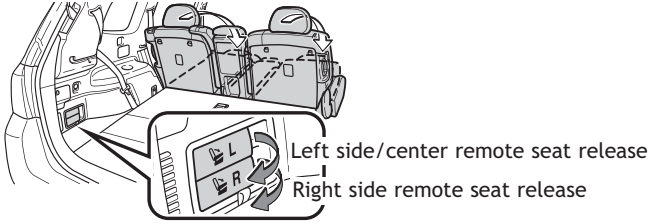

From inside

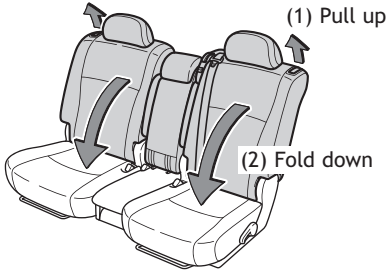

## Windshield wipers & washers

Front

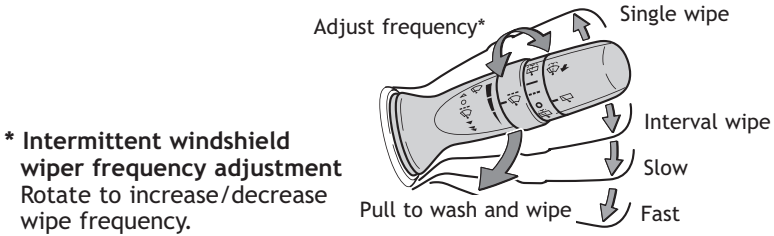

Rear

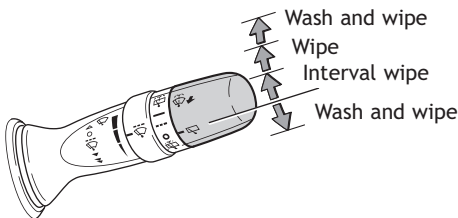

## Lights & turn signals

### Headlights

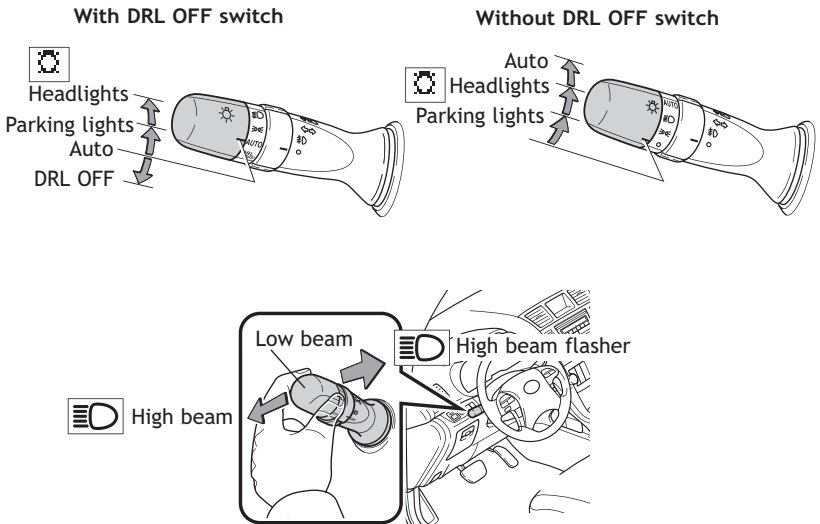

- Daytime Running Light system (DRL) (if equipped) Automatically turns on the turn signal lights at a reduced intensity.
- Automatic light cut off system Automatically turns lights off after a delay of 30 seconds.

### Front fog lights (if equipped)

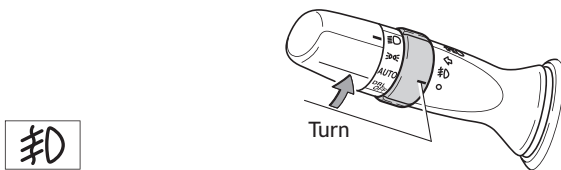

Front fog lights come on only when the headlights are on low beam.

### Turn signals

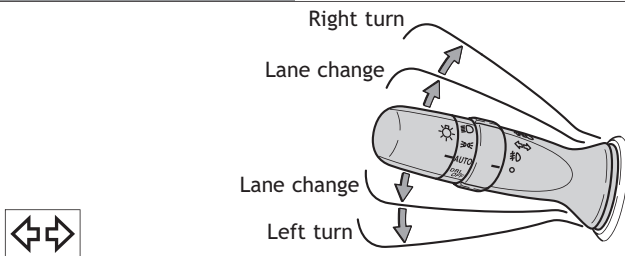

## Power outlets-12V DC

Instrument panel (with seat heater)

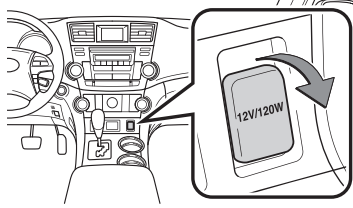

Instrument panel (without seat heater)

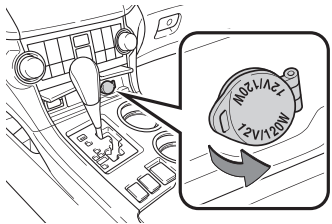

Center console

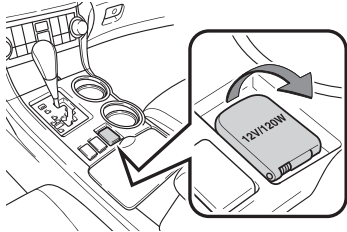

Luggage compartment

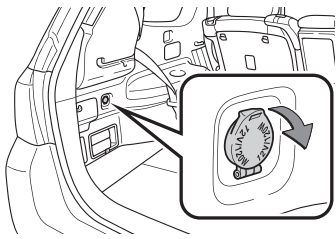

Key/Engine switch must be in the "ACC" or "ON" position to be used.

## Power outlets-115V AC (if equipped)

ON/OFF switch

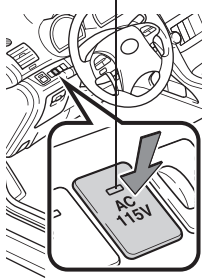

Beside second row seat

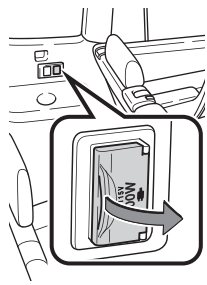

Key/Engine switch must be in the "ON" position to be used.

## Multi-information display (if equipped)

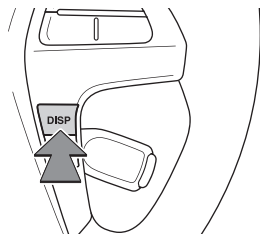
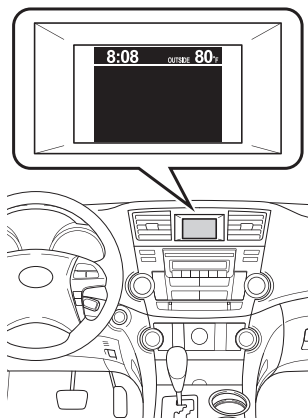

Push "DISP" to change information in the following:

- (1) Average gas mileage after refueling
- (2) Current gas mileage
- (3) Miles left on remaining fuel
- (4) Driving distance from engine start
- (5) Average gas mileage
- (6) Average gas mileage history

Push and hold "DISP" to set up the displays and the rearview monitor displays.

## Windows-Power

Driver side

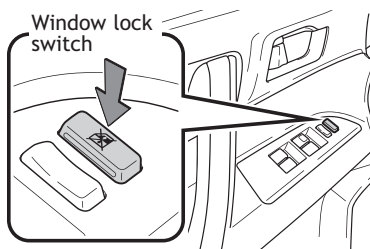
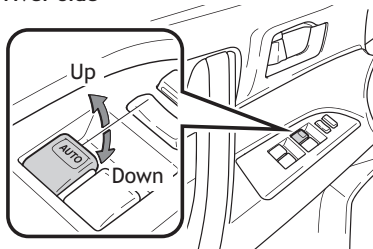

**Automatic operation (Driver's window only)** Push the switch completely down or pull it completely up and release to fully open or close. To stop window midway, lightly push the switch in the opposite direction.

**Window lock switch** Deactivates all passenger windows. Driver's window remains operable.

## Telephone controls (Bluetooth® (if equipped))

Audio unit

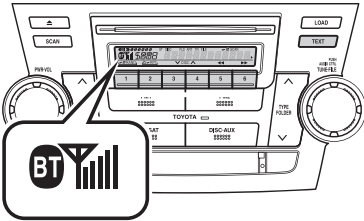

Microphone

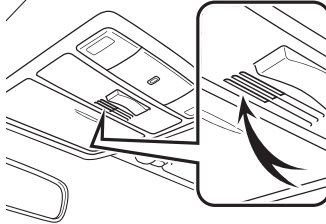

Steering wheel telephone controls

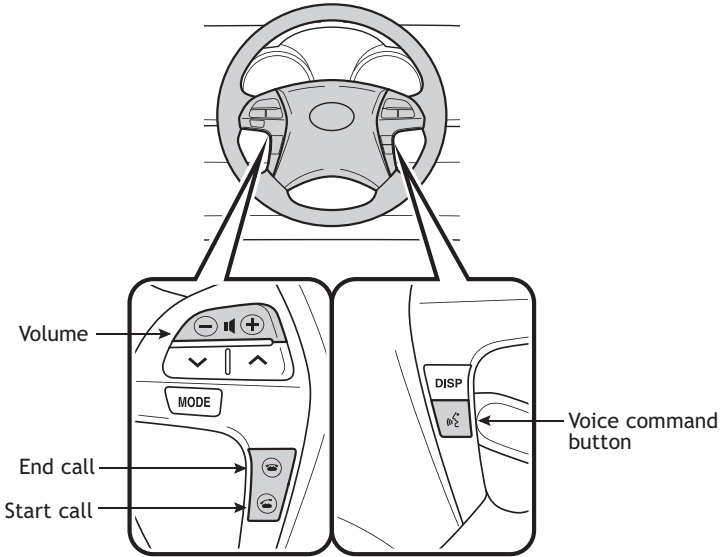

Bluetooth® technology allows dialing or receipt of calls without taking hands from the steering wheel or using a cable to connect the telephone and the system.

Refer to “Hands-free phone system (for cellular phone),” Section 3-4 in the *Owner’s Manual* for more details.

## Air Conditioning/Heating

### Front manual Air Conditioning

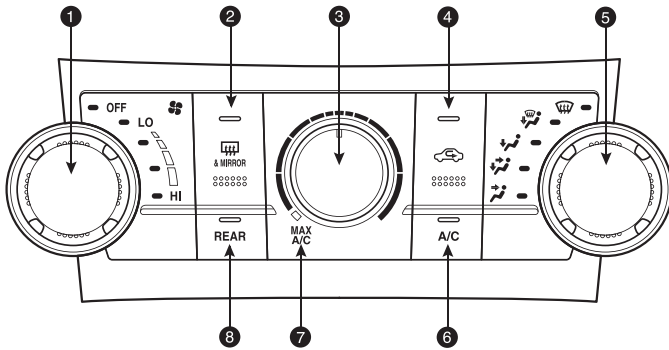

- 1 Fan speed
- 2 Outside rearview mirror (if equipped)/Rear window defogger
- 3 Temperature selector
- 4 Fresh or recirculated cabin air
- 5 Airflow vent  
In “” or “” mode, use fresh air (“” indicator OFF) to reduce window fogging.
- 6 Air Conditioning ON/OFF  
Use fresh air to quickly cool interior, then change to recirculate for cooler air.
- 7 Use for quick cooling. MAX A/C changes air intake to recirculate.
- 8 Rear Air Conditioning ON/OFF

### Rear manual Air Conditioning (if equipped)

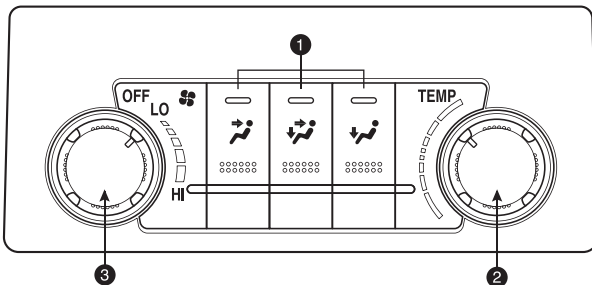

- 1 Airflow vent
- 2 Temperature selector
- 3 Fan speed

## Front automatic Air Conditioning

With rear Air Conditioning

Without rear Air Conditioning

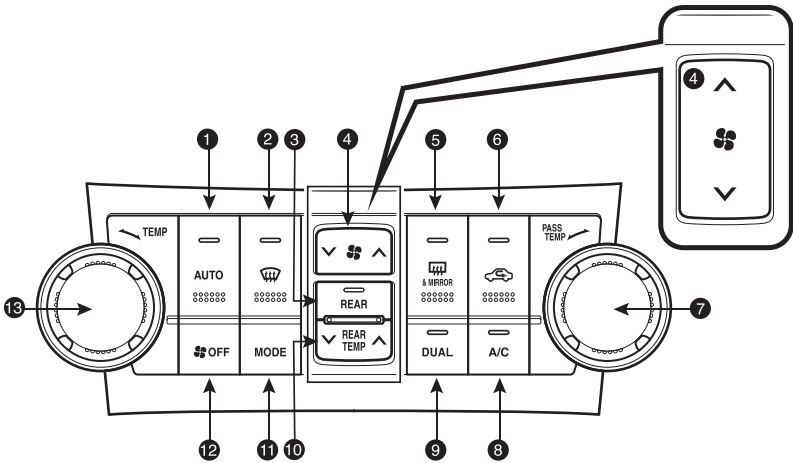

- 1 Automatic climate control ON  
Adjusting the temperature setting will cause the airflow vents, air intake and fan to adjust automatically.
- 2 Windshield airflow/defogger
- 3 Rear Air Conditioning ON/OFF
- 4 Fan speed
- 5 Outside rearview mirror (if equipped)/Rear window defogger
- 6 Fresh or recirculated cabin air
- 7 Temperature selector (front passenger side)
- 8 Air Conditioning ON/OFF
- 9 "DUAL" button  
Indicator ON: Separate temperature settings for driver, front passenger and rear passengers.  
Indicator OFF: Synchronize temperature settings for driver and all passengers.
- 10 Temperature selector (rear passenger)
- 11 Airflow vent  
In "☁" or "☁" mode, use fresh air ("☁" indicator OFF) to reduce window fogging.
- 12 Climate control OFF
- 13 Temperature selector (driver side)

## Rear automatic Air Conditioning (if equipped)

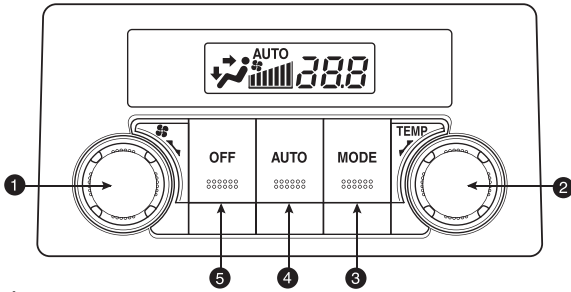

- 1 Fan speed
- 2 Temperature selector
- 3 Airflow vent
- 4 Automatic climate control ON
- 5 Climate control OFF

## Seat heaters (if equipped)

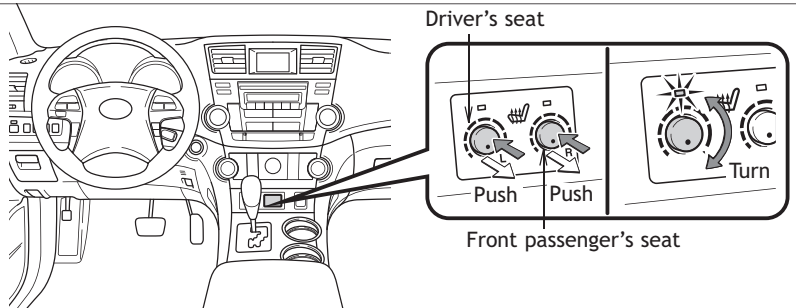

Push knob to pop the controller out. Turn clockwise for heater.

## Clock

Without multi-information display

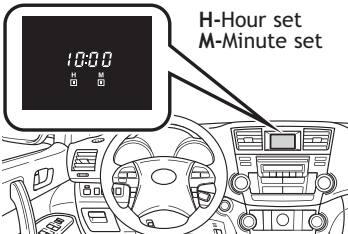

With multi-information display

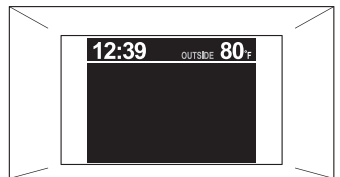

With multi-information display Press and hold “DISP” button. Select “CLOCK” on menu screen. Adjust as indicated on screen.



## Cruise control

### Turning system ON/OFF

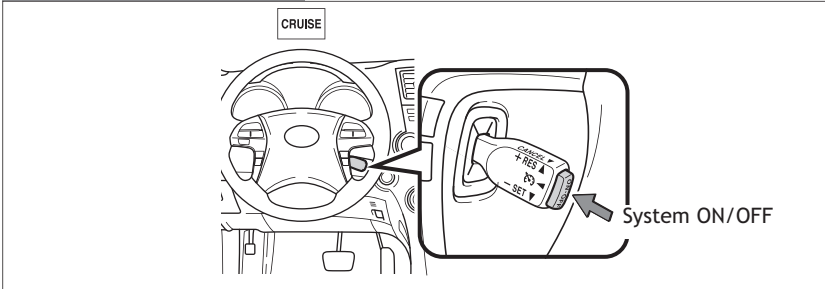

### Functions

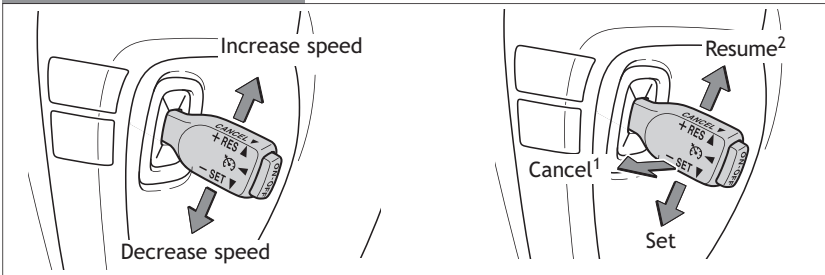

<sup>1</sup> The set speed may also be cancelled by depressing the brake pedal.

<sup>2</sup> The set speed may be resumed once vehicle speed exceeds 25 mph.

## Garage door opener (HomeLink®)\* (if equipped)

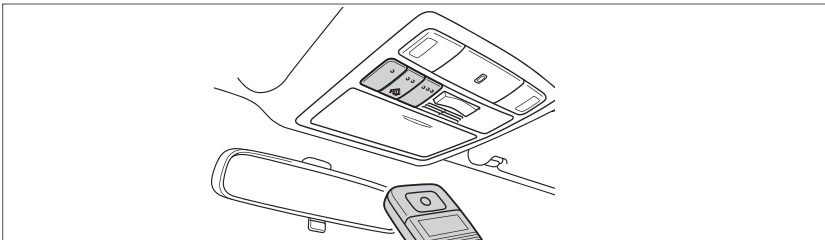

Garage door openers manufactured under license from HomeLink®\* can be programmed to operate garage doors, estate gates, security lighting, etc.

Refer to "Garage door opener," Section 3-7 in the *Owner's Manual* for more details.

For programming assistance, contact the Toyota Customer Experience Center at 1-800-331-4331, or visit <http://www.homelink.com>.

\* HomeLink® is a registered trademark of Johnson Controls, Inc.

Audio

Type 1

Preset buttons - functions in other modes indicated above number

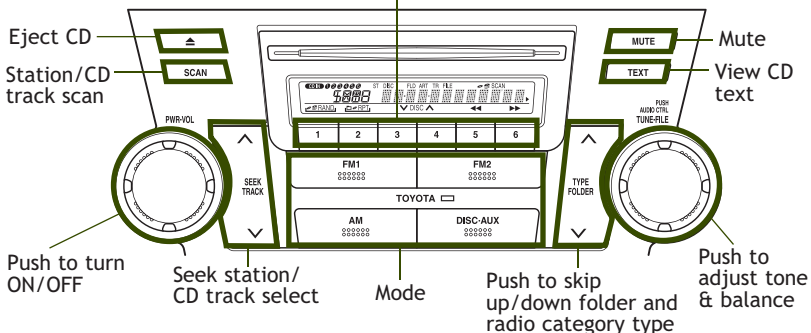

Type 2 additional functions

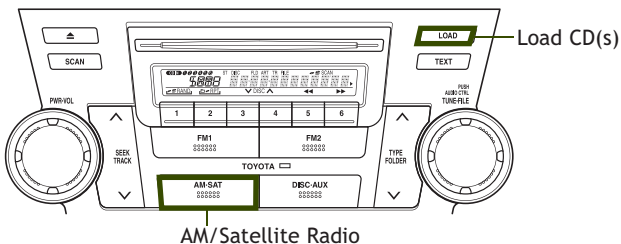

Type 3 (with JBL speakers and Bluetooth® function)

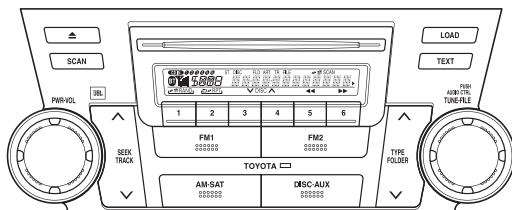

CD PLAYER

To scan tracks on a disc Push and hold “SCAN.” Push again to hold selection.

CD changer (Types 2 and 3 only)

- To load one disc Push “LOAD” and insert one disc.
- To load multiple discs Push and hold “LOAD” until you hear a beep. Insert one disc. Shutter will close and then re-open for next disc.

To select a file (MP3/WMA only) Turn “TUNE·FILE.”

To select a folder (MP3/WMA only) Push either side of “FOLDER.”

## RADIO

**To preset stations** Tune in the desired station and hold down a preset button (1-6) until you hear a beep. Push desired preset button (1-6) to select.

**To scan stations** Push and hold “SCAN” to scan preset stations. Push again to hold selection.

## AUX audio jack

Without seat heater

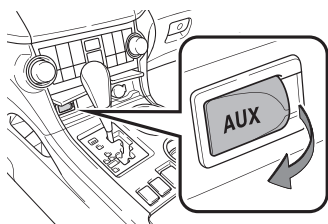

With seat heater

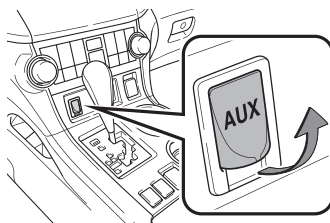

By inserting a mini plug into the AUX audio jack, you can listen to music from a portable audio device through the vehicle’s speaker system while in AUX mode.

## Steering wheel controls (if equipped)

Audio control

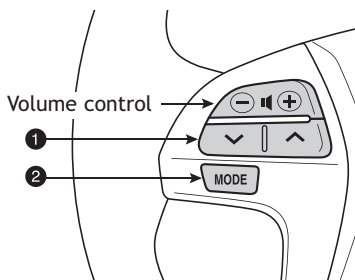

A/C control

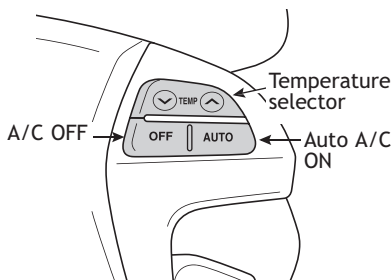

### ① “V A”

-In **radio mode** Push to select a preset station; push and hold to seek the next strong station.

-In **CD mode** Push to skip up or down to next/previous track.

### ② “MODE”

Push to turn audio ON and select an audio mode. Push and hold to turn the audio system OFF.

## Rear seat entertainment system (if equipped)

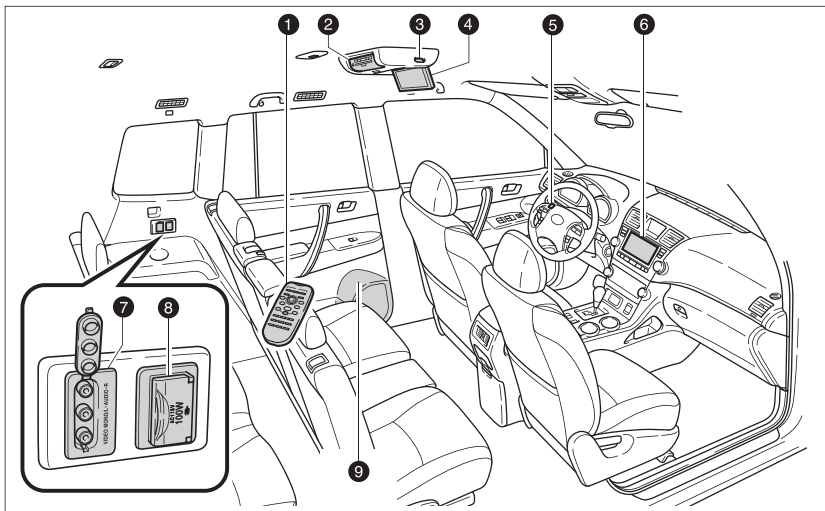

- 1 Remote control
- 2 DVD player
- 3 Headphone volume control and headphone jacks
- 4 DVD screen
- 5 115V AC Power outlet ON/OFF switch
- 6 Front audio system
- 7 A/V input adapter
- 8 115V AC Power outlet
- 9 Wireless headphones

## Downhill Assist Control system (DAC) (if equipped)

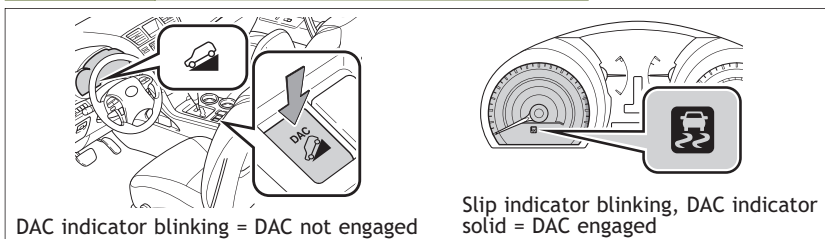

DAC helps the vehicle to descend steep hills while maintaining a low speed without brake pedal operation. Press the “DAC” button (system will engage only when shifter is in S1 or R mode). Pressing the button again will turn system off.

Refer to the *Owner’s Manual* for more details.

## Hill-start Assist Control (HAC)

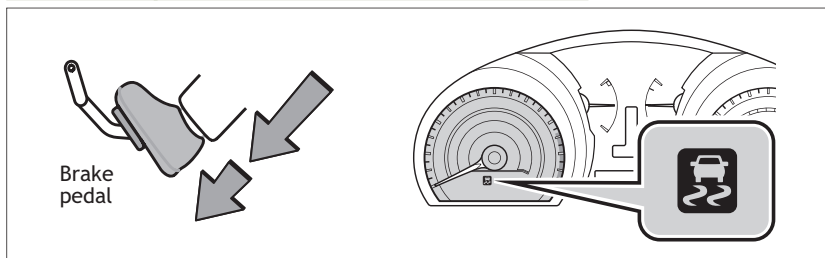

HAC helps prevent rolling backwards on an incline. To engage, push further down on brake pedal while at a complete stop until a beep sounds and slip indicator illuminates. HAC holds for approximately 2 seconds after releasing brake pedal.

Refer to the *Owner's Manual* for more details.

## Cup holders

### Front

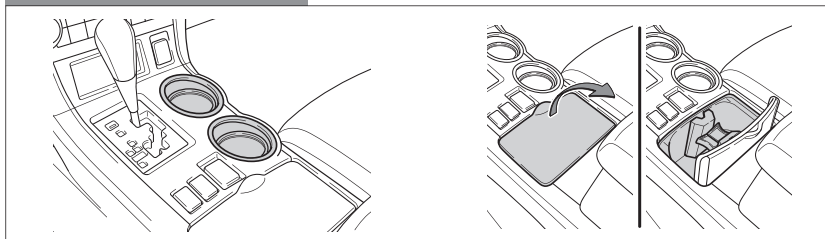

### Console box

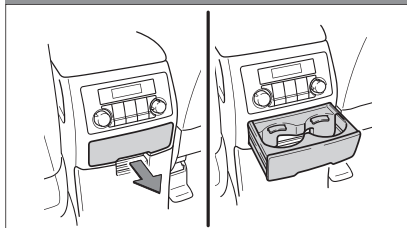

### Rear

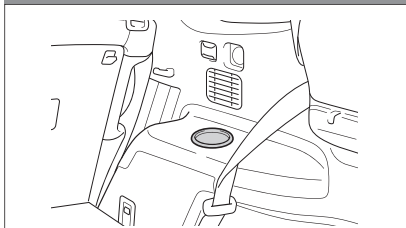

### Side table

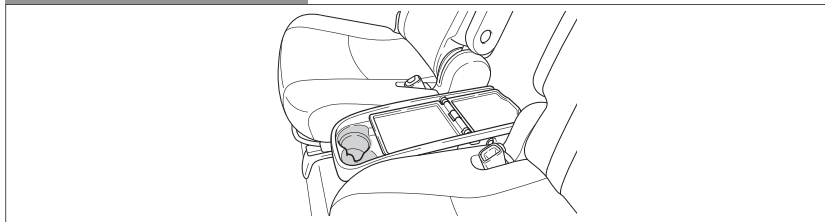

# SAFETY AND EMERGENCY FEATURES

## Seatbelts

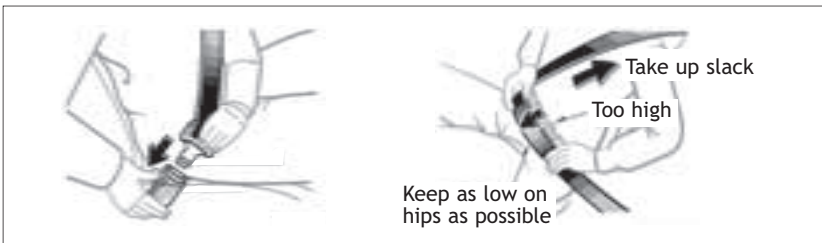

If belt is fully extended, then retracted even slightly, it cannot be re-extended beyond that point, unless fully retracted again. This feature is used to help hold child restraint systems securely.

To find more information about seatbelts, and how to install a child restraint system, refer to the *Owner's Manual*.

## Tire Pressure Monitoring (warning) System

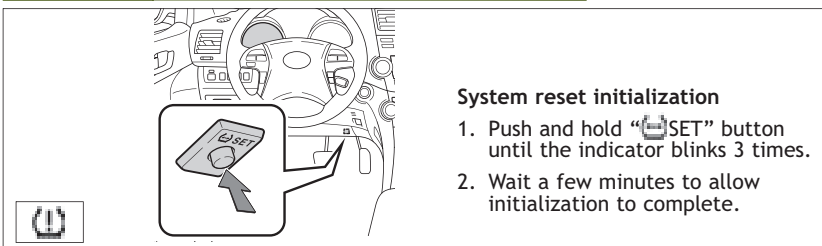

### System reset initialization

1. Push and hold “SET” button until the indicator blinks 3 times.
2. Wait a few minutes to allow initialization to complete.

After adjusting tire pressures, or after tires have been rotated or replaced, turn the ignition switch to “ON” and press and hold the “SET” button until indicator blinks three times. Let the vehicle sit for a few minutes to allow initialization to complete.

Refer to the load label on the door jamb or the *Owner's Manual* for tire inflation specifications.

If the tire pressure indicator flashes for more than 60 seconds and then remains on, take the vehicle to your local Toyota dealer.

**Note:** The warning light may come on due to temperature changes or changes in tire pressure from natural air leakage. If the system has not been initialized recently, setting the tire pressures to factory specifications should turn off the light.

## Abbreviation/Acronym list

ABBREVIATIONS	MEANING
2WD	2 Wheel Drive
4WD	4 Wheel Drive
A/C	Air Conditioning
ABS	Anti-lock Brake System
ACC	Accessory
ALR	Automatic Locking Retractor
CRS	Child Restraint System
DAC	Downhill Assist Control
DISP	Display
ECU	Electronic Control Unit
EDR	Event Data Recorder
ELR	Emergency Locking Retractor
EPS	Electric Power Steering
GAWR	Gross Axle Weight Rating
GVM	Gross Vehicle Mass
I/M	Emission Inspection and Maintenance
LATCH	Lower Anchors and Tethers for Children
LED	Light Emitting Diode
OBD	On Board Diagnostics
SRS	Supplemental Restraint System
TIN	Tire Identification Number
TEMP	Temperature
TPMS	Tire Pressure Warning System
TRAC	Traction Control
VIN	Vehicle Identification Number
VSC	Vehicle Stability Control

## For your information

### **Main Owner's Manual**

Please note that this manual covers all models and all equipment, including options. Therefore, you may find some explanations for equipment not installed on your vehicle.

All specifications provided in this manual are current at the time of printing. However, because of the Toyota policy of continual product improvement, we reserve the right to make changes at any time without notice.

Depending on specifications, the vehicle shown in the illustrations may differ from your vehicle in terms of equipment.

### **Accessories, spare parts and modification of your Toyota**

A wide variety of non-genuine spare parts and accessories for Toyota vehicles are currently available on the market. You should know that these parts are not covered by Toyota warranty and that Toyota is not responsible for their performance, repair, or replacement, or for any damage they may cause to, or adverse effect they may have on, your Toyota vehicle.

This vehicle should not be modified with non-genuine Toyota products. Modification with non-genuine Toyota products may affect performance, safety or durability, and may even violate governmental regulations. In addition, damage or performance problems resulting from the modification may not be covered under warranty.

### **Installation of a mobile two-way radio system**

As the installation of a mobile two-way radio system in your vehicle may affect electronic systems such as the multi-port fuel injection system/sequential multi-port fuel injection system, cruise control system, anti-lock brake system, SRS airbag system or seat belt pretensioner system, be sure to check with your Toyota dealer for precautionary measures or special instructions regarding installation.



## **Scrapping of your Toyota**

The SRS airbag and seat belt pretensioner devices in your Toyota contain explosive chemicals. If the vehicle is scrapped with the airbags and seat belt pretensioners left as they are, this may cause an accident such as fire. Be sure to have the systems of the SRS airbag and seat belt pretensioner removed and disposed of by a qualified service shop or by your Toyota dealer before you scrap your vehicle.

## **Perchlorate Material**

Special handling may apply, See [www.dtsc.ca.gov/hazardouswaste/perchlorate](http://www.dtsc.ca.gov/hazardouswaste/perchlorate).

Your vehicle has components that may contain perchlorate. These components may include airbag, seat belt pretensioners, and wireless remote control batteries.



## CAUTION

### ■ **General precautions while driving**

**Driving under the influence:** Never drive your vehicle when under the influence of alcohol or drugs that have impaired your ability to operate your vehicle. Alcohol and certain drugs delay reaction time, impair judgment and reduce coordination, which could lead to an accident that could result in death or serious injury.

**Defensive driving:** Always drive defensively. Anticipate mistakes that other drivers or pedestrians might make and be ready to avoid accidents.

**Driver distraction:** Always give your full attention to driving. Anything that distracts the driver, such as adjusting controls, talking on a cellular phone or reading can result in a collision with resulting death or serious injury to you, your occupants or others.

### ■ **General precaution regarding children's safety**

Never leave children unattended in the vehicle, and never allow children to have or use the key.

Children may be able to start the vehicle or shift the vehicle into neutral. There is also a danger that children may injure themselves by playing with the windows, the moon roof, or other features of the vehicle. In addition, heat build-up or extremely cold temperatures inside the vehicle can be fatal to children.

# Symbols used throughout this manual

## Cautions & Notices

### CAUTION

This is a warning against anything which may cause death or injury to people if the warning is ignored. You are informed about what you must or must not do in order to reduce the risk of injury to yourself and others.

### NOTICE

This is a warning against anything which may cause damage to the vehicle or its equipment if the warning is ignored. You are informed about what you must or must not do in order to avoid or reduce the risk of damage to your Toyota and its equipment.

## Symbols used in illustrations



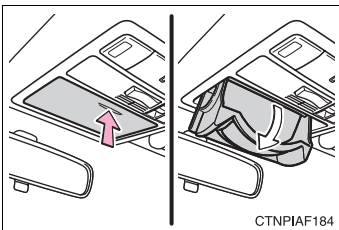

### Safety symbol

The symbol of a circle with a slash through it means “Do not”, “Do not do this”, or “Do not let this happen”.



### Arrows indicating operations

-  Indicates the action (pushing, turning, etc.) used to operate switches and other devices.
-  Indicates the outcome of an operation (e.g. a lid opens).



# TABLE OF CONTENTS

1	<b>Before driving</b>	Adjusting and operating features such as door locks, mirrors, and steering column.
2	<b>When driving</b>	Driving, stopping and safe-driving information.
3	<b>Interior features</b>	Air conditioning and audio systems, as well as other interior features for a comfortable driving experience.
4	<b>Maintenance and care</b>	Cleaning and protecting your vehicle, performing do-it-yourself maintenance, and maintenance information.
5	<b>When trouble arises</b>	What to do if the vehicle needs to be towed, gets a flat tire, or is involved in an accident.
6	<b>Vehicle specifications</b>	Detailed vehicle information.
7	<b>For owners</b>	Reporting safety defects for U.S. owners and seat belt instructions for Canadian owners
	<b>Index</b>	Alphabetical listing of information contained in this manual.

# Keys

The following keys are provided with the vehicle.

► Vehicles without smart key system (type A)

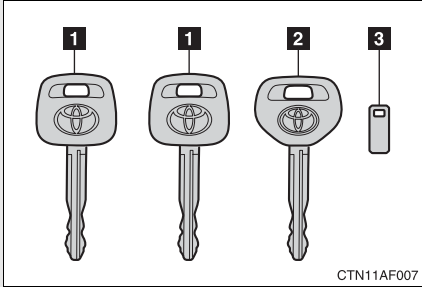

- 1** Master keys
- 2** Valet key
- 3** Key number plate

► Vehicles without smart key system (type B)

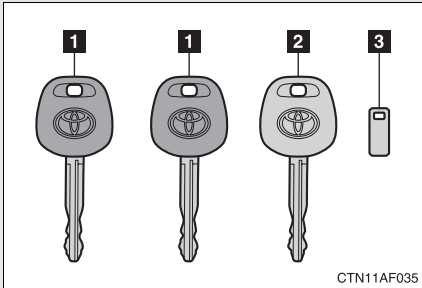

- 1** Master keys
- 2** Valet key
- 3** Key number plate

► Vehicles with smart key system

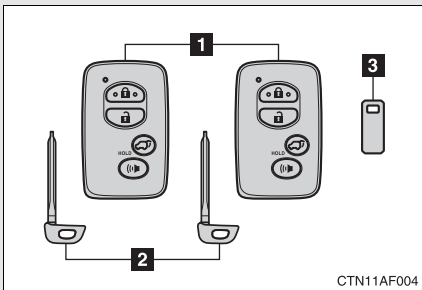

- 1** Electronic keys
  - Operating the smart key system (→P. 33)
  - Operating the wireless remote control function (→P. 54)
- 2** Mechanical keys
- 3** Key number plate

## Using the mechanical key (vehicles with smart key system)

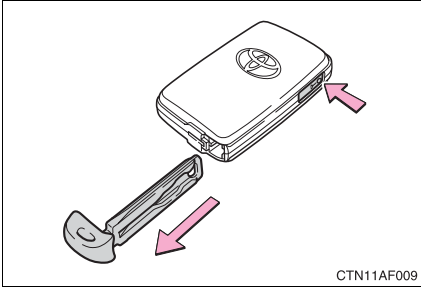

Take out the mechanical key.

After using the mechanical key, store it in the electronic key. Carry the mechanical key together with the electronic key. If the electronic key battery is depleted, you will need the mechanical key. (→P. 539)

1

Before driving

### ■ When required to leave a key to the vehicle with a parking attendant

Lock the glove box as circumstances demand. (→P. 376)

Vehicles without smart key system: Carry the master key for your own use and leave the valet key only with the attendant.

Vehicles with smart key system: Remove the mechanical key for your own use and provide the attendant with the electronic key only.

### ■ Key number plate

Keep the plate in a safe place such as your wallet, not in the vehicle. In the event that a key is lost, a new key can be made by your Toyota dealer using the key number plate. (→P. 538)

### ■ When riding in an aircraft (vehicles with smart key system)

When bringing an electronic key onto an aircraft, make sure you do not press any buttons on the electronic key while inside the aircraft cabin. If you are carrying an electronic key in your bag etc, ensure that the buttons are not likely to be pressed accidentally. Pressing a button may cause the electronic key to emit radio waves that could interfere with the operation of the aircraft.



## NOTICE

### ■ To prevent key damage

- Do not subject the keys to strong shocks, expose them to high temperatures by placing them in direct sunlight, or get them wet.
- Do not expose the keys to electromagnetic materials or attach any material that blocks electromagnetic waves to the key surface.
- Do not disassemble the key.



## 1-2. Opening, closing and locking the doors Smart key system\*

The following operations can be performed simply by carrying the electronic key on your person, for example in your pocket.

(The driver should always carry the electronic key.)

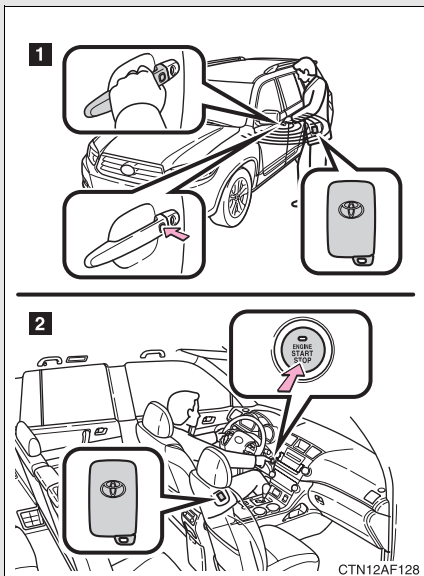

- 1** Locks and unlocks the doors (→P. 34)
- 2** Starts the engine (→P. 173)

1

Before driving

\*: If equipped

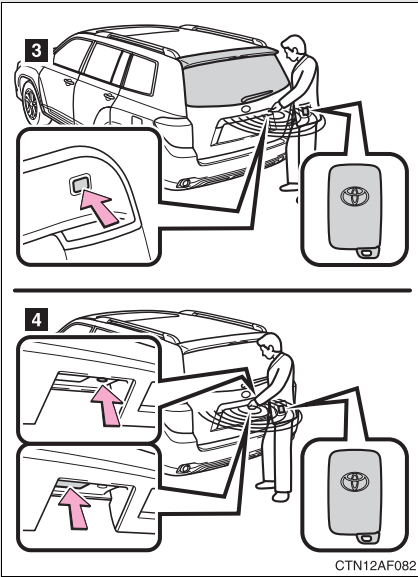

**3** Opens the glass hatch  
(→P. 36)

**4** Locks and unlocks the  
doors (→P. 34)

## Unlocking and locking the doors

### ► Front door handles

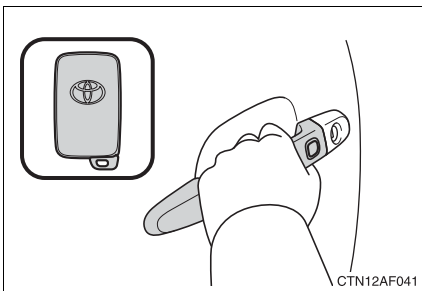

Grip the handle to unlock the  
doors.

Make sure to touch the sensor on  
the back of the handle.

The door cannot be unlocked for  
3 seconds after the door is  
locked.

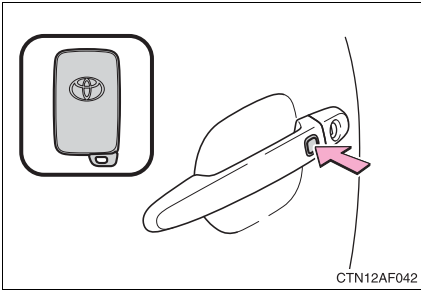

Press the lock button to lock the doors.

► Back door handle

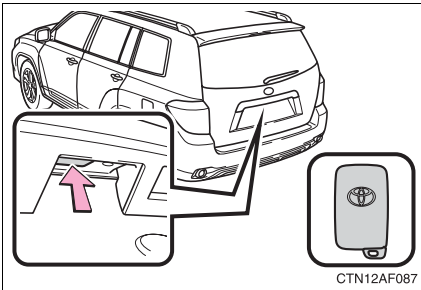

Press the button to unlock the door.

The door cannot be unlocked for 3 seconds after the door is locked.

Lock the back door again when you leave the vehicle. The back door will not lock automatically after it has been opened and then closed.

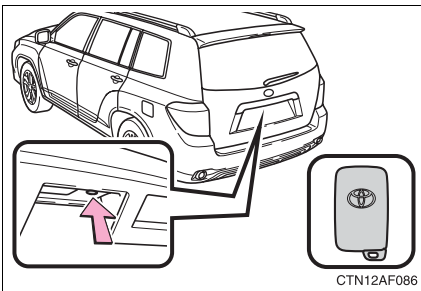

Press the button to lock the door.

## Opening the glass hatch

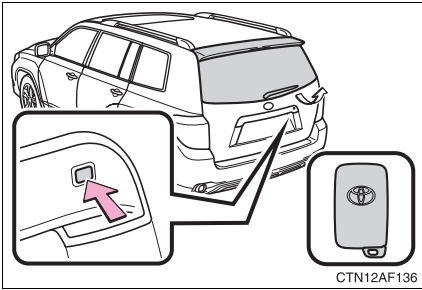

Press and hold the button to open the glass hatch. The glass hatch will pop up.

The glass hatch can be unlocked only when the back door is closed.

Lock the glass hatch again when you leave the vehicle. The glass hatch will not lock automatically after it has been opened and then closed.

## Antenna location and effective range

### ■ Antenna location

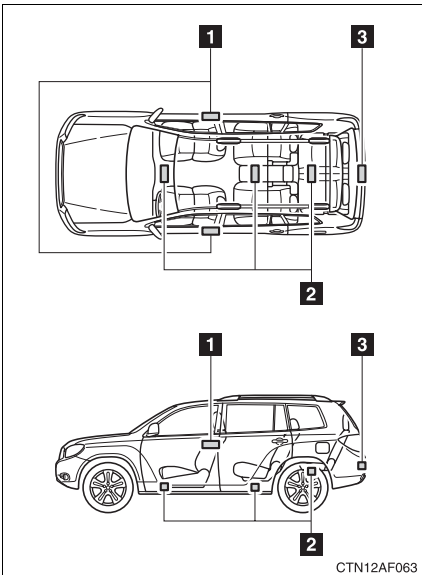

- 1 Antennas outside the cabin
- 2 Antennas inside the cabin
- 3 Antenna outside the luggage compartment

■ **Effective range (areas within which the electronic key is detected)**

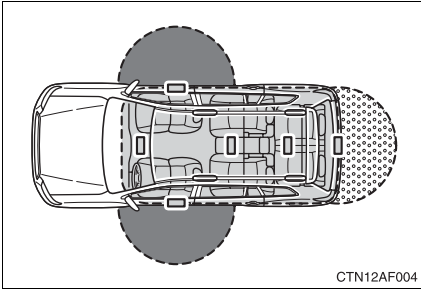

- When locking or unlocking the doors

The system can be operated when the electronic key is within about 2.3 ft. (0.7 m) of either of the outside front door handles.

- When starting the engine or changing “ENGINE START STOP” switch modes

The system can be operated when the electronic key is inside the vehicle.

- When opening the glass hatch and locking or unlocking the doors

This system can be operated when the electronic key is within about 2.3 ft. (0.7 m) of the back door handle.

### ■ Operation signals

A buzzer sounds and the emergency flashers flash to indicate that the doors have been locked/unlocked. (Locked: Once; Unlocked: Twice)

### ■ Conditions affecting operation

The smart key system uses weak radio waves. In the following situations, the communication between the electronic key and the vehicle may be affected, preventing the smart key system and wireless remote control from operating properly. (Ways of coping: →P. 539)





- When the electronic key battery is depleted
- Near a TV tower, electronic power plant, gas station, radio station, large display, airport or other facility that generates strong radio waves or electrical noise
- When carrying a portable radio, cellular phone, cordless phone or other wireless communication devices
- When the electronic key has come into contact with, or is covered by a metallic object
- When multiple electronic keys are in the vicinity
- When carrying or using the electronic key together with the following devices that emit radio waves
  - Another vehicle's electronic key
  - A wireless key that emits radio waves
  - Personal computer
- If window tint with a metallic content or metallic objects are attached to the rear window

### ■ Switching the door unlock function



It is possible to set which doors the entry function unlocks.

**STEP 1** Turn the "ENGINE START STOP" switch OFF.

**STEP 2** When the indicator on the key surface is turned off, push and hold

 ,  , or  for approximately 5 seconds while pushing  on the key.

The setting changes each time an operation is performed, as shown below. (When changing the setting continuously, release the buttons, wait for at least 5 seconds, and repeat step 2.)

Multi-information display	Unlocking doors	Beep
	Hold the driver's door handle to unlock only the driver's door.	Exterior: Beeps three times Interior: Pings once
	Hold the front passenger's door handle to unlock all doors.	
	Hold either front door handle to unlock all doors.	Exterior: Beeps twice Interior: Pings once

**STEP 3** Unlock the doors using the wireless remote control and open one of the doors.

If a door is not opened within 60 seconds after  is pressed, the doors will be locked again and the alarm will automatically be set.

In case that the alarm is triggered, immediately stop the alarm. (→P. 122)

### ■ Battery-saving function

In the following circumstances, the entry function is disabled in order to prevent the vehicle and electronic key batteries from discharging.

- When the entry function has not been used for 2 weeks or more
- When the electronic key has been left within approximately 3 ft. (1 m) of the vehicle for 10 minutes or more

The system will resume operation when...

- The vehicle is locked using the door handle lock button.
- The vehicle is locked/unlocked using the wireless remote control function. (→P. 54)
- The vehicle is locked/unlocked using the mechanical key. (→P. 539)

### ■ Electronic key battery depletion

- The standard battery life is 1 to 2 years. (The battery becomes depleted even if the electronic key is not used.) If the smart key system or the wireless remote control function does not operate, or the detection area becomes smaller, the battery may be depleted. Replace the battery when necessary. (→P. 473)
- To avoid serious deterioration, do not leave the electronic key within 3 ft. (1 m) of the following electrical appliances that produce a magnetic field.
  - TVs
  - Personal computers
  - Recharging cellular phones or cordless phones
  - Table lamps

### ■ To operate the system properly

Make sure to carry the electronic key when operating the system. Do not get the electronic key too close to the vehicle when operating the system from the outside of the vehicle.

Depending on the position and holding condition of the electronic key, the key may not be detected correctly and the system may not operate properly. (The alarm may go off accidentally, or the door lock prevention may not function.)

### ■ Note for the entry function

- Even when the electronic key is within the effective range (detection areas), the system may not operate properly in the following cases.
  - The electronic key is too close to the window or outside door handle, near the ground, or in a high place when the doors are locked or unlocked.
  - The electronic key is on the instrument panel, luggage cover, floor or in the glove box when the engine is started or “ENGINE START STOP” switch modes are changed.
- As long as the electronic key is within the effective range, the doors may be locked or unlocked by anyone.
- Even if the electronic key is not inside the vehicle, it may be possible to start the engine if the electronic key is near the window.



- The doors may unlock if a large amount of water splashes on the door handle, such as in the rain or in a car wash. (The doors will automatically be locked after approximately 60 seconds if the doors are not opened and closed.)
- Gripping the door handle when wearing a glove may not unlock the door.
- If the wireless remote control is used to lock the doors when the electronic key is near the vehicle, there is a possibility that the door may not be unlocked by the entry function. (Use the wireless remote control to unlock the doors.)

### ■ When the vehicle is not driven for extended periods

To prevent theft of the vehicle, do not leave the electronic key within 6 ft. (2 m) of the vehicle.

### ■ Security feature

If a door is not opened within approximately 60 seconds after the vehicle is unlocked, the security feature automatically locks the vehicle again.

### ■ Alarms and warning indicators

A combination of exterior and interior alarms as well as warning lights and warning messages shown on the multi-information display are used to reduce the chance of vehicle theft and accidents resulting from erroneous operation.

- When any warning lights come on:  
Take appropriate measures according to which warning light comes on. (→P. 510)
- When a warning message is shown on the multi-information display:  
Take appropriate measures according to the warning message on the multi-information display. (→P. 521)

## 1-2. Opening, closing and locking the doors

- When an alarm sounds:

Take appropriate measures according to the following table.

Alarm	Situation	Correction procedure
Exterior alarm sounds once for 2 seconds	Tried to lock the doors and the glass hatch using the entry function while the electronic key is still inside the passenger compartment.	Retrieve the electronic key from the passenger compartment and lock the doors and the glass hatch again.
	Tried to close the glass hatch with the electronic key inside and all doors were locked.	Retrieve the electronic key and close the glass hatch.
	Tried to exit the vehicle with the electronic key and lock the doors without first turning the "ENGINE START STOP" switch OFF.	Turn the "ENGINE START STOP" switch OFF and lock the doors again.
Exterior alarm sounds once for 10 seconds	Tried to lock the vehicle using the entry function while a door is open.	Close all of the doors and lock the doors again.
Interior alarm sounds continuously	Tried to open the door and exit the vehicle without shifting the shift lever to P.	Shift the shift lever to P.
Interior alarm beeps repeatedly	Switched to ACCESSORY mode while the driver's door is open. (Opened the driver's door when the "ENGINE START STOP" switch is in ACCESSORY mode.)	Turn the "ENGINE START STOP" switch OFF and close the driver's door.
	Turned the "ENGINE START STOP" switch OFF while the driver's door is open.	Close the driver's door.

Alarm	Situation	Correction procedure
Interior and exterior alarms sound continuously.*	Tried to close the driver's door after carrying the key outside the vehicle with the "ENGINE START STOP" switch in IGNITION ON or ACCESSORY mode and without the shift lever being in P.	Shift the shift lever to P, turn the "ENGINE START STOP" switch OFF and close the driver's door again.
Interior alarm beeps once.*	The electronic key has a low battery.	Replace the electronic key battery.
	Tried to start the engine without the electronic key being present, or when the electronic key was not functioning normally.	Start the engine with the electronic key present.
Interior alarm beeps once and exterior alarm sounds 3 times.*	Tried to close the driver's door after carrying the key outside the vehicle without turning the "ENGINE START STOP" switch OFF.	Turn the "ENGINE START STOP" switch OFF and close the driver's door again.
	An occupant carried the electronic key outside the vehicle and closed the door when the "ENGINE START STOP" switch was in IGNITION ON or ACCESSORY mode.	Bring the electronic key back into the vehicle.

\* : A message will be shown on the multi-information display.

### ■ If the smart key system does not operate properly

- Locking and unlocking the doors: Use the mechanical key. (→P. 539)
- Starting the engine. (→P. 539)

### ■ When the electronic key battery is fully depleted

→P. 473

■ **Customization that can be configured at Toyota dealer**

It is possible to deactivate the smart key system etc.  
(Customizable features →P. 582)

■ **Certification for the smart key system**

► For vehicles sold in the U.S.A.

FCC ID: NI4TMLF-3

**NOTE:**

This device complies with Part 15 of the FCC Rules. Operation is subject to the following two conditions: (1) This device may not cause harmful interference, and (2) this device must accept any interference received, including interference that may cause undesired operation.

**NOTICE:**

This equipment has been tested and found to comply with the limits for a Class B digital device, pursuant to Part 15 of the FCC Rules. These limits are designed to provide reasonable protection against harmful interference in a residential installation. This equipment generates, uses and can radiate radio frequency energy and, if not installed and used in accordance with the instructions, may cause harmful interference to radio communications. However, there is no guarantee that interference will not occur in a particular installation. If this equipment does cause harmful interference to radio or television reception, which can be determined by turning the equipment off and on, the user is encouraged to try to correct the interference by one or more of the following measures:

- Reorient or relocate the receiving antenna.
- Increase the separation between the equipment and receiver.
- Connect the equipment into an outlet on a circuit different from that to which the receiver is connected.
- Consult the dealer or an experienced radio/TV technician for help.

**FCC WARNING:**

Changes or modifications not expressly approved by the party responsible for compliance could void the user's authority to operate the equipment.

TCB

GRANT OF EQUIPMENT AUTHORIZATION

TCB

Certification Issued Under the Authority of the Federal Communications Commission By:

Underwriters Laboratories, Inc.- SantaClara 333 Pflingsten Road Northbrook, IL 60062 United States

Date of Grant: 06/29/2004

Application Dated: 06/29/2004

Denso Corporation 1-1, Showa-cho Kariya-shi, Aichi-ken, 448 Japan

Attention: Kazuo Sakakibara , General Manager

NOT TRANSFERABLE

EQUIPMENT AUTHORIZATION is hereby issued to the named GRANTEE, and is VALID ONLY for the equipment identified hereon for use under the Commission's Rules and Regulations listed below.

FCC IDENTIFIER: [REDACTED] Name of Grantee: Denso Corporation Equipment Class: Part 15 Security/Remote Control Transmitter Notes: Keyless Entry Vehicle Transmitter

Table with 5 columns: Grant Notes, FCC Rule Parts, Frequency Range (MHZ), Output Watts, Frequency Tolerance, Emission Designator. Row 1: 15.231, 315.0 - 315.0



1 Before driving

TCB

TCB

GRANT OF EQUIPMENT  
AUTHORIZATION  
Certification  
Issued Under the Authority of the  
Federal Communications Commission  
By:

British Approvals Board for  
Telecommunications - B  
Balfour House Churchfield Road  
Walton-on-Thames, Surrey, KT12 2TD

Date of Grant: 06/15/2005  
Application Dated: 06/15/2005

Toyota Motor Corporation  
1, Toyota-Cho  
Toyota Aichi, 471-71  
Japan

Attention: Kazumori Sakai, General Manager

NOT TRANSFERABLE

EQUIPMENT AUTHORIZATION is hereby issued to the named GRANTEE, and is  
VALID ONLY for the equipment identified hereon for use under the Commission's Rules  
and Regulations listed below.

FCC IDENTIFIER: NI4TMLR-3

Name of Grantee: Toyota Motor Corporation

Equipment Class: Part 15 Low Power Transmitter Below 1705 kHz

Notes: Smart LF Oscillator

<u>Grant Notes</u>	<u>FCC Rule Parts</u>	<u>Frequency Range (MHz)</u>	<u>Output Watts</u>	<u>Frequency Tolerance</u>	<u>Emission Designator</u>
	15C	0.1342 - 0.1342			

TCB

GRANT OF EQUIPMENT  
AUTHORIZATION

TCB

Certification  
Issued Under the Authority of the  
Federal Communications Commission  
By:

Underwriters Laboratories, Inc.-San Jose      Date of Grant: 12/07/2006  
333 Pflingsten Road  
Northbrook, IL 60062      Application Dated: 12/07/2006

Denso Corporation  
1-1, Showa-cho  
Kariya-shi, Aichi-ken, 448  
Japan

Attention: Kazuo Sakakibara , Senior Manager

NOT TRANSFERABLE

EQUIPMENT AUTHORIZATION is hereby issued to the named GRANTEE, and  
is VALID ONLY for the equipment identified hereon for use under the  
Commission's Rules and Regulations listed below.

FCC IDENTIFIER: **BY02225**  
Name of Grantee: **[REDACTED]**  
Equipment Class: **Communications Receiver used w/Pt 15**  
Notes: **Transmitter**  
**Vehicle Entry System Receiver**

Grant Notes	FCC Rule Parts	Frequency Range (MHZ)	Output Watts	Frequency Tolerance	Emission Designator
	15B	314.35 - 314.35			

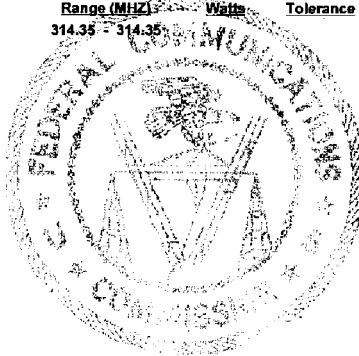

1  
Before driving

► For vehicles sold in Canada

**NOTE:**

Operation is subject to the following two conditions: (1) this device may not cause interference, and (2) this device must accept any interference, including interference that may cause undesired operation of the device.





**Certification & Engineering Bureau (ISO 9001)**

3701 carling Avenue  
Bldg.94  
P.O. Box 11490 Station "H"  
Ottawa, Ontario  
K2H 8S2

Tel No. (613) 990-4389  
Fax No. (613) 990-4752

July 30, 2004

Our File: 46390 -1551  
Submission No.: 101699  
Radio Cert. No.: 1551A-14AAB

**DENSO CORPORATION**

1-1, Showa-Cho, Kariya-Shi  
Aichi-Ken,  
448-8661 Japan

**Attention: Mr. Yasuhiro Shimizu**

Dear Sir/Madame,

I have reviewed the test report and related documents, and am pleased to advise that this device meets our procedural and specification requirements for certification. The field offices have been notified.

The assigned certification number and the model number must be shown on each equipment model. This certification identification information may be shown on the equipment model identification plate or on a separate label that shall be indelible and tamper proof. The certification number shall be prefixed with the letters "IC.". Radio equipment is certified as described on the attached certification certificate.

Certificate(s) are attached for the following model(s):

14AAB

A website has been established which includes the status of applications.  
The address is <http://spectrum.ic.gc.ca/~cert/>.

Sincerely

Daniel Sigouin  
Certification Officer  
Telecom Certification Section



1  
Before driving

## 1-2. Opening, closing and locking the doors



Industry  
Canada

Industrie  
Canada

Submission No. > 101699

### TECHNICAL ACCEPTANCE CERTIFICATE

### CERTIFICAT D'ACCEPTABILITÉ TECHNIQUE

CERTIFICATION No. > 1551A-14AAB  
No. DE CERTIFICATION

ISSUED TO > DENSO CORPORATION  
DÉLIVRÉ À

TYPE OF EQUIPMENT > Keyless Entry  
GENRE DE MATÉRIEL

TRADE NAME AND MODEL > 14AAB  
MARQUE ET MODÈLE

FREQUENCY RANGE BANDE DE FRÉQUENCES	EMISSION TYPE GENRE D'ÉMISSION	R.F. POWER PUISSANCE H.F.	SPECIFICATION/ ISSUE SPÉCIFICATION/ ÉDITION
314.3500 MHz	53K4A1D	400.00 mW	RSS210 5

Certification of equipment means only that the equipment has met the requirements of the above noted specifications. License applications, where applicable to use certified equipment, are acted on accordingly by the issuing office and will depend on the existing radio environment, service and location of operation.

L'homologation de matériel terminal signifie seulement qu'il est conforme aux exigences du cahier des charges mentionné ci-dessus. Les demandes de licence, le cas échéant en vue de l'utilisation de matériel certifié seront traitées en conséquence par le bureau chargé de délivrer les dites licences, en tenant compte du milieu radioélectrique ambiant, du service radio existant et de l'emplacement de la station.

This certificate is issued on condition that the holder complies and will continue to comply with the requirements of the radio standards specifications and procedures issued by the Department.

Le présent certificat est délivré à condition que le détenteur se conforme et continue à se conformer aux cahiers des charges et procédures sur les normes radioélectriques publiées par le ministère.

ISSUED UNDER THE AUTHORITY OF MINISTER OF INDUSTRY  
DÉLIVRÉ AVEC L'AUTORISATION DU MINISTRE DES INDUSTRIES

DATE July 30 2004

FOR

Bob Corey  
DIRECTOR GENERAL  
SPECTRUM ENGINEERING

DIRECTEUR GÉNÉRAL  
GÉNIE DU SPECTRE

Canada



**Underwriters Laboratories Inc.®**

Underwriters Laboratories Inc.  
333 Pfingsten Road  
Northbrook, IL 60062-2096 USA  
Phone: +1-847-272-5800  
Fax: +1-847-272-8129

## Certificate of Compliance to Industry Canada Radio Equipment Requirements

<b>Certificate Holder Company Name:</b>	Densu Corporation	<b>IC Certification Number:</b>	1551A-13BZS
<b>Certificate Holder Address:</b>	1-1 Showa-cho, Kariya-shi Aichi-ken 448-8661 JAPAN		
<b>Equipment Category:</b>	Vehicle Entry System receiver		
<b>Model Designation:</b>	13BZS	<b>Emission Designation (TRC-43):</b>	N/A
<b>Standard Number:</b>	RSS-210	<b>Standard Issue</b>	Issue 6, September 2005
	RSS-GEN	<b>Date/Edition:</b>	Issue 1, September 2005
<b>Frequency Range of Device:</b>	314.35 MHz	<b>RF Output:</b>	N/A <input type="checkbox"/> <b>Conducted</b> <input type="checkbox"/> <b>Field Strength</b>
<b>Antenna Type:</b>	Built-in (fixed)	<b>Connection Type:</b>	Integral <b>Gain:</b> N/A
<b>Test Laboratory Name:</b>	UL Apex Co., Ltd.		
<b>Test Laboratory Address:</b>	4383-326 Asama-cho Ise-shi, Mie-ken 516-0021, Japan		
<b>Test Laboratory Company Number:</b>	4247A		
<b>Test Laboratory Contact Person:</b>	Naoki Sakamoto		
<b>Test Laboratory Phone Number:</b>	81-596-24-8116		
<b>Test Laboratory Fax Number:</b>	81-596-24-8124		
<b>Test Laboratory Email Address:</b>	Naoki.Sakamoto@jp.ul.com		

Certification of equipment means only that the equipment has met the requirements of the above noted specification. License applications, where applicable to use certified equipment, are acted on accordingly by the issuing office and will depend on the existing radio environment, service and location of operation.

This certificate is issued on condition that the holder complies and will continue to comply with requirements and procedures issued by Industry Canada.

Certified equipment shall not be distributed, leased, sold, or offered for sale in Canada before the details of the certification have been added to the Industry Canada Certification and Engineering Bureau's Radio Equipment List (REL) located on their Website at <http://strategis.ic.gc.ca/app/sit/retel/search/newRadioSearch.do?language=eng>.

Authorized Signature:

Jack Steiner  
Section Manager  
International EMC Services

Date: December 7, 2006

R3CB - ICCC CB Program Certification Certificate  
0670-00020 - Issue 1.4

TÜV America Inc  
Foreign Certification Body (FCB)  
20040 Mesa Rim Road  
San Diego, CA 92121

Phone: (858) 878 1400  
Fax: (858) 548-0384  
E-mail: fcb@tuvam.com  
Industry Canada Company Number 9097  
www.TUVamerica.com/fcb



## FCB TECHNICAL ACCEPTANCE CERTIFICATE

**CERTIFICATE No.:** T25911-00-03AA  
**ISSUE DATE:** 28 June 2005  
**ISSUED TO:** **TOYOTA MOTOR CORPORATION**  
1 Toyota-Cho  
Toyota Aichi  
471-8572 JAPAN

**Equipment Category:** Vehicle Device  
**Trade Name and Model No.:** TMLF-3  
**Frequency Range:** 134.2 kHz  
**Emission Designator:** A1D  
**RF Power Rating:** 63.25 microWatts  
**Antenna Information:** Integral  
**Type of Modulation:** AM  
**Test Lab and IC No.:** MIKES BABT Product Service GmbH  
Ohmstrasse 2-4  
94342 Strasskirchen  
GERMANY  
Klaus Gegenfurtner; klaus.gegenfurtner@mikes-germany.de  
Phone: 0049 9424 9407 37; Fax: 0049 9424 9407 60; IC ID: 3009

**IC Company No., UPN and Filing Type:** 2842A-TMLF3  
Stg1e  
**IC Radio Standards:** RSS-210, Issue 5, November 2001

  
\_\_\_\_\_  
Technical Certifier

27 June 2005  
\_\_\_\_\_  
Date

Certification of equipment means only that the equipment fits the requirements of the above noted specification. License applications, where applicable to use certified equipment are ruled on accordingly by the issuing office and will depend on the existing radio environment, service and location of operation. This certificate is issued on condition that the holder complies and will continue to comply with requirements and procedures issued by Industry Canada.

Issued by TÜV America, Inc. FCB per IC recognition under the terms of the APEC MRA, PHASE II, and REC-C&L.

NOTE: Certified equipment that is not distributed, leased, sold, offered for sale in Canada before the details of the certification have been added to the REL (Rev. 2, 5/20/04)

 **CAUTION****■ Caution regarding interference with electronic devices**

● People with implanted pacemakers or cardiac defibrillators should keep away from the smart key system antennas. (→P. 36) The radio waves may affect the operation of such devices. If necessary, the entry function can be disabled. Ask your Toyota dealer for details, such as the frequency of radio waves and timing of emitting the radio waves. Then, consult your doctor to see if you should disable the entry function.

● User of any electrical medical device other than implanted pacemakers and implanted cardiac defibrillators should consult the manufacturer of the device for information about its operation under the influence of radio waves.

Radio waves could have unexpected effects on the operation of such medical devices.

Ask your Toyota dealer for details for disabling the entry function.

## 1-2. Opening, closing and locking the doors

### Wireless remote control

The wireless remote control can be used to lock and unlock the vehicle from outside the vehicle.

► Vehicles without smart key system (type A)

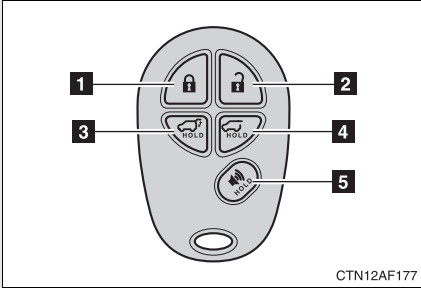

**1** Locks all doors

**2** Unlocks all doors

Pressing the button unlocks the driver's door. Pressing the button again within 3 seconds unlocks the other doors.

**3** Pushing and holding: Opens and closes the power back door

**4** Pushing and holding: Opens the glass hatch

The glass hatch can be opened only when the back door is closed.

**5** Pushing and holding: Sounds alarm

► Vehicles without smart key system (type B)

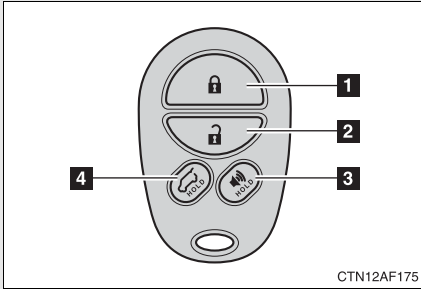

**1** Locks all doors

**2** Unlocks all doors

Pressing the button unlocks the driver's door. Pressing the button again within 3 seconds unlocks the other doors.

**3** Pushing and holding:  
Sounds alarm

**4** Pushing and holding:  
Opens the glass hatch  
(vehicles with glass hatch)

The glass hatch can be opened only when the back door is closed.

► Vehicles with smart key system

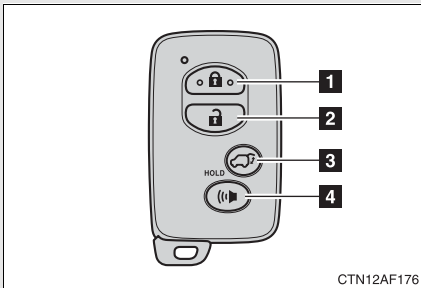

**1** Locks all doors

**2** Unlocks all doors

Pressing the button unlocks the driver's door. Pressing the button again within 3 seconds unlocks the other doors.

**3** Pushing and holding:  
Opens and closes the  
power back door  
(vehicles with power back door)

**4** Pushing and holding:  
Sounds alarm

## ■ Operation signals

**Doors:** A buzzer sounds and the emergency flashers flash to indicate that the doors have been locked/unlocked. (Locked: Once; Unlocked: Twice)

**Back door:** A buzzer sounds and the emergency flashers flash twice to indicate that the back door has been opened/closed.

## ■ Panic mode

### ► Vehicles without smart key system

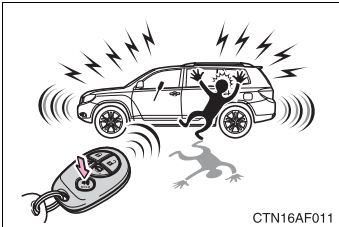

When  is pushed for longer than about one second, an alarm will sound for about 60 seconds and the vehicle lights will flash to deter any person from trying to break into or damage your vehicle.

To stop the alarm, push any button on the wireless remote control.

### ► Vehicles with smart key system



When  is pushed for longer than about one second, an alarm will sound for about 60 seconds and the vehicle lights will flash to deter any person from trying to break into or damage your vehicle.

To stop the alarm, push any button on the wireless remote control.

## ■ Door lock buzzer

If a door is not fully closed, a buzzer sounds continuously if an attempt to lock the door is made. Fully close the door to stop the buzzer, and lock the vehicle once more.



### ■ Key battery depletion

- ▶ Vehicles without smart key system

The standard battery life is 1 to 2 years. (The battery becomes depleted even if the key is not used.) If the wireless remote control function does not operate, the battery may be depleted. Replace the battery when necessary. (→P. 472)

- ▶ Vehicles with smart key system  
→P. 473

### ■ If the wireless remote control does not operate properly

- ▶ Vehicles without smart key system

Locking and unlocking the doors: Use the key. (→P. 66)

- ▶ Vehicles with smart key system

- Locking and unlocking the doors: Use the mechanical key. (→P. 539)
- Starting the engine. (→P. 173)

### ■ Security feature

If a door is not opened within approximately 60 seconds after the vehicle is unlocked, the security feature automatically locks the vehicle again.

### ■ Alarm

Using the wireless remote control to lock the doors will set the alarm system. (→P. 122)

### ■ Conditions affecting operation

#### ▶ Vehicles without smart key system

The wireless remote control function may not operate normally in the following situations.

- Near a TV tower, radio station, electric power plant, airport or other facility that generates strong radio waves
- When carrying a portable radio, cellular phone or other wireless communication device
- When multiple wireless keys are in the vicinity
- When the wireless key has come into contact with, or is covered by a metallic object
- When a wireless key (that emits radio waves) is being used nearby
- When the wireless key has been left near an electrical appliance such as a personal computer

#### ▶ Vehicles with smart key system

→P. 38

### ■ Customization that can be configured at Toyota dealer

Settings (e.g. wireless remote control) can be changed.

(Customizable features →P. 582)

### ■ Reversing the operation of the power back door

Pressing the wireless remote control switch again while the power back door is operating will cause the operation to reverse. However, the reverse operation cannot be performed for the first second after automatic operation starts, even if the wireless remote control switch is pressed again.

### ■ When riding in an aircraft (vehicle without smart key system)

When bringing a wireless remote control onto an aircraft, make sure you do not press any buttons on the wireless remote control while inside the aircraft cabin. If you are carrying a wireless remote control in your bag etc, ensure that the buttons are not likely to be pressed accidentally. Pressing a button may cause the wireless remote control to emit radio waves that could interfere with the operation of the aircraft.

## ■ Certification for wireless remote control

► For vehicles sold in the U.S.A.

### NOTE:

This device complies with Part 15 of the FCC Rules. Operation is subject to the following two conditions: (1) This device may not cause harmful interference, and (2) this device must accept any interference received, including interference that may cause undesired operation.

### NOTICE:

This equipment has been tested and found to comply with the limits for a Class B digital device, pursuant to Part 15 of the FCC Rules. These limits are designed to provide reasonable protection against harmful interference in a residential installation. This equipment generates, uses and can radiate radio frequency energy and, if not installed and used in accordance with the instructions, may cause harmful interference to radio communications. However, there is no guarantee that interference will not occur in a particular installation. If this equipment does cause harmful interference to radio or television reception, which can be determined by turning the equipment off and on, the user is encouraged to try to correct the interference by one or more of the following measures:

- Reorient or relocate the receiving antenna.
- Increase the separation between the equipment and receiver.
- Connect the equipment into an outlet on a circuit different from that to which the receiver is connected.
- Consult the dealer or an experienced radio-TV technician for help.

### FCC WARNING:

Changes or modifications not expressly approved by the party responsible for compliance could void the user's authority to operate the equipment.

TCB

GRANT OF EQUIPMENT  
AUTHORIZATION  
Certification  
Issued Under the Authority of the  
Federal Communications  
Commission  
By:

TCB

American TCB, Inc.  
6731 Whittier Avenue  
Suite C110  
McLean, VA 22101

Date of Grant: 09/30/2002

Application Dated: 09/30/2002

TRW Inc  
24175 Research Drive  
Farmington Hills, MI 48335-2642  
Attention: Kim App

NOT TRANSFERABLE

EQUIPMENT AUTHORIZATION is hereby issued to the named GRANTEE, and is VALID ONLY for the equipment identified hereon for use under the Commission's Rules and Regulations listed below.

FCC IDENTIFIER: [REDACTED]

Name of Grantee: [REDACTED]

Equipment Class: Part 15 Security/Remote Control Transmitter

Notes: Automotive Remote Control

Grant Notes

FCC Rule Part	Frequency Range (MHZ)	Output Watts	Frequency Tolerance	Emission Designator
15.231	315 - 315			

**TCB**

**GRANT OF EQUIPMENT  
AUTHORIZATION**

**TCB**

**Certification**  
Issued Under the Authority of the  
Federal Communications Commission  
By:

American TCB, Inc.  
6731 Whitfier Avenue Suite C110  
McLean, VA 22101  
United States

Date of Grant: 08/10/2004  
Application Dated: 08/10/2004

TRW Inc  
24175 Research Drive  
Farmington Hills, MI 48335-2642  
United States

Attention: Kim App , Design Engineer

**NOT TRANSFERABLE**

EQUIPMENT AUTHORIZATION is hereby issued to the named GRANTEE, and is VALID ONLY for the equipment identified hereon for use under the Commission's Rules and Regulations listed below.

FCC IDENTIFIER: **G0434B**  
Name of Grantee: **TRW Inc**  
Equipment Class: **Communications Receiver used w/PI 15 Transmitter**  
Notes: **Automotive Security/Convenience Receiver**

Grant Notes

<u>FCC Rule Parts</u>	<u>Frequency Range (MHZ)</u>	<u>Output Watts</u>	<u>Frequency Tolerance</u>	<u>Emission Designator</u>
15B	315.0 - 315.0			

1

Before driving

► For vehicles sold in Canada

**NOTE:**

Operation is subject to the following two conditions: (1) this device may not cause interference, and (2) this device must accept any interference, including interference that may cause undesired operation of the device.

Industry  
Canada / Industrie  
Canada

No. ► 16836

TECHNICAL ACCEPTANCE  
CERTIFICATECERTIFICAT D'ACCEPTABILITÉ  
TECHNIQUE

CERTIFICATION NO. NO. DE CERTIFICATION	►	1470A-1T		
ISSUED TO DELVRE A	►	TRW INC.		
TYPE OF EQUIPMENT GENRE DE MATERIEL	►	LOW POWER TRANSMITTER		
TRADE NAME AND MODEL MARQUE ET MODELE	►	500N592N (TX)		
FREQUENCY RANGE BANDE DE FREQUENCES	►	299 MHz to 320 MHz		
EMISSON DESIGNATION DESIGNATION DEMISSION	►	225KA1D		
R.F. POWER RATING PUSSANCE NOMINALE H.F.	►	4 uWatt		
CERTIFIED TO CERTIFIE SELON LE	►	SPECIFICATION CAHER DES CHARGES	RSS210	ISSUE 5 EDITION

Certification of equipment means only that the equipment has met the requirements of the above noted specifications. License applications, where applicable to use certified equipment, are acted on accordingly by the issuing office and will depend on the existing radio environment, service and location of operation.

This certificate is issued on condition that the holder complies and will continue to comply with the requirements of the radio standards specifications and procedures issued by the Department.

ISSUED UNDER THE AUTHORITY OF MINISTER OF INDUSTRY  
DELVRE AVEC L'AUTORISATION DU MINISTRE DES INDUSTRIES

DATE October 1, 2002

L'homologation de matériel terminal signifie seulement qu'il est conforme aux exigences du cahier des charges mentionné ci-dessus. Les demandes de licences, le cas échéant en vue de l'utilisation de matériel certifié seront traitées en conséquence par le bureau chargé de délivrer lesdites licences, en tenant compte du milieu radioélectrique ambiant, du service radio existant et de l'emplacement de la station.

Le présent certificat est délivré à condition que le détenteur se conforme et continue de se conformer aux cahiers des charges et procédures sur les normes radioélectriques publiées par le ministère.

FOR

DIRECTOR GENERAL  
SPECTRUM  
ENGINEERING  
BRANCH

DIRECTEUR GÉNÉRAL  
GÉNÉ  
DU SPECTRE

Canada



American Telecommunications Certification Body Inc.  
6731 Whittier Ave, McLean, VA 22101

August 19, 2004

Our Ref: ATCB001565

**TRW Inc.**  
24175 Research Drive  
Farmington Hills, MI  
48335-2642 USA

**Attention: Keith Fraley**

Dear Sir/Madame:

American TCB has reviewed the related documents and is pleased to advise that this application meets Industry Canada's procedural and specification requirements for certification. Copies of the original submission documents should be maintain for 10 years.

The assigned certification number must be shown on each equipment model. This certification identification information may be shown on the equipment model identification plate or on a separate label that shall be indelible and tamper proof. The certification number shall be prefixed with the letters "IC:". The radio equipment is certified as described on the attached certificate(s).

We have notified the Bureau so they may record this equipment in the Department's Radio Equipment List (REL). Please note that certified equipment shall not be distributed, leased, sold, or offered for sale in Canada before the details of the certification appear in the REL. Status of this listing in the Industry Canada's REL list may be found at the following web address:

[http://strategis.ic.gc.ca/cgi-bin/sc\\_mrksv/spectrum/reTelSearch/search.pl?lang=e&db=rel](http://strategis.ic.gc.ca/cgi-bin/sc_mrksv/spectrum/reTelSearch/search.pl?lang=e&db=rel)

Sincerely,

William H. Graff  
President and Director of Engineering

080304-9





American Telecommunications Certification Body Inc.  
6731 Whittier Ave, McLean, VA 22101

REF No. ► ATCB001565

**TECHNICAL ACCEPTANCE  
CERTIFICATE**

**CERTIFICAT D'ACCEPTABILITÉ  
TECHNIQUE**

CERTIFICATION No. No. DE CERTIFICATION	► 1470A-6R		
ISSUED TO DÉLIVRÉ À	► TRW Inc. 24175 Research Drive Farmington Hills, MI 48335-2642 USA		
TYPE OF EQUIPMENT TYPE DE MATÉRIEL	► Receiver, Vehicular Device		
TRADE NAME AND MODEL MARQUE ET MODÈLE	► 500N		
FREQUENCY RANGE BANDE DE FRÉQUENCES	► 315 MHz		
EMISSION DESIGNATION DESIGNATION D'ÉMISSION	► N/A		
R.F. POWER RATING PUISSANCE NOMINALE H.F.	► N/A		
ANTENNA ANTENNE	► Integral		
TEST LABORATORY LABORATOIRE D'ESSAI	► University of Michigan / EECS 3228 EECS Building 1301 Beal Avenue Ann Arbor, Michigan 48109-2122 USA	SITE NUMBER NUMÉRO DE SITE	► 2057
CERTIFIED TO CERTIFIÉ SELON LE	► SPECIFICATION CAHIER DES CHARGES	RSS-210	ISSUE 5 as Amended ÉDITION

Certification of equipment means only that the equipment has met the requirements of the above noted specification. License applications, where applicable to use certified equipment, are acted on accordingly by the issuing office and will depend on the existing radio environment, service and location of operation.

This certificate is issued on condition that the holder complies and will continue to comply with the requirements of the radio standards specifications and procedures issued by Industry Canada.

DATE OF ISSUE: August 10, 2004  
Revised on August 19, 2004

L'homologation de matériel terminal signifie seulement qu'il est conforme aux exigences du cahier des charges mentionné ci-dessus. Les demandes de licence, le cas échéant en vue de l'utilisation de matériel certifié seront traitées en conséquence par le bureau chargé de délivrer lesdites licences, en tenant compte du milieu radioélectrique ambiant, du service radio existant et de l'emplacement de la station.

Le présent certificat est délivré à condition que le détenteur se conforme et continue à se conformer aux cahiers des charges et procédures sur les normes radioélectriques publiées par l'industrie Canada.

William H. Graff  
President and Director of Engineering

080304-9

1  
Before driving

## Side doors

The vehicle can be locked and unlocked using the entry function, wireless remote control, key or door lock switch.

■ **Entry function (vehicles with smart key system)**

→P. 33

■ **Wireless remote control**

→P. 54

■ **Key**

▶ **Vehicles without smart key system**

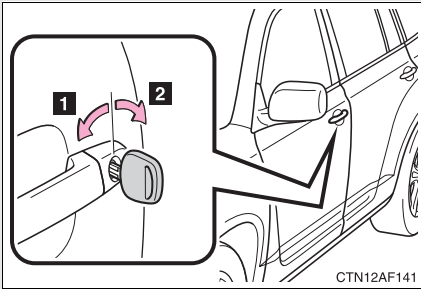

**1** Locks all doors

**2** Unlocks all doors

Turning the key unlocks the driver's door. Turning the key again unlocks the other doors.

▶ **Vehicles with smart key system**

The doors can also be locked and unlocked with the mechanical key. (→P. 539)

### ■ Door lock switch

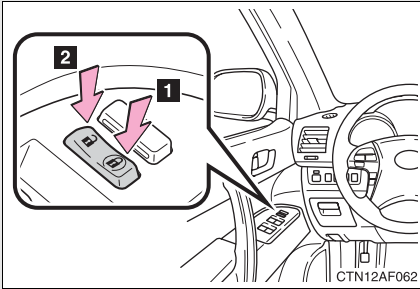

- 1** Locks all doors
- 2** Unlocks all doors

### ■ Inside lock button

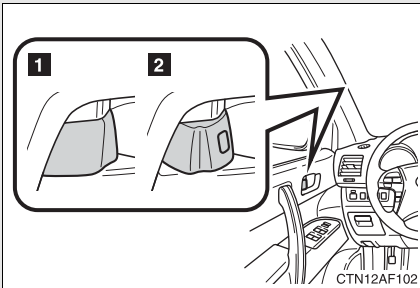

- 1** Locks the door
- 2** Unlocks the door

Pulling the door handle can open the front door even if the lock button is in the lock position.

### Rear door child-protector lock

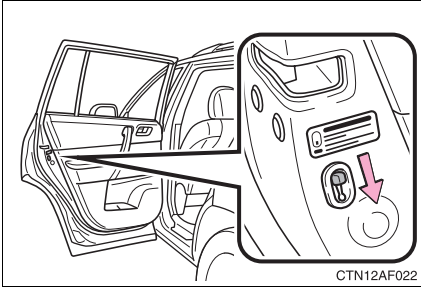

The door cannot be opened from inside the vehicle when the lock is set.

These locks can be set to prevent children from opening the rear doors. Push down on each rear door switch to lock both rear doors.

### Automatic door locking and unlocking systems

The following functions can be set or cancelled:

Function	Operation
Shift position linked door locking function	Shifting the shift lever out of P locks all doors.
Shift position linked door unlocking function	Shifting the shift lever to P unlocks all doors.

#### ■ Setting and canceling the functions

To switch between setting and canceling, follow the procedure below:

**STEP 1** Vehicles without smart key system:

Close all the doors and switch the engine switch to the “ON” position. (Perform step 2 within 10 seconds.)

Vehicles with smart key system:

Close all the doors and switch the “ENGINE START STOP” switch to IGNITION ON mode. (Perform step 2 within 10 seconds.)

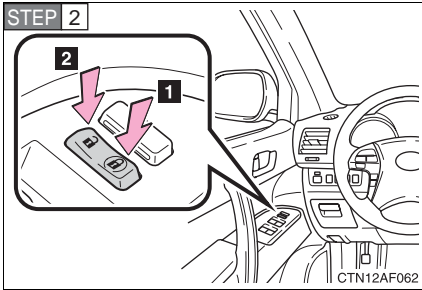

Shift the shift lever to P or N, and press and hold the driver's door lock switch (1 or 2) for approximately 5 seconds and then release it.

The shift lever and switch positions corresponding to the desired function to be set or canceled are shown in the following table.

Function	Shift lever position	Switch position
Shift position linked door locking function	P	1
Shift position linked door unlocking function		2

When the setting or canceling operation is complete, all doors are locked and then unlocked.

■ **When locking the doors using the key**

▶ Vehicles without smart key system

The door cannot be locked if the key is in the engine switch.

▶ Vehicles with smart key system

The door cannot be locked if the “ENGINE START STOP” switch is in ACCESSORY or IGNITION ON mode, or the electronic key is left inside the vehicle.

Depending on the position of the electronic key, the key may not be detected correctly and the door may be locked.

■ **Customization that can be configured at Toyota dealer**

Settings (e.g. door unlocking function) can be changed.  
(Customizable features →P. 582)

 CAUTION

■ **To prevent an accident**

Observe the following precautions while driving the vehicle.

Failing to do so may result in a door opening and an occupant falling out, resulting in death or serious injury.

- Always use a seat belt.
- Always lock the doors.
- Ensure that all doors are properly closed.
- Do not pull the inside handle of the doors while driving.

The doors may be opened and the passengers are thrown out of the vehicle and it may result in serious injury or death.

Be especially careful for the front doors, the doors may be opened even if the inside lock buttons are in locked position.

- Set the rear door child protector locks when children are seated in the rear seats.

## 1-2. Opening, closing and locking the doors

### Back door

The back door can be locked/unlocked and opened by the following procedures.

#### ■ Locking and unlocking the back door

##### ▶ Door lock switch

→P. 67

##### ▶ Entry function (vehicles with smart key system)

→P. 34

##### ▶ Wireless remote control

→P. 54

##### ▶ Key

→P. 66

#### ■ Opening the back door from the outside the vehicle

##### ▶ Back door opener

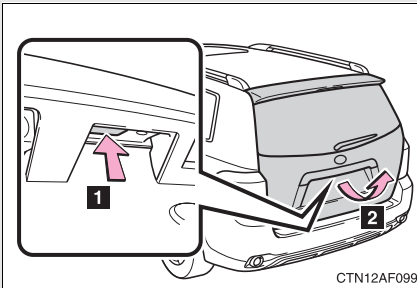

**1** Push up

**2** Raise

##### ▶ Wireless remote control (vehicles with power back door)

→P. 54

■ **Opening the back door from the inside the vehicle (vehicles with power back door)**

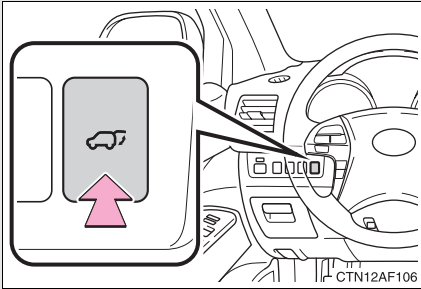

Push and hold the switch to open/close.

Pushing the switch again while the power back door is operating will cause the operation to reverse.

However, the reverse operation cannot be performed for the first second after pushing the switch to operate the door.

**Power back door switch (vehicles with power back door)**

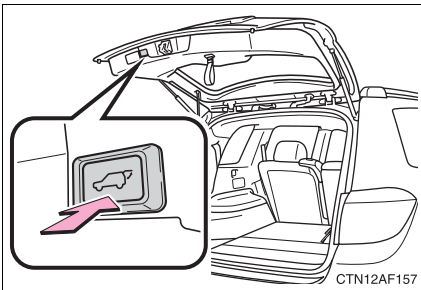

Push the switch to close.

Pushing the switch again while the power back door is closing will cause it to open again.

However, the reverse operation cannot be performed for the first second after pushing the switch to close the door.

A buzzer sounds and the emergency flashers flash twice to indicate that the back door has been opened/closed.

The back door can be opened even if it is locked. Lock the back door again when you leave the vehicle. The back door will not lock automatically after it has been opened and then closed.



**Canceling the power back door system (vehicles with power back door)**

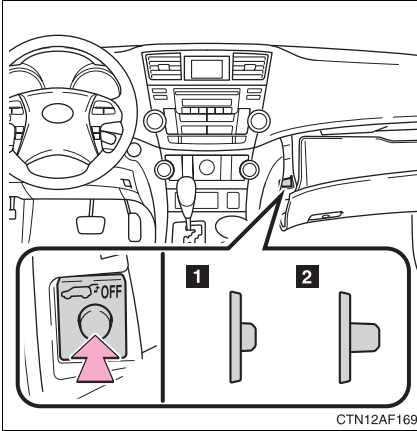

Turn the main switch in the glove box off to disable the power back door system.

**1** On

**2** Off

The back door cannot be opened even with the wireless remote control or power back door switch.

1

Before driving

**■ Back door strap**

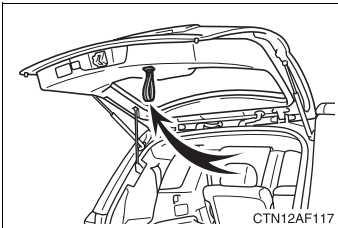

Use the strap when closing.

■ **If the back door opener is inoperative**

The back door can be operated from the inside.

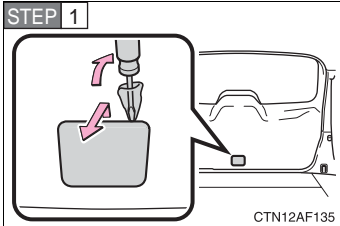

Remove the cover.

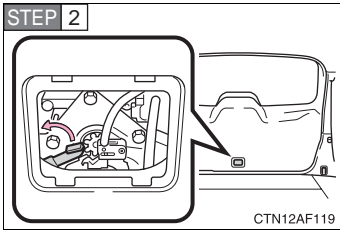

Turn the lever.

■ **The power back door can be opened when**

- The “ENGINE START STOP” switch is in IGNITION ON mode, and the shift lever is in P.
- The “ENGINE START STOP” switch is in OFF or in ACCESSORY mode.

The power back door can be opened even when the glass hatch is opened. The glass hatch will not be closed when the power back door is being closed. Close the glass hatch manually.

■ **Jam protection function (vehicles with power back door)**

If anything obstructs the power back door while it is closing/opening, the back door will automatically operate in the opposite direction.

■ **If the power back door does not work**

The back door must be initialized. To initialize, close the back door completely by hand.

■ **Back door closer (vehicles with power back door)**

In the event that the back door is left slightly open, the back door closer will automatically close it to the fully closed position.

■ **Fall-down protection function (vehicles with power back door)**

While the power back door is opening automatically, applying excessive force to it will stop the opening operation to prevent the power back door from rapidly falling down.

■ **Customization that can be configured at Toyota dealer**

Settings (e.g. wireless remote control) can be changed.  
(Customizable features →P. 582)

 **CAUTION**

Observe the following precautions.  
Failure to do so may result in death or serious injury.

■ **Caution while driving**

Keep the back door closed.

If the back door is open, the luggage will be thrown out and exhaust gases will enter the vehicle.

■ **Operating the power back door**

- Check to make sure that passengers do not have any part of their body in a position where it could be caught or hit when the back door is being operated.
- Careful attention is needed so as not to get your fingers trapped as the back door automatically closes when it has not been fully closed.
- Do not allow children to operate the back door.  
Closing the back door on someone can cause serious injury, and in some instances, even death.

 CAUTION

■ **Jam protection function (vehicles with power back door)**

- Never try jamming any part of your body to activate the jam protection function intentionally.
- The jam protection function may not work if something gets caught just before the back door is fully closed.

 NOTICE

■ **To prevent damage to the back door components**

- Do not apply any force, paint or let any other foreign matter on the damper.
- Do not apply excessive force when the back door closer is operating.
- Make sure there is nothing in the doorway before closing.

## Glass hatch\*

The glass hatch can be opened using the glass hatch opener or wireless remote control.

■ **Wireless remote control (vehicles without smart key system)**

→P. 54

■ **Entry function (vehicles with smart key system)**

→P. 34

■ **Glass hatch opener**

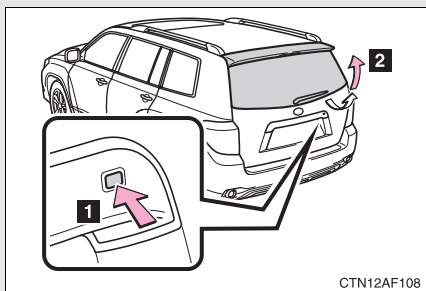

**1** Press and hold the button to pop up the glass hatch.

**2** Raise

The glass hatch can be opened only when the back door is closed.

The glass hatch cannot be opened when the back door is locked. Unlock the back door to open the glass hatch.

(→P. 54)

■ **Opening and closing the glass hatch**

- Make sure that the rear wiper is switched off.
- Do not rotate the rear wiper arm while the glass hatch is opening. (If the rear wiper arm is rotated, close the glass hatch as it is then switch on the wiper. The rear wiper arm will return to the correct position automatically after wiping.)
- Make sure that the back door is closed before closing the glass hatch.

\*: If equipped

**! CAUTION**

**■ Operating the glass hatch**

- Do not open the glass hatch while the vehicle is moving.
- Do not open the glass hatch while the rear wiper is switched on. (If the rear wiper is switched on while the glass hatch is opening, the wiper motor drive disc is swinging at the door panel.)

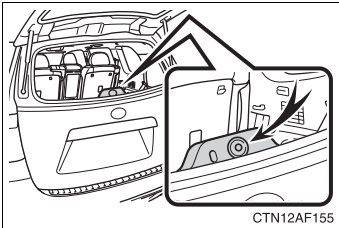

- Do not insert any object in the wiper motor drive disc.

- Do not close the glass hatch while the rear wiper is switched on. The rear wiper arm must be restarted suddenly after closing the glass hatch.

If as above are not follow, it may be interfered with you then hurt you.

**■ Caution while driving**

Keep the back door and glass hatch closed.

This not only keeps the luggage from being thrown out but also prevents exhaust gases from entering the vehicle.

# 1-3. Adjustable components (seats, mirrors, steering wheel)

## Front seats

### ► Manual seat

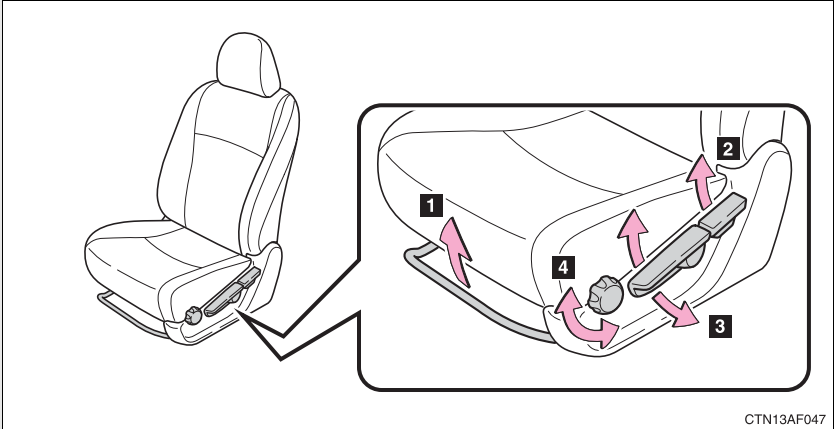

CTN13AF047

- 1** Seat position adjustment lever
- 2** Seatback angle adjustment lever
- 3** Vertical height adjustment lever (driver's side only)
- 4** Seat cushion (front) angle adjustment knob (driver's side only)

Pull up the lever until the lock is completely released.

► Power seat

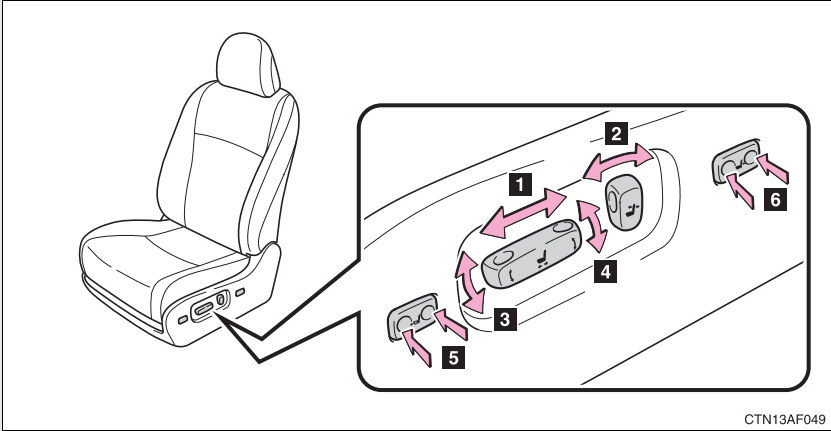

- 1 Seat position adjustment switch
- 2 Seatback angle adjustment switch
- 3 Seat cushion (front) angle adjustment switch (driver's side only)
- 4 Vertical height adjustment switch (driver's side only)
- 5 Driver's seat leg support adjustment switch (if equipped)
- 6 Seat lumbar support adjustment switch (driver's side only)

**Active head restraints**

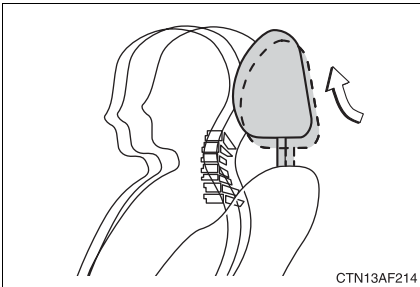

When the occupant's lower back presses against the seatback during a rear-end collision, the head restraint moves slightly forward and upward to help reduce the risk of whiplash on the seat occupant.



### ■ Active head restraints

Even small forces applied to the seatback may cause the head restraint to move. Pushing up a locked head restraint forcibly may appear the head restraint inner structure. These do not indicate problems.

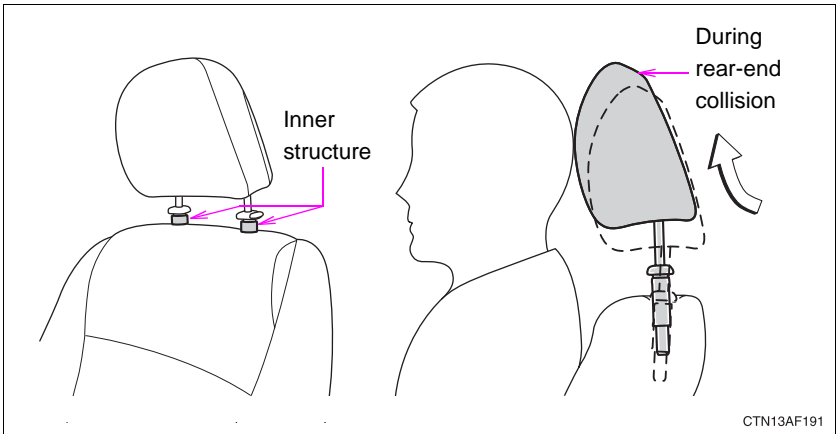

### ⚠ CAUTION

#### ■ Seat adjustment

- Be careful that the seat does not hit passengers or luggage.
- Do not recline the seat more than necessary when the vehicle is in motion to reduce the risk of sliding under the lap belt.  
If the seat is too reclined, the lap belt may slide past the hips and apply restraint forces directly to the abdomen or your neck may contact the shoulder belt, increasing the risk of death or serious injury in the event of an accident.
- Manual seat only: After adjusting the seat, make sure that the seat is locked in position.

## Rear seats

### ■ Second seats

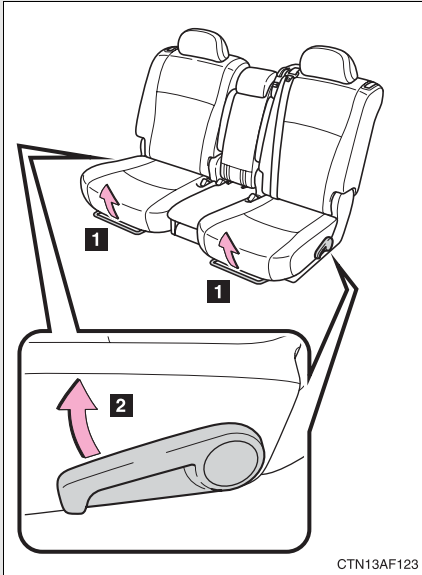

**1** Seat position adjustment lever

**2** Seatback angle adjustment lever

Pull up the lever until the lock is completely released.

### ■ Third seats (if equipped)

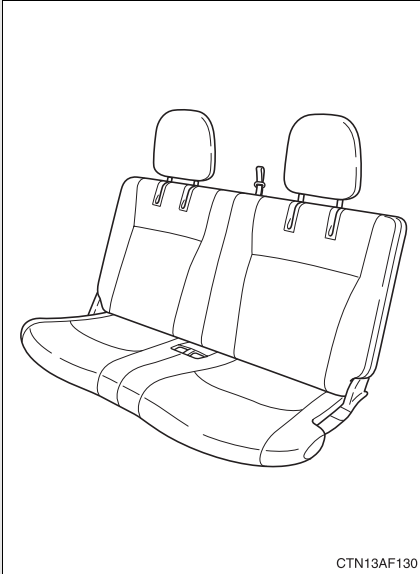

The third seats do not have a seat adjustment function.

### Moving a second seat for third seats access (vehicles with third seats)

#### ■ Getting in the vehicle (right side only)

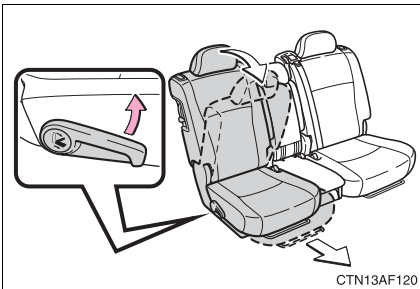

Pull up the lever and fold down the seatback. The seat will slide forward.

Move the seat to the front-most position.

■ **Getting out of the vehicle (right side only)**

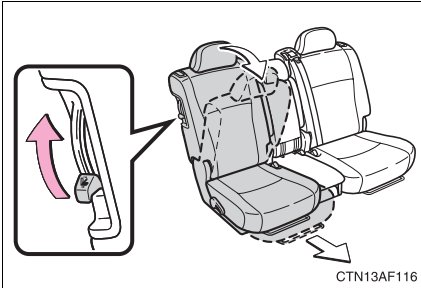

Lift the lever on the side of the seatback and fold down the seatback. The seat will slide forward.

Move the seat to the front-most position.

■ **After passengers have entered/exited the vehicle**

Lift up the seatback and slide the seat backward until it locks.

**Folding down the second seats**

■ **Before folding down the second seats**

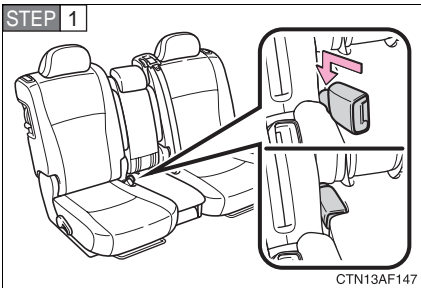

Stow the rear center seat belt buckle.

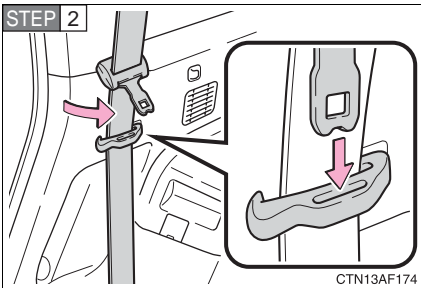

Pass the outer seat belts through the seat belt hangers and secure the seat belt plates.

This prevents the shoulder belt from being damaged.

Make sure that the seat belts are removed from the hangers before using them.

### ■ Folding down the second seats

#### ▶ From inside

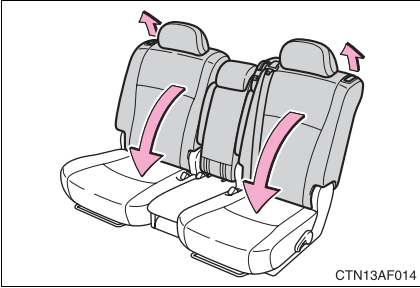

Pull the lever to unlock the seat-back and then fold the seatback down.

#### ▶ From outside (if equipped)

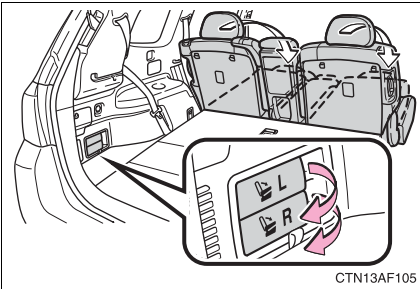

Pull the lever.

L: Left side and center second seats

R: Right side second seat

### ■ After folding down the second seats

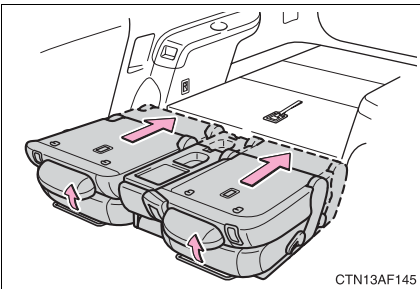

Slide the folded second seats to the rear-most position.

## Folding down the third seats (vehicles with third seats)

### ■ Before folding down the third seats

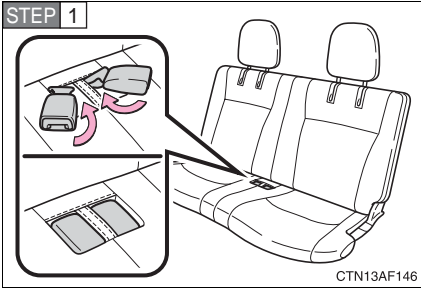

Stow the third seat belt buckles.

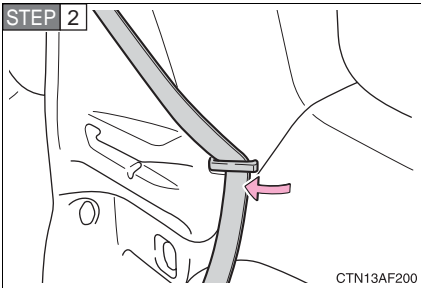

Pass the seat belts through the seat belt hangers.

This prevents the shoulder belt from being damaged.

Make sure that the seat belts are removed from the hangers before using them.

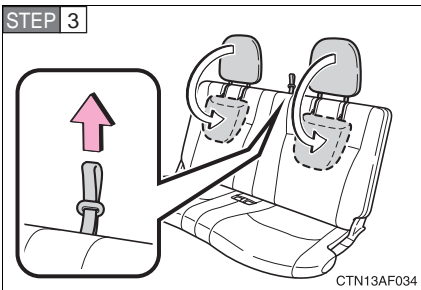

Pull the strap to fold down the head restraints.

### ■ Folding down the third seats

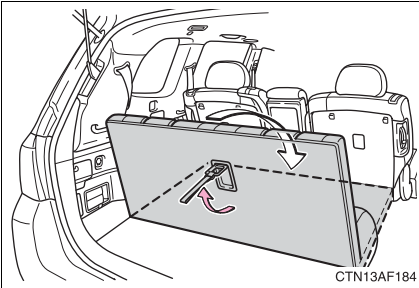

Pull the strap on the third seat-back fold-down lever toward you to fold down the seatback.

### Removing the second center seat

#### ■ Before removing the second center seat

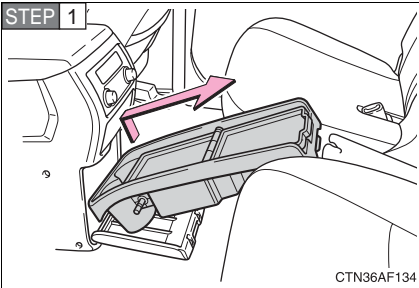

Take out the side table from the console box.

**STEP 2** Lower the second center seat head restraint to the lowest position. (→P. 91)

#### ■ Removing the second center seat

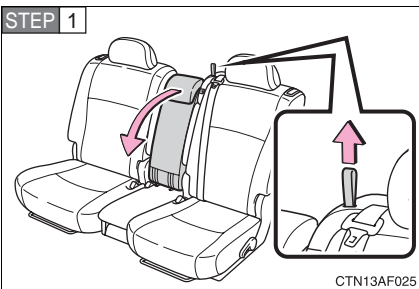

Fold down the second center seatback while pulling the seatback lock release strap.

1-3. Adjustable components (seats, mirrors, steering wheel)

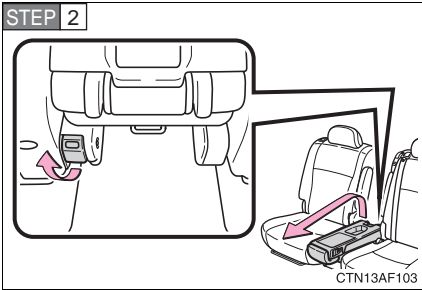

Pull the lock release lever to remove the second center seat.

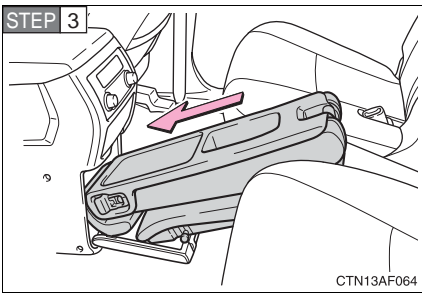

Stow the second center seat in the console box.

**STEP 4** Make sure that the seat is securely locked in position and close the console box door.



## Installing the second center seat

### ■ Before installing the second center seat

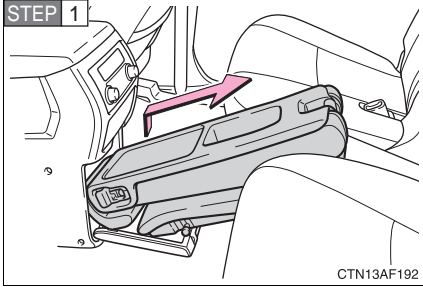

Take out the second center seat from the console box.

**STEP 2** Remove the side table, if used, from the second seat.  
(→P. 386)

### ■ Installing the second center seat

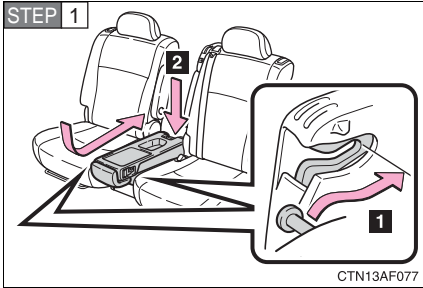

- 1** Fully engage the front pins with the hooks, and swing the second center seat downward.
- 2** Push down on the second center seat to engage the rear pin locks.

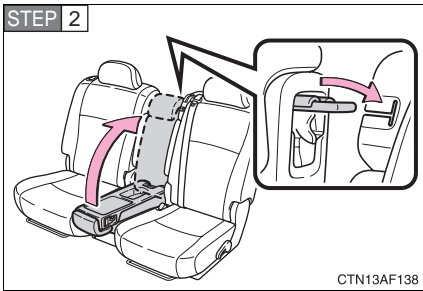

Unfold the seatback and lock it.  
Stow the side table in the console box.

 **CAUTION**

■ **When adjusting a rear seat or removing the second center seat**

- Be careful that the seat does not hit passengers or luggage.
- Do not recline the seat more than necessary when the vehicle is in motion to reduce the risk of sliding under the lap belt. If the seat is too reclined, the lap belt may slide past the hips and apply restraint forces directly to the abdomen or your neck may contact the shoulder belt, increasing the risk of death or serious injury in the event of an accident.
- Be careful not to get your hands or feet caught in the seat.

■ **Before folding down the rear seats**

Do not fold down a rear seat when there are passengers sitting in the rear seats or when there is luggage placed on the rear seats.

■ **After adjusting the seats**

Observe the following precautions. Failure to do so may result in death or serious injury.

- Make sure that the seat and seatback are securely locked in position by lightly rocking them back and forth.
- Second center seat: Make sure the seat is locked in place by trying to shake the seatback and lift up the rear part of the seat cushion.
- Check that the seat belts are not twisted or caught under the seat.

■ **Caution while driving**

Keep the console box closed.

Injuries may result in the event of an accident or sudden braking.

 **NOTICE**

■ **When folding down the second seats**

Do not fold the seatback forward with the luggage cover hooks attached.

■ **Removed second center seat**

Avoid putting heavy loads on the seat. The metallic seat pins may be damaged, and you may be unable to correctly reinstall the seat.

# 1-3. Adjustable components (seats, mirrors, steering wheel)

## Head restraints

### ■ Adjusting the head restraints

#### ► Front seats

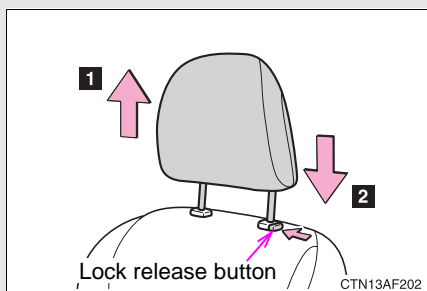

#### Vertical adjustment

##### 1 Up

Pull the head restraints up.

##### 2 Down

Push the head restraint down while pushing the lock release button.

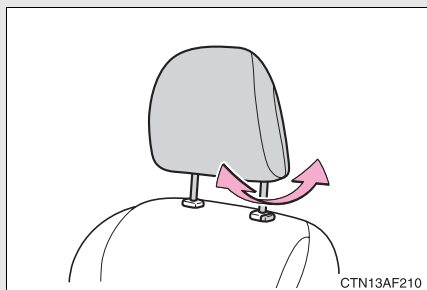

#### Angle adjustment (if equipped)

#### ► Second seats

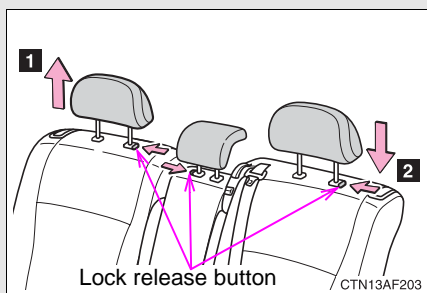

##### 1 Up

Pull the head restraints up.

##### 2 Down

Push the head restraint down while pushing the lock release button.

When using the center seat, raise the head restraint from the stowed position.

■ **When using the third seat head restraints (vehicles with third seats)**

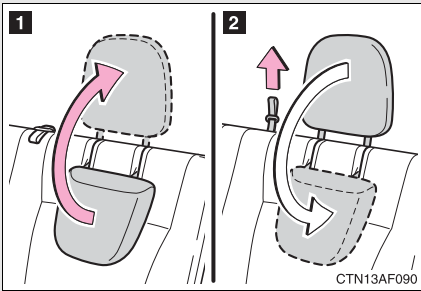

- 1 To use
- 2 To fold

■ **Adjusting the height of the head restraints (except second center seat and third seats)**

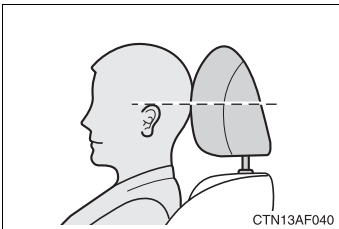

Make sure that the head restraints are adjusted so that the center of the head restraint is closest to the top of your ears.

■ **Removing the front and second seat outer head restraints**

**STEP 1** Pull the head restraint up while pushing the lock release button.

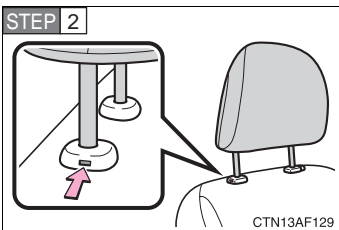

Push a flathead screwdriver into the slot. (The slot is located on the opposite side of the head restraint to the lock released button.)

**STEP 3** While pushing in the screwdriver, pull up the head restraint.

■ **Installing the front head restraints and second seat outer head restraints**

**STEP 1** Align the head restraint with the installation holes.

**STEP 2** Push down the head restraint to the lowest position while pushing the lock release button.

 **CAUTION**

■ **Head restraint precautions**

Observe the following precautions regarding the head restraints. Failure to do so may result in death or serious injury.

- Use the head restraints designed for each respective seat.
- Adjust the head restraints to the correct position at all times.
- After adjusting the head restraints, push down on them and make sure they are locked in position.
- Do not drive with the head restraints removed.

## 1-3. Adjustable components (seats, mirrors, steering wheel)

### Seat belts

**Make sure that all occupants are wearing their seat belts before driving the vehicle.**

#### ■ Correct use of the seat belts

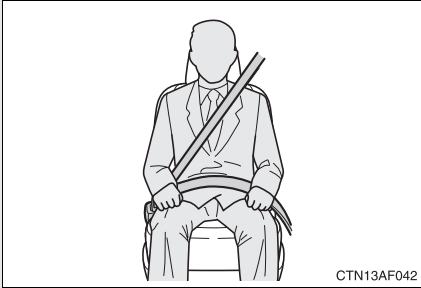

- Extend the shoulder belt so that it comes fully over the shoulder, but does not come into contact with the neck or slide off the shoulder.
- Position the lap belt as low as possible over the hips.
- Adjust the position of the seatback. Sit up straight and well back in the seat.
- Do not twist the seat belt.

#### ■ Fastening and releasing the seat belt

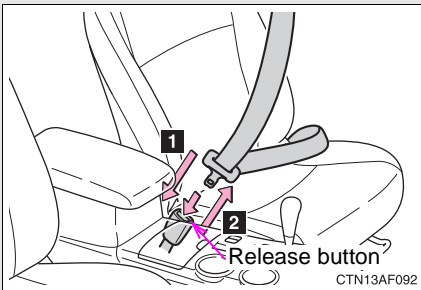

##### 1 Fastening the belt

Push the tab into the buckle until a clicking sound is heard.

##### 2 Releasing the belt

Press the release button.

### ■ Adjusting the height of the belt (front seats)

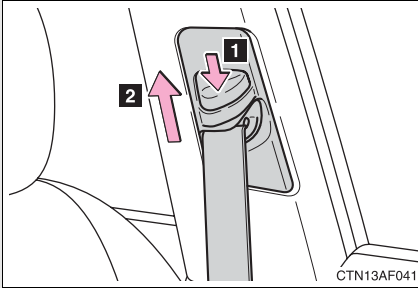

**1** Down

**2** Up

Move the height adjuster up and down as needed until you hear a click.

### ■ Seat belt pretensioners (front seats)

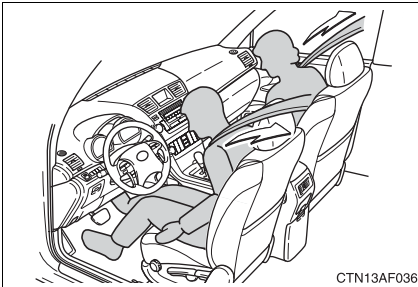

The pretensioner helps the seat belt to quickly restrain the occupant by retracting the seat belt when the vehicle is subjected to certain types of severe frontal collision or a vehicle rollover.

The pretensioner may not activate in the event of a minor frontal impact, a side impact or a rear impact.

### ■ Emergency locking retractor (ELR)

The retractor will lock the belt during a sudden stop or on impact. It may also lock if you lean forward too quickly. A slow, easy motion will allow the belt to extend so that you can move around fully.

### ■ Automatic locking retractor (ALR)

When a passenger's shoulder belt is completely extended and then retracted even slightly, the belt is locked in that position and cannot be extended. This feature is used to hold the child restraint system (CRS) firmly. To free the belt again, fully retract the belt and then pull the belt out once more. (→P. 151)

### ■ Pregnant women

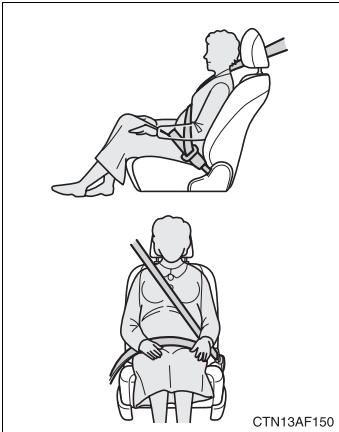

Obtain medical advice and wear the seat belt in the proper way. (→P. 94)

Women who are pregnant should position the lap belt as low as possible over the hips in the same manner as other occupants. Extend the shoulder belt completely over the shoulder and position the belt across the chest. Avoid belt contact over the rounding of the abdominal area.

If the seat belt is not worn properly, not only a pregnant woman, but also the fetus could suffer death or serious injury as a result of sudden braking or a collision.

### ■ People suffering illness

Obtain medical advice and wear the seat belt in the proper way.

### ■ When not using the rear seat belts

#### ▶ Second seat belts

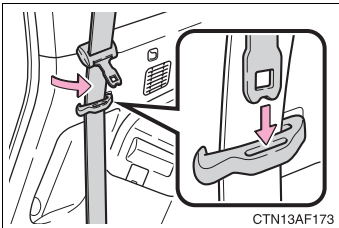

Pass the outer seat belts through the seat belt hangers and secure the seat belt plates to prevent the shoulder belts from being damaged.

#### ▶ Third seat belts (vehicles with third seat)

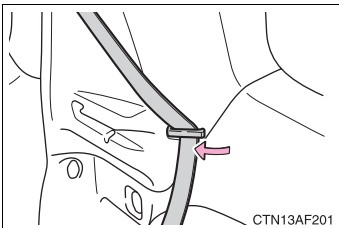

Pass the outer seat belts through the seat belt hangers to prevent the shoulder belts from being damaged.



### ■ Child seat belt usage

The seat belts of your vehicle were principally designed for persons of adult size.

- Use a child restraint system appropriate for the child, until the child becomes large enough to properly wear the vehicle's seat belt. (→P. 146)
- When the child becomes large enough to properly wear the vehicle's seat belt, follow the instructions on P. 94 regarding seat belt usage.

### ■ Replacing the belt after the pretensioner has been activated

If the vehicle is involved in multiple collisions, the pretensioner will activate for the first collision, but will not activate for the second or subsequent collisions.

### ■ Seat belt extender

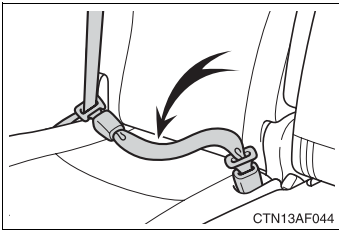

If your seat belts cannot be fastened securely because they are not long enough, a personalized seat belt extender is available from your Toyota dealer free of charge.

## ⚠ CAUTION

Observe the following precautions to reduce the risk of injury in the event of sudden braking or an accident.

Failure to do so may cause death or severe injury.

### ■ Wearing a seat belt

- Ensure that all passengers wear a seat belt.
- Always wear a seat belt properly.
- Each seat belt should be used by one person only. Do not use a seat belt for more than one person at once, including children.
- Toyota recommends that children be seated in the rear seat and always use a seat belt and/or an appropriate child restraint system.

 **CAUTION**

- Do not recline the seat any more than necessary to achieve a proper seating position. The seat belt is most effective when the occupants are sitting up straight and well back in the seats.
- Do not wear the shoulder belt under your arm.
- Always wear your seat belt low and snug across your hips.

■ **Adjustable shoulder anchor**

Always make sure the shoulder belt is positioned across the center of your shoulder. The belt should be kept away from your neck, but not falling off your shoulder. Failure to do so could reduce the amount of protection in an accident and cause death or serious injuries in a collision. (→P. 95)

■ **Seat belt pretensioners**

- Do not place anything, such as a cushion, on the front passenger's seat. Doing so will disperse the passenger's weight, which prevents the sensor from detecting the passenger's weight properly. As a result, the seat belt pretensioner for the front passenger's seat may not activate in the event of a collision.
- If the pretensioner has activated, the seat belt becomes locked: it cannot be further extended, nor will it return to the stowed position. The seat belt cannot be used again and must be replaced at your Toyota dealer.

■ **Child restraint lock function belt precaution**

Do not allow children to play with the child restraint lock function belt. If the belt becomes twisted around a child's neck, it will not be possible to pull the belt out leading to choking or other serious injuries that could result in death. If this occurs and the buckle cannot be unfastened, scissors should be used to cut the belt.

 CAUTION**■ Seat belt damage and wear**

- Do not damage the seat belts by allowing the belt, plate, or buckle to be jammed in the door.
- Inspect the seat belt system periodically. Check for cuts, fraying, and loose parts. Do not use a damaged seat belt until it is replaced. Damaged seat belt cannot protect an occupant from death or serious injury.
- Ensure that the belt and tab are locked and the belt is not twisted. If the seat belt does not function correctly, immediately contact your Toyota dealer.
- Replace the seat assembly, including the belts, if your vehicle has been involved in a serious accident, even if there is no obvious damage.
- Do not attempt to install, remove, modify, disassemble or dispose of the seat belts. Have any necessary repairs carried out by your Toyota dealer. Inappropriate handling of the pretensioner may prevent it from operating properly resulting in death or serious injury.

**■ Using a seat belt extender**

- Do not wear the seat belt extender if you can fasten the seat belt without the extender.
- Do not use the seat belt extender when installing a child restraint system because the belt will not securely hold the child restraint system, increasing the risk of death or serious injury in the event of an accident.
- The personalized extender may not be safe on another vehicle, when used by another person, or at a different seating position other than the one originally intended.

 NOTICE**■ When using a seat belt extender**

When releasing the seat belt, press on the buckle release button on the extender, not on the seat belt.

This helps prevent damage to the vehicle interior and the extender itself.

## 1-3. Adjustable components (seats, mirrors, steering wheel)

### Steering wheel

The steering wheel can be adjusted to a comfortable position.

STEP 1

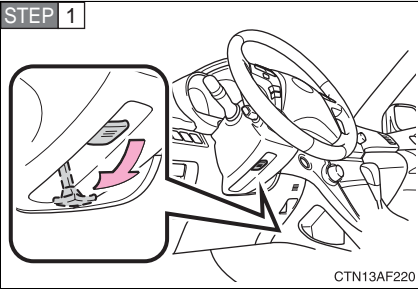

Hold the steering wheel and press the lever down.

STEP 2

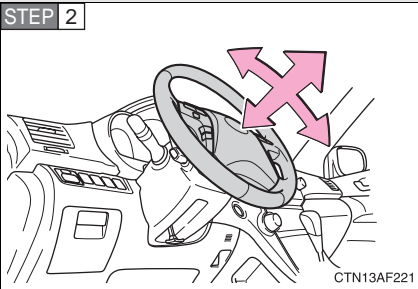

Adjust to the ideal position by moving the steering wheel horizontally and vertically.

After adjustment, pull the lever up to secure the steering wheel.

#### CAUTION

##### ■ Caution while driving

Do not adjust the steering wheel while driving. Doing so may cause the driver to mishandle the vehicle and an accident, resulting in death or serious injury.

##### ■ After adjusting the steering wheel

Make sure that the steering wheel is securely locked. Otherwise, the steering wheel may move suddenly, possibly causing an accident and resulting in death or serious injury.

## 1-3. Adjustable components (seats, mirrors, steering wheel)

### Anti-glare inside rear view mirror

Glare from the headlights of vehicles behind can be reduced by using the following functions.

#### ► Manual anti-glare inside rear view mirror

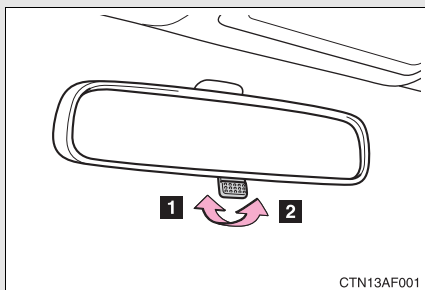

- 1 Normal position
- 2 Anti-glare position

#### ► Auto anti-glare inside rear view mirror

In automatic mode, sensors are used to detect the headlights of vehicles behind and automatically reduces the reflected light.

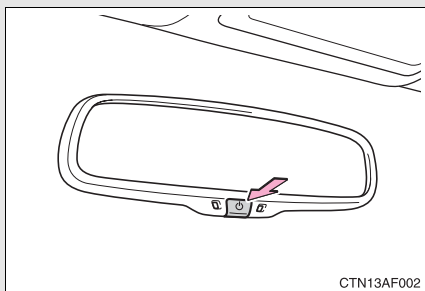

Turns automatic mode on/off

The indicator comes on when automatic mode is turned on.

Vehicles without smart key system:

The mirror will revert to automatic mode each time the engine switch is turned to the "ON" position.

Vehicles with smart key system:

The mirror will revert to automatic mode each time the "ENGINE START STOP" switch is turned to IGNITION ON mode.

■ **To prevent sensor error (vehicles with auto anti-glare inside rear view mirror)**

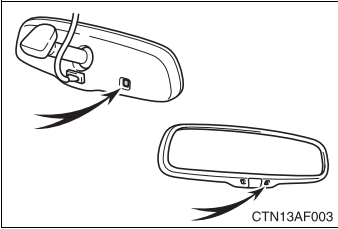

To ensure that the sensors operate properly, do not touch or cover them.

**! CAUTION**

■ **Caution while driving**

Do not adjust the position of the mirror while driving.

Doing so may lead to mishandling of the vehicle and an accident, resulting in death or serious injury.

# 1-3. Adjustable components (seats, mirrors, steering wheel)

## Outside rear view mirrors

Mirror angle can be adjusted using the switches.

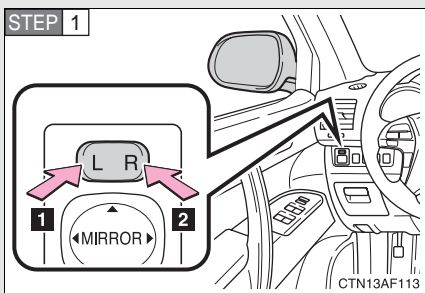

Select a mirror to adjust.

- 1** Left
- 2** Right

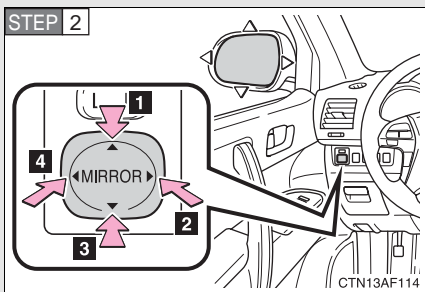

Adjust the mirror.

- 1** Up
- 2** Right
- 3** Down
- 4** Left

## Folding back the mirrors

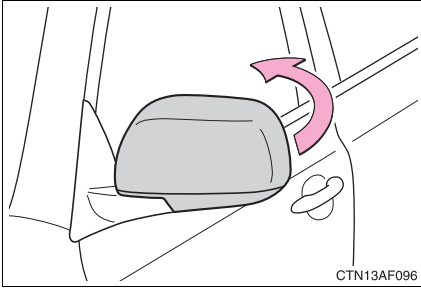

Push backward to fold the mirrors.

### ■ The outside rear view mirrors can be operated when

- ▶ Vehicles without smart key system

The engine switch is in the “ACC” or “ON” position.

- ▶ Vehicles with smart key system

The “ENGINE START STOP” switch is in ACCESSORY or IGNITION ON mode.

### ■ When the mirrors are fogged up (vehicles with outside rear view mirror defoggers)

Turn on the mirror defoggers to defog the mirrors. (→P. 277)



 CAUTION

■ **When driving the vehicle**

Observe the following precautions while driving.

Failing to do so may result in loss of control of the vehicle and cause an accident, resulting in death or serious injury.

- Do not adjust the mirrors while driving.
- Do not drive with the mirrors folded back.
- Both the driver and passenger side mirrors must be extended and properly adjusted before driving.

■ **When the mirror defoggers are operating (vehicles with outside rear view mirror defoggers)**

Do not touch the rear view mirror surfaces, as they can become very hot and burn you.

## 1-4. Opening and closing the windows and moon roof Power windows

The power windows can be opened and closed using the following switches.

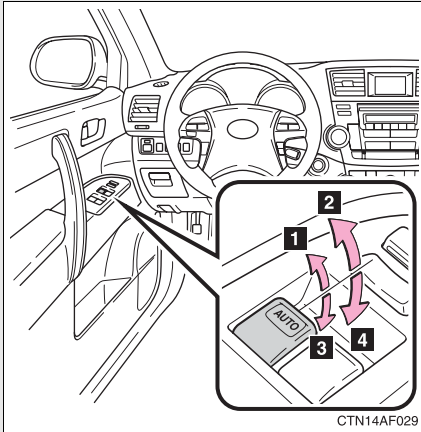

- 1 Closing
- 2 One-touch closing (driver's window only)\*
- 3 Opening
- 4 One-touch opening (driver's window only)\*

\*: Pressing the switch in the opposite direction will stop window travel partway.

### Lock switch

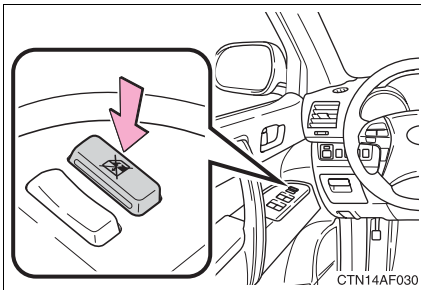

Press the switch down to lock the passenger window switches.

Use this switch to prevent children from accidentally opening or closing a passenger window.

### ■ The power windows can be operated when

- ▶ Vehicles without smart key system  
The engine switch is in the “ON” position.
- ▶ Vehicles with smart key system  
The “ENGINE START STOP” switch is in IGNITION ON mode.

### ■ Operating the power windows after turning the engine off (driver’s window only)

- ▶ Vehicles without smart key system  
The power windows can be operated for approximately 45 seconds after the engine switch is turned to the “ACC” or “LOCK” position. They cannot, however, be operated once either front door is opened.
- ▶ Vehicles with smart key system  
The power windows can be operated for approximately 45 seconds after the “ENGINE START STOP” switch is turned to ACCESSORY mode or turned OFF. They cannot, however, be operated once either front door is opened.

### ■ Jam protection function (driver’s window only)

If an object becomes caught between the window and the window frame, window travel is stopped and the window is opened slightly.

## CAUTION

### ■ Closing the windows

Observe the following precautions.  
Failing to do so may result in death or serious injury.

- Check to make sure that all passengers do not have any part of their body in a position where it could be caught when a window is being operated.
- Do not allow children to operate the power windows.  
Closing a power window on someone can cause serious injury, and in some instances, even death.

### ■ Jam protection function (driver’s window only)

- Never try jamming any part of your body to activate the jam protection function intentionally.
- The jam protection function may not work if something gets caught just before the window fully closes.

## 1-4. Opening and closing the windows and moon roof Moon roof\*

Use the overhead switches to open, close, and tilt the moon roof up and down.

### ■ Opening and closing

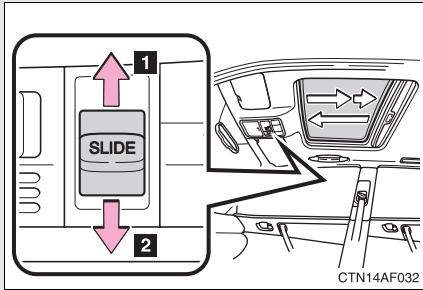

#### 1 Open

The moon roof stops slightly before the fully opened position.

Move the switch backward again to fully open.

#### 2 Close

Move the switch forward to stop the moon roof partway.

### ■ Tilting up and down

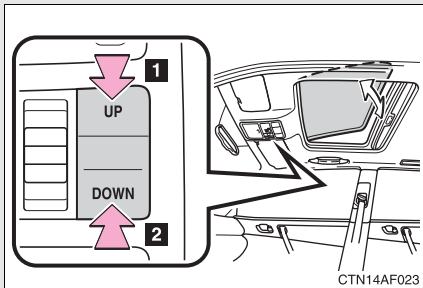

#### 1 Tilt up

#### 2 Tilt down

Push the switch in either direction to stop the moon roof partway.

\*: If equipped

---

**■ The moon roof can be operated when****▶ Vehicles without smart key system**

The engine switch is in the “ON” position.

**▶ Vehicles with smart key system**

The “ENGINE START STOP” switch is in IGNITION ON mode.

**■ Operating the moon roof after turning the engine off****▶ Vehicles without smart key system**

The moon roof can be operated for approximately 45 seconds after the engine switch is turned to the “ACC” or “LOCK” position. It cannot, however, be operated once either front door is opened.

**▶ Vehicles with smart key system**

The moon roof can be operated for approximately 45 seconds after the “ENGINE START STOP” switch is turned to ACCESSORY mode or turned OFF. They cannot, however, be operated once either front door is opened.

**■ Jam protection function**

If an object is detected between the moon roof and the frame while closing or tilting down, travel is stopped and the moon roof opens slightly.

**■ If the moon roof cannot be closed**

If the moon roof cannot be closed automatically, such as when the jam protection function activates accidentally due to a malfunction, pressing and holding the switch closes the moon roof.

**■ To reduce wind noise**

Drive with the moon roof opened to slightly before the fully open position as driving with the moon roof opened fully will cause wind noise.

**■ Sunshade**

The sunshade can be opened and closed manually. However, the sunshade will open automatically when the moon roof is opened.

■ **Moon roof open reminder function (vehicles with multi-information display)**

▶ Vehicles without smart key system

An alarm will sound when the driver's door is opened with the moon roof not fully closed and the engine switch OFF.

▶ Vehicles with smart key system

An alarm will sound when the driver's door is opened with the moon roof not fully closed and the "ENGINE START STOP" switch OFF.

 **CAUTION**

■ **Opening the moon roof**

Observe the following precautions.

Failure to do so may cause death or serious injury.

- Do not allow any passengers to put their hands or heads outside the vehicle while it is moving.
- Do not sit on top of the moon roof.

■ **Closing the moon roof**

Observe the following precautions.

Failing to do so may result in death or serious injury.

- Check to make sure that all passengers do not have any part of their bodies in a position where it could be caught when the moon roof is being operated.
- Do not allow children to operate the moon roof.  
Closing the moon roof on someone can cause death or serious injury.

■ **Jam protection function**

- Never try jamming any part of your body to activate the jam protection function intentionally.
- The jam protection function may not work if something gets caught just before the moon roof fully closes.

## Opening the fuel tank cap

**Perform the following steps to open the fuel tank cap.**

### ■ Before refueling the vehicle

▶ Vehicles without smart key system

Turn the engine switch OFF and ensure that all the doors and windows are closed.

▶ Vehicles with smart key system

Turn the “ENGINE START STOP” switch OFF and ensure that all the doors and windows are closed.

### ■ Opening the fuel tank cap

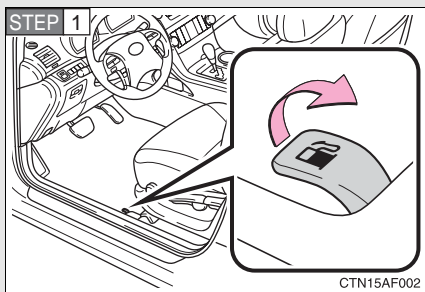

Open the fuel filler door.

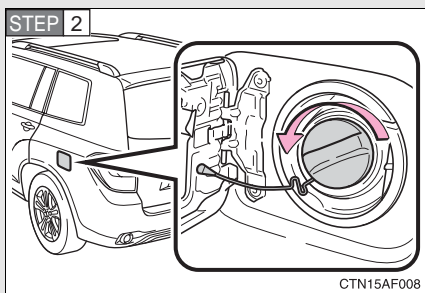

Turn the fuel tank cap slowly to open.

STEP 3

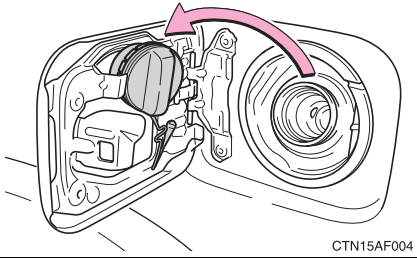

Hang the fuel tank cap on the back of the fuel filler door.

### Closing the fuel tank cap

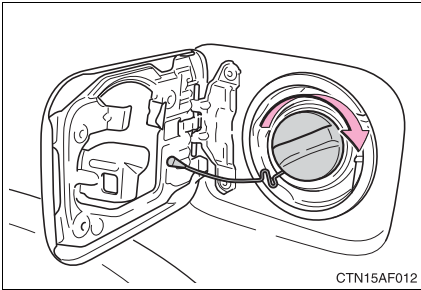

When replacing the fuel tank cap, turn it until a clicking sound is heard.

After releasing your hand, the cap will turn slightly to the opposite direction.

### ■ Fuel types

Use unleaded gasoline. (Octane rating 87 [Research Octane Number 91] or higher)

### ■ Fuel tank capacity

Approximately 19.2 gal. (72.5 L, 15.9 Imp. gal.)



 **CAUTION****■ Refueling the vehicle**

Observe the following precautions while refueling the vehicle.  
Failure to do so may result in death or serious injury.

- Touch the vehicle or some other metal surface to discharge any static electricity.  
Sparks resulting from discharging static electricity may cause the fuel vapors to ignite.
- Always hold the grips on the fuel tank cap and turn it slowly to remove it.  
A whooshing sound may be heard when the fuel tank cap is loosened.  
Wait until the sound cannot be heard before fully removing the cap.  
In hot weather, pressurized fuel may spray out of the filler neck and cause injury.
- Do not allow anyone that has not discharged static electricity from their bodies to come close to an open fuel tank.
- Do not inhale vaporized fuel.  
Fuel contains substances that are harmful if inhaled.
- Do not smoke while refueling the vehicle.  
Doing so may cause the fuel to ignite and cause a fire.
- Do not return to the vehicle or touch any person or object that is statically charged.  
This may cause static electricity to build up, resulting in a possible ignition hazard.

**■ When replacing the fuel cap**

Do not use anything but a genuine Toyota fuel tank cap designed for your vehicle. Doing so may cause a fire or other incident which may result in death or serious injury.



**NOTICE**

**■ Refueling**

Do not spill fuel during refueling.

Doing so may damage the vehicle, such as causing the exhaust systems to operate abnormally or damaging fuel system components or the vehicle's painted surface.

**The vehicle's keys have built-in transponder chips that prevent the engine from starting if the key has not been previously registered in the vehicle's on-board computer.**

**Never leave the keys inside the vehicle when you leave the vehicle.**

► Vehicles without navigation system

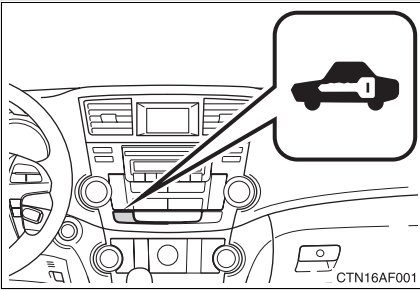

Vehicles without smart key system: The indicator light flashes after the key has been removed from the engine switch to indicate that the system is operating.

Vehicles with smart key system: The indicator light flashes after the "ENGINE START STOP" switch has been turned OFF to indicate that the system is operating.

\*: If equipped

► Vehicles with navigation system

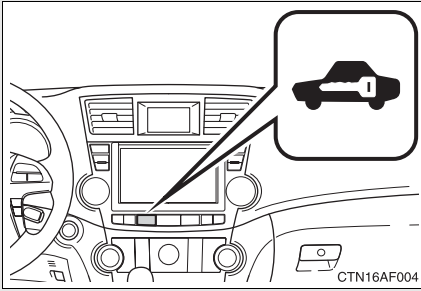

Vehicles without smart key system: The indicator light flashes after the key has been removed from the engine switch to indicate that the system is operating.

Vehicles with smart key system: The indicator light flashes after the “ENGINE START STOP” switch has been turned OFF to indicate that the system is operating.

---

**■ System maintenance**

The vehicle has a maintenance-free type of engine immobilizer system.

**■ Conditions that may cause the system to malfunction**

- If the key is in contact with a metallic object
- If the key is in close proximity to or touching a key with the security system (key with a built-in transponder chip) of another vehicle

**■ Certifications for the engine immobilizer system**

- For vehicles sold in the U.S.A.
- ▶ Vehicles without smart key system

FCC ID: MOZRI-20BTY

- ▶ Vehicles with smart key system

FCC ID: NI4TMIMB-1

This device complies with Part 15 of the FCC Rules. Operation is subject to the following two conditions: (1) this device may not cause harmful interference, and (2) this device must accept any interference received, including interference that may cause undesired operation.

**FCC WARNING:**

Changes or modifications not expressly approved by the party responsible for compliance could void the user's authority to operate the equipment.

**TCB**

**GRANT OF EQUIPMENT  
AUTHORIZATION**

**TCB**

**Certification  
Issued Under the Authority of the  
Federal Communications Commission  
By:**

**Compliance Certification Services  
561F Monterey Road  
Morgan Hill, CA 95037**

**Date of Grant: 01/21/2002  
Application Dated: 01/21/2002**

**Tokai Rika Co Ltd  
Oguchi-Cho, Niwa-Gun  
Aichi-Ken 480-01,  
Japan**

**Attention: Reiko Kagimoto , General Manager**

**NOT TRANSFERABLE**

EQUIPMENT AUTHORIZATION is hereby issued to the named GRANTEE,  
and is VALID ONLY for the equipment identified hereon for use under the  
Commission's Rules and Regulations listed below.

**FCC IDENTIFIER: MOZRI-20BTY**

**Name of Grantee: Tokai Rika Co Ltd**

**Equipment Class: Part 15 Low Power Transmitter Below 1705 kHz  
Notes: Immobilizer System for Cars**

<u>Grant Notes</u>	<u>FCC Rule Parts</u>	<u>Frequency Range (MHz)</u>	<u>Output Watts</u>	<u>Frequency Tolerance</u>	<u>Emission Designator</u>
	15C	0.1342 - 0.1342			

- For vehicles sold in Canada

This device complied with RSS-210 of Industry Canada.

Operation is subject to the following two conditions: (1) this device may not cause interference, and (2) this device must accept any interference, including interference that may cause undesired operation of the device.



Industry  
Canada

Industrie  
Canada

No. ► 15411

**TECHNICAL ACCEPTANCE  
CERTIFICATE**

**CERTIFICAT D'ACCEPTABILITÉ  
TECHNIQUE**

CERTIFICATION No. No. DE CERTIFICATION	►	2584A 12035		
ISSUED TO DELIVRÉ À	►	TOKAI RIKAI CO. LTD.		
TYPE OF EQUIPMENT GENRE DE MATÉRIEL	►	Low Power Device		
TRADE NAME AND MODEL MARQUE ET MODÈLE	►	RI-208TY		
FREQUENCY RANGE BANDE DE FRÉQUENCES	►	134.2 kHz		
EMISSION DESIGNATION DESIGNATION D'ÉMISSION	►	—A1D		
R.F. POWER RATING PUISSANCE NOMINALE R.F.	►	< 10Watt		
CERTIFIED TO CERTIFIÉ SELON LE	►	SPECIFICATION CAHIER DES CHARGES	TSS210	ISSUE 5 ÉDITION

Certification of equipment means only that the equipment has met the requirements of the above noted specifications. License applications, where applicable to use certified equipment, are acted on accordingly by the issuing office and will depend on the existing radio environment, service and location of operation.

This certificate is issued on condition that the holder complies and will continue to comply with the requirements of the radio standards specifications and procedures issued by the Department.

ISSUED UNDER THE AUTHORITY OF MINISTER OF INDUSTRY  
DELIVRÉ AVEC L'AUTORISATION DU MINISTRE DES INDUSTRIE

DATE January 28, 2002

L'homologation de matériel terminal signifie seulement qu'il est conforme aux exigences du cahier des charges mentionné ci-dessus. Les demandes de licence, le cas échéant en vue de l'utilisation de matériel certifié seront traitées en conséquence par le bureau chargé de délivrer lesdites licences, en tenant compte du milieu radioélectrique ambiant, du service radio existant et de l'emplacement de la station.

Le présent certificat est délivré à condition que le détenteur se conforme et continue à se conformer aux cahiers des charges et procédures sur les normes radioélectriques publiées par le ministère.

FOR

DIRECTOR GENERAL  
SPECTRUM  
ENGINEERING  
BRANCH

DIRECTEUR GÉNÉRAL  
GÉNIE  
DU SPECTRE

Canada



**NOTICE****■ To prevent damage to the key**

Do not modify, remove or disable the engine immobilizer system.

If any unauthorized changes or modifications are made, the proper operation of the system cannot be guaranteed.

## Alarm\*

**The system sounds the alarm and flashes the lights when forcible entry is detected.**

### ■ Triggering of the alarm

The alarm is triggered in the following situations.

- A locked door is unlocked or opened in any way other than using the wireless remote control door lock function or entry function (vehicles with smart key system). The doors will lock again automatically.
- The hood is opened while the vehicle is locked.
- The locked glass hatch is opened in any way other than using the wireless remote control door lock function or entry function (vehicles with smart key system).
- The battery is reconnected.

\*: If equipped

## ■ Setting the alarm system

### ► Vehicles without navigation system

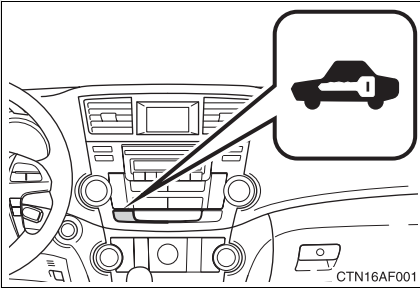

Close the doors and hood, and lock all doors using the wireless remote control door lock function or entry function (vehicles with smart key system). The system will be set automatically after 30 seconds.

The indicator light changes from being on to flashing when the system is set.

### ► Vehicles with navigation system

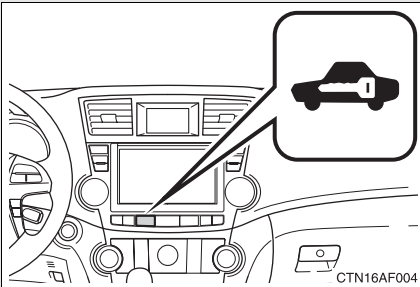

Close the doors and hood, and lock all doors using the wireless remote control door lock function or entry function (vehicles with smart key system). The system will be set automatically after 30 seconds.

The indicator light changes from being on to flashing when the system is set.

### ■ Deactivating or stopping the alarm

Unlock the doors using the wireless remote control door lock function or the entry function (vehicles with smart key system).

---

### ■ Items to check before locking the vehicle

To prevent unexpected triggering of the alarm and vehicle theft, make sure of the following.

- Nobody is in the vehicle.
- The windows and moon roof are closed before the alarm is set.
- No valuables or other personal items are left in the vehicle.

### ■ Panic mode

→P. 56

### ■ When the battery is disconnected

Be sure to cancel the alarm system.

If the battery is disconnected before canceling the alarm, the system may be triggered when the battery is reconnected.

### ■ When using the key to unlock the doors

Deactivate the alarm.

# 1-6. Theft deterrent system

## Theft prevention labels (U.S.A.)

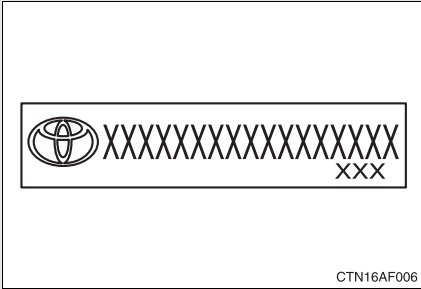

These labels are attached to the vehicle to reduce vehicle theft by facilitating the tracing and recovery of parts from stolen vehicles. Do not remove under penalty of law.

## Correct driving posture

Drive in a good posture as follows:

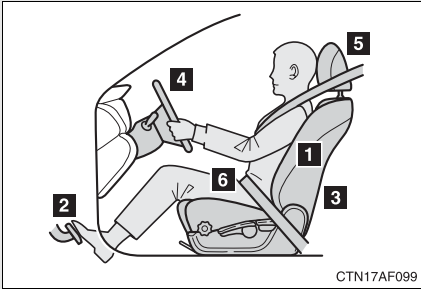

- 1** Sit upright and well back in the seat. (→P. 79)
- 2** Adjust the position of the seat forward or backward to ensure the pedals can be reached and easily depressed to the extent required. (→P. 79)
- 3** Adjust the seatback so that the controls are easily operable.
- 4** Adjust the tilt and telescopic positions of the steering wheel downward so the air-bag is facing your chest. (→P. 100)
- 5** Lock the head restraint in place with the center of the head restraint closest to the top of your ears. (→P. 91)
- 6** Wear the seat belt correctly. (→P. 94)

 **CAUTION****■ While driving**

- Do not adjust the position of the driver's seat while driving. Doing so could cause the driver to lose control of the vehicle.
- Do not place a cushion between the driver or passenger and the seatback. A cushion may prevent correct posture from being achieved, and reduce the effectiveness of the seat belt and head restraint, increasing the risk of death or serious injury to the driver or passenger.
- Do not place anything under the front seats. Objects placed under the front seats may become jammed in the seat tracks and stop the seat from locking in place. This may lead to an accident. The adjustment mechanism may also be damaged.

**■ Adjusting the seat position**

- Take care when adjusting the seat position to ensure that other passengers are not injured by the moving seat.
- Do not put your hands under the seat or near the moving parts to avoid injury. Fingers or hands may become jammed in the seat mechanism.

## SRS airbags

The SRS airbags inflate when the vehicle is subjected to certain types of severe impacts that may cause significant injury to the occupants. They work together with the seat belts to help reduce the risk of death or serious injury.

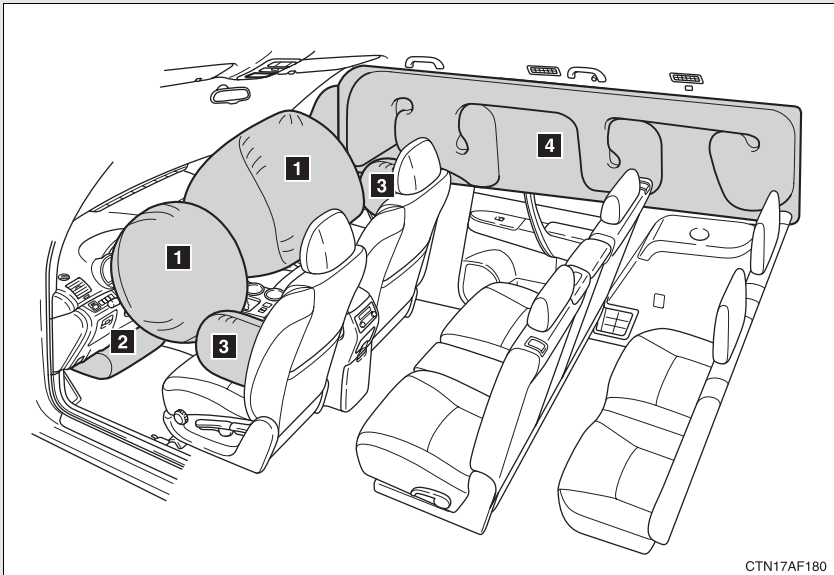

### ► Front airbags

#### **1** Driver airbag/front passenger airbag

Can help protect the head and chest of the driver and front passenger from impact with interior components.

#### **2** Driver knee airbag

Can help provide driver protection.

### ► Side and curtain shield airbags

#### **3** Side airbags

Can help protect the torso of the front seat occupants.

#### **4** Curtain shield airbags

Can help protect primarily the head of outside occupants.



## Airbag system components

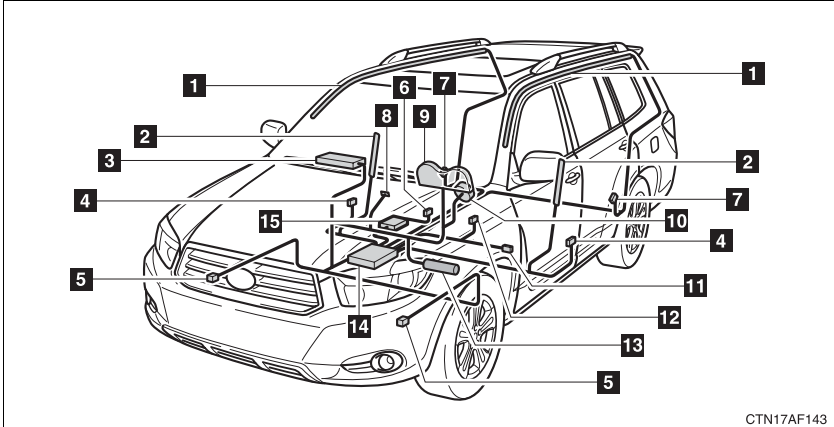

CTN17AF143

- |  |   |
|--|---|
| <b>1</b> Curtain shield airbags                          | <b>9</b> SRS warning light                            |
| <b>2</b> Side airbags                                    | <b>10</b> Driver airbag                               |
| <b>3</b> Front passenger airbag                          | <b>11</b> Driver's seat position sensor               |
| <b>4</b> Side and curtain shield airbag sensors          | <b>12</b> Driver's seat belt buckle switch            |
| <b>5</b> Front airbag sensors                            | <b>13</b> Driver knee airbag                          |
| <b>6</b> Front passenger's seat belt buckle switch       | <b>14</b> Airbag sensor assembly                      |
| <b>7</b> Curtain shield airbag sensors                   | <b>15</b> Occupant detection system (ECU and sensors) |
| <b>8</b> "AIR BAG ON" and "AIR BAG OFF" indicator lights |   |

Your vehicle is equipped with ADVANCED AIRBAGS designed based on US motor vehicle safety standards (FMVSS208). The airbag system controls airbag deployment power for the driver and front passenger. The driver airbag system consists of the driver seat's position sensor etc. The front passenger's airbag system consists of the front passenger occupant classification sensor etc.

The main SRS airbag system components are shown above. The SRS airbag system is controlled by the airbag sensor assembly. The airbag sensor assembly consists of a safing sensor and an airbag sensor.

In certain types of severe frontal or side impacts, the SRS airbag system triggers the airbag inflators. A chemical reaction in the inflators quickly fills the airbags with non-toxic gas to help restrain the motion of the occupants.

---

### ■ SRS warning light

This warning light system monitors the airbag sensor assembly, front airbag sensors, side and curtain shield airbag sensor assemblies, curtain shield airbag sensor assemblies, driver's seat position sensor, driver's seat belt buckle switch, front passenger occupant classification system, "AIR BAG ON" and "AIR BAG OFF" indicator lights, front passenger's seat belt buckle switch, front seat belt pretensioner assemblies, inflators, interconnecting wiring and power sources. (→P. 511)

### ■ If the SRS airbags deploy (inflate)

- Bruising and slight abrasions may result from contact with a deploying (inflating) SRS airbag.
- A loud noise and white powder will be emitted.
- Parts of the airbag module (steering wheel hub, airbag cover and inflator) as well as the front seats, and parts of the front and rear pillars and roof side rail, may be hot for several minutes. The airbag itself may also be hot.
- The windshield may crack.

### ■ Operating conditions (front airbags)

- The SRS front airbags will deploy if the severity of the frontal impact is above the designed threshold level, comparable to an approximate 15 mph (25 km/h) collision when the vehicle impacts straight into a fixed barrier that does not move or deform.

However, this threshold velocity will be considerably higher if the vehicle strikes an object, such as a parked vehicle or sign pole, which can move or deform on impact, or if the vehicle is involved in an underride collision (e.g. a collision in which the front of the vehicle “underrides”, or goes under, the bed of a truck, etc.).

- It is possible that in some collisions where the forward deceleration of the vehicle is very close to the designed threshold level, the SRS front airbags and the seat belt pretensioners may not activate together.
- The SRS front passenger airbag will not activate if there is no passenger sitting in the front passenger seat. However, the front passenger airbag may deploy if luggage is put in the seat, or the seat belt is fastened, even if the seat is unoccupied. (→P. 140)

### ■ Operating conditions (side airbags)

- The SRS side airbags are designed to inflate when the passenger compartment is subjected to a severe impact from the side.
- The SRS side airbag on the passenger seat will not activate if there is no passenger sitting in the front passenger seat. However, the side airbag on the passenger seat may deploy if luggage is put in the seat, or the seat belt is fastened, even if the seat is unoccupied. (→P. 140)

### ■ Operating conditions (curtain shield airbags)

The SRS curtain shield airbags are designed to inflate when the passenger compartment is subjected to a severe impact from the side or vehicle roll-over.

### ■ Conditions under which the SRS airbags may deploy (inflate), other than a collision

The SRS front airbags may also deploy if a serious impact occurs to the underside of your vehicle. Some examples are shown in the illustration.

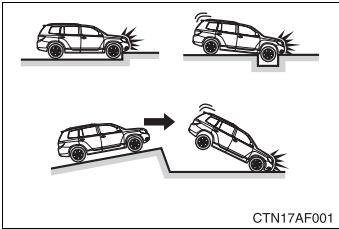

- Hitting a curb, edge of pavement or hard surface
- Falling into or jumping over a deep hole
- Landing hard or vehicle falling

The SRS curtain shield airbags may also deploy under the situation shown in the illustration.

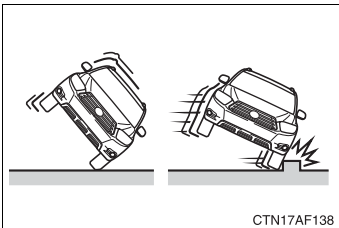

- The angle of vehicle tip-up is marginal.
- The vehicle skids and hits a curb stone.

### ■ Types of collisions that may not deploy the SRS airbag (front airbags)

The SRS front airbags are generally not designed to inflate if the vehicle is involved in a side or rear collision, if it rolls over, or if it is involved in a low-speed frontal collision. But, whenever a collision of any type causes sufficient forward deceleration of the vehicle, deployment of the SRS front airbags may occur.

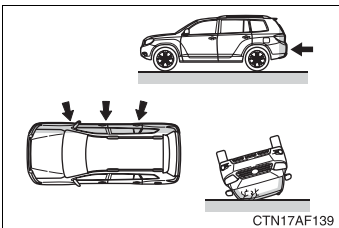

- Collision from the side
- Collision from the rear
- Vehicle rollover

### ■ Types of collisions that may not deploy the SRS airbag (side airbags and curtain shield airbags)

The SRS side airbag and curtain shield airbag system may not activate if the vehicle is subjected to a collision from the side at certain angles, or a collision to the side of the vehicle body other than the passenger compartment.

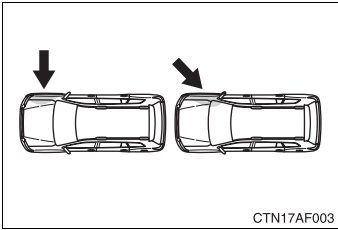

CTN17AF003

- Collision from the side to the vehicle body other than the passenger compartment
- Collision from the side at an angle

The SRS side airbags are not generally designed to inflate if the vehicle is involved in a frontal or rear collision, if it rolls over, or if it is involved in a low-speed side collision.

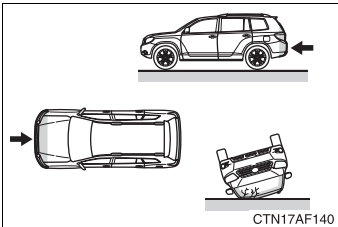

CTN17AF140

- Collision from the front
- Collision from the rear
- Vehicle rollover

The SRS curtain shield airbags are not generally designed to inflate if the vehicle is involved in a frontal or rear collision, if it pitches end over end, or if it is involved in a low-speed side collision.

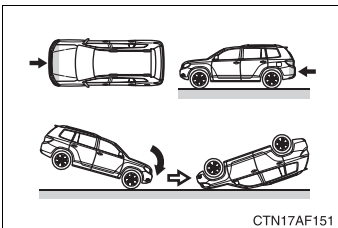

CTN17AF151

- Collision from the front
- Collision from the rear
- Pitching end over end

### ■ When to contact your Toyota dealer

In the following cases, contact your Toyota dealer as soon as possible. Do not disconnect the battery cables before contacting your Toyota dealer.

- Any of the SRS airbags have been inflated.

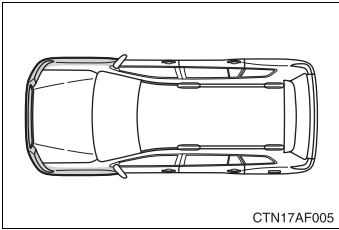

- The front of the vehicle is damaged or deformed, or was involved in an accident that was not severe enough to cause the SRS airbags to inflate.

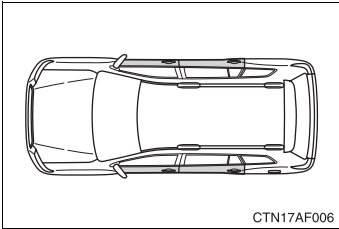

- A portion of a door is damaged or deformed, or the vehicle was involved in an accident that was not severe enough to cause the SRS side airbags and curtain shield airbags to inflate.

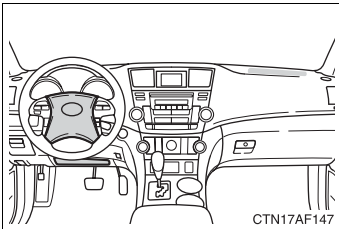

- The pad section of the steering wheel or dashboard or lower portion of the instrument panel is scratched, cracked, or otherwise damaged.

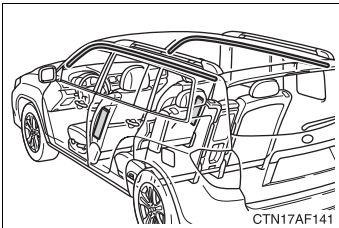

- The surface of the seats with the side airbag is scratched, cracked or otherwise damaged.
- The portion of the front pillars, rear pillars or roof side rail garnishes (padding) containing the curtain shield airbags inside is scratched, cracked or otherwise damaged.

 **CAUTION**
**■ SRS airbag precautions**

Observe the following precautions regarding the airbags.  
Failure to do so may cause death or serious injury.

- The driver and all passengers in the vehicle must wear their seat belts properly.

The SRS airbags are supplemental devices to be used with the seat belts.

- The SRS driver airbag deploys with considerable force, and can cause death or serious injury especially if the driver is very close to the airbag. The National Highway Traffic Safety Administration (“NHTSA”) advises:

Since the risk zone for the driver’s airbag is the first 2 - 3 in. (50 - 75 mm) of inflation, placing yourself 10 in. (250 mm) from your driver airbag provides you with a clear margin of safety. This distance is measured from the center of the steering wheel to your breastbone. If you sit less than 10 in. (250 mm) away now, you can change your driving position in several ways:

- Move your seat to the rear as far as you can while still reaching the pedals comfortably.
- Slightly recline the back of the seat.  
Although vehicle designs vary, many drivers can achieve the 10 in. (250 mm) distance, even with the driver seat all the way forward, simply by reclining the back of the seat somewhat. If reclining the back of your seat makes it hard to see the road, raise yourself by using a firm, non-slippery cushion, or raise the seat if your vehicle has that feature.
- If your steering wheel is adjustable, tilt it downward. This points the airbag toward your chest instead of your head and neck.

The seat should be adjusted as recommended by NHTSA above, while still maintaining control of the foot pedals, steering wheel, and your view of the instrument panel controls.

**! CAUTION**

**■ SRS airbag precautions**

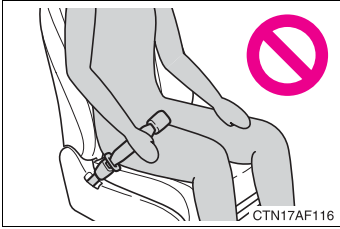

- If the seat belt extender has been connected to the driver's seat belt buckle but the seat belt extender has not also been fastened to the latch plate of the driver's seat belt, the SRS driver's airbag system will judge that the driver is wearing the seat belt even though the seat belt has not been connected. In this case, the driver's airbag may not activate correctly in a collision, resulting in death or serious injury in the event of collision. Be sure to wear the seat belt with the seat belt extender.
- The SRS front passenger airbag also deploys with considerable force, and can cause death or serious injury especially if the front passenger is very close to the airbag. The front passenger seat should be as far from the airbag as possible with the seatback adjusted, so the front passenger sits upright.
- Improperly seated and/or restrained infants and children can be killed or seriously injured by a deploying airbag. An infant or child who is too small to use a seat belt should be properly secured using a child restraint system. Toyota strongly recommends that all infants and children be placed in the rear seats of the vehicle and properly restrained. The rear seats are the safest for infants and children. (→P. 146)

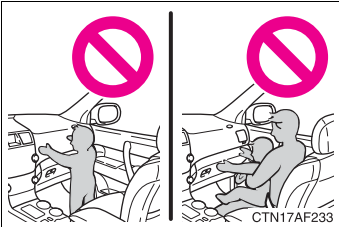
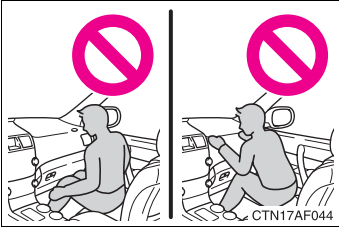

**! CAUTION****■ SRS airbag precautions**

- Do not sit on the edge of the seat or lean against the dashboard.
- Do not allow a child to stand in front of the SRS front passenger airbag unit or sit on the knees of a front passenger.
- Do not drive the vehicle while the driver or passenger has items resting on their knees.
- Do not lean against the door, the roof side rail or the front, side and rear pillars.
- Do not allow anyone to kneel on the passenger seat toward the door or put their head or hands outside the vehicle.

**! CAUTION**

**■ SRS airbag precautions**

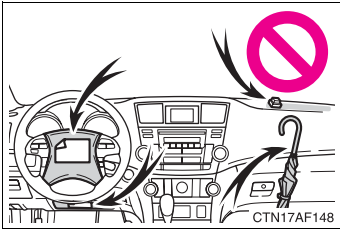

- Do not attach anything to or lean anything against areas such as the dashboard, steering wheel pad or lower portion of the instrument panel.

These items can become projectiles when SRS driver, front passenger and knee airbags deploy.



- Do not attach anything to areas such as the door, windshield glass, side door glass, front and rear pillars, roof side rail or assist grip.

- Do not hang coat hangers or other hard objects on the coat hooks. All of these items could become projectiles and seriously injure or kill you, should the SRS curtain shield airbag deploy.

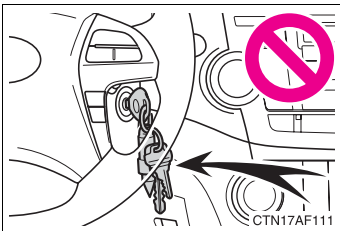

- Vehicles without smart key system: Do not attach any heavy, sharp or hard objects such as keys or accessories to the key. The objects may restrict the SRS knee airbag inflation or be thrust into the driver's seat area by the force of the deploying airbag, thus causing a danger.

- If the vinyl cover is put on the area where the SRS knee airbag will deploy, be sure to remove it.
- Do not use seat accessories which cover the parts where the SRS side airbags inflate as they may interfere with inflation of the airbags.
- Do not strike or apply significant levels of force to the area of the SRS airbag components (→P. 129).  
Doing so can cause the SRS airbags to malfunction.

 **CAUTION****■ SRS airbag precautions**

- Do not touch any of the component parts immediately after the SRS airbags have deployed (inflated) as they may be hot.
- If breathing becomes difficult after the SRS airbag has deployed, open a door or window to allow fresh air in, or leave the vehicle if it is safe to do so. Wash off any residue as soon as possible to prevent skin irritation.
- If the areas where the SRS airbags are stored, such as the steering wheel pad and front and rear pillar garnishes, are damaged or cracked, have them replaced by your Toyota dealer.

**■ Modification and disposal of SRS airbag system components**

Do not dispose of your vehicle or perform any of the following modifications without consulting your Toyota dealer.

The SRS airbags may malfunction or deploy (inflate) accidentally, causing death or serious injury.

- Installation, removal, disassembly and repair of the SRS airbags.
- Repairs, modifications, removal or replacement of the steering wheel, instrument panel, dashboard, seats or seat upholstery, front, side and rear pillars or roof side rails.
- Repairs or modifications of the front fender, front bumper, or side of the occupant compartment.
- Installation of snow plows, winches, etc. to the front grille (bull bars, kangaroo bar etc.).
- Modifications to the vehicle's suspension system.
- Installation of electronic devices such as mobile two-way radios or CD players.
- Modifications to your vehicle for a person with a physical disability.

## Front passenger occupant classification system

Your vehicle is equipped with a front passenger occupant classification system. This system detects the conditions of the front passenger seat and activates or deactivates the devices for front passenger.

### ► Vehicles without navigation system

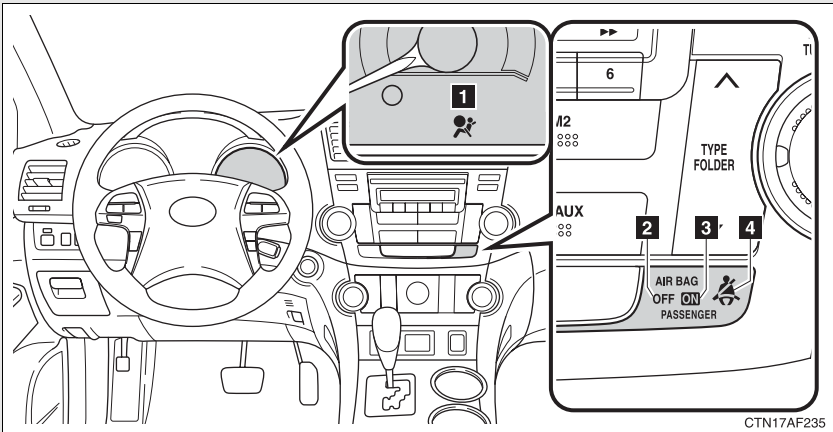

### ► Vehicles with navigation system

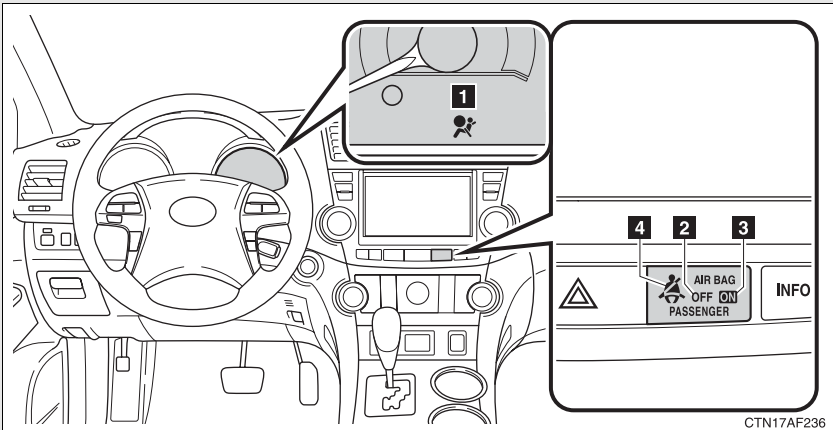

**1** SRS warning light

**2** "AIR BAG OFF" indicator light

**3** "AIR BAG ON" indicator light

**4** Front passenger's seat belt reminder light

## Conditions and operation of the front passenger occupant classification system

### ■ Adult\*<sup>1</sup>

Indicator/ warning light	"AIR BAG ON" and "AIR BAG OFF" indicator lights	"AIR BAG ON"
	SRS warning light	Off
	Front passenger's seat belt reminder light	Flashing* <sup>2</sup>
Devices	Front passenger airbag	Activated
	Side airbag on the front passenger seat	
	Curtain shield airbag in the front passenger side	
	Front passenger's seat belt pretensioner	

### ■ Child\*<sup>3</sup> or child restraint system\*<sup>4</sup>

Indicator/ warning light	"AIR BAG ON" and "AIR BAG OFF" indicator lights	"AIR BAG OFF"* <sup>5</sup>
	SRS warning light	Off
	Front passenger's seat belt reminder light	Flashing* <sup>2</sup>
Devices	Front passenger airbag	Deactivated
	Side airbag on the front passenger seat	
	Curtain shield airbag in the front passenger side	Activated
	Front passenger's seat belt pretensioner	

■ **Unoccupied**

Indicator/ warning light	“AIR BAG ON” and “AIR BAG OFF” indicator lights	Not illuminated
	SRS warning light	Off
	Front passenger's seat belt reminder light	
Devices	Front passenger airbag	Deactivated
	Side airbag on the front passenger seat	
	Curtain shield airbag in the front passenger side	Activated
	Front passenger's seat belt pretensioner	Deactivated

■ **There is a malfunction in the system**

Indicator/ warning light	“AIR BAG ON” and “AIR BAG OFF” indicator lights	“AIR BAG OFF”
	SRS warning light	On
	Front passenger's seat belt reminder light	Off
Devices	Front passenger airbag	Deactivated
	Side airbag on the front passenger seat	
	Curtain shield airbag in the front passenger side	Activated
	Front passenger's seat belt pretensioner	

\*1: The system judges a person of adult size as an adult. When a smaller adult sits in the front passenger seat, the system may recognize him/her as a child depending on his/her physique and posture.

\*2: In the event the front passenger does not wear a seat belt.

\*3: When a larger child who has outgrown a child restraint system sits in the front passenger seat, the system may recognize him/her as an adult depending on his/her physique or posture.

- \*4: Never install a rear-facing child restraint system on the front passenger seat. A forward-facing child restraint system should only be installed on the front passenger seat when it is unavoidable. (→P. 147)
- \*5: In case the indicator is not illuminated, consult this manual as for installing the child restraint system properly. (→P. 151)

 CAUTION

**■ Front passenger occupant classification system precautions**

Observe the following precautions regarding front passenger occupant classification system.

Failure to do so may cause death or serious injury.

- Wear the seat belt properly.
- Make sure the front passenger's seat belt tab has not been left inserted into the buckle before someone sits in the front passenger seat.
- Make sure the "AIR BAG OFF" indicator light is not illuminated when using the seat belt extender for the front passenger seat. If the "AIR BAG OFF" indicator light is illuminated, disconnect the extender tongue from the seat belt buckle, then reconnect the seat belt. Reconnect the seat belt extender after making sure the "AIR BAG ON" indicator light is illuminated. If you use the seat belt extender while the "AIR BAG OFF" indicator light is illuminated, the front passenger airbag, side airbag on the front passenger side may not activate correctly, which could cause death or serious injury in the event of collision.
- Do not apply a heavy load to the front passenger seat or equipment (e.g. seatback pocket).
- Do not put weight on the front passenger seat by putting your hands or feet on the front passenger seat seatback from the rear passenger seat.
- Do not let a rear passenger lift the front passenger seat with their feet or press on the seatback with their legs.
- Do not put objects under the front passenger seat.
- Do not recline the front passenger seatback so far that it touches a rear seat. This may cause the "AIR BAG OFF" indicator light to be illuminated, which indicates that the passenger's airbags will not deploy in the event of a severe accident. If the seatback touches the rear seat, return the seatback to a position where it does not touch the rear seat. Keep the front passenger seatback as upright as possible when the vehicle is moving. Reclining the seatback excessively may lessen the effectiveness of the seat belt system.



 CAUTION**■ Front passenger occupant classification system precautions**

- If an adult sits in the front passenger seat, the “AIR BAG ON” indicator light is illuminated. If the “AIR BAG OFF” indicator is illuminated, ask the passenger to sit up straight, well back in the seat, feet on the floor, and with the seat belt worn correctly. If the “AIR BAG OFF” indicator still remains illuminated, either ask the passenger to move to the rear seat, or if that is not possible, move the front passenger seat fully rearward.
- When it is unavoidable to install the forward-facing child restraint system on the front passenger seat, install the child restraint system on the front passenger seat in the proper order. (→P. 151)
- Do not modify or remove the front seats.
- Do not kick the front passenger seat or subject it to severe impact. Otherwise, the SRS warning light may come on to indicate a malfunction of the detection system. In this case, contact your Toyota dealer immediately.
- Child restraint systems installed on the rear seat should not contact the front seatbacks.
- Do not use a seat accessory, such as a cushion or seat cover, that covers the seat cushion surface.
- Do not modify or replace the upholstery of the front seat.

## Child restraint systems

**A child restraint system for a small child or baby must itself be properly restrained on the seat with the lap portion of the lap/shoulder belt.**

**The laws of all 50 states of the U.S.A. and Canada now require the use of child restraint systems.**

### Points to remember

Studies have shown that installing a child restraint on a rear seat is much safer than installing one to the front passenger seat.

- Choose a child restraint system that suits your vehicle and is appropriate to the age and size of the child.
- For installation details, follow the instructions provided with the child restraint system.

General installation instructions are provided in this manual.  
(→P. 151)

## Types of child restraints

Child restraint systems are classified into the following 3 types according to the age and size of the child.

▶ Rear facing — Infant seat/convertible seat

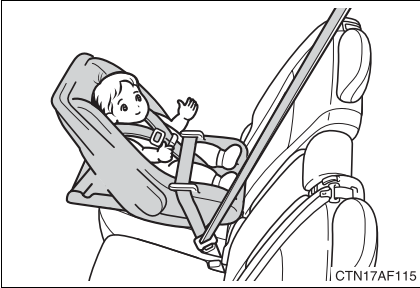

▶ Forward facing — Convertible seat



▶ Booster seat

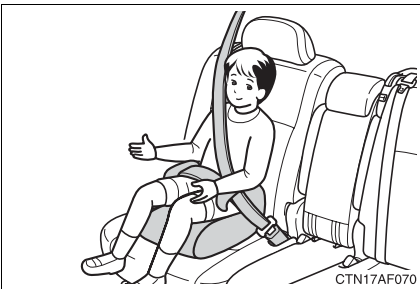

### ■ Selecting an appropriate child restraint system

- Use a child restraint system appropriate for the child until the child becomes large enough to properly wear the vehicle's seat belt.
- If a child is too large for a child restraint system, sit the child on a rear seat and use the vehicle's seat belt. (→P. 94)

### CAUTION

#### ■ Child restraint precautions

- For effective protection in automobile accidents and sudden stops, a child must be properly restrained, using a seat belt or child restraint system depending on the age and size of the child. Holding a child in your arms is not a substitute for a child restraint system. In an accident, the child can be crushed against the windshield, or between you and the vehicle's interior.
- Toyota strongly urges the use of a proper child restraint system that conforms to the size of the child, installed on the rear seat. According to accident statistics, the child is safer when properly restrained in the rear seat than in the front seat.
- Never install a rear-facing child restraint system on the front passenger seat even if "AIR BAG OFF" indicator light is illuminated. In the event of an accident, the force of the rapid inflation of the front passenger airbag can cause death or serious injury to the child if the rear-facing child restraint system is installed on the front passenger seat.

 **CAUTION****■ Child restraint precautions**

- A forward-facing child restraint system may be allowed to be installed on the front passenger seat only when it is unavoidable. A child restraint system that requires a top tether strap should not be used in the front passenger seat since there is no top tether strap anchor for the front passenger seat. Adjust the seatback as upright as possible and always move the seat as far back as possible even if the “AIR BAG OFF” indicator light is illuminated, because the front passenger airbag could inflate with considerable speed and force. Otherwise, the child may be killed or seriously injured.
- Do not use the seat belt extender when installing a child restraint system on the front or rear passenger seat. If installing a child restraint system with the seat belt extender connected to the seat belt, the seat belt will not securely hold the child restraint system, which could cause death or serious injury to the child or other passengers in the event of an accident.
- Do not allow the child to lean his/her head or any part of his/her body against the door or the area of the seat, front and rear pillars or roof side rail from which the side airbags or curtain shield airbags deploy even if the child is seated in the child restraint system. It is dangerous if the side airbags and curtain shield airbags inflate, and the impact could cause death or serious injury to the child.
- Make sure you have complied with all installation instructions provided by the child restraint manufacturer and that the system is properly secured. If it is not secured properly, it may cause death or serious injury to the child in the event of a sudden stop or an accident.

**■ Child restraint lock function belt precaution**

Do not allow children to play with the child restraint lock function belt. If the belt becomes twisted around a child's neck, it will not be possible to pull the belt out leading to choking or other serious injuries that could result in death. If this occurs and the buckle cannot be unfastened, scissors should be used to cut the belt.



**CAUTION**

**■ When the child restraint system is not in use**

- Keep the child restraint system properly secured on the seat even if it is not in use.  
Do not store the restraint unsecured in the passenger compartment.
- If it is necessary to detach the child restraint system, remove it from the vehicle or store it securely in the luggage compartment. This will prevent it from injuring passengers in the event of a sudden stop or accident.

# Installing child restraints

**Follow the child restraint system manufacturer's instructions. Firmly secure child restraints to the rear seats using the LATCH anchors or a seat belt. Attach the top tether strap when installing a child restraint.**

**The lap/shoulder belt can be used if your child restraint system is not compatible with the LATCH (Lower Anchors and Tethers for Children) system.**

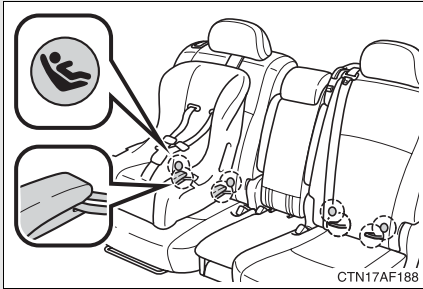

Second seat: Child restraint LATCH anchors

LATCH anchors are provided for the rear outside seats. (Buttons displaying the location of the anchors are attached to the seats.)

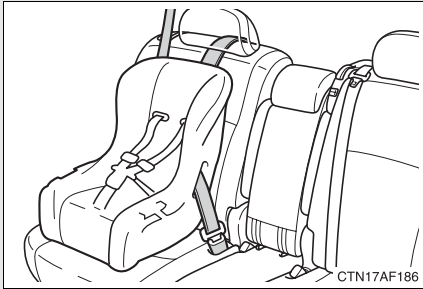

Seat belts equipped with a child restraint locking mechanism (ALR/ELR belts except driver's seat belt)

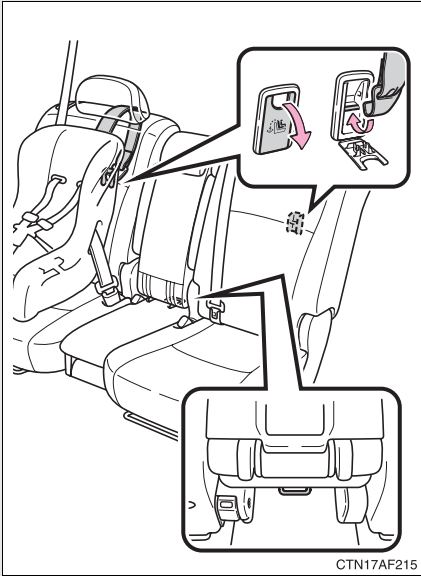

**Second seat: Anchor brackets  
(for top tether strap)**

Anchor brackets are provided  
for the second seats.



## Installation with LATCH system

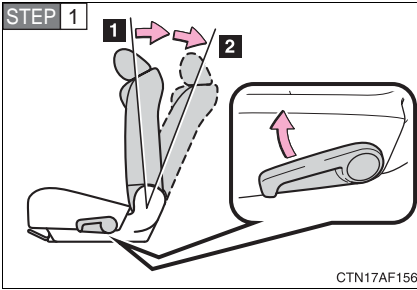

Fold the seatback while pulling the lever. Return the seatback and secure it at the 1st lock position (most upright position). Adjust the seatback to the 3rd lock position. (→P. 82)

**1** 1st lock position

**2** 3rd lock position

### ► Type A

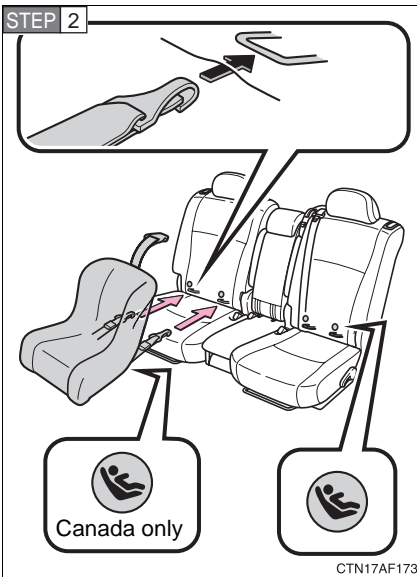

Latch the hooks of the lower straps onto the LATCH anchors.

The bars are installed in the clearance between the seat cushion and seatback.

If the child restraint has a top tether strap, the top tether strap should be latched onto the top tether strap anchors.

For owners in Canada:

The symbol on a child restraint system indicates the presence of a lower connector system.

► Type B

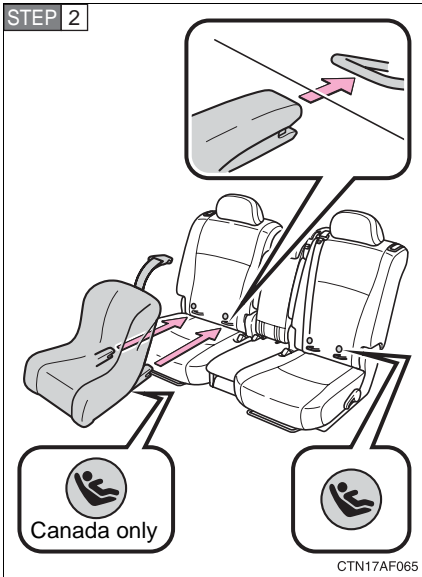

Latch the buckles onto the LATCH anchors.

The bars are installed in the clearance between the seat cushion and seatback.

If the child restraint has a top tether strap, the top tether strap should be latched onto the top tether strap anchors.

For owners in Canada:

The symbol on a child restraint system indicates the presence of a lower connector system.

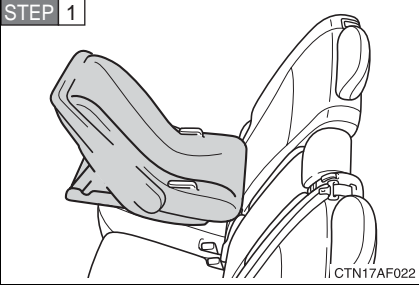
**Installing child restraints using a seat belt (child restraint lock function belt)****■ Rear facing — Infant seat/convertible seat****STEP 1**

Place the child seat on the rear seat facing the rear of the vehicle.

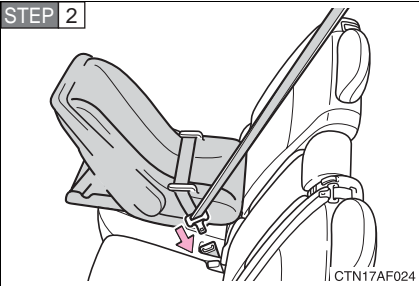
**STEP 2**

Run the seat belt through the child seat and insert the plate into the buckle. Make sure that the belt is not twisted.

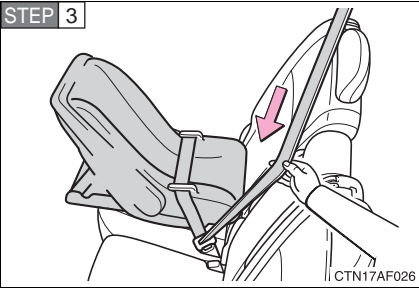
**STEP 3**

Fully extend the shoulder belt and then allow it to retract slightly in order to activate the ALR lock mode.

Lock mode allows the seat belt to retract only.

1

Before driving

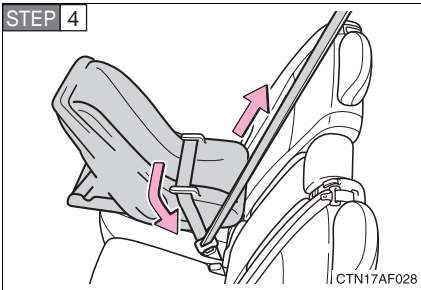

While pushing the child seat down into the rear seat, allow the shoulder belt to retract until the child seat is securely in place.

After the shoulder belt has retracted to a point where there is no slack in the belt, pull the belt to check that it cannot be extended.

### ■ Forward facing — Convertible seat

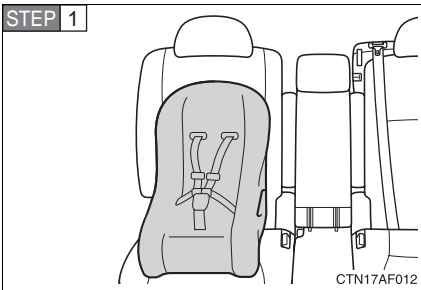

Place the child seat on the seat facing the front of the vehicle.

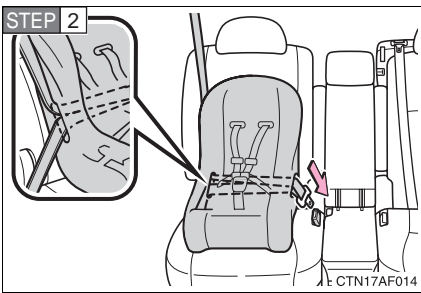

Run the seat belt through the child seat and insert the plate into the buckle. Make sure that the belt is not twisted.

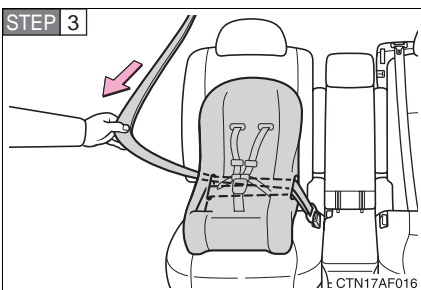

Fully extend the shoulder strap and then allow it to retract slightly into the ALR lock mode.

Lock mode allows the seat belt to retract only.

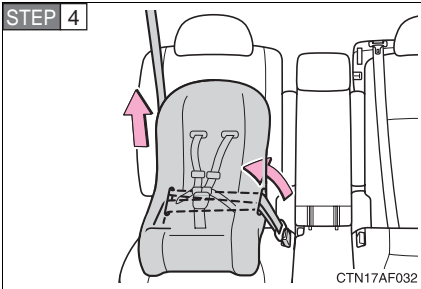

While pushing the child seat into the rear seat, allow the shoulder belt to retract until the child seat is securely in place.

After the shoulder belt has retracted to a point where there is no slack in the belt, pull the belt to check that it cannot be extended.

**STEP 5** If the child restraint has a top tether strap, the top tether strap should be latched onto the top tether strap anchors.

### ■ Booster seat

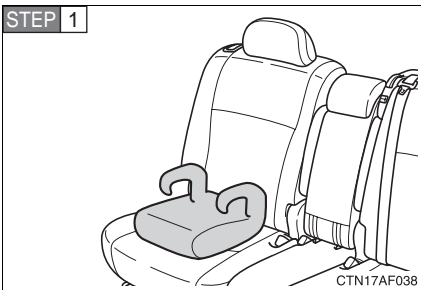

Place the booster seat on the seat facing the front of the vehicle.

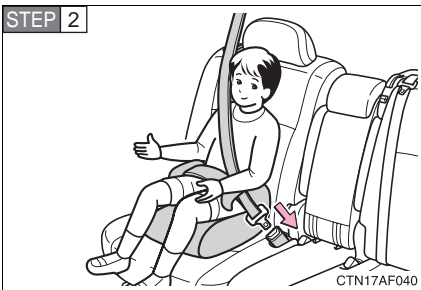

Sit the child in the booster seat. Fit the seat belt to the booster seat according to the manufacturer's instructions and insert the plate into the buckle. Make sure that the belt is not twisted.

Check that the shoulder belt is correctly positioned over the child's shoulder, and that the lap belt is as low as possible.

(→P. 94)

### Removing a child restraint installed with a seat belt

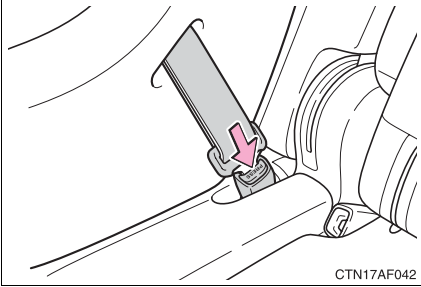

Push the buckle release button and fully retract the seat belt.

### Child restraint systems with a top tether strap (second seat only)

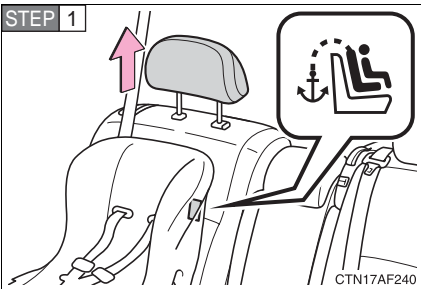

Secure the child restraint using the seat belt or lower anchors, and adjust the head restraint to the upmost position.

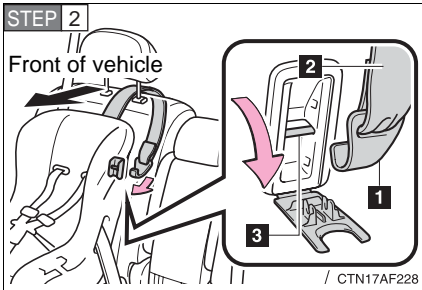

Outside seat: Open the anchor bracket cover, latch the hook onto the anchor bracket and tighten the top tether strap.

Center seat: Latch the hook onto the anchor bracket and tighten the top tether strap.

Make sure the top tether strap is securely latched.

- 1** Hook
- 2** Top strap
- 3** Anchor bracket

Adjust the head restraint to the downmost position.

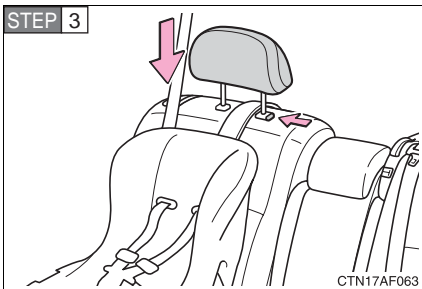

### ■ Laws and regulations pertaining to anchorages

The LATCH system conforms to FMVSS225 or CMVSS210.2.

Child restraint systems conforming to FMVSS213 or CMVSS213 specifications can be used.

This vehicle is designed to conform to the SAE J1819.

**! CAUTION**

**■ When installing a booster seat**

Do not fully extend the shoulder belt to prevent the belt from going to ALR lock mode. (→P. 95)

ALR mode causes the belt to tighten only which could cause injury or discomfort to the child.

**■ When installing a child restraint system**

Follow the directions given in the child restraint system installation manual and fix the child restraint system securely in place.

If the child restraint system is not correctly fixed in place, the child or other passengers may be seriously injured or even killed in the event of sudden braking or an accident.

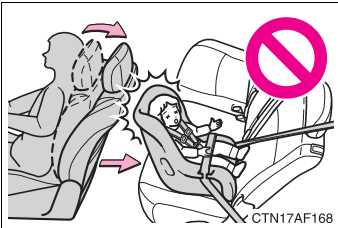

● If the driver's seat interferes with the child restraint system and prevents it from being attached correctly, attach the child restraint system to the right-hand rear seat.

● Adjust the front passenger seat or second seats so that it does not interfere with the child restraint system.

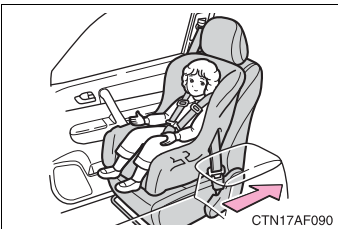

● Only put a forward-facing or booster child seat on the front seat when unavoidable. When installing a forward-facing or booster child seat on the front passenger seat, move the seat as far back as possible even if "AIR BAG OFF" indicator light is illuminated. Failing to do so may result in death or serious injury if the airbags deploy (inflate).



 **CAUTION****■ When installing a child restraint system**

- When installing a child restraint system in the rear center seat, adjust both seat cushions to the same position and align seatbacks at the same angle. The seatbacks must be adjusted to the same angle. Otherwise, the child restraint system cannot be securely restrained and this may cause death or serious injuries in an accident.
- When using the LATCH anchors for a child restraint system, move the seat as far back as possible (second seat only), with the seatback close to the child restraint system.
- When a booster seat is installed, always ensure that the shoulder belt is positioned across the center of the child's shoulder. The belt should be kept away from the child's neck, but not so that it could fall off the child's shoulder. Failing to do so may result in death or serious injury in the event of an accident or sudden braking.
- Ensure that the belt and tab are securely locked and the seat belt is not twisted.
- Push and pull the child seat from side to side and forward to be sure it is secure.
- After securing a child restraint system, never adjust the seat.
- Follow all installation instructions provided by the child restraint system manufacturer.

**■ Do not use a seat belt extender**

If a seat belt extender is used when installing a child restraint system, the seat belt will not securely hold the child restraint system, which could cause death or serious injury to the child or other passengers in the event of an accident.

**■ To correctly attach a child restraint system to the anchors**

When using the LATCH anchors, be sure that there are no foreign objects around the anchors and that the seat belt is not caught behind the child restraint. Make sure the child restraint system is securely attached, or it may cause death or serious injury to the child or other passengers in the event of a sudden stop or an accident.



## 2-1. Driving procedures

# Driving the vehicle

The following procedures should be observed to ensure safe driving.

### ■ Starting the engine

→P. 173, 177

### ■ Driving

**STEP 1** With the brake pedal depressed, shift the shift lever to D. (→P. 180)

**STEP 2** Release the parking brake. (→P. 186)

**STEP 3** Gradually release the brake pedal and gently depress the accelerator pedal to accelerate the vehicle.

### ■ Stopping

**STEP 1** With the shift lever in D, depress the brake pedal.

**STEP 2** If necessary, set the parking brake.

When the vehicle is stopped for an extended period of time, shift the shift lever to P or N. (→P. 180)

### ■ Parking the vehicle

**STEP 1** With the shift lever in D, depress the brake pedal.

**STEP 2** Set the parking brake. (→P. 186)

**STEP 3** Shift the shift lever to P. (→P. 180)

When parking on a hill, if necessary, block the wheels.

**STEP 4** Vehicles without smart key system:

Turn the engine switch to the “LOCK” position to stop the engine.

Vehicles with smart key system:

Turn the “ENGINE START STOP” switch OFF to stop the engine.

**STEP 5** Lock the door, making sure that you have the key on your person.

## Starting on a steep uphill

- STEP 1** Firmly set the parking brake and shift the shift lever to D.
- STEP 2** Gently depress the accelerator pedal.
- STEP 3** Release the parking brake.

### ■ Driving in the rain

- Drive carefully when it is raining, because visibility will be reduced, the windows may become fogged-up, and the road will be slippery.
- Drive carefully when it starts to rain, because the road surface will be especially slippery.
- Refrain from high speeds when driving on an expressway in the rain, because there may be a layer of water between the tires and the road surface, preventing the steering and brakes from operating properly.

### ■ Breaking in your new Toyota

To extend the life of the vehicle, the following precautions are recommended to observe:

- For the first 186 miles (300 km):  
Avoid sudden stops.
- For the first 500 miles (800 km):  
Do not tow a trailer.
- For the first 621 miles (1000 km):
  - Do not drive at extremely high speeds.
  - Avoid sudden acceleration.
  - Do not drive continuously in the low gears.
  - Do not drive at a constant speed for extended periods.

### ■ Drum-in-disc type parking brake system

Your vehicle has a drum-in-disc type parking brake system.

This type of brake system needs bedding-down of the brake shoes periodically or whenever the parking brake shoes and/or drums are replaced.

Have your Toyota dealer perform the bedding-down.

### ■ Operating your vehicle in a foreign country

Comply with the relevant vehicle registration laws and confirm the availability of the correct fuel. (→P. 555)

### ■ Normal characteristics after turning off the engine

Approximately five hours after the engine is turned off, you may hear sound coming from under the vehicle for several minutes. This is the sound of a fuel evaporation leakage check and, it does not indicate a malfunction.

## CAUTION

### ■ When starting the vehicle

Always keep your foot on the brake pedal while stopped with the engine running. This prevents the vehicle from creeping.

### ■ When driving the vehicle

- Do not drive if you are unfamiliar with the location of the brake and accelerator pedals to avoid depressing the wrong pedal.
  - Accidentally depressing the accelerator pedal instead of the brake pedal will result in sudden acceleration that may lead to an accident that could result in death or serious injury.
  - When backing up, you may twist your body around, leading to a difficulty in operating the pedals. Make sure to operate the pedals properly.
  - Make sure to keep a correct driving posture even when moving the vehicle only slightly, allowing you to depress the brake and accelerator pedals properly.
  - Depress the brake pedal using your right foot. Depressing the brake pedal using your left foot may delay response in an emergency, resulting in an accident.
- Do not drive the vehicle over or stop the vehicle near flammable materials. The exhaust system and exhaust gases can be extremely hot. This may cause a fire if there is any flammable material nearby.

 CAUTION

- Do not let the vehicle roll backwards while the shift lever is in a driving position, or roll forward while the shift lever is in R.  
Doing so may cause the engine to stall or lead to poor brake and steering performance, resulting in an accident or damage to the vehicle.
- If the smell of exhaust is noticed inside the vehicle, open the windows and check that the back door is closed. Large amounts of exhaust in the vehicle can cause driver drowsiness and an accident, resulting in death or a serious health hazard. Have the vehicle inspected by your Toyota dealer immediately.
- Do not under any circumstances shift the shift lever to P, R or N while the vehicle is moving.  
Doing so can cause significant damage to the transmission system and may result in a loss of vehicle control.
- Do not shift the shift lever to N while the vehicle is moving.  
Doing so may cause the engine brake to not operate properly and lead to an accident.
- Do not turn the engine off while driving.  
The power steering and brake booster systems will not operate properly if the engine is not running.
- Use engine braking (downshift) to maintain a safe speed when driving down a steep hill.  
Using the brakes continuously may cause the brakes to overheat and lose effectiveness. (→P. 181)
- When stopped on an inclined surface, use the brake pedal and parking brake to prevent the vehicle from rolling backward or forward and causing an accident.
- Do not adjust the position of the steering wheel, the seat, or the inside or outside rear view mirrors while driving.  
Doing so may result in a loss of vehicle control that can cause accidents that may result in death or serious injury.
- Always check that all passengers' arms, heads or other parts of their bodies are not outside the vehicle, as this may result in death or serious injury.
- Do not drive the vehicle off-road.  
This is not a 4WD vehicle designed for real off-road driving. Proceed with all due caution if it becomes unavoidable to drive off-road.

 **CAUTION**

- 4WD models: Do not drive across a river or through other bodies of water. This may cause electric/electronic components to short circuit, damage the engine or cause other serious damage to the vehicle.

- Do not drive in excess of the speed limit. Even if the legal speed limit permits it, do not drive over 85 mph (140 km/h) unless your vehicle has high-speed capability tires. Driving over 85 mph (140 km/h) may result in tire failure, loss of control and possible injury. Be sure to consult a tire dealer to determine whether the tires on your vehicle are high-speed capability tires or not before driving at such speeds.

■ **When driving on slippery road surfaces**

- Sudden braking, acceleration and steering may cause tire slippage and reduce your ability to control the vehicle, resulting in an accident.

- Sudden changes in engine speed, such as engine braking caused by up-shifting or down-shifting, may cause the vehicle to skid, resulting in an accident.

- After driving through a puddle, lightly depress the brake pedal to make sure that the brakes are functioning properly. Wet brake pads may prevent the brakes from functioning properly. If the brakes on only one side are wet and not functioning properly, steering control may be affected, resulting in an accident.

■ **When shifting the shift lever**

Be careful not to shift the shift lever with the accelerator pedal depressed. This may lead to unexpected rapid acceleration of the vehicle that may cause an accident and result in death or serious injury.

■ **When the vehicle is stopped**

- Do not race the engine.

If the vehicle is in any gear other than P or N, the vehicle may accelerate suddenly and unexpectedly, and may cause an accident.

- Do not leave the vehicle with the engine running for a long time.

If such a situation cannot be avoided, park the vehicle in an open space and check that exhaust fumes do not enter the vehicle interior.

- Always keep a foot on the brake pedal while the engine is running to prevent an accident caused by the vehicle moving.

 **CAUTION****■ When the vehicle is parked**

- Do not leave glasses, cigarette lighters, spray cans, or soft drink cans in the vehicle when it is in the sun.

Doing so may result in the following.

- Gas may leak from a cigarette lighter or spray can, and may lead to a fire.
  - The temperature inside the vehicle may cause the plastic lenses and plastic material of eye glasses to deform or crack.
  - Soft drink cans may fracture, causing the contents to spray over the interior of the vehicle, and may also cause a short circuit in the vehicle's electrical components.
- Always apply the parking brake, shift the shift lever to P, stop the engine and lock the vehicle.  
Do not leave the vehicle unattended while the engine is running.
  - Do not touch the exhaust pipe while the engine is running or immediately after turning the engine off.  
Doing so may cause burns.
  - Do not leave the engine running in an area with snow build-up, or where it is snowing. If snowbanks build up around the vehicle while the engine is running, exhaust gases may collect and enter the vehicle. This may lead to death or a serious health hazard.

**■ Exhaust gases**

Exhaust gases include harmful carbon monoxide (CO) that is colorless and odorless. Inhaling exhaust gases may lead to death or a serious health hazard.

- If the vehicle is in a poorly ventilated area, stop the engine. In a closed area, such as a garage, exhaust gases may collect and enter the vehicle. This may lead to death or a serious health hazard.
- The exhaust should be checked occasionally. If there is a hole or crack caused by corrosion, damage to a joint or abnormal exhaust noise, be sure to have the vehicle inspected and repaired by your Toyota dealer. Failure to do so may allow exhaust gases to enter the vehicle, resulting in death or a serious health hazard.



 **CAUTION**

■ **When taking a nap in the vehicle**

Always turn the engine off. Otherwise, you may accidentally move the shift lever or depress the accelerator pedal, which could cause an accident or fire due to engine overheating. Additionally, if the vehicle is parked in a poorly ventilated area, exhaust gases may collect and enter the vehicle, leading to death or a serious health hazard.

■ **When braking the vehicle**

- When the brakes are wet, drive more cautiously.

Braking distance increases when the brakes are wet, and may cause one side of the vehicle to brake differently than the other side. Also the parking brake may not securely hold the vehicle.

- If the power brake assist function does not operate, do not follow other vehicles closely and avoid downhills or sharp turns that require braking.

In this case, braking is still possible, but it will require more force on the pedal than usual. Braking distance may also increase.

- Do not pump the brake pedal if the engine stalls.

Each push on the brake pedal uses up the reserve for the power-assisted brakes.

- The brake system consists of 2 individual hydraulic systems: If one of the systems fails, the other will still operate. In this case, the brake pedal should be depressed more firmly than usual and braking distance becomes longer.

Do not drive your vehicle with only a single brake system. Have your brakes fixed immediately.

■ **If the vehicle becomes stuck or bogged (4WD models)**

Do not spin the wheels recklessly when any of the tires is up in the air, or stuck in sand or mud etc. This may damage the drive system components or propel the vehicle forward (or in another direction) and cause an accident.

 **CAUTION**

■ **If you hear a squealing or scraping noise (brake pad wear limit indicators)**

Have the brake pads checked and replaced by your Toyota dealer as soon as possible.

The rotor damage can result if the pads are not replaced when needed.

It is dangerous to drive the vehicle when the wear limits of the brake pads and/or those of the brake discs are exceeded.

■ **If you get a flat tire while driving**

A flat or damaged tire may cause the following situations. Hold the steering wheel firmly and gradually press the brake pedal to slow down the vehicle.

- It may be difficult to control your vehicle.
- The vehicle will make abnormal sounds.
- The vehicle will behave abnormally.

Replace a flat tire with a new one. (→P. 526)

 **NOTICE**

■ **When driving the vehicle**

Do not use the accelerator pedal or depress the accelerator and brake pedals together to hold the vehicle on a hill.

■ **When parking the vehicle**

Always put the shift lever in P. Failure to do so may cause the vehicle to move or the vehicle may accelerate suddenly if the accelerator pedal is accidentally depressed.

■ **Avoiding damage to vehicle parts**

- Do not turn the steering wheel fully in either direction and hold it there for a long time.  
Doing so may damage the power steering motor.
- When driving over bumps in the road, drive as slowly as possible to avoid damaging the wheels, underside of the vehicle, etc.

 NOTICE

■ **When encountering flooded roads**

Do not drive on a road that has flooded after heavy rain etc. Doing so may cause the following serious damage to the vehicle.

- Engine stalling
- Short in electrical components
- Engine damage caused by water immersion

In the event that you drive on a flooded road and the vehicle is flooded, be sure to have your Toyota dealer check the following.

- Brake function
- Changes in quantity and quality of oil and fluid used for the engine, transaxle, transfer (4WD models), differential (4WD models), etc.
- Lubricant condition for the propeller shaft (4WD models), bearings and suspension joints (where possible) and the function of all joints, bearings, etc.

**Performing the following operations when carrying the electronic key on your person starts the engine or changes “ENGINE START STOP” switch mode.**

■ **Starting the engine**

The engine can be started in any mode by operating the “ENGINE START STOP” switch at the same time as depressing the brake pedal.

**STEP 1** Check that the parking brake is set.

**STEP 2** Check that the shift lever is set in P.

**STEP 3** Sit in the driver’s seat and firmly depress the brake pedal.

The “ENGINE START STOP” switch indicator turns green. If the indicator does not turn green, the engine cannot be started.

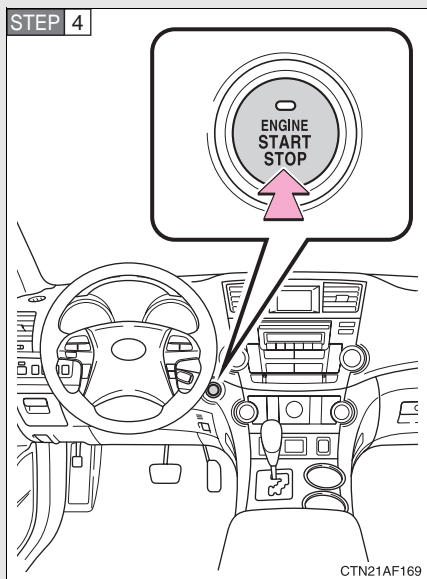

Press the “ENGINE START STOP” switch.

The engine can be started from any mode.

Continue depressing the brake pedal until the engine is completely started.

The engine will crank until it starts or for up to 30 seconds, whichever is less.

### ■ Changing “ENGINE START STOP” switch modes

Modes can be changed by pressing the “ENGINE START STOP” switch with the brake pedal released. (The mode changes each time the switch is pressed.)

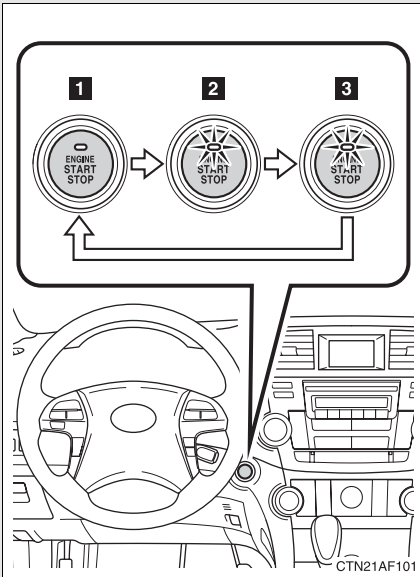

#### 1 OFF\*

The emergency flashers can be used.

#### 2 ACCESSORY mode

Some electrical components such as the audio system can be used.

The “ENGINE START STOP” switch indicator turns amber.

#### 3 IGNITION ON mode

All electrical components can be used.

The “ENGINE START STOP” switch indicator turns amber.

\*: The engine cannot be switched to OFF unless the shift lever is in P.

### ■ Steering lock release

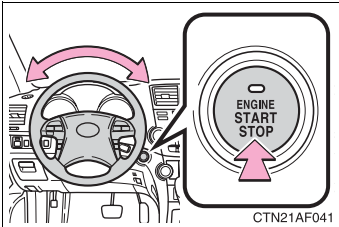

Make sure that the steering wheel lock is released.

To release the steering wheel lock, gently turn the wheel left or right while pressing the “ENGINE START STOP” switch.

When the steering wheel lock is not released, the “ENGINE START STOP” switch indicator will flash in green.

### ■ If the engine does not start

The engine immobilizer system may not have been deactivated. (→P. 115)

### ■ When the “ENGINE START STOP” switch indicator flashes in amber

The system may be malfunctioning. Have the vehicle inspected by your Toyota dealer immediately.

### ■ Auto power off function

If the vehicle is left in ACCESSORY mode for more than an hour with the shift lever in P, the “ENGINE START STOP” switch will automatically turn off.

### ■ Key battery depletion

→P. 40

### ■ When the electronic key battery is discharged

→P. 473

### ■ Conditions affecting operation

→P. 38

### ■ Note for the entry function

→P. 40

 CAUTION

■ **When starting the engine**

Always start the engine while sitting in the driver's seat. Do not depress the accelerator pedal while starting the engine under any circumstances. Doing so may cause an accident resulting in death or serious injury.

■ **Stopping the engine in an emergency**

If you want to stop the engine in an emergency while driving the vehicle, push and hold the "ENGINE START STOP" switch for more than 3 seconds. However, do not touch the "ENGINE START STOP" switch while driving except in an emergency. If the engine stops while the vehicle is being driven, this could lead to an unexpected accident.

 NOTICE

■ **To prevent battery discharge**

Do not leave the "ENGINE START STOP" switch in ACCESSORY or IGNITION ON mode for long periods without the engine running.

■ **When starting the engine**

- Do not race a cold engine.
- If the engine becomes difficult to start or stalls frequently, have the engine checked immediately.

■ **Starting the engine**

- STEP 1** Check that the parking brake is set.
- STEP 2** Check that the shift lever is set in P.
- STEP 3** Sit in the driver's seat and firmly depress the brake pedal.
- STEP 4** Turn the engine switch to the "START" position and start the engine.

■ **Changing engine switch position**

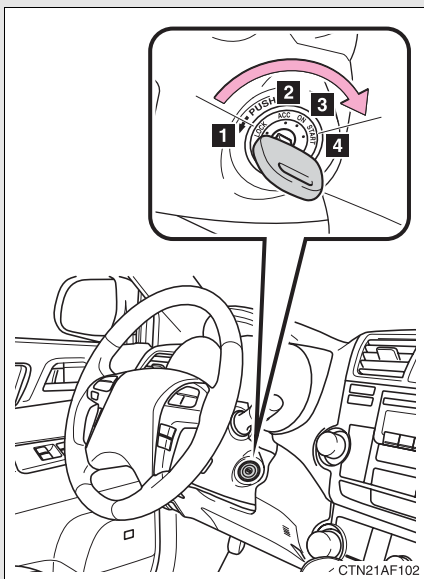

**1** "LOCK"

The steering wheel is locked and the key can be removed. (The key can be removed only when the shift lever is in P.)

**2** "ACC"

Some electrical components such as the audio system can be used.

**3** "ON"

All electrical components can be used.

**4** "START"

For starting the engine.



### ■ Turning the key from “ACC” to “LOCK”

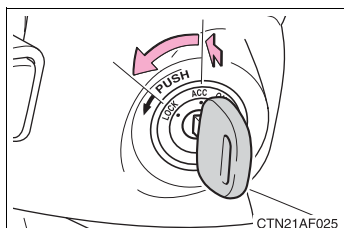

**STEP 1** Shift the shift lever to P.  
(→P. 180)

**STEP 2** Push in the key and turn to the  
“LOCK” position.

### ■ Steering lock release

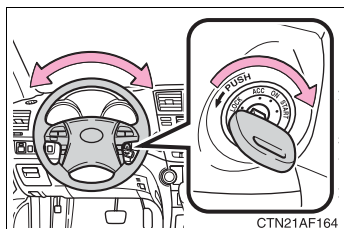

When starting the engine, the engine switch may seem stuck in the “LOCK” position. To free it, turn the key while turning the steering wheel slightly in either direction.

### ■ If the engine does not start (vehicles with engine immobilizer system)

The engine immobilizer system may not have been deactivated. (→P. 115)

### ■ Key reminder function

A buzzer sounds if the driver’s door is opened, while the key is in the “LOCK” or “ACC” position to remind you to remove the key.

## ! CAUTION

### ■ When starting the engine

Always start the engine while sitting in the driver’s seat. Do not depress the accelerator while starting the engine under any circumstances.

Doing so may cause an accident resulting in death or serious injury.

### ■ Caution when driving

Do not turn the engine switch to the “LOCK” position while driving. If, in an emergency, you must turn the engine off while the vehicle is moving, turn the key only to the “ACC” position.

**NOTICE****■ To prevent battery discharge**

Do not leave the key in the “ACC” or “ON” position for a long period if the engine is not running.

**■ When starting the engine**

- Do not crank for more than 30 seconds at a time. This may overheat the starter and wiring systems.
- Do not race a cold engine.
- If the engine becomes difficult to start or stalls frequently, have the engine checked immediately.



## ■ Shift position uses

Shift position	Function
P	Parking the vehicle or starting the engine
R	Reversing
N	Neutral
D	Normal driving <sup>*1</sup>
S	S mode driving (→P. 182) <sup>*2</sup>

\*1: Shifting to the D position allows the system to select a gear suitable for the driving conditions. Setting the shift lever to D position is recommended for normal driving.

\*2: Selecting shift ranges using S mode restricts the upper limit of the possible gear ranges, controls engine braking forces, and prevents unnecessary upshifting.

## ■ Selecting the snow mode

Use the snow mode for accelerating and driving on slippery road surfaces, such as on snow.

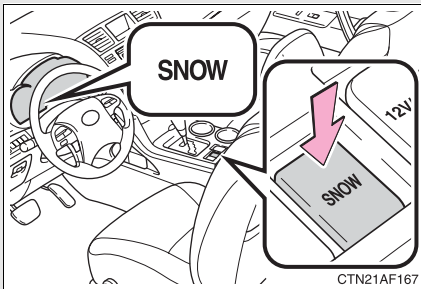

Press the “SNOW” switch.  
The indicator will come on.

Press the switch once more to  
cancel the snow mode.

## Changing shift ranges in S mode

Shift the shift lever to the S position and operate the shift lever.

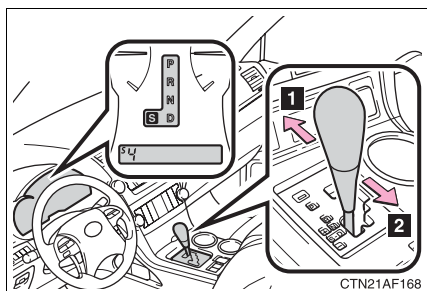

- 1 Upshifting
- 2 Downshifting

### ▶ 2.7 L 4-cylinder (1AR-FE) engine

The initial shift range in S mode is automatically set to 5 or 4 according to the vehicle speed.

When the shift range is “5” or lower, holding the shift lever toward “+” sets the shift range to “6”.

### ▶ 3.5 L V6 (2GR-FE) engine

The initial shift range in S mode is automatically set to 4.

When the shift range is “4” or lower, holding the shift lever toward “+” sets the shift range to “5”.

## ■ Shift ranges and their functions

Shift range	Function	
	2.7 L 4-cylinder (1AR-FE) engine	3.5 L V6 (2GR-FE) engine
6	Automatically selecting gears between 1 and 6 according to vehicle speed and driving conditions.	—
5	Automatically selecting gears between 1 and 5 according to vehicle speed and driving conditions.	
4	Automatically selecting gears between 1 and 4 according to vehicle speed and driving conditions.	
3	Automatically selecting gears between 1 and 3 according to vehicle speed and driving conditions.	
2	Automatically selecting gears between 1 and 2 according to vehicle speed and driving conditions.	
1	Setting the gear at 1.	

A lower shift range will provide greater engine braking forces than a higher shift range.

## ■ Downshifting restrictions

The shift lever cannot be downshifted if the following speeds are exceeded.

### ▶ 2.7 L 4-cylinder (1AR-FE) engine

mph (km/h)

Downshifting	Maximum speed
5 → 4	98 (158)
4 → 3	70 (114)
3 → 2	47 (77)
2 → 1	21 (34)

## ▶ 3.5 L V6 (2GR-FE) engine

mph (km/h)

Downshifting	Maximum speed
4 → 3	93 (150)
3 → 2	57 (92)
2 → 1	24 (39)

■ **When driving with the cruise control system**

## ▶ 2.7 L 4-cylinder (1AR-FE) engine

Engine braking will not operate in the S mode, even when downshifting from “6” to “5” or “5” to “4”. (→P. 211)

## ▶ 3.5 L V6 (2GR-FE) engine

Engine braking will not operate in the S mode, even when downshifting from “5” to “4”. (→P. 211)

■ **Snow mode automatic deactivation**

Snow mode is automatically deactivated if the engine is turned off after driving in snow mode.

■ **If the shift lever cannot be shifted from P**

→P. 537

■ **If the S indicator does not come on even after shifting the shift lever to S**

This may indicate a malfunction in the automatic transmission system. Have the vehicle inspected by your Toyota dealer immediately.

(In this situation, the vehicle will operate as if the shift lever is in D.)

## 2-1. Driving procedures

### Turn signal lever

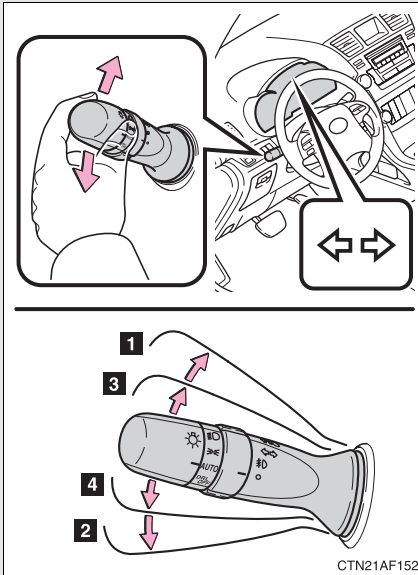

- 1 Right turn
- 2 Left turn
- 3 Move and hold the lever partway to signal a lane change.

The right hand signal will flash until you release the lever.

- 4 Move and hold the lever partway to signal a lane change.

The left hand signal will flash until you release the lever.

2

When driving

#### ■ Turn signals can be operated when

- ▶ Vehicles without smart key system

The engine switch is in the "ON" position.

- ▶ Vehicles with smart key system

The "ENGINE START STOP" switch is in IGNITION ON mode.

#### ■ If the indicators flash faster than usual

Check that a light bulb in the front or rear turn signal lights has not burned out.



## Parking brake

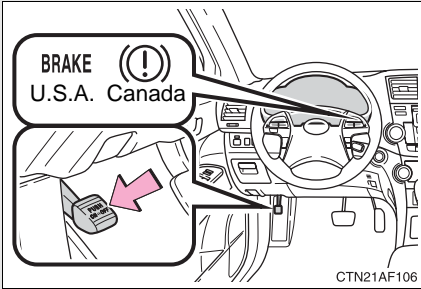

Sets the parking brake\*

(Depress the pedal again releases the parking brake.)

\*: Fully depress the parking brake pedal with your left foot while depressing the brake pedal with your right foot.

### NOTICE

#### ■ Before driving

Fully release the parking brake.

Driving the vehicle with the parking brake set will lead to brake components overheating, which may affect braking performance and increase brake wear.

## Horn

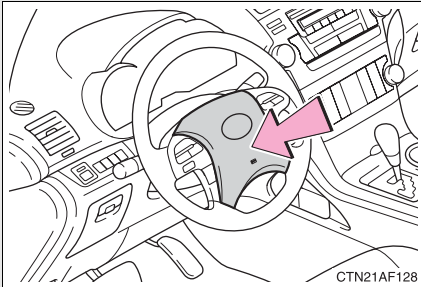

To sound the horn, press on or close to the  mark.

### ■ After adjusting the steering wheel

Make sure that the steering wheel is securely locked.

The horn may not sound if the steering wheel is not securely locked.

(→P. 100)

## 2-2. Instrument cluster

### Gauges and meters

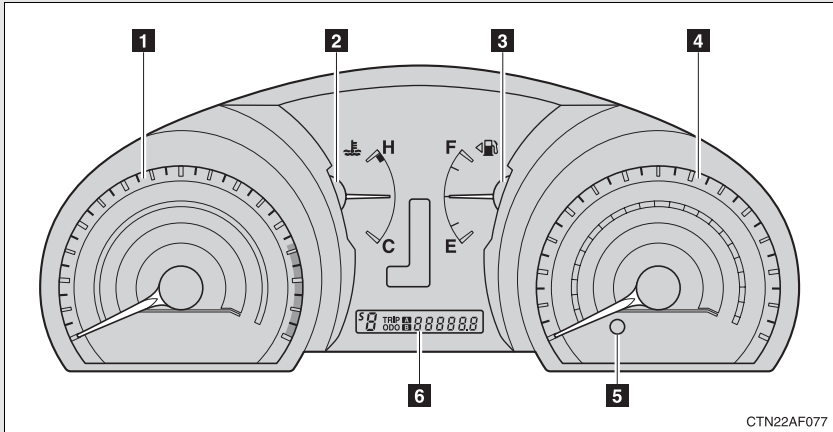

► Vehicles without smart key system

The following gauges and meters illuminate when the engine switch is in the “ON” position.

► Vehicles with smart key system

The following gauges and meters illuminate when the “ENGINE START STOP” switch is in IGNITION ON mode.

**1** Tachometer

Displays the engine speed in revolutions per minute.

**2** Engine coolant temperature gauge

Displays the engine coolant temperature.

**3** Fuel gauge

Displays the quantity of fuel remaining in the tank.

**4** Speedometer

Displays the vehicle speed.

**5** Odometer/trip meter switching and trip meter resetting button

Switches between odometer and trip meter displays. Pushing and holding the button will reset the trip meter when the trip meter is being displayed.

**6 Odometer/Trip meter****▶ Odometer**

Displays the total distance the vehicle has been driven.

**▶ Trip meter**

Displays the distance the vehicle has been driven since the meter was last reset. Trip meters A and B can be used to record and display different distances independently.

**Instrument panel light control**

The brightness of the instrument panel lights can be adjusted.

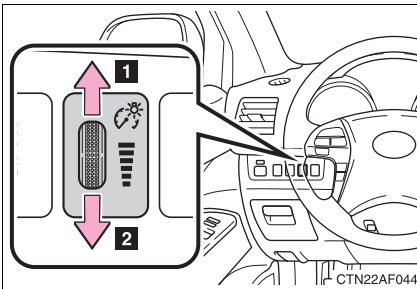
**1** Brighter**2** Darker

When the headlight switch is turned on, the brightness will be reduced slightly unless the control dial is turned fully up.

**⚠ NOTICE****■ To prevent damage to the engine and its components**

- Do not let the indicator needle of the tachometer enter the red zone, which indicates the maximum engine speed.
- The engine may be overheating if the temperature gauge is in the red zone (H). In this case, immediately stop the vehicle in a safe place, and check the engine after it has cooled completely. (→P. 545)

# Indicators and warning lights

The indicator and warning lights on the instrument cluster and center panel inform the driver of the status of the vehicle's various systems.

► Instrument cluster

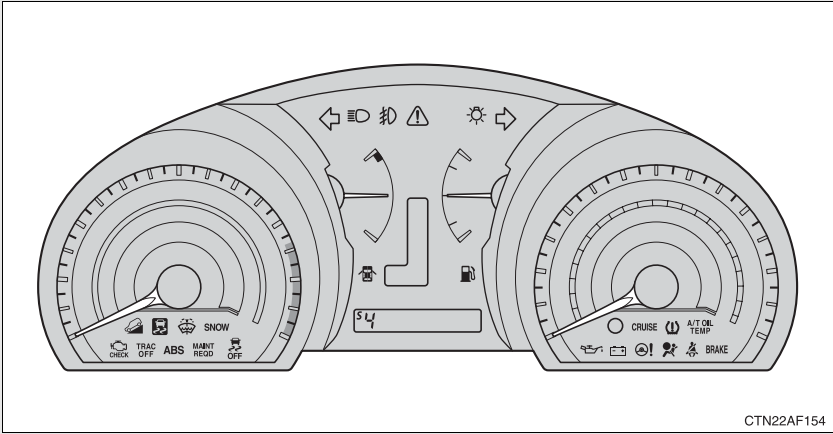

► Center panel (vehicles without navigation system)

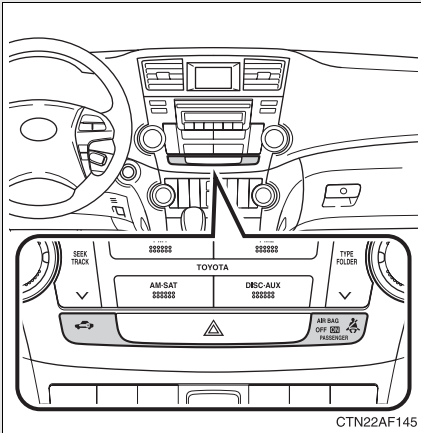

### ► Center panel (vehicles with navigation system)

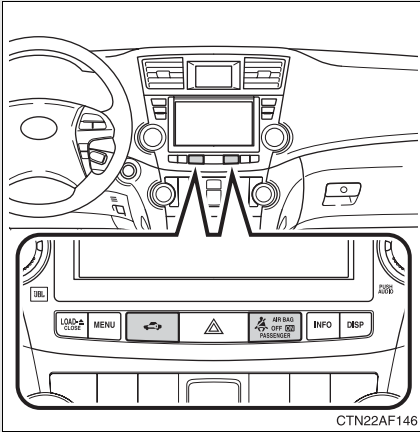

#### ■ Indicators

The indicators inform the driver of the operating state of the vehicle's various systems.



Turn signal indicator  
(→P. 185)



(U.S.A.)

Headlight indicator  
(→P. 203)



Headlight high beam indicator (→P. 205)



(Canada)

Tail light indicator  
(→P. 203)



(4WD models)

\*  
Downhill assist control system indicator  
(→P. 225)



(if equipped)

Front fog light indicator  
(→P. 207)



\*  
Slip indicator  
(→P. 219)



"SNOW" indicator  
(→P. 181)

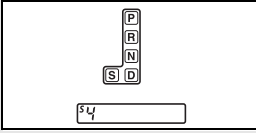

Shift position and shift range indicators (→P. 180)



\* SRS airbag on-off indicator (→P. 140)



\* Enhanced VSC off indicator (→P. 220)



Cruise control indicator (→P. 211)



(if equipped)

Engine immobilizer/alarm indicator (→P. 115, 122)



\* "TRAC OFF" indicator (→P. 219)

\*: These lights turn on when the engine switch is turned to the "ON" position (vehicles without smart key system) or the "ENGINE START STOP" switch is turned to IGNITION ON mode (vehicles with smart key system) to indicate that a system check is being performed. They will turn off after the engine is started, or after a few seconds. There may be a malfunction in a system if a light does not come on, or if the lights do not turn off. Have the vehicle inspected by your Toyota dealer for details.

### ■ Warning lights

Warning lights inform the driver of malfunctions in any of the vehicle's systems. (→P. 510)

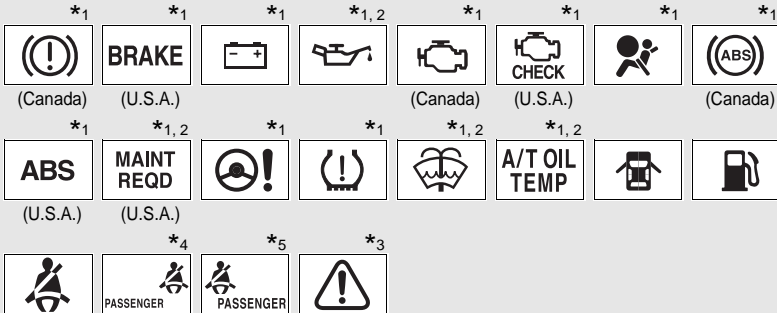

\*1: These lights turn on when the engine switch is turned to the “ON” position (vehicles without smart key system) or the “ENGINE START STOP” switch is turned to IGNITION ON mode (vehicles with smart key system) to indicate that a system check is being performed. They will turn off after the engine is started, or after a few seconds. There may be a malfunction in a system if a light does not come on, or if the lights do not turn off. Have the vehicle inspected by your Toyota dealer for details.

\*2: Vehicles without multi-information display

\*3: Vehicles with multi-information display

\*4: Vehicles without navigation system

\*5: Vehicles with navigation system

 **CAUTION**

**■ If a safety system warning light does not come on**

Should a safety system light such as the ABS and SRS airbag warning light not come on when you start the engine, this could mean that these systems are not available to help protect you in an accident, which could result in death or serious injury. Have the vehicle inspected by your Toyota dealer immediately if this occurs.



## Multi-information display\*

The multi-information display presents the driver with a variety of driving-related data, including the current outside temperature and clock.

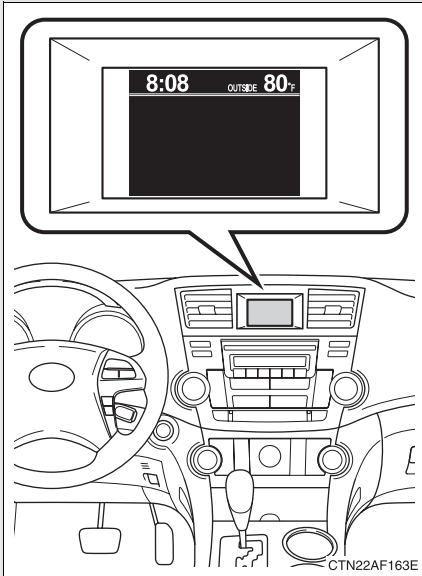

- Outside temperature

Indicates the outside temperature.

The temperature range that can be displayed is from -40°F (-40°C) to 122°F (50°C).

- Clock (→ P. 197)

Indicates and sets the time.

- Trip information (→P. 195)

Displays cruising range, fuel consumption and other cruising-related information.

- Automatic air conditioning system display (if equipped) (→P. 263)

Automatically displayed when the automatic air conditioning is turned on.

- Rear view monitor (if equipped) (→P. 214)

Automatically displayed when the shift lever is moved into the R position.

\*: If equipped

● **Warning messages**  
(→P. 521)

Automatically displayed when a malfunction occurs in one of the vehicle's systems.

## Trip information

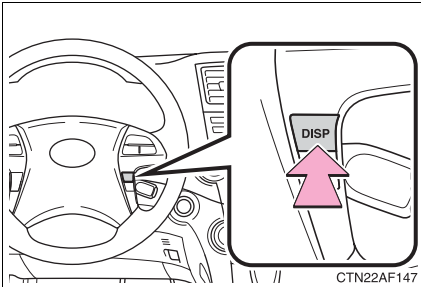

Push the “DISP” button to display trip information.

Display items can be switched by pressing the “DISP” button.

■ **Average fuel consumption after refueling**

Displays the average fuel consumption since the vehicle was last refueled.

■ **Instantaneous fuel consumption**

Displays the instantaneous fuel consumption.

■ **Cruising range**

Displays the estimated maximum distance that can be driven with the quantity of fuel remaining.

- This distance is computed based on your average fuel consumption. As a result, the actual distance that can be driven may differ from that displayed.
- When only a small amount of fuel is added to the tank, the display may not be updated.

■ **Driving distance**

Displays the driving distance since the engine was started.

### ■ Average fuel consumption

Displays the average fuel consumption since the function was reset.

This function can be reset by pressing the “DISP” button for longer than one second when the average fuel consumption is displayed.

When the function is reset, the previous five average fuel consumption values will automatically be displayed for six seconds.

### ■ Average fuel consumption history

Displays the previous five average fuel consumption values.

## Setting up the displays

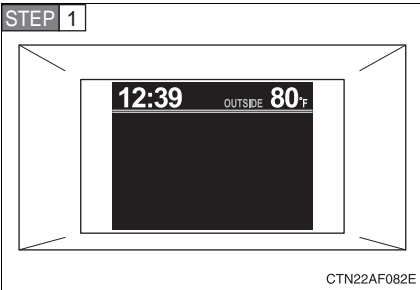

Display the set up screen on the multi-information display when the vehicle is stopped.

Press and hold the “DISP” button to display the set up screen.

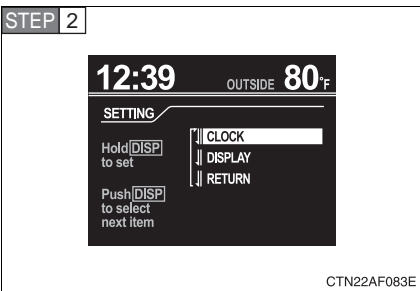

Select the desired item on the menu screen.

Press and hold the “DISP” button to enter the setting mode.

## ■ Setting the clock

**STEP 1** Select “CLOCK” on the menu screen. Press and hold the “DISP” button until the display changes.

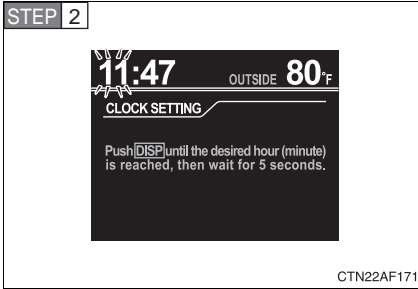

Press the “DISP” button to adjust the hours.

After adjusting the hours, wait 5 seconds to allow the hours to be automatically input.

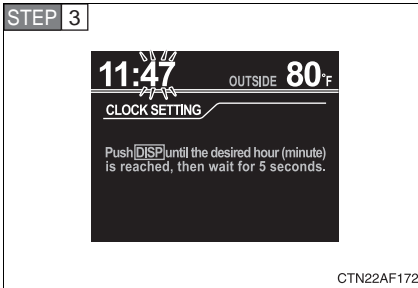

Press the “DISP” button to adjust the minutes.

After adjusting the minutes, wait 5 seconds to allow the minutes to be automatically input.

## ■ Setting the display

**STEP 1** Select “DISPLAY” on the menu screen. Press and hold the “DISP” button until the display changes.

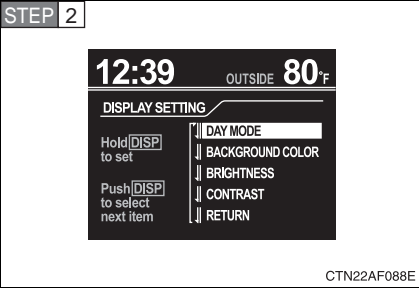

Select the desired item on the menu screen.

Press and hold the “DISP” button to enter the setting mode.

### ● Setting the day mode

**STEP 1** Select “DAY MODE” on the menu screen. Press and hold the “DISP” button until the display changes.

**STEP 2** Press the “DISP” button to select “ON” or “OFF”.

After setting the day mode, wait 5 seconds to allow the mode to be automatically input.

### ● Setting the background color

**STEP 1** Select “BACKGROUND COLOR” on the menu screen. Press and hold the “DISP” button until the display changes.

**STEP 2** Press the “DISP” button to select “BLACK” or “BLUE”.

After selecting a background color, wait 5 seconds to allow the color to be automatically input.

### ● Setting the brightness

**STEP 1** Select “BRIGHTNESS” on the menu screen. Press and hold the “DISP” button until the display changes.

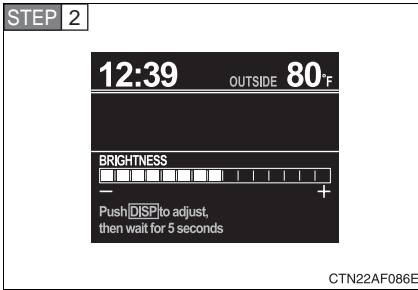

Press the “DISP” button to adjust the brightness.

+: Brighter

-: Darker

After adjusting the brightness, wait 5 seconds to allow the brightness to be automatically input.

### ● Setting the contrast

**STEP 1** Select “CONTRAST” on the menu screen. Press and hold the “DISP” button until the display changes.

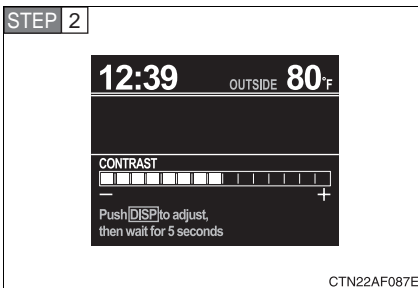

Press the “DISP” button to adjust the contrast.

+: Strengthen

-: Weaken

After adjusting the contrast, wait 5 seconds to allow the contrast to be automatically input.

### ● Returning to the previous screen

Select “RETURN” on the menu screen. Press and hold the “DISP” button until the display changes.

## Setting up the rear view monitor display

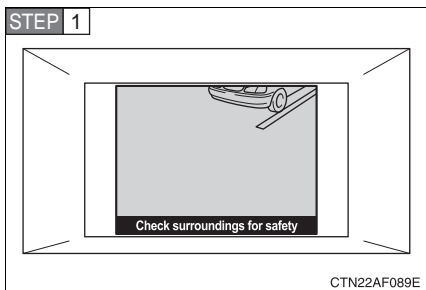

Display the set up screen on the multi-information display when the vehicle is stopped and the rear view monitor is turned on.

Press and hold the “DISP” button to display the set up screen.

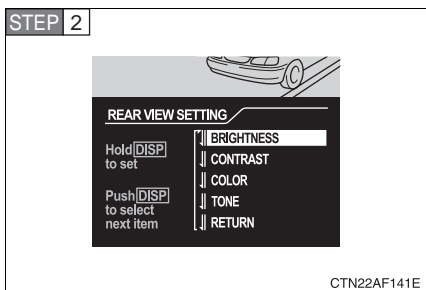

Select the desired item on the menu screen.

Press and hold the “DISP” button to enter the adjustment mode.

### ■ Setting the brightness

**STEP 1** Select “BRIGHTNESS” on the menu screen. Press and hold the “DISP” button until the display changes.

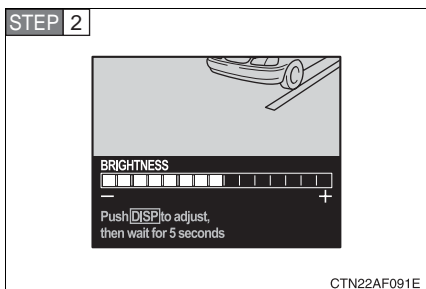

Press the “DISP” button to adjust the brightness.

+: Brighter

-: Darker

After adjusting the brightness, wait 5 seconds to allow the brightness to be automatically input.

## ■ Setting the contrast

**STEP 1** Select “CONTRAST” on the menu screen. Press and hold the “DISP” button until the display changes.

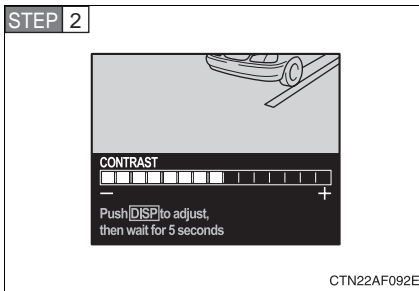

Press the “DISP” button to adjust the contrast.

+: Strengthen

-: Weaken

After adjusting the contrast, wait 5 seconds to allow the contrast to be automatically input.

## ■ Setting the color

**STEP 1** Select “COLOR” on the menu screen. Press and hold the “DISP” button until the display changes.

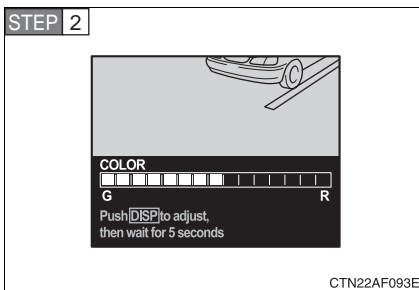

Press the “DISP” button to adjust the color.

G: Green

R: Red

After selecting a color, wait 5 seconds to allow the color to be automatically input.

## ■ Setting the tone

**STEP 1** Select “TONE” on the menu screen. Press and hold the “DISP” button until the display changes.

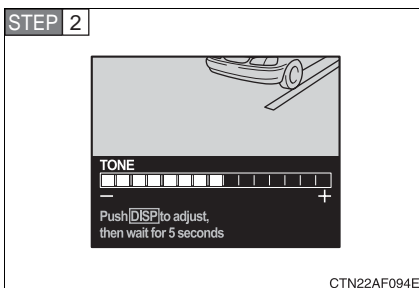

Press the “DISP” button to adjust the tone.

+: Brighter

-: Darker

After adjusting the tone, wait 5 seconds to allow the tone to be automatically input.



### ■ Returning to the previous screen

Select “RETURN” on the menu screen. Press and hold the “DISP” button until the display changes.

---

### ■ System check display

#### ▶ Vehicles without smart key system

After the engine switch is turned to the “ON” position, “SYSTEM CHECK” is displayed while system operation is checked. When the system check is complete, the normal screen will return. When the system check is complete, the normal screen will return.

#### ▶ Vehicles with smart key system

After the “ENGINE START STOP” switch is turned to IGNITION ON mode, “SYSTEM CHECK” is displayed while system operation is checked. When the system check is complete, the normal screen will return. When the system check is complete, the normal screen will return.

### ■ Liquid crystal display

Small bright spots or dots may appear on the liquid crystal display. This is a particular characteristic of liquid crystal displays and does not indicate a malfunction. No action is required.

### ■ Outside temperature display

When stopped, or driving at low speeds (less than 12 mph [20 km/h]), the correct outside temperature may not be displayed, or the display may take longer than normal to change.

### ■ Customization that can be configured at Toyota dealer

Setting of language selection can be changed.  
(Customizable features →P. 582)

### NOTICE

#### ■ The multi-information display at low temperatures

Allow the interior of the vehicle to warm up before using the liquid crystal information display. At extremely low temperatures, the information display monitor may respond slowly, and display changes may be delayed.

# Headlight switch

The headlights can be operated manually or automatically.

► Type A

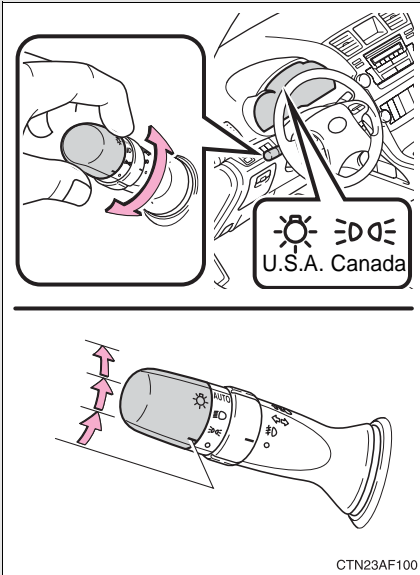

The side marker, parking, tail, license plate and instrument panel lights turn on.



The headlights and all lights listed above turn on.

**AUTO**

(if equipped)

The headlights and parking lights turn on and off automatically.

(Vehicles without smart key system: When the engine switch is turned to the "ON" position.

Vehicles with smart key system:

When the "ENGINE START STOP" switch is turned to IGNITION ON mode.)

► Type B

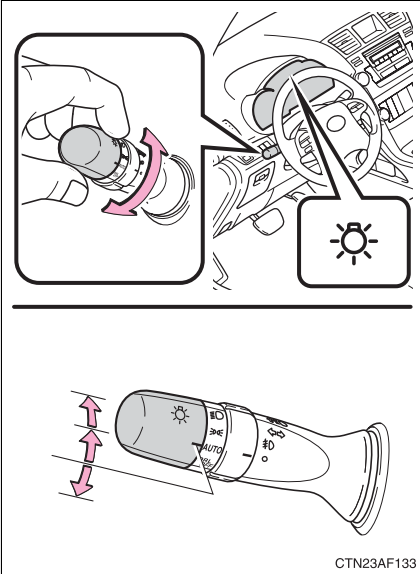

The side marker, parking, tail, license plate and instrument panel lights turn on.



The headlights and all lights listed above turn on.

**AUTO**

The headlights and parking lights turn on and off automatically.

(Vehicles without smart key system:

When the engine switch is turned to the “ON” position.

Vehicles with smart key system:

When the “ENGINE START STOP” switch is turned to IGNITION ON mode.)

**DRL OFF**

Daytime running light system is off.

## Turning on the high beam headlights

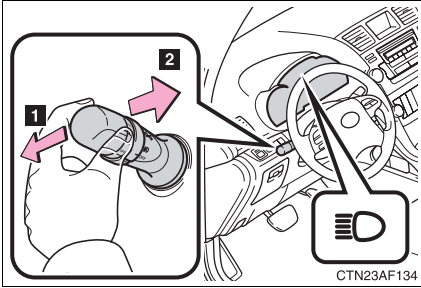

**1** With the headlights on, push the lever forward to turn on the high beams.

Pull the lever back to the center position to turn the high beams off.

**2** Pull the lever toward you to turn on the high beams.

Release the lever to turn them off. You can flash the high beams with the headlights on or off.

2

When driving

### ■ Daytime running light system (if equipped)

To make your vehicle more visible to other drivers, the headlights turn on automatically (at a reduced intensity) whenever the engine is started and the parking brake is released. Daytime running lights are not designed for use at night.

U.S.A.: Daytime running lights can be turned off by operating the switch.

### ■ Headlight control sensor (if equipped)

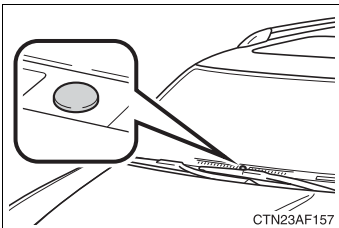



The sensor may not function properly if an object is placed on the sensor, or anything that blocks the sensor is affixed to the windshield.

Doing so interferes with the sensor detecting the level of ambient light and may cause the automatic headlight system to malfunction.

### ■ Automatic light off system



#### ▶ Vehicles without smart key system

The headlights and tail lights turn off 30 seconds after drivers door is opened and closed if the engine switch has been turned to the “ACC” or “LOCK” position.

To turn the lights on again, turn the engine switch to the “ON” position, or turn the headlight switch off and then back to  or .

#### ▶ Vehicles with smart key system

The headlights and tail lights turn off 30 seconds after drivers door is opened and closed if the “ENGINE START STOP” switch has been turned to ACCESSORY mode or turned to OFF.

To turn the lights on again, turn the “ENGINE START STOP” switch to IGNITION ON mode, or turn the headlight switch off and then back to  or .

### ■ Customization that can be configured at Toyota dealer

Settings (e.g. daytime running light system) can be changed.  
(Customizable features →P. 582)

#### NOTICE

#### ■ To prevent battery discharge

Do not leave the lights on longer than necessary when the engine is not running.

## 2-3. Operating the lights and wipers Fog light switch\*

The fog lights improve visibility in difficult driving conditions, such as in rain or fog. They can be turned on only when the headlights are on in low beam.

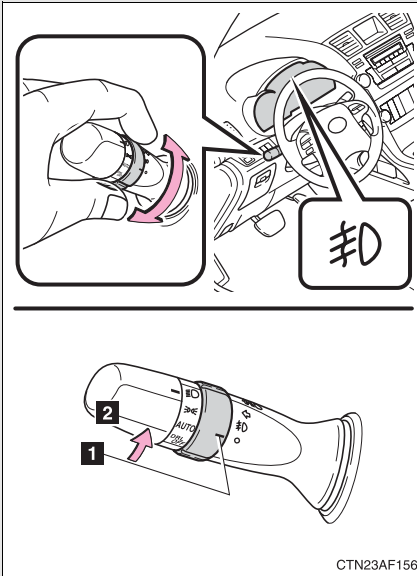

- 1 Off
- 2 Front fog lights on

## 2-3. Operating the lights and wipers Windshield wipers and washer

**Wiper intervals can be adjusted for intermittent operation.**

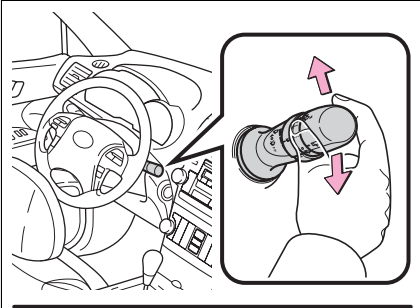

- 1** Intermittent windshield wiper operation
- 2** Low speed windshield wiper operation
- 3** High speed windshield wiper operation
- 4** Temporary operation

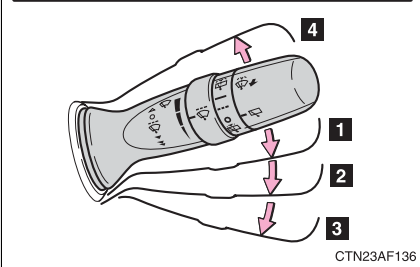

CTN23AF136

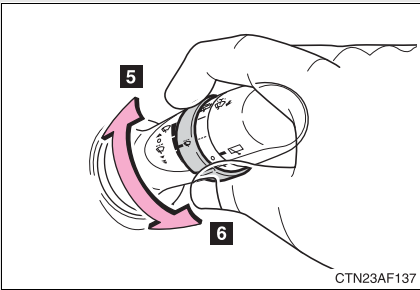

CTN23AF137

- 5** Increases the intermittent windshield wiper frequency
- 6** Decreases the intermittent windshield wiper frequency

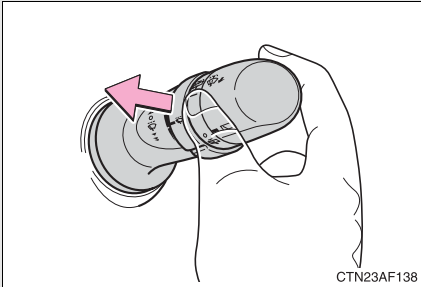

### Wash/wipe operation

Wipers operate automatically.

2

When driving

#### ■ The windshield wipers and washer can be operated when

- ▶ Vehicles without smart key system

The engine switch is in the "ON" position.

- ▶ Vehicles with smart key system

The "ENGINE START STOP" switch is in IGNITION ON mode.

#### ■ If no windshield washer fluid sprays

Check that the washer nozzles are not blocked and if there is washer fluid in the windshield washer fluid reservoir.

#### NOTICE

##### ■ When the windshield is dry

Do not use the wipers, as they may damage the windshield.

##### ■ When there is no washer fluid spray from the nozzle

Damage to the washer fluid pump may be caused if the lever is pulled toward you and held continually.

##### ■ When a nozzle is blocked

Do not try to clear it with a pin or other object. The nozzle will be damaged.



## 2-3. Operating the lights and wipers

### Rear window wiper and washer

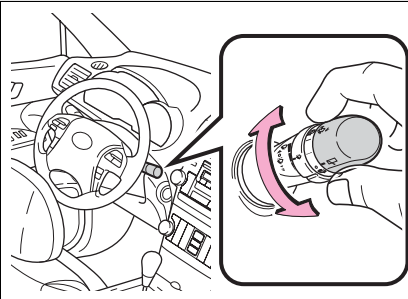

- 1 Intermittent window wiper operation
- 2 Normal window wiper operation
- 3 Washer/wiper dual operation
- 4 Washer/wiper dual operation

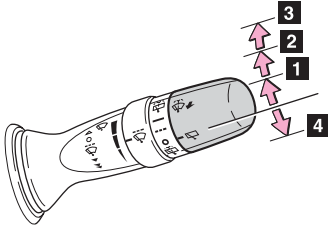

CTN23AF153

#### ■ The rear window wiper and washer can be operated when

- ▶ Vehicles without smart key system  
The engine switch is in the “ON” position.
- ▶ Vehicles with smart key system  
The “ENGINE START STOP” switch is in IGNITION ON mode.

#### ⚠ NOTICE

#### ■ When the rear window is dry

Do not use the wipers, as they may damage the rear window.

## 2-4. Using other driving systems

### Cruise control\*

Use cruise control to maintain a set speed without using the accelerator.

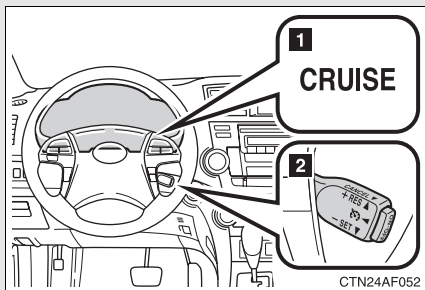

- 1 Indicator
- 2 Cruise control switch

#### ■ Set the vehicle speed

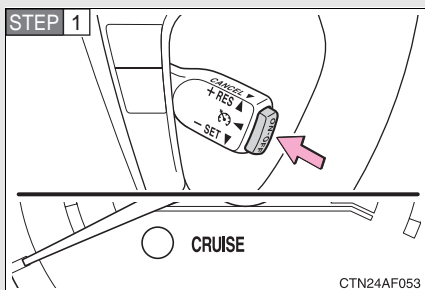

Turn the "ON-OFF" button on.

Press the button once more to deactivate the cruise control.

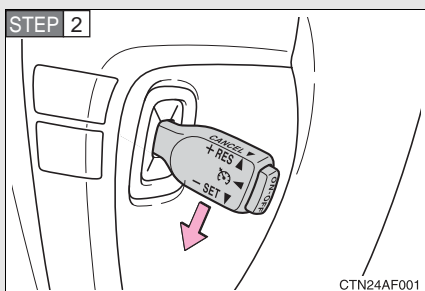

Accelerate or decelerate to the desired speed and push the lever down to set the cruise control speed.

\*: If equipped

### ■ Adjusting the speed setting

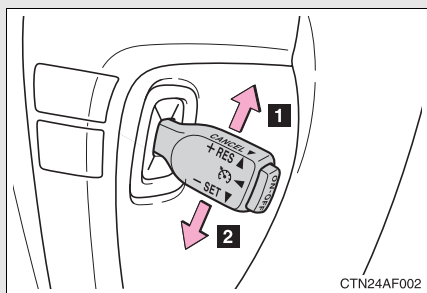

- 1 Increase speed
- 2 Decrease speed

Hold the lever until the desired speed setting is obtained.

Fine adjustment of the set speed can be made by lightly pushing the lever up or down and releasing it.

### ■ Canceling and resuming regular acceleration

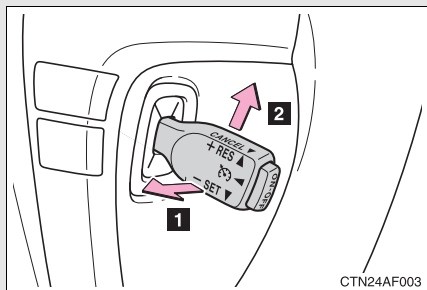

- 1 Cancel

Push the lever towards you to cancel cruise control.

The speed setting is also canceled when the brakes are applied.

- 2 Resume

To resume cruise control and return to the set speed, push the lever up.

### ■ Cruise control can be set when

- 2.7 L 4-cylinder (1AR-FE) engine: The shift lever is in D, 4, 5 or 6 range of S.
- 3.5 L V6 (2GR-FE) engine: The shift lever is in D, 4 or 5 range of S.
- Vehicle speed is above approximately 25 mph (40 km/h). Within the limits of the engine's capabilities, cruising speed can be maintained on up or down grades.

### ■ Accelerating

The vehicle can be accelerated normally. After acceleration, the set speed resumes.

### ■ Automatic cruise control cancellation

The set speed is automatically cancelled in any of the following situations.

- Actual vehicle speed falls more than 10 mph (16 km/h) below the preset vehicle speed.  
At this time, the memorized set speed is not retained.
- Actual vehicle speed is below 25 mph (40 km/h).
- Enhanced VSC is activated.

### ■ If the cruise control indicator light flashes

Turn the “ON-OFF” button off once, and then reactivate the system.

If the cruise control speed cannot be set or if the cruise control cancels immediately after being activated, there may be a malfunction in the cruise control system. Contact your Toyota dealer and have your Toyota inspected.

## CAUTION

### ■ To avoid operating the cruise control by mistake

Keep the “ON-OFF” button off when not in use.

### ■ Situations unsuitable for cruise control

Do not use cruise control in any of the following situations.

Doing so may result in control of the vehicle being lost and could cause an accident resulting in death or serious injury.

- In heavy traffic
- On roads with sharp bends
- On winding roads
- On slippery roads, such as those covered with rain, ice or snow
- On steep hills

## 2-4. Using other driving systems

### Rear view monitor system (vehicles with multi-information display)

▶ Vehicles with navigation system

Refer to the “Navigation System Owner’s Manual”.

▶ Vehicles without navigation system

The rear view monitor system assists the driver by displaying an image of the area behind the vehicle. The image is displayed in reverse on the screen. This reversed image is a similar image to the one on the inside rear view mirror.

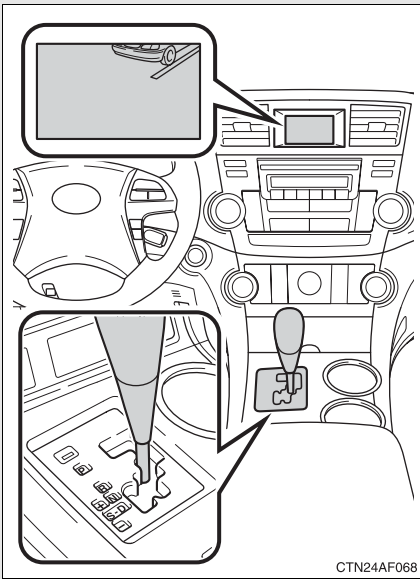

The rear view image is displayed when the shift lever is in the R position.

If the shift lever is shifted out of R, the screen returns to the previous one.

### ■ Displayed area

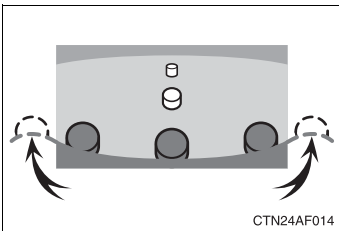
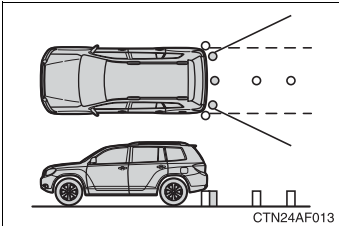

The area covered by the camera is limited. Objects that are close to either corner of the bumper or under the bumper cannot be seen on the screen.

The area displayed on the screen may vary according to vehicle orientation or road conditions.

### ■ Rear view monitor system camera

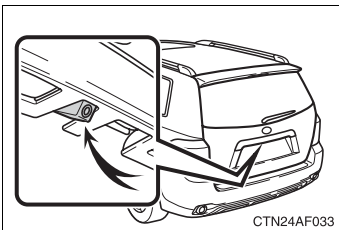

In the following cases, it may become difficult to see the images on the screen, even when the system is functioning correctly.

- The vehicle is in a dark area, such as at night.
- The temperature near the lens is extremely high or low.
- Water droplets are on the camera lens or humidity is high, such as when it rains.
- Foreign matter, such as snow or mud, adheres to the camera lens.
- The sun or headlights are shining directly into the camera lens.

### ■ Smear effect

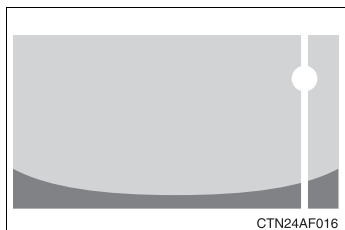

If a bright light, such as sunlight reflected off the vehicle body, is picked up by the camera, a smear effect\* characteristic to the camera may occur.

\*: Smear effect: A phenomenon that occurs when a bright light is picked up by the camera; when transmitted by the camera, the light source appears to have a vertical streak above and below it.

### ■ Setting the rear view monitor system display

→P. 200

 CAUTION

■ **When using the rear view monitor system, observe the following precautions to avoid an accident that could result in death or serious injuries.**

- Never depend solely on the monitor system when reversing.
- Always check visually and with the mirrors to confirm your intended path is clear.
- Depicted distances between objects and flat surfaces differ from actual distances.
- Do not use the system if the back door is open.

■ **Conditions which may affect the rear view monitor system**

- If the back of the vehicle has been hit, the camera's position and mounting angle may have changed. Have the vehicle inspected by your Toyota dealer.
- Rapid temperature changes, such as when hot water is poured on the vehicle in cold weather, may cause the system to function abnormally.
- If the camera lens is dirty, it cannot transmit a clear image. Rinse with water and wipe with a soft cloth. If extremely dirty, wash with a mild cleanser and rinse.
- The displayed image may be darker and moving images may be slightly distorted when the system is cold.



## Driving assist systems

**To help enhance driving safety and performance, the following systems operate automatically in response to various driving situations. Be aware, however, that these systems are supplementary and should not be relied upon too heavily when operating the vehicle.**

### ■ **ABS (Anti-lock Brake System)**

Helps to prevent wheel lock when the brakes are applied suddenly, or if the brakes are applied while driving on a slippery road surface.

### ■ **Brake assist**

Generates an increased level of braking force after the brake pedal is depressed when the system detects a panic stop situation.

### ■ **Enhanced VSC (Enhanced Vehicle Stability Control)**

Helps the driver to control skidding when swerving suddenly or turning on slippery road surfaces.

### ■ **TRAC (Traction Control)**

Maintains drive power and prevents the front wheels (2WD models) or four wheels (4WD models) from spinning when starting the vehicle or accelerating on slippery roads.

### ■ **Hill-start assist control**

→P. 223

### ■ **Downhill assist control system (4WD models only)**

→P. 225

### ■ **EPS (Electric Power Steering)**

Employs an electric motor to reduce the amount of effort needed to turn the steering wheel.

### When the Enhanced VSC/TRAC systems are operating

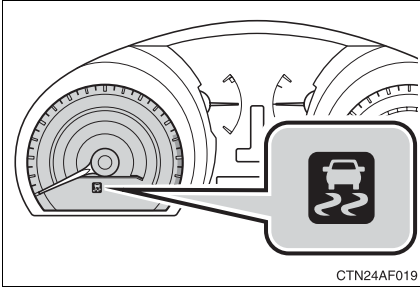

If the vehicle is in danger of slipping, rolling backwards when starting on an incline, or the front wheels (2WD models) or four wheels (4WD models) spin, the indicator flashes to indicate that the Enhanced VSC/TRAC systems have been engaged.

A buzzer (intermittent) sounds to indicate that Enhanced VSC is operating.

### To disable TRAC and/or Enhanced VSC

If the vehicle gets stuck in fresh snow or mud, TRAC and Enhanced VSC may reduce power from the engine to the wheels. You may need to turn the system off to enable you to rock the vehicle in order to free it.

#### ■ Turning off TRAC

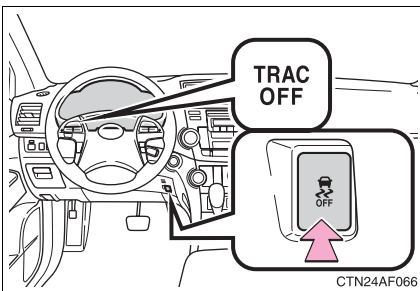

Quickly push and release the button to turn off TRAC.

The "TRAC OFF" indicator light should come on.

Push the button again to turn the system back on.

## ■ Turning off TRAC and Enhanced VSC

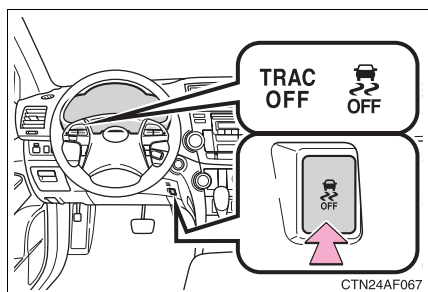

Push and hold the button while the vehicle is stopped to turn off TRAC and Enhanced VSC.

The “TRAC OFF” and Enhanced VSC off indicator light should come on.

Push the button again to turn the system back on.

## ■ Automatic reactivation of TRAC and Enhanced VSC

### ▶ Vehicles without smart key system

Turning the engine switch to the “OFF” position after turning off the TRAC and Enhanced VSC systems will automatically re-enable them.

### ▶ Vehicles with smart key system

Turning the “ENGINE START STOP” switch OFF after turning off the TRAC and Enhanced VSC systems will automatically re-enable them.

## ■ Automatic TRAC reactivation

If only the TRAC system is turned off, the TRAC system will turn on when vehicle speed increases.

## ■ Automatic TRAC and Enhanced VSC reactivation

If the TRAC and Enhanced VSC systems are turned off, the systems will not turn on even when vehicle speed increases.

## ■ Sounds and vibrations caused by the ABS, TRAC, Enhanced VSC and brake assist

- A sound may be heard from the engine compartment when the engine is started or just after the vehicle begins to move. This sound does not indicate that a malfunction has occurred in any of these systems.
- Any of the following conditions may occur when the above systems are operating. None of these indicates that a malfunction has occurred.
  - Vibrations may be felt through the vehicle body and steering.
  - A motor sound may be heard after the vehicle comes to a stop.
  - The brake pedal may pulsate slightly when the ABS is activated.
  - The brake pedal may move down slightly after the ABS is activated.

### ■ EPS operation sound

When the steering wheel operates, a motor sound (whirring sound) may be heard.

This does not indicate a malfunction.

### ■ Reduced effectiveness of EPS

The effectiveness of EPS is reduced to prevent the system from overheating when there is frequent steering input over an extended period of time. The steering wheel may feel heavy as a result. Should this occur, refrain from excessive steering input or stop the vehicle and turn the engine off. The system should return to normal within 10 minutes.

### ■ If the slip indicator comes on...

It may indicate a malfunction in the Enhanced VSC and TRAC. Contact your Toyota dealer.

## CAUTION

### ■ The ABS does not operate effectively when

- Tires with inadequate gripping ability are used (such as excessively worn tires on a snow covered road).
- The vehicle hydroplanes while driving at high speed on wet or slick road.

### ■ Stopping distance when the ABS is operating on the wet or slick roads

The ABS is not designed to shorten the vehicle's stopping distance. Always maintain a safe distance from the vehicle in front of you in the following situations.

- When driving on dirt, gravel or snow-covered roads
- When driving with tire chains
- When driving over bumps in the road
- When driving over roads with potholes or uneven roads

 **CAUTION**

■ **TRAC may not operate effectively when**

Directional control and power may not be achievable while driving on slippery road surfaces even if the TRAC system is operating.

Do not drive the vehicle in conditions where stability and power may be lost.

■ **When the Enhanced VSC is activated**

The slip indicator light flashes and a warning buzzer sounds. Always drive carefully. Reckless driving may cause an accident. Exercise particular care when the indicator light flashes and a buzzer sounds.

■ **When TRAC and Enhanced VSC are off**

Be especially careful and drive at a speed appropriate to the road conditions. As these are systems to ensure vehicle stability and driving force, do not turn off TRAC and Enhanced VSC unless necessary.

■ **Replacing tires**

Make sure that all tires are of the same size, brand, tread pattern and total load capacity. In addition, make sure that the tires are inflated to the appropriate tire pressure level.

The ABS and Enhanced VSC systems will not function correctly if different tires are fitted on the vehicle.

Contact your Toyota dealer for further information when replacing tires or wheels.

■ **Handling of tires and suspension**

Using tires with any kind of problem or modifying the suspension will affect the driving assist systems, and may cause the system to malfunction.

## 2-4. Using other driving systems

### Hill-start assist control

**Hill-start assist control helps to prevent the vehicle from rolling backwards when starting on incline or slippery slope.**

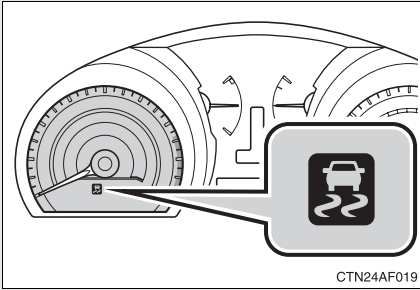

To engage hill-start assist control, further depress the brake pedal when the vehicle is stopped completely.

A buzzer will sound once to indicate the system is activated. The slip indicator will also start flashing.

2

When driving

#### ■ Hill-start assist control operating conditions

The system operates in the following situations:

- The shift lever is in a position other than P.
- The parking brake is not applied.
- The accelerator pedal is not depressed.

#### ■ Hill-start assist control

- While hill-start assist control is operating, the brakes remain automatically applied after the driver releases the brake pedal. The stop lights and the high mounted stoplight turn on.
- Hill-start assist control operates for about 2 seconds after the brake pedal is released.
- If the slip indicator does not flash and the buzzer does not sound when the brake pedal is further depressed, slightly reduce the pressure on the brake pedal (do not allow the vehicle to roll backward) and then firmly depress it again. If the system still does not operate, check that the operating conditions explained above have been met.

■ **Hill-start assist control buzzer**

- When hill-start assist control is activated, the buzzer will sound once.
- In the following situations, hill-start assist control will be canceled and the buzzer will sound twice.
  - No attempt is made to drive the vehicle within approximately 2 seconds of releasing the brake pedal.
  - The shift lever is moved to P.
  - The parking brake is applied.
  - The brake pedal is depressed again.

■ **If the slip indicator comes on...**

It may indicate a malfunction in the system. Contact your Toyota dealer.

 **CAUTION**

■ **Hill-start assist control**

- Hill-start assist control may not operate effectively on extremely steep inclines or roads covered in ice.
- Do not use hill-start assist control to stop or park the vehicle on an incline.

## Downhill assist control system (4WD models only)

With the downhill assist control system, the vehicle is able to descend a steep hill, maintaining a constant low speed of about 3 mph (5 km/h) without brake pedal operation.

### ■ Activating the downhill assist control system

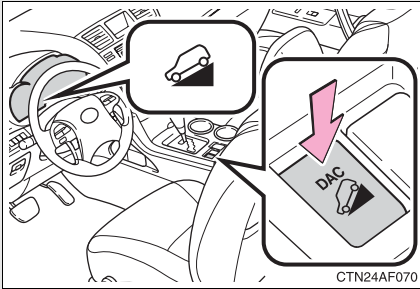

Press the "DAC" switch.

The downhill assist control system indicator will come on to indicate that the downhill assist control system is activated.

Pressing the switch again turns the system off.

### While the downhill assist control system is operating

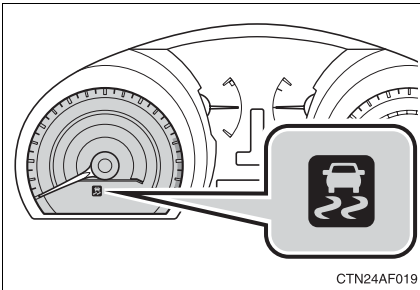

The slip indicator will flash to indicate that the downhill assist control system is operating, and the stop lights and high mounted stoplight will turn on.



■ **Conditions in which the downhill assist control system does not operate**

- In the following situations, the downhill assist control system indicator flashes and the downhill assist control system does not operate or will stop operating:
  - The shift lever is not in 1 range of S mode or R.
  - The vehicle speed is higher than 15 mph (25 km/h).
- If the accelerate or brake pedal is depressed, the downhill assist control system will stop operating with the downhill assist control system indicator stayed on.

■ **If the “DAC” switch is turned off during operation of the downhill assist control system**

The downhill assist control system gradually ceases operation. The downhill assist control system indicator will flash during the canceling operation, and then go off when the system is fully off.

■ **Downhill assist control system operation sound**

- A sound may be heard from the engine compartment during operation of the downhill assist control system. This sound does not indicate a malfunction.
- If the accelerator or brake pedal is depressed during operation of the downhill assist control system, a sound caused by the release of system operation may be heard, or you may feel the brake pedal push-back. This does not indicate a malfunction.

■ **When the downhill assist control system operates continuously**

The brake actuator may overheat. In that case, the downhill assist control system will stop operating, a buzzer will sound and the downhill assist control system indicator will start flashing. Refrain from using the system until the downhill assist control system indicator stays on. (There is no problem with continuing driving normally.)

■ **If the slip indicator comes on...**

It may indicate a malfunction in the system. Contact your Toyota dealer.

 CAUTION**■ Conditions which may affect the downhill assist control system operation**

- Do not rely too heavily on the downhill assist control system. On extremely steep inclines, icy surfaces or muddy roads, the vehicle may slip and the system may not be able to maintain the constant low vehicle speed of about 3 mph (5 km/h), leading to an accident causing death or serious injury.
- Do not shift the shift lever to R while driving forward, or to D while driving backward. Doing so may cause the wheels to lock up, leading to an accident causing death or serious injury. In addition, excessive stress will be applied to the automatic transmission, possibly resulting in damage.

## Off-road precautions

This vehicle belongs to the utility vehicle class, which has higher ground clearance and narrower tread in relation to the height of its center of gravity to make it capable of performing in a wide variety of off-road applications.

### Off-road vehicle feature

- Specific design characteristics give it a higher center of gravity than ordinary passenger cars. This vehicle design feature causes this type of vehicle to be more likely to rollover. And, utility vehicles have a significantly higher rollover rate than other types of vehicles.
- An advantage of the higher ground clearance is a better view of the road allowing you to anticipate problems.
- It is not designed for cornering at the same speeds as ordinary passenger cars any more than low-slung sports cars designed to perform satisfactorily under off-road conditions. Therefore, sharp turns at excessive speeds may cause rollover.

 CAUTION**Off-road vehicle precautions**

Always observe the following precautions to minimize the risk of serious personal injury or damage to your vehicle:

- In a rollover crash, an unbelted person is significantly more likely to die than a person wearing a seat belt. Therefore, the driver and all passengers should fasten their seat belts whenever the vehicle is moving.
- Avoid sharp turns or abrupt maneuvers, if at all possible.  
Failure to operate this vehicle correctly may result in loss of control or vehicle rollover causing death or serious injury.
- Loading cargo on the roof luggage carrier will make the center of the vehicle gravity higher. Avoid high speeds, sudden starts, sharp turns, sudden braking or abrupt maneuvers, otherwise it may result in loss of control or vehicle rollover due to failure to operate this vehicle correctly.
- Always slow down in gusty crosswinds. Because of its profile and higher center of gravity, your vehicle is more sensitive to side winds than an ordinary passenger car. Slowing down will allow you to have better control.
- Do not drive horizontally across steep slopes. Driving straight up or straight down is preferred. Your vehicle (or any similar off-road vehicle) can tip over sideways much more easily than forward or backward.

## Off-road driving

When driving your vehicle off-road, please observe the following precautions to ensure your driving enjoyment and to help prevent the closure of areas to off-road vehicles.

- Drive your vehicle only in areas where off-road vehicles are permitted to travel.
- Respect private property. Get owner's permission before entering private property.
- Do not enter areas that are closed. Honor gates, barriers and signs that restrict travel.
- Stay on established roads. When conditions are wet, driving techniques should be changed or travel delayed to prevent damage to roads.

---

### ■ Additional information for off-road driving

► For owners in U.S. mainland, Hawaii and Puerto Rico:

To obtain additional information pertaining to driving your vehicle off-road, consult the following organizations.

- State and Local Parks and Recreation Departments
- State Motor Vehicle Bureau
- Recreational Vehicle Clubs
- U.S. Forest Service and Bureau of Land Management

 **CAUTION****■ Off-road driving precautions**

Always observe the following precautions to minimize the risk of serious personal injury or damage to your vehicle:

- Drive carefully when off the road. Do not take unnecessary risks by driving in dangerous places.
- Do not grip the steering wheel spokes when driving off-road. A bad bump could jerk the wheel and injure your hands. Keep both hands and especially your thumbs on the outside of the rim.
- Always check your brakes for effectiveness immediately after driving in sand, mud, water or snow.
- After driving through tall grass, mud, rock, sand, rivers, etc., check that there is no grass, bush, paper, rags, stone, sand, etc. adhering or trapped on the underbody. Clear off any such matter from the underbody. If the vehicle is used with these materials trapped or adhering to the underbody, a breakdown or fire could occur.
- When driving off-road or in rugged terrain, do not drive at excessive speeds, jump, make sharp turns, strike objects, etc. This may cause loss of control or vehicle rollover causing death or serious injury. You are also risking expensive damage to your vehicle's suspension and chassis.

 **NOTICE****■ To prevent the water damage**

Take all necessary safety measures to ensure that water damage to the engine or other components does not occur.

- Water entering the engine air intake will cause severe engine damage.
- Water entering the automatic transmission will cause deterioration in shift quality, locking up of your transmission accompanied by vibration, and ultimately damage.
- Water can wash the grease from wheel bearings, causing rusting and premature failure, and may also enter the differentials, transmission and transfer case, reducing the gear oil's lubricating qualities.

 NOTICE

■ **When you drive through water**

If driving through water, such as when crossing shallow streams, first check the depth of the water and the bottom of the river bed for firmness. Drive slowly and avoid deep water.

■ **Inspection after off-road driving**

- Sand and mud that has accumulated in brake drums and around brake discs may affect braking efficiency and may damage brake system components.
- Always perform a maintenance inspection after each day of off-road driving that has taken you through rough terrain, sand, mud, or water. For scheduled maintenance information, refer to the “Scheduled Maintenance Guide” or “Owner’s Manual Supplement”.

## 2-5. Driving information

# Cargo and luggage

**Take notice of the following information about storage precautions, cargo capacity and load.**

- Stow cargo and luggage in the luggage compartment whenever possible. Be sure all items are secured in place.
- Be careful to keep the vehicle level. Placing the weight as far forward as possible helps maintain vehicle balance.
- For better fuel economy, do not carry unnecessary weight.

### Capacity and distribution

Cargo capacity depends on the total weight of the occupants.

(Cargo capacity) = (Total load capacity) - (Total weight of occupants)

#### Steps for Determining Correct Load Limit—

- (1) Locate the statement “The combined weight of occupants and cargo should never exceed XXX kg or XXX lbs.” on your vehicle's placard.
- (2) Determine the combined weight of the driver and passengers that will be riding in your vehicle.
- (3) Subtract the combined weight of the driver and passengers from XXX kg or XXX lbs.
- (4) The resulting figure equals the available amount of cargo and luggage load capacity.  
For example, if the “XXX” amount equals 1400 lbs. and there will be five 150 lb passengers in your vehicle, the amount of available cargo and luggage load capacity is 650 lbs. (1400 - 750 (5 × 150) = 650 lbs.)
- (5) Determine the combined weight of luggage and cargo being loaded on the vehicle. That weight may not safely exceed the available cargo and luggage load capacity calculated in Step 4.



(6) If your vehicle will be towing a trailer, load from your trailer will be transferred to your vehicle. Consult this manual to determine how this reduces the available cargo and luggage load capacity of your vehicle.

### Example on your vehicle

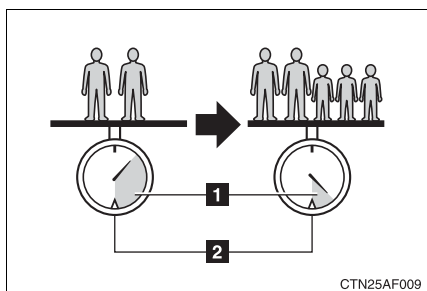

- 1** Cargo capacity
- 2** Total load capacity

When 2 people with the combined weight of 366 lb. (166 kg) are riding in your vehicle, which has a total load capacity of 1200 lb. (544 kg), the available amount of cargo and luggage load capacity will be as follows:

$$1200 \text{ lb.} - 366 \text{ lb.} = 834 \text{ lb.} \quad (544 \text{ kg} - 166 \text{ kg} = 378 \text{ kg})$$

In this condition, if 3 more passengers with the combined weight of 388 lb. (176 kg) get on, the available cargo and luggage load will be reduced as follows:

$$834 \text{ lb.} - 388 \text{ lb.} = 446 \text{ lb.} \quad (378 \text{ kg} - 176 \text{ kg} = 202 \text{ kg})$$

As shown in the above example, if the number of occupants increases, the cargo and luggage load will be reduced by an amount that equals the increased weight due to the additional occupants. In other words, if an increase in the number of occupants causes an excess of the total load capacity (combined weight of occupants plus cargo and luggage load), you must reduce the cargo and luggage on your vehicle.

 **CAUTION****■ Things that must not be carried in the luggage compartment**

The following things may cause a fire if loaded in the luggage compartment.

- Receptacles containing gasoline
- Aerosol cans

**■ Storage precautions**

Observe the following precautions.

Failing to do so may result in death or serious injury.

● Do not place cargo or luggage in or on the following locations as the item may get under the brake or accelerator pedal and prevent the pedals from being depressed properly, block the driver's vision, or hit the driver or passengers, causing an accident.

- Driver's feet
- Front passenger or rear seats (when stacking items)
- Luggage cover
- Instrument panel
- Dashboard
- Auxiliary box or tray that has no lid

- Secure all items in the occupant compartment, as they may shift and injure someone during an accident or sudden braking.
- Never allow anyone to ride in the luggage compartment. It is not designed for passengers. They should ride in their seats with their seat belts properly fastened. Otherwise, they are much more likely to suffer serious bodily injury, in the event of sudden braking or an accident.

**■ Capacity and distribution**

- Do not exceed the maximum axle weight rating or the total vehicle weight rating.
- Even if the total load of occupant's weight and the cargo load is less than the total load capacity, do not apply the load unevenly. Improper loading may cause deterioration of steering or braking control which may cause death or serious injury.

**! CAUTION**

**■ Roof luggage carrier precautions**

To use the roof rails as a roof luggage carrier, you must fit the roof rails with two or more genuine Toyota cross rails or their equivalent.

When you load cargo on the roof luggage carrier, observe the following:

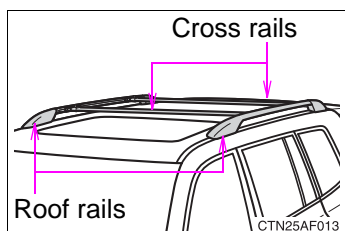

- Place the cargo so that its weight is distributed evenly between the front and rear axles.
- If loading long or wide cargo, never exceed the vehicle overall length or width. (→P. 552)

- Before driving, make sure the cargo is securely fastened on the roof luggage carrier.
- Loading cargo on the roof luggage carrier will make the center of the vehicle gravity higher. Avoid high speeds, sudden starts, sharp turns, sudden braking or abrupt maneuvers, otherwise it may result in loss of control or vehicle rollover due to failure to operate this vehicle correctly and result in death or serious injury.
- If driving for a long distance, on rough roads, or at high speeds, stop the vehicle now and then during the trip to make sure the cargo remains in its place.
- Do not exceed 100 lb. (45 kg) cargo weight on the roof luggage carrier.

**Vehicle load limits include total load capacity, seating capacity, towing capacity and cargo capacity.**

■ **Total load capacity: 1200 lb. (544 kg)**

Total load capacity means the combined weight of occupants, cargo and luggage.

■ **Seating capacity: 5 or 7 occupants (Front 2, Rear 3 or 5)**

Seating capacity means the maximum number of occupants whose estimated average weight is 150 lb. (68 kg) per person.

■ **Towing capacity**

▶ **2.7 L 4-cylinder (1AR-FE) engine**

**Without towing package: 1500 lb. (680 kg)**

**With towing package: 3500 lb. (1500 kg)**

▶ **3.5 L V6 (2GR-FE) engine**

**Without towing package: 2000 lb. (900 kg)**

**With towing package: 5000 lb. (2000 kg)**

Towing capacity means the maximum gross trailer weight (trailer weight plus its cargo weight) that your vehicle is able to tow.

■ **Cargo capacity**

Cargo capacity may increase or decrease depending on the weight and the number of occupants.

■ **Total load capacity and seating capacity**

These details are also described on the tire and loading information label. (→P. 463)

 **CAUTION**

■ **Overloading the vehicle**

Do not overload the vehicle.

It may not only cause damage to the tires, but also degrade steering and braking ability, resulting in an accident.

**Carry out the necessary preparations and inspections before driving the vehicle in winter. Always drive the vehicle in a manner appropriate to the prevailing weather conditions.**

■ **Pre-winter preparations**

- Use fluids that are appropriate to the prevailing outside temperatures.
  - Engine oil
  - Engine coolant
  - Washer fluid
- Have a service technician inspect the level and specific gravity of battery electrolyte.
- Have the vehicle fitted with four snow tires or purchase a set of tire chains for the front tires.

Ensure that all tires are the same size and brand, and that chains match the size of the tires.

■ **Before driving the vehicle**

Observe the following according to the driving conditions.

- Do not try to forcibly open a window or move a wiper that is frozen. Pour warm water over the frozen area to melt the ice. Wipe away the water immediately to prevent it from freezing.
- To ensure proper operation of the climate control system fan, remove any snow that has accumulated on the air inlet vents in front of the windshield.
- Remove any ice that has accumulated on the vehicle chassis.
- Periodically check for and remove any excess ice or snow that may have accumulated in the wheel well or on the brakes.

### ■ When driving the vehicle

Accelerate the vehicle slowly and drive at a reduced speed suitable to road conditions.

### ■ When parking the vehicle

Park the vehicle and move the shift lever to P without setting the parking brake. The parking brake may freeze up, preventing it from being released.

## Selecting tire chains

Use the correct tire chain size when mounting the snow chains. Chain size is regulated for each tire size.

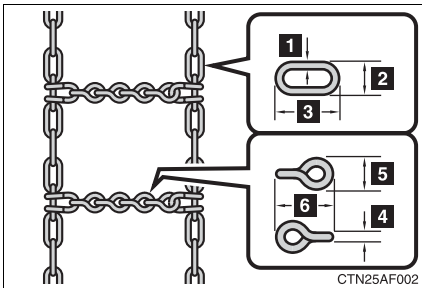

#### ► Side chain

- 1 0.12 in. (3 mm) in diameter
- 2 0.39 in. (10 mm) in width
- 3 1.18 in. (30 mm) in length

#### ► Cross chain

- 4 0.16 in. (4 mm) in diameter
- 5 0.55 in. (14 mm) in width
- 6 0.98 in. (25 mm) in length

## Regulations on the use of snow chains

- Regulations regarding the use of tire chains vary according to location and type of road. Always check local regulations before installing chains.
- Install the chains on the front tires.
- Retighten the chains after driving 1/4 - 1/2 mile (0.5 - 1.0 km).

### ■ Tire chains

Observe the following precautions when installing and removing chains.

- Install and remove tire chains in a safe location.
- Install tire chains on the front tires.
- Install tire chains following the instructions provided in the accompanying manual.

### CAUTION

#### ■ Driving with snow tires

Observe the following precautions to reduce the risk of accidents.

Failing to do so may result in a loss of vehicle control and cause death or serious injury.

- Use tires of the specified size.
- Maintain the recommended level of air pressure.
- Do not drive in excess of 75 mph (120 km/h), regardless of the type of snow tires being used.
- Snow tires should be installed on all wheels.

#### ■ Driving with tire chains

Observe the following precautions to reduce the risk of accidents.

Failing to do so may result in the vehicle being unable to be driven safely, and may cause death or serious injury.

- Do not drive in excess of the speed limit specified for the tire chains being used or 30 mph (50 km/h), whichever is lower.
- Avoid driving on bumpy road surfaces or over potholes.
- Avoid sudden turns and braking.
- Slow down sufficiently before entering a curve to ensure that vehicle control is maintained.

 NOTICE**■ Repairing or replacing snow tires**

Request repairs of and obtain replacement snow tires from Toyota dealers or legitimate tire retailers.

This is because the removal and attachment of snow tires affects the operation of the tire pressure warning valves and transmitters.

**■ Fitting tire chains**

The tire pressure warning valves and transmitters may not function correctly when tire chains are fitted.



## Trailer towing

**Your vehicle is designed primarily as a passenger carrying vehicle. Towing a trailer will have an adverse effect on handling, performance, braking, durability, and fuel consumption. For your safety and the safety of others, do not overload the vehicle or trailer.**

**To tow a trailer safely, use extreme care and drive the vehicle in accordance with the trailer's characteristics and operating conditions.**

**The vehicle stability and braking performance are affected by trailer stability, brake setting and performance, and the hitch.**

**Toyota warranties do not apply to damage or malfunction caused by towing a trailer for commercial purposes.**

**Contact your Toyota dealer for further information about additional requirements such as a towing kit.**

## Weight limits

Confirm that the gross trailer weight, gross vehicle weight, gross axle weight and trailer tongue load are all within the limits.

lb. (kg)

	Towing capacity	
	2.7 L 4-cylinder (1AR-FE) engine	3.5 L V6 (2GR-FE) engine
Without towing package	1500 (680)	2000 (900)
With towing package	3500 (1500)	5000 (2000)

- The gross trailer weight must never exceed towing capacity described in the table above.

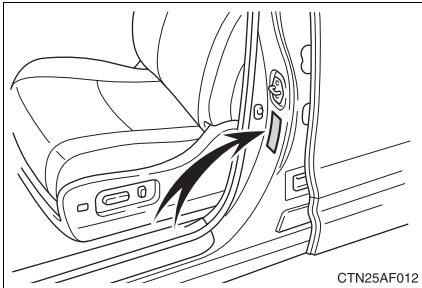

- The gross vehicle weight must never exceed the GVWR indicated the Certification Label.
- The gross axle weight on each axle must never exceed the GAWR indicated the Certification Label.

<b>Towing related term</b>
----------------------------

Towing related term	Meaning
GVWR (Gross Vehicle Weight Rating)	The maximum allowable gross vehicle weight. The gross vehicle weight is the total weight of the vehicle. When towing a trailer, it is the sum of the vehicle weight (including the occupants, cargo and any optional equipment installed on the vehicle) and the tongue load.
GAWR (Gross Axle Weight Rating)	The maximum allowable gross axle weight. The gross axle weight is the load placed on each axle (front and rear).
Gross trailer weight	The sum of the trailer weight and the weight of the cargo in the trailer
Towing capacity	The maximum allowable gross trailer weight. Towing capacity is calculated considering the base vehicle with necessary vehicle equipment and occupants. Additional optional equipment, passengers and cargo in the vehicle will reduce the towing capacity, gross trailer weight include the trailer, cargo and necessary equipment for towing.
Tongue load	The load placed on the trailer hitch ball

## Trailer tongue load

- A recommended tongue load varies in accordance with the types of trailers or towing as described below.
  - In order to ensure the recommended values shown below, the trailer must be loaded by referring to the following instructions. The trailer cargo load should be distributed so that the tongue load is 9 to 11% of the gross trailer weight, not exceeding the following.
    - ▶ 2.7 L 4-cylinder (1AR-FE) engine
      - Without towing package: 150 lb. (68 kg)
      - With towing package: 350 lb. (150 kg)
    - ▶ 3.5 L V6 (2GR-FE) engine
      - Without towing package: 200 lb. (90 kg)
      - With towing package: 500 lb. (200 kg)
- (Tongue load / Gross trailer weight x 100 = 9 to 11%)
- If the gross trailer weight is over 2000 lbs. (900 kg), it is necessary to use a sway control device with sufficient capacity.

The gross trailer weight and tongue load can be measured with platform scales found at a highway weighing station, building supply company, trucking company, junk yard, etc.

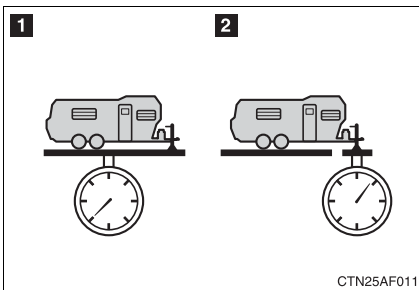

- 1** Gross trailer weight
- 2** Tongue load

## Hitch

Trailer hitch assemblies have different weight capacities established by the hitch manufacturer. Even though the vehicle may be rated for towing a higher weight, the operator must never exceed the maximum weight rating specified for the trailer hitch.

## Trailer towing tips

Your vehicle will handle differently when towing a trailer. The 3 main causes of vehicle-trailer accidents are driver error, excessive speed and improper trailer loading. Keep the following in mind when towing.

- Before starting out, check the trailer lights and the vehicle-trailer connections. Recheck after driving a short distance.
- Practice turning, stopping and reversing with the trailer attached in an area away from traffic until you become accustomed to the feel of the vehicle.
- Reversing with a trailer attached is difficult and requires practice. Grip the bottom of the steering wheel and move your hand to the left to move the trailer to the left. Move your hand to the right to move the trailer to right. (This is generally opposite to reversing without a trailer attached.) Avoid sharp or prolonged turning. Have someone guide you when reversing to reduce the risk of an accident.
- As stopping distance is increased when towing a trailer, vehicle-to-vehicle distance should be increased. For each 10 mph (16 km/h) of speed, allow at least one vehicle and trailer length.
- Avoid sudden braking as you may skid, resulting in jackknifing and loss of control. This is especially true on wet or slippery surfaces.
- Avoid jerky starts or sudden acceleration.
- Avoid jerky steering and sharp turns, and slow down before making turns.

- Note that when making a turn, the trailer wheels will be closer than the vehicle wheels to the inside of the turn. Compensate by making a larger than normal turning radius.
- Crosswinds and rough roads will adversely affect handling of your vehicle and trailer, causing sway. Periodically check the rear to prepare for being passed by large trucks or buses, which may cause your vehicle and trailer to sway. If swaying occurs, firmly grip the steering wheel, reduce speed immediately but gradually, and steer straight ahead. Never increase speed. If you make no extreme correction with the steering or brakes, your vehicle and trailer will stabilize.
- Take care when passing other vehicles. Passing requires considerable distance. After passing a vehicle, do not forget the length of your trailer, and be sure you have plenty of room before changing lanes.
- 2.7 L 4-cylinder (1AR-FE) engine: In order to maintain engine braking efficiency when driving on a long steep downgrade, do not use overdrive. Transmission shift range position must be in 5 in S mode.
- 3.5 L V6 (2GR-FE) engine: In order to maintain engine braking efficiency when driving on a long steep downgrade, do not use overdrive. Transmission shift range position must be in 4 in S mode.
- Due to the added load of the trailer, your vehicle's engine may overheat on hot days (at temperatures over 85°F [30°C]) when driving up a long or steep grade. If the engine coolant temperature gauge indicates overheating, immediately turn off the air conditioning (if in use), pull your vehicle off the road and stop in a safe spot. (→P. 545)

- Always place wheel blocks under both the vehicle and the trailer wheels when parking. Apply the parking brake firmly, and put the transmission in P. Avoid parking on a slope, but if unavoidable, do so only after performing the following:

**STEP 1** Apply the brakes and keep them applied.

**STEP 2** Have someone place wheel blocks under both the vehicle and trailer wheels.

**STEP 3** When the wheel blocks are in place, release the brakes slowly until the blocks absorb the load.

**STEP 4** Apply the parking brake firmly.

**STEP 5** Shift into P and turn off the engine.

- When restarting after parking on a slope:

**STEP 1** With the transmission in the P position, start the engine. Be sure to keep the brake pedal pressed.

**STEP 2** Shift into 3, 2, 1, or the R position (if reversing).

**STEP 3** Release the parking brake and brake pedal and slowly pull or back away from the wheel blocks. Stop and apply the brakes.

**STEP 4** Have someone retrieve the blocks.

### ■ Before towing

Check that the following conditions are met:

- The vehicle's tires are properly inflated. (→P. 562)
- Trailer tires are inflated according to the trailer manufacturer's recommendation.
- All trailer lights work.
- All lights work each time you connect them.
- The vehicle remains level when a loaded or unloaded trailer is hitched. Do not drive if the vehicle is not level, and check for improper tongue load, overloading, worn suspension, or other possible causes.
- The trailer cargo is securely loaded.
- The rear view mirrors conform to all applicable federal, state/provincial or local regulations. If they do not, install rear view mirrors appropriate for towing purposes.

### ■ Break-in schedule

If your vehicle is new or equipped with any new power train components (such as an engine, transmission, differential and wheel bearing), Toyota recommends that you do not tow a trailer until it has been driven for over 2000 miles (3200 km).

However, avoid full throttle acceleration.

### ■ Maintenance

- If you tow a trailer, your vehicle will require more frequent maintenance due to the additional load. (See "Scheduled Maintenance Guide" or "Owner's Manual Supplement".)
- Retighten the fixing bolts of the towing ball and bracket after approximately 600 miles (1000 km) of trailer towing.



 **CAUTION**

■ **Trailer towing precautions**

- Follow all the instructions described in this section. Failure to do so could cause an accident resulting in death or serious injury.
- Exceeding the towing capacity, GVWR or GAWR can cause an accident resulting in death or serious personal injuries.

■ **To avoid accident or injury**

- Do not exceed 45 mph (72 km/h) or the posted towing speed limit, whichever is lower. As instability (swaying) of the towing vehicle-trailer combination increases as speed increases, exceeding 45 mph (72 km/h) may cause loss of control.
- Do not exceed the trailer hitch assembly weight, gross vehicle weight, gross axle weight and trailer tongue load capacities.
- Never load more weight in the back than in the front of the trailer. About 60% of the load should be in the front half of the trailer, and the remaining 40% in the rear.
- Do not use cruise control when you are towing.
- Slow down and downshift before descending steep or long downhill grades. Do not make sudden downshifts.
- Avoid holding the brake pedal down too long or applying the brakes too frequently. This could cause the brakes to overheat and result in reduced braking efficiency.
- Do not tow the vehicle with the compact spare tire installed.

■ **Hitches**

- If you wish to install a trailer hitch, contact your Toyota dealer.
- Use only a hitch that conforms to the gross trailer weight requirement.
- 2.7 L 4-cylinder (1AR-FE) engine: The towing capacity of 3500 lb. (1500 kg) can only be guaranteed when using a genuine Toyota hitch assembly or equivalent.
- 3.5 L V6 (2GR-FE) engine: The towing capacity of 5000 lb. (2000 kg) can only be guaranteed when using a genuine Toyota hitch assembly or equivalent.
- Follow the directions supplied by the hitch manufacturer.

 **CAUTION**

- Lubricate the hitch ball with a light coat of grease.
- Remove the trailer hitch whenever you are not towing a trailer. After removing the hitch, seal any mounting hole in the vehicle body to prevent entry of any substances into the vehicle.

**■ When towing a trailer**

- If the gross trailer weight exceeds 1000 lb. (453 kg), trailer brakes are required. Toyota recommends trailers with brakes that conform to all applicable federal and state/provincial regulations.
- Never tap into your vehicle's hydraulic system, as this will lower the vehicle's braking effectiveness.
- Never tow a trailer without using a safety chain securely attached to both the trailer and the vehicle. If damage occurs to the coupling unit or hitch ball, there is danger of the trailer wandering into another lane.

 **NOTICE****■ When installing a trailer hitch**

- Use only the position recommended by your Toyota dealer. Do not install the trailer hitch on the bumper as this may cause body damage.
- Do not use axle-mounted hitches, as they can cause damage to the axle housing, wheel bearings, wheels or tires.

**■ Safety chain**

A safety chain must always be used between the towing vehicle and the trailer. Leave sufficient slack in the chain for turns. The chain should cross under the trailer tongue to prevent the tongue from dropping to the ground in the case that it becomes damaged or separated. For the correct safety chain installation procedure, ask your Toyota dealer.

**■ Do not directly splice trailer lights**

Directly splicing trailer lights may damage your vehicle's electrical system and cause a malfunction.

## 2-5. Driving information

### Dinghy towing

Your vehicle is not designed to be dinghy towed (with 4 wheels on the ground) behind a motor home.

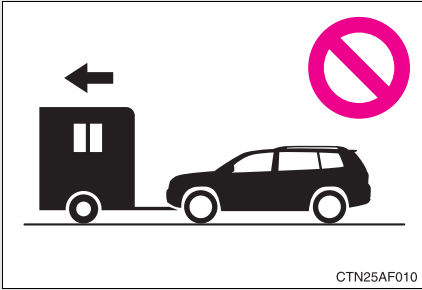

#### NOTICE

**■ To avoid serious damage to your vehicle**

Do not tow your vehicle with 4 wheels on the ground.



### 3-1. Using the air conditioning system and defogger Front manual air conditioning system\*

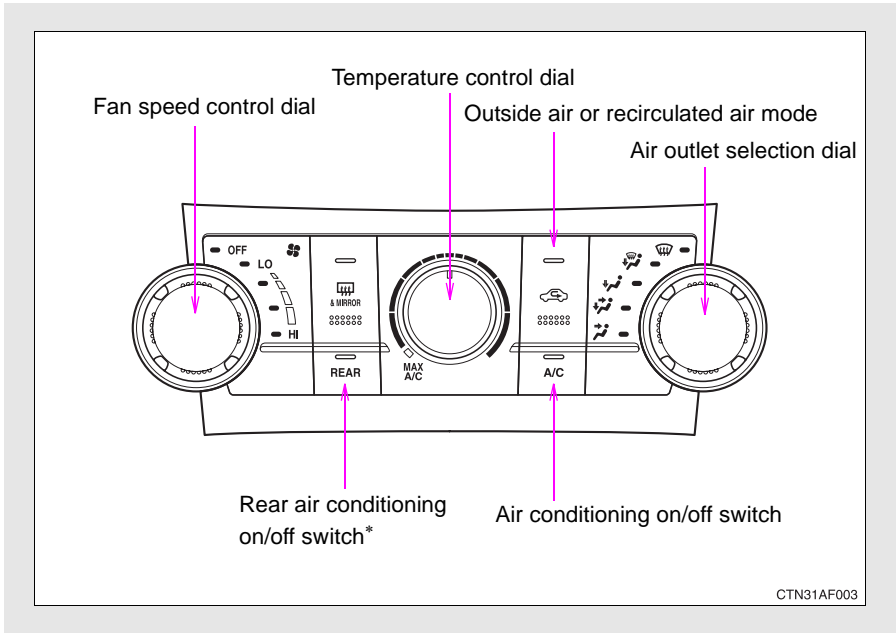

#### Adjusting the settings

##### ■ Adjusting the temperature setting

Turn the temperature control dial clockwise (warm) or counter-clockwise (cool).

If  is not pressed, the system will blow ambient temperature air or heated air.

For quick cooling, turn the temperature selector knob to the "MAX A/C" position. The air conditioning will automatically turn on in  (recirculated air) mode.

\*: If equipped

■ **Adjusting the fan speed**

Turn the fan speed control dial clockwise (increase) or counter-clockwise (decrease).

Turn the dial to "OFF" to turn the fan off.

■ **Changing the air outlets**

Set the air outlet selection dial to an appropriate position.

The positions between the air outlet selections shown below can be also selected for more detailed adjustment.

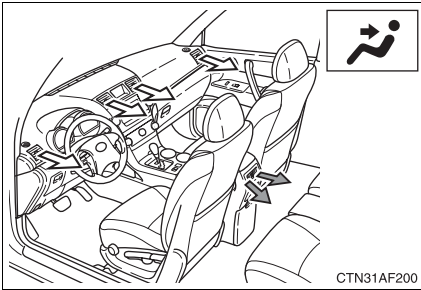

Upper body

➔ : Vehicles without rear air conditioning system

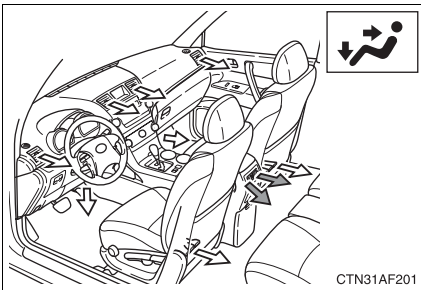

Upper body and feet

➔ : Vehicles without rear air conditioning system

### 3-1. Using the air conditioning system and defogger

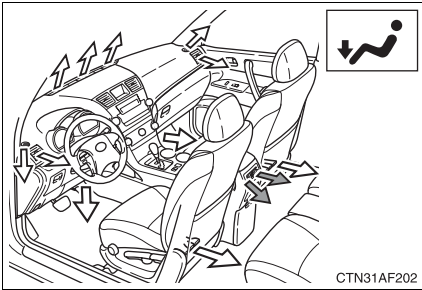

Feet

➡ : Vehicles without rear air conditioning system

▶ Without rear air conditioning system

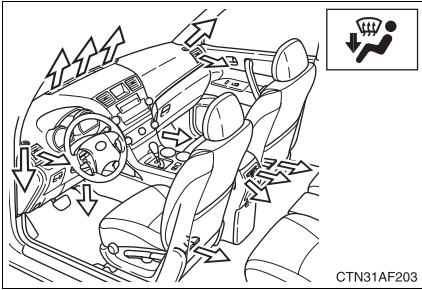

Feet and windshield

▶ With rear air conditioning system

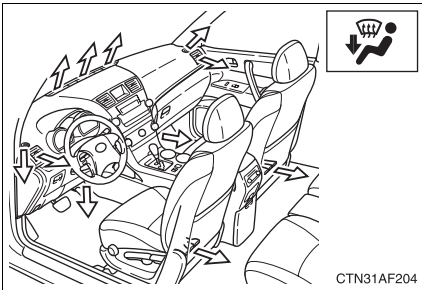

Feet and windshield

## ■ Switching between outside air and recirculated air modes



The mode switches between outside air mode (indicator off) and recirculated air mode (indicator on) modes each time  is pressed.

## Defogging the windshield

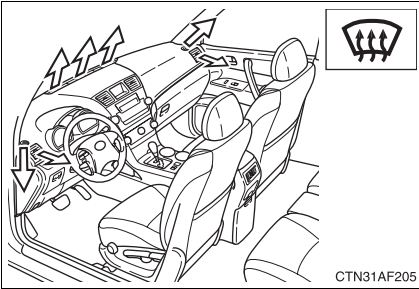

Set the air outlet selection dial to  position.

The air conditioning system operates automatically.

Recirculated air mode may automatically switch to outside air mode.



## Adjusting the position of and opening and closing the air outlets

### ► Front center outlets

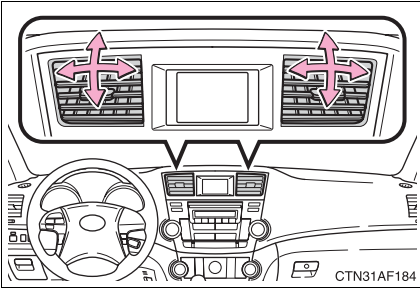

Direct air flow to the left or right, up or down.

### ► Front side outlets

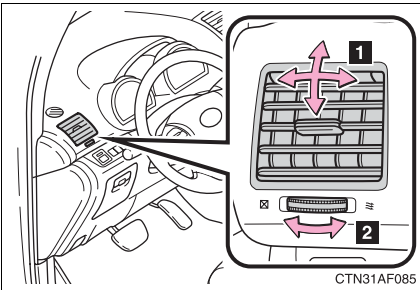

**1** Direct air flow to the left or right, up or down.

**2** Turn the knob to open or close the vent.

### ► Rear center outlets (vehicles without rear air conditioning system)

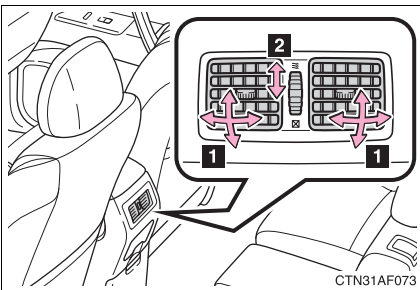

**1** Direct air flow to the left or right, up or down.

**2** Turn the knob to open or close the vent.

### ■ Using the system in recirculated air mode

The windows will fog up more easily if the recirculated air mode is used for an extended period.

### ■ Window defogger feature

In order to prevent the windows from fogging up, recirculated air mode may automatically switch to outside air mode if the ambient temperature drops. This feature can be cancelled by pushing and holding the air intake mode switch for longer than 2 seconds. The feature will be reactivated when the engine switch is turned to the "ACC" or "LOCK" position.

### ■ When outside air temperature approaches 32°F (0°C)

The air conditioning system may not operate even when  is pressed.

### ■ When the indicator light on flashes (2.7 L 4-cylinder (1AR-FE) engine only)

Press  and turn off the air conditioning system before turning it on once more. There may be a problem in the air conditioning system if the indicator light continues to flash. Turn the air conditioning system off and have it inspected by your Toyota dealer.

### ■ When is selected for the air outlets used

For your driving comfort, air flowing to the feet may be warmer than air flowing to the upper body depending on the position of the temperature adjustment dial.

 CAUTION

■ **To prevent the windshield from fogging up**

Do not set the air outlet selection dial to  during cool air operation in extremely humid weather. The difference between the temperature of the outside air and that of the windshield can cause the outer surface of the windshield to fog up, blocking your vision.

 NOTICE

■ **To prevent battery discharge**

Do not leave the air conditioning system on longer than necessary when the engine is off.

### 3-1. Using the air conditioning system and defogger Front automatic air conditioning system\*

**Airflow and outlets are automatically adjusted according to the temperature setting.**

► Control panel

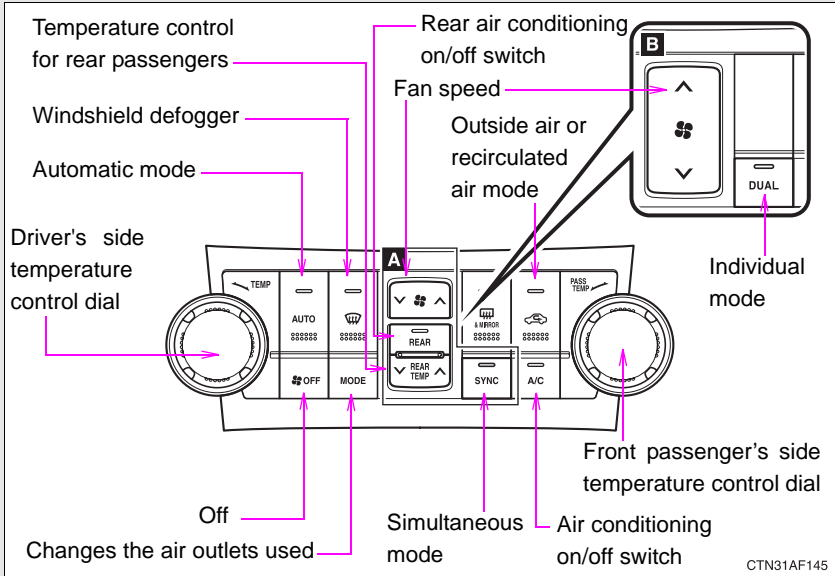

**A** Vehicles with rear air conditioning system

**B** Vehicles without rear air conditioning system

\*: If equipped

► Multi-information display

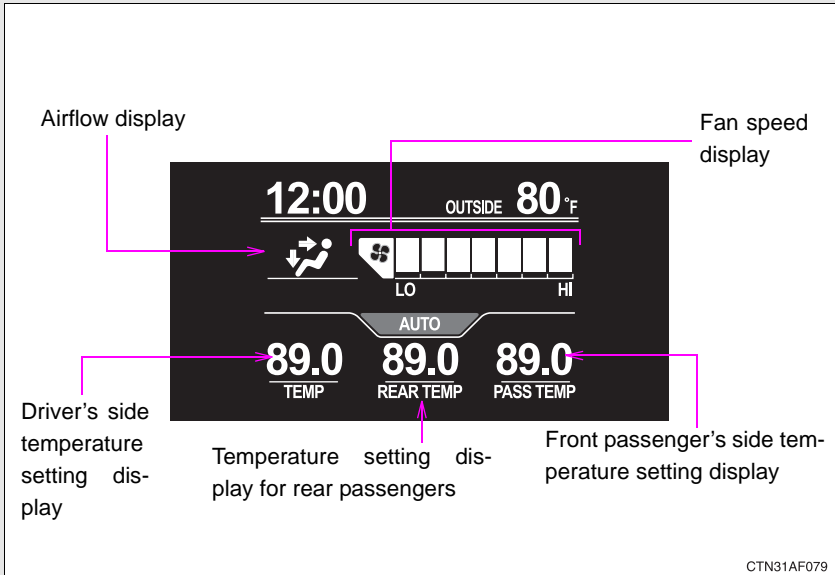

**Using the automatic mode**

**STEP 1** Press



➡ The air conditioning system begins to operate. Air outlets and fan speed are automatically adjusted according to the temperature setting.

“AUTO” will be displayed on the multi-information display.



**STEP 2** Turn the temperature control dial clockwise (warm) or counterclockwise (cool).

Air outlets and fan speed for the right-hand and left-hand seats may be set separately depending on the temperature setting.

## Adjusting the settings

### ■ Adjusting the temperature setting

Turn the temperature control dial clockwise (warm) or counter-clockwise (cool).

The air conditioning system switches between individual and simultaneous modes each time  (without rear air conditioning system) or  (with rear air conditioning system) is pressed.

Simultaneous mode: Only the driver's side temperature control dial can be used to adjust the temperature for all seats.

The indicator status will be as follows:

Without rear air conditioning system:  (off)

With rear air conditioning system:  (on)



Individual mode: The temperature for the driver's, front passenger's and rear seats (→P. 274) can be adjusted separately. Operating the passenger's side or rear (with rear air conditioning system) temperature control will enter individual mode.

The indicator status will be as follows:

Without rear air conditioning system:  (on)

With rear air conditioning system:  (off)

### ■ Adjusting the fan speed

Press “^” (increase) or “v” (decrease) on  or  .

The fan speed is shown on the multi-information display. (7 levels)

Press  to turn the fan off.

### ■ Changing the air outlets

Press  .

The air outlets switch each time either side of  is pressed. The air flow shown on the display indicates the following.

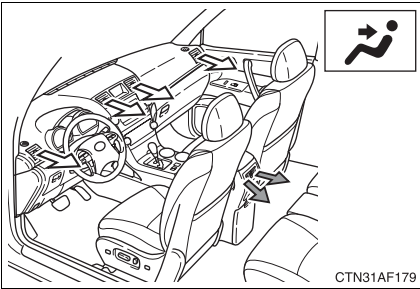

Upper body

 : Vehicles without rear air conditioning system

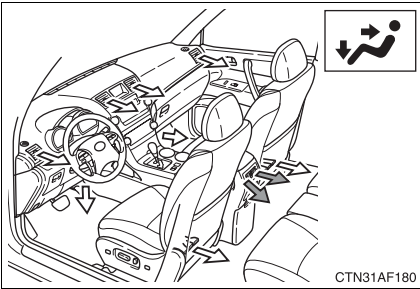

Upper body and feet

 : Vehicles without rear air conditioning system

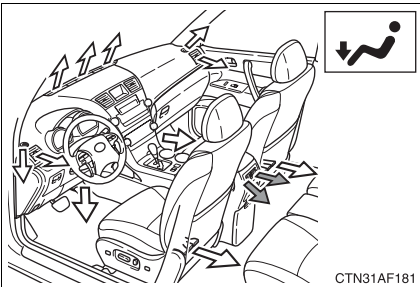

Feet

 : Vehicles without rear air conditioning system

▶ Without rear air conditioning system

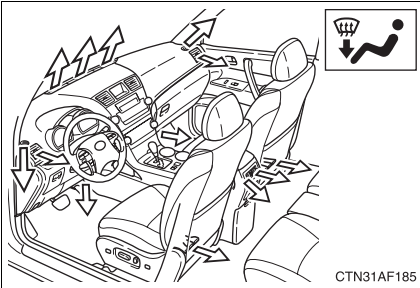

Feet and windshield

▶ With rear air conditioning system

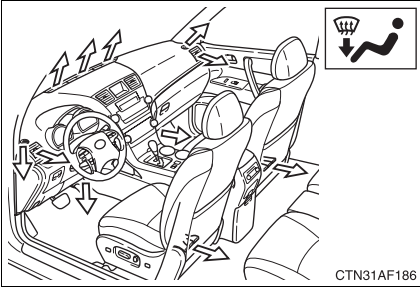

Feet and windshield

■ Switching between outside air and recirculated air modes

Press



The mode switches between outside air mode (indicator off) and recircu-

lated air mode (indicator on) modes each time



is pressed.



## Changing the rear seat settings (if equipped)

### ■ Adjusting the temperature setting

Press “^” on  to increase the temperature and “v” to decrease the temperature.

The air conditioning system switches between individual and simultaneous modes each time  is pressed.

## Defogging the windshield

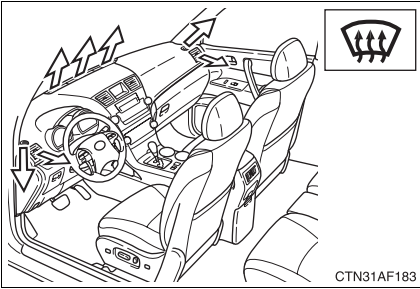

The air conditioning system operates automatically.

## Adjusting the position of and opening and closing the air outlets

### ► Front center outlets

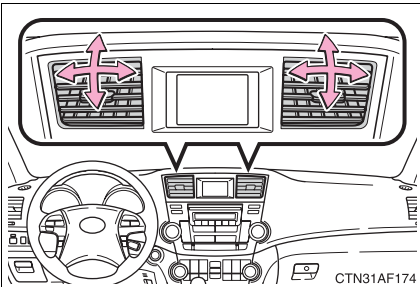

Direct air flow to the left or right, up or down.

► Front side outlets

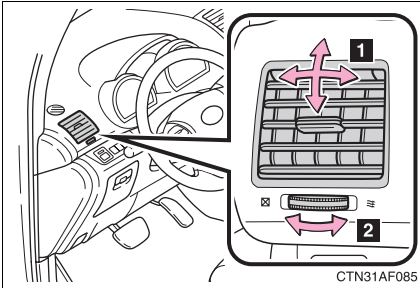

- 1 Direct air flow to the left or right, up or down.
- 2 Turn the knob to open or close the vent.

► Rear center outlets (vehicles without rear air conditioning system)

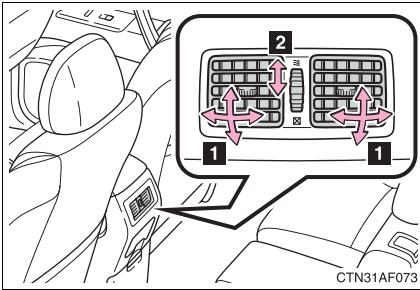

- 1 Direct air flow to the left or right, up or down.
- 2 Turn the knob to open or close the vent.

■ Using the automatic mode

Fan speed is adjusted automatically in accordance with the temperature setting and ambient conditions. As a result, the following may occur.

- The system may switch automatically to recirculated mode when the coolest temperature setting is selected in summer.
- Immediately after the switch is pressed, the fan may stop for a while until warm or cool air is ready to flow.
- Cool air may flow to the area around the upper body when the heater is on.

■ Using the system in recirculated air mode

The windows will fog up more easily if the recirculated air mode is used for an extended period.

■ **Window defogger feature**

Recirculated air mode may automatically switch to  (outside air) mode in situations where the windows need to be defogged.

■ **When outside temperature approaches 32°F (0°C)**

The air conditioning system may not operate even when  is pressed.

 **CAUTION**

■ **To prevent the windshield from fogging up**

Do not use  during cool air operation in extremely humid weather. The difference between the temperature of the outside air and that of the windshield can cause the outer surface of the windshield to fog up, blocking your vision.

 **NOTICE**

■ **To prevent battery discharge**

Do not leave the air conditioning system on longer than necessary when the engine is off.

### 3-1. Using the air conditioning system and defogger Rear manual air conditioning system\*

**Airflow and outlets are automatically adjusted according to the temperature setting.**

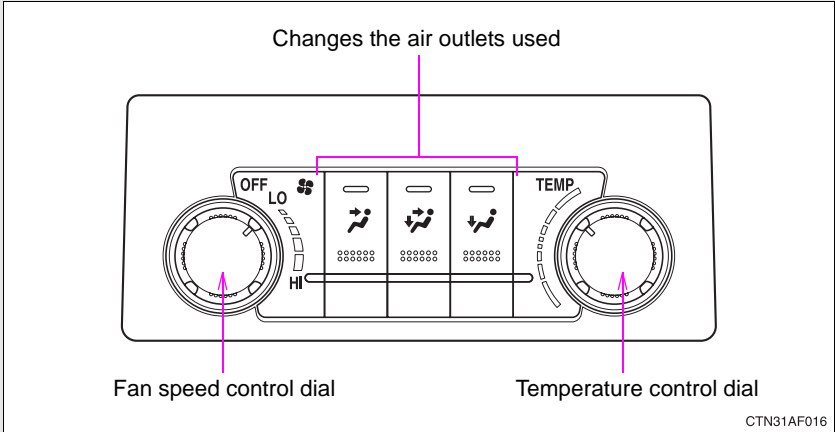

\*: If equipped

## Adjusting the settings

### ■ Adjusting the temperature setting

Turn the temperature control dial clockwise (warm) or counter-clockwise (cool).

### ■ Changing the air outlets

Press the desired  ,  or  .

Air flows as shown below according to the mode selected.

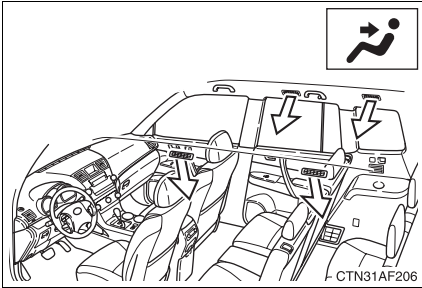

Upper body

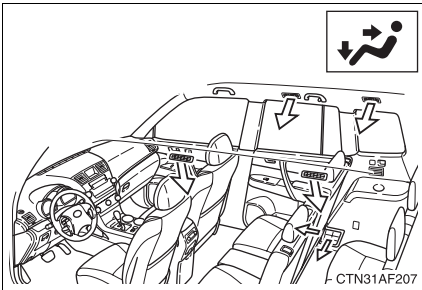

Upper body and feet

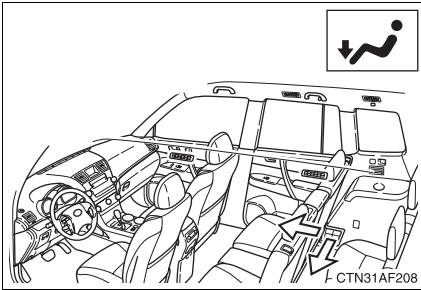

Feet

■ **Adjusting the fan speed**

Turn the fan speed control dial clockwise (increase) or counter-clockwise (decrease).

**Adjusting the position of and opening and closing the roof side air outlets**

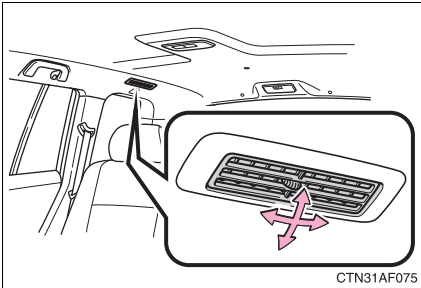

Direct air flow to the left or right, up or down.

 **NOTICE**

■ **To prevent battery discharge**

Do not leave the air conditioning system on longer than necessary when the engine is off.

### 3-1. Using the air conditioning system and defogger Rear automatic air conditioning system\*

**Airflow and outlets are automatically adjusted according to the temperature setting.**

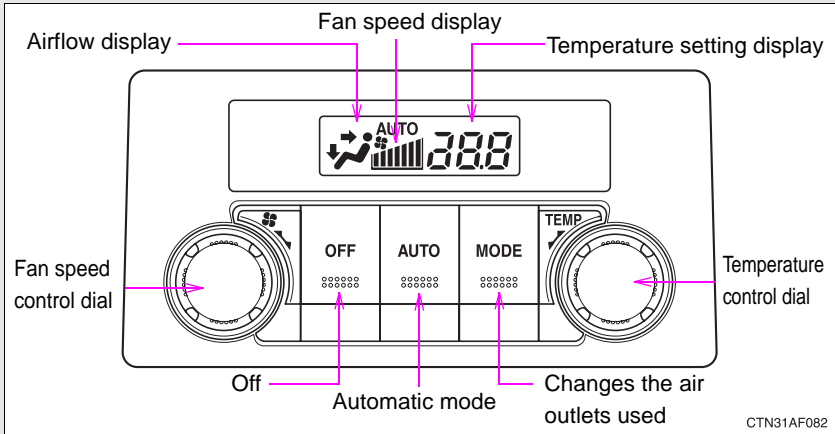

#### Using the automatic mode

**STEP 1** Press



➡ The air conditioning system will operate, and air outlets and fan speed will be set automatically.

“AUTO” will be displayed on the control panel.

**STEP 2** Turn the temperature control dial clockwise (warm) or counterclockwise (cool).

\*: If equipped

## Adjusting the settings

### ■ Adjusting the temperature setting

Turn the temperature control dial clockwise (warm) or counter-clockwise (cool).

### ■ Changing the air outlets

Press



.

The air outlets change as follows each time  is pressed.

Air flows as shown below according to the mode selected.

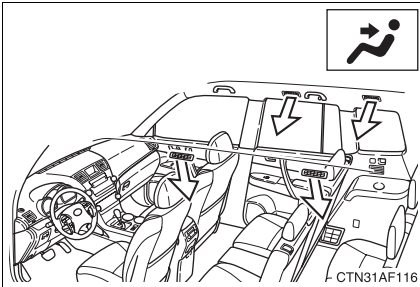

Upper body

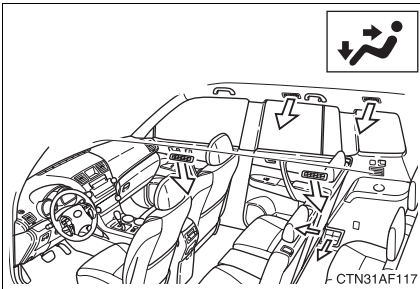

Upper body and feet



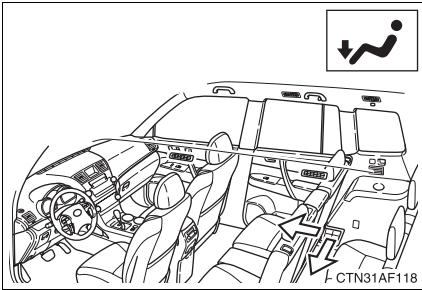

Feet

### ■ Adjusting the fan speed

Turn the fan speed control dial clockwise (increase) or counter-clockwise (decrease).

Press  to turn the fan off.

### Adjusting the position of and opening and closing the roof side air outlets

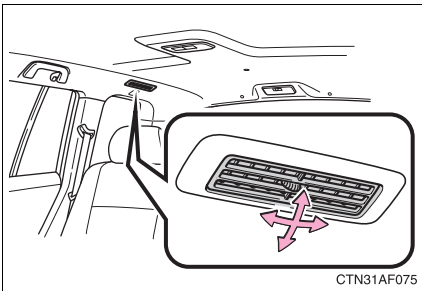

Direct air flow to the left or right, up or down.

### NOTICE

#### ■ To prevent battery discharge

Do not leave the air conditioning system on longer than necessary when the engine is off.

### 3-1. Using the air conditioning system and defogger Rear window and outside rear view mirror defoggers

#### Clear the rear window using the defogger.

##### ► Vehicles with manual air conditioning system

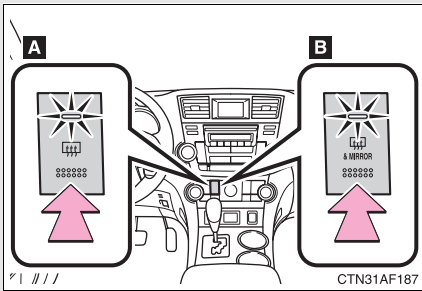

##### On/off

Press the button to turn on the rear window defogger. The indicator light will come on. The defoggers will automatically turn off after 15 to 60 minutes. The operation time changes according to the ambient temperature and vehicle speed. Pressing the button again also turns the defogger off.

##### **A** Vehicles without outside rear view mirror defoggers

##### **B** Vehicles with outside rear view mirror defoggers

##### ► Vehicles with automatic air conditioning system

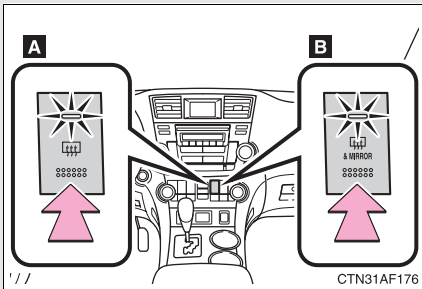

##### On/off

Press the button to turn on the rear window defogger. The indicator light will come on. The defoggers will automatically turn off after 15 to 60 minutes. The operation time changes according to the ambient temperature and vehicle speed. Pressing the button again also turns the defogger off.

##### **A** Vehicles without outside rear view mirror defoggers

##### **B** Vehicles with outside rear view mirror defoggers

■ **The defogger can be operated when**

- ▶ Vehicles without smart key system

The engine switch is in the “ON” position.

- ▶ Vehicles with smart key system

The “ENGINE START STOP” switch is in IGNITION ON mode.

■ **Outside rear view mirror defoggers (vehicles with outside rear view mirror defoggers)**

Turning the rear window defogger on will turn the outside rear view mirror defoggers on.

 **CAUTION**

■ **Outside rear view mirror defoggers (vehicles with outside rear view mirror defoggers)**

The surfaces of the outside rear view mirrors become hot. Do not touch them to prevent from burning yourself.

### 3-1. Using the air conditioning system and defogger Windshield wiper de-icer\*

This feature is used to prevent ice from building up on the windshield and wiper blades.

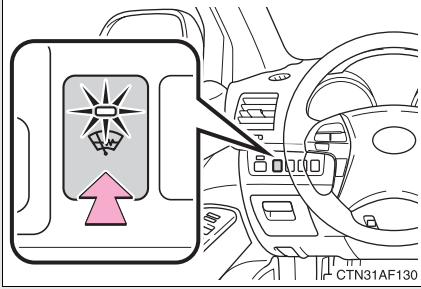

#### On/off

Press the button to turn on the windshield wiper de-icer. The indicator light will come on. The windshield wiper de-icer will automatically turn off after approximately 15 minutes.

#### ■ The de-icer can be operated when

- ▶ Vehicles without smart key system

The engine switch is in the "ON" position.

- ▶ Vehicles with smart key system

The "ENGINE START STOP" switch is in IGNITION ON mode.

#### ⚠ CAUTION

#### ■ When the windshield wiper de-icer is on

Do not touch the glass at the lower part of the windshield or to the side of the front pillars as the surfaces can become very hot and burn you.

## 3-1. Using the air conditioning system and defogger Using the steering wheel climate remote control switches\*

Some air conditioning features can be controlled using the switches on the steering wheel.

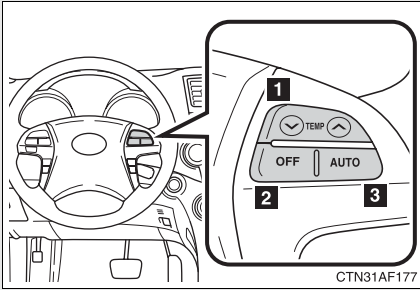

- 1 Temperature control
- 2 Off
- 3 Automatic mode

### Using the automatic mode

**STEP 1** Press  .

➡ The air conditioning system will operate, and air outlets and fan speed will be set automatically.

“AUTO” will be displayed on the multi-information display.

**STEP 2** Press “^” on  to increase the temperature and “v” to decrease the temperature.

### Adjusting the temperature setting

Press “^” on  to increase the temperature and “v” to decrease the temperature.

### Turning off the fan

Press  .

\*: If equipped

## 3-2. Using the audio system

### Audio system

#### ▶ With navigation system

Owners of models equipped with a navigation system should refer to the “Navigation System Owner’s Manual”.

#### ▶ Without navigation system

Type A: CD player and AM/FM radio (with CD changer controller)

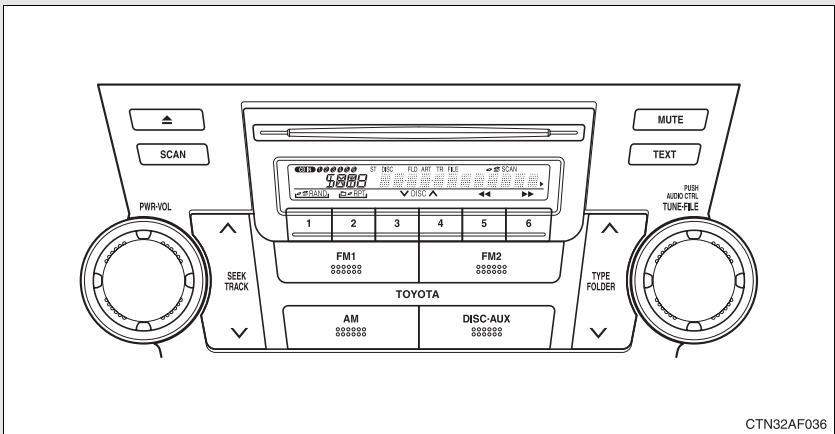

Type B: CD player with changer and AM/FM radio

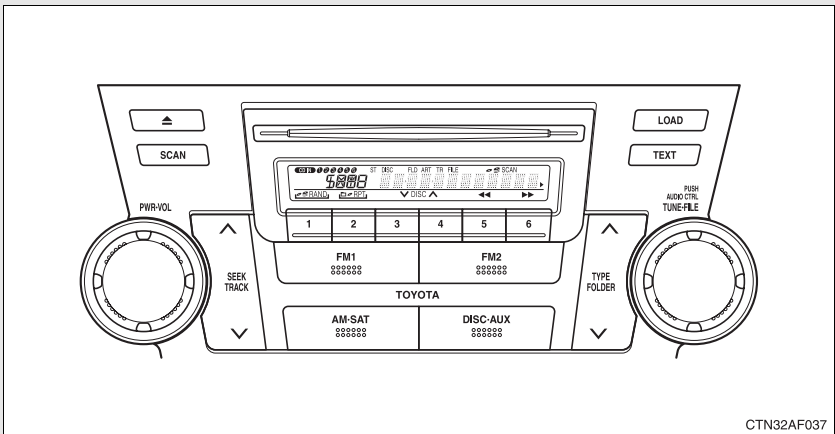

Type C: CD player with changer and AM/FM radio

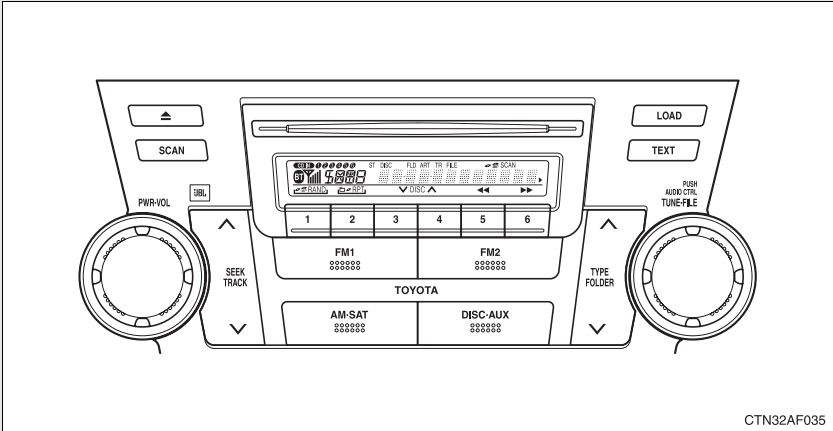

Title	Page
Using the radio	P. 284
Using the CD player	P. 290
Playing back MP3 and WMA discs	P. 297
Optimal use of the audio system	P. 304
Using the AUX adapter	P. 307
Using the steering wheel audio switches	P. 309

■ Using cellular phones

Interference may be heard through the audio system's speakers if a cellular phone is being used inside or close to the vehicle while the audio system is operating.

 **CAUTION**
**■ For vehicles sold in U.S.A. and Canada**
**● Part 15 of the FCC Rules**

FCC Warning:

Any unauthorized changes or modifications to this equipment will void the user's authority to operate this device.

**● Laser products**

- Do not take this unit apart or attempt to make any changes yourself. This is an intricate unit that uses a laser pickup to retrieve information from the surface of compact discs. The laser is carefully shielded so that its rays remain inside the cabinet. Therefore, never try to disassemble the player or alter any of its parts since you may be exposed to laser rays and dangerous voltages.
- This product utilizes a laser. Use of controls or adjustments or performance of procedures other than those specified herein may result in hazardous radiation exposure.

 **NOTICE**
**■ To prevent battery discharge**

Do not leave the audio system on longer than necessary with the engine is off.

**■ To avoid damaging the audio system**

Take care not to spill drinks or other fluids over the audio system.



## 3-2. Using the audio system

### Using the radio

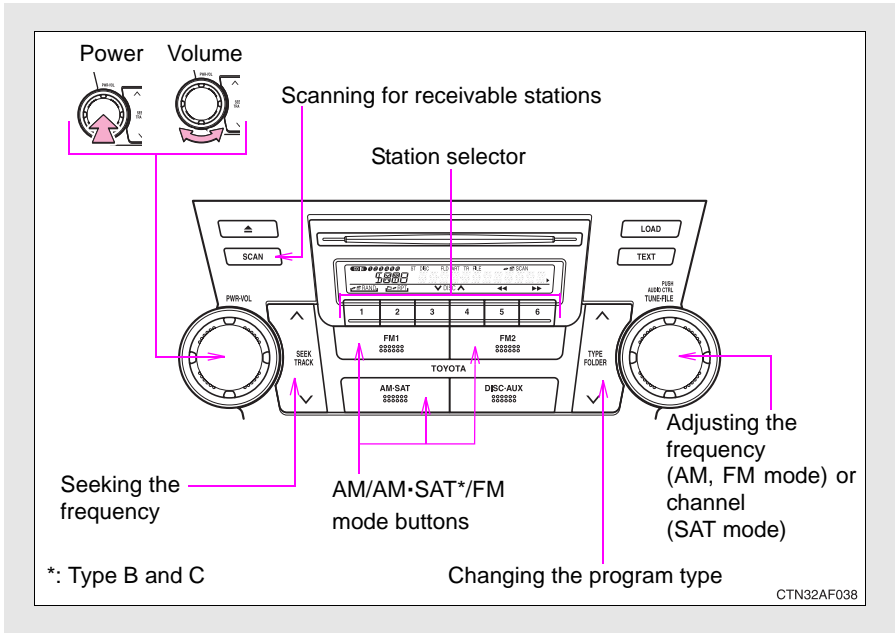



### Setting station presets (excluding XM<sup>®</sup> Satellite Radio)

**STEP 1** Search for desired stations by turning the  or pressing

“^” or “v” on



**STEP 2** Press and hold the button (from  to ) the station is to be set to until you hear a beep.

### Scanning radio stations (excluding XM<sup>®</sup> Satellite Radio)

#### ■ Scanning the preset radio stations

**STEP 1** Press and hold  until you hear a beep.

Preset stations will be played for 5 seconds each.

**STEP 2** When the desired station is reached, press  once again.

## ■ Scanning all radio stations within range

**STEP 1** Press .

All stations with reception will be played for 5 seconds each.

**STEP 2** When the desired station is reached, press  once again.

## XM<sup>®</sup> Satellite Radio (type B and C)

### ■ Receiving XM<sup>®</sup> Satellite Radio

**STEP 1** Press and hold  until SAT appears in the display.



The display changes as follows each time  is pressed.

AM → SAT1 → SAT2 → SAT3

**STEP 2** Turn  to select the desired channel in all categories, or

press “^” or “v” on  to select the desired channel in the current category.

### ■ Setting XM<sup>®</sup> Satellite Radio channel presets

Select the desired channel. Press and hold the button (from  to ) the channel is to be set to until you hear a beep.

### ■ Changing the channel category

Press “^” or “v” on the .

### ■ Scanning XM<sup>®</sup> Satellite Radio channels

- Scanning channels in the current category

**STEP 1** Press .

**STEP 2** When the desired channel is reached, press  again.

### ● Scanning preset channels

**STEP 1** Press and hold **SCAN** until you hear a beep.

**STEP 2** When the desired channel is reached, press **SCAN** again.

### ■ Displaying text information

Press **TEXT** .

The display will show up to 10 characters.

The display changes as follows each time the button is pressed.

- CH NAME
- TITLE (SONG/PROGRAM TITLE)
- NAME (ARTIST NAME/FEATURE)
- CH NUMBER

### Silencing a sound (type A only)

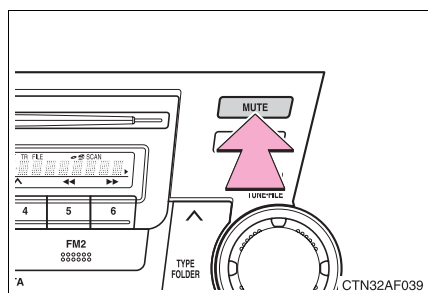

Press **MUTE** .

### ■ When the battery is disconnected

Stations presets are erased.

### ■ Reception sensitivity

- Maintaining perfect radio reception at all times is difficult due to the continually changing position of the antenna, differences in signal strength and surrounding objects, such as trains and transmitters.
- Mast type antenna — The radio antenna is mounted on the right-side front fender. The antenna can be removed from the base by turning it.
- Print type antenna — The radio antenna is mounted inside the left-side rear quarter window. To maintain clear radio reception, do not attach metallic window tinting or other metallic objects to the antenna wire mounted inside the left-side rear quarter window.

### ■ XM<sup>®</sup> Satellite Radio (type B and C)

An XM<sup>®</sup> Satellite Radio is a tuner designed exclusively to receive broadcasts provided under a separate subscription. Availability is limited to the 48 contiguous states and 10 Canadian provinces.

#### ● XM<sup>®</sup> subscriptions

For detailed information about XM<sup>®</sup> Satellite Radio or to subscribe:  
U.S.A. —

Visit on the web at [www.xmradio.com](http://www.xmradio.com) or call 1-800-967-2346.

Canada —

Visit on the web at [www.xmradio.ca](http://www.xmradio.ca) or call 1-877-438-9677.

#### ● Radio ID

You will need the radio ID when activating XM<sup>®</sup> service or reporting a problem. Select “CH000” using , and the receiver's 8-character ID number will appear.

#### ● Satellite tuner

The tuner supports only Audio Services (Music and Talk) and the accompanying Text Information of XM<sup>®</sup> Satellite Radio.

■ **If the satellite radio does not operate normally (type B and C)**

If a problem occurs with the XM<sup>®</sup> tuner, a message will appear on the display. Refer to the table below to identify the problem, and take the suggested corrective action.

ANTENNA	The XM <sup>®</sup> antenna is not connected. Check whether the XM <sup>®</sup> antenna cable is attached securely.
	There is a short-circuit in the antenna or the surrounding antenna cable. See a Toyota certified dealer.
UPDATING	You have not subscribed to the XM <sup>®</sup> Satellite Radio. The radio is being updated with the latest encryption code. Contact the XM <sup>®</sup> Satellite Radio for subscription information. When a contract is canceled, you can choose the "CH000" and all free-to-air channels.
	The premium channel you selected is not authorized. Wait for about 2 seconds until the radio returns to the previous channel or "CH001". If it does not change automatically, select another channel. If you want to listen to the premium channel, contact the XM <sup>®</sup> Satellite Radio.
NO SIGNAL	The XM <sup>®</sup> signal is too weak at the current location. Wait until your vehicle reaches a location with a stronger signal.
LOADING	The unit is acquiring audio or program information. Wait until the unit has received the information.
OFF AIR	The channel you selected is not broadcasting any programming. Select another channel.
-----	There is no song/program title or artist name/feature associated with the channel at that time. No action needed.

---	The channel you selected is no longer available. Wait for about 2 seconds until the radio returns to the previous channel or "CH001". If it does not change automatically, select another channel.
-----	--

Contact the XM<sup>®</sup> Listener Care Center at 1-800-967-2346 (U.S.A.) or 1-877-438-9677 (Canada).

### ■ Certifications for the radio tuner

This equipment has been tested and found to comply with the limits for a class B digital device, pursuant to Part 15 of the FCC Rules. These limits are designed to provide reasonable protection against harmful interference in a residential installation. This equipment generates, uses and can radiate radio frequency energy and, if not installed and used in accordance with the instructions, may cause harmful interference to radio communications. However, there is no guarantee that interference will not occur in a particular installation.

If this equipment does cause harmful interference to radio or television reception, which can be determined by turning the equipment off and on, the user is encouraged to try to correct the interference by trying one or more of the following:

- Reorienting or relocating the receiving antenna.
- Increasing the separation between the equipment and receiver.
- Connecting the equipment into an outlet on a circuit different from that to which the receiver is connected.
- Consulting the dealer or an experienced radio/TV technician for help.



### NOTICE

#### ■ To prevent damage, remove the antenna in the following cases. (mast type antenna)

- The antenna will touch the ceiling of a garage.
- A cover will be put on the vehicle.

## 3-2. Using the audio system Using the CD player

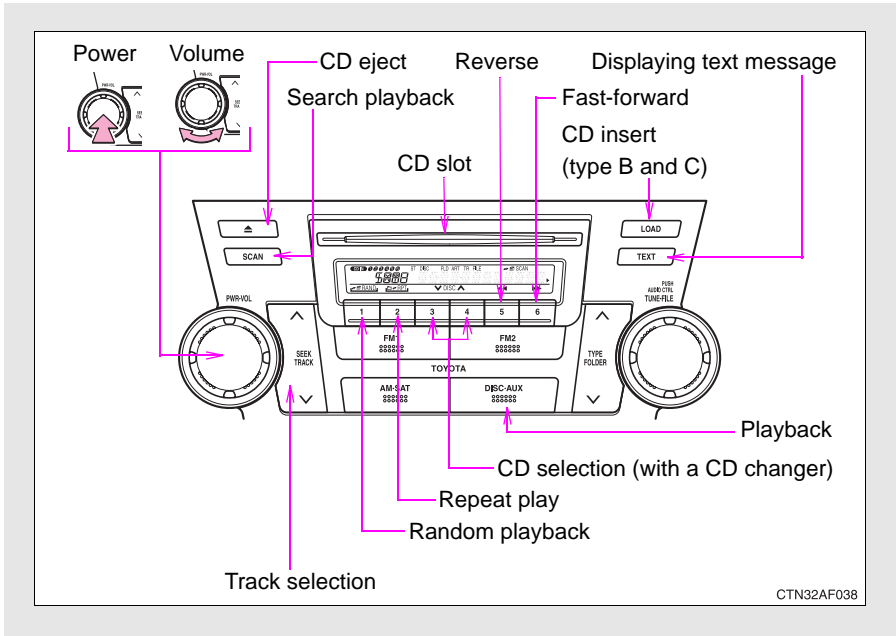

### Loading CDs

#### ■ Loading a CD

##### ▶ Type A

Insert a CD.

##### ▶ Type B and C

**STEP 1** Press **LOAD**.

"WAIT" is shown on the display.

**STEP 2** Insert a CD when the indicator on the slot turns from amber to green.

The display changes from "WAIT" to "LOAD".

### ■ Loading multiple CDs (type B and C)

**STEP 1** Press and hold  until you hear a beep.  
“WAIT” is shown on the display.

**STEP 2** Insert a CD when the indicator on the slot turns from amber to green.

The display changes from “WAIT” to “LOAD”.

The indicator on the slot turns to amber when the CD is inserted.

**STEP 3** Insert the next CD when the indicator on the slot turns from amber to green again.

Repeat the procedure for the remaining CDs.

To stop the operation, press  .



## Ejecting CDs

### ■ Ejecting a CD

#### ▶ Type A

Press  and remove the CD.

#### ▶ Type B and C

**STEP 1** To select the CD to be ejected, press  (∨) or  (∧).

The number of the CD selected is shown on the display.

**STEP 2** Press  and remove the CD.

### ■ Ejecting all the CDs (type B and C)

Press and hold  until you hear a beep, and then remove the CDs.

## Selecting a track

Press “∧” to move up or “∨” to move down using  until the desired track number is displayed.



## Fast-forwarding and reversing tracks

To fast-forward or reverse, press and hold “^” or “v” on



## Scanning tracks



**STEP 1** Press  .

The first ten seconds of each track will be played.

**STEP 2** Press  again when the desired track is reached.

## Selecting a CD (with a CD changer)

### ■ To select a CD to play

To select the desired CD, press  (v) or  (^).

### ■ To scan loaded CDs

**STEP 1** Press and hold  until you hear a beep.

The first ten seconds of the first track on each CD will be played.

**STEP 2** Press  again when the desired CD is reached.

## Repeat play

### ■ To repeat a track

Press  (RPT).

### ■ To repeat all of the tracks on a CD (CD player with changer only)

Press and hold  (RPT) until you hear a beep.

## Random playback

### ■ Current CD

Press  (RAND).

Tracks are played in a random order until  is pressed once more.

### ■ All CDs (with a CD changer)

Press and hold  until you hear a beep.

Tracks on all loaded CDs are played in a random order until  (RAND) is pressed once more.

## Switching the display

Press  .

Each time  is pressed, the display changes in the order of “Track no./Elapsed time”→“CD title”→“Track name”.

## Silencing a sound (type A only)

→P. 286

### ■ Display

Up to 12 characters can be displayed at a time.



If there are 13 characters or more, pressing and holding  for 1 second or more will display the remaining characters.

A maximum of 24 characters can be displayed.

If  is pressed for 1 second or more again or has not been pressed for 6 seconds or more, the display will return to the first 12 characters.

Depending on the contents recorded, the characters may not be displayed properly or may not be displayed at all.

### ■ Canceling random and repeat playback

Press  (RAND),  (RPT) or  again.

### ■ Error messages

“ERROR”: This indicates a trouble either in the CD or inside the player.  
The CD may be dirty, damaged or inserted up-side down.

### ■ Discs that can be used

Discs with the marks shown below can be used.

Playback may not be possible depending on recording format or disc features, or due to scratches, dirt or deterioration.



CDs with copy-protect features may not be used.

### ■ CD player protection feature

To protect the internal components, playback is automatically stopped when a problem is detected while the CD player is being used.

### ■ If CDs are left inside the CD player or in the ejected position for extended periods

CDs may be damaged and may not play properly.

### ■ Lens cleaners

Do not use lens cleaners. Doing so may damage the CD player.

 NOTICE

**■ CDs and adapters that cannot be used**

Do not use the following types of CDs, 3 in. (8 cm) CD adapters or Dual Disc.

Doing so may damage the CD player and/or the CD insert/eject function.

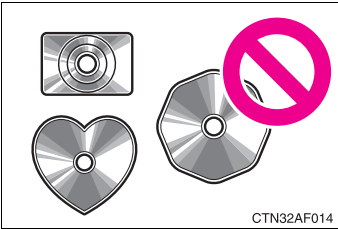

- CDs that have a diameter that is not 4.7 in. (12 cm)

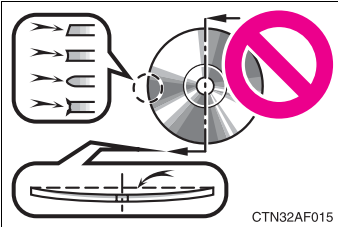

- Low-quality and deformed CDs

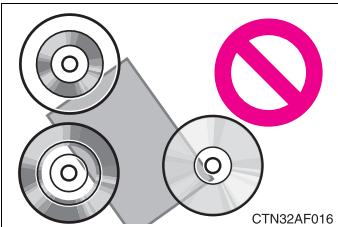

- CDs with a transparent or translucent recording area

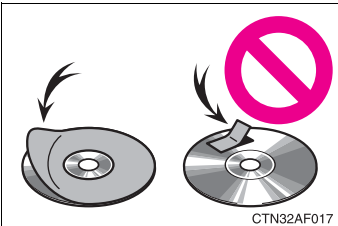

- CDs that have had tape, stickers or CD-R labels attached to them, or that have had the label peeled off

 NOTICE

■ **CD player precautions**

Failure to follow the precautions below may result in serious damage to the CDs or the player itself.

- Do not insert anything other than CDs into the CD slot.
- Do not apply oil to the CD player.
- Store CDs away from direct sunlight.
- Never try to disassemble any part of the CD player.

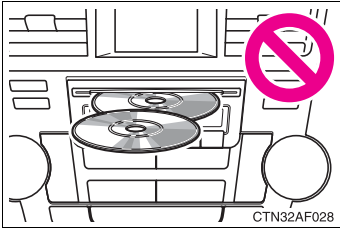

- Do not insert more than one CD at a time.

## 3-2. Using the audio system

### Playing back MP3 and WMA discs

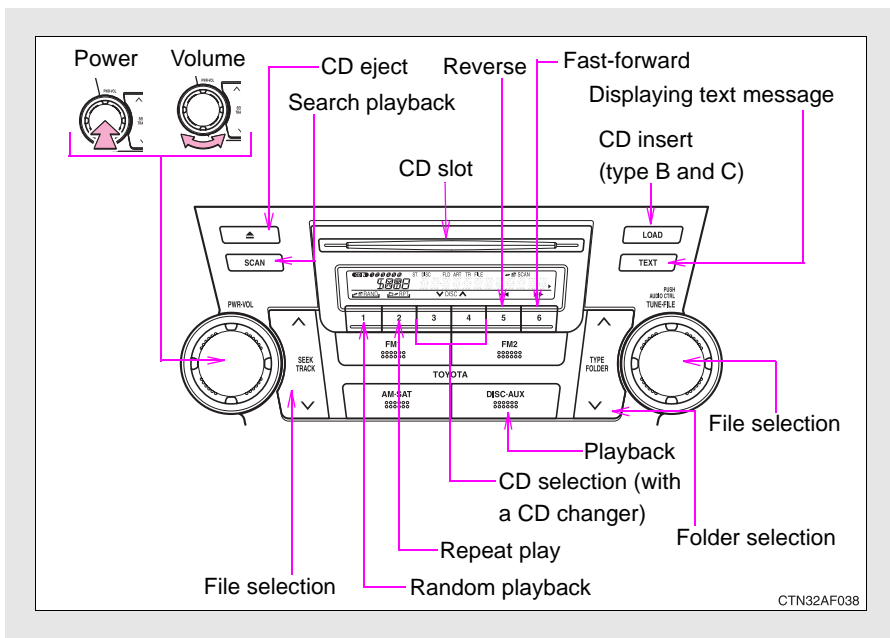

#### Loading and ejecting MP3 and WMA discs

→P. 290

#### Selecting a CD (with a CD changer)



→P. 292

## Selecting and scanning a folder

### ■ Selecting folders one at a time

Press “^” or “v” on  to select the desired folder.

### ■ Selecting the desired folder by cueing the first file of each folder



Press and hold  until you hear a beep. When the desired folder is reached, press  once again.

### ■ Returning to the first folder

Press and hold “v” on  until you hear a beep.

## Selecting and scanning files

### ■ Selecting one file at a time

Turn the  or press “^” or “v” on  to select the desired file.

### ■ Selecting the desired file by cueing the files in the folder

Press  .

When the desired file is reached, press  once again.

## Fast-forwarding and reversing files

To fast-forward or reverse, press and hold “^” or “v” on  .

## Repeat play

### ■ To repeat a file

Press  (RPT).

### ■ To repeat all of the files on a folder

Press and hold  (RPT) until you hear a beep.

## Random playback

### ■ To play files from a particular folder in random order

Press  (RAND).

### ■ To play all of the files on a disc in random order

Press and hold  (RAND) until you hear a beep.

## Switching the display

Press .

Each time  is pressed, the display changes in the order of “Folder no./File no./Elapsed time”→“Folder name”→“File name”→“Album title” (MP3 only)→“Track title”→“Artist name”.

## Silencing a sound (type A only)

→P. 286



■ **Display**

→P. 294

■ **Canceling random and repeat playback**

→P. 294

■ **Error messages**

“ERROR”: This indicates a trouble either in the CD or inside the player.  
The CD may be dirty, damaged or inserted up-side down.

“NO MUSIC”: This indicates that the MP3/WMA file is not included in the CD.

■ **Discs that can be used**

→P. 294

■ **CD player protection feature**

→P. 294

■ **If CDs are left inside the CD player or in the ejected position for extended periods**

→P. 294

■ **Lens cleaners**

→P. 294

## ■ MP3 and WMA files

MP3 (MPEG Audio LAYER3) is a standard audio compression format.

Files can be compressed to approximately 1/10 of their original size by using MP3 compression.

WMA (Windows Media <sup>TM</sup> Audio) is a Microsoft audio compression format.

This format compresses audio data to a size smaller than that of the MP3 format.

There is a limit to the MP3 and WMA file standards that can be used and to the media/formats on which the files are recorded.

### ● MP3 file compatibility

- Compatible standards  
MP3 (MPEG1 LAYER3, MPEG2 LSF LAYER3)
- Compatible sampling frequencies  
MPEG1 LAYER3: 32, 44.1, 48 (kHz)  
MPEG2 LSF LAYER3: 16, 22.05, 24 (kHz)
- Compatible bit rates (compatible with VBR)  
MPEG1 LAYER3: 64, 80, 96, 112, 128, 160, 192, 224, 256, 320 (kbps)  
MPEG2 LSF LAYER3: 64, 80, 96, 112, 128, 144, 160 (kbps)
- Compatible channel modes: stereo, joint stereo, dual channel and monaural

### ● WMA file compatibility

- Compatible standards  
WMA Ver. 7, 8, 9
- Compatible sampling frequencies  
32, 44.1, 48 (kHz)
- Compatible bit rates (only compatible with 2-channel playback)  
Ver. 7, 8: CBR 48, 64, 80, 96, 128, 160, 192 (kbps)  
Ver. 9: CBR 48, 64, 80, 96, 128, 160, 192, 256, 320 (kbps)

### ● Compatible media

Media that can be used for MP3 and WMA playback are CD-Rs and CD-RWs.

Playback in some instances may not be possible, depending on the status of the CD-R or CD-RW. Playback may not be possible or the audio may jump if the disc is scratched or marked with fingerprints.

### ● Compatible disc formats

The following disc formats can be used.

- Disc formats: CD-ROM Mode 1 and Mode 2  
CD-ROM XA Mode 2, Form 1 and Form 2
- File formats: ISO9660 Level 1, Level 2, (Romeo, Joliet)  
MP3 and WMA files written in any format other than those listed above may not play correctly, and their file names and folder names may not be displayed correctly.

Items related to standards and limitations are as follows.

- Maximum directory hierarchy: 8 levels
- Maximum length of folder names/file names: 32 characters
- Maximum number of folders: 192 (including the root)
- Maximum number of files per disc: 255

### ● File names

The only files that can be recognized as MP3/WMA and played are those with the extension .mp3 or .wma.

### ● Multi-sessions

As the audio system is compatible with multi-sessions, it is possible to play discs that contain MP3 and WMA files. However, only the first session can be played.

### ● ID3 and WMA tags

ID3 tags can be added to MP3 files, making it possible to record the track title, artist name, etc.

The system is compatible with ID3 Ver. 1.0, 1.1, and Ver. 2.2, 2.3 ID3 tags. (The number of characters is based on ID3 Ver. 1.0 and 1.1.)

WMA tags can be added to WMA files, making it possible to record the track title and artist name in the same way as with ID3 tags.

### ● MP3 and WMA playback

When a disc containing MP3 or WMA files is inserted, all files on the disc are first checked. Once the file check is finished, the first MP3 or WMA file is played. To make the file check finish more quickly, we recommend you do not write in any files other than MP3 or WMA files or create any unnecessary folders.

If the discs contain a mixture of music data and MP3 or WMA format data, only music data can be played.

### ● Extensions

If the file extensions .mp3 and .wma are used for files other than MP3 and WMA files, they will be mistakenly recognized and played as MP3 and WMA files. This may result in large amounts of interference and damage to the speakers.

### ● Playback

- To play MP3 file with steady sound quality, we recommend a fixed bit rate of at least 128 kbps and a sampling frequency of 44.1 kHz.
- CD-R or CD-RW playback may not be possible in some instances, depending on the characteristics of the disc.
- There is a wide variety of freeware and other encoding software for MP3 and WMA files on the market, and depending on the status of the encoding and the file format, poor sound quality or noise at the start of playback may result. In some cases, playback may not be possible at all.
- When files other than MP3 or WMA files are recorded on a disc, it may take more time to recognize the disc and in some cases, playback may not be possible at all.
- Microsoft, Windows, and Windows Media are the registered trademarks of Microsoft Corporation in the U.S. and other countries.



#### NOTICE

##### ■ CDs and adapters that cannot be used

→P. 295

##### ■ CD player precautions

→P. 296

## 3-2. Using the audio system

### Optimal use of the audio system

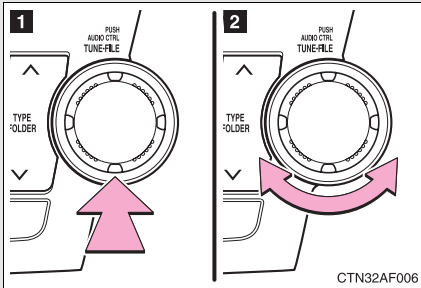

**1** Displays the current mode

**2** Changes the following setting

- Sound quality and volume balance (→P. 305)

The sound quality and balance setting can be changed to produce the best sound.

- Automatic Sound Levelizer on/off (→P. 306)

- Rear seat entertainment system lock on/off (→P. 306)

## Using the audio control function

### ■ Changing sound quality modes

Pressing  selects the mode to be changed in the following order.

“BAS”→“MID”<sup>\*1</sup>→“TRE”→“FAD”→“BAL”→“ASL”→“RSE”<sup>\*2</sup>

<sup>\*1</sup>: Type C only

<sup>\*2</sup>: Vehicles with rear seat entertainment system

### ■ Adjusting sound quality

Turning  adjusts the level.

Mode displayed	Sound quality mode	Level	Turn to the left	Turn to the right
BAS	Bass*	-5 to 5	Low	High
MID	Mid-range* (type C only)	-5 to 5		
TRE	Treble*	-5 to 5		
FAD	Front/rear volume balance	R7 to F7	Shifts to rear	Shifts to front
BAL	Left/right volume balance	L7 to R7	Shifts to left	Shifts to right

\*: The sound quality level is adjusted individually in each radio mode or CD mode.

## ■ Adjusting the Automatic Sound Levelizer (ASL)

### ▶ Type A and B

When “ASL” is selected, turning  to the right changes the amount of “ASL” in the order of “LOW”, “MID” and “HIGH”.

Turning  to the left turns “ASL” off.

ASL automatically adjusts the volume and tone quality according to vehicle speed.

### ▶ Type C

When “ASL” is selected, turning  to the right turns “ASL” on,

and turning  to the left turns “ASL” off.

“ASL” automatically adjusts the volume and tone quality according to the noise level as you drive your vehicle.

## ■ Setting the rear seat entertainment system lock (if equipped)



When “RSE” is selected, turn

 until “ON”/“OFF” is displayed.

The rear seat entertainment system lock remains on, even when the “ENGINE START STOP” switch or the engine switch is turned off.

## 3-2. Using the audio system Using the AUX adapter

This adapter can be used to connect a portable audio device and listen to it through the vehicle's speakers.

**STEP 1** Open the cover and connect the portable audio device.

### ► Vehicles without seat heater

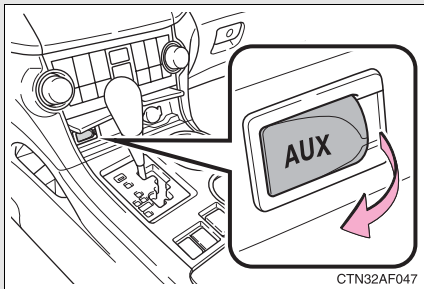

### ► Vehicles with seat heater

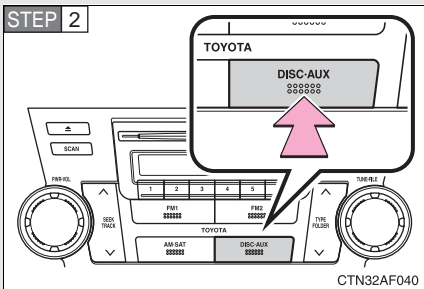
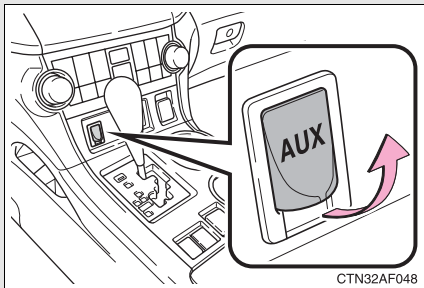

Press

DISC-AUX  
DISC-AUX



■ **Operating portable audio devices connected to the audio system**

The volume can be adjusted using the vehicle's audio controls. All other adjustments must be made on the portable audio device itself.

■ **When using a portable audio device connected to the power outlet**

Noise may occur during playback. Use the power source of the portable audio device.

## Using the steering wheel audio switches\*

Some audio features can be controlled using the switches on the steering wheel.

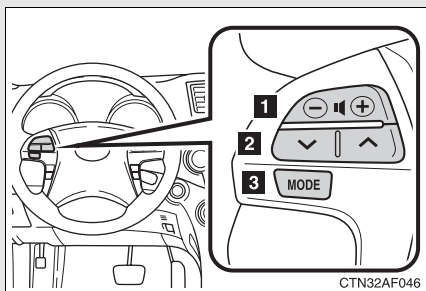

- 1 Volume
- 2 Radio: Selects radio stations  
CD: Selects tracks, files (MP3 and WMA) and discs
- 3 Turns the power on, selects audio source

### Turning on the power

Press **MODE** when the audio system is turned off.

The audio system can be turned off by holding **MODE** down until you hear a beep.

### Changing the audio source

Press **MODE** when the audio system is turned on. The audio source changes as follows each time **MODE** is pressed.

CD player without changer:

FM1→FM2→CD→AUX→AM

CD player with changer:

FM1→FM2→CD changer→AUX→AM→SAT1→SAT2→SAT3

## Adjusting the volume

Press “+” on  to increase the volume and “-” to decrease the volume.

Press and hold  to continue increasing or decreasing the volume.

## Selecting a radio station

**STEP 1** Press  to select radio mode.

**STEP 2** Press “^” or “v” on  to select a preset station.

To scan for receivable stations, press and hold  until you hear a beep.

## Selecting a track/file

**STEP 1** Press  to select CD mode.

**STEP 2** Press “^” or “v” on  to select the desired track/file.

## Selecting a folder (CD player without changer only)

**STEP 1** Press  to select CD mode.

**STEP 2** Press and hold “^” or “v” on  until you hear a beep.

## Selecting a disc in the CD player (CD player with changer only)

**STEP 1** Press  to select CD mode.

**STEP 2** Press and hold “^” or “v” on  until you hear a beep.

## CAUTION

### To reduce the risk of an accident

Exercise care when operating the audio switches on the steering wheel.

## Rear seat entertainment system features\*

The rear seat entertainment system is designed for the rear passengers to enjoy audio and DVD video separately from the front audio system.

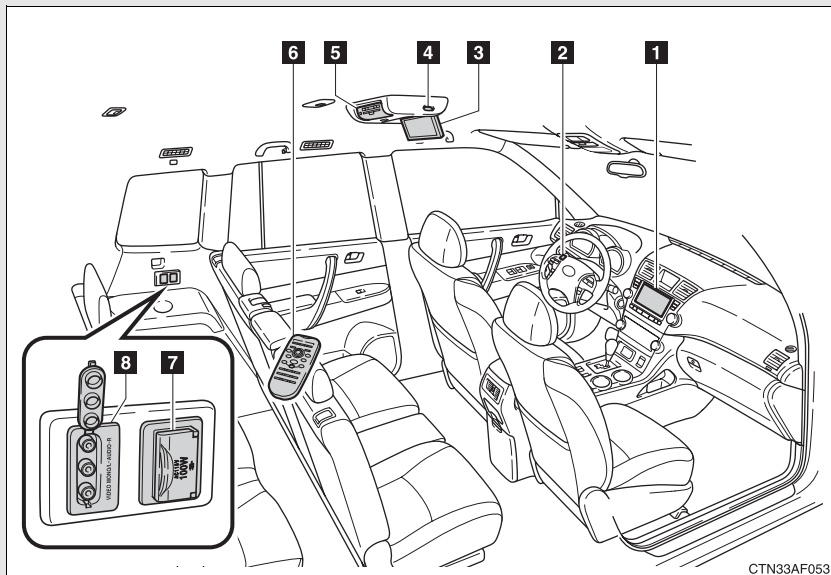

- 1** Front audio system
- 2** Power outlet main switch
- 3** Display
- 4** Headphone volume control dials and headphone jacks
- 5** DVD player
- 6** Rear seat entertainment system controller
- 7** Power outlet
- 8** A/V input adapter

\*: If equipped

## Opening and closing the display

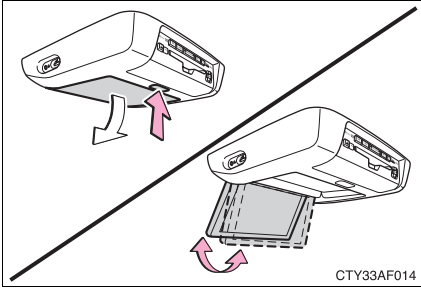

Press the lock release button to open the display.

Pull the display down to an easily viewable angle (between 90° and 125°).

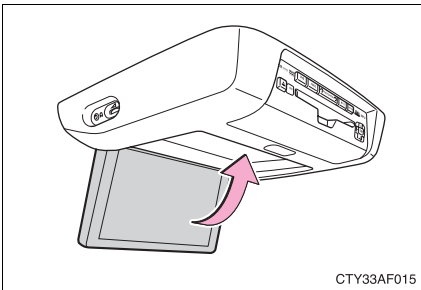

To close the display, push the display up until a click is heard.

The illumination of the screen is automatically turned off when the display is closed. However, the rear seat entertainment system is not turned off.

## Loading a disc

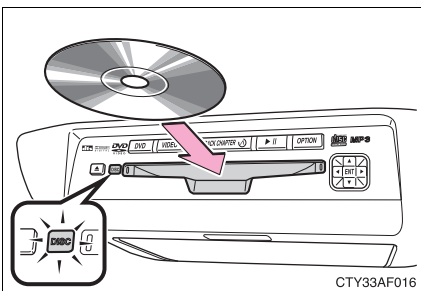



Insert the disc into the slot with the label side up.

The “DISC” indicator light turns on while the disc is loaded.

The player will play the track or chapter, and will repeat it after it reaches the end.

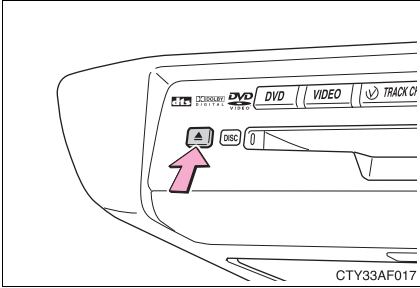
## Ejecting a disc



Press  and remove the disc.

## Headphone jacks

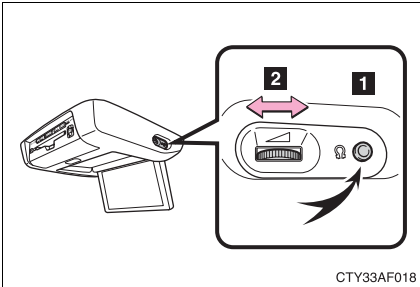

**1** To use the headphones, connect them to the jack.

**2** To adjust the volume

Right side dial: Turn it toward the front of the vehicle to increase the volume. Turn it toward the rear of the vehicle to decrease the volume.

Left side dial: Turn it toward the rear of the vehicle to increase the volume. Turn it toward the front of the vehicle to decrease the volume.

---

■ **The rear seat entertainment system can be used when**

- ▶ Vehicles without smart key system

The engine switch is in the “ACC” or “ON” position.

- ▶ Vehicles with smart key system

The “ENGINE START STOP” switch is in ACCESSORY or IGNITION ON mode.

■ **Discs that can be used**

Discs with the marks shown below can be used.

Playback may not be possible depending on recording format or disc features, or due to scratches, dirt or deterioration.



■ **When  appears on the screen**

It indicates that the selected switch cannot work.

■ **Rear system lock**

→P. 306

■ **Error messages**

“DISC CHECK”: Indicates that the disc is dirty, damaged or was inserted upside down. Clean the disc or insert it correctly.

“REGION ERROR”: Indicates that the DVD region code is not set properly.

“DVD ERROR”: Indicates that there is a problem inside the player. Eject the disc. Set the disc again.  
If the malfunction still exists, take the vehicle to your Toyota dealer.

### ■ Before using the remote controller (for new vehicle owners)

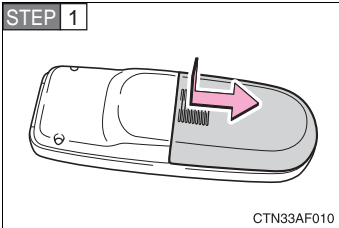

Remove the cover.

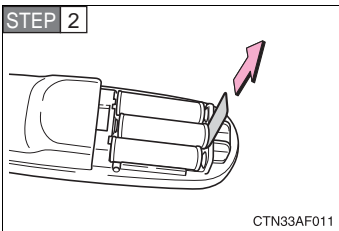

Remove the insulating sheet.

### ■ When the remote controller battery is fully depleted

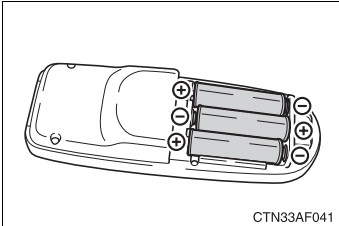

Remove the depleted batteries and install new 3 AA batteries.

### ■ If the remote controller batteries are discharged

The following symptoms may occur.

- The rear seat entertainment system control will not function properly.
- The operational range is reduced.

### ■ When using 3 AA batteries

Batteries can be purchased at your Toyota dealer, electric appliance shop, or camera stores.

Replace only with the same or equivalent type recommended by a Toyota dealer.

Dispose of used batteries according to the local laws.



### ■ Headphones

With some headphones generally available in the market, it may be difficult to catch signals properly. Toyota recommends the use of Toyota genuine wireless headphones.

Please contact your Toyota dealer for further details.

### ■ Volume

- Adjust the volume when you connect the headphones to the jack. Loud sounds may have a significant impact on the human body.
- Conversational speech on some DVDs is recorded at a low volume to emphasize the impact of sound effects. If you adjust the volume assuming that the conversations represent the maximum volume level that the DVD will play, you may be startled by louder sound effects or when you change to a different audio source. Be sure to adjust the volume with this in mind.

### CAUTION

#### ■ While driving

Do not use headphones.  
Doing so may cause an accident, resulting in death or serious injury.

#### ■ When the rear seat entertainment system is not used

Keep the display closed.  
In the event of an accident or sudden braking, the opened display may hit an occupant's body, resulting in injury.

#### ■ To prevent accidents and electric shock

Do not disassemble or modify the remote controller.

#### ■ When the remote controller is not used

Stow the remote controller.  
Injuries may result in the event of an accident or sudden braking.

#### ■ Removed battery and other parts

Keep away from children.  
These parts are small and if swallowed by a child they can cause choking.

 NOTICE**■ For normal operation after replacing the battery**

Observe the following precautions to prevent accidents.

- Always work with dry hands.  
Moisture may cause the battery to rust.
- Do not touch or move any other components inside the remote control.
- Do not bend either of the battery terminals.

### 3-3. Using the rear audio system

## Using the DVD player (DVD video)

### ■ Remote controller

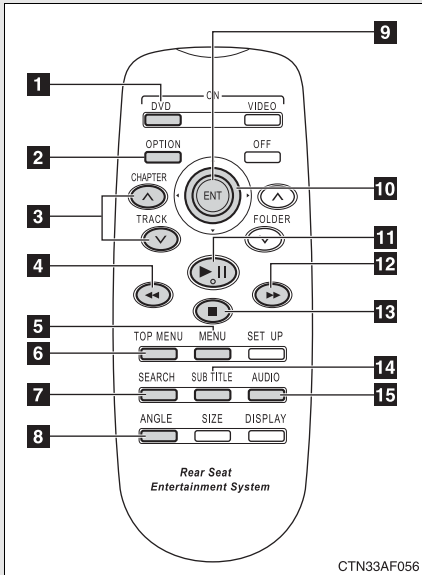

- 1** Turning on the DVD mode
- 2** Turning on or off the operation switches (icon) on the display
- 3** Selecting a chapter
- 4** Reversing a disc
- 5** Turning on the menu screen
- 6** Turning on the title selection screen
- 7** Searching the title
- 8** Changing the screen angle
- 9** Inputting the selected switch (icon)
- 10** Selecting a switch (icon)
- 11** Playing/pausing a disc
- 12** Fast forwarding a disc
- 13** Stopping a disc
- 14** Changing the subtitle language
- 15** Changing the audio language

## ■ Unit

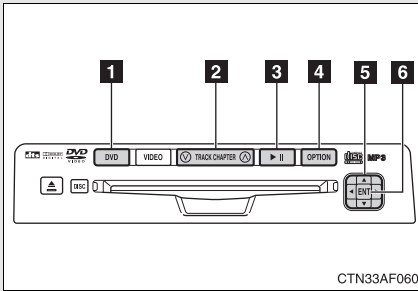

CTN33AF060

- 1 Turning on the DVD mode
- 2 Skipping to the desired chapter
- 3 Playing/pausing a disc
- 4 Turning on or off the operation switches (icon) on the display
- 5 Selecting a switch (icon)
- 6 Inputting the selected switch (icon)

## ■ Display (page 1)

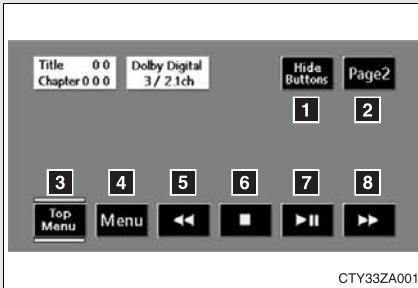

CTY33ZA001

- 1 Turning off the operation switches (icon) on the display
- 2 Displaying page 2
- 3 Turning on or off the title selection screen for the disc
- 4 Turning on or off the menu screen for the disc
- 5 Reversing a disc
- 6 Stopping a disc
- 7 Pausing the disc/canceling the pause
- 8 Fast forwarding a disc

### ■ Display (page 2)

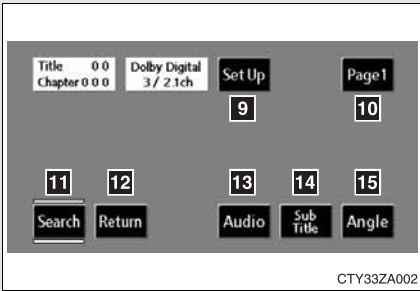

- 9 Displaying the initial setting screen
- 10 Displaying page 1
- 11 Search for a title
- 12 Returning to the previous screen
- 13 Changing the audio language
- 14 Changing the subtitle language
- 15 Changing the angle

### ■ Operating from the front audio system

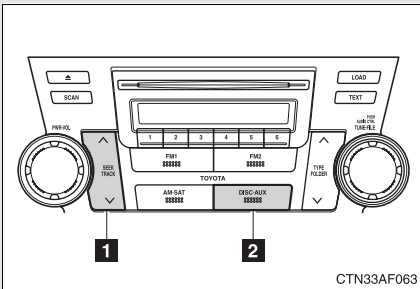

- 1 Selecting a chapter

This operation is available only when the DVD player system is selected for the speakers.

- 2 Selecting either the front audio system or DVD player audio for the speakers

 NOTICE

### ■ Cleaning the display

Wipe the display with a dry soft cloth.

If the screen is wiped with a rough cloth, the surface of the screen may be scratched.



### ■ To prevent damage to the remote controller



- Keep the remote control away from direct sunlight, temperature heat and high humidity.
- Do not drop or knock the remote controller against hard objects.
- Do not sit on or place heavy objects on the remote controller.

### ■ DVD player



Never try to disassemble or oil any part of the DVD player. Do not insert anything other than a disc into the slot.

## Turning on or off the operation switches



Press  or  to turn on the operation switches.

Press  or  once again or select  to turn off the operation switches.

## Turning on the title selection screen

Press  or select  to turn on the title selection screen. For the operation of the title selection screen, see the separate manual for the DVD disc.

## Turning on the menu screen

Press  or select  to turn on the menu screen. For the operation of the menu screen, see the separate manual for the DVD disc.

### Returning to the previous screen

Select **Return** to return to the previous screen. For the operation of the menu screen, see the separate manual for the DVD disc.

### Searching for a title

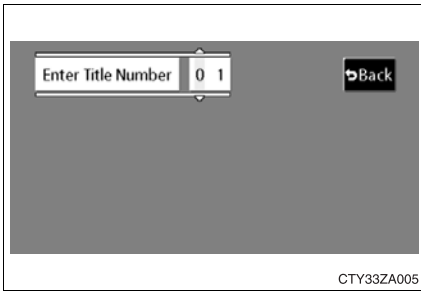

Press **SEARCH** or select **Search** to display the screen to search for a title.

Select the title number, and press



or to input it.

Select **Back** to return to the previous screen.

### Changing the subtitle language

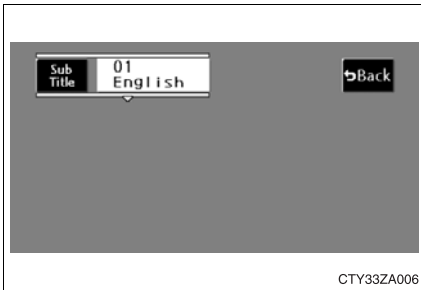

Press **SUB TITLE** or select **Sub Title** to display the subtitle language screen.

Each time **SUB TITLE** is pressed or

**Sub Title** is selected, another language stored on the disc is selected.

Select **Back** to return to the previous screen.

## Changing the audio language

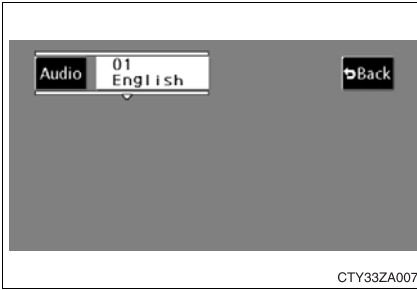



Press  or select **Audio** to display the audio language screen.

Each time  is pressed or **Audio** is selected, another language stored on the disc is selected.

Select **Back** to return to the previous screen.

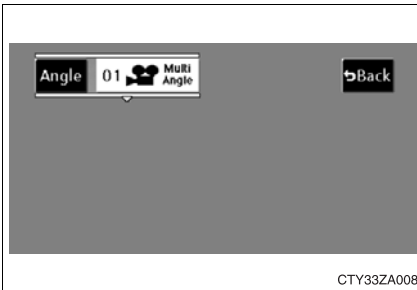
## Changing the angle



Press  or select **Angle** to display the screen to change the angle.

Each time  is pressed or **Angle** is selected, the angle changes.

Select **Back** to return to the previous screen.









■ **DVD player and DVD video discs**

This DVD player is compatible NTSC color TV formats. DVD video discs conforming to other formats such as PAL or SECAM cannot be used.

■ **Region codes**

Some DVD video discs have a region code indicating where you can use them. If the DVD video disc is not labeled “ALL” or “1”, you cannot use it in this DVD player. If you attempt to play an inappropriate DVD video disc in this player, “REGION CODE ERROR” appears on the screen. Even if the DVD video disc does not have a region code, in some cases you cannot use it.

■ **Marks shown on DVD video discs**

	Indicates NTSC format of color TV.
	Indicates the number of audio tracks.
	Indicates the number of language subtitles.
	Indicates the number of angles.
	Indicates the screen to be selected. Wide screen: 16:9 Standard: 4:3
	Indicates regions in which this video disc can be played. ALL: all countries Number: region code

## ■ DVD video disc glossary

- **DVD video discs:** Digital Versatile Discs that hold world's standard video. DVD video discs have adopted "MPEG2", one of the world standards of digital compression technologies. The picture data is compressed by 1/40 on average and stored. Variable rate encoded technology has been adopted in which the volume of data assigned to the picture is changed depending on the picture format. Audio data is stored using PCM and Dolby digital, which enables higher sound. Furthermore, multi-angle and multi-language features will also help you enjoy the more advanced technology of DVD video.
- **Viewer restrictions:** This feature limits what can be viewed in conformity with the level of restrictions of the country. The level of restrictions varies depending on the DVD video disc. Some DVD video discs cannot be played at all, or violent scenes are skipped or replaced with other scenes.
  - Level 1: DVD video discs for children can be played.
  - Level 2 - 7: DVD video discs for children and G-rated movies can be played.
  - Level 8: All types of DVD video discs can be played.
- **Multi-angle feature:** Allows you to enjoy the same scene at different angles.
- **Multi-language feature:** Allows you to select the language of the subtitles and audio.
- **Region codes:** Region codes are provided on DVD players and DVD discs. If the DVD video disc does not have the same region code as the DVD player, you cannot play the disc on the DVD player.
- **Audio:** This DVD player can play linear PCM, Dolby digital, dts and MPEG audio format DVD. Other decoded type cannot be played.
- **Title and chapter:** Video and audio programs stored on DVD video discs are divided into sections by title and chapter.
- **Title:** The largest unit of the video and audio programs stored on DVD video discs. Usually, one piece of a movie, one album, or one audio program is assigned as a title.
- **Chapter:** A unit smaller than a title. A title comprises multiple chapters.

■ **Audio**

Manufactured under license from Dolby Laboratories. “Dolby”, “Pro Logic”, and  are trademarks of Dolby<sup>®</sup> Laboratories. Confidential unpublished works.

1992-1997 Dolby<sup>®</sup> Laboratories. All rights reserved.

“dts” is a trademark of Digital Theater Systems, Inc.

### 3-3. Using the rear audio system Using the DVD player (video CD)

#### ■ Remote controller

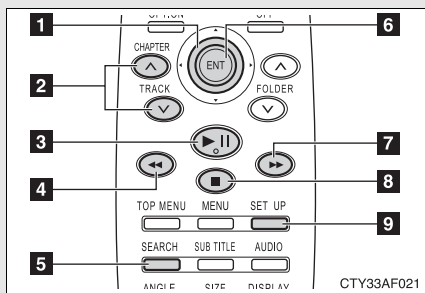

- 1 Selecting a switch (icon)
- 2 Selecting a chapter
- 3 Playing/pausing a disc
- 4 Reversing a disc
- 5 Displaying operation switches (icon)
- 6 Inputting the selected switch (icon)
- 7 Fast forwarding a disc
- 8 Stopping a disc
- 9 Changing the initial setting

#### ■ Unit

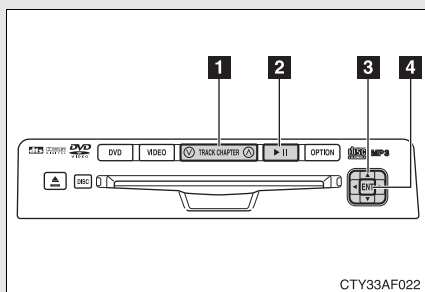

- 1 Skipping to the desired chapter
- 2 Playing/pausing a disc
- 3 Selecting a switch (icon)
- 4 Inputting the selected switch (icon)

### ■ Display (page 1)

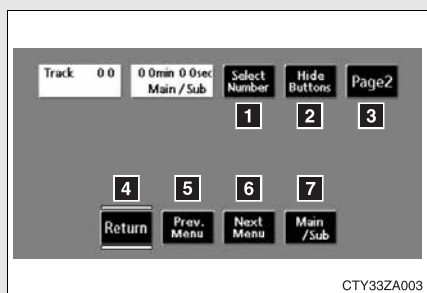

- 1 Selecting a disc menu number
- 2 Turning off the menu screen
- 3 Displaying page 2
- 4 Turning on the disc menu
- 5 Returning to the previous page screen (with the disc menu displayed)
- 6 Proceeding to the next page screen (with the disc menu displayed)
- 7 Changing to a multiplex transmission

### ■ Display (page 2)

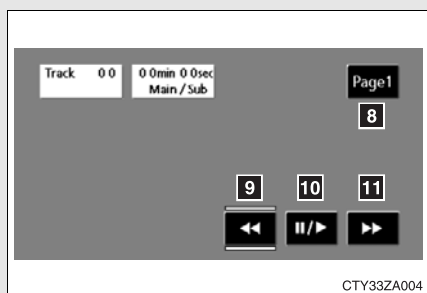

- 8 Displaying page 1
- 9 Reversing a disc
- 10 Pausing the disc/canceling the pause
- 11 Fast forwarding a disc

## ■ Operating from the front audio system

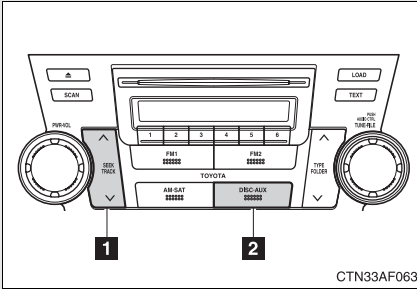



### 1 Selecting a chapter

This operation is available only when the DVD player system is selected for the speakers.

### 2 Selecting either the front audio system or DVD player audio for the speakers

## Selecting a disc menu number

Select **Select Number** to display the disc menu number search screen.



Select the disc menu number, and press  or  to input it.

Select **Back** to return to the previous screen.

### 3-3. Using the rear audio system

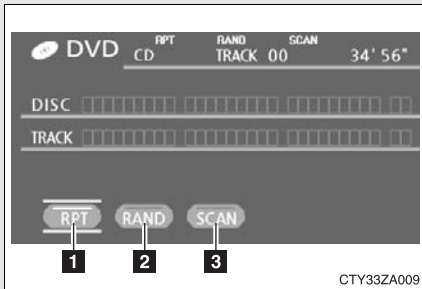
## Using the DVD player (audio CD/CD text)



Using the control screen, press  or  to display the control screen.

- 1 Repeat play  
Random playback
- 3 Search playback

### ■ Operating from the front audio system

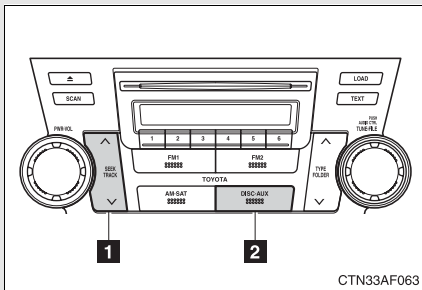

- 1 Selecting a track

This operation is available only when the DVD player system is selected for the speakers.

- 2 Selecting either the front audio system or DVD player audio for the speakers



### ■ Canceling random, repeat and scan play

Select  ,  or  again.

### 3-3. Using the rear audio system Using the DVD player (MP3 discs)

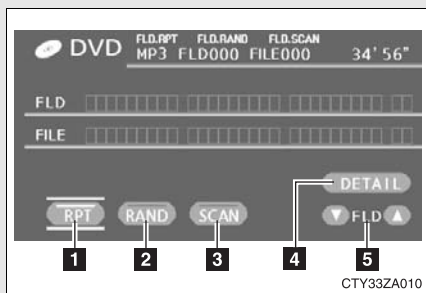
#### ■ Using the control screen



Press  or  to display the control screen.

- 1 Repeat play
- 2 Random playback
- 3 Search playback
- 4 Displaying file information
- 5 Selecting a folder

#### ■ Operating from the front audio system

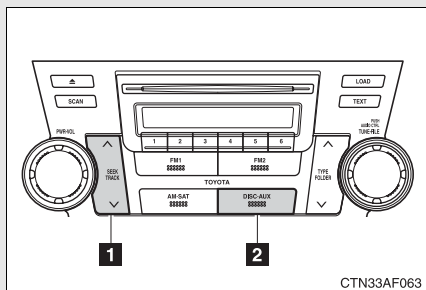

- 1 Selecting a file

This operation is available only when the DVD player system is selected for the speakers.

- 2 Selecting either the front audio system or DVD player audio for the speakers





## Repeat play

### ■ Repeat a file

Select **RPT** .

### ■ Repeat all of files in a folder



Select **RPT** , and press and hold  or .

## Random playback

### ■ Playing files from a particular folder in random order

Select **RAND** .

### ■ Playing all of the files on a disc in random order

Select **RAND** , and press and hold  or .



## Search playback

### ■ Selecting the desired file by cueing the files in the folder

Select **SCAN** .

The player will scan all the files in the folder. Each file will be played for 10 seconds.

### ■ Selecting the desired file by cueing the folders on the disc

Select **SCAN** , and press and hold  or .

The player will scan all the folders on the disc. The first file in each folder will be played for 10 seconds.



---

### ■ Canceling random, repeat and play back

Select **RPT** , **RAND** or **SCAN** again.

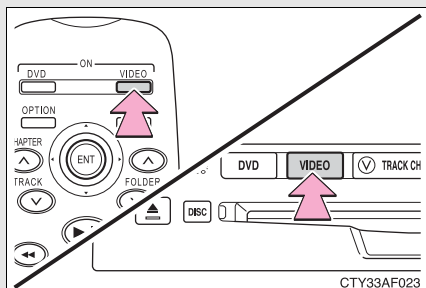
### 3-3. Using the rear audio system Using the video mode



Press  or  to select the video mode.

Before switching to the video mode, connect the audio source to the A/V input adapter.

#### Using the adapter

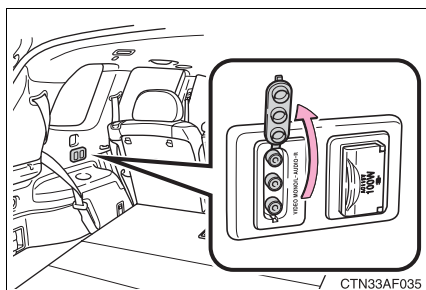

Open the cover.

The A/V input adapter is composed of 3 input adapters.

Yellow: Image input adapter

White: Left channel audio input adapter

Red: Right channel audio input adapter

#### ■ A/V input adapter

The rear seat entertainment system plays videos and sound when audio-video equipment is connected to the A/V input adapter. For details, refer to the manufacturer's instructions.

#### ■ Power outlet

The power outlet is used to connect the audio device. (→P. 392)

 NOTICE

■ **When the A/V input adapter is not in use**

Keep the A/V input adapter cover closed.

Inserting anything other than an appropriate plug may cause electrical failure or short circuit.

### 3-3. Using the rear audio system

## Changing the initial setting

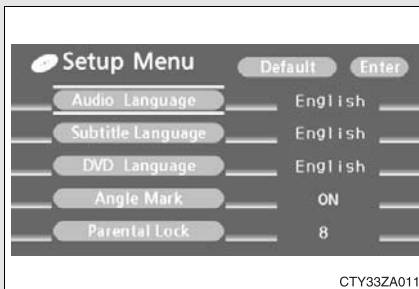

Press  or select **Set Up** to display the initial setting screen.



The following initialization can be changed here.

- “Audio Language”
- “Subtitle Language”
- “DVD Language”
- “Angle Mark”
- “Parental Lock”

### Changing the audio language





Select “Audio Language”.

Select the language you want to hear, and press  or  to input it.



Select “Others” if you cannot find the language you want to hear. Enter the appropriate 4-digit language code. (→P. 339)



Select a number, and press  or  to input it.

If a code that is not in the list is entered, “Incorrect Code” will appear on the screen.

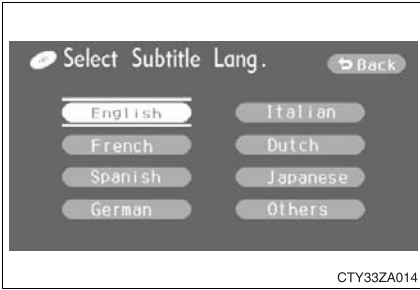
## Changing the subtitle language



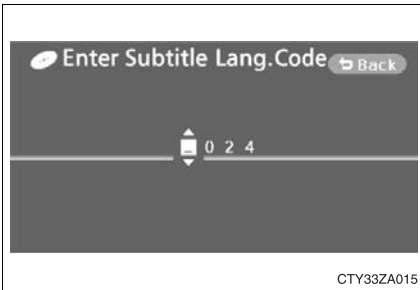

Select "Subtitle Language".

Select the language you want to read, and press  or  to input it.



Select "Others" if you cannot find the language you want to read. Enter the appropriate 4-digit language code. (→P. 339)



Select a number, and press  or  to input it.

If a code that is not in the list is entered, "Incorrect Code" will appear on the screen.

## Changing the DVD language



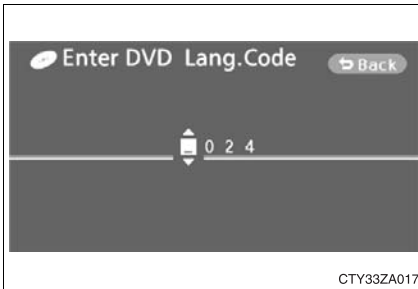

Select “DVD Language”.

Select the language you want to read, and press  or  to input it.



Select “Others” if you cannot find the language you want to read. Enter the appropriate 4-digit language code. (→P. 339)

Select a number, and press  or  to input it.

If a code that is not in the list is entered, “Incorrect Code” will appear on the screen.

## Turning on or off the angle mark

The angle mark can be turned on for discs that are multi-angle compatible.

Each time you press  or  when “Angle Mark” is selected, the angle mark turns on or off alternately.

## Setting viewer restriction levels

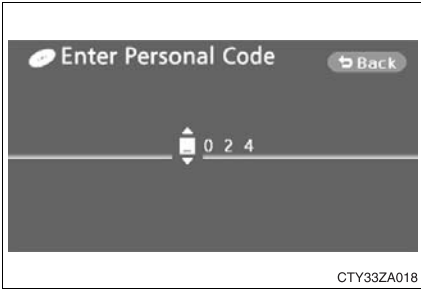

Setting a password allows the viewer restriction to be effective.

Select "Parental Lock".

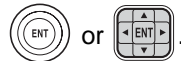

Enter the password and press



The setting cannot be changed unless the password is entered.

When you forget the password, initialize the password. (→P. 339)

Select a restriction level (1-8),

and press  or . The smaller the level number, the stricter the age limit.

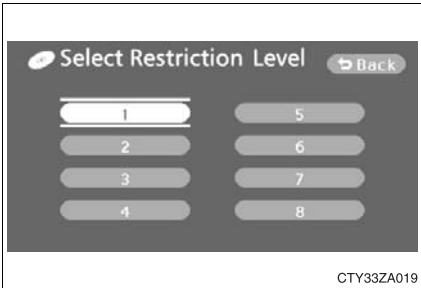

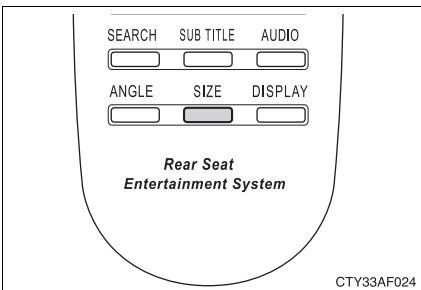

## Setting the display mode



Pressing  changes the display modes sequentially as follows:

Normal → Wide 1 → Wide 2

### ■ Returning to the previous screen

Select , and press  or .

### ■ To initialize the password

Press  on the remote controller or unit ten times when the screen to enter the personal code is displayed.

### ■ Language code list

Code	Language
0514	English
0618	French
0405	German
0920	Italian
0519	Spanish
2608	Chinese
1412	Dutch
1620	Portuguese
1922	Swedish
1821	Russian
1115	Korean
0512	Greek
0101	Afar
0102	Abkhazian
0106	Afrikaans
0113	Amharic
0118	Arabic
0119	Assamese
0125	Aymara
0126	Azerbaijani
0201	Bashkir
0205	Byelorussian
0207	Bulgarian

Code	Language
0208	Bihari
0209	Bislama
0214	Bengali
0215	Tibetan
0218	Breton
0301	Catalan
0315	Corsican
0319	Czech
0325	Welsh
0401	Danish
0426	Bhutani
0515	Esperanto
0520	Estonian
0521	Basque
0601	Persian
0609	Finnish
0610	Fiji
0615	Faroese
0625	Frisian
0701	Irish
0704	Scots-Gaelic
0712	Galician
0714	Guarani



### 3-3. Using the rear audio system

Code	Language
0721	Gujarati
0801	Hausa
0809	Hindi
0818	Croatian
1821	Hungarian
1825	Armenian
0901	Interlingua
0905	Interlingue
0911	Inupiak
0914	Indonesian
0919	Icelandic
0923	Hebrew
1001	Japanese
1009	Yiddish
1023	Javanese
1101	Georgian
1111	Kazakh
1112	Greenlandic
1113	Cambodian
1114	Kannada
1119	Kashmiri
1121	Kurdish
1125	Kirghiz
1201	Latin
1214	Lingala
1215	Laothian
1220	Lithuanian
1222	Latvian
1307	Malagasy
1309	Maori

Code	Language
1311	Macedonian
1312	Malayalam
1314	Mongolian
1315	Moldavian
1318	Marathi
1319	Malay
1320	Maltese
1325	Burmese
1401	Nauru
1405	Nepali
1415	Norwegian
1503	Occitan
1513	(Afan) Oromo
1518	Oriya
1601	Punjabi
1612	Polish
1619	Pashto, Pushto
1721	Quechua
1813	Rhaeto-Romance
1814	Kirundi
1815	Romanian
1823	Kinyarwanda
1901	Sanskrit
1904	Sindhi
1907	Sangho
1908	Serbo-Croatian
1909	Sinhalese
1911	Slovak
1912	Slovenian
1913	Samoan

Code	Language
1914	Shona
1915	Somali
1917	Albanian
1918	Serbian
1919	Siswati
1920	Sesotho
1921	Sundanese
1923	Swahili
2001	Tamil
2005	Telugu
2007	Tajik
2008	Thai
2009	Tigrinya
2011	Turkmen
2012	Tagalog

Code	Language
2014	Setswana
2015	Tonga
2018	Turkish
2019	Tsonga
2020	Tatar
2023	Twi
2111	Ukrainian
2118	Urdu
2126	Uzbek
2209	Vietnamese
2215	Volapük
2315	Wolof
2408	Xhosa
2515	Yoruba
2621	Zulu

■ Adjusting the screen

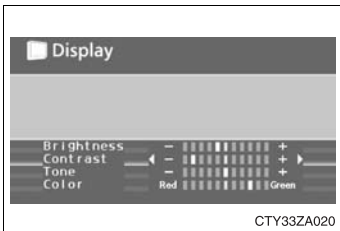

Press  .

Select the “Brightness”, “Contrast”, “Tone” or “Color”, and make adjustments.

Press  or  or  to input it.

	“-” or “Red”	+” or “Green”
“Brightness”	Darkens	Brightens
“Contrast”	Weakens the contrast	Strengthens the contrast
“Tone” (if displayed)	Weakens the tone	Strengthens the tone
“Color” (if displayed)	Strengthens the red color	Strengthens the green color

## 3-4. Using the hands-free phone system (for cellular phone) Hands-free phone system (for cellular phone) features\*

### ▶ Vehicles with navigation system

**Owners of models equipped with a navigation system should refer to the “Navigation System Owner's Manual”.**

### ▶ Vehicles without navigation system

**This system supports Bluetooth®, which allows you to make or receive calls without using cables to connect a cellular phone and the system, and without operating the cellular phone.**

Title	Page
Using the hands-free phone system (for cellular phone)	P. 346
Making a phone call	P. 353
Setting a cellular phone	P. 357
Security and system setup	P. 362
Using the phone book	P. 365

### ■ When using the hands-free system

- The audio system and voice guidance are muted when making a call.
- If both parties speak at the same time it may be difficult to hear.
- If the received call volume is overly loud, an echo may be heard.
- Try to face toward the microphone as much as possible when speaking.
- In the following circumstances it may be difficult to hear the other party:
  - When driving on unpaved roads
  - When driving at high speeds
  - If the window is open
  - If the air conditioning is blowing directly on the microphone
  - If the air conditioning is set to high

\*: If equipped

■ **Conditions under which the system will not operate**

- If using a mobile phone that does not support Bluetooth®
- If the mobile phone is switched off
- If you are outside service range
- If the mobile phone is not connected
- If the mobile phone's battery is low

■ **Bluetooth® antenna**

The antenna is built into the display. If the mobile phone is behind the seat or in the console box, or touching or covered by metal objects, connection status may deteriorate.

■ **Signal status**

This display may not correspond exactly with the mobile phone itself.

■ **About Bluetooth®**

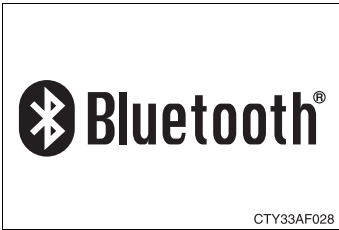

Bluetooth is a registered trademark of Bluetooth SIG, Inc.

■ **Compatible models**

Compatible with HFP (Hands Free Profile) Ver. 1.0 and OPP (Object Push Profile) Ver. 1.1.

If your cellular phone does not support HFP, you cannot enter the Bluetooth® phone. If your cellular phone supports OPP alone, you cannot use the Bluetooth® phone.

■ **Certification for the hands-free phone system**

FCC ID: HYQBTAU01A

IC ID: 1551A-BTAU01A

MADE IN JAPAN

This device complies with Part 15 of the FCC Rules and RSS-210. Operation is subject to the following two conditions: (1) This device may not cause harmful interference, and (2) This device must accept any interference received, including interference that may cause undesired operation.

**NOTICE:**

This equipment has been tested and found to comply with the limits for a Class B digital device, pursuant to Part 15 of the FCC Rules. These limits are designed to provide reasonable protection against harmful interference in a residential installation. This equipment generates, uses and can radiate radio frequency energy and, if not installed and used in accordance with the instructions, may cause harmful interference to radio communications. However, there is no guarantee that interference will not occur in a particular installation. If this equipment does cause harmful interference to radio or television reception, which can be determined by turning the equipment off and on, the user is encouraged to try to correct the interference by one or more of the following measures:

- Reorient or relocate the receiving antenna.
- Increase the separation between the equipment and receiver.
- Connect the equipment into an outlet on a circuit different from that to which the receiver is connected.
- Consult the dealer or an experienced radio/TV technician for help.

**FCC WARNING:**

Changes or modifications not expressly approved by the party responsible for compliance could void the user's authority to operate the equipment.

**CAUTION:**

**Radio Frequency Radiation Exposure**

This equipment complies with FCC radiation exposure limits set forth, for uncontrolled equipment and meets the FCC radio frequency (RF) Exposure Guidelines in Supplement C to OET65. This equipment has very low levels of RF energy that it deemed to comply without maximum permissive exposure evaluation (MPE). But it is desirable that it should be installed and operated with at least 7.9 in (20 cm) and more between the radiator and person's body (excluding extremities: hands, wrists, feet and legs).

**Co-location:**

This transmitter must not be co-located or operated in conjunction with any other antenna or transmitter.

 **CAUTION**

■ **Caution while driving**

Do not use a cellular phone or connect the Bluetooth® phone.

 **NOTICE**

■ **When leaving the vehicle**

Do not leave a cellular phone in the vehicle. The inside of the vehicle may become hot, causing damage to the phone.

## 3-4. Using the hands-free phone system (for cellular phone) Using the hands-free phone system\*

### ■ Audio unit

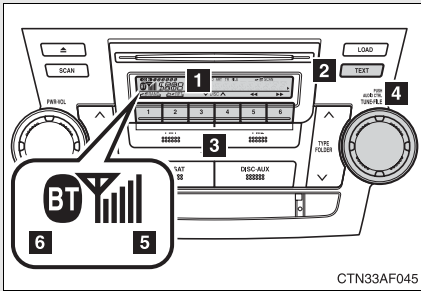

**1** Displays such items as messages, names, and phone numbers

Lower-case characters and special characters, such as an umlaut, cannot be displayed.

**2** Push and hold: Displays information that is too long to be displayed at one time on the screen

**3** Selects speed dials

**4** Selects items such as menu or numbers

Turn: Selects an item

Press: Inputs the selected item

**5** Displays the reception level

**6** Displays Bluetooth® connection condition

If “BT” is not displayed, the hands-free phone system cannot be used.

\*: If equipped

### ■ Steering wheel telephone switches

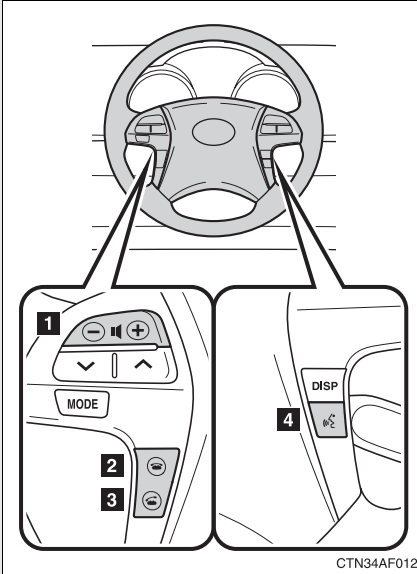

#### 1 Volume

The voice guidance volume cannot be adjusted by using this switch.

#### 2 Hands-free phone system off/ends a call/refuses a call

#### 3 Hands-free phone system on/starts a call

#### 4 Press: Voice command system on

Press and hold: Voice command system off

### ■ Microphone

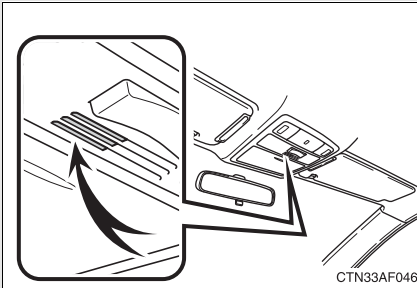



## Operating the system by using a voice command

By following voice guidance instructions output from the speaker, voice commands can be given to allow for operation of the hands-free phone system without checking the display or operating .

### ■ Operation procedure when using a voice command

Press  and say a command for a desired function.  
(→P. 350)

### ■ Auxiliary commands when using a voice command

The following auxiliary commands can be used when operating the system using a voice command:

Cancel: Exits the hands-free phone system

Repeat: Repeats the previous voice guidance instruction

Go back: Returns to the previous procedure

Help: Reads aloud the function summary if a help comment is registered for the selected function



## Using the hands-free phone system for the first time

Before using the hands-free phone system, it is necessary to register a cellular phone in the system. The phone registration mode will be entered automatically when starting the system with no cellular phone registered. Follow the procedure below to register a cellular phone:

**STEP 1** Press  or .

The introductory guidance and phone name registration instructions are heard.

**STEP 2** Register a phone name by either of the following methods.

- a. Select "Record Name" by using , and say a name to be registered.
- b. Press  and say a name to be registered.

Voice guidance instruction to confirm the input is heard.

**STEP 3** Select "Confirm" by using a voice command or .

A passkey is displayed and heard, and voice guidance instruction for inputting the passkey into the cellular phone is heard.

**STEP 4** Input the passkey into the cellular phone.

Refer to the manual that comes with the cellular phone for the operation of the phone.

Guidance for registration completion is heard.

<b>Menu list of the hands-free phone system</b>
---

■ Normal operation

First menu	Second menu	Third menu	Operation detail
Callback	-	-	Dialing a number stored in the incoming history memory
Redial	-	-	Dialing a number stored in the outgoing history memory
Dial by number	-	-	Dialing by inputting a number
Dial by name	-	-	Dialing by inputting a name registered in the phone book
Phonebook	Add Entry	-	Adding a new number
	Change Name	-	Changing a name in the phone book
	Delete Entry	-	Deleting the phone book data
	Delete Speed Dial (Del Spd Dial)	-	Deleting a registered speed dial
	List Names	-	Listing the phone book data
	Set Speed Dial (Speed Dial)	-	Registering a speed dial

First menu	Second menu	Third menu	Operation detail
Setup	Security	Set PIN	Setting a PIN code
		Phonebook Lock	Locking the phone book
		Phonebook Unlock	Unlocking the phone book
	Phone Setup	Pair Phone	Registering a cellular phone to be used
		Change Name	Changing a registered name of a cellular phone
		Delete	Deleting a registered cellular phone
		List Phones	Listing the registered cellular phones
		Select Phone	Selecting a cellular phone to be used
	System Setup	Set Passkey	Changing the passkey
		Guidance Volume (Guidance Vol)	Setting voice guidance volume
Initialize		Initialization	

### ■ Using a short cut key

First menu	Second menu	Operation detail
Dial "XXX (name)"	-	Dialing a number registered in the phone book
Phone book add entry	-	Adding a new number
Phone book change name	-	Changing a name of a phone number in the phone book

First menu	Second menu	Operation detail
Phone book delete entry	-	Deleting phone book data
Phone book set speed dial	-	Registering speed dial
Phone book delete speed dial	-	Deleting speed dial
Phonebook	Phonebook Unlock	Unlocking the phone book
	Phonebook Lock	Locking the phone book

**■ Automatic adjustment of volume**

When vehicle speed is 50 mph (80 km/h) or more, the volume automatically increases. The volume returns to the previous volume setting when vehicle speed drops to 43 mph (70 km/h) or less.

**■ When using a voice command**

- For numbers, say a combination of single digits from zero to nine, # (pound), \* (star), and + (plus).
- Say a command correctly and clearly.

**■ The system may not recognize your voice in the following situations:**

- When driving on a rough road
- When driving at high speeds
- When air is blowing out of the vents onto the microphone
- When the air conditioning fan emits a loud noise

**■ The following cannot be performed while driving:**

- Operating the system with 
- Registering a cellular phone to the system

**■ Changing the passkey**

→P. 360

## Making a phone call

### ■ Making a phone call

- Dialing by inputting a number  
“Dial by number”
- Dialing by inputting a name  
“Dial by name”
- Speed dialing
- Dialing a number stored in the outgoing history memory  
“Redial”
- Dialing a number stored in the incoming history memory  
“Call back”

### ■ Receiving a phone call

- Answering the phone
- Refusing the call

### ■ Transferring a call

### ■ Using a call history memory



- Dialing
- Storing data in the phone book
- Deleting

### Dialing by inputting a number

**STEP 1** Press  and say “Dial by number”.

**STEP 2** Press  and say the phone number.



**STEP 3** Dial by one of the following methods:

- a. Press  .
- b. Press  and say “Dial”.
- c. Select “Dial” by using  .



### Dialing by inputting a name

**STEP 1** Press  and say “Dial by name”.

**STEP 2** Select a registered name to be input by either of the following methods:

- a. Press  and say a registered name.
- b. Press  and say “List names”. Press  while the desired name is being read aloud.

**STEP 3** Dial by one of the following methods:

- a. Press  .
- b. Press  and say “Dial”.
- c. Select “Dial” by using  .

### Speed dialing

**STEP 1** Press  .

**STEP 2** Press the preset button in which the desired number is registered.

**STEP 3** Press  .

### When receiving a phone call

#### ■ Answering the phone

Press  .

#### ■ Refusing the call

Press  .

### Transferring a call

A call can be transferred between the cellular phone and system while dialing, receiving a call, or during a call. Use one of the following methods:

- a. Operate the cellular phone.

Refer to the manual that comes with the cellular phone for the operation of the phone.

- b. Press  \*1.

- c. Press  and say “Call Transfer” \*2.

\*1: This operation can be performed only when transferring a call from the cellular phone to the system during a call.

\*2: While the vehicle is in motion, a call cannot be transferred from the system to the cellular phone.

### Using a call history memory

Follow the procedure below to use a number stored in call history memory:

**STEP 1** Press  and say “Redial” (when using a number stored in the outgoing history memory) or “Call back” (when using a number stored in the incoming history memory).



**STEP 2** Select the number by either of the following methods:

a. Say “Previous” or “Go back” until the desired number is displayed.

b. Select the desired number by using  .

The following operations can be performed:

Dialing: Press  or select “Dial” by using a voice command or

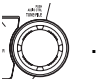

Storing the number in the phone book: Select “Store” by using a

voice command or  .

Deleting: Select “Delete” by using a voice command or  .

---

■ **Call history**

Up to 5 numbers can be stored in each of the outgoing and incoming history memories.

■ **When talking on the phone**

- Do not talk simultaneously with the other party.
- Keep the volume of the receiving voice down. Otherwise, voice echo will increase.

## 3-4. Using the hands-free phone system (for cellular phone) Setting a cellular phone

**Registering a cellular phone in the hands-free phone system allows the system to function. The following function can be used for registered cellular phones:**

### ■ Functions and operation procedures

To enter menu for each function, follow the steps below by using a

voice command or  :

- Registering a cellular phone
  1. "Setup" → 2. "Phone Setup" → 3. "Pair Phone"
- Selecting a cellular phone to be used
  1. "Setup" → 2. "Phone Setup" → 3. "Select Phone"
- Changing a registered name
  1. "Setup" → 2. "Phone Setup" → 3. "Change Name"
- Listing the registered cellular phones
  1. "Setup" → 2. "Phone Setup" → 3. "List Phones"
- Deleting a cellular phone
  1. "Setup" → 2. "Phone Setup" → 3. "Delete"
- Changing the passkey
  1. "Setup" → 2. "Phone Setup" → 3. "Set Passkey"

### Registering a cellular phone

Select "Pair Phone" by using a voice command or  , and do the procedure for registering a cellular phone. (→P. 349)



## Selecting a cellular phone to be used

**STEP 1** Select “Select Phone” by using a voice command or  .

### ► Pattern A

**STEP 2** Select a cellular phone to be used by either of the following methods, and select “Confirm” by using a voice command or



- Press  and say the desired phone name.
- Press  and say “List phones”. While the name of the desired cellular phone is being read aloud, press  .





### ► Pattern B



**STEP 2** Select a cellular phone to be used by using  .

## Changing a registered name

**STEP 1** Select “Change Name” by using a voice command or  .

**STEP 2** Select a name of cellular phone to be changed by either of the following methods:

- Press  and say the desired phone name, and select “Confirm” by using a voice command or  .
- Press  and say “List phones”. While the desired phone name is being read aloud, press  .
- Select the desired phone name by using  .

**STEP 3** Press  or select “Record Name” by using , and say a new name.

**STEP 4** Select “Confirm” by using a voice command or  .

### Listing the registered cellular phones

Selecting “List Phones” by using a voice command or  begins reading aloud the list of the registered cellular phones. When listing is complete, the system returns to “Phone Setup”.

Pressing  while a name of cellular phone is being read selects the cellular phone, and the following functions will be available:

- Selecting a cellular phone: “Select Phone”
- Changing a registered name: “Change Name”
- Deleting a cellular phone: “Delete”



## Deleting a cellular phone

**STEP 1** Select “Delete” by using a voice command or  .

### ► Pattern A

**STEP 2** Select a cellular phone to be deleted by either of the following methods and select “Confirm” by using a voice command or



- Press  and say the name of the desired cellular phone.
- Press  and say “List phones”. While the name of the desired cellular phone is being read aloud, press  .



### ► Pattern B

**STEP 2** Select a desired cellular phone to be deleted by using  .

## Changing the passkey

**STEP 1** Select “Set Passkey” by using a voice command or  .

### ► Pattern A

**STEP 2** Press  , say a 4 to 8-digit number, and select “Confirm” by using a voice command or  .

► Pattern B

**STEP 2** Select a 4 to 8-digit number by using  .

The number should be input 1 digit at a time.

**STEP 3** When the entire number to be registered as a passkey has been input, press  once again.

---

■ **The number of cellular phones that can be registered**

Up to 6 cellular phones can be registered in the system.

## 3-4. Using the hands-free phone system (for cellular phone) Security and system setup

To enter the menu of each setting, follow the steps below:

### ■ Security setting items and operation procedure

- Setting or changing the PIN (Personal Identification Number)
  1. "Setup" → 2. "Security" → 3. "Set PIN"
- Locking the phone book
  1. "Setup" → 2. "Security" → 3. "Phonebook Lock"
- Unlocking the phone book
  1. "Setup" → 2. "Security" → 3. "Phonebook Unlock"

### ■ System setup items and operation procedure

- Setting voice guidance volume
  1. "Setup" → 2. "System Setup" → 3. "Guidance Vol"
- Initialization
  1. "Setup" → 2. "System Setup" → 3. "Initialize"





can only be used for system setup operation.

## Setting or changing the PIN

### ■ Setting a PIN

**STEP 1** Select "Set PIN" by using a voice command or  .

**STEP 2** Enter a PIN by using a voice command or  .

When using  , input the code 1 digit at a time.

### ■ Changing the PIN

**STEP 1** Select "Set PIN" by using a voice command or  .

**STEP 2** Enter the registered PIN by using a voice command or  .



**STEP 3** Enter a new PIN by using a voice command or  .

When using  , input the code 1 digit at a time.

**Locking or unlocking the phone book**

**STEP 1** Select “Phonebook lock (Phbk Lock)” or “Phonebook unlock (Phbk Unlock)” by using a voice command or  .

**STEP 2** Input the PIN by either of the following methods and select “Confirm” by using a voice command or  :

- a. Press  and say the registered PIN.
- b. Input a new PIN by using  .

**Setting voice guidance volume**

**STEP 1** Select “Guidance Vol” by using  .

**STEP 2** Change the voice guidance volume.

To decrease the volume: Turn  counterclockwise.

To increase the volume: Turn  clockwise.



## Initialization

**STEP 1** Select “Initialize” and then “Confirm” by using  .

**STEP 2** Select “Confirm” by using  again.

### ■ Initialization

● The following data in the system can be initialized:

- Phone book
- Outgoing and incoming history
- Speed dial
- Registered cellular phone data
- Security code

● Once the initialization has been completed, the data cannot be restored to its original state.

### ■ When the phone book is locked

The following functions cannot be used:

- Dialing by inputting a name
- Speed dialing
- Dialing a number stored in the call history memory
- Using the phone book

## 3-4. Using the hands-free phone system (for cellular phone) Using the phone book

To enter the menu of each setting, follow the steps below:

- Adding a new phone number  
1. "Phonebook" → 2. "Add Entry"
- Setting speed dial  
1. "Phonebook" → 2. "Set Speed Dial (Speed Dial)"
- Changing a registered name  
1. "Phonebook" → 2. "Change Name"
- Deleting registered data  
1. "Phonebook" → 2. "Delete Entry"
- Deleting speed dial  
1. "Phonebook" → 2. "Delete Speed Dial (Del Spd Dial)"
- Listing the registered data  
1. "Phonebook" → 2. "List Names"

### Adding a new phone number

The following methods can be used to add a new phone number:

- Inputting a phone number by using a voice command
- Transferring data from the cellular phone
- Inputting a phone number by using 
- Selecting a phone number from outgoing or incoming history

#### ■ Adding procedure

**STEP 1** Select "Add Entry" by using a voice command or .

**STEP 2** Use one of the following methods to input a telephone number:

► Inputting a telephone number by using a voice command

STEP2-1 Select “By Voice” by using a voice command or



STEP2-2 Press , say the desired number, and select “Confirm” by using a voice command.

► Transferring data from the cellular phone

STEP2-1 Select “By Phone” and then “Confirm” by using a

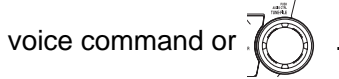



STEP2-2 Transfer the data from the cellular phone.

Refer to the manual that comes with the cellular phone for the details of transferring data.

STEP2-3 Select the data to be registered by either of the following methods:

a. Say “Previous” or “Next” until the desired data is displayed, and select “Confirm” by using a voice command.

b. Select the desired data by using  .

► Inputting a phone number by using 

STEP2-1 Select “Manual Input” by using  .

STEP2-2 Input a phone number by using  , and press

 once again.

Input the phone number 1 digit at a time.

► Selecting a phone number from outgoing or incoming history

STEP2-1 Select “Call History” by using a voice command or

 .

STEP2-2 Select “Outgoing” or “Incoming” by using a voice

command or  .

STEP2-3 Select the data to be registered by either of the following methods:

a. Say “Previous” or “Go back” until the desired data is displayed, and select “Confirm” by using a voice command.

b. Select the desired data by using  .

**STEP 3** Select the name to be registered by either of the following methods, and select “Confirm” by using a voice command or



a. Press  and say the desired name.

b. Select “Record Name” by using , and say the desired name.



**STEP 4** Select “Confirm” by using a voice command or  again.



In **STEP 3**, selecting “Set Speed Dial (Speed Dial)” instead of “Confirm” registers the newly added phone number as speed dial.

## Setting speed dial

**STEP 1** Select “Set Speed Dial (Speed Dial)” by using a voice command or .

**STEP 2** Select the data to be registered as speed dial by either of the following methods:

a. Press , say desired number, and select “Confirm” by using a voice command or .

b. Press , and say “List names”. While the desired name is being read aloud, press , and select “Confirm” by using a voice command or .

c. Select the desired data by using .







**STEP 3** Select the desired preset button, and register the data into speed dial by either of the following methods:



- a. Press the desired preset button, and select “Confirm” by using a voice command or  .
- b. Press and hold the desired preset button.

**Changing a registered name**

**STEP 1** Select “Change Name” by using a voice command or  .

**STEP 2** Select a name to be changed by either of the following methods:

- a. Press  , say desired name, and select “Confirm” by using a voice command or  .
- b. Press  , and say “List names”. During the desired name is read aloud, press  , and select “Confirm” by using a voice command or  .
- c. Select the desired name by using  .

**STEP 3** Select “Record Name” with  or  .



**STEP 4** Say a new name, and select “Confirm” by using a voice command or  .

## Deleting registered data

**STEP 1** Select “Delete Entry” by using a voice command or  .

### ► Pattern A

**STEP 2** Select data to be deleted by either of the following methods, and select “Confirm” by using a voice command or  :

- Press  , and say the name of the desired phone number to be deleted.
- Press  , say “List phones”. While the name of the desired phone number is being read aloud, press  .

### ► Pattern B

**STEP 2** Select data to be deleted by using  .

## Deleting speed dial

**STEP 1** Select “Delete Speed Dial (Del Spd Dial)” by using a voice command or  .

**STEP 2** Press the preset button in which the desired speed dial is registered, and select “Confirm” by using a voice command or  .

### Listing the registered data

Selecting “List names” by using a voice command begins reading the list of the registered data.

When listing is complete, the system returns to “Phonebook”.

Pressing  while a data is being read aloud selects the data, and the following function will be available.

- Dialing: “Dial”
- Changing a registered name: “Change Name”
- Deleting an entry: “Delete Entry”
- Setting speed dial: “Set Speed Dial (Speed Dial)”

---

#### ■ Limitation of number of digits

A phone number that exceeds 24 digits cannot be registered.



## Interior lights list

Your Toyota is equipped with the illuminated entry system to assist in entering the vehicle. Owing to the function of the system, the lights shown in the following illustration automatically turn on/off according to the presence of the electronic key (vehicles with smart key system), whether the doors are locked/unlocked, whether the doors or glass hatch (if equipped) are opened/closed, and the “ENGINE START STOP” switch mode or the engine switch position.

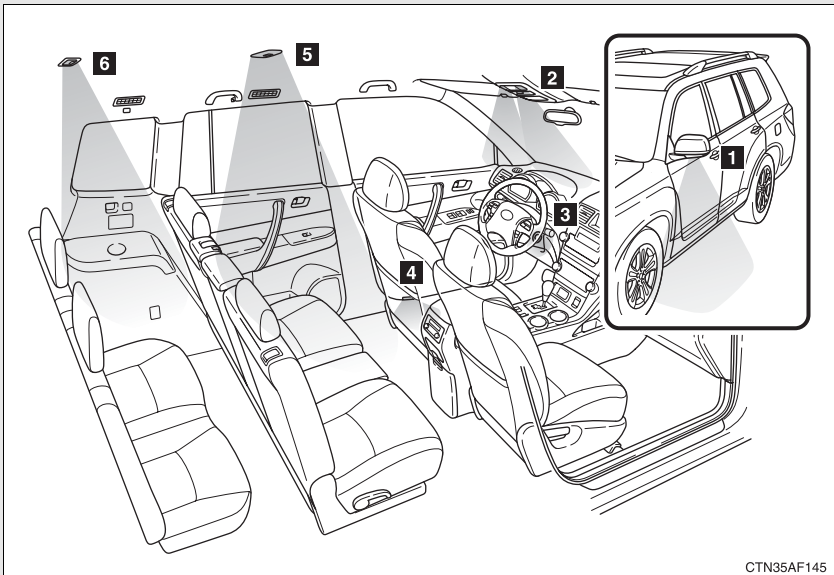

CTN35AF145

- 1** Outer foot lights (vehicles with smart key system)
- 2** Personal/interior lights (→P. 373)
- 3** Engine switch light (vehicles without smart key system)
- 4** Front door courtesy light
- 5** Personal/interior light or interior light (→P. 373, 374)
- 6** Interior light (→P. 374)

## Personal/interior light main switch

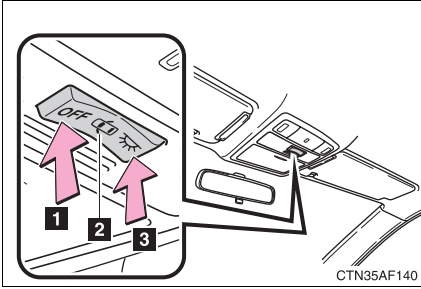

### 1 "OFF"

The personal/interior lights and interior light can be individually turned on or off.

### 2 Door position

The personal/interior lights and interior light come on when a door or the glass hatch (if equipped) is opened. They turn off when the doors and glass hatch are closed.

### 3 On

The personal/interior lights and interior light cannot be individually turned off.

## Personal/interior lights

### ► Front

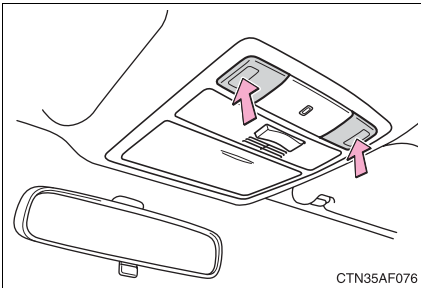

### On/off

The illuminated entry system is activated even if the light is turned off when the personal/interior light main switch is in door position.

► Center (if equipped)

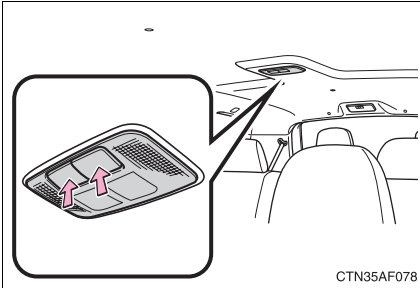

On/off

The illuminated entry system is activated even if the light is turned off when the personal/interior light main switch is in door position.

**Interior light**

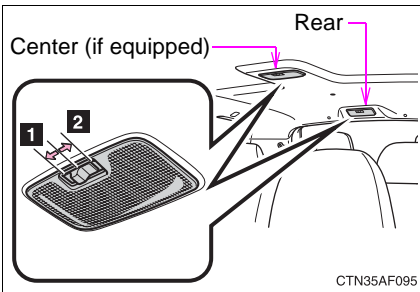

- 1 Off
- 2 On

The illuminated entry system is activated even if the light is turned off when the personal/interior light main switch is in door position.

■ **To prevent the battery discharge**

If the lights remain on when the door is not fully closed and the personal/interior light main switch is in door position, the lights will go off automatically after 20 minutes.

■ **Customization that can be configured at Toyota dealer**

Settings (e.g. The time elapsed before lights turn off) can be changed.  
(Customizable features →P. 582)

## 3-6. Using the storage features

### List of storage features

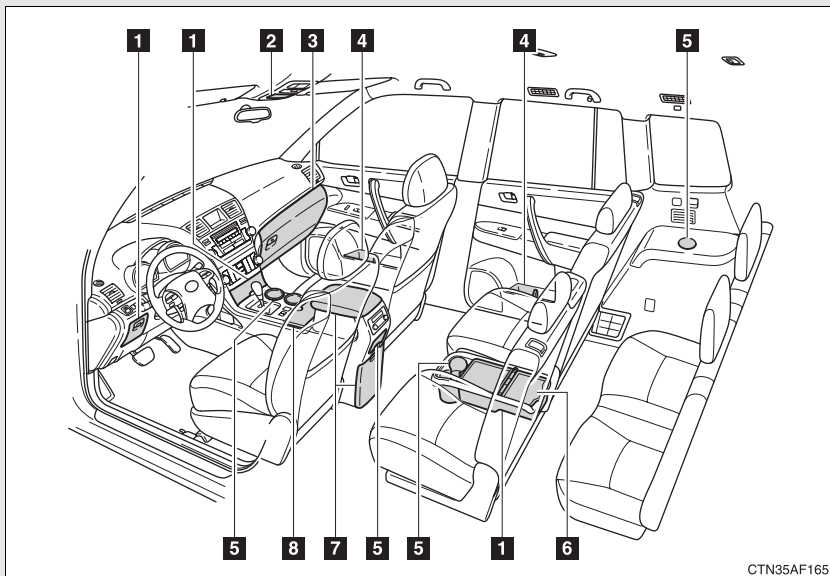

- 1** Auxiliary boxes
- 2** Overhead console
- 3** Glove box
- 4** Bottle holders
- 5** Cup holders
- 6** Side table
- 7** Console box
- 8** Auxiliary box & cup holder

## Glove box

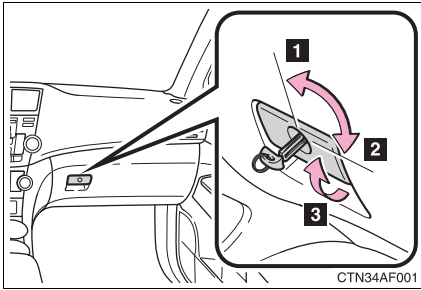

- 1** Unlock with the master key (vehicles without smart key system) or mechanical key (vehicles with smart key system)
- 2** Lock with the master key (vehicles without smart key system) or mechanical key (vehicles with smart key system)
- 3** Open (pull lever)

### ■ Power back door main switch (vehicles with power back door)

The power back door main switch is located in the glove box. (→P. 73)

## ⚠ CAUTION

### ■ Caution while driving

Keep the glove box closed.

Injuries may result in the event of an accident or sudden braking.

## Console box

### ► Upper

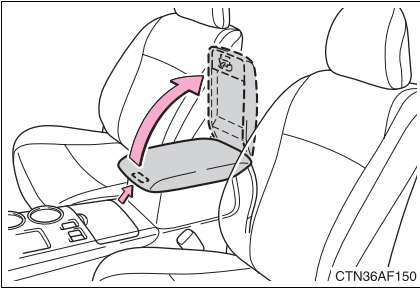

Pull up the knob to release the lock. Lift the lid.

### ► Lower

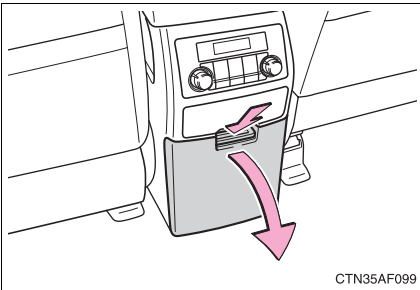

Push down the lever.

## ⚠ CAUTION

### ■ Caution while driving

Keep the console box closed.  
Injuries may result in the event of an accident or sudden braking.

## Overhead console

The overhead console is useful for temporarily storing sunglasses and similar small items.

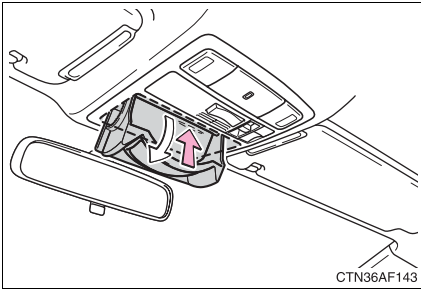

Press in the lid.

### ⚠ CAUTION

#### ■ Items that should not be left in the overhead console

Do not leave glasses or lighters in the console.

If the interior of the vehicle becomes hot, lighters may explode and glasses may warp or become cracked.

#### ■ Caution while driving

Do not leave the overhead console open while driving.

Items stored in it may fall out and cause injury.

#### ■ Size of stored items

Do not put large items in the overhead console.

The overhead console may not be able to be shut from the conversation mirror state.

#### ■ Maximum storage weight

Do not place any object heavier than 0.4 lb. (200 g) in it. The console may be opened and cause injury.

## Cup holders

### ► Front (type A)

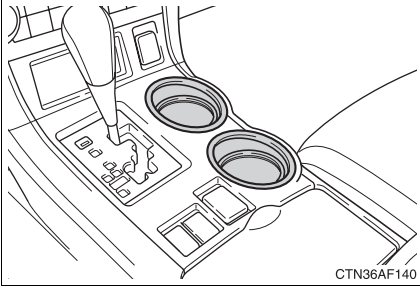

Removing the adapters changes the size. (→P. 381)

### ► Front (type B)

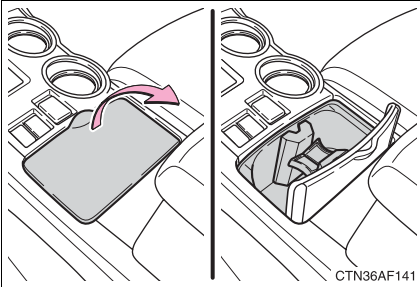

Lift the lid.

### ► Console box

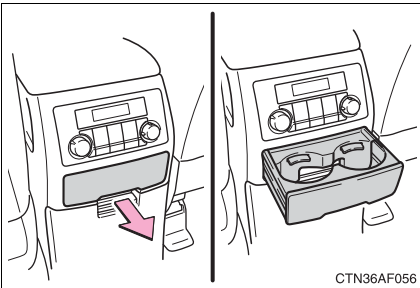

Pull out the cup holder.



► Side table

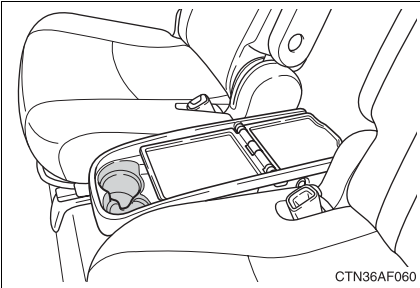

Install the side table before using the cup holder. (→P. 386)

Removing the adapters changes the size. (→P. 381)

► Rear (vehicles without third seat)

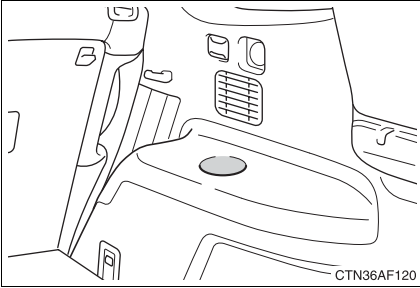

► Rear (vehicles with third seat)

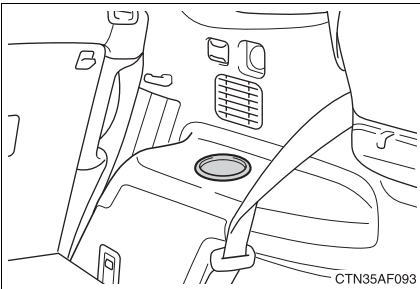

Removing the adapters changes the size. (→P. 381)

■ **Adjusting size of the cup holder (front [type A], front [type B], side table, rear [vehicles with third seats])**

▶ **Front (type A)**

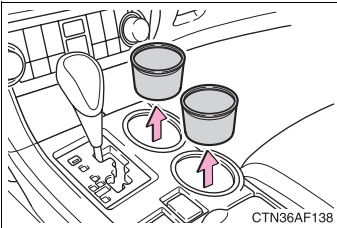

Remove the adapter.

▶ **Front (type B)**

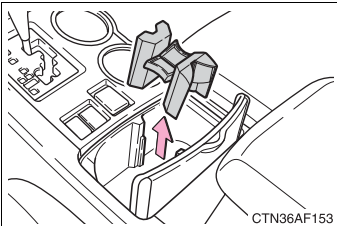

Remove the separator.

▶ **Side table**

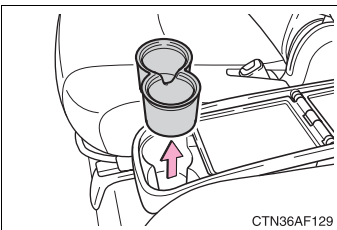

Remove the adapter.

▶ **Rear (vehicles with third seat)**

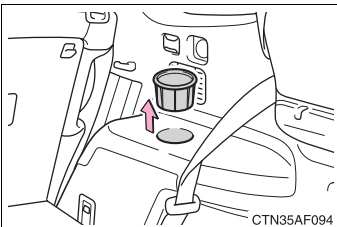

Remove the adapter.

 **CAUTION****■ Items unsuitable for the cup holder**

Do not place anything other than cups or aluminum cans in the cup holders. Other items may be thrown out of the holders in the event of an accident or sudden braking and cause injury. If possible, cover hot drinks to prevent burns.

**■ When not in use**

Front (type B) and console box cup holders: Keep the cup holders closed. Injuries may result in the event of an accident or sudden braking.

## Bottle holders

### ► Front

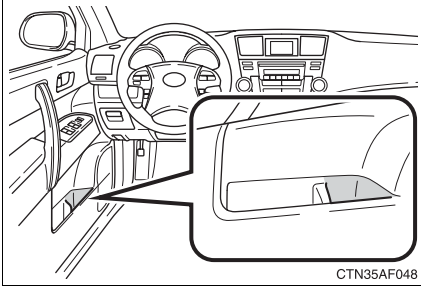

### ► Rear

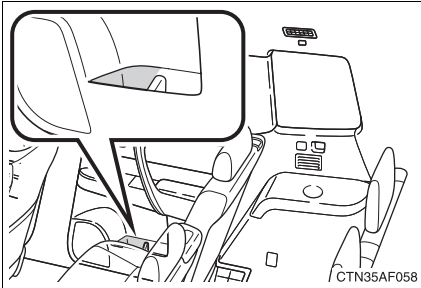

### ⚠ CAUTION

#### ■ Items unsuitable for the bottle holder

Do not place anything other than a bottle in the bottle holders. Other items may be thrown out of the holders in the event of an accident or sudden braking and cause injury.

### ⚠ NOTICE

#### ■ When stowing a bottle

Put the cap on before stowing a bottle. Do not place open bottles in the bottle holders. The contents may spill.

### Auxiliary boxes

► Type A

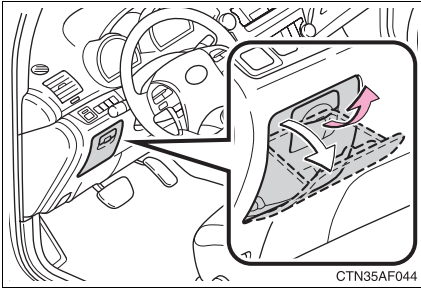

Pull up the lever.

► Type B

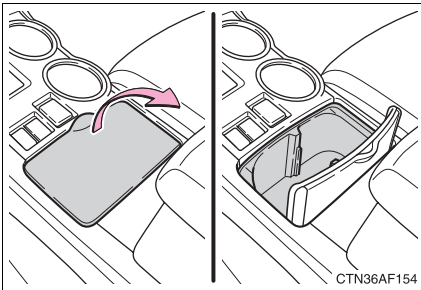

Lift the lid.

Remove the separator to use the box. (→P. 381)

► Type C (if equipped)

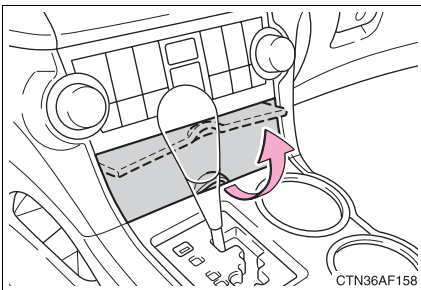

Lift the lid.

## ► Type D

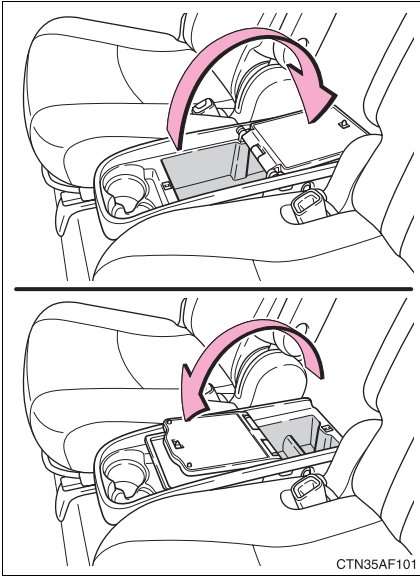

Lift the lid.

## ■ Auxiliary box (type D)

Install the side table. (→P. 386)

 CAUTION

## ■ Caution while driving

Keep the auxiliary boxes closed.  
Injuries may result in the event of an accident or sudden braking.

## Side table

### ■ Installing the side table

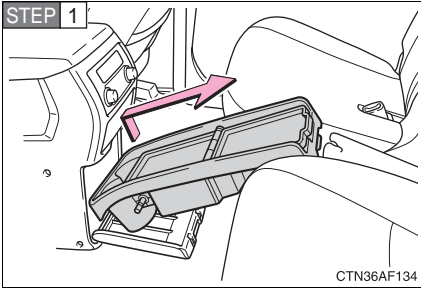

Take out the side table from the console box.

**STEP 2** Remove the second center seat. (→P. 87)

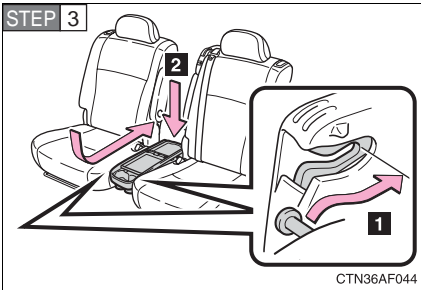

**1** Engage the front pins of the side table with the hooks.

**2** Push down on the side table to engage the rear pin locks.

### ■ Removing the side table

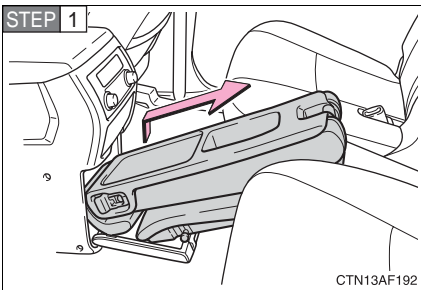

Take out the second center seat from the console box.

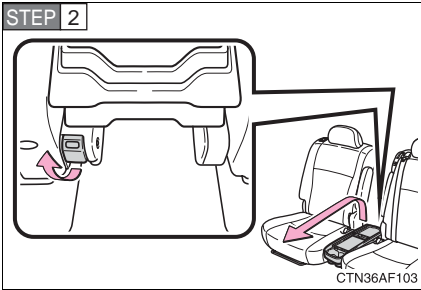

Pull the lock release lever to remove the side table.

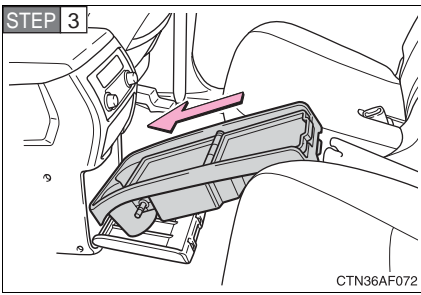

Stow the side table in the console box.

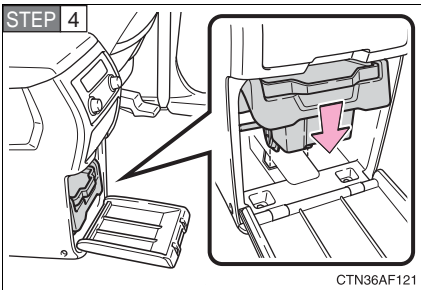

Push down on the end to engage the pins in the holes and close the console box door.

Make sure that the side table is securely locked in position.

**! CAUTION**

**■ Caution while driving**

Keep the console box closed.  
Injuries may result in the event of an accident or sudden braking.



## Sun visors

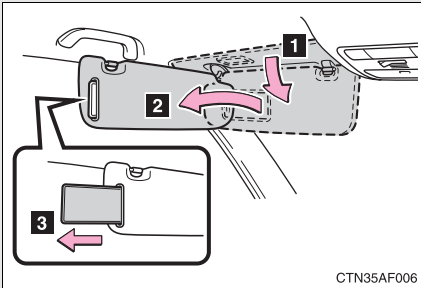

- 1** Forward position  
Flip down.
- 2** Side position  
Flip down, unhook, and swing to the side.
- 3** Side extender  
Place in side position then slide backwards.

## Vanity mirrors

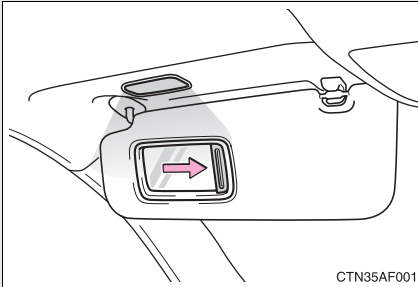

Slide the cover.

The light turns on when the cover is opened. (vehicles with vanity mirror light)

 **NOTICE**

**■ To prevent the battery from being discharged**

Do not leave the vanity lights on for extended periods while the engine is stopped.

### 3-7. Other interior features

## Clock (vehicles without multi-information display)

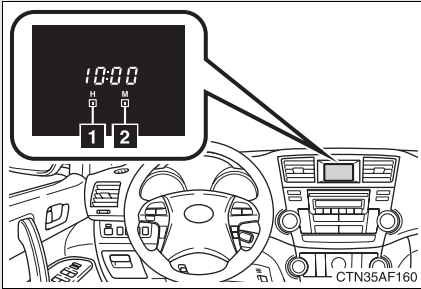

- 1 Adjusts the hours.
- 2 Adjusts the minutes.

#### ■ The clock is displayed when

The engine switch is in the “ACC” or “ON” position.

### 3-7. Other interior features

## Conversation mirror

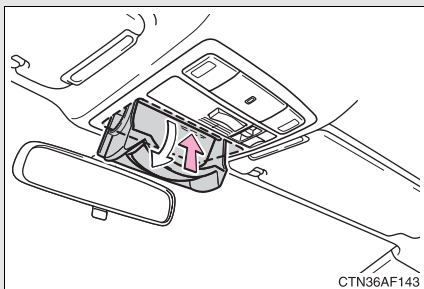

Press in the lid.

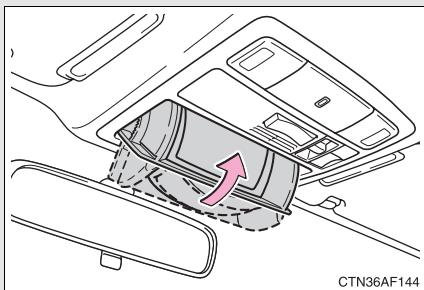

Push the lid back up half way.

- **To use the overhead console from the conversation mirror state**  
Fully close the lid, then open it again. (→P. 378)

## Power outlets

**The power outlet can be used for a following component.**

12 V: Accessories that run on less than 10 A.

115 VAC: Accessories that use less than 100 W.

■ **12 V**

▶ **Type A\*<sup>1</sup>**

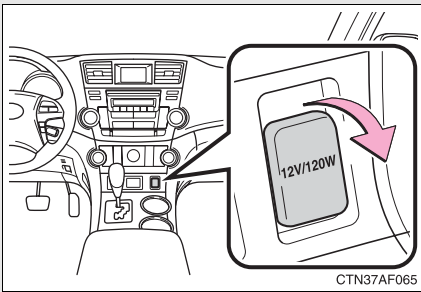

▶ **Type B\*<sup>2</sup>**

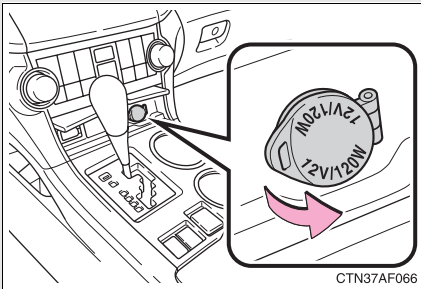

► Type C

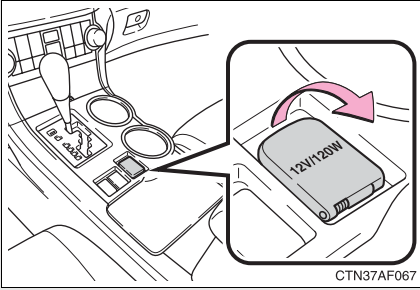

► Type D

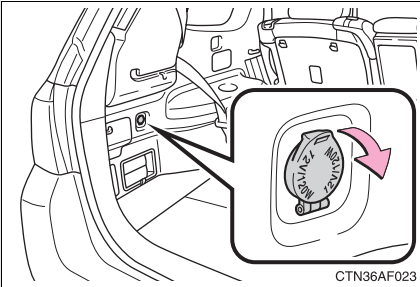

■ 115 VAC\*3

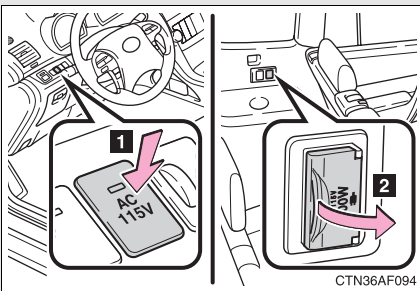

**1** Main switch

To use the power outlet, turn on the main switch.

**2** Power outlet socket

\*1: Vehicles with seat heater

\*2: Vehicles without seat heater

\*3: Vehicles with rear entertainment system

■ **The power outlet can be used when**

▶ **12 V**

Vehicles without smart key system:

The engine switch is in the “ACC” or “ON” position.

Vehicles with smart key system:

The “ENGINE START STOP” switch is in ACCESSORY or IGNITION ON mode.

▶ **115 VAC**

Vehicles without smart key system:

The engine switch is in the “ON” position.

Vehicles with smart key system:

The “ENGINE START STOP” switch is in IGNITION ON mode.

 NOTICE**■ To avoid damaging the power outlet**

Close the power outlet lid when the power outlet is not in use.

Foreign objects or liquids that enter the power outlet may cause a short circuit.

**■ To prevent the fuse from being blown****▶ 12 V**

Do not use an accessory that uses more than 12 V 10 A.

**▶ 115 VAC**

Do not use a 115 VAC appliance that requires more than 100 W.

If a 115 VAC appliance that consumes more than 100 W is used, the protection circuit will cut the power supply.

**■ To prevent the battery discharge**

Do not use the power outlet longer than necessary when the engine is off.

**■ Appliances that may not operate properly (115 VAC)**

The following 115 VAC appliances may not operate properly even if their power consumption is under 100 W.

- Appliances with high initial peak wattage
- Measuring devices that process precise data
- Other appliances that require an extremely stable power supply



## Seat heaters\*

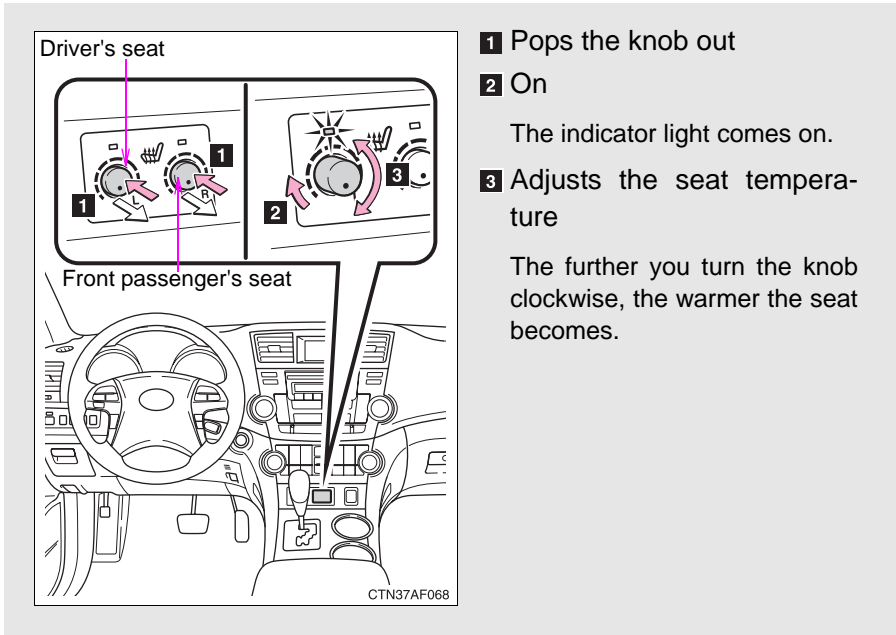

### ■ The seat heaters can be used when

- ▶ Vehicles without smart key system  
The engine switch is in the “ON” position.
- ▶ Vehicles with smart key system  
The “ENGINE START STOP” switch is in IGNITION ON mode.

### ■ When not in use

- Turn the knob fully counterclockwise. The indicator light turns off.
- Press the knob into the recessed position.

\*: If equipped

 **CAUTION****■ Burns**

- Use caution when seating the following persons in a seat with the seat heater on to avoid the possibility of burns:
  - Babies, small children, the elderly, the sick and the disabled
  - Persons with sensitive skin
  - Persons who are fatigued
  - Persons who have taken alcohol or drugs that induce sleep (sleeping drugs, cold remedies, etc.)
- Do not cover the seat with anything when using the seat heater. Using the seat heater with a blanket or cushion increases the temperature of the seat and may lead to overheating.

 **NOTICE****■ To prevent seat heater damage**

Do not put unevenly weighted objects on the seat and do not stick sharp objects (needles, nails, etc.) into the seat.

**■ To prevent battery discharge**

Turn the switches off when the engine is not running.

## Armrests

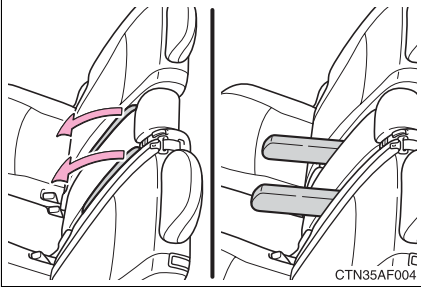

Pull the armrest down for use.

 NOTICE

 **To prevent damage to the armrest**

Do not place too much strain on the armrest.

## Floor mat

**Securely place a mat that matches the size of the space on the carpet.**

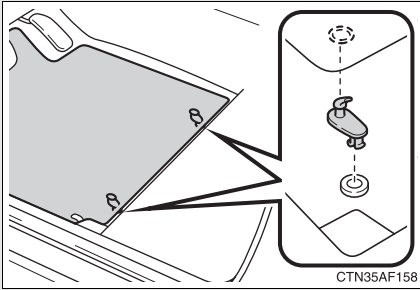

Secure the driver's floor mat using the hooks provided.

### CAUTION

#### ■ When inserting the floor mat

Observe the following precautions.

Failure to do so may result in the floor mat slipping and interfering with the movement of the pedals during driving, resulting in an accident.

- Make sure the floor mat is properly placed on the vehicle carpet and the correct side faces upward.
- Do not place floor mats on top of existing mats.

## 3-7. Other interior features

### Luggage compartment features

#### ■ Cargo hooks

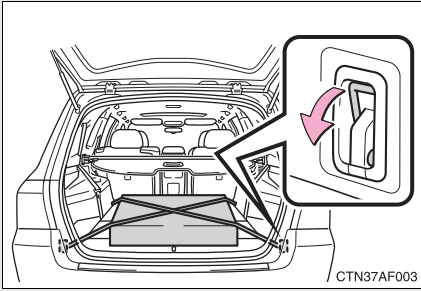

Cargo hooks are provided for securing loose items.

#### ■ Shopping bag hooks

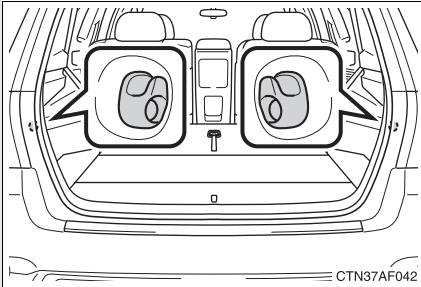

#### ■ Auxiliary box

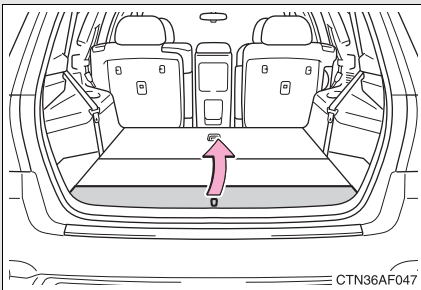

Lift the center deck board.

### ■ Separating luggage compartment

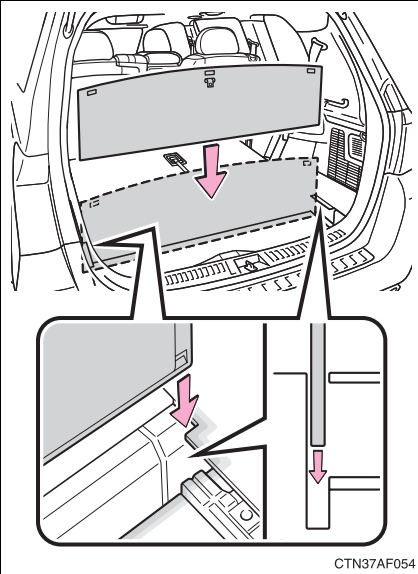

The center deck board can be used to separate the luggage compartment.

Remove the center deck board and insert it upright into the groove.

The board cannot be inserted when the luggage cover is stowed.

■ **Luggage cover (vehicles with luggage cover)**

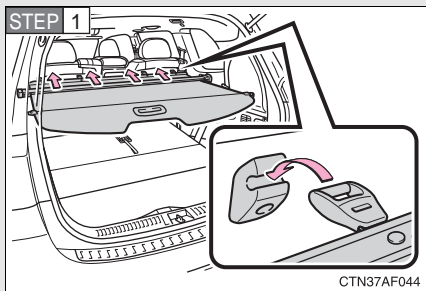

Hang the hooks on the hook brackets on the second seat seatback.

Vehicles with the third seat:  
When using the luggage cover, the third seat must be fold down. (→P. 86)

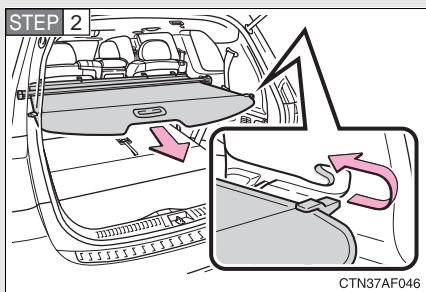

Pull out the luggage cover and engage both ends to secure it.

■ **When taking out luggage through the glass hatch (vehicles with glass hatch)**

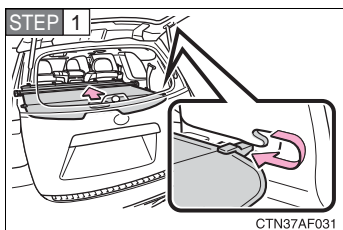

Pull the luggage cover to disengage both ends.

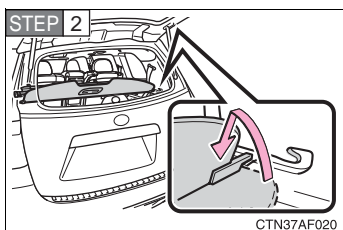

Engage both ends of the luggage cover with the grooves shown in the illustration and stand the cover upright.

### ■ Removing the luggage cover (vehicles with luggage cover)

The luggage cover can be removed by following the procedure below.

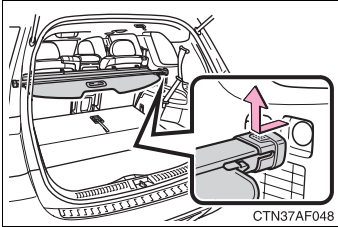

- 1 Detach the hooks.
- 2 Push in the left side of the luggage cover while keeping hold of the right side. Then raise the right side and pull the luggage cover out.

### ■ Luggage storage box (vehicles without third seat)

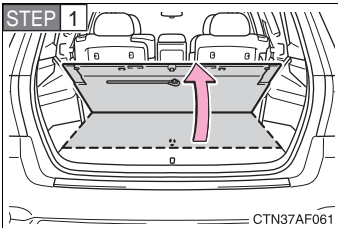

Lift the deck board.

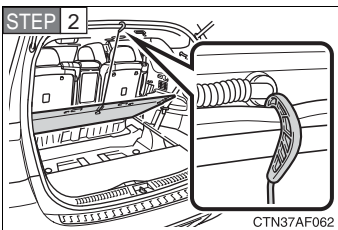

Secure the board using the hook.



■ **Stowing the luggage cover (vehicles with luggage cover)**

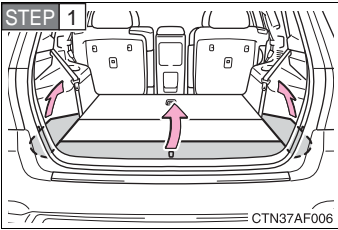

Remove the side deck boards and open the center deck board.

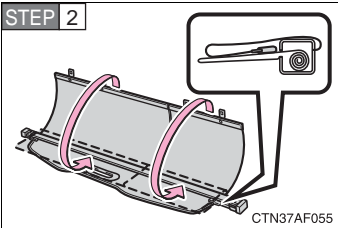

Fold the flaps on top of the luggage cover with the hooks rolled inside.

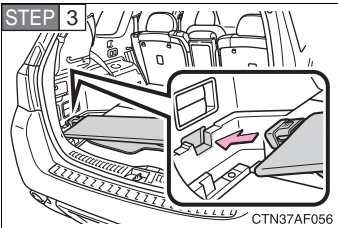

Place the left end of the luggage cover in the recess on the left-hand side and then lower the right end into the recess on the right-hand side.

**! CAUTION**

■ **When the cargo hooks are not in use**

To avoid injury, always return the cargo hooks to their positions when they are not in use.

■ **Caution while driving**

Do not drive with any of the deck boards opened. Items may fall out and cause injury.

 NOTICE**■ Shopping bag hook weight capacity**

Do not hang any object heavier than 4 lb. (2 kg) on shopping bag hooks.

**■ While driving**

Do not drive with the luggage cover standing upright in the grooves as the luggage cover may fall down.

**■ Before inserting the center deck board into the luggage compartment**

Make sure the luggage cover is not stowed.

**■ Closing the back door (vehicles without third seat)**

Do not close the back door with the hook attached, or the hook may be damaged.

## Garage door opener\*

The garage door opener can be programmed to operate garage doors, gates, entry doors, door locks, home lighting systems, and security systems, and other devices.

The garage door opener (HomeLink® Universal Transceiver) is manufactured under license from HomeLink®.

### Programming the HomeLink® (for U.S.A. owners)

The HomeLink® compatible transceiver in your vehicle has 3 buttons which can be programmed to operate 3 different devices. Refer to the programming method below appropriate for the device.

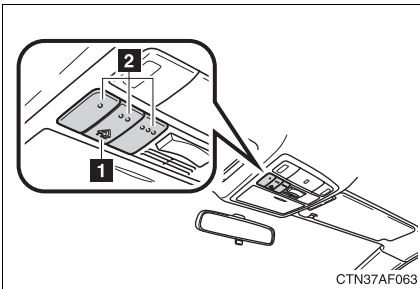

**1** Indicator

**2** Buttons

### ■ Programming the HomeLink®

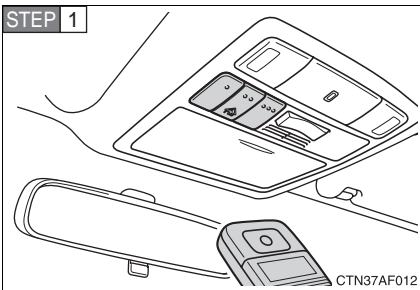

Point the remote control for the device 1 to 3 in. (25 to 75 mm) from the HomeLink® control buttons.

Keep the indicator light on the HomeLink® in view while programming.

\*: If equipped

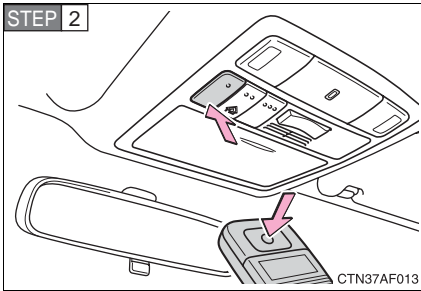

Press and hold down one of the buttons on the HomeLink<sup>®</sup> and the button on the transmitter. When the indicator light on the HomeLink<sup>®</sup> changes from a slow to a rapid flash after 20 seconds, you can release both buttons.

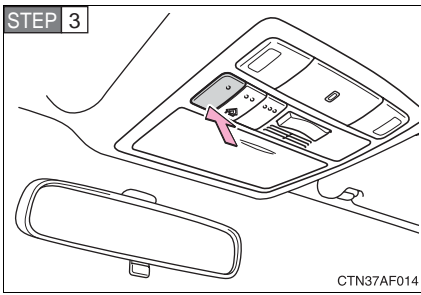

Test the operation of the HomeLink<sup>®</sup> by pressing the newly programmed button.

If programming a garage door opener, check to see if the garage door opens and closes. If the garage door does not operate, see if your garage transmitter is of the Rolling Code type. Press and hold the programmed HomeLink<sup>®</sup> button. The garage door has the rolling code feature if the indicator light (on the HomeLink<sup>®</sup>) flashes rapidly for 2 seconds and then remains lit. If your transmitter is the Rolling Code type, proceed to the heading "Programming a rolling code system".

**STEP 4** Repeat the steps above to program another device for each of the remaining HomeLink<sup>®</sup> buttons.

### ■ Programming a Rolling Code system (for U.S.A. owners)

If your device is Rolling Code equipped, follow the steps under the heading “Programming the HomeLink®” before proceeding with the steps listed below.

**STEP 1** Locate the training button on the ceiling mounted garage door opener motor. The exact location and color of the button may vary by brand of garage door opener.

Refer to the operation manual supplied with the garage door opener for the location of the training button.

**STEP 2** Press the training button.

**STEP 3** Press and release the vehicle’s programmed HomeLink® button twice. The garage door may open.

If the garage door opens, the programming process is complete. If the door does not open, press and release the button a third time. This third press and release will complete the programming process by opening the garage door.

The ceiling mounted garage door opener motor should now recognize the HomeLink® transceiver and operate the garage door.

**STEP 4** Repeat the steps above to program another rolling code system for any of the remaining HomeLink® buttons.

### ■ Programming an entry gate (for U.S.A. owners)/Programming all devices in the Canadian market

**STEP 1** Place your transmitter 1 to 3 in. (25 to 75 mm) away from the surface of the HomeLink®.

Keep the indicator light on the HomeLink® in view while programming.

**STEP 2** Press and hold the selected HomeLink® button.

**STEP 3** Repeatedly press and release (cycle) the device’s remote control button for two seconds each until step 4 is complete.

**STEP 4** When the indicator light on the HomeLink® compatible transceiver start to flashing rapidly, release the buttons.

**STEP 5** Test the operation of the HomeLink<sup>®</sup> by pressing the newly programmed button. Check to see if the gate/device operates correctly.

**STEP 6** Repeat the steps above to program another device for each of the remaining HomeLink<sup>®</sup> buttons.

### ■ Programming other devices

To program other devices such as home security systems, home door locks or lighting, contact your authorized Toyota dealer for assistance.

### ■ Reprogramming a button

The individual HomeLink<sup>®</sup> buttons cannot be erased but can be reprogrammed. To reprogram a button, follow the programming instructions.

## Operating the HomeLink<sup>®</sup>

Press the appropriate HomeLink<sup>®</sup> button. The HomeLink<sup>®</sup> indicator light on the HomeLink<sup>®</sup> transceiver should turn on.

The HomeLink<sup>®</sup> continues to send a signal for up to 20 seconds as long as the button is pressed.

## Erasing the entire HomeLink<sup>®</sup> memory (all three programs)

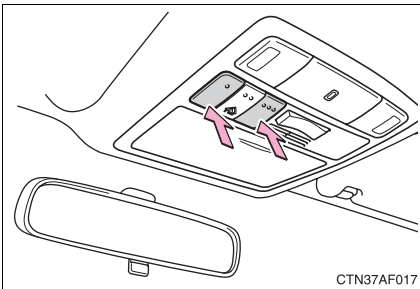

Press and hold down the 2 outside buttons for 20 seconds until the indicator light flashes.

If you sell your vehicle, be sure to erase the programs stored in the HomeLink<sup>®</sup> memory.

---

■ **Before programming**

- Install a new battery in the transmitter.
- The battery side of the transmitter must be pointed away from the HomeLink®.

■ **Certification for the garage door opener**

This device complies with Part 15 of the FCC Rules and with RSS-210 of the IC Rules.

Operation is subject to the following two conditions: (1) This device may not cause harmful interference, and (2) this device must accept any interference received, including interference that may cause undesired operation.

**WARNING:** This transmitter has been tested and complies with FCC and IC rules. Changes or modifications not expressly approved by the party responsible for compliance could void the user's authority to operate the device.

 **CAUTION**

■ **When programming a garage door or other remote control device**

The garage door may operate, so ensure people and objects are out of danger to prevent potential harm.

■ **Conforming to federal safety standards**

Do not use the HomeLink® Compatible Transceiver with any garage door opener or device that lacks safety stop and reverse features as required by federal safety standards.

This includes any garage door that cannot detect an obstruction object. A door or device without these features increases the risk of death or serious injury.

# Compass\*

The compass on the inside rear view mirror indicates the direction in which the vehicle is heading.

## ■ Operation

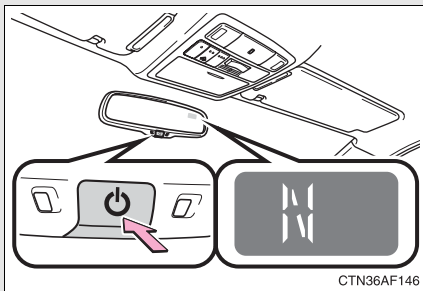

To turn the compass on or off, press the switch.

## ■ Displays and directions

Display	Direction
N	North
NE	Northeast
E	East
SE	Southeast
S	South
SW	Southwest
W	West
NW	Northwest

\*: If equipped



## Calibrating the compass

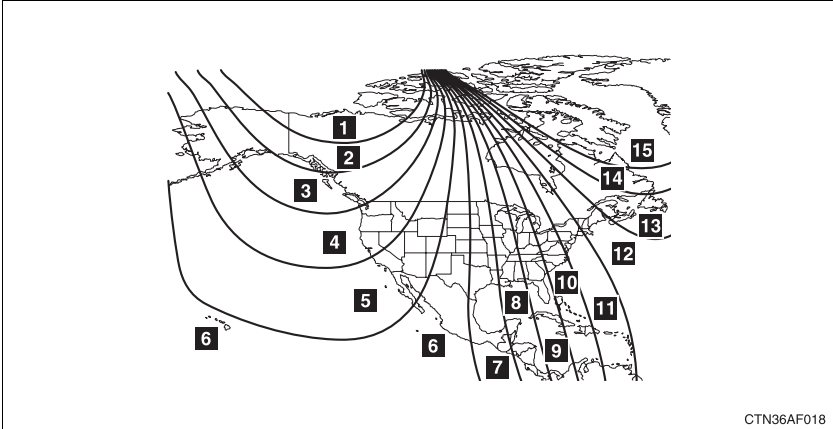

The direction display deviates from the true direction determined by the earth's magnetic field. The amount of deviation varies according to the geographic position of the vehicle.

If you cross over a map boundary shown in illustration, the compass will deviate.

To obtain higher precision or perfect calibration, refer to the following.

### ■ Deviation calibration

**STEP 1** Stop the vehicle where it is safe to drive in a circle.

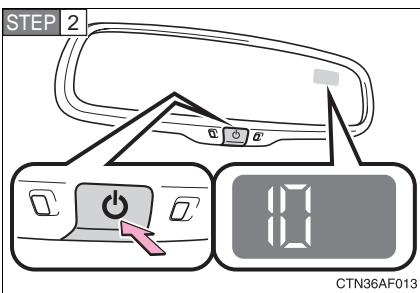

Press the switch until a number (1 to 15) appears on the compass display.

**STEP 3** Press the switch, and referring to the map above, select the number of the zone where you are.

If the direction is displayed several seconds after adjustment, the calibration is complete.

### ■ Circling calibration

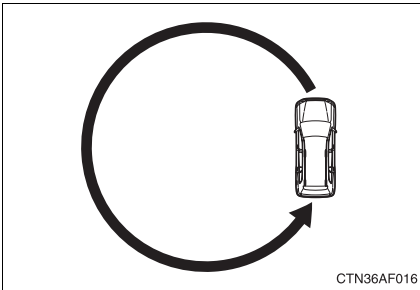

When C appears on the display, drive the vehicle at 5 mph (8 km/h) or less in a circle until a direction is displayed.

If there is not enough space to drive in a circle, drive around the block until the direction is displayed.

### ■ Conditions unfavorable to correct operation

The compass may not show the correct direction in the following conditions:

- The vehicle is stopped immediately after turning.
- The vehicle is on an inclined surface.
- The vehicle is in a place where the earth's magnetic field is subject to interference by artificial magnetic fields (underground car park/parking lot, under a steel tower, between buildings, roof car park/parking lot, near an intersection, near a large vehicle, etc.).
- The vehicle has become magnetized.  
(There is a magnet or metal object near the inside rear view mirror.)
- The battery has been disconnected.
- A door is open.

### ⚠ CAUTION

#### ■ While driving the vehicle

Do not adjust the display. Be sure to adjust the display only when the vehicle is stopped.

#### ■ When doing the circling calibration

Be sure to secure a wide space, and watch out for people and vehicles in the neighborhood. Do not violate any local traffic rules while performing circling calibration.

 NOTICE

■ **To avoid the compass malfunctions**

Do not place magnets or any metal objects near the inside rear view mirror. Doing this may cause a malfunction of the compass sensor.

■ **To ensure normal operation of the compass**

- Do not perform circling calibration of the compass in a place where the earth's magnetic field is subject to interference by artificial magnetic fields.
- During calibration, do not operate electric systems (moon roof, power windows, etc.) as they may interfere with the calibration.

## Cleaning and protecting the vehicle exterior

**Perform the following to protect the vehicle and maintain it in prime condition.**

- Working from top to bottom, liberally apply water to the vehicle body, wheel wells and underside of the vehicle to remove any dirt and dust.  
Wash the vehicle body using a sponge or soft cloth, such as a chamois.
- For hard-to-remove marks, use car wash soap and rinse thoroughly with water.
- Wipe away any water.
- Wax the vehicle when the waterproof coating deteriorates.

If water does not bead on a clean surface, apply wax when the vehicle body is cool.

---

### ■ Automatic car washes

- Before washing the vehicle, do the following.
  - Fold the mirrors back.
  - Remove the antenna. (mast type only)
  - Turn the power back door system off.
- Brushes used in automatic car washes may scratch the vehicle surface and harm your vehicle's paint.

### ■ High pressure car washes

- Do not allow the nozzles of the car wash to come within close proximity of the windows.
- Before car wash, check that the fuel filler door on your vehicle is closed properly.

### ■ Aluminum wheels

Remove any dirt immediately by using a neutral detergent. Do not use hard brushes or abrasive cleaners. Do not use strong or harsh chemical cleaners. Use the same mild detergent and wax as used on the paint.

### ■ Bumpers

Do not scrub with abrasive cleaners.

### ■ To prevent deterioration and body corrosion

- Wash the vehicle immediately in the following cases:
  - After driving near the sea coast
  - After driving on salted roads
  - If you see coal tar or tree sap on the paint surface
  - If you see dead insects or insect droppings on the paint
  - After driving in an area contaminated with soot, oily smoke, mine dust, iron powder or chemical substances
  - If the vehicle becomes heavily soiled in dust or mud
  - If liquids such as benzene and gasoline are spilled on the paint surface
- If the paint is chipped or scratched, have it repaired immediately.

#### CAUTION

#### ■ Caution about the exhaust pipe

Exhaust gasses cause the exhaust pipe to become quite hot.

When washing the vehicle, be careful not to touch the pipe until it has cooled sufficiently, as touching a hot exhaust pipe can cause burns.

 NOTICE

■ **To protect your vehicle's painted surfaces**

Do not use organic cleaners such as benzene or gasoline.

■ **If the windshield washer nozzle become blocked**

Contact your Toyota dealer. Do not try to clear it with a pin or other object. This may damage the nozzle.

■ **Cleaning the exterior lights**

● Wash carefully. Do not use organic substances or scrub with a hard brush. This may damage the surfaces of the lights.

● Do not apply wax on the surfaces of the lights. Wax may cause damage to the lenses.

■ **To prevent damage to the windshield wiper arms**

When lifting the wiper arms away from the windshield, pull the driver side wiper arm upward first, and repeat for the passenger side. When returning the wipers to their original position, do so from the passenger side first.

## Cleaning and protecting the vehicle interior

**The following procedures will help protect your vehicle's interior and keep it in top condition:**

### ■ **Protecting the vehicle interior**

Remove dirt and dust using a vacuum cleaner. Wipe dirty surfaces with a cloth dampened with lukewarm water.

### ■ **Cleaning the leather areas**

- Remove dirt and dust using a vacuum cleaner.
- Wipe any excess dirt and dust with a soft cloth dampened with diluted detergent.

Use a diluted water solution of approximately 5% neutral wool detergent.

- Wring out any excess water from the cloth and thoroughly wipe off all remaining traces of detergent.
- Wipe the surface with a dry, soft cloth to remove any remaining moisture. Allow the leather to dry in a shaded ventilated area.

### ■ **Synthetic leather areas**

- Remove loose dirt using a vacuum cleaner.
- Apply a mild soap solution to the synthetic leather.
- Allow the solution to soak in for a few minutes. Remove the dirt and wipe off the solution with a clean, damp cloth.

### ■ **Cleaning the inside of the rear window or left-side rear quarter window**

Do not use glass cleaner to clean the rear window or left-side rear quarter window, as this may cause damage to the rear window defogger heater wires or print type antenna (if equipped). Use a cloth dampened with luke-warm water to gently wipe the windows clean. Wipe the windows in strokes running parallel to the heater wires or print type antenna (if equipped).

### ■ **Caring for leather areas**

Toyota recommends cleaning the interior of the vehicle at least twice a year to maintain the quality of the vehicle's interior.

### ■ **Shampooing the carpets**

There are several commercial foaming-type cleaners available. Use a sponge or brush to apply the foam. Rub in overlapping circles. Do not apply water. Excellent results are obtained by keeping the carpet as dry as possible.

### ■ **Seat belts**

Clean with mild soap and lukewarm water using a cloth or sponge. Also check the belts periodically for excessive wear, fraying or cuts.

## CAUTION

### ■ **Water in the vehicle**

- Do not splash or spill liquid in the vehicle.

Doing so may cause electrical components etc. to malfunction or catch fire.

- Do not get any of the SRS components or wiring in the vehicle interior wet. (→P. 129)

Electrical malfunction may cause the airbags to deploy or not function properly, resulting in death or severe injury.



 NOTICE**■ Cleaning detergents**

Do not use organic substances such as benzene or gasoline, acidic or alkaline solutions, dye, bleach or other detergent. Doing so may discolor the vehicle interior or cause streaks or damage to painted surfaces.

**■ Preventing damage to leather surfaces**

Observe the following precautions to avoid damage to and deterioration of leather surfaces.

- Remove any dust or dirt on leather surfaces immediately.
- Do not expose the vehicle to direct sunlight for extended periods of time. Park the vehicle in the shade, especially during summer.
- Do not place items made of vinyl, plastic, or that contain wax on the upholstery, as they may stick to the leather surface if the vehicle interior heats up significantly.

**■ Water on the floor**

Do not wash the vehicle floor with water.

Vehicle systems such as the audio system may be damaged if water comes into contact with electrical components under the floor of the vehicle, and may also cause the body to rust.

**■ Cleaning the inside of the rear window or left-side rear quarter window**

Be careful not to scratch or damage the heater wires or print type antenna (if equipped).

## Maintenance requirements

**To ensure safe and economical driving, day-to-day care and regular maintenance is essential. It is the owner's responsibility to perform regular checks. Toyota recommends the following maintenance.**

### ■ General maintenance

General maintenance should be performed on a daily basis. This can be done by yourself or by a Toyota dealer.

### ■ Scheduled maintenance

Scheduled maintenance should be performed at specified intervals according to the maintenance schedule.

For details about maintenance items and schedules, refer to the "Scheduled Maintenance Guide" or "Owner's Manual Supplement".

### ■ Do-it-yourself maintenance

You can perform some maintenance procedures yourself. Please be aware that do-it-yourself maintenance may affect warranty coverage.

The use of Toyota Repair Manuals is recommended.

For details about warranty coverage, see the separate "Owner's Warranty Information Booklet" or "Owner's Manual Supplement".

---

### ■ Repair and replacement

It is recommended that genuine Toyota parts be used for repair to ensure performance of each system. If non-Toyota parts are used in replacement or if a repair shop other than a Toyota dealer performs repairs, confirm the warranty coverage.

**■ Allow inspection and repairs to be performed by a Toyota dealer**

- Toyota technicians are well-trained specialists and are kept up to date with the latest service information. They are well informed about the operations of all systems on your vehicle.
- Keep a copy of the repair order. It proves that the maintenance that has been performed is under warranty coverage. If any problem should arise while your vehicle is under warranty, your Toyota dealer will promptly take care of it.

**⚠ CAUTION****■ Warning in handling of battery**

- Engine exhaust, some of its constituents, and a wide variety of automobile components contain or emit chemicals known to the State of California to cause cancer and birth defects and other reproductive harm. Work in a well ventilated area.
- Oils, fuels and fluids contained in vehicles as well as waste produced by component wear contain or emit chemicals known to the State of California to cause cancer and birth defects or other reproductive harm. Avoid exposure and wash any affected area immediately.
- Battery posts, terminals and related accessories contain lead and lead compounds which are known to cause brain damage. Wash your hands after handling. (→P. 449)

## General maintenance

Listed below are the general maintenance items that should be performed at the intervals specified in the “Scheduled Maintenance Guide” or “Owner’s Manual Supplement”. It is recommended that any problem you notice should be brought to the attention of your Toyota dealer or qualified service shop for advice.

### Engine compartment

Items	Check points
Battery	Maintenance-free. (→P. 449)
Brake fluid	At the correct level? (→P. 448)
Engine coolant	At the correct level? (→P. 445)
Engine oil	At the correct level? (→P. 440)
Exhaust system	No fumes or strange sounds?
Radiator/condenser/hoses	Not blocked with foreign matter? (→P. 447)
Washer fluid	At the correct level? (→P. 452)

<b>Vehicle interior</b>
-------------------------

Items	Check points
Accelerator pedal	<ul style="list-style-type: none"> <li>• Moves smoothly (without uneven pedal effort or catching)?</li> </ul>
Automatic transmission “Park” mechanism	<ul style="list-style-type: none"> <li>• Can the vehicle be held securely on an incline with the shift lever in P?</li> </ul>
Brake pedal	<ul style="list-style-type: none"> <li>• Moves smoothly?</li> <li>• Does it have appropriate clearance and correct amount of free play?</li> </ul>
Brakes	<ul style="list-style-type: none"> <li>• Not pull to one side when applied?</li> <li>• Loss of brake effectiveness?</li> <li>• Spongy feeling brake pedal?</li> <li>• Pedal almost touches floor?</li> </ul>
Head restraints	<ul style="list-style-type: none"> <li>• Move smoothly and lock securely?</li> </ul>
Indicators/buzzers	<ul style="list-style-type: none"> <li>• Function properly?</li> </ul>
Lights	<ul style="list-style-type: none"> <li>• Do all the lights come on?</li> <li>• Headlights aimed correctly?</li> </ul>
Parking brake	<ul style="list-style-type: none"> <li>• Moves smoothly?</li> <li>• Can hold the vehicle securely on an incline?</li> </ul>
Seat belts	<ul style="list-style-type: none"> <li>• Does the seat belt system operate smoothly?</li> <li>• Are the belts undamaged?</li> </ul>
Seats	<ul style="list-style-type: none"> <li>• Do the seat controls operate properly?</li> </ul>
Steering wheel	<ul style="list-style-type: none"> <li>• Moves smoothly?</li> <li>• Has correct free play?</li> <li>• No strange noises?</li> </ul>

## Vehicle exterior

Items	Check points
Door	<ul style="list-style-type: none"> <li>• Operate smoothly?</li> </ul>
Engine hood	<ul style="list-style-type: none"> <li>• The lock system works properly?</li> </ul>
Fluid leaks	<ul style="list-style-type: none"> <li>• Is there any leakage after parking?</li> </ul>
Tire	<ul style="list-style-type: none"> <li>• Inflation pressure is correct?</li> <li>• Tire surfaces not worn or damaged?</li> <li>• Tires rotated according to the maintenance schedule?</li> <li>• Wheel nuts are not loose?</li> </ul>

### CAUTION

#### ■ If the engine is running

Turn the engine off and ensure that there is adequate ventilation before performing maintenance checks.

**Some states have vehicle emission inspection programs which include OBD (On Board Diagnostics) checks. The OBD system monitors the operation of the emission control system.**

■ **If the malfunction indicator lamp comes on**

The OBD system determines that a problem exists somewhere in the emission control system. Your vehicle may not pass the I/M test and may need to be repaired. Contact your Toyota dealer to service the vehicle.

■ **Your vehicle may not pass the I/M test:**

- When the battery is disconnected or discharged

Readiness codes that are set during ordinary driving are erased.

Also, depending on your driving habits, the readiness codes may not be completely set.

- When the fuel tank cap is loose

The malfunction indicator lamp comes on as a temporary malfunction and your vehicle may not pass the I/M test.

■ **When the malfunction indicator lamp goes off after several driving trips**

The error code in the OBD system will not be cleared unless the vehicle is driven 40 or more times.

■ **If your vehicle does not pass the I/M test**

Contact your Toyota dealer to prepare the vehicle for re-testing.

## Do-it-yourself service precautions

**If you perform maintenance yourself, be sure to follow the correct procedures as given in these sections.**

Items	Parts and tools
Battery condition (→P. 449)	<ul style="list-style-type: none"> <li>• Warm water</li> <li>• Baking soda</li> <li>• Grease</li> <li>• Conventional wrench (for terminal clamp bolts)</li> </ul>
Brake fluid level (→P. 448)	<ul style="list-style-type: none"> <li>• FMVSS No.116 DOT 3 or SAE J1703 brake fluid</li> <li>• Rag or paper towel</li> <li>• Funnel (used only for adding brake fluid)</li> </ul>
Engine coolant level (→P. 445)	<ul style="list-style-type: none"> <li>• “Toyota Super Long Life Coolant” or similar high quality ethylene glycol based non-silicate, non-amine, non-nitrite and non-borate coolant with long-life hybrid organic acid technology. For the U.S.A.: “Toyota Super Long Life Coolant” is pre-mixed with 50% coolant and 50% deionized water. For Canada: “Toyota Super Long Life Coolant” is pre-mixed with 55% coolant and 45% deionized water.</li> <li>• Funnel (used only for adding engine coolant)</li> </ul>
Engine oil level (→P. 440)	<ul style="list-style-type: none"> <li>• “Toyota Genuine Motor Oil” or equivalent</li> <li>• Rag or paper towel, funnel (used only for adding oil)</li> </ul>



Items	Parts and tools
Fuses (→P. 475)	<ul style="list-style-type: none"> <li>• Fuse with same amperage rating as original</li> </ul>
Radiator and condenser (→P. 447)	—
Tire inflation pressure (→P. 463)	<ul style="list-style-type: none"> <li>• Tire pressure gauge</li> <li>• Compressed air source</li> </ul>
Washer fluid (→P. 452)	<ul style="list-style-type: none"> <li>• Water washer fluid containing antifreeze (for winter use)</li> <li>• Funnel</li> </ul>

 **CAUTION**

The engine compartment contains many mechanisms and fluids that may move suddenly, become hot, or become electrically energized. To avoid death or serious injury observe the following precautions.

**■ When working on the engine compartment**

- Keep hands, clothing, and tools away from the moving fan and engine drive belt.
- Be careful not to touch the engine, radiator, exhaust manifold, etc. right after driving as they may be hot. Oil and other fluids may also be hot.
- Do not leave anything that may burn easily, such as paper or rags, in the engine compartment.
- Do not smoke, cause sparks or expose an open flame to fuel or the battery. Fuel and battery fumes are flammable.
- Be extremely cautious when working on the battery. It contains poisonous and corrosive sulfuric acid.
- Take care because brake fluid can harm your hands or eyes and damage painted surfaces.

If fluid gets on your hands or in your eyes, flush the affected area with clean water immediately.

If you still experience discomfort, see a doctor.

- Do not touch the engine compartment when the electric cooling fan is operating.

Vehicles without smart key system: The electric cooling fan may keep rotating for about 3 minutes even after the engine switch is turned to the "LOCK" position.

With the engine switch in the "ON" position, the electric cooling fan may automatically start to run if the air conditioning is on and/or the coolant temperature is high. Be sure the engine switch is in the "LOCK" position when working near the electric cooling fan or radiator grille.

Vehicles with smart key system: The electric cooling fan may keep rotating for about 3 minutes even after the "ENGINE START STOP" switch is OFF. With the "ENGINE START STOP" switch in IGNITION ON mode, the electric cooling fan may automatically start to run if the air conditioning is on and/or the coolant temperature is high. Be sure the "ENGINE START STOP" switch is OFF when working near the electric cooling fan or radiator grille.

 **CAUTION****■ Safety glasses**

Wear safety glasses to prevent flying or falling material, fluid spray, etc. from getting in the eyes.

 **NOTICE****■ If you remove the air cleaner filter**

Driving with the air cleaner filter removed may cause excessive engine wear due to dirt in the air. Also a backfire could cause a fire in the engine compartment.

## 4-3. Do-it-yourself maintenance

### Hood

**Release the lock from the inside of the vehicle to open the hood.**

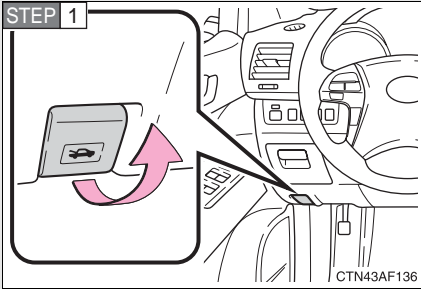

Pull the hood release lever.

The hood will pop up slightly.

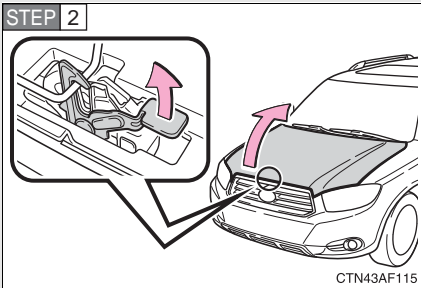

Lift the auxiliary catch lever and lift the hood.

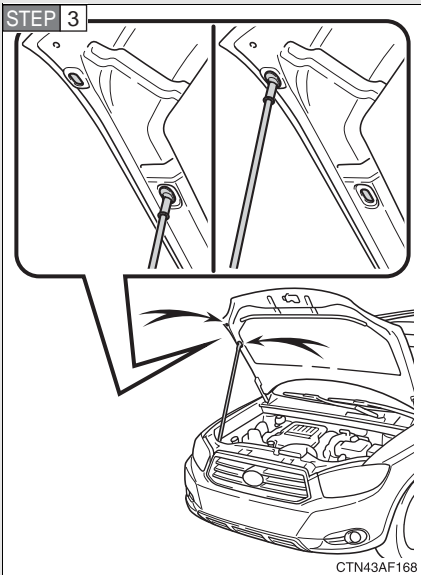

Hold the hood open by inserting the supporting rod into either of the slots.

 **CAUTION****■ Pre-driving check**

Check that the hood is fully closed and locked.

If the hood is not locked properly, it may open while the vehicle is in motion and cause an accident, which may result in death or serious injury.

**■ After installing the support rod into the slot**

Make sure the rod supports the hood securely from falling down on to your head or body.

 **NOTICE****■ When closing the hood**

Be sure to return the support rod to its clip before closing the hood. Closing the hood with the support rod up could cause the hood to bend.

## 4-3. Do-it-yourself maintenance

### Positioning a floor jack

**When raising your vehicle with a floor jack, position the jack correctly. Improper placement may damage your vehicle or cause injury.**

#### ► Front

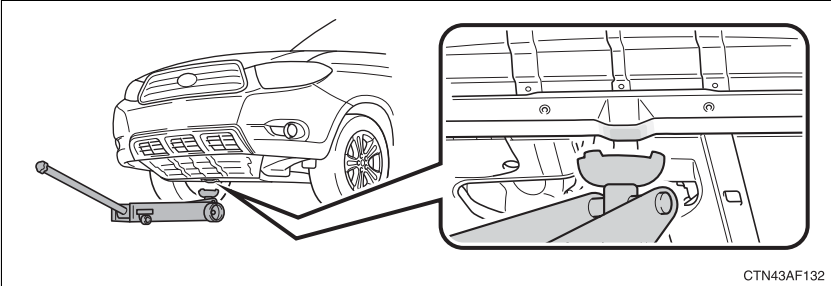

#### ► Rear (2WD models)

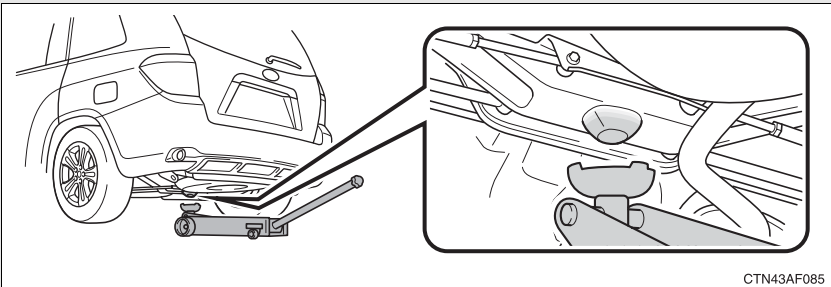

#### ► Rear (4WD models)

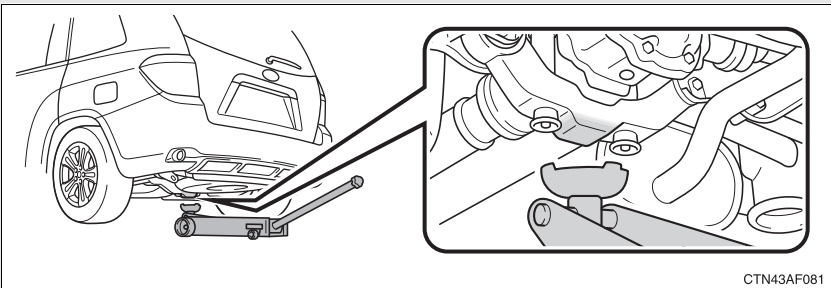

## Removing the front jack point cover (3.5 L V6 (2GR-FE) engine)

Before jacking, remove the jack point cover.

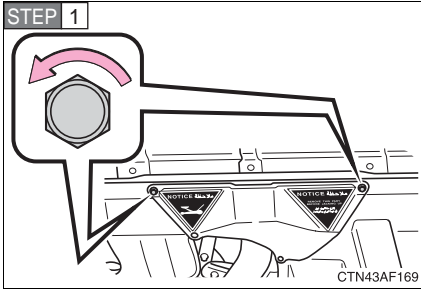

Turn the bolts counterclockwise and remove them.

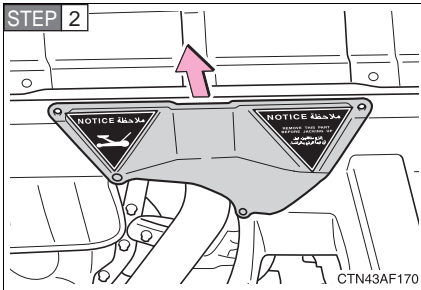

Remove the cover.

**! CAUTION**

**■ When raising your vehicle**

Make sure to observe the following to reduce the possibility of death or serious injury.

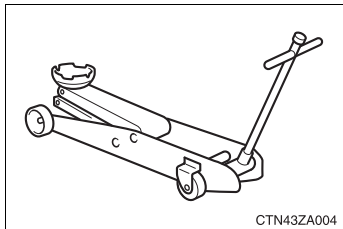

● Lift up the vehicle using a floor jack such as the one shown in the illustration.

- Do not use the jack that was supplied with your vehicle.
- Do not put any part of your body or get underneath the vehicle supported only by the floor jack.  
Always use automotive jack stands on a solid, level surface.
- Do not start the engine while the vehicle is supported by the floor jack.
- Stop the vehicle on level firm ground, firmly set the parking brake and shift the shift lever in P.
- Make sure to set the floor jack properly at the jack point.  
Raising the vehicle with an improperly positioned floor jack will damage the vehicle and may cause the vehicle to fall off the floor jack.
- Do not raise the vehicle while someone is in the vehicle.
- When raising the vehicle, do not place any objects on top of or underneath the floor jack.

**! NOTICE**

**■ Front jack point cover**

- After installing the front jack point cover, make sure it is securely in its original position.
- Before jacking up your vehicles, remove the front jack point cover. Otherwise, the cover may be damaged.



## 4-3. Do-it-yourself maintenance

### Engine compartment

#### ► 2.7 L 4-cylinder (1AR-FE) engine

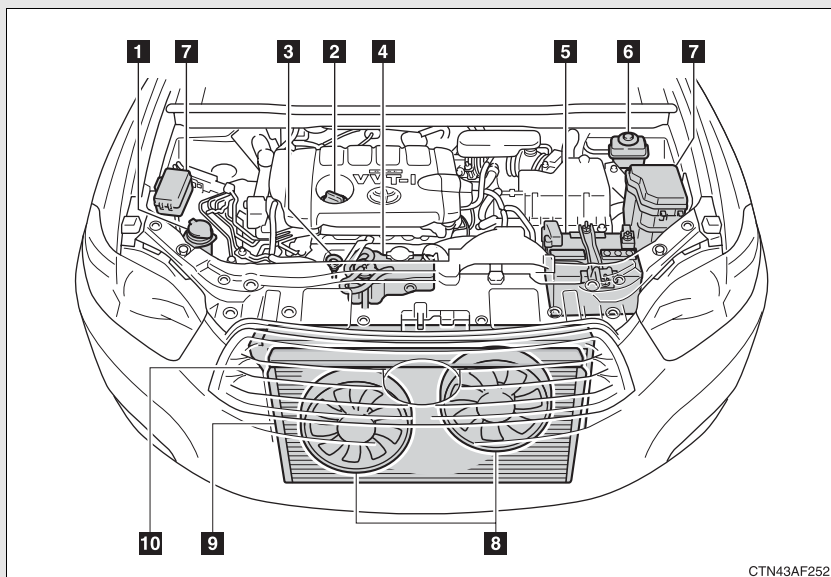

CTN43AF252

- |   |   |
|---|---|
| <b>1</b> Washer fluid tank (→P. 452)            | <b>5</b> Battery (→P. 449)                  |
| <b>2</b> Engine oil filler cap<br>(→P. 441)     | <b>6</b> Brake fluid reservoir<br>(→P. 448) |
| <b>3</b> Engine oil level dipstick<br>(→P. 440) | <b>7</b> Fuse boxes (→P. 475)               |
| <b>4</b> Engine coolant reservoir<br>(→P. 445)  | <b>8</b> Electric cooling fans              |
|   | <b>9</b> Condenser (→P. 447)                |
|   | <b>10</b> Radiator (→P. 447)                |

► 3.5 L V6 (2GR-FE) engine

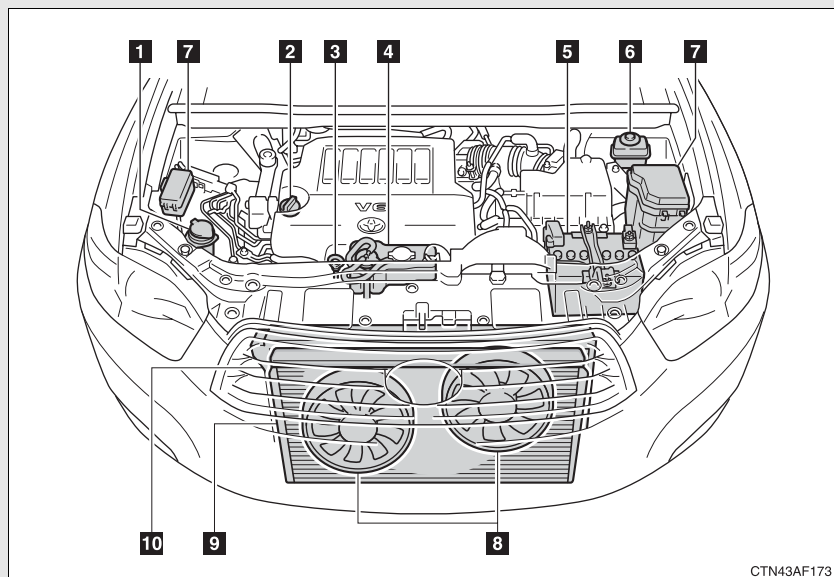

CTN43AF173

- |  |  |
|--|--|
| <b>1</b> Washer fluid tank (→P. 452)         | <b>5</b> Battery (→P. 449)               |
| <b>2</b> Engine oil filler cap (→P. 441)     | <b>6</b> Brake fluid reservoir (→P. 448) |
| <b>3</b> Engine oil level dipstick (→P. 440) | <b>7</b> Fuse boxes (→P. 475)            |
| <b>4</b> Engine coolant reservoir (→P. 445)  | <b>8</b> Electric cooling fans           |
|  | <b>9</b> Condenser (→P. 447)             |
|  | <b>10</b> Radiator (→P. 447)             |

## Engine compartment cover

### ■ Removing the engine compartment cover

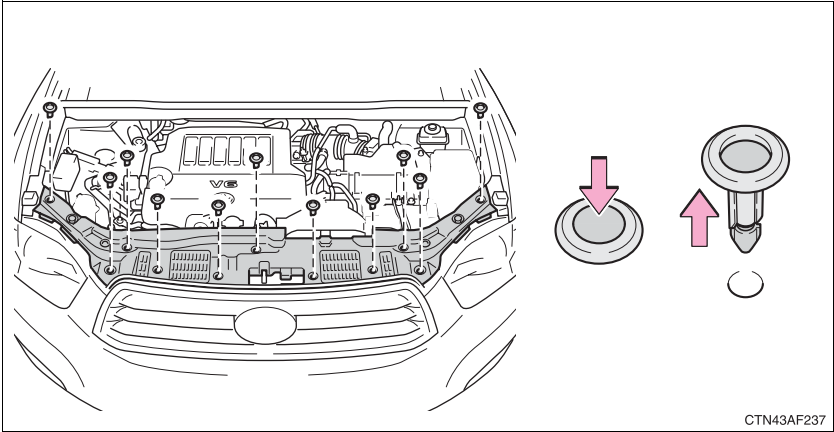

### ■ Installing the clips

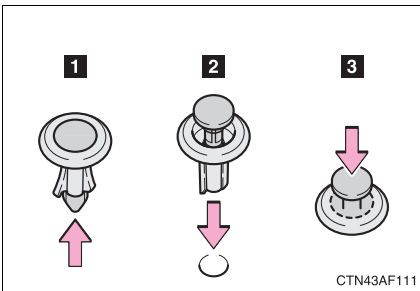

## Engine oil

With the engine at operating temperature and turned off, check the oil level on the dipstick.

### ■ Checking the engine oil

**STEP 1** Park the vehicle on level ground. After turning off the engine, wait more than five minutes for the oil to drain back into the bottom of the engine.

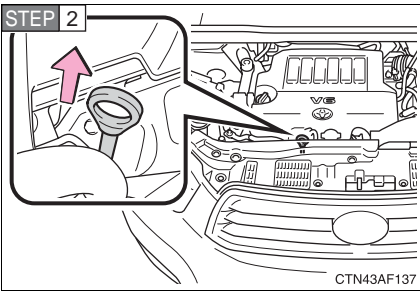

Hold a rag under the end and pull the dipstick out.

**STEP 3** Wipe the dipstick clean.

**STEP 4** Reinsert the dipstick fully.

**STEP 5** Holding a rag under the end, pull the dipstick out and check the oil level.

**STEP 6** Wipe the dipstick and reinsert it fully.

► 2.7 L 4-cylinder (1AR-FE) engine

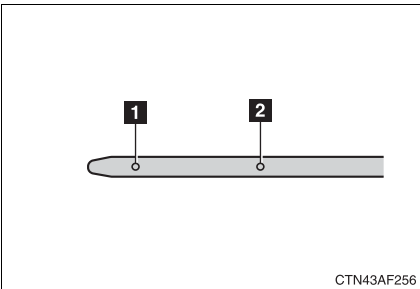

**1** Low

**2** Full

### ▶ 3.5 L V6 (2GR-FE) engine

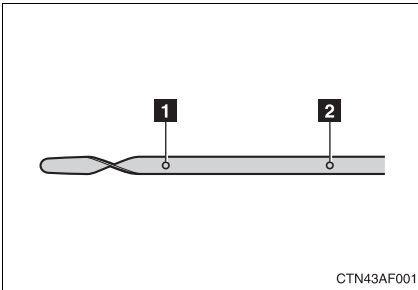

**1** Low

**2** Full

CTN43AF001

### ■ Adding engine oil

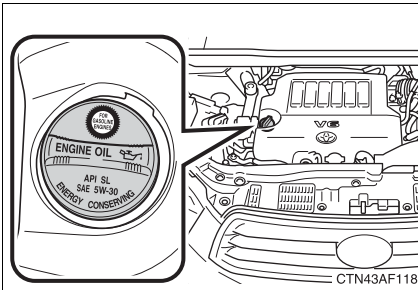

If the oil level is below or near the low level mark, add engine oil of the same type as already in the engine.

CTN43AF118

Make sure to check the oil type and prepare the items needed before adding oil.

Oil grade	ILSAC multi-grade engine oil
Items	Clean funnel

**STEP 1** Remove the oil filler cap.

**STEP 2** Add engine oil slowly, checking the dipstick.

**STEP 3** Install the filler cap, turning it clockwise.

The approximate quantity of oil needed to raise the level from low to full on the dipstick is indicated as follows:

1.6 qt. (1.5 L, 1.3 Imp. qt.)

■ Recommended viscosity (2.7 L 4-cylinder (1AR-FE) engine)

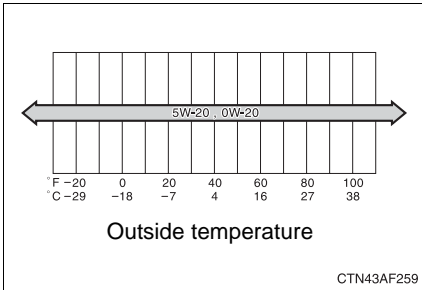

SAE 5W-20 or 0W-20 engine oil may be used. However, SAE 0W-20 is the best choice for good fuel economy and good starting in cold weather.

■ Recommended viscosity (3.5 L V6 (2GR-FE) engine)

▶ Without towing package

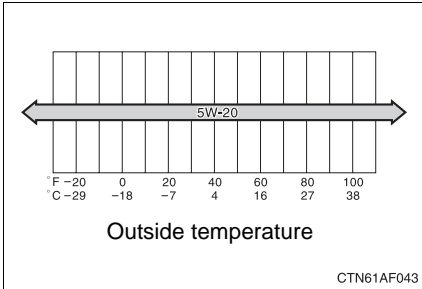

SAE 5W-20 is the best choice for good fuel economy, and good starting in cold weather.

▶ With towing package

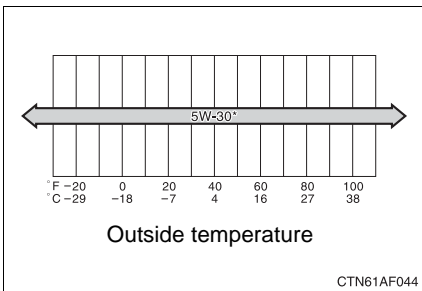

SAE 5W-30 is the best choice for good fuel economy, and good starting in cold weather.

\*: If SAE 5W-30 oil is not available, SAE 10W-30 oil may be used. However, it should be replaced with SAE 5W-30 at the next oil change.

## ■ How to read oil container labels

Some oil containers are labeled with ILSAC certification marks that help you to select the proper oil.

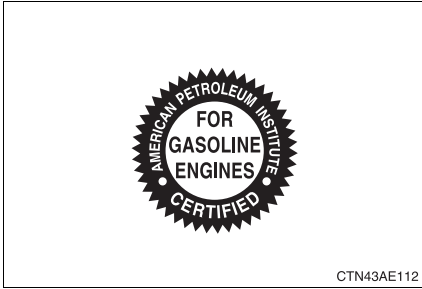

Oil identification mark

The ILSAC (International Lubricant Standardization and Approval Committee) Certification Mark is added to some oil containers to help you select the oil you should use.

## ■ Engine oil consumption

- The amount of engine oil consumed depends on the oil viscosity, the quality of the oil and the way the vehicle is driven.
- More oil is consumed under driving conditions such as high speeds and frequent acceleration and deceleration.
- A new engine consumes more oil.
- When judging the amount of oil consumption, keep in mind that the oil may have become diluted, making it difficult to judge the true level accurately.
- Oil consumption: Max. 1.1 qt./600 miles, 0.9 Imp. qt./600 miles (1.0 L per 1000 km)
- If your vehicle consume more than 1.1 qt. (1.0 L, 0.9 Imp. qt.) every 600 miles (1000 km), contact your Toyota dealer.

## ■ Changing the engine oil (U.S.A. only)

To reset the oil change system, follow the procedure below:

▶ Vehicles without smart key system

**STEP 1** Set the engine switch to the “LOCK” position with the trip meter A reading shown. (→P. 188)

**STEP 2** While pressing the trip meter reset button, set the engine switch to the “ON” position.

► Vehicles with smart key system

**STEP 1** Set the “ENGINE START STOP” switch OFF with the trip meter A reading shown. (→P. 188)

**STEP 2** While pressing the trip meter reset button, set the “ENGINE START STOP” switch to the IGNITION ON mode.

**STEP 3** Without multi-information display: Continue to press and hold the button until the trip meter displays “000000”.

With multi-information display: Continue to press and hold the button until “COMPLETE” appears on the multi-information display.

 **CAUTION**

■ **Used engine oil**

- Used engine oil contains potentially harmful contaminants which may cause skin disorders such as inflammation or skin cancer, so care should be taken to avoid prolonged and repeated contact. To remove used engine oil from your skin, wash thoroughly with soap and water.
- Dispose of used oil and filters only in a safe and acceptable manner. Do not dispose of used oil and filters in household trash, in sewers or onto the ground. Call your Toyota dealer, service station or auto parts store for information concerning recycling or disposal.
- Do not leave used engine oil within the reach of children.

 **NOTICE**

■ **To prevent serious engine damage**

Check the oil level on a regular basis.

■ **When replacing the engine oil**

- Be careful not to spill engine oil on the vehicle components.
- Avoid overfilling, as the engine could be damaged.
- Check the oil level on the dipstick every time you refill the vehicle.
- Be sure the engine oil filler cap is properly tightened.



## Engine coolant

The coolant level is satisfactory if it is between the “FULL” and “LOW” lines on the reservoir when the engine is cold.

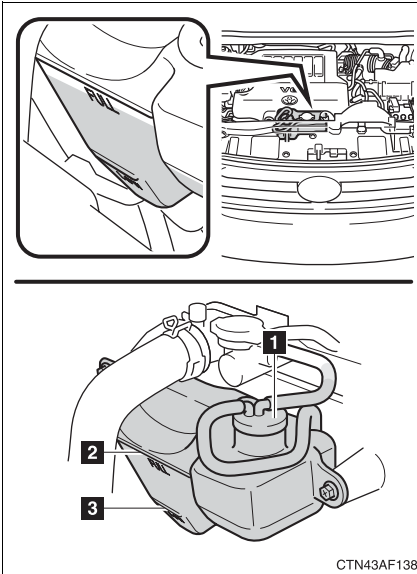

**1** Reservoir cap

**2** “FULL”

**3** “LOW”

If the level is on or below the “LOW” line, add coolant up to the “FULL” line.

■ **If the coolant level drops within a short time after replenishing**

Visually check the radiator, hoses, engine coolant filler cap, radiator cap, drain cock and water pump.

If you cannot find a leak, have your Toyota dealer pressure test the cap and check for leaks in the cooling system.

■ **Coolant selection**

Only use “Toyota Super Long Life Coolant” or similar high quality ethylene glycol based non-silicate, non-amine, non-nitrite, and non-borate coolant with long-life hybrid organic acid technology.

U.S.A.: Toyota Super Long Life Coolant is a mixture of 50% coolant and 50% deionized water. (Enabled: -31°F [-35°C])

Canada: Toyota Super Long Life Coolant is a mixture of 55% coolant and 45% deionized water. (Enabled: -44°F [-42°C])

For more details about engine coolant, contact your Toyota dealer.

 **CAUTION**

■ **When the engine is hot**

Do not remove the coolant reservoir cap.

The cooling system may be under pressure and may spray hot coolant if the cap is removed, causing burns or other injuries.

 **NOTICE**

■ **When adding engine coolant**

Coolant is neither plain water nor straight antifreeze. The correct mixture of water and antifreeze must be used to provide proper lubrication, corrosion protection and cooling. Be sure to read the antifreeze or coolant label.

■ **If you spill coolant**

Be sure to wash it off with water to prevent damage to parts or paint.

## Radiator and condenser

Check the radiator and condenser, and clear any foreign objects. If either of the above parts are extremely dirty or you are not sure of their condition, have your vehicle checked by your Toyota dealer.

### CAUTION

#### ■ When the engine is hot

Do not touch the radiator or condenser as they may be hot and may cause burns.

#### ■ When the electric cooling fan is operating

Do not touch the engine compartment.

Vehicles without smart key system: The electric cooling fans may keep rotating for about 3 minutes after the engine switch is turned to the "LOCK" position.

With the engine switch in the "ON" position, the electric cooling fans may automatically start to run if the air conditioning is on and/or the coolant temperature is high. Be sure the engine switch is in the "LOCK" position when working near the electric cooling fan or radiator grille.

Vehicles with smart key system: The electric cooling fan may keep rotating for about 3 minutes even after the "ENGINE START STOP" switch is OFF.

With the "ENGINE START STOP" switch in IGNITION ON mode, the electric cooling fans may automatically start to run if the air conditioning is on and/or the coolant temperature is high. Be sure the "ENGINE START STOP" switch is OFF when working near the electric cooling fans or radiator grille.

## Brake fluid

### ■ Checking fluid level

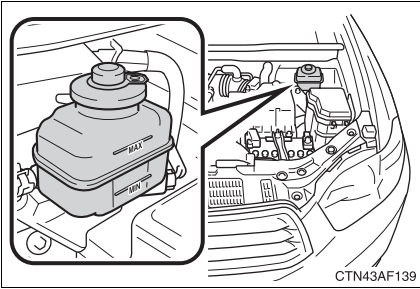

The brake fluid level should be between the “MAX” and “MIN” lines on the tank.

Make sure to check the fluid type and prepare the necessary items.

### ■ Adding fluid

Fluid type	SAE J1703 or FMVSS No.116 DOT 3
Items	Clean funnel

### ■ Brake fluid can absorb moisture from the air

Excess moisture in the fluid can cause a dangerous loss of braking efficiency. Use only newly opened brake fluid.

## ⚠ CAUTION

### ■ When filling the reservoir

Take care because brake fluid can harm your hands or eyes and damage painted surfaces.

If fluid gets in your eyes, flush your eyes with clean water immediately.

If you still experience discomfort, see a doctor.

 NOTICE

■ If the fluid level is low or high

It is normal for the brake fluid level to go down slightly as the brake pads wear or when the fluid level in the accumulator is high.

If the reservoir needs frequent refilling, it may indicate a serious problem.

## Battery

### ■ Battery exterior

Make sure that the battery terminals are not corroded and that there are no loose connections, cracks, or loose clamps.

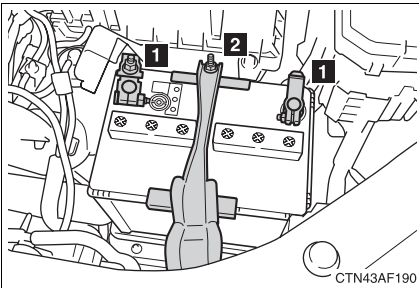

**1** Terminals

**2** Hold-down clamp

### ■ Checking battery condition

Check the battery condition using the indicator color.

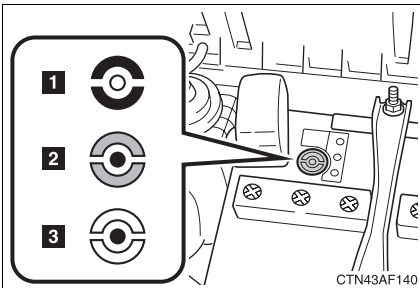

**1** Red: Not working properly, have the battery checked by your Toyota dealer.

**2** Blue: Good condition

**3** White: Charging is necessary. Have the vehicle inspected by your Toyota dealer.

### ■ Before recharging

When recharging, the battery produces hydrogen gas which is flammable and explosive. Therefore, before recharging:

- If recharging with the battery installed on the vehicle, be sure to disconnect the ground cable.
- Make sure the power switch on the charger is off when connecting and disconnecting the charger cables to the battery.

### ■ After recharging the battery (vehicles with smart key system)

The engine may not start. Follow the procedure below to initialize the system.

**STEP 1** Shift the shift lever to P.

**STEP 2** Open and close any of the doors.

**STEP 3** Restart the engine.

## CAUTION

### ■ Chemicals in the battery

A battery contains poisonous and corrosive sulfuric acid and may produce hydrogen gas which is flammable and explosive. To reduce the risk of death or serious injury, take the following precautions while working on or near battery:

- Do not cause sparks by touching the battery terminals with tools.
- Do not smoke or light a match near the battery.
- Avoid contact with eyes, skin and clothes.
- Never inhale or swallow electrolyte.
- Wear protective safety glasses when working near the battery.
- Keep children away from the battery.

### ■ Where to safety charge the battery

Always charge the battery in an open area. Do not charge the battery in a garage or closed room where there is not sufficient ventilation.

 **CAUTION****■ How to recharge the battery**

Only perform a slow charge (5 A or less). The battery may explode if charged at a quicker rate.

**■ Emergency measures regarding electrolyte****● If electrolyte gets in your eyes**

Flush your eyes with clean water for at least 15 minutes and get immediate medical attention. If possible, continue to apply water with a sponge or cloth while traveling to the nearest medical facility.

**● If electrolyte gets on your skin**

Wash the affected area thoroughly. If you feel pain or burning, get medical attention immediately.

**● If electrolyte gets on your clothes**

It can soak through clothing on to your skin. Immediately take off the clothing and follow the procedure above if necessary.

**● If you accidentally swallow electrolyte**

Drink a large quantity of water or milk. Follow with milk of magnesia, beaten raw egg or vegetable oil. Get emergency medical attention immediately.

 **NOTICE****■ When recharging the battery**

Never recharge the battery while the engine is running. Also, be sure all accessories are turned off.

## Washer fluid

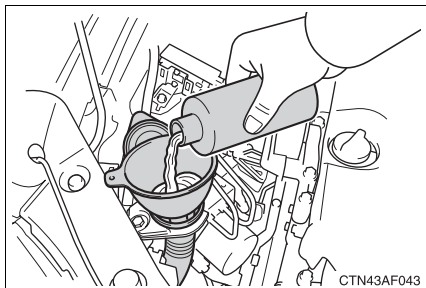

Add washer fluid in the following situations.

- Any washer does not work.
- The low washer fluid warning light comes on (vehicles without multi-information display).
- The warning message appears on the multi-information display (vehicles with multi-information display).

### CAUTION

#### ■ When adding the washer fluid

Do not add the washer fluid when the engine is hot or running, as the washer fluid contains alcohol and may catch fire if spilled on the engine etc.

### NOTICE

#### ■ Do not use any fluid other than washer fluid

Do not use soapy water or engine antifreeze instead of washer fluid. Doing so may cause streaking on the vehicle's painted surfaces.

#### ■ Diluting washer fluid

Dilute washer fluid with water as necessary. Refer to the freezing temperatures listed on the washer fluid tank.



# Tires

Replace or rotate tires in accordance with maintenance schedules and treadwear.

## ■ Checking tires

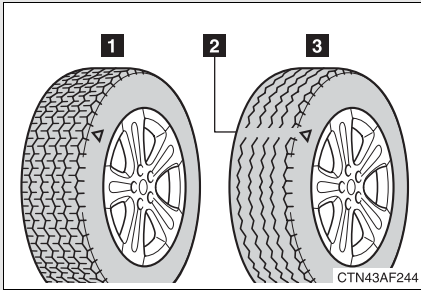

- 1 New tread
- 2 Treadwear indicator
- 3 Worn tread

The location of treadwear indicators is shown by the “TWI” or “△” marks, etc., molded on the sidewall of each tire.

Check spare tire condition and inflation pressure if not rotated.

## ■ Tire rotation

► Vehicles without compact spare tire

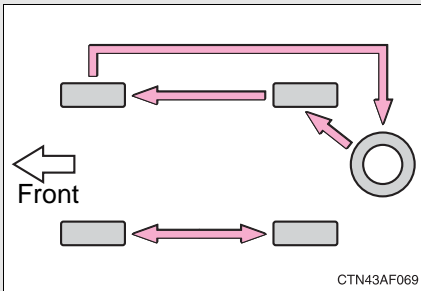

Rotate the tires in the order shown.

To equalize tire wear and extend tire life, Toyota recommends that tire rotation is carried out at the same interval as tire inspection.

► Vehicles with compact spare tire

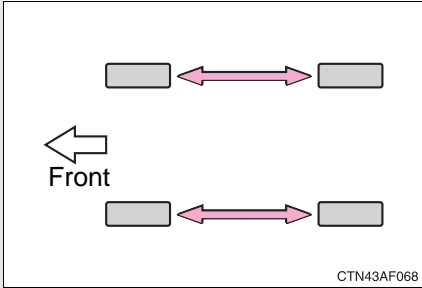

Rotate the tires in the order shown.

To equalize tire wear and extend tire life, Toyota recommends that tire rotation is carried out at the same interval as tire inspection.

■ The tire pressure warning system

Your Toyota is equipped with a tire pressure warning system that uses tire pressure warning valves and transmitters to detect low tire inflation pressure before serious problems arise. (→P. 513, 521)

Vehicles with compact spare tire: The compact spare tire is not equipped with the tire pressure warning valve and transmitters.

### Installing tire pressure warning valves and transmitters

When replacing tires or wheels, tire pressure warning valves and transmitters must also be installed.

When new tire pressure warning valves and transmitters are installed, new tire pressure warning valve and transmitter ID codes must be registered in the tire pressure warning computer and the tire pressure warning system must be initialized. Have tire pressure warning valve and transmitter ID codes registered by your Toyota dealer. (→P. 457)

### Initializing the tire pressure warning system

- **The tire pressure warning system must be initialized when the tire inflation pressure is changed (such as when changing traveling speed or towing a trailer.)**

When the tire pressure warning system is initialized, the current tire inflation pressure is set as the benchmark pressure.

- **How to initialize the tire pressure warning system**

**STEP 1** Park the vehicle in safe place and turn the “ENGINE START STOP” switch or the engine switch OFF.

While the vehicle is moving, initialization is not performed.

**STEP 2** Adjust the tire inflation pressure to the specified cold tire inflation pressure level. (→P. 562)

Make sure to adjust the tire pressure to the specified cold tire inflation pressure level. The tire pressure warning system will operate based on this pressure level.

**STEP 3** Turn the “ENGINE START STOP” switch to IGNITION ON mode (vehicles with smart key system) or the engine switch to the “ON” position (vehicles without smart key system).

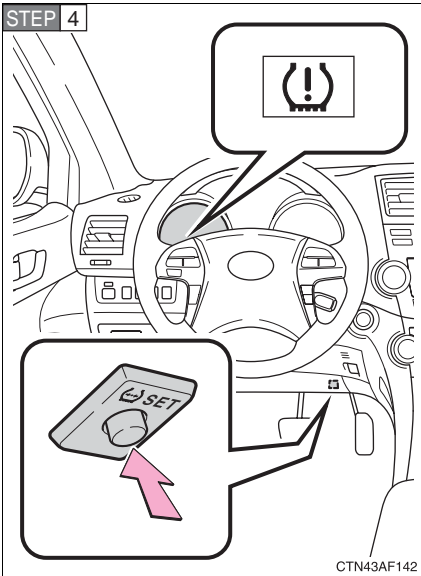

Push and hold the tire pressure warning reset switch until the tire pressure warning light blinks slowly 3 times.

► Vehicles without smart key system

**STEP 5** Wait for a few minutes with the engine switch in the “ON” position, and then turn the engine switch to the “LOCK” position.

► Vehicles with smart key system

**STEP 5** Wait for a few minutes with IGNITION ON mode, and then turn the “ENGINE START STOP” switch OFF.

## Registering ID codes

The tire pressure warning valve and transmitter is equipped with a unique ID code. When replacing a tire pressure warning valve and transmitter, it is necessary to register the ID code of tire pressure warning valve and transmitter. Have the ID code registered by your Toyota dealer.

### ■ When to replace your vehicle's tires

Tires should be replaced if:

- You have tire damage such as cuts, splits, cracks deep enough to expose the fabric, or bulges indicating internal damage
- A tire goes flat repeatedly or cannot be properly repaired due to the size or location of a cut or other damage

If you are not sure, consult with your Toyota dealer.

### ■ Replacing tires and wheels

If the ID code of the tire pressure warning valve and transmitter is not registered, the tire pressure warning system will not work properly. After driving for about 20 minutes, the tire pressure warning light comes on after blinking for 1 minute to indicate a system malfunction.

### ■ Tire life

Any tire over 6 years old must be checked by a qualified technician even if they have seldom or never been used or damage is not obvious.

### ■ If the tread wears down below 0.16 in. (4 mm) on snow tires

The effectiveness of snow tires is lost.

### ■ When the tire pressure warning valves and transmitter are removed from the wheel on occasions such as when replacing tires

The tire inflation pressure data updated before servicing is retained.

### ■ Maximum load of tire

Check that the maximum load of the replaced tire is greater than 1/2 of the Gross Axle Weight Ratings (GAWR) of either the front axle or the rear axle, whichever is greater.

As for the maximum load of the tire, see the load limit at maximum cold tire inflation pressure mentioned on the sidewall of the tire, and as for the Gross Axle Weight Ratings (GAWR), see the Certification Label.

(→P. 463, 570).

### ■ Tire types

#### 1 Summer tires

Summer tires are high-speed performance tires best suited to highway driving under dry conditions. Since summer tires do not have the same traction performance as snow tires, summer tires are inadequate for driving on snow-covered or icy roads. For driving on snow-covered roads or icy roads, the use of snow tires is recommended. When installing snow tires, be sure to replace all four tires.

#### 2 All season tires

All season tires are designed to provide better traction in snow and to be adequate for driving in most winter conditions, as well as for use year round. All season tires, however, do not have adequate traction performance compared with snow tires in heavy or loose snow. Also, all season tires fall short in acceleration and handling performance compared with summer tires in highway driving.

#### 3 Snow tires

For driving on snow-covered roads or icy roads, we recommend using snow tires. If you need snow tires, select tires of the same size, construction and load capacity as the originally installed tires. Since your vehicle has radial tires as original equipment, make sure your snow tires also have radial construction. Do not install studded tires without first checking local regulations for possible restriction. Snow tires should be installed on all wheels. (→P. 238)

**■ Initializing the tire pressure warning system**

Initialize the tire pressure warning system with the tire inflation pressure adjusted to the specified level.

**■ If you push the tire pressure warning reset switch accidentally**

If initialization is performed, adjust the tire inflation pressure to the specified level and initialize the tire pressure warning system again.

**■ When the initialization of the tire pressure warning system has failed**

Initialization can be completed in a few minutes. However, in the following cases, the settings have not been recorded and the system will not operate properly. If repeated attempts to record tire inflation pressure settings are unsuccessful, have the vehicle inspected by your Toyota dealer.

- When operating the tire pressure warning reset switch, the tire pressure warning light does not flash 3 times.
- After carrying out the initialization procedure, the tire pressure warning light blinks for 1 minute then stays on after driving for about 20 minutes.

**■ Routine tire inflation pressure checks**

The tire pressure warning system does not replace routine tire inflation pressure checks. Make sure to check tire inflation pressure as part of your routine of daily vehicle checks.

### ■ Tire pressure warning system certification

► For vehicles sold in the U.S.A.

This device complies with Part 15 of the FCC Rules. Operation is subject to the following two conditions: (1) this device may not cause harmful interference, and (2) this device must accept any interference received, including interference that may cause undesired operation.

FCC ID: PAXPMV107J

IC ID: 3729A-PMV107J

FCC ID: HYQ13BCX

IC ID: 1551A-13BCX

**FCC WARNING:**

Changes or modifications not expressly approved by the party responsible for compliance could void the user's authority to operate the equipment.

► For vehicles sold in Canada

Operation is subject to the following two conditions: (1) this device may not cause interference, and (2) this device must accept any interference, including interference that may cause undesired operation of the device.



 **CAUTION****■ When inspecting or replacing tires**

Observe the following precautions to prevent accidents. Failure to do so may cause damage to parts of the drive train, as well as dangerous handling characteristics, which may lead to an accident resulting in death or serious injury.

- Do not mix tires of different makes, models, tread patterns or tread-wear.
- Do not use tire sizes other than those recommended by Toyota.
- Do not mix radial, bias-belted, or bias-ply tires.
- Do not mix summer, all season and winter tires.
- Do not tow the vehicle with the spare tire installed.

**■ When initializing the tire pressure warning system**

Do not push the tire pressure warning reset switch without first adjusting the tire inflation pressure to the specified level. Otherwise, the tire pressure warning light may not come on even if the tire inflation pressure is low, or it may come on when the tire inflation pressure is actually normal.

 NOTICE

■ **Repairing or replacing tires, wheels and tire pressure warning valves and transmitters**

When removing or fitting the wheels, tires or the tire pressure warning valve and transmitter, contact your Toyota dealer as the tire pressure warning valve and transmitter may be damaged if not handled correctly.

■ **To avoid damaging the tire pressure warning valves and transmitters**

Do not use liquid sealants on flat tires.

■ **Do not use puncture sealant sprays to repair flats**

Puncture sealant sprays may damage tire pressure warning valves and transmitters.

■ **Driving on rough roads**

Take particular care when driving on roads with loose surfaces or potholes.

These conditions may cause losses in tire inflation pressure, reducing the cushioning ability of the tires. In addition, driving on rough roads may cause damage to the tires themselves, as well as the vehicle's wheels and body.

■ **If tire inflation pressures become low while driving**

Do not continue driving, or your tires and/or wheels may be ruined.

## 4-3. Do-it-yourself maintenance

### Tire inflation pressure

#### ■ Tire inflation pressure

The recommended cold tire inflation pressure and tire size is displayed on the tire and loading information label. (→P. 570)

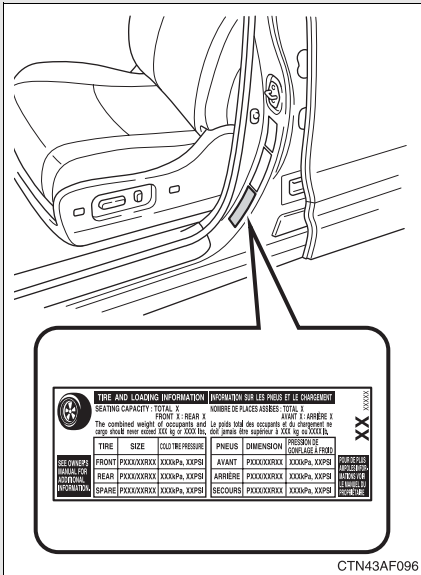

### ■ Inspection and adjustment procedure

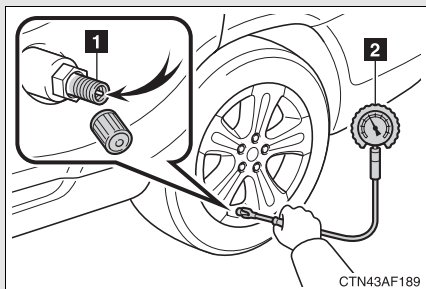

- 1 Tire valve
- 2 Tire pressure gauge

**STEP 1** Remove the tire valve cap.

**STEP 2** Press the tip of the tire pressure gauge onto the tire valve.

**STEP 3** Read the pressure using the graduations of the gauge.

**STEP 4** If the tire inflation pressure is not within the recommended levels, adjust the pressure.

If you add too much air, press the center of the valve to lower.

**STEP 5** After completing the tire inflation pressure measurement and adjustment, apply soapy water to the valve and check for leakage.

**STEP 6** Reinstall the tire valve cap.

### ■ Tire inflation pressure check interval

You should check tire inflation pressure every two weeks, or at least once a month.

Do not forget to check the spare.

**■ Effects of incorrect tire inflation pressure**

Driving with incorrect tire inflation pressure may result in the following:

- Reduced fuel efficiency
- Reduced driving comfort and tire life
- Reduced safety
- Damage to the drive train

If a tire needs frequent refilling, have it checked by your Toyota dealer.

**■ Instructions for checking tire inflation pressure**

When checking tire inflation pressure, observe the following:

- Check only when the tires are cold.  
If your vehicle has been parked for at least 3 hours and has not been driven for more than 1 mile or 1.5 km, you will get an accurate cold tire inflation pressure reading.
- Always use a tire pressure gauge.  
The appearance of the tire can be misleading. In addition, tire inflation pressures that are even just a few pounds off can degrade ride and handling.
- Do not bleed or reduce tire inflation pressure after driving. It is normal for the tire inflation pressure to be higher after driving.
- Never exceed the vehicle capacity weight.  
Passengers and luggage weight should be placed so that the vehicle is balanced.

 CAUTION

■ **Proper inflation is critical to save tire performance**

Keep your tires properly inflated.

Otherwise, the following conditions may occur and result in an accident causing death or serious injury.

- Excessive wear
- Uneven wear
- Poor handling
- Possibility of blowouts resulting from overheated tires
- Poor sealing of the tire bead
- Wheel deformation and/or tire separation
- A greater possibility of tire damage from road hazards

 NOTICE

■ **When inspecting and adjusting tire inflation pressure**

Be sure to reinstall the tire valve caps.

Without the valve caps, dirt or moisture could get into the valve and cause air leakage, which could result in an accident. If the caps have been lost, replace them as soon as possible.

## Wheels

**If a wheel is bent, cracked or heavily corroded, it should be replaced.**

**Otherwise, the tire may separate from the wheel or cause loss of handling control.**

### ■ Wheel selection

When replacing wheels, care should be taken to ensure that they are equivalent to those removed in load capacity, diameter, rim width, and offset.

Replacement wheels are available at your Toyota dealer.

Toyota does not recommend using:

- Wheels of different sizes or types
- Used wheels
- Bent wheels that have been straightened

### ■ Aluminum wheel precautions

- Use only Toyota wheel nuts and wrenches designed for use with your aluminum wheels.
- When rotating, repairing or changing your tires, check that the wheel nuts are still tight after driving 1000 miles (1600 km).
- Be careful not to damage the aluminum wheels when using tire chains.
- Use only Toyota genuine balance weights or equivalent and a plastic or rubber hammer when balancing your wheels.

### ■ When replacing wheels

The wheels of your Toyota are equipped with tire pressure warning valves and transmitters that allow the tire pressure warning system to provide advanced warning in the event of a loss in tire inflation pressure. Whenever wheels are replaced, the tire pressure warning valves and transmitters must be installed. (→P. 455)

 CAUTION

■ **When replacing wheels**

- Do not use wheels that are a different size from those recommended in the Owner's Manual, as this may result in loss of handling control.
- Never use an inner tube in a leaking wheel which is designed for a tubeless tire. Doing so may result in an accident, causing serious injury or death.

 NOTICE

■ **Replacing tire pressure warning valves and transmitters**

- Because tire repair or replacement may affect the tire pressure warning valves and transmitters, make sure to have tires serviced by your Toyota dealer or other qualified service shop. In addition, make sure to purchase your tire pressure warning valves and transmitters at your Toyota dealer.
- Ensure that only genuine Toyota wheels are used on your vehicle. Tire pressure warning valves and transmitters may not work properly with non-genuine wheels.



## 4-3. Do-it-yourself maintenance

### Air conditioning filter

The air conditioning filter must be changed regularly to maintain air conditioning efficiency.

#### ■ Removal method

**STEP 1** Vehicles without smart key system: Turn the engine switch OFF.

Vehicles with smart key system: Turn the “ENGINE START STOP” switch OFF.

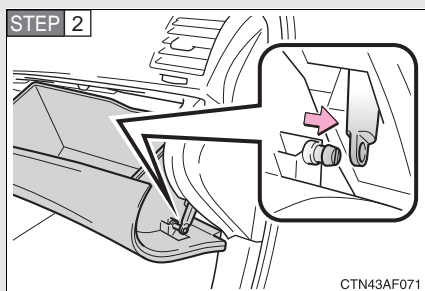

Open the glove box. Slide off the damper.

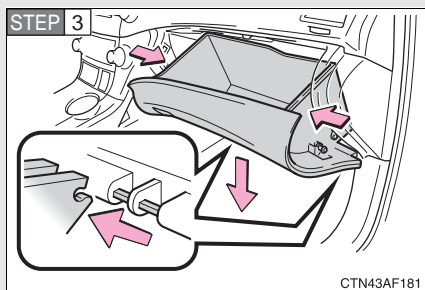

Push each side of the glove box to release the pins. Then disconnect the claws at the bottom and remove the glove box.

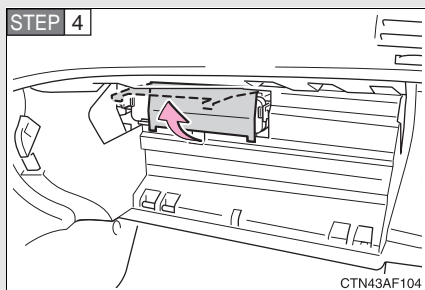

Lift up the cover.

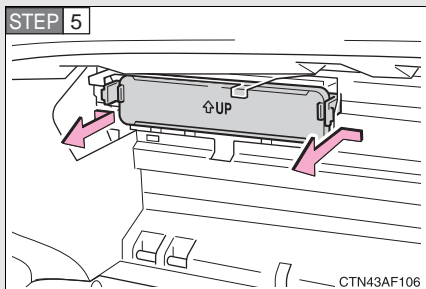

Remove the filter cover.

### ■ Replacement method

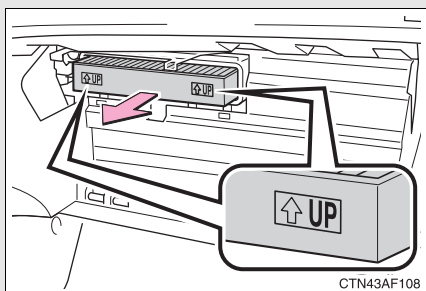

Remove the air conditioning filter and replace it with a new one.

The “↑UP” marks shown on the filter should be pointing up.

### ■ Checking interval

Inspect and replace the air conditioning filter according to the maintenance schedule. In dusty areas or areas with heavy traffic flow, replacement may be required. (For scheduled maintenance information, please refer to the “Scheduled Maintenance Guide” or “Owner’s Manual Supplement”.)

### ■ If air flow from the vents decreases dramatically

The filter may be clogged. Check the filter and replace if necessary.

 NOTICE**■ When using the air conditioning system**

Make sure that a filter is always installed.

Using the air conditioning system without a filter may cause damage to the system.

**Replace the battery with a new one if it is discharged.**

■ **You will need the following items:**

- Flathead screwdriver (To prevent damage to the key, cover the tip of the screwdriver with a rag.)
- Small Phillips-head screwdriver
- Lithium battery CR2032 (vehicles without smart key system), CR1632 (vehicles with smart key system)

■ **Replacing the battery (vehicles without smart key system)**

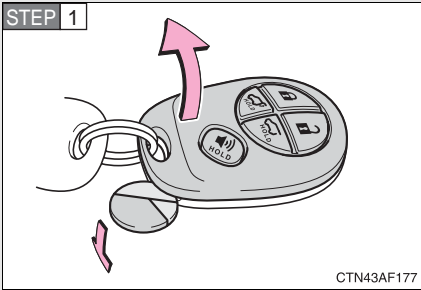

Remove the cover using a coin protected with tape etc.

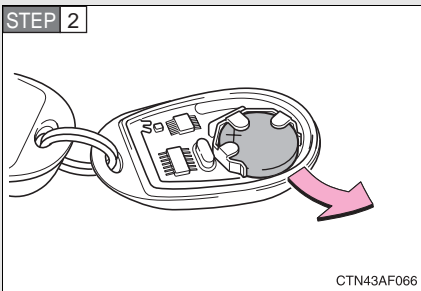

Remove the discharged transmitter battery.

Insert a new battery with the "+" terminal facing up.

### ■ Replacing the battery (vehicles with smart key system)

STEP 1

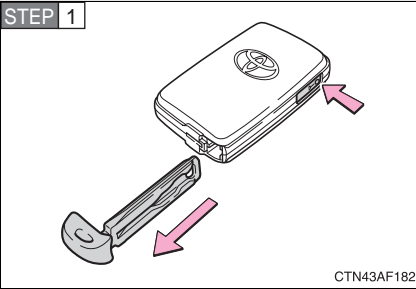

Take out the mechanical key.

STEP 2

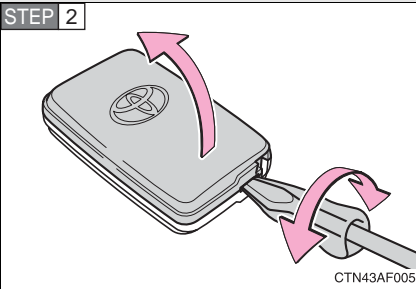

Remove the cover.

STEP 3

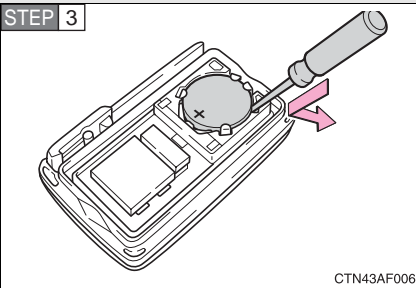

Remove the depleted battery.

Insert a new battery with the “+” terminal facing up.

■ **If the electronic key battery is discharged**

The following symptoms may occur.

- The smart key system and wireless remote control will not function properly.
- The operational range is reduced.

■ **Use a CR2032 (vehicles without smart key system) or CR1632 (vehicles with smart key system) lithium battery**

- Batteries can be purchased at your Toyota dealer, jewelers, or camera stores.
- Replace only with the same or equivalent type recommended by your Toyota dealer.
- Dispose of used batteries according to the local laws.

 **CAUTION**

■ **Removed battery and other parts**

Keep away from children.

These parts are small and if swallowed by a child they can cause choking.

 **NOTICE**

■ **For normal operation after replacing the battery**

Observe the following precautions to prevent accidents.

- Always work with dry hands.  
Moisture may cause the battery to rust.
- Do not touch or move any other components inside the remote control.
- Do not bend either of the battery terminals.

## 4-3. Do-it-yourself maintenance

### Checking and replacing fuses

**If any of the electrical components do not operate, a fuse may have blown. If this happens, check and replace the fuses as necessary.**

**STEP 1** Vehicles without smart key system: Turn the engine switch OFF.

Vehicles with smart key system: Turn the “ENGINE START STOP” switch OFF.

**STEP 2** Open the fuse box cover.

#### ► Engine compartment

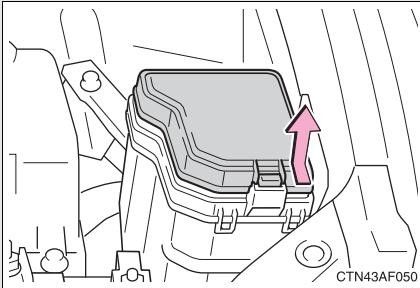

Type A: Push the tab in and lift the fuse box cover off.

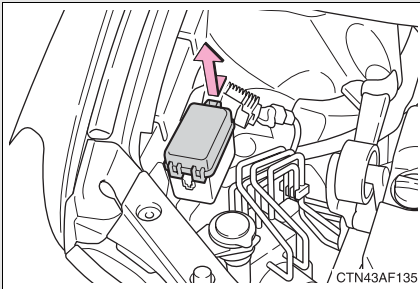

Type B: Push the tab in and lift the fuse box cover off. (if equipped)

► Under the instrument panel

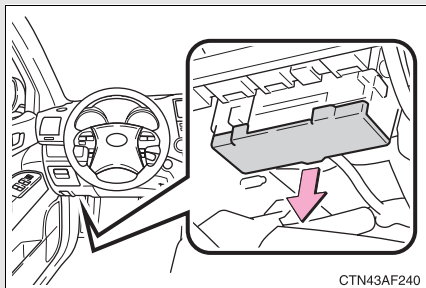

Remove the lid.

**STEP 3** After a system failure, see “Fuse layout and amperage ratings” (→P. 478) for details about which fuse to check.

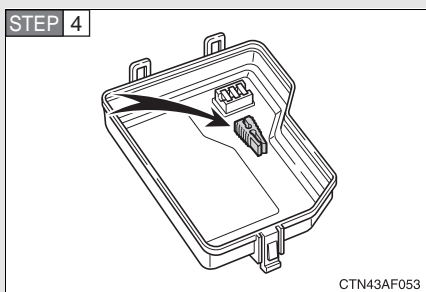

Remove the fuse with the pull-out tool.

**STEP 5** Check if the fuse has blown.

► Type A

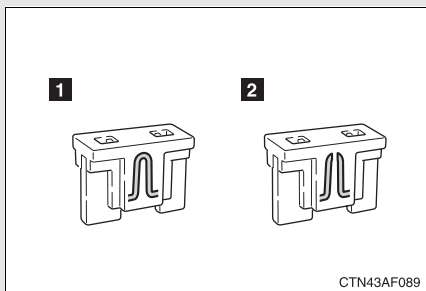

**1** Normal fuse

**2** Blown fuse

Replace it with one of an appropriate amperage rating. The amperage rating can be found on the fuse box lid.

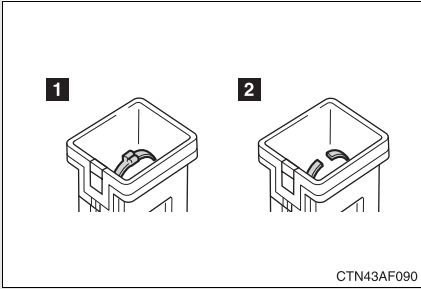

## ▶ Type B

**1** Normal fuse**2** Blown fuse

Replace it with one of an appropriate amperage rating. The amperage rating can be found on the fuse box lid.

## ▶ Type C

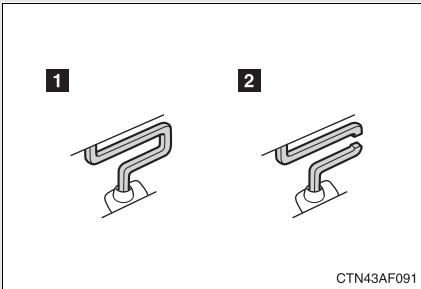
**1** Normal fuse**2** Blown fuse

Contact your Toyota dealer.

## ▶ Type D

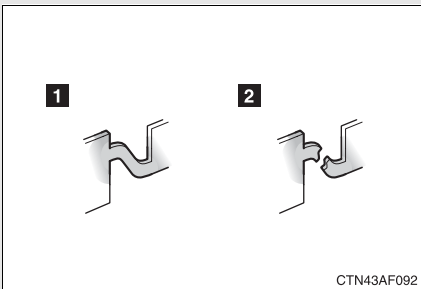
**1** Normal fuse**2** Blown fuse

Contact your Toyota dealer.

**Fuse layout and amperage ratings**

■ **Engine compartment**

► Type A (fuse block on the back of the cover)

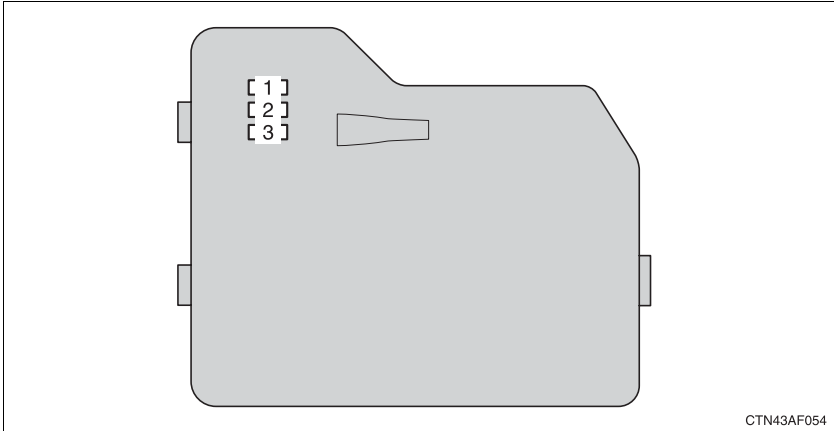

CTN43AF054

► Type A (fuse block)

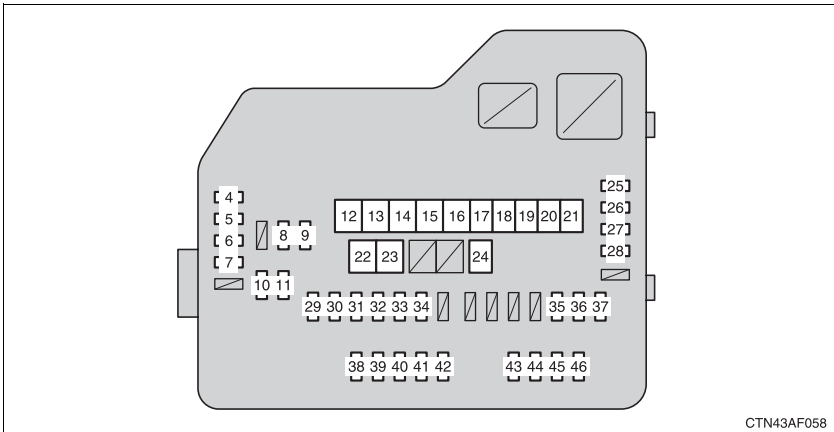

CTN43AF058

Fuse		Ampere	Circuit
1	SPARE	7.5 A	Spare fuse
2	SPARE	15 A	Spare fuse
3	SPARE	25 A	Spare fuse

Fuse		Ampere	Circuit
4	DEF RLY	10 A	Rear window defogger
5	MIR HTR	20 A	MIR HTR (15 A)
6	P/OUT	20 A	Power outlet
7	DOOR 1	25 A	Multiplex communication system
8	EFI NO.2	10 A	Multiport fuel injection system/ sequential multiport fuel injection system
9	EFI NO.3	10 A	Multiport fuel injection system/ sequential multiport fuel injection system
10	INJ NO.1	15 A	Starting system
11	INJ NO.2	10 A	Starting system
12	HTR	50 A	Air conditioning system
13	VSC NO.1	50 A	Enhanced vehicle stability control system
14	FAN MAIN	50 A	Electric cooling fan
15	VSC NO.2	30 A	Enhanced vehicle stability control system
16	PTC NO.1	50 A	PTC heater
17	PTC NO.2	30 A	PTC heater
18	PTC NO.3	30 A	PTC heater
19	RR CLR	40 A	Air conditioning system
20	RR DEF	30 A	Rear window defogger
21	PBD	30 A	Power back door
22	ALT	140 A	MIR HTR, P/OUT, DOOR 1, HTR, RR DEF, FAN MAIN, ABS NO.1, PTC NO.1, RR CLR, PTC NO.2, PTC NO.3, ABS NO.2, PBD
23	EPS	80 A	Electric power steering
24	ST	30 A	Starting system

Fuse		Ampere	Circuit
25	CRT	10 A	Rear seat entertainment system
26	RADIO1	15 A	Audio system
27	ECU-B	10 A	Steering sensor, gauges and meters, clock, air conditioning system, main body ECU, wireless remote control, smart key system, power back door, on-board diagnosis system
28	DOME	10 A	Vanity lights, personal lights, interior light, gauges and meters, engine switch light, door courtesy lights, power back door
29	AMP	15 A	Audio system
30	TOWING	30 A	Trailer lights
31	IG2	25 A	INJ NO.1, INJ NO.2
32	STR LOCK	20 A	Steering lock system
33	EFI MAIN	25 A	EFI NO.2, EFI NO.3
34	HAZ	15 A	Turn signal lights
35	G/H	10 A	Power door lock system, multiplex communication system
36	ALT-S	7.5 A	Charging system
37	AM2	7.5 A	Multiplex communication system
38	H-LP LH	15 A	Left-hand headlight (high beam)
39	H-LP RH	15 A	Right-hand headlight (high beam)
40	H-LP LL	15 A	Left-hand headlight (low beam)
41	H-LP RL	15 A	Right-hand headlight (low beam)
42	HORN	10 A	Horn
43	EFI NO.1	10 A	Multiport fuel injection system/ sequential multiport fuel injection system, smart key system

Fuse		Ampere	Circuit
44	ETCS	10 A	Multiport fuel injection system/ sequential multiport fuel injection system, electronic throttle control system
45	A/F	20 A	Air fuel ratio sensor
46	S-HORN	7.5 A	Horn

► Type B (if equipped)

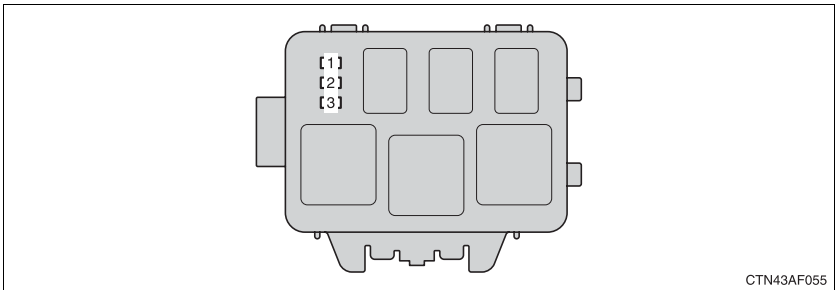

Fuse		Ampere	Circuit
1	INV-W/P	15 A	No circuit
2	IGCT NO.2	7.5 A	No circuit
3	A/C-D	10 A	No circuit

■ Under the instrument panel

► Front side of the fuse block

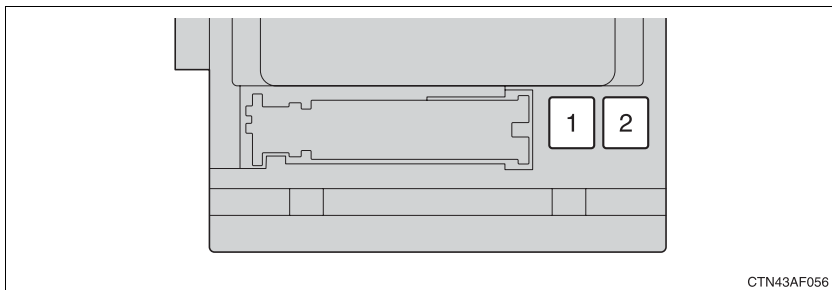

CTN43AF056

► Fuse block

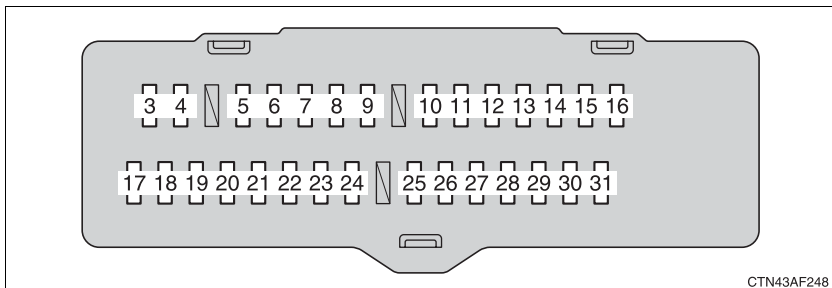

CTN43AF248

Fuse		Ampere	Circuit
1	P/SEAT	30 A	Power seat
2	POWER	30 A	Power windows
3	RR DOOR RH	25 A	Power windows
4	RR DOOR LH	25 A	Power windows
5	FR FOG	15 A	Front fog lights
6	OBD	7.5 A	On-board diagnosis system
7	FR DEF	25 A	Windshield wiper deicer
8	STOP	10 A	Stop lights, enhanced vehicle stability control system
9	DOOR NO.2	25 A	Power windows
10	AM1	7.5 A	Starting system

Fuse		Ampere	Circuit
11	RR FOG	7.5 A	No circuit
12	A/C NO.1	10 A	Air conditioning system
13	FUEL OPN	7.5 A	No circuit
14	S/ROOF	30 A	Electric moon roof
15	TAIL	15 A	Parking lights, tail lights, license plate lights, front fog lights, trailer lights
16	PANEL	7.5 A	Glove box light, emergency flashers, audio system, outside rear view mirror defoggers, clock, power door lock system, seat heaters, rear seat entertainment system, enhanced vehicle stability control system, instrument panel light control dial, electronic controlled transmission switch, automatic transmission, downhill assist control system, steering switches
17	ECU IG NO.1	10 A	Multiplex communication system, electric moon roof, electronically controlled automatic transmission system, power back door, seat heaters, tire pressure warning system, electronic power steering, automatic transmission
18	ECU IG NO.2	7.5 A	Enhanced vehicle stability control system
19	A/C NO.2	10 A	Air conditioning system
20	WASH	20 A	Windshield wipers and washer
21	S-HTR	20 A	Seat heaters

#### 4-3. Do-it-yourself maintenance

Fuse		Ampere	Circuit
22	GAUGE NO.1	10 A	Audio system, outside rear view mirror defoggers, back-up lights, charging system, emergency flashers, traction control system, instrument panel light control dial, windshield wiper deicer
23	FR WIP	30 A	Windshield wipers and washer
24	RR WIP	15 A	Rear window wiper and washer
25	IGN	10 A	Multiport fuel injection system/ sequential multiport fuel injection system, steering lock system, anti-lock brake system, smart key system, SRS airbag system
26	GAUGE NO.2	7.5 A	Gauges and meters, rear view monitor
27	ECU-ACC	7.5 A	Auto anti-glare rear view mirrors, shift lock system, smart key system
28	ACC SOCK NO.1	10 A	Power outlet
29	ACC SOCK NO.2	20 A	Power outlet
30	RADIO NO.2	7.5 A	Audio system, clock, rear seat entertainment system, charging system, interior lights, personal lights
31	MIR HTR	15 A	Outside rear view mirror defoggers



**■ After a fuse is replaced**

- If the lights do not turn on even after the fuse has been replaced, a bulb may need replacement. (→P. 486)
- If the replaced fuse blows again, have the vehicle inspected by your Toyota dealer.

**■ If there is an overload in the circuits**

The fuses are designed to blow before the entire wiring harness is damaged.

 **CAUTION****■ To prevent system breakdowns and vehicle fire**

Observe the following precautions.

Failing to do so may cause damage, and possibly a fire or injury.

- Never use a fuse of a higher amperage rating than indicated, or use any other object in place of a fuse.
- Always use a genuine Toyota fuse or equivalent.  
Never replace a fuse with a wire, even as a temporary fix.  
This can cause extensive damage or even fire.
- Do not modify fuses or the fuse box.

 **NOTICE****■ Before replacing fuses**

Have the cause of electrical overload determined and repaired by your Toyota dealer as soon as possible.

## Light bulbs

You may replace the following bulbs yourself. The difficulty level of replacement varies depending on the bulb. If necessary bulb replacement seems difficult to perform, contact your Toyota dealer.

For more information about replacing other light bulbs, contact your Toyota dealer.

■ **Prepare a replacement light bulb.**

Check the wattage of the light bulb being replaced. (→P. 566)

■ **Remove the engine compartment cover.**

→P. 439

■ **Turn the power back door main switch OFF. (vehicles with power back door)**

→P. 73

■ **Front bulb locations**

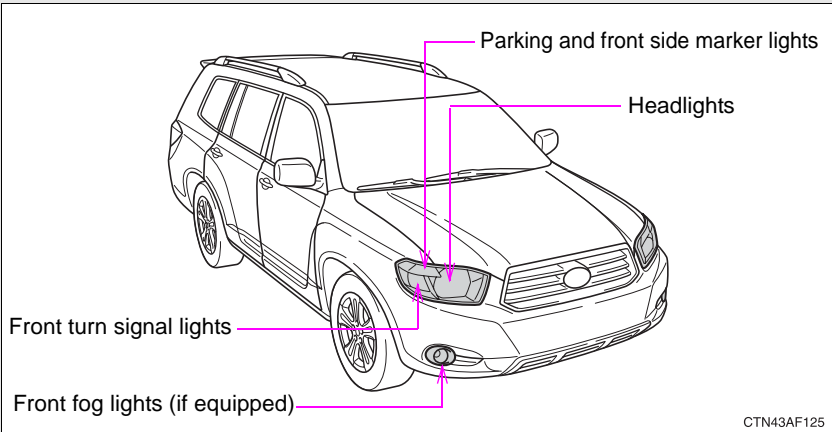

### ■ Rear bulb locations

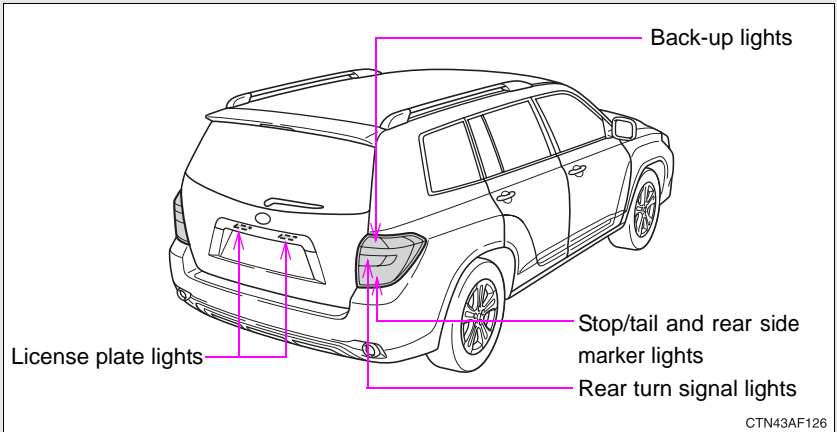

### Replacing light bulbs

#### ■ Headlights

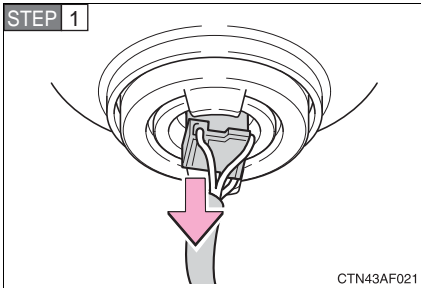

Unplug the connector.

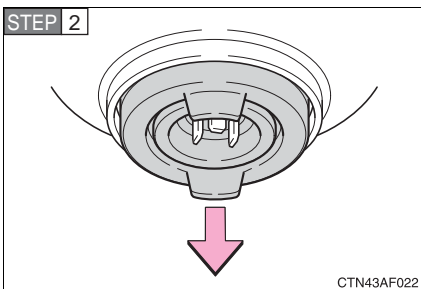

Remove the rubber cover.

STEP 3

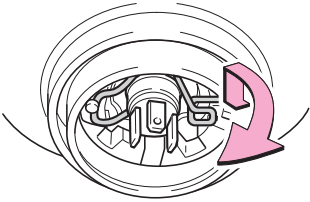

CTN43AF023

Release the bulb retaining spring.

STEP 4

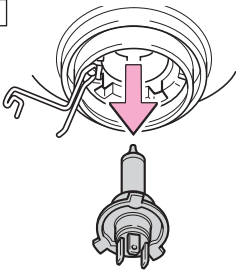

CTN43AF024

Remove the bulb.

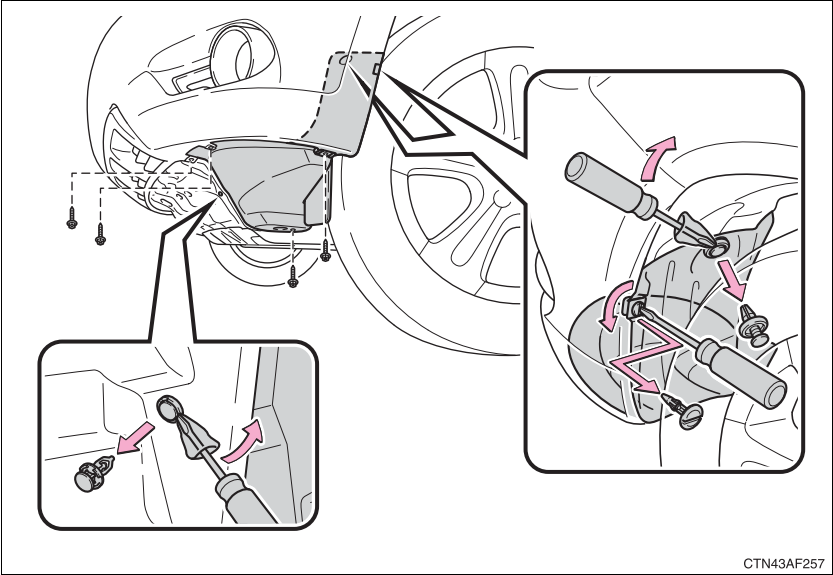
**■ Front fog lights (if equipped)****STEP 1** Remove the fender liner bolts and clips as follows.**▶ Left side**

► Right side

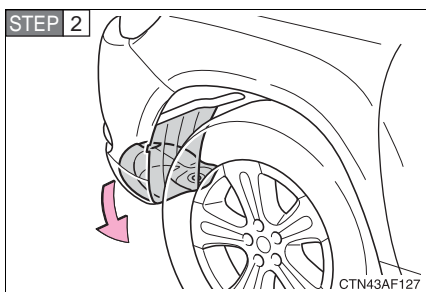
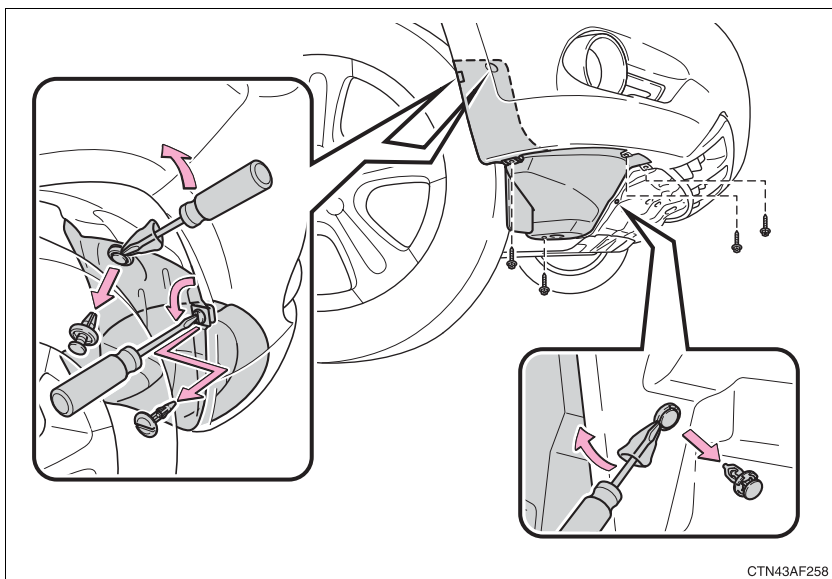

Remove the fender liner.

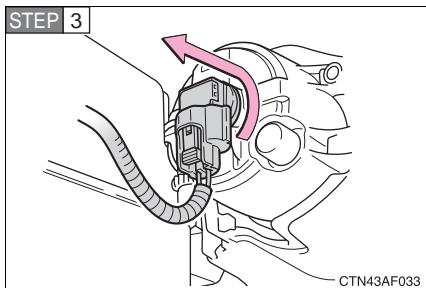

Turn the bulb base counterclockwise.

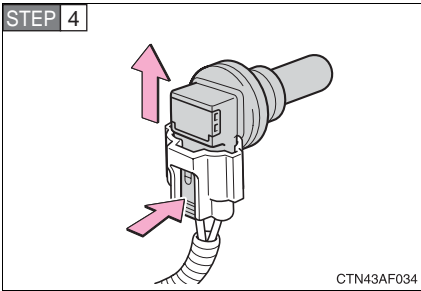

Unplug the connector while depressing the lock release.

### ■ Parking and front side marker lights

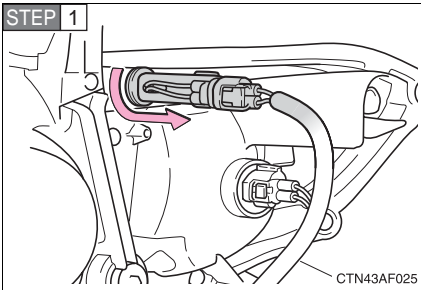

Turn the bulb base counterclockwise.

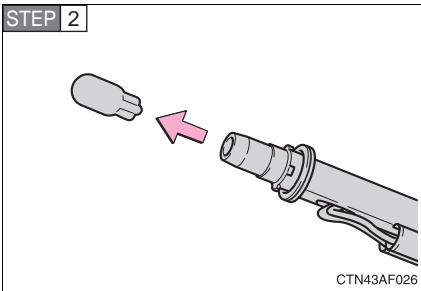

Remove the light bulb.

### ■ Front turn signal lights

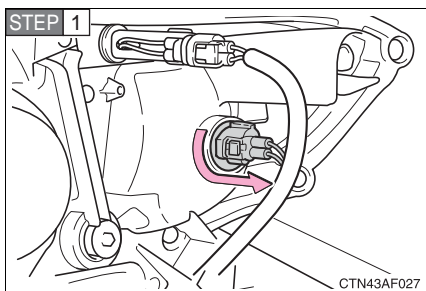

Turn the bulb base counterclockwise.

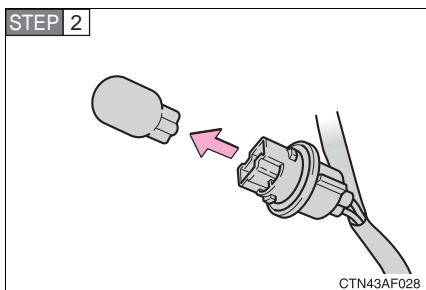

Remove the light bulb.



## ■ Back-up lights, stop/tail and rear side marker lights

### ▶ Left side

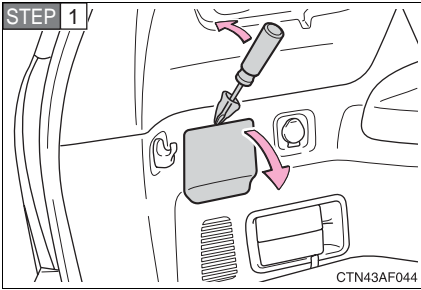

Open the back door and remove the cover.

To protect the cover, place a rag between the flathead screwdriver and cover as shown in the illustrations.

### ▶ Right side

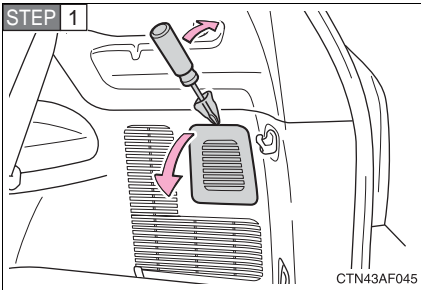

Open the back door and remove the cover.

To protect the cover, place a rag between the flathead screwdriver and cover as shown in the illustrations.

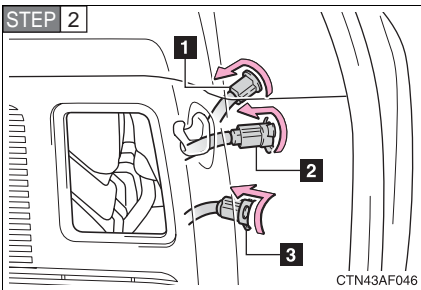

Turn the bulb base counterclockwise.

- 1** Back-up light
- 2** Rear turn signal light
- 3** Stop/tail and rear side marker light

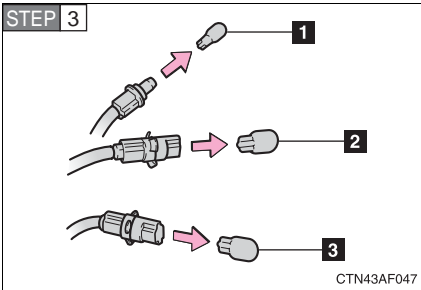

Remove the light bulb.

- 1 Back-up light
- 2 Rear turn signal light
- 3 Stop/tail and rear side marker light

### ■ License plate lights

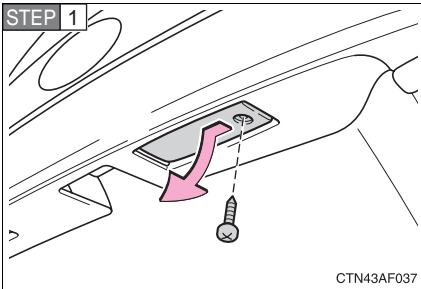

Remove the screw and remove the unit.

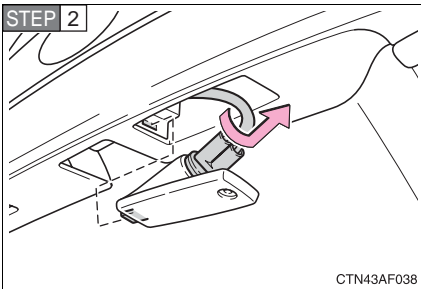

Turn the bulb base counterclockwise.

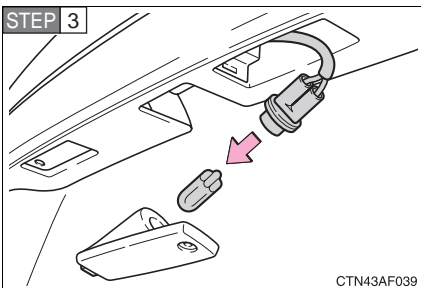

Remove the light bulb.

### ■ High mounted stoplight and outer foot lights

If the high mounted stoplight or outer foot lights has burnt out, have it replaced by your Toyota dealer.

### ■ Condensation build-up on the inside of the lens

Contact your Toyota dealer for more information in the following situations. Temporary condensation build-up on the inside of the headlight lens does not indicate a malfunction.

- Large drops of water are built up on the inside of the lens.
- Water has built up inside the headlight.

### ■ LED high mounted stoplight

The high mounted stoplight consists of a number of LEDs. If any of the LEDs burn out, take your vehicle to your Toyota dealer to have the light replaced.

### ■ Installing the fender liner clips

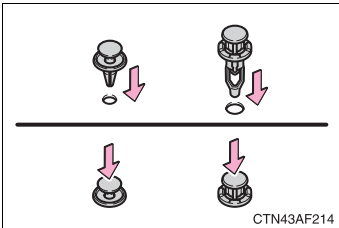

Insert the clips.

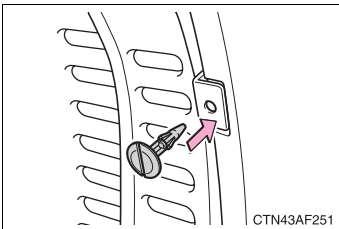

Insert the clip.

 **CAUTION**

■ **Replacing light bulbs**

- Turn off the headlights. Do not attempt to replace the bulb immediately after turning off the headlights.  
The bulbs become very hot and may cause burns.
- Do not touch the glass portion of the light bulb with bare hands. Hold the bulb by the plastic or metal portion.  
If the bulb is scratched or dropped it may blow out or crack.
- Fully install light bulbs and any parts used to secure them. Failing to do so may result in heat damage, fire, or water entering the headlight unit. This may damage the headlights or cause condensation to build up on the lens.

■ **To prevent damage or fire**

Make sure bulbs are fully seated and locked.

## 5-1. Essential information

# Emergency flashers

**Use the emergency flashers if the vehicle malfunctions or is involved in an accident.**

### ► Vehicles without navigation system

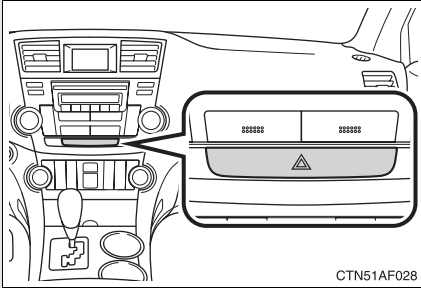

Press the switch to flash all the turn signal lights. To turn them off, press the switch once again.

### ► Vehicles with navigation system

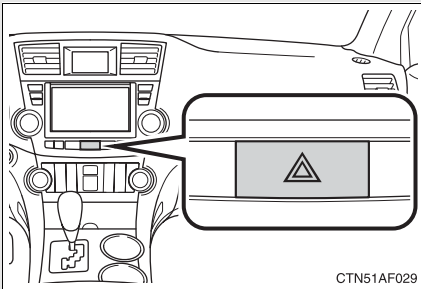

Press the switch to flash all the turn signal lights. To turn them off, press the switch once again.

### NOTICE

#### ■ To prevent battery discharge

Do not leave the emergency flashers on longer than necessary when the engine is not running.

## If your vehicle needs to be towed

**If towing is necessary, we recommend having your vehicle towed by your Toyota dealer or a commercial towing service, using a lift-type truck or a flat bed truck.**

**Use a safety chain system for all towing, and abide by all state/provincial and local laws.**

**2WD models: If towing from the front, the vehicle's rear wheels and axles must be in good condition. (→P. 503)**

**If they are damaged, use a towing dolly or flat bed truck.**

### **Before towing**

The following may indicate a problem with your transmission. Contact your Toyota dealer before towing.

- The engine is running, but the vehicle will not move.
- The vehicle makes an abnormal sound.

## Emergency towing

If a tow truck is not available, in an emergency your vehicle may be temporarily towed using a cable or chain secured to the emergency towing eyelet(s). This should only be attempted on hard surfaced roads for short distances at low speeds.

A driver must be in the vehicle to steer and operate the brakes. The vehicle's wheels, drive train, axles, steering and brakes must be in good condition.

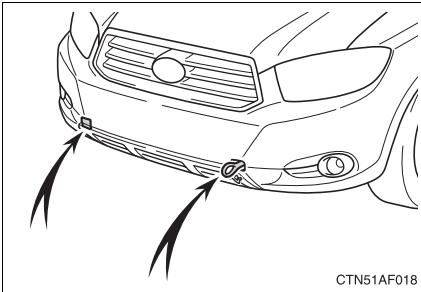

Towing eyelets

### Emergency towing procedure

**STEP 1** Release the parking brake.

**STEP 2** Shift the shift lever to N.

**STEP 3** Vehicles without smart key system:

Turn the engine switch to “ACC” (engine off) or “ON” (engine running) position.

Vehicles with smart key system:

Turn the “ENGINE START STOP” switch to ACCESSORY (engine off) or IGNITION ON (engine running) mode.

## ⚠ CAUTION

### ■ Caution while towing

- Use extreme caution when towing the vehicle.  
Avoid sudden starts or erratic driving maneuvers which place excessive stress on the emergency towing eyelets and the cables or chains.
- If the engine is not running, the power assist for the brakes and steering will not function, making steering and braking more difficult.

## ⚠ NOTICE

### ■ To prevent causing serious damage to the transmission

Never tow this vehicle from the rear with the front wheels on the ground. This may cause serious damage to the transmission.

## Installing towing eyelet

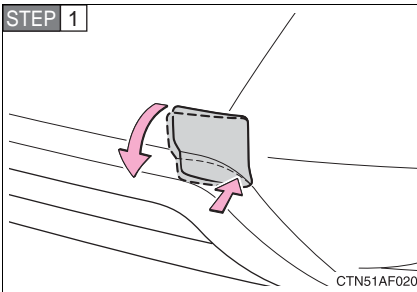

Remove the eyelet cover while pushing it.

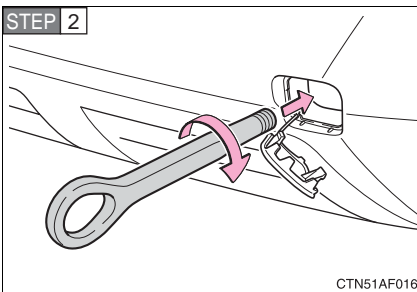

Insert the towing eyelet into the hole and tighten partially by hand.



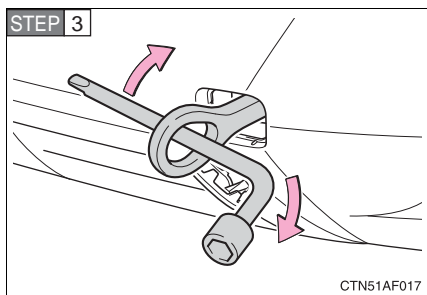

Tighten down the towing eyelet securely using a wheel nut wrench.

■ **Location of the emergency towing eyelet**

→P. 522

**! CAUTION**

■ **Installing towing eyelet to the vehicle**

Make sure that towing eyelet is installed securely.

If not securely installed, towing eyelet may come loose during towing. This may lead to accidents that cause serious injury or even death.

## Towing with a sling-type truck

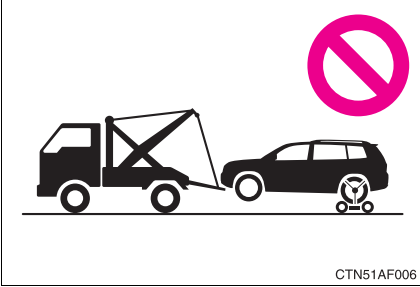

### NOTICE

#### ■ To prevent body damage

Do not tow with a sling-type truck, either from the front or rear.

## Towing with a wheel lift-type truck

### ► From front (2WD models)

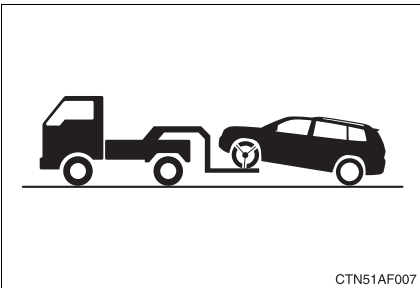

Release the parking brake.

► From front (4WD models)

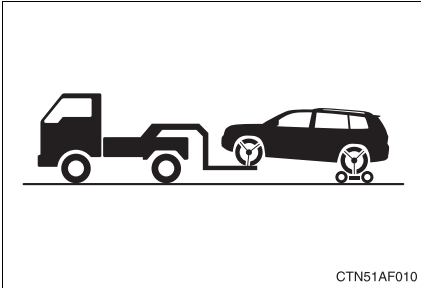

Use a towing dolly under the rear wheels.

 NOTICE

■ **To prevent damaging the vehicle**

When raising the vehicle, ensure adequate ground clearance for towing at the opposite end of the raised vehicle. Without adequate clearance, the vehicle could be damaged while being towed.

■ **To prevent causing serious damage to the transmission (4WD models)**

Never tow this vehicle from the front with the rear wheels on the ground.

► From rear

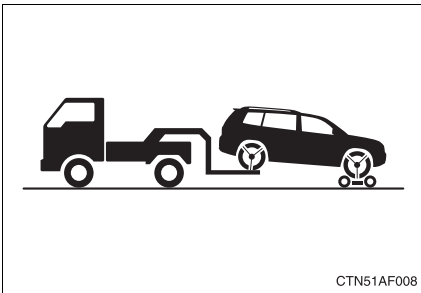

Use a towing dolly under the front wheels.

 NOTICE

■ **To prevent causing serious damage to the transmission**

Never tow this vehicle from the rear with the front wheels on the ground.

## Using a flat bed truck

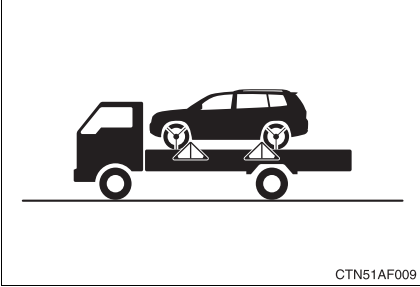

If you use chains or cables to tie down your vehicle, the angles shaded in black must be 45°.

Do not overly tighten the tie downs or the vehicle may be damaged.

## If you think something is wrong

**If you notice any of the following symptoms, your vehicle probably needs adjustment or repair. Contact your Toyota dealer as soon as possible.**

### ■ Visible symptoms

- Fluid leaks under the vehicle  
(Water dripping from the air conditioning after use is normal.)
- Flat-looking tires or uneven tire wear
- Engine coolant temperature gauge needle continually points higher than normal

### ■ Audible symptoms

- Changes in exhaust sound
- Excessive tire squeal when cornering
- Strange noises related to the suspension system
- Pinging or other noises related to the engine

### ■ Operational symptoms

- Engine missing, stumbling or running rough
- Appreciable loss of power
- Vehicle pulls heavily to one side when braking
- Vehicle pulls heavily to one side when driving on a level road
- Loss of brake effectiveness, spongy feeling, pedal almost touches the floor

## 5-1. Essential information

# Fuel pump shut off system

**To minimize the risk of fuel leakage when the engine stalls or an air-bag inflates upon collision, the fuel pump shut off system stops supplying fuel to the engine.**

Follow the procedure below to restart the engine after the system is activated.

▶ Vehicles without smart key system

**STEP 1** Turn the engine switch to the “ACC” or “LOCK” position.

**STEP 2** Restart the engine.

▶ Vehicles with smart key system

**STEP 1** Turn the “ENGINE START STOP” switch OFF.

**STEP 2** Restart the engine.

 **NOTICE**

■ **Before starting the engine**

Inspect the ground under the vehicle.

If you find that fuel has leaked onto the ground, the fuel system has been damaged and is in need of repair. Do not restart the engine.

## 5-1. Essential information

# Event data recorder

**Your vehicle has computers that monitor and control certain aspects of your vehicle. These computers assist in driving and maintaining optimal vehicle performance.**

Besides storing data useful for troubleshooting, there is an event data recorder (EDR) that records data in a crash or a near car crash event.

### **In a crash or a near car crash event**

The SRS airbag sensor assembly contains the EDR. In a crash or a near car crash event, this device may record some or all of the following information:

- Engine speed
- Whether the brake pedal was depressed or not
- Vehicle speed
- To what extent the accelerator pedal was depressed
- Position of the transmission shift lever
- Whether the driver and front passenger wore seat belts or not
- Driver's seat position
- SRS airbag deployment data
- SRS airbag system diagnostic data
- Front passenger's occupant classification

The information above is intended to be used for the purpose of improving vehicle safety performance. Unlike general data recorders, the EDR does not record sound data such as conversation between passengers.

## Disclosure of the data

Toyota will not disclose the data recorded in an EDR to a third party except when:

- An agreement from the vehicle's owner (or the leasing company for a leased vehicle) is obtained
- Officially requested by the police or other authorities
- Used as a defense for Toyota in a law suit
- Ordered by a court law

However, if necessary Toyota will:

- Use the data for research on Toyota vehicle safety performance
- Disclose the data to a third party for research purposes without disclosing details of the vehicle owner, and only when it is deemed necessary
- Disclose summarized data cleared of vehicle identification information to a non-Toyota organization for research purposes





## 5-2. Steps to take in an emergency

### If a warning light turns on or a warning buzzer sounds...

**Calmly perform the following actions if any of the warning lights turn on or flash. If a light turns on or flashes, but then turns off, this does not necessarily indicate a malfunction in the system.**

**Stop the vehicle immediately. Continuing to drive the vehicle may be dangerous.**

The following warning indicates a possible problem in the brake system. Immediately stop the vehicle in a safe place and contact your Toyota dealer.



Warning light	Warning light/Details
 (U.S.A.)  (Canada)	<b>Brake system warning light (warning buzzer)*</b> <ul style="list-style-type: none"><li>• Low brake fluid</li><li>• Malfunction in the brake system</li></ul> This light also comes on when the parking brake is not released. If the light turns off after the parking brake is fully released, the system is operating normally.

\*: Parking brake engaged warning buzzer:

A buzzer sounds to indicate that the parking brake is still engaged (with the vehicle having reached a speed of 3 mph [5 km/h]).



### Stop the vehicle immediately.



The following warnings indicate the possibility of damage to the vehicle that may lead to an accident. Immediately stop the vehicle in a safe place and contact your Toyota dealer.

Warning light	Warning light/Details
	<p><b>Charging system warning light</b> Indicates a malfunction in the vehicle's charging system.</p>
	<p><b>Low engine oil pressure warning light (vehicles without multi-information display)</b> Indicates that the engine oil pressure is too low.</p>

### Have the vehicle inspected immediately.

Failing to investigate the cause of the following warnings may lead to the system operating abnormally and possibly cause an accident. Have the vehicle inspected by your Toyota dealer immediately.

Warning light	Warning light/Details
 (U.S.A.)  (Canada)	<p><b>Malfunction indicator lamp</b> Indicates a malfunction in:</p> <ul style="list-style-type: none"> <li>• The electronic engine control system;</li> <li>• The electronic throttle control system;</li> <li>• The electronic automatic transmission control system.</li> </ul>
	<p><b>SRS warning light</b> Indicates a malfunction in:</p> <ul style="list-style-type: none"> <li>• The SRS airbag system;</li> <li>• The front passenger occupant classification system; or</li> <li>• The seat belt pretensioner system.</li> </ul>

Warning light	Warning light/Details
 (U.S.A.)  (Canada)	<p><b>ABS warning light</b>                      Indicates a malfunction in:</p> <ul style="list-style-type: none"> <li>• ABS; or</li> <li>• The brake assist system.</li> </ul>
	<p><b>Electric power steering warning light</b>                      Indicates a malfunction in the EPS (Electric Power Steering) system.</p>

**■ If the malfunction indicator lamp comes on while driving**

First check the following:







- Is the fuel empty?  
 If it is, fill the fuel tank immediately.
- Is the fuel tank cap loose?  
 If it is, tighten it securely.





The light will go off after taking several driving trips.

If the light does not go off even after several trips, contact your Toyota dealer as soon as possible.

**Follow the correction procedures.**

After taking the specified steps to correct the suspected problem, check that the warning light turns off.

Warning light	Warning light/Details	Correction procedure
	<b>Open door warning light (warning buzzer)*<sup>1</sup></b> Indicates that a door is not fully closed.	Check that all doors are closed.
	<b>Low fuel level warning light</b> Indicates that remaining fuel is about 2.2 gal. (8.3 L, 1.8 Imp. gal.) or less	Refuel the vehicle.
	<b>Driver's seat belt reminder light (warning buzzer)*<sup>2</sup></b> Warns the driver to fasten his/her seat belt.	Fasten the seat belt.
<div style="display: flex; flex-direction: column; align-items: center;"> <div style="display: flex; align-items: center; margin-bottom: 10px;">  <span style="margin-left: 5px;">*<sup>3</sup></span> </div> <div style="display: flex; align-items: center;">  <span style="margin-left: 5px;">*<sup>4</sup></span> </div> <p>(On the center panel)</p> </div>	<b>Front passenger's seat belt reminder light (warning buzzer)*<sup>2</sup></b> Warns the front passenger to fasten his or her seat belt.	Fasten the seat belt.
	<b>Automatic transmission fluid temperature warning light (vehicles without multi-information display)</b> Indicates that the automatic transmission fluid temperature is too high.	Stop the vehicle in a safe place and shift the shift lever to P. If the light does not go off, contact your Toyota dealer.

Warning light	Warning light/Details	Correction procedure
	<p><b>Low washer fluid warning light (vehicles without multi-information display)</b> Low level of washer fluid</p>	Fill the tank.
	<p><b>Engine oil replacement reminder light (vehicles without multi-information display)</b></p>	
	<p>Illuminates for about 3 seconds and then flashes for about 12 seconds: Indicates that the engine oil is scheduled to be changed.</p>	Check and change the engine oil if necessary.
	<p>Comes on and remains: Indicates that the engine oil should be changed.</p>	Check and change the engine oil.
	<p><b>Tire pressure warning light</b></p>	
	<p>When the light comes on: Low tire inflation pressure</p>	Adjust the tire inflation pressure.
	<p>When the light comes on after blinking for 1 minute: Malfunction in the tire pressure warning system</p>	Have the system checked by your Toyota dealer.
	<p><b>Master warning light (vehicles with multi-information display)</b> A buzzer sounds and the warning light comes on and flashes to indicate that the master warning system has detected a malfunction.</p>	→P. 521

**\*1: Open door warning buzzer:**

The open door warning buzzer sounds to alert one or more of the doors is not fully closed (with the vehicle having reached a speed of 3 mph [5 km/h]).

**\*2: Driver's and front passenger's seat belt reminders:**

The driver's and front passenger's seat belt reminders sound to alert the driver and front passenger that his or her seat belt is not fastened. These buzzers sound for 10 seconds after the vehicle has reached a speed of at least 12 mph (20 km/h). Then, if the seat belt is still unfastened, the buzzer will sound in a different tone for 20 more seconds.

**\*3: Vehicles without navigation system****\*4: Vehicles with navigation system****■ Key reminder buzzer (vehicles without smart key system)**

The buzzer indicates that the key has not been removed with the engine off and the driver's door opened.

**■ Open moon roof reminder buzzer (vehicles with multi-information display)**

The buzzer indicates that the moon roof is not fully closed with the engine off and the driver's door opened.

**■ Front passenger detection sensor and passenger seat belt reminder**

- If luggage is placed on the front passenger seat, the front passenger detection sensor may cause the warning light to flash, even if a passenger is not sitting in the seat.
- If a cushion is placed on the seat, the sensor may not detect a passenger, and the warning light may not operate properly.

**■ Engine oil replacement reminder light (U.S.A. — vehicles without multi-information display)**

The engine oil replacement reminder light will come on and flash at approximately 4500 miles (7200 km) after an oil change. When the distance driven after an oil change exceeds approximately 5000 miles (8000 km), the light will come on and remain on.

**■ Changing the engine oil (U.S.A. only)**

Make sure to reset the oil change system. (→P. 443)

### ■ When the tire pressure warning light comes on

Check the tire inflation pressure and adjust to the appropriate level. Pushing the tire pressure warning reset switch does not turn off the tire pressure warning light.

### ■ The tire pressure warning light may turn on due to natural causes

The tire pressure warning light may turn on due to natural causes such as natural air leaks or tire inflation pressure changes caused by temperature. In this case, adjusting the tire inflation pressure will turn off the warning light (after a few minutes).

### ■ When a tire is replaced with a spare tire

#### ▶ Without compact spare tire

The spare tire is also equipped with the tire pressure warning valve and transmitter. The tire pressure warning light will turn on if the tire inflation pressure of the spare tire is low. If a tire goes flat, even though the flat tire is replaced with the spare tire, the tire pressure warning light does not turn off. Replace the spare tire with the repaired tire and adjust the proper tire inflation pressure. The tire pressure warning light will turn off after a few minutes.

#### ▶ With compact spare tire

The compact spare tire is not equipped with the tire pressure warning valve and transmitter. If a tire goes flat, the tire pressure warning light will not turn off even though the flat tire is replaced with the spare tire. Replace the spare tire with the repaired tire and adjust the proper tire inflation pressure. The tire pressure warning light will turn off after a few minutes.

### ■ If the tire pressure warning system is inoperative

The tire pressure warning system will be disabled in the following conditions:

(When the condition becomes normal, the system will work properly.)

- If tires not equipped with tire pressure warning valves and transmitters are used.
- If the ID code on the tire pressure warning valves and transmitters is not registered in the tire pressure warning computer.
- If the tire inflation pressure is 73 psi (500 kPa, 5.1 kgf/cm<sup>2</sup> or bar) or higher.

The tire pressure warning system may be disabled in the following conditions:

(When the condition becomes normal, the system will work properly.)

- If electronic devices or facilities using similar radio wave frequencies are nearby.
- If a radio set at similar frequencies is in use in the vehicle.
- If a window tint that affects the radio wave signals is installed.
- If there is a lot of snow or ice on the vehicle, in particular around the wheels or wheel housings.
- If non-genuine Toyota wheels are used. (Even if you use Toyota wheels, the tire pressure warning system may not work properly with some types of tires.)
- If tire chains are used.
- ▶ Vehicles without compact spare tire
  - If the spare tire is in a location subject to poor radio wave signal reception.
  - If a large metallic object which can interfere with signal reception is put in the luggage room.



■ **If the tire pressure warning light comes on after blinking for 1 minute frequently**

▶ Vehicles without smart key system

If the tire pressure warning light comes on after blinking for 1 minute frequently when the engine switch is turned to the “ON” position, have it checked by your Toyota dealer.

▶ Vehicles with smart key system

If the tire pressure warning light comes on after blinking for 1 minute frequently when the “ENGINE START STOP” switch is turned to IGNITION ON mode, have it checked by your Toyota dealer.

 CAUTION**■ If the tire pressure warning light comes on**

Be sure to observe the following precautions. Failure to do so could cause loss of vehicle control and result in death or serious injury.

- Stop your vehicle in a safe place as soon as possible. Adjust the tire inflation pressure immediately.
- If the tire pressure warning light comes on even after tire inflation pressure adjustment, it is probable that you have a flat tire. Check the tires. If the tire is flat, change to the spare tire and have the flat tire repaired by the nearest Toyota dealer.
- Avoid abrupt maneuvering and braking. If the vehicle tires deteriorate, you could lose control of the steering wheel or the brakes.

**■ If a blowout or sudden air leakage should occur**

The tire pressure warning system may not activate immediately.

**■ Maintenance of the tires**

Each tire, including the spare (if provided), should be checked monthly when cold and inflated to the inflation pressure recommended by the vehicle manufacturer on the vehicle placard or tire inflation pressure label (tire and load information label). (If your vehicle has tires of a different size than the size indicated on the vehicle placard or tire inflation pressure label [tire and load information label], you should determine the proper tire inflation pressure for those tires.)

As an added safety feature, your vehicle has been equipped with a tire pressure monitoring system (TPMS-tire pressure warning system) that illuminates a low tire pressure telltale (tire pressure warning light) when one or more of your tires is significantly under-inflated. Accordingly, when the low tire pressure telltale (tire pressure warning light) illuminates, you should stop and check your tires as soon as possible, and inflate them to the proper pressure. Driving on a significantly under-inflated tire causes the tire to overheat and can lead to tire failure. Under-inflation also reduces fuel efficiency and tire tread life, and may affect the vehicle's handling and stopping ability.

 CAUTION

Please note that the TPMS (tire pressure warning system) is not a substitute for proper tire maintenance, and it is the driver's responsibility to maintain correct tire pressure, even if under-inflation has not reached the level to trigger illumination of the TPMS low tire pressure telltale (tire pressure warning light).

Your vehicle has also been equipped with a TPMS (tire pressure warning system) malfunction indicator to indicate when the system is not operating properly. The TPMS (tire pressure warning system) malfunction indicator is combined with the low tire pressure telltale (tire pressure warning light). When the system detects a malfunction, the telltale will flash for approximately one minute and then remain continuously illuminated. This sequence will continue upon subsequent vehicle start-ups as long as the malfunction exists. When the malfunction indicator is illuminated, the system may not be able to detect or signal low tire pressure as intended.

TPMS (tire pressure warning system) malfunctions may occur for a variety of reasons, including the installation of replacement or alternate tires or wheels on the vehicle that prevent the TPMS (tire pressure warning system) from functioning properly. Always check the TPMS (tire pressure warning system) malfunction telltale after replacing one or more tires or wheels on your vehicle to ensure that the replacement or alternate tires and wheels allow the TPMS (tire pressure warning system) to continue to function properly.

 NOTICE

■ **Precaution when installing a different tire**

When a tire of a different specification or maker is installed, the tire pressure warning system may not operate properly.

## 5-2. Steps to take in an emergency

If a warning message is displayed (vehicles with multi-information display)

The multi-information display shows warnings of system malfunctions or incorrectly performed operations. When a message is shown, perform corrections as indicated in the message.

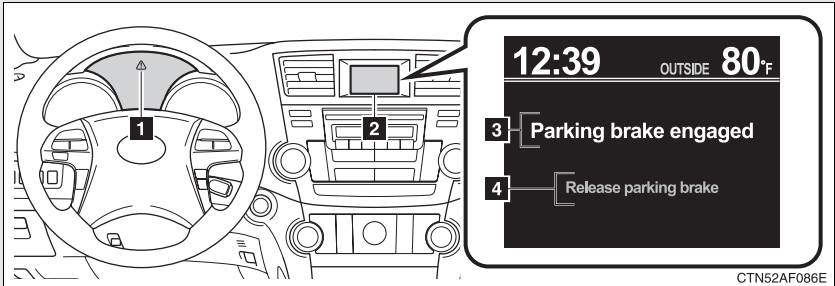

### 1 Master warning light

The master warning light also comes on or flashes in order to indicate that a message is currently being displayed on the multi-information display.

### 2 Multi-information display

### 3 Warning message

### 4 Correction procedure

## Warning buzzer

A buzzer may sound when a warning message is shown on the multi-information display.

## If the warning message is shown again after its correction procedure has been performed

Contact your Toyota dealer as soon as possible.

## 5-2. Steps to take in an emergency If you have a flat tire

**Remove the flat tire and replace it with the spare provided.**

■ **Before jacking up the vehicle**

- Stop the vehicle on a hard, flat surface.
- Set the parking brake.
- Shift the shift lever to P.
- Stop the engine.
- Turn on the emergency flashers.

■ **Location of the spare tire, jack and tools**

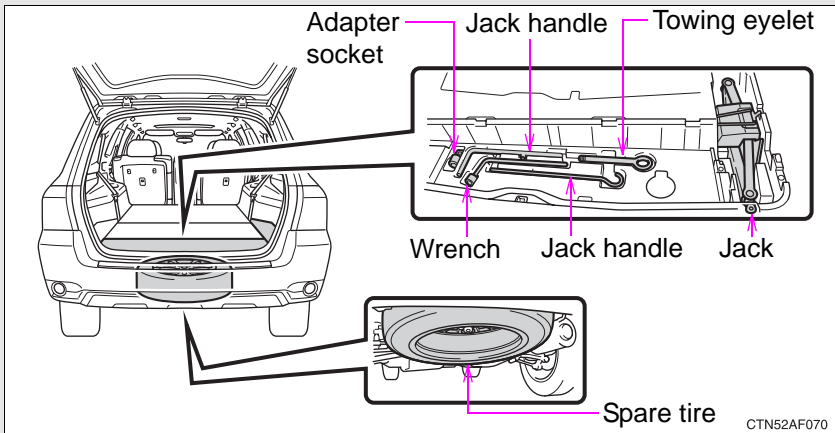

## Taking out the jack

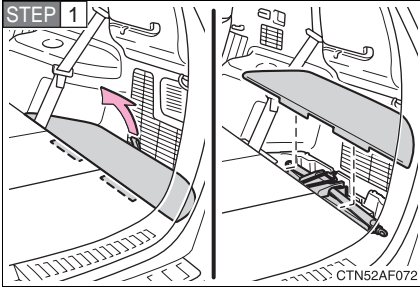

Remove the right side deck board.

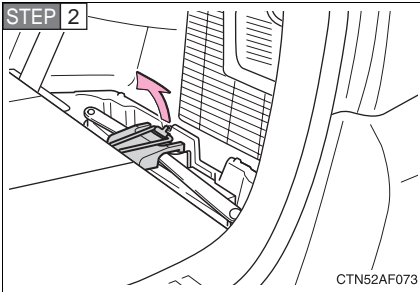

Unhook the tightening strap and remove the pad.

After storing the jack, make sure it is securely held by the tightening strap.

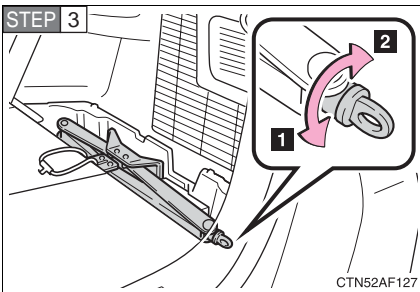

## Taking out the spare tire

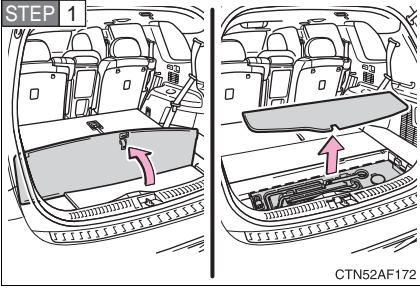

Open the center deck board and remove the cover.

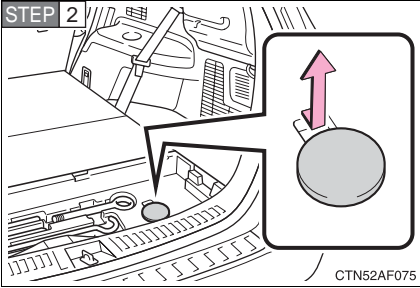

Remove the cover.

If it is difficult to remove the cover, you can use the key.

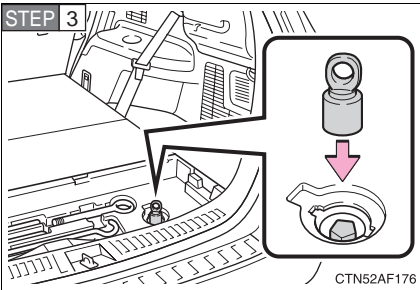

Attach the adapter socket (for removing a spare tire) on the spare tire clamp bolt.

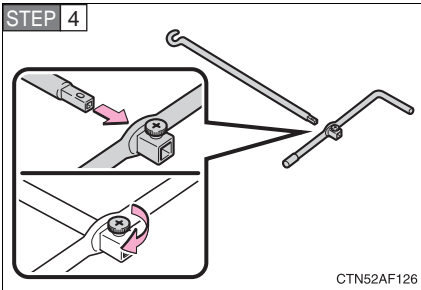

Assemble the jack handle and tighten the screw.

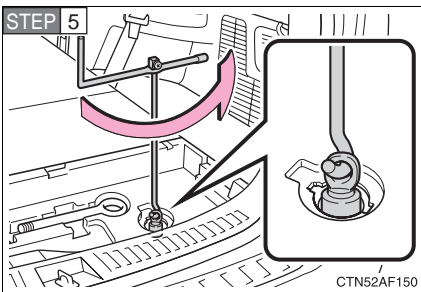

Connect the jack handle and the adapter socket. Turn the jack handle.

The tire will be lowered completely to the ground.

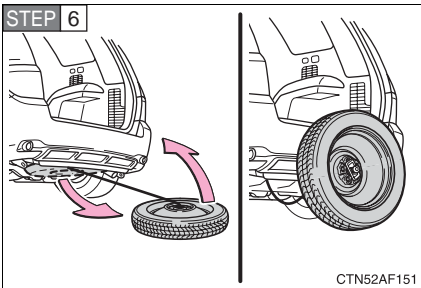

Pull out the spare tire and stand it against the bumper.

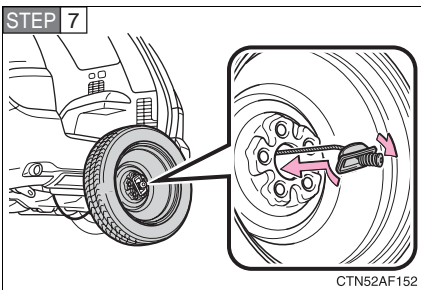

Remove the holding bracket.



## Replacing a flat tire

STEP 1

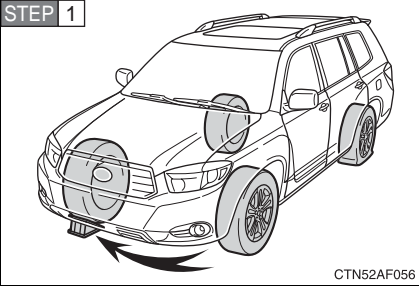

Chock the tires.

Flat tire		Wheel chock positions
Front	Left-hand side	Behind the rear right-hand side tire
	Right-hand side	Behind the rear left-hand side tire
Rear	Left-hand side	In front of the front right-hand side tire
	Right-hand side	In front of the front left-hand side tire

STEP 2

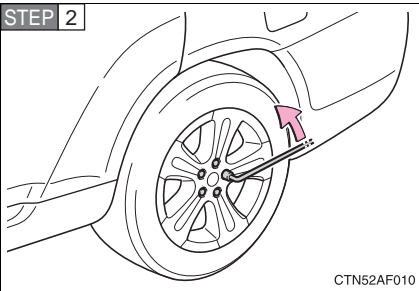

Slightly loosen the wheel nuts (one turn).

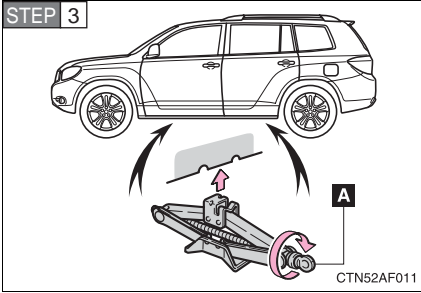

Turn the tire jack portion “A” by hand until the notch of the jack is in contact with the jack point.

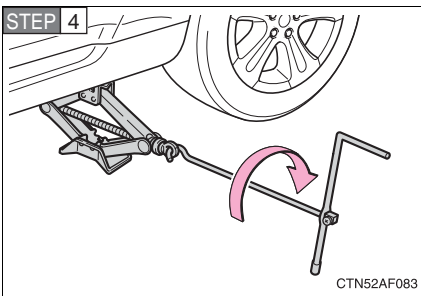

Raise the vehicle until the tire is slightly raised off the ground.

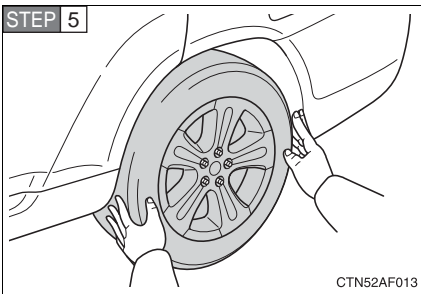

Remove all the wheel nuts and the tire.

When resting the tire on the ground, place the tire so that the wheel design faces up to avoid scratching the wheel surface.

## Installing the tire

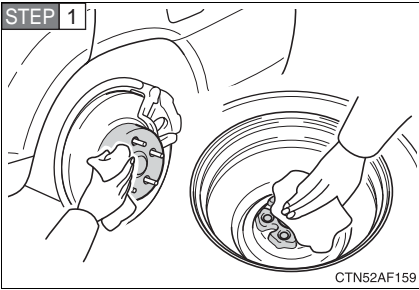

Remove any dirt or foreign matter from the wheel contact surface.

If foreign matter is on the wheel contact surface, the wheel nuts may loosen while the vehicle is in motion, and the tire may come off the vehicle.

**STEP 2** Install the tire and loosely tighten each wheel nut by hand by approximately the same amount.

### ► Vehicles without compact spare tire

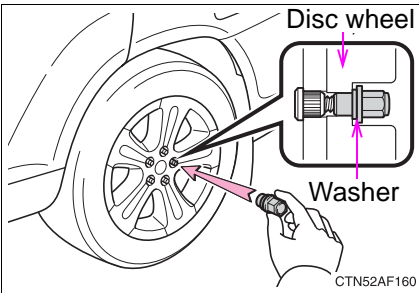

Turn the nut washers until they come into contact with the disc wheel.

### ► Vehicles with compact spare tire

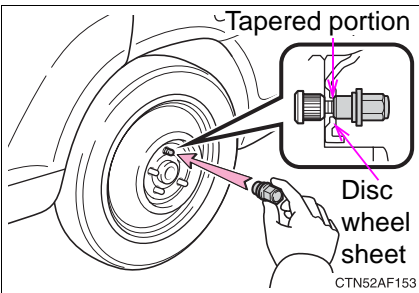

Tighten the nuts until the tapered portion comes into loose contact with the disc wheel sheet.

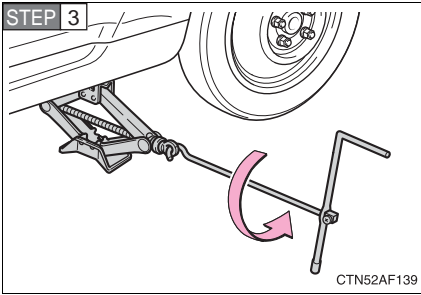

Lower the vehicle.

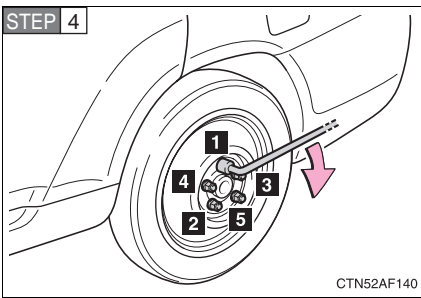

Firmly tighten each nut two or three times in the order shown in the illustration.

**Tightening torque:**  
76 ft•lbf (103 N•m, 10.5 kgf•m)

### Stowing the flat tire, jack and all tools

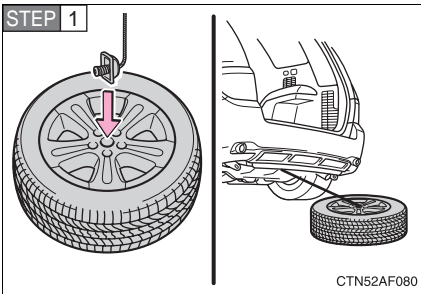

Remove the center wheel ornament by pushing from the reverse side.

Put the flat tire on the ground with the outer side facing up and install the holding bracket.

Be careful not to lose the wheel ornament.

**STEP 2** Turn the spare tire clamp bolt clockwise with a jack handle and adapter socket until you hear a click.

**STEP 3** Stow the jack and all tools.

■ **The compact spare tire**

- The compact spare tire is identified by the label “TEMPORARY USE ONLY” on the tire sidewall.  
Use the compact spare tire temporarily only in an emergency.
- Make sure to check the tire inflation pressure of the compact spare tire. (→P. 562)

■ **When using the compact spare tire**

As the compact spare tire is not equipped with the tire pressure warning valve and transmitter, low inflation pressure of the spare tire will not be warned. Also, if you replace the compact spare tire after the tire pressure warning light comes on, the light remains on.

■ **If you have a flat front tire on a road covered with snow or ice (vehicles with compact spare tire)**

Install the spare tire on the rear of the vehicle. Perform the following steps and fit tire chains to the front tires.

**STEP 1** Replace a rear tire with the compact spare tire.

**STEP 2** Replace the flat front tire with the tire removed from the rear of the vehicle.

**STEP 3** Fit tire chains to the front tires.

■ **After completing the tire change**

The tire pressure warning system must be reset. (→P. 455)

 CAUTION**■ Using the tire jack**

Improper use of the tire jack may lead to death or serious injuries due to the vehicle suddenly falling off the jack.

- Do not use the tire jack for any purpose other than replacing tires or installing and removing tire chains.
- Only use the tire jack that comes with this vehicle for replacing a flat tire.  
Do not use it on other vehicles, and do not use other tire jacks for replacing tires on this vehicle.
- Always check that the tire jack is securely set to the jack point.
- Do not put any part of your body under the vehicle supported by a jack.
- Do not start or run the engine while your vehicle is supported by the jack.
- Do not raise the vehicle while someone is in it.
- When raising the vehicle, do not put an object on or under the jack.
- Do not raise the vehicle to a height greater than that required to replace the tire.
- Use a jack stand if it is necessary to get under the vehicle.

Take particular care when lowering the vehicle to ensure that no one working on or near the vehicle will be injured.

 **CAUTION**

■ **Replacing a flat tire**

Observe the following precautions to reduce the risk of death or serious injury.

- Never use oil or grease on the wheel bolts or wheel nuts.

Oil and grease may cause the wheel nuts to be excessively tightened, leading to bolt or disc wheel damage. In addition, the oil or grease can cause the wheel nuts to loosen and the wheel may fall off, causing a serious accident. Remove any oil or grease from the wheel bolts or wheel nuts.

- Have the wheel nuts tightened with a torque wrench to 76 ft•lbf (103 N•m, 10.5 kgf•m) as soon as possible after changing wheels.

Failure to follow these precautions could cause the nuts to loosen and the wheel may fall off, which could lead to an accident causing death or serious injury.

■ **When using the compact spare tire**

- Remember that your compact spare tire is specifically designed for use with your vehicle. Do not use your compact spare tire on another vehicle.

- Do not use two compact spare tires simultaneously.

- Replace the compact spare tire with a standard tire as soon as possible.

- Avoid sudden acceleration, deceleration and braking, as well as sharp cornering.

■ **Speed limit when using the compact spare tire**

Do not drive at speeds in excess of 50 mph (80 km/h) when a compact spare tire is installed on the vehicle.

The compact spare tire is not designed for driving at high speeds. Failing to observe this precaution may lead to an accident causing death or serious injury.

 CAUTION**■ When the compact spare tire is attached**

The vehicle speed may not be correctly detected, and the following systems may not operate correctly:

- ABS & Brake assist
- Enhanced VSC
- TRAC
- Cruise control system
- Navigation system (if equipped)

Also, not only can the following system not be utilized fully, it may actually negatively effect the drive-train components:  
(4WD models)

- 4WD system



 NOTICE

■ **Do not drive the vehicle with a flat tire.**

Do not continue driving with a flat tire.

Driving even a short distance with a flat tire can damage the tire and the wheel beyond repair.

■ **Be careful when driving over bumps with the compact spare tire installed on the vehicle.**

The vehicle becomes lower when driving with the compact spare tire compared to when driving with standard tires. Be careful when driving over uneven road surfaces.

■ **Driving with tire chains and the compact spare tire**

Do not fit tire chains to the compact spare tire.

Tire chains may damage the vehicle body and adversely affect driving performance.

■ **When replacing the tires**

When removing or fitting the wheels, tires or the tire pressure warning valve and transmitter, contact your Toyota dealer as the tire pressure warning valve and transmitter may be damaged if not handled correctly.

■ **To avoid damaging the tire pressure warning valves and transmitters**

Do not use liquid sealants on flat tires.

■ **When stowing the flat tire**

● Ensure that there is no object caught between the tire and the vehicle underbody.

● Tighten the spare tire clamp bolt to hold the spare wheel carrier by the hook securely.

## 5-2. Steps to take in an emergency If the engine will not start

**If the engine still does not start after following the correct starting procedure (→P. 173, 177) or releasing the steering lock (→P. 175, 178), confirm the following points.**

■ **The engine will not start even when the starter motor operates normally.**

One of the following may be the cause of the problem.

- There may not be sufficient fuel in the vehicle's tank.  
Refuel the vehicle.
- The engine may be flooded.  
Try to restart the engine once more following correct starting procedures. (→P. 173, 177)
- There may be a malfunction in the engine immobilizer system.  
(→P. 115)

■ **The starter motor turns over slowly, the interior lights and headlights are dim, or the horn does not sound or sounds at a low volume.**

One of the following may be the cause of the problem.

- The battery may be discharged. (→P. 541)
- The battery terminal connections may be loose or corroded.

■ **The starter motor does not turn over (vehicles with smart key system).**

The engine starting system may be malfunctioning due to an electrical problem such as an open circuit or a blown fuse. However, an interim measure is available to start the engine.  
(→P. 536)

■ **The starter motor does not turn over, the interior lights and headlights do not turn on, or the horn does not sound.**

One of the following may be the cause of the problem.

- One or both of the battery terminals may be disconnected.
- The battery may be discharged. (→P. 541)
- There may be a malfunction in the steering lock system (vehicles with smart key system).

Contact your Toyota dealer if the problem cannot be repaired, or if repair procedures are unknown.

**Emergency start function (vehicles with smart key system)**

When the engine does not start, the following steps can be used as an interim measure to start the engine if the “ENGINE START STOP” switch is functioning normally.

**STEP 1** Set the parking brake.

**STEP 2** Shift the shift lever to P.

**STEP 3** Set the “ENGINE START STOP” switch to ACCESSORY mode.

**STEP 4** Push and hold the “ENGINE START STOP” switch about 15 seconds while depressing the brake pedal firmly.

Even if the engine can be started using the above steps, the system may be malfunctioning. Have the vehicle checked by your Toyota dealer.

## 5-2. Steps to take in an emergency

### If the shift lever cannot be shifted from P

If the shift lever cannot be shifted with your foot on the brake, there may be a problem with the shift lock system (a system to prevent accidental operation of the shift lever). Have the vehicle inspected by your Toyota dealer immediately.

The following steps may be used as an emergency measure to ensure that the shift lever can be shifted.

**STEP 1** Set the parking brake.

**STEP 2** Vehicles without smart key system: Turn the engine switch to the “ACC” position.

Vehicles with smart key system: Turn the “ENGINE START STOP” switch to ACCESSORY mode.

**STEP 3** Depress the brake pedal.

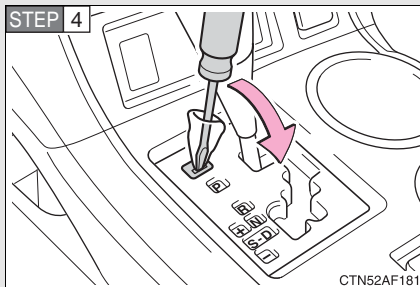

Pry the cover up with a flat-head screwdriver or equivalent.

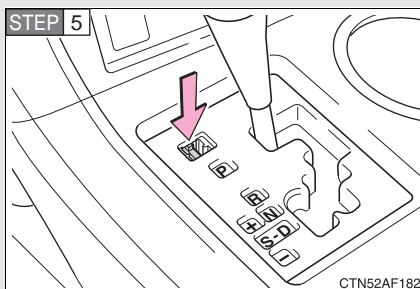

Press the shift lock override button.

The shift lever can be shifted while the button is pressed.

■ **Keys**

New genuine keys can be made by your Toyota dealer.

For vehicles with the smart key system, bring the other key and the key number stamped on the key number plate.

For vehicles without the smart key system, bring a master key and the key number stamped on the key number plate.

■ **Wireless remote control transmitter (vehicles without smart key system)**

New genuine wireless remote control transmitters can be purchased and programmed by your Toyota dealer. If a wireless remote control transmitter has been lost, bring the other wireless remote control transmitter when going to pick up the new transmitter.

## 5-2. Steps to take in an emergency

If the electronic key does not operate properly (vehicles with smart key system)

If communication between the electronic key and vehicle is interrupted (→P. 38) or the electronic key cannot be used because the battery is depleted, the smart key system and wireless remote control cannot be used. In such cases, the doors can be opened or the engine can be started by following the procedure below.

### Locking and unlocking the doors, and mechanical key linked functions

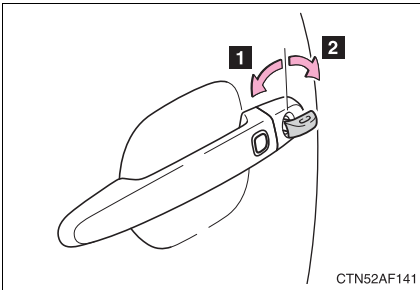

Using the mechanical key (→P. 31) in order to perform the following operations:

- 1** Locks all doors
- 2** Unlocks all doors

Turning the key rearward unlocks the driver's door. Turning the key once again unlocks the other doors.

### Changing "ENGINE START STOP" switch modes and starting the engine

**STEP 1** Shift the shift lever to P and apply the brakes.

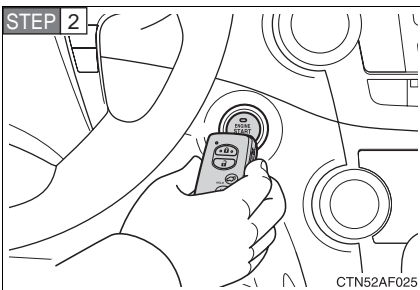

Touch the Toyota emblem side of the electronic key to the "ENGINE START STOP" switch.

If any of the doors is opened and closed while the key is being touched to the switch, an alarm will sound to indicate that the start function cannot detect the electronic key.

**STEP 3** To change “ENGINE START STOP” switch modes: Within 5 seconds of the buzzer sounding, release the brake pedal and press the “ENGINE START STOP” switch. Modes can be changed each time the switch is pressed. (→P. 174)

To start the engine: Press the “ENGINE START STOP” switch within 5 seconds after the buzzer sounds, keeping the brake pedal depressed.

In the event that the “ENGINE START STOP” switch still cannot be operated, contact your Toyota dealer.

---

### ■ Stopping the engine

Shift the shift lever to P and press the “ENGINE START STOP” switch as you normally do when stopping the engine.

### ■ Replacing the electronic key battery

As the above procedure is a temporary measure, it is recommended that the electronic key battery be replaced immediately when the battery depletes. (→P. 473)

## 5-2. Steps to take in an emergency If the battery is discharged

The following procedures may be used to start the engine if the vehicle's battery is discharged.

You can call your Toyota dealer or qualified repair shop.

If you have a set of jumper (or booster) cables and a second vehicle with a 12-volt battery, you can jump start your Toyota following the steps below.

**STEP 1** Connect the jumper cables.

► 2.7 L 4-cylinder (1AR-FE) engine

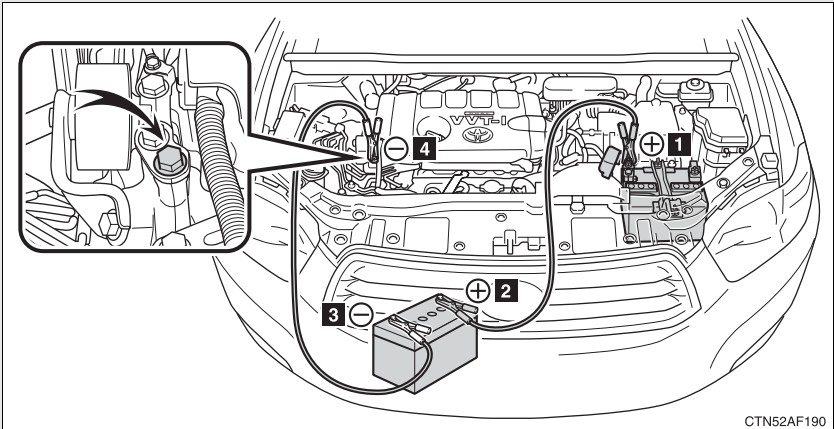



► 3.5 L V6 (2GR-FE) engine

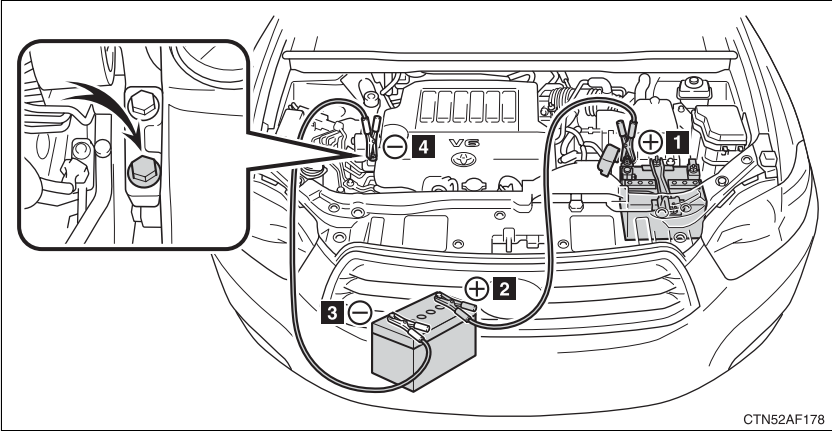

- 1** Positive (+) battery terminal on your vehicle
- 2** Positive (+) battery terminal on the second vehicle
- 3** Negative (-) battery terminal on the second vehicle
- 4** Connect the jumper cable to ground on your vehicle as shown in the illustration.

**STEP 2** Start the engine of the second vehicle. Increase the engine speed slightly and maintain at that level for approximately 5 minutes to recharge the battery of your vehicle.

**STEP 3** Vehicles with smart key system:  
Open and close any of the doors with the “ENGINE START STOP” switch OFF.

**STEP 4** Vehicles without smart key system:

Maintain the engine speed of the second vehicle, and turn the engine switch to the “ON” position, then start the vehicle's engine.

Vehicles with smart key system:

Maintain the engine speed of the second vehicle, and turn the “ENGINE START STOP” switch to IGNITION ON mode, then start the vehicle's engine.

**STEP 5** Once the vehicle's engine has started, remove the jumper cables in the exact reverse order in which they were connected.

Once the engine starts, have the vehicle checked at your Toyota dealer as soon as possible.

**■ Starting the engine when the battery is discharged**

The engine cannot be started by push-starting.

**■ To prevent battery discharge**

- Turn off the headlights and the audio system while the engine is turned off.
- Turn off any unnecessary electrical components when the vehicle is running at a low speed for an extended period, such as in heavy traffic, etc.

**■ When the battery is removed or discharge**

- The power back door must be initialized (→P. 75)
- The tire inflation pressure warning system must be initialized. (→P. 455)

 **CAUTION**

■ **Avoiding battery fires or explosions**

Observe the following precautions to prevent accidentally igniting the flammable gas that may be emitted from the battery.

- Make sure the jumper cable is connected to the correct terminal and that it is not unintentionally in contact with any part other than the intended terminal.
- Do not allow the jumper cables to come into contact with the “+” and “-” terminals.
- Do not smoke, use matches, cigarette lighters or allow open flame near the battery.

■ **Battery precautions**

The battery contains poisonous and corrosive acidic electrolyte, while related parts contain lead and lead compounds. Observe the following precautions when handling the battery.

- When working with the battery, always wear safety glasses and take care not to allow any battery fluids (acid) to come into contact with skin, clothing or the vehicle body.
- Do not lean over the battery.
- In the event that battery fluid comes into contact with the skin or eyes, immediately wash the affected area with water and seek medical attention. Place a wet sponge or cloth over the affected area until medical attention can be received.
- Always wash your hands after handling the battery support, terminals, and other battery-related parts.
- Do not allow children near the battery.

 **NOTICE**

■ **When handling jumper cables**

Be careful that the jumper cables do not become tangled in the cooling fan or any of the belts when connecting or disconnecting them.

## 5-2. Steps to take in an emergency If your vehicle overheats

### If your engine overheats:

**STEP 1** Stop the vehicle in a safe place and turn off the air conditioning system.

**STEP 2** Check to see if steam is coming out from under the hood.

If you see steam:

Stop the engine. Carefully lift the hood after the steam subsides and then restart the engine.

If you do not see steam:

Leave the engine running and carefully lift the hood.

**STEP 3** Remove the engine compartment cover. (→P. 439)

**STEP 4** Check to see if the cooling fan is operating.

If the fan is operating:

Wait until the temperature of the engine (shown on the instrument cluster) begins to fall and then stop the engine.

If the fan is not operating:

Stop the engine and call your Toyota dealer.

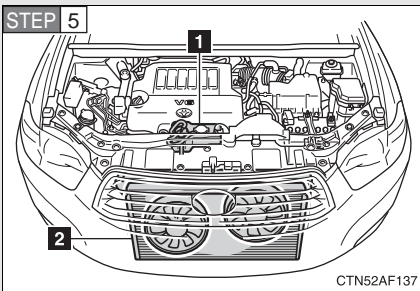

After the engine has cooled down sufficiently, check the engine coolant level and inspect the radiator core (radiator) for any leaks.

**1** Engine coolant reservoir

**2** Radiator

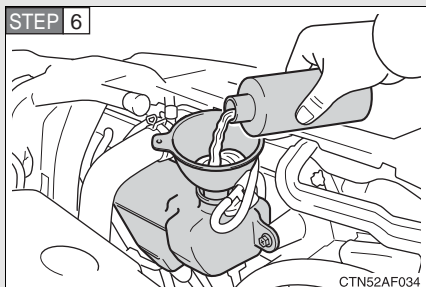

Add engine coolant if necessary.

Water can be used in an emergency if engine coolant is unavailable. (→P. 558)

Have the vehicle checked at the nearest Toyota dealer as soon as possible.

### ■ Overheating

If you observe the following, your vehicle may be overheating.

- The engine coolant temperature gauge enters the red zone or a loss of power is experienced.
- Steam is coming from under the hood.

### ⚠ CAUTION

#### ■ To prevent an accident or injury when inspecting under the hood of your vehicle

- If steam is seen coming from under the hood, do not open the hood until the steam has subsided. The engine compartment may be very hot, causing serious injury such as burns.
- Keep hands and clothing away from the fan and other belts while the engine is running.
- Do not loosen the coolant reservoir cap while the engine and radiator are hot.

Serious injury, such as burns, may result from hot coolant and steam released under pressure.

**NOTICE****■ When adding engine coolant**

Wait until the engine has cooled down before adding engine coolant.

When adding coolant, do so slowly. Adding cool coolant to a hot engine too quickly can cause damage to the engine.

## 5-2. Steps to take in an emergency If the vehicle becomes stuck

**Carry out the following procedures if the tires spin or the vehicle becomes stuck in mud, dirt, or snow.**

**STEP 1** Stop the engine. Set the parking brake and put the shift lever in P.

**STEP 2** Remove the mud, snow, or sand from around the stuck tire.

**STEP 3** Place wood, stones or some other material to help provide traction under the tires.

**STEP 4** Restart the engine.

**STEP 5** Shift the shift lever to the D or R position and carefully apply the accelerator to free the vehicle.

Turn off TRAC and/or Enhanced VSC if these functions are hampering your attempts to free the vehicle. (→P. 219)

### CAUTION

#### ■ **When attempting to free a stuck vehicle**

If you choose to rock the vehicle back and forth to free it, make sure the surrounding area is clear, to avoid striking other vehicles, objects or persons. The vehicle may also lunge forward or lunge back suddenly as it becomes free. Use extreme caution.

#### ■ **When shifting the shift lever**

Be careful not to shift the shift lever with the accelerator pedal depressed. This may lead to unexpected rapid acceleration of the vehicle that may cause an accident and result in death or serious injury.



**NOTICE**

■ **To avoid damaging the transmission and other components**

- Avoid spinning the wheels and do not rev the engine.
- If the vehicle remains stuck after trying these procedures, the vehicle may require towing to be freed.





## 6-1. Specifications

### Maintenance data (fuel, oil level, etc.)

#### Dimensions and weights

Overall length		188.4 in. (4785 mm)
Overall width		75.2 in. (1910 mm)
Overall height		<ul style="list-style-type: none"> <li>▶ Without roof rails 68.1 in. (1730 mm)</li> <li>▶ With roof rails 69.3 in. (1760 mm)</li> </ul>
Wheelbase		109.8 in. (2790 mm)
Front tread		64.0 in. (1625 mm) 64.2 in. (1630 mm)* <sup>1</sup>
Rear tread	2WD models	64.2 in. (1630 mm) 64.8 in. (1645 mm)* <sup>1</sup>
	4WD models	64.0 in. (1625 mm) 64.6 in. (1640 mm)* <sup>1</sup>
Vehicle capacity weight (Occupant + luggage)		1200 lb. (544 kg)
Towing capacity (Trailer weight + cargo)	2.7 L 4-cylinder (1AR-FE) engine	1500 lb. (680 kg)* <sup>2</sup> 3500 lb. (1500 kg)* <sup>3</sup>
	3.5 L V6 (2GR-FE) engine	2000 lb. (900 kg)* <sup>2</sup> 5000 lb. (2000 kg)* <sup>3</sup>

\*1: GVM condition

\*2: Without towing package

\*3: With towing package

## Vehicle identification

### ■ Vehicle identification number

The vehicle identification number (VIN) is the legal identifier for your vehicle. This is the primary identification number for your Toyota. It is used in registering the ownership of your vehicle.

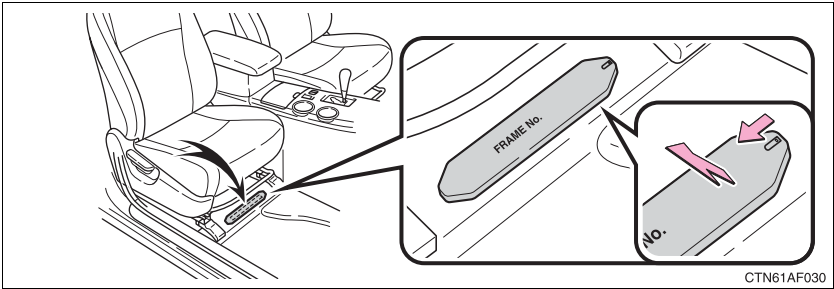

CTN61AF030

This number is stamped under the right-hand front seat.

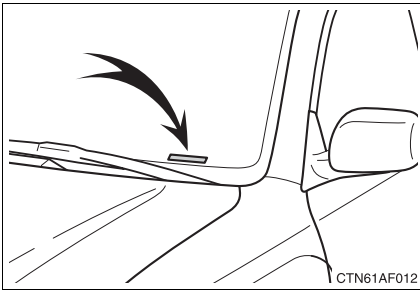

CTN61AF012

This number is also stamped on the top left of the instrument panel.

### ■ Certification Label

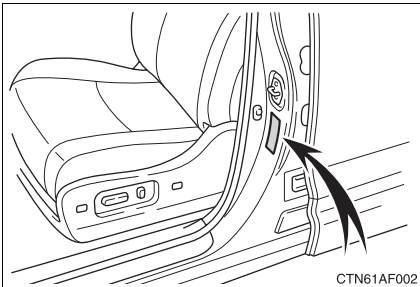

CTN61AF002

This number is also on the Certification Label on the driver's side center pillar.

■ **Engine number**

The engine number is stamped on the engine block as shown.

▶ **2.7 L 4-cylinder (1AR-FE) engine**

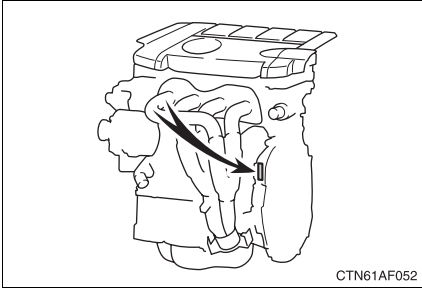

▶ **3.5 L V6 (2GR-FE) engine**

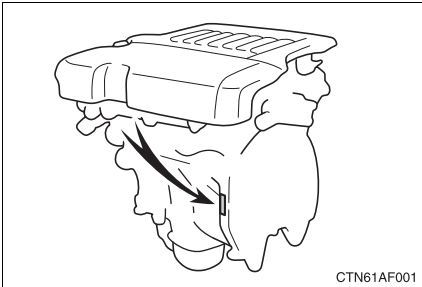

**Engine**

Model	1AR-FE	2GR-FE
Type	4-cylinder in line, 4-cycle, gasoline	6-cylinder V type, 4-cycle, gasoline
Bore and stroke	3.54 × 4.13 in. (90.0 × 105.0 mm)	3.70 × 3.27 in. (94.0 × 83.0 mm)
Displacement	163.0 cu.in. (2672 cm <sup>3</sup> )	210.9 cu.in. (3456 cm <sup>3</sup> )
Drive belt tension	Automatic adjustment	

**Fuel**

Fuel type	Unleaded gasoline only
Octane rating	87 (Research Octane Number 91) or higher
Fuel tank capacity (Reference)	19.2 gal. (72.5 L, 15.9 Imp. gal.)

**Lubrication system**

<p>Oil capacity Drain and refill (Reference)</p> <ul style="list-style-type: none"> <li>▶ Without filter</li>   <li>▶ With filter</li> </ul>	<ul style="list-style-type: none"> <li>▶ 2.7 L 4-cylinder (1AR-FE) engine 4.2 qt. (4.0 L, 3.5 Imp. qt.)</li> <li>▶ 3.5 L V6 (2GR-FE) engine 6.0 qt. (5.7 L, 5.0 Imp. qt.)</li>   <li>▶ 2.7 L 4-cylinder (1AR-FE) engine 4.7 qt. (4.4 L, 3.9 Imp. qt.)</li> <li>▶ 3.5 L V6 (2GR-FE) engine 6.4 qt. (6.1 L, 5.4 Imp. qt.)</li> </ul>
<p>Oil grade</p>	<p>ILSAC multi-grade engine oil</p>

Recommended oil viscosity (2.7 L 4-cylinder (1AR-FE) engine)

Use Toyota approved "Toyota Genuine Motor Oil" or equivalent to satisfy the grade and viscosity shown below.

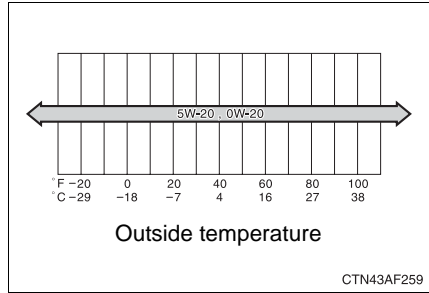

Recommended oil viscosity (3.5 L V6 (2GR-FE) engine)

Use Toyota approved "Toyota Genuine Motor Oil" or equivalent to satisfy the grade and viscosity shown below.

▶ Vehicles without towing package

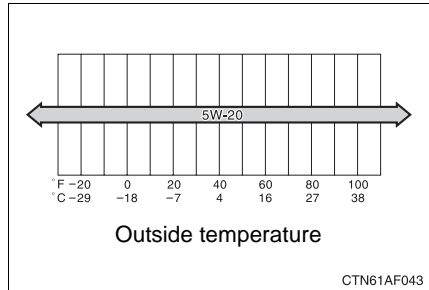

▶ Vehicles with towing package

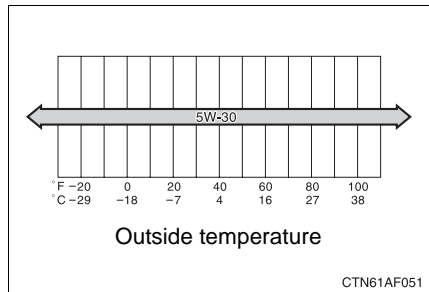

Oil viscosity

- The 5W portion of the oil viscosity rating indicates the characteristic of the oil which allows cold startability. Oils with a lower value before the W allow for easier starting of the engine in cold weather.
- The 30 in 5W-30 indicates the oil viscosity when the oil is at its operating temperature. An oil with a higher viscosity may be better suited if the vehicle is operated at high speeds, or under extreme load conditions.

**Cooling system**

Capacity (Reference)	2.7 L 4-cylinder (1AR-FE) engine	<ul style="list-style-type: none"> <li>▶ Without rear air conditioning system 7.3 qt. (6.9 L, 6.1 Imp. qt.) 8.0 qt. (7.6 L, 6.7 Imp. qt.)*</li> <li>▶ With rear air conditioning system 9.6 qt. (9.1 L, 8.0 Imp. qt.) 10.4 qt. (9.8 L, 8.6 Imp. qt.)*</li> </ul>
	3.5 L V6 (2GR-FE) engine	<ul style="list-style-type: none"> <li>▶ Without rear air conditioning system 9.3 qt. (8.8 L, 7.7 Imp. qt.) 10.0 qt. (9.5 L, 8.4 Imp. qt.)*</li> <li>▶ With rear air conditioning system 11.6 qt. (11.0 L, 9.7 Imp. qt.) 12.4 qt. (11.7 L, 10.3 Imp. qt.)*</li> </ul>
Coolant type	<p>Use either of the following.</p> <ul style="list-style-type: none"> <li>• “Toyota Super Long Life Coolant”</li> <li>• Similar high-quality ethylene glycol-based non-silicate, non-amine, non-nitrite, and non-borate coolant with long-life hybrid organic acid technology</li> </ul> <p>Do not use plain water alone.</p>	

\*: With towing package



## Ignition system

Spark plug	<ul style="list-style-type: none"> <li>▶ 2.7 L 4-cylinder (1AR-FE) engine DENSO, SK16HR11</li> <li>▶ 3.5 L V6 (2GR-FE) engine DENSO FK20HR11</li> </ul>
Make	
Gap	

0.043 in. (1.1 mm)

### NOTICE

#### ■ Iridium-tipped spark plugs

Use only iridium-tipped spark plugs. Do not adjust gap when tuning engine.

## Electrical system

Battery	<p>12.6 — 12.8 V Fully charged 12.2 — 12.4 V Half charged 11.8 — 12.0 V Discharged (*: Voltage is checked 20 minutes after the engine and all the lights are turned off)</p>
Open voltage* at 68°F (20°C):	
Charging rates	5 A max.

**Rear differential (4WD models)**

Oil capacity	1.0 qt. (0.9 L, 0.8 Imp. qt.)
Oil type	Hypoid gear oil API GL-5
Recommended oil viscosity	Above 0°F (-18°C): SAE 90 Below 0°F (-18°C): SAE 80W or 80W-90

**Automatic transaxle**

Fluid capacity*	<ul style="list-style-type: none"> <li>▶ 2.7 L 4-cylinder (1AR-FE) engine 6.9 qt. (6.5 L, 5.7 Imp. qt.)</li> <li>▶ 3.5 L V6 (2GR-FE) engine 2WD models: 9.3 qt. (8.8 L, 7.7 Imp. qt.) 4WD models: 9.5 qt. (9.0 L, 7.9 Imp. qt.)</li> </ul>
Fluid type	Toyota Genuine ATF WS

\*: The fluid capacity is the quantity of reference. If replacement is necessary, contact your Toyota dealer.

 **NOTICE**

**Automatic transmission fluid type**

Using automatic transmission fluid other than “Toyota Genuine ATF WS” may cause deterioration in shift quality, locking up of your transmission accompanied by vibration, and ultimately damage the automatic transmission of your vehicle.

**Transfer (4WD models)**

Oil capacity	1.0 qt. (0.9 L, 0.8 Imp. qt.)
Oil type	Hypoid gear oil API GL-5
Recommended oil viscosity	Above 0°F (-18°C): SAE 90 Below 0°F (-18°C): SAE 80W or 80W-90

**Brakes**

Pedal clearance* <sup>1</sup>	3.3 in. (84.4 mm) Min.
Pedal free play	0.08 — 0.12 in. (2 — 3 mm)
Brake pad wear limit	0.04 in. (1.0 mm)
Parking brake lining wear limit	0.04 in. (1.0 mm)
Parking brake pedal travel* <sup>2</sup>	8 — 10 clicks
Fluid type	SAE J1703 or FMVSS No. 116 DOT 3

\*1: Minimum pedal clearance when depressed with a force of 110 lbf (490 N, 50 kgf) while the engine is running

\*2: Parking brake pedal travel when depressed with a force of 66 lbf (294 N, 30 kgf)

**Steering**

Free play	Less than 1.2 in. (30 mm)
-----------	---------------------------

## Tires and wheels

### ► Type A

Tire size	P245/65R17 105S
Tire inflation pressure (Recommended cold tire inflation pressure)	<p>Driving under normal conditions</p> <p>Front: 30 psi (210 kPa, 2.1 kgf/cm<sup>2</sup> or bar)</p> <p>Rear: 30 psi (210 kPa, 2.1 kgf/cm<sup>2</sup> or bar)</p> <p>Spare: 30 psi (210 kPa, 2.1 kgf/cm<sup>2</sup> or bar)</p> <p>Driving at high speeds above 100 mph (160 km/h) (in countries where such speeds are permitted by law)</p> <p>Add 5 psi (30 kPa, 0.3 kgf/cm<sup>2</sup> or bar) to the front tires and rear tires. Never exceed the maximum cold tire inflation pressure indi- cated on the tire sidewall.</p>
Wheel size	17 × 7 1/2 J
Wheel nut torque	76 ft•lbf (103 N•m, 10.5 kgf•m)

## ► Type B

Tire size	P245/55R19 103S
Tire inflation pressure (Recommended cold tire inflation pressure)	<p>Driving under normal conditions</p> <p>Front: 30 psi (210 kPa, 2.1 kgf/cm<sup>2</sup> or bar)</p> <p>Rear: 30 psi (210 kPa, 2.1 kgf/cm<sup>2</sup> or bar)</p> <p>Spare: 30 psi (210 kPa, 2.1 kgf/cm<sup>2</sup> or bar)</p> <p>Driving at high speeds above 100 mph (160 km/h) (in countries where such speeds are permitted by law)</p> <p>Add 5 psi (30 kPa, 0.3 kgf/cm<sup>2</sup> or bar) to the front tires and rear tires. Never exceed the maximum cold tire inflation pressure indi- cated on the tire sidewall.</p> <p>When towing trailer</p> <p>Add 6 psi (40 kPa, 0.4 kgf/cm<sup>2</sup> or bar) to the rear tires. Never exceed the maximum cold tire inflation pressure indicated on the tire sidewall.</p>
Wheel size	19 × 7 1/2 J
Wheel nut torque	76 ft•lbf (103 N•m, 10.5 kgf•m)

## ► Type C

Tire size	P245/65R17 105S, T165/90D18 107M (spare)
Tire inflation pressure (Recommended cold tire inflation pressure)	<p>Driving under normal conditions</p> <p>Front: 30 psi (210 kPa, 2.1 kgf/cm<sup>2</sup> or bar)</p> <p>Rear: 30 psi (210 kPa, 2.1 kgf/cm<sup>2</sup> or bar)</p> <p>Driving at high speeds above 100 mph (160 km/h) (in countries where such speeds are permitted by law) Add 5 psi (30 kPa, 0.3 kgf/cm<sup>2</sup> or bar) to the front tires and rear tires. Never exceed the maximum cold tire inflation pressure indicated on the tire sidewall.</p> <p>Spare: 60 psi (420 kPa, 4.2 kgf/cm<sup>2</sup> or bar)</p>
Wheel size	17 × 7 1/2 J, 18 × 4T (spare)
Wheel nut torque	76 ft•lbf (103 N•m, 10.5 kgf•m)

## ► Type D

Tire size	P245/55R19 103S, T165/90D18 107M (spare)
Tire inflation pressure (Recommended cold tire inflation pressure)	<p>Driving under normal conditions</p> <p>Front: 30 psi (210 kPa, 2.1 kgf/cm<sup>2</sup> or bar)</p> <p>Rear: 30 psi (210 kPa, 2.1 kgf/cm<sup>2</sup> or bar)</p> <p>Driving at high speeds above 100 mph (160 km/h) (in countries where such speeds are permitted by law) Add 5 psi (30 kPa, 0.3 kgf/cm<sup>2</sup> or bar) to the front tires and rear tires. Never exceed the maximum cold tire inflation pressure indicated on the tire sidewall.</p> <p>When towing trailer Add 6 psi (40 kPa, 0.4 kgf/cm<sup>2</sup> or bar) to the rear tires. Never exceed the maximum cold tire inflation pressure indicated on the tire sidewall.</p> <p>Spare: 60 psi (420 kPa, 4.2 kgf/cm<sup>2</sup> or bar)</p>
Wheel size	19 × 7 1/2 J, 18 × 4T (spare)
Wheel nut torque	76 ft•lbf (103 N•m, 10.5 kgf•m)

**Light bulbs**

	Light Bulbs	Bulb No.	W	Type
Exterior	Headlights	—	60/55	C
	Front turn signal lights	—	21	B
	Parking/front side marker lights	—	5	B
	Front fog lights*	—	55	A
	Rear turn signal lights	—	21	D
	Back-up lights	—	16	D
	Stop/tail and rear side marker lights	—	21/5	D
	License plate lights	—	5	D
	Outer foot lights*	—	5	D
Interior	Vanity lights	—	8	D
	Personal/interior lights (front)	—	5	D
	Personal/interior lights (center)*	—	5	D
	Interior light	—	8	D
	Door courtesy lights	—	5	D

A: H11 halogen bulbs

B: Wedge base bulbs (amber)

C: HB2 halogen bulbs

D: Wedge base bulbs (clear)

\*: If equipped



**Your vehicle must use only unleaded gasoline.**

**Select octane rating 87 (Research Octane Number 91) or higher. Use of unleaded gasoline with an octane rating lower than 87 may result in engine knocking. Persistent knocking can lead to engine damage.**

At minimum, the gasoline you use should meet the specifications of ASTM D4814 in the U.S.A. and CGSB3.5-M93 in Canada.

---

■ **Fuel tank opening for unleaded gasoline**

To help prevent incorrect fueling, your Toyota has a fuel tank opening that only accommodates the special nozzle on unleaded fuel pumps.

■ **If your engine knocks**

- Consult your Toyota dealer.
- You may occasionally notice light knocking for a short time while accelerating or driving uphill. This is normal and there is no need for concern.

■ **Gasoline quality**

In very few cases, driveability problems may be caused by the brand of gasoline you are using. If driveability problems persist, try changing the brand of gasoline. If this does not correct the problem, consult your Toyota dealer.

■ **Gasoline quality standards**

- Automotive manufacturers in the US, Europe and Japan have developed a specification for fuel quality called World-Wide Fuel Charter (WWFC) that is expected to be applied worldwide.
- The WWFC consists of four categories that are based on required emission levels. In the US, category 4 has been adopted.
- The WWFC improves air quality by lowering emissions in vehicle fleets, and customer satisfaction through better performance.

■ **Toyota recommends the use of gasoline containing detergent additives**

- Toyota recommends the use of gasoline that contains detergent additives to avoid build-up of engine deposits.
- All gasoline sold in the US contains detergent additives to clean and/or keep clean intake systems.

■ **Toyota recommends the use of cleaner burning gasoline**

Cleaner burning gasoline, including reformulated gasoline that contains oxygenates such as ethanol or MTBE (Methyl Tertiary Butyl Ether) is available in many areas.

Toyota recommends the use of cleaner burning gasoline and appropriately blended reformulated gasoline. These types of gasoline provide excellent vehicle performance, reduce vehicle emissions and improve air quality.

■ **Toyota does not recommend blended gasoline**

- Toyota allows the use of oxygenate blended gasoline where the oxygenate content is up to 10% ethanol or 15% MTBE.
- If you use gasohol in your Toyota, be sure that it has an octane rating no lower than 87.
- Toyota does not recommend the use of gasoline containing methanol.

■ **Toyota does not recommend gasoline containing MMT**

Some gasoline contains octane enhancing additive called MMT (Methylcyclopentadienyl Manganese Tricarbonyl).

Toyota does not recommend the use of gasoline that contains MMT. If fuel containing MMT is used, your emission control system may be adversely affected.

The malfunction indicator lamp on the instrument cluster may come on. If this happens, contact your Toyota dealer for service.

 NOTICE**■ Notice on fuel quality**

- Do not use improper fuels. If improper fuels are used the engine will be damaged.
- Do not use leaded gasoline.  
Leaded gasoline will cause the three-way catalytic converter to lose its effectiveness and the emission control system to function improperly.
- Do not use gasohol other than that stated here.  
Other gasohol may cause fuel system damage or vehicle performance problems.

**■ Fuel-related poor driveability**

If after using a different type of fuel, poor driveability is encountered (poor hot starting, vaporization, engine knocking, etc.), discontinue the use of that type of fuel.

**■ When refueling with gasohol**

Take care not to spill gasohol. It can damage your vehicle's paint.

# 6-1. Specifications

## Tire information

### Typical tire symbols

#### ► Full-size spare tire

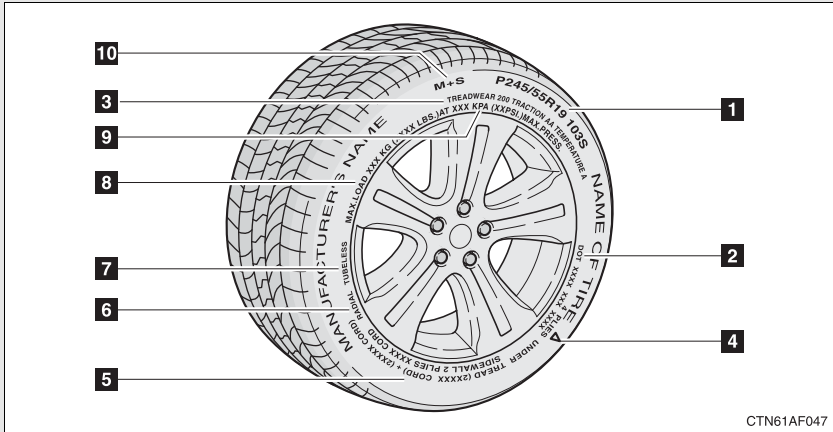

#### ► Compact spare tire

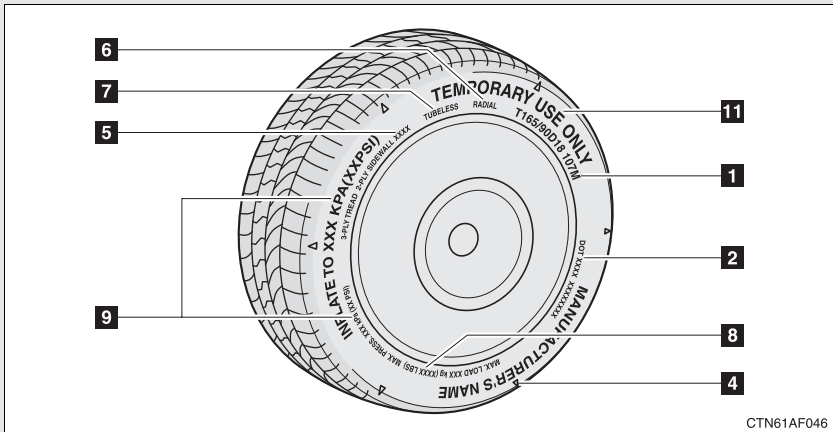

- 1** Tire size (→P. 573)
- 2** DOT and Tire Identification Number (TIN) (→P. 572)
- 3** Uniform tire quality grading  
For details, see “Uniform tire quality grading” that follows.
- 4** Location of treadwear indicators (→P. 453)

**5** Tire ply composition and materials

Plies are layers of rubber-coated parallel cords. Cords are the strands which form the plies in a tire.

**6** Radial tires or bias-ply tires

A radial tire has "RADIAL" on the sidewall. A tire not marked "RADIAL" is a bias-ply tire.

**7** TUBELESS or TUBE TYPE

A tubeless tire does not have a tube and air is directly filled in the tire. A tube type tire has a tube inside the tire and the tube maintains the air pressure.

**8** Load limit at maximum cold tire inflation pressure (→P. 458)**9** Maximum cold tire inflation pressure (→P. 562)

This means the pressure to which a tire may be inflated.

**10** Summer tire or all season tire (→P. 458)

An all season tire has "M+S" on the sidewall. A tire not marked "M+S" is a summer tire.

**11** "TEMPORARY USE ONLY" (→P. 530)

A compact spare tire is identified by the phrase "TEMPORARY USE ONLY" molded into its sidewall. This tire is designed for temporary emergency use only.

## Typical DOT and tire identification number (TIN)

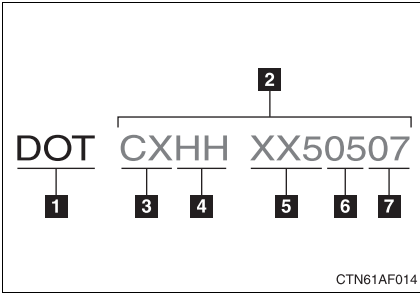

- 1** DOT symbol\*
- 2** Tire Identification Number (TIN)
- 3** Tire manufacturer's identification mark
- 4** Tire size code
- 5** Manufacturer's optional tire type code (3 or 4 letters)
- 6** Manufacturing week
- 7** Manufacturing year

\*: The DOT symbol certifies that the tire conforms to applicable Federal Motor Vehicle Safety Standards.

## Tire size

### ■ Typical tire size information

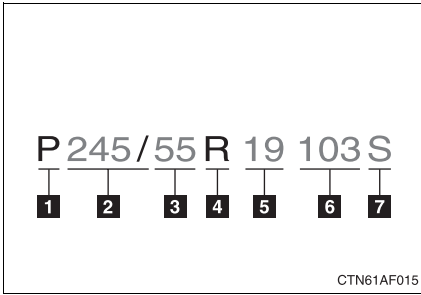

The illustration indicates typical tire size.

- 1** Tire use  
(P = Passenger car,  
T = Temporary use)
- 2** Section width (millimeters)
- 3** Aspect ratio  
(tire height to section width)
- 4** Tire construction code  
(R = Radial, D = Diagonal)
- 5** Wheel diameter (inches)
- 6** Load index (2 digits or 3 digits)
- 7** Speed symbol  
(alphabet with one letter)

### ■ Tire dimensions

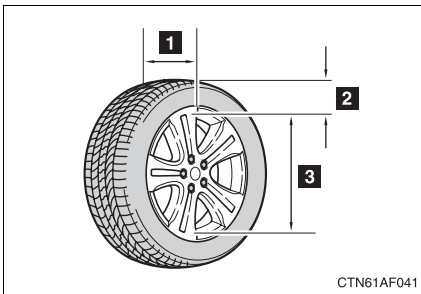

- 1** Section width
- 2** Tire height
- 3** Wheel diameter

## Tire section names

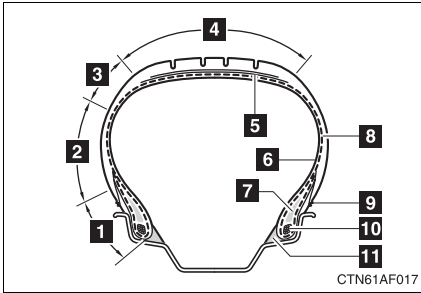

- 1** Bead
- 2** Sidewall
- 3** Shoulder
- 4** Tread
- 5** Belt
- 6** Inner liner
- 7** Reinforcing rubber
- 8** Carcass
- 9** Rim lines
- 10** Bead wires
- 11** Chafer

## Uniform Tire Quality Grading

This information has been prepared in accordance with regulations issued by the National Highway Traffic Safety Administration of the U.S. Department of Transportation.

It provides the purchasers and/or prospective purchasers of Toyota vehicles with information on uniform tire quality grading.

Your Toyota dealer will help answer any questions you may have as you read this information.

### ■ DOT quality grades

All passenger vehicle tires must conform to Federal Safety Requirements in addition to these grades. Quality grades can be found where applicable on the tire sidewall between tread shoulder and maximum section width.

For example: Treadwear 200 Traction AA Temperature A



## ■ Treadwear

The treadwear grade is a comparative rating based on the wear rate of the tire when tested under controlled conditions on a specified government test course.

For example, a tire graded 150 would wear one and a half (1 - 1/2) times as well on the government course as a tire graded 100.

The relative performance of tires depends upon the actual conditions of their use, however, and may depart significantly from the norm due to variations in driving habits, service practices and differences in road characteristics and climate.

## ■ Traction AA, A, B, C

The traction grades, from highest to lowest, are AA, A, B and C, and they represent the tire's ability to stop on wet pavement as measured under controlled conditions on specified government test surfaces of asphalt and concrete.

A tire marked C may have poor traction performance.

Warning: The traction grade assigned to this tire is based on braking (straight ahead) traction tests and does not include cornering (turning) traction.

## ■ Temperature A, B, C

The temperature grades are A (the highest), B, and C, representing the tire's resistance to the generation of heat and its ability to dissipate heat when tested under controlled conditions on a specified indoor laboratory test wheel.

Sustained high temperature can cause the material of the tire to degenerate and reduce tire life, and excessive temperature can lead to sudden tire failure.

The grade C corresponds to a level of performance which all passenger car tires must meet under the Federal Motor Vehicle Safety Standard No. 109.

Grades B and A represent higher levels of performance on the laboratory test wheel than the minimum required by law.

Warning: The temperature grades for this tire are established for a tire that is properly inflated and not overloaded.

Excessive speed, underinflation, or excessive loading, either separately or in combination, can cause heat buildup and possible tire failure.

### Glossary of tire terminology

Tire related term	Meaning
Cold tire inflation pressure	Tire pressure when the vehicle has been parked for three hours or more, or has not been driven more than 1 mile or 1.5 km under that condition
Maximum inflation pressure	The maximum cold inflated pressure to which a tire may be inflated, shown on the sidewall of the tire
Recommended inflation pressure	Cold tire inflation pressure recommended by a manufacturer
Accessory weight	The combined weight (in excess of those standard items which may be replaced) of automatic transmission, power steering, power brakes, power windows, power seats, radio and heater, to the extent that these items are available as factory-installed equipment (whether installed or not)
Curb weight	The weight of a motor vehicle with standard equipment, including the maximum capacity of fuel, oil and coolant, and if so equipped, air conditioning and additional weight optional engine
Maximum loaded vehicle weight	The sum of: (a) Curb weight (b) Accessory weight (c) Vehicle capacity weight (d) Production options weight

Tire related term	Meaning
Normal occupant weight	150 lb. (68 kg) times the number of occupants specified in the second column of Table 1* that follows
Occupant distribution	Distribution of occupants in a vehicle as specified in the third column of Table 1* below
Production options weight	The combined weight of installed regular production options weighing over 5 lb. (2.3 kg) in excess of the standard items which they replace, not previously considered in curb weight or accessory weight, including heavy duty brakes, ride levelers, roof rack, heavy duty 12-volt battery, and special trim
Rim	A metal support for a tire or a tire and tube assembly upon which the tire beads are seated
Rim diameter (Wheel diameter)	Nominal diameter of the bead seat
Rim size designation	Rim diameter and width
Rim type designation	The industry manufacturer's designation for a rim by style or code
Rim width	Nominal distance between rim flanges
Vehicle capacity weight (Total load capacity)	The rated cargo and luggage load plus 150 lb. (68 kg) times the vehicle's designated seating capacity
Vehicle maximum load on the tire	The load on an individual tire that is determined by distributing to each axle its share of the maximum loaded vehicle weight, and dividing by two
Vehicle normal load on the tire	The load on an individual tire that is determined by distributing to each axle its share of curb weight, accessory weight, and normal occupant weight (distributed in accordance with Table 1* below), and dividing by two

Tire related term	Meaning
Weather side	The surface area of the rim not covered by the inflated tire
Bead	The part of the tire that is made of steel wires, wrapped or reinforced by ply cords and that is shaped to fit the rim
Bead separation	A breakdown of the bond between components in the bead
Bias ply tire	A pneumatic tire in which the ply cords that extend to the beads are laid at alternate angles substantially less than 90 degrees to the centerline of the tread
Carcass	The tire structure, except tread and sidewall rubber which, when inflated, bears the load
Chunking	The breaking away of pieces of the tread or sidewall
Cord	The strands forming the plies in the tire
Cord separation	The parting of cords from adjacent rubber compounds
Cracking	Any parting within the tread, sidewall, or innerliner of the tire extending to cord material
CT	A pneumatic tire with an inverted flange tire and rim system in which the rim is designed with rim flanges pointed radially inward and the tire is designed to fit on the underside of the rim in a manner that encloses the rim flanges inside the air cavity of the tire
Extra load tire	A tire designed to operate at higher loads and at higher inflation pressures than the corresponding standard tire
Groove	The space between two adjacent tread ribs
Innerliner	The layer(s) forming the inside surface of a tubeless tire that contains the inflating medium within the tire

Tire related term	Meaning
Innerliner separation	The parting of the innerliner from cord material in the carcass
Intended outboard sidewall	<p>(a) The sidewall that contains a whitewall, bears white lettering, or bears manufacturer, brand, and/or model name molding that is higher or deeper than the same molding on the other sidewall of the tire, or</p> <p>(b) The outward facing sidewall of an asymmetrical tire that has a particular side that must always face outward when mounted on a vehicle</p>
Light truck (LT) tire	A tire designated by its manufacturer as primarily intended for use on lightweight trucks or multipurpose passenger vehicles
Load rating	The maximum load that a tire is rated to carry for a given inflation pressure
Maximum load rating	The load rating for a tire at the maximum permissible inflation pressure for that tire
Maximum permissible inflation pressure	The maximum cold inflation pressure to which a tire may be inflated
Measuring rim	The rim on which a tire is fitted for physical dimension requirements
Open splice	Any parting at any junction of tread, sidewall, or innerliner that extends to cord material
Outer diameter	The overall diameter of an inflated new tire
Overall width	The linear distance between the exteriors of the sidewalls of an inflated tire, including elevations due to labeling, decorations, or protective bands or ribs
Passenger car tire	A tire intended for use on passenger cars, multipurpose passenger vehicles, and trucks, that have a gross vehicle weight rating (GVWR) of 10,000 lb. or less.

Tire related term	Meaning
Ply	A layer of rubber-coated parallel cords
Ply separation	A parting of rubber compound between adjacent plies
Pneumatic tire	A mechanical device made of rubber, chemicals, fabric and steel or other materials, that, when mounted on an automotive wheel, provides the traction and contains the gas or fluid that sustains the load
Radial ply tire	A pneumatic tire in which the ply cords that extend to the beads are laid at substantially 90 degrees to the centerline of the tread
Reinforced tire	A tire designed to operate at higher loads and at higher inflation pressures than the corresponding standard tire
Section width	The linear distance between the exteriors of the sidewalls of an inflated tire, excluding elevations due to labeling, decoration, or protective bands
Sidewall	That portion of a tire between the tread and bead
Sidewall separation	The parting of the rubber compound from the cord material in the sidewall
Snow tire	A tire that attains a traction index equal to or greater than 110, compared to the ASTM E-1136 Standard Reference Test Tire, when using the snow traction test as described in ASTM F-1805-00, Standard Test Method for Single Wheel Driving Traction in a Straight Line on Snow-and Ice-Covered Surfaces, and which is marked with an Alpine Symbol (  ) on at least one sidewall
Test rim	The rim on which a tire is fitted for testing, and may be any rim listed as appropriate for use with that tire

Tire related term	Meaning
Tread	That portion of a tire that comes into contact with the road
Tread rib	A tread section running circumferentially around a tire
Tread separation	Pulling away of the tread from the tire carcass
Treadwear indicators (TWI)	The projections within the principal grooves designed to give a visual indication of the degrees of wear of the tread
Wheel-holding fixture	The fixture used to hold the wheel and tire assembly securely during testing

\*: Table 1 — Occupant loading and distribution for vehicle normal load for various designated seating capacities

Designated seating capacity, Number of occupants	Vehicle normal load, Number of occupants	Occupant distribution in a normally loaded vehicle
2 through 4	2	2 in front
5 through 10	3	2 in front, 1 in second seat
11 through 15	5	2 in front, 1 in second seat, 1 in third seat, 1 in fourth seat
16 through 20	7	2 in front, 2 in second seat, 2 in third seat, 1 in fourth seat

## Customizable features

**Your vehicle includes a variety of electronic features that can be personalized to your preferences. Programming these preferences requires specialized equipment and may be performed by your Toyota dealer.**

Some function settings are changed simultaneously with other functions being customized. Contact your Toyota dealer.

Item	Function	Default setting	Customized setting
Door lock (→P. 66, 539)	Speed-detecting auto- matic door lock function	Off	On
	Opening driver's door unlocks all doors	Off	On
	Shifting gears to P unlocks all doors	On	Off
	Shifting gears to posi- tion other than P locks all doors	On	Off
	Unlocking using a key	Driver's door unlocked in one step, all doors unlocked in two steps	All doors unlocked in one step
Smart key system (→P. 33)	Smart key system	On	Off
	Operation signal (Emergency flashers)	On	Off



Item	Function	Default setting	Customized setting
Wireless remote control (→P. 54)	Wireless remote control	On	Off
	Unlocking operation	Driver's door unlocked in one step, all doors unlocked in two steps	All doors unlocked in one step
	Automatic door lock function to be activated if door is not opened after being unlocked	On	Off
	Time elapsed before automatic door lock function is activated if door is not opened after being unlocked	60 seconds	30 seconds
			120 seconds
	Operation signal (Emergency flashers)	On	Off
	Door lock buzzer	On	Off
	Operation signal (Buzzer)	On	Off
	Panic function	On	Off
Glass hatch opening operation	Push and hold	Push twice	
		One short push	
Automatic light control system (→P. 203)	Light sensor sensitivity	Level 3	Level 1 to 5
	Time elapsed before headlights automatically turn off after doors are closed	30 seconds	0 second
			60 seconds
90 seconds			
Lights (→P. 203)	Daytime running light system (U.S.A. only)	On	Off

Item	Function	Default setting	Customized setting
Alarm system (→P. 122)	Time elapsed before the alarm is set	14 seconds	30 seconds
Multi-information display (→P. 194)	Language selection	English	French
			Spanish
			Chinese
Illumination (→P. 372)	Time elapsed before lights turn off	15 seconds	7.5 seconds
			30 seconds
	Operation when the doors are unlocked	On	Off
	Operation after the “ENGINE START STOP” switch or the engine switch is turned OFF	On	Off
	Outer foot lights	On	Off

## Items to initialize

**The following items must be initialized for normal system operation in cases such as after the battery is reconnected, or maintenance is performed on the vehicle.**

Item	When to initialize	Reference
Power back door	<ul style="list-style-type: none"> <li>• After reconnecting or changing the battery</li> <li>• After changing a fuse</li> </ul>	P. 71
Tire pressure warning system	<ul style="list-style-type: none"> <li>• When changing the tire inflation pressure by changing traveling speed or towing trailer, etc.</li> </ul>	P. 453



## Reporting safety defects for U.S. owners

If you believe that your vehicle has a defect which could cause a crash or could cause injury or death, you should immediately inform the National Highway Traffic Safety Administration (NHTSA) in addition to notifying Toyota Motor Sales, U.S.A., Inc. (Toll-free: 1-800-331-4331).

If NHTSA receives similar complaints, it may open an investigation, and if it finds that a safety defect exists in a group of vehicles, it may order a recall and remedy campaign. However, NHTSA cannot become involved in individual problems between you, your dealer, or Toyota Motor Sales, U.S.A., Inc.

To contact NHTSA, you may call the Vehicle Safety Hotline toll-free at 1-888-327-4236 (TTY: 1-800-424-9153); go to <http://www.safercar.gov>; or write to: Administrator, NHTSA, 1200 New Jersey Ave, S.E., Washington, DC 20590. You can also obtain other information about motor vehicle safety from <http://www.safercar.gov>.

## Seat belt instructions for Canadian owners (in French)

The following is a French explanation of seat belt instructions extracted from the seat belt section in this manual.

See the seat belt section for more detailed seat belt instructions in English.

### Utilisation correcte des ceintures de sécurité

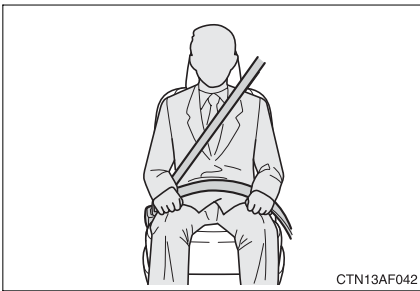

- Tendez la sangle diagonale de sorte qu'elle couvre complètement l'épaule, sans entrer en contact avec le cou ou glisser de l'épaule.
- Placez la sangle abdominale le plus bas possible sur les hanches.
- Réglez la position du dossier de siège. Asseyez-vous le dos le plus droit possible et caliez-vous bien dans le siège.
- Ne vrillez pas la ceinture de sécurité.

## Entretien et soin

### ■ Ceintures de sécurité

Nettoyez avec un chiffon ou une éponge humectée d'eau savonneuse tiède. Profitez de l'occasion pour vérifier régulièrement que les ceintures ne sont pas effilochées, entaillées, ou ne paraissent pas exagérément usées.

### ATTENTION

#### ■ Détérioration et usure des ceintures de sécurité

Inspectez les ceintures de sécurité périodiquement. Contrôlez qu'elles ne sont pas entaillées, effilochées, et que leurs ancrages ne sont pas desserrés. N'utilisez pas une ceinture de sécurité défectueuse avant qu'elle ne soit remplacée. Une ceinture de sécurité défectueuse n'apporte aucune garantie de protection de l'occupant en cas d'accident.

<b>A</b>	<p><b>A/C</b>..... 256, 263, 271, 274</p> <p><b>ABS</b>..... 218</p> <p><b>Active head restraints</b>..... 80</p> <p><b>Air conditioning filter</b>..... 469</p> <p><b>Air conditioning system</b></p> <ul style="list-style-type: none"> <li>Air conditioning filter ..... 469</li> <li>Front automatic air conditioning system ..... 263</li> <li>Front manual air conditioning system..... 256</li> <li>Rear automatic air conditioning system ..... 274</li> <li>Rear manual air conditioning system..... 271</li> </ul> <p><b>Airbags</b></p> <ul style="list-style-type: none"> <li>Airbag operating conditions..... 131</li> <li>Airbag precautions for your child..... 135</li> <li>Airbag warning light..... 511</li> <li>Curtain shield airbag operating conditions..... 131</li> <li>Curtain shield airbag precautions ..... 135</li> <li>Front passenger occupant classification system ..... 140</li> <li>General airbag precautions ..... 135</li> <li>Locations of airbags ..... 128</li> <li>Modification and disposal of airbags ..... 139</li> <li>Proper driving posture..... 126, 135</li> <li>Side airbag operating conditions..... 131</li> <li>Side airbag precautions..... 135</li> <li>SRS airbags ..... 128</li> </ul>	<p><b>Alarm</b>.....122</p> <p><b>Antenna</b>.....287</p> <p><b>Anti-lock brake system</b>.....218</p> <p><b>Armrest</b> .....398</p> <p><b>Audio input</b>.....307</p> <p><b>Audio system</b></p> <ul style="list-style-type: none"> <li>A/V input adapter .....333</li> <li>Antenna.....287</li> <li>Audio input .....307</li> <li>Audio visual input.....333</li> <li>AUX adapter.....307</li> <li>CD player/changer .....290</li> <li>DVD player.....318</li> <li>MP3/WMA disc.....297</li> <li>Optimal use .....304</li> <li>Portable music player.....307</li> <li>Radio.....284</li> <li>Rear seat entertainment system .....311</li> <li>Steering wheel audio switch.....309</li> <li>Type .....281</li> </ul> <p><b>Audio visual input</b>.....333</p> <p><b>Automatic light control system</b> .....203</p> <p><b>Automatic transmission</b> .....180</p> <p><b>AUX adapter</b> .....307</p> <p><b>Auxiliary box</b> ..... 384</p> <p><b>A/V input adapter</b> .....333</p>
----------	--	---



<b>B</b>	<b>Back-up lights</b>	
	Replacing light bulbs .....	486
	Wattage .....	566
	<b>Back door</b>	
	Back door .....	71
	Wireless remote control .....	54
	Smart key system.....	33
	<b>Battery</b>	
	Checking .....	449
	If the vehicle has a discharged battery.....	541
	Preparing and checking before winter .....	238
	<b>Bluetooth®</b> .....	346
	<b>Bottle holder</b> .....	383
	<b>Brakes</b>	
	Fluid .....	448
	Parking brake .....	186
	<b>Brake assist</b> .....	218
	<b>Break-in tips</b> .....	165

<b>C</b>	<b>Care</b>	
	Exterior.....	416
	Interior.....	419
	Seat belts .....	420
	<b>Cargo capacity</b> .....	237
	<b>Cargo hooks</b> .....	400
	<b>CD changer</b> .....	290
	<b>CD player</b> .....	290
	<b>Chains</b> .....	238
	<b>Child restraint system</b>	
	Booster seats, definition.....	146
	Booster seats, installation .....	151
	Convertible seats, definition .....	146
	Convertible seats, installation.....	151
	Front passenger occupant classification system.....	140
	Infant seats, definition .....	146
	Infant seats, installation .....	151
	Installing CRS with lower anchorage.....	153
	Installing CRS with seat belts .....	155
	Installing CRS with top straps.....	158

**Child safety**  
 Airbag precautions ..... 135  
 Battery precautions ..... 450, 544  
 Child restraint system..... 146  
 Child-protectors ..... 68  
 How your child should wear  
   the seat belt ..... 97  
 Installing child restraints ..... 151  
 Moon roof precautions..... 110  
 Power window lock switch.... 106  
 Power window precautions... 107  
 Removed key battery  
   precautions ..... 474  
 Seat belt extender  
   precautions ..... 99  
 Seat belt precautions..... 97  
 Seat heater precautions ..... 397  
**Child-protectors ..... 68**  
**Cleaning**  
   Exterior ..... 416  
   Interior ..... 419  
   Seat belts ..... 420  
**Clock ..... 194, 390**  
**Compass ..... 411**  
**Condenser ..... 447**  
**Console box..... 377**  
**Conversation mirror..... 391**  
**Cooling system**  
   Engine overheating ..... 545  
**Cruise control..... 211**  
**Cup holders ..... 379**  
**Curtain shield airbags ..... 128**  
**Customizable features..... 582**

**D** **Daytime running light  
 system .....205**  
**Defogger**  
   Rear window .....277  
   Side mirrors.....277  
**Dimension.....552**  
**Dinghy towing .....252**  
**Display**  
   Trip information ..... 194  
   Warning message .....521  
**Do-it-yourself maintenance.....428**  
**Door courtesy lights**  
   Door courtesy lights .....372  
   Wattage.....566  
**Doors**  
   Door glasses .....106  
   Door lock.....33, 54, 66  
   Side mirrors.....103  
**Downhill assist control  
 system .....225**  
**Driver's seat belt reminder  
 light.....513**  
**Driving**  
   Break-in tips ..... 165  
   Correct posture ..... 126  
   Procedures.....164  
   Winter driving tips.....238  
**DVD player.....318**

**E** **Electric power steering** .....218

**Electronic key**

If your electronic key battery is discharged .....539

**Emergency flashers**

Switch.....498

**Emergency, in case of**

If the back door opener is inoperative .....74

If the electronic key does not operate properly.....539

If the engine will not start .....535

If the shift lever cannot be shifted from P.....537

If the vehicle has a discharged battery.....541

If the warning buzzer sounds... .....510

If the warning light turns on.....510

If the warning message is displayed.....521

If you have a flat tire .....522

If you lose your keys/ wireless remote control transmitter.....538

If you think something is wrong.....506

If your vehicle becomes stuck .....548

If your vehicle needs to be towed .....499

If your vehicle overheats .....545

**Engine**

Compartment .....437

Engine switch.....173, 177

Hood .....432

How to start the engine.....173, 177

Identification number.....553

If the engine will not start .....535

Ignition switch .....173, 177

Overheating .....545

**Engine compartment cover** ....439

**Engine coolant**

Capacity .....558

Checking .....445

Preparing and checking before winter .....238

**Engine coolant temperature gauge**.....188

**Engine immobilizer system** ....115

**Engine oil**

Capacity .....556

Checking .....440

Preparing and checking before winter .....238

**Engine oil maintenance**

**data** .....443

**Enhanced vehicle stability**

**control** .....218

**Enhanced VSC** .....218

**EPS**.....218

**Event data recorder** .....508

<b>F</b>	<b>Floor mat.....</b>	<b>399</b>
	<b>Fluid</b>	
	Brake .....	448
	Washer .....	452
	<b>Fog lights</b>	
	Replacing light bulbs .....	486
	Switch.....	207
	Wattage .....	566
	<b>Front automatic air conditioning system.....</b>	<b>263</b>
	<b>Front fog lights</b>	
	Replacing light bulbs .....	486
	Switch.....	207
	Wattage .....	566
	<b>Front manual air conditioning system .....</b>	<b>256</b>
	<b>Front passenger occupant classification system.....</b>	<b>140</b>
	<b>Front passenger's seat belt reminder light.....</b>	<b>513</b>
	<b>Front seats</b>	
	Adjustment .....	79

<b>Front side marker lights</b>	
Replacing light bulbs .....	486
Switch.....	203
Wattage .....	566
<b>Front turn signal lights</b>	
Replacing light bulbs .....	486
Wattage .....	566
<b>Fuel</b>	
Capacity .....	555
Fuel gauge .....	188
Fuel pump shut off system .....	507
Gas station information .....	608
Information .....	567
Refueling .....	111
Type .....	555
<b>Fuel door.....</b>	<b>111</b>
<b>Fuel filler door .....</b>	<b>111</b>
<b>Fuel pump shut off system .....</b>	<b>507</b>
<b>Fuses.....</b>	<b>475</b>

<b>G</b>	<b>Garage door opener</b> .....	<b>406</b>
	<b>Gas station information</b> .....	<b>608</b>
	<b>Gauges</b> .....	<b>188</b>
	<b>Glove box</b> .....	<b>376</b>
<b>H</b>	<b>Hands-free system</b>	
	<b>(for cellular phone)</b> .....	<b>342</b>
	<b>Hazard lights switch</b> .....	<b>498</b>
	<b>Head restraints</b>	
	Active head restraints.....	<b>80</b>
	Adjusting .....	<b>91</b>
	<b>Headlights</b>	
	Replacing light bulbs .....	<b>486</b>
	Switch.....	<b>203</b>
	Wattage.....	<b>566</b>
	<b>Heaters</b>	
	Seat heaters.....	<b>396</b>
	Side mirror.....	<b>277</b>
	<b>Hood</b> .....	<b>432</b>
	<b>Hooks</b>	
	Cargo hook.....	<b>400</b>
	Shopping bag.....	<b>400</b>
	<b>Horn</b> .....	<b>187</b>

<b>I</b>	<b>I/M test</b> .....	<b>427</b>
	<b>Identification</b>	
	Engine.....	<b>553</b>
	Vehicle .....	<b>553</b>
	<b>Ignition switch</b> .....	<b>174, 177</b>
	<b>Illuminated entry system</b> .....	<b>372</b>
	<b>Indicator lights</b> .....	<b>190</b>
	<b>Initialization</b>	
	Items to initialize .....	<b>585</b>
	<b>Inside rear view mirror</b> .....	<b>101</b>
	<b>Interior lights</b>	
	Interior lights .....	<b>372</b>
	Switch .....	<b>373, 374</b>
	Wattage.....	<b>566</b>
<b>J</b>	<b>Jack</b>	
	Positioning a floor jack .....	<b>434</b>
	Vehicle-equipped jack.....	<b>522</b>
	<b>Jack handle</b> .....	<b>522</b>

**K** **Keyless entry**..... 54

**Keys**

- Electronic key ..... 30
- Engine switch ..... 174, 177
- If the electronic key does not operate properly..... 539
- If you lose your keys/  
wireless remote control transmitter ..... 538
- Ignition switch..... 174, 177
- Keyless entry..... 54
- Key number ..... 30
- Keys ..... 30
- Mechanical key..... 30
- Wireless remote control key ..... 54

**L** **License plate lights**

- Replacing light bulbs .....486
- Wattage .....566

**Light bulbs**

- Replacing .....486
- Wattage.....566

**Lights**

- Door courtesy lights .....372
- Emergency flasher switch .....498
- Fog light switch .....207
- Hazard light switch .....498
- Headlight switch .....203
- Interior light switch .....373, 374
- Outer foot lights.....372
- Personal light switch .....373
- Replacing light bulbs .....486
- Turn signal lever.....185
- Vanity lights.....389
- Wattage.....566

**Load capacity**.....237

**Lock steering column**.....175, 178

**Luggage cover** .....402

<b>M</b>	<b>Maintenance</b>	
	Do-it-yourself	
	maintenance .....	428
	General maintenance.....	424
	Maintenance data.....	552
	Maintenance requirements....	422
	<b>Meter</b>	
	Instrument panel light	
	control.....	189
	Meters .....	188
	<b>Mirrors</b>	
	Conversation mirror.....	391
	Inside rear view mirror.....	101
	Side mirror heaters.....	277
	Side mirrors.....	103
	Vanity mirrors .....	389
	<b>Moon roof</b> .....	108
	<b>MP3 disc</b> .....	297
	<b>Multi-information</b>	
	display .....	194

<b>O</b>	<b>Off-road precautions</b> .....	228
	<b>Odometer</b> .....	188
	<b>Oil</b>	
	Engine oil .....	440
	<b>Opener</b>	
	Back door.....	71
	Fuel filler door .....	111
	Glass hatch.....	77
	Hood .....	432
	<b>Outside rear view mirrors</b>	
	Adjusting and folding.....	103
	<b>Outside temperature</b>	
	display .....	195
	<b>Overhead console</b> .....	378
	<b>Overheating, Engine</b> .....	545
<b>P</b>	<b>Parking brake</b> .....	186
	<b>Parking lights</b>	
	Replacing light bulbs.....	486
	Switch .....	203
	Wattage.....	566
	<b>Personal/interior lights</b>	
	Switch .....	373
	Wattage.....	566
	<b>Power outlet</b> .....	392
	<b>Power windows</b> .....	106

<b>R</b>	<b>Radiator</b> .....	<b>447</b>
	<b>Radio</b> .....	<b>284</b>
	<b>Rear automatic air conditioning system</b> .....	<b>274</b>
	<b>Rear manual air conditioning system</b> .....	<b>271</b>
	<b>Rear seat</b>	
	Adjustment .....	82
	Folding down second seatback.....	84
	Folding down third seatback.....	86
	Removing the second center seat .....	87
	Stowing the second center seat .....	87
	<b>Rear seat entertainment system</b> .....	<b>311</b>
	<b>Rear turn signal lights</b>	
	Replacing light bulbs .....	486
	Wattage .....	566
	<b>Rear view mirror</b>	
	Compass .....	411
	<b>Rear view monitor system</b> .....	<b>214</b>
	<b>Rear window defogger</b> .....	<b>277</b>
	<b>Rear window wiper</b> .....	<b>210</b>
	<b>Replacing</b>	
	Fuses.....	475
	Key battery .....	472
	Light bulbs.....	486
	Tires .....	522
	<b>Reporting safety defects for U.S. owners</b> .....	<b>588</b>

<b>S</b>	<b>Seat belts</b>	
	Adjusting the seat belt.....	94
	Automatic Locking Retractor .....	95
	Child restraint system installation.....	151
	Cleaning and maintaining the seat belts .....	420
	Emergency Locking Retractor .....	95
	How to wear your seat belt.....	94
	How your child should wear the seat belt .....	97
	Pregnant women, proper seat belt use .....	96
	Reminder light .....	513
	Seat belt extenders .....	97
	Seat belt pretensioners .....	95
	<b>Seat heaters</b> .....	<b>396</b>
	<b>Seating capacity</b> .....	<b>237</b>
	<b>Seats</b>	
	Adjustment .....	79, 82
	Adjustment precaution .....	81, 90
	Child seats/child restraint system installation .....	151
	Cleaning.....	419
	Head restraint.....	91
	Properly sitting in the seat.....	126
	Seat heaters.....	396



<b>Service reminder indicators</b> .....	<b>190</b>
<b>Shift lever</b>	
Automatic transmission .....	180
If the shift lever cannot be shifted from P .....	537
<b>Shift lock system</b> .....	<b>537</b>
<b>Shopping bag hooks</b> .....	<b>400</b>
<b>Side airbags</b> .....	<b>128</b>
<b>Side marker lights</b>	
Replacing .....	486
Switch.....	203
Wattage.....	566
<b>Side mirrors</b>	
Adjusting and folding.....	103
<b>Side table</b> .....	<b>386</b>
<b>Smart key system</b>	
Entry function .....	33
Starting the engine .....	173
<b>Spare tire</b>	
Inflation pressure.....	562
Storage location .....	522
<b>Spark plug</b> .....	<b>559</b>
<b>Specifications</b> .....	<b>552</b>
<b>Speech command switch</b> .....	<b>347</b>
<b>Speedometer</b> .....	<b>188</b>
<b>Steering</b>	
Column lock release.....	175, 178

<b>Steering wheel</b>	
Adjustment .....	100
Audio switches .....	309
Climate remote control switches.....	280
<b>Stop lights</b>	
Replacing light bulbs .....	486
Wattage.....	566
<b>Storage feature</b> .....	<b>375</b>
<b>Storage precautions</b> .....	<b>235</b>
<b>Stuck</b>	
If your vehicle becomes stuck .....	548
<b>Sun visors</b> .....	<b>388</b>
<b>Switch</b>	
Emergency flasher switch .....	498
Engine switch.....	174, 177
Fog light switch .....	207
Hazard light switch.....	498
Ignition switch .....	174, 177
Light switches .....	203
Power door lock switch .....	67
Power window switch.....	106
SNOW switch.....	181
Window lock switch.....	106
Wiper and washer switch.....	208, 210

**T**

**Tachometer** ..... 188

**Tail lights**

- Replacing light bulbs ..... 486
- Switch ..... 203
- Wattage ..... 566

**Talk switch** ..... 347

**Telephone switch** ..... 347

**Theft deterrent system**

- Alarm ..... 122
- Engine immobilizer system... 115

**Theft prevention labels** ..... 125

**Tire inflation pressure** ..... 463

**Tire information**

- Glossary ..... 576
- Size ..... 573
- Tire identification number .... 572
- Uniform tire quality grading ..... 574

**Tires**

- Chains ..... 238
- Checking ..... 453
- If you have a flat tire ..... 522
- Inflation pressure ..... 463
- Information ..... 570
- Replacing ..... 522
- Rotating tires ..... 453
- Size ..... 562
- Snow tires ..... 238
- Tire pressure warning system ..... 453, 513

**Tools** ..... 522

**Total load capacity** ..... 237

**Towing**

- Dinghy towing ..... 252
- Emergency towing ..... 500
- Trailer towing ..... 242

**Traction control** ..... 218

**TRAC** ..... 218

**Trip information** ..... 194

**Trip meter** ..... 188

**Turn signal lights**

- Replacing light bulbs ..... 486
- Switch ..... 185
- Wattage ..... 566

**V** **Valet key** .....30

**Vanity lights**

Vanity lights .....389

Wattage .....566

**Vanity mirrors**.....389

**Vehicle identification**

number .....553

**W** **Warning buzzers**

Brake system .....510

Open door .....513

Seat belt reminder .....513

**Warning lights**

Anti-lock brake system .....511

Brake assist system .....511

Brake system .....510

Charging system .....511

Electric power steering  
system .....511

Electronic engine control  
system .....511

Engine oil pressure .....511

Malfunction indicator lamp ....511

Master warning light .....513

Open door .....513

Pretensioners .....511

Seat belt reminder light .....513

SRS airbags .....511

Tire pressure warning light....513

**Warning messages** .....521

**Washer**

Checking .....452

Preparing and checking  
before winter .....238

Switch .....208, 210

**Washing and waxing** .....416

**Weight**

Cargo capacity .....233

Load limits .....237

Weight.....552

**Wheels** .....467

**Window glasses** .....106

**Window lock switch**.....106

**Windows**

Power windows .....106

Rear window defogger .....277

Washer.....208, 210

**Windshield wiper de-icer** .....279

**Windshield wipers** .....208

**Wireless remote control key**

Replacing the battery .....472

Wireless remote control key....54

**WMA disc**.....297

What to do if...

What to do if...

A tire punctures	P. 522	If you have a flat tire
The engine does not start	P. 535	If the engine will not start
	P. 115	Engine immobilizer system
	P. 541	If the battery is discharged
The shift lever cannot be moved out	P. 537	If the shift lever cannot be shifted from P
The engine coolant temperature gauge enters the red zone	P. 545	If your vehicle overheats
The key is lost	P. 538	If you lose your keys/ wireless remote control transmitter
The battery runs out	P. 541	If the battery is discharged
The doors cannot be locked	P. 66	Side doors
	P. 71	Back door
The horn begins to sound	P. 122	Alarm
The vehicle is stuck in mud or sand	P. 548	If the vehicle becomes stuck

A warning light or indicator light comes on

P. 510

If a warning light turns on or a warning buzzer sounds...

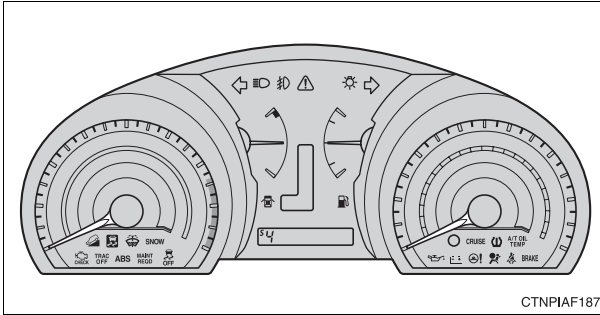

### ■ Warning lights

**BRAKE**

Brake system warning light

or



P. 510



Low fuel level warning light

P. 513



Driver's seat belt reminder light

P. 513



Charging system warning light

P. 511



Front passenger's seat belt reminder light

OR



P. 513



Low engine oil pressure warning light

P. 511



Malfunction indicator lamp

or



P. 511



Master warning light

P. 513

**MAINT REQD**

Engine oil replacement reminder light

P. 513



SRS warning light

P. 511



Low washer fluid warning light

P. 513



Open door warning light

P. 513

 ABS warning light

or

 P. 511

 Automatic transmission fluid temperature warning light P. 513

 Tire pressure warning light P. 513

 Electric power steering warning light P. 511

A warning message is displayed

P. 521 If a warning message is displayed

## GAS STATION INFORMATION

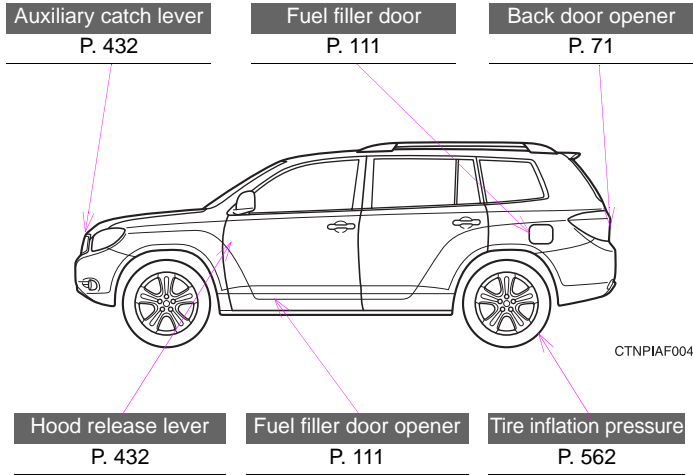

Fuel tank capacity (Reference)	19.2 gal. (72.5 L, 15.9 Imp. gal.)
Fuel type	Unleaded gasoline with an Octane Rating of 87 (Research Octane Number 91)
Cold tire inflation pressure	P. 562
Engine oil capacity Drain and refill (Reference)	P. 556
Engine oil type	<p>Toyota Genuine Motor Oil or equivalent Oil grade: P. 556 ILSAC multigrade engine oil Recommended oil viscosity:</p> <ul style="list-style-type: none"> <li>▶ 2.7 L 4-cylinder (1AR-FE) engine 5W-20 and 0W-20</li> <li>▶ 3.5 L V6 (2GR-FE) engine Without towing package: 5W-20 With towing package: 5W-30</li> </ul>