

## Abbreviation/Acronym list

ABBREVIATIONS	MEANING
2WD	2 Wheel Drive
4WD	4 Wheel Drive
A/C	Air Conditioning
ABS	Anti-lock Brake System
ACC	Accessory
ALR	Automatic Locking Retractor
AUTO LSD	Automatic Limited Slip Differential
AVG	Average
CRS	Child Restraint System
DAC	Downhill Assist Control
DISP	Display
ECU	Electronic Control Unit
EDR	Event Data Recorder
ELR	Emergency Locking Retractor
EPS	Electric Power Steering
GAWR	Gross Axle Weight Rating
GVWR	Gross Vehicle Weight Rating
I/M	Emission Inspection and Maintenance
LATCH	Lower Anchors and Tethers for Children
LED	Light Emitting Diode
MMT	Methylcyclopentadienyl Manganese Tricarbonyl
M+S	Mud and Snow
MTBE	Methyl Tertiary Butyl Ether
OBD	On Board Diagnostics
RFT	Run-Flat Tire
SRS	Supplemental Restraint System
TIN	Tire Identification Number

ABBREVIATIONS	MEANING
TPMS	Tire Pressure Warning System
TRAC	Traction control
VIN	Vehicle Identification Number
VSC	Vehicle Stability Control

## For your information

### **Main Owner's Manual**

Please note that this manual covers all models and all equipment, including options. Therefore, you may find some explanations for equipment not installed on your vehicle.

All specifications provided in this manual are current at the time of printing. However, because of the Toyota policy of continual product improvement, we reserve the right to make changes at any time without notice.

Depending on specifications, the vehicle shown in the illustrations may differ from your vehicle in terms of equipment.

### **Noise from under vehicle after turning off the engine**

Approximately five hours after the engine is turned off, you may hear sound coming from under the vehicle for several minutes. This is the sound of a fuel evaporation leakage check and it does not indicate a malfunction.

### **Accessories, spare parts and modification of your Toyota**

A wide variety of non-genuine spare parts and accessories for Toyota vehicles are currently available on the market. You should know that these parts are not covered by Toyota warranty and that Toyota is not responsible for their performance, repair, or replacement, or for any damage they may cause to, or adverse effect they may have on, your Toyota vehicle.

This vehicle should not be modified with non-genuine Toyota products. Modification with non-genuine Toyota products may affect performance, safety or durability, and may even violate governmental regulations. In addition, damage or performance problems resulting from the modification may not be covered under warranty.

## **Installation of a mobile two-way radio system**

As the installation of a mobile two-way radio system in your vehicle may affect electronic systems such as the multi-port fuel injection system/sequential multi-port fuel injection system, cruise control system, anti-lock brake system, SRS airbag system or seat belt pretensioner system, be sure to check with your Toyota dealer for precautionary measures or special instructions regarding installation.

## **Scrapping of your Toyota**

The SRS airbag and seat belt pretensioner devices in your Toyota contain explosive chemicals. If the vehicle is scrapped with the airbags and seat belt pretensioners left as they are, this may cause an accident such as fire. Be sure to have the systems of the SRS airbag and seat belt pretensioner removed and disposed of by a qualified service shop or by your Toyota dealer before you scrap your vehicle.

## **Perchlorate Material**

Special handling may apply, See [www.dtsc.ca.gov/hazardouswaste/perchlorate](http://www.dtsc.ca.gov/hazardouswaste/perchlorate). Your vehicle has components that may contain perchlorate. These components may include airbag, seat belt pretensioners, and wireless remote control batteries.



## CAUTION

### ■ General precautions while driving

**Driving under the influence:** Never drive your vehicle when under the influence of alcohol or drugs that have impaired your ability to operate your vehicle. Alcohol and certain drugs delay reaction time, impair judgment and reduce coordination, which could lead to an accident that could result in death or serious injury.

**Defensive driving:** Always drive defensively. Anticipate mistakes that other drivers or pedestrians might make and be ready to avoid accidents.

**Driver distraction:** Always give your full attention to driving. Anything that distracts the driver, such as adjusting controls, talking on a cellular phone or reading can result in a collision with resulting death or serious injury to you, your occupants or others.

### ■ General precaution regarding children's safety

Never leave children unattended in the vehicle, and never allow children to have or use the key.

Children may be able to start the vehicle or shift the vehicle into neutral. There is also a danger that children may injure themselves by playing with the windows, the moon roof, or other features of the vehicle. In addition, heat build-up or extremely cold temperatures inside the vehicle can be fatal to children.

## Symbols used throughout this manual

### Cautions & Notices

#### CAUTION

This is a warning against anything which may cause death or injury to people if the warning is ignored. You are informed about what you must or must not do in order to reduce the risk of injury to yourself and others.

#### NOTICE

This is a warning against anything which may cause damage to the vehicle or its equipment if the warning is ignored. You are informed about what you must or must not do in order to avoid or reduce the risk of damage to your Toyota and its equipment.

### Symbols used in illustrations



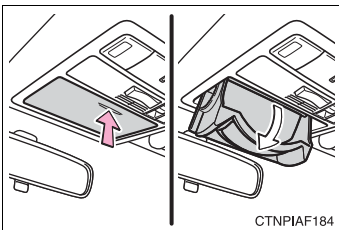

#### Safety symbol

The symbol of a circle with a slash through it means “Do not”, “Do not do this”, or “Do not let this happen”.



#### Arrows indicating operations

-  Indicates the action (pushing, turning, etc.) used to operate switches and other devices.
-  Indicates the outcome of an operation (e.g. a lid opens).



## TABLE OF CONTENTS

1	<b>Before driving</b>	Adjusting and operating features such as door locks, mirrors, and steering column.
2	<b>When driving</b>	Driving, stopping and safe-driving information.
3	<b>Interior features</b>	Air conditioning and audio systems, as well as other interior features for a comfortable driving experience.
4	<b>Maintenance and care</b>	Cleaning and protecting your vehicle, performing do-it-yourself maintenance, and maintenance information.
5	<b>When trouble arises</b>	What to do if the vehicle needs to be towed, gets a flat tire, or is involved in an accident.
6	<b>Vehicle specifications</b>	Detailed vehicle information.
7	<b>For owners</b>	Reporting safety defects for U.S. owners and seat belt and SRS airbag instructions for Canadian owners
	<b>Index</b>	Alphabetical listing of information contained in this manual.



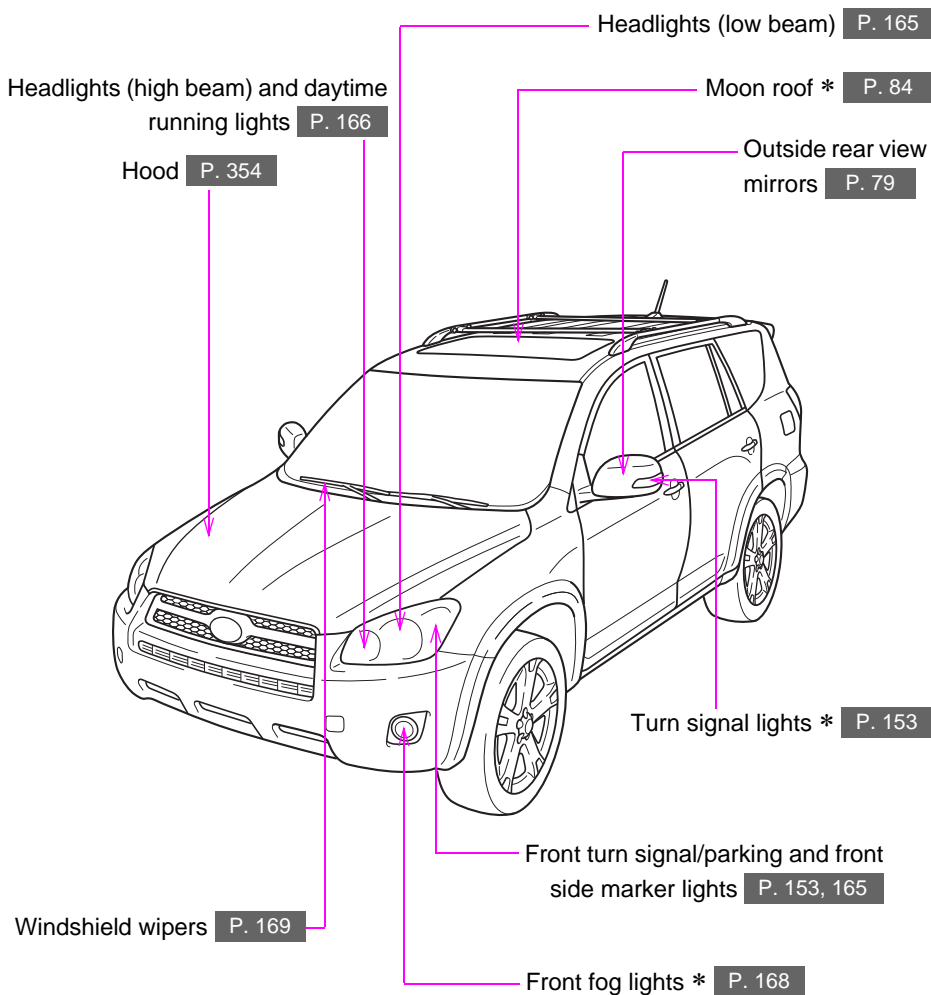

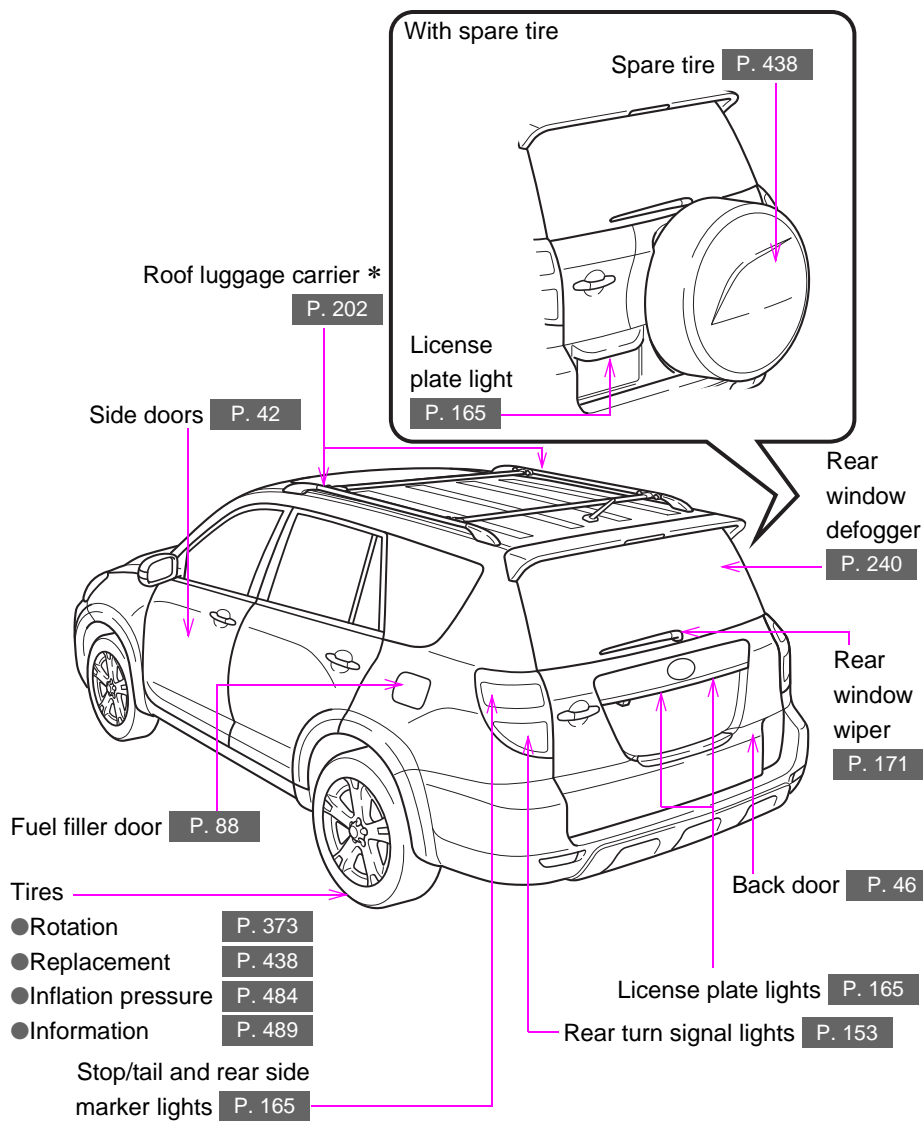

\*: If equipped

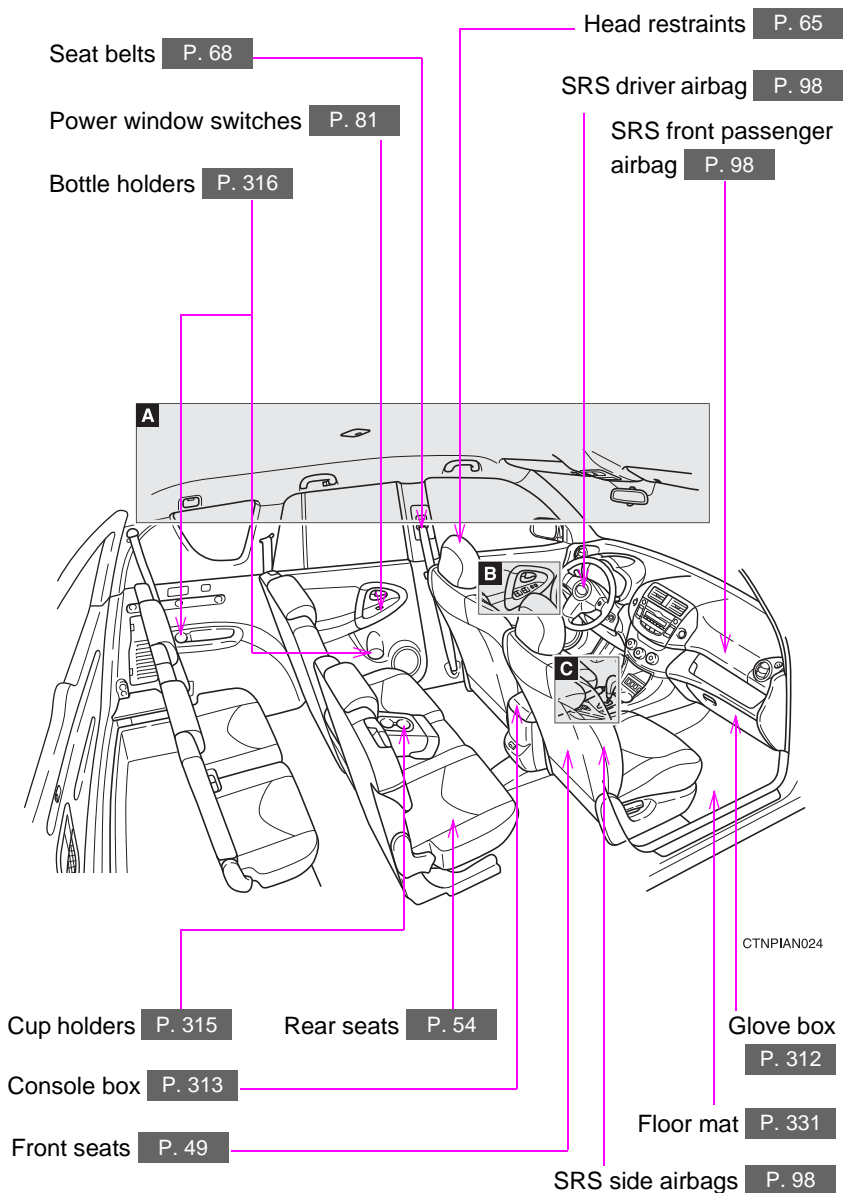

**A**

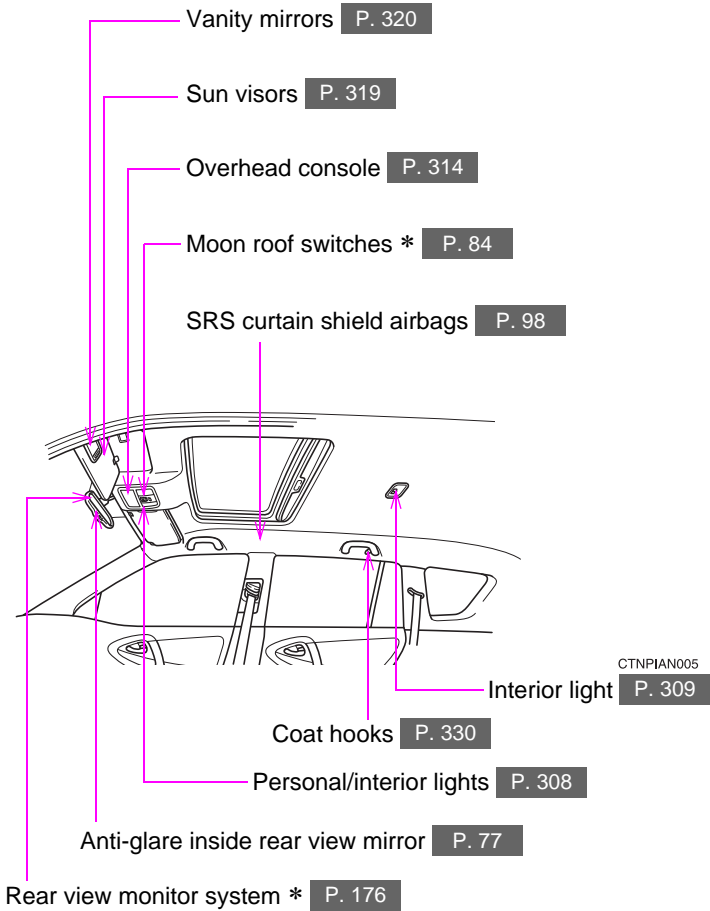

\*: If equipped

**B**

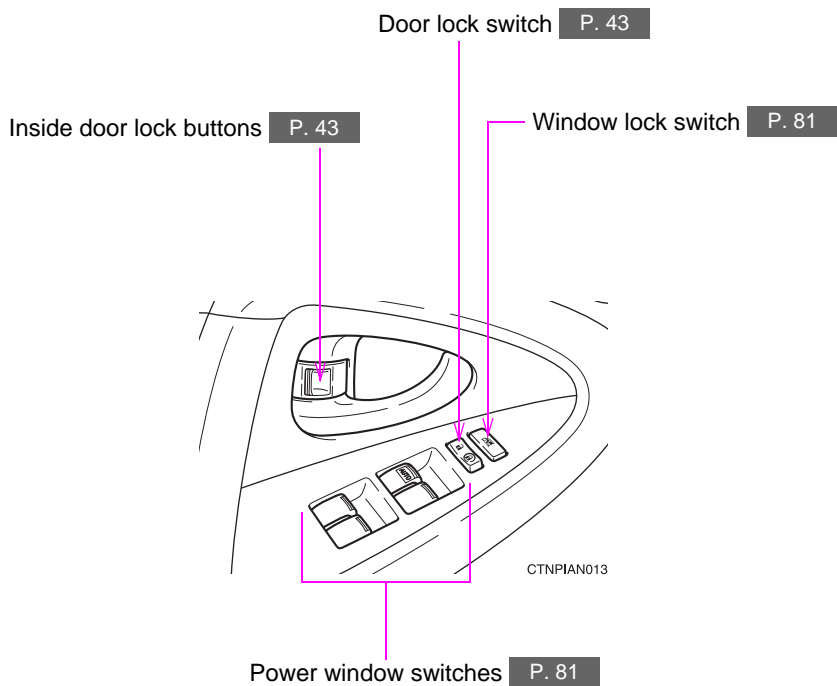

**C**

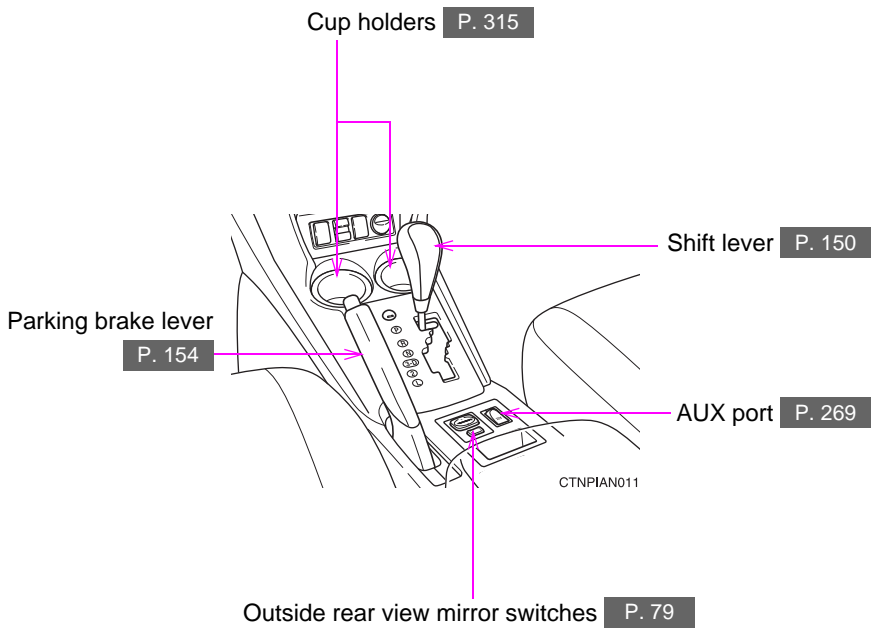

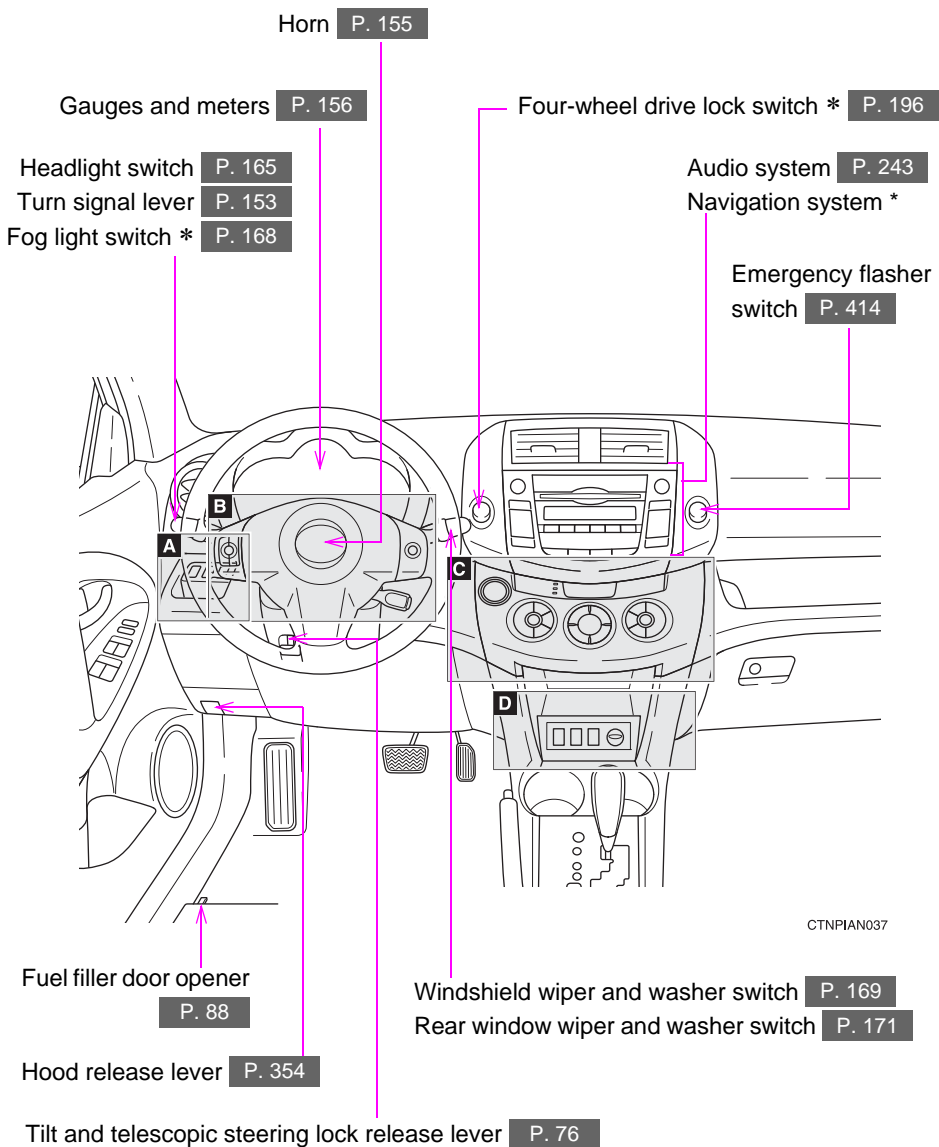

CTNPIAN037

**A**

Instrument panel light control dial P. 157

“DAC” switch \* P. 193

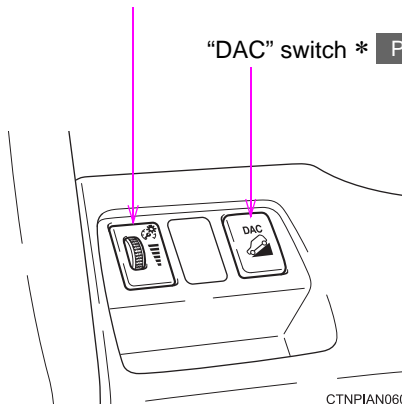

CTNPIAN060

\*: If equipped

\*: Refer to “Navigation System Owner’s Manual”.



**B**

► **Without hands-free phone system**

Audio remote control switches \*, \* P. 270

“DISP” switch P. 163

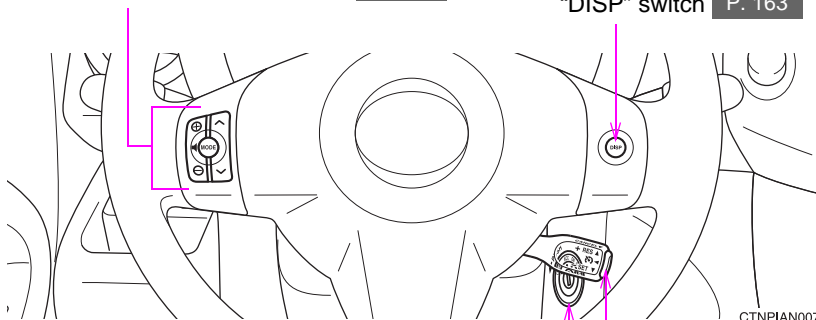

CTNPIAN007

Engine (ignition) switch  
(without smart key system) P. 147

Cruise control switch P. 172

► **With hands-free phone system**

Audio remote control switches P. 270

Telephone switch P. 278

“DISP” switch P. 163

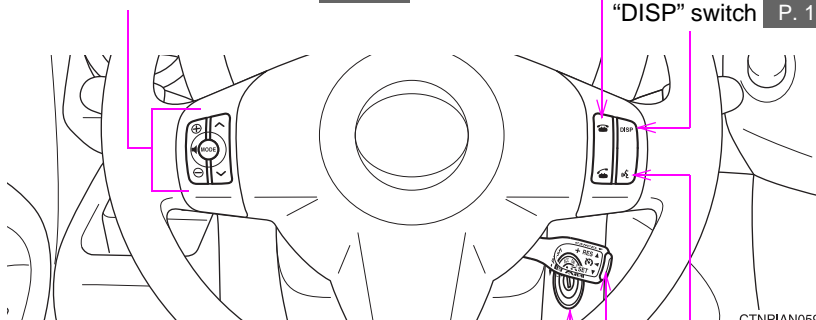

CTNPIAN059

Engine (ignition) switch  
(without smart key system) P. 147

Talk switch P. 278

Cruise control switch P. 172

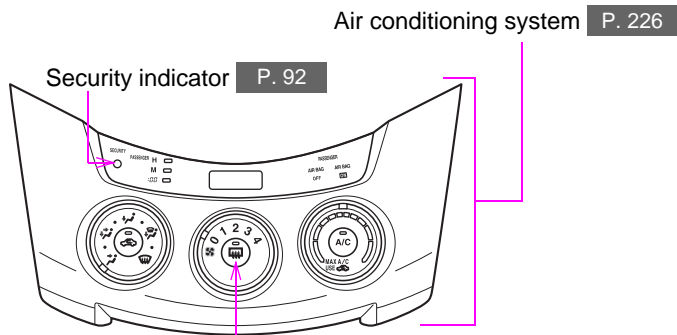
**C****► With a manual air conditioning system**

Rear window defogger switch P. 240

Outside rear view mirror defogger switch \* P. 240

**► With an automatic air conditioning system**

Engine (ignition) switch  
(with smart key system) P. 143

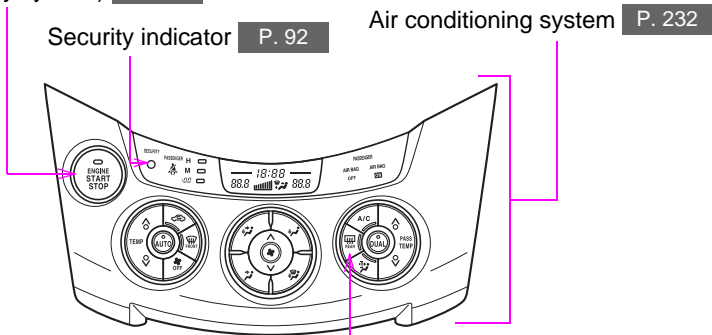

Rear window and outside rear view mirror defogger switch P. 240

\*: If equipped

\*: Refer to "Navigation System Owner's Manual".

**D**

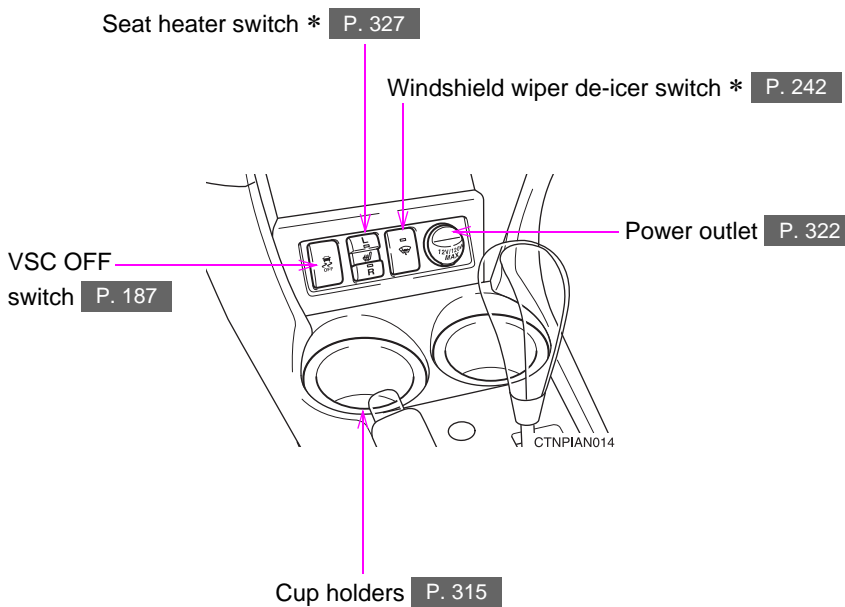

\*: If equipped

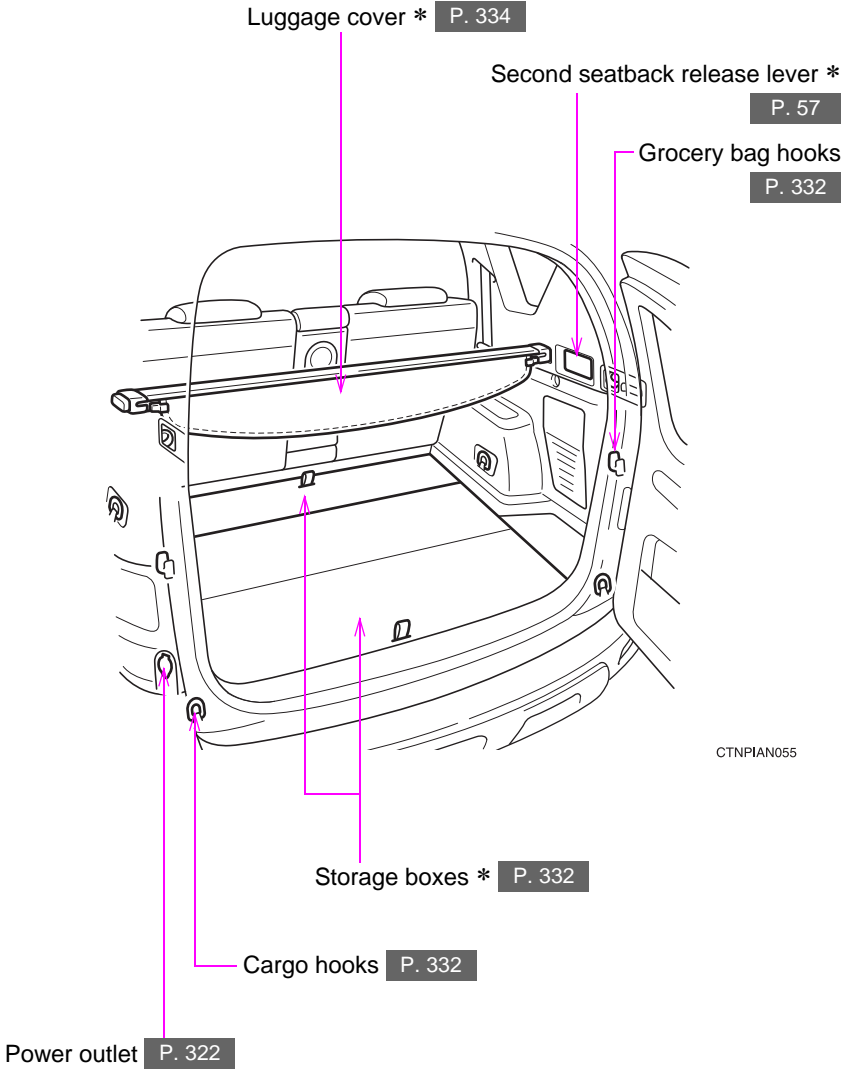

CTNPIAN055

\*: If equipped



ToyotaOwnersOnline.com

CUSTOMER EXPERIENCE CENTER

1-800-331-4331

RAV4

2 0 1 1

QUICK REFERENCE  
GUIDE



# 2011 RAV4

This *Quick Reference Guide* is a summary of basic vehicle operations. It contains brief descriptions of fundamental operations so you can locate and use the vehicle's main equipment quickly and easily.

The *Quick Reference Guide* is not intended as a substitute for the *Owner's Manual* located in the vehicle's glove box. We strongly encourage you to review the *Owner's Manual* and supplementary manuals so you will have a better understanding of the vehicle's capabilities and limitations.

Your dealership and the entire staff of Toyota Motor Sales, U.S.A., Inc. wish you many years of satisfied driving in your new RAV4.

## ! A word about safe vehicle operations

This *Quick Reference Guide* is not a full description of RAV4 operations. Every RAV4 owner should review the *Owner's Manual* that accompanies this vehicle.

Pay special attention to the boxed information highlighted in color throughout the *Owner's Manual*. Each box contains safe operating instructions to help you avoid injury or equipment malfunction.

All information in this *Quick Reference Guide* is current at the time of printing. Toyota reserves the right to make changes at any time without notice.

## Spare tire (if equipped) & tools

### Tool location

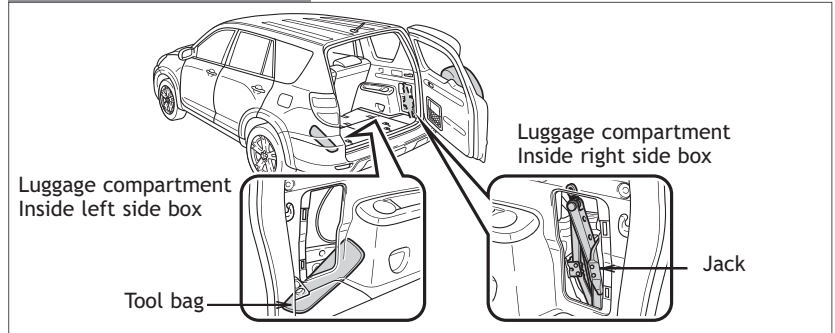

### Removing the spare tire

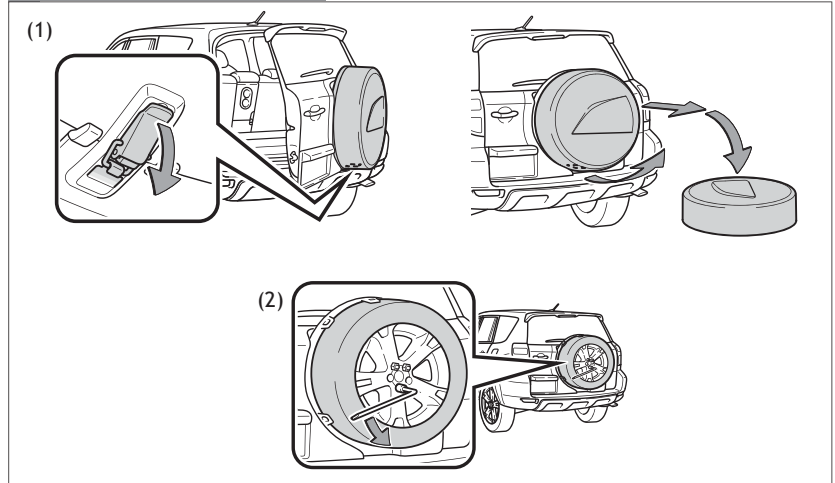

- (1) To remove the spare tire cover,\* open the back door. Unhook the latch on the bottom of the cover. Close the back door. Remove the spare tire cover by holding the bottom and lifting it up and away from the vehicle.
- (2) To remove the spare tire, turn the wheel nuts counterclockwise with the wheel nut wrench and remove.

Refer to the *Owner's Manual* for tire changing and jack positioning procedures.

\* If equipped

# INDEX

## OVERVIEW

Engine maintenance	9
Fuel tank door release and cap	8
Hood release	8
Indicator symbols	4-5
Instrument cluster	4
Instrument panel	2-3
<b>Keyless entry*</b>	<b>6</b>
<b>Smart Key system*</b>	<b>7</b>

## FEATURES/OPERATIONS

Active torque control 4WD (4WD models)	11
Air Conditioning/Heating	18-19
Audio	20-21
Automatic Transmission	10
Clock	19
Cruise control	23
Door locks	16
Downhill Assist Control (DAC)	22
Hill-start Assist Control (HAC)	23
Light control-Instrument panel	19
Lights & turn signals	14
Moonroof	16
Parking brake	10
Power outlets-12V DC	22
Power outlets-120V AC	22
Seat adjustments-Front	12
Seat adjustments-Second row seats	12
Seat heaters	18
Seats-Folding down second row seats	13
Seats-Head restraints	11
Seats-Stowing third row seats	13
Telephone controls (Bluetooth®)	17
Tilt and telescopic steering wheel	17
VSC OFF button	16
Windows-Power	15
Windshield wipers & washers	15

## SAFETY AND

## EMERGENCY FEATURES

Doors-Child safety locks	24
Seat belts	24
Seat belts-Shoulder belt anchor	24
Spare tire & tools	25
Tire Pressure Monitoring (warning) System	24

\* Visit your Toyota dealer for information on customizing this feature.

# OVERVIEW

## Instrument panel

### Steering wheel controls

Without telephone controls

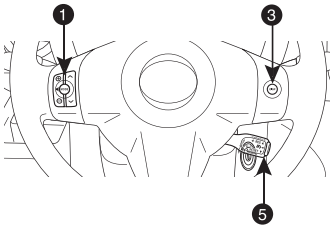

With telephone controls

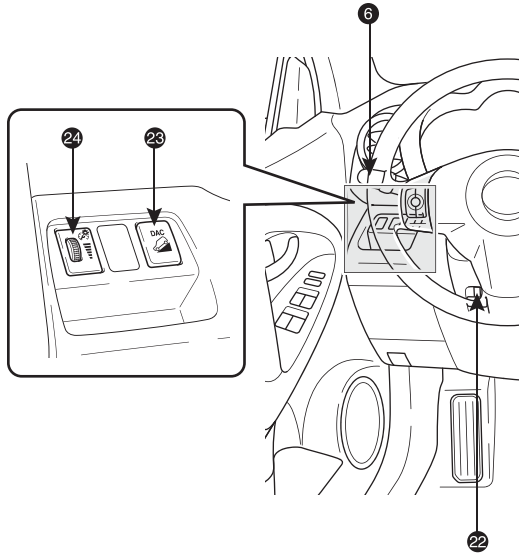
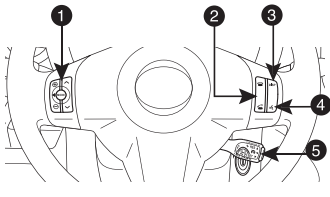

- ❶ Steering wheel audio controls<sup>1</sup>
- ❷ Telephone controls<sup>1</sup>
- ❸ Trip information display switch
- ❹ Speech command button<sup>1</sup>
- ❺ Cruise control
- ❻ Headlight, turn signal and fog light<sup>1</sup> control
- ❼ Wiper and washer controls
- ❽ Four-wheel drive lock switch (4WD models)
- ❾ Audio system/Navigation system<sup>1,2</sup>
- ❿ Emergency flasher switch
- ⓫ Air Conditioning controls
- ⓬ "ENGINE START STOP" button (Smart Key)<sup>1</sup>
- ⓭ Engine immobilizer indicator
- ⓮ Front passenger seat belt reminder light
- ⓯ Clock and Air Conditioning display



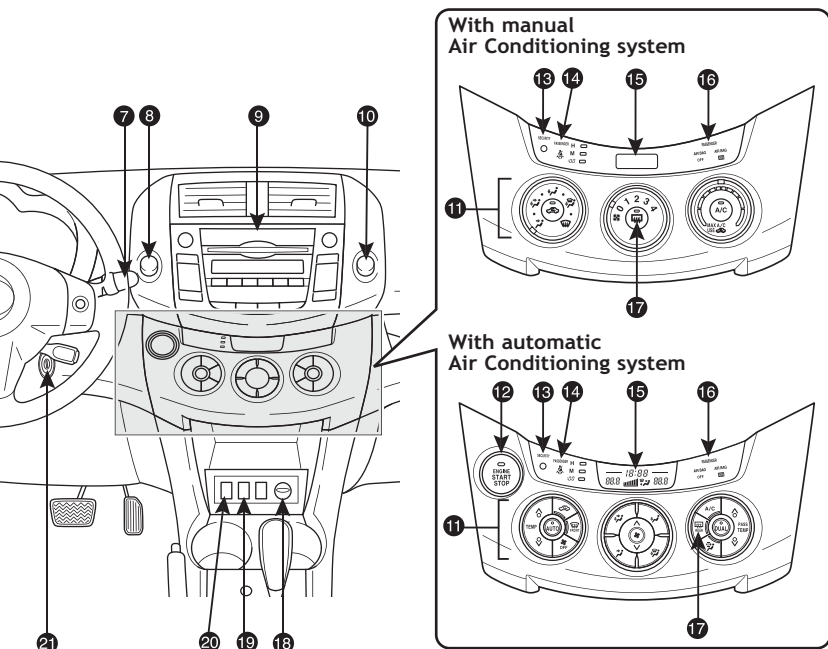

- 16 Front passenger occupant classification indicator
- 17 Rear window and outside rearview mirror defogger switch<sup>1</sup>
- 18 12V DC Power outlet
- 19 Seat heater switch<sup>1</sup>
- 20 VSC OFF switch
- 21 Ignition switch (standard key)<sup>1</sup>
- 22 Tilt and telescopic steering release
- 23 Downhill Assist Control (DAC) switch<sup>1</sup>
- 24 Instrument panel light control

<sup>1</sup> If equipped





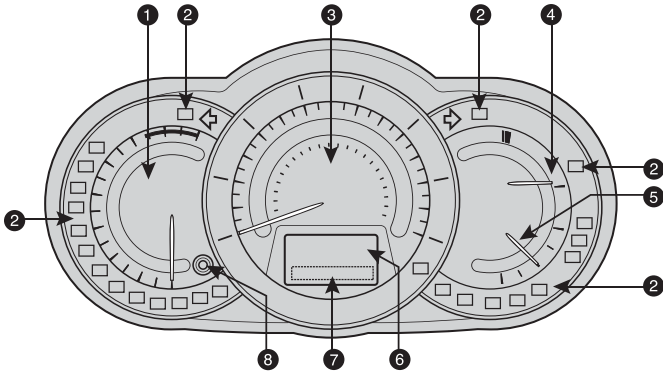

<sup>2</sup> Vehicles with navigation system: for details, refer to the "Navigation" section of the *Owner's Manual*.

## Instrument cluster























- 1 Tachometer
- 2 Service indicator and reminder
- 3 Speedometer
- 4 Engine coolant temperature
- 5 Fuel gauge
- 6 Odometer, two trip meters and trip information display
- 7 Automatic Transmission shift position indicator
- 8 Odometer/trip meter switch and trip meter reset button

## Indicator symbols

<b>BRAKE</b>	Brake system warning <sup>1</sup>
	<b>PASSENGER</b>  Driver/Front passenger seat belt reminder (alarm will sound if speed is over 12 mph)
	Charging system warning <sup>1</sup>
	Low engine oil pressure warning <sup>1</sup>
	Malfunction/Check Engine indicator <sup>1</sup>
	Low fuel level warning
<b>MAINT REQD</b>	Engine oil replacement reminder <sup>1</sup>
	Open door warning

<sup>1</sup> If indicator does not turn off within a few seconds of starting engine, there may be a malfunction or the vehicle inspected by our nearest dealer

<sup>2</sup> For details refer to our wheel drive lock switch operation section in Owner's Manual

	Airbag warning <sup>1</sup>
	Automatic Transmission fluid temperature warning <sup>1</sup>
	Low Tire Pressure Warning <sup>1</sup>
	4WD warning <sup>1</sup>
	Electric power steering system warning <sup>1</sup>
	Low windshield washer fluid level warning
	Front passenger occupant classification indicator
	Headlight low/high beam indicator
	Turn signal indicator
	Fog light indicator
	Automatic Transmission indicator (4-speed)
	Automatic Transmission indicator (5-speed)
	Four-wheel drive lock indicator <sup>1,2</sup>
	Vehicle Stability Control (VSC) OFF indicator <sup>1</sup>
	Slip indicator/Hill-start Assist Control (HAC) indicator/Downhill Assist Control (DAC) indicator <sup>1</sup>
	AUTO Limited Slip Differential indicator <sup>1</sup>
	Downhill Assist Control indicator <sup>1</sup>
	Cruise control indicator <sup>3</sup>
	Anti-lock Brake System warning <sup>1</sup>
	Smart Key system warning
	Traction Control OFF indicator <sup>1</sup>

<sup>1</sup> For more information on these features, refer to the Owner's Manual.

## Keyless entry

Beep sound can be switched ON or OFF. Refer to the *Owner's Manual* for more details.

### Locking operation

Without Smart Key system



With Smart Key system



Push



### Unlocking operation

Without Smart Key system

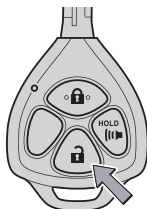

With Smart Key system

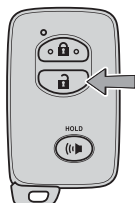

Push ONCE: Driver door  
TWICE: All doors



**NOTE:** If a door is not opened within 60 seconds of unlocking, all doors will relock for safety.

### Panic button



Push and hold



## Smart Key system (if equipped)

### Start function

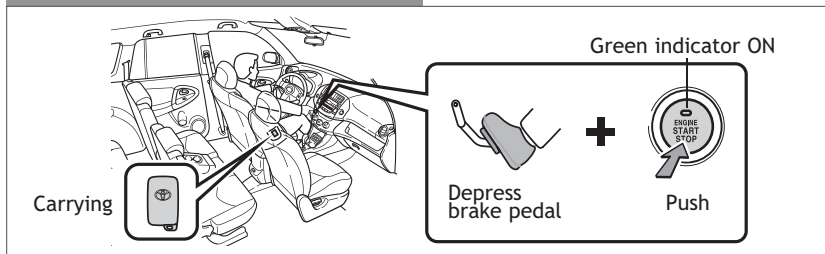

**NOTE:** Gear shift lever must be in Park and brake pedal depressed.

### Power (without starting engine)

Without depressing the brake pedal, pressing the "ENGINE START STOP" switch will change the operation mode in succession from:

#### ACCESSORY

Accessories such as the radio will operate.

#### ON

Power ON; the engine not running.

#### OFF

All systems OFF.

### Locking operation

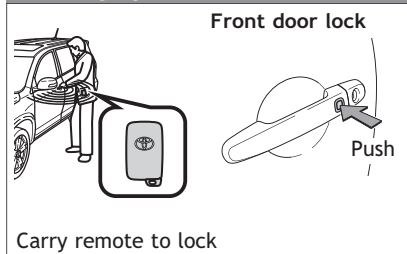

### Unlocking operation

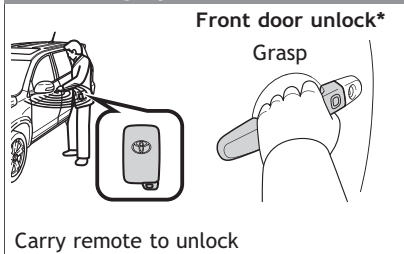

### Back door lock/unlock

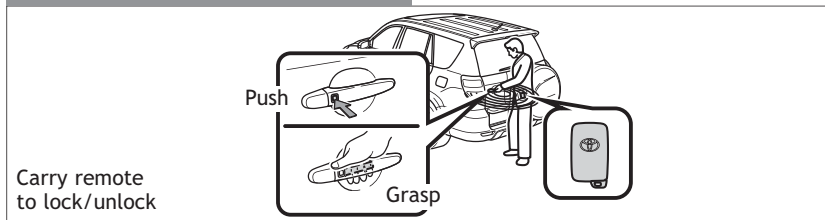

\* Driver door unlocking function can be programmed to unlock driver door only, or all doors. Grasping passenger door handle will unlock all doors.

**NOTE:** Doors may also be locked/unlocked using remote.

## Fuel tank door release and cap

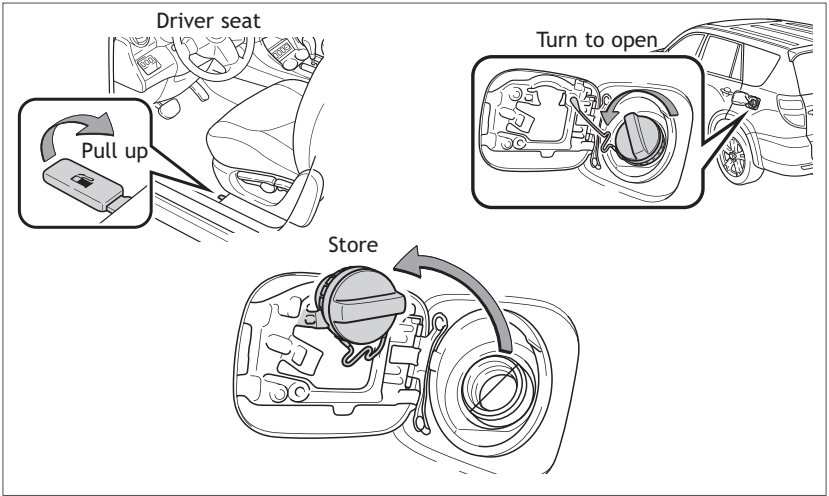

**NOTE:** Tighten until one click is heard. If the cap is not tightened enough, Check Engine "  " indicator may illuminate.

## Hood release

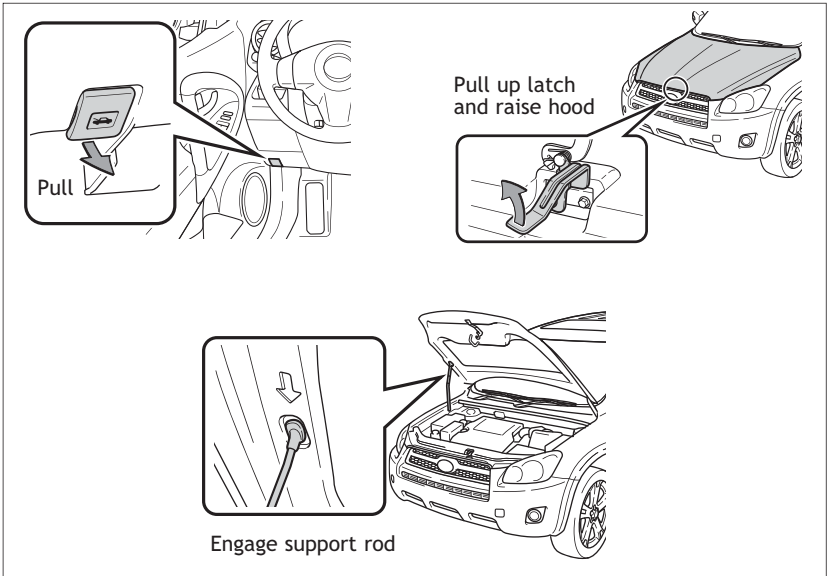

## Engine maintenance

### 4 cylinder (2AR-FE) engine

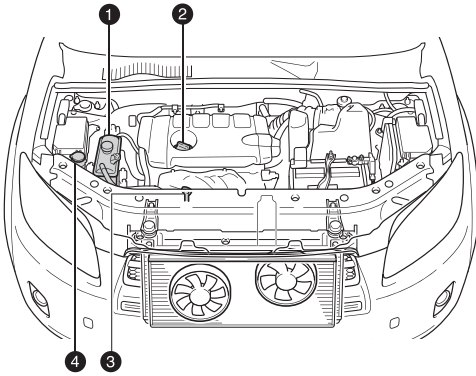

### V6 (2GR-FE) engine

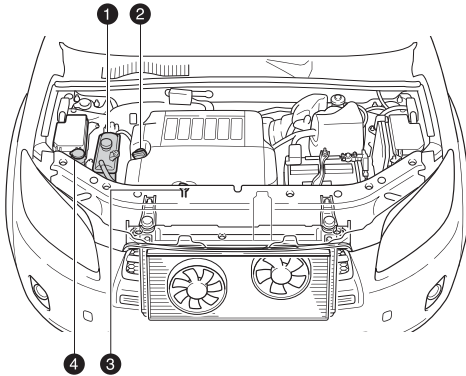

- 1 Engine coolant reservoir
- 2 Engine oil filler cap
- 3 Engine oil level dipstick
- 4 Windshield and back window washer fluid tank

**NOTE:** Regularly scheduled maintenance, including oil changes, will help extend the life of your vehicle and maintain performance. Please refer to the "Warranty Maintenance Guide."

# FEATURES/OPERATIONS

## Automatic Transmission

### 4-speed models

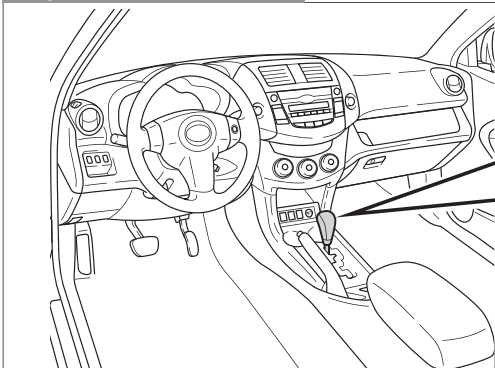

- P** Park\*
- R** Reverse
- N** Neutral
- D** Drive
- 3** Third gear
- 2** Second gear
- L** First gear

### 5-speed models

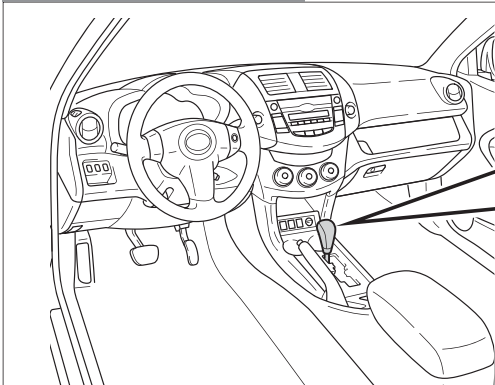

- P** Park\*
- R** Reverse
- N** Neutral
- D** Drive
- 4** Fourth gear
- 3** Third gear
- 2** Second gear
- L** First gear

\* The ignition/"ENGINE START STOP" switch must be "ON" and the brake pedal depressed to shift from Park.

Downshifting increases power going uphill, or provides engine braking downhill. For best fuel economy during normal driving conditions, always drive with the shift lever in the "D" position.

## Parking brake

Set

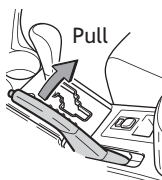

**BRAKE**

Release

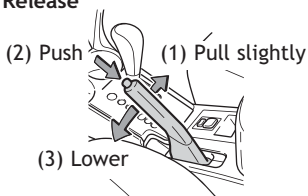



## Active torque control 4WD (4WD models)

### Four-wheel drive lock switch

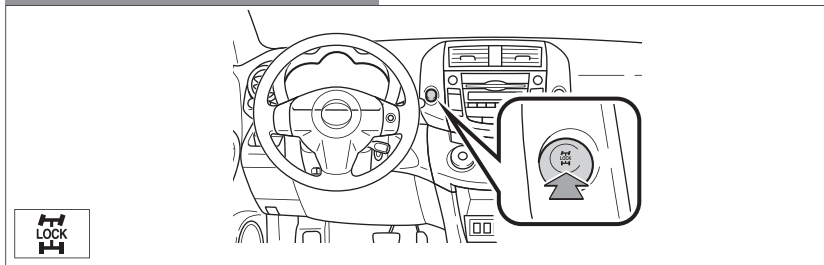

Push the switch to ensure that the engine torque is applied to the four wheels.

**NOTE:** Should **ONLY** be used when wheel spinning occurs on loose or unpaved surfaces.

Refer to the *Owner's Manual* for more details.

## Seats-Head restraints

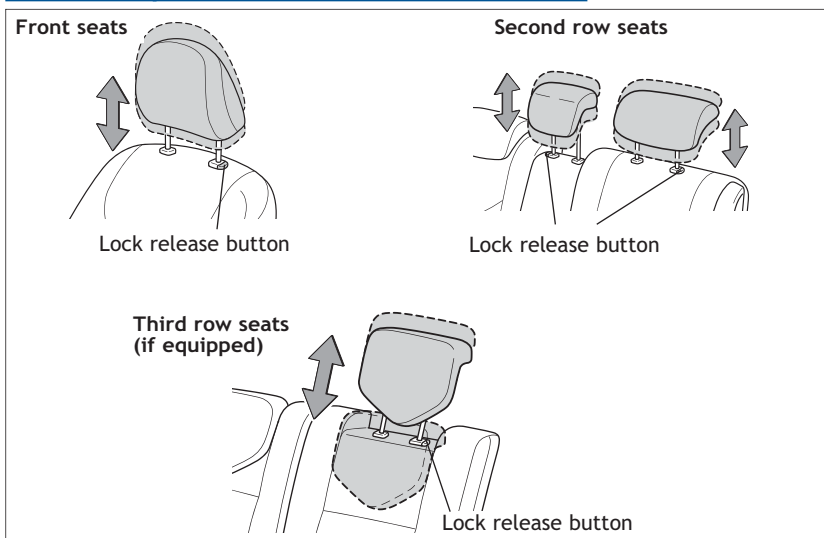

## Seat adjustments-Front

### Manual seat

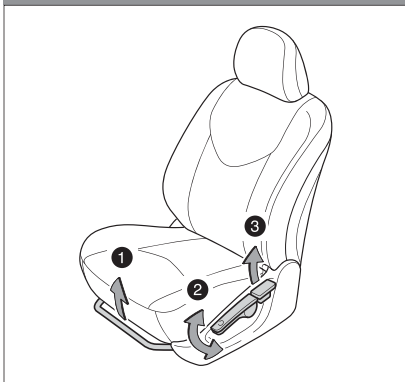

### Power seat (driver side only)



- ① Seat position (forward/backward)
- ② Height crank (driver side only)
- ③ Seatback angle
- ④ Seat position, cushion angle and height
- ⑤ Seatback angle
- ⑥ Lumbar support

## Seat adjustments-Second row seats

### Vehicles with third row seats

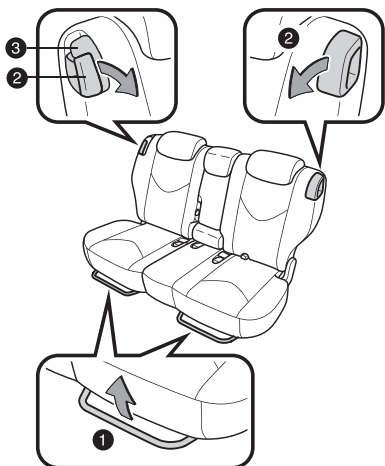

### Vehicles without third row seats

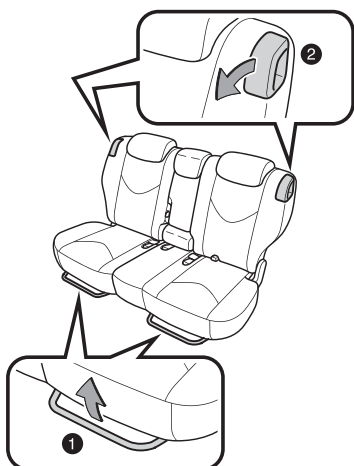

- ① Seat position (forward/backward)
- ② Seatback angle
- ③ Seatback lock release

## Seats-Folding down second row seats

From inside

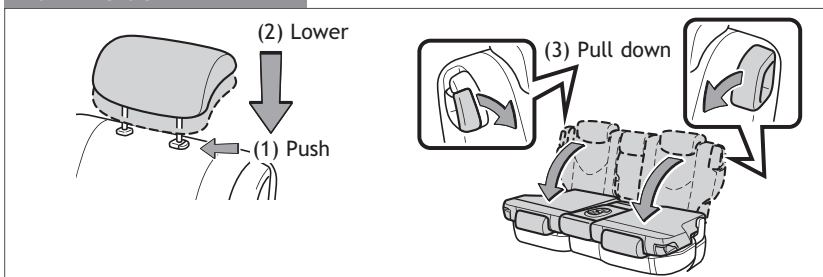

From outside (vehicles without third row seats)

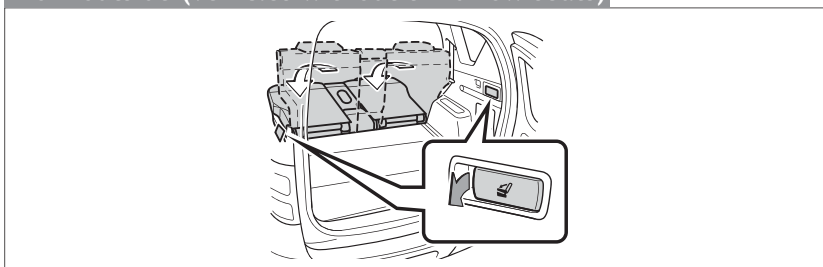

## Seats-Stowing third row seats (if equipped)

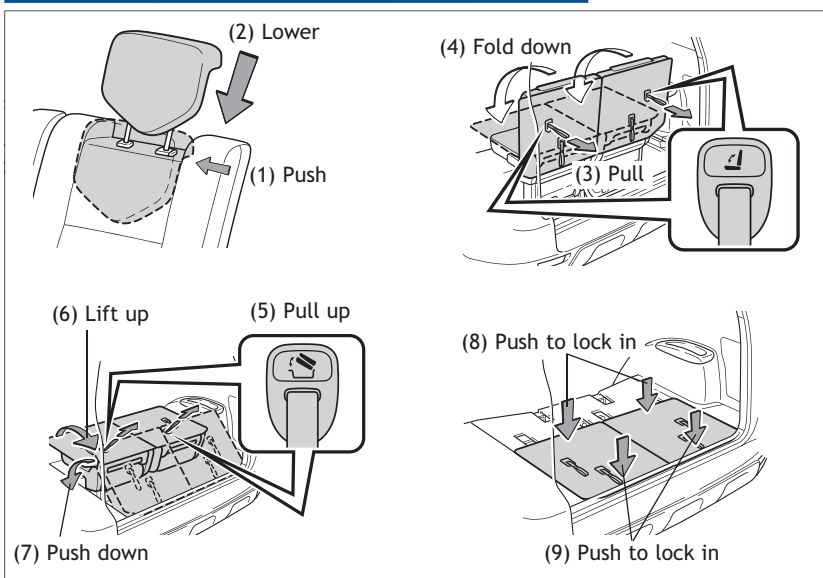

## Lights & turn signals

### Headlights

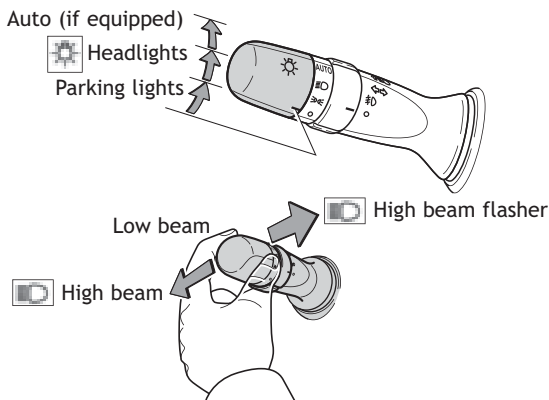

#### -Daytime Running Light system (DRL) (if equipped)

Automatically turns on the headlights at a reduced intensity.

-Automatic light cut off system Will automatically turn lights off after a delay of 30 seconds.

### Turn signals

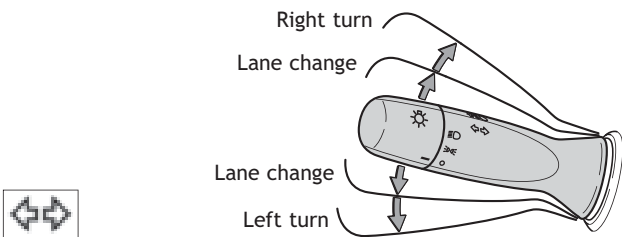

### Fog lights (if equipped)

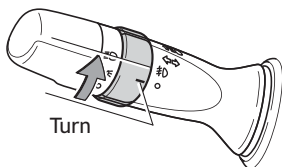

Front fog lights come on only when the headlights are on low beam.

## Windshield wipers & washers

### Front

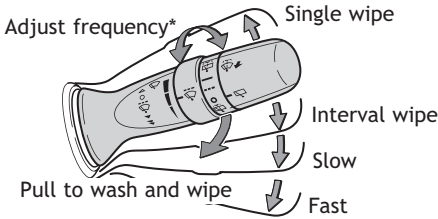

**\* Intermittent windshield wiper frequency adjustment**  
Rotate to increase/decrease wipe frequency.

### Rear

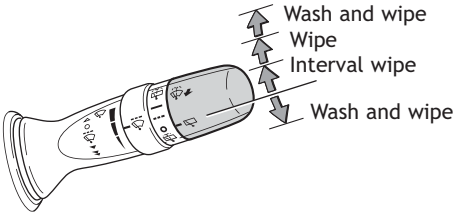

## Windows-Power

### Driver side

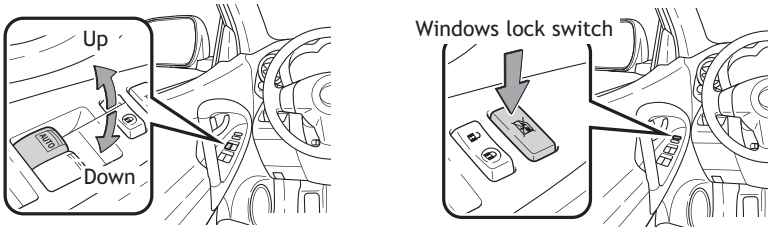

**Automatic operation (driver side only)** Push the switch completely down or pull it completely up and release to fully open or close. To stop window midway, lightly push the switch in the opposite direction.

**Window lock switch** Deactivates all passenger windows. Driver's window remains operable.

**NOTE:** If the battery is disconnected, the window needs to be reinitialized. Refer to the *Owner's Manual* for more details.

## Moonroof (if equipped)

### Sliding operation

Push once to open partway; again to open completely.

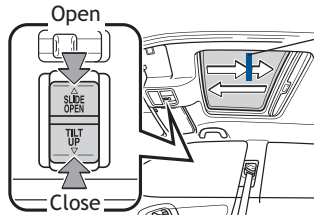

Recommended open position to minimize wind noise

### Tilting operation

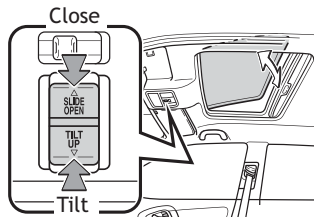

**NOTE:** If battery is disconnected, the moonroof needs to be reinitialized. Refer to the *Owner's Manual* for more details.

## Door locks

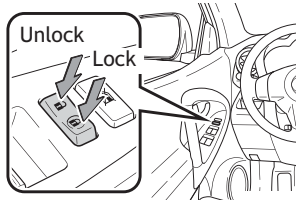

## VSC OFF button

TRAC  
OFF

AUTO  
LSD

VSC  
OFF

VSC OFF button

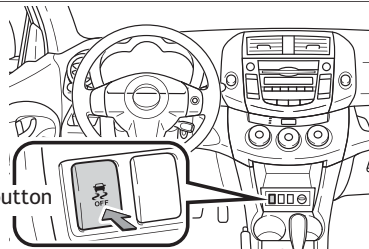

The VSC OFF button is used to switch between modes related to the TRAC, VSC and Auto LSD functions (2WD models.)

Refer to Section 2-4 of the *Owner's Manual* for more information.

## Telephone controls (Bluetooth®) (if equipped)

Audio unit

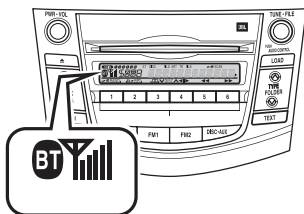

Microphone

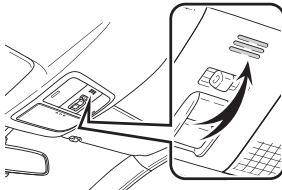

Steering wheel telephone switches

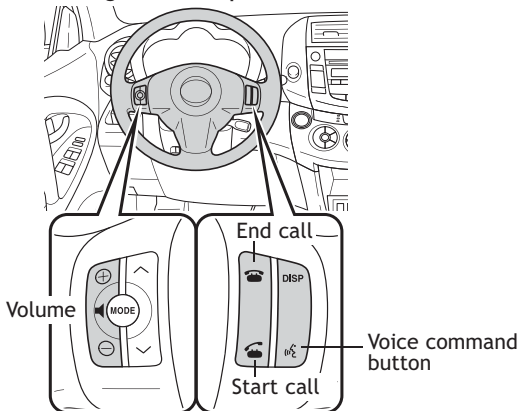

Bluetooth® technology allows dialing or receipt of calls without taking hands from the steering wheel or using a cable to connect the compatible telephone and the system.

Refer to "Using the hands-free phone system (for cellular phone)," Section 3-3 in the *Owner's Manual*, or go to [Toyota.LetsTalk.com](http://Toyota.LetsTalk.com) for more information about phone connections and compatibility.

## Tilt and telescopic steering wheel

Lock release lever



Angle Length

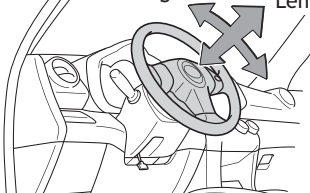

Hold wheel, push lever down, set angle and length, and return lever.

**NOTE:** Do not attempt to adjust while the vehicle is in motion.

**Seat heaters (if equipped)**

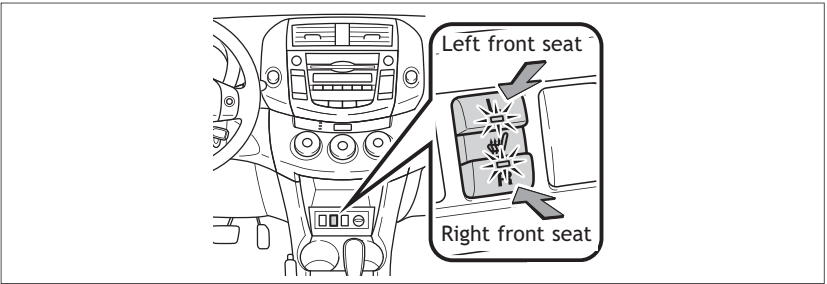

**Air Conditioning/Heating**

**Automatic Air Conditioning**

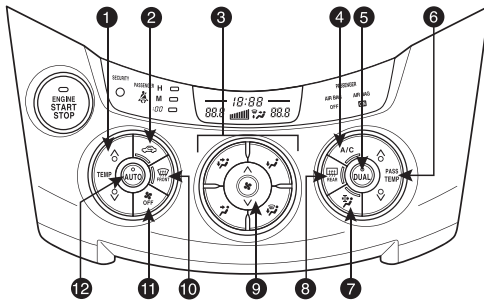

- 1 Temperature selector (driver side)
- 2 Recirculate cabin air (fresh air when OFF)
- 3 Airflow vent  
In "☁" mode, use fresh air ("☁" indicator OFF) to reduce window fogging. "☁" mode uses fresh air only.
- 4 Air Conditioning ON/OFF
- 5 "DUAL" button  
**Indicator ON:** Separate temperature settings for driver and passenger.  
**Indicator OFF:** Synchronize temperature settings for driver and passenger.
- 6 Temperature selector (front passenger side)
- 7 Micro dust and pollen filter ON/OFF
- 8 Rear defogger
- 9 Fan speed
- 10 Windshield defogger
- 11 Climate control OFF
- 12 Automatic climate control ON  
Adjust the temperature setting, and airflow vents and fan will adjust automatically.



## Manual Air Conditioning

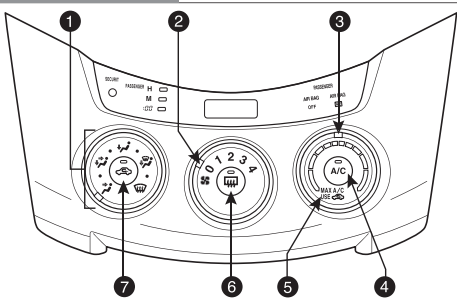

- ① Airflow vent  
 “” or “” mode uses fresh air only (“” indicator “OFF”) to reduce window fogging.
- ② Fan speed
- ③ Temperature selector
- ④ Air Conditioning ON/OFF
- ⑤ Select for maximum cooling. Air intake will automatically be set to recirculate.
- ⑥ Rear defogger
- ⑦ Fresh or recirculated cabin air

## Clock

<p><b>Manual Air Conditioning system</b></p>	<p><b>Automatic Air Conditioning system</b></p>
<p>H- Hour set                  M- Minute set                  :00- Round off minutes</p>	

## Light control-Instrument panel

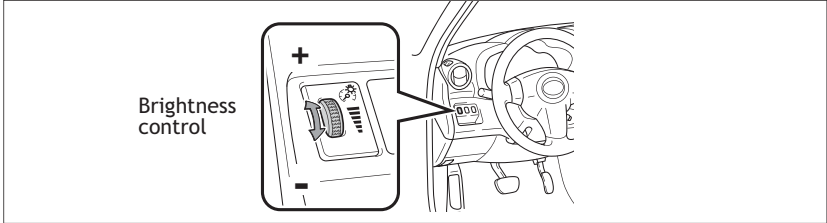

With the dial turned fully up, instrument panel lights will not dim when the headlights are turned ON.

Audio

Type 1

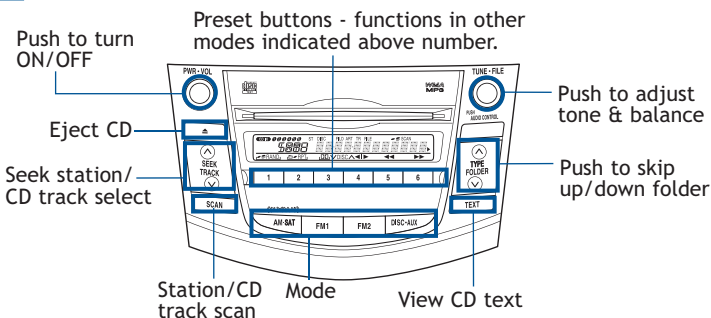

Type 2 additional functions

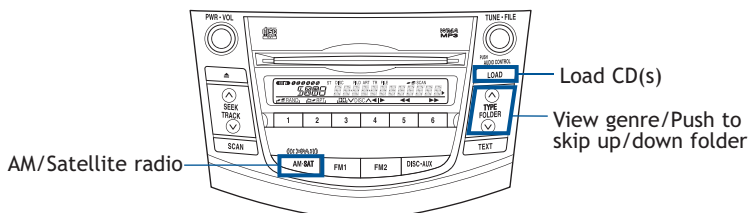

Type 2 (with JBL speakers)

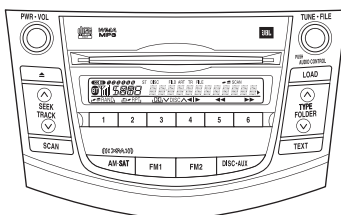

CD player

To scan tracks on a disc Push "SCAN." Push again to hold selection.  
 CD Changer (Type 2)

- To load one disc Push "LOAD" and insert one disc.
- To load multiple discs Push and hold "LOAD" until you hear a beep. Insert one disc. *Wait until the green indicator illuminates and shutter opens to insert next disc.*

To select a file (MP3/WMA only) Turn "TUNE-FILE."

To select a folder (MP3/WMA only) Push either side of "TYPE/FOLDER."

## Radio

**To preset stations** Tune in the desired station and hold down a preset button (1-6) until you hear a beep. Push desired preset button (1-6) to select.

**To scan stations** Push "SCAN." Push and hold to scan preset stations. Push again to hold selection.

## Steering wheel controls (if equipped)

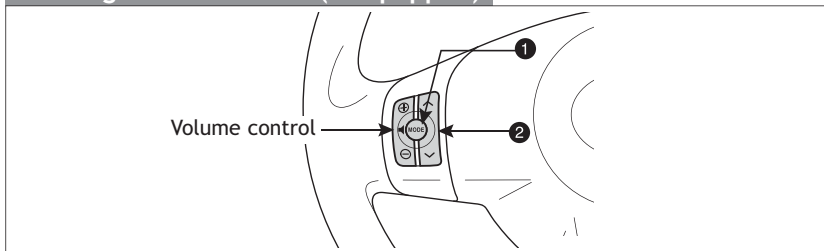

### 1 "MODE"

Push to turn audio ON and select an audio mode. Push and hold to turn the audio OFF.

### 2 "▲▼"

Use to search within the selected audio medium (radio, CD, iPod®, etc.).

## Auxiliary (AUX) port

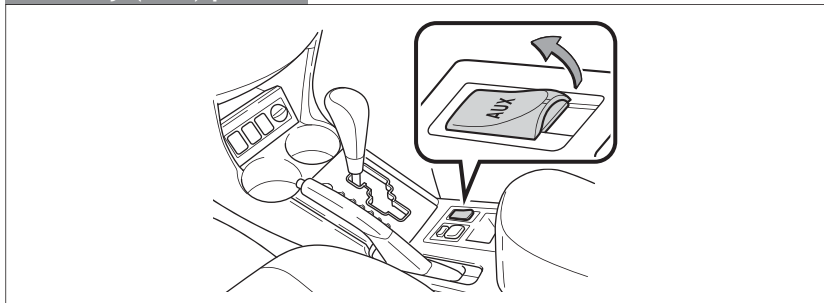

By inserting a mini plug into the AUX port, you can listen to music from a portable audio device through the vehicle's speaker system while in AUX mode.

## Power outlets-12V DC

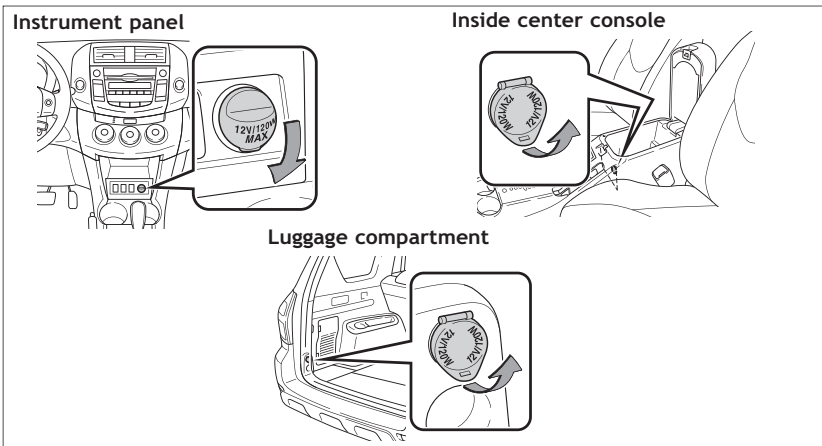

**NOTE:** Designed for car accessories. Ignition switch/"ENGINE START STOP" switch must be in the "ACC" or "ON" position to be used.

## Power outlets-120V AC (if equipped)

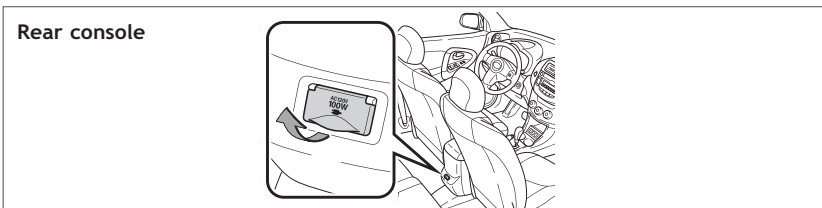

**NOTE:** Ignition switch/"ENGINE START STOP" switch must be in the "ON" position to be used.

## Downhill Assist Control (DAC) (if equipped)

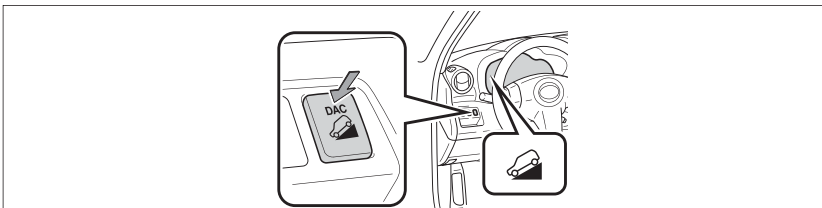

DAC helps the vehicle to descend steep hills while maintaining a low speed without brake pedal operation. Press the "DAC" button (indicator will blink). Shift into L or R to activate (indicator will be solid). Pressing the button again will turn system off.

Refer to the Owner's Manual for more details.

## Hill-start Assist Control (HAC) (if equipped)

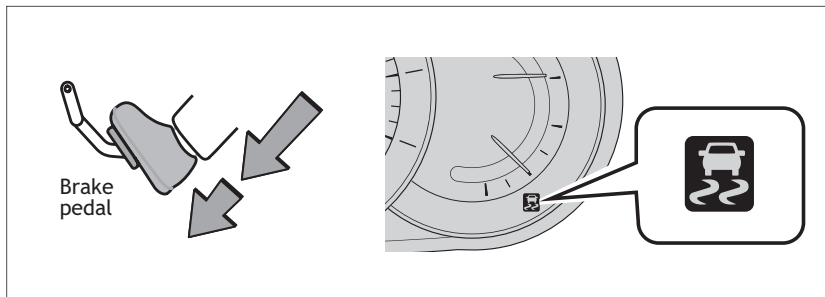

HAC helps prevent rolling backwards on an incline. To engage, push further down on brake pedal while at a complete stop until a beep sounds and slip indicator illuminates. HAC holds for approximately 2 seconds after releasing brake pedal.

Refer to the *Owner's Manual* for more details.

## Cruise control

### Turning system ON/OFF

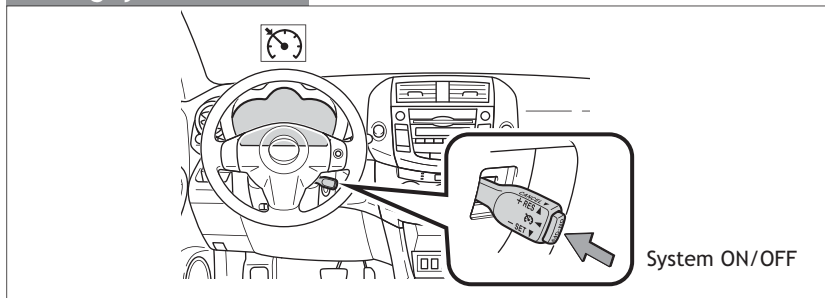

### Functions

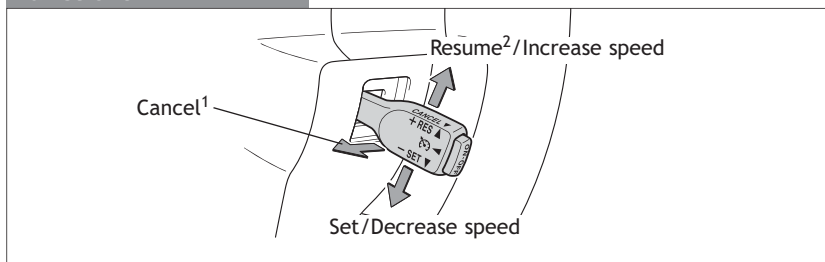

<sup>1</sup> The set speed may also be cancelled by depressing the brake pedal.

<sup>2</sup> The set speed may be resumed once vehicle speed exceeds 25 mph.

Refer to the *Owner's Manual* for more details.

# SAFETY AND EMERGENCY FEATURES

## Doors-Child safety locks

Rear door

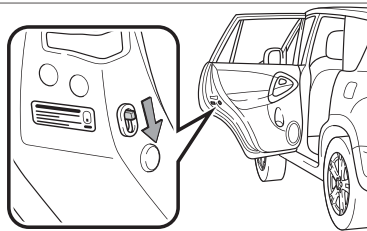

Moving the lever to "LOCK" will allow the door to be opened only from the outside.

## Seat belts

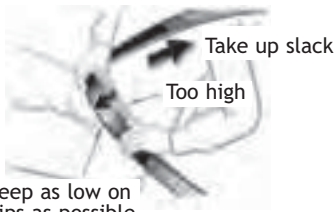

Keep as low on hips as possible

If belt is fully extended, then retracted even slightly, it cannot be re-extended beyond that point, unless fully retracted again. This feature is used to help hold child restraint systems securely.

To find more information about seat belts, and how to install a child restraint system, refer to the *Owner's Manual*.

## Seat belts-Shoulder belt anchor

Push up or squeeze lock release to lower

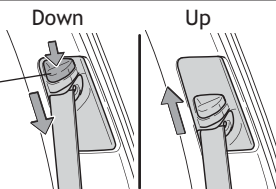

## Tire Pressure Monitoring (warning) System

If tire pressure becomes critically low on any of the tires (including the spare), "ⓘ" indicator will come on. Correctly adjusting tire inflation will turn off the light after a few minutes. If the light does not turn off, have the system checked by your Toyota dealer.

Refer to the *Owner's Manual* for more details.

**1 Before driving**

**1-1. Key information**  
 Keys ..... 24

**1-2. Opening, closing and locking the doors**  
 Smart key system..... 26  
 Wireless remote control ..... 38  
 Side doors ..... 42  
 Back door ..... 46

**1-3. Adjustable components (seats, mirrors, steering wheel)**  
 Front seats ..... 49  
 Rear seats..... 54  
 Head restraints ..... 65  
 Seat belts ..... 68  
 Steering wheel ..... 76  
 Anti-glare inside rear view mirror..... 77  
 Outside rear view mirrors ..... 79

**1-4. Opening and closing the windows and moon roof**  
 Power windows ..... 81  
 Moon roof ..... 84

**1-5. Refueling**  
 Opening the fuel tank cap .... 88

**1-6. Theft deterrent system**

Engine immobilizer system ..... 92  
 Theft prevention labels (U.S.A.)..... 95

**1-7. Safety information**

Correct driving posture ..... 96  
 SRS airbags ..... 98  
 Front passenger occupant classification system..... 110  
 Child restraint systems ..... 116  
 Installing child restraints .... 120

**2 When driving**

**2-1. Driving procedures**

Driving the vehicle ..... 134  
 Engine (ignition) switch (vehicles with smart key system) ..... 143  
 Engine (ignition) switch (vehicles without smart key system) ..... 147  
 Automatic transmission ..... 150  
 Turn signal lever ..... 153  
 Parking brake ..... 154  
 Horn..... 155

**2-2. Instrument cluster**

Gauges and meters ..... 156  
 Indicators and warning lights ..... 159  
 Trip information display ..... 162

**2-3. Operating the lights and wipers**

Headlight switch..... 165  
Fog light switch ..... 168  
Windshield wipers and washer ..... 169  
Rear window wiper and washer ..... 171

**2-4. Using other driving systems**

Cruise control..... 172  
Rear view monitor system (vehicles with auto anti-glare inside rear view mirror) ..... 176  
Driving assist systems ..... 184  
Hill-start assist control..... 191  
Downhill assist control system ..... 193  
Four-wheel drive lock switch (4WD models)..... 196

**2-5. Driving information**

Utility vehicle precautions ..... 197  
Cargo and luggage ..... 202  
Vehicle load limits ..... 208  
Winter driving tips ..... 210  
Trailer towing ..... 214  
Dinghy towing ..... 224

**3 Interior features**

**3-1. Using the air conditioning system and defogger**

Manual air conditioning system..... 226  
Automatic air conditioning system..... 232  
Rear window and outside rear view mirror defoggers ..... 240  
Windshield wiper de-icer .... 242

**3-2. Using the audio system**

Audio system types ..... 243  
Using the radio ..... 246  
Using the CD player ..... 252  
Playing back MP3 and WMA discs ..... 259  
Optimal use of the audio system..... 266  
Using the AUX port..... 269  
Using the steering wheel audio switches..... 270

**3-3. Using the hands-free phone system (for cellular phone)**

Hands-free phone system (for cellular phone) features ..... 273  
Using the hands-free phone system (for cellular phone) ..... 277  
Making a phone call ..... 285  
Setting a cellular phone..... 291





Security and system  
 setup ..... 296  
 Using the phone book ..... 299

**3-4. Using the interior lights**

Interior lights list ..... 307  
 • Personal/interior light  
 main switch ..... 308  
 • Personal/interior lights..... 308  
 • Interior light ..... 309  
 • Luggage compartment  
 light ..... 309

**3-5. Using the storage features**

List of storage features..... 311  
 • Glove box ..... 312  
 • Console box ..... 313  
 • Overhead console ..... 314  
 • Cup holders..... 315  
 • Bottle holders ..... 316  
 • Auxiliary box..... 318

**3-6. Other interior features**

Sun visors ..... 319  
 Vanity mirrors ..... 320  
 Clock ..... 321  
 Power outlets ..... 322  
 Seat heaters..... 327  
 Armrest..... 329  
 Coat hooks ..... 330  
 Floor mat ..... 331  
 Luggage compartment  
 features ..... 332

**4 Maintenance and care**

**4-1. Maintenance and care**

Cleaning and protecting  
 the vehicle exterior ..... 338  
 Cleaning and protecting  
 the vehicle interior ..... 341

**4-2. Maintenance**

Maintenance  
 requirements ..... 344  
 General maintenance ..... 346  
 Emission inspection and  
 maintenance (I/M)  
 programs ..... 349

**4-3. Do-it-yourself maintenance**

Do-it-yourself service  
 precautions ..... 350  
 Hood ..... 354  
 Positioning a floor jack..... 356  
 Engine compartment ..... 358  
 Tires..... 373  
 Tire inflation pressure ..... 380  
 Wheels..... 384  
 Air conditioning filter ..... 386  
 Key battery ..... 388  
 Checking and replacing  
 fuses ..... 392  
 Light bulbs ..... 404

**5 When trouble arises**

**5-1. Essential information**

Emergency flashers ..... 414

If your vehicle needs to be towed .....	415
If you think something is wrong .....	422
Fuel pump shut off system .....	423
Event data recorder .....	424

## 5-2. Steps to take in an emergency

If a warning light turns on or a warning buzzer sounds... ..	426
If you have a flat tire (vehicles with standard tires) .....	438
If you have a flat tire (vehicles with run-flat tires) .....	457
If the engine will not start ....	458
If the shift lever cannot be shifted from P.....	459
If you lose your keys .....	460
If the electronic key does not operate properly (vehicles with smart key system).....	461
If the battery is discharged .....	463
If your vehicle overheats .....	466
If the vehicle becomes stuck .....	468
If your vehicle has to be stopped in an emergency .....	470

## 6 Vehicle specifications

### 6-1. Specifications

Maintenance data (fuel, oil level, etc.) .....	474
Fuel information.....	486
Tire information .....	489

### 6-2. Customization

Customizable features.....	500
----------------------------	-----

### 6-3. Initialization

Items to initialize .....	503
---------------------------	-----

## 7 For owners

Reporting safety defects for U.S. owners .....	506
Seat belt instructions for Canadian owners (in French).....	507
SRS airbag instructions for Canadian owners (in French).....	509

## Index

Abbreviation list.....	520
Alphabetical index .....	522
What to do if... ..	533

## 1-1. Key information

# Keys

The following keys are provided with the vehicle.

### ► Vehicles without smart key system

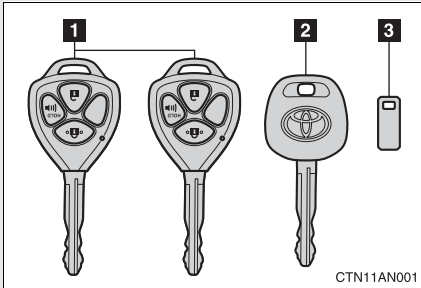

#### 1 Master keys

Operating the wireless remote control function (→P. 38)

#### 2 Valet key

#### 3 Key number plate

### ► Vehicles with smart key system

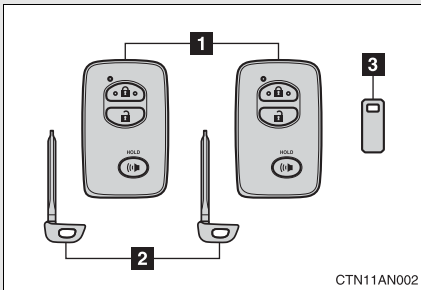

#### 1 Electronic keys

- Operating the smart key system (→P. 26)
- Operating the wireless remote control function (→P. 38)

#### 2 Mechanical keys

#### 3 Key number plate

## Using the mechanical key (vehicles with smart key system)

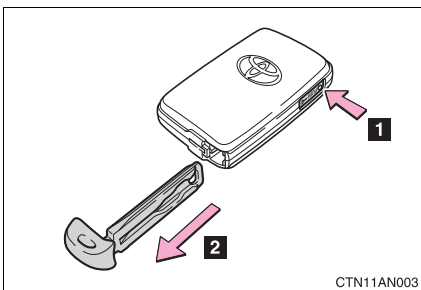

Take out the mechanical key.

After using the mechanical key, store it in the electronic key. Carry the mechanical key together with the electronic key. If the electronic key battery is depleted or the entry function does not operate properly, you will need the mechanical key. (→P. 461)

**■ When required to leave a key to the vehicle with a parking attendant**

Lock the glove box as circumstances demand. (→P. 312)

Vehicles without smart key system: Carry the master key for your own use and leave the valet key only with the attendant.

Vehicles with smart key system: Remove the mechanical key for your own use and provide the attendant with the electronic key only.

**■ Key number plate**

Keep the plate in a safe place such as your wallet, not in the vehicle. In the event that a key is lost, a new key can be made by your Toyota dealer using the key number plate. (→P. 460)

**■ When riding in an aircraft**

When bringing a key with wireless remote control function onto an aircraft, make sure you do not press any buttons on the key while inside the aircraft cabin. If you are carrying the key in your bag etc, ensure that the buttons are not likely to be pressed accidentally. Pressing a button may cause the key to emit radio waves that could interfere with the operation of the aircraft.

**NOTICE****■ To prevent key damage**

- Do not subject the keys to strong shocks, expose them to high temperatures by placing them in direct sunlight, or get them wet.
- Do not expose the keys to electromagnetic materials or attach any material that blocks electromagnetic waves to the key surface.
- Do not disassemble the key.

## 1-2. Opening, closing and locking the doors Smart key system\*

The following operations can be performed simply by carrying the electronic key on your person, for example in your pocket.  
(The driver should always carry the electronic key.)

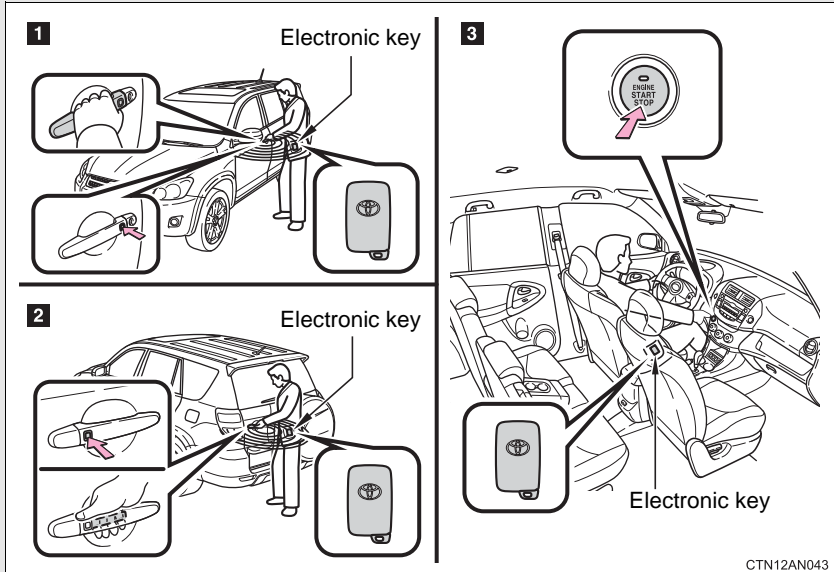

- 1** Locks and unlocks the doors (→P. 27)
- 2** Locks and unlocks the back door (→P. 27)
- 3** Starts the engine (→P. 143)

\*: If equipped

**Unlocking and locking the doors and back door (front and back door handles only)**

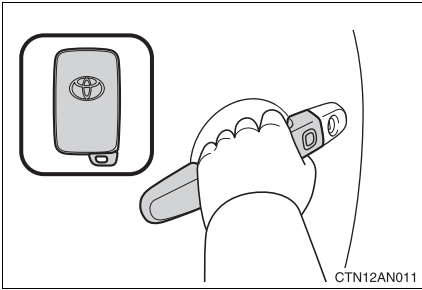

Grip the handle to unlock the doors.

Make sure to touch the sensor on the back of the handle.

The doors cannot be unlocked for 3 seconds after the doors are locked.

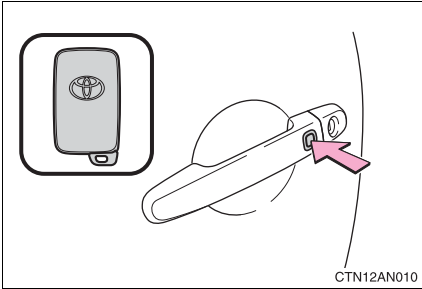

Press the lock button to lock the doors.

## Antenna location and effective range

### ■ Antenna location

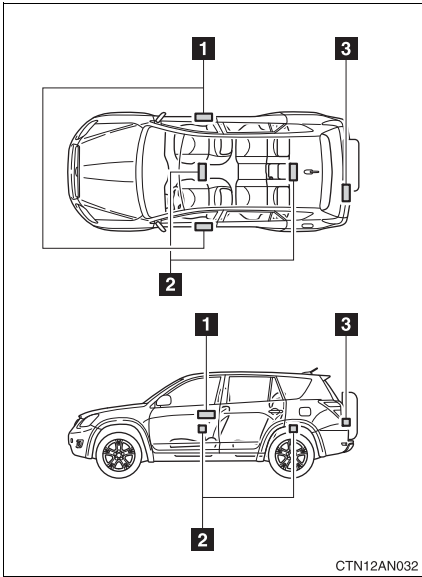

- 1** Antennas outside the cabin
- 2** Antennas inside the cabin
- 3** Antenna outside the luggage compartment

■ **Effective range (areas within which the electronic key is detected)**

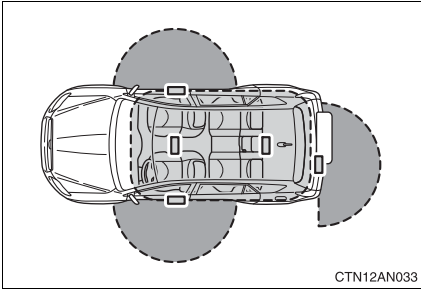

- When locking or unlocking the doors

The system can be operated when the electronic key is within about 2.3 ft. (0.7 m) of either of the outside front door handles and back door.

- When starting the engine or changing “ENGINE START STOP” switch modes

The system can be operated when the electronic key is inside the vehicle.



### ■ Operation signals

A buzzer sounds and the emergency flashers flash to indicate that the doors have been locked/unlocked. (Locked: Once; Unlocked: Twice)

### ■ Conditions affecting operation



The smart key system uses weak radio waves. In the following situations, the communication between the electronic key and the vehicle may be affected, preventing the smart key system and wireless remote control from operating properly. (Ways of coping: →P. 461)

- When the electronic key battery is depleted
- Near a TV tower, electric power plant, gas station, radio station, large display, airport or other facility that generates strong radio waves or electrical noise
- When carrying a portable radio, cellular phone, cordless phone or other wireless communication devices
- When the electronic key is in contact with, or is covered by a metallic object
- When multiple electronic keys are in the vicinity
- When carrying or using the electronic key together with the following devices that emit radio waves
  - Another vehicle's electronic key
  - A wireless key that emits radio waves
  - Personal computer
- If window tint with a metallic content or metallic objects is attached to the rear window

### ■ Switching the door unlock function

It is possible to set which doors the entry function unlocks.

**STEP 1** Turn the "ENGINE START STOP" switch OFF.

**STEP 2** When the indicator on the key surface is turned off, push and hold  or  for approximately 5 seconds while pushing  on the key.

The setting changes each time an operation is performed, as shown below. (When changing the setting continuously, release the buttons, wait for at least 5 seconds, and repeat step 2.)

Mode	Unlocking doors	Beep
Driver's door unlocking mode	Hold the driver's door handle to unlock only the driver's door.	Exterior: Beeps twice Interior: Pings once
	Hold the front passenger's door handle to unlock all doors	
All doors unlocking mode	Hold either front and back door handle to unlock all doors	Exterior: Beeps twice Interior: Pings once

1

Before driving

### ■ Battery-saving function

In the following circumstances, the entry function is disabled in order to prevent the vehicle and electronic key batteries from discharging.

- When the entry function has not been used for 2 weeks or more
- When the electronic key has been left within approximately 3 ft. (1 m) of the vehicle for 10 minutes or more

The system will resume operation when...

- The vehicle is locked using the door handle lock button.
- The vehicle is locked/unlocked using the wireless remote control function. (→P. 38)
- The vehicle is locked/unlocked using the mechanical key. (→P. 461)

### ■ Electronic key battery depletion

- The standard battery life is 1 to 2 years. (The battery becomes depleted even if the electronic key is not used.) If the smart key system or the wireless remote control function does not operate, or the detection area becomes smaller, the battery may be depleted. Replace the battery when necessary. (→P. 388)
- If the battery becomes low, an alarm will sound in the cabin when the engine stops. (→P. 33)
- To avoid serious deterioration, do not leave the electronic key within 3 ft. (1 m) of the following electrical appliances that produce a magnetic field:
  - TVs
  - Personal computers
  - Recharging cellular phones or cordless phones
  - Table lamps

### ■ To operate the system properly

Make sure to carry the electronic key when operating the system. Do not get the electronic key too close to the vehicle when operating the system from the outside of the vehicle.

Depending on the position and holding condition of the electronic key, the key may not be detected correctly and the system may not operate properly. (The alarm may go off accidentally, or the door lock prevention may not function.)

### ■ Note for the entry function

- Even when the electronic key is within the effective range (detection areas), the system may not operate properly in the following cases.
  - The electronic key is too close to the window or outside door handle, near the ground, or in a high place when the doors are locked or unlocked.
  - The electronic key is on the instrument panel, luggage cover or floor, in the glove box when the engine is started or “ENGINE START STOP” switch modes are changed.
- As long as the electronic key is within the effective range, the doors may be locked or unlocked by anyone.
- Even if the electronic key is not inside the vehicle, it may be possible to start the engine if the electronic key is near the window.

- The doors may unlock if a large amount of water splashes on the door handle, such as in the rain or in a car wash. (The doors will automatically be locked after approximately 60 seconds if the doors are not opened and closed.)
- Gripping the door handle when wearing a glove may not unlock the door.
- If the wireless remote control is used to lock the doors when the electronic key is near the vehicle, there is a possibility that the door may not be unlocked by the entry function. (Use the wireless remote control to unlock the doors.)

#### ■ When the vehicle is not driven for extended periods

To prevent theft of the vehicle, do not leave the electronic key within 6 ft. (2 m) of the vehicle.

#### ■ Security feature

If a door is not opened within approximately 60 seconds after the vehicle is unlocked, the anti-theft system automatically locks the vehicle again.

#### ■ Alarms and warning indicators

A combination of exterior and interior alarms as well as warning lights are used to prevent the theft of the vehicle and accidents resulting from erroneous operation.

- When any warning lights come on:  
Take appropriate measures in response to which warning light comes on.  
(→P. 426)

## 1-2. Opening, closing and locking the doors

- When an alarm sounds:

Take appropriate measures according to the following table.

Alarm	Situation	Correction procedure
Exterior alarm sounds once for 2 seconds	Tried to lock the doors using the entry function while the electronic key is still inside the passenger compartment.	Retrieve the electronic key from the passenger compartment and lock the doors again.
Exterior alarm sounds once for 60 seconds	Tried to exit the vehicle with the electronic key and lock the doors without first turning the "ENGINE START STOP" switch OFF.	Turn the "ENGINE START STOP" switch OFF and lock the doors again.
Exterior alarm sounds once for 10 seconds	Tried to lock the vehicle using the entry function while a door is open.	Close all of the doors and lock the doors again.
Interior alarm sounds continuously	Tried to open the door and exit the vehicle without shifting the shift lever to P.	Shift the shift lever to P.
Interior alarm beeps repeatedly	Switched to ACCESSORY mode while the driver's door is open. (Opened the driver's door when the "ENGINE START STOP" switch is in ACCESSORY mode.)	Turn the "ENGINE START STOP" switch OFF and close the driver's door.
	Turned the "ENGINE START STOP" switch OFF while the driver's door is open.	Close the driver's door.

Alarm	Situation	Correction procedure
Interior and exterior alarms sound continuously.	Tried to close the driver's door after carrying the key outside the vehicle with the "ENGINE START STOP" switch in IGNITION ON or ACCESSORY mode and without the shift lever being in P.	Shift the shift lever to P, turn the "ENGINE START STOP" switch OFF and close the driver's door again.
Interior alarm beeps once.	The electronic key has a low battery.	Replace the electronic key battery.
	Tried to start the engine without the electronic key being present, or when the electronic key was not functioning normally.	Start the engine with the electronic key present.
Interior alarm beeps once and exterior alarm sounds 3 times.	Tried to close the driver's door after carrying the key outside the vehicle without turning the "ENGINE START STOP" switch OFF.	Turn the "ENGINE START STOP" switch OFF and close the driver's door again.
	An occupant carried the electronic key outside the vehicle and closed the door when the "ENGINE START STOP" switch was in IGNITION ON or ACCESSORY mode.	Bring the electronic key back into the vehicle.

■ **If the smart key system does not operate properly**

- Locking and unlocking the doors: Use the mechanical key. (→P. 461)
- Starting the engine. (→P. 461)

■ **When the electronic key battery is fully depleted**

→P. 388

■ **Customization that can be configured at Toyota dealer**

It is possible to deactivate the smart key system etc.  
(Customizable features →P. 500)

■ **Certification for the smart key system**

▶ For vehicles sold in the U.S.A.

FCC ID: HYQ14AEM

FCC ID: NI4TMLF-2

FCC ID: HYQ14AAB

FCC ID: HYQ13BZS

FCC ID: HYQ14ABK

FCC ID: HYQ13CZA

NOTE:

This device complies with part 15 of the FCC Rules. Operation is subject to the following two conditions: (1) This device may not cause harmful interference, and (2) this device must accept any interference received, including interference that may cause undesired operation.

FCC WARNING:

Changes or modifications not expressly approved by the party responsible for compliance could void the user's authority to operate the equipment.

▶ For vehicles sold in Canada

NOTE:

Operation is subject to the following two conditions: (1) this device may not cause interference, and (2) this device must accept any interference, including interference that may cause undesired operation of the device.

 **CAUTION****■ Caution regarding interference with electronic devices**

● People with implanted pacemakers or cardiac defibrillators should keep away from smart key system antennas. (→P. 28) The radio waves may affect the operation of such devices. If necessary, the entry function can be disabled. Ask your Toyota dealer for details, such as the frequency of radio waves and timing of emitting the radio waves. Then, consult your doctor to see if you should disable the entry function.

● User of any electrical medical device other than implanted pacemakers and implanted cardiac defibrillators should consult the manufacturer of the device for information about its operation under the influence of radio waves.

Radio waves could have unexpected effects on the operation of such medical devices.

Ask your Toyota dealer for details for disabling the entry function.



## 1-2. Opening, closing and locking the doors

### Wireless remote control

The wireless remote control can be used to lock and unlock the vehicle from outside the vehicle.

#### ► Vehicles without smart key system

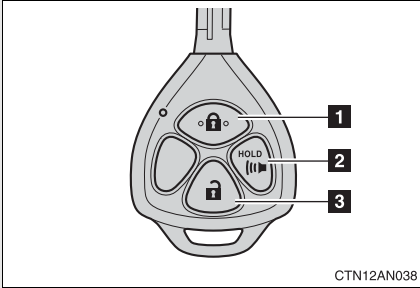

- 1 Locks all doors
  - 2 Pushing and holding:  
Sounds alarm
  - 3 Unlocks all doors
- Pressing the button unlocks the driver's door. Pressing the button again within 3 seconds unlocks the other doors.

#### ► Vehicles with smart key system

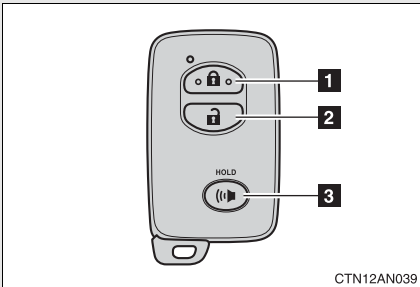

- 1 Locks all doors
  - 2 Unlocks all doors
- Pressing the button unlocks the driver's door. Pressing the button again within 3 seconds unlocks the other doors.
- 3 Pushing and holding:  
Sounds alarm

#### ■ Operation signals

Doors: A buzzer sounds and the emergency flashers flash to indicate that the doors have been locked/unlocked. (Locked: Once; Unlocked: Twice)

## ■ Panic mode

### ▶ Vehicles without smart key system

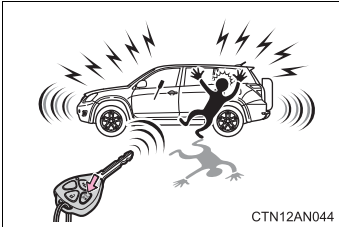

When  is pushed for longer than about one second, an alarm will sound for about 60 seconds and the vehicle lights will flash to deter any person from trying to break into or damage your vehicle.

To stop the alarm, push any button on the wireless remote control.

### ▶ Vehicles with smart key system



When  is pushed for longer than about one second, an alarm will sound for about 60 seconds and the vehicle lights will flash to deter any person from trying to break into or damage your vehicle.

To stop the alarm, push any button on the wireless remote control.

## ■ Door lock buzzer

If a door is not fully closed, a buzzer sounds continuously if an attempt to lock the door is made. Fully close the door to stop the buzzer, and lock the vehicle once more.

## ■ Key battery depletion

### ▶ Vehicles without smart key system

If the wireless remote control function does not operate, the battery may be depleted. Replace the battery when necessary. (→P. 388)

### ▶ Vehicles with smart key system

→P. 388

■ **If the wireless remote control does not operate**

- ▶ Vehicles without smart key system

Locking and unlocking the doors: Use the key. (→P. 42)

- ▶ Vehicles with smart key system

- Locking and unlocking the doors: Use the mechanical key. (→P. 461)
- Starting the engine. (→P. 461)

■ **Security feature**

If a door is not opened within approximately 60 seconds after the vehicle is unlocked, the anti-theft system automatically locks the vehicle again.

■ **Conditions affecting operation**

- ▶ Vehicles without smart key system

The wireless remote control function may not operate normally in the following situations.

- Near a TV tower, radio station, electric power plant, airport or other facility that generates strong radio waves
- When carrying a portable radio, cellular phone or other wireless communication devices
- When multiple wireless keys are in the vicinity
- When the wireless key is in contact with, or is covered by a metallic object
- When a wireless key (that emits radio waves) is being used nearby
- When the wireless key has been left near an electrical appliance such as a personal computer

- ▶ Vehicles with smart key system

→P. 30

■ **Customization that can be configured at Toyota dealer**

Settings (e.g. wireless remote control) can be changed.  
(Customizable features →P. 500)

**■ Certification for wireless remote control (vehicles without smart key system)**

► For vehicles sold in the U.S.A.

FCC ID: HYQ12BBY

FCC ID: HYQ13BBZ

FCC ID: HYQ12BDC

FCC ID: HYQ13BDC

**NOTE:**

This device complies with part 15 of the FCC Rules. Operation is subject to the following two conditions: (1) This device may not cause harmful interference, and (2) this device must accept any interference received, including interference that may cause undesired operation.

**FCC WARNING:**

Changes or modifications not expressly approved by the party responsible for compliance could void the user's authority to operate the equipment.

► For vehicles sold in Canada

**NOTE:**

Operation is subject to the following two conditions: (1) this device may not cause interference, and (2) this device must accept any interference, including interference that may cause undesired operation of the device.

**■ Certification for wireless remote control (vehicles with smart key system)**

→P. 36

## Side doors

The vehicle can be locked and unlocked using the entry function, wireless remote control, key or door lock switch.

■ **Entry function (vehicles with smart key system)**

→P. 26

■ **Wireless remote control**

→P. 38

■ **Key**

▶ **Vehicles without smart key system**

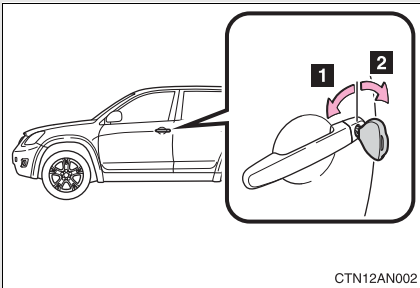

**1** Locks all doors

**2** Unlocks all doors

Turning the key unlocks the driver's door. Turning the key again within 3 seconds unlocks the other doors.

▶ **Vehicles with smart key system**

The doors can also be locked and unlocked with the mechanical key. (→P. 461)

### ■ Door lock switch

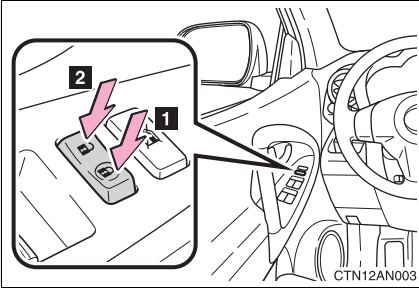

- 1** Locks all doors
- 2** Unlocks all doors

### ■ Inside lock button

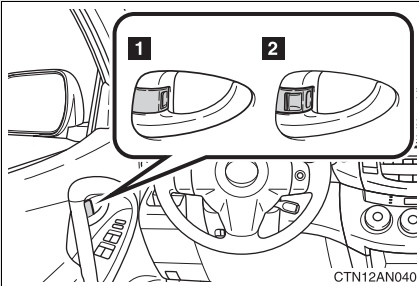

- 1** Locks the door
- 2** Unlocks the door

Pulling the door handle can open the front door even if the lock button is in the lock position.

### Locking the front doors from the outside without the wireless remote control or key

- STEP 1** Move the inside door lock button to the lock position.
- STEP 2** Close the door.

### Rear door child-protector locks

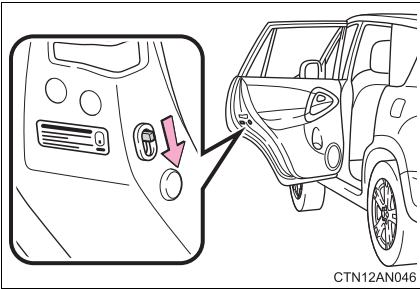

The door cannot be opened from inside the vehicle when the child-protector lock is set.

These locks can be set to prevent children from opening the rear doors. Push down on each rear door switch to lock both rear doors.

■ **When all the doors are locked with the entry function (vehicles with smart key system), wireless remote control or key**

The doors cannot be unlocked with the door lock switch.

The door lock switch can be reset by unlocking all the doors with the entry function (vehicles with smart key system), wireless remote control or key.

■ **The doors cannot be locked when**

▶ Vehicles without smart key system

The key is in the engine switch and either front door is open.

▶ Vehicles with smart key system

The “ENGINE START STOP” switch is in ACCESSORY or IGNITION ON mode, or the electronic key is left inside the vehicle.

Depending on the position of the electronic key, the key may not be detected correctly and the door may be locked.

■ **Customization that can be configured at Toyota dealer**

Settings (e.g. door unlocking function) can be changed.  
(Customizable features →P. 500)

 **CAUTION**

■ **To prevent an accident**

Observe the following precautions while driving the vehicle.

Failing to do so may result in a door opening and an occupant falling out, resulting in death or serious injury.

● Always use a seat belt.

● Always lock the doors.

● Ensure that all doors are properly closed.

● Do not pull the inside handle of the doors while driving.

The doors may be opened and the passengers are thrown out of the vehicle and it may result in serious injury or death.

Be especially careful for the front doors, as the doors may be opened even if the inside lock buttons are in locked position.

● Set the rear door child protector locks when children are seated in the rear seats.



## Back door

The back door can be opened using the back door handle. The back door can be locked and unlocked using the wireless remote control, entry function (vehicles with smart key system) or door lock switch.

■ **Entry function (vehicles with smart key system)**

→P. 27

■ **Wireless remote control**

→P. 38

■ **Door lock switch**

→P. 43

---

■ **Customization that can be configured at Toyota dealer**

Settings (e.g. wireless remote control) can be changed.  
(Customizable features →P. 500)

 **CAUTION**

■ **Caution while driving**

- Keep the back door closed while driving.

If the back door is left open, it may hit near-by objects while driving or luggage may be unexpectedly thrown out, causing an accident.

In addition, exhaust gases may enter the vehicle, causing death or a serious health hazard. Make sure to close the back door before driving.

- Before driving the vehicle, make sure that the back door is fully closed. If the back door is not fully closed, it may open unexpectedly while driving, causing an accident.
- Never let anyone sit in the luggage compartment. In the event of sudden braking or a collision, they are susceptible to death or serious injury.

 **CAUTION****■ Caution while parking**

If the open back door hides the stop, tail or rear turn signal lights, other road users must be warned of the presence of your vehicle by a warning triangle or other device.

**■ When children are in the vehicle**

Observe the following precautions.

Failure to do so may result in death or serious injury.

- Do not leave children alone in the luggage compartment.

If a child is accidentally locked in the luggage compartment, they could have heat exhaustion.

- Do not allow a child to open or close the back door.

Doing so may cause the back door to operate unexpectedly, or cause the child's hands, head, or neck to be caught by the closing back door.

**■ Operating the back door**

Observe the following precautions.

Failure to do so may cause parts of the body to be caught, resulting in serious injury.

- When opening or closing the back door, thoroughly check to make sure the surrounding area is safe.
- If anyone is in the vicinity, make sure they are safe and let them know that the back door is about to open or close.

**! CAUTION**

- Use caution when opening or closing the back door in windy weather as it may move abruptly in strong wind.

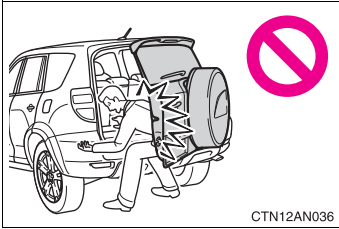

- The back door may close if it is not opened fully. It is more difficult to open or close the back door on an incline than on a level surface, so beware of the back door unexpectedly opening or closing by itself. Make sure that the back door is fully open and secure before using the luggage compartment.

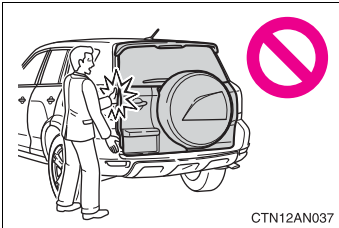

- When closing the back door, take extra care to prevent your fingers etc. from being caught.
- When closing the back door, make sure to press it lightly on its outer surface.

- Do not attach any accessories other than genuine Toyota parts to the back door. Such additional weight on the back door may interfere with the safety opening and closing operation of the back door.
- If the open back door hides the stop, tail, rear side marker or rear turn signal lights while you are parked, other road users must be warned of the presence of your vehicle by a warning triangle or other device.

## Front seats

### ► Manual seat

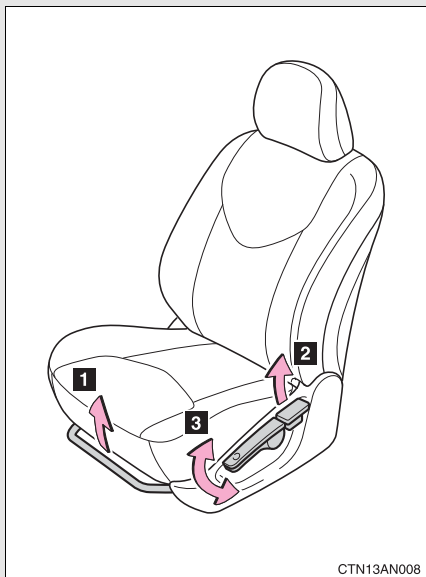

CTN13AN008

- 1** Seat position adjustment lever
- 2** Seatback angle adjustment lever
- 3** Vertical height adjustment lever (driver's side only)

► Power seat (driver's side only)

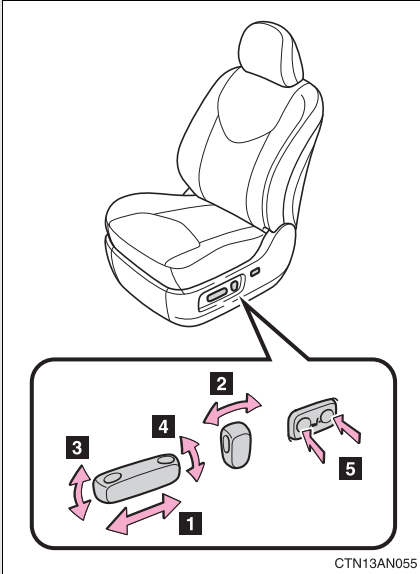

- 1** Seat position adjustment switch
- 2** Seatback angle adjustment switch
- 3** Seat cushion (front) angle adjustment switch
- 4** Vertical height adjustment switch
- 5** Seat lumbar support adjustment switch

## Flattening front seatbacks

The front seats can be moved into a flat seat arrangement.

### ► Manual seat

**STEP 1** Slide the second seats as far back as possible. (→P. 54)

**STEP 2** Remove the front head restraint. (→P. 65)

**STEP 3**

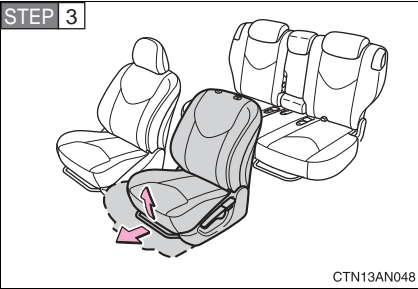

Slide the front seat further forward than the front-most lock position.

**STEP 4**

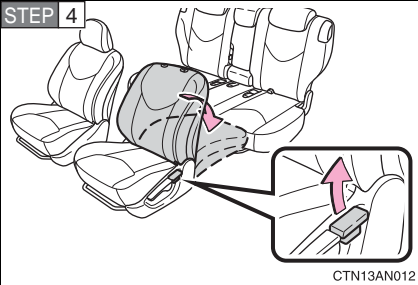

Pull the seatback angle adjustment lever up to unlock and push down the seatback.

After returning the seat to its original position, be certain to replace the head restraint.

► Power seat

**STEP 1** Slide the second seats as far back as possible. (→P. 54)

**STEP 2** Remove the front head restraint. (→P. 65)

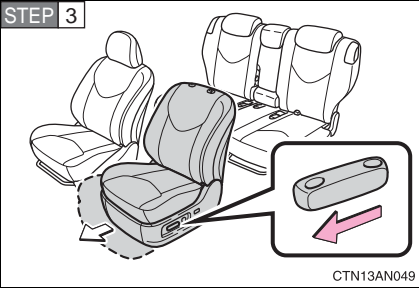

Push the seat position adjusting switch forward to slide the seat to the front-most position.

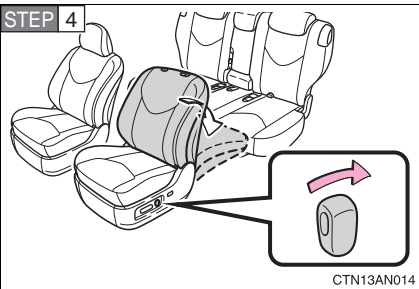

Move the seatback angle adjusting switch backward to flatten the seatback.

After returning the seat to its original position, be certain to replace the head restraint.

**Active head restraints**

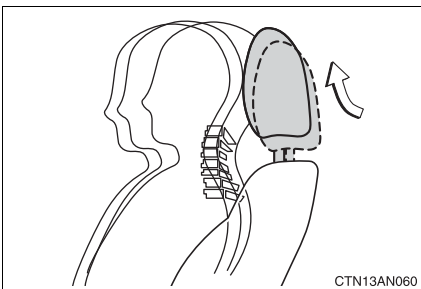

When the occupant's lower back presses against the seatback during a rear-end collision, the head restraint moves slightly forward and upward to help reduce the risk of whiplash on the seat occupant.

### ■ Active head restraints

Even small forces applied to the seatback may cause the head restraint to move. Pushing up a locked head restraint forcibly may appear the head restraint inner structure. These do not indicate problems.

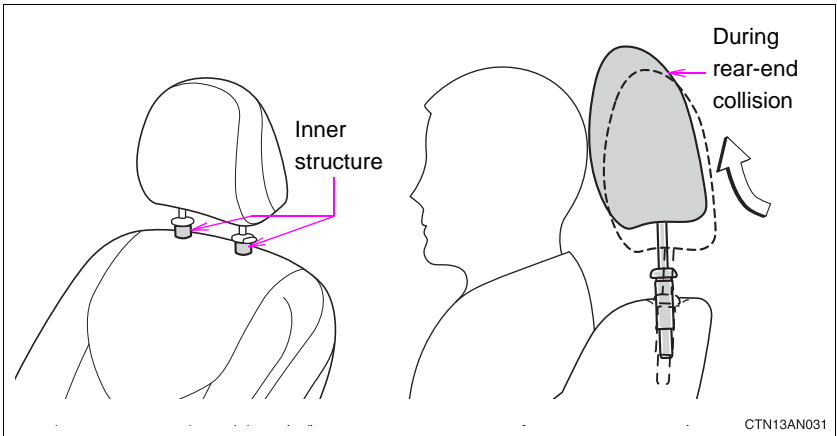

### ⚠ CAUTION

#### ■ Seat adjustment

- Be careful that the seat does not hit passengers or luggage.
- Do not recline the seat more than necessary when the vehicle is in motion to reduce the risk of sliding under the lap belt.  
If the seat is too reclined, the lap belt may slide past the hips and apply restraint forces directly to the abdomen or your neck may contact the shoulder belt, increasing the risk of death or serious injury in the event of an accident.
- Manual seat only: After adjusting the seat, make sure that the seat is locked in position.



# 1-3. Adjustable components (seats, mirrors, steering wheel)

## Rear seats

### ■ Second seats

#### ► Vehicles with third seat

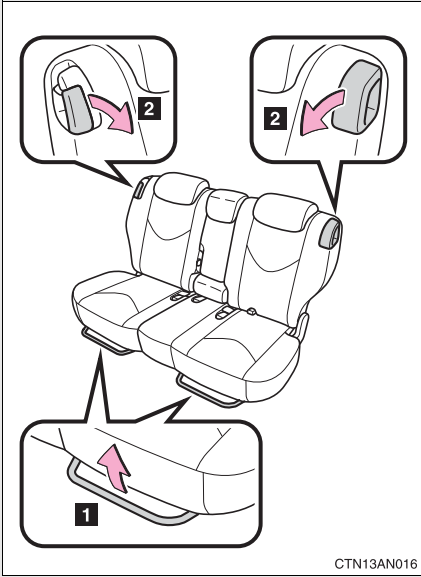

**1** Seat position adjustment levers

**2** Seatback angle adjustment levers

When a person sits in the second center position, align all seatbacks at the same angle.

► Vehicles without third seat

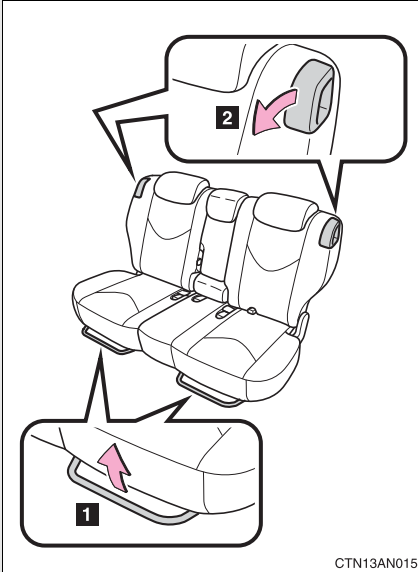

- 1** Seat position adjustment levers
- 2** Seatback angle adjustment levers

When a person sits in the second center position, align all seatbacks at the same angle.

■ **Third seats (if equipped)**

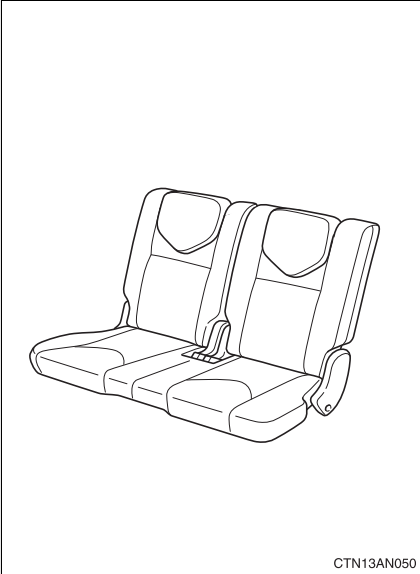

The third seats do not have a seat adjustment function.

**Moving a second seats for third seats entry (vehicles with third seats)**

■ **Getting in the vehicle (right side only)**

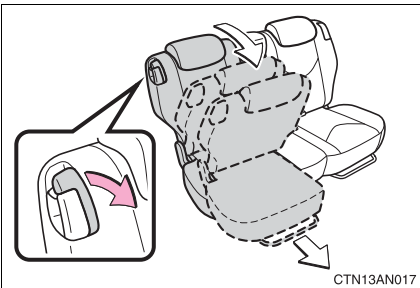

Pull the lever forward and fold down the seatback. The seat will slide forward.

After passengers are in, lift up the seatback and return the seat to the original position.

## Folding second seats

Folding down the second seats will enlarge the luggage compartment.

### ■ Before folding the second seats

**STEP 1** Stow the second center seat belt. (→P. 70)

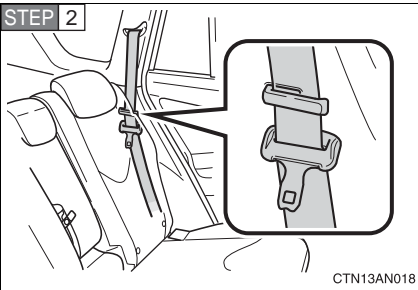

Make sure the outside seat belt passes through the hanger when folding the second seat.

This prevents the shoulder belt from being damaged.

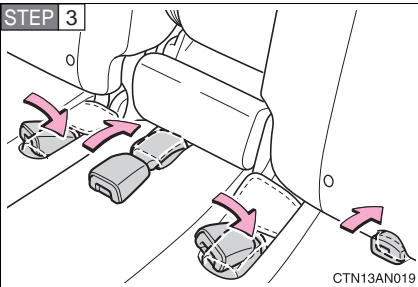

Stow the second seat belt buckles.

**STEP 4** Lower the head restraint to the lowest position. (→P. 65)

**STEP 5** Raise the armrest until it locks. (→P. 329)

## ■ Folding second seats

**STEP 1** Slide the second seats as far back as possible. (→P. 54)

### ► From inside

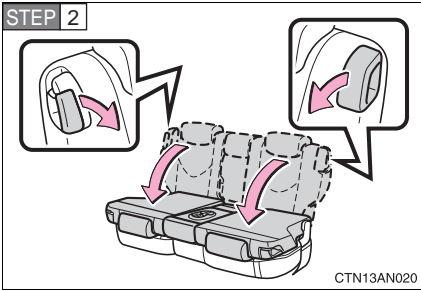

Pull down the seatback angle adjustment lever and fold down the seatback.

### ► From outside (vehicles without third seats)

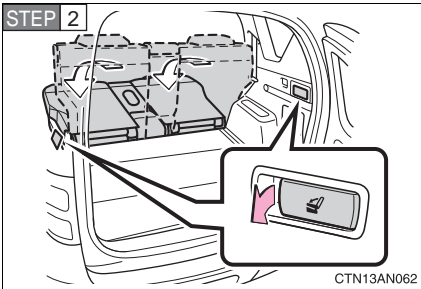

Open the back door and pull the lock release lever to fold down the second seat.

## Stowing third seats (vehicles with third seats)

### ■ Before stowing the third seats

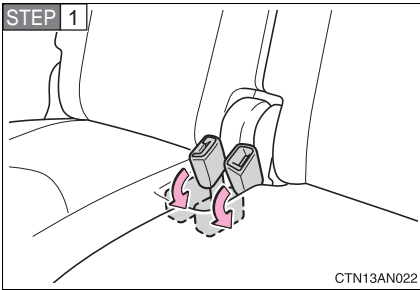

Stow the third seat belt buckles.

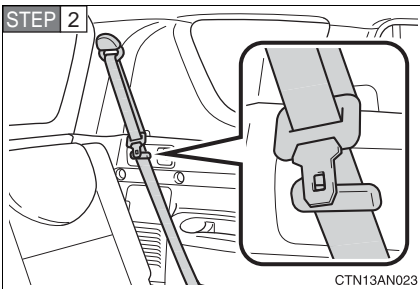

Pass the seat belts through the seat belt hangers.

This prevents the shoulder belt from being damaged.

STEP 3 Lower the head restraint to the lowest position. (→P. 65)

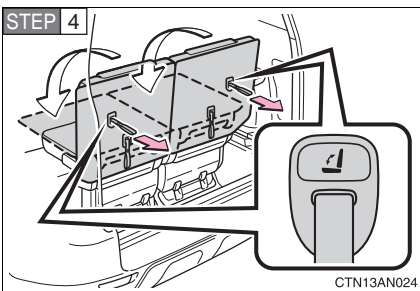

Pull the seatback lock release strap to fold down the seatback.

Make sure it is locked securely.

### ■ Stowing third seats

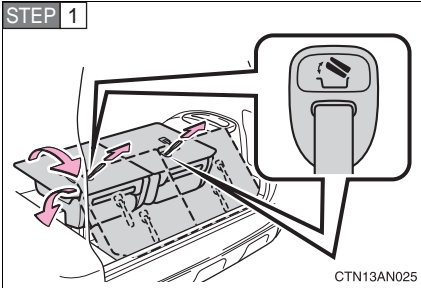

Pull and hold the seat lock release strap and lift up the seat rearward and then push the seat down.

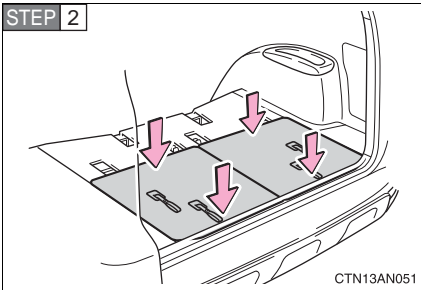

Push the seat on the front side against the floor and push the seat on rear side against the floor.

Make sure it is locked securely.

## ■ Returning third seats

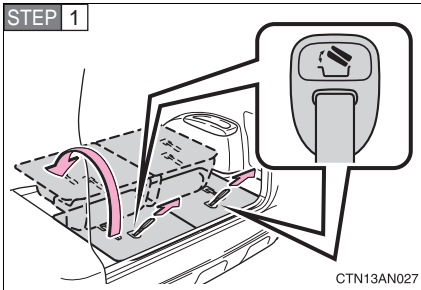

Pull the seat lock release strap, lift the seat up and move the seat forward. Lock the seat into place.

Make sure it is locked securely.

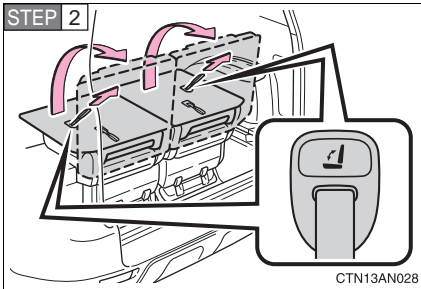

Pull the seatback lock release strap and raise the seatback.

If the seat does not lift up when the seat lock release strap is pulled, lock the seatback again.



 **CAUTION**

■ **Seat adjustment**

Observe the following precautions.

Failure to do so may result in death or serious injuries.

- The seat belts provide maximum protection in a frontal or rear collision when the driver and the front passenger are sitting up straight and well back in the seats.

If you are reclined, the lap belt may slide past your hips and apply restraint forces directly to the abdomen or your neck may contact the shoulder belt.

- Be careful not to get your hands or feet pinched in the seat.
- Do not adjust the seat while the vehicle is moving as the seat may unexpectedly move and cause the driver to lose control of the vehicle.
- Be careful that the seat does not hit a passenger or luggage.
- Do not put objects under the seats.

Otherwise, the objects may interfere with the seat-lock mechanism or unexpectedly push up the seat position adjustment lever and the seat may suddenly move, causing the driver to lose control of the vehicle.

- Avoid reclining the seatback any more than needed.
- Adjust both seat cushions to the same position and align all seatbacks at the same angle when a person sits in the rear center position.

Otherwise, the person cannot wear the seat belt properly and this may cause death or serious injuries in a collision.

 CAUTION

■ **When folding second seats**

- Do not fold the second seatback when passengers sit or luggage is placed on the seat.
- Do not allow passengers to ride on the folded seat or in the luggage compartment while driving.
- Make sure that no passengers or luggage are on the rear seats.
- Make sure the seatback is securely locked by pushing forward and rearward on the top of the seatback.

Failure to do so will prevent the seat belt from operating properly.

■ **When stowing third seats**

- Make sure that no passenger or luggage are on the seats. Then, hold the seat and slowly move it.

Otherwise, people may be injured or luggage may be damaged if the seat hits them.

- Make sure the seat is securely locked by pushing forward and rearward on the top of the seatback or by trying to pull up the edge of the bottom cushion.

Failure to do so will prevent the seat belt from operating properly.

- Make sure the seat belts are not twisted or caught in the seatback and are arranged in their proper position ready for use.
- Do not stow or return the seats when you are inside the vehicle in order to prevent pinching your hands or feet in the seat.

Be sure to stow and return the seats from outside the vehicle.

 CAUTION

■ **After adjusting a seat**

- After adjusting the seat position, try sliding it forward and backward to make sure it is locked in position.
- After adjusting the seatback, push your body against the seatback to make sure it is locked in position.
- Make sure the seat belts are not twisted or caught in the seatback and are arranged in their proper position and are ready for use.

 NOTICE

■ **Before folding the seats**

To prevent damage to the seat belt buckles, stow them before folding the seatback.

# 1-3. Adjustable components (seats, mirrors, steering wheel)

## Head restraints

Head restraints are provided for all seats.

### ► Front seats

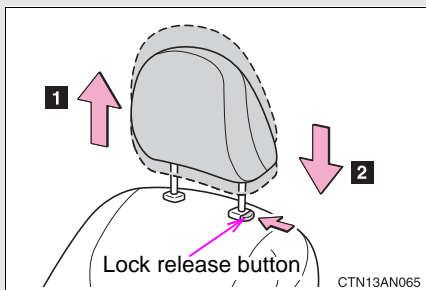

#### 1 Up

Pull the head restraints up.

#### 2 Down

Push the head restraint down while pushing the lock release button.

### ► Second seats

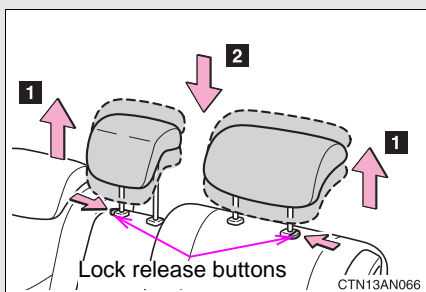

### ► Third seats (if equipped)

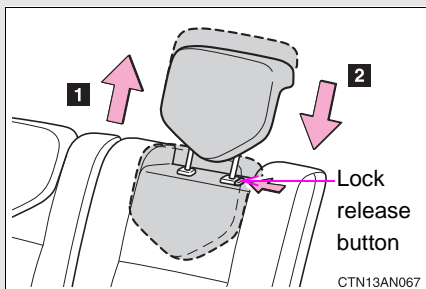

■ **Removing the head restraints**

▶ **Except second center seat**

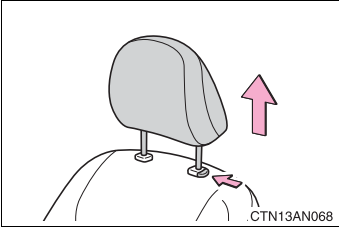

Pull the head restraint up while pushing the lock release button.

▶ **Second center seat**

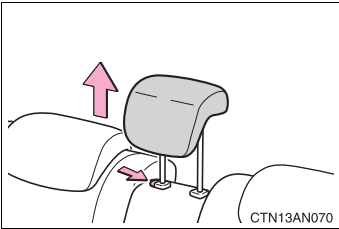

■ **Installing the head restraints**

▶ **Except second center seat**

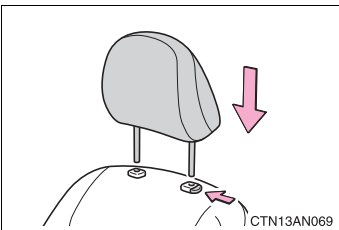

Align the head restraint with the installation holes and push it down while pressing the lock release button.

► Second center seat

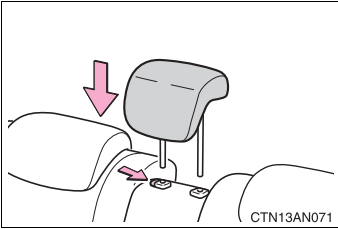

■ Adjusting the height of the head restraints

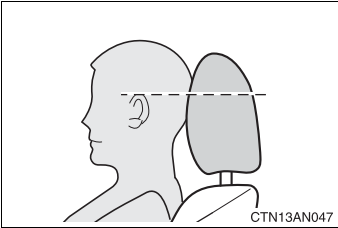

Make sure that the head restraints are adjusted so that the center of the head restraint is closest to the top of your ears.

■ Adjusting the rear seat head restraints

Always raise the head restraint one level from the stowed position when using.

**⚠ CAUTION**

■ Head restraint precautions

Observe the following precautions regarding the head restraints. Failure to do so may result in death or serious injury.

- Use the head restraints designed for each respective seat.
- Adjust the head restraints to the correct position at all times.
- After adjusting the head restraints, push down on them and make sure they are locked in position.
- Do not drive with the head restraints removed.

## Seat belts

**Make sure that all occupants are wearing their seat belts before driving the vehicle.**

### ■ Correct use of the seat belts

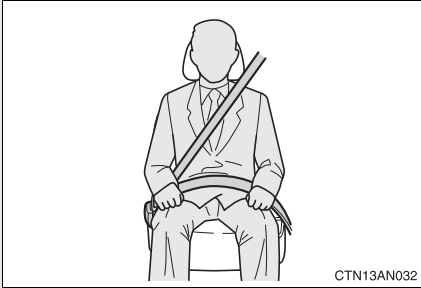

- Extend the shoulder belt so that it comes fully over the shoulder, but does not come into contact with the neck or slide off the shoulder.
- Position the lap belt as low as possible over the hips.
- Adjust the position of the seatback. Sit up straight and well back in the seat.
- Do not twist the seat belt.

### ■ Fastening and releasing the seat belt

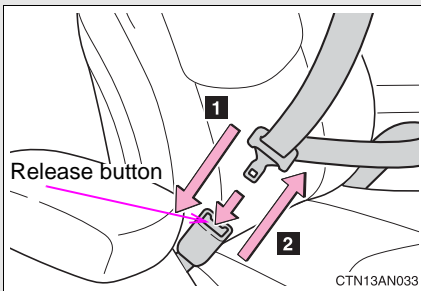

#### 1 Fastening the belt

Push the tab into the buckle until a clicking sound is heard.

#### 2 Releasing the belt

Press the release button.

### ■ Adjusting the height of the belt (front seats)

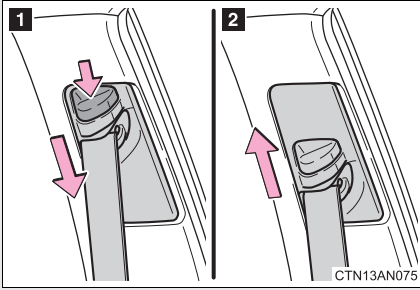

**1** Down

**2** Up

Move the height adjuster up and down as needed.

### Second center seat belt

The second center seat belt is a 3-point type restraint with 2 buckles. Both seat belt buckles must be correctly located and securely latched for proper operation.

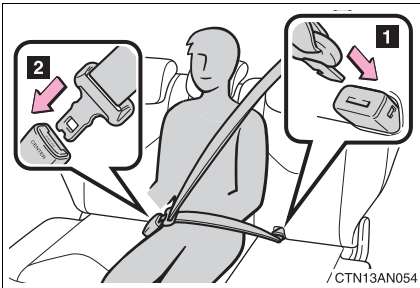

Make sure that the buckle **1** is securely latched ready for use of the center seat belt.

**1** Matches the tab with hook end.

**2** Matches the tab with round end.



### ■ Releasing method

The second center seat belt can be completely released only when necessary such as when folding down the second seats.

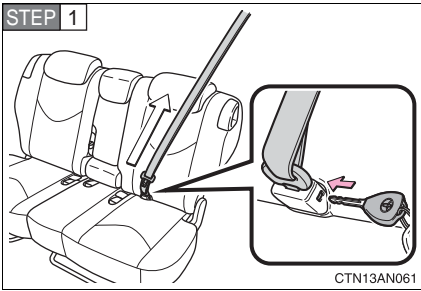

Insert the key into the hole on the center seat belt buckle to release the tab (with hook end), and allow the belt to retract.

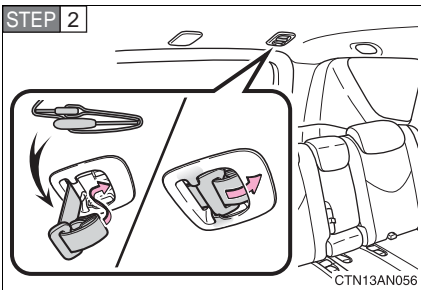

Stow the seat belt tabs in the cover located on the roof as shown.

### Seat belt pretensioners (front seats)

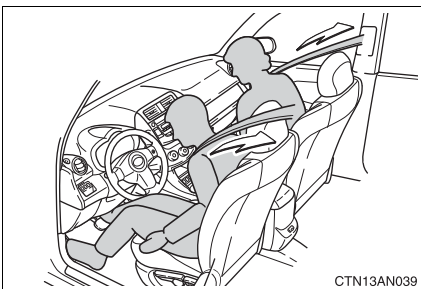

The pretensioner helps the seat belt to quickly restrain the occupant by retracting the seat belt when the vehicle is subjected to certain types of severe frontal collision or a vehicle rollover.

The pretensioner may not activate in the event of a minor frontal impact, a side impact or a rear impact.

### ■ Emergency locking retractor (ELR)

The retractor will lock the belt during a sudden stop or on impact. It may also lock if you lean forward too quickly. A slow, easy motion will allow the belt to extend so that you can move around fully.

### ■ Automatic locking retractor (ALR)

When a passenger's shoulder belt is completely extended and then retracted even slightly, the belt is locked in that position and cannot be extended. This feature is used to hold the child restraint system (CRS) firmly. To free the belt again, fully retract the belt and then pull the belt out once more. (→P. 120)

### ■ Pregnant women

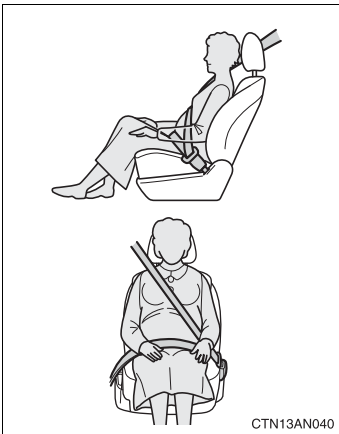

Obtain medical advice and wear the seat belt in the proper way. (→P. 68)

Women who are pregnant should position the lap belt as low as possible over the hips in the same manner as other occupants. Extend the shoulder belt completely over the shoulder and position the belt across the chest. Avoid belt contact over the rounding of the abdominal area.

If the seat belt is not worn properly, not only a pregnant woman, but also the fetus could suffer death or serious injury as a result of sudden braking or a collision.

### ■ People suffering illness

Obtain medical advice and wear the seat belt in the proper way.

## ■ When not using the rear seat belts

### ▶ Second seats

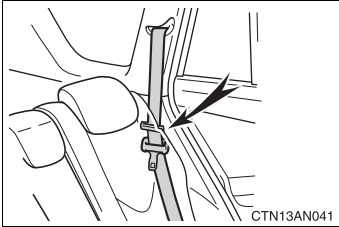

Pass the outer seat belts through the seat belt hangers and secure the seat belt plates to prevent the shoulder belts from being damaged.

### ▶ Third seats

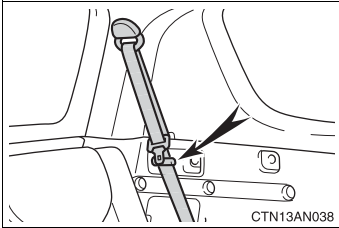

Pass the seat belts through the seat belt hangers to prevent the shoulder belts from being damaged.

## ■ Child seat belt usage

The seat belts of your vehicle were principally designed for persons of adult size.

- Use a child restraint system appropriate for the child, until the child becomes large enough to properly wear the vehicle's seat belt. (→P. 116)
- When the child becomes large enough to properly wear the vehicle's seat belt, follow the instructions on P. 68 regarding seat belt usage.

## ■ Replacing the belt after the pretensioner has been activated

If the vehicle is involved in multiple collisions, the pretensioner will activate for the first collision, but will not activate for the second or subsequent collisions.

## ■ Seat belt extender

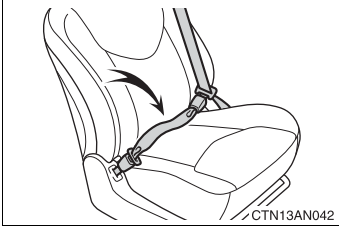

If your seat belts cannot be fastened securely because they are not long enough, a personalized seat belt extender is available from your Toyota dealer free of charge.

### ⚠ CAUTION

Observe the following precautions to reduce the risk of injury in the event of sudden braking, sudden swerving or an accident. Failing to do so may cause death or severe injury.

#### ■ Wearing a seat belt

- Ensure that all passengers wear a seat belt.
- Always wear a seat belt properly.
- Each seat belt should be used by one person only. Do not use a seat belt for more than one person at once, including children.
- Toyota recommends that children be seated in the rear seat and always use a seat belt and/or an appropriate child restraint system.
- Do not recline the seat any more than necessary to achieve a proper seating position. The seat belt is most effective when the occupants are sitting up straight and well back in the seats.
- Do not wear the shoulder belt under your arm.
- Always wear your seat belt low and snug across your hips.

#### ■ Adjustable shoulder anchor

Always make sure the shoulder belt is positioned across the center of your shoulder. The belt should be kept away from your neck, but not falling off your shoulder. Failure to do so could reduce the amount of protection in an accident and cause death or serious injuries in the event of a sudden stop, sudden swerve or accident. (→P. 69)

 **CAUTION**

■ **Seat belt pretensioners**

- Do not place anything, such as a cushion, on the front passenger's seat. Doing so will disperse the passenger's weight, which prevents the sensor from detecting the passenger's weight properly. As a result, the seat belt pretensioner for the front passenger's seat may not activate in the event of a collision.
- If the pretensioner has activated, the SRS warning light will come on. In that case, the seat belt cannot be used again and must be replaced at your Toyota dealer.

■ **Child restraint lock function belt precaution**

Do not allow children to play with the child restraint lock function belt. If the belt becomes twisted around a child's neck, it will not be possible to pull the belt out leading to choking or other serious injuries that could result in death. If this occurs and the buckle cannot be unfastened, scissors should be used to cut the belt.

■ **Seat belt damage and wear**

- Do not damage the seat belts by allowing the belt, plate, or buckle to be jammed in the door.
- Inspect the seat belt system periodically. Check for cuts, fraying, and loose parts. Do not use a damaged seat belt until it is replaced. Damaged seat belt cannot protect an occupant from death or serious injury.
- Ensure that the belt and tab are locked and the belt is not twisted. If the seat belt does not function correctly, immediately contact your Toyota dealer.
- Replace the seat assembly, including the belts, if your vehicle has been involved in a serious accident, even if there is no obvious damage.
- Do not attempt to install, remove, modify, disassemble or dispose of the seat belts. Have any necessary repairs carried out by your Toyota dealer. Inappropriate handling of the pretensioner may prevent it from operating properly resulting in death or serious injury.

**⚠ CAUTION**

■ **When using the second center seat belt**

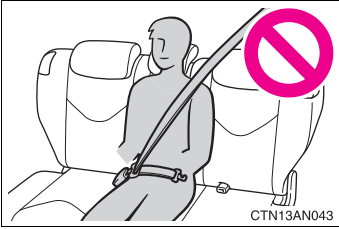

Do not use the second center seat belt with either buckle released.

Fastening only one of the buckles may result in death or serious injury in case of sudden braking or a collision.

■ **Using a seat belt extender**

- Do not wear the seat belt extender if you can fasten the seat belt without the extender.
- Do not use the seat belt extender when installing a child restraint system because the belt will not securely hold the child restraint system, increasing the risk of death or serious injury in the event of an accident.
- The personalized extender may not be safe on another vehicle, when used by another person, or at a different seating position other than the one originally intended.

**⚠ NOTICE**

■ **When using a seat belt extender**

When releasing the seat belt, press on the buckle release button on the extender, not on the seat belt.

This helps prevent damage to the vehicle interior and the extender itself.

## 1-3. Adjustable components (seats, mirrors, steering wheel)

### Steering wheel

The steering wheel can be adjusted to a comfortable position.

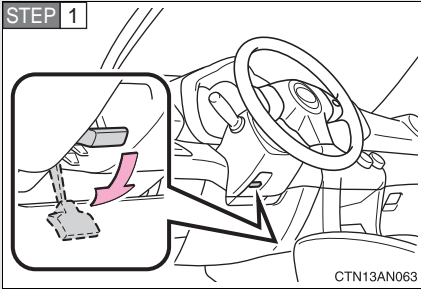

Hold the steering wheel and press the lever down.

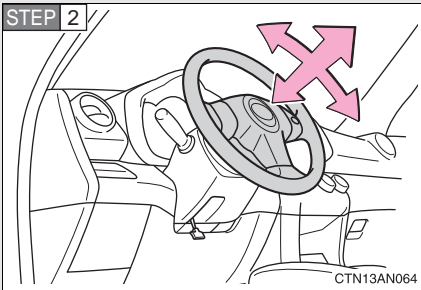

Adjust to the ideal position by moving the steering wheel horizontally and vertically.

After adjustment, pull the lever up to secure the steering wheel.

#### CAUTION

##### ■ Caution while driving

Do not adjust the steering wheel while driving.

Doing so may cause the driver to mishandle the vehicle and an accident, resulting in death or serious injury.

##### ■ After adjusting the steering wheel

Make sure that the steering wheel is securely locked.

Otherwise, the steering wheel may move suddenly, possibly causing an accident and resulting in death or serious injury.

## 1-3. Adjustable components (seats, mirrors, steering wheel)

### Anti-glare inside rear view mirror

Glare from the headlights of vehicles behind can be reduced by using the following functions.

#### ► Manual anti-glare inside rear view mirror

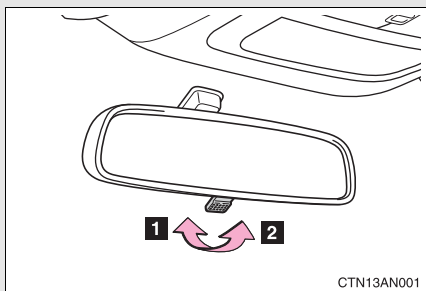

- 1 Normal position
- 2 Anti-glare position

#### ► Auto anti-glare inside rear view mirror

In automatic mode, sensors are used to detect the headlights of vehicles behind and the reflected light is automatically reduced.

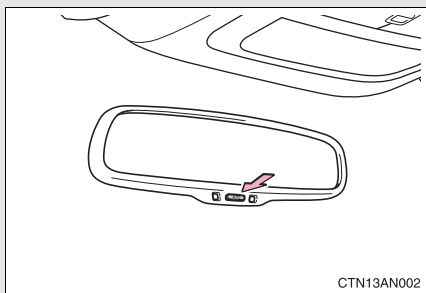

#### Turns automatic mode on/off

The indicator comes on when automatic mode is turned ON.

Vehicles without smart key system:

The mirror will revert to the automatic mode each time the engine switch is turned to the "ON" position.

Vehicles with smart key system:

The mirror will revert to the automatic mode each time the "ENGINE START STOP" switch is turned to IGNITION ON mode.



## Adjusting the height of rear view mirror

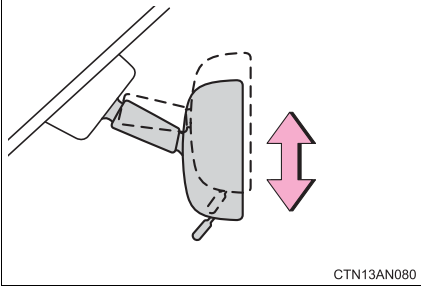

Adjust the height of the rear view mirror by moving it up and down.

### ■ To prevent sensor error (vehicles with auto anti-glare inside rear view mirror)

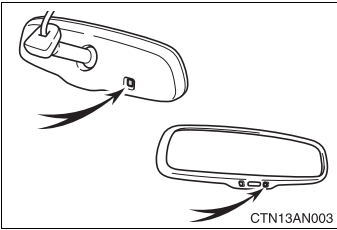

To ensure that the sensors operate properly, do not touch or cover them.

### ⚠ CAUTION

#### ■ Caution while driving

Do not adjust the position of the mirror while driving.

Doing so may lead to mishandling of the vehicle and an accident, resulting in death or serious injury.

# 1-3. Adjustable components (seats, mirrors, steering wheel)

## Outside rear view mirrors

### ► Vehicles without smart key system

Mirror angle can be adjusted using the switch when the engine switch is in the “ACC” or “ON” position.

### ► Vehicles with smart key system

Mirror angle can be adjusted using the switch when the “ENGINE START STOP” switch is in ACCESSORY or IGNITION ON mode.

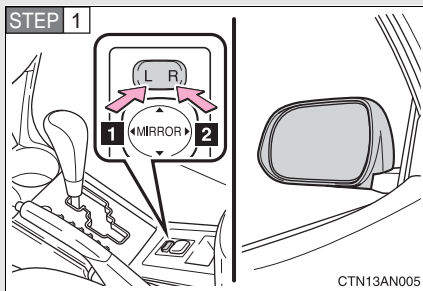

Select a mirror to adjust.

- 1** Left
- 2** Right

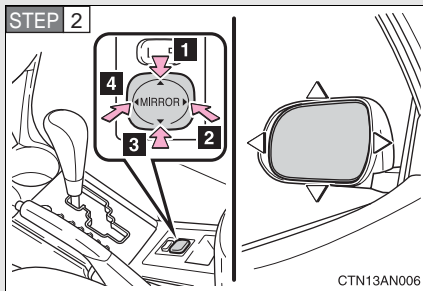

Adjust the mirror.

- 1** Up
- 2** Right
- 3** Down
- 4** Left

## Folding back the mirrors

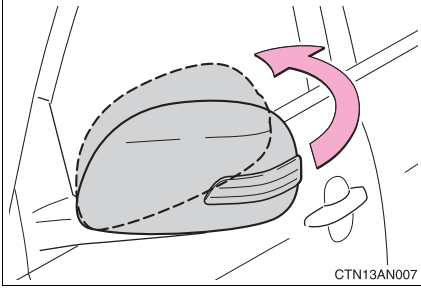

Push backward to fold the mirrors.

### ■ When the mirrors are fogged up (vehicles with outside rear view mirror defoggers)

Turn on the mirror defoggers to defog the mirrors. (→P. 240)

## ⚠ CAUTION

### ■ When driving the vehicle

Observe the following precautions while driving.

Failing to do so may result in loss of control of the vehicle and cause an accident, resulting in death or serious injury.

- Do not adjust the mirrors while driving.
- Do not drive with the mirrors folded back.
- Both the driver and passenger side mirrors must be extended and properly adjusted before driving.

### ■ When the mirror defoggers are operating (vehicles with outside rear view mirror defoggers)

Do not touch the rear view mirror surfaces, as they can become very hot and burn you.

# 1-4. Opening and closing the windows and moon roof

## Power windows

The power windows can be opened and closed using the following switches.

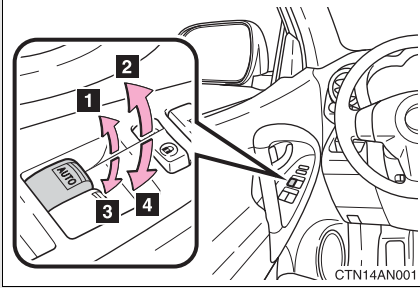

- 1** Closing
- 2** One-touch closing (driver's window only)\*
- 3** Opening
- 4** One-touch opening (driver's window only)\*

\*: Pressing the switch in the opposite direction will stop window travel partway.

### Lock switch

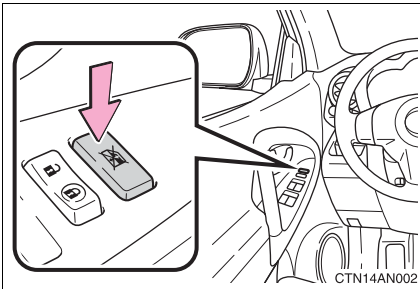

Press the switch down to lock the passenger window switches.

Use this switch to prevent children from accidentally opening or closing a passenger window.

■ **The power windows can be operated when**

- ▶ Vehicles without smart key system

The engine switch is in the “ON” position.

- ▶ Vehicles with smart key system

The “ENGINE START STOP” switch is in IGNITION ON mode.

■ **Operating the power windows after turning the engine off (front windows only)**

- ▶ Vehicles without smart key system

The power windows can be operated for approximately 45 seconds after the engine switch is turned to the “ACC” or “LOCK” position. They cannot, however, be operated once either front door is opened.

- ▶ Vehicles with smart key system

The power windows can be operated for approximately 45 seconds after the “ENGINE START STOP” switch is turned to ACCESSORY mode or turned OFF. They cannot, however, be operated once either front door is opened.

■ **Jam protection function (driver’s window only)**

If an object becomes caught between the window and the window frame, window travel is stopped and the window is opened slightly.

■ **When the battery is disconnected**

The power windows must be initialized in order to ensure proper operation. (Initialize each window with the respective switches.)

**STEP 1** Open the window fully.

**STEP 2** Fully close the window by pulling the switch up and holding it for 1 second.

 **CAUTION****■ Closing the windows**

Observe the following precautions.

Failing to do so may result in death or serious injury.

- Check to make sure that all passengers do not have any part of their body in a position where it could be caught when a window is being operated.
- Do not allow children to operate the power windows.  
Closing a power window on someone can cause serious injury, and in some instances, even death.

**■ Jam protection function (driver's window only)**

- Never try jamming any part of your body to activate the jam protection function intentionally.
- The jam protection function may not work if something gets caught just before the window fully closes.

## 1-4. Opening and closing the windows and moon roof Moon roof\*

Use the overhead switches to open, close, and tilt the moon roof up and down.

### ■ Opening and closing

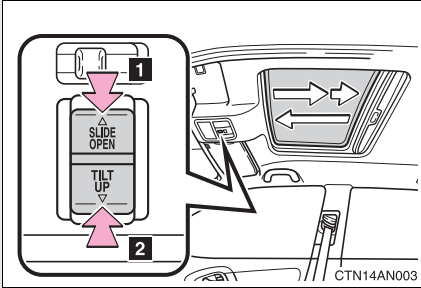

#### 1 Open

The moon roof stops slightly before the fully opened position.

Press the switch again to fully open.

#### 2 Close

Press either side of the switch to stop the moon roof partway.

### ■ Tilting up and down

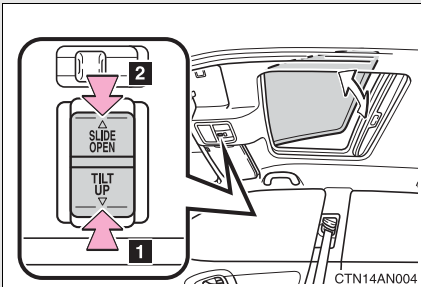

#### 1 Tilt up

#### 2 Tilt down

Press either side of the switch to stop the moon roof partway.

### ■ The moon roof can be operated when

▶ Vehicles without smart key system  
The engine switch is in the "ON" position.

▶ Vehicles with smart key system  
The "ENGINE START STOP" switch is in IGNITION ON mode.

\*: If equipped

### ■ Operating the moon roof after turning the engine off

#### ▶ Vehicles without smart key system

The moon roof can be operated for approximately 45 seconds after the engine switch is turned to the “ACC” or “LOCK” position. They cannot, however, be operated once either front door is opened.

#### ▶ Vehicles with smart key system

The moon roof can be operated for approximately 45 seconds after the “ENGINE START STOP” switch is turned to ACCESSORY mode or turned OFF. They cannot, however, be operated once either front door is opened.

### ■ Jam protection function

If an object is detected between the moon roof and the frame while closing or tilting down, travel is stopped and the moon roof opens slightly.

### ■ If the moon roof cannot be closed

If the moon roof cannot be closed automatically, such as when the jam protection function activates accidentally due to a malfunction, press and hold the “TILT UP” side of the switch until the moon roof slide closed completely.

### ■ To reduce wind noise

Drive with the moon roof opened to a position that is slightly before the fully open position as driving with the moon roof opened fully will cause wind noise.

### ■ Sunshade

The sunshade can be opened and closed manually. However, the sunshade will open automatically when the moon roof is opened.

### ■ Opening the moon roof by small degrees

Quickly press and release the switch.

### ■ When the battery is disconnected

The moon roof must be initialized in order to ensure proper operation.

Press and hold the “TILT UP” side of the switch until the moon roof tilts up completely.



### ■ When the moon roof does not close normally

Perform the following procedure:

- If the moon roof closes but then re-opens slightly

**STEP 1** Stop the vehicle.

**STEP 2** Press and hold the “TILT UP” switch.\*<sup>1</sup>

The moon roof will close, reopen and pause for approximately 10 seconds.\*<sup>2</sup> Then it will close again, tilt up and pause for approximately 1 second. Finally, it will tilt down, open and close.

**STEP 3** Check to make sure that the moon roof is completely closed and then release the switch.

- If the moon roof tilts down but then tilts back up

**STEP 1** Stop the vehicle.

**STEP 2** Press and hold the “TILT UP” switch\*<sup>1</sup> until the moon roof moves into the tilt up position and stops.

**STEP 3** Release the “TILT UP” switch once and then press and hold the “TILT UP” switch again.\*<sup>1</sup>

The moon roof will pause for approximately 10 seconds in the tilt up position.\*<sup>2</sup> Then it will adjust slightly and pause for approximately 1 second. Finally, it will tilt down, open and close.

**STEP 4** Check to make sure that the moon roof is completely closed and then release the switch.

\*<sup>1</sup>:If the switch is released at the incorrect time, the procedure will have to be performed again from the beginning.

\*<sup>2</sup>:If the switch is released after the above mentioned 10 second pause, automatic operation will be disabled. In that case, press and hold the “TILT UP” switch, and the moon roof will tilt up and pause for approximately 1 second. Then it will tilt down, open and close. Check to make sure that the moon roof is completely closed and then release the switch.

If the moon roof does not fully close even after performing the above procedure correctly, have the vehicle inspected by your Toyota dealer.

 **CAUTION****■ Opening the moon roof**

Observe the following precautions.

Failing to do so may cause death or serious injury.

- Do not allow any passengers to put their hands or heads outside the vehicle while it is moving.
- Do not sit on top of the moon roof.

**■ Closing the moon roof**

Observe the following precautions.

Failing to do so may result in death or serious injury.

- Check to make sure that all passengers do not have any part of their bodies in a position where it could be caught when the moon roof is being operated.
- Do not allow children to operate the moon roof.  
Closing the moon roof on someone can cause death or serious injury.

**■ Jam protection function**

- Never try jamming any part of your body to activate the jam protection function intentionally.
- The jam protection function may not work if something gets caught just before the moon roof fully closes.

## Opening the fuel tank cap

**Perform the following steps to open the fuel tank cap.**

### ■ Before refueling the vehicle

▶ Vehicles without smart key system

Turn the engine switch to the “LOCK” position and ensure that all the doors and windows are closed.

▶ Vehicles with smart key system

Turn the “ENGINE START STOP” switch OFF and ensure that all the doors and windows are closed.

### ■ Opening the fuel tank cap

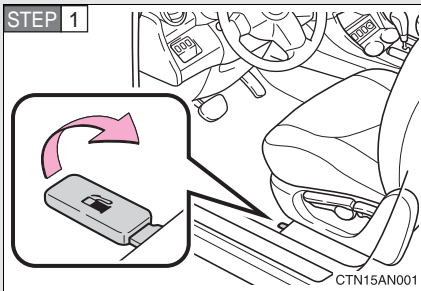

Pull up the fuel filler door opener.

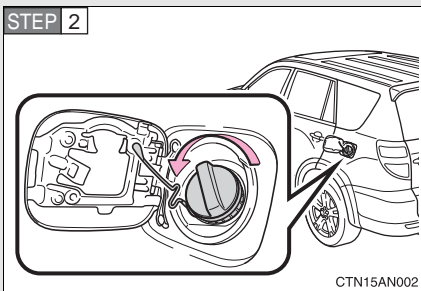

Turn the fuel tank cap slowly to open.

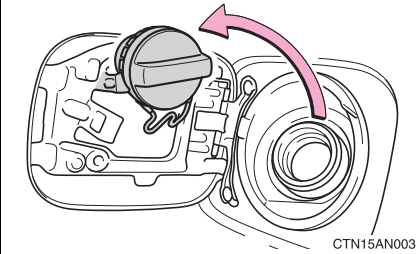
**STEP 3**

Hang the fuel tank cap on the back of the fuel filler door.

### Closing the fuel tank cap

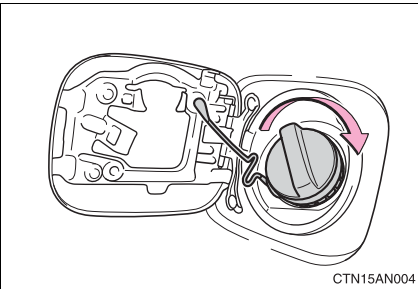

When replacing the fuel tank cap, turn it until a clicking sound is heard.

After releasing your hand, the cap will turn slightly to the opposite direction.

#### ■ Fuel types

Use unleaded gasoline. (Octane rating 87 [Research Octane Number 91] or higher)

#### ■ Fuel tank capacity

Approximately 15.9 gal. (60 L, 13.2 Imp. gal.)

 **CAUTION**

■ **Refueling the vehicle**

Observe the following precautions while refueling the vehicle.  
Failure to do so may result in death or serious injury.

- Touch the vehicle or some other metal surface to discharge any static electricity.  
Sparks resulting from discharging static electricity may cause the fuel vapors to ignite.
- Always hold the grips on the fuel tank cap and turn it slowly to remove it.  
A whooshing sound may be heard when the fuel tank cap is loosened.  
Wait until the sound cannot be heard before fully removing the cap.  
In hot weather, pressurized fuel may spray out of the filler neck and cause injury.
- Do not allow anyone that has not discharged static electricity from their bodies to come close to an open fuel tank.
- Do not inhale vaporized fuel.  
Fuel contains substances that are harmful if inhaled.
- Do not smoke while refueling the vehicle.  
Doing so may cause the fuel to ignite and cause a fire.
- Do not return to the vehicle or touch any person or object that is statically charged.  
This may cause static electricity to build up, resulting in a possible ignition hazard.

■ **When replacing the fuel cap**

Do not use anything but a genuine Toyota fuel tank cap designed for your vehicle. Doing so may cause a fire or other incident which may result in death or serious injury.

 NOTICE**■ Refueling**

Do not spill fuel during refueling.

Doing so may damage the vehicle, such as causing the exhaust systems to operate abnormally or damaging fuel system components or the vehicle's painted surface.

## 1-6. Theft deterrent system Engine immobilizer system

The vehicle's keys have built-in transponder chips that prevent the engine from starting if the key has not been previously registered in the vehicle's on-board computer.

**Never leave the keys inside the vehicle when you leave the vehicle.**

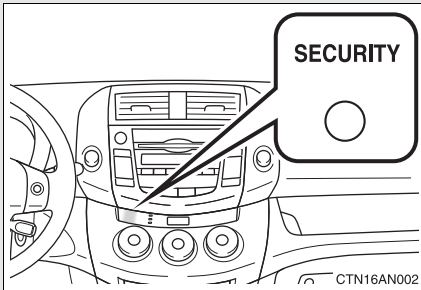

Vehicles without smart key system: The indicator light flashes after the key has been removed from the engine switch to indicate that the system is operating.

The indicator light stops flashing after the registered key has been inserted into the engine switch to indicate that the system has been canceled.

Vehicles with smart key system: The indicator light flashes after the “ENGINE START STOP” switch has been turned OFF to indicate that the system is operating.

The indicator light stops flashing after the “ENGINE START STOP” switch has been turned to ACCESSORY or IGNITION ON mode to indicate that the system has been canceled.

**■ System maintenance**

The vehicle has a maintenance-free type engine immobilizer system.

**■ Conditions that may cause the system to malfunction**

- If the key is in contact with a metallic object
- If the key is in close proximity to or touching a key to the security system (key with a built-in transponder chip) of another vehicle

**■ Certifications for the engine immobilizer system**

- For vehicles sold in the U.S.A.
- ▶ Vehicles without smart key system

FCC ID: MOZRI-20BTY

FCC ID: MOZRI-21BTY

- ▶ Vehicles with smart key system

FCC ID: NI4TMIMB-1

This device complies with Part 15 of the FCC Rules. Operation is subject to the following two conditions: (1) this device may not cause harmful interference, and (2) this device must accept any interference received, including interference that may cause undesired operation.

**FCC WARNING:**

Changes or modifications not expressly approved by the party responsible for compliance could void the user's authority to operate the equipment.

- For vehicles sold in Canada

This device complied with RSS-210 of Industry Canada.

Operation is subject to the following two conditions: (1) this device may not cause interference, and (2) this device must accept any interference, including interference that may cause undesired operation of the device.





**NOTICE**

■ **To ensure the system operates correctly**

Do not modify or remove the system. If modified or removed, the proper operation of the system cannot be guaranteed.

1-6. Theft deterrent system

Theft prevention labels (U.S.A.)

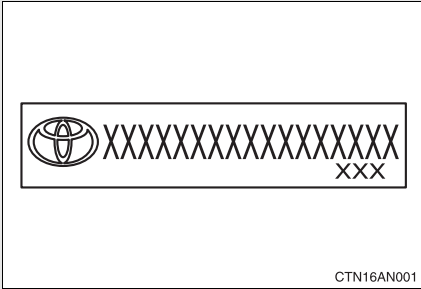

These labels are attached to the vehicle to reduce vehicle theft by facilitating the tracing and recovery of parts from stolen vehicles. Do not remove under penalty of law.

## Correct driving posture

Drive in a good posture as follows:

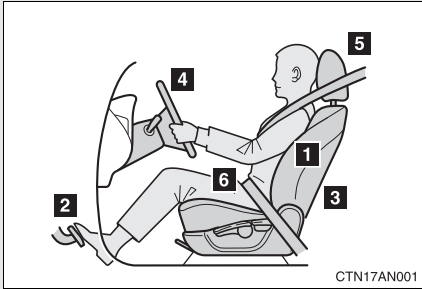

- 1** Sit upright and well back in the seat. (→P. 49)
- 2** Adjust the position of the seat forward or backward to ensure the pedals can be reached and easily depressed to the extent required. (→P. 49)
- 3** Adjust the seatback so that the controls are easily operable.
- 4** Adjust the tilt and telescopic positions of the steering wheel downward so the air-bag is facing your chest. (→P. 76)
- 5** Lock the head restraint in place with the center of the head restraint closest to the top of your ears. (→P. 65)
- 6** Wear the seat belt correctly. (→P. 68)

 **CAUTION****■ While driving**

- Do not adjust the position of the driver's seat while driving. Doing so could cause the driver to lose control of the vehicle.
- Do not place a cushion between the driver or passenger and the seatback. A cushion may prevent correct posture from being achieved, and reduce the effectiveness of the seat belt and head restraint, increasing the risk of death or serious injury to the driver or passenger.
- Do not place anything under the front seats. Objects placed under the front seats may become jammed in the seat tracks and stop the seat from locking in place. This may lead to an accident. The adjustment mechanism may also be damaged.

**■ Adjusting the seat position**

- Take care when adjusting the seat position to ensure that other passengers are not injured by the moving seat.
- Do not put your hands under the seat or near the moving parts to avoid injury. Fingers or hands may become jammed in the seat mechanism.

## 1-7. Safety information

### SRS airbags

The SRS airbags inflate when the vehicle is subjected to certain types of severe impacts that may cause significant injury to the occupants. They work together with the seat belts to help reduce the risk of death or serious injury.

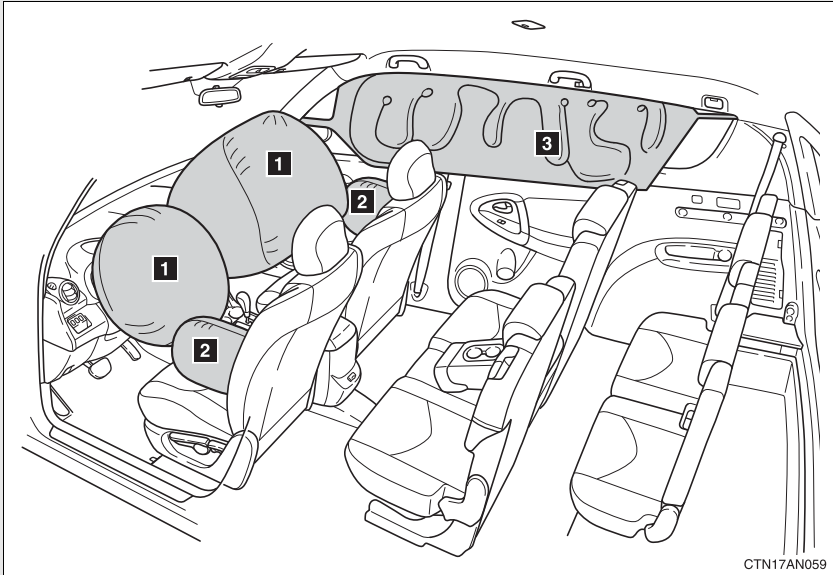

#### ► Front airbags

##### **1** Driver airbag/front passenger airbag

Can help protect the head and chest of the driver and front passenger from impact with interior components.

#### ► Side and curtain shield airbags

##### **2** Side airbags

Can help protect the torso of the front seat occupants.

##### **3** Curtain shield airbags

Can help protect primarily the head of occupants in the outer seats.

## Airbag system components

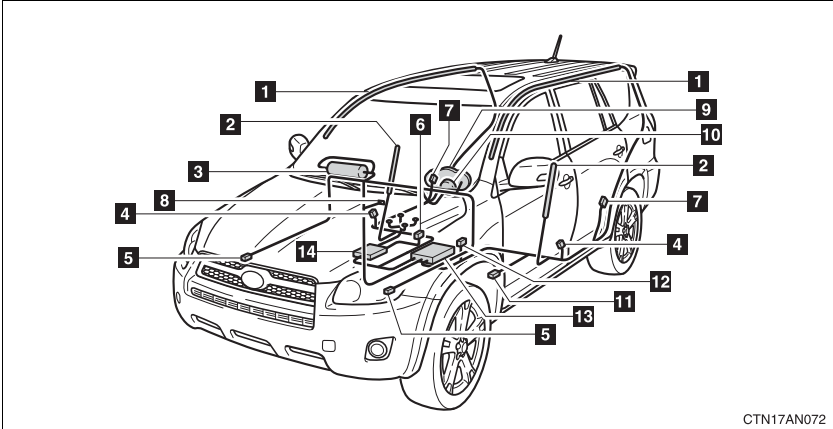

CTN17AN072

- |  |  |
|--|--|
| <b>1</b> Curtain shield airbags                          | <b>9</b> SRS warning light   |
| <b>2</b> Side airbags                                    | <b>10</b> Driver airbag  |
| <b>3</b> Front passenger airbag                          | <b>11</b> Driver's seat position sensor                                    |
| <b>4</b> Side and curtain shield airbag sensors          | <b>12</b> Driver's seat belt buckle switch                                 |
| <b>5</b> Front airbag sensors                            | <b>13</b> Airbag sensor assembly   |
| <b>6</b> Front passenger's seat belt buckle switch       | <b>14</b> Front passenger occupant classification system (ECU and sensors) |
| <b>7</b> Curtain shield airbag sensors                   |  |
| <b>8</b> "AIR BAG ON" and "AIR BAG OFF" indicator lights |  |

Your vehicle is equipped with ADVANCED AIRBAGS designed based on US motor vehicle safety standards (FMVSS208). The airbag system controls airbag deployment power for the driver and front passenger. The driver airbag system consists of the driver seat's position sensor etc. The front passenger's airbag system consists of the front passenger occupant classification sensor etc.

The main SRS airbag system components are shown above. The SRS airbag system is controlled by the airbag sensor assembly. The airbag sensor assembly consists of a safing sensor and an airbag sensor.

In certain types of severe frontal or side impacts, the SRS airbag system triggers the airbag inflators. A chemical reaction in the inflators quickly fills the airbags with non-toxic gas to help restrain the motion of the occupants.

---

### ■ SRS warning light

This warning light system monitors the airbag sensor assembly, front airbag sensors, side and curtain shield airbag sensors, curtain shield airbag sensors, driver's seat position sensor, driver's seat belt buckle switch, front passenger occupant classification system, "AIR BAG ON" and "AIR BAG OFF" indicator lights, front passenger's seat belt buckle switch, seat belt pretensioner assemblies, inflators, interconnecting wiring and power sources. (→P. 427)

### ■ If the SRS airbags deploy (inflate)

- Bruising and slight abrasions may result from contact with a deploying (inflating) SRS airbag.
- A loud noise and white powder will be emitted.
- Parts of the airbag module (steering wheel hub, airbag cover and inflator) as well as the front seats, and parts of the front and rear pillars and roof side rail, may be hot for several minutes. The airbag itself may also be hot.
- The windshield may crack.

## ■ SRS airbag deployment conditions

### ► Front airbags

- The SRS front airbags will deploy in the event of an impact that exceeds the set threshold level (the level of force corresponding to an approximately 12 - 18 mph [20 - 30 km/h] frontal collision with a fixed wall that does not move or deform).

However, this threshold velocity will be considerably higher if the vehicle strikes an object, such as a parked vehicle or sign pole, which can move or deform on impact, or if the vehicle is involved in an underride collision (e.g. a collision in which the front of the vehicle “underrides”, or goes under, the bed of a truck, etc.).

- It is possible that in some collisions where the forward deceleration of the vehicle is very close to the designed threshold level, the SRS front airbags and the seat belt pretensioners may not activate together.
- The SRS front passenger airbag will not activate if there is no passenger sitting in the front passenger seat. However, the front passenger airbag may deploy if luggage is put in the seat, or the seat belt is fastened, even if the seat is unoccupied. (→P. 110)

### ► Side airbags and curtain shield airbags

- The SRS side airbags and SRS curtain shield airbags will deploy in the event of an impact that exceeds the set threshold level (the level of force corresponding to the impact force produced by an approximately 3300 lb. [1500 kg] vehicle colliding with the vehicle cabin from a direction perpendicular to the vehicle orientation at an approximately speed of 12 - 18 mph [20 - 30 km/h]) or vehicle rollover.
- The SRS side airbag on the passenger seat will not activate if there is no passenger sitting in the front passenger seat. However, the side airbag on the passenger seat may deploy if luggage is put in the seat, or the seat belt is fastened, even if the seat is unoccupied. (→P. 110)
- The SRS curtain shield airbags are designed to inflate when the passenger compartment is subjected to a severe impact from the side or vehicle rollover.



■ **Conditions under which the SRS airbags may deploy (inflate), other than a collision**

The SRS front airbags may also deploy if a serious impact occurs to the underside of your vehicle. Some examples are shown in the illustration.

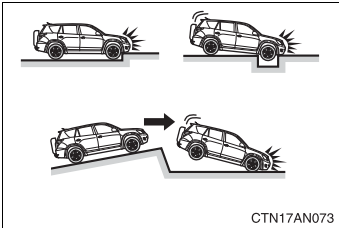

- Hitting a curb, edge of pavement or hard surface
- Falling into or jumping over a deep hole
- Landing hard or vehicle falling

The SRS curtain shield airbags may also deploy under the situation shown in the illustration.

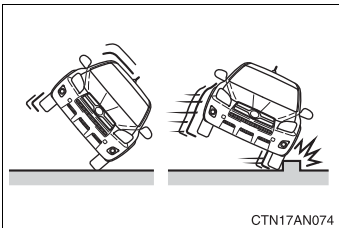

- The angle of vehicle tip-up is marginal.
- The vehicle skids and hits a curb stone.

■ **Types of collisions that may not deploy the SRS front airbags**

The SRS front airbags are generally not designed to inflate if the vehicle is involved in a side or rear collision, if it rolls over, or if it is involved in a low-speed frontal collision. But, whenever a collision of any type causes sufficient forward deceleration of the vehicle, deployment of the SRS front airbags may occur.

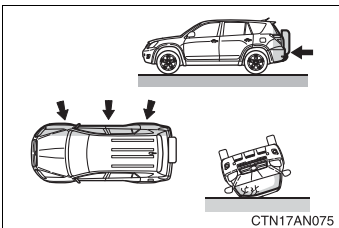

- Collision from the side
- Collision from the rear
- Vehicle rollover

## ■ Types of collisions that may not deploy the SRS side airbags and curtain shield airbags

The SRS side airbag and curtain shield airbag system may not activate if the vehicle is subjected to a collision from the side at certain angles, or a collision to the side of the vehicle body other than the passenger compartment.

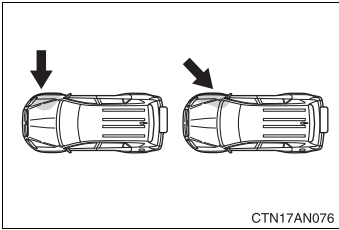

- Collision from the side to the vehicle body other than the passenger compartment
- Collision from the side at an angle

The SRS side airbags are not generally designed to inflate if the vehicle is involved in a frontal or rear collision, if it rolls over, or if it is involved in a low-speed side collision.

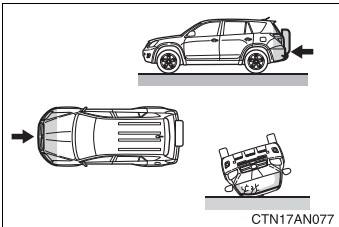

- Collision from the front
- Collision from the rear
- Vehicle rollover

The SRS curtain shield airbags are not generally designed to inflate if the vehicle is involved in a frontal or rear collision, if it pitches end over end, or if it is involved in a low-speed side collision.

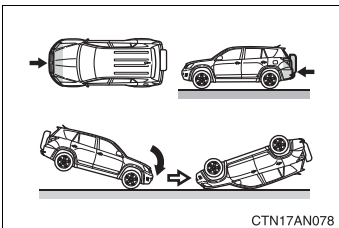

- Collision from the front
- Collision from the rear
- Pitching end over end

### ■ When to contact your Toyota dealer

In the following cases, contact your Toyota dealer as soon as possible.

- Any of the SRS airbags have been inflated.

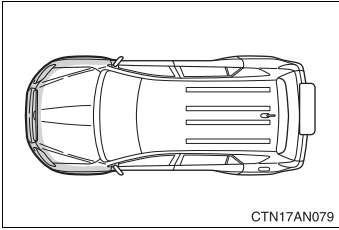

- The front of the vehicle is damaged or deformed, or was involved in an accident that was not severe enough to cause the SRS airbags to inflate.

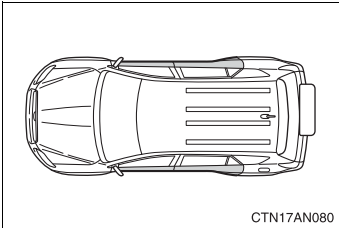

- A portion of a door is damaged or deformed, or the vehicle was involved in an accident that was not severe enough to cause the SRS side airbags and curtain shield airbags to inflate.

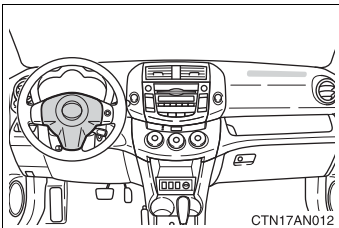

- The pad section of the steering wheel or dashboard is scratched, cracked, or otherwise damaged.

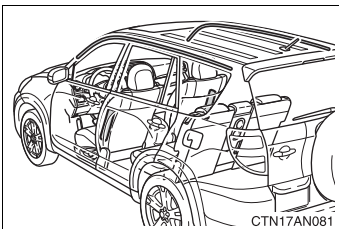

- The surface of the seats with the side airbag is scratched, cracked or otherwise damaged.
- The portion of the front pillars, rear pillars or roof side rail garnishes (padding) containing the curtain shield airbags inside is scratched, cracked or otherwise damaged.

 **CAUTION**
**■ SRS airbag precautions**

Observe the following precautions regarding the airbags.  
Failure to do so may cause death or serious injury.

- The driver and all passengers in the vehicle must wear their seat belts properly.

The SRS airbags are supplemental devices to be used with the seat belts.

- The SRS driver airbag deploys with considerable force, and can cause death or serious injury especially if the driver is very close to the airbag. The National Highway Traffic Safety Administration (“NHTSA”) advises:

Since the risk zone for the driver’s airbag is the first 2 - 3 in. (50 - 75 mm) of inflation, placing yourself 10 in. (250 mm) from your driver airbag provides you with a clear margin of safety. This distance is measured from the center of the steering wheel to your breastbone. If you sit less than 10 in. (250 mm) away now, you can change your driving position in several ways:

- Move your seat to the rear as far as you can while still reaching the pedals comfortably.
- Slightly recline the back of the seat.

Although vehicle designs vary, many drivers can achieve the 10 in. (250 mm) distance, even with the driver seat all the way forward, simply by reclining the back of the seat somewhat. If reclining the back of your seat makes it hard to see the road, raise yourself by using a firm, non-slippery cushion, or raise the seat if your vehicle has that feature.

- If your steering wheel is adjustable, tilt it downward. This points the airbag toward your chest instead of your head and neck.

The seat should be adjusted as recommended by NHTSA above, while still maintaining control of the foot pedals, steering wheel, and your view of the instrument panel controls.

**! CAUTION**

**■ SRS airbag precautions**

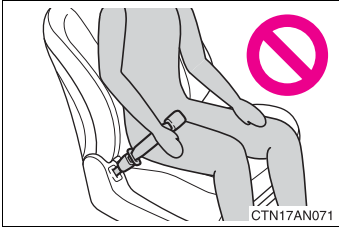

- If the seat belt extender has been connected to the driver's seat belt buckle but the seat belt extender has not also been fastened to the latch plate of the driver's seat belt, the SRS driver's airbag system will judge that the driver is wearing the seat belt even though the seat belt has not been connected. In this case, the driver's airbag may not activate correctly in a collision, resulting in death or serious injury in the event of collision. Be sure to wear the seat belt with the seat belt extender.
- The SRS front passenger airbag also deploys with considerable force, and can cause death or serious injury especially if the front passenger is very close to the airbag. The front passenger seat should be as far from the airbag as possible with the seatback adjusted, so the front passenger sits upright.
- Improperly seated and/or restrained infants and children can be killed or seriously injured by a deploying airbag. An infant or child who is too small to use a seat belt should be properly secured using a child restraint system. Toyota strongly recommends that all infants and children be placed in the rear seats of the vehicle and properly restrained. The rear seats are the safest for infants and children. (→P. 116)

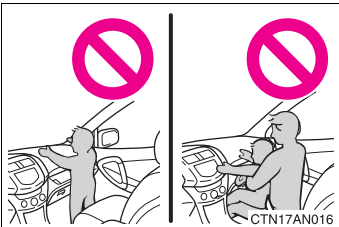
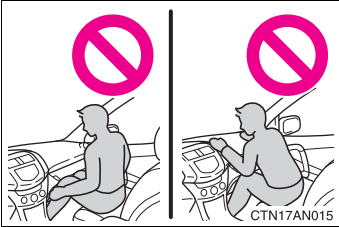
**! CAUTION****■ SRS airbag precautions**

- Do not sit on the edge of the seat or lean against the dashboard.
- Do not allow a child to stand in front of the SRS front passenger airbag unit or sit on the knees of a front passenger.
- Do not drive the vehicle while the driver or passenger has items resting on their knees.
- Do not lean against the door, the roof side rail or the front, side and rear pillars.
- Do not allow anyone to kneel on the passenger seat toward the door or put their head or hands outside the vehicle.

**! CAUTION**

**■ SRS airbag precautions**

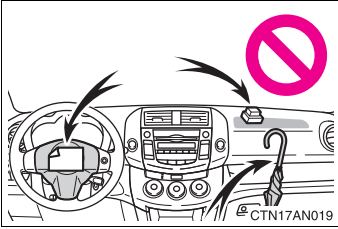

- Do not attach anything to or lean anything against areas such as the dashboard or steering wheel pad. These items can become projectiles when SRS driver and front passenger airbags deploy.

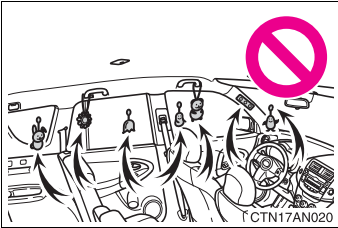

- Do not attach anything to areas such as the door, windshield glass, side door glass, front and rear pillars or roof side rail garnish.
- Do not hang coat hangers or other hard objects on the coat hooks. All of these items could become projectiles and seriously injure or kill you, should the SRS curtain shield airbag deploy.

- Do not use seat accessories which cover the parts where the SRS side airbags inflate as they may interfere with inflation of the airbags.
- Do not strike or apply significant levels of force to the area of the SRS airbag components (→P. 99). Doing so can cause the SRS airbags to malfunction.

 **CAUTION****■ SRS airbag precautions**

- Do not touch any of the component parts immediately after the SRS airbags have deployed (inflated) as they may be hot.
- If breathing becomes difficult after the SRS airbag has deployed, open a door or window to allow fresh air in, or leave the vehicle if it is safe to do so. Wash off any residue as soon as possible to prevent skin irritation.
- If the areas where the SRS airbags are stored, such as the steering wheel pad and front and rear pillar garnishes, are damaged or cracked, have them replaced by your Toyota dealer.

**■ Modification and disposal of SRS airbag system components**

Do not dispose of your vehicle or perform any of the following modifications without consulting your Toyota dealer.

The SRS airbags may malfunction or deploy (inflate) accidentally, causing death or serious injury.

- Installation, removal, disassembly and repair of the SRS airbags.
- Repairs, modifications, removal or replacement of the steering wheel, instrument panel, dashboard, seats or seat upholstery, front, side and rear pillars or roof side rail.
- Repairs or modifications of the front fender, front bumper, or side of the occupant compartment.
- Installation of snow plows, winches, etc. to the front grille (bull bars, kangaroo bar etc.).
- Modifications to the vehicle's suspension system.
- Installation of electronic devices such as mobile two-way radios or CD players.
- Modifications to your vehicle for a person with a physical disability.



## Front passenger occupant classification system

Your vehicle is equipped with a front passenger occupant classification system. This system detects the conditions of the front passenger seat and activates or deactivates the devices for front passenger.

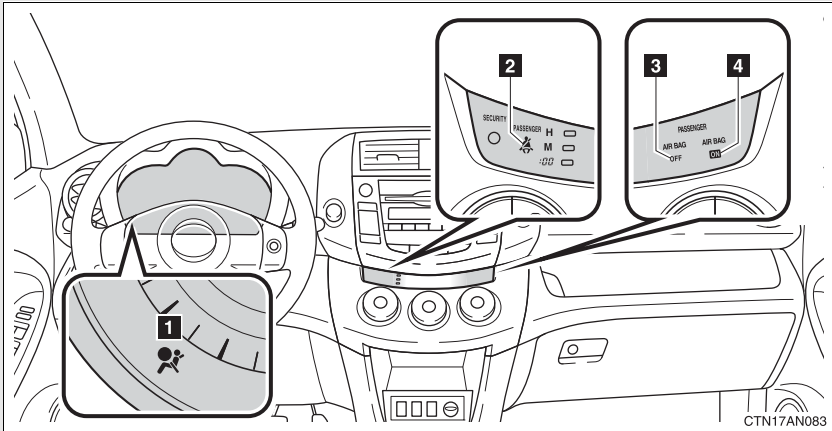

- 1 SRS warning light
- 2 Front passenger's seat belt reminder light
- 3 "AIR BAG OFF" indicator light
- 4 "AIR BAG ON" indicator light

## Conditions and operation of the front passenger occupant classification system

### ■ Adult\*<sup>1</sup>

Indicator/ warning light	“AIR BAG ON” and “AIR BAG OFF” indicator lights	“AIR BAG ON”
	SRS warning light	Off
	Front passenger's seat belt reminder light	Flashing* <sup>2</sup>
Devices	Front passenger airbag	Activated
	Side airbag on the front passenger seat	
	Curtain shield airbag in the front passenger side	
	Front passenger's seat belt pretensioner	

### ■ Child\*<sup>3</sup> or child restraint system\*<sup>4</sup>

Indicator/ warning light	“AIR BAG ON” and “AIR BAG OFF” indicator lights	“AIR BAG OFF”* <sup>5</sup>
	SRS warning light	Off
	Front passenger's seat belt reminder light	Flashing* <sup>2</sup>
Devices	Front passenger airbag	Deactivated
	Side airbag on the front passenger seat	
	Curtain shield airbag in the front passenger side	Activated
	Front passenger's seat belt pretensioner	

## ■ Unoccupied

Indicator/ warning light	“AIR BAG ON” and “AIR BAG OFF” indicator lights	Not illuminated
	SRS warning light	Off
	Front passenger's seat belt reminder light	
Devices	Front passenger airbag	Deactivated
	Side airbag on the front passenger seat	
	Curtain shield airbag in the front passenger side	Activated
	Front passenger's seat belt pretensioner	Deactivated

## ■ There is a malfunction in the system

Indicator/ warning light	“AIR BAG ON” and “AIR BAG OFF” indicator lights	“AIR BAG OFF”
	SRS warning light	On
	Front passenger's seat belt reminder light	Off
Devices	Front passenger airbag	Deactivated
	Side airbag on the front passenger seat	
	Curtain shield airbag in the front passenger side	Activated
	Front passenger's seat belt pretensioner	

- \*1: The system judges a person of adult size as an adult. When a smaller adult sits in the front passenger seat, the system may recognize him/her as a child depending on his/her physique and posture.
- \*2: In the event the front passenger does not wear a seat belt.
- \*3: When a larger child who has outgrown a child restraint system sits in the front passenger seat, the system may recognize him/her as an adult depending on his/her physique or posture.

- \*4: Never install a rear-facing child restraint system on the front passenger seat. A forward-facing child restraint system should only be installed on the front passenger seat when it is unavoidable. (→P. 117)
- \*5: In case the indicator is not illuminated, consult this manual as for installing the child restraint system properly. (→P. 120)

 CAUTION

**■ Front passenger occupant classification system precautions**

Observe the following precautions regarding front passenger occupant classification system.

Failure to do so may cause death or serious injury.

- Wear the seat belt properly.
- Make sure the front passenger's seat belt tab has not been left inserted into the buckle before someone sits in the front passenger seat.
- Make sure the "AIR BAG OFF" indicator light is not illuminated when using the seat belt extender for the front passenger seat. If the "AIR BAG OFF" indicator light is illuminated, disconnect the extender tongue from the seat belt buckle, then reconnect the seat belt. Reconnect the seat belt extender after making sure the "AIR BAG ON" indicator light is illuminated. If you use the seat belt extender while the "AIR BAG OFF" indicator light is illuminated, the front passenger airbag, side airbag on the front passenger side may not activate correctly, which could cause death or serious injury in the event of collision.
- Do not apply a heavy load to the front passenger seat or equipment (e.g. seatback pocket).
- Do not put weight on the front passenger seat by putting your hands or feet on the front passenger seat seatback from the second seat.
- Do not let a passenger in the second seat lift the front passenger seat with their feet or press on the seatback with their legs.
- Do not put objects under the front passenger seat.
- Do not recline the front passenger seatback so far that it touches a second seat. This may cause the "AIR BAG OFF" indicator light to be illuminated, which indicates that the passenger's airbags will not deploy in the event of a severe accident. If the seatback touches the second seat, return the seatback to a position where it does not touch the second seat. Keep the front passenger seatback as upright as possible when the vehicle is moving. Reclining the seatback excessively may lessen the effectiveness of the seat belt system.

 CAUTION**■ Front passenger occupant classification system precautions**

- If an adult sits in the front passenger seat, the “AIR BAG ON” indicator light is illuminated. If the “AIR BAG OFF” indicator is illuminated, ask the passenger to sit up straight, well back in the seat, feet on the floor, and with the seat belt worn correctly. If the “AIR BAG OFF” indicator still remains illuminated, either ask the passenger to move to the second seat, or if that is not possible, move the front passenger seat fully rearward.
- When it is unavoidable to install the forward-facing child restraint system on the front passenger seat, install the child restraint system on the front passenger seat in the proper order. (→P. 120)
- Do not modify or remove the front seats.
- Do not kick the front passenger seat or subject it to severe impact. Otherwise, the SRS warning light may come on to indicate a malfunction of the detection system. In this case, contact your Toyota dealer immediately.
- Child restraint systems installed on the second seat should not contact the front seatbacks.
- Do not use a seat accessory, such as a cushion or seat cover, that covers the seat cushion surface.
- Do not modify or replace the upholstery of the front seat.

## Child restraint systems

**A child restraint system for a small child or baby must itself be properly restrained on the seat with the lap portion of the lap/shoulder belt.**

**The laws of all 50 states of the U.S.A. and Canada now require the use of child restraint systems.**

### Points to remember

Studies have shown that installing a child restraint on a rear seat is much safer than installing one to the front passenger seat.

- Choose a child restraint system that suits your vehicle and is appropriate to the age and size of the child.
- For installation details, follow the instructions provided with the child restraint system.

General installation instructions are provided in this manual.

(→P. 120)

## Types of child restraint

Child restraint systems are classified into the following 3 types according to the age and size of the child.

▶ Rear facing — Infant seat/convertible seat

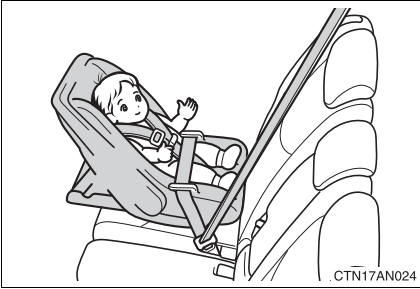

▶ Forward facing — Convertible seat

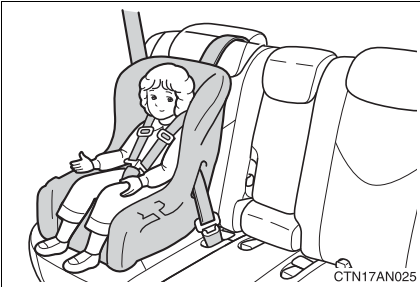

▶ Booster seat

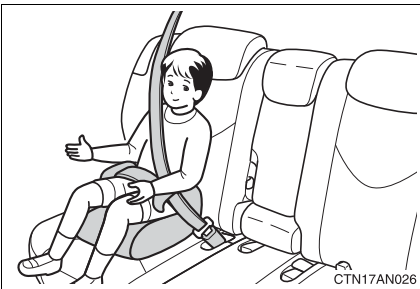



### ■ Selecting an appropriate child restraint system

- Use a child restraint system appropriate for the child until the child becomes large enough to properly wear the vehicle's seat belt.
- If a child is too large for a child restraint system, sit the child on a rear seat and use the vehicle's seat belt. (→P. 68)

### CAUTION

#### ■ Child restraint precautions

- For effective protection in automobile accidents and sudden stops, a child must be properly restrained, using a seat belt or child restraint system depending on the age and size of the child. Holding a child in your arms is not a substitute for a child restraint system. In an accident, the child can be crushed against the windshield, or between you and the vehicle's interior.
- Toyota strongly urges the use of a proper child restraint system that conforms to the size of the child, installed on the rear seat. According to accident statistics, the child is safer when properly restrained in the rear seat than in the front seat.
- Never install a rear-facing child restraint system on the front passenger seat even if "AIR BAG OFF" indicator light is illuminated. In the event of an accident, the force of the rapid inflation of the front passenger airbag can cause death or serious injury to the child if the rear-facing child restraint system is installed on the front passenger seat.
- A forward-facing child restraint system may be installed on the front passenger seat only when it is unavoidable. A child restraint system that requires a top tether strap should not be used in the front passenger seat since there is no top tether strap anchor for the front passenger seat. Adjust the seatback as upright as possible and always move the seat as far back as possible even if the "AIR BAG OFF" indicator light is illuminated, because the front passenger airbag could inflate with considerable speed and force. Otherwise, the child may be killed or seriously injured.

 **CAUTION****■ Child restraint precautions**

- Do not use the seat belt extender when installing a child restraint system on the front or rear passenger seat. If installing a child restraint system with the seat belt extender connected to the seat belt, the seat belt will not securely hold the child restraint system, which could cause death or serious injury to the child or other passengers in the event of a sudden stop, sudden swerve or accident.
- Do not allow the child to lean his/her head or any part of his/her body against the door or the area of the seat, front and rear pillars or roof side rail from which the side airbags or curtain shield airbags deploy even if the child is seated in the child restraint system. It is dangerous if the side airbags and curtain shield airbags inflate, and the impact could cause death or serious injury to the child.
- Make sure you have complied with all installation instructions provided by the child restraint manufacturer and that the system is properly secured. If it is not secured properly, it may cause death or serious injury to the child in the event of a sudden stop, sudden swerve or an accident.

**■ Child restraint lock function belt precaution**

Do not allow children to play with the child restraint lock function belt. If the belt becomes twisted around a child's neck, it will not be possible to pull the belt out leading to choking or other serious injuries that could result in death. If this occurs and the buckle cannot be unfastened, scissors should be used to cut the belt.

**■ When the child restraint system is not in use**

- Keep the child restraint system properly secured on the seat even if it is not in use.  
Do not store the restraint unsecured in the passenger compartment.
- If it is necessary to detach the child restraint system, remove it from the vehicle or store it securely in the luggage compartment. This will prevent it from injuring passengers in the event of a sudden stop, sudden swerve or accident.

## Installing child restraints

**Follow the child restraint system manufacturer's instructions. Firmly secure child restraints to the outside rear seats using the LATCH anchors or a seat belt. Attach the top tether strap when installing a child restraint.**

**The lap/shoulder belt can be used if your child restraint system is not compatible with the LATCH (Lower Anchors and Tethers for Children) system.**

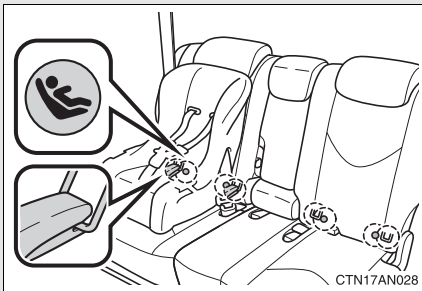

**Second outside seats: Child restraint LATCH anchors**

LATCH anchors are provided for the rear outside seats. (Buttons displaying the location of the anchors are attached to the seats.)

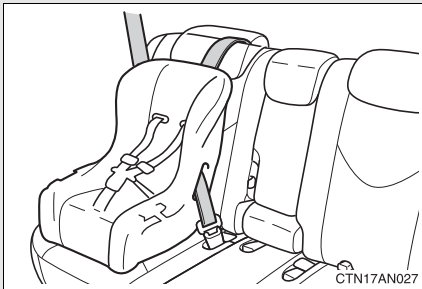

**Seat belts equipped with a child restraint locking mechanism (ALR/ELR belts except driver's seat belt)**

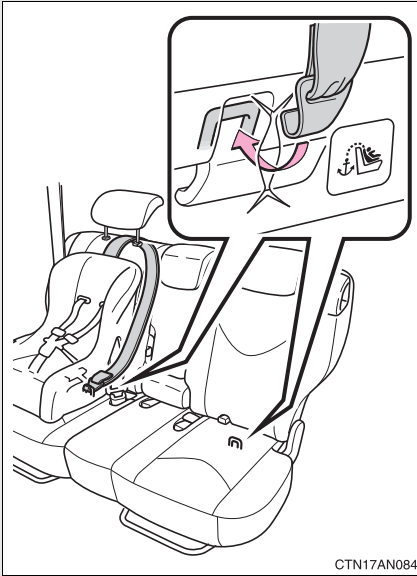

**Second outside seats: Anchor brackets (for top tether strap)**

Anchor brackets are provided for the second outside seats.

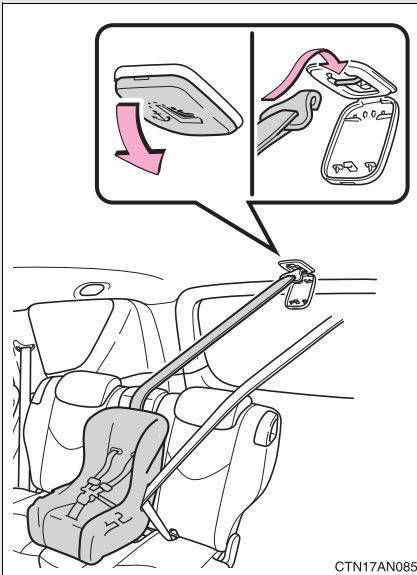

**Second center seat: Anchor brackets (for top tether strap)**

An anchor bracket is provided for the second center seat.

**Installation with LATCH system (second outside seats only)**

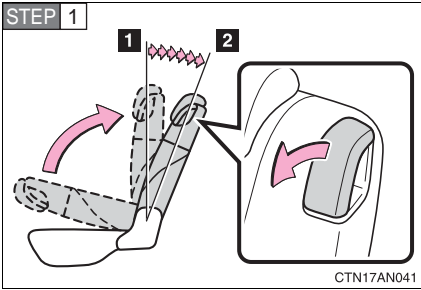

Fold the seatback while pulling the lever. Return the seatback and secure it at the 1st lock position (most upright position). Adjust the seatback to the 7th lock position. (→P. 54)

**1** 1st lock position

**2** 7th lock position

► Type A

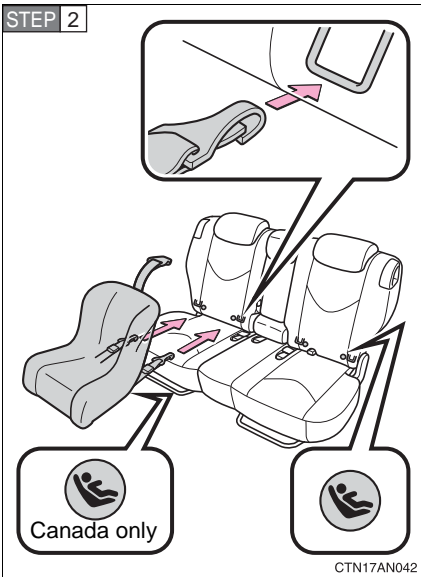

Latch the hooks of the lower straps onto the LATCH anchors.

The bars are installed in the clearance between the seat cushion and seatback.

If the child restraint has a top tether strap, the top tether strap should be latched onto the top tether strap anchor.

For owners in Canada:

The symbol on a child restraint system indicates the presence of a lower connector system.

## ► Type B

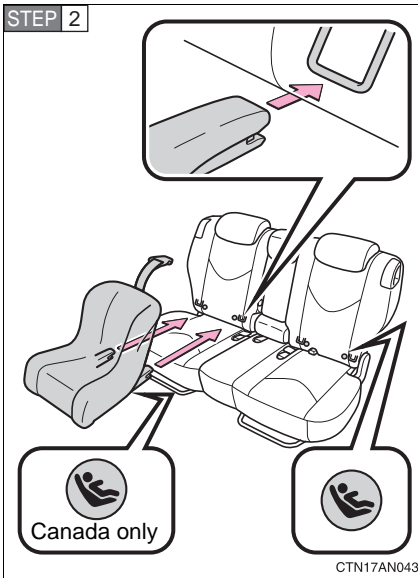

Latch the buckles onto the LATCH anchors.

The bars are installed in the clearance between the seat cushion and seatback.

If the child restraint has a top tether strap, the top tether strap should be latched onto the top tether strap anchor.

For owners in Canada:

The symbol on a child restraint system indicates the presence of a lower connector system.

1

Before driving

**Installing child restraints using a seat belt (child restraint lock function belt)**

**■ Rear facing — Infant seat/convertible seat**

STEP 1

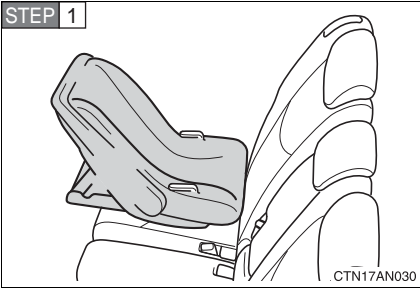

Place the child seat on the rear seat facing the rear of the vehicle.

STEP 2

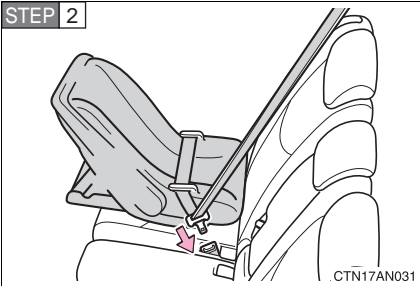

Run the seat belt through the child seat and insert the plate into the buckle. Make sure that the belt is not twisted.

STEP 3

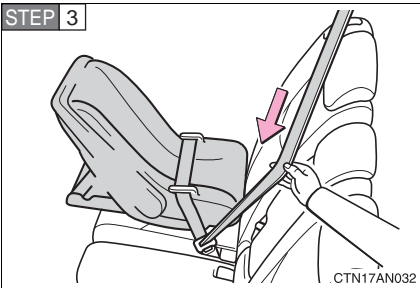

Fully extend the shoulder belt and then allow it to retract slightly in order to activate the ALR lock mode.

Lock mode allows the seat belt to retract only.

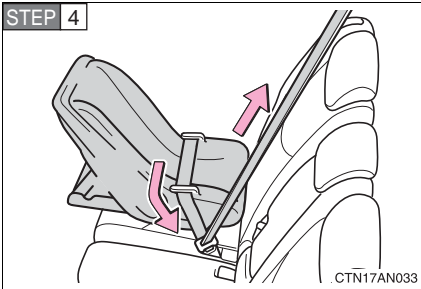

While pushing the child seat down into the rear seat, allow the shoulder belt to retract until the child seat is securely in place.

After the shoulder belt has retracted to a point where there is no slack in the belt, pull the belt to check that it cannot be extended.

### ■ Forward facing — Convertible seat

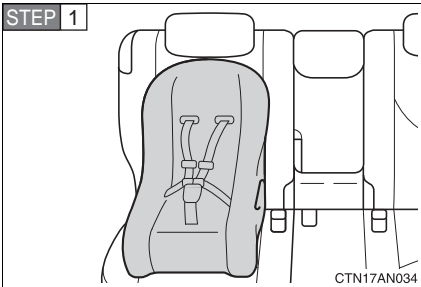

Place the child seat on the seat facing the front of the vehicle.

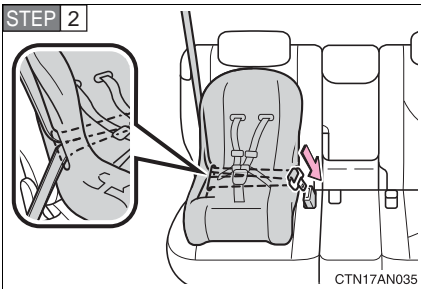

Run the seat belt through the child seat and insert the plate into the buckle. Make sure that the belt is not twisted.

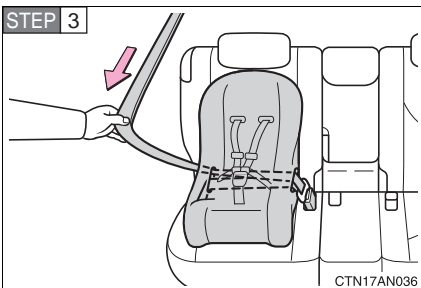

Fully extend the shoulder strap and then allow it to retract slightly into the ALR lock mode.

Lock mode allows the seat belt to retract only.



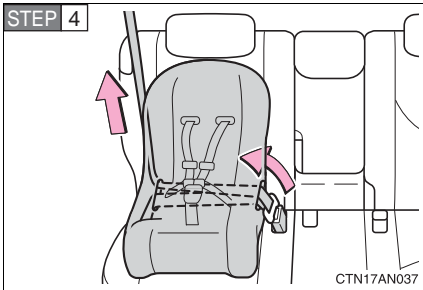

While pushing the child seat into the rear seat, allow the shoulder belt to retract until the child seat is securely in place.

After the shoulder belt has retracted to a point where there is no slack in the belt, pull the belt to check that it cannot be extended.

**STEP 5** If the child restraint has a top tether strap, the top tether strap should be latched onto the top tether strap anchor. (→P. 127)

### ■ Booster seat

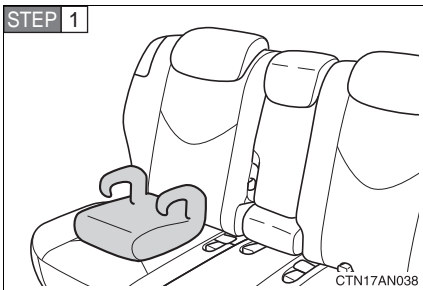

Place the booster seat on the seat facing the front of the vehicle.

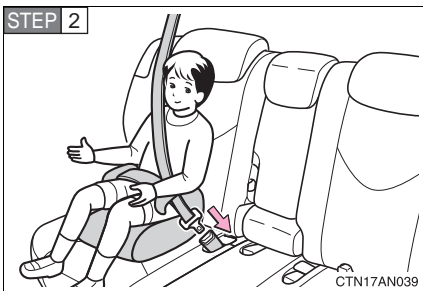

Sit the child in the booster seat. Fit the seat belt to the booster seat according to the manufacturer's instructions and insert the plate into the buckle. Make sure that the belt is not twisted.

Check that the shoulder belt is correctly positioned over the child's shoulder, and that the lap belt is as low as possible.

(→P. 68)

## Removing a child restraint installed with a seat belt

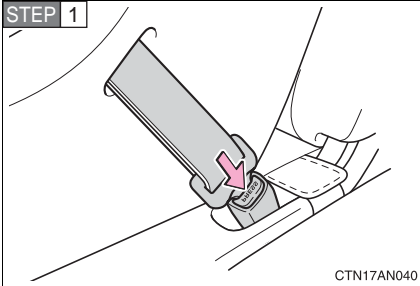

Push the buckle release button and fully retract the seat belt.

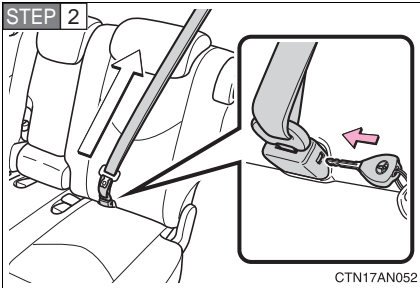

Second center seat: Release the center seat belt as shown in the illustration after removing the child restraint.

## Child restraint systems with a top tether strap (second seats only)

### ■ Outside seats

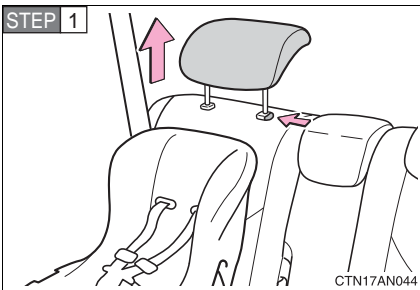

Remove the head restraint.

## 1-7. Safety information

STEP 2

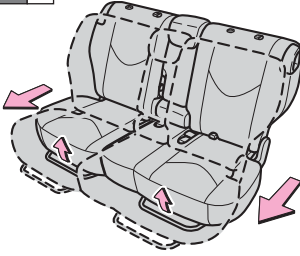

CTN17AN056

Slide the seats forward slightly if it is in the rear-most position.

STEP 3 Front of vehicle

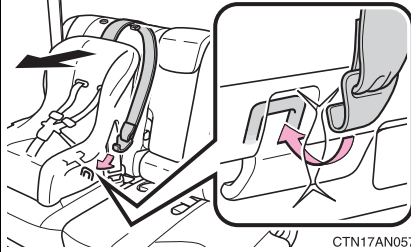

CTN17AN057

Secure the child restraint using the seat belt. Latch the hook onto the anchor bracket and tighten the top tether strap.

Make sure the top tether strap is securely latched.

STEP 4

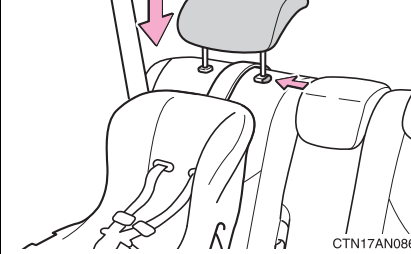

CTN17AN086

Replace the head restraint.

STEP 5

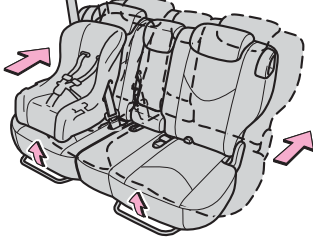

CTN17AN082

Move the seats to the rear-most lock position.

## ■ Center seat

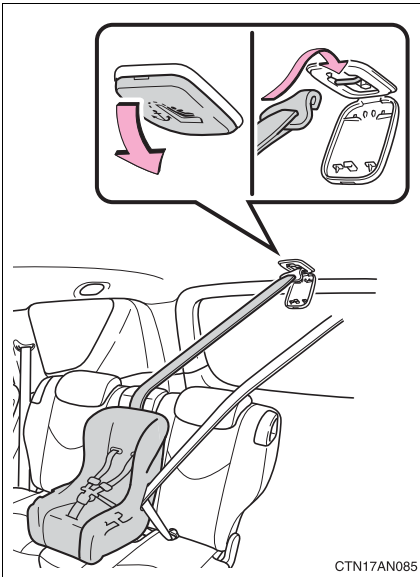

Open the anchor bracket cover. Secure the child restraint using the seat belt. Latch the hook onto the anchor bracket and tighten the top tether strap.

Make sure the top tether strap is securely latched.

1

Before driving

## ■ Laws and regulations pertaining to anchorages

The LATCH system conforms to FMVSS225 or CMVSS210.2.

Child restraint systems conforming to FMVSS213 or CMVSS213 specifications can be used.

This vehicle is designed to conform to the SAE J1819.

**! CAUTION**

**■ When installing a booster seat**

Do not fully extend the shoulder belt to prevent the belt from going to ALR lock mode. (→P. 71)

ALR mode causes the belt to tighten only which could cause injury or discomfort to the child.

**■ When installing a child restraint system**

Follow the directions given in the child restraint system installation manual and fix the child restraint system securely in place.

If the child restraint system is not correctly fixed in place, the child or other passengers may be seriously injured or even killed in the event of sudden braking, sudden swerving or an accident.

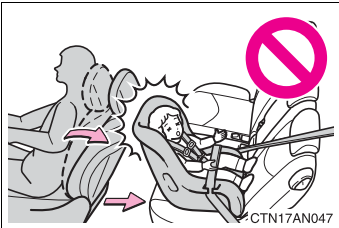

● If the driver's seat interferes with the child restraint system and prevents it from being attached correctly, attach the child restraint system to the right-hand rear seat.

● Adjust the front passenger seat or second seats so that it does not interfere with the child restraint system.

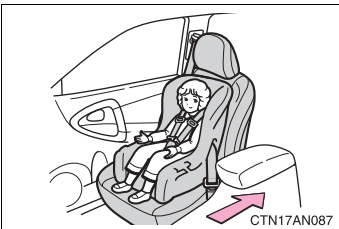

● Only put a forward-facing or booster child seat on the front seat when unavoidable. When installing a forward-facing or booster child seat on the front passenger seat, move the seat as far back as possible even if "AIR BAG OFF" indicator light is illuminated. Failing to do so may result in death or serious injury if the airbags deploy (inflate).

 **CAUTION****■ When installing a child restraint system**

- When installing a child restraint system in the rear center seat, adjust both seat cushions to the same position and align seatbacks at the same angle. Otherwise, the child restraint system cannot be securely restrained and this may cause death or serious injuries in the event of sudden braking, sudden swerving or an accident.
- When using the LATCH anchors for a child restraint system, move the seat as far back as possible (second seat only), with the seatback close to the child restraint system.
- When a booster seat is installed, always ensure that the shoulder belt is positioned across the center of the child's shoulder. The belt should be kept away from the child's neck, but not so that it could fall off the child's shoulder. Failing to do so may result in death or serious injury in the event of sudden braking, sudden swerving or an accident.
- Ensure that the belt and tab are securely locked and the seat belt is not twisted.
- Push and pull the child seat from side to side and forward to be sure it is secure.
- After securing a child restraint system, never adjust the seat.
- Follow all installation instructions provided by the child restraint system manufacturer.

**■ Do not use a seat belt extender**

If a seat belt extender is used when installing a child restraint system, the seat belt will not securely hold the child restraint system, which could cause death or serious injury to the child or other passengers in the event of sudden braking, sudden swerving or an accident.

**■ To correctly attach a child restraint system to the anchors**

When using the LATCH anchors, be sure that there are no foreign objects around the anchors and that the seat belt is not caught behind the child restraint. Make sure the child restraint system is securely attached, or it may cause death or serious injury to the child or other passengers in the event of a sudden stop, sudden swerve or accident.



## 2-1. Driving procedures

# Driving the vehicle

The following procedures should be observed to ensure safe driving.

### ■ Starting the engine

→P. 143, 147

### ■ Driving

**STEP 1** With the brake pedal depressed, shift the shift lever to D. (→P. 150)

**STEP 2** Release the parking brake. (→P. 154)

**STEP 3** Gradually release the brake pedal and gently depress the accelerator pedal to accelerate the vehicle.

### ■ Stopping

**STEP 1** With the shift lever in D, depress the brake pedal.

**STEP 2** If necessary, set the parking brake.

When the vehicle is stopped for an extended period of time, shift the shift lever to P or N. (→P. 150)

### ■ Parking the vehicle

**STEP 1** With the shift lever in D, depress the brake pedal.

**STEP 2** Set the parking brake. (→P. 154)

**STEP 3** Shift the shift lever to P. (→P. 150)

When parking on a hill, if necessary, block the wheels.

**STEP 4** Vehicles without smart key system:

Turn the engine switch to the “LOCK” position to stop the engine.

Vehicles with smart key system:

Press the “ENGINE START STOP” switch to stop the engine.

**STEP 5** Lock the door, making sure that you have the key on your person.



## Starting on a steep uphill

- STEP 1** Firmly set the parking brake and shift the shift lever to D.
- STEP 2** Gently depress the accelerator pedal.
- STEP 3** Release the parking brake.

### ■ Driving in the rain

- Drive carefully when it is raining, because visibility will be reduced, the windows may become fogged-up, and the road will be slippery.
- Drive carefully when it starts to rain, because the road surface will be especially slippery.
- Refrain from high speeds when driving on an expressway in the rain, because there may be a layer of water between the tires and the road surface, preventing the steering and brakes from operating properly.

### ■ Breaking in your new Toyota

To extend the life of the vehicle, the following precautions are recommended to observe:

- For the first 200 miles (300 km):  
Avoid sudden stops.
- For the first 500 miles (800 km):  
Do not tow a trailer.
- For the first 1000 miles (1600 km):
  - Do not drive at extremely high speeds.
  - Avoid sudden acceleration.
  - Do not drive continuously in the low gears.
  - Do not drive at a constant speed for extended periods.

### ■ Drum-in-disc type parking brake system

Your vehicle has a drum-in-disc type parking brake system.

This type of brake system needs bedding-down of the brake shoes periodically or whenever the parking brake shoes and/or drums are replaced.

Have your Toyota dealer perform the bedding-down.

### ■ Operating your vehicle in a foreign country

Comply with the relevant vehicle registration laws and confirm the availability of the correct fuel. (→P. 478)

#### CAUTION

##### ■ When starting the vehicle

Always keep your foot on the brake pedal while stopped with the engine running. This prevents the vehicle from creeping.

##### ■ When driving the vehicle

- Do not drive if you are unfamiliar with the location of the brake and accelerator pedals to avoid depressing the wrong pedal.
  - Accidentally depressing the accelerator pedal instead of the brake pedal will result in sudden acceleration that may lead to an accident that could result in death or serious injury.
  - When backing up, you may twist your body around, leading to a difficulty in operating the pedals. Make sure to operate the pedals properly.
  - Make sure to keep a correct driving posture even when moving the vehicle only slightly, allowing you to depress the brake and accelerator pedals properly.
  - Depress the brake pedal using your right foot. Depressing the brake pedal using your left foot may delay response in an emergency, resulting in an accident.
- Do not drive the vehicle over or stop the vehicle near flammable materials. The exhaust system and exhaust gases can be extremely hot. This may cause a fire if there is any flammable material nearby.
- Do not let the vehicle roll backwards while the shift lever is in a driving position, or roll forward while the shift lever is in R. Doing so may cause the engine to stall or lead to poor brake and steering performance, resulting in an accident or damage to the vehicle.
- If the smell of exhaust is noticed inside the vehicle, open the windows and check that the back door is closed. Large amounts of exhaust in the vehicle can cause driver drowsiness and an accident, resulting in death or a serious health hazard. Have the vehicle inspected by your Toyota dealer immediately.

 CAUTION

- Do not under any circumstances shift the shift lever to P, R or N while the vehicle is moving.  
Doing so can cause significant damage to the transmission system and may result in a loss of vehicle control.
- Do not shift the shift lever to N while the vehicle is moving.  
Doing so may cause the engine brake to not operate properly and lead to an accident.
- Do not turn the engine off while driving.  
The power steering and brake booster systems will not operate properly if the engine is not running.
- Use engine braking (downshift) to maintain a safe speed when driving down a steep hill.  
Using the brakes continuously may cause the brakes to overheat and lose effectiveness. (→P. 151)
- Do not adjust the position of the steering wheel, the seat, or the inside or outside rear view mirrors while driving.  
Doing so may result in a loss of vehicle control that can cause accidents that may result in death or serious injury.
- Always check that all passengers' arms, heads or other parts of their bodies are not outside the vehicle, as this may result in death or serious injury.
- Do not drive the vehicle off-road.  
This is not a 4WD vehicle designed for real off-road driving. Proceed with all due caution if it becomes unavoidable to drive off-road.
- Do not drive across river crossings or through other bodies of water.  
This may cause electric/electronic components to short circuit, damage the engine or cause other serious damage to the vehicle.
- Do not drive in excess of the speed limit. Even if the legal speed limit permits it, do not drive over 85 mph (140 km/h) unless your vehicle has high-speed capability tires. Driving over 85 mph (140 km/h) may result in tire failure, loss of control and possible injury. Be sure to consult a tire dealer to determine whether the tires on your vehicle are high-speed capability tires or not before driving at such speeds.

 **CAUTION**

■ **When driving on slippery road surfaces**

- Sudden braking, acceleration and steering may cause tire slippage and reduce your ability to control the vehicle, resulting in an accident.
- Sudden changes in engine speed, such as engine braking caused by up-shifting or down-shifting, may cause the vehicle to skid, resulting in an accident.
- After driving through a puddle, lightly depress the brake pedal to make sure that the brakes are functioning properly. Wet brake pads may prevent the brakes from functioning properly. If the brakes on only one side are wet and not functioning properly, steering control may be affected, resulting in an accident.

■ **When shifting the shift lever**

Be careful not to shift the shift lever with the accelerator pedal depressed. This may lead to unexpected rapid acceleration of the vehicle that may cause an accident and result in death or serious injury.

■ **When the vehicle is stopped**

- Do not race the engine.  
If the vehicle is in any gear other than P or N, the vehicle may accelerate suddenly and unexpectedly, and may cause an accident.
- Do not leave the vehicle with the engine running for a long time.  
If such a situation cannot be avoided, park the vehicle in an open space and check that exhaust fumes do not enter the vehicle interior.
- In order to prevent accidents due to the vehicle rolling away, always keep depressing the brake pedal while the engine is running, and apply the parking brake as necessary.
- If the vehicle is stopped on an incline, in order to prevent accidents caused by the vehicle rolling forward or backward, always depress the brake pedal and securely apply the parking brake as needed.
- Avoid revving or racing the engine.  
Running the engine at high speed while the vehicle is stopped may cause the exhaust system to overheat, which could result in a fire if combustible material is nearby.

 **CAUTION****■ When the vehicle is parked**

- Do not leave glasses, cigarette lighters, spray cans, or soft drink cans in the vehicle when it is in the sun.

Doing so may result in the following.

- Gas may leak from a cigarette lighter or spray can, and may lead to a fire.
  - The temperature inside the vehicle may cause the plastic lenses and plastic material of eye glasses to deform or crack.
  - Soft drink cans may fracture, causing the contents to spray over the interior of the vehicle, and may also cause a short circuit in the vehicle's electrical components.
- Always apply the parking brake, shift the shift lever to P, stop the engine and lock the vehicle.  
Do not leave the vehicle unattended while the engine is running.
  - Do not touch the exhaust pipe while the engine is running or immediately after turning the engine off.  
Doing so may cause burns.
  - Do not leave the engine running in an area with snow build-up, or where it is snowing. If snowbanks build up around the vehicle while the engine is running, exhaust gases may collect and enter the vehicle. This may lead to death or a serious health hazard.

**■ Exhaust gases**

Exhaust gases include harmful carbon monoxide (CO) that is colorless and odorless. Inhaling exhaust gases may lead to death or a serious health hazard.

- If the vehicle is in a poorly ventilated area, stop the engine. In a closed area, such as a garage, exhaust gases may collect and enter the vehicle. This may lead to death or a serious health hazard.
- The exhaust should be checked occasionally. If there is a hole or crack caused by corrosion, damage to a joint or abnormal exhaust noise, be sure to have the vehicle inspected and repaired by your Toyota dealer. Failure to do so may allow exhaust gases to enter the vehicle, resulting in death or a serious health hazard.

 **CAUTION**

■ **When taking a nap in the vehicle**

Always turn the engine off. Otherwise, you may accidentally move the shift lever or depress the accelerator pedal, which could cause an accident or fire due to engine overheating. Additionally, if the vehicle is parked in a poorly ventilated area, exhaust gases may collect and enter the vehicle, leading to death or a serious health hazard.

■ **When braking the vehicle**

- When the brakes are wet, drive more cautiously.

Braking distance increases when the brakes are wet, and may cause one side of the vehicle to brake differently than the other side. Also the parking brake may not securely hold the vehicle.

- If the power brake assist function does not operate, do not follow other vehicles closely and avoid downhills or sharp turns that require braking.

In this case, braking is still possible, but it will require more force on the pedal than usual. Braking distance may also increase.

- Do not pump the brake pedal if the engine stalls.

Each push on the brake pedal uses up the reserve for the power-assisted brakes.

- The brake system consists of 2 individual hydraulic systems: If one of the systems fails, the other will still operate. In this case, the brake pedal should be depressed more firmly than usual and braking distance becomes longer.

Do not drive your vehicle with only a single brake system. Have your brakes fixed immediately.

■ **If the vehicle becomes stuck or bogged (4WD models)**

Do not spin the wheels recklessly when any of the tires is up in the air, or stuck in sand or mud etc. This may damage the drive system components or propel the vehicle forward (or in another direction) and cause an accident.

 NOTICE**■ When driving the vehicle**

- Do not depress the accelerator and brake pedals at the same time during driving. If the brake pedal is depressed while driving with the accelerator pedal depressed, driving torque may be restrained.
- Do not use the accelerator pedal or depress the accelerator and brake pedals together to hold the vehicle on a hill.

**■ When parking the vehicle**

Always put the shift lever in P. Failure to do so may cause the vehicle to move or the vehicle may accelerate suddenly if the accelerator pedal is accidentally depressed.

**■ Avoiding damage to vehicle parts**

- Do not turn the steering wheel fully in either direction and hold it there for a long time.  
Doing so may damage the power steering motor.
- When driving over bumps in the road, drive as slowly as possible to avoid damaging the wheels, underside of the vehicle, etc.

**■ If you hear a squealing or scraping noise (brake pad wear limit indicators)**

Have the brake pads checked and replaced by your Toyota dealer as soon as possible.

The rotor damage can result if the pads are not replaced when needed.

It is dangerous to drive the vehicle when the wear limits of the brake pads and/or those of the brake discs are exceeded.

**■ If you get a flat tire while driving**

A flat or damaged tire may cause the following situations. Hold the steering wheel firmly and gradually press the brake pedal to slow down the vehicle.

- It may be difficult to control your vehicle.
- The vehicle will make abnormal sounds.
- The vehicle will behave abnormally.

Replace the flat tire with a new one. (→P. 443)

 NOTICE

■ **When encountering flooded roads**

Do not drive on a road that has flooded after heavy rain etc. Doing so may cause the following serious damage to the vehicle.

- Engine stalling
- Short in electrical components
- Engine damage caused by water immersion

In the event that you drive on a flooded road and the vehicle is flooded, be sure to have your Toyota dealer check the following.

- Brake function
- Changes in quantity and quality of oil and fluid used for the engine, transaxle, transfer (4WD models), rear differential (4WD models), etc.
- Lubricant condition for the propeller shaft (4WD models), bearings and suspension joints (where possible) and the function of all joints, bearings, etc.



**Performing the following operations when carrying the electronic key on your person starts the engine or changes “ENGINE START STOP” switch modes.**

■ **Starting the engine**

The engine can be started in any mode by operating the “ENGINE START STOP” switch at the same time as depressing the brake pedal.

**STEP 1** Check that the parking brake is set.

**STEP 2** Check that the shift lever is set in P.

**STEP 3** Sit in the driver’s seat and firmly depress the brake pedal.

The “ENGINE START STOP” switch indicator turns green. If the indicator does not turn green, the engine cannot be started.

**STEP 4**

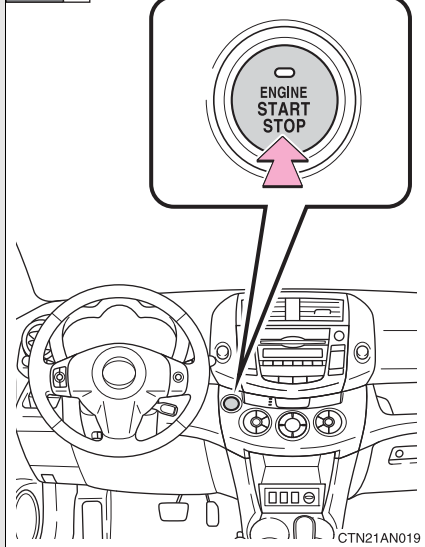

Press the “ENGINE START STOP” switch.

The engine will crank until it starts or for up to 30 seconds, whichever is less.

Continue depressing the brake pedal until the engine is completely started.

The engine can be started from any mode.

### ■ Changing “ENGINE START STOP” switch mode

Modes can be changed by pressing the “ENGINE START STOP” switch with the brake pedal released. (The mode changes each time the switch is pressed.)

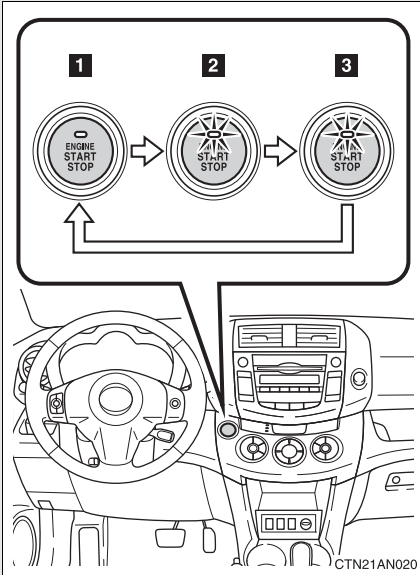

#### 1 OFF\*

The emergency flashers can be used.

#### 2 ACCESSORY mode

Some electrical components such as the audio system can be used.

The “ENGINE START STOP” switch indicator turns amber.

#### 3 IGNITION ON mode

All electrical components can be used.

The “ENGINE START STOP” switch indicator turns amber.

\*: If the shift lever is in a position other than P when turning off the engine, the “ENGINE START STOP” switch will be turned to ACCESSORY mode, not to OFF.

### ■ Steering lock release

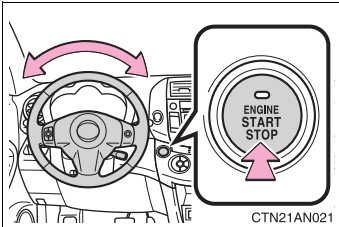

Make sure that the steering wheel lock is released.

To release the steering wheel lock, gently turn the wheel left or right while pressing the “ENGINE START STOP” switch.

When the steering wheel lock does not release, the “ENGINE START STOP” switch indicator will flash green.

### ■ If the engine does not start

The engine immobilizer system may not have been deactivated. (→P. 92)

### ■ When the “ENGINE START STOP” switch indicator flashes in amber

The system may be malfunctioning. Have the vehicle inspected by your Toyota dealer immediately.

### ■ Auto power off function

If the vehicle is left in ACCESSORY mode for more than an hour with the shift lever in P, the “ENGINE START STOP” switch will automatically turn OFF.

### ■ Electronic key battery depletion

→P. 32

### ■ When the electronic key battery is discharged

→P. 389

### ■ Conditions affecting operation

→P. 30

### ■ Note for the entry function

→P. 32

 CAUTION

■ **When starting the engine**

Always start the engine while sitting in the driver's seat. Do not depress the accelerator pedal while starting the engine under any circumstances. Doing so may cause an accident resulting in death or serious injury.

■ **Stopping the engine in an emergency**

If you want to stop the engine in an emergency while driving the vehicle, push and hold the “ENGINE START STOP” switch for more than 3 seconds. However, do not touch the “ENGINE START STOP” switch while driving except in an emergency. If the engine stops while the vehicle is being driven, this could lead to an unexpected accident.

 NOTICE

■ **To prevent battery discharge**

Do not leave the “ENGINE START STOP” switch in ACCESSORY or IGNITION ON mode for long periods without the engine running.

■ **When starting the engine**

- Do not race a cold engine.
- If the engine becomes difficult to start or stalls frequently, have the engine checked immediately.

■ **Starting the engine**

- STEP 1** Check that the parking brake is set.
- STEP 2** Check that the shift lever is set in P.
- STEP 3** Sit in the driver's seat and firmly depress the brake pedal.
- STEP 4** Turn the engine switch to the "START" position to start the engine.

■ **Engine (ignition) switch**

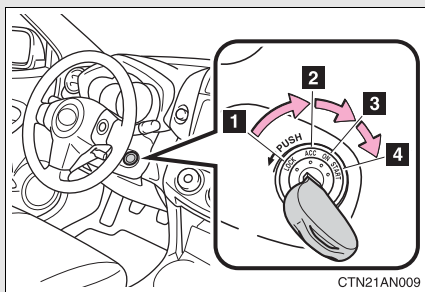

**1** "LOCK"

The steering wheel is locked and the key can be removed. (The key can be removed only when the shift lever is in "P".)

**2** "ACC"

Some electrical components such as the audio system can be used.

**3** "ON"

All electrical components can be used.

**4** "START"

For starting the engine.

### ■ Turning the key from “ACC” to “LOCK”

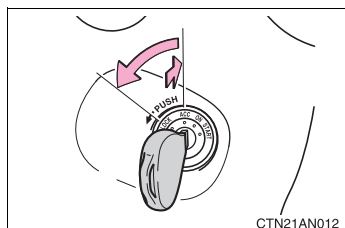

**STEP 1** Shift the shift lever to P.  
(→P. 150)

**STEP 2** Push in the key and turn to the  
“LOCK” position.

### ■ Steering lock release

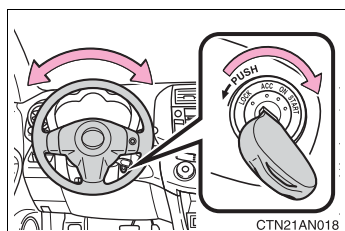

When starting the engine, the engine switch may seem stuck in the “LOCK” position. To free it, turn the key while turning the steering wheel slightly in either direction.

### ■ If the engine does not start

The engine immobilizer system may not have been deactivated. (→P. 92)

### ■ Key reminder function

A buzzer sounds if the driver’s door is opened, while the engine switch is in the “LOCK” or “ACC” position to remind you to remove the key.

## ! CAUTION

### ■ When starting the engine

Always start the engine while sitting in the driver’s seat. Do not press the accelerator while starting the engine under any circumstances.

Doing so may cause an accident resulting in death or serious injury.

### ■ Caution when driving

Do not turn the engine switch to the “LOCK” position while driving. If, in an emergency, you must turn the engine off while the vehicle is moving, turn the key only to the “ACC” position.

**NOTICE****■ To prevent battery discharge**

Do not leave the key in the “ACC” or “ON” position for a long period if the engine is not running.

**■ When starting the engine**

- Do not crank for more than 30 seconds at a time. This may overheat the starter and wiring systems.
- Do not race a cold engine.
- If the engine becomes difficult to start or stalls frequently, have the engine checked immediately.

## 2-1. Driving procedures

### Automatic transmission

Select a shift position appropriate for the driving conditions.

#### ■ Shifting the shift lever

##### ▶ 4-speed models

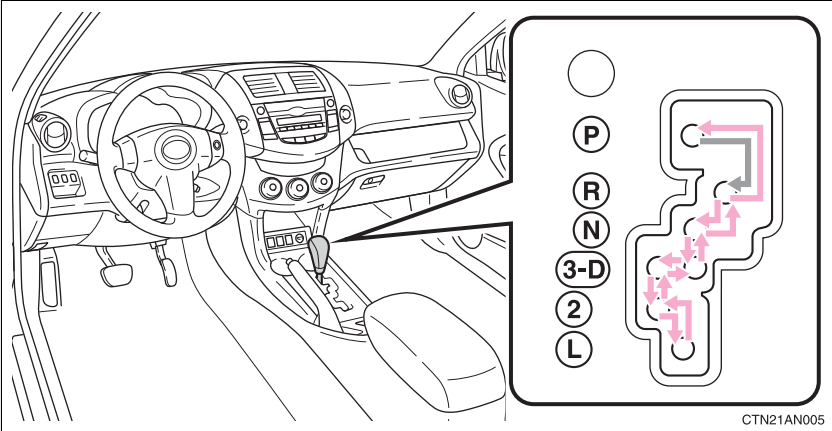

##### ▶ 5-speed models

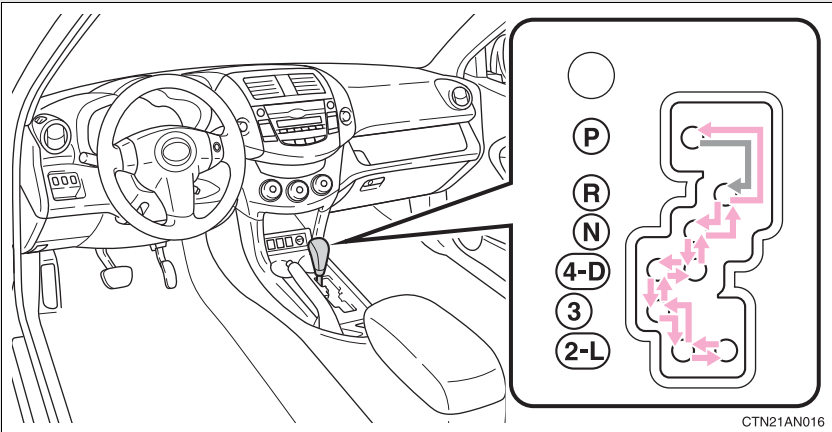





Vehicles without smart key system:

While the engine switch is in the “ON” position, depress the brake pedal and move the shift lever.

Vehicles with smart key system:

While the “ENGINE START STOP” switch is in IGNITION ON mode, depress the brake pedal and move the shift lever.

### ■ Shift position uses

Shift position	Function	
	4-speed models	5-speed models
P	Parking the vehicle/starting the engine	
R	Reversing	
N	Neutral	
D	Normal driving*	
4		Position for engine braking
3,2	Position for more powerful engine braking	
L	Position for maximum engine braking	

\*: Shifting to the D position allows the system to select a gear suitable for the driving conditions.

Setting the shift lever to the D position is recommended for normal driving.

**Downshifting restrictions**

The shift lever cannot be downshifted if the following speeds are exceeded.

## ▶ 4-speed models (2WD)

mph (km/h)

Downshifting	Maximum speed
3 → 2	75 (121)
2 → L	37 (60)

## ▶ 4-speed models (4WD)

mph (km/h)

Downshifting	Maximum speed
3 → 2	72 (117)
2 → L	36 (58)

## ▶ 5-speed models

mph (km/h)

Downshifting	Maximum speed
4 → 3	100 (161)
3 → 2	62 (99)
2 → L	26 (42)

**When driving with the cruise control system**

## ▶ 4-speed models

Engine braking will not occur when downshifting from D to 3. (→P. 172)

## ▶ 5-speed models

Engine braking will not occur when downshifting from D to 4. (→P. 172)

**If the shift lever cannot be shifted from P**

→P. 459

## 2-1. Driving procedures

### Turn signal lever

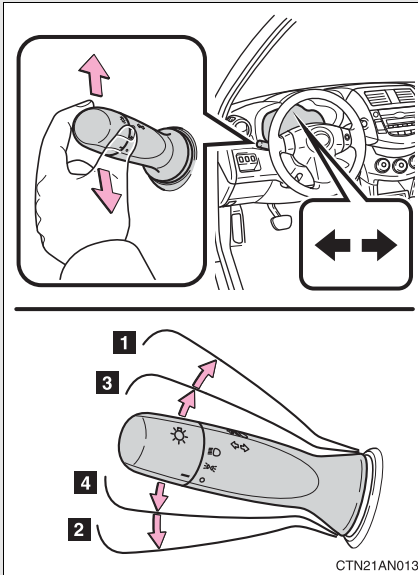

- 1 Right turn
- 2 Left turn
- 3 Move and hold the lever partway to signal a lane change.

The right hand signal will flash until you release the lever.

- 4 Move and hold the lever partway to signal a lane change.

The left hand signal will flash until you release the lever.

2

When driving

#### ■ Turn signals can be operated when

- ▶ Vehicles without smart key system

The engine switch is in the "ON" position.

- ▶ Vehicles with smart key system

The "ENGINE START STOP" switch is in IGNITION ON mode.

#### ■ If the indicators flash faster than usual

Check that a light bulb in the front or rear turn signal lights has not burned out.

## Parking brake

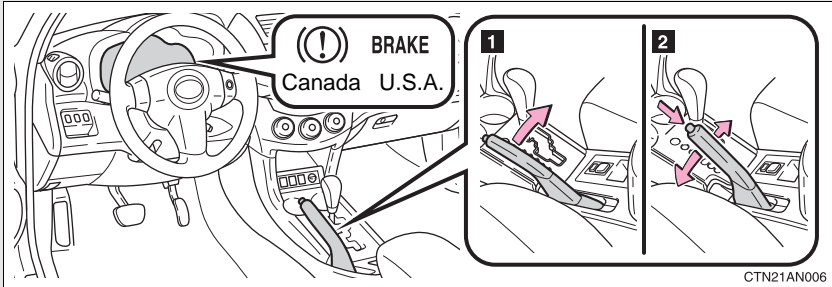

**1** Sets the parking brake

Fully apply the parking brake while depressing the brake pedal.

**2** Releases the parking brake

Slightly raise the lever and lower it completely while pressing the button.

**■ Usage in winter time**

See “Winter driving tips” for parking brake usage in winter time. (→P. 210)

**⚠ NOTICE**

**■ Before driving**

Fully release the parking brake.

Driving the vehicle with the parking brake set will lead to brake components overheating, which may affect braking performance and increase brake wear.

## Horn

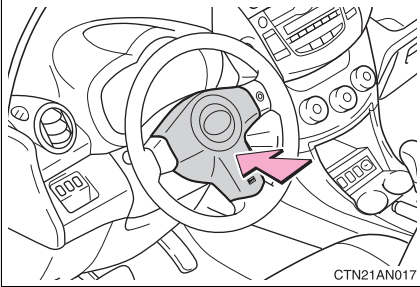

To sound the horn, press on or close to the  mark.

### ■ After adjusting the steering wheel

Make sure that the steering wheel is securely locked.

The horn may not sound if the steering wheel is not securely locked.

(→P. 76)

## 2-2. Instrument cluster

### Gauges and meters

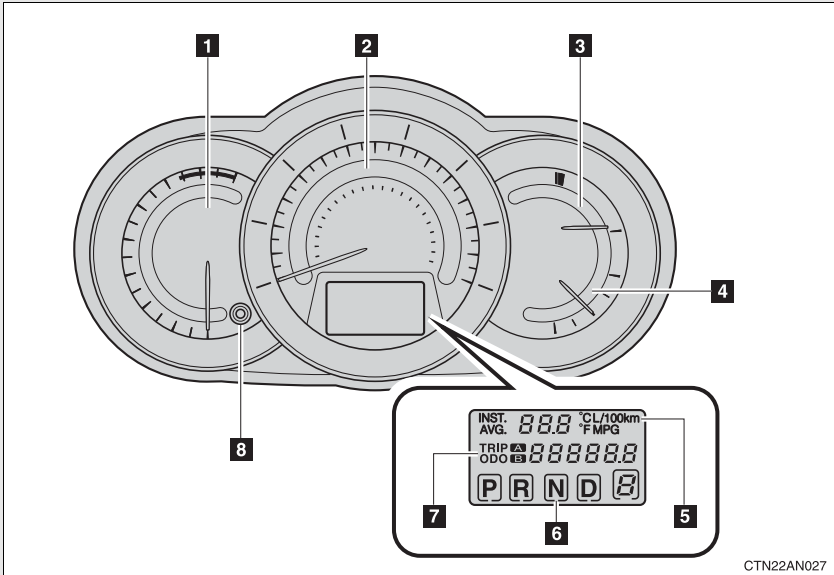

#### ▶ Vehicles without smart key system

The following gauges, meters and displays illuminate when the engine switch is in the “ON” position.

#### ▶ Vehicles with smart key system

The following gauges, meters and displays illuminate when the “ENGINE START STOP” switch is in IGNITION ON mode.

#### **1** Tachometer

Displays the engine speed in revolutions per minute.

#### **2** Speedometer

Displays the vehicle speed.

#### **3** Engine coolant temperature gauge

Displays the engine coolant temperature.

#### **4** Fuel gauge

Displays the quantity of fuel remaining in the tank.

**5** Trip information display

→P. 162

**6** Automatic transmission shift position indicator lights

→P. 150

**7** Odometer/trip meter

## ▶ Odometer

Displays the total distance the vehicle has been driven.

## ▶ Trip meter

Displays the distance the vehicle has been driven since the meter was last reset. Trip meters A and B can be used to record and display different distances independently.

**8** Odometer/trip meter switching and trip meter resetting button

Switches between odometer and trip meter displays. Pushing and holding the button will reset the trip meter when the trip meter is being displayed.

**Instrument panel light control**

The brightness of the instrument panel lights can be adjusted.

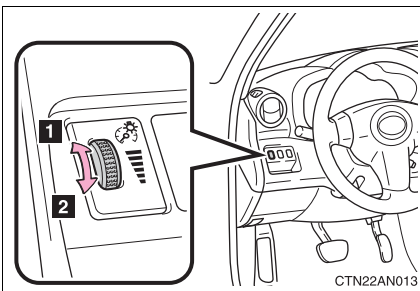
**1** Brighter**2** Darker

When the headlight switch is turned on, the brightness will be reduced slightly unless the control dial is turned fully up.

 NOTICE

■ **To prevent damage to the engine and its components**

- Do not let the indicator needle of the tachometer enter the red zone, which indicates the maximum engine speed.
- The engine may be overheating if the temperature gauge is in the red zone (H). In this case, immediately stop the vehicle in a safe place, and check the engine after it has cooled completely. (→P. 466)



# Indicators and warning lights

The indicator and warning lights on the instrument cluster and center panel inform the driver of the status of the vehicle's various systems.

## ■ Instrument cluster

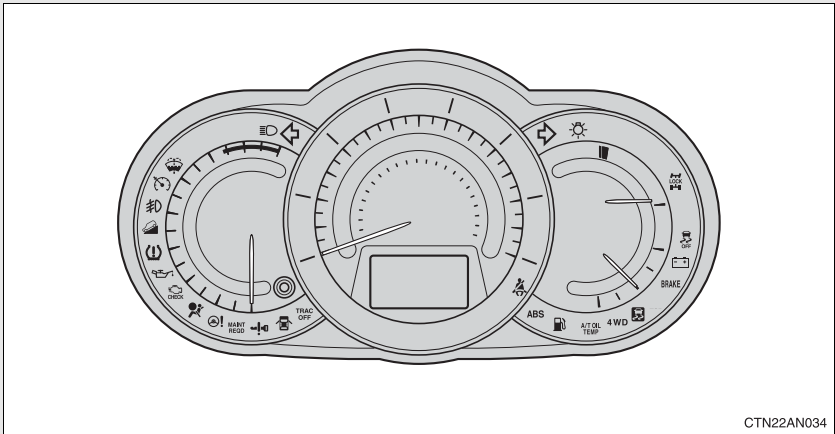

## ■ Center panel

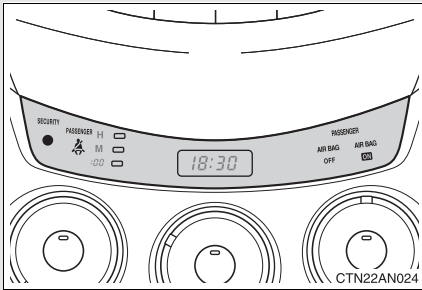

## ■ Indicators

The indicators inform the driver of the operating state of the vehicle's various systems.



Turn signal indicator  
(→P. 153)



(U.S.A.)

Headlight indicator  
(→P. 165)



Headlight high beam indicator (→P. 166)



(Canada)

Tail light indicator  
(→P. 165)



(if equipped)

<sup>\*1</sup>  
Downhill assist control system indicator  
(→P. 193)



(if equipped)

Front fog light indicator  
(→P. 168)



<sup>\*1, 2</sup>

Slip indicator  
(→P. 185)



(2WD models)

<sup>\*1</sup>  
“AUTO LSD” indicator  
(→P. 186)



(4WD models)

<sup>\*1</sup>  
Four-wheel drive lock indicator (→P. 196)



<sup>\*1</sup>

“AIR BAG ON” and “AIR BAG OFF” indicator (→P. 110)



<sup>\*1</sup>

VSC OFF indicator  
(→P. 186)



Cruise control indicator  
(→P. 172)



Engine immobilizer system indicator (→P. 92)



(4WD models)

<sup>\*1</sup>  
“TRAC OFF” indicator  
(→P. 187)

<sup>\*1</sup>: These lights turn on when the “ENGINE START STOP” switch is turned to IGNITION ON mode (vehicles with smart key system) or the engine switch is turned to the “ON” position (vehicles without smart key system) to indicate that a system check is being performed. They will turn off after the engine is started, or after a few seconds. There may be a malfunction in a system if a light does not come on, or if the lights do not turn off. Have the vehicle inspected by your Toyota dealer for details.

\*2: The light flashes to indicate that the system is operating.

## ■ Warning lights

Warning lights inform the driver of malfunctions in any of the vehicle's systems. (→P. 426)

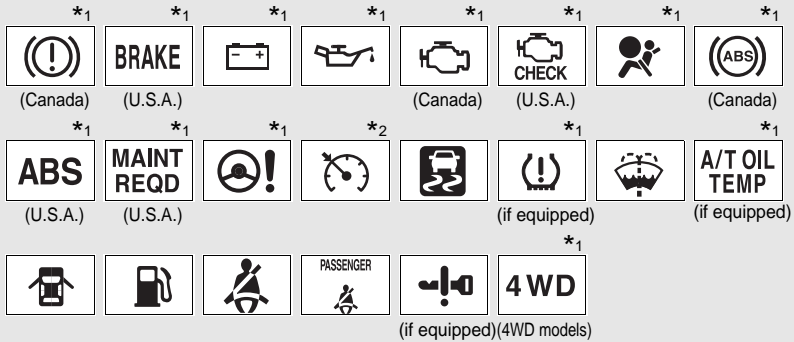

\*1: These lights turn on when the “ENGINE START STOP” switch is turned to IGNITION ON mode (vehicles with smart key system) or the engine switch is turned to the “ON” position (vehicles without smart key system) to indicate that a system check is being performed. They will turn off after the engine is started, or after a few seconds. There may be a malfunction in a system if a light does not come on, or if the lights do not turn off. Have the vehicle inspected by your Toyota dealer for details.

\*2: The light flashes to indicate a malfunction.

## ⚠ CAUTION

### ■ If a safety system warning light does not come on

Should a safety system light such as the ABS and SRS airbag warning light not come on when you start the engine, this could mean that these systems are not available to help protect you in an accident, which could result in death or serious injury. Have the vehicle inspected by your Toyota dealer immediately if this occurs.

## Trip information display

The trip information display presents the driver with a variety of driving-related data, including the current outside temperature.

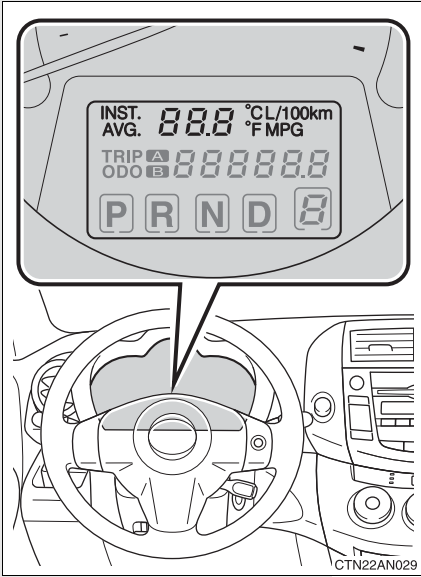

Trip information (→P. 163)

Displays outside temperature and fuel consumption.

## Trip information

### ► Type A

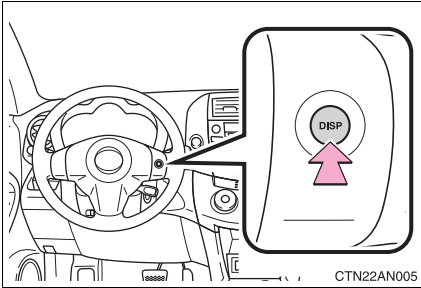

Push the “DISP” button to display trip information.

Display items can be switched by pressing the “DISP” button.

### ► Type B

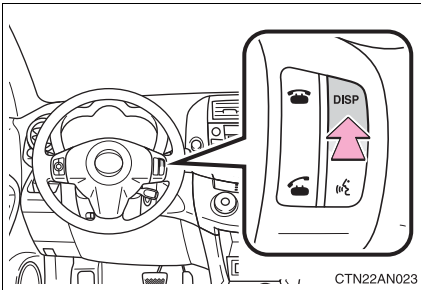

Push the “DISP” button to display trip information.

Display items can be switched by pressing the “DISP” button.

## ■ Outside temperature

Indicates the outside temperature.



The temperature range that can be displayed is from -40°F (-40°C) to 122°F (50°C).

When the outside air temperature falls below 37°F (3°C) while driving, the temperature display flashes to indicate that the outside air temperature is becoming low.

## ■ Instantaneous fuel consumption

Displays the instantaneous fuel consumption.



### ■ Average fuel consumption



Displays the average fuel consumption since the function was reset.

To reset the calculations, return the mode to "AVG" and push and hold the "DISP" button until the display shows "0".

### ■ Display

In the following situations, the correct outside temperature may not be displayed, or the display may take longer than normal to change.

- When stopped, or driving at low speeds (less than 12 mph [20 km/h])
- When the outside temperature has changed suddenly (at the entrance/exit of a garage, tunnel, etc.)

## Headlight switch

The headlights can be operated manually or automatically.

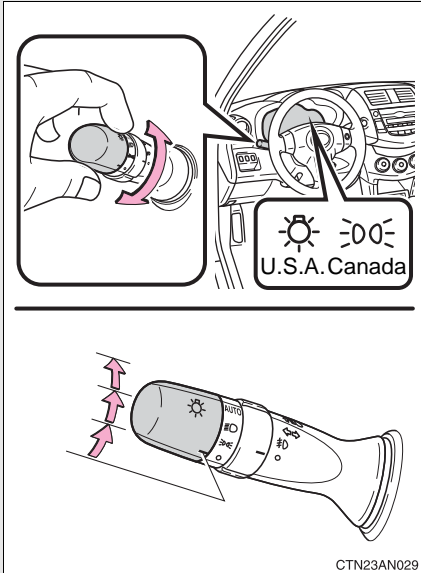

 The daytime running lights turn on.

 The side marker, parking, tail, license plate, daytime running lights and instrument panel lights turn on.

 The headlights and all lights listed above (except daytime running lights) turn on.

**AUTO** (if equipped) The headlights, parking lights and daytime running lights turn on and off automatically. (When the “ENGINE START STOP” switch or the engine switch is in ON)

## Turning on the high beam headlights

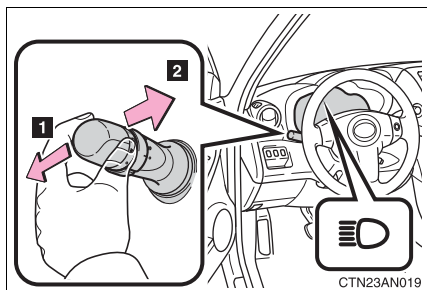

**1** With the headlights on, push the lever forward to turn on the high beams.

Pull the lever back to the center position to turn the high beams off.

**2** Pull the lever toward you to turn on the high beams.

Release the lever to turn them off. You can flash the high beams with the headlights on or off.

### ■ Daytime running light system (if equipped)

- To make your vehicle more visible to other drivers, the headlights turn on automatically (at a reduced intensity) whenever the engine is started and the parking brake is released. Daytime running lights are not designed for use at night.
- Compared to turning on the headlights, the daytime running light system offers greater durability and consumes less electricity, so it can help improve fuel economy.

### ■ Headlight control sensor (with automatic light control system)

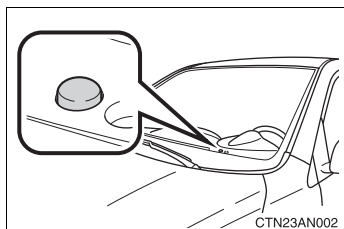

The sensor may not function properly if an object is placed on the sensor, or anything that blocks the sensor is affixed to the windshield.



Doing so interferes with the sensor detecting the level of ambient light and may cause the automatic headlight system to malfunction.



### ■ Automatic light off system



#### ▶ Vehicles without smart key system:

The headlights and tail lights turn off 30 seconds after driver's door is opened and closed if the engine switch has been turned to "ACC" or "LOCK" position.

To turn the lights on again, turn the engine switch to the "ON" position, or turn the headlight switch off and then back to  or .

#### ▶ Vehicles with smart key system:

The headlights and tail lights turn off 30 seconds after driver's door is opened and closed if the "ENGINE START STOP" switch has been turned to ACCESSORY mode or turned OFF.

To turn the lights on again, turn the "ENGINE START STOP" switch to IGNITION ON mode, or turn the headlight switch off and then back to  or .

### ■ Customization that can be configured at Toyota dealer

Settings (e.g. light sensor sensitivity) can be deactivated.  
(Customizable features →P. 500)



#### NOTICE

#### ■ To prevent battery discharge

Do not leave the lights on longer than necessary when the engine is not running.

## Fog light switch\*

The fog lights improve visibility in difficult driving conditions, such as in rain or fog. They can be turned on only when the headlights are on low beam.

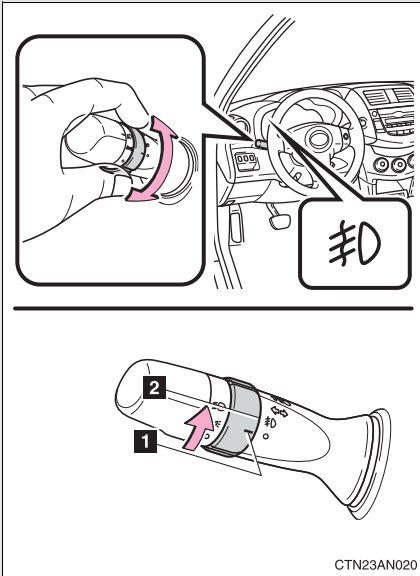

**1** Off

**2** Front fog lights on

CTN23AN020

\*: If equipped

## 2-3. Operating the lights and wipers Windshield wipers and washer

**Wiper intervals can be adjusted for intermittent operation.**

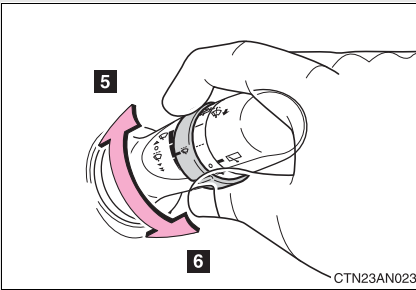
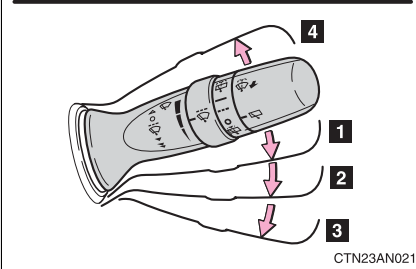
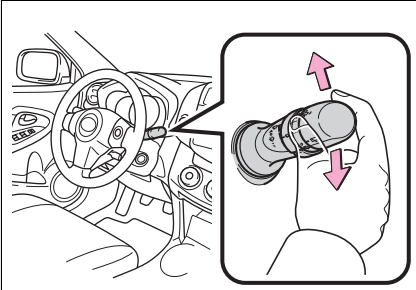

- 1** Intermittent windshield wiper operation
- 2** Low speed windshield wiper operation
- 3** High speed windshield wiper operation
- 4** Temporary operation
  
- 5** Increases the intermittent windshield wiper frequency
- 6** Decreases the intermittent windshield wiper frequency

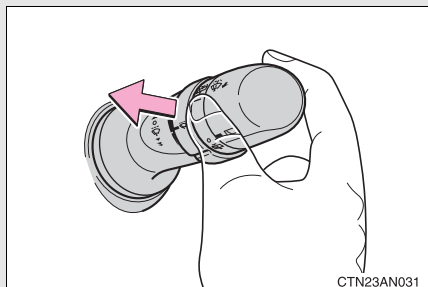

### Wash/wipe operation

Wipers operate automatically.

#### ■ The windshield wipers and washer can be operated when

▶ Vehicles without smart key system  
The engine switch is in the “ON” position.

▶ Vehicles with smart key system  
The “ENGINE START STOP” switch is in IGNITION ON mode.

#### ■ If no windshield washer fluid sprays

Check that the washer nozzles are not blocked and if there is washer fluid in the windshield washer fluid reservoir.

#### NOTICE

##### ■ When the windshield is dry

Do not use the wipers, as they may damage the windshield.

##### ■ When there is no washer fluid spray from the nozzle

Damage to the washer fluid pump may be caused if the lever is pulled toward you and held continually.

##### ■ When a nozzle is blocked

Do not try to clear it with a pin or other object. The nozzle will be damaged.

## Rear window wiper and washer

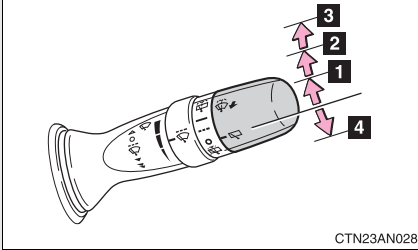
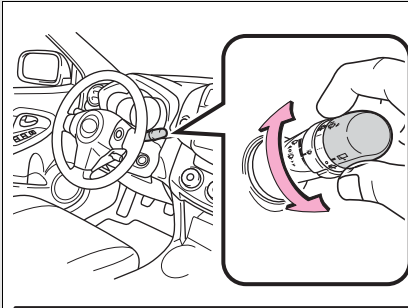

CTN23AN028

- 1 Intermittent window wiper operation
- 2 Normal window wiper operation
- 3 Washer/wiper dual operation
- 4 Washer/wiper dual operation

### ■ The rear window wiper and washer can be operated when

- ▶ Vehicles without smart key system

The engine switch is in the “ON” position.

- ▶ Vehicles with smart key system

The “ENGINE START STOP” switch is in IGNITION ON mode.

### ⚠ NOTICE

#### ■ When the rear window is dry

Do not use the wipers, as they may damage the rear window.

#### ■ When a nozzle is blocked

Do not try to clear it with a pin or other object. The nozzle will be damaged.

## 2-4. Using other driving systems

# Cruise control

Use the cruise control to maintain a set speed without depressing the accelerator pedal.

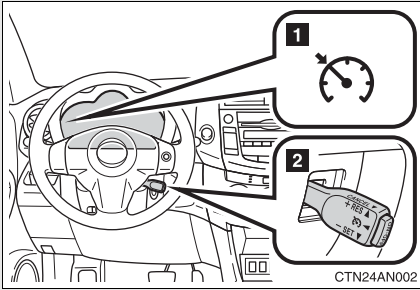

- 1 Indicator
- 2 Cruise control switch

### ■ Setting the vehicle speed

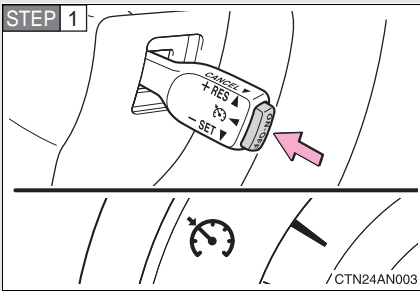

Press the "ON-OFF" button to activate the cruise control.

Press the button again to deactivate the cruise control.

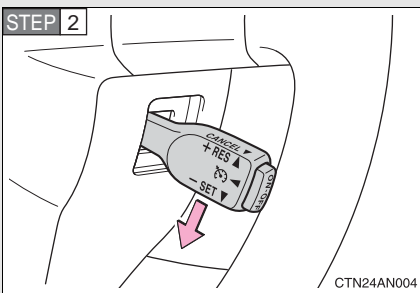

Accelerate or decelerate to the desired speed, and push the lever down to set the speed.

### ■ Adjusting the set speed

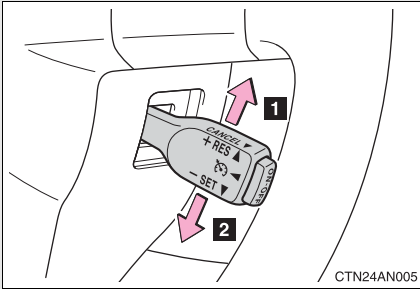

- 1** Increase the speed
- 2** Decrease the speed

Hold the lever until the desired speed setting is obtained.

Fine adjustment of the set speed can be made by lightly pushing the lever up or down and releasing it.

### ■ Canceling and resuming the constant speed control

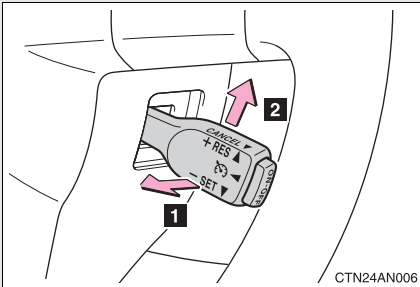

- 1** Pulling the lever toward you cancels the constant speed control.

The speed setting is also canceled when the brakes are applied.

- 2** Pushing the lever up resumes the constant speed control.

### ■ Cruise control can be set when

- The shift lever is in D or 3 (4-speed models), or D or 4 (5-speed models).
- Vehicle speed is above approximately 25 mph (40 km/h).

### ■ Accelerating

The vehicle can be accelerated normally. After acceleration, the set speed resumes.

### ■ Coast braking function

- Holding the lever down to decrease the set speed activates the brake system automatically, decelerating the vehicle quickly.  
While the brake system is operating, the stop lights and high mounted stoplight will turn on.
- A sound may be heard from the engine compartment during the operation of the brake system. The sound means the brake system is operating and it does not indicate a malfunction.

### ■ Automatic cruise control cancellation

Cruise control will stop maintaining the vehicle speed in any of the following situations.

- Actual vehicle speed falls more than approximately 10 mph (16 km/h) below the preset vehicle speed.  
At this time, the memorized set speed is not retained.
- Actual vehicle speed is below approximately 25 mph (40 km/h).
- VSC is activated.

### ■ If the cruise control indicator light flashes

Press the "ON-OFF" button once to deactivate the system, and then press the button again to reactivate the system.

If the cruise control speed cannot be set or if the cruise control cancels immediately after being activated, there may be a malfunction in the cruise control system. Have the vehicle inspected by your Toyota dealer.



 **CAUTION****■ To avoid operating the cruise control by mistake**

Switch the cruise control off using the “ON-OFF” button when not in use.

**■ Situations unsuitable for cruise control**

Do not use cruise control in any of the following situations.

Doing so may result in loss of control and could cause an accident resulting in death or serious injury.

- In heavy traffic
- On roads with sharp bends
- On winding roads
- On slippery roads, such as those covered with rain, ice or snow
- On steep hills  
Vehicle speed may exceed the set speed when driving down a steep hill.
- When your vehicle is towing a trailer or during emergency towing

## 2-4. Using other driving systems

### Rear view monitor system (vehicles with auto anti-glare inside rear view mirror)

The rear view monitor system assists the driver by displaying an image of the area behind the vehicle. The image is displayed in reverse on the screen. This reversed image is a similar image to the one on the inside rear view mirror.

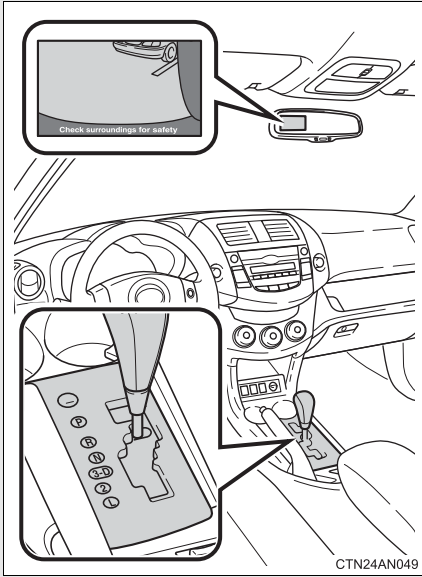

The rear view image is displayed on the inside rear view mirror.

The screen turns off in the following situations:

- The shift lever is shifted out of R.
- The back door is opened.
- The screen remains on for approximately 5 minutes.

### ■ The rear view monitor system can be operated when

- ▶ Vehicles without smart key system

The shift lever is in R, the back door is fully closed and the engine switch is in the “ON” position.

- ▶ Vehicles with smart key system

The shift lever is in R, the back door is fully closed and the “ENGINE START STOP” switch is in IGNITION ON mode.

### ■ Changing display modes

The rear view monitor display mode can be changed while the screen is on.

- To temporarily disable the rear view monitor system

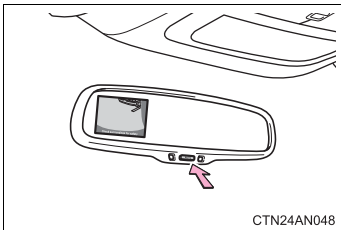

Push the “AUTO” button.

The indicator will turn amber.

- ▶ Vehicles without smart key system

The system will be re-enabled once the engine switch is turned OFF and then turned to the “ON” position.

- ▶ Vehicles with smart key system

The system will be re-enabled once the “ENGINE START STOP” switch is turned OFF and then turned to IGNITION ON mode.

- To constantly disable the rear view monitor system

Push and hold the “AUTO” button for 12 to 15 seconds.

The screen will turn off and on after 6 seconds. Keep pushing the button until the screen turns back off. The indicator will flash amber.

- ▶ Vehicles without smart key system

The system will not automatically turn on again after the engine switch is OFF and then turned to the “ON” position.

- ▶ Vehicles with smart key system

The system will not automatically turn on again after the “ENGINE START STOP” switch is OFF and then turned to IGNITION ON mode.

- To re-enable the rear view monitor system

Push the “AUTO” button. The indicator will turn green.

### ■ Selecting a language (English, French or Spanish)

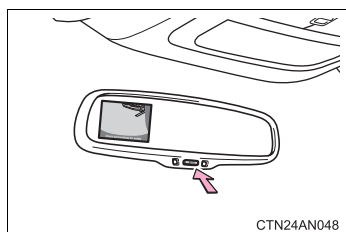

- STEP 1** Push and hold the “AUTO” button for 6 to 12 seconds.

The screen will turn on and the indicator will turn green.

- STEP 2** Push the “AUTO” button.

Each time the “AUTO” button is pushed and released, the language changes. A message will flash in the mirror for 5 seconds after the button is released, indicating that the change has been completed.

## ■ Displayed area

### ▶ Vehicles without spare tire

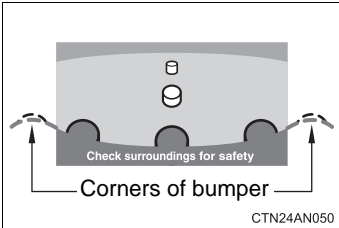
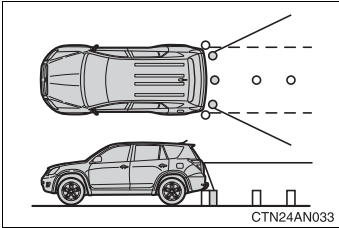

### ▶ Vehicles with spare tire

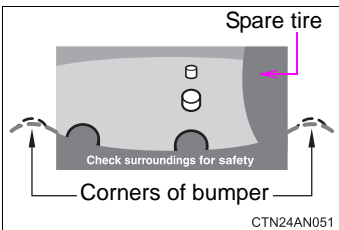
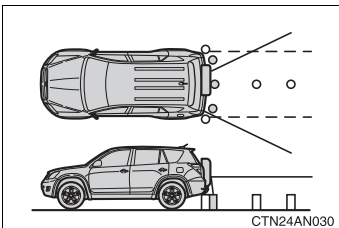

The area covered by the camera is limited. Objects that are close to either corner of the bumper or under the bumper cannot be seen on the screen.

The area displayed on the screen may vary according to vehicle orientation or road conditions.

The area covered by the camera is limited. Objects that are close to either corner of the bumper or under the bumper cannot be seen on the screen.

The area displayed on the screen may vary according to vehicle orientation or road conditions.

The area displayed on the screen is reduced because the spare tire partially blocks the field of view of the camera. Also, the rear mounted spare tire extends past the rear bumper.

## ■ Rear view monitor system camera

### ▶ Vehicles without spare tire

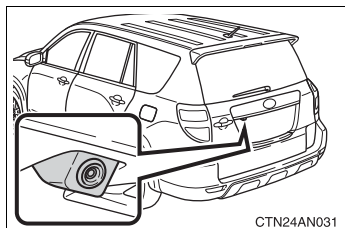

In the following cases, it may become difficult to see images on the screen even if the system functions correctly.

- The vehicle is in a dark area, such as at night.
- The temperature near the lens is extremely high or low.
- Water droplets are on the camera lens or humidity is high, such as when it rains.
- Foreign matter, such as snow or mud, adheres to the camera lens.
- The camera lens is scratched or has dirt on it.
- The sun or headlights are shining directly into the camera lens.
- A bright object such as a white wall is reflected in the mirror surface over the screen.

► Vehicles with spare tire

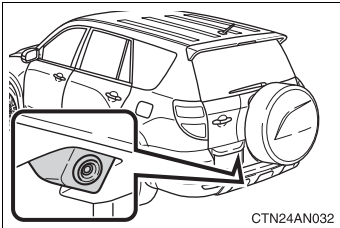

In the following cases, it may become difficult to see images on the screen even if the system functions correctly.

- The vehicle is in a dark area, such as at night.
- The temperature near the lens is extremely high or low.
- Water droplets are on the camera lens or humidity is high, such as when it rains.
- Foreign matter, such as snow or mud, adheres to the camera lens.
- The camera lens is scratched or has dirt on it.
- The sun or headlights are shining directly into the camera lens.
- A bright object such as a white wall is reflected in the mirror surface over the screen.

### ■ Smear effect



If a bright light, such as sunlight reflected off the vehicle body, is picked up by the camera, a smear effect\* characteristic to the camera may occur.

\*: Smear effect: A phenomenon that occurs when a bright light is picked up by the camera; when transmitted by the camera, the light source appears to have a vertical streak above and below it.

### ■ Flicker effect

When the camera is used under fluorescent light, sodium lights, or mercury lights etc., the lights and the illuminated areas may appear to flicker.

## ⚠ CAUTION

### ■ When using the rear view monitor system

Observe the following precautions to avoid an accident that could result in death or serious injuries.

- The rear view monitor system is a supplement device intended to assist back up. Never depend solely on the rear view monitor system when reversing. Always check visually and with the mirrors to confirm your intended path is clear. Use caution just as you would when backing up any vehicle.
- The camera has a special lens. Depicted distances between objects and flat surfaces differ from actual distances.
- Vehicles with spare tire: The spare tire is the rear-most edge of the vehicle extending past the rear bumper. Take care not to hit any obstacles with the spare tire while reversing.



 CAUTION**■ Conditions which may affect the rear view monitor system**

- If the back of the vehicle has been hit, the camera's position and mounting angle may have changed. Have the vehicle inspected by your Toyota dealer.
- When the outside temperature is low, the displayed image may become faint or dark, and moving images will be distorted, or not entirely visible.
- Rapid temperature changes, such as when hot water is poured on the vehicle in cold weather, may cause the system to function abnormally.
- If the camera lens is dirty, it cannot transmit a clear image. Rinse with water and wipe with a soft cloth. If the camera lens is extremely dirty, wash with a mild cleanser and rinse.
- When replacing tires, please consult your Toyota dealer. If you replace the tires, the area displayed on the screen may change.

 NOTICE**■ To prevent damage to the camera**

- As the camera has a water proof construction, do not detach, disassemble or modify it. This may cause incorrect operation.
- When washing the vehicle, do not apply intensive bursts of water to the camera or camera area. Doing so may result in camera malfunctions.
- Take care so that organic solvent, car wax, window cleaner or glass coat does not adhere to the camera. If this happens, wipe it off as soon as possible.

# Driving assist systems

**To help enhance driving safety and performance, the following systems operate automatically in response to various driving situations. Be aware, however, that these systems are supplementary and should not be relied upon too heavily when operating the vehicle.**

### ■ **ABS (Anti-lock Brake System)**

Helps to prevent wheel lock when the brakes are applied suddenly, or if the brakes are applied while driving on a slippery road surface.

### ■ **Brake assist**

Generates an increased level of braking force after the brake pedal is depressed, when the system detects a panic stop situation.

### ■ **VSC (Vehicle Stability Control)**

Helps the driver to control skidding when swerving suddenly or turning on slippery road surfaces.

### ■ **TRAC (Traction Control)**

Maintains drive power and prevents the drive wheels from spinning when starting the vehicle or accelerating on slippery roads.

### ■ **AUTO LSD function (2WD models)**

The AUTO LSD function is activated when the system is in TRAC off mode. It operates when one of the drive wheels is spinning, such as when the wheel is spinning freely on ice or mud. The system applies the brakes to the spinning wheel and transfers some of the torque to the other wheel to secure drive power.

### ■ **Active Torque Control 4WD system (4WD models)**

Automatically switches from front-wheel drive to four-wheel drive (4WD) according to the driving conditions, helping to ensure reliable handling and stability. Examples of conditions where the system will switch to 4WD are when cornering, going uphill, starting off or accelerating, and when the road surface is slippery due to snow, rain, etc.

### ■ **EPS (Electric Power Steering)**

Employs an electric motor to reduce the amount of effort needed to turn the steering wheel.

### ■ Enhanced VSC (Enhanced Vehicle Stability Control)

Provides cooperative control of the ABS, TRC, VSC and EPS. Helps to maintain directional stability when swerving on slippery road surface by controlling steering performance.

### ■ Hill-start assist control (if equipped)

(→P. 191)

### ■ Downhill assist control system (if equipped)

(→P. 193)

## When the VSC/TRAC are operating

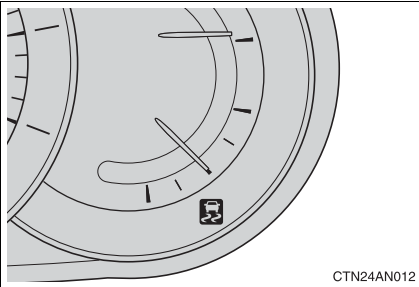

If the vehicle is in danger of slipping or if any of the drive wheels spins, the slip indicator light flashes to indicate that the VSC/TRAC systems are operating.

A buzzer (intermittent) sounds to indicate that VSC is operating.

## To disable TRAC and/or VSC (2WD models)

If the vehicle gets stuck in fresh snow or mud, TRAC and VSC may reduce power from the engine to the wheels. You may need to turn the system off to enable you to rock the vehicle in order to free it. The AUTO LSD function is activated when the system is in TRAC off mode.

### ■ Turning off TRAC

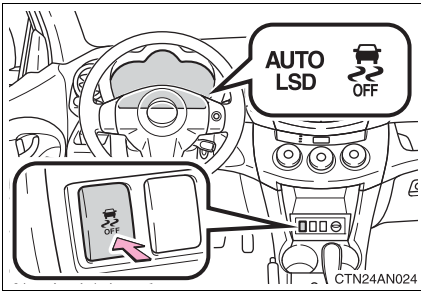

Quickly push and release the button to turn off TRAC.

The "AUTO LSD" and VSC OFF indicator lights should come on.

While the AUTO LSD function is operating the slip indicator light flashes.

Push the button again to turn the system back on.

### ■ Turning off TRAC and VSC

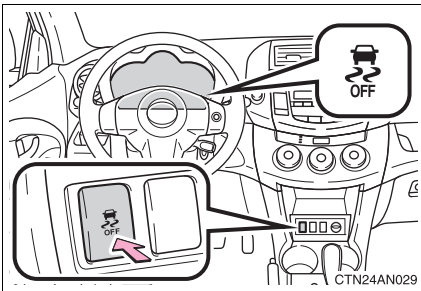

Push and hold the button while the vehicle is stopped to turn off TRAC and VSC.

The VSC OFF indicator light should come on.

Push the button again to turn the system back on.

## To disable TRAC and/or VSC (4WD models)

If the vehicle gets stuck in fresh snow or mud, TRAC and VSC may reduce power from the engine to the wheels. You may need to turn the system off to enable you to rock the vehicle in order to free it.

### ■ Turning off TRAC

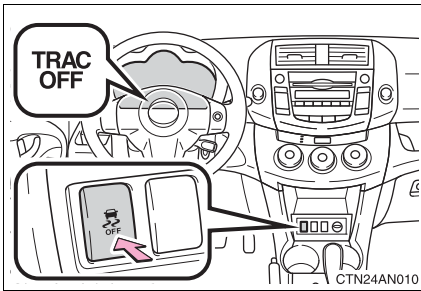

Quickly push and release the button to turn off TRAC.

The “TRAC OFF” indicator light should come on.

Push the button again to turn the system back on.

### ■ Turning off TRAC and VSC

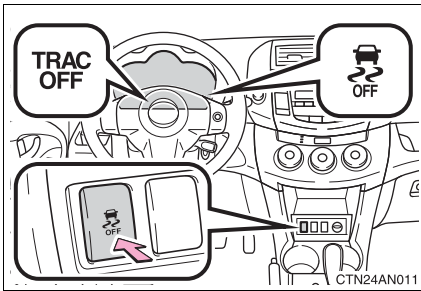

Push and hold the button while the vehicle is stopped to turn off TRAC and VSC.

The “TRAC OFF” and VSC OFF indicator lights should come on.

Push the button again to turn the system back on.

### ■ Automatic reactivation of TRAC and VSC

#### ▶ Vehicles without smart key system

Turning the engine switch OFF after turning off the TRAC and VSC systems will automatically re-enable them.

#### ▶ Vehicles with smart key system

Turning the “ENGINE START STOP” switch OFF after turning off the TRAC and VSC systems will automatically re-enable them.

### ■ Automatic TRAC reactivation

#### ▶ 2WD models

If only the TRAC system is turned off, the TRAC system will be reactivated while vehicle speed is increased.

#### ▶ 4WD models

If only the TRAC system is turned off, the TRAC system will turn on when vehicle speed increases.

### ■ Automatic TRAC and VSC reactivation

If the TRAC and VSC systems are turned off, the systems will not turn on even when vehicle speed increases.

### ■ Sounds and vibrations caused by the ABS, TRAC and VSC

- A sound may be heard from the engine compartment when the engine is started or just after the vehicle begins to move. This sound does not indicate that a malfunction has occurred in any of these systems.
- Any of the following conditions may occur when the above systems are operating. None of these indicates that a malfunction has occurred.
  - Vibrations may be felt through the vehicle body and steering.
  - A motor sound may be heard after the vehicle comes to a stop.
  - The brake pedal may pulsate slightly when the ABS is activated.
  - The brake pedal may move down slightly after the ABS is activated.

### ■ When the AUTO LSD function operates continuously

The brake actuator may overheat. In that case, the system will stop the AUTO LSD function, a buzzer will sound and the slip indicator will stay on steady. Refrain from using the AUTO LSD function until the slip indicator goes off. (There is no problem with continuing driving normally.)

### ■ EPS operation sound

When the steering wheel operates, a motor sound (whirring sound) may be heard.

This does not indicate a malfunction.

### ■ Reduced effectiveness of EPS

The effectiveness of EPS is reduced to prevent the system from overheating when there is frequent steering input over an extended period of time. The steering wheel may feel heavy as a result. Should this occur, refrain from excessive steering input or stop the vehicle and turn the engine off. The system should return to normal within 10 minutes.

### ■ If the slip indicator comes on

It may indicate a malfunction in the VSC, TRAC and AUTO LSD function. Contact your Toyota dealer.

## CAUTION

### ■ The ABS does not operate effectively when

- Tires with inadequate gripping ability are used (such as excessively worn tires on a snow covered road).
- The vehicle hydroplanes while driving at high speed on wet or slick road.

### ■ Stopping distance when the ABS is operating on the wet or slick roads

The ABS is not designed to shorten the vehicle's stopping distance. Always maintain a safe distance from the vehicle in front of you in the following situations.

- When driving on dirt, gravel or snow-covered roads
- When driving with tire chains
- When driving over bumps in the road
- When driving over roads with potholes or uneven roads

### ■ TRAC may not operate effectively when

Directional control and power may not be achievable while driving on slippery road surfaces, even if the TRAC system is operating.

Do not drive the vehicle in conditions where stability and power may be lost.

 **CAUTION**

■ **When the VSC is activated**

The slip indicator flashes and a warning buzzer sounds. Always drive carefully. Reckless driving may cause an accident. Exercise particular care when the indicator light flashes and a buzzer sounds.

■ **When TRAC and VSC are off**

Be especially careful and drive at a speed appropriate to the road conditions. As these are systems to ensure vehicle stability and driving force, do not turn off TRAC and VSC unless necessary.

■ **Replacing tires**

Make sure that all tires are of the same size, brand, tread pattern and total load capacity. In addition, make sure that the tires are inflated to the appropriate tire pressure level.

The ABS and VSC systems will not function correctly if different tires are fitted on the vehicle.

Contact your Toyota dealer for further information when replacing tires or wheels.

■ **Handling of tires and suspension**

Using tires with any kind of problem or modifying the suspension will affect the driving assist systems, and may cause the system to malfunction.



## 2-4. Using other driving systems

### Hill-start assist control\*

**Hill-start assist control helps to prevent the vehicle from rolling backwards when starting on an incline or slippery slope.**

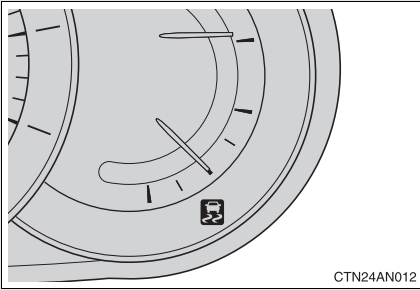

To engage hill-start assist control, further depress the brake pedal when the vehicle is stopped completely.

A buzzer will sound once to indicate the system is activated. The slip indicator will also start flashing.

#### ■ Hill-start assist control operating conditions

- The shift lever is in a position other than P.
- The parking brake is not applied.
- The accelerator pedal is not depressed.

#### ■ Hill-start assist control

- While hill-start assist control is operating, the brakes remain automatically applied after the driver releases the brake pedal. The stop lights and the high mounted stoplight turn on.
- Hill-start assist control operates for about 2 seconds after the brake pedal is released.
- If the slip indicator does not flash and the buzzer does not sound when the brake pedal is further depressed, slightly reduce the pressure on the brake pedal (do not allow the vehicle to roll backward) and then firmly depress it again. If the system still does not operate, check if the operating conditions explained above have been met.

\*: If equipped

### ■ Hill-start assist control buzzer

- When hill-start assist control is activated, the buzzer will sound once when the shift lever is in a position other than R.
- In the following situations, hill-start assist control will be canceled and the buzzer will sound twice when the shift lever is in a position other than R.
  - No attempt is made to drive the vehicle within approximately 2 seconds of releasing the brake pedal.
  - The shift lever is moved to P.
  - The parking brake is applied.
  - The brake pedal is depressed again.
- When the shift lever is in R, the buzzer indicating the start and end of the operation does not sound. Use the slip indicator status (flashing or off) to confirm if hill-start assist control is operating.

### ■ If the slip indicator comes on

It may indicate a malfunction in the system. Contact your Toyota dealer.

### CAUTION

#### ■ Hill-start assist control

- Do not overly rely on hill-start assist control. Hill-start assist control may not operate effectively on extremely steep inclines or roads covered in ice.
- Unlike the parking brake, hill-start assist control is not intended to hold the vehicle stationary for an extended period of time. Do not attempt to use hill-start assist control to hold the vehicle on an incline for an extended period of time, as doing so may lead to an accident.

## Downhill assist control system\*

With the downhill assist control system, the vehicle is able to descend a steep hill while maintaining a constant low speed of about 3 mph (5 km/h) without brake pedal operation.

### ■ Activating the downhill assist control system

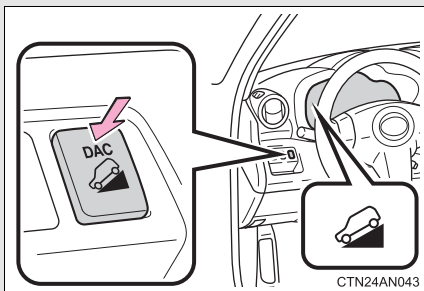

Press the "DAC" switch.

The downhill assist control system indicator will come on to indicate that the downhill assist control system is activated.

Pressing the switch again turns the system off.

### While the downhill assist control system is operating

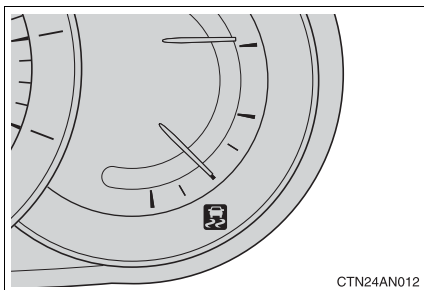

The slip indicator will flash to indicate that the downhill assist control system is operating, and the stop lights and high mounted stoplight will turn on.

\*: If equipped

■ **Conditions in which the downhill assist control system does not operate or will stop operating**

- In the following situations, the downhill assist control system indicator flashes and the downhill assist control system does not operate or will stop operating:
  - The shift lever is not in L or R.
  - The vehicle speed is higher than 15 mph (25 km/h).
- If the accelerate or brake pedal is depressed, the downhill assist control system will stop operating with the downhill assist control system indicator stayed on.

■ **If the “DAC” switch is turned off while the downhill assist control system is operating**

The downhill assist control system gradually ceases operation. The downhill assist control system indicator will flash during the canceling operation, and then go off when the system is fully off.

■ **Downhill assist control system operation sound**

- A sound may be heard from the engine compartment while the downhill assist control system is operating. This sound does not indicate a malfunction.
- If the accelerator or brake pedal is depressed while the downhill assist control system is operating, a sound caused by the release of system operation may be heard, or you may feel the brake pedal push-back. This does not indicate a malfunction.

■ **When the downhill assist control system operates continuously**

The brake actuator may overheat. In that case, the downhill assist control system will stop operating, a buzzer will sound and the downhill assist control system indicator will start flashing. Refrain from using the system until the downhill assist control system indicator stays on. (There is no problem with continuing driving normally.)

■ **If the slip indicator comes on**

It may indicate a malfunction in the system. Contact your Toyota dealer.

 CAUTION**■ Conditions which may affect the downhill assist control system operation**

- Do not rely too heavily on the downhill assist control system. On extremely steep inclines, icy surfaces or muddy roads, the vehicle may slip and the system may not be able to maintain the constant low vehicle speed of about 3 mph (5 km/h), leading to an accident causing death or serious injury.
- Do not shift the shift lever to R while driving forward, or to D while driving backward. Doing so may cause the wheels to lock up, leading to an accident causing death or serious injury. In addition, excessive stress will be applied to the automatic transmission, possibly resulting in damage.

## Four-wheel drive lock switch (4WD models)

Four-wheel drive lock mode can be used when a large amount of drive power needs to be applied to all the wheels, such as when the vehicle gets stuck in mud and you need to free it.

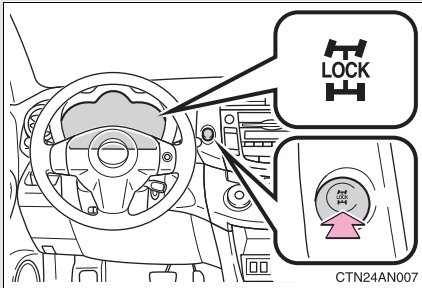

Press the switch.

The torque of the engine is distributed to the rear wheels to the maximum extent possible in accordance with driving conditions.

Pressing the switch again cancels four-wheel drive lock mode and returns the Active Torque Control 4WD system to normal mode. (→P. 184)

### ■ Four-wheel drive lock mode can be operated when

- ▶ Vehicles without smart key system

The engine switch is in the "ON" position.

- ▶ Vehicles with smart key system

The "ENGINE START STOP" switch is in IGNITION ON mode.

### ■ Four-wheel drive lock mode

- Four-wheel drive lock mode is canceled when the brakes are applied to ensure the ABS and VSC systems operate effectively.
- Four-wheel drive lock mode is canceled when the vehicle speed exceeds 25 mph (40 km/h).

## Utility vehicle precautions

This vehicle belongs to the utility vehicle class, which has higher ground clearance and narrower tread in relation to the height of its center of gravity to make it capable of performing in a wide variety of off-road applications.

### Off-road vehicle feature

- Specific design characteristics give it a higher center of gravity than ordinary passenger cars. This vehicle design feature causes this type of vehicle to be more likely to rollover. And, utility vehicles have a significantly higher rollover rate than other types of vehicles.
- An advantage of the higher ground clearance is a better view of the road allowing you to anticipate problems.
- It is not designed for cornering at the same speeds as ordinary passenger cars any more than low-slung sports cars designed to perform satisfactorily under off-road conditions. Therefore, sharp turns at excessive speeds may cause rollover.

 CAUTION

■ **Off-road vehicle precautions**

Always observe the following precautions to minimize the risk of serious personal injury or damage to your vehicle:

- In a rollover crash, an unbelted person is significantly more likely to die than a person wearing a seat belt. Therefore, the driver and all passengers should fasten their seat belts whenever the vehicle is moving.
- Avoid sharp turns or abrupt maneuvers, if at all possible.  
Failure to operate this vehicle correctly may result in loss of control or vehicle rollover causing death or serious injury.
- Loading cargo on the roof luggage carrier will make the center of the vehicle gravity higher. Avoid high speeds, sudden starts, sharp turns, sudden braking or abrupt maneuvers, otherwise it may result in loss of control or vehicle rollover due to failure to operate this vehicle correctly.
- Always slow down in gusty crosswinds. Because of its profile and higher center of gravity, your vehicle is more sensitive to side winds than an ordinary passenger car. Slowing down will allow you to have better control.
- Do not drive horizontally across steep slopes. Driving straight up or straight down is preferred. Your vehicle (or any similar off-road vehicle) can tip over sideways much more easily than forward or backward.



## Off-road driving

When driving your vehicle off-road, please observe the following precautions to ensure your driving enjoyment and to help prevent the closure of areas to off-road vehicles.

- Drive your vehicle only in areas where off-road vehicles are permitted to travel.
- Respect private property. Get owner's permission before entering private property.
- Do not enter areas that are closed. Honor gates, barriers and signs that restrict travel.
- Stay on established roads. When conditions are wet, driving techniques should be changed or travel delayed to prevent damage to roads.

---

### ■ Additional information for off-road driving

► For owners in U.S. mainland, Hawaii and Puerto Rico:

To obtain additional information pertaining to driving your vehicle off-road, consult the following organizations.

- State and Local Parks and Recreation Departments
- State Motor Vehicle Bureau
- Recreational Vehicle Clubs
- U.S. Forest Service and Bureau of Land Management

 CAUTION

■ **Off-road driving precautions**

Always observe the following precautions to minimize the risk of death or serious personal injury or damage to your vehicle:

- Drive carefully when off the road. Do not take unnecessary risks by driving in dangerous places.
- Do not grip the steering wheel spokes when driving off-road. A bad bump could jerk the wheel and injure your hands. Keep both hands and especially your thumbs on the outside of the rim.
- Always check your brakes for effectiveness immediately after driving in sand, mud, water or snow.
- After driving through tall grass, mud, rock, sand, water, etc., check that there is no grass, bush, paper, rags, stone, sand, etc. adhering or trapped on the underbody. Clear off any such matter from the underbody. If the vehicle is used with these materials trapped or adhering to the underbody, a breakdown or fire could occur.
- When driving off-road or in rugged terrain, do not drive at excessive speeds, jump, make sharp turns, strike objects, etc. This may cause loss of control or vehicle rollover causing death or serious injury. You are also risking expensive damage to your vehicle's suspension and chassis.

 NOTICE

■ **To prevent the water damage**

Take all necessary safety measures to ensure that water damage to the engine or other components does not occur.

- Water entering the engine air intake will cause severe engine damage.
- Water entering the automatic transmission will cause deterioration in shift quality, locking up of your transmission accompanied by vibration, and ultimately damage.
- Water can wash the grease from wheel bearings, causing rusting and premature failure, and may also enter the differentials, transmission and transfer case, reducing the gear oil's lubricating qualities.

 NOTICE**■ When you drive through water**

If driving through water, such as when crossing shallow streams, first check the depth of the water and the bottom of the stream for firmness. Drive slowly and avoid deep water.

**■ Inspection after off-road driving**

- Sand and mud that has accumulated around brake discs may affect braking efficiency and may damage brake system components.
- Always perform a maintenance inspection after each day of off-road driving that has taken you through rough terrain, sand, mud, or water. For scheduled maintenance information, refer to the “Scheduled Maintenance Guide” or “Owner’s Manual Supplement”.

## 2-5. Driving information

# Cargo and luggage

**Take notice of the following information about storage precautions, cargo capacity and load.**

- Stow cargo and luggage in the luggage compartment whenever possible. Be sure all items are secured in place.
- Be careful to keep the vehicle level. Placing the weight as far forward as possible helps maintain vehicle balance.
- For better fuel economy, do not carry unnecessary weight.

### ■ Roof luggage carrier (if equipped)

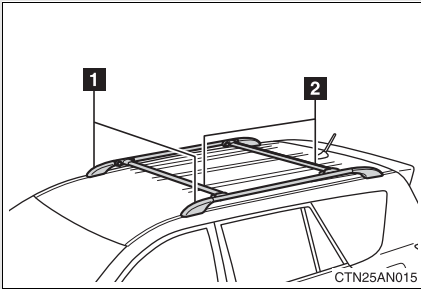

- 1 Roof rails
- 2 Cross rails

### Adjusting the cross rail positions

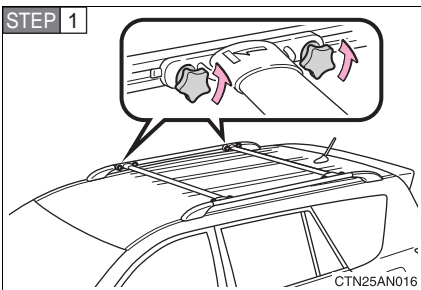

Turn the knobs counterclockwise to release the cross rails.

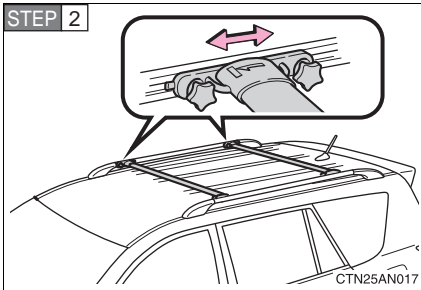

Slide the cross rails to the appropriate position for loading luggage and turn the knobs clockwise to tighten the cross rails securely.

## Capacity and distribution

Cargo capacity depends on the total weight of the occupants.

(Cargo capacity) = (Total load capacity) - (Total weight of occupants)

### Steps for Determining Correct Load Limit—

- (1) Locate the statement “The combined weight of occupants and cargo should never exceed XXX kg or XXX lbs.” on your vehicle's placard.
- (2) Determine the combined weight of the driver and passengers that will be riding in your vehicle.
- (3) Subtract the combined weight of the driver and passengers from XXX kg or XXX lbs.
- (4) The resulting figure equals the available amount of cargo and luggage load capacity.

For example, if the “XXX” amount equals 1400 lbs. and there will be five 150 lb passengers in your vehicle, the amount of available cargo and luggage load capacity is 650 lbs. (1400 - 750 (5 × 150) = 650 lbs.)

- (5) Determine the combined weight of luggage and cargo being loaded on the vehicle. That weight may not safely exceed the available cargo and luggage load capacity calculated in Step 4.

(6) If your vehicle will be towing a trailer, load from your trailer will be transferred to your vehicle. Consult this manual to determine how this reduces the available cargo and luggage load capacity of your vehicle.

**Example on your vehicle**

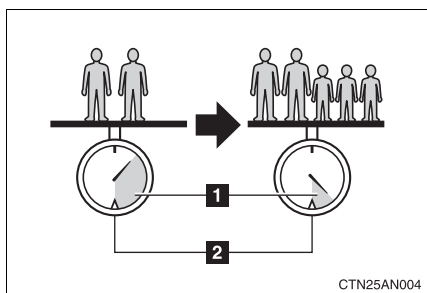

- 1** Cargo capacity
- 2** Total load capacity

When 2 people with the combined weight of 366 lb. (166 kg) are riding in your vehicle, the available amount of cargo and luggage load capacity will be as follows:

Without third seat

Total load capacity: 825 lb. (370 kg)

825 lb. - 366 lb. = 459 lb. (370 kg - 166 kg = 204 kg)

With third seat

Total load capacity: 1155 lb. (520 kg)

1155 lb. - 366 lb. = 789 lb. (520 kg - 166 kg = 354 kg)

In this condition, if 3 more passengers with the combined weight of 388 lb. (176 kg) get on, the available cargo and luggage load will be reduced as follows:

Without third seat

459 lb. - 388 lb. = 71 lb. (204 kg - 176 kg = 28 kg)

With third seat

789 lb. - 388 lb. = 401 lb. (354 kg - 176 kg = 178 kg)

As shown in the above example, if the number of occupants increases, the cargo and luggage load will be reduced by an amount that equals the increased weight due to the additional occupants. In other words, if an increase in the number of occupants causes an excess of the total load capacity (combined weight of occupants plus cargo and luggage load), you must reduce the cargo and luggage on your vehicle.

### CAUTION

#### ■ Things that must not be carried in the luggage compartment

The following things may cause a fire if loaded in the luggage compartment.

- Receptacles containing gasoline
- Aerosol cans

#### ■ Storage precautions

Observe the following precautions.

Failing to do so may result in death or serious injury.

- Do not place cargo or luggage in or on the following locations as the item may get under the brake or accelerator pedal and prevent the pedals from being depressed properly, block the driver's vision, or hit the driver or passengers, causing an accident.
  - Driver's feet
  - Front passenger or rear seats (when stacking items)
  - Luggage cover
  - Instrument panel
  - Dashboard
  - Auxiliary box or tray that has no lid
- Secure all items in the occupant compartment, as they may shift and injure someone during sudden braking, sudden swerving or an accident.
- Never allow anyone to ride in the luggage compartment. It is not designed for passengers. They should ride in their seats with their seat belts properly fastened. Otherwise, they are much more likely to suffer serious bodily injury, in the event of sudden braking, sudden swerving or an accident.

 **CAUTION**

■ **Capacity and distribution**

- Do not exceed the maximum axle weight rating or the total vehicle weight rating.
- Even if the total load of occupant's weight and the cargo load is less than the total load capacity, do not apply the load unevenly. Improper loading may cause deterioration of steering or braking control which may cause death or serious injury.

■ **Roof luggage carrier precautions**

When you load cargo on the roof luggage carrier, observe the following:

- Place the cargo so that its weight is distributed evenly between the front and rear axles.
- If loading long or wide cargo, never exceed the vehicle overall length or width. (→P. 474)
- Before driving, make sure the cargo is securely fastened on the roof luggage carrier.
- Loading cargo on the roof luggage carrier will make the center of the vehicle gravity higher. Avoid high speeds, sudden starts, sharp turns, sudden braking or abrupt maneuvers, otherwise it may result in loss of control or vehicle rollover due to failure to operate this vehicle correctly and result in death or serious injury.
- If driving for a long distance, on rough roads, or at high speeds, stop the vehicle now and then during the trip to make sure the cargo remains in its place.
- Do not exceed 102.6 lb. (46.2 kg) cargo weight on the roof luggage carrier.

■ **Cross rail adjustment**

Make sure the cross rails are locked securely by pushing forward and rearward them.

Failure to do so may cause an unexpected accident or severe injury in the event of emergency braking or a collision.





**NOTICE**

■ **When loading luggage (vehicles with moon roof)**

Be careful not to scratch the surface of the moon roof.

## Vehicle load limits

**Vehicle load limits include total load capacity, seating capacity, towing capacity and cargo capacity.**

■ **Total load capacity: Without third seat**

**825 lb. (370 kg)**

**With third seat**

**1155 lb. (520 kg)**

Total load capacity means the combined weight of occupants, cargo and luggage.

■ **Seating capacity: Without third seat**

**5 occupants (Front 2, Rear 3)**

**With third seat**

**7 occupants (Front 2, Rear 5)**

Seating capacity means the maximum number of occupants whose estimated average weight is 150 lb. (68 kg) per person.

■ **Towing capacity**

**2.5 L 4-cylinder (2AR-FE) engine: 1500 lb. (680 kg)**

**3.5 L V6 (2GR-FE) engine: Without towing package**

**2000 lb. (905 kg)**

**With towing package**

**3500 lb. (1585 kg)**

Towing capacity means the maximum gross trailer weight (trailer weight plus its cargo weight) that your vehicle is able to tow.

■ **Cargo capacity**

Cargo capacity may increase or decrease depending on the weight and the number of occupants.

---

■ **Total load capacity and seating capacity**

These details are also described on the tire and loading information label. (→P. 380)

 **CAUTION****■ Overloading the vehicle**

Do not overload the vehicle.

It may not only cause damage to the tires, but also degrade steering and braking ability, resulting in an accident.

## 2-5. Driving information

# Winter driving tips

**Carry out the necessary preparations and inspections before driving the vehicle in winter. Always drive the vehicle in a manner appropriate to the prevailing weather conditions.**

### ■ Pre-winter preparations

- Use fluids that are appropriate to the prevailing outside temperatures.
  - Engine oil
  - Engine coolant
  - Washer fluid
- Have a service technician inspect the level and specific gravity of battery electrolyte.
- Have the vehicle fitted with four snow tires or purchase a set of tire chains for the front tires.

Ensure that all tires are the same size and brand, and that chains match the size of the tires.

### ■ Before driving the vehicle

Observe the following according to the driving conditions.

- Do not try to forcibly open a window or move a wiper that is frozen. Pour warm water over the frozen area to melt the ice. Wipe away the water immediately to prevent it from freezing.
- To ensure proper operation of the climate control system fan, remove any snow that has accumulated on the air inlet vents in front of the windshield.
- Remove any ice that has accumulated on the vehicle chassis.
- Periodically check for and remove any excess ice or snow that may have accumulated in the wheel well or on the brakes.

### ■ When driving the vehicle

Accelerate the vehicle slowly and drive at a reduced speed suitable to road conditions.

### ■ When parking the vehicle

Park the vehicle and move the shift lever to P without setting the parking brake. The parking brake may freeze up, preventing it from being released. If necessary, block the wheels to prevent inadvertent sliding or creeping.

## Selecting tire chains

Use the correct tire chain size when mounting the snow chains. Chain size is regulated for each tire size.

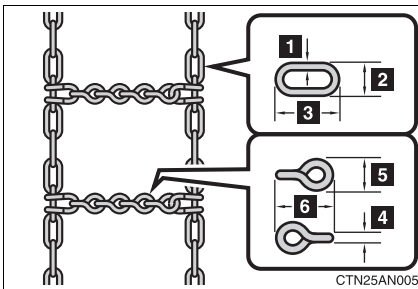

#### ► Side chain

- 1** 0.12 in. (3 mm) in diameter
- 2** 0.39 in. (10 mm) in width
- 3** 1.18 in. (30 mm) in length

#### ► Cross chain

- 4** 0.16 in. (4 mm) in diameter
- 5** 0.55 in. (14 mm) in width
- 6** 0.98 in. (25 mm) in length

## Regulations on the use of snow chains

- Regulations regarding the use of tire chains vary according to location and type of road. Always check local regulations before installing chains.
- Install the chains on the front tires.
- Retighten the chains after driving 1/4 - 1/2 mile (0.5 - 1.0 km).

### ■ Tire chain installation

Observe the following precautions when installing and removing chains.

- Install and remove tire chains in a safe location.
- Install tire chains on the front tires.
- Install tire chains following the instructions provided in the accompanying manual.

### CAUTION

#### ■ Driving with snow tires

Observe the following precautions to reduce the risk of accidents.

Failing to do so may result in a loss of vehicle control and cause death or serious injury.

- Use tires of the specified size.
- Maintain the recommended level of air pressure.
- Do not drive in excess of 75 mph (120 km/h), regardless of the type of snow tires being used.
- Snow tires should be installed on all wheels.
- Do not mix tires of different makes, models, tread patterns or treadwear.

#### ■ Driving with tire chains

Observe the following precautions to reduce the risk of accidents.

Failing to do so may result in the vehicle being unable to be driven safely, and may cause death or serious injury.

- Do not drive in excess of the speed limit specified for the tire chains being used or 30 mph (50 km/h), whichever is lower.
- Avoid driving on bumpy road surfaces or over potholes.
- Avoid sudden turns and braking, as use of chains may adversely affect vehicle handling.
- Slow down sufficiently before entering a curve to ensure that vehicle control is maintained.

**NOTICE**

Vehicles with a tire pressure warning system:

**■ Repairing or replacing snow tires**

Request repairs of and obtain replacement snow tires from Toyota dealers or legitimate tire retailers.

This is because the removal and attachment of snow tires affects the operation of the tire pressure warning valves and transmitters.

**■ Fitting tire chains**

The tire pressure warning valves and transmitters may not function correctly when tire chains are fitted.

## Trailer towing

Your vehicle is designed primarily as a passenger-carrying vehicle. Towing a trailer will have an adverse effect on handling, performance, braking, durability, and fuel consumption. For your safety and the safety of others, do not overload the vehicle or trailer.

Toyota warranties do not apply to damage or malfunction caused by towing a trailer for commercial purposes.

### ■ Weight limits

Confirm that the total trailer weight, gross vehicle weight, gross axle weight and trailer tongue load are all within the limits.

### ■ Gross vehicle weight

The gross vehicle weight must not exceed the Gross Vehicle Weight Rating (GVWR) indicated on the Certification Label. The gross vehicle weight is the sum weight of the unloaded vehicle, driver, passengers, luggage, hitch and trailer tongue load. Also included is the weight of any special equipment installed on your vehicle.

### ■ Gross axle weight

The load on either the front or rear axle resulting from distribution of the gross vehicle weight on both axles must not exceed the Gross Axle Weight Rating (GAWR) listed on the Certification Label.

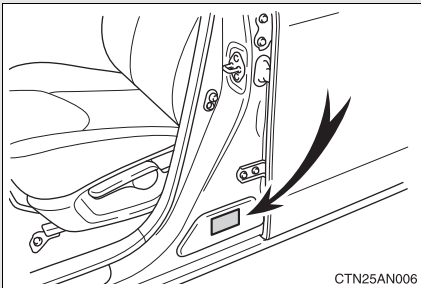

Certification label

CTN25AN006



### ■ Trailer tongue load

The trailer cargo load should be distributed so that the tongue load is 9 to 11% of the total trailer weight, not exceeding the maximum load of the following. (Tongue load / Total trailer weight x 100 = 9 to 11%)

▶ 2.5 L 4-cylinder (2AR-FE) engine: 150 lb. (68 kg)

▶ 3.5 L V6 (2GR-FE) engine

Without towing package: 200 lb. (90 kg)

With towing package: 350 lb. (158 kg)

If the gross trailer weight is over 2000 lbs. (907 kg), it is necessary to use a sway control device with sufficient capacity.

The total trailer weight and tongue load can be measured with platform scales found at highway weighing stations, building supply companies, trucking companies, junk yards, etc.

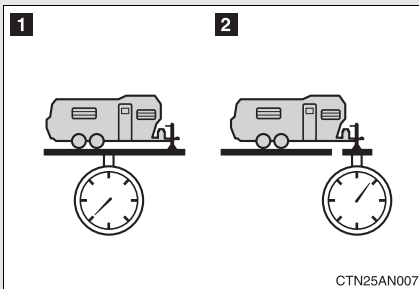

**1** Total trailer weight

**2** Tongue load

CTN25AN007

## **Towing a trailer**

Contact your Toyota dealer for further information about additional requirements such as a towing kit, etc.

## **Hitch**

Trailer hitch assemblies have different weight capacities established by the hitch manufacturer. Even though the vehicle may be rated for towing a higher weight, the operator must never exceed the maximum weight rating specified for the trailer hitch.

## Selecting a trailer ball

Use the correct trailer ball for your application.

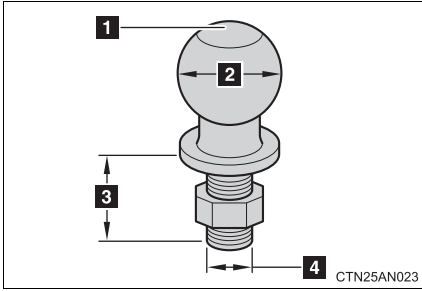

### 1 Trailer ball load rating

Matches or exceeds the gross trailer weight rating of the trailer.

### 2 Ball diameter

Matches the size of the trailer coupler. Most couplers are stamped with the required trailer ball size.

Trailer class	Typical trailer ball size
IV	2 5/16 in.
II and III	2 in.
I	1 7/8 in.

### 3 Shank length

Protrudes beyond the bottom of the lock washer and nut at least 2 threads.

### 4 Shank diameter

Matches the ball mount hole diameter size.

## Connecting trailer lights

Please consult your dealer when installing trailer lights, as incorrect installation may cause damage to the vehicle's lights. Please take care to comply with your state's laws when installing trailer lights.

---

### ■ Before towing

- Ensure that your vehicle's tires are properly inflated. (→P. 484)
- Trailer tires should be inflated according to the trailer manufacturer's recommendation.
- All trailer lights must work in order to be legal.
- Confirm all lights work each time you connect them.
- The trailer ball is set up at the proper height for the coupler on the trailer.
- Check that your vehicle remains level when a loaded or unloaded trailer is hitched. Do not drive if the vehicle is not level, and check for improper tongue load, overloading, worn suspension, or other possible causes.
- Make sure the trailer cargo is securely loaded.
- Check that your rear view mirrors conform to any federal, state/provincial or local regulations. If they do not, install rear view mirrors appropriate for towing purposes.

### ■ Break-in schedule

Toyota recommends that you do not use a new vehicle or a vehicle with any new power train components (engine, transmission, differential, wheel bearings, etc.) to tow a trailer for the first 500 miles (800 km) of driving.

### ■ Maintenance

- If you tow a trailer, your vehicle will require more frequent maintenance due to the additional load. (See "Scheduled Maintenance Guide" or "Owner's Manual Supplement".)
- Retighten the fixing bolts of the towing ball and bracket after approximately 600 miles (1000 km) of trailer towing.

 **CAUTION****■ To avoid accident or injury**

- Do not exceed the trailer hitch assembly weight, gross vehicle weight, gross axle weight and trailer tongue load capacities.
- Never load more weight in the back than in the front of the trailer. About 60% of the load should be in the front half of the trailer, and the remaining 40% in the rear.
- Do not use cruise control when you are towing.

**■ Hitches**

- Use only a hitch that conforms to the total trailer weight requirement.
- Follow the directions supplied by the hitch manufacturer.
- Lubricate the hitch ball with a light coat of grease.
- Remove the trailer hitch whenever you are not towing a trailer. After removing the hitch, seal any mounting hole in the vehicle body to prevent entry of any substances into the vehicle.

**■ When towing a trailer**

- If the gross trailer weight exceeds 600 lb. (272 kg), trailer brakes are required.
- Never tap into your vehicle's hydraulic system, as this will lower the vehicle's braking effectiveness.
- Never tow a trailer without using a safety chain securely attached to both the trailer and the vehicle. If damage occurs to the coupling unit or hitch ball, there is danger of the trailer wandering into another lane.

 NOTICE

■ **When installing a trailer hitch**

- Use only the position recommended by your Toyota dealer. Do not install the trailer hitch on the bumper; this may cause body damage.
- Do not use axle-mounted hitches, as they can cause damage to the axle housing, wheel bearings, wheels or tires.

■ **Brakes**

Toyota recommends trailers with brakes that conform to all applicable federal and state/provincial regulations.

■ **Safety chain**

A safety chain must always be used between the towing vehicle and the trailer. Leave sufficient slack in the chain for turns. The chain should cross under the trailer tongue to prevent the tongue from dropping to the ground in the case that it becomes damaged or separated. For the correct safety chain installation procedure, ask your Toyota dealer.

■ **Do not directly splice trailer lights**

Directly splicing trailer lights may damage your vehicle's electrical system and cause a malfunction.

**Trailer towing tips**

Your vehicle will handle differently when towing a trailer. In order to avoid accident, death or serious injury, keep the following in mind when towing:

- Before starting out, check the trailer lights and the vehicle-trailer connections. Recheck after driving a short distance.
- Practice turning, stopping and reversing with the trailer attached in an area away from traffic until you become accustomed to the feel of the vehicle.

- Reversing with a trailer attached is difficult and requires practice. Grip the bottom of the steering wheel and move your hand to the left to move the trailer to the left. Move your hand to the right to move the trailer to right. (This is generally opposite to reversing without a trailer attached.) Avoid sharp or prolonged turning. Have someone guide you when reversing to reduce the risk of an accident.
- As stopping distance is increased when towing a trailer, vehicle-to-vehicle distance should be increased. For each 10 mph (16 km/h) of speed, allow at least one vehicle and trailer length.
- Avoid sudden braking as you may skid, resulting in jackknifing and loss of control. This is especially true on wet or slippery surfaces.
- Avoid jerky starts or sudden acceleration.
- Avoid jerky steering and sharp turns, and slow down before making turns.
- Note that when making a turn, the trailer wheels will be closer than the vehicle wheels to the inside of the turn. Compensate by making a larger than normal turning radius.
- Crosswinds and rough roads will adversely affect handling of your vehicle and trailer, causing sway. Periodically check the rear to prepare for being passed by large trucks or buses, which may cause your vehicle and trailer to sway. If swaying occurs, firmly grip the steering wheel, reduce speed immediately but gradually, and steer straight ahead. Never increase speed. If you make no extreme correction with the steering or brakes, your vehicle and trailer will stabilize.
- Take care when passing other vehicles. Passing requires considerable distance. After passing a vehicle, do not forget the length of your trailer, and be sure you have plenty of room before changing lanes.
- In order to maintain efficient engine braking and electrical charging performance, do not use overdrive.

- Due to the added load of the trailer, your vehicle's engine may overheat on hot days (at temperatures over 85°F [30°C]) when driving up a long or steep grade. If the engine coolant temperature gauge indicates overheating, immediately turn off the air conditioning (if in use), pull your vehicle off the road and stop in a safe spot. (→P. 466)

- Always place wheel blocks under both the vehicle and the trailer wheels when parking. Apply the parking brake firmly, and put the transmission in P. Avoid parking on a slope, but if unavoidable, do so only after performing the following:

**STEP 1** Apply the brakes and keep them applied.

**STEP 2** Have someone place wheel blocks under both the vehicle and trailer wheels.

**STEP 3** When the wheel blocks are in place, release the brakes slowly until the blocks absorb the load.

**STEP 4** Apply the parking brake firmly.

**STEP 5** Shift into P and turn off the engine.

- When restarting after parking on a slope:

**STEP 1** With the transmission in P, start the engine. Be sure to keep the brake pedal pressed.

**STEP 2** Shift into a forward gear. If reversing, shift into R.

**STEP 3** Release the parking brake and brake pedal, and slowly pull or back away from the wheel blocks. Stop and apply the brakes.

**STEP 4** Have someone retrieve the blocks.



 **CAUTION****■ To avoid an accident**

- Do not exceed 45 mph (72 km/h) or posted towing speed limit, whichever is lower. As instability (swaying) of the towing vehicle-trailer combination increases as speed increases, exceeding 45 mph (72 km/h) may cause loss of control.
- Slow down and downshift before descending steep or long downhill grades. Do not make sudden downshifts.
- Avoid holding the brake pedal down too long or applying the brakes too frequently. This could cause the brakes to overheat and result in reduced braking efficiency.
- Do not use cruise control when you are towing.

## 2-5. Driving information

### Dinghy towing

**Your vehicle is not designed to be dinghy towed (with 4 wheels on the ground) behind a motor home.**

#### NOTICE

##### **■ To avoid serious damage to your vehicle**

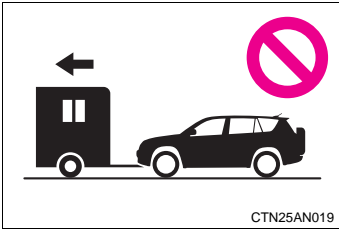

Do not tow your vehicle with 4 wheels on the ground.

##### **■ To prevent causing serious damage to the transmission and Active Torque Control 4WD system (4WD models)**

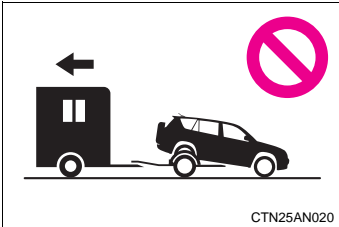

2WD models: Never tow this vehicle from the rear with the front wheels on the ground. This may cause serious damage to the transmission.

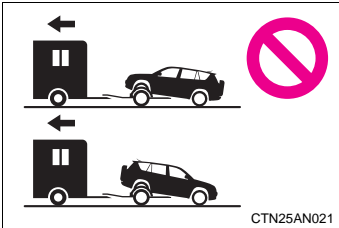

4WD models: Never tow this vehicle with any of the wheels on the ground. This may cause serious damage to the transmission and Active Torque Control 4WD system.

## 3-1. Using the air conditioning system and defogger Manual air conditioning system\*

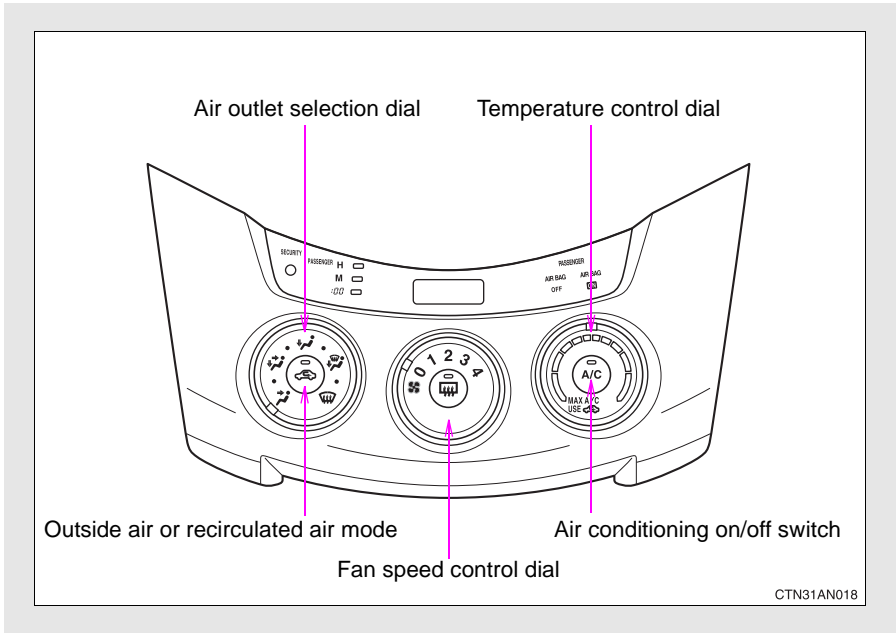

### Adjusting the settings

#### ■ Adjusting the temperature setting

Turn the temperature control dial clockwise (warm) or counter-clockwise (cool).

If  is not pressed, the system will blow ambient temperature air or heated air.

#### ■ Adjusting the fan speed

Turn the fan speed control dial clockwise (increase) or counter-clockwise (decrease).

Set the dial to "0" to turn the fan off.

\*: If equipped

### ■ Changing the air outlets

Set the air outlet selection dial to an appropriate position.

The positions between the air outlet selections shown below can be also selected for more detailed adjustment.

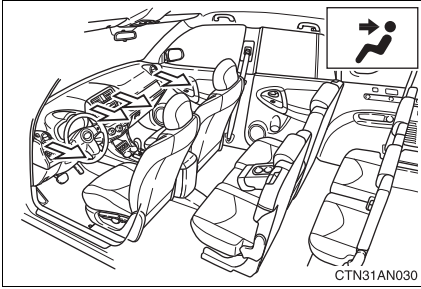

Air flows to the upper body.

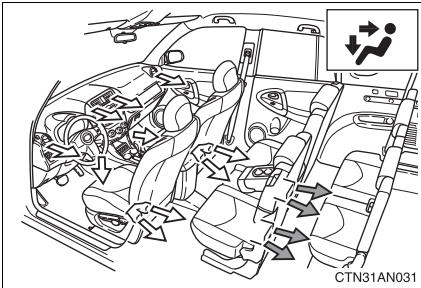

Air flows to the upper body and feet.

➡ : Vehicles with third seats

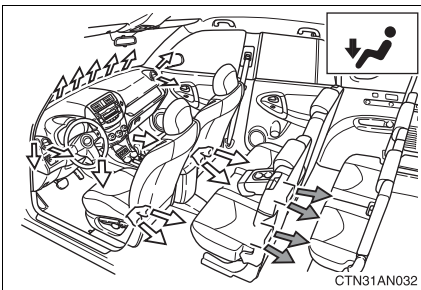

Air flows mainly to the feet.

➡ : Vehicles with third seats

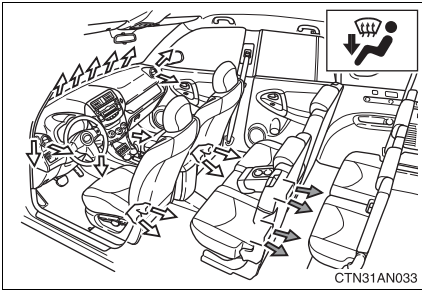

Air flows to the feet and the windshield defogger operates.

The air intake is automatically switched to outside air mode. It is not possible to return to recirculated air mode when the dial is set at this position.

Pressing  to turn the air conditioning on clears the windshield and side windows faster.

➡ : Vehicles with third seats

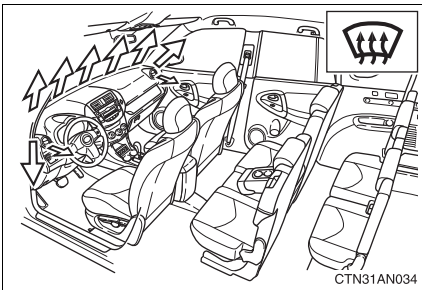

Air flows to the windshield and side windows.

The air intake is automatically switched to outside air mode. It is not possible to return to recirculated air mode when the dial is set at this position.

Pressing  to turn the air conditioning on clears the windshield and side windows faster.

### ■ Switching between outside air and recirculated air modes

Press .

The mode switches between outside air mode (indicator off) and recirculated air mode (indicator on) each time  is pressed.

### Adjusting the position of the air outlets

► Front outlets (center)

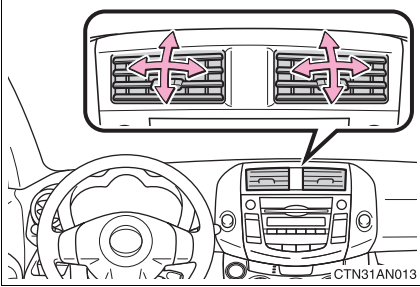

Direct air flow to the left or right, up or down.

► Front outlets (right and left sides)

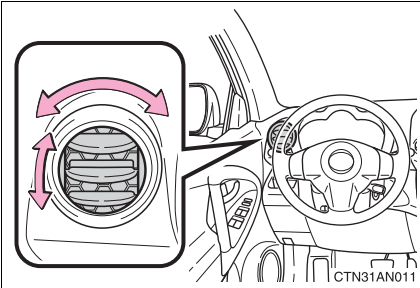

Direct air flow to the left or right, up or down.

### Opening and closing the side outlets

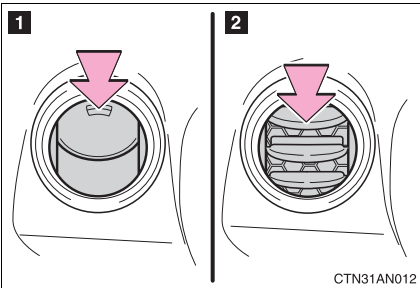

- 1** Open the vent.
- 2** Close the vent.

■ **Using the system in recirculated air mode**

The windows will fog up more easily if the recirculated air mode is used for an extended period.

■ **Window defogger feature**

Recirculated air mode may automatically be switched to outside air mode in situations where the windows need to be defogged.

■ **When outside air temperature approaches 32°F (0°C)**

The air conditioning system may not operate even when  is pressed.

■ **When the indicator light on  flashes**

Press  and turn off the air conditioning system before turning it on once more. There may be a problem in the air conditioning system if the indicator light keeps flashing. Turn the air conditioning system off and have it inspected by your Toyota dealer.

■ **When  is selected for the air outlets used**

For your driving comfort, air flowing to the feet may be warmer than air flowing to the upper body depending on the position of the temperature setting.

■ **Air conditioning odors**

- During use, various odors from inside and outside the vehicle may enter into and accumulate in the air conditioning system. This may then cause odor to be emitted from the vents.

- To reduce potential odors from occurring:  
It is recommended that the air conditioning system be set to outside air mode prior to turning the vehicle off.

 **CAUTION**

■ **To prevent the windshield from fogging up**

Do not set the air outlet selection dial to  during cool air operation in extremely humid weather. The difference between the temperature of the outside air and that of the windshield can cause the outer surface of the windshield to fog up, blocking your vision.



**NOTICE**

■ **To prevent battery discharge**

Do not leave the air conditioning system on longer than necessary when the engine is off.



### 3-1. Using the air conditioning system and defogger Automatic air conditioning system\*

**Airflow and outlets are automatically adjusted according to the temperature setting.**

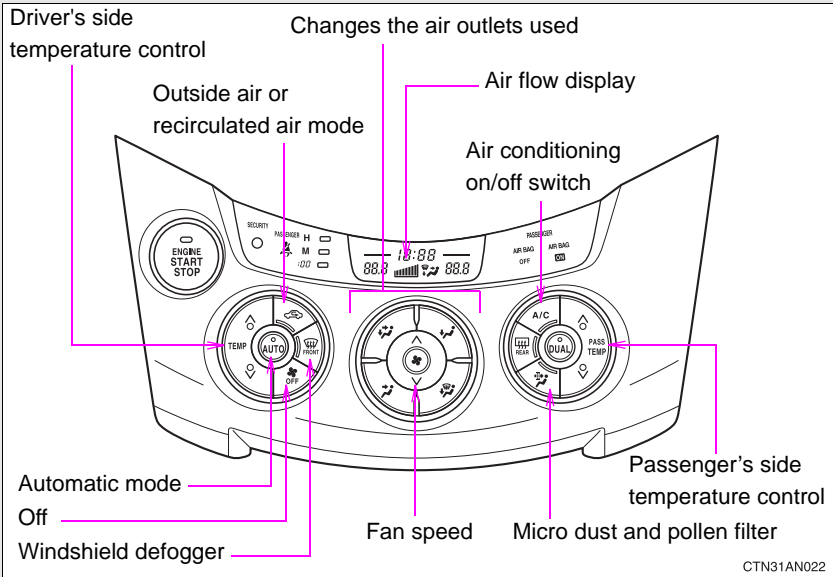

#### Using the automatic mode

**STEP 1** Press .

The air conditioning system begins to operate. Air outlets and fan speed are automatically adjusted according to the temperature setting.

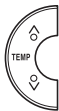
**STEP 2** Press “^” on  to increase the temperature and “v” to decrease the temperature.

Air outlets and fan speed for the driver and passenger seats may be set separately depending on the temperature setting.



\*: If equipped

## Adjusting the settings

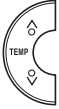
### ■ Adjusting the temperature setting

Press “^” on  to increase the temperature and “v” to decrease the temperature.

The air conditioning system switches between individual and simultaneous modes each time  is pressed.

Simultaneous mode (the indicator on  is off): Only  (driver's side) can be used to adjust the temperature for all seats.

Individual mode (the indicator on  is on): The temperature for the driver and passenger seats can be adjusted separately. Operating the passenger's side temperature control starts individual mode.

### ■ Adjusting the fan speed

Press “^” (increase) or “v” (decrease) on  .

The fan speed is shown on the display. (7 levels)

Press  to turn the fan off.

### ■ Changing the air outlets

Press the desired button, , ,  or .

The air flow shown on the display indicates the following.

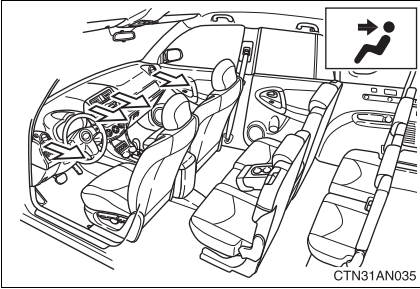

Air flows to the upper body.

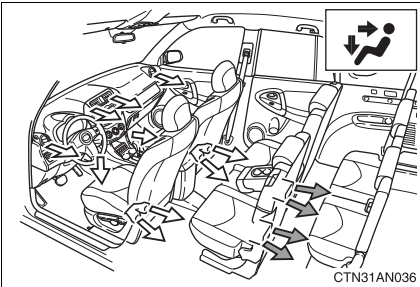

Air flows to the upper body and feet.

➔ : Vehicles with third seats

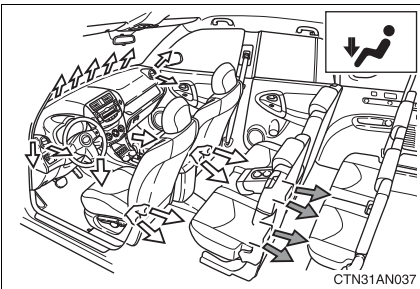

Air flows mainly to the feet.

➔ : Vehicles with third seats

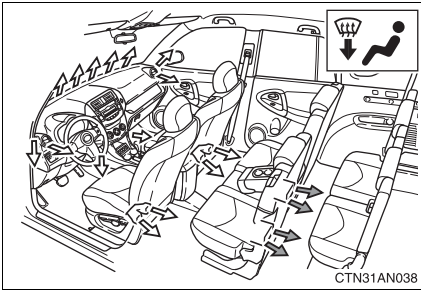

Air flows to the feet and the windshield defogger operates.

➔ : Vehicles with third seats

### ■ Switching between outside air and recirculated air modes

Press .

The mode switches between outside air mode (indicator off) and recirculated air mode (indicator on) each time  is pressed.

### Defogging the windshield

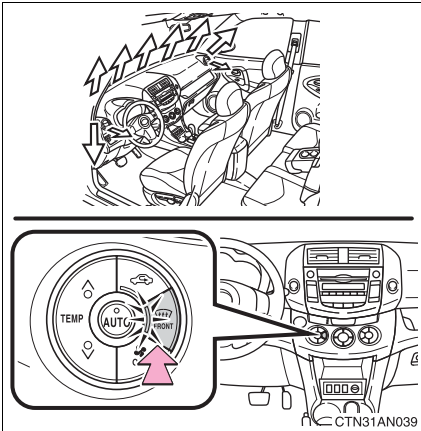

Press .

Air flows to the windshield and side windows.

The air conditioning system operates automatically.

Recirculated air mode will automatically switch to outside air mode. It is not possible to return to recirculated air mode when the switch is on.

### Micro dust and pollen filter

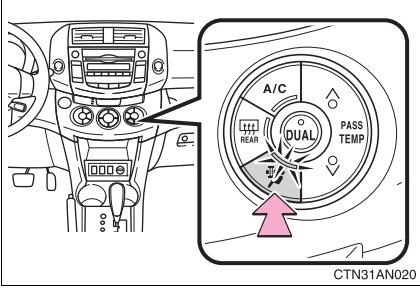

Press .

Outside air mode will be switched to recirculated air mode. Pollen is removed from the air and the air flows to the upper part of the body.

Usually the system will turn off automatically after approximately 3 minutes.

To stop the operation, press

 again.

### Adjusting the position of the air outlets

► Front outlets (center)

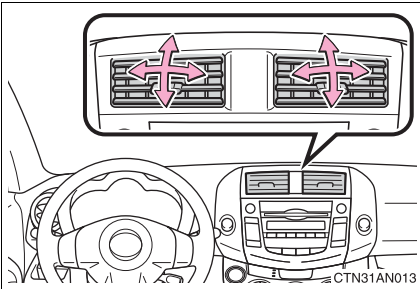

Direct air flow to the left or right, up or down.

► Front outlets (right and left sides)

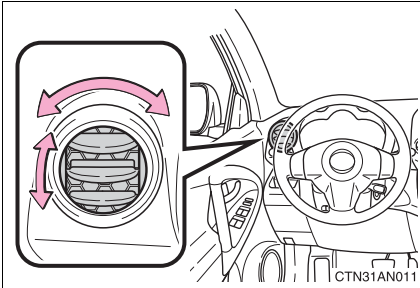

Direct air flow to the left or right, up or down.

### Opening and closing the side outlets

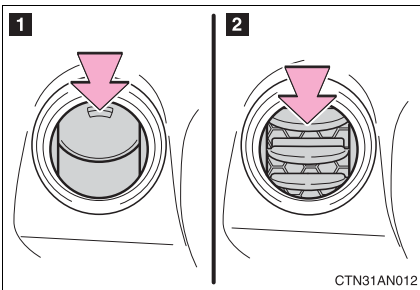

- 1 Open the vent.
- 2 Close the vent.

### ■ Using the automatic mode

Fan speed is adjusted automatically in accordance with the temperature setting and ambient conditions. In addition, the following may occur.

- Immediately after  is pressed, the fan may stop for a while until warm or cool air is ready to flow.
- Cool air may flow to the area around the upper body when the heater is on.

### ■ Using the system in recirculated air mode

The windows will fog up more easily if the recirculated air mode is used for an extended period.

■ **Switching between outside air and recirculated air modes**

Recirculated air mode or outside air mode may be automatically switched to in accordance with the temperature setting and the inside temperature.

■ **Window defogger feature**

Recirculated air mode may automatically switch to outside air mode in situations where the windows need to be defogged.

■ **When outside temperature approaches 32°F (0°C)**

The air conditioning system may not operate even when  is pressed.

■ **When  is selected for the air outlets used**

For your driving comfort, air flowing to the feet may be warmer than air flowing to the upper body depending on the position of the temperature setting.

■ **Micro dust and pollen filter**

● In order to prevent the windows from fogging up when the outside air is cold, the following may occur.

- Outside air mode is not switched to recirculated air mode.
- The air conditioning system operates automatically.
- The operation is canceled after 1 minute.

● In rainy weather, the windows may fog up. Press  .

■ **When the indicator light on  flashes**

Press  and turn off the air conditioning system before turning it on once more. There may be a problem in the air conditioning system if the indicator light keep flashing. Turn the air conditioning system off and have it inspected by your Toyota dealer.

■ **Air conditioning odors**

● During use, various odors from inside and outside the vehicle may enter into and accumulate in the air conditioning system. This may then cause odor to be emitted from the vents.

● To reduce potential odors from occurring:

- It is recommended that the air conditioning system be set to outside air mode prior to turning the vehicle off.
- The start timing of the blower may be delayed for a short period of time immediately after the air conditioning system is started in automatic mode.

 CAUTION

■ **To prevent the windshield from fogging up**

Do not use  during cool air operation in extremely humid weather. The difference between the temperature of the outside air and that of the windshield can cause the outer surface of the windshield to fog up, blocking your vision.

 NOTICE

■ **To prevent battery discharge**

Do not leave the air conditioning system on longer than necessary when the engine is off.



### 3-1. Using the air conditioning system and defogger Rear window and outside rear view mirror defoggers

The rear window defogger is used to defog the rear window. The outside rear view mirror defoggers\* are used to remove frost, dew or raindrops from the outside rear view mirrors.

► Vehicles with manual air conditioning system

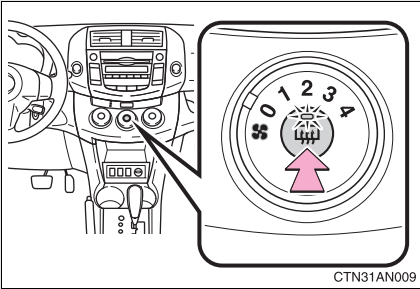

On/off

The defoggers will automatically turn off after approximately 15 minutes.

► Vehicles with automatic air conditioning system

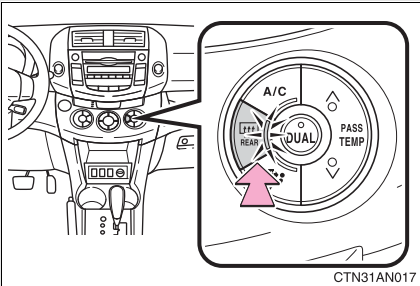

On/off

The defoggers will automatically turn off after approximately 15 minutes.

\*: Vehicles with outside rear view mirror defoggers

■ **The defogger can be operated when**

- ▶ Vehicles without smart key system

The engine switch is in the “ON” position.

- ▶ Vehicles with smart key system

The “ENGINE START STOP” switch is in IGNITION ON mode.

■ **Outside rear view mirror defoggers (vehicles with outside rear view mirror defoggers)**

Turning the rear window defogger on will turn the outside rear view mirror defoggers on.

 **CAUTION**

■ **Outside rear view mirror defoggers (vehicles with outside rear view mirror defoggers)**

The surfaces of the outside rear view mirrors become hot. Do not touch them to prevent from burning yourself.

### 3-1. Using the air conditioning system and defogger Windshield wiper de-icer\*

This feature is used to prevent ice from building up on the windshield and wiper blades.

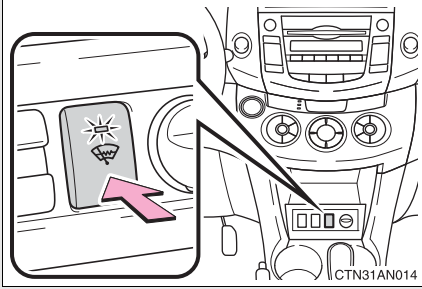

On/off

The de-icer will automatically turn off after approximately 15 minutes.

#### ■ The de-icer can be operated when

- ▶ Vehicles without smart key system

The engine switch is in the "ON" position.

- ▶ Vehicles with smart key system

The "ENGINE START STOP" switch is in IGNITION ON mode.

#### ⚠ CAUTION

#### ■ When the windshield wiper de-icer is on

Do not touch the glass at the lower part of the windshield or to the side of the front pillars as the surfaces can become very hot and burn you.

\*: If equipped

## 3-2. Using the audio system

### Audio system types

#### ▶ With navigation system

Owners of models equipped with a navigation system should refer to the “Navigation System Owner’s Manual”.

#### ▶ Without navigation system (type A)

CD player with changer controller and AM/FM radio

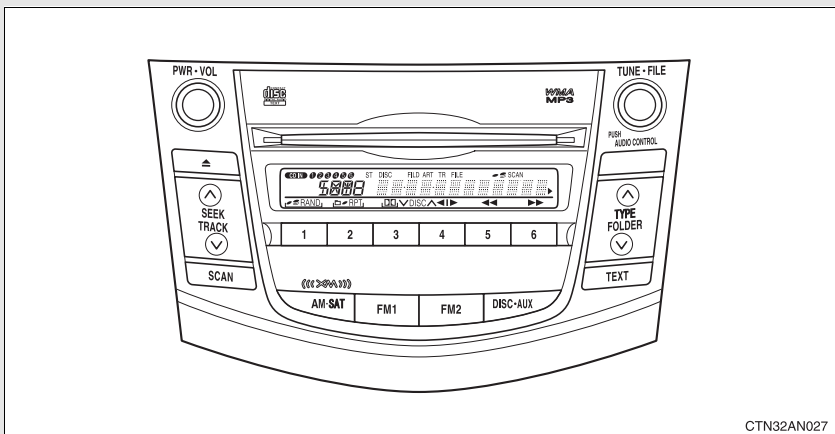

#### ▶ Without navigation system (type B)

CD player with changer and AM/FM radio

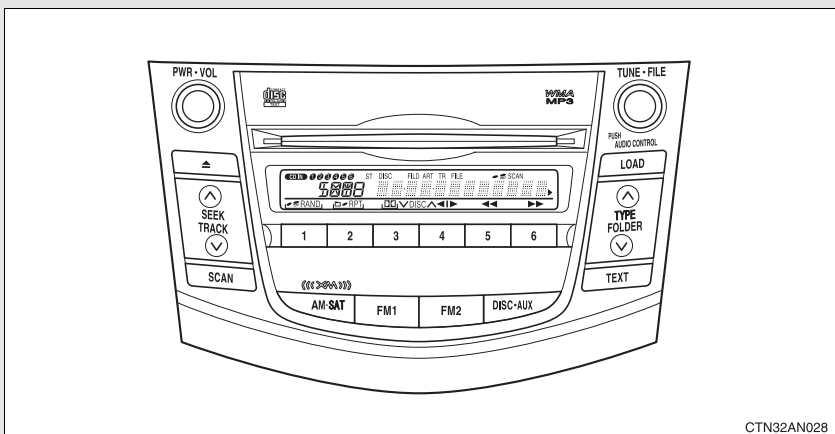

► Without navigation system (type C)  
 CD player with changer and AM/FM radio

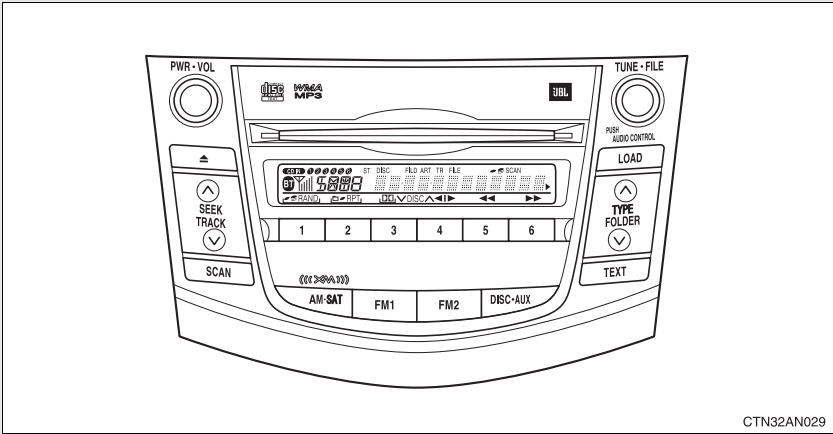

Title	Page
Using the radio	P. 246
Using the CD player	P. 252
Playing back MP3 and WMA discs	P. 259
Optimal use of the audio system	P. 266
Using the AUX port	P. 269
Using the steering wheel audio switches	P. 270

■ Using cellular phones

Interference may be heard through the audio system's speakers if a cellular phone is being used inside or close to the vehicle while the audio system is operating.

 **CAUTION****■ For vehicles sold in U.S.A. and Canada (for U.S.A. and Canada)****● Part 15 of the FCC Rules**

FCC Warning:

Any unauthorized changes or modifications to this equipment will void the user's authority to operate this device.

**● Laser products**

- Do not take this unit apart or attempt to make any changes yourself. This is an intricate unit that uses a laser pickup to retrieve information from the surface of compact discs. The laser is carefully shielded so that its rays remain inside the cabinet. Therefore, never try to disassemble the player or alter any of its parts since you may be exposed to laser rays and dangerous voltages.
- This product utilizes a laser. Use of controls or adjustments or performance of procedures other than those specified herein may result in hazardous radiation exposure.

 **NOTICE****■ To prevent battery discharge**

Do not leave the audio system on longer than necessary when the engine is off.

**■ To avoid damaging the audio system**

Take care not to spill drinks or other fluids over the audio system.

## 3-2. Using the audio system Using the radio

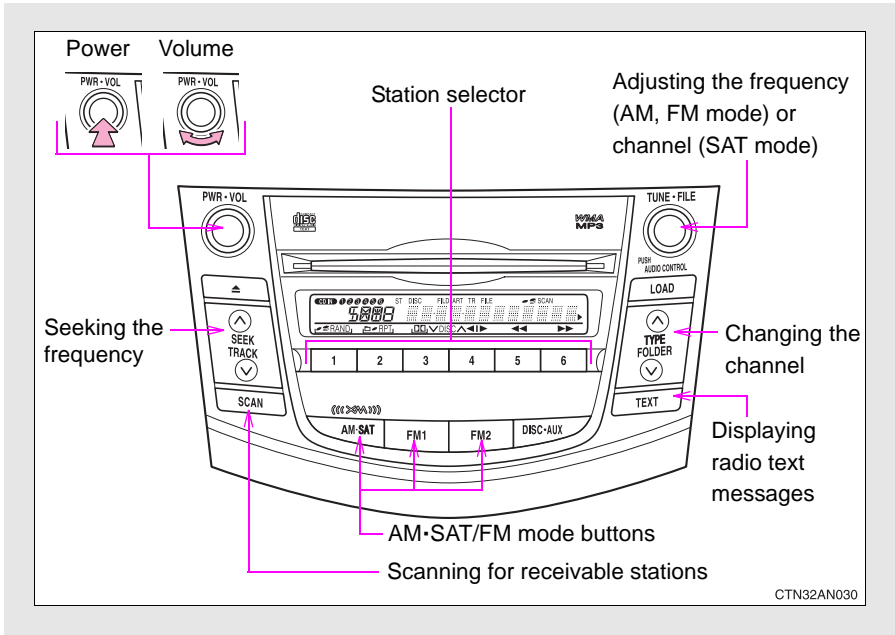

### Setting station presets (excluding XM<sup>®</sup> Satellite Radio)

**STEP 1** Search for desired stations by turning  or pressing "∧"

or "∨" on .

**STEP 2** Press and hold the button (from  to ) the station is to be set to until you hear a beep.

## Scanning radio stations (excluding XM<sup>®</sup> Satellite Radio)

### ■ Scanning the preset radio stations

**STEP 1** Press and hold  until you hear a beep.

Preset stations will be played for 5 seconds each.

**STEP 2** When the desired station is reached, press  once again.

### ■ Scanning all radio stations within range

**STEP 1** Press  .

All stations with reception will be played for 5 seconds each.

**STEP 2** When the desired station is reached, press  once again.

## XM<sup>®</sup> Satellite Radio (if equipped)

### ■ Receiving XM<sup>®</sup> Satellite Radio

**STEP 1** Press  .

The display changes as follows each time  is pressed.



AM → SAT1 → SAT2 → SAT3



**STEP 2** Turn  to select the desired channel in the all categories,

or press “^” or “v” on  to select the desired channel in the current category.

### ■ Setting XM<sup>®</sup> Satellite Radio channel presets

Select the desired channel. Press and hold the button (from  to  ) the channel is to be set to until you hear a beep.





## ■ Changing the channel category

Press “^” or “v” on  .

## ■ Scanning XM<sup>®</sup> Satellite Radio channels

- Scanning channels in the current category

**STEP 1** Press  .

**STEP 2** When the desired channel is reached, press  again.

- Scanning preset channels

**STEP 1** Press and hold  until you hear a beep.

**STEP 2** When the desired channel is reached, press  again.

## ■ Displaying text information

Press  .

The display will show up to 10 characters.

The display changes as follows each time  is pressed.

- Channel name
- Title (song/program title)
- Name (artist name/feature)
- Channel number

### ■ When the battery is disconnected

Station presets are erased.

### ■ Reception sensitivity

- Cargo loaded on the roof luggage carrier, especially metal objects, may adversely affect the reception of XM<sup>®</sup> Satellite Radio.
- Maintaining perfect radio reception at all times is difficult due to the continually changing position of the antenna, differences in signal strength and surrounding objects, such as trains, transmitters, etc.
- The radio antenna is mounted on the roof. The antenna can be removed from the base by turning it.

### ■ XM<sup>®</sup> Satellite Radio (if equipped)

An XM<sup>®</sup> Satellite Radio is a tuner designed exclusively to receive broadcasts provided under a separate subscription. Availability is limited to the 48 contiguous states and 10 Canadian provinces.

#### ● XM<sup>®</sup> subscriptions

For detailed information about XM<sup>®</sup> Satellite Radio or to subscribe:  
U.S.A. —

Visit on the web at [www.xmradio.com](http://www.xmradio.com) or call 1-800-967-2346.

Canada —

Visit on the web at [www.xmradio.ca](http://www.xmradio.ca) or call 1-877-438-9677.

#### ● Radio ID

You will need the radio ID when activating XM<sup>®</sup> service or reporting a problem. Select "CH000" using  , and the receiver's 8-character ID number will appear.

#### ● Satellite tuner

The tuner supports only Audio Services (Music and Talk) and the accompanying Text Information of XM<sup>®</sup> Satellite Radio.

■ **If the satellite radio does not operate normally (if equipped)**

If a problem occurs with the XM<sup>®</sup> tuner, a message will appear on the display. Refer to the table below to identify the problem, and take the suggested corrective action.

“ANTENNA”	The XM <sup>®</sup> antenna is not connected. Check whether the XM <sup>®</sup> antenna cable is attached securely.
	There is a short-circuit in the antenna or the surrounding antenna cable. See a Toyota certified dealer.
“UPDATING”	You have not subscribed to the XM <sup>®</sup> Satellite Radio. The radio is being updated with the latest encryption code. Contact the XM <sup>®</sup> Satellite Radio for subscription information. When a contract is canceled, you can choose the “CH000” and all free-to-air channels.
	The premium channel you selected is not authorized. Wait for about 2 seconds until the radio returns to the previous channel or “CH001”. If it does not change automatically, select another channel. If you want to listen to the premium channel, contact the XM <sup>®</sup> Satellite Radio.
“NO SIGNAL”	The XM <sup>®</sup> signal is too weak at the current location. Wait until your vehicle reaches a location with a stronger signal.
“LOADING”	The unit is acquiring audio or program information. Wait until the unit has received the information.
“OFF AIR”	The channel you selected is not broadcasting any programming. Select another channel.
“-----”	There is no song/program title or artist name/feature associated with the channel at that time. No action is needed.

“---”

The channel you selected is no longer available. Wait for about 2 seconds until the radio returns to the previous channel or “CH001”. If it does not change automatically, select another channel.

Contact the XM<sup>®</sup> Listener Care Center at 1-800-967-2346 (U.S.A.) or 1-877-438-9677 (Canada).

### ■ Certifications for the radio tuner

This equipment has been tested and found to comply with the limits for a class B digital device, pursuant to Part 15 of the FCC Rules. These limits are designed to provide reasonable protection against harmful interference in a residential installation. This equipment generates, uses and can radiate radio frequency energy and, if not installed and used in accordance with the instructions, may cause harmful interference to radio communications. However, there is no guarantee that interference will not occur in a particular installation.

If this equipment does cause harmful interference to radio or television reception, which can be determined by turning the equipment off and on, the user is encouraged to try to correct the interference by trying one or more of the following:

- Reorienting or relocating the receiving antenna.
- Increasing the separation between the equipment and receiver.
- Connecting the equipment into an outlet on a circuit different from that to which the receiver is connected.
- Consulting the dealer or an experienced radio/TV technician for help.



### NOTICE

#### ■ To prevent damage, remove the antenna in the following cases.

- The antenna will touch the ceiling of a garage.
- A cover will be put on the vehicle.

## 3-2. Using the audio system Using the CD player

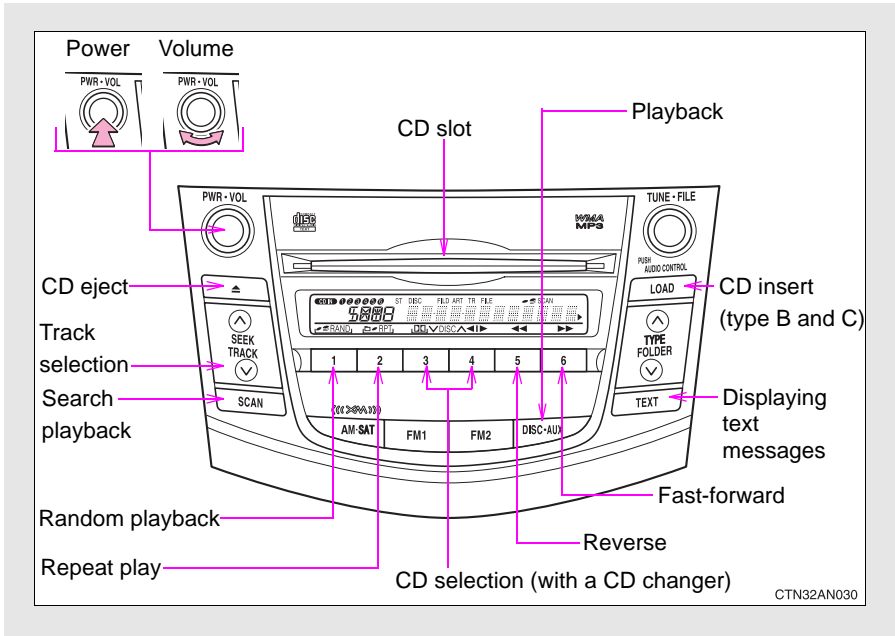

### Loading CDs

#### ■ Loading a CD

##### ▶ Type A

Insert a CD.

##### ▶ Type B and C

**STEP 1** Press **LOAD**.

“WAIT” is shown on the display.

**STEP 2** Insert a CD when the indicator on the slot turns from amber to green.

The display changes from “WAIT” to “LOAD”.

### ■ Loading multiple CDs (type B and C)

**STEP 1** Press and hold  until you hear a beep.  
“WAIT” is shown on the display.

**STEP 2** Insert a CD when the indicator on the slot turns from amber to green.

The display changes from “WAIT” to “LOAD”.

The indicator on the slot turns to amber when the CD is inserted.

**STEP 3** Insert the next CD when the indicator on the slot turns from amber to green again.

Repeat the procedure for the remaining CDs.

To stop the operation, press .



## Ejecting CDs

### ■ Ejecting a CD

#### ▶ Type A

Press  and remove the CD.

#### ▶ Type B and C

**STEP 1** To select the CD to be ejected, press  (∨) or  (∧).  
The number of the CD selected is shown on the display.

**STEP 2** Press  and remove the CD.

### ■ Ejecting all the CDs (type B and C)

Press and hold  until you hear a beep, and then remove the CDs.

## Selecting a track

Press “∧” to move up or “∨” to move down using  until the desired track number is displayed.

## Fast-forwarding and reversing tracks

To fast-forward or reverse, press  (reverse) or  (fast-forward).

## Scanning tracks

**STEP 1** Press  .

The first ten seconds of each track will be played.

**STEP 2** Press  again when the desired track is reached.

## Selecting a CD (with a CD changer)

### ■ To select a CD to play

To select the desired CD, press  (v) or  (^).

### ■ To scan loaded CDs

**STEP 1** Press and hold  until you hear a beep.

The first 10 seconds of the first track on each CD will be played.

**STEP 2** Press  again when the desired CD is reached.

## Repeat play

### ■ To repeat a track

Press  (RPT).

### ■ To repeat all of the tracks on a CD (with a CD changer)

Press and hold  (RPT) until you hear a beep.

## Random playback

### ■ Current CD

Press  (RAND).

Tracks are played in a random order until  is pressed once more.

### ■ All CDs (with a CD changer)

Press and hold  (RAND) until you hear a beep.

Tracks on all loaded CDs are played in a random order until  is pressed once more.

## Switching the display

Press  .

Each time  is pressed, the display changes in the order of Track no./Elapsed time→CD title→Track name.

### ■ Display

Up to 12 characters can be displayed at a time.

If there are 13 characters or more, pressing and holding  for 1 second or more will display the remaining characters.

A maximum of 24 characters can be displayed.

If  is pressed for 1 second or more again or has not been pressed for 6 seconds or more, the display will return to the first 12 characters.

Depending on the contents recorded, the characters may not be displayed properly or may not be displayed at all.



■ **Canceling random, repeat and scan playback**

Press  (RAND),  (RPT) or  again.

■ **Error messages**

“ERROR”: This indicates a problem either with the CD or inside the player. The CD may be dirty, damaged or inserted upside down.

“WAIT”: Operation has stopped due to a high temperature inside the player. Wait for a while and then press  . Contact your Toyota dealer if the CD still cannot be played back.

■ **Discs that can be used**

Discs with the marks shown below can be used.

Playback may not be possible depending on recording format or disc features, or due to scratches, dirt or deterioration.



CDs with copy-protect features may not be used.

■ **CD player protection feature**

To protect the internal components, playback is automatically stopped when a problem is detected while the CD player is being used.

■ **If CDs are left inside the CD player or in the ejected position for extended periods**

CDs may be damaged and may not play properly.

■ **Lens cleaners**

Do not use lens cleaners. Doing so may damage the CD player.

 NOTICE

**■ CDs that cannot be used**

Do not use the following types of CDs or Dual Discs.

Doing so may damage the CD player and/or the CD insert/eject function.

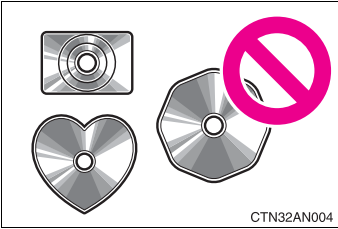

- Type A: CDs that have a diameter other than 4.7 in. (12 cm) or 3 in. (8 cm)
- Type B and C: CDs that have a diameter that is not 4.7 in. (12 cm)

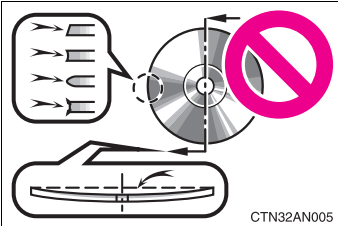

- Low-quality and deformed CDs

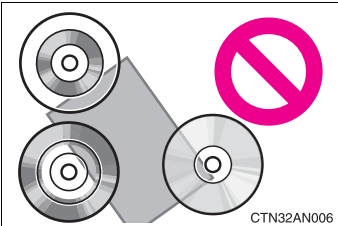

- CDs with a transparent or translucent recording area

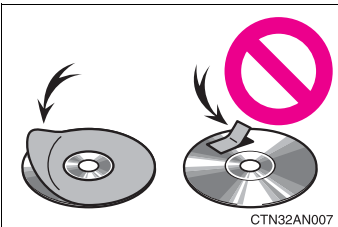

- CDs that have had tape, stickers or CD-R labels attached to them, or that have had the label peeled off

 NOTICE

■ **CD player precautions**

Failure to follow the precautions below may result in serious damage to the CDs or the player itself.

- Do not insert anything other than CDs into the CD slot.
- Do not apply oil to the CD player.
- Store CDs away from direct sunlight.
- Never try to disassemble any part of the CD player.

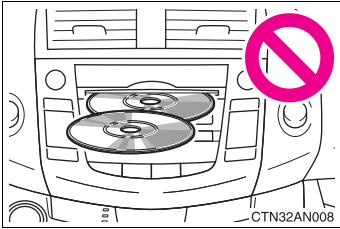

- Do not insert more than one CD at a time.

## 3-2. Using the audio system

### Playing back MP3 and WMA discs

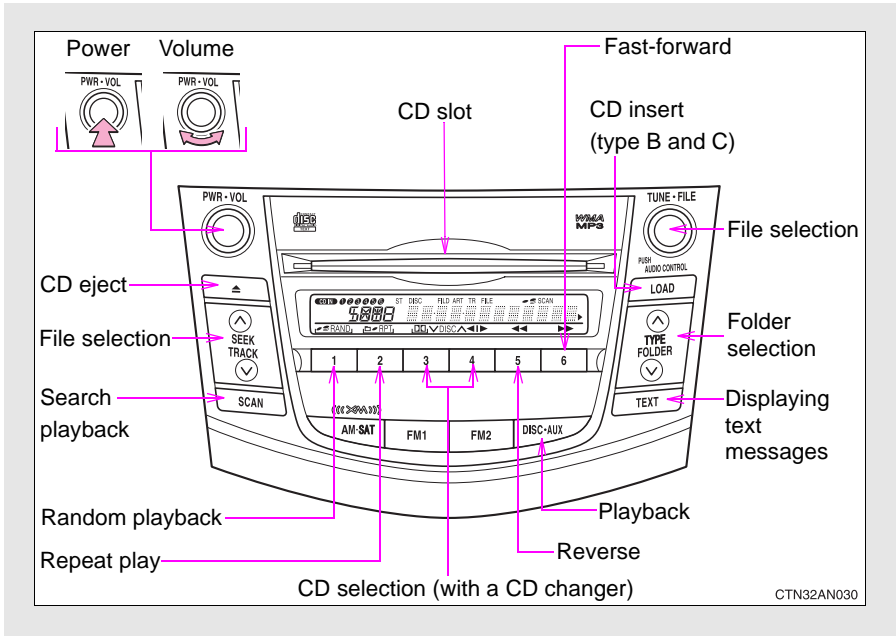

#### Loading and ejecting MP3 and WMA discs

→P. 252

#### Selecting an MP3 and WMA disc (with a CD changer)



→P. 254

## Selecting and scanning a folder

### ■ Selecting folders one at a time

Press “^” or “v” on  to select the desired folder.

### ■ Selecting the desired folder by cueing the first file of each folder



Press and hold  until you hear a beep. When the desired folder is reached, press  once again.

### ■ Returning to the first folder

Press and hold “v” on  until you hear a beep.

## Selecting and scanning files

### ■ Selecting one file at a time



Turn  or press “^” or “v” on  to select the desired file.

### ■ Selecting the desired file by cueing the files in the folder

Press  .

When the desired file is reached, press  once again.

## Fast-forwarding and reversing files

To fast-forward or reverse, press  (reverse) or  (fast-forward).

## Repeat play

### ■ To repeat a file

Press  (RPT).

### ■ To repeat all of the files in a folder

Press and hold  (RPT) until you hear a beep.

## Random playback

### ■ To play files from a particular folder in random order

Press  (RAND).

### ■ To play all of the files on a disc in random order

Press and hold  (RAND) until you hear a beep.

## Switching the display

Press  .

Each time  is pressed, the display changes in the order of Folder no./File no./Elapsed time→Folder name→File name→Album title (MP3 only)→Track title→Artist name.

■ **Display**

→P. 255

■ **Canceling random, repeat and scan playback**

→P. 256

■ **Error messages**

“ERROR”: This indicates a trouble either in the CD or inside the player. The CD may be dirty, damaged or inserted up-side down.

“WAIT”: Operation has stopped due to a high temperature inside the player. Wait for a while and then press  . Contact your Toyota dealer if the CD still cannot be played back.

“NO MUSIC”: This indicates that the MP3/WMA file is not included in the CD.

■ **Discs that can be used**

→P. 256

■ **CD player protection feature**

→P. 256

■ **If CDs are left inside the CD player or in the ejected position for extended periods**

→P. 256

■ **Lens cleaners**

→P. 256

## ■ MP3 and WMA files

MP3 (MPEG Audio LAYER3) is a standard audio compression format.

Files can be compressed to approximately 1/10 of their original size using MP3 compression.

WMA (Windows Media <sup>TM</sup> Audio) is a Microsoft audio compression format.

This format compresses audio data to a size smaller than that of the MP3 format.

There is a limit to the MP3 and WMA file standards that can be used and to the media/formats on which the files are recorded.

### ● MP3 file compatibility

- Compatible standards  
MP3 (MPEG1 LAYER3, MPEG2 LSF LAYER3)
- Compatible sampling frequencies  
MPEG1 LAYER3: 32, 44.1, 48 (kHz)  
MPEG2 LSF LAYER3: 16, 22.05, 24 (kHz)
- Compatible bit rates (compatible with VBR)  
MPEG1 LAYER3: 64, 80, 96, 112, 128, 160, 192, 224, 256, 320 (kbps)  
MPEG2 LSF LAYER3: 64, 80, 96, 112, 128, 144, 160 (kbps)
- Compatible channel modes: stereo, joint stereo, dual channel and monaural

### ● WMA file compatibility

- Compatible standards  
WMA Ver. 7, 8, 9
- Compatible sampling frequencies  
32, 44.1, 48 (kHz)
- Compatible bit rates (only compatible with 2-channel playback)  
Ver. 7, 8: CBR 48, 64, 80, 96, 128, 160, 192 (kbps)  
Ver. 9: CBR 48, 64, 80, 96, 128, 160, 192, 256, 320 (kbps)

### ● Compatible media

Media that can be used for MP3 and WMA playback are CD-Rs and CD-RWs.

Playback in some instances may not be possible if the CD-R or CD-RW is not finalized. Playback may not be possible or the audio may jump if the disc is scratched or marked with fingerprints.



### ● Compatible disc formats

The following disc formats can be used.

- Disc formats: CD-ROM Mode 1 and Mode 2  
CD-ROM XA Mode 2, Form 1 and Form 2
- File formats: ISO9660 Level 1, Level 2, (Romeo, Joliet)  
MP3 and WMA files written in any format other than those listed above may not play correctly, and their file names and folder names may not be displayed correctly.

Items related to standards and limitations are as follows.

- Maximum directory hierarchy: 8 levels
- Maximum length of folder names/file names: 32 characters
- Maximum number of folders: 192 (including the root)
- Maximum number of files per disc: 255

### ● File names

The only files that can be recognized as MP3/WMA and played are those with the extension .mp3 or .wma.

### ● Multi-sessions

As the audio system is compatible with multi-sessions, it is possible to play discs that contain MP3 and WMA files. However, only the first session can be played.

### ● ID3 and WMA tags

ID3 tags can be added to MP3 files, making it possible to record the track title, artist name, etc.

The system is compatible with ID3 Ver. 1.0, 1.1, and Ver. 2.2, 2.3 ID3 tags. (The number of characters is based on ID3 Ver. 1.0 and 1.1.)

WMA tags can be added to WMA files, making it possible to record the track title and artist name in the same way as with ID3 tags.

### ● MP3 and WMA playback

When a disc containing MP3 or WMA files is inserted, all files on the disc are first checked. Once the file check is finished, the first MP3 or WMA file is played. To make the file check finish more quickly, we recommend you do not write in any files other than MP3 or WMA files or create any unnecessary folders.

If the discs contain a mixture of music data and MP3 or WMA format data, only music data can be played.

### ● Extensions

If the file extensions .mp3 and .wma are used for files other than MP3 and WMA files, they will be mistakenly recognized and played as MP3 and WMA files. This may result in large amounts of interference and damage to the speakers.

### ● Playback

- To play MP3 file with steady sound quality, we recommend a fixed bit rate of at least 128 kbps and a sampling frequency of 44.1 kHz.
- CD-R or CD-RW playback may not be possible in some instances, depending on the characteristics of the disc.
- There is a wide variety of freeware and other encoding software for MP3 and WMA files on the market, and depending on the status of the encoding and the file format, poor sound quality or noise at the start of playback may result. In some cases, playback may not be possible at all.
- When files other than MP3 or WMA files are recorded on a disc, it may take more time to recognize the disc and in some cases, playback may not be possible at all.
- Microsoft, Windows, and Windows Media are the registered trademarks of Microsoft Corporation in the U.S. and other countries.



#### NOTICE

#### ■ CDs that cannot be used

→P. 257

#### ■ CD player precautions

→P. 258

## 3-2. Using the audio system

### Optimal use of the audio system

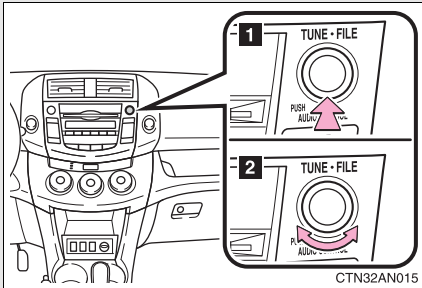

- 1** Displays the current mode
- 2** Changes the following setting

- Sound quality and volume balance (→P. 267)

The sound quality and balance setting can be changed to produce the best sound.

- Volume and tone quality level (Automatic Sound Levelizer) (→P. 268)

## Using the audio control function

### ■ Changing sound quality modes

Pressing  selects the mode to be changed in the following order.

“BAS” → “MID”\* → “TRE” → “FAD” → “BAL” → “ASL”



\*: Type C only

### ■ Adjusting sound quality

Turning  adjusts the level.

Mode displayed	Sound quality mode	Level	Turn to the left	Turn to the right
“BAS”*	Bass	-5 to 5	Low	High
“MID”*	Mid-range (type C only)	-5 to 5		
“TRE”*	Treble	-5 to 5		
“FAD”	Front/rear volume balance	R7 to F7	Shifts to rear	Shifts to front
“BAL”	Left/right volume balance	L7 to R7	Shifts to left	Shifts to right

\*: The sound quality level is adjusted individually in each radio mode or CD mode.

### ■ Adjusting the Automatic Sound Levelizer (ASL)

#### ▶ Type A and B

When “ASL” is selected, turning  to the right changes the “ASL” level in the order of “LOW”, “MID” and “HIGH”.

Turning  to the left turns “ASL” off.

ASL automatically adjusts the volume and tone quality according to vehicle speed.

#### ▶ Type C

When “ASL” is selected, turning  to the right turns “ASL” on,

and turning  to the left turns “ASL” off.

ASL automatically adjusts the volume and tone quality according to the noise level as you drive your vehicle.

---

### ■ Trademark owned by SRS Labs, Inc. (type A)



The audio systems utilize SRS FOCUS<sup>®</sup> and SRS TruBass<sup>®</sup> audio enhancement technologies, under license from SRS Labs, Inc., in all modes except AM radio mode.

FOCUS, TruBass, SRS and  symbols are trademarks of SRS Labs, Inc.

FOCUS and TruBass technologies are incorporated under license from SRS Labs, Inc.

## 3-2. Using the audio system

### Using the AUX port

This port can be used to connect a portable audio device and listen to it through the vehicle's speakers.

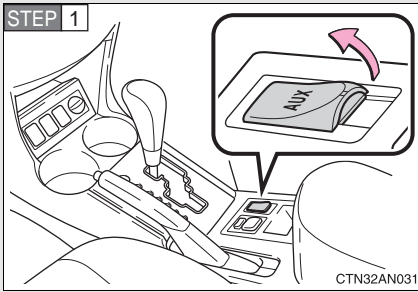

Open the cover and connect the portable audio device.

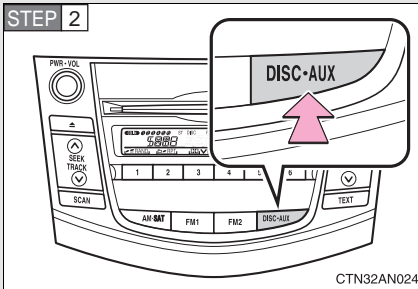

Press  .

#### ■ Operating portable audio devices connected to the audio system

The volume can be adjusted using the vehicle's audio controls. All other adjustments must be made on the portable audio device itself.

#### ■ When using a portable audio device connected to the power outlet

Noise may occur during playback. Use the power source of the portable audio device.

Some audio features can be controlled using the switches on the steering wheel.

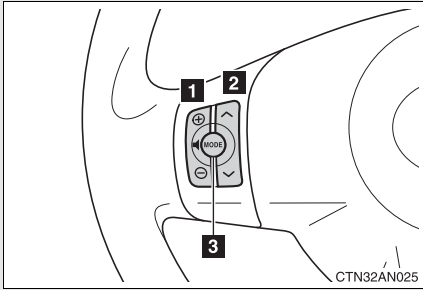



- 1** Volume
- 2** Radio: Selects radio stations  
CD: Selects tracks, files (MP3 and WMA) and discs
- 3** Turns the power on, selects audio source

### Turning on the power

Press  when the audio system is turned off.

The audio system can be turned off by holding  down until you hear a beep.

### Changing the audio source

Press  when the audio system is turned on. The audio source changes as follows each time  is pressed.

Type A:

FM1→FM2→CD→AUX→AM→SAT1→SAT2→SAT3



Type B and C:

FM1→FM2→CD changer→AUX→AM→SAT1→SAT2→SAT3



\*: If equipped

## Adjusting the volume

Press “+” on  to increase the volume and “-” to decrease the volume.

Press and hold  to continue increasing or decreasing the volume.

## Selecting a radio station

**STEP 1** Press  to select the radio mode.

**STEP 2** Press “^” or “v” on  to select a preset station.

To scan for receivable stations, press and hold  until you hear a beep.

## Selecting a track/file

**STEP 1** Press  to select the CD mode.

**STEP 2** Press “^” or “v” on  to select the desired track/file.

## Selecting a folder (type A)

**STEP 1** Press  to select the CD mode.

**STEP 2** Press and hold “^” or “v” on  until you hear a beep.

## Selecting a disc in the CD player (with a CD changer)

**STEP 1** Press  to select the CD mode.

**STEP 2** Press and hold “^” or “v” on  until you hear a beep.



 CAUTION

■ **To reduce the risk of an accident**

Exercise care when operating the audio switches on the steering wheel.

### 3-3. Using the hands-free phone system (for cellular phone) Hands-free phone system (for cellular phone) features\*

**This system supports Bluetooth<sup>®</sup>, which allows you to make or receive calls without using cables to connect a cellular phone and the system, and without operating the cellular phone.**

Title	Page
Using the hands-free phone system (for cellular phone)	P. 277
Making a phone call	P. 285
Setting a cellular phone	P. 291
Security and system setup	P. 296
Using the phone book	P. 299

#### ■ Conditions affecting operation

The hands-free phone system may not operate normally in the following situations:

- The cellular phone is turned off, or located outside the service area.
- The cellular phone has a low battery.
- The cellular phone is not connected to the system.
- The cellular phone is behind the seat or in the glove box, or metal material covers or touches the phone.

#### ■ When transferring ownership of the vehicle

Be sure to initialize the system to prevent personal data from being improperly accessed.

\*: If equipped

■ **Required profiles for the cellular phone**

- HFP (Hands Free Profile) Ver. 1.0
- OPP (Object Push Profile) Ver. 1.1

If your cellular phone does not support HFP, the Bluetooth® phone cannot be entered and OPP serviced cannot be provided separately.

■ **Trademark owned by Bluetooth SIG. Inc.**



■ **Certification for the hands-free phone system**

FCC ID: ACJ932C5ZZZ035

IC ID: 216J-C5ZZZ035

MADE IN JAPAN/MEXICO

NOTE:

This device complies with Part 15 of the FCC Rules and RSS-210. Operation is subject to the following two conditions: (1) This device may not cause harmful interference, and (2) This device must accept any interference received, including interference that may cause undesired operation.

**NOTICE:**

This equipment has been tested and found to comply with the limits for a Class B digital device, pursuant to Part 15 of the FCC Rules. These limits are designed to provide reasonable protection against harmful interference in a residential installation. This equipment generates, uses and can radiate radio frequency energy and, if not installed and used in accordance with the instructions, may cause harmful interference to radio communications. However, there is no guarantee that interference will not occur in a particular installation. If this equipment does cause harmful interference to radio or television reception, which can be determined by turning the equipment off and on, the user is encouraged to try to correct the interference by one or more of the following measures:

- Reorient or relocate the receiving antenna.
- Increase the separation between the equipment and receiver.
- Connect the equipment into an outlet on a circuit different from that to which the receiver is connected.
- Consult the dealer or an experienced radio/TV technician for help.

**FCC WARNING:**

Changes or modifications in construction not expressly approved by the party responsible for compliance could void the user's authority to operate the equipment.

**CAUTION:****Radio Frequency Radiation Exposure**

This equipment complies with FCC/IC radiation exposure limits set forth for uncontrolled equipment and meets the FCC radio frequency (RF) Exposure Guidelines in Supplement C to OET65 and RSS-102 of the IC radio frequency (RF) Exposure rules. This equipment has very low levels of RF energy that it deemed to comply without maximum permissive exposure evaluation (MPE). But it is desirable that it should be installed and operated with at least 20 cm and more between the radiator and person's body (excluding extremities: hands, wrists, feet and legs).

**Co-location:**

This transmitter must not be co-located or operated in conjunction with any other antenna or transmitter.

 **CAUTION**

■ **Caution while driving**

Do not use a cellular phone or connect the Bluetooth® phone.

 **NOTICE**

■ **To prevent damage to a cellular phone**

Do not leave a cellular phone in the vehicle. The temperature inside may become high resulting in damage to the phone.

### 3-3. Using the hands-free phone system (for cellular phone) Using the hands-free phone system (for cellular phone)\*

#### ■ Audio unit

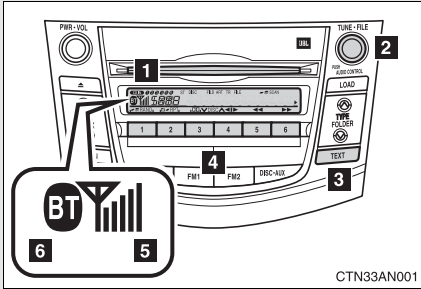

- 1 Displays such items as messages, name, and phone number

Lower-case characters and special characters, such as an umlaut, cannot be displayed.

- 2 Selects items such as menu or number

Turn: Selects an item

Press: Inputs the selected item

- 3 Press and hold: Displays information that is too long to be displayed at one time on the screen

- 4 Selects speed dials

- 5 Displays the reception level

- 6 Displays Bluetooth® connection condition

If “BT” is not displayed, the hands-free phone system cannot be used.

### ■ Steering wheel telephone switches

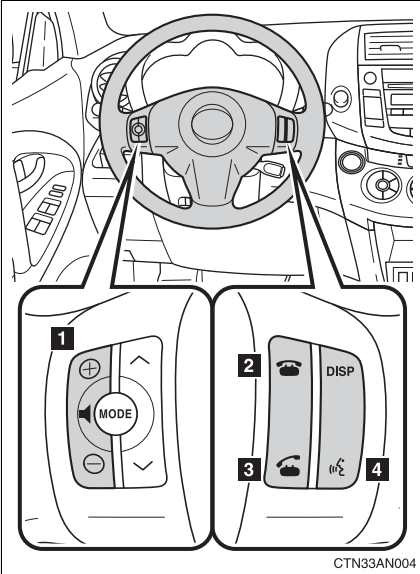

#### 1 Volume

The voice guidance volume cannot be adjusted using this button.

#### 2 Hands-free phone system off/ends a call/refuses a call

#### 3 Hands-free phone system on/starts a call

#### 4 Press: Voice command system on

Press and hold: Voice command system off

### ■ Microphone

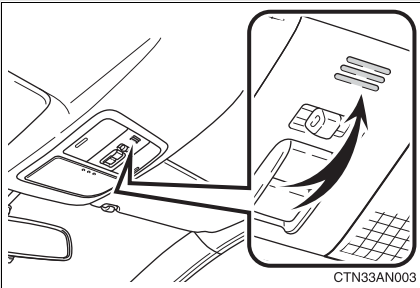

## Operating the system using a voice command

By following voice guidance instructions output from the speaker, voice commands can be given to allow for operation of the hands-free phone system without checking the display or operating  .

### ■ Operation procedure when using a voice command

Press  and say a command for a desired function.  
(→P. 281)

### ■ Auxiliary commands when using a voice command

The following auxiliary commands can be used when operating the system using a voice command:

- Cancel: Exits the hands-free phone system
- Repeat: Repeats the previous voice guidance instruction
- Go back: Returns to the previous procedure
- Help: Reads aloud the function summary if a help comment is registered for the selected function





### Using the hands-free phone system for the first time

Before using the hands-free phone system, it is necessary to register a cellular phone in the system. The phone registration mode will be entered automatically when starting the system with no cellular phone registered. Follow the procedure below to register a cellular phone:

**STEP 1** Press  or .

The introductory guidance and phone name registration instructions are heard.

**STEP 2** Register a phone name by either of the following methods.

- a. Select "Record Name" using , and say a name to be registered.
- b. Press  and say a name to be registered.

A voice guidance instruction to confirm the input is heard.

**STEP 3** Select "Confirm" using a voice command or .

A passkey is displayed and heard, and a voice guidance instruction for inputting the passkey into the cellular phone is heard.

**STEP 4** Input the passkey into the cellular phone.

Refer to the manual that comes with the cellular phone for the operation of the phone.

Guidance for registration completion is heard.

<b>Menu list of the hands-free phone system</b>
---

■ **Normal operation**

First menu	Second menu	Third menu	Operation detail
Callback	-	-	Dialing a number stored in the incoming call history memory
Redial	-	-	Dialing a number stored in the outgoing call history memory
Dial by number	-	-	Dialing by inputting a number
Dial by name	-	-	Dialing by inputting a name registered in the phone book
Phonebook	Add Entry	-	Adding a new number
	Change Name	-	Changing a name in the phone book
	Delete Entry	-	Deleting the phone book data
	Delete Speed Dial (Del Spd Dial)	-	Deleting a registered speed dial
	List Names	-	Listing the phone book data
	Set Speed Dial (Speed Dial)	-	Registering a speed dial

### 3-3. Using the hands-free phone system (for cellular phone)

First menu	Second menu	Third menu	Operation detail
Setup	Security	Set PIN	Setting a PIN code
		Phonebook Lock	Locking the phone book
		Phonebook Unlock	Unlocking the phone book
	Phone Setup	Pair Phone	Registering the cellular phone to be used
		Change Name	Changing a registered name of a cellular phone
		Delete	Deleting a registered cellular phone
		List Phones	Listing the registered cellular phones
		Select Phone	Selecting a cellular phone to be used
		Set Passkey	Changing the passkey
	System Setup	Guidance Volume (Guidance Vol)	Setting voice guidance volume
Initialize		Initialization	

### ■ Using a short cut key

First menu	Second menu	Operation detail
Dial "XXX (name)"	-	Dialing a number registered in the phone book
Phone book add entry	-	Adding a new number
Phone book change name	-	Changing the name of a phone number in the phone book
Phone book delete entry	-	Deleting phone book data
Phone book list names	-	Listing the phone book data
Phone book set speed dial	-	Registering a speed dial
Phone book delete speed dial	-	Deleting a speed dial
Phonebook	Phonebook Unlock	Unlocking the phone book
	Phonebook Lock	Locking the phone book

■ **Automatic adjustment of volume**

When vehicle speed is 50 mph (80 km/h) or more, the volume automatically increases. The volume returns to the previous volume setting when vehicle speed drops to 43 mph (70 km/h) or less.

■ **When using a voice command**

- For numbers, say a combination of single digits from zero to nine, # (pound), \* (star), and + (plus).
- Say a command correctly and clearly.

■ **The system may not recognize your voice in the following situations:**

- When driving on a rough road
- When driving at high speeds
- When air is blowing out of the vents onto the microphone
- When the air conditioning fan emits a loud noise

■ **The following cannot be performed while driving:**

- Operating the system with  TUNE-FILE
- Registering a cellular phone to the system

■ **Changing the passkey**

→P. 294

## Making a phone call

### ■ Making a phone call

- Dialing by inputting a number  
“Dial by number”
- Dialing by inputting a name  
“Dial by name”
- Speed dialing
- Dialing a number stored in the outgoing history memory  
“Redial”
- Dialing a number stored in the incoming history memory  
“Call back”

### ■ Receiving a phone call

- Answering the phone
- Refusing the call

### ■ Transferring a call

### ■ Using the call history memory

- Dialing
- Storing data in the phone book
- Deleting

## Dialing by inputting a number

**STEP 1** Press  and say "Dial by number".

**STEP 2** Press  and say the phone number.

**STEP 3** Dial by one of the following methods:

a. Press  .

b. Press  and say "Dial".



c. Select "Dial" using  .

## Dialing by inputting a name

**STEP 1** Press  and say “Dial by name”.

**STEP 2** Select a registered name to be input by either of the following methods:

a. Press  and say a registered name.

b. Press  and say “List names”. Press  while the desired name is being read aloud.

**STEP 3** Dial by one of the following methods:

a. Press  .

b. Press  and say “Dial”.

c. Select “Dial” using  .

## Speed dialing

**STEP 1** Press  .

**STEP 2** Press the preset button in which the desired number is registered.

**STEP 3** Press  .



### When receiving a phone call

#### ■ Answering the phone

Press  .

#### ■ Refusing the call

Press  .

### Transferring a call

A call can be transferred between the cellular phone and system while dialing or receiving a call, or during a call. Use one of the following methods:

- a. Operate the cellular phone.

Refer to the manual that comes with the cellular phone for the operation of the phone.

- b. Press  \*1.

- c. Press  and say "Call Transfer" \*2.

\*1: This operation can be performed only when transferring a call from the cellular phone to the system during a call.

\*2: While the vehicle is in motion, a call cannot be transferred from the system to the cellular phone.

## Using the call history memory

Follow the procedure below to use a number stored in the call history memory:

**STEP 1** Press  and say “Redial” (when using a number stored in the outgoing call history memory) or “Call back” (when using a number stored in the incoming call history memory).

**STEP 2** Select the number by either of the following methods:

a. Say “Previous” or “Go back” until the desired number is displayed.

b. Select the desired number using  .

The following operations can be performed:

Dialing: Press  or select “Dial” using a voice command or



Storing the number in the phone book: Select “Store” using a voice

command or  .

Deleting: Select “Delete” using a voice command or  .

■ **Call history**

Up to 5 phone numbers can be stored in each of the outgoing and incoming call history memories.

■ **When talking on the phone**

- Do not talk simultaneously with the other party.
- Keep the volume of the received voice down. Otherwise, voice echo will increase.

## 3-3. Using the hands-free phone system (for cellular phone) Setting a cellular phone

**Registering a cellular phone in the hands-free phone system allows the system to function. The following functions can be used for registered cellular phones:**

### ■ Functions and operation procedures

To enter the menu for each function, follow the steps below using a

voice command or  :

- Registering a cellular phone
  1. "Setup" → 2. "Phone Setup" → 3. "Pair Phone"
- Selecting the cellular phone to be used
  1. "Setup" → 2. "Phone Setup" → 3. "Select Phone"
- Changing a registered name
  1. "Setup" → 2. "Phone Setup" → 3. "Change Name"
- Listing the registered cellular phones
  1. "Setup" → 2. "Phone Setup" → 3. "List Phones"
- Deleting a cellular phone
  1. "Setup" → 2. "Phone Setup" → 3. "Delete"
- Changing the passkey
  1. "Setup" → 2. "Phone Setup" → 3. "Set Passkey"

### Registering a cellular phone

Select "Pair Phone" using a voice command or  , and do the procedure for registering a cellular phone. (→P. 280)

### Selecting the cellular phone to be used



**STEP 1** Select “Select Phone” using a voice command or  .

► Pattern A

**STEP 2** Select the cellular phone to be used by either of the following methods, and select “Confirm” using a voice command or



a. Press  and say the desired phone name.

b. Press  and say “List phones”. While the name of the desired cellular phone is being read aloud, press  .

► Pattern B

**STEP 2** Select the cellular phone to be used using  .



### Changing a registered name

**STEP 1** Select “Change Name” using a voice command or  .



**STEP 2** Select the name of the cellular phone to be changed by one of the following methods:

a. Press  and say the desired phone name, and select

“Confirm” using a voice command or  .

b. Press  and say “List phones”. While the desired phone name is being read aloud, press .

c. Select the desired phone name using .

**STEP 3** Press  or select “Record Name” using , and say a new name.

**STEP 4** Select “Confirm” using a voice command or .

### Listing the registered cellular phones

Selecting “List Phones” using a voice command or  causes the list of registered cellular phones to be read aloud. When listing is complete, the system returns to “Phone Setup”.

Pressing  while the name of a cellular phone is being read selects the cellular phone, and the following functions will be available:

- Selecting a cellular phone: “Select Phone”
- Changing a registered name: “Change Name”
- Deleting a cellular phone: “Delete”

## Deleting a cellular phone



**STEP 1** Select “Delete” using a voice command or  .

### ► Pattern A

**STEP 2** Select the cellular phone to be deleted by either of the following methods and select “Confirm” using a voice command or



a. Press  and say the name of the desired cellular phone.

b. Press  and say “List phones”. While the name of the desired cellular phone is being read aloud, press  .

### ► Pattern B

**STEP 2** Select the desired cellular phone to be deleted using  .

## Changing the passkey

**STEP 1** Select “Set Passkey” using a voice command or  .

### ► Pattern A

**STEP 2** Press  , say a 4 to 8-digit number, and select “Confirm”

using a voice command or  .

► Pattern B

**STEP 2** Select a 4 to 8-digit number using  .

The number should be input 1 digit at a time.

**STEP 3** When the entire number to be registered as a passkey has been input, press  once again.

---

■ **The number of cellular phones that can be registered**

Up to 6 cellular phones can be registered in the system.



### 3-3. Using the hands-free phone system (for cellular phone)

## Security and system setup

To enter the menu of each setting, follow the steps below:

#### ■ Security setting items and operation procedure

- Setting or changing the PIN (Personal Identification Number)
  1. "Setup" → 2. "Security" → 3. "Set PIN"
- Locking the phone book
  1. "Setup" → 2. "Security" → 3. "Phonebook Lock"
- Unlocking the phone book
  1. "Setup" → 2. "Security" → 3. "Phonebook Unlock"

#### ■ System setup items and operation procedure

- Setting voice guidance volume
  1. "Setup" → 2. "System Setup" → 3. "Guidance Vol"
- Initialization
  1. "Setup" → 2. "System Setup" → 3. "Initialize"





can only be used for system setup operation.

### Setting or changing the PIN

#### ■ Setting a PIN

**STEP 1** Select "Set PIN" using a voice command or  .

**STEP 2** Enter a PIN using a voice command or  .

When using  , input the code 1 digit at a time.

#### ■ Changing the PIN

**STEP 1** Select "Set PIN" using a voice command or  .

**STEP 2** Enter the registered PIN using a voice command or  .

**STEP 3** Enter a new PIN using a voice command or  .

When using  , input the code 1 digit at a time.

### Locking or unlocking the phone book

**STEP 1** Select “Phonebook lock (Phbk Lock)” or “Phonebook unlock (Phbk Unlock)” using a voice command or  .

**STEP 2** Input the PIN by either of the following methods and select “Confirm” using a voice command or  :

a. Press  and say the registered PIN.

b. Input a registered PIN using  .

### Setting voice guidance volume

**STEP 1** Select “Guidance Vol” using  .

**STEP 2** Change the voice guidance volume.

To decrease the volume: Turn  counterclockwise.

To increase the volume: Turn  clockwise.

## Initialization

**STEP 1** Select “Initialize” and then “Confirm” using  .

**STEP 2** Select “Confirm” using  .

### ■ Initialization

- The following data in the system can be initialized:
  - Phone book
  - Outgoing and incoming call history
  - Speed dials
  - Registered cellular phone data
  - Security code
- Once the initialization has been completed, the data cannot be restored to its original state.

### ■ When the phone book is locked

The following functions cannot be used:

- Dialing by inputting a name
- Speed dialing
- Dialing a number stored in the call history memory
- Using the phone book

## 3-3. Using the hands-free phone system (for cellular phone) Using the phone book

To enter the menu of each setting, follow the steps below:

- Adding a new phone number
  1. "Phonebook" → 2. "Add Entry"
- Setting speed dial
  1. "Phonebook" → 2. "Set Speed Dial (Speed Dial)"
- Changing a registered name
  1. "Phonebook" → 2. "Change Name"
- Deleting registered data
  1. "Phonebook" → 2. "Delete Entry"
- Deleting speed dial
  1. "Phonebook" → 2. "Delete Speed Dial (Del Spd Dial)"
- Listing the registered data
  1. "Phonebook" → 2. "List Names"

### Adding a new phone number

The following methods can be used to add a new phone number:

- Inputting a phone number using a voice command
- Transferring data from the cellular phone
- Inputting a phone number using  TUNE-FILE
- Selecting a phone number from outgoing or incoming call history

### ■ Adding procedure

**STEP 1** Select “Add Entry” using a voice command or  .

**STEP 2** Use one of the following methods to input a phone number:

▶ Inputting a phone number using a voice command

STEP2-1: Select “By Voice” using a voice command or  .

STEP2-2: Press  , say the desired number, and select “Confirm” using a voice command.

▶ Transferring data from the cellular phone

STEP2-1: Select “By Phone” and then “Confirm” using a voice command or  .

STEP2-2: Transfer the data from the cellular phone.

Refer to the manual that comes with the cellular phone for the details of transferring data.

STEP2-3: Select the data to be registered by either of the following methods:

a. Say “Previous” or “Next” until the desired data is displayed, and select “Confirm” using a voice command.

b. Select the desired data using  .

► Inputting a phone number using 

STEP2-1: Select “Manual Input” using  .

STEP2-2: Input a phone number using  .

Input the phone number 1 digit at a time.

STEP2-3: When the entire number has been input, press

 once again.

► Selecting a phone number from outgoing or incoming call history

STEP2-1: Select “Call History” using a voice command or

 .

STEP2-2: Select “Outgoing” or “Incoming” using a voice com-

mand or  .

STEP2-3: Select the data to be registered by either of the following methods:

a. Say “Previous” or “Go back” until the desired data is displayed, and select “Confirm” using a voice command.

b. Select the desired data using  .

**STEP 3** Select the name to be registered by either of the following methods, and select “Confirm” using a voice command or



a. Press  and say the desired name.

b. Select “Record Name” using  , and say the desired name.

**STEP 4** Select “Confirm” using a voice command or  .

In **STEP 3** , selecting “Set Speed Dial (Speed Dial)” instead of “Confirm” registers the newly added phone number as a speed dial.

## Setting speed dials



**STEP 1** Select “Set Speed Dial (Speed Dial)” using a voice command



**STEP 2** Select the data to be registered as a speed dial by one of the following methods:

a. Press  , say desired name, and select “Confirm”

using a voice command or  .

b. Press  , and say “List names”. While the desired name is being read aloud, press  , and select “Confirm” using a voice command or  .

c. Select the desired data using  .

**STEP 3** Select the desired preset button, and register the data into speed dial by either of the following methods:

a. Press the desired preset button, and select “Confirm” using



a voice command or  .

b. Press and hold the desired preset button.



### Changing a registered name

**STEP 1** Select “Change Name” using a voice command or  .



**STEP 2** Select the name to be changed by one of the following methods.

a. Press  , say desired name, and select “Confirm” using a voice command or  .



b. Press  , and say “List names”. While the desired name is being read aloud, press  , and select “Confirm” using a voice command or  .

c. Select the desired name using  .

**STEP 3** Press  or select “Record Name” using  , and say a new name.

**STEP 4** Select “Confirm” using a voice command or  .



### Deleting registered data

**STEP 1** Select “Delete Entry” using a voice command or  .

#### ► Pattern A

**STEP 2** Select the data to be deleted by either of the following methods, and select “Confirm” using a voice command or  :

a. Press  , and say the name of the desired phone number to be deleted.

b. Press  , say “List phones”. While the name of the desired phone number is being read aloud, press  .

► Pattern B

**STEP 2** Select the data to be deleted using  .

**Deleting speed dials**

**STEP 1** Select “Delete Speed Dial (Del Spd Dial)” using a voice command or  .

**STEP 2** Press the preset button in which the desired speed dial is registered, and select “Confirm” using a voice command or  .

**Listing the registered data**

Selecting “List names” using a voice command causes a list of the registered data to be read aloud.

When listing is complete, the system returns to “Phonebook”.

Pressing  while the desired data is being read aloud selects the data, and the following function will be available.

- Dialing: “Dial”
- Changing a registered name: “Change Name”
- Deleting an entry: “Delete Entry”
- Setting a speed dial: “Set Speed Dial (Speed Dial)”

■ **Limitation of number of digits**

A phone number that exceeds 24 digits cannot be registered.

## Interior lights list

Your Toyota is equipped with the illuminated entry system to assist in entering the vehicle. Owing to the function of the system, the lights shown in the following illustration (except the luggage compartment light) automatically turn on/off according to the presence of the electronic key (vehicles with smart key system), whether the doors are locked/unlocked, whether the doors are opened/closed, and the “ENGINE START STOP” switch mode or the engine switch position.

The luggage compartment light turns on/off according to whether the back door is opened/closed.

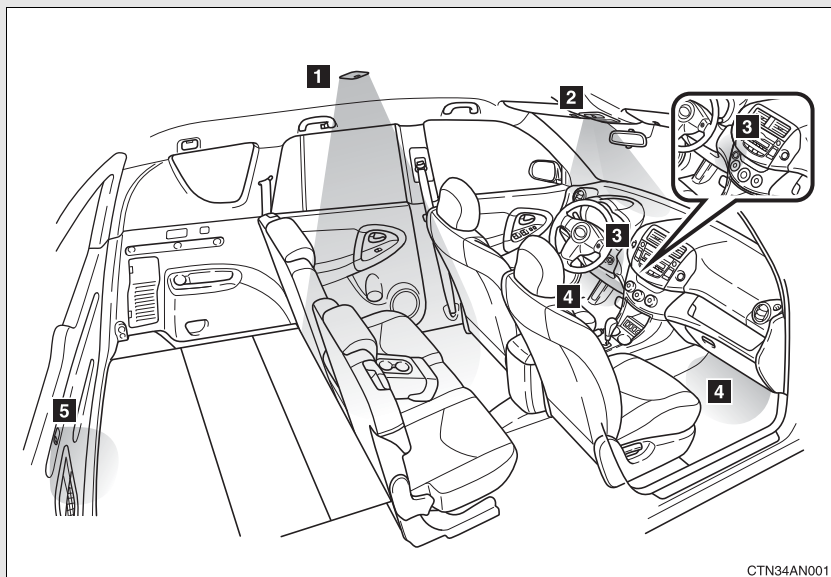

- 1** Interior light (→P. 309)
- 2** Personal/interior lights (→P. 308)
- 3** Engine switch light
- 4** Foot lights (if equipped)
- 5** Luggage compartment light (turns on/off according to whether the back door is opened/closed)

CTN34AN001

**Personal/interior light main switch**

► Type A

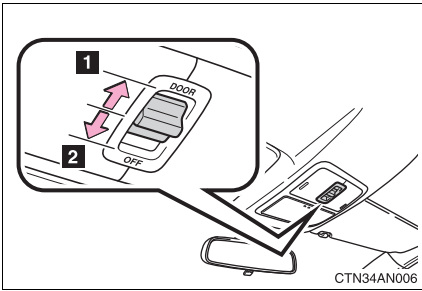

**1** Door position

The personal lights and interior light come on when a door is opened. They go off when the doors are closed.

**2** Off

The personal lights and interior light can be individually turned on or off.

► Type B

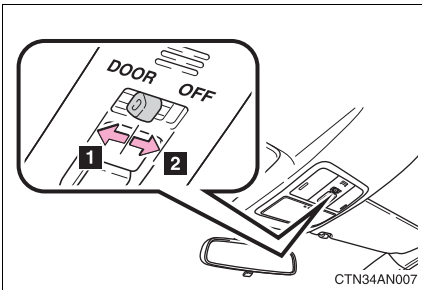

**Personal/interior lights**

► Type A

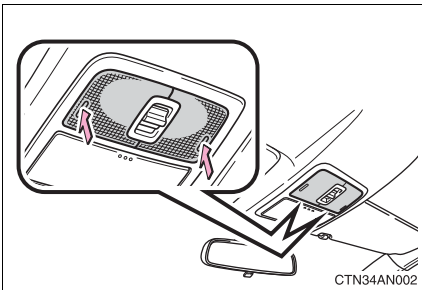

On/off

► Type B

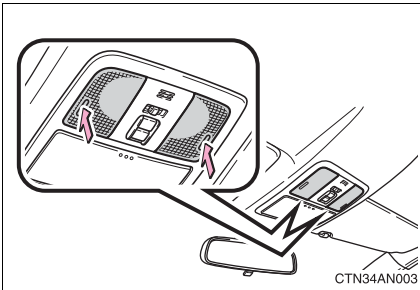

On/off

**Interior light**

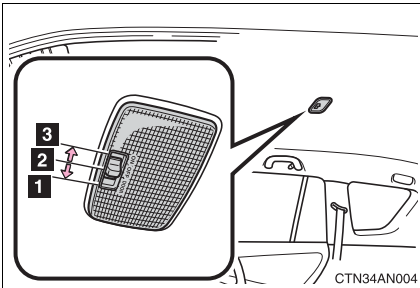

- 1** Door position
- 2** Off
- 3** On

**Luggage compartment light**

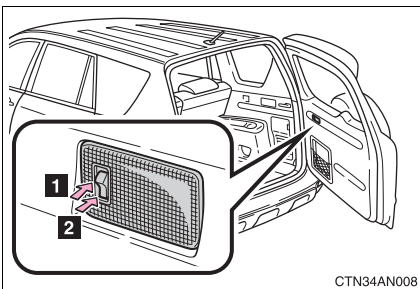

- 1** On
- 2** Off

■ **To prevent battery discharge (excluding luggage compartment light)**

If the lights remain on when a door is not fully closed and the personal/interior light main switch is in door position, the lights will go off automatically after 20 minutes.

■ **Customization that can be configured at Toyota dealer**

Settings (e.g. the time elapsed before lights turn off) can be changed.  
(Customizable features →P. 500)

## 3-5. Using the storage features

### List of storage features

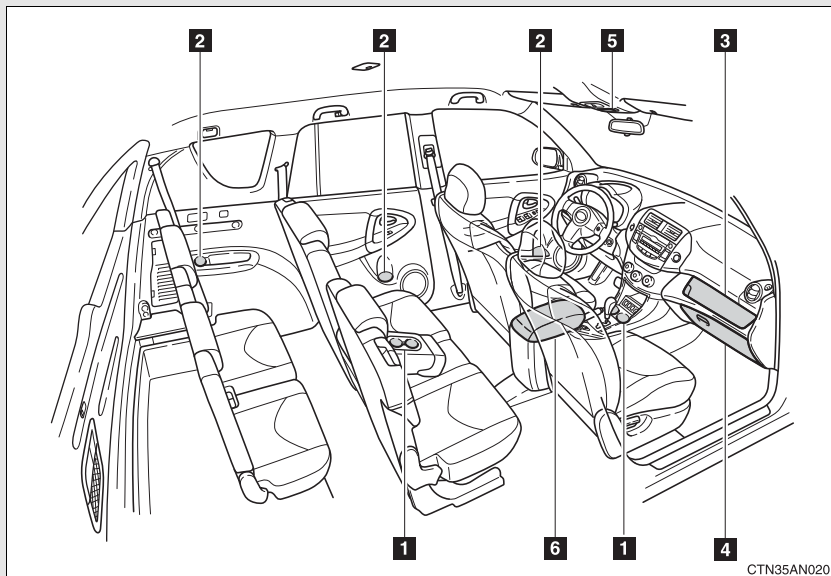

- 1** Cup holders
- 2** Bottle holders
- 3** Auxiliary box
- 4** Glove box
- 5** Overhead console
- 6** Console box

#### **!** CAUTION

##### **■ Items that should not be left in the storage spaces**

Do not leave glasses, lighters or spray cans in the storage spaces, as this may cause the following when cabin temperature becomes high:

- Glasses may be deformed by heat or cracked if they come into contact with other stored items.
- Lighters or spray cans may explode. If they come into contact with other stored items, the lighter may catch fire or the spray can may release gas, causing a fire hazard.

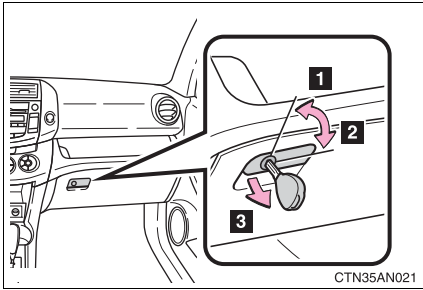

**Glove box**

- 1** Unlock with the master key (vehicles without smart key system) or mechanical key (vehicles with smart key system)
- 2** Lock with the master key (vehicles without smart key system) or mechanical key (vehicles with smart key system)
- 3** Open (pull lever)

**! CAUTION****■ Caution while driving**

Keep the glove box closed.

Injuries may result in the event of an accident or sudden braking.

## Console box

### ► Upper tray

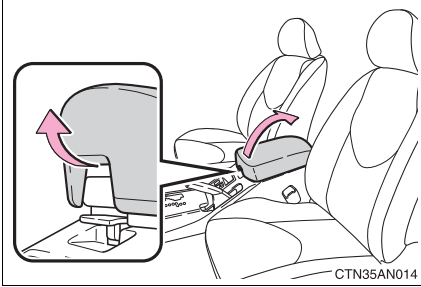

Lift the lid.

### ► Lower box

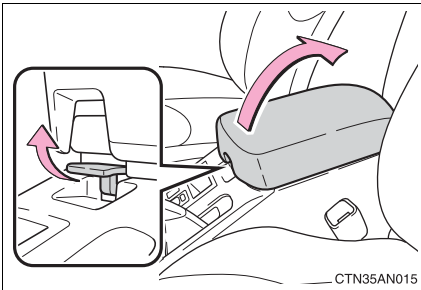

Pull the lever up and lift the lid.

## ⚠ CAUTION

### ■ Caution while driving

Keep the console box closed.

Injuries may result in the event of an accident or sudden braking.

**Overhead console**

The overhead console is useful for temporarily storing sunglasses and similar small items.

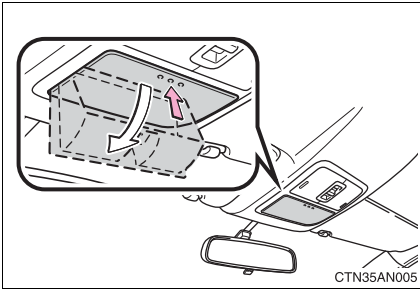

Press the lid.

**⚠ CAUTION****■ Caution while driving**

Keep the overhead console closed.  
Injuries may result in the event of an accident or sudden braking.

**■ Items unsuitable for storing**

Do not store items heavier than 0.4 lb. (0.2 kg).  
Doing so may cause the overhead console to open and the items inside may fall out, resulting in an accident.

**Cup holders**

▶ Type A

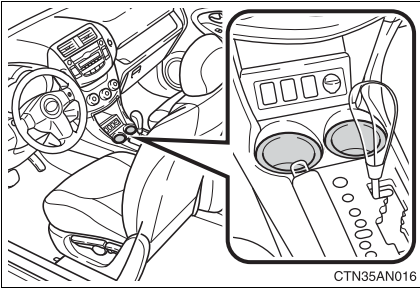

Removing the adapters changes the size. (→P. 315)

▶ Type B

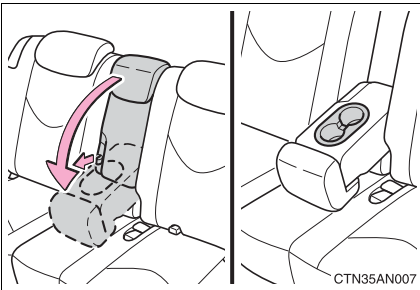

To use the cup holders, pull the strap forward and fold down the center seatback.

■ Adjusting size of the cup holders (type A only)

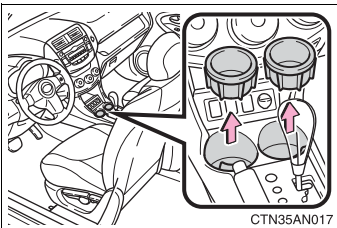

Remove the adapters.

**! CAUTION****■ Items unsuitable for the cup holder**

Do not place anything other than cups or aluminum cans in the cup holders. Other items may be thrown out of the holders in the event of an accident or sudden braking and cause injury. If possible, cover hot drinks to prevent burns.

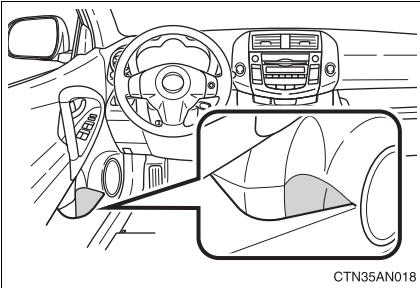
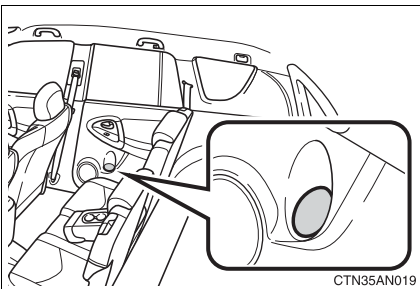
**Bottle holders****► Front seat****► Second seat**

► Third seat

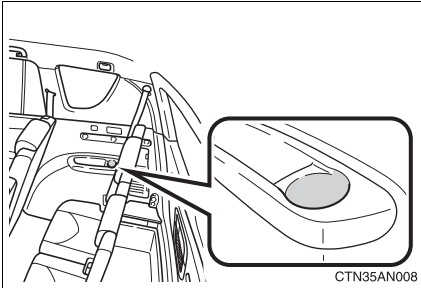

**! CAUTION**

**■ Items unsuitable for the bottle holder**

Do not place anything other than a bottle in the bottle holders. Other items may be thrown out of the holders in the event of an accident or sudden braking and cause injury.

**! NOTICE**

**■ Items that should not be stowed in the bottle holders**

Put the cap on before stowing a bottle. Do not place open bottles in the bottle holders, or glasses and paper cups containing liquid. The contents may spill and glasses may break.

## Auxiliary box

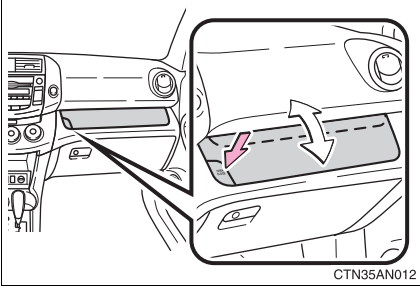

To open and close the auxiliary box, press the button.

### CAUTION

#### ■ Caution while driving

Keep the auxiliary box closed.  
Injuries may result in the event of an accident or sudden braking.

### NOTICE

#### ■ Operating the auxiliary box

If it is difficult to open or close the auxiliary box on a steep hill, move the vehicle to a level place. To avoid damage to the auxiliary box, do not apply excessive force to operate it.

## Sun visors

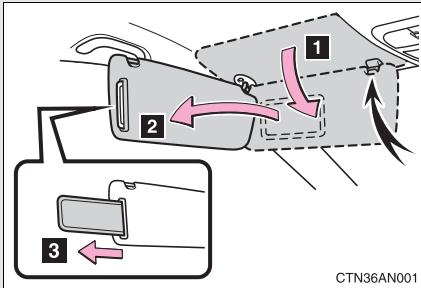

- 1** Forward position:  
Flip down.
- 2** Side position:  
Flip down, unhook, and swing to the side.
- 3** Side extender:  
Place in side position then slide backwards.



### 3-6. Other interior features

## Vanity mirrors

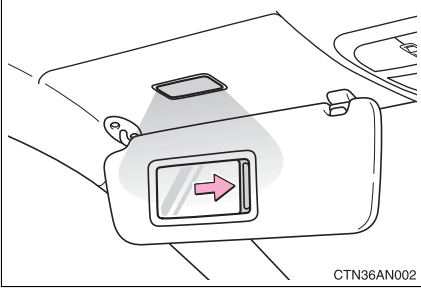

Slide the cover.

The light turns on when the cover is opened.

# Clock

▶ Vehicles with a manual air conditioning system

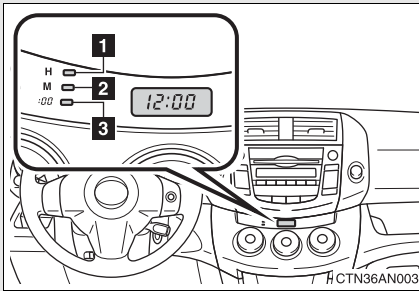

- 1 Adjusts the hours.
- 2 Adjusts the minutes.
- 3 Rounds to the nearest hour.\*

\*: e.g. 1:00 to 1:29 → 1:00

1:30 to 1:59 → 2:00

▶ Vehicles with an automatic air conditioning system

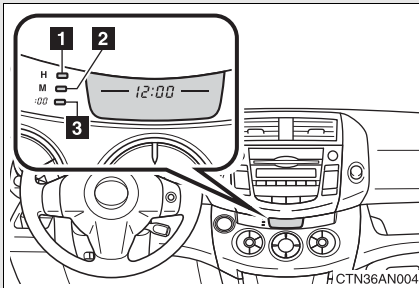

- 1 Adjusts the hours.
- 2 Adjusts the minutes.
- 3 Rounds to the nearest hour.\*

\*: e.g. 1:00 to 1:29 → 1:00

1:30 to 1:59 → 2:00

■ **The clock is displayed when**

▶ Vehicles without smart key system

The engine switch is in the “ACC” or “ON” position.

▶ Vehicles with smart key system

The “ENGINE START STOP” switch is in ACCESSORY or IGNITION ON mode.

■ **When disconnecting and reconnecting battery terminals**

The time display will automatically be set to 1:00.

### 3-6. Other interior features

## Power outlets

**The power outlet can be used for a following component.**

12 V: Accessories that use less than 10 A.

120 VAC: Accessories that use less than 100 W.

#### ■ 12 V

##### ► Type A

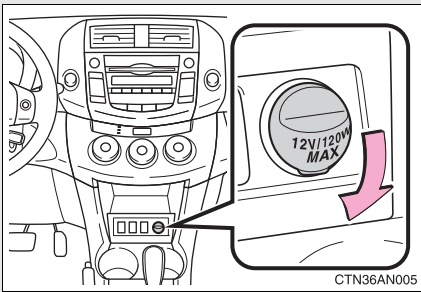

##### ► Type B

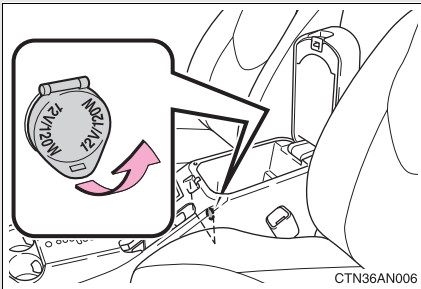

##### ► Type C

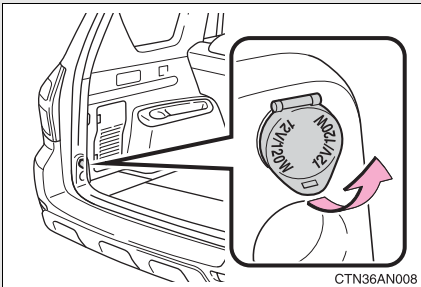

### ■ 120 VAC (if equipped)

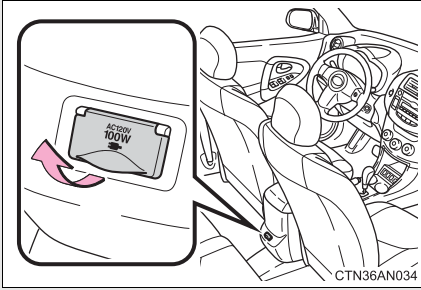

### ■ The power outlet can be used when

#### ▶ 12 V

- Vehicles without smart key system  
The engine switch is in the “ACC” or “ON” position.
- Vehicles with smart key system  
The “ENGINE START STOP” switch is in ACCESSORY or IGNITION ON mode.

#### ▶ 120 VAC

- Vehicles without smart key system  
The engine switch is in the “ON” position.
- Vehicles with smart key system  
The “ENGINE START STOP” switch is in IGNITION ON mode.

 CAUTION

■ **Using a power outlet**

Observe the following precautions to reduce the risk of injury.

- Use of the power outlet when it is wet with water or snow may result in electrical shocks and is extremely dangerous. The power outlet must be thoroughly dried before use.
- Do not allow children to use or play with the power outlet.
- Be careful not to get any part of your body caught in the power outlet lid.
- When using electrical appliances, strictly follow any cautions and notices written on their labels and in the manufacturers' instruction manuals.
- Do not modify, disassemble or repair the power outlet or its inverter in any way. Doing so may result in unexpected malfunctions or accidents, which could cause serious damage or injuries. Contact your Toyota dealer for any necessary repairs.

■ **To prevent injuries and accidents, securely fix all electric appliances before use and do not use any appliances that may do any of the following:**

- Distract the driver while driving, or hamper safe driving.
- Result in a fire or burn injuries due to the appliance rolling, falling or overheating while driving.
- Emit steam while the windows of the cabin are closed.

■ **To prevent unexpected accidents, such as electric shocks, do not perform any of the following:**

- Using the power outlet for electric heaters while sleeping.
- Contaminating the power outlet with liquid substances or mud.
- Handling electrical appliance plugs at the power outlet with wet hands or feet.
- Inserting foreign objects into the power outlet.
- Using malfunctioning electric appliances.
- Inserting inappropriate or badly fitting plugs into the power outlet.

 NOTICE**■ To avoid damaging the power outlet and the plug**

- Close the power outlet lid when not in use.
- Do not allow foreign objects or liquids to enter the power outlet, as this may cause a short circuit.
- Do not use plug adaptors to connect too many plugs to the power outlet.
- After removing a plug, gently close the power outlet lid.

**■ To prevent the fuse from being blown****▶ 12 V**

Do not use an accessory that uses more than 12 V 10 A.

**▶ 120 VAC**

Do not use a 120 VAC appliance that requires more than 100 W.

If a 120 VAC appliance that consumes more than 100 W is used, the protection circuit will cut the power supply.

**■ To prevent battery discharge**

Do not use the power outlet longer than necessary when the engine is not running.

**■ Appliances that may not operate properly (120 VAC)**

The following 120 VAC appliances may not operate properly even if their power consumption is under 100 W.

- Appliances with high initial peak wattage
- Measuring devices that process precise data
- Other appliances that require an extremely stable power supply

 NOTICE

■ **To prevent any damage caused by heat**

- Do not use any electrical appliances that give off intense heat, such as toasters, in any locations including the internal or external trim, seats and deck.
- Do not use any electrical appliances that are easily affected by vibration or heat inside the vehicle. Vibration while driving, or the heat of the sun while parking, may result in damage to those electrical appliances.

■ **If any electrical appliances are to be used while driving**

Securely fasten both the appliances and their cables to prevent them from falling or getting caught in any of the power train components.

■ **If the power outlet is loose when an electrical appliance plug is connected**

Replace the outlet. Contact your Toyota dealer for any necessary replacements.

■ **If the power outlet gets dirty**

Use a soft, clean cloth to wipe it gently. Do not use any cleansing materials, such as organic solvents, wax, or compound cleaners, as these may damage the power outlet or cause it to malfunction.

## Seat heaters\*

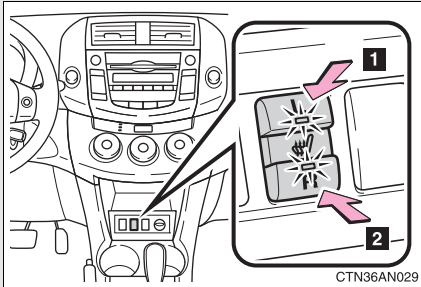

- 1 Heats the driver's seat
- 2 Heats the front passenger's seat

The indicator light is on while the seat heater is operating.

Push the switch once again to turn off the seat heater.

### ■ The seat heaters can be used when

- ▶ Vehicles without smart key system

The engine switch is in the "ON" position.

- ▶ Vehicles with smart key system

The "ENGINE START STOP" switch is in IGNITION ON mode.

### ⚠ CAUTION

#### ■ Burns

- Use caution when seating the following persons in a seat with the seat heater on to avoid the possibility of burns:
  - Babies, small children, the elderly, the sick and the disabled
  - Persons with sensitive skin
  - Persons who are fatigued
  - Persons who have taken alcohol or drugs that induce sleep (sleeping drugs, cold remedies, etc.)
- Do not cover the seat with anything when using the seat heater. Using the seat heater with a blanket or cushion increases the temperature of the seat and may lead to overheating.





**NOTICE**

■ **To prevent seat heater damage**

Do not put unevenly weighted objects on the seat and do not stick sharp objects (needles, nails, etc.) into the seat.

■ **To prevent battery discharge**

Turn the switches off when the engine is not running.

## Armrest

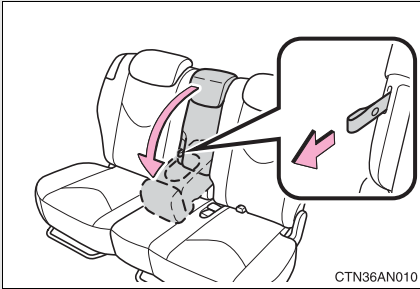

To use the armrest, pull the strap forward and fold down the center seatback.

 **NOTICE**

**■ To prevent damage to the armrest**

Do not place too much strain on the armrest.

## Coat hooks

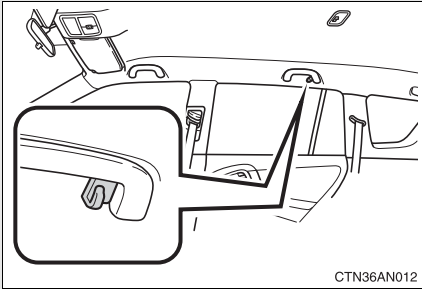

### CAUTION

#### ■ Items that must not be hung on the hook

Do not hang a coat hanger or other hard or sharp objects on the hook. If the SRS curtain shield airbags deploy, these items may become projectiles that cause death or serious injury.

### NOTICE

#### ■ To prevent damage to the coat hook

Do not place too much load on the coat hook.

## Floor mat

**Use only floor mats designed specifically for vehicles of the same model and model year as your vehicle. Fix them securely in place onto the carpet.**

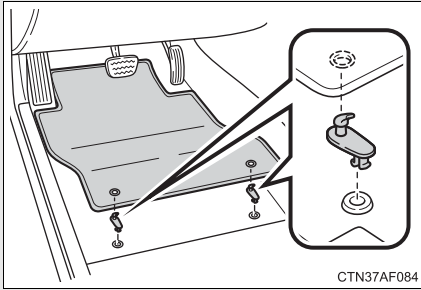

Fix the floor mat in place using the retaining hooks (clips) provided.

For details, refer to the floor mat retention clip installation instructions supplied with the clips.

### ⚠ CAUTION

Observe the following precautions.

Failure to do so may cause the driver's floor mat to slip, possibly interfering with the pedals while driving. An unexpectedly high speed may result or it may become difficult to stop the vehicle, leading to a serious accident.

#### ■ When installing the driver's floor mat

- Do not use floor mats designed for other models or different model year vehicles, even if they are Toyota Genuine floor mats.
- Only use floor mats designed for the driver's seat.
- Always install the floor mat securely using the retaining hooks (clips) provided.
- Do not use two or more floor mats on top of each other.
- Do not place the floor mat bottom-side up or upside-down.

#### ■ Before driving

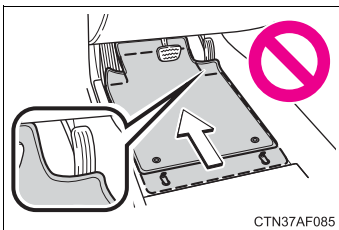

- Check that the floor mat is securely fixed in the right place with all the provided retaining hooks (clips). Be especially careful to perform this check after cleaning the floor.
- With the engine stopped and the shift lever in P, fully depress each pedal to the floor to make sure it does not interfere with the floor mat.

## 3-6. Other interior features

# Luggage compartment features

### ■ Cargo hooks

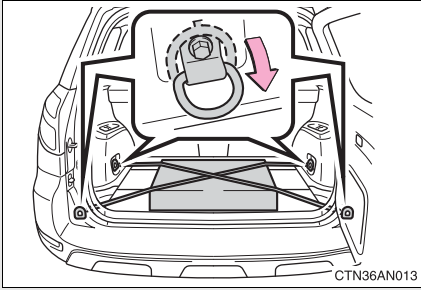

Cargo hooks are provided for securing loose items.

### ■ Grocery bag hooks

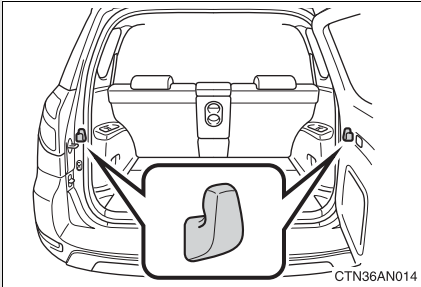

### ■ Storage box (vehicles without third seats)

#### ► Type A

The rear deck board can be folded up into two positions.

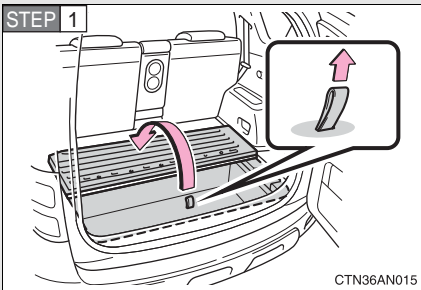

Lift the rear deck board.

STEP 2

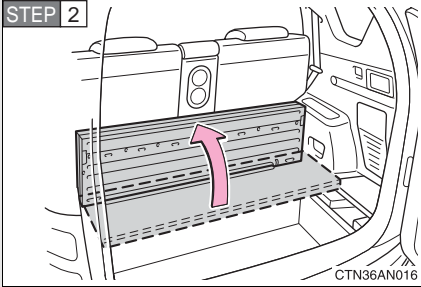

Fold up the deck board.

The lid can be removed.

► Type B

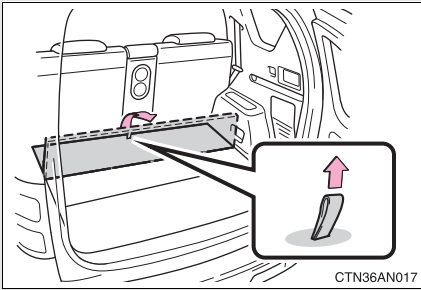

Lift the front deck board.

### ■ Luggage cover (if equipped)

STEP 1

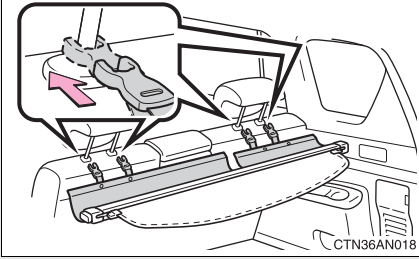

Attach the hooks to the head restraints.

If necessary, move the second seats to enable the hook engagement.

STEP 2

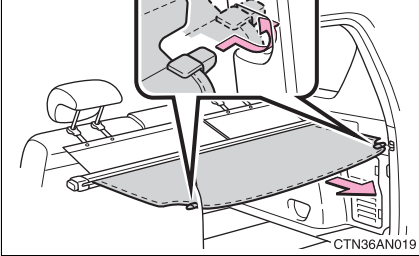

Pull out the luggage cover and hook onto the anchors.

### Removing the luggage cover (if equipped)

The luggage cover can be removed by following the procedure below.

STEP 1 Detach the hooks of the luggage cover.

STEP 2

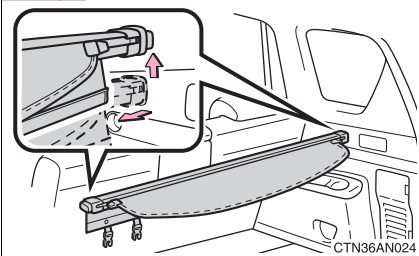

Compress the end of the luggage cover and lift the luggage cover up.

## Stowing the luggage cover (if equipped)

STEP 1

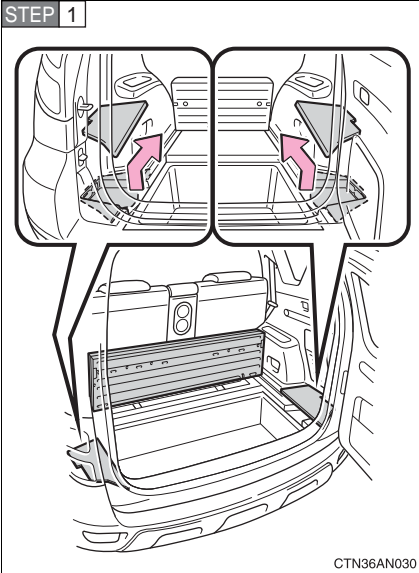

Open the rear deck board and remove the deck side cover.

STEP 2

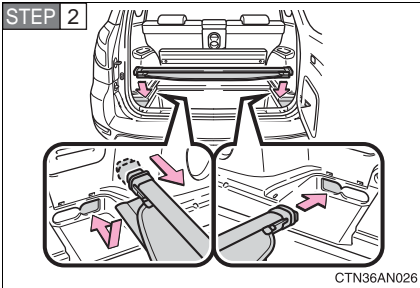

Insert the right end of the luggage cover into the recess, then compress the left end of the luggage cover and insert it into the recess.



 CAUTION

■ **When the cargo hooks are not in use**

To avoid injury, always return the cargo hooks to their stowed positions.

■ **Caution while driving**

- Do not drive with any of the deck boards opened. Items may fall out and cause injury.
- Do not place anything on the luggage cover to avoid death or serious injury.

■ **When installing/stowing the luggage cover**

Make sure that the luggage cover is securely installed/stowed. Failure to do so may result in serious injury in the event of sudden braking or a collision.

 NOTICE

■ **To prevent damage to the grocery bag hooks**

Do not hang heavy loads on the hooks.

## Cleaning and protecting the vehicle exterior

**Perform the following to protect the vehicle and maintain it in prime condition.**

- Working from top to bottom, liberally apply water to the vehicle body, wheel wells and underside of the vehicle to remove any dirt and dust.  
Wash the vehicle body using a sponge or soft cloth, such as a chamois.
- For hard-to-remove marks, use car wash soap and rinse thoroughly with water.
- Wipe away any water.
- Wax the vehicle when the waterproof coating deteriorates.

If water does not bead on a clean surface, apply wax when the vehicle body is cool.

---

### ■ Automatic car washes

- Before washing the vehicle, do the following.
  - Fold the mirrors back.
  - Remove the antenna.

Make sure to re-install the antenna and extend the mirrors before driving.

- Brushes used in automatic car washes may scratch the vehicle surface and harm your vehicle's paint.

### ■ High pressure car washes

- Do not allow the nozzles of the car wash to come within close proximity of the windows.
- Before car wash, check that the fuel filler door on your vehicle is closed properly.

### ■ Aluminum wheels

- Remove any dirt immediately by using a neutral detergent. Do not use hard brushes or abrasive cleaners. Do not use strong or harsh chemical cleaners. Use the same mild detergent and wax as used on the paint.
- Do not use detergent on the wheels when they are hot, for example after driving for long distance in the hot weather.
- Wash detergent from the wheels immediately after use.

### ■ Bumpers

Do not scrub with abrasive cleaners.

#### CAUTION

#### ■ When washing the vehicle

Do not apply water to the inside of the engine compartment. Doing so may cause the electrical components etc. to catch fire.

#### ■ Precautions regarding the exhaust pipe

Exhaust gasses cause the exhaust pipe to become quite hot.

When washing the vehicle, be careful not to touch the pipe until it has cooled sufficiently, as touching a hot exhaust pipe can cause burns.

 NOTICE

■ **To prevent paint deterioration and corrosion on the body and components (aluminum wheels etc.)**

● Wash the vehicle immediately in the following cases:

- After driving near the sea coast
- After driving on salted roads
- If you see coal tar or tree sap on the paint surface
- If you see dead insects or insect droppings on the paint
- After driving in an area contaminated with soot, oily smoke, mine dust, iron powder or chemical substances
- If the vehicle becomes heavily soiled in dust or mud
- If liquids such as benzene and gasoline are spilled on the paint surface

● If the paint is chipped or scratched, have it repaired immediately.

● To prevent the wheels from corroding, remove any dirt and store in a place with low humidity when storing the wheels.

■ **Cleaning the exterior lights**

● Wash carefully. Do not use organic substances or scrub with a hard brush. This may damage the surfaces of the lights.

● Do not apply wax on the surfaces of the lights. Wax may cause damage to the lenses.

■ **Antenna installation and removal precautions**

● Before driving, ensure that the antenna is installed.

● When the antenna is removed, such as before entering an automatic car wash, make sure to store it in a suitable place so as not to lose it. Also, before driving, make sure to reinstall the antenna in its original position.

■ **To prevent damage to the windshield wiper arms**

When lifting the wiper arms away from the windshield, pull the driver side wiper arm upward first, and repeat for the passenger side. When returning the wipers to their original position, do so from the passenger side first.

**The following procedures will help protect your vehicle's interior and keep it in top condition:**

## ■ **Protecting the vehicle interior**

Remove dirt and dust using a vacuum cleaner. Wipe dirty surfaces with a cloth dampened with lukewarm water.

## ■ **Cleaning the leather areas**

- Remove dirt and dust using a vacuum cleaner.
- Wipe any excess dirt and dust with a soft cloth dampened with diluted detergent.

Use a diluted water solution of approximately 5% neutral wool detergent.

- Wring out any excess water from the cloth and thoroughly wipe off all remaining traces of detergent.
- Wipe the surface with a dry, soft cloth to remove any remaining moisture. Allow the leather to dry in a shaded ventilated area.

## ■ **Synthetic leather areas**

- Remove loose dirt using a vacuum cleaner.
- Apply a mild soap solution to the synthetic leather.
- Allow the solution to soak in for a few minutes. Remove the dirt and wipe off the solution with a clean, damp cloth.

### ■ Caring for leather areas

Toyota recommends cleaning the interior of the vehicle at least twice a year to maintain the quality of the vehicle's interior.

### ■ Shampooing the carpets

There are several commercial foaming-type cleaners available. Use a sponge or brush to apply the foam. Rub in overlapping circles. Do not apply water. Excellent results are obtained by keeping the carpet as dry as possible.

### ■ Seat belts

Clean with mild soap and lukewarm water using a cloth or sponge. Also check the belts periodically for excessive wear, fraying or cuts.

## CAUTION

### ■ Water in the vehicle

- Do not splash or spill liquid in the vehicle. Doing so may cause electrical components etc. to malfunction or catch fire.
- Do not get any of the SRS components or wiring in the vehicle interior wet. (→P. 98)

Electrical malfunction may cause the airbags to deploy or not function properly, resulting in death or severe injury.

### ■ Cleaning the interior (especially instrument panel)

Do not use polish wax or polish cleaner. The instrument panel may reflect off the windshield, obstructing the driver's view and leading to an accident, resulting in death or serious injury.

 NOTICE**■ Cleaning detergents**

- Do not use organic substances such as benzene or gasoline, acidic or alkaline solutions, dye, bleach or other detergent. Doing so may discolor the vehicle interior or cause streaks or damage to painted surfaces.
- Do not use polish wax or polish cleaner. The instrument panel's or other interior part's painted surface may be damaged.

**■ Preventing damage to leather surfaces**

Observe the following precautions to avoid damage to and deterioration of leather surfaces.

- Remove any dust or dirt on leather surfaces immediately.
- Do not expose the vehicle to direct sunlight for extended periods of time. Park the vehicle in the shade, especially during summer.
- Do not place items made of vinyl, plastic, or that contain wax on the upholstery, as they may stick to the leather surface if the vehicle interior heats up significantly.

**■ Water on the floor**

Do not wash the vehicle floor with water.

Vehicle systems such as the audio system may be damaged if water comes into contact with electrical components under the floor of the vehicle, and may also cause the body to rust.

**■ Cleaning the inside of the rear window**

- Do not use glass cleaner to clean the rear window, as this may cause damage to the rear window defogger heater wires. Use a cloth dampened with lukewarm water to gently wipe the windows clean. Wipe the windows in strokes running parallel to the heater wires.
- Be careful not to scratch or damage the heater wires.

## Maintenance requirements

**To ensure safe and economical driving, day-to-day care and regular maintenance is essential. It is the owner's responsibility to perform regular checks. Toyota recommends the following maintenance.**

### ■ General maintenance

General maintenance should be performed on a daily basis. This can be done by yourself or by a Toyota dealer.

### ■ Scheduled maintenance

Scheduled maintenance should be performed at specified intervals according to the maintenance schedule.

For details about maintenance items and schedules, refer to the "Scheduled Maintenance Guide" or "Owner's Manual Supplement".

### ■ Do-it-yourself maintenance

You can perform some maintenance procedures yourself. Please be aware that do-it-yourself maintenance may affect warranty coverage.

The use of Toyota Repair Manuals is recommended.

For details about warranty coverage, see the separate "Owner's Warranty Information Booklet" or "Owner's Manual Supplement".

---

### ■ Repair and replacement

It is recommended that genuine Toyota parts be used for repair to ensure performance of each system. If non-Toyota parts are used in replacement or if a repair shop other than a Toyota dealer performs repairs, confirm the warranty coverage.



**■ Allow inspection and repairs to be performed by a Toyota dealer**

- Toyota technicians are well-trained specialists and are kept up to date with the latest service information. They are well informed about the operations of all systems on your vehicle.
- Keep a copy of the repair order. It proves that the maintenance that has been performed is under warranty coverage. If any problem should arise while your vehicle is under warranty, your Toyota dealer will promptly take care of it.

**⚠ CAUTION****■ Warning in handling of battery**

- Engine exhaust, some of its constituents, and a wide variety of automobile components contain or emit chemicals known to the State of California to cause cancer and birth defects and other reproductive harm. Work in a well ventilated area.
- Oils, fuels and fluids contained in vehicles as well as waste produced by component wear contain or emit chemicals known to the State of California to cause cancer and birth defects or other reproductive harm. Avoid exposure and wash any affected area immediately.
- Battery posts, terminals and related accessories contain lead and lead compounds which are known to cause brain damage. Wash your hands after handling. (→P. 369)

## General maintenance

Listed below are the general maintenance items that should be performed at the intervals specified in the “Scheduled Maintenance Guide” or “Owner’s Manual Supplement”. It is recommended that any problem you notice should be brought to the attention of your Toyota dealer or qualified service shop for advice.

### Engine compartment

Items	Check points
Battery	Maintenance-free. (→P. 369)
Brake fluid	At the correct level? (→P. 367)
Engine coolant	At the correct level? (→P. 365)
Engine oil	At the correct level? (→P. 361)
Exhaust system	No fumes or strange sounds?
Radiator/condenser/hoses	Not blocked with foreign matter? (→P. 366)
Washer fluid	At the correct level? (→P. 372)

<b>Vehicle interior</b>
-------------------------

Items	Check points
Accelerator pedal	<ul style="list-style-type: none"> <li>• Moves smoothly (without uneven pedal effort or catching)?</li> </ul>
Automatic transmission “Park” mechanism	<ul style="list-style-type: none"> <li>• Can the vehicle be held securely on an incline with the shift lever in P?</li> </ul>
Brake pedal	<ul style="list-style-type: none"> <li>• Moves smoothly?</li> <li>• Does it have appropriate clearance and correct amount of free play?</li> </ul>
Brakes	<ul style="list-style-type: none"> <li>• Not pull to one side when applied?</li> <li>• Loss of brake effectiveness?</li> <li>• Spongy feeling brake pedal?</li> <li>• Pedal almost touches floor?</li> </ul>
Head restraints	<ul style="list-style-type: none"> <li>• Move smoothly and lock securely?</li> </ul>
Indicators/buzzers	<ul style="list-style-type: none"> <li>• Function properly?</li> </ul>
Lights	<ul style="list-style-type: none"> <li>• Do all the lights come on?</li> <li>• Headlights aimed correctly?</li> </ul>
Parking brake	<ul style="list-style-type: none"> <li>• Moves smoothly?</li> <li>• Can hold the vehicle securely on an incline?</li> </ul>
Seat belts	<ul style="list-style-type: none"> <li>• Does the seat belt system operate smoothly?</li> <li>• Are the belts undamaged?</li> </ul>
Seats	<ul style="list-style-type: none"> <li>• Do the seat controls operate properly?</li> </ul>
Steering wheel	<ul style="list-style-type: none"> <li>• Moves smoothly?</li> <li>• Has correct free play?</li> <li>• No strange noises?</li> </ul>

## Vehicle exterior

Items	Check points
Doors	<ul style="list-style-type: none"> <li>• Operate smoothly?</li> </ul>
Engine hood	<ul style="list-style-type: none"> <li>• The lock system works properly?</li> </ul>
Fluid leaks	<ul style="list-style-type: none"> <li>• Is there any leakage after parking?</li> </ul>
Tires	<ul style="list-style-type: none"> <li>• Inflation pressure is correct?</li> <li>• Tire surfaces not worn or damaged?</li> <li>• Tires rotated according to the maintenance schedule?</li> <li>• Wheel nuts are not loose?</li> </ul>



### CAUTION

#### ■ If the engine is running

Turn the engine off and ensure that there is adequate ventilation before performing maintenance checks.

**Some states have vehicle emission inspection programs which include OBD (On Board Diagnostics) checks. The OBD system monitors the operation of the emission control system.**

■ **If the malfunction indicator lamp comes on**

The OBD system determines that a problem exists somewhere in the emission control system. Your vehicle may not pass the I/M test and may need to be repaired. Contact your Toyota dealer to service the vehicle.

■ **Your vehicle may not pass the I/M test:**

- When the battery is disconnected or discharged

Readiness codes that are set during ordinary driving are erased.

Also, depending on your driving habits, the readiness codes may not be completely set.

- When the fuel tank cap is loose

The malfunction indicator lamp comes on as a temporary malfunction and your vehicle may not pass the I/M test.

■ **When the malfunction indicator lamp goes off after several driving trips**

The error code in the OBD system will not be cleared unless the vehicle is driven 40 or more times.

■ **If your vehicle does not pass the I/M test**

Contact your Toyota dealer to prepare the vehicle for re-testing.

## Do-it-yourself service precautions

**If you perform maintenance yourself, be sure to follow the correct procedures as given in these sections.**

Items	Parts and tools
Battery condition (→P. 369)	<ul style="list-style-type: none"> <li>• Warm water</li> <li>• Baking soda</li> <li>• Grease</li> <li>• Conventional wrench (for terminal clamp bolts)</li> </ul>
Brake fluid level (→P. 367)	<ul style="list-style-type: none"> <li>• FMVSS No.116 DOT 3 or SAE J1703 brake fluid</li> <li>• Rag or paper towel</li> <li>• Funnel (used only for adding brake fluid)</li> </ul>
Engine coolant level (→P. 365)	<ul style="list-style-type: none"> <li>• “Toyota Super Long Life Coolant” or similar high quality ethylene glycol based non-silicate, non-amine, non-nitrite and non-borate coolant with long-life hybrid organic acid technology. For the U.S.A.: “Toyota Super Long Life Coolant” is pre-mixed with 50% coolant and 50% deionized water. For Canada: “Toyota Super Long Life Coolant” is pre-mixed with 55% coolant and 45% deionized water.</li> <li>• Funnel (used only for adding engine coolant)</li> </ul>
Engine oil level (→P. 361)	<ul style="list-style-type: none"> <li>• Toyota Genuine Motor Oil or equivalent</li> <li>• Rag or paper towel, funnel (used only for adding oil)</li> </ul>

Items	Parts and tools
Fuses (→P. 392)	<ul style="list-style-type: none"> <li>• Fuse with same amperage rating as original</li> </ul>
Radiator and condenser (→P. 366)	—
Tire inflation pressure (→P. 380)	<ul style="list-style-type: none"> <li>• Tire pressure gauge</li> <li>• Compressed air source</li> </ul>
Washer fluid (→P. 372)	<ul style="list-style-type: none"> <li>• Water washer fluid containing antifreeze (for winter use)</li> <li>• Funnel</li> </ul>
Light bulb (→P. 404)	<ul style="list-style-type: none"> <li>• Bulb with same number and wattage rating as original</li> <li>• Flathead screwdriver</li> </ul>

 **CAUTION**

The engine compartment contains many mechanisms and fluids that may move suddenly, become hot, or become electrically energized. To avoid death or serious injury, observe the following precautions.

■ **When working on the engine compartment**

- Keep hands, clothing, and tools away from the moving fans and engine drive belt.
- Be careful not to touch the engine, radiator, exhaust manifold, etc. right after driving as they may be hot. Oil and other fluids may also be hot.
- Do not leave anything that may burn easily, such as paper or rags, in the engine compartment.
- Do not smoke, cause sparks or expose an open flame to fuel or the battery. Fuel and battery fumes are flammable.
- Be extremely cautious when working on the battery. It contains poisonous and corrosive sulfuric acid.
- Take care because brake fluid can harm your hands or eyes and damage painted surfaces.

If fluid gets on your hands or in your eyes, flush the affected area with clean water immediately.

If you still experience discomfort, see a doctor.

■ **When working near the electric cooling fans or radiator grille**

Vehicles without smart key system: Be sure the engine switch is OFF. With the engine switch in the “ON” position, the electric cooling fans may automatically start to run if the air conditioning is on and/or the coolant temperature is high. (→P. 366)

Vehicles with smart key system: Be sure the “ENGINE START STOP” switch is OFF. With the “ENGINE START STOP” switch in IGNITION ON mode, the electric cooling fans may automatically start to run if the air conditioning is on and/or the coolant temperature is high. (→P. 366)

■ **Safety glasses**

Wear safety glasses to prevent flying or falling material, fluid spray, etc. from getting in the eyes.



 NOTICE**■ If you remove the air cleaner filter**

Driving with the air cleaner removed may cause excessive engine wear due to dirt in the air. Also a backfire could cause a fire in the engine compartment.

## 4-3. Do-it-yourself maintenance

### Hood

**Release the lock from the inside of the vehicle to open the hood.**

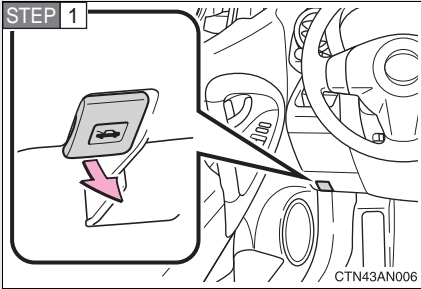

Pull the hood release lever.

The hood will pop up slightly.

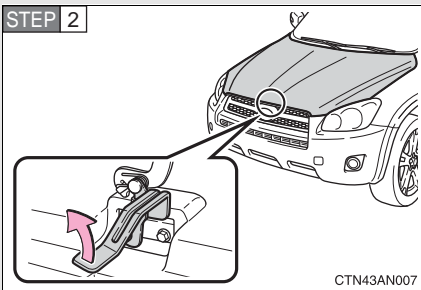

Lift the auxiliary catch lever and lift the hood.

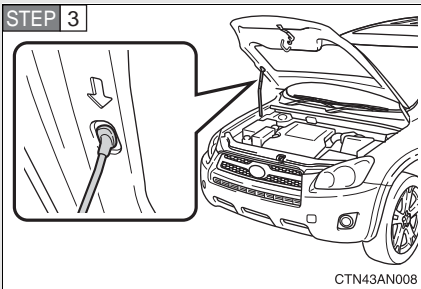

Hold the hood open by inserting the supporting rod into the slot.

 **CAUTION****■ Pre-driving check**

Check that the hood is fully closed and locked.

If the hood is not locked properly, it may open while the vehicle is in motion and cause an accident, which may result in death or serious injury.

**■ After installing the support rod into the slot**

Make sure the rod supports the hood securely from falling down on to your head or body.

 **NOTICE****■ When closing the hood**

Be sure to return the support rod to its clip before closing the hood. Closing the hood with the support rod up could cause the hood to bend.

## 4-3. Do-it-yourself maintenance

### Positioning a floor jack

**When raising your vehicle with a floor jack, position the jack correctly. Improper placement may damage your vehicle or cause injury.**

#### ■ Front

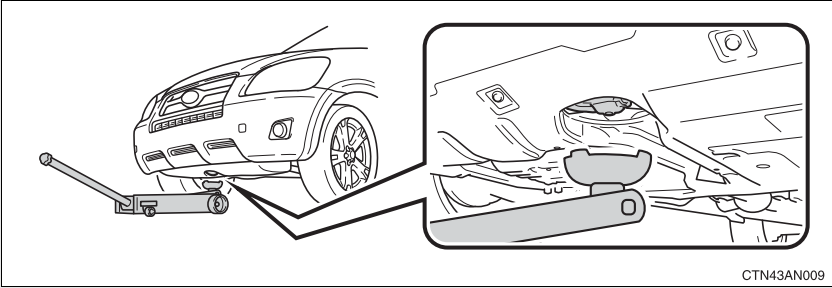

#### ■ Rear

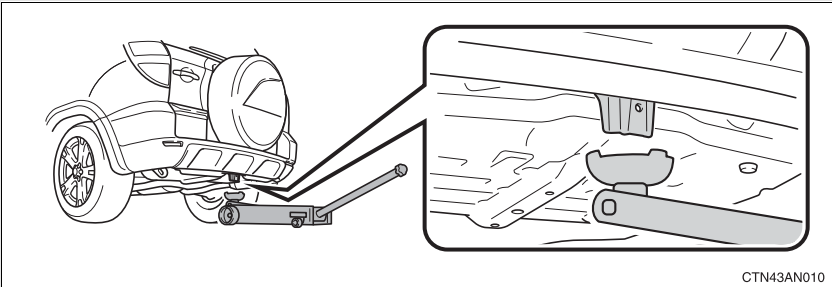

## ⚠ CAUTION

### ■ When raising your vehicle

Make sure to observe the following to reduce the possibility of death or serious injury.

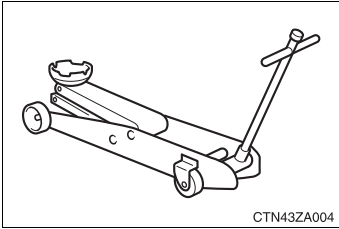

- Lift up the vehicle using a floor jack such as the one shown in the illustration.

- When using a floor jack, follow the instructions of the manual provided with the jack.
- Do not use the jack that was supplied with your vehicle.
- Do not put any part of your body or get underneath the vehicle supported only by the floor jack.
- Always use floor jack and/or automotive jack stands on a solid, flat, level surface.
- Do not start the engine while the vehicle is supported by the floor jack.
- Stop the vehicle on level firm ground, firmly set the parking brake and shift the shift lever in P.
- Make sure to set the floor jack properly at the jack point.  
Raising the vehicle with an improperly positioned floor jack will damage the vehicle and may cause the vehicle to fall off the floor jack.
- Do not raise the vehicle while someone is in the vehicle.
- When raising the vehicle, do not place any objects on top of or underneath the floor jack.

## 4-3. Do-it-yourself maintenance

### Engine compartment

#### ► 2.5 L 4-cylinder (2AR-FE) engine

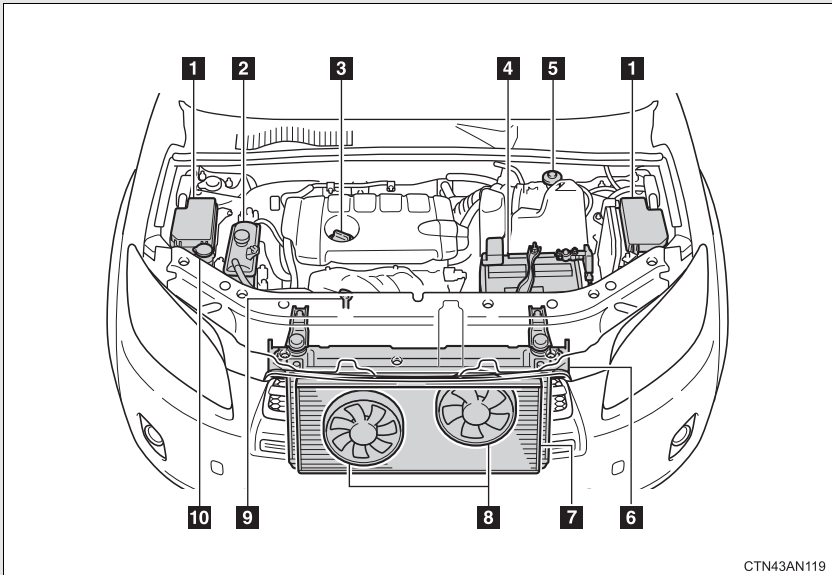

CTN43AN119

- |                                   |           |                                    |           |
|-----------------------------------|-----------|------------------------------------|-----------|
| <b>1</b> Fuse boxes               | (→P. 392) | <b>6</b> Radiator                  | (→P. 366) |
| <b>2</b> Engine coolant reservoir | (→P. 365) | <b>7</b> Condenser                 | (→P. 366) |
| <b>3</b> Engine oil filler cap    | (→P. 362) | <b>8</b> Electric cooling fans     |           |
| <b>4</b> Battery                  | (→P. 369) | <b>9</b> Engine oil level dipstick | (→P. 361) |
| <b>5</b> Brake fluid reservoir    | (→P. 367) | <b>10</b> Washer fluid tank        | (→P. 372) |

## ▶ 3.5 L V6 (2GR-FE) engine

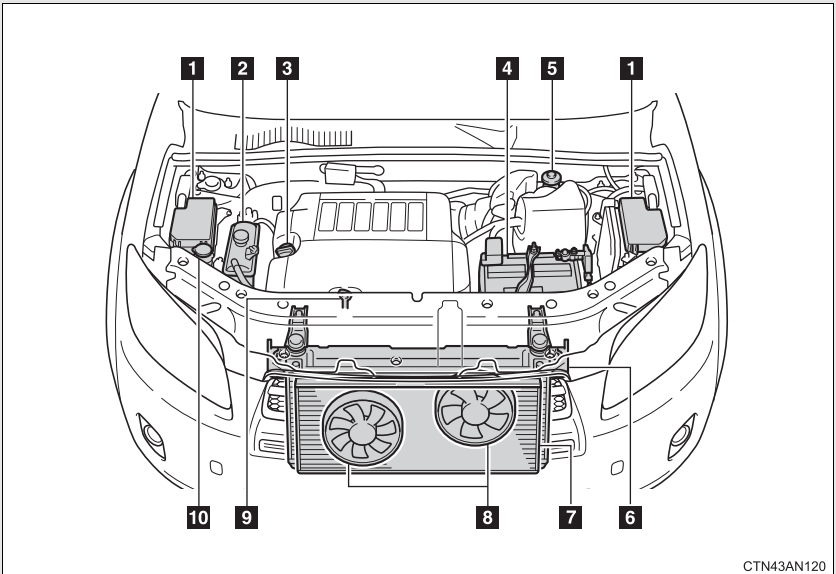

CTN43AN120

- |                                   |           |                                    |           |
|-----------------------------------|-----------|------------------------------------|-----------|
| <b>1</b> Fuse boxes               | (→P. 392) | <b>6</b> Radiator                  | (→P. 366) |
| <b>2</b> Engine coolant reservoir | (→P. 365) | <b>7</b> Condenser                 | (→P. 366) |
| <b>3</b> Engine oil filler cap    | (→P. 362) | <b>8</b> Electric cooling fans     |           |
| <b>4</b> Battery                  | (→P. 369) | <b>9</b> Engine oil level dipstick | (→P. 361) |
| <b>5</b> Brake fluid reservoir    | (→P. 367) | <b>10</b> Washer fluid tank        | (→P. 372) |

## Engine compartment cover

### ■ Removing the engine compartment cover

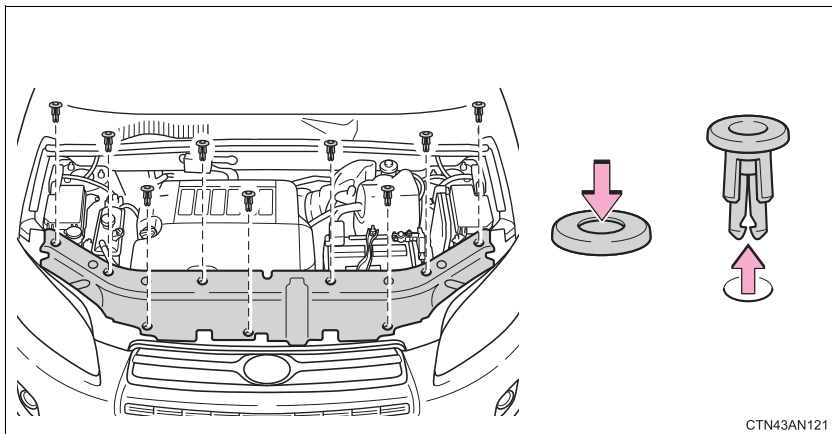

### ■ Installing the clips

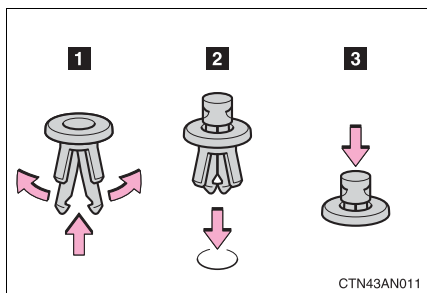



## Engine oil

With the engine at operating temperature and turned off, check the oil level on the dipstick.

### ■ Checking the engine oil

**STEP 1** Park the vehicle on level ground. After turning off the engine, wait more than five minutes for the oil to drain back into the bottom of the engine.

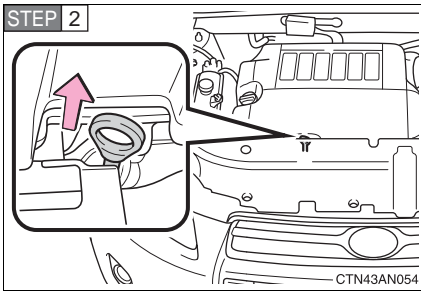

Hold a rag under the end and pull the dipstick out.

**STEP 3** Wipe the dipstick clean.

**STEP 4** Reinsert the dipstick fully.

**STEP 5** Holding a rag under the end, pull the dipstick out and check the oil level.

**STEP 6** Wipe the dipstick and reinsert it fully.

▶ 2.5 L 4-cylinder (2AR-FE) engine

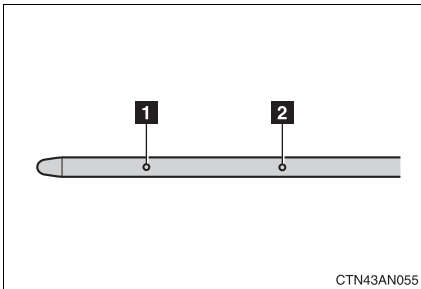

**1** Low

**2** Full

▶ 3.5 L V6 (2GR-FE) engine

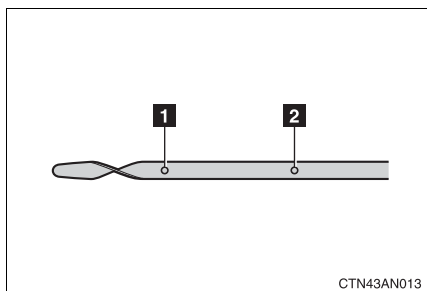

**1** Low

**2** Full

CTN43AN013

■ Adding engine oil

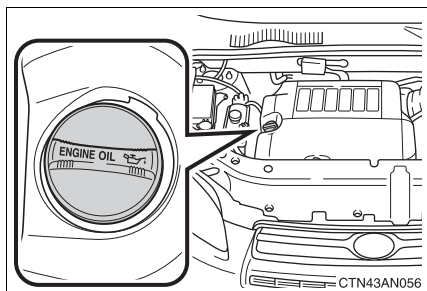

If the oil level is below or near the low level mark, add engine oil of the same type as already in the engine.

CTN43AN056

Make sure to check the oil type and prepare the items needed before adding oil.

Engine oil selection	→P. 478
Oil quantity (Low → Full)	1.6 qt. (1.5 L, 1.3 Imp. qt.)
Item	Clean funnel

**STEP 1** Remove the oil filler cap by turning it counterclockwise.

**STEP 2** Add engine oil slowly, checking the dipstick.

**STEP 3** Install the oil filler cap by turning it clockwise.

### ■ Engine oil consumption

- The amount of engine oil consumed depends on the oil viscosity, the quality of the oil and the way the vehicle is driven.
- More oil is consumed under driving conditions such as high speeds and frequent acceleration and deceleration.
- A new engine consumes more oil.
- When judging the amount of oil consumption, keep in mind that the oil may have become diluted, making it difficult to judge the true level accurately.
- Oil consumption: Max. 1.1 qt./600 miles, 0.9 Imp. qt./600 miles (1.0 L per 1000 km)
- If your vehicle consumes more than 1.1 qt. (1.0 L, 0.9 Imp. qt.) every 600 miles (1000 km), contact your Toyota dealer.

### ■ Changing the engine oil (U.S.A. only)

To reset the oil change system, follow the procedure below:

#### ▶ Vehicles without smart key system

**STEP 1** Turn the engine switch off with the trip meter A reading shown. (→P. 156)

**STEP 2** While pressing the trip meter reset button, turn the engine switch to the “ON” position.

**STEP 3** Press and hold the button until the trip meter displays “000000”.

#### ▶ Vehicles with smart key system

**STEP 1** Turn the “ENGINE START STOP” switch off with the trip meter A reading shown. (→P. 156)

**STEP 2** While pressing the trip meter reset button, turn the “ENGINE START STOP” switch to IGNITION ON mode.

**STEP 3** Press and hold the button until the trip meter displays “000000”.

 **CAUTION**

■ **Used engine oil**

- Used engine oil contains potentially harmful contaminants which may cause skin disorders such as inflammation or skin cancer, so care should be taken to avoid prolonged and repeated contact. To remove used engine oil from your skin, wash thoroughly with soap and water.
- Dispose of used oil and filters only in a safe and acceptable manner. Do not dispose of used oil and filters in household trash, in sewers or onto the ground. Call your Toyota dealer, service station or auto parts store for information concerning recycling or disposal.
- Do not leave used engine oil within the reach of children.

 **NOTICE**

■ **To prevent serious engine damage**

Check the oil level on a regular basis.

■ **When replacing the engine oil**

- Be careful not to spill engine oil on the vehicle components.
- Avoid overfilling, as the engine could be damaged.
- Check the oil level on the dipstick every time you refill the vehicle.
- Be sure the engine oil filler cap is properly tightened.

## Engine coolant

The coolant level is satisfactory if it is between the “FULL” and “LOW” lines on the reservoir when the engine is cold.

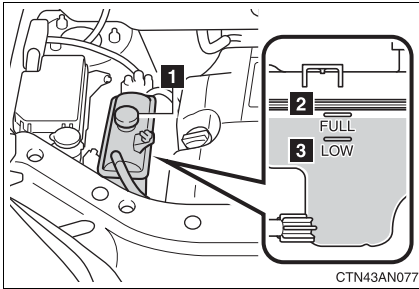

**1** Reservoir cap

**2** “FULL”

**3** “LOW”

If the level is on or below the “LOW” line, add coolant up to the “FULL” line.

### ■ If the coolant level drops within a short time after replenishing

Visually check the radiator, hoses, engine coolant reservoir cap, drain cock and water pump.

If you cannot find a leak, have your Toyota dealer test the cap and check for leaks in the cooling system.

### ■ Coolant selection

Only use “Toyota Super Long Life Coolant” or similar high quality ethylene glycol based non-silicate, non-amine, non-nitrite, and non-borate coolant with long-life hybrid organic acid technology.

U.S.A.: “Toyota Super Long Life Coolant” is a mixture of 50% coolant and 50% deionized water. (Enabled: -31°F [-35°C])

Canada: “Toyota Super Long Life Coolant” is a mixture of 55% coolant and 45% deionized water. (Enabled: -44°F [-42°C])

For more details about engine coolant, contact your Toyota dealer.

## ⚠ CAUTION

### ■ When the engine is hot

Do not remove the coolant reservoir cap.

The cooling system may be under pressure and may spray hot coolant if the cap is removed, causing burns or other injuries.

 NOTICE

■ **When adding engine coolant**

Coolant is neither plain water nor straight antifreeze. The correct mixture of water and antifreeze must be used to provide proper lubrication, corrosion protection and cooling. Be sure to read the antifreeze or coolant label.

■ **If you spill coolant**

Be sure to wash it off with water to prevent damage to parts or paint.

**Radiator and condenser**

Check the radiator and condenser, and clear any foreign objects. If either of the above parts are extremely dirty or you are not sure of their condition, have your vehicle checked by your Toyota dealer.

 CAUTION

■ **When the engine is hot**

Do not touch the radiator or condenser as they may be hot and may cause burns.

## Brake fluid

### ■ Checking fluid level

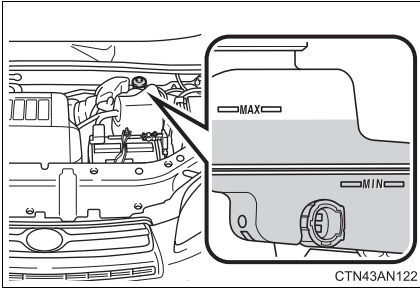

The brake fluid level should be between the “MAX” and “MIN” lines on the tank.

Make sure to check the fluid type and prepare the necessary items.

### ■ Adding fluid

Fluid type	SAE J1703 or FMVSS No.116 DOT 3 brake fluid
Items	Clean funnel

### ■ Brake fluid can absorb moisture from the air

Excess moisture in the fluid can cause a dangerous loss of braking efficiency. Use only newly opened brake fluid.

 **CAUTION**

■ **When filling the reservoir**

Take care because brake fluid can harm your hands or eyes and damage painted surfaces.

If fluid gets on your hands or in your eyes, flush the affected area with clean water immediately.

If you still experience discomfort, see a doctor.

 **NOTICE**

■ **If the fluid level is low or high**

It is normal for the brake fluid level to go down slightly as the brake pads wear or when the fluid level in the accumulator is high.

If the reservoir needs frequent refilling, it may indicate a serious problem.



## Battery

### ■ Battery exterior

Make sure that the battery terminals are not corroded and that there are no loose connections, cracks, or loose clamps.

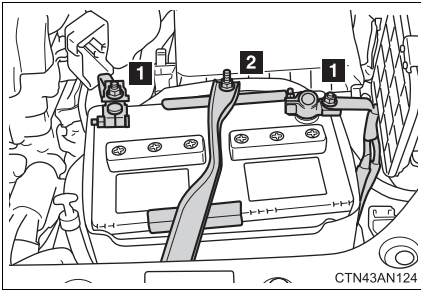

**1** Terminals

**2** Hold-down clamp

### ■ Checking battery fluid

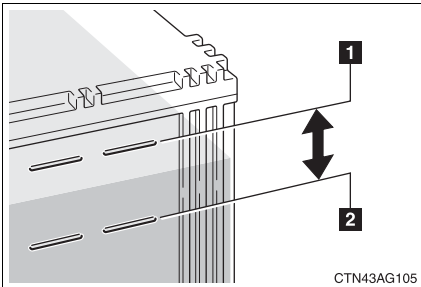

Check that the level is between the “UPPER” and “LOWER” lines.

**1** “UPPER” line

**2** “LOWER” line

If the fluid level is at or below the “LOWER” line, add distilled water.

### ■ Before recharging

When recharging, the battery produces hydrogen gas which is flammable and explosive. Therefore, before recharging:

- If recharging with the battery installed on the vehicle, be sure to disconnect the ground cable.
- Make sure the power switch on the charger is off when connecting and disconnecting the charger cables to the battery.

■ **After recharging/reconnecting the battery (vehicles with smart key system)**

In some cases, the engine may not start. Follow the procedure below to initialize the system.

**STEP 1** Shift the shift lever to P, and turn the “ENGINE START STOP” switch OFF.

**STEP 2** Open and close any of the doors.

**STEP 3** Start the engine. (If the engine does not start first time, repeat the procedure.)

 **CAUTION**

■ **Chemicals in the battery**

A battery contains poisonous and corrosive sulfuric acid and may produce hydrogen gas which is flammable and explosive. To reduce the risk of death or serious injury, take the following precautions while working on or near the battery:

- Do not cause sparks by touching the battery terminals with tools.
- Do not smoke or light a match near the battery.
- Avoid contact with eyes, skin and clothes.
- Never inhale or swallow electrolyte.
- Wear protective safety glasses when working near the battery.
- Keep children away from the battery.

■ **Where to safely charge the battery**

Always charge the battery in an open area. Do not charge the battery in a garage or closed room where there is not sufficient ventilation.

■ **How to recharge the battery**

Only perform a slow charge (5 A or less). The battery may explode if charged at a quicker rate.

 **CAUTION****■ Emergency measures regarding electrolyte**

- If electrolyte gets in your eyes  
Flush your eyes with clean water for at least 15 minutes and get immediate medical attention. If possible, continue to apply water with a sponge or cloth while traveling to the nearest medical facility.
- If electrolyte gets on your skin  
Wash the affected area thoroughly. If you feel pain or burning, get medical attention immediately.
- If electrolyte gets on your clothes  
It can soak through clothing on to your skin. Immediately take off the clothing and follow the procedure above if necessary.
- If you accidentally swallow electrolyte  
Drink a large quantity of water or milk. Get emergency medical attention immediately.

 **NOTICE****■ When recharging the battery**

Never recharge the battery while the engine is running. Also, be sure all accessories are turned off.

## Washer fluid

- For vehicles sold in U.S.A.

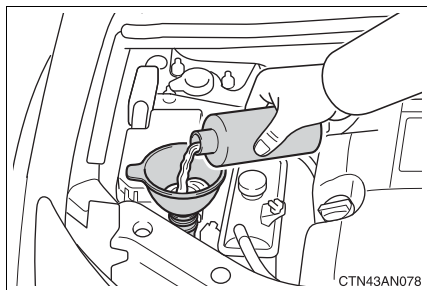

Add washer fluid in the following situations.

- Any washer does not work.
- The low washer fluid warning light comes on.

- For vehicles sold in Canada

If any washer does not work or the low windshield washer fluid warning light comes on, the washer tank may be empty. Add washer fluid.

### CAUTION

#### ■ When filling the washer fluid

Do not refill the washer fluid when the engine is hot or running, as the washer fluid contains alcohol and may catch fire if spilled on the engine etc.

### NOTICE

#### ■ Do not use any fluid other than washer fluid

Do not use soapy water or engine antifreeze instead of washer fluid. Doing so may cause streaking on the vehicle's painted surfaces.

#### ■ Diluting washer fluid

Dilute washer fluid with water as necessary. Refer to the freezing temperatures listed on the washer fluid tank.

# Tires

Replace or rotate tires in accordance with maintenance schedules and treadwear.

## ■ Checking tires

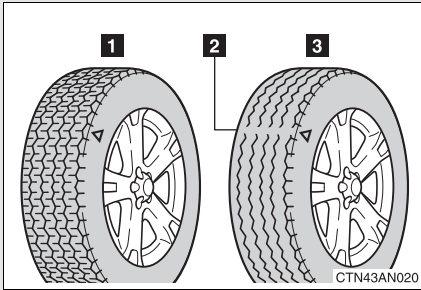

- 1 New tread
- 2 Treadwear indicator
- 3 Worn tread

The location of treadwear indicators is shown by the “TWI” or “△” marks, etc., molded on the sidewall of each tire.

Check spare tire condition and inflation pressure if not rotated.

## ■ Tire rotation

- ▶ Vehicles with a spare tire of the same wheel type as the installed tires

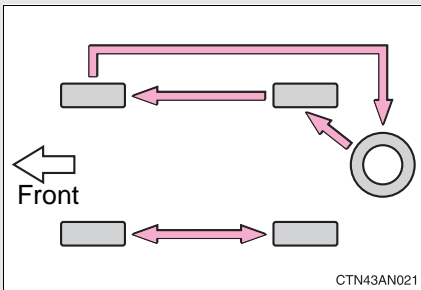

Rotate the tires in the order shown.

To equalize tire wear and extend tire life, Toyota recommends that tire rotation is carried out at the same interval as tire inspection.

- ▶ Except vehicles with a spare tire of the same wheel type as the installed tires

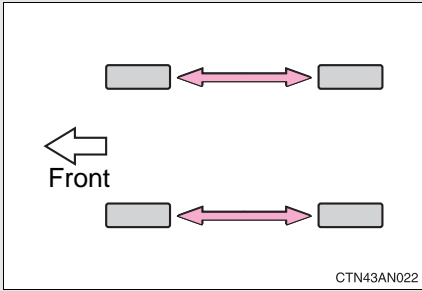

Rotate the tires in the order shown.

To equalize tire wear and extend tire life, Toyota recommends that tire rotation is carried out at the same interval as tire inspection.

### ■ The tire pressure warning system (if equipped)

Your Toyota is equipped with a tire pressure warning system that uses tire pressure warning valves and transmitters to detect low tire inflation pressure before serious problems arise. (→P. 429)

**Installing tire pressure warning valves and transmitters (vehicles with a tire pressure warning system)**

When replacing tires or wheels, tire pressure warning valves and transmitters must also be installed.

When new tire pressure warning valves and transmitters are installed, new tire pressure warning valve and transmitter ID codes must be registered in the tire pressure warning computer and the tire pressure warning system must be initialized. Have tire pressure warning valve and transmitter ID codes registered by your Toyota dealer. (→P. 375)

**Registering ID codes (vehicles with a tire pressure warning system)**

The tire pressure warning valve and transmitter is equipped with a unique ID code. When replacing a tire pressure warning valve and transmitter, it is necessary to register the ID code of tire pressure warning valve and transmitter. Have the ID code registered by your Toyota dealer.

### ■ When to replace your vehicle's tires

Tires should be replaced if:

- You have tire damage such as cuts, splits, cracks deep enough to expose the fabric, or bulges indicating internal damage.
- A tire goes flat repeatedly or cannot be properly repaired due to the size or location of a cut or other damage.

If you are not sure, consult with your Toyota dealer.

### ■ Replacing tires and wheels (vehicles with a tire pressure warning system)

If the ID code of the tire pressure warning valve and transmitter is not registered, the tire pressure warning system will not work properly. After driving for about 20 minutes, the tire pressure warning light comes on after blinking for 1 minute to indicate a system malfunction.

### ■ Tire life

Any tire over 6 years old must be checked by a qualified technician even if they have seldom or never been used or damage is not obvious.

### ■ If the tread wears down below 0.16 in. (4 mm) on snow tires

The effectiveness of snow tires is lost.

### ■ Maximum load of tire

Check that the number given by dividing the maximum load by 1.10 of the replacement tire is greater than 1/2 of the Gross Axle Weight Ratings (GAWR) of either the front axle or the rear axle, whichever is greater.

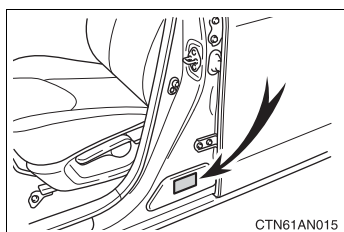

For the GAWR, see the Certification Label. For the maximum load of the tire, see the load limit at maximum cold tire inflation pressure mentioned on the sidewall of the tire. (→P. 489)



## ■ Tire types

### 1 Summer tires

Summer tires are high-speed performance tires best suited to highway driving under dry conditions. Since summer tires do not have the same traction performance as snow tires, summer tires are inadequate for driving on snow-covered or icy roads. For driving on snow-covered roads or icy roads, the use of snow tires is recommended. When installing snow tires, be sure to replace all four tires.

### 2 All season tires

All season tires are designed to provide better traction in snow and to be adequate for driving in most winter conditions, as well as for use year round. All season tires, however, do not have adequate traction performance compared with snow tires in heavy or loose snow. Also, all season tires fall short in acceleration and handling performance compared with summer tires in highway driving.

### 3 Snow tires

For driving on snow-covered roads or icy roads, we recommend using snow tires. If you need snow tires, select tires of the same size, construction and load capacity as the originally installed tires. Since your vehicle has radial tires as original equipment, make sure your snow tires also have radial construction. Do not install studded tires without first checking local regulations for possible restriction. Snow tires should be installed on all wheels. (→P. 210)

## ■ Routine tire inflation pressure checks

The tire pressure warning system does not replace routine tire inflation pressure checks. Make sure to check tire inflation pressure as part of your routine of daily vehicle checks.

### ■ Tire pressure warning system certification

FCC ID: PAXPMV107J

FCC ID: HYQ13BCX

► For vehicles sold in the U.S.A.

This device complies with part 15 of the FCC Rules. Operation is subject to the following two conditions: (1) This device may not cause harmful interference, and (2) this device must accept any interference received, including interference that may cause undesired operation.

FCC WARNING:

Changes or modifications not expressly approved by the party responsible for compliance could void the user's authority to operate the equipment.

► For vehicles sold in Canada

Operation is subject to the following two conditions: (1) this device may not cause interference, and (2) this device must accept any interference, including interference that may cause undesired operation of the device.

### CAUTION

#### ■ When inspecting or replacing tires

Observe the following precautions to prevent accidents. Failure to do so may cause damage to parts of the drive train, as well as dangerous handling characteristics, which may lead to an accident resulting in death or serious injury.

- Do not mix tires of different makes, models or tread patterns.  
Also, do not mix tires of remarkably different treadwear.
- Do not use tire sizes other than those recommended by Toyota.
- Do not mix differently constructed tires (radial, bias-belted or bias-ply tires).
- Do not mix summer, all season and snow tires.
- Do not tow the vehicle with the spare tire installed.

 NOTICE

■ **Repairing or replacing tires, wheels, tire pressure warning valves and transmitters and tire valve caps (vehicles with a tire pressure warning system)**

- When removing or fitting the wheels, tires or the tire pressure warning valve and transmitter, contact your Toyota dealer as the tire pressure warning valve and transmitter may be damaged if not handled correctly.
- When replacing tire valve caps, do not use tire valve caps other than those specified. The cap may become stuck.

■ **To avoid damaging the tire pressure warning valves and transmitters (vehicles with a tire pressure warning system)**

Do not use liquid sealants on flat tires.

■ **Do not use puncture sealant sprays to repair flats (vehicles with a tire pressure warning system)**

Puncture sealant sprays may damage tire pressure warning valves and transmitters.

■ **Driving on rough roads**

Take particular care when driving on roads with loose surfaces or potholes.

These conditions may cause losses in tire inflation pressure, reducing the cushioning ability of the tires. In addition, driving on rough roads may cause damage to the tires themselves, as well as the vehicle's wheels and body.

■ **If tire inflation pressures become low while driving**

Do not continue driving, or your tires and/or wheels may be ruined.

## 4-3. Do-it-yourself maintenance

### Tire inflation pressure

#### ■ Tire inflation pressure

The recommended cold tire inflation pressure and tire size is displayed on the tire and loading information label. (→P. 489)

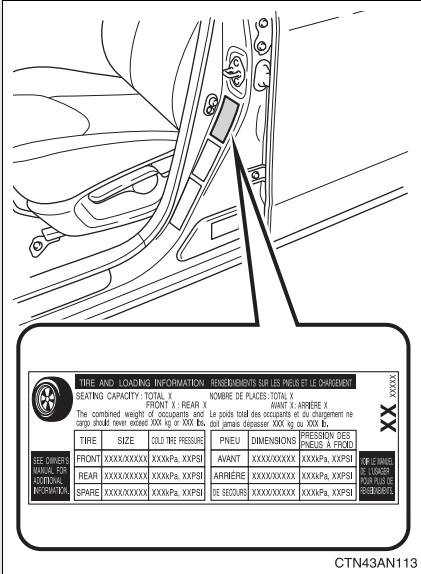

### ■ Inspection and adjustment procedure

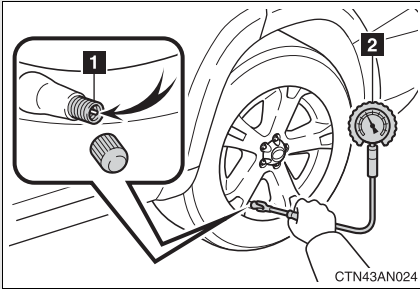

**1** Tire valve

**2** Tire pressure gauge

**STEP 1** Remove the tire valve cap.

**STEP 2** Press the tip of the tire pressure gauge onto the tire valve.

**STEP 3** Read the pressure using the graduations of the gauge.

**STEP 4** If the tire inflation pressure is not within the recommended levels, adjust the pressure.

If you add too much air, press the center of the valve to lower.

**STEP 5** After completing the tire inflation pressure measurement and adjustment, apply soapy water to the valve and check for leakage.

**STEP 6** Reinstall the tire valve cap.

### ■ Tire inflation pressure check interval

You should check tire inflation pressure every two weeks, or at least once a month.

Do not forget to check the spare.

### ■ Effects of incorrect tire inflation pressure

Driving with incorrect tire inflation pressure may result in the following:

- Reduced fuel efficiency
- Reduced driving comfort and tire life
- Reduced safety
- Damage to the drive train

If a tire needs frequent refilling, have it checked by your Toyota dealer.

### ■ Instructions for checking tire inflation pressure

When checking tire inflation pressure, observe the following:

- Check only when the tires are cold.  
If your vehicle has been parked for at least 3 hours and has not been driven for more than 1 mile or 1.5 km, you will get an accurate cold tire inflation pressure reading.
- Always use a tire pressure gauge.  
The appearance of the tire can be misleading. In addition, tire inflation pressures that are even just a few pounds off can degrade ride and handling.
- Do not bleed or reduce tire inflation pressure after driving. It is normal for the tire inflation pressure to be higher after driving.
- Never exceed the vehicle capacity weight.  
Passengers and luggage weight should be placed so that the vehicle is balanced.

 **CAUTION****■ Proper inflation is critical to save tire performance**

Keep your tires properly inflated.

Otherwise, the following conditions may occur and result in an accident causing death or serious injury.

- Excessive wear
- Uneven wear
- Poor handling
- Possibility of blowouts resulting from overheated tires
- Poor sealing of the tire bead
- Wheel deformation and/or tire separation
- A greater possibility of tire damage from road hazards

 **NOTICE****■ When inspecting and adjusting tire inflation pressure**

Be sure to reinstall the tire valve caps.

Without the valve caps, dirt or moisture could get into the valve and cause air leakage, which could result in an accident. If the caps have been lost, replace them as soon as possible.

## Wheels

**If a wheel is bent, cracked or heavily corroded, it should be replaced.**

**Otherwise, the tire may separate from the wheel or cause loss of handling control.**

### ■ Wheel selection

When replacing wheels, care should be taken to ensure that they are equivalent to those removed in load capacity, diameter, rim width, and inset\*.

Replacement wheels are available at your Toyota dealer.

\*: Conventionally referred to as “offset”.

Toyota does not recommend using:

- Wheels of different sizes or types
- Used wheels
- Bent wheels that have been straightened

### ■ Aluminum wheel precautions

- Use only Toyota wheel nuts and wrenches designed for use with your aluminum wheels.
- When rotating, repairing or changing your tires, check that the wheel nuts are still tight after driving 1000 miles (1600 km).
- Be careful not to damage the aluminum wheels when using tire chains.
- Use only Toyota genuine balance weights or equivalent and a plastic or rubber hammer when balancing your wheels.



### ■ When replacing wheels (vehicles with a tire pressure warning system)

The wheels of your Toyota are equipped with tire pressure warning valves and transmitters that allow the tire pressure warning system to provide advanced warning in the event of a loss in tire inflation pressure. Whenever wheels are replaced, the tire pressure warning valves and transmitters must be installed. (→P. 375)

#### CAUTION

### ■ When replacing wheels

- Do not use wheels that are a different size from those recommended in the Owner's Manual, as this may result in loss of handling control.
- Never use an inner tube in a leaking wheel which is designed for a tubeless tire. Doing so may result in an accident, causing serious injury or death.

#### NOTICE

### ■ Replacing tire pressure warning valves and transmitters (vehicles with a tire pressure warning system)

- Because tire repair or replacement may affect the tire pressure warning valves and transmitters, make sure to have tires serviced by your Toyota dealer or other qualified service shop. In addition, make sure to purchase your tire pressure warning valves and transmitters at your Toyota dealer.
- Ensure that only genuine Toyota wheels are used on your vehicle. Tire pressure warning valves and transmitters may not work properly with non-genuine wheels.

## 4-3. Do-it-yourself maintenance

### Air conditioning filter

The air conditioning filter must be changed regularly to maintain air conditioning efficiency.

#### ■ Removal method

**STEP 1** Vehicles without smart key system: Turn the engine switch off.

Vehicles with smart key system: Turn the “ENGINE START STOP” switch off.

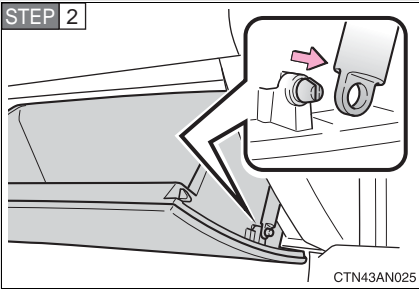

Open the glove box. Slide off the damper.

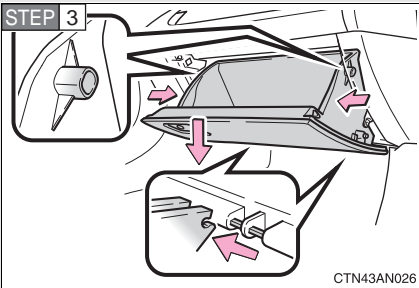

Push in each side of the glove box to disconnect the claws.

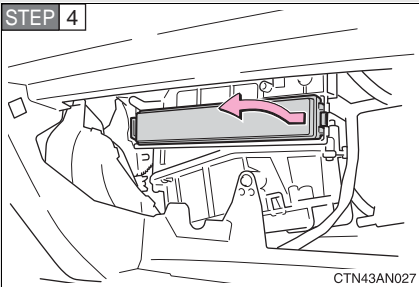

Remove the filter cover.

### ■ Replacement method

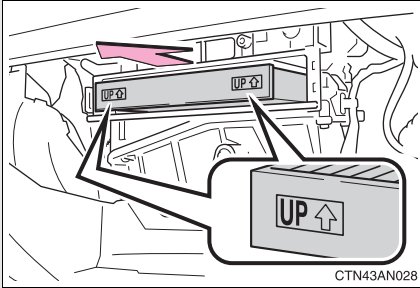

Remove the air conditioning filter and replace it with a new one.

The “UP↑” marks shown on the filter should be pointing up.

### ■ Checking interval

Inspect and replace the air conditioning filter according to the maintenance schedule. In dusty areas or areas with heavy traffic flow, early replacement may be required. (For scheduled maintenance information, please refer to the “Scheduled Maintenance Guide” or “Owner’s Manual Supplement”.)

### ■ If air flow from the vents decreases dramatically

The filter may be clogged. Check the filter and replace it if necessary.

### ⚠ NOTICE

#### ■ When using the air conditioning system

Make sure that a filter is always installed.

Using the air conditioning system without a filter may cause damage to the system.

## Key battery

**Replace the battery with a new one if it is discharged.**

■ **You will need the following items:**

- Flathead screwdriver (To prevent damage to the key, cover the tip of the screwdriver with a rag.)
- Small Flathead screwdriver
- Lithium battery CR2016 (vehicles without smart key system) or CR1632 (vehicles with smart key system)

■ **Replacing the battery (vehicles without smart key system)**

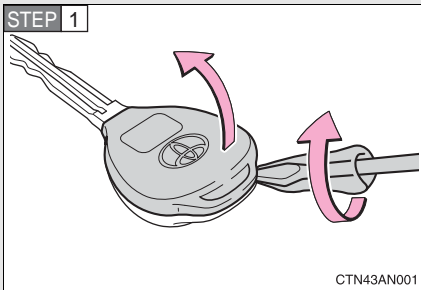

Remove the cover.

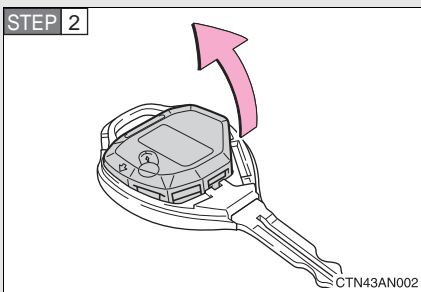

Remove the module.

**STEP 3**

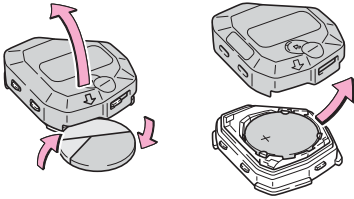

CTN43AN003

Open the case cover using a coin protected with tape etc. and remove the depleted battery.

Insert a new battery with the “+” terminal facing up.

**■ Replacing the battery (vehicles with smart key system)**

**STEP 1**

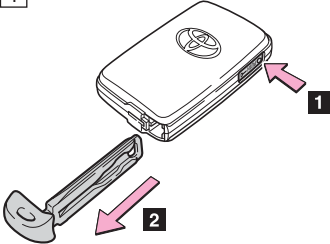

CTN43AN044

Take out the mechanical key.

**STEP 2**

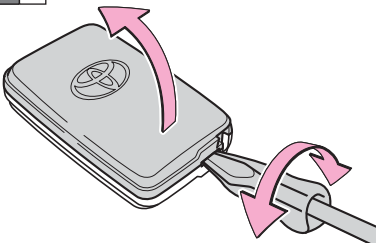

CTN43AN004

Remove the cover.

STEP 3

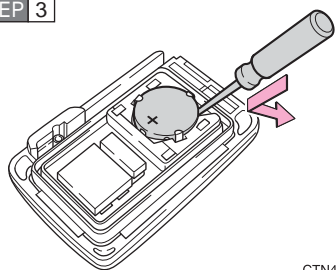

Remove the depleted battery.

Insert a new battery with the “+” terminal facing up.

■ **If the key battery is depleted**

The following symptoms may occur.

- The smart key system and wireless remote control will not function properly.
- The operational range is reduced.

■ **Use a CR2016 (vehicles without smart key system) or CR1632 (vehicles with smart key system) lithium battery**

- Batteries can be purchased at your Toyota dealer, jewelers, or camera stores.
- Replace only with the same or equivalent type recommended by your Toyota dealer.
- Dispose of used batteries according to the local laws.

**! CAUTION**

■ **Removed battery and other parts**

Keep away from children. These parts are small and if swallowed by a child, they can cause choking. Failure to do so could result in death or serious injury.

 NOTICE**■ For normal operation after replacing the battery**

Observe the following precautions to prevent accidents.

- Always work with dry hands.  
Moisture may cause the battery to rust.
- Do not touch or move any other components inside the remote control.
- Do not bend either of the battery terminals.

## 4-3. Do-it-yourself maintenance

### Checking and replacing fuses

If any of the electrical components do not operate, a fuse may have blown. If this happens, check and replace the fuses as necessary.

**STEP 1** Vehicles without smart key system: Turn the engine switch off.

Vehicles with smart key system: Turn the “ENGINE START STOP” switch off.

**STEP 2** The fuses are located in the following places. To check the fuses, follow the instructions below.

**STEP 3** Open the fuse box cover.

#### ► Engine compartment

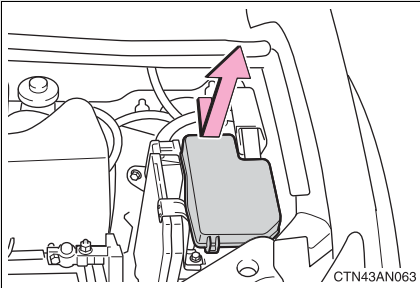

Type A: Push the tab in and lift the lid off.

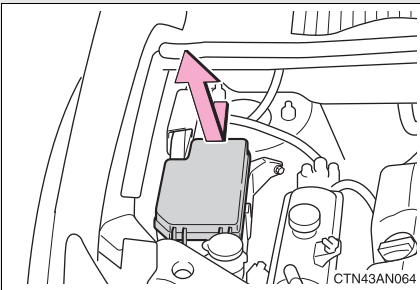

Type B: Push the tab in and lift the lid off.



► Under the instrument panel

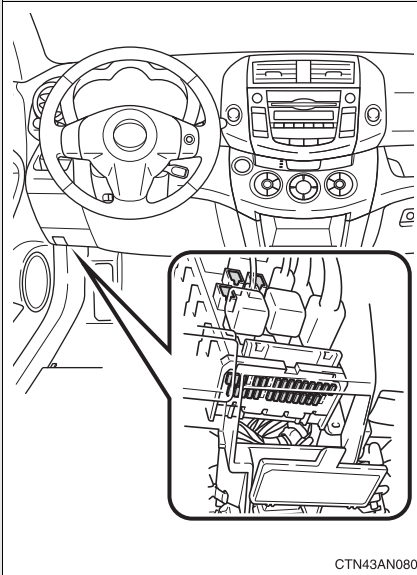

Remove the lid.

**STEP 4** After a system failure, see “Fuse layout and amperage ratings” (→P. 396) for details about which fuse to check.

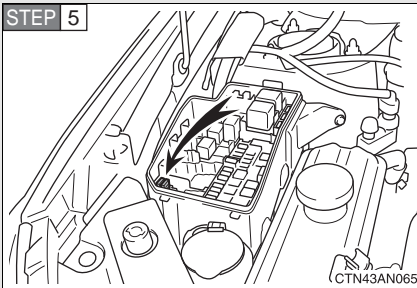

Remove the fuse with the pull-out tool.

**STEP 6** Check if the fuse has blown.

► Type A

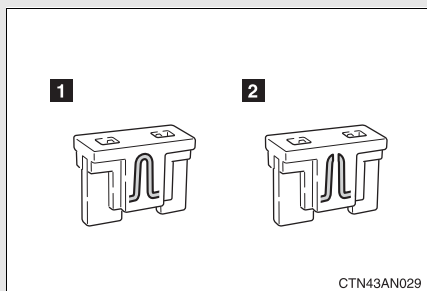

**1** Normal fuse

**2** Blown fuse

Replace it with one of an appropriate amperage rating. The amperage rating can be found on the fuse box lid.

► Type B

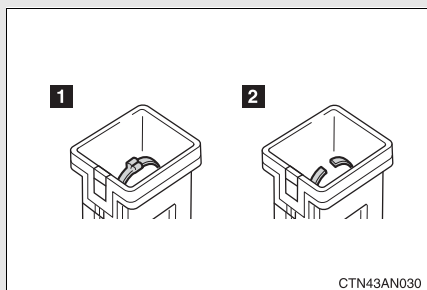

**1** Normal fuse

**2** Blown fuse

Replace it with one of an appropriate amperage rating. The amperage rating can be found on the fuse box lid.

► Type C

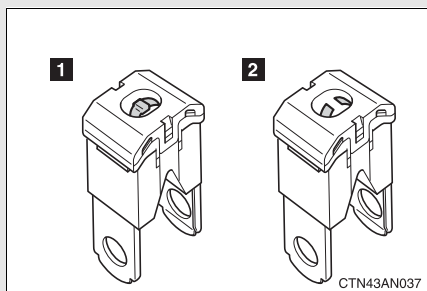

**1** Normal fuse

**2** Blown fuse

Contact your Toyota dealer.

## ▶ Type D

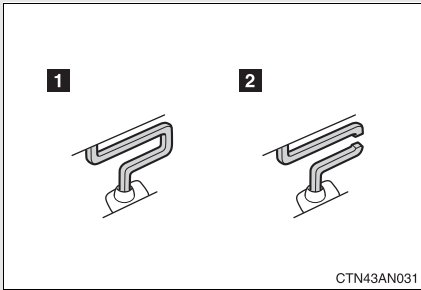

**1** Normal fuse

**2** Blown fuse

Contact your Toyota dealer.

## ▶ Type E

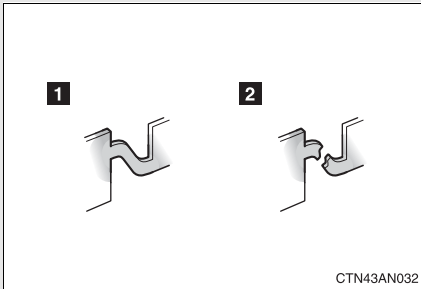

**1** Normal fuse

**2** Blown fuse

Contact your Toyota dealer.

## Fuse layout and amperage ratings

### ■ Engine compartment

#### ▶ Type A (passenger's side)

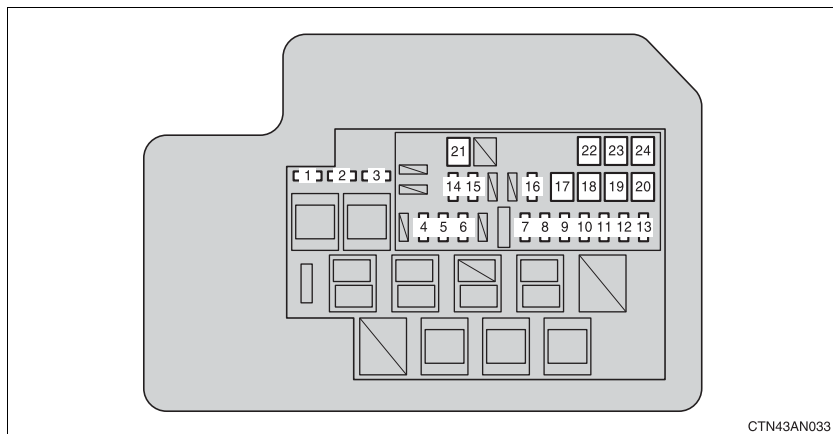

CTN43AN033

Fuse		Ampere	Circuit
1	SPARE	30 A	Spare fuse
2	SPARE	20 A	Spare fuse
3	SPARE	10 A	Spare fuse
4	ECU-B2	7.5 A	Air conditioning system, power windows, smart key system
5	ALT-S	7.5 A	Charging system
6	STR LOCK	20 A	Smart key system
7	RAD NO.1	20 A	Audio system

Fuse		Ampere	Circuit
8	ECU-B	10 A	Gauges and meters, clock, main body ECU, wireless remote control, smart key system, audio system, front passenger occupant classification system, ABS, TRAC, VSC, AUTO LSD, downhill assist control system, hill-start assist control system, Active Torque Control 4WD system
9	DOME	10 A	Vanity lights, personal/interior lights, interior light, luggage compartment light, engine switch light, foot lights
10	H-LP LH	10 A	Left-hand headlight (high beam)
11	H-LP RH	10 A	Right-hand headlight (high beam)
12	H-LP LL	10 A	Left-hand headlight (low beam)
13	H-LP RL	10 A	Right-hand headlight (low beam)
14	AC INV	15 A	AC inverter
15	TOWING* <sup>1</sup>	30 A	No circuit
16	DEICER	20 A	Windshield wiper deicer
17	HTR	50 A	Air conditioning system
18	PTC NO.3	50 A	No circuit
19	PTC NO.2	50 A	No circuit
20	PTC NO.1	50 A	No circuit
21	HEAD MAIN	50 A	H-LP LH, H-LP RH, H-LP LL, H-LP RL fuses
22	RDI* <sup>2</sup>	30 A	Electric cooling fan
	FAN 2* <sup>1</sup>	50 A	

Fuse		Ampere	Circuit
23	CDS* <sup>2</sup>	30 A	Electric cooling fan
	FAN 1* <sup>3</sup>	50 A	
24	H-LP CLN	30 A	No circuit

\*1: Vehicles with towing package

\*2: Vehicles with 2.5 L 4-cylinder (2AR-FE) engine

\*3: Vehicles with 3.5 L V6 (2GR-FE) engine

► Type B (driver's side)

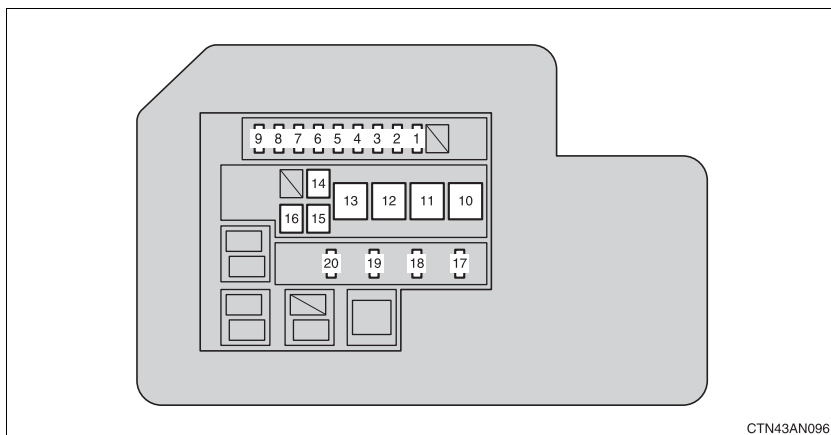

CTN43AN096

Fuse		Ampere	Circuit
1	AMP	30 A	Audio system
2	AM2	30 A	Starting system
3	IG2	15 A	Starting system, multiport fuel injection system/sequential multiport fuel injection system
4	HAZ	10 A	Emergency flashers
5	ETCS	10 A	Multiport fuel injection system/sequential multiport fuel injection system

Fuse		Ampere	Circuit
6	AM2-2	7.5 A	Starting system
7	EFI NO.1	10 A	Multiport fuel injection system/ sequential multiport fuel injection system
8	EFI NO.2	10 A	Multiport fuel injection system/ sequential multiport fuel injection system
9	EFI NO.3	7.5 A	No circuit
10	GROW	80 A	No circuit
11	EPMS	60 A	Electric power steering system
12	MAIN	80 A	HEAD MAIN, ECU-B2, ALT-S, STR LOCK, DOME, ECU-B, RAD NO.1 fuses
13	ALT	120 A <sup>*1</sup>	ABS 1, ABS 2, RDI <sup>*3</sup> , CDS <sup>*3</sup> , FAN 1 <sup>*4</sup> , AC INV, TOWING, HTR, DEICER fuses
		140 A <sup>*2</sup>	ABS 1, ABS 2, FAN 1, FAN 2, AC INV, TOWING, HTR, DEICER fuses
14	P/I	50 A	EFI MAIN, HORN, A/F, fuses
15	ABS2	30 A	ABS, TRAC, VSC, AUTO LSD function, downhill assist control system, hill-start assist control sys- tem
16	ABS1	50 A	ABS, TRAC, VSC, AUTO LSD function, downhill assist control system, hill-start assist control sys- tem
17	EFI MAIN	20 A	Multiport fuel injection system/ sequential multiport fuel injection system, EFI NO.1, EFI NO.2, fuses
18	HORN	10 A	Horn
19	EDU	25 A	No circuit

Fuse		Ampere	Circuit
20	A/F	20 A	A/F sensor, fuel pump <sup>*3</sup>

\*1: Vehicles without towing package

\*2: Vehicles with towing package

\*3: Vehicles with 2.5 L 4-cylinder (2AR-FE) engine

\*4: Vehicles with 3.5 L V6 (2GR-FE) engine

### ■ Under the instrument panel

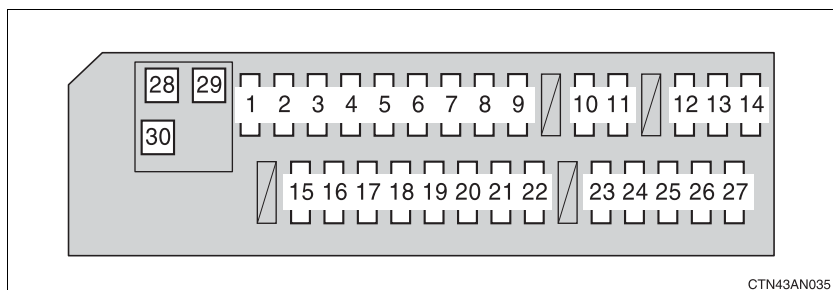

Fuse		Ampere	Circuit
1	TAIL	10 A	Parking lights, tail lights, license plate light, front fog lights, rear side marker lights
2	PANEL	7.5 A	Clock, instrument panel lights, audio system
3	GAUGE 1	10 A	Back-up lights, charging system
4	D FR DOOR	20 A	Power windows (front doors)
5	RL DOOR	20 A	Power windows
6	RR DOOR	20 A	Power windows
7	S/ROOF	25 A	Electric moon roof
8	CIG	15 A	Power outlet



Fuse		Ampere	Circuit
9	ACC	7.5 A	Audio system, power outlets, power rear view mirror control, automatic transmission shift lock system, main body ECU, clock, smart key system
10	MIR HTR	10 A	Outside rear view mirror defoggers
11	PWR OUTLET	15 A	Power outlet
12	RR FOG	10 A	No circuit
13	IGN	7.5 A	Multiport fuel injection system/ sequential multiport fuel injection system, steering lock system, front passenger occupant classification system, smart key system, SRS airbag system
14	GAUGE 2	7.5 A	Gauges and meters
15	S-HTR	15 A	Seat heaters
16	FR WIP	25 A	Windshield wipers
17	RR WIP	15 A	Rear window wiper
18	WSH	15 A	Windshield washer, rear window washer
19	ECU IG 1	10 A	Electric cooling fan, ABS, TRAC, VSC, AUTO LSD function, downhill assist control system, hill-start assist control system, Active Torque Control 4WD system, automatic transmission shift lock system, air conditioning system, main body ECU, electric moon roof, stop/tail lights, electric power steering system, clock, AC inverter, auto anti-glare inside rear view mirror
20	ECU IG 2	10 A	Air conditioning system, rear window defogger, emergency flashers

Fuse		Ampere	Circuit
21	OBD	7.5 A	On-board diagnosis system
22	STOP	10 A	Stop/tail lights, high mounted stop-light, automatic transmission shift lock system, multiport fuel injection system/sequential multiport fuel injection system, ABS, TRAC, VSC, AUTO LSD system, downhill assist control system, hill-start assist control system
23	DOOR	25 A	Main body ECU, power door lock system
24	ACC-B	25 A	ACC, CIG, fuses
25	4WD	7.5 A	Active Torque Control 4WD system
26	FR FOG	15 A	Front fog lights
27	AM1*	7.5 A	Starting system
28	DEF	30 A	Rear window defogger, MIR HTR fuse
29	P/SEAT	30 A	Power seat
30	POWER	30 A	Power windows

\*: Vehicles without smart key system

**■ After a fuse is replaced**

- If the lights do not turn on even after the fuse has been replaced, a bulb may need replacement. (→P. 404)
- If the replaced fuse blows again, have the vehicle inspected by your Toyota dealer.

**■ If there is an overload in the circuits**

The fuses are designed to blow before the entire wiring harness is damaged.

**⚠ CAUTION****■ To prevent system breakdowns and vehicle fire**

Observe the following precautions.

Failing to do so may cause damage, and possibly a fire or injury.

- Never use a fuse of a higher amperage rating than indicated, or use any other object in place of a fuse.
- Always use a genuine Toyota fuse or equivalent.  
Never replace a fuse with a wire, even as a temporary fix.  
This can cause extensive damage or even fire.
- Do not modify fuses or the fuse box.

**⚠ NOTICE****■ Before replacing fuses**

Have the cause of electrical overload determined and repaired by your Toyota dealer as soon as possible.

## Light bulbs

You may replace the following bulbs yourself. The difficulty level of replacement varies depending on the bulb. If necessary bulb replacement seems difficult to perform, contact your Toyota dealer.

For more information about replacing other light bulbs, contact your Toyota dealer.

### ■ Preparing a light bulb for replacement

Check the wattage of the light bulb being replaced. (→P. 485)

### ■ Removing the engine compartment cover

→P. 360

### ■ Front bulb locations

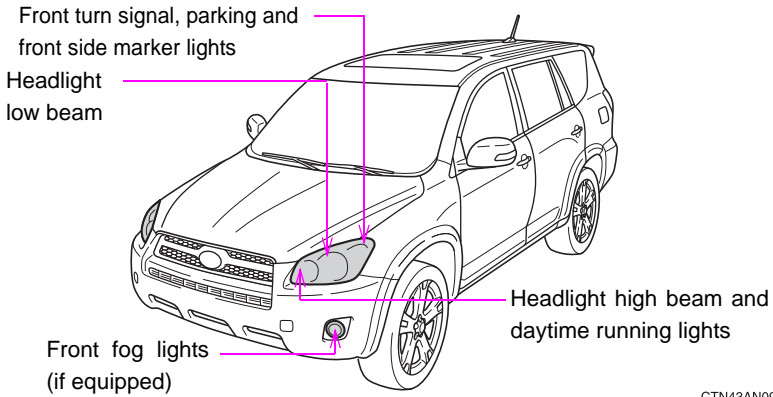

CTN43AN093

■ **Rear bulb locations**

▶ **Vehicles without a spare tire**

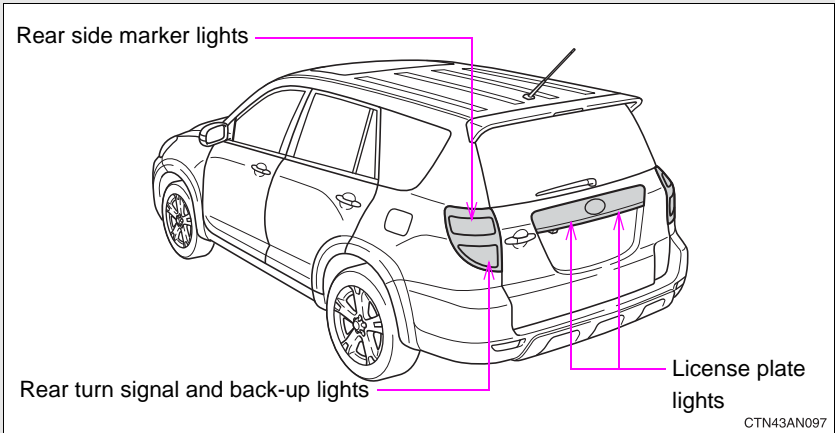

▶ **Vehicles with a spare tire**

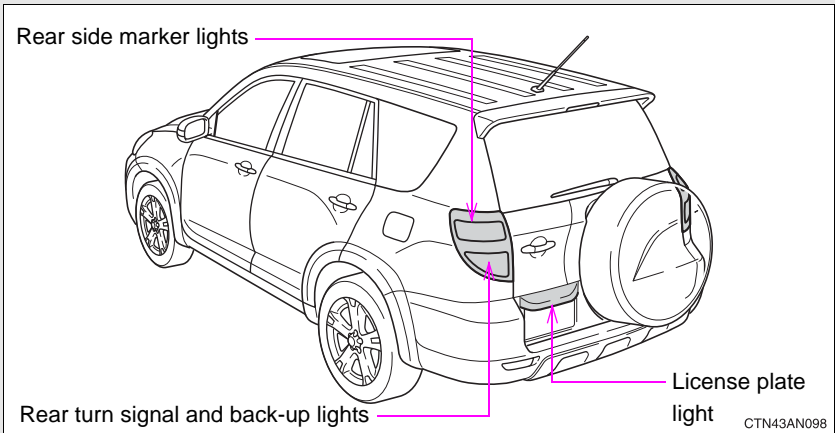

## Replacing light bulbs

### ■ Headlights

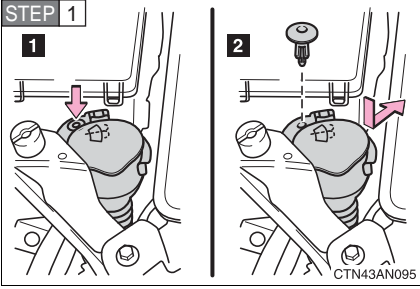

Right side only: Remove the clip and move it aside to allow easy access to the light bulbs.

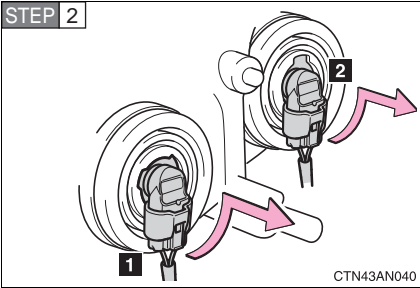

Turn the bulb base counterclockwise.

- 1 Headlight (low beam)
- 2 Headlight (high beam)

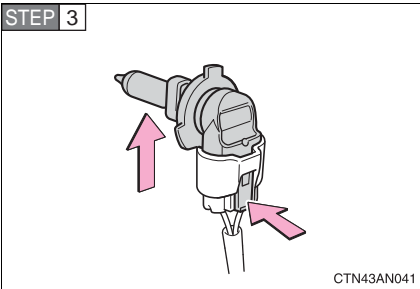

Unplug the connector while depressing the lock release.

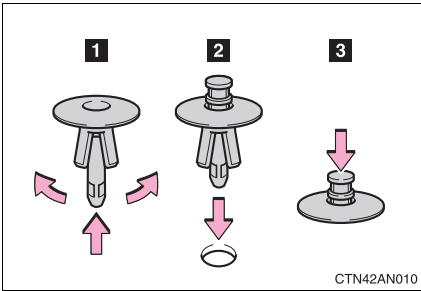

Reinstalling the clip

■ Front turn signal, parking and front side marker lights

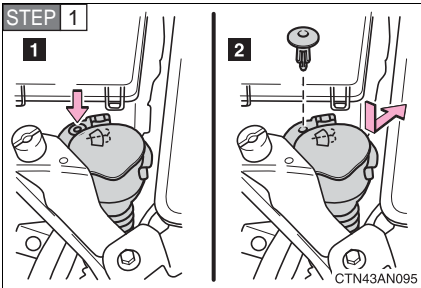

Right side only: Remove the clip and move it aside to allow easy access to the light bulbs.

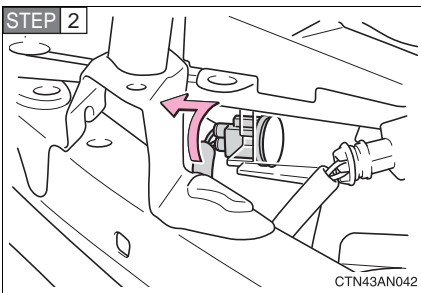

Turn the bulb base counterclockwise.

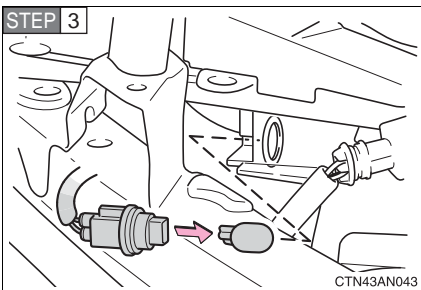

Remove the light bulb.

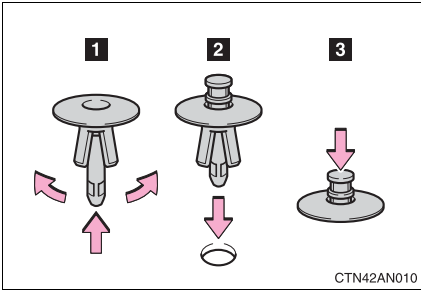

Reinstalling the clip

■ Front fog lights (if equipped)

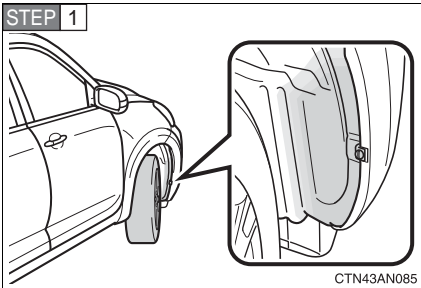

Turn the steering wheel in the opposite direction of the front fog light that you wish to replace.

For example, if you wish to replace the front fog light on the right side, turn the steering wheel to the left.

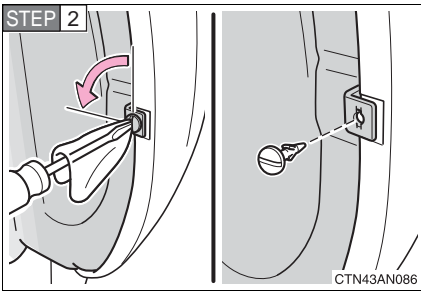

Remove the clip using a flathead screwdriver wrapped in a rag.

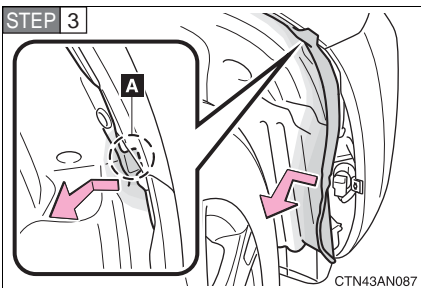

Move section "A" of the fender liner to the inner side of the vehicle, partly removing it and thereby allowing access to the front fog light.



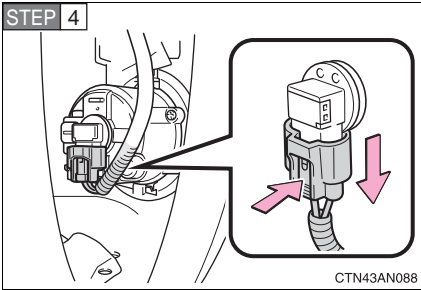

Unplug the connector while depressing the lock release.

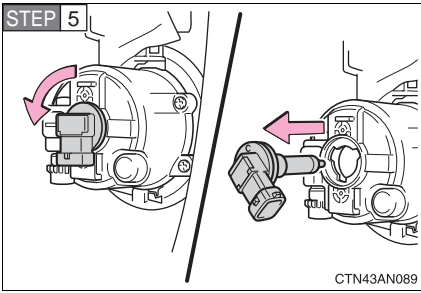

Turn the bulb base counterclockwise.

■ **Back-up lights, rear turn signal and rear side marker lights**

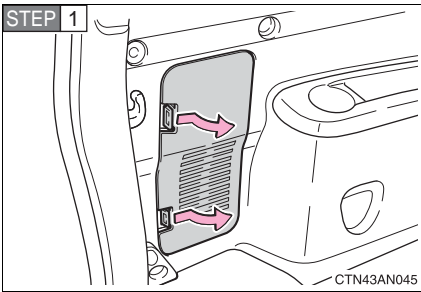

Open the back door (→P. 46) and remove the cover.

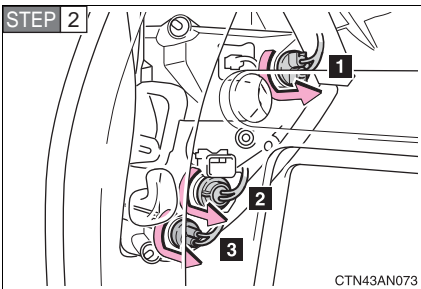

Turn the bulb base counterclockwise.

- 1** Rear side marker light
- 2** Rear turn signal light
- 3** Back-up light

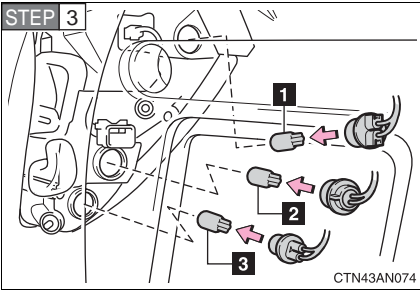

Remove the light bulb.

- 1 Rear side marker light
- 2 Rear turn signal light
- 3 Back-up light

### ■ License plate lights

► Vehicles without a spare tire

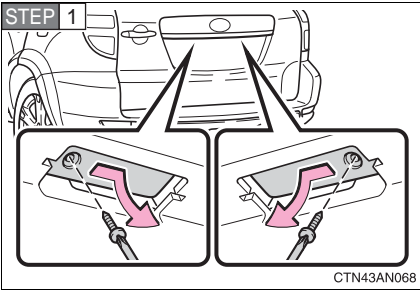

Remove the cover as shown in the illustration.

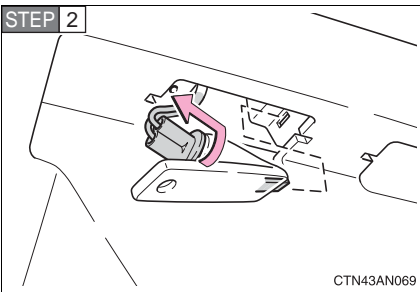

Turn the bulb base counterclockwise.

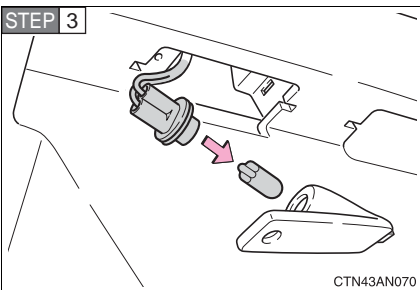

Remove the light bulb.

► Vehicles with a spare tire

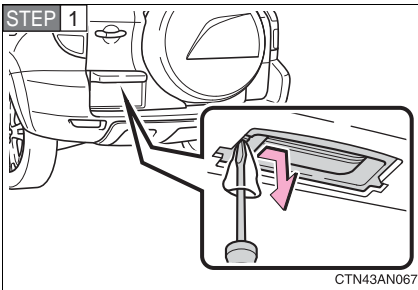

Use a flathead screwdriver to disengage the side of the lamp.

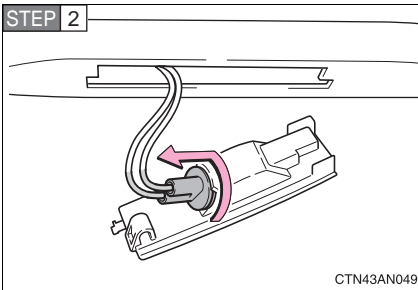

Turn the bulb base counterclockwise.

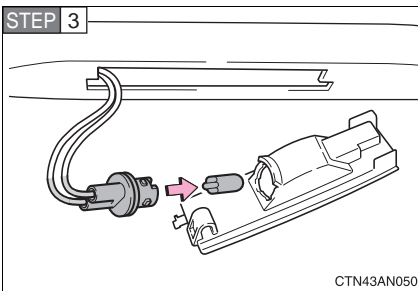

Remove the light bulb.

■ Light other than the above

If any of the lights listed below has burnt out, have it replaced by your Toyota dealer.

- High mounted stoplight
- Stop/tail lights
- Side turn signal lights (if equipped)

■ **Condensation build-up on the inside of the lens**

Contact your Toyota dealer for more information in the following situations. Temporary condensation build-up on the inside of the headlight lens does not indicate a malfunction.

- Large drops of water are built up on the inside of the lens.
- Water has built up inside the headlight.

■ **LED side turn signal lights (if equipped), stop/tail lights and high mounted stoplight**

The side turn signal lights, stop/tail lights and high mounted stoplight consists of a number of LEDs. If any of the LEDs burn out, take your vehicle to your Toyota dealer to have the light replaced.

 **CAUTION**

■ **Replacing light bulbs**

- Turn off the lights. Do not attempt to replace the bulb immediately after turning off the lights.  
The bulbs become very hot and may cause burns.
- Do not touch the glass portion of the light bulb with bare hands. Hold the bulb by the plastic or metal portion.  
If the bulb is scratched or dropped it may blow out or crack.
- Fully install light bulbs and any parts used to secure them. Failing to do so may result in heat damage, fire, or water entering the headlight unit. This may damage the headlights or cause condensation to build up on the lens.

■ **To prevent damage or fire**

Make sure bulbs are fully seated and locked.

## 5-1. Essential information

### Emergency flashers

Use the emergency flashers if the vehicle malfunctions or is involved in an accident.

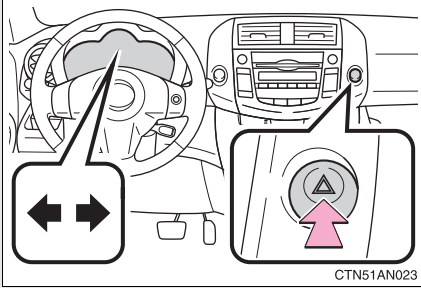

Press the switch to flash all the turn signal lights. To turn them off, press the switch once again.

#### NOTICE

##### ■ To prevent battery discharge

Do not leave the emergency flashers on longer than necessary when the engine is not running.

## If your vehicle needs to be towed

**If towing is necessary, we recommend having your vehicle towed by your Toyota dealer or a commercial towing service, using a wheel-lift type truck or a flat bed truck.**

**Use a safety chain system for all towing, and abide by all state/provincial and local laws.**

**2WD models: If towing your vehicle with a wheel-lift type truck from the front, the vehicle's rear wheels and axles must be in good conditions. (→P. 418, 421)**

**If they are damaged, use a towing dolly or flat bed truck.**

**4WD models: If towing your vehicle with a wheel-lift type truck, use a towing dolly. (→P. 418, 421)**

### **Before towing**

The following may indicate a problem with your transmission. Contact your Toyota dealer before towing.

- The engine is running, but the vehicle will not move.
- The vehicle makes an abnormal sound.

## Emergency towing

If a tow truck is not available, in an emergency your vehicle may be temporarily towed using a cable or chain secured to the emergency towing eyelet. This should only be attempted on hard surfaced roads for short distances at low speeds.

A driver must be in the vehicle to steer and operate the brakes. The vehicle's wheels, drive train, axles, steering and brakes must be in good condition.

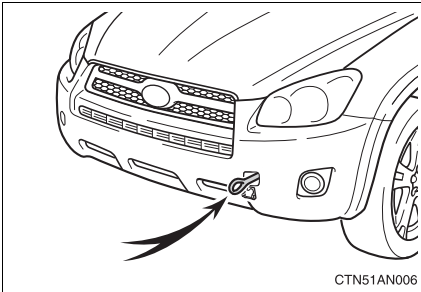

Towing eyelet

## Installing towing eyelet

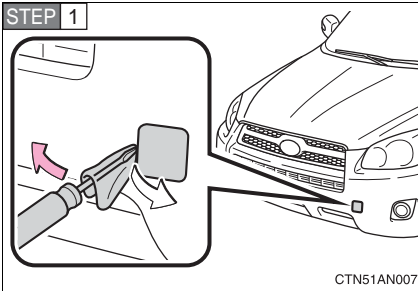

Remove the eyelet cover using a flathead screwdriver.

To protect the bodywork, place a rag between the screwdriver and the vehicle body, as shown in the illustration.

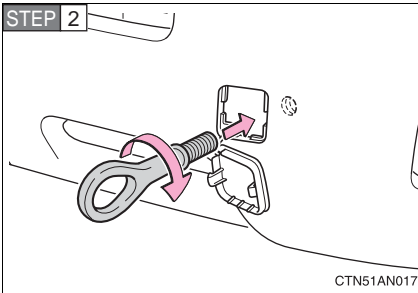

Insert the towing eyelet into the hole and tighten partially by hand.

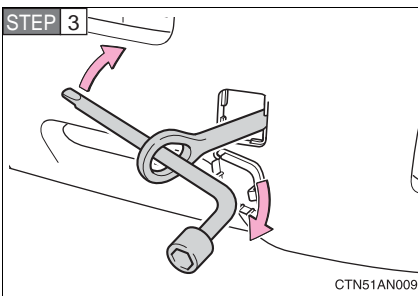

Tighten down the towing eyelet securely using a wheel nut wrench.



### Towing with a sling-type truck

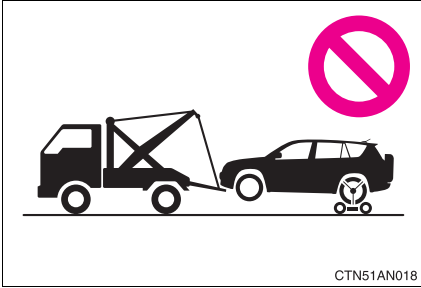

Do not tow with a sling-type truck to prevent body damage.

### Towing with a wheel-lift type truck

- ▶ From the front (2WD models)

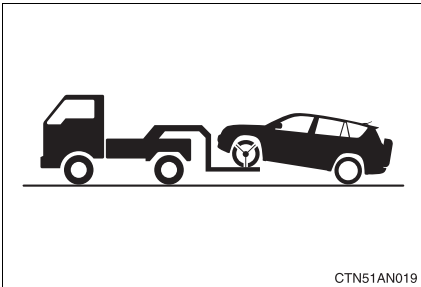

Release the parking brake.

- ▶ From the front (4WD models)

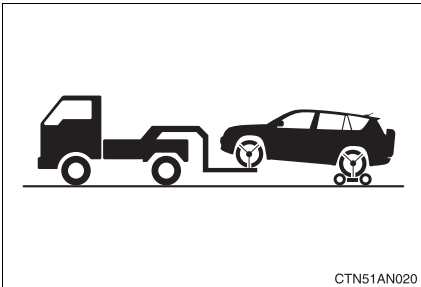

Use a towing dolly under the rear wheels.

► From the rear

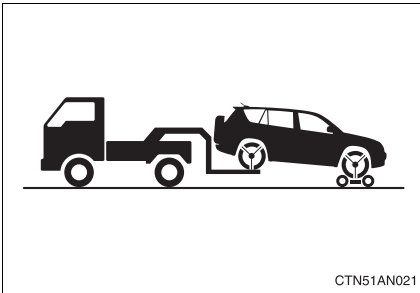

Use a towing dolly under the front wheels.

### Using a flat bed truck

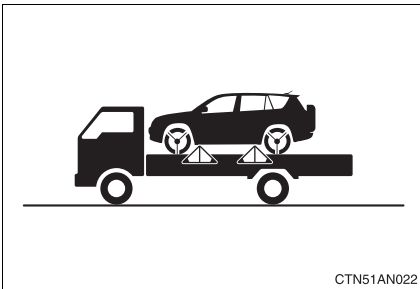

If you use chains or cables to tie down your vehicle, the angles shaded in black must be 45°.

Do not overly tighten the tie downs or the vehicle may be damaged.

### ■ Emergency towing procedure

**STEP 1** Release the parking brake.

**STEP 2** Shift the shift lever to N.

**STEP 3** Vehicles without smart key system: Turn the engine switch to “ACC” (engine off) or “ON” (engine running) position.

Vehicles with smart key system: Turn the “ENGINE START STOP” switch to ACCESSORY (engine off) or IGNITION ON (engine running) mode.

### ■ Location of the emergency towing eyelet

The emergency towing eyelet is in the tool bag. (→P. 438)

 **CAUTION**

■ **Caution while towing**

- Use extreme caution when towing the vehicle.  
Avoid sudden starts or erratic driving maneuvers which place excessive stress on the emergency towing eyelet and the cables or chains. Always use caution for the surroundings and other vehicles while towing.
- If the engine is not running, the power assist for the brakes and steering will not function, making steering and braking more difficult.

■ **Installing towing eyelet to the vehicle**

Make sure that towing eyelet is installed securely.  
If not securely installed, towing eyelet may come loose during towing. This may lead to accidents that cause serious injury or even death.

 NOTICE

■ **To prevent body damage when towing with a sling-type truck**

Do not tow with a sling-type truck, either from the front or rear.

■ **To prevent causing serious damage to the transmission and Active Torque Control 4WD system (4WD models) when towing using a wheel-lift type truck**

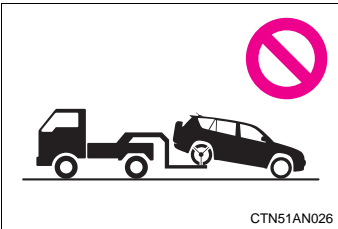

2WD models: Never tow this vehicle from the rear with the front wheels on the ground. This may cause serious damage to the transmission. If towing from the rear, use a towing dolly.

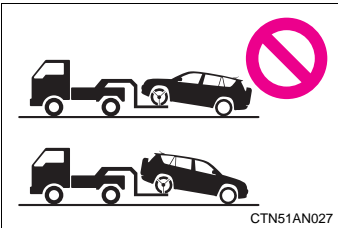

4WD models: Never tow this vehicle with any of the wheels on the ground. This may cause serious damage to the transmission and Active Torque Control 4WD system. Use a towing dolly.

■ **To prevent damaging the vehicle when towing using a wheel-lift type truck**

When raising the vehicle, ensure adequate ground clearance for towing at the opposite end of the raised vehicle. Without adequate clearance, the vehicle could be damaged while being towed.

■ **Recreational towing (behind motor home, etc.)**

Never dinghy tow your vehicle to prevent causing serious damage to the Active Torque Control 4WD system (4WD models) and transmission. (→P. 224)

## If you think something is wrong

**If you notice any of the following symptoms, your vehicle probably needs adjustment or repair. Contact your Toyota dealer as soon as possible.**

### ■ Visible symptoms

- Fluid leaks under the vehicle  
(Water dripping from the air conditioning after use is normal.)
- Flat-looking tires or uneven tire wear
- Engine coolant temperature gauge needle continually points higher than normal

### ■ Audible symptoms

- Changes in exhaust sound
- Excessive tire squeal when cornering
- Strange noises related to the suspension system
- Pinging or other noises related to the engine

### ■ Operational symptoms

- Engine missing, stumbling or running rough
- Appreciable loss of power
- Vehicle pulls heavily to one side when braking
- Vehicle pulls heavily to one side when driving on a level road
- Loss of brake effectiveness, spongy feeling, pedal almost touches the floor

## 5-1. Essential information

### Fuel pump shut off system

**To minimize the risk of fuel leakage when the engine stalls or an air-bag inflates upon collision, the fuel pump shut off system stops supplying fuel to the engine.**

Follow the procedure below to restart the engine after the system is activated.

▶ Vehicles without smart key system

**STEP 1** Turn the engine switch to the “ACC” or “LOCK” position.

**STEP 2** Restart the engine.

▶ Vehicles with smart key system

**STEP 1** Turn the “ENGINE START STOP” switch OFF.

**STEP 2** Restart the engine.

 **NOTICE**

■ **Before starting the engine**

Inspect the ground under the vehicle.

If you find that fuel has leaked onto the ground, the fuel system has been damaged and is in need of repair. Do not restart the engine.

## 5-1. Essential information

### Event data recorder

**Your vehicle has computers that monitor and control certain aspects of your vehicle. These computers assist in driving and maintaining optimal vehicle performance.**

Besides storing data useful for troubleshooting, there is an event data recorder (EDR) that records data in a crash or a near car crash event.

#### **In a crash or a near car crash event**

The SRS airbag sensor assembly contains the EDR. In a crash or a near car crash event, this device may record some or all of the following information:

- Engine speed
- Whether the brake pedal was applied or not
- Vehicle speed
- To what extent the accelerator pedal was depressed
- Position of the transmission shift lever
- Whether the driver and front passenger wore seat belts or not
- Driver's seat position
- SRS airbag deployment data
- SRS airbag system diagnostic data
- Front passenger's occupant classification

The information above is intended to be used for the purpose of improving vehicle safety performance. Unlike general data recorders, the EDR does not record sound data such as conversation between passengers.

**Disclosure of the data**

Toyota will not disclose the data recorded in an EDR to a third party except when:

- An agreement from the vehicle's owner (or the leasing company for a leased vehicle) is obtained
- Officially requested by the police or other authorities
- Used as a defense for Toyota in a law suit
- Ordered by a court law

However, if necessary Toyota will:

- Use the data for research on Toyota vehicle safety performance
- Disclose the data to a third party for research purposes without disclosing details of the vehicle owner, and only when it is deemed necessary
- Disclose summarized data cleared of vehicle identification information to a non-Toyota organization for research purposes





## 5-2. Steps to take in an emergency

### If a warning light turns on or a warning buzzer sounds...

**Calmly perform the following actions if any of the warning lights turn on or flash. If a light turns on or flashes, but then turns off, this does not necessarily indicate a malfunction in the system.**

**Stop the vehicle immediately. Continuing to drive the vehicle may be dangerous.**

The following warning indicates a possible problem in the brake system. Immediately stop the vehicle in a safe place and contact your Toyota dealer.



Warning light	Warning light/Details
 (U.S.A.)  (Canada)	<b>Brake system warning light (warning buzzer)*</b> <ul style="list-style-type: none"><li>• Low brake fluid</li><li>• Malfunction in the brake system</li></ul> This light also comes on when the parking brake is not released. If the light turns off after the parking brake is fully released the system is operating normally.

\*: Parking brake engaged warning buzzer:

The buzzer sounds to indicate that the parking brake is still engaged (with the vehicle having reached a speed of 3 mph [5 km/h]).



**Stop the vehicle immediately.**





The following warning indicates the possibility of damage to the vehicle that may lead to an accident. Immediately stop the vehicle in a safe place and contact your Toyota dealer.

Warning light	Warning light/Details
	<b>Charging system warning light</b> Indicates a malfunction in the vehicle's charging system.
	<b>Low engine oil pressure warning light</b> Indicates that the engine oil pressure is too low.

**Have the vehicle inspected immediately.**





Failing to investigate the cause of the following warnings may lead to the system operating abnormally and possibly cause an accident. Have the vehicle inspected by your Toyota dealer immediately.





Warning light	Warning light/Details
 (U.S.A.)	<b>Malfunction indicator lamp</b> Indicates a malfunction in: <ul style="list-style-type: none"> <li>• The emission control system;</li> <li>• The electronic engine control system;</li> <li>• The electronic throttle control system; or</li> <li>• The electronic automatic transmission control system.</li> </ul>
 (Canada)	
	<b>SRS warning light</b> Indicates a malfunction in: <ul style="list-style-type: none"> <li>• The SRS airbag system;</li> <li>• The front passenger occupant classification system; or</li> <li>• The seat belt pretensioner system.</li> </ul>

Warning light	Warning light/Details
<div data-bbox="114 253 208 315" style="border: 1px solid black; padding: 2px; display: inline-block;"><b>ABS</b></div> (U.S.A.) <div data-bbox="114 363 208 425" style="border: 1px solid black; padding: 2px; display: inline-block;"></div> (Canada)	<p><b>“ABS” warning light</b>                      Indicates a malfunction in:</p> <ul style="list-style-type: none"> <li>• The ABS;</li> <li>• The brake assist system.</li> </ul>
<div data-bbox="114 480 208 542" style="border: 1px solid black; padding: 2px; display: inline-block;"></div>	<p><b>Electric power steering warning light</b>                      Indicates a malfunction in the EPS system.</p>
<div data-bbox="114 574 208 636" style="border: 1px solid black; padding: 2px; display: inline-block;"></div> (Flashes)	<p><b>Cruise control indicator light</b>                      Indicates a malfunction in the cruise control system.</p>
<div data-bbox="114 764 208 826" style="border: 1px solid black; padding: 2px; display: inline-block;"></div>	<p><b>Slip indicator light</b>                      Indicates a malfunction in:</p> <ul style="list-style-type: none"> <li>• The VSC;</li> <li>• The TRAC;</li> <li>• The AUTO LSD function;</li> <li>• The hill-start assist control; and</li> <li>• The downhill assist control system.</li> </ul>
<div data-bbox="114 964 208 1026" style="border: 1px solid black; padding: 2px; display: inline-block;"><b>4WD</b></div> (Comes on)	<p><b>Active Torque Control 4WD system warning light (4WD models)</b>                      Indicates a malfunction in the Active Torque Control 4WD system.                      (When the light flashes. →P. 429)</p>

**Follow the correction procedures.**

After taking the specified steps to correct the suspected problem, check that the warning light turns off.

Warning light	Warning light/Details	Correction procedure
	<b>Open door warning light</b> Indicates that a door is not fully closed.	Check that all doors are closed.
	<b>Low fuel level warning light</b> Indicates that remaining fuel is about 2.4 gal. (9.0 L, 2.0 Imp. gal.) or less	Refuel the vehicle.
	<b>Driver's seat belt reminder light (warning buzzer)*</b> Warns the driver to fasten his/her seat belt.	Fasten the seat belt.
 (on the center panel)	<b>Front passenger's seat belt reminder light (warning buzzer)*</b> Warns the front passenger to fasten his or her seat belt.	Fasten the seat belt.
 (Flashes)	<b>Active Torque Control 4WD system warning light (4WD models)</b> Indicates that the driveline temperature is too high. (When the light comes on. →P. 427)	Reduce vehicle speed (until the light goes off) or stop the vehicle at a safe place and allow the engine to idle until the light goes off.



Warning light	Warning light/Details	Correction procedure
	<p><b>Automatic transmission fluid temperature warning light (if equipped)</b> Indicates that the automatic transmission fluid temperature is too high.</p>	<p>Stop the vehicle in a safe place and shift the shift lever to P. If the light does not go off, contact your Toyota dealer.</p>
	<p><b>Low washer fluid warning light</b> Low level of washer fluid</p>	<p>Fill the tank.</p>
	<p><b>Engine oil replacement reminder light</b></p>	
	<p>Illuminates for about 3 seconds and then flashes for about 15 seconds approximately 4500 miles (7200 km) after the engine oil is changed: Indicates that the engine oil is scheduled to be changed.</p>	<p>Check the engine oil, and change it if necessary.</p>
	<p>Comes on and remains on if the distance driven exceeds 5000 miles (8000 km): Indicates that the engine oil should be changed.</p>	<p>Check and change the engine oil.</p>
	<p><b>Tire pressure warning light (if equipped)</b></p>	
	<p>When the light comes on: Low tire inflation pressure</p>	<p>Adjust the tire inflation pressure.</p>
	<p>When the light comes on after blinking for 1 minute: Malfunction in the tire pressure warning system</p>	<p>Have the system checked by your Toyota dealer.</p>

\*: Driver's and front passenger's seat belt warning buzzers:



The driver's and front passenger's seat belt warning buzzers sound to alert the driver and front passenger that his or her seat belt is not fastened. The buzzer sounds intermittently for 10 seconds after the vehicle has reached a speed of 12 mph (20 km/h). Then, if the seat belt is still unfastened, the buzzer will sound at a different tone for 20 more seconds.

**Follow the correction procedures. (vehicles with smart key system)**

After taking the specified steps to correct the suspected problem, check that the warning light turns off.

Interior buzzer	Exterior buzzer	Warning light	Warning light/Details	Correction procedure
Once	—	 (Comes on for 8 seconds.)	<b>Smart key system warning light</b> Indicates that the electronic key is not present when the "ENGINE START STOP" switch is pressed.	Confirm the location of the electronic key*.
Once	3 times		<b>Smart key system warning light</b> Indicates that a door other than the driver's door has been opened and closed with the "ENGINE START STOP" switch in any mode other than OFF and the electronic key has been taken out of the detection area.	Confirm the location of the electronic key.

## 5-2. Steps to take in an emergency

Interior buzzer	Exterior buzzer	Warning light	Warning light/Details	Correction procedure
Once	3 times		<p><b>Smart key system warning light</b></p> <p>Indicates that the driver's door has been opened and closed with the shift lever in P, the "ENGINE START STOP" switch in any mode other than OFF and the electronic key has been taken out of the detection area.</p>	<p>Turn the "ENGINE START STOP" switch OFF or confirm the location of the electronic key.</p>
Continuous	Continuous		<p><b>Smart key system warning light</b></p> <p>Indicates that the driver's door has been opened and closed with the shift lever not in P, the "ENGINE START STOP" switch in any mode other than OFF and the electronic key has been taken out of the detection area.</p>	<ul style="list-style-type: none"> <li>• Shift the shift lever to P.</li> <li>• Confirm the location of the electronic key.</li> </ul>

\*: If the engine does not start when the electronic key is inside the vehicle, the electronic key battery may be depleted or there may be difficulties receiving the signal from the key. (→P. 30)

---

**■ If the malfunction indicator lamp comes on while driving**

First check the following:

- Is the fuel tank empty?  
If it is, fill the fuel tank immediately.
- Is the fuel tank cap loose?  
If it is, tighten it securely.

The malfunction indicator lamp will go off after taking several driving trips. If the malfunction indicator lamp does not go off even after several trips, contact your Toyota dealer as soon as possible.

**■ Front passenger detection sensor and passenger seat belt reminder**

- If luggage is placed on the front passenger seat, the front passenger detection sensor may cause the warning light to flash, even if a passenger is not sitting in the seat.
- If a cushion is placed on the seat, the sensor may not detect a passenger, and the warning light may not operate properly.

**■ Electric power steering warning light**

The electric power steering warning light may come on when the voltage is low or the voltage drops.

**■ Changing the engine oil (U.S.A. only)**

Make sure to reset the oil change system. (→P. 363)

**■ The tire pressure warning light may turn on due to natural causes**

The tire pressure warning light may turn on due to natural causes such as natural air leaks or tire inflation pressure changes caused by temperature. In this case, adjusting the tire inflation pressure will turn off the warning light (after a few minutes).

**■ When a tire is replaced with a spare tire (vehicles with a tire pressure warning system)**

The spare tire is also equipped with the tire pressure warning valve and transmitter. The tire pressure warning light will turn on if the tire inflation pressure of the spare tire is low. If a tire goes flat, even though the flat tire is replaced with the spare tire, the tire pressure warning light does not turn off. Replace the spare tire with the repaired tire and adjust the proper tire inflation pressure. The tire pressure warning light will turn off after a few minutes.



■ **If the tire pressure warning system is inoperative**

The tire pressure warning system will be disabled in the following conditions:

(When the condition becomes normal, the system will work properly.)

- If tires not equipped with tire pressure warning valves and transmitters are used.
- If the ID code on the tire pressure warning valves and transmitters is not registered in the tire pressure warning computer.
- If the tire inflation pressure is 73 psi (500 kPa, 5.1 kgf/cm<sup>2</sup> or bar) or higher.

The tire pressure warning system may be disabled in the following conditions:

(When the condition becomes normal, the system will work properly.)

- If electronic devices or facilities using similar radio wave frequencies are nearby.
- If a radio set at similar frequencies is in use in the vehicle.
- If a window tint that affects the radio wave signals is installed.
- If there is a lot of snow or ice on the vehicle, in particular around the wheels or wheel housings.
- If non-genuine Toyota wheels are used. (Even if you use Toyota wheels, the tire pressure warning system may not work properly with some types of tires.)
- If tire chains are used.
- If the spare tire is in a location subject to poor radio wave signal reception.
- If a large metallic object which can interfere with signal reception is put in the luggage compartment.

■ **If the tire pressure warning light comes on after blinking for 1 minute frequently**

If the tire pressure warning light comes on after flashing for 1 minute frequently when the “ENGINE START STOP” switch or the engine switch is turned ON, have it checked by your Toyota dealer.

### ■ Customization that can be configured at Toyota dealer

The vehicle speed linked seat belt reminder buzzer can be disabled. (Customizable features →P. 500) However, Toyota recommends that the seat belt reminder buzzer be operational to alert the driver and front passenger that the seat belts are not fastened.

#### CAUTION

#### ■ When the electric power steering warning light comes on

The steering wheel may become extremely heavy.

If the steering wheel becomes heavier than usual when operating, firmly hold and operate it using more force than usual.

#### ■ If the tire pressure warning light comes on

Be sure to observe the following precautions. Failure to do so could cause loss of vehicle control and result in death or serious injury.

##### ● Vehicles with run-flat tires:

- Decelerate to the lowest appropriate speed as soon as possible. Do not drive over 55 mph (90 km/h).
- Check and adjust the tire inflation pressure immediately.
- If the tire pressure warning light comes on even after tire inflation pressure adjustment, it is probable that you have a flat tire. Have the tire replaced by the nearest Toyota dealer.
- Avoid abrupt maneuvering and braking. If the vehicle tires deteriorate, you could lose control of the steering wheel or the brakes.

##### ● Vehicles with standard tires:

- Stop your vehicle in a safe place as soon as possible. Adjust the tire inflation pressure immediately.
- If the tire pressure warning light comes on even after tire inflation pressure adjustment, it is probable that you have a flat tire. Check the tires. If the tire is flat, change to the spare tire and have the flat tire repaired by the nearest Toyota dealer.
- Avoid abrupt maneuvering and braking. If the vehicle tires deteriorate, you could lose control of the steering wheel or the brakes.

#### ■ If a blowout or sudden air leakage should occur

The tire pressure warning system may not activate immediately.

 CAUTION

■ **Maintenance of the tires**

Each tire, including the spare (if provided), should be checked monthly when cold and inflated to the inflation pressure recommended by the vehicle manufacturer on the vehicle placard or tire inflation pressure label (tire and load information label). (If your vehicle has tires of a different size than the size indicated on the vehicle placard or tire inflation pressure label [tire and load information label], you should determine the proper tire inflation pressure for those tires.)

As an added safety feature, your vehicle has been equipped with a tire pressure monitoring system (TPMS-tire pressure warning system) that illuminates a low tire pressure telltale (tire pressure warning light) when one or more of your tires is significantly under-inflated. Accordingly, when the low tire pressure telltale (tire pressure warning light) illuminates, you should stop and check your tires as soon as possible, and inflate them to the proper pressure. Driving on a significantly under-inflated tire causes the tire to overheat and can lead to tire failure. Under-inflation also reduces fuel efficiency and tire tread life, and may affect the vehicle's handling and stopping ability.

Please note that the TPMS (tire pressure warning system) is not a substitute for proper tire maintenance, and it is the driver's responsibility to maintain correct tire pressure, even if under-inflation has not reached the level to trigger illumination of the TPMS low tire pressure telltale (tire pressure warning light).

 CAUTION

Your vehicle has also been equipped with a TPMS (tire pressure warning system) malfunction indicator to indicate when the system is not operating properly. The TPMS (tire pressure warning system) malfunction indicator is combined with the low tire pressure telltale (tire pressure warning light). When the system detects a malfunction, the telltale will flash for approximately one minute and then remain continuously illuminated. This sequence will continue upon subsequent vehicle start-ups as long as the malfunction exists. When the malfunction indicator is illuminated, the system may not be able to detect or signal low tire pressure as intended.

TPMS (tire pressure warning system) malfunctions may occur for a variety of reasons, including the installation of replacement or alternate tires or wheels on the vehicle that prevent the TPMS (tire pressure warning system) from functioning properly. Always check the TPMS (tire pressure warning system) malfunction telltale after replacing one or more tires or wheels on your vehicle to ensure that the replacement or alternate tires and wheels allow the TPMS (tire pressure warning system) to continue to function properly.

 NOTICE**■ Precaution when installing a different tire**

When a tire of a different specification or maker is installed, the tire pressure warning system may not operate properly.

## 5-2. Steps to take in an emergency

### If you have a flat tire (vehicles with standard tires)

**Remove the flat tire and replace it with the spare provided.**

■ **Before jacking up the vehicle**

- Stop the vehicle on a hard, flat surface.
- Set the parking brake.
- Shift the shift lever to P.
- Stop the engine.
- Turn on the emergency flashers.

■ **Location of the spare tire, jack and tools**

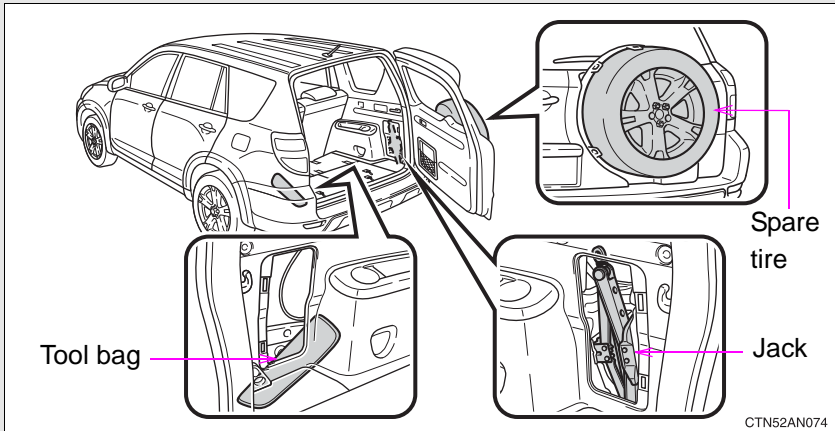

## Taking out the jack

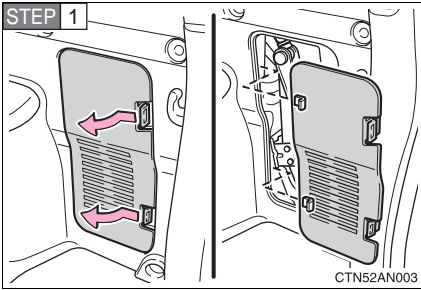

Disengage the claws and remove the cover.

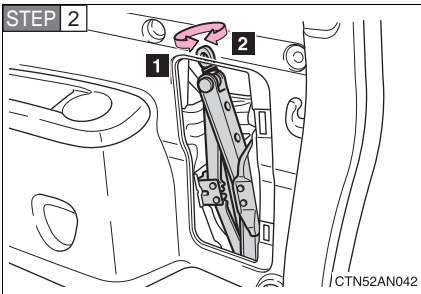

**1** Loosen

**2** Tighten

Loosen and take out the jack.

## Taking out the tool bag

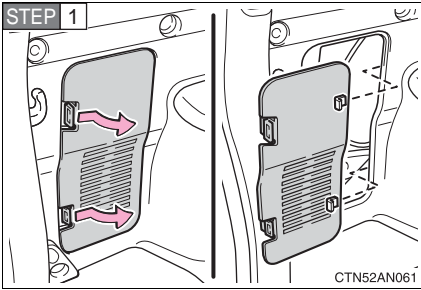

Disengage the claws and remove the cover.

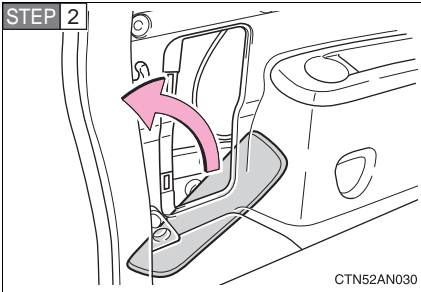

Take out the tool bag.

## Taking out the spare tire (vehicles with the spare tire cover)

### STEP 1

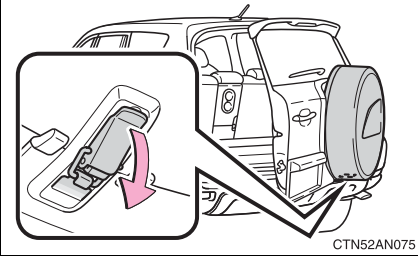

Open the back door. Unlock the latch handle which is on the bottom of the spare tire cover.

### STEP 2

Close the back door.

### STEP 3

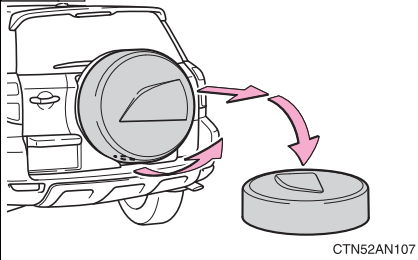

Remove the spare tire cover by holding the bottom and lifting it up and away from the vehicle.

When placing the spare tire cover on the ground, make sure the cover design side faces up to avoid scratching the cover surface.

### STEP 4

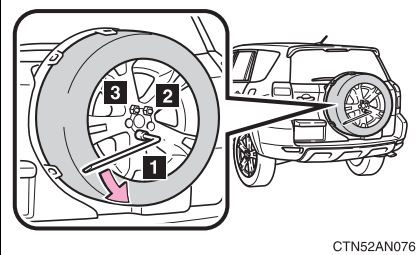

Using the wheel nut wrench, loosen the hold-down nuts by turning them counterclockwise until they can be loosened by hand. Follow the order shown in the illustration.

### STEP 5

Remove all the wheel nuts and the spare tire.

When placing the spare tire on the ground, make sure the wheel design side faces up to avoid scratching the wheel surface.



**Taking out the spare tire (vehicles without the spare tire cover)**

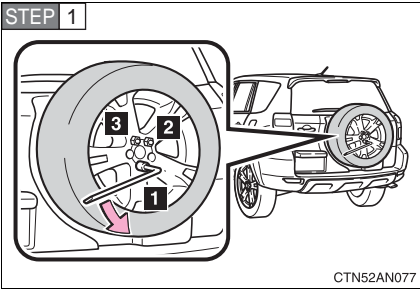

Using the wheel nut wrench, loosen the hold-down nuts by turning them counterclockwise until they can be loosened by hand. Follow the order shown in the illustration.

**STEP 2** Remove all the wheel nuts and the spare tire.

When placing the spare tire on the ground, make sure the wheel design side faces up to avoid scratching the wheel surface.

**Replacing a flat tire**

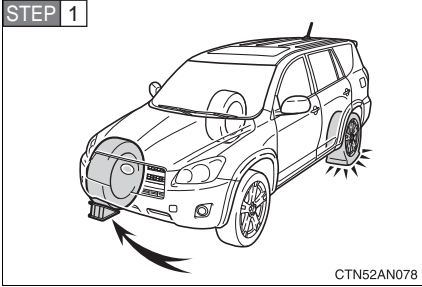

Chock the tires.

Flat tire		Wheel chock positions
Front	Left-hand side	Behind the rear right-hand side tire
	Right-hand side	Behind the rear left-hand side tire
Rear	Left-hand side	In front of the front right-hand side tire
	Right-hand side	In front of the front left-hand side tire

**STEP 2** Remove the wheel ornament using the wheel nut wrench as shown below.

► 16-inch wheel

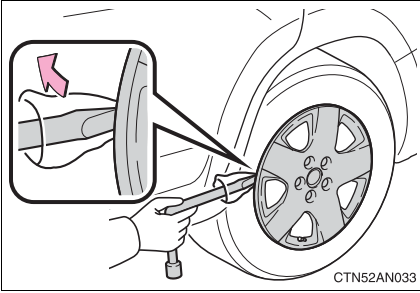

To protect the wheel ornament, place a rag between the wrench and the wheel ornament, as shown in the illustration.

► 17-inch and 18-inch wheels

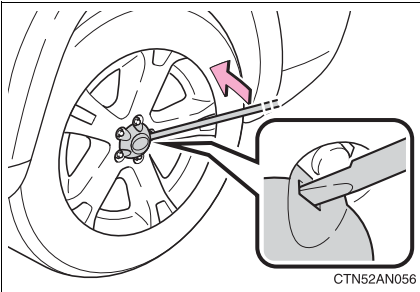

**STEP 3**

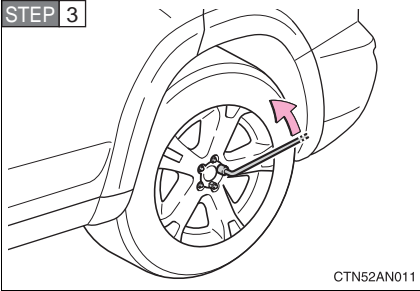

Slightly loosen the wheel nuts (one turn).

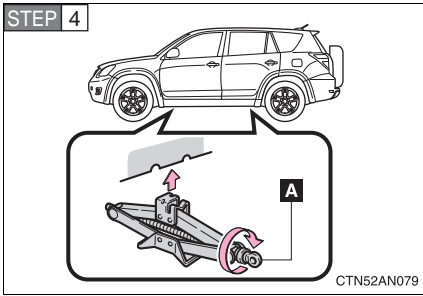

Turn the tire jack portion “A” by hand until the notch of the jack is in contact with the jack point.

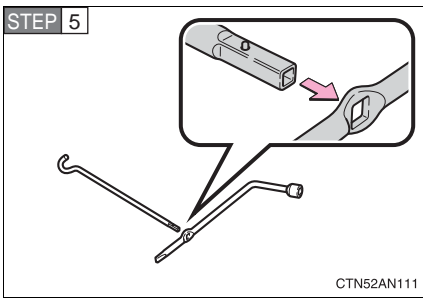

Type A: Assemble the jack handle extension.

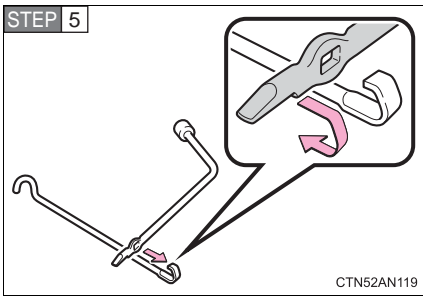

Type B: Assemble the jack handle extension.

## 5-2. Steps to take in an emergency

**STEP 6** Raise the vehicle until the tire is slightly raised off the ground.

### ► Type A

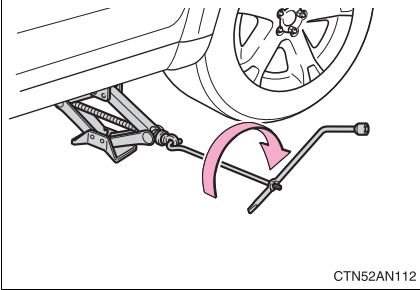

### ► Type B

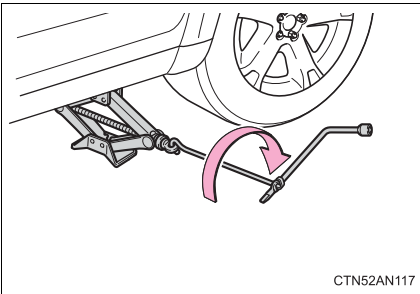

### ► Type C

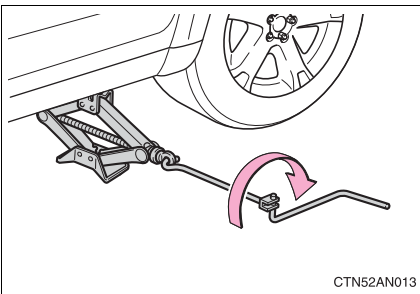

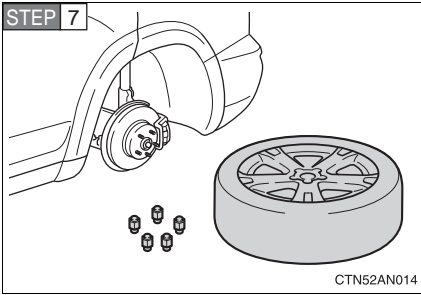

Remove all the wheel nuts and the tire.

When resting the tire on the ground, place the tire so that the wheel design faces up to avoid scratching the wheel surface.

### Installing the tire

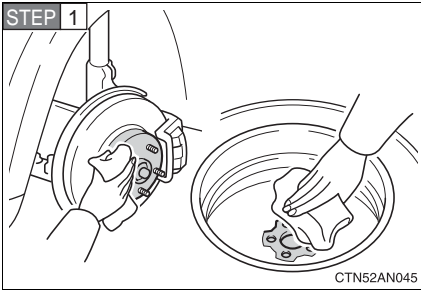

Remove any dirt or foreign matter from the wheel contact surface.

If foreign matter is on the wheel contact surface, the wheel nuts may loosen while the vehicle is in motion, and the tire may come off the vehicle.

**STEP 2** Install the tire and loosely tighten each wheel nut by hand by approximately the same amount.

► Replacing a steel wheel with a steel wheel

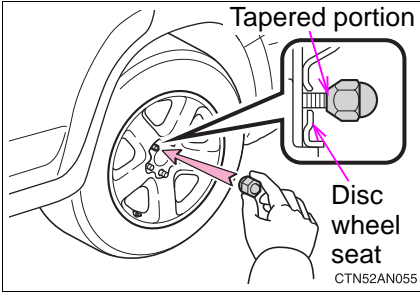

Tighten the nuts until the tapered portion comes into loose contact with the disc wheel seat.

► Replacing an aluminum wheel with a steel wheel

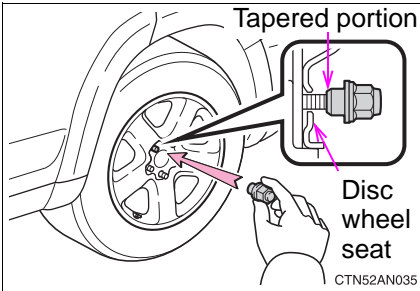

Tighten the nuts until the tapered portion comes into loose contact with the disc wheel seat.

► Replacing an aluminum wheel with an aluminum wheel

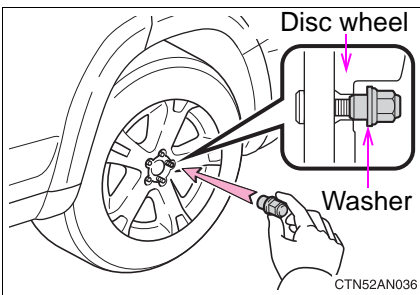

Turn the nut washers until they come into contact with the disc wheel.

**STEP 3** Lower the vehicle.

► Type A

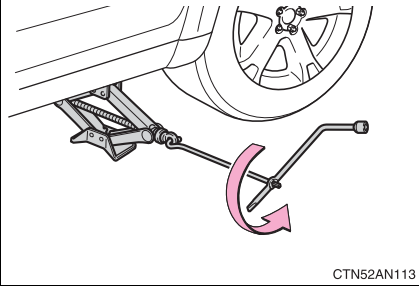

► Type B

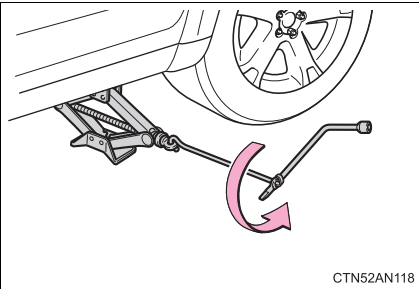

► Type C

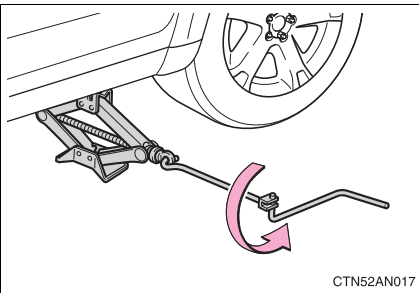



## 5-2. Steps to take in an emergency

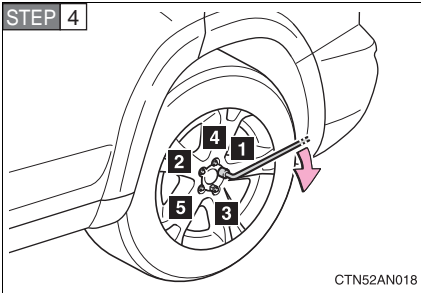

Firmly tighten each nut two or three times in the order shown in the illustration.

**Tightening torque:**  
76 ft•lbf (103 N•m, 10.5 kgf•m)

**STEP 5** Reinstall the wheel ornament.

► 16-inch wheel

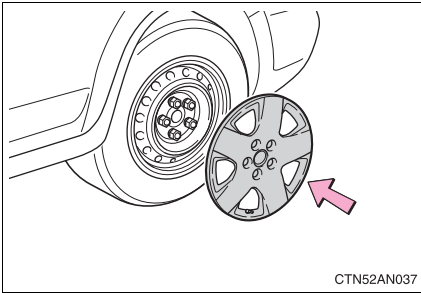

► 17-inch and 18-inch wheels

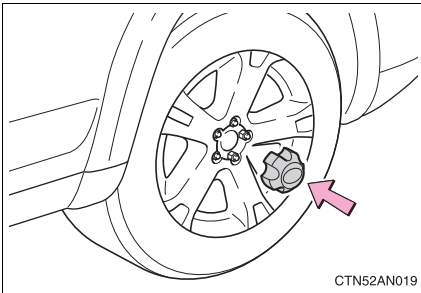

## Stowing the flat tire

**STEP 1** Remove any dirt or foreign matter from the disc wheel seat and the wheel contact surface.

**STEP 2**

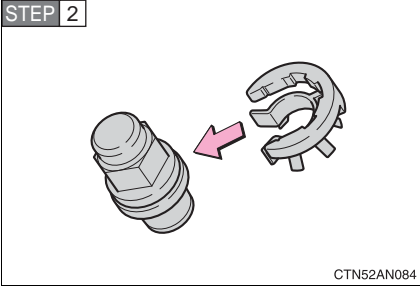

Vehicles with aluminum wheels and a steel wheel for the spare: Remove the plastic rings from the wheel nuts of the spare tire carrier.

**STEP 3** Close the back door.

**STEP 4** Stow the flat tire on the back door and tighten all wheel nuts by hand.

**STEP 5**

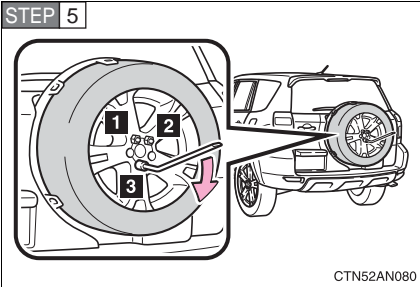

Using the wheel nut wrench, tighten the hold-down nuts by turning them clockwise. Follow the order shown in the illustration.

**Tightening torque:**  
66.4 ft•lbf (90 N•m, 9.1 kgf•m)

## 5-2. Steps to take in an emergency

### STEP 6

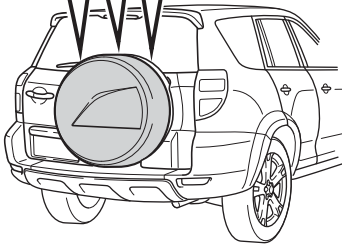
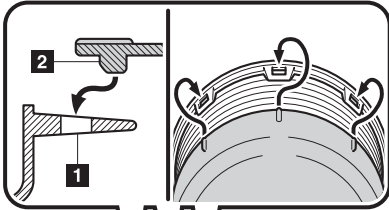

CTN52AN108

#### 1 Upper slots

#### 2 Hooks

To install the spare tire cover, insert the hooks under the guides to the upper slots and lower the cover.

### STEP 7

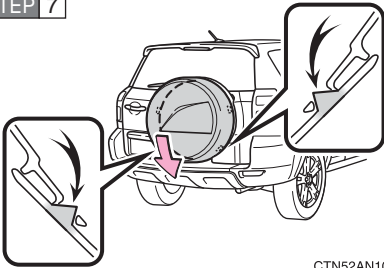

CTN52AN109

Attach the cover by hooking the 2 inner protrusions.

Check that the cover is securely attached.

### STEP 8

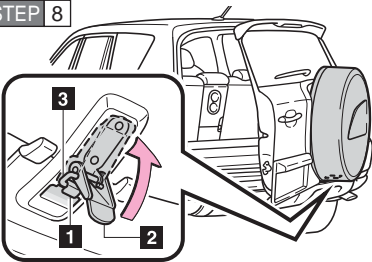

CTN52AN082

#### 1 Hook

#### 2 Latch handle

#### 3 Clasp

Open the back door and lock the latch handle which is on the bottom of the cover.

### STEP 9 Close the back door.

**STEP 10** Stow the jack and all tools securely, and replace all the covers.

■ **When reinstalling the wheel ornament (vehicles with 16-inch wheels)**

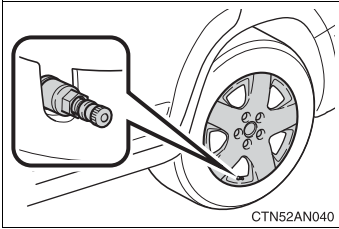

Align the cutout of the wheel ornament with the valve stem as shown.

■ **After completing the tire change (vehicles with a tire pressure warning system)**

The tire pressure warning system must be reset. (→P. 375)

■ **After repairing the flat tire (vehicles with aluminum wheels and a steel wheel for the spare)**

Be sure to reinstall the plastic rings to the wheel nuts before stowing the spare tire. If the steel wheel is stowed without reinstalling the plastic rings to the wheel nuts, the spare tire carrier may produce abnormal noise when the vehicle is moving.

 **CAUTION**

■ **Using the tire jack**

Improper use of the tire jack may lead to death or serious injuries due to the vehicle suddenly falling off the jack.

- Do not use the tire jack for any purpose other than replacing tires or installing and removing tire chains.
- Only use the tire jack that comes with this vehicle for replacing a flat tire.  
Do not use it on other vehicles, and do not use other tire jacks for replacing tires on this vehicle.
- Always check that the tire jack is securely set to the jack point.
- Do not put any part of your body under the vehicle while it is supported by the jack.
- Do not start or run the engine while your vehicle is supported by the jack.
- Do not raise the vehicle while someone is in it.
- When raising the vehicle, do not put an object on or under the jack.
- Do not raise the vehicle to a height greater than that required to replace the tire.
- Use a jack stand if it is necessary to get under the vehicle.
- Stop the vehicle on firm, flat and level ground, firmly set the parking brake and put the transmission in "P". Block the wheel diagonally opposite to the one being changed if necessary.

Take particular care when lowering the vehicle to ensure that no one working on or near the vehicle will be injured.

■ **Using the jack handle (type A)**

Insert the square head securely until you hear a click to prevent the extension parts from coming apart unexpectedly.

 CAUTION**■ Replacing a flat tire**

Observe the following precautions to reduce the risk of death or serious injury:

- Do not try to remove the ornament by hand. Take due care in handling the ornament to avoid unexpected personal injury.
- Never use oil or grease on the wheel bolts or wheel nuts.  
Oil and grease may cause the wheel nuts to be excessively tightened, leading to bolt or disc wheel damage. In addition, the oil or grease can cause the wheel nuts to loosen and the wheel may fall off, causing a serious accident. Remove any oil or grease from the wheel bolts or wheel nuts.
- Have the wheel nuts tightened with a torque wrench to 76 ft•lbf (103 N•m, 10.5 kgf•m) as soon as possible after changing wheels.  
Failure to follow these precautions could cause the nuts to loosen and the wheel may fall off, which could lead to an accident causing death or serious injury.
- Do not attach a heavily damaged wheel ornament, as it may fly off the wheel while the vehicle is moving.
- Make sure that the rubber rings are not installed to the wheel nuts for aluminum wheel. Otherwise, the nuts may become loose and the wheel may fall off, which may cause a serious accident.

 NOTICE

■ **Do not drive the vehicle with a flat tire**

Do not continue driving with a flat tire.

Driving even a short distance with a flat tire can damage the tire and the wheel beyond repair.

■ **When replacing the tires (vehicles with a tire pressure warning system)**

When removing or fitting the wheels, tires or the tire pressure warning valve and transmitter, contact your Toyota dealer as the tire pressure warning valve and transmitter may be damaged if not handled correctly.

■ **To avoid damaging the tire pressure warning valves and transmitters (vehicles with a tire pressure warning system)**

Do not use liquid sealants on flat tires.

## 5-2. Steps to take in an emergency

### If you have a flat tire (vehicles with run-flat tires)

Take your vehicle to the nearest Toyota dealer or authorized tire dealer as soon as possible.

- Run-flat tires (A “RFT” or “DSST” mark is molded on the sidewall)

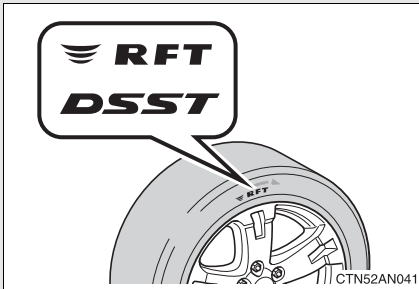

You can continue driving a vehicle with run-flat tires even if any tire goes flat.

It is possible to run for a maximum of 100 miles (160 km) at a speed below 55 mph (90 km/h) after the tire pressure warning light comes on. (→P. 426)

- In some condition (such as at high temperatures)

You cannot continue driving for up to 100 miles (160 km).

- If you cannot distinguish between the standard tires and run-flat tires

Consult your Toyota dealer.

- For the detailed information on run-flat tires

See the tire warranty book.

#### NOTICE

- When replacing the tires

When removing or fitting the wheels, tires or the tire pressure warning valve and transmitter, contact your Toyota dealer as the tire pressure warning valve and transmitter may be damaged if not handled correctly.

- To avoid damaging the tire pressure warning valves and transmitters

Do not use liquid sealants on flat tires.



## 5-2. Steps to take in an emergency If the engine will not start

**If the engine will not start even though correct starting procedures are being followed (→P. 143, 147) or releasing the steering lock, (→P. 143, 147), consider each of the following points.**

**■ The engine will not start even when the starter motor operates normally.**

One of the following may be the cause of the problem.

- There may not be sufficient fuel in the vehicle's tank.  
Refuel the vehicle.
- The engine may be flooded.  
Try to restart the engine once more following correct starting procedures. (→P. 143, 147)
- There may be a malfunction in the engine immobilizer system.  
(→P. 92)

**■ The starter motor turns over slowly, the interior lights and headlights are dim, or the horn does not sound or sounds at a low volume.**

One of the following may be the cause of the problem.

- The battery may be discharged. (→P. 463)
- The battery terminal connections may be loose or corroded.

**■ The starter motor does not turn over, the interior lights and headlights do not turn on, or the horn does not sound.**

One of the following may be the cause of the problem.

- One or both of the battery terminals may be disconnected.
- The battery may be discharged. (→P. 463)
- There may be a malfunction in the steering lock system (vehicles with smart key system).

Contact your Toyota dealer if the problem cannot be repaired, or if repair procedures are unknown.

## 5-2. Steps to take in an emergency

### If the shift lever cannot be shifted from P

If the shift lever cannot be shifted with your foot on the brake, there may be a problem with the shift lock system (a system to prevent accidental operation of the shift lever). Have the vehicle inspected by your Toyota dealer.

The following steps may be used as an emergency measure to ensure that the shift lever can be shifted.

**STEP 1** Set the parking brake.

**STEP 2** Vehicles without smart key system: Turn the engine switch to the “LOCK” position.

Vehicles with smart key system: Turn the “ENGINE START STOP” switch off.

**STEP 3** Depress the brake pedal.

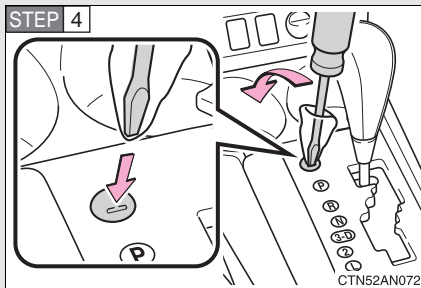

Pry the cover up with a flat-head screwdriver or equivalent.

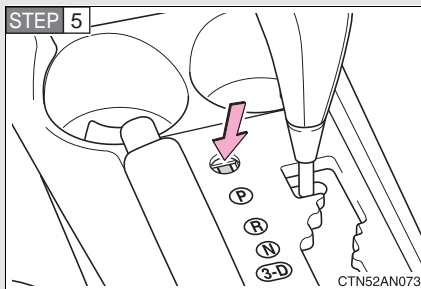

Press the shift lock override button.

The shift lever can be shifted while the button is pressed.

## If you lose your keys

**New genuine keys can be made by your Toyota dealer.**

**For vehicles with the smart key system, bring the other key and the key number stamped on the key number plate.**

**For vehicles without the smart key system, bring a master key and the key number stamped on the key number plate.**

## 5-2. Steps to take in an emergency

If the electronic key does not operate properly (vehicles with smart key system)

If communication between the electronic key and the vehicle is interrupted (→P. 30) or the electronic key cannot be used because the battery is depleted, the smart key system and wireless remote control cannot be used. In such cases, the doors and back door can be opened and the engine can be started by following the procedure below.

### Locking and unlocking the doors with the mechanical key

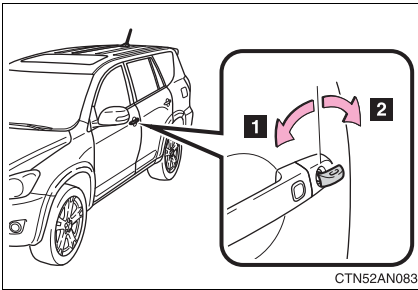

Using the mechanical key (→P. 24) in order to perform the following operations:

- 1 Locks all doors
- 2 Unlocks all doors

Turning the key unlock the driver's door. Turning the key once again unlocks the other doors.

### Changing "ENGINE START STOP" switch modes and starting the engine

**STEP 1** Shift the shift lever to P and apply the brakes.

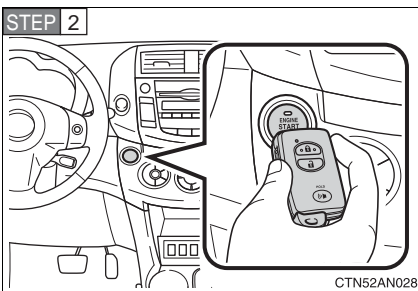

Touch the Toyota emblem side of the electronic key to the "ENGINE START STOP" switch.

If any of the doors is opened and closed while the key is being touched to the switch, an alarm will sound to indicate that the start function cannot detect the electronic key.

**STEP 3** To change “ENGINE START STOP” switch modes: Within 5 seconds after the buzzer sounds, release the brake pedal and press the “ENGINE START STOP” switch. Modes can be changed each time the switch is pressed. (→P. 144)

To start the engine: Press the “ENGINE START STOP” switch within 5 seconds after the buzzer sounds, keeping the brake pedal depressed.

In the event that the “ENGINE START STOP” switch still cannot be operated, contact your Toyota dealer.

---

### ■ Stopping the engine

Shift the shift lever to P and press the “ENGINE START STOP” switch as you normally do when stopping the engine.

### ■ Replacing the key battery

As the above procedure is a temporary measure, it is recommended that the electronic key battery be replaced immediately when the battery is depleted. (→P. 389)

## 5-2. Steps to take in an emergency If the battery is discharged

The following procedures may be used to start the engine if the vehicle's battery is discharged.

You can call your Toyota dealer or qualified repair shop.

If you have a set of jumper (or booster) cables and a second vehicle with a 12-volt battery, you can jump start your Toyota following the steps below.

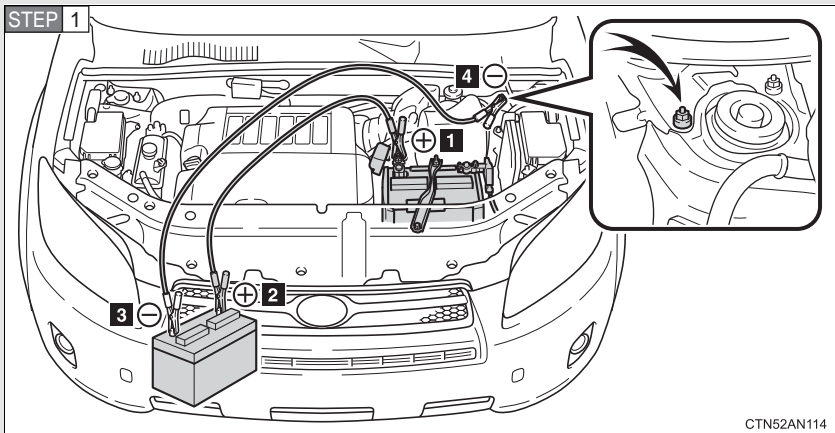

Connecting the jumper cables

- 1** Positive (+) battery terminal on your vehicle
- 2** Positive (+) battery terminal on the second vehicle
- 3** Negative (-) battery terminal on the second vehicle
- 4** Connect the jumper cable to ground on your vehicle as shown in the illustration.

**STEP 2** Start the engine of the second vehicle. Increase the engine speed slightly and maintain at that level for approximately 5 minutes to recharge the battery of your vehicle.

**STEP 3** Vehicles with smart key system — Open and close any of the doors with the “ENGINE START STOP” switch OFF.

**STEP 4** Maintain the engine speed of the second vehicle, and turn the engine switch to the “ON” position (vehicles without smart key system) or turn the “ENGINE START STOP” switch to IGNITION ON mode (vehicles with smart key system), to start the vehicle's engine.

**STEP 5** Once the vehicle's engine has started, remove the jumper cables in the exact reverse order in which they were connected.

Once the engine starts, have the vehicle checked at your Toyota dealer as soon as possible.

---

#### ■ Starting the engine when the battery is discharged

The engine cannot be started by push-starting.

#### ■ To prevent battery discharge

- Turn off the headlights and the audio system while the engine is turned off.
- Turn off any unnecessary electrical components when the vehicle is running at a low speed for an extended period, such as in heavy traffic, etc.

 CAUTION**■ Avoiding battery fires or explosions**

Observe the following precautions to prevent accidentally igniting the flammable gas that may be emitted from the battery.

- Make sure the jumper cable is connected to the correct terminal and that it is not unintentionally in contact with any part other than the intended terminal.
- Do not allow the jumper cables to come into contact with the “+” and “-” terminals.
- Do not smoke, use matches, cigarette lighters or allow open flame near the battery.

**■ Battery precautions**

The battery contains poisonous and corrosive acidic electrolyte, while related parts contain lead and lead compounds. Observe the following precautions when handling the battery.

- When working with the battery, always wear safety glasses and take care not to allow any battery fluids (acid) to come into contact with skin, clothing or the vehicle body.
- Do not lean over the battery.
- In the event that battery fluid comes into contact with the skin or eyes, immediately wash the affected area with water and seek medical attention. Place a wet sponge or cloth over the affected area until medical attention can be received.
- Always wash your hands after handling the battery support, terminals, and other battery-related parts.
- Do not allow children near the battery.

 NOTICE**■ When handling jumper cables**

Be careful that the jumper cables do not become tangled in the cooling fans or any of the belts when connecting or disconnecting them.



## 5-2. Steps to take in an emergency If your vehicle overheats

### If your engine overheats:

**STEP 1** Stop the vehicle in a safe place and turn off the air conditioning system.

**STEP 2** Check to see if steam is coming out from under the hood.

If you see steam:

Stop the engine. Carefully lift the hood after the steam subsides and then restart the engine.

If you do not see steam:

Leave the engine running and carefully lift the hood.

**STEP 3** Check to see if the cooling fans are operating.

If the fans are operating:

Wait until the temperature of the engine (shown on the instrument cluster) begins to fall and then stop the engine.

If the fans are not operating:

Stop the engine and call your Toyota dealer.

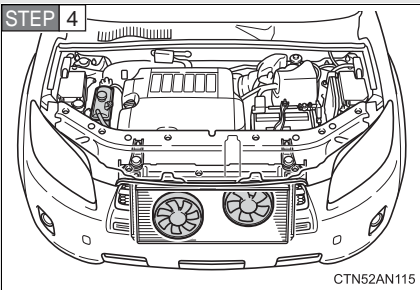

After the engine has cooled down sufficiently, check the engine coolant level and inspect the radiator core (radiator) for any leaks.

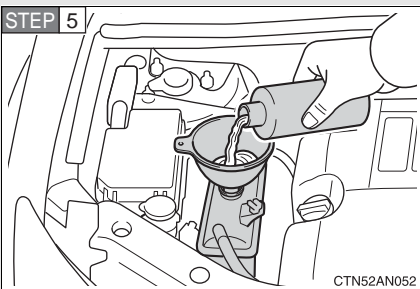

Add engine coolant if necessary.

Water can be used in an emergency if engine coolant is unavailable. (→P. 480)

Have the vehicle checked at the nearest Toyota dealer as soon as possible.

### ■ Overheating

If you observe the following, your vehicle may be overheating.

- The engine coolant temperature gauge enters the red zone or a loss of power is experienced.
- Steam is coming from under the hood.

### CAUTION

#### ■ To prevent an accident or injury when inspecting under the hood of your vehicle

- If steam is seen coming from under the hood, do not open the hood until the steam has subsided. The engine compartment may be very hot, causing serious injury such as burns.
- Keep hands and clothing away from the fan and other belts while the engine is running.
- Do not loosen the coolant reservoir cap while the engine and radiator are hot.  
Serious injury, such as burns, may result from hot coolant and steam released under pressure.

### NOTICE

#### ■ When adding engine coolant

Wait until the engine has cooled down before adding engine coolant. When adding coolant, do so slowly. Adding cool coolant to a hot engine too quickly can cause damage to the engine.

## 5-2. Steps to take in an emergency

### If the vehicle becomes stuck

**Carry out the following procedures if the tires spin or the vehicle becomes stuck in mud, dirt, or snow.**

**STEP 1** Stop the engine. Set the parking brake and put the shift lever in P.

**STEP 2** Remove the mud, snow, or sand from around the stuck tire.

**STEP 3** Place wood, stones or some other material to help provide traction under the tires.

**STEP 4** Restart the engine.

**STEP 5** 4WD models: Activate four-wheel drive lock mode. (→P. 196)

**STEP 6** Shift the shift lever to the D or R position, release the parking brake and carefully depress the accelerator pedal to free the vehicle.

Turn off TRAC and/or VSC if these functions are hampering your attempts to free the vehicle. (→P. 186)

#### CAUTION

##### ■ When attempting to free a stuck vehicle

If you choose to rock the vehicle back and forth to free it, make sure the surrounding area is clear, to avoid striking other vehicles, objects or persons. The vehicle may also lunge forward or lunge back suddenly as it becomes free. Use extreme caution.

##### ■ When shifting the shift lever

Be careful not to shift the shift lever with the accelerator pedal depressed. This may lead to unexpected rapid acceleration of the vehicle that may cause an accident and result in death or serious injury.



**NOTICE**

■ **To avoid damaging the transmission and other components**

- Avoid spinning the wheels and do not rev the engine.
- If the vehicle remains stuck after trying these procedures, the vehicle may require towing to be freed.

## 5-2. Steps to take in an emergency

### If your vehicle has to be stopped in an emergency

**Only in an emergency, such as if it becomes impossible to stop the vehicle in the normal way, stop the vehicle using the following procedure:**

**STEP 1** Steadily step on the brake pedal with both feet and firmly depress it.

Do not pump the brake pedal repeatedly as this will increase the effort required to slow the vehicle.

**STEP 2** Shift the shift lever to N.

► If the shift lever is shifted to N

**STEP 3** After slowing down, stop the vehicle in a safe place by the road.

**STEP 4** Stop the engine.

► If the shift lever cannot be shifted to N

**STEP 3** Keep depressing the brake pedal with both feet to reduce vehicle speed as much as possible.

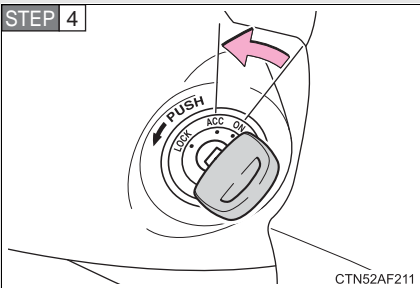

Vehicles without a smart key system: Stop the engine by turning the engine switch to the “ACC” position.

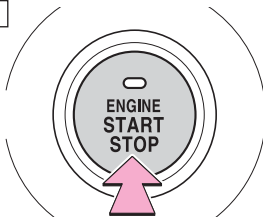
**STEP 4**

Press and hold for 3 seconds or more

CTN52AF205

Vehicles with a smart key system: Stop the engine by pressing and holding the “ENGINE START STOP” switch for 3 consecutive seconds or more.

**STEP 5** Stop the vehicle in a safe place by the road.

**! CAUTION**

**■ If the engine has to be turned off while driving**

- Power assist for the brakes and steering wheel will be lost, making the brake pedal harder to depress and the steering wheel heavier to turn. Decelerate as much as possible before turning off the engine.
- Vehicles without a smart key system: Never attempt to remove the key, as doing so will lock the steering wheel.



<b>Dimensions and weights</b>	
-------------------------------	--

Overall length	178.7 in. (4540 mm) <sup>*1</sup> 180.7 in. (4590 mm) <sup>*2</sup> 180.9 in. (4595 mm) <sup>*3</sup> 181.1 in. (4600 mm) <sup>*4</sup> 181.9 in. (4620 mm) <sup>*5</sup>
Overall width	▶ Without over fender 71.5 in. (1815 mm) ▶ With over fender 73.0 in. (1855 mm)
Overall height <sup>*6</sup>	▶ Without roof rails 66.3 in. (1685 mm) 66.5 in. (1690 mm) <sup>*7</sup> ▶ With roof rails 68.7 in. (1745 mm) 69.1 in. (1755 mm) <sup>*7</sup>
Wheelbase	104.7 in. (2660 mm)
Front tread	61.4 in. (1560 mm) 61.8 in. (1570 mm) <sup>*4</sup>
Rear tread	61.4 in. (1560 mm) 61.8 in. (1570 mm) <sup>*4</sup>
Vehicle capacity weight (Occupants + luggage)	825 lb. (370 kg) 1155 lb. (520 kg) <sup>*7</sup>



Towing capacity (Trailer weight + cargo)	<ul style="list-style-type: none"> <li>▶ 2.5 L 4-cylinder (2AR-FE) engine 1500 lb. (680 kg)</li> <li>▶ 3.5 L V6 (2GR-FE) engine 2000 lb. (905 kg) 3500 lb. (1585 kg)*<sup>8</sup></li> </ul>
---	--

\*1: Without spare tire

\*2: 215/70R16 tires

\*3: 225/65R17 tires

\*4: 235/55R18 tires

\*5: With spare tire cover

\*6: Unladen vehicle

\*7: With third seats

\*8: With towing package

## Vehicle identification

### ■ Vehicle identification number

The vehicle identification number (VIN) is the legal identifier for your vehicle. This is the primary identification number for your Toyota. It is used in registering the ownership of your vehicle.

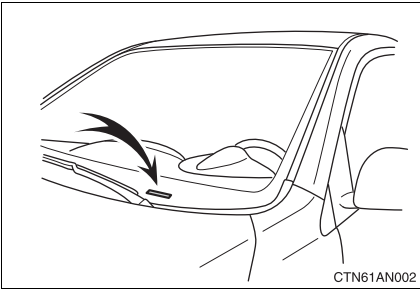

This number is stamped on the top left of the instrument panel.

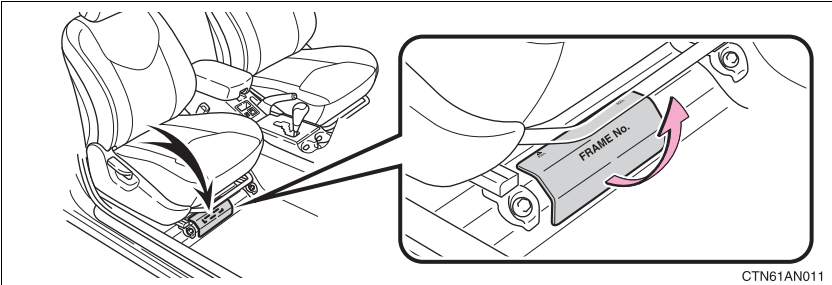

On some models, this number is stamped under the front passenger's seat.

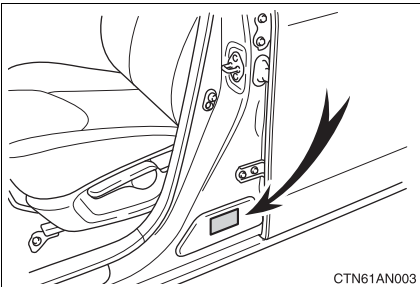

This number is also on the Certification Label.

## ■ Engine number

The engine number is stamped on the engine block as shown.

### ▶ 2.5 L 4-cylinder (2AR-FE) engine

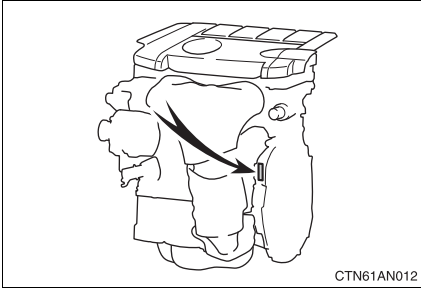

### ▶ 3.5 L V6 (2GR-FE) engine

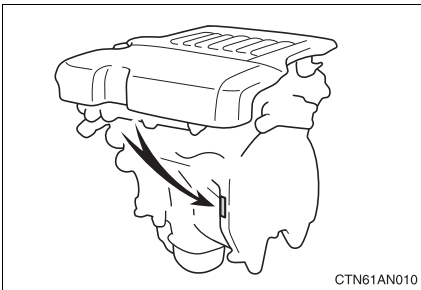

## Engine

Model	2AR-FE	2GR-FE
Type	4-cylinder in line, 4-cycle, gasoline	6-cylinder V type, 4-cycle, gasoline
Bore and stroke	3.54 × 3.86 in. (90.0 × 98.0 mm)	3.70 × 3.27 in. (94.0 × 83.0 mm)
Displacement	152.2 cu.in. (2494 cm <sup>3</sup> )	210.9 cu.in. (3456 cm <sup>3</sup> )
Drive belt tension	Automatic adjustment	

**Fuel**

Fuel type	Unleaded gasoline only
Octane rating	87 (Research Octane Number 91) or higher
Fuel tank capacity (Reference)	15.9 gal. (60 L, 13.2 Imp. gal.)

**Lubrication system**

Oil capacity (Drain and refill — reference)	
▶ Without filter	<ul style="list-style-type: none"> <li>▶ 2.5 L 4-cylinder (2AR-FE) engine 4.2 qt. (4.0 L, 3.5 Imp. qt.)</li> <li>▶ 3.5 L V6 (2GR-FE) engine 6.0 qt. (5.7 L, 5.0 Imp. qt.)</li> </ul>
▶ With filter	<ul style="list-style-type: none"> <li>▶ 2.5 L 4-cylinder (2AR-FE) engine 4.7 qt. (4.4 L, 3.9 Imp. qt.)</li> <li>▶ 3.5 L V6 (2GR-FE) engine 6.4 qt. (6.1 L, 5.4 Imp. qt.)</li> </ul>

**■ Engine oil selection**

“Toyota Genuine Motor Oil” is used in your Toyota vehicle. Use Toyota approved “Toyota Genuine Motor Oil” or equivalent to satisfy the following grade and viscosity.

Oil grade: ILSAC multigrade engine oil

Recommended viscosity:

- ▶ 2.5 L 4-cylinder (2AR-FE) engine  
SAE 5W-20 or 0W-20

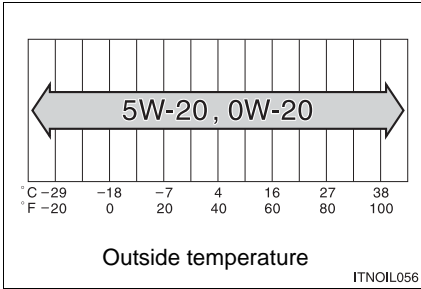

SAE 5W-20 or 0W-20 engine oil may be used. However, SAE 0W-20 is the best choice for good fuel economy and good starting in cold weather.

The 0W portion of the oil viscosity rating indicates the characteristic of the oil which allows cold startability. Oils with a lower value before the W allow for easier starting of the engine in cold weather.

The 20 in 0W-20 indicates the oil viscosity when the oil is at its operating temperature. An oil with a higher viscosity may be better suited if the vehicle is operated at high speeds, or under extreme load conditions.

- ▶ 3.5 L V6 (2GR-FE) engine  
SAE 5W-30

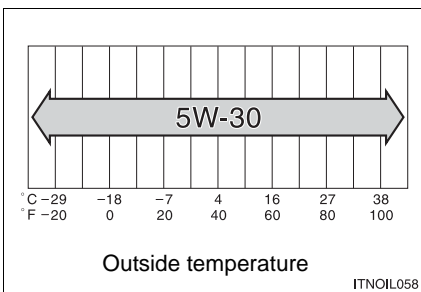

SAE 5W-30 is the best choice for good fuel economy and good starting in cold weather.

If SAE 5W-30 is not available, SAE 10W-30 oil may be used. However, it should be replaced with SAE 5W-30 at the next oil change.

The 5W portion of the oil viscosity rating indicates the characteristic of the oil which allows cold startability. Oils with a lower value before the W allow for easier starting of the engine in cold weather.

The 30 in 5W-30 indicates the oil viscosity when the oil is at its operating temperature. An oil with a higher viscosity may be better suited if the vehicle is operated at high speeds, or under extreme load conditions.

How to read oil container label:

The ILSAC (International Lubricant Standardization and Approval Committee) Certification Mark is added to some oil containers to help you select the oil you should use.

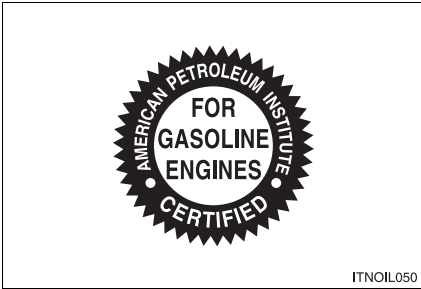

**Cooling system**

Capacity (Reference)	<ul style="list-style-type: none"> <li>▶ 2.5 L 4-cylinder (2AR-FE) engine 7.2 qt. (6.8 L, 6.0 Imp. qt.)</li> <li>▶ 3.5 L V6 (2GR-FE) engine 9.4 qt. (8.9 L, 7.8 Imp. qt.) 9.8 qt. (9.3 L, 8.2 Imp. qt.)*</li> </ul>
Coolant type	<p>Use either of the following.</p> <ul style="list-style-type: none"> <li>• “Toyota Super Long Life Coolant”</li> <li>• Similar high-quality ethylene glycol-based non-silicate, non-amine, non-nitrite, and non-borate coolant with long-life hybrid organic acid technology</li> </ul> <p>Do not use plain water alone.</p>

\*: With towing package

## Ignition system

Spark plug Make	<ul style="list-style-type: none"> <li>▶ 2.5 L 4-cylinder (2AR-FE) engine DENSO, SK16HR11</li> <li>▶ 3.5 L V6 (2GR-FE) engine DENSO FK20HR11</li> </ul>
Gap	0.043 in. (1.1 mm)

### NOTICE

#### ■ Iridium-tipped spark plugs

Use only iridium-tipped spark plugs. Do not adjust gap when tuning the engine.

## Electrical system

Battery	
Open voltage* at 68°F (20°C):	12.6 — 12.8 V Fully charged 12.2 — 12.4 V Half charged 11.8 — 12.0 V Discharged (*: Voltage is checked 20 minutes after the engine and all the lights are turned off)
Charging rates	5 A max.

## Rear differential (4WD models)

Oil capacity	0.5 qt. (0.5 L, 0.4 Imp. qt.)
Oil type	Hypoid gear oil API GL-5
Recommended oil viscosity	Above 0°F (-18°C): SAE 90 Below 0°F (-18°C): SAE 80W or SAE 80W-90

### Automatic transaxle

Fluid capacity	<ul style="list-style-type: none"> <li>▶ 4-speed models 8.6 qt. (8.1 L, 7.1 Imp. qt.)</li> <li>▶ 5-speed models 9.3 qt. (8.8 L, 7.7 Imp. qt.)</li> </ul>
Fluid type	Toyota Genuine ATF WS

### NOTICE

#### ■ Automatic transmission fluid type

Using automatic transmission fluid other than “Toyota Genuine ATF WS” may cause deterioration in shift quality, locking up of your transmission accompanied by vibration, and ultimately damage the automatic transmission of your vehicle.

### Transfer (4WD models)

Oil capacity	0.48 qt. (0.45 L, 0.40 Imp. qt.)
Oil type	Hypoid gear oil API GL-5
Recommended oil viscosity	Above 0°F (-18°C): SAE 90 Below 0°F (-18°C): SAE 80W or SAE 80W-90



## Brakes

Pedal clearance* <sup>1</sup>	<ul style="list-style-type: none"> <li>▶ Without third seats 3.7 in. (95 mm)</li> <li>▶ With third seats 4.7 in. (120 mm)</li> </ul>
Pedal free play	0.04 — 0.24 in. (1 — 6 mm)
Brake pad wear limit	0.04 in. (1.0 mm)
Parking brake lining wear limit	0.04 in. (1.0 mm)
Parking brake pedal travel* <sup>2</sup>	6 — 8 clicks
Fluid type	SAE J1703 or FMVSS No. 116 DOT 3

\*<sup>1</sup>: Minimum pedal clearance when depressed with a force of 110 lbf (490 N, 50 kgf) while the engine is running

\*<sup>2</sup>: Parking brake pedal travel when depressed with a force of 45 lbf (200 N, 21 kgf)

## Steering

Free play	Less than 1.2 in. (30 mm)
-----------	---------------------------

<b>Tires and wheels</b>
-------------------------

## ► Type A

Tire size	215/70R16 99H, 225/65R17 101H, 235/55R18 99H
Tire inflation pressure (Recommended cold tire inflation pressure)	Front: 32 psi (220 kPa, 2.2 kgf/cm <sup>2</sup> or bar) Rear: 32 psi (220 kPa, 2.2 kgf/cm <sup>2</sup> or bar) Spare: 32 psi (220 kPa, 2.2 kgf/cm <sup>2</sup> or bar)
Wheel size	16 × 6 1/2 J, 17 × 6 1/2 J <sup>*1</sup> , 17 × 7J <sup>*2</sup> , 18 × 7 1/2 J
Wheel nut torque	76 ft•lbf (103 N•m, 10.5 kgf•m)

\*1: Steel wheels

\*2: Aluminum wheels

## ► Type B

Tire size	P235/55R18 99H
Tire inflation pressure (Recommended cold tire inflation pressure)	Front: 32 psi (220 kPa, 2.2 kgf/cm <sup>2</sup> or bar) Rear: 32 psi (220 kPa, 2.2 kgf/cm <sup>2</sup> or bar)
Wheel size	18 × 7 1/2 J
Wheel nut torque	76 ft•lbf (103 N•m, 10.5 kgf•m)

<b>Light bulbs</b>
--------------------

	Light Bulbs	Bulb No.	W	Type
Exterior	Headlights			
	High beam	9005	60	A
	Low beam	9006	51	B
	Front fog lights*	—	55	C
	Front turn signal/parking, front side marker lights	7443	21/5	D
	Rear side marker lights	—	5	D
	Rear turn signal lights	7440	21	E
Interior	Back-up lights	921	16	D
	License plate lights	168	5	D
	Vanity lights	—	8	D
	Front personal lights	—	8	D
	Interior light	—	8	F
	Luggage compartment light	—	5	F

A: HB3 halogen bulbs

B: HB4 halogen bulbs

C: H11 halogen bulbs

D: Wedge base bulbs (clear)

E: Wedge base bulbs (amber)

F: Double end bulbs

\*: If equipped

## 6-1. Specifications

# Fuel information

**Your vehicle must use only unleaded gasoline.**

**Select octane rating 87 (Research Octane Number 91) or higher. Use of unleaded gasoline with an octane rating lower than 87 may result in engine knocking. Persistent knocking can lead to engine damage.**

At minimum, the gasoline you use should meet the specifications of ASTM D4814 in the U.S.A. and CGSB3.5-M93 in Canada.

---

### ■ Fuel tank opening for unleaded gasoline

To help prevent incorrect fueling, your Toyota has a fuel tank opening that only accommodates the special nozzle on unleaded fuel pumps.

### ■ If your engine knocks

- Consult your Toyota dealer.
- You may occasionally notice light knocking for a short time while accelerating or driving uphill. This is normal and there is no need for concern.

### ■ Gasoline quality

In very few cases, driveability problems may be caused by the brand of gasoline you are using. If driveability problems persist, try changing the brand of gasoline. If this does not correct the problem, consult your Toyota dealer.

### ■ Gasoline quality standards

- Automotive manufacturers in the US, Europe and Japan have developed a specification for fuel quality called World-Wide Fuel Charter (WWFC) that is expected to be applied worldwide.
- The WWFC consists of four categories that are based on required emission levels. In the US, category 4 has been adopted.
- The WWFC improves air quality by lowering emissions in vehicle fleets, and customer satisfaction through better performance.

**■ Toyota recommends the use of gasoline containing detergent additives**

- Toyota recommends the use of gasoline that contains detergent additives to avoid build-up of engine deposits.
- All gasoline sold in the US contains detergent additives to clean and/or keep clean intake systems.

**■ Toyota recommends the use of cleaner burning gasoline**

Cleaner burning gasoline, including reformulated gasoline that contains oxygenates such as ethanol or MTBE (Methyl Tertiary Butyl Ether) is available in many areas.

Toyota recommends the use of cleaner burning gasoline and appropriately blended reformulated gasoline. These types of gasoline provide excellent vehicle performance, reduce vehicle emissions and improve air quality.

**■ Toyota does not recommend blended gasoline**

- Toyota allows the use of oxygenate blended gasoline where the oxygenate content is up to 10% ethanol or 15% MTBE.
- If you use gasohol in your Toyota, be sure that it has an octane rating no lower than 87.
- Toyota does not recommend the use of gasoline containing methanol.

**■ Toyota does not recommend gasoline containing MMT**

Some gasoline contains octane enhancing additive called MMT (Methylcyclopentadienyl Manganese Tricarbonyl).

Toyota does not recommend the use of gasoline that contains MMT. If fuel containing MMT is used, your emission control system may be adversely affected.

The malfunction indicator lamp on the instrument cluster may come on. If this happens, contact your Toyota dealer for service.

 NOTICE

■ **Notice on fuel quality**

- Do not use improper fuels. If improper fuels are used the engine will be damaged.
- Do not use leaded gasoline.  
Leaded gasoline can cause damage to your vehicle's three-way catalytic converters causing the emission control system to malfunction and the emission control system to function improperly.
- Do not use gasohol other than that stated here.  
Other gasohol may cause fuel system damage or vehicle performance problems.
- Using unleaded gasoline with an octane number or rating lower than that stated here will cause persistent heavy knocking.  
At worst, this will lead to engine damage.

■ **Fuel-related poor driveability**

If after using a different type of fuel, poor driveability is encountered (poor hot starting, vaporization, engine knocking, etc.), discontinue the use of that type of fuel.

■ **When refueling with gasohol**

Take care not to spill gasohol. It can damage your vehicle's paint.

## 6-1. Specifications

### Tire information

#### Typical tire symbols

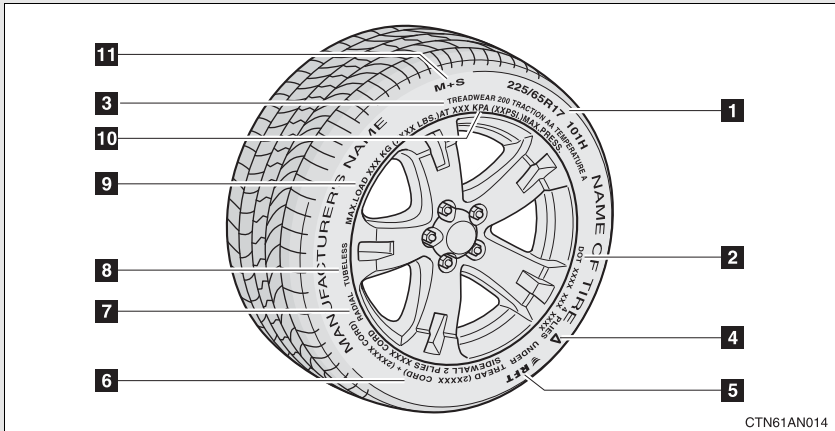

**1** Tire size (→P. 491)

**2** DOT and Tire Identification Number (TIN) (→P. 490)

**3** Uniform tire quality grading

For details, see “Uniform tire quality grading” that follows.

**4** Location of treadwear indicators (→P. 373)

**5** Run-flat tire (RFT) or standard tire (→P. 457)

This vehicle can be equipped with either run-flat tires (RFT) or standard tires. A “RFT” or “DSST” mark is molded on the sidewall of the run-flat tire.

**6** Tire ply composition and materials

Plies are layers of rubber-coated parallel cords. Cords are the strands which form the plies in a tire.

**7** Radial tires or bias-ply tires

A radial tire has “RADIAL” on the sidewall. A tire not marked “RADIAL” is a bias-ply tire.

**8** TUBELESS or TUBE TYPE

A tubeless tire does not have a tube and air is directly filled in the tire. A tube type tire has a tube inside the tire and the tube maintains the air pressure.

**9** Load limit at maximum cold tire inflation pressure (→P. 376)

**10** Maximum cold tire inflation pressure (→P. 484)

This means the pressure to which a tire may be inflated.

**11** Summer tire or all season tire (→P. 377)

An all season tire has “M+S” on the sidewall. A tire not marked “M+S” is a summer tire.

### Typical DOT and tire identification number (TIN)

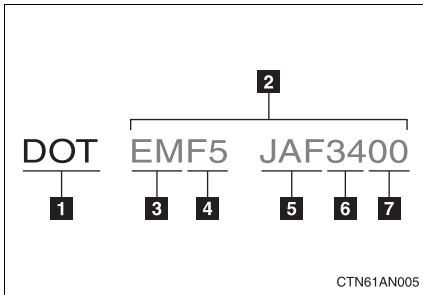

**1** DOT symbol\*

**2** Tire Identification Number (TIN)

**3** Tire manufacturer's identification mark

**4** Tire size code

**5** Manufacturer's optional tire type code (3 or 4 letters)

**6** Manufacturing week

**7** Manufacturing year

\*: The DOT symbol certifies that the tire conforms to applicable Federal Motor Vehicle Safety Standards.



## Tire size

### ■ Typical tire size information

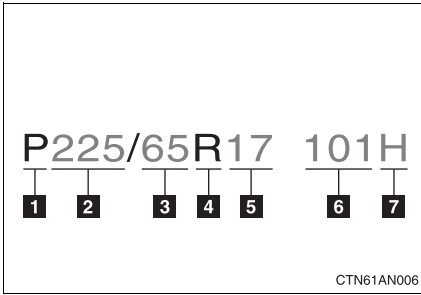

The illustration indicates typical tire size.

- 1** Tire use  
(P = Passenger car,  
T = Temporary use)
- 2** Section width (millimeters)
- 3** Aspect ratio  
(tire height to section width)
- 4** Tire construction code  
(R = Radial, D = Diagonal)
- 5** Wheel diameter (inches)
- 6** Load index (2 digits or 3 digits)
- 7** Speed symbol  
(alphabet with one letter)

### ■ Tire dimensions

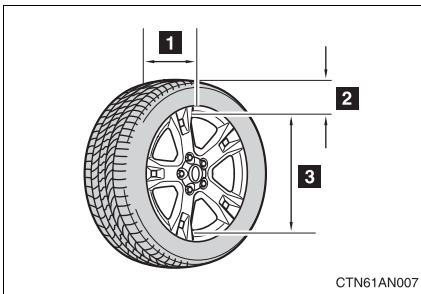

- 1** Section width
- 2** Tire height
- 3** Wheel diameter

## Tire section names

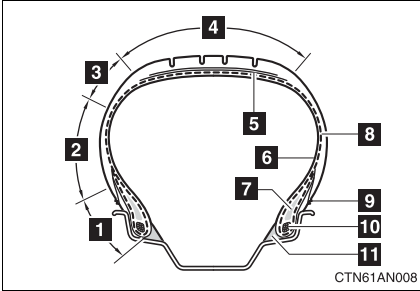

- 1** Bead
- 2** Sidewall
- 3** Shoulder
- 4** Tread
- 5** Belt
- 6** Inner liner
- 7** Reinforcing rubber
- 8** Carcass
- 9** Rim lines
- 10** Bead wires
- 11** Chafer

## Uniform Tire Quality Grading

This information has been prepared in accordance with regulations issued by the National Highway Traffic Safety Administration of the U.S. Department of Transportation.

It provides the purchasers and/or prospective purchasers of Toyota vehicles with information on uniform tire quality grading.

Your Toyota dealer will help answer any questions you may have as you read this information.

### ■ DOT quality grades

All passenger vehicle tires must conform to Federal Safety Requirements in addition to these grades. Quality grades can be found where applicable on the tire sidewall between tread shoulder and maximum section width.

For example: Treadwear 200 Traction AA Temperature A

### ■ Treadwear

The treadwear grade is a comparative rating based on the wear rate of the tire when tested under controlled conditions on a specified government test course.

For example, a tire graded 150 would wear one and a half (1 - 1/2) times as well on the government course as a tire graded 100.

The relative performance of tires depends upon the actual conditions of their use, however, and may depart significantly from the norm due to variations in driving habits, service practices and differences in road characteristics and climate.

### ■ Traction AA, A, B, C

The traction grades, from highest to lowest, are AA, A, B and C, and they represent the tire's ability to stop on wet pavement as measured under controlled conditions on specified government test surfaces of asphalt and concrete.

A tire marked C may have poor traction performance.

Warning: The traction grade assigned to this tire is based on braking (straight ahead) traction tests and does not include cornering (turning) traction.

### ■ Temperature A, B, C

The temperature grades are A (the highest), B, and C, representing the tire's resistance to the generation of heat and its ability to dissipate heat when tested under controlled conditions on a specified indoor laboratory test wheel.

Sustained high temperature can cause the material of the tire to degenerate and reduce tire life, and excessive temperature can lead to sudden tire failure.

The grade C corresponds to a level of performance which all passenger car tires must meet under the Federal Motor Vehicle Safety Standard No. 109.

Grades B and A represent higher levels of performance on the laboratory test wheel than the minimum required by law.

Warning: The temperature grades for this tire are established for a tire that is properly inflated and not overloaded.

Excessive speed, underinflation, or excessive loading, either separately or in combination, can cause heat buildup and possible tire failure.

### Glossary of tire terminology

Tire related term	Meaning
Cold tire inflation pressure	Tire pressure when the vehicle has been parked for three hours or more, or has not been driven more than 1 mile or 1.5 km under that condition
Maximum inflation pressure	The maximum cold inflated pressure to which a tire may be inflated, shown on the sidewall of the tire
Recommended inflation pressure	Cold tire inflation pressure recommended by a manufacturer
Accessory weight	The combined weight (in excess of those standard items which may be replaced) of automatic transmission, power steering, power brakes, power windows, power seats, radio and heater, to the extent that these items are available as factory-installed equipment (whether installed or not)
Curb weight	The weight of a motor vehicle with standard equipment, including the maximum capacity of fuel, oil and coolant, and if so equipped, air conditioning and additional weight optional engine
Maximum loaded vehicle weight	The sum of: (a) Curb weight (b) Accessory weight (c) Vehicle capacity weight (d) Production options weight

Tire related term	Meaning
Normal occupant weight	150 lb. (68 kg) times the number of occupants specified in the second column of Table 1* that follows
Occupant distribution	Distribution of occupants in a vehicle as specified in the third column of Table 1* below
Production options weight	The combined weight of installed regular production options weighing over 5 lb. (2.3 kg) in excess of the standard items which they replace, not previously considered in curb weight or accessory weight, including heavy duty brakes, ride levelers, roof rack, heavy duty battery, and special trim
Rim	A metal support for a tire or a tire and tube assembly upon which the tire beads are seated
Rim diameter (Wheel diameter)	Nominal diameter of the bead seat
Rim size designation	Rim diameter and width
Rim type designation	The industry manufacturer's designation for a rim by style or code
Rim width	Nominal distance between rim flanges
Vehicle capacity weight (Total load capacity)	The rated cargo and luggage load plus 150 lb. (68 kg) times the vehicle's designated seating capacity
Vehicle maximum load on the tire	The load on an individual tire that is determined by distributing to each axle its share of the maximum loaded vehicle weight, and dividing by two
Vehicle normal load on the tire	The load on an individual tire that is determined by distributing to each axle its share of curb weight, accessory weight, and normal occupant weight (distributed in accordance with Table 1* below), and dividing by two

Tire related term	Meaning
Weather side	The surface area of the rim not covered by the inflated tire
Bead	The part of the tire that is made of steel wires, wrapped or reinforced by ply cords and that is shaped to fit the rim
Bead separation	A breakdown of the bond between components in the bead
Bias ply tire	A pneumatic tire in which the ply cords that extend to the beads are laid at alternate angles substantially less than 90 degrees to the centerline of the tread
Carcass	The tire structure, except tread and sidewall rubber which, when inflated, bears the load
Chunking	The breaking away of pieces of the tread or sidewall
Cord	The strands forming the plies in the tire
Cord separation	The parting of cords from adjacent rubber compounds
Cracking	Any parting within the tread, sidewall, or innerliner of the tire extending to cord material
CT	A pneumatic tire with an inverted flange tire and rim system in which the rim is designed with rim flanges pointed radially inward and the tire is designed to fit on the underside of the rim in a manner that encloses the rim flanges inside the air cavity of the tire
Extra load tire	A tire designed to operate at higher loads and at higher inflation pressures than the corresponding standard tire
Groove	The space between two adjacent tread ribs
Innerliner	The layer(s) forming the inside surface of a tubeless tire that contains the inflating medium within the tire

Tire related term	Meaning
Innerliner separation	The parting of the innerliner from cord material in the carcass
Intended outboard sidewall	<p>(a) The sidewall that contains a whitewall, bears white lettering, or bears manufacturer, brand, and/or model name molding that is higher or deeper than the same molding on the other sidewall of the tire, or</p> <p>(b) The outward facing sidewall of an asymmetrical tire that has a particular side that must always face outward when mounted on a vehicle</p>
Light truck (LT) tire	A tire designated by its manufacturer as primarily intended for use on lightweight trucks or multipurpose passenger vehicles
Load rating	The maximum load that a tire is rated to carry for a given inflation pressure
Maximum load rating	The load rating for a tire at the maximum permissible inflation pressure for that tire
Maximum permissible inflation pressure	The maximum cold inflation pressure to which a tire may be inflated
Measuring rim	The rim on which a tire is fitted for physical dimension requirements
Open splice	Any parting at any junction of tread, sidewall, or innerliner that extends to cord material
Outer diameter	The overall diameter of an inflated new tire
Overall width	The linear distance between the exteriors of the sidewalls of an inflated tire, including elevations due to labeling, decorations, or protective bands or ribs
Passenger car tire	A tire intended for use on passenger cars, multipurpose passenger vehicles, and trucks, that have a gross vehicle weight rating (GVWR) of 10,000 lb. or less.

Tire related term	Meaning
Ply	A layer of rubber-coated parallel cords
Ply separation	A parting of rubber compound between adjacent plies
Pneumatic tire	A mechanical device made of rubber, chemicals, fabric and steel or other materials, that, when mounted on an automotive wheel, provides the traction and contains the gas or fluid that sustains the load
Radial ply tire	A pneumatic tire in which the ply cords that extend to the beads are laid at substantially 90 degrees to the centerline of the tread
Reinforced tire	A tire designed to operate at higher loads and at higher inflation pressures than the corresponding standard tire
Section width	The linear distance between the exteriors of the sidewalls of an inflated tire, excluding elevations due to labeling, decoration, or protective bands
Sidewall	That portion of a tire between the tread and bead
Sidewall separation	The parting of the rubber compound from the cord material in the sidewall
Snow tire	A tire that attains a traction index equal to or greater than 110, compared to the ASTM E-1136 Standard Reference Test Tire, when using the snow traction test as described in ASTM F-1805-00, Standard Test Method for Single Wheel Driving Traction in a Straight Line on Snow-and Ice-Covered Surfaces, and which is marked with an Alpine Symbol (  ) on at least one sidewall
Test rim	The rim on which a tire is fitted for testing, and may be any rim listed as appropriate for use with that tire



Tire related term	Meaning
Tread	That portion of a tire that comes into contact with the road
Tread rib	A tread section running circumferentially around a tire
Tread separation	Pulling away of the tread from the tire carcass
Treadwear indicators (TWI)	The projections within the principal grooves designed to give a visual indication of the degrees of wear of the tread
Wheel-holding fixture	The fixture used to hold the wheel and tire assembly securely during testing

\*:Table 1 — Occupant loading and distribution for vehicle normal load for various designated seating capacities

Designated seating capacity, Number of occupants	Vehicle normal load, Number of occupants	Occupant distribution in a normally loaded vehicle
2 through 4	2	2 in front
5 through 10	3	2 in front, 1 in second seat
11 through 15	5	2 in front, 1 in second seat, 1 in third seat, 1 in fourth seat
16 through 20	7	2 in front, 2 in second seat, 2 in third seat, 1 in fourth seat

## Customizable features

**Your vehicle includes a variety of electronic features that can be personalized to your preferences. Programming these preferences requires specialized equipment and may be performed by your Toyota dealer.**

Some function settings are changed simultaneously with other functions being customized. Contact your Toyota dealer.

Item	Function	Default setting	Customized setting
Smart key system (if equipped) (→P. 26)	Smart key system	On	Off
	Operation signal (Emergency flashers)	On	Off
	Operation signal (Buzzer)	On	Off
Wireless remote control (→P. 38)	Wireless remote control	On	Off
	Unlocking operation	Driver's door unlocked in one step, all doors unlocked in two steps	All doors unlocked in one step
	Automatic door lock function to be activated if door is not opened after being unlocked	On	Off
	Time elapsed before automatic door lock function is activated if door is not opened after being unlocked	60 seconds	30 seconds
			120 seconds
	Operation signal (Emergency flashers)	On	Off
Door lock buzzer	On	Off	

Item	Function	Default setting	Customized setting
Wireless remote control (→P. 38)	Operation signal (Buzzer)	On	Off
	Panic function	On	Off
Door lock (→P. 42, 461)	Unlocking using a key	Driver's door unlocked in one step, all doors unlocked in two steps	All doors unlocked in one step
Automatic light control system (→P. 165)	Light sensor sensitivity	Level 3	Level 1 to 5
	Time elapsed before headlights automatically turn off after doors are closed	30 seconds	0 second
			60 seconds
90 seconds			
Lights (→P. 165)	Daytime running light system (U.S.A. only)	On	Off
Illumination (→P. 307)	Time elapsed before lights turn off	15 seconds	7.5 seconds
			30 seconds
	Operation when the doors are unlocked	On	Off
	Vehicles with smart key system: Operation after the "ENGINE START STOP" switch is turned OFF Vehicles without smart key system: Operation after the engine switch is turned to the "LOCK" position	On	Off
	Front foot lights	On	Off

Item	Function	Default setting	Customized setting
Seat belt reminder (→P. 429)	Vehicle speed linked seat belt reminder buzzer	On	Off

## Items to initialize

**The following items must be initialized for normal system operation in cases such as after the battery is reconnected, or maintenance is performed on the vehicle.**

Item	When to initialize	Reference
Power window	After reconnecting or changing the battery	P. 81
Moon roof (if equipped)	After reconnecting or changing the battery	P. 84
Engine oil maintenance data (U.S.A. only)	After changing engine oil	P. 429



## Reporting safety defects for U.S. owners

If you believe that your vehicle has a defect which could cause a crash or could cause injury or death, you should immediately inform the National Highway Traffic Safety Administration (NHTSA) in addition to notifying Toyota Motor Sales, U.S.A., Inc. (Toll-free: 1-800-331-4331).

If NHTSA receives similar complaints, it may open an investigation, and if it finds that a safety defect exists in a group of vehicles, it may order a recall and remedy campaign. However, NHTSA cannot become involved in individual problems between you, your dealer, or Toyota Motor Sales, U.S.A., Inc.

To contact NHTSA, you may call the Vehicle Safety Hotline toll-free at 1-888-327-4236 (TTY: 1-800-424-9153); go to <http://www.safercar.gov>; or write to: Administrator, NHTSA, 1200 New Jersey Ave, S.E., Washington, DC 20590. You can also obtain other information about motor vehicle safety from <http://www.safercar.gov>.

## Seat belt instructions for Canadian owners (in French)

The following is a French explanation of seat belt instructions extracted from the seat belt section in this manual.

See the seat belt section for more detailed seat belt instructions in English.

### Utilisation correcte des ceintures de sécurité

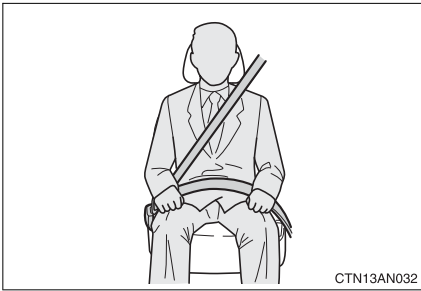

- Tendez la sangle diagonale de sorte qu'elle couvre complètement l'épaule, sans entrer en contact avec le cou ou glisser de l'épaule.
- Placez la sangle abdominale le plus bas possible sur les hanches.
- Réglez la position du dossier de siège. Asseyez-vous le dos le plus droit possible et caliez-vous bien dans le siège.
- Ne vrillez pas la ceinture de sécurité.



## ATTENTION

### ■ Lorsque vous utilisez la ceinture de sécurité du siège central de la deuxième rangée

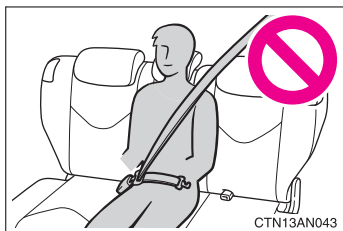

N'utilisez pas la ceinture de sécurité du siège central de deuxième rangée si l'une des 2 boucles est déverrouillée.

Si une seule des boucles est verrouillée, ceci peut entraîner des blessures graves, voire mortelles en cas de freinage brusque ou de collision.

## Entretien et soin

### ■ Ceintures de sécurité

Nettoyez avec un chiffon ou une éponge humectée d'eau savonneuse tiède. Profitez de l'occasion pour vérifier régulièrement que les ceintures ne sont pas effilochées, entaillées, ou ne paraissent pas exagérément usées.

## ATTENTION

### ■ Détérioration et usure des ceintures de sécurité

Inspectez les ceintures de sécurité périodiquement. Contrôlez qu'elles ne sont pas entaillées, effilochées, et que leurs ancrages ne sont pas desserrés. N'utilisez pas une ceinture de sécurité défectueuse avant qu'elle ne soit remplacée. Une ceinture de sécurité défectueuse n'apporte aucune garantie de protection de l'occupant en cas d'accident.

## SRS airbag instructions for Canadian owners (in French)

The following is a French explanation of SRS airbag instructions extracted from the SRS airbag section in this manual.

See the SRS airbag section for more detailed SRS airbag instructions in English.

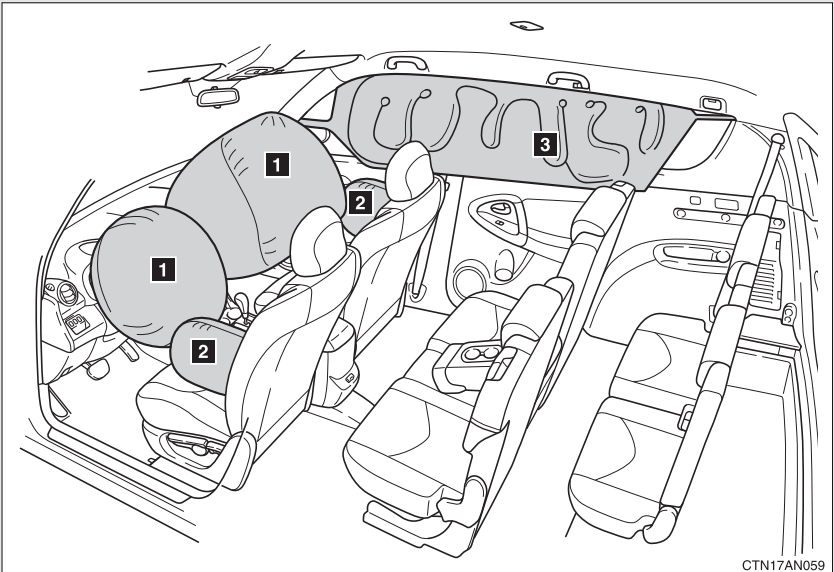

CTN17AN059

### ► Sacs de sécurité gonflables frontaux

#### **1** Sac de sécurité gonflable conducteur/sac de sécurité gonflable passager avant

Participent à la protection de la tête et du thorax du conducteur et du passager contre les chocs avec les éléments de l'habitacle.

► Sacs de sécurité gonflables latéraux et rideau

2 Sacs de sécurité gonflables latéraux

Participent à la protection du thorax des occupants des sièges avant.

3 Sacs de sécurité gonflables rideau

Participent principalement à la protection de la tête des occupants assis aux places extérieures.

## Composition du système de sacs de sécurité gonflables

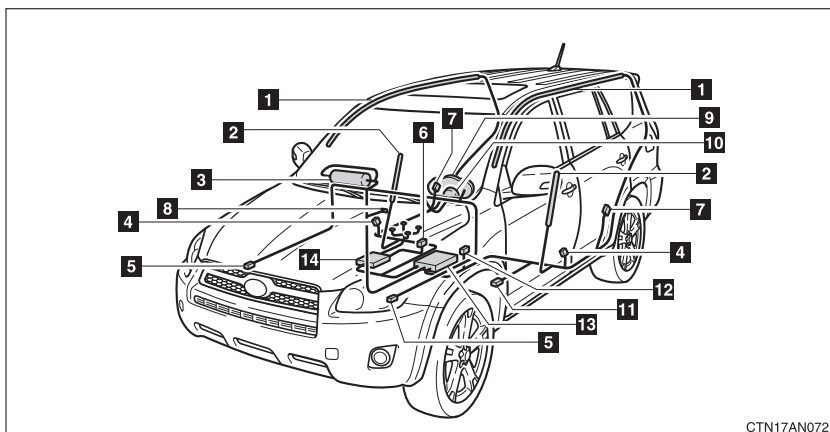

CTN17AN072

- |  |   |
|--|---|
| <b>1</b> Sacs de sécurité gonflables rideau                          | <b>8</b> Témoins “AIR BAG ON” et “AIR BAG OFF”  |
| <b>2</b> Sacs de sécurité gonflables latéraux                        | <b>9</b> Voyant SRS   |
| <b>3</b> Sac de sécurité gonflable passager avant                    | <b>10</b> Sac de sécurité gonflable conducteur  |
| <b>4</b> Capteurs de sacs de sécurité gonflables latéraux et rideau  | <b>11</b> Capteur de la position du siège conducteur  |
| <b>5</b> Capteurs de sacs de sécurité gonflables frontaux            | <b>12</b> Contacteur de boucle de ceinture de sécurité conducteur                           |
| <b>6</b> Contacteur de boucle de ceinture de sécurité passager avant | <b>13</b> Boîtier électronique de sacs de sécurité gonflables                               |
| <b>7</b> Capteurs de sacs de sécurité gonflables rideau              | <b>14</b> Système de classification de l'occupant du siège passager avant (ECU et capteurs) |

Votre véhicule est équipé de SACS DE SÉCURITÉ GONFLABLES INTELLIGENTS (ADVANCED AIRBAGS) conçus selon les normes de sécurité américaines applicables aux véhicules à moteur (FMVSS208). Le système de sac de sécurité gonflable contrôle la puissance de déploiement des sacs de sécurité gonflables conducteur et passager avant. Le système de sac de sécurité gonflable conducteur se compose d'un capteur de position de siège conducteur, etc. Le système de sac de sécurité gonflable passager avant se compose d'un capteur de classification des occupants du siège passager avant, etc..

Les principaux éléments du système de sacs de sécurité gonflables SRS sont illustrés ci-dessus. Le système des sacs de sécurité gonflables SRS est commandé par un boîtier électronique. Ce boîtier intègre un capteur de sécurité et un capteur de sac de sécurité gonflable.

Lorsque la violence du choc frontal ou latéral l'exige, le système de sacs de sécurité gonflables SRS déclenche les dispositifs pyrotechniques de gonflage (générateurs de gaz). Le déploiement rapide des sacs de sécurité gonflables est obtenu au moyen d'une réaction chimique dans les dispositifs pyrotechniques, qui produit un gaz inoffensif permettant d'amortir le mouvement des occupants.



## ATTENTION

### ■ Précautions à observer avec les sacs de sécurité gonflables SRS

Respectez les précautions suivantes avec les sacs de sécurité gonflables. À défaut, des blessures graves, voire mortelles, pourraient s'ensuivre.

- Le conducteur et tous les passagers à bord du véhicule doivent porter leur ceinture de sécurité correctement.

Les sacs de sécurité gonflables SRS sont des dispositifs de protection complémentaires aux ceintures de sécurité.

- Le sac de sécurité gonflable SRS conducteur se déploie avec une violence considérable, qui peut être très dangereuse voire mortelle si le conducteur se trouve très près du sac de sécurité gonflable. L'autorité fédérale chargée de la sécurité routière aux États-Unis, la NHTSA (National Highway Traffic Safety Administration) conseille:

La zone à risque du sac de sécurité gonflable conducteur se situant dans les premiers 2 - 3 in. (50 - 75 mm) de déploiement, vous disposez d'une marge de sécurité confortable en vous plaçant à 10 in. (250 mm) de votre sac de sécurité gonflable conducteur. Cette distance est à mesurer entre le moyeu du volant de direction et le sternum. Si à présent vous êtes assis à moins de 10 in. (250 mm), vous pouvez changer votre position de conduite de plusieurs façons:

- Reculez votre siège autant que vous le permet la longueur de vos jambes (vous devez toujours atteindre confortablement les pédales).
- Inclinez légèrement le dossier du siège.

Bien que les véhicules puissent être différents les uns des autres, la plupart des conducteurs peuvent s'asseoir à une distance de 10 in. (250 mm), même avec le siège conducteur complètement avancé, simplement en inclinant un peu le dossier de siège. Si vous voyez mal la route après avoir incliné votre siège, utilisez un coussin ferme et non glissant pour vous surélever ou bien remontez l'assise du siège si votre véhicule est doté de ce dispositif.

- Si votre volant de direction est réglable, inclinez-le vers le bas. Cela a pour effet d'orienter le sac de sécurité gonflable en direction de votre poitrine plutôt que de votre tête et de votre cou.

Le siège doit être réglé selon les recommandations de la NHTSA ci-dessus, tout en conservant le contrôle des pédales, du volant de direction et la vue des commandes du tableau de bord.

## ATTENTION

### ■ Précautions à observer avec les sacs de sécurité gonflables SRS

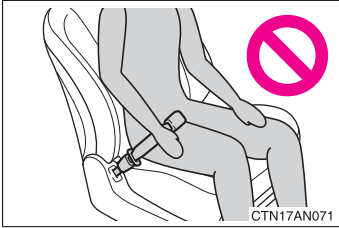

- Si vous attachez une rallonge de ceinture de sécurité à la boucle du siège conducteur, mais pas à la ceinture de sécurité proprement dite, le système de sac de sécurité gonflable SRS conducteur pense que vous avez attaché votre ceinture de sécurité, alors qu'en fait c'est faux. Dans ce cas, il se peut que le sac de sécurité gonflable conducteur ne se déploie pas correctement en cas d'accident, et vous risquez d'être tué ou grièvement blessé. Veillez donc à porter la ceinture de sécurité avec la rallonge de ceinture de sécurité.
- Le sac de sécurité gonflable SRS du passager avant se déploie également avec une violence considérable, qui peut être très dangereuse voire mortelle si le passager se trouve très près du sac de sécurité gonflable. Éloignez le siège passager au maximum du sac de sécurité gonflable, et réglez le dossier de siège de sorte telle sorte que le passager avant soit assis bien droit dans son siège.
- Les nourrissons et les enfants qui ne sont pas correctement assis et/ou protégés peuvent être grièvement blessés ou tués par le déploiement d'un sac de sécurité gonflable. Installez les enfants trop jeunes pour pouvoir utiliser la ceinture de sécurité dans un siège de sécurité enfant. Toyota recommande vivement que les nourrissons et les jeunes enfants soient installés sur le siège arrière du véhicule et convenablement attachés. C'est à l'arrière que les nourrissons et les enfants sont les mieux protégés.
- N'installez jamais un siège de sécurité enfant type dos à la route sur le siège passager avant, même si le témoin "AIR BAG OFF" est allumé. En cas d'accident, la vitesse et la violence de déploiement du sac de sécurité gonflable du passager avant peut tuer ou blesser grièvement l'enfant si le siège de sécurité enfant type dos à la route est installé sur le siège avant.

**ATTENTION**

**■ Précautions à observer avec les sacs de sécurité gonflables SRS**

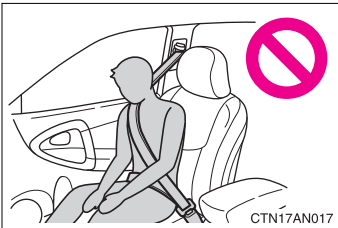
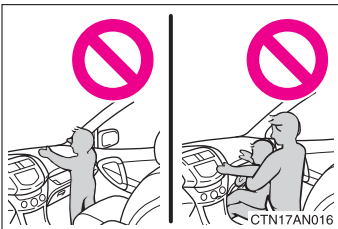
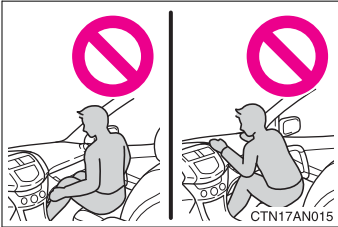

- Ne vous asseyez pas sur le bord du siège et ne vous appuyez pas contre la planche de bord.
- Ne laissez pas un enfant rester debout devant le sac de sécurité gonflable SRS passager avant ou bien s'asseoir sur les genoux du passager avant.
- Ne conduisez pas le véhicule avec quelque chose sur les genoux, et n'autorisez pas non plus le passager à voyager avec quelque chose sur les genoux.
- Ne vous appuyez pas contre la porte, contre le rail latéral de toit ou contre les montants avant, latéraux et arrière.
- Ne laissez personne s'agenouiller sur le siège passager et se pencher vers la porte ou bien mettre sa tête ou ses mains à l'extérieur du véhicule.



## ATTENTION

### ■ Précautions à observer avec les sacs de sécurité gonflables SRS

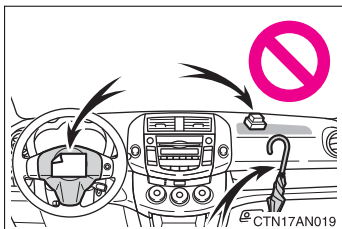

- Ne fixez ni ne posez aucun objet sur la planche de bord ou la garniture centrale du volant de direction.

Au déploiement des sacs de sécurité gonflables SRS conducteur et passager avant, tout objet risque de se transformer en projectile.

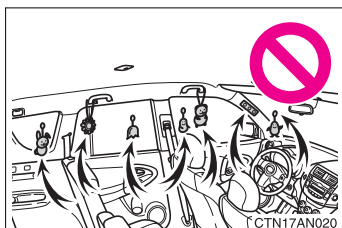

- Ne fixez aucun objet sur les portes, la vitre de pare-brise, les vitres latérales, les montants avant et arrière ou la garniture de rail latéral de toit.

- Ne suspendez aux crochets à vêtements aucun cintre nu ni aucun objet dur. En cas de déploiement du sac de sécurité gonflable SRS rideau, ces objets peuvent se transformer en projectiles capables de vous blesser grièvement, voire de vous tuer.

- N'utilisez aucun accessoire de siège venant recouvrir les zones de déploiement des sacs de sécurité gonflables SRS latéraux, car il risquerait d'en gêner le déploiement.

- Évitez de faire subir des chocs ou des pressions excessives aux zones renfermant les composants des sacs de sécurité gonflables SRS (→P. 511).

En effet, cela pourrait entraîner un fonctionnement anormal des sacs de sécurité gonflables SRS.



## ATTENTION

### ■ Précautions à observer avec les sacs de sécurité gonflables SRS

- Ne touchez aucun composant du système immédiatement après le déclenchement (déploiement) des sacs de sécurité gonflables SRS, car ils sont alors encore très chauds.
- Si vous avez des difficultés à respirer après le déploiement d'un sac de sécurité gonflable SRS, ouvrez une porte ou une vitre pour faire entrer de l'air frais, ou bien descendez du véhicule si cela ne présente pas de danger. Essayez tout résidu dès que possible afin d'éviter d'éventuelles irritations de la peau.
- Si les parties renfermant les sacs de sécurité gonflables SRS, telles que la garniture du moyeu de volant et les garnitures de montants avant et arrière, apparaissent abîmées ou craquelées, faites-les remplacer par votre concessionnaire Toyota.

## ATTENTION

### ■ **Modification et mise au rebut des éléments du système de sacs de sécurité gonflables SRS**

Consultez impérativement votre concessionnaire Toyota si vous avez besoin d'intervenir sur votre véhicule ou de procéder à l'une des modifications suivantes.

Les sacs de sécurité gonflables SRS risquent de ne pas fonctionner correctement ou de se déployer (gonfler) accidentellement, provoquant ainsi des blessures graves, voire mortelles.

- Installation, dépose, démontage et réparations des sacs de sécurité gonflables SRS.
- Réparations, modifications, dépose ou remplacement du volant, du combiné d'instruments, de la planche de bord, des sièges ou de leur garnissage, des montants avant, latéraux et arrière ou des rails latéraux de toit.
- Réparations ou modifications de l'aile avant, du bouclier avant, ou du côté de l'habitacle.
- Installation de chasse-neige, de treuils, etc. sur la calandre (pare-buffle, pare-kangourou, etc.).
- Modifications des suspensions du véhicule.
- Installation d'appareils électroniques tels que radio émetteur/récepteur ou lecteurs CD.
- Aménagements apportés au véhicule pour une personne atteinte d'un handicap physique.

<b>A</b>	<b>A/C</b> .....	<b>226, 232</b>	<b>Antenna</b> .....	<b>249</b>
	<b>ABS</b> .....	<b>184</b>	<b>Anti-lock brake system</b> .....	<b>184</b>
	<b>Active head restraints</b> .....	<b>53</b>	<b>Armrest</b> .....	<b>329</b>
	<b>Air conditioning filter</b> .....	<b>386</b>	<b>Audio input</b> .....	<b>269</b>
	<b>Air conditioning system</b>		<b>Audio system</b>	
	Air conditioning filter.....	386	Antenna.....	249
	Automatic air		Audio input .....	269
	conditioning system .....	232	AUX port .....	269
	Manual air conditioning		CD player/changer .....	252
	system .....	226	MP3/WMA disc .....	259
	<b>Airbags</b>		Optimal use.....	266
	Airbag operating		Portable music player .....	269
	conditions.....	101	Radio.....	246
	Airbag precautions for your		Steering wheel audio	
	child .....	105	switch.....	270
	Airbag warning light.....	427	Type .....	243
	Curtain shield airbag		<b>Automatic air</b>	
	operating conditions.....	101	<b>conditioning system</b> .....	<b>232</b>
	Curtain shield airbag		<b>Automatic light control</b>	
	precautions .....	105	<b>system</b> .....	<b>165</b>
	Front passenger occupant		<b>Automatic transmission</b> .....	<b>150</b>
	classification system .....	110	<b>AUX port</b> .....	<b>269</b>
	General airbag		<b>Auxiliary box</b> .....	<b>318</b>
	precautions .....	105		
	Locations of airbags.....	98		
	Modification and disposal of			
	airbags.....	109		
	Proper driving			
	posture.....	96, 105		
	Side airbag operating			
	conditions.....	101		
	Side airbag precautions .....	105		
	SRS airbags .....	98		

<b>B</b>	<b>Back-up lights</b>	
	Replacing light bulbs .....	404
	Wattage .....	485
	<b>Back door</b>	
	Back door .....	46
	Wireless remote control.....	38
	Smart key system.....	26
	<b>Battery</b>	
	Checking .....	369
	If the vehicle has a	
	discharged battery .....	463
	Preparing and checking	
	before winter .....	210
	<b>Bluetooth®</b> .....	<b>277</b>
	<b>Bottle holder</b> .....	<b>316</b>
	<b>Brakes</b>	
	Fluid.....	367
	Parking brake .....	154

<b>C</b>	<b>Care</b>	
	Exterior.....	338
	Interior .....	341
	Seat belts .....	342
	<b>Cargo capacity</b> .....	<b>208</b>
	<b>Cargo hooks</b> .....	<b>332</b>
	<b>CD changer</b> .....	<b>252</b>
	<b>CD player</b> .....	<b>252</b>
	<b>Chains</b> .....	<b>210</b>
	<b>Child restraint system</b>	
	Booster seats, definition.....	116
	Booster seats, installation .....	120
	Convertible seats,	
	definition .....	116
	Convertible seats,	
	installation.....	120
	Front passenger occupant	
	classification system.....	110
	Infant seats, definition .....	116
	Infant seats, installation.....	120
	Installing CRS with	
	LATCH anchors .....	122
	Installing CRS with seat	
	belts .....	124
	Installing CRS with a top	
	tether strap.....	127

**Child safety**

Airbag precautions ..... 105  
 Battery precautions ..... 370, 465  
 Child restraint system..... 116  
 Child-protectors..... 44  
 How your child should wear  
   the seat belt ..... 72  
 Installing child restraints..... 120  
 Moon roof precautions ..... 87  
 Power window lock switch..... 81  
 Power window precautions ..... 83  
 Removed key battery  
   precautions ..... 390  
 Seat belt extender  
   precautions ..... 75  
 Seat belt precautions ..... 73  
 Seat heater precautions ..... 327

**Child-protectors ..... 44**

**Cleaning**

Exterior ..... 338  
 Interior ..... 341  
 Seat belts ..... 342

**Clock ..... 321**

**Condenser ..... 366**

**Console box ..... 313**

**Cooling system**

Engine overheating ..... 466

**Cruise control..... 172**

**Cup holders ..... 315**

**Curtain shield airbags ..... 98**

**Customizable features..... 500**

**D**

**Daytime running light**

**system ..... 166**

**Defogger**

Rear window ..... 240  
 Side mirrors..... 240

**Dimensions ..... 474**

**Dinghy towing ..... 224**

**Display**

Trip information ..... 162

**Do-it-yourself maintenance .... 350**

**Door courtesy lights**

Door courtesies lights ..... 307  
 Wattage..... 485

**Doors**

Door glasses ..... 81  
 Door lock..... 26, 38, 42  
 Side mirrors..... 79

**Downhill assist control**

**system ..... 193**

**Driver's seat belt reminder**

**light..... 429**

**Driving**

Break-in tips ..... 135  
 Correct posture ..... 96  
 Procedures..... 134  
 Winter driving tips ..... 210

<b>E</b>	<b>Electric power steering.....</b>	<b>184</b>
	<b>Electronic key</b>	
	If your electronic key battery is discharged.....	461
	<b>Emergency flasher</b>	
	Switch.....	414
	<b>Emergency, in case of</b>	
	If a warning buzzer sounds.....	426
	If a warning light turns on.....	426
	If the electronic key does not operate properly.....	461
	If the engine will not start.....	458
	If the shift lever cannot be shifted.....	459
	If the vehicle has a discharged battery.....	463
	If you have a flat tire.....	438
	If you lose your keys.....	460
	If you think something is wrong.....	422
	If your vehicle becomes stuck.....	468
	If your vehicle has to be stopped in an emergency.....	470
	If your vehicle needs to be towed.....	415
	If your vehicle overheats.....	466

<b>Engine</b>	
Compartment.....	358
Engine switch.....	143, 147
Hood.....	354
How to start the engine.....	143, 147
Identification number.....	476
If the engine will not start.....	458
Ignition switch.....	143, 147
Overheating.....	466
<b>Engine compartment cover.....</b>	<b>360</b>
<b>Engine coolant</b>	
Capacity.....	480
Checking.....	365
Preparing and checking before winter.....	210
<b>Engine coolant temperature     gauge.....</b>	<b>156</b>
<b>Engine immobilizer system.....</b>	<b>92</b>
<b>Engine oil</b>	
Capacity.....	478
Checking.....	361
Preparing and checking before winter.....	210
<b>Engine oil maintenance     data.....</b>	<b>363</b>
<b>Enhanced vehicle stability     control.....</b>	<b>185</b>
<b>Enhanced VSC.....</b>	<b>185</b>
<b>EPS.....</b>	<b>184</b>
<b>Event data recorder.....</b>	<b>424</b>

<b>F</b>	<b>Floor mat</b> .....	<b>331</b>
	<b>Fluid</b>	
	Brake.....	367
	Washer.....	372
	<b>Fog lights</b>	
	Replacing light bulbs.....	404
	Switch.....	168
	Wattage.....	485
	<b>Front fog lights</b>	
	Replacing light bulbs.....	404
	Switch.....	168
	Wattage.....	485
	<b>Front passenger occupant classification system</b> .....	<b>110</b>
	<b>Front passenger's seat belt reminder light</b> .....	<b>429</b>
	<b>Front seats</b>	
	Adjustment.....	49
	<b>Front side marker lights</b>	
	Replacing light bulbs.....	404
	Switch.....	165
	Wattage.....	485
	<b>Front turn signal lights</b>	
	Replacing light bulbs.....	404
	Wattage.....	485
	<b>Fuel</b>	
	Capacity.....	478
	Fuel gauge.....	156
	Fuel pump shut off system.....	423
	Gas station information.....	536
	Information.....	486
	Refueling.....	88
	Type.....	478
	<b>Fuel door</b> .....	<b>88</b>
	<b>Fuel filler door</b> .....	<b>88</b>
	<b>Fuel pump shut off system</b> .....	<b>423</b>
	<b>Fuses</b> .....	<b>392</b>

<b>G</b>	<b>Gas station information</b> .....	<b>536</b>
	<b>Gauges</b> .....	<b>156</b>
	<b>Glove box</b> .....	<b>312</b>
	<b>Grocery bag hooks</b> .....	<b>332</b>
<b>H</b>	<b>Hands-free system (for cellular phone)</b> .....	<b>273</b>
	<b>Hazard lights</b>	
	Switch.....	414
	<b>Head restraints</b>	
	Adjusting.....	65
	<b>Headlights</b>	
	Replacing light bulbs.....	404
	Switch.....	165
	Wattage.....	485
	<b>Heaters</b>	
	Seat heaters.....	327
	Side mirrors.....	240
	<b>Hood</b> .....	<b>354</b>
	<b>Hooks</b>	
	Cargo hook.....	332
	Grocery bag.....	332
	<b>Horn</b> .....	<b>155</b>



<b>I</b>	<b>I/M test</b> .....	<b>349</b>
	<b>Identification</b>	
	Engine .....	476
	Vehicle.....	476
	<b>Ignition switch</b> .....	<b>144, 147</b>
	<b>Illuminated entry system</b> .....	<b>307</b>
	<b>Indicator lights</b> .....	<b>159</b>
	<b>Initialization</b>	
	Items to initialize.....	503
	<b>Inside rear view mirror</b> .....	<b>77</b>
	<b>Interior lights</b>	
	Interior lights.....	307
	Switch.....	309, 308
	Wattage.....	485
<b>J</b>	<b>Jack</b>	
	Positioning a floor jack .....	356
	Vehicle-equipped jack .....	438
	<b>Jack handle</b> .....	<b>438</b>
<b>K</b>	<b>Keyless entry</b> .....	<b>38</b>
	<b>Keys</b>	
	Electronic key .....	24
	Engine switch .....	144, 147
	If the electronic key does not operate properly.....	461
	If you lose your keys/ wireless remote control transmitter.....	460
	Ignition switch.....	144, 147
	Key number .....	24
	Keyless entry.....	38
	Keys .....	24
	Mechanical key.....	24
	Wireless remote control key .....	38

<b>L</b>	<b>License plate lights</b>	
	Replacing light bulbs .....	404
	Wattage.....	485
	<b>Light bulbs</b>	
	Replacing .....	404
	Wattage.....	485
	<b>Lights</b>	
	Door courtesy lights .....	307
	Emergency flasher switch .....	414
	Fog light switch .....	168
	Hazard light switch .....	414
	Headlight switch .....	165
	Interior light switch .....	308, 309
	Luggage compartment light .....	309
	Personal light switch .....	308
	Replacing light bulbs .....	404
	Turn signal lever.....	153
	Vanity lights.....	320
	Wattage.....	485
	<b>Load capacity</b> .....	<b>208</b>
	<b>Lock steering column</b> .....	<b>145, 148</b>
	<b>Luggage cover</b> .....	<b>334</b>

<b>M</b>	<b>Maintenance</b>	
	Do-it-yourself	
	maintenance .....	350
	General maintenance.....	346
	Maintenance data.....	474
	Maintenance requirements....	344
	<b>Manual air conditioning</b>	
	<b>system</b> .....	226
	<b>Meter</b>	
	Instrument panel light	
	control.....	157
	Meters .....	156
	<b>Micro dust and pollen filter</b> ....	236
	<b>Mirrors</b>	
	Inside rear view mirror.....	77
	Side mirror heaters.....	240
	Side mirrors.....	79
	Vanity mirrors .....	320
	<b>Moon roof</b> .....	84
	<b>MP3 disc</b> .....	259
<b>N</b>	<b>Noise from under vehicle</b> .....	18

<b>O</b>	<b>Odometer</b> .....	156
	<b>Oil</b>	
	Engine oil .....	361
	<b>Opener</b>	
	Hood .....	354
	<b>Outside rear view mirrors</b>	
	Adjusting and folding.....	79
	<b>Outside temperature</b>	
	<b>display</b> .....	163
	<b>Overhead console</b> .....	314
	<b>Overheating, Engine</b> .....	466
<b>P</b>	<b>Parking brake</b> .....	154
	<b>Parking lights</b>	
	Replacing light bulbs.....	404
	Switch .....	165
	Wattage.....	485
	<b>Personal/interior lights</b>	
	Switch .....	308
	Wattage.....	485
	<b>Power outlet</b> .....	322
	<b>Power windows</b> .....	81

<b>R</b>	<b>Radiator</b> .....	<b>366</b>
	<b>Radio</b> .....	<b>246</b>
	<b>Rear seat</b>	
	Adjustment .....	54
	Folding down second seatback.....	57
	Folding down third seatback.....	59
	<b>Rear turn signal lights</b>	
	Replacing light bulbs .....	404
	Wattage .....	485
	<b>Rear view monitor system</b> .....	<b>176</b>
	<b>Rear window defogger</b> .....	<b>240</b>
	<b>Rear window wiper</b> .....	<b>171</b>
	<b>Replacing</b>	
	Fuses.....	392
	Key battery .....	388
	Light bulbs .....	404
	Tires .....	438
	<b>Reporting safety defects for U.S. owners</b> .....	<b>506</b>

<b>S</b>	<b>Seat belts</b>	
	Adjusting the seat belt.....	68
	Automatic Locking Retractor .....	71
	Child restraint system installation.....	120
	Cleaning and maintaining the seat belts .....	342
	Emergency Locking Retractor .....	71
	How to wear your seat belt.....	68
	How your child should wear the seat belt .....	72
	Pregnant women, proper seat belt use .....	71
	Reminder light .....	429
	Seat belt extenders .....	73
	Seat belt pretensioners .....	70
	<b>Seat heaters</b> .....	<b>327</b>
	<b>Seating capacity</b> .....	<b>208</b>
	<b>Seats</b>	
	Adjustment .....	49, 54
	Adjustment precaution .....	53, 62
	Child seats/child restraint system installation .....	120
	Cleaning.....	341
	Head restraints.....	65
	Properly sitting in the seat.....	96
	Seat heaters.....	327

<b>Service reminder</b>	
<b>indicators</b> .....	159
<b>Shift lever</b>	
Automatic transmission .....	150
If the shift lever cannot be shifted from P .....	459
<b>Shift lock system</b> .....	459
<b>Side airbags</b> .....	98
<b>Side marker lights</b>	
Replacing light bulbs .....	404
Switch .....	165
Wattage .....	485
<b>Side mirrors</b>	
Adjusting and folding .....	79
<b>Smart key system</b>	
Entry function .....	26
Starting the engine .....	143
<b>Spare tire</b>	
Inflation pressure .....	484
Storage location .....	438
<b>Spark plug</b> .....	481
<b>Specifications</b> .....	474
<b>Speech command switch</b> .....	278
<b>Speedometer</b> .....	156
<b>Steering</b>	
Column lock release .....	145, 148
<b>Steering wheel</b>	
Adjustment .....	76
Audio switches .....	270
<b>Stop lights</b>	
Replacing light bulbs .....	404
Wattage .....	485
<b>Storage feature</b> .....	311
<b>Storage precautions</b> .....	205
<b>Stuck</b>	
If your vehicle becomes stuck .....	468
<b>Sun visors</b> .....	319
<b>Switch</b>	
Emergency flasher switch .....	414
Engine switch .....	144, 147
Fog light switch .....	168
Hazard light switch .....	414
Ignition switch .....	144, 147
Light switches .....	165
Power door lock switch .....	43
Power window switches .....	81
Window lock switch .....	81
Wiper and washer switch .....	169, 171

<b>T</b>	<b>Tachometer</b> .....	<b>156</b>
	<b>Tail lights</b>	
	Replacing light bulbs .....	404
	Switch.....	165
	Wattage.....	485
	<b>Talk switch</b> .....	<b>278</b>
	<b>Telephone switch</b> .....	<b>278</b>
	<b>Theft deterrent system</b>	
	Engine immobilizer system.....	92
	<b>Theft prevention labels</b> .....	<b>95</b>
	<b>Tire inflation pressure</b> .....	<b>380</b>
	<b>Tire information</b>	
	Glossary .....	494
	Size .....	491
	Tire identification number .....	490
	Uniform tire quality grading.....	492
	<b>Tires</b>	
	Chains .....	210
	Checking .....	373
	If you have a flat tire.....	438
	Inflation pressure.....	380
	Information .....	489
	Replacing .....	438
	Rotating tires .....	373
	Size .....	484
	Snow tires.....	210
	Tire pressure warning system.....	373, 429

<b>Tools</b> .....	<b>438</b>
<b>Total load capacity</b> .....	<b>208</b>
<b>Towing</b>	
Dinghy towing.....	224
Emergency towing.....	416
Trailer towing.....	214
<b>Traction control</b> .....	<b>184</b>
<b>TRAC</b> .....	<b>184</b>
<b>Trip information</b> .....	<b>162</b>
<b>Trip meter</b> .....	<b>156</b>
<b>Turn signal lights</b>	
Replacing light bulbs .....	404
Switch.....	153
Wattage.....	485

**U** **Utility vehicle precautions** ..... **197**

**V** **Valet key** .....

<b>Valet key</b> .....	<b>24</b>
<b>Vanity lights</b>	
Vanity lights.....	320
Wattage.....	485
<b>Vanity mirrors</b> .....	<b>320</b>
<b>Vehicle identification</b>	
<b>number</b> .....	<b>476</b>
<b>Vehicle Stability Control</b> .....	<b>184</b>
<b>VSC</b> .....	<b>184</b>

**W**

**Warning buzzers**

- Brake system .....426
- Seat belt reminder.....429

**Warning lights**

- Active Torque Control
  - 4WD system .....427, 429
- Anti-lock brake system.....427
- Automatic transmission
  - fluid temperature.....429
- Brake assist system .....427
- Brake system .....426
- Charging system .....427
- Cruise control indicator
  - light .....427
- Electric power steering.....427
- Engine oil pressure .....427
- Engine oil replacement
  - reminder light .....429
- Low fuel level .....429
- Low washer fluid .....429
- Malfunction indicator lamp ....427
- Open door .....429
- Pretensioners .....427
- Seat belt reminder light .....429
- Slip indicator light .....427
- Smart key system.....431
- SRS airbags .....427
- Tire pressure warning light....429

**Washer**

- Checking .....372
- Preparing and checking
  - before winter .....210
- Switch .....169, 171

**Washing and waxing .....338**

**Weight**

- Cargo capacity .....202
- Load limits .....208
- Weight.....474

**Wheels .....384**

**Window glasses .....81**

**Window lock switch.....81**

**Windows**

- Power windows .....81
- Rear window defogger .....240
- Washer.....169, 171

**Windshield wiper de-icer .....242**

**Windshield wipers .....169**

**Wireless remote control key**

- Replacing the battery .....388
- Wireless remote control key....38

**WMA disc.....259**

What to do if...

What to do if...

A tire punctures	P. 438	If you have a flat tire
The engine does not start	P. 458	If the engine will not start
	P. 92	Engine immobilizer system
	P. 463	If the battery is discharged
The shift lever cannot be moved out	P. 459	If the shift lever cannot be shifted from P
The engine coolant temperature gauge enters the red zone	P. 466	If your vehicle overheats
The key is lost	P. 460	If you lose your keys
The battery runs out	P. 463	If the battery is discharged
The doors cannot be locked	P. 42	Side doors
	P. 46	Back door
The vehicle is stuck in mud or sand	P. 468	If the vehicle becomes stuck
A warning light or indicator light comes on	P. 426	If a warning light turns on or a warning buzzer sounds...

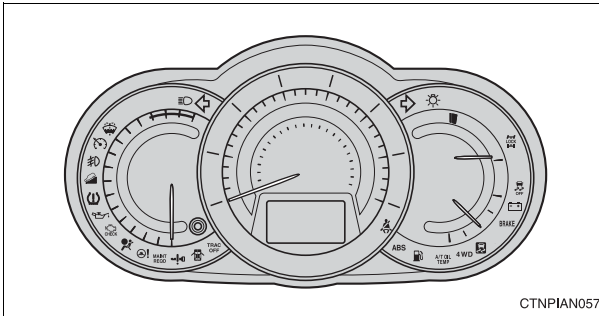

### ■ Warning lights



Brake system warning light

or



P. 426



Charging system warning light P. 427



Low engine oil pressure warning light P. 427



or



P. 427



SRS warning light P. 427



Open door warning light P. 429



Electric power steering warning light P. 427



Active Torque Control 4WD system warning light P. 427



Low fuel level warning light P. 429



Driver's seat belt reminder light P. 429



Front passenger's seat belt reminder light P. 429



Engine oil replacement reminder light P. 429



Low washer fluid warning light P. 429



Automatic transmission fluid temperature warning light P. 429





 "ABS" warning light

or

 P. 427

 Tire pressure warning light P. 429

 Smart key system warning light P. 431

 Cruise control indicator light\* P. 427

 Slip indicator light P. 427

\*: The light flashes to indicate a malfunction.

## GAS STATION INFORMATION

**Auxiliary catch lever**

P. 354

**Fuel filler door**

P. 88

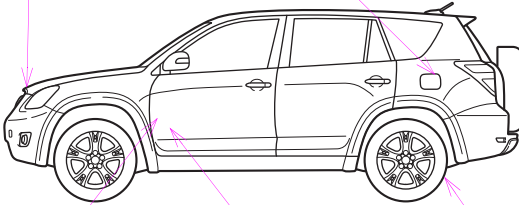

CTNPIAN033

**Hood release lever**

P. 354

**Fuel filler door opener**

P. 88

**Tire inflation pressure**

P. 484

Fuel tank capacity (Reference)	15.9 gal. (60 L, 13.2 Imp. gal.)
Fuel type	Unleaded gasoline with an Octane Rating of 87 (Research Octane Number 91)
Cold tire inflation pressure	P. 484
Engine oil capacity (Drain and refill — reference)	P. 478
Engine oil type	Toyota Genuine Motor Oil or equivalent Oil grade: P. 478 ILSAC multigrade engine oil Recommended oil viscosity: SAE 5W-20 or 0W-20 (2.5 L 4-cylinder [2AR-FE] engine) SAE 5W-30 (3.5 L V6 [2GR-FE] engine)