

| | | |
|----|------------------------------------|---|
| | Pictorial index | Search by illustration |
| 1 | For safety and security | Make sure to read through them |
| 2 | Instrument cluster | How to read the gauges and meters, the variety of warning lights and indicators, etc. |
| 3 | Operation of each component | Opening and closing the doors and windows, adjustment before driving, etc. |
| 4 | Driving | Operations and advices which are necessary for driving |
| 5 | Multimedia | Operating the multimedia system |
| 6 | Interior features | Usage of the interior features, etc. |
| 7 | Maintenance and care | Caring for your vehicle and maintenance procedures |
| 8 | When trouble arises | What to do in case of malfunction or emergency |
| 9 | Vehicle specifications | Vehicle specifications, customizable features, etc. |
| 10 | For owners | Reporting safety defects for U.S. owners, and seat belt and SRS airbag instructions for Canadian owners |
| | Index | Search by symptom |
| | | Search alphabetically |

| | |
|---------------------------|----|
| For your information..... | 8 |
| Reading this manual | 12 |
| How to search..... | 13 |
| Pictorial index | 14 |

1 For safety and security

| | |
|---|----|
| 1-1. For safe use | |
| Before driving | 28 |
| For safety drive | 30 |
| Seat belts | 32 |
| SRS airbags | 38 |
| Front passenger occupant classification system | 50 |
| Safety information for children | 55 |
| Child restraint systems..... | 56 |
| Installing child restraints..... | 60 |
| Exhaust gas precautions..... | 77 |
| 1-2. Theft deterrent system | |
| Engine immobilizer system..... | 78 |
| Alarm..... | 80 |

2 Instrument cluster

| | |
|---------------------------------------|----|
| 2. Instrument cluster | |
| Warning lights and indicators..... | 84 |
| Gauges and meters..... | 88 |
| Trip information display | 91 |
| Multi-information display | 93 |

3 Operation of each component

| | |
|--|-----|
| 3-1. Key information | |
| Keys..... | 100 |
| 3-2. Opening, closing and locking the doors | |
| Side doors | 102 |
| Tailgate..... | 108 |
| 3-3. Adjusting the seats | |
| Front seats..... | 113 |
| Rear seats (Double Cab and CrewMax models)..... | 116 |
| Driving position memory (driver's seat)..... | 118 |
| Head restraints | 122 |
| 3-4. Adjusting the steering wheel and mirrors | |
| Steering wheel..... | 126 |
| Inside rear view mirror | 129 |
| Outside rear view mirrors | 132 |
| 3-5. Opening, closing the windows and moon roof | |
| Power windows..... | 136 |
| Back window..... | 139 |
| Power back window..... | 140 |
| Moon roof | 142 |

4 Driving

4-1. Before driving

| | |
|---------------------------|-----|
| Driving the vehicle..... | 146 |
| Cargo and luggage..... | 153 |
| Vehicle load limits | 156 |
| Trailer towing..... | 158 |
| Dinghy towing..... | 178 |

4-2. Driving procedures

| | |
|--------------------------------|-----|
| Engine (ignition) switch | 179 |
| Automatic transmission | 181 |
| Turn signal lever..... | 186 |
| Parking brake | 187 |
| Horn | 188 |

4-3. Operating the lights and wipers

| | |
|------------------------------------|-----|
| Headlight switch | 189 |
| Fog light switch | 192 |
| Windshield wipers and washer | 193 |

4-4. Refueling

| | |
|---------------------------------|-----|
| Opening the fuel tank cap | 196 |
|---------------------------------|-----|

4-5. Using the driving support systems

| | |
|--------------------------------|-----|
| Cruise control | 200 |
| Intuitive parking assist..... | 203 |
| Rear view monitor system..... | 209 |
| BSM (Blind Spot Monitor) | 218 |
| Four-wheel drive system ... | 226 |
| AUTO LSD system..... | 229 |
| Driving assist systems..... | 231 |

4-6. Driving tips

| | |
|----------------------------|-----|
| Winter driving tips..... | 240 |
| Off-road precautions | 244 |

5 Multimedia

5-1. Basic Operations

| | |
|-----------------------------|-----|
| Multimedia system types ... | 250 |
| Entune Audio | 252 |
| USB Port/AUX Port..... | 255 |

5-2. Setup

| | |
|------------------------|-----|
| Setup menu | 256 |
| General settings | 257 |
| Audio settings | 259 |
| Display settings | 260 |
| Voice settings | 261 |

5-3. Using the audio system

| | |
|---------------------------------|-----|
| Basic audio operations | 262 |
| Selecting the audio source..... | 263 |
| List screen operation | 264 |
| Sound settings..... | 266 |

5-4. Using the radio

| | |
|-----------------------|-----|
| Radio operation | 267 |
|-----------------------|-----|

5-5. Playing an audio CD and MP3/WMA/AAC discs

| | |
|--------------------------|-----|
| CD player operation..... | 269 |
|--------------------------|-----|

5-6. Using an external device

| | |
|--|-----|
| Listening to an iPod..... | 274 |
| Listening to a USB memory device | 278 |
| Using the AUX port..... | 282 |

| | |
|--|-----|
| 5-7. Connecting Bluetooth® | |
| Preparations to use wireless communication..... | 283 |
| Registering a Bluetooth® audio player for the first time | 287 |
| Registering a Bluetooth® phone for the first time ... | 288 |
| Registering a Bluetooth® device..... | 289 |
| Connecting a Bluetooth® device..... | 291 |
| Displaying a Bluetooth® device details | 293 |
| Detailed Bluetooth® system settings | 294 |
| 5-8. Bluetooth® audio | |
| Listening to Bluetooth® audio | 295 |
| 5-9. Bluetooth® phone | |
| Using a Bluetooth® phone | 296 |
| Making a call | 298 |
| Receiving a call | 301 |
| Speaking on the phone | 302 |
| Bluetooth® phone message function..... | 305 |
| Using the steering wheel switches..... | 309 |
| Bluetooth® phone settings..... | 310 |
| Contact/Call History Settings | 312 |
| What to do if... (Troubleshooting)..... | 321 |
| 5-10. Using the voice command system | |
| Voice command system.... | 325 |

| | |
|-------------------------|-----|
| 5-11. Bluetooth® | |
| Bluetooth® | 327 |
| 5-12. Antenna | |
| Antenna | 332 |

6 Interior features

| | |
|---|-----|
| 6-1. Using the air conditioning system | |
| Manual air conditioning system | 336 |
| Automatic air conditioning system | 343 |
| Seat heaters/ seat ventilators | 350 |
| 6-2. Using the interior lights | |
| Interior lights list..... | 353 |
| • Personal/interior lights main switch | 354 |
| • Personal/interior lights | 354 |
| • Cargo lamp main switch | 355 |
| 6-3. Using the storage features | |
| List of storage features | 356 |
| • Glove box | 358 |
| • Console box (front separated type seat) | 359 |
| • Card holder | 360 |
| • Map holder (front bench type seat)..... | 362 |
| • Pen holder | 363 |
| • Tissue pocket | 364 |
| • Overhead console | 365 |
| • Cup holders | 366 |
| • Bottle holders | 368 |
| • Auxiliary boxes (front bench type seat)..... | 369 |
| • Storage box..... | 371 |
| Luggage compartment features | 373 |

6-4. Other interior features

| | |
|-------------------------------------|-----|
| Other interior features | 374 |
| • Sun visors | 374 |
| • Vanity mirrors | 374 |
| • Clock | 375 |
| • Outside temperature display | 376 |
| • Power outlets | 377 |
| • Armrest | 379 |
| • Assist grips | 380 |
| Garage door opener | 381 |
| Compass | 387 |

7 Maintenance and care

7-1. Maintenance and care

| | |
|--|-----|
| Cleaning and protecting the vehicle exterior | 392 |
| Cleaning and protecting the vehicle interior | 394 |

7-2. Maintenance

| | |
|--|-----|
| Maintenance requirements | 397 |
| General maintenance | 399 |
| Emission inspection and maintenance (I/M) programs | 402 |

7-3. Do-it-yourself maintenance

| | |
|--|-----|
| Do-it-yourself service precautions | 403 |
| Hood | 405 |
| Engine compartment | 406 |
| Tires | 417 |
| Tire inflation pressure | 425 |
| Wheels | 428 |
| Air conditioning filter | 431 |
| Wireless remote control battery | 434 |
| Checking and replacing fuses | 436 |
| Light bulbs | 439 |

8 When trouble arises

8-1. Essential information

| | |
|---|-----|
| Emergency flashers | 456 |
| If your vehicle has to be stopped in an emergency | 457 |

8-2. Steps to take in an emergency

| | |
|---|-----|
| If your vehicle needs to be towed | 458 |
| If you think something is wrong | 462 |
| Fuel pump shut off system | 463 |
| If a warning light turns on or a warning buzzer sounds | 464 |
| If a warning message is displayed (vehicles with multi-information display) | 472 |
| If you have a flat tire | 475 |
| If the engine will not start | 490 |
| If the shift lever cannot be shifted from P | 491 |
| If the vehicle battery is discharged | 493 |
| If your vehicle overheats | 496 |
| If the vehicle becomes stuck | 498 |

9 Vehicle specifications

9-1. Specifications

| | |
|---|-----|
| Maintenance data (fuel, oil level, etc.) | 500 |
| Fuel information | 516 |
| Tire information | 520 |

9-2. Customization

| | |
|-----------------------------|-----|
| Customizable features | 530 |
|-----------------------------|-----|

9-3. Items to initialize

| | |
|--------------------------|-----|
| Items to initialize..... | 535 |
|--------------------------|-----|

10 For owners

| | |
|---|-----|
| Reporting safety defects for U.S. owners..... | 538 |
| Seat belt instructions for Canadian owners (in French) | 539 |
| SRS airbag instructions for Canadian owners (in French) | 541 |
| Camper information | 550 |

Index

| | |
|---|-----|
| What to do if... (Troubleshooting) | 558 |
| Alphabetical index..... | 561 |

For vehicles with Entune Audio Plus or Entune Premium Audio, refer to the “NAVIGATION SYSTEM OWNER’S MANUAL” for information regarding the multimedia system.

Multimedia system types: →P. 250

1

2

3

4

5

6

7

8

9

10

For your information

Main Owner's Manual

Please note that this manual applies to all models and all equipment, including options. Therefore, you may find some explanations for equipment not installed on your vehicle.

All specifications provided in this manual are current at the time of printing. However, because of the Toyota policy of continual product improvement, we reserve the right to make changes at any time without notice.

Depending on specifications, the vehicle shown in the illustrations may differ from your vehicle in terms of equipment.

Noise from under vehicle after turning off the engine

Approximately five hours after the engine is turned off, you may hear sound coming from under the vehicle for several minutes. This is the sound of a fuel evaporation leakage check and, it does not indicate a malfunction.

Accessories, spare parts and modification of your Toyota

A wide variety of non-genuine spare parts and accessories for Toyota vehicles are currently available in the market. You should know that Toyota does not warrant these products and is not responsible for their performance, repair, or replacement, or for any damage they may cause to, or adverse effect they may have on, your Toyota vehicle.

This vehicle should not be modified with non-genuine Toyota products. Modification with non-genuine Toyota products could affect its performance, safety or durability, and may even violate governmental regulations. In addition, damage or performance problems resulting from the modification may not be covered under warranty.

Installation of a mobile two-way radio system

The installation of a mobile two-way radio system in your vehicle could affect electronic systems such as:

- Multiport fuel injection system/sequential multiport fuel injection system
- Cruise control system (if equipped)
- Anti-lock brake system
- SRS airbag system
- Seat belt pretensioner system

Be sure to check with your Toyota dealer for precautionary measures or special instructions regarding installation of a mobile two-way radio system.

Vehicle data recordings

Your Toyota is equipped with several sophisticated computers that will record certain data, such as:

- Engine speed
- Accelerator status
- Brake status
- Vehicle speed
- Shift position

The recorded data varies according to the vehicle grade level and options with which it is equipped. Furthermore, these computers do not record conversations, sounds or pictures.

● Data usage

Toyota may use the data recorded in these computers to diagnose malfunctions, conduct research and development, and improve quality.

Toyota will not disclose the recorded data to a third party except:

- With the consent of the vehicle owner or with the consent of the lessee if the vehicle is leased
- In response to an official request by the police, a court of law or a government agency
- For use by Toyota in a lawsuit
- For research purposes where the data is not tied to a specific vehicle or vehicle owner

Event data recorder

This vehicle is equipped with an event data recorder (EDR). The main purpose of an EDR is to record, in certain crash or near crash-like situations, such as an air bag deployment or hitting a road obstacle, data that will assist in understanding how a vehicle's systems performed. The EDR is designed to record data related to vehicle dynamics and safety systems for a short period of time, typically 30 seconds or less.

The EDR in this vehicle is designed to record such data as:

- How various systems in your vehicle were operating;
- Whether or not the driver and passenger safety belts were buckled/fastened;
- How far (if at all) the driver was depressing the accelerator and/or brake pedal; and,
- How fast the vehicle was traveling.

These data can help provide a better understanding of the circumstances in which crashes and injuries occur.

NOTE: EDR data are recorded by your vehicle only if a nontrivial crash situation occurs; no data are recorded by the EDR under normal driving conditions and no personal data (e.g., name, gender, age, and crash location) are recorded. However, other parties, such as law enforcement, could combine the EDR data with the type of personally identifying data routinely acquired during a crash investigation.

To read data recorded by an EDR, special equipment is required, and access to the vehicle or the EDR is needed. In addition to the vehicle manufacturer, other parties, such as law enforcement, that have the special equipment, can read the information if they have access to the vehicle or the EDR.

● Disclosure of the EDR data

Toyota will not disclose the data recorded in an EDR to a third party except when:

- An agreement from the vehicle's owner (or the lessee for a leased vehicle) is obtained
- In response to an official request by the police, a court of law or a government agency
- For use by Toyota in a lawsuit

However, if necessary, Toyota may:

- Use the data for research on vehicle safety performance
- Disclose the data to a third party for research purposes without disclosing information about the specific vehicle or vehicle owner

Scrapping of your Toyota

The SRS airbag and seat belt pretensioner devices in your Toyota contain explosive chemicals. If the vehicle is scrapped with the airbags and seat belt pretensioners left as they are, this may cause an accident such as fire. Be sure to have the systems of the SRS airbag and seat belt pretensioner removed and disposed of by a qualified service shop or by your Toyota dealer before you scrap your vehicle.

Perchlorate Material

Special handling may apply,
See www.dtsc.ca.gov/hazardouswaste/perchlorate.

Your vehicle has components that may contain perchlorate. These components may include airbag, seat belt pretensioners, and wireless remote control batteries.

CAUTION

■ General precautions while driving

Driving under the influence: Never drive your vehicle when under the influence of alcohol or drugs that have impaired your ability to operate your vehicle. Alcohol and certain drugs delay reaction time, impair judgment and reduce coordination, which could lead to an accident that could result in death or serious injury.

Defensive driving: Always drive defensively. Anticipate mistakes that other drivers or pedestrians might make and be ready to avoid accidents.

Driver distraction: Always give your full attention to driving. Anything that distracts the driver, such as adjusting controls, talking on a cellular phone or reading can result in a collision with resulting death or serious injury to you, your occupants or others.

■ General precaution regarding children's safety

Never leave children unattended in the vehicle, and never allow children to have or use the key.

Children may be able to start the vehicle or shift the vehicle into neutral. There is also a danger that children may injure themselves by playing with the windows, the moon roof, or other features of the vehicle. In addition, heat build-up or extremely cold temperatures inside the vehicle can be fatal to children.

Reading this manual



CAUTION:

Explains something that, if not obeyed, could cause death or serious injury to people.



NOTICE:

Explains something that, if not obeyed, could cause damage to or a malfunction in the vehicle or its equipment.



Indicates operating or working procedures. Follow the steps in numerical order.



Indicates the action (pushing, turning, etc.) used to operate switches and other devices.



Indicates the outcome of an operation (e.g. a lid opens).

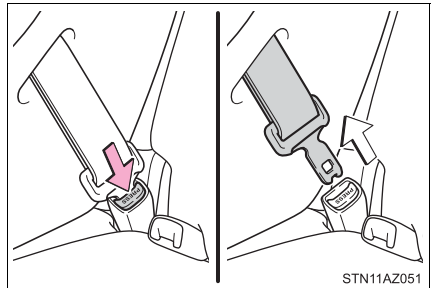

Indicates the component or position being explained.



Means “Do not”, “Do not do this”, or “Do not let this happen”.

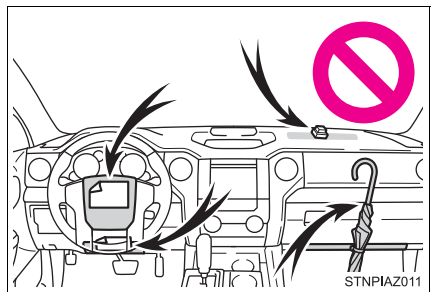

How to search

■ Searching by name

- Alphabetical indexP. 561

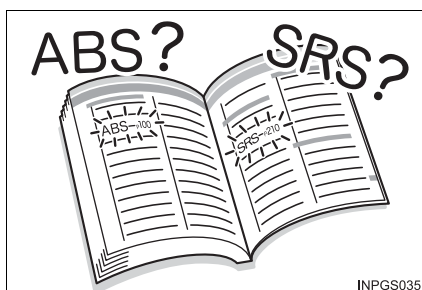

■ Searching by installation position

- Pictorial indexP. 14

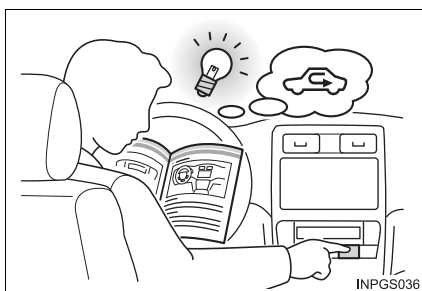

■ Searching by symptom or sound

- What to do if...
(Troubleshooting)P. 558



■ Searching by title

- Table of contentsP. 2

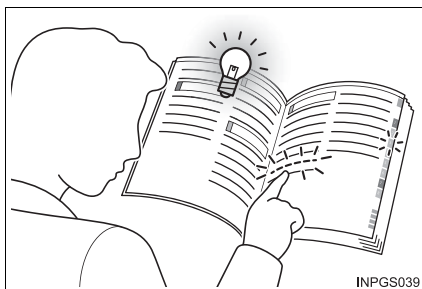

Pictorial index

Exterior

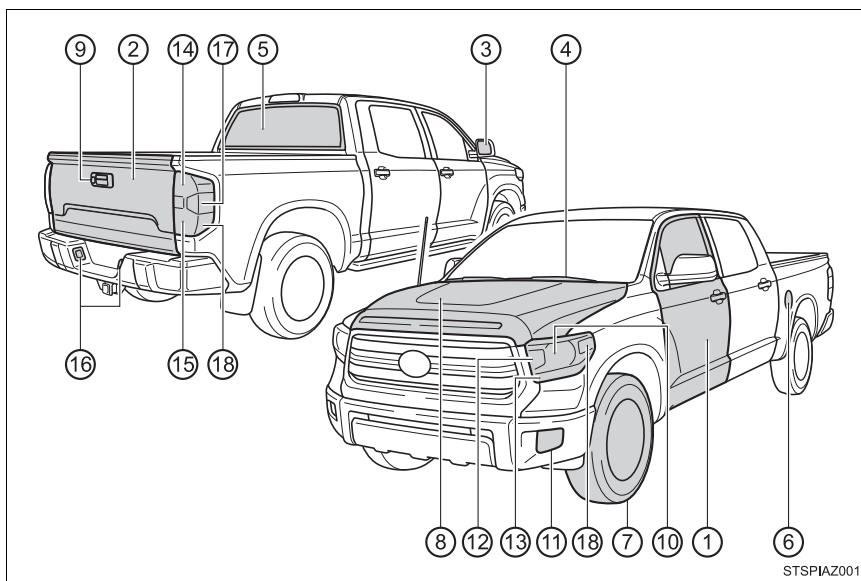

The illustration represents the CrewMax models and may differ from the body shape of other models.

- ① **Side doors** **P. 102**
 Locking/unlocking P. 102
 Opening/closing the door glasses P. 136
 Warning lights/warning messages*¹ P. 466, 473
- ② **Tailgate** **P. 108**
 Locking/unlocking P. 108
 Opening/closing the tailgate P. 108
 Removing the tailgate P. 109
- ③ **Outside rear view mirrors** **P. 132**
 Adjusting the mirror angle P. 132
 Folding the mirrors P. 133
 Driving position memory*² P. 118
 Defogging the mirrors*³ P. 338, 345
- ④ **Windshield wipers** **P. 193**
 Precautions against winter season P. 240
 To prevent freezing (windshield wiper de-icer)*³ P. 339, 346
- ⑤ **Back window** **P. 139, 140**

- ⑥ **Fuel filler door** **P. 196**
 Refueling method. P. 196
 Fuel type/fuel tank capacity P. 508
- ⑦ **Tires** **P. 417**
 Tire size/inflation pressure P. 513
 Winter tires/tire chain P. 240
 Checking/rotation/tire pressure warning system P. 417
 Coping with flat tires P. 475
- ⑧ **Hood** **P. 405**
 Opening P. 405
 Engine oil P. 508
 Coping with overheat P. 496
- ⑨ **Camera** **P. 209**

Light bulbs of the exterior lights for driving

(Replacing method: P. 439, Watts: P. 515)

- ⑩ **Headlights** **P. 189**
- ⑪ **Fog lights**^{*3} **P. 192**
- ⑫ **Front turn signal lights** **P. 186**
 Parking lights (bulb type)^{*3}/
 daytime running lights (bulb type)^{*3} **P. 189**
- ⑬ **Parking lights (LED type)^{*3}/**
 daytime running lights (LED type)^{*3} **P. 189**
- ⑭ **Rear turn signal lights** **P. 186**
- ⑮ **Tail lights** **P. 189**
- ⑯ **License plate lights** **P. 189**
- ⑰ **Back-up lights**
 Shifting the shift lever to R. P. 181
- ⑱ **Side marker lights** **P. 189**

*1: Vehicles with multi-information display

*2: If equipped on CrewMax models

*3: If equipped

Instrument panel

► Front separated type seats

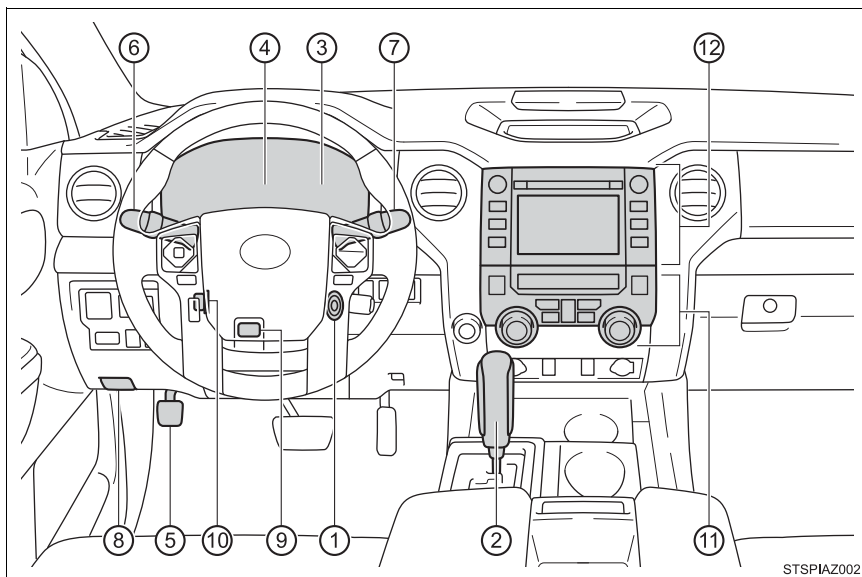

STSPIAZ002

- | | | |
|---|--|---------------|
| ① | Engine switch | P. 179 |
| | Starting the engine/changing the positions | P. 179 |
| | Emergency stop of the engine | P. 457 |
| | When the engine will not start | P. 490 |
| ② | Shift lever | P. 181 |
| | Changing the shift position. | P. 181 |
| | Precautions against towing | P. 458 |
| | When the shift lever does not move. | P. 491 |
| ③ | Meters | P. 88 |
| | Reading the meters/adjusting the instrument panel light. | P. 88 |
| | Warning lights/indicator lights | P. 84 |
| | When the warning lights come on | P. 464 |
| ④ | Multi-information display | P. 93 |
| | Display | P. 93 |
| | When the warning messages are displayed | P. 472 |
| ⑤ | Parking brake pedal | P. 187 |
| | Applying/releasing | P. 187 |
| | Precautions against winter season | P. 241 |
| | Warning buzzer/message*2 | P. 464, 473 |

- ⑥ **Turn signal lever** **P. 186**
 - Headlight switch. P. 189
 - Headlights/parking lights/tail lights/
daytime running lights^{*1} P. 189
 - Fog lights^{*1} P. 192
- ⑦ **Windshield wiper and washer switch** **P. 193**
 - Usage P. 193
 - Adding washer fluid P. 416
 - Warning messages^{*2} P. 473
- ⑧ **Hood lock release lever** **P. 405**
- ⑨ **Tilt and telescopic steering lock release lever^{*3}** **P. 126**
- ⑩ **Tilt and telescopic steering control switch^{*4}** **P. 127**
 - Adjustment P. 127
 - Driving position memory P. 118
- ⑪ **Manual air conditioning system^{*1}** **P. 336**
Automatic air conditioning system^{*1} **P. 343**
 - Usage P. 336, 343
 - Back window defogger^{*5} P. 338, 345
 - Windshield wiper de-icer^{*1} P. 339, 346
- ⑫ **Multimedia system** **P. 250**

*1: If equipped

*2: Vehicles with multi-information display

*3: Vehicles without driving position memory

*4: Vehicles with driving position memory

*5: For CrewMax models

► Front bench type seat

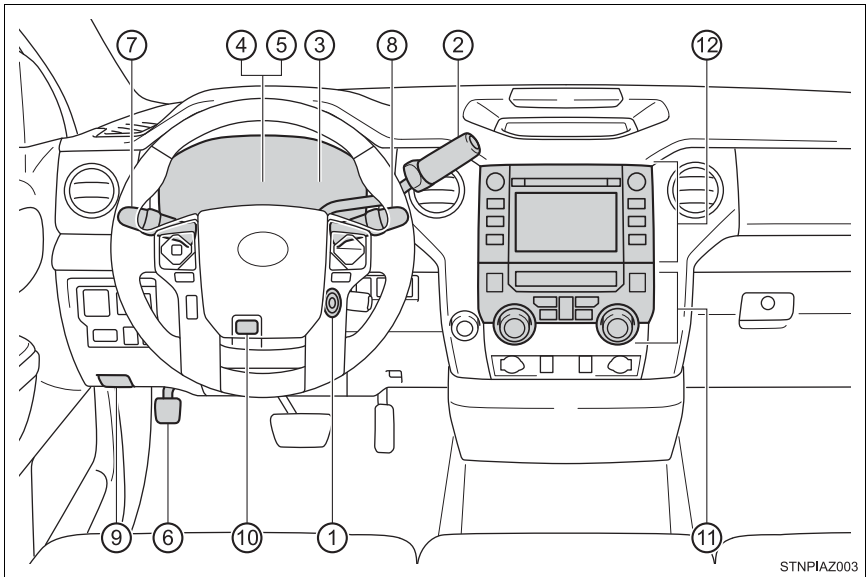

STNPIAZ003

- | | | |
|---|--|---------------|
| ① | Engine switch | P. 179 |
| | Starting the engine/changing the positions | P. 179 |
| | Emergency stop of the engine | P. 457 |
| | When the engine will not start | P. 490 |
| ② | Shift lever | P. 181 |
| | Changing the shift position. | P. 181 |
| | Precautions against towing | P. 458 |
| | When the shift lever does not move. | P. 491 |
| ③ | Meters | P. 88 |
| | Reading the meters/adjusting the instrument panel light. | P. 88 |
| | Warning lights/indicator lights | P. 84 |
| | When the warning lights come on | P. 464 |
| ④ | Trip information display*1 | P. 91 |
| | Display | P. 91 |
| ⑤ | Multi-information display*1 | P. 93 |
| | Display | P. 93 |
| | When the warning messages are displayed | P. 472 |

- ⑥ **Parking brake pedal** P. 187
 - Applying/releasing P. 187
 - Precautions against winter season P. 241
 - Warning buzzer/message^{*2} P. 464, 473
- ⑦ **Turn signal lever** P. 186
 - Headlight switch P. 189
 - Headlights/parking lights/tail lights/
daytime running lights^{*1} P. 189
 - Fog lights^{*1} P. 192
- ⑧ **Windshield wiper and washer switch** P. 193
 - Usage P. 193
 - Adding washer fluid P. 416
 - Warning lights/warning messages^{*2} P. 467, 473
- ⑨ **Hood lock release lever** P. 405
- ⑩ **Tilt steering lock release lever** P. 126
- ⑪ **Manual air conditioning system^{*1}** P. 336
 - Automatic air conditioning system^{*1}** P. 343
 - Usage P. 336, 343
 - Back window defogger^{*3} P. 338, 345
 - Windshield wiper de-icer^{*1} P. 339, 346
- ⑫ **Multimedia system** P. 250

^{*1}: If equipped

^{*2}: Vehicles with multi-information display

^{*3}: For CrewMax models

Switches

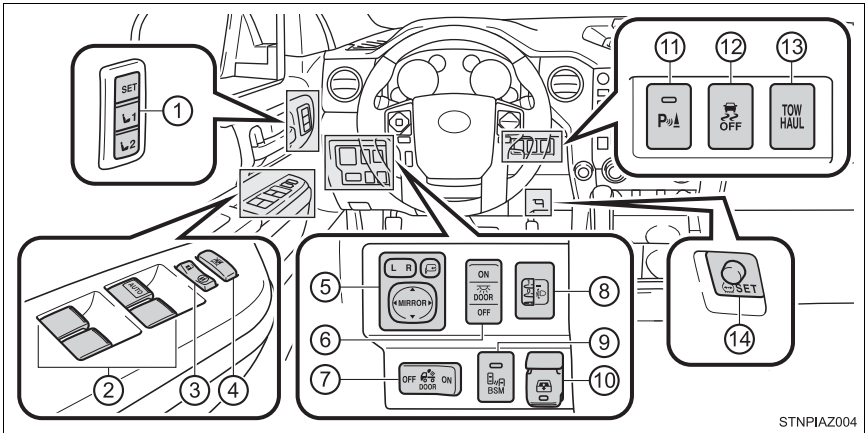

STNPIAZ004

The illustration represents the instrument panel for the front separated type seat.

- | | | |
|---|---|-----------------------|
| ① | Driving position memory switches* ¹ | P. 118 |
| ② | Power window switches* ² | P. 136 |
| ③ | Door lock switch* ² | P. 105 |
| ④ | Window lock switch* ² | P. 136 |
| ⑤ | Outside rear view mirror switches* ² | P. 132 |
| ⑥ | Personal/interior lights main switch | P. 354 |
| ⑦ | Cargo lamp main switch | P. 355 |
| ⑧ | Manual headlight leveling dial* ² | P. 190 |
| ⑨ | BSM main switch* ² | P. 218 |
| ⑩ | Power back window switch* ³ | P. 140 |
| ⑪ | Intuitive parking assist switch* ² | P. 203 |
| ⑫ | VSC off switch | P. 229, 232, 234, 236 |
| ⑬ | TOW/HAUL switch* ² | P. 184 |
| ⑭ | Tire pressure warning reset switch | P. 419 |

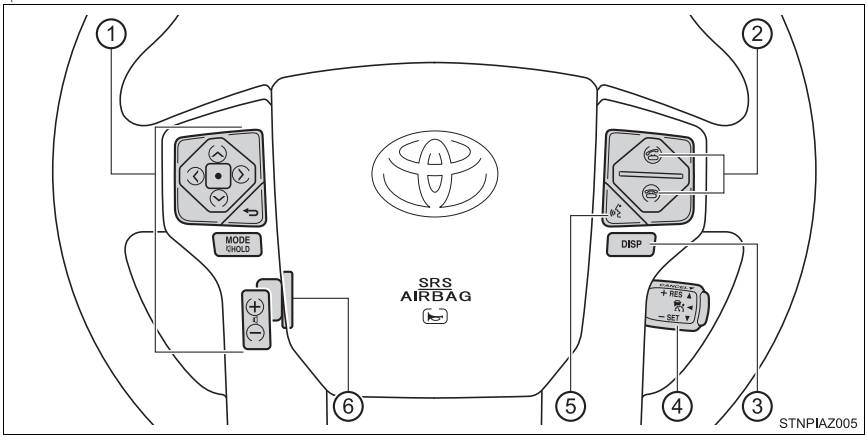

- ① Audio remote control switches*5
- ② Telephone switches..... P. 309
- ③ “DISP” button*2..... P. 94
- ④ Cruise control switch*2..... P. 200
- ⑤ Talk switch..... P. 325
- ⑥ Tilt and telescopic steering control switch*4..... P. 127

*1: Vehicles with tilt and telescopic steering control switch

*2: If equipped

*3: For CrewMax models and if equipped on Double Cab models

*4: Vehicles with driving position memory

*5: Refer to the “NAVIGATION SYSTEM OWNER’S MANUAL”.

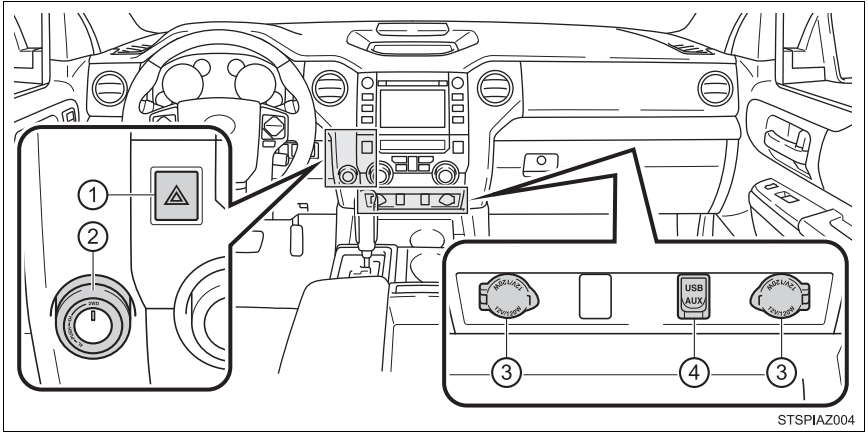

- ① Emergency flasher switch P. 456
- ② Front-wheel drive control switch*1 P. 226
- ③ Power outlets P. 377
- ④ AUX port/USB port. P. 255

Interior

► Front separated type seats

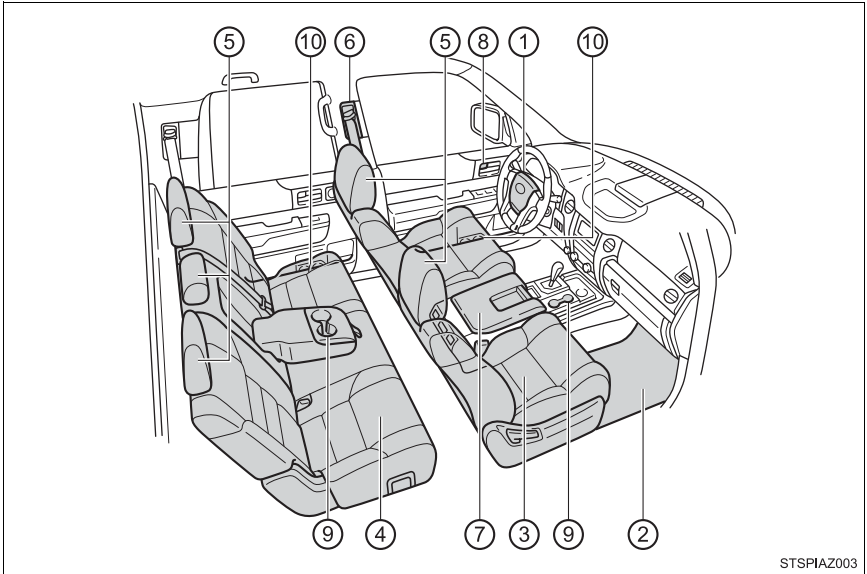

STSPIAZ003

| | |
|-----------------------------|--------|
| ① SRS airbags | P. 38 |
| ② Floor mats | P. 28 |
| ③ Front seats | P. 113 |
| ④ Rear seats*2 | P. 116 |
| ⑤ Head restraints | P. 122 |
| ⑥ Seat belts | P. 32 |
| ⑦ Console box | P. 359 |
| ⑧ Inside lock buttons | P. 105 |
| ⑨ Cup holders | P. 366 |
| ⑩ Bottle holders | P. 368 |

*1: If equipped

*2: For Double Cab and CrewMax models

► Front bench type seat

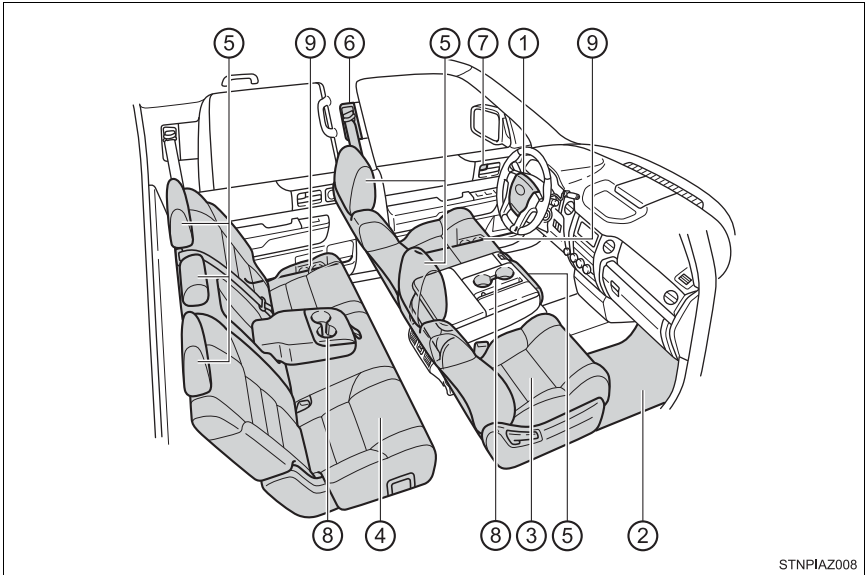

STNPIAZ008

| | |
|-----------------------------|--------|
| ① SRS airbags | P. 38 |
| ② Floor mats | P. 28 |
| ③ Front seats | P. 113 |
| ④ Rear seats *1 | P. 116 |
| ⑤ Head restraints | P. 122 |
| ⑥ Seat belts | P. 32 |
| ⑦ Inside lock buttons | P. 105 |
| ⑧ Cup holders | P. 366 |
| ⑨ Bottle holders | P. 368 |

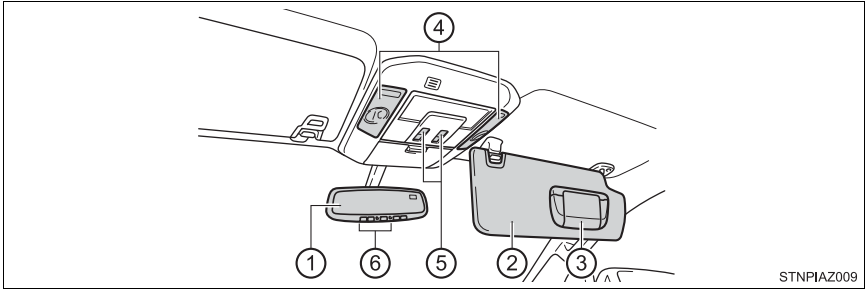

- | | | |
|---|--|---------------|
| ① | Inside rear view mirror | P. 129 |
| ② | Sun visors | P. 374 |
| ③ | Vanity mirrors ^{*2} | P. 374 |
| ④ | Personal/interior lights ^{*3} | P. 354 |
| ⑤ | Moon roof switches ^{*2} | P. 142 |
| ⑥ | Garage door opener switches ^{*2} | P. 381 |

*1: For Double Cab and CrewMax models

*2: If equipped

*3: The illustration shows the front, but they are also equipped in the rear.

For safety and security

1

1-1. For safe use

| | |
|---|----|
| Before driving | 28 |
| For safety drive | 30 |
| Seat belts | 32 |
| SRS airbags | 38 |
| Front passenger occupant classification system | 50 |
| Safety information for children | 55 |
| Child restraint systems..... | 56 |
| Installing child restraints..... | 60 |
| Exhaust gas precautions..... | 77 |

1-2. Theft deterrent system

| | |
|------------------------------------|----|
| Engine immobilizer system | 78 |
| Alarm..... | 80 |

Before driving

Floor mat

Use only floor mats designed specifically for vehicles of the same model and model year as your vehicle. Fix them securely in place onto the carpet.

- 1 Insert the retaining hooks (clips) into the floor mat eyelets.

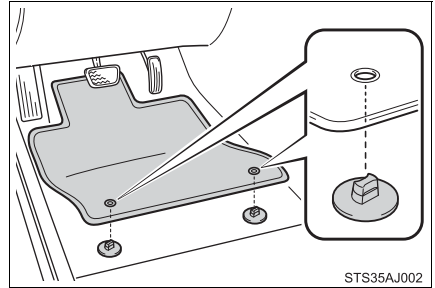

- 2 Turn the upper knob of each retaining hook (clip) to secure the floor mats in place.

*: Always align the \triangle marks.

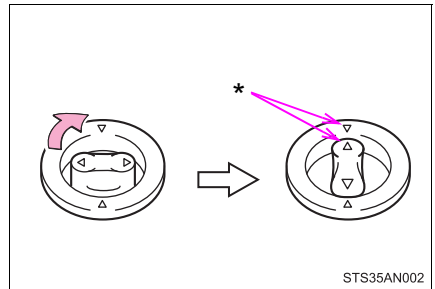

The shape of the retaining hooks (clips) may differ from that shown in the illustration.

⚠ CAUTION

Observe the following precautions.

Failure to do so may cause the driver's floor mat to slip, possibly interfering with the pedals while driving. An unexpectedly high speed may result or it may become difficult to stop the vehicle, leading to an accident, or leading to death or a serious injury.

■ When installing the driver's floor mat

- Do not use floor mats designed for other models or different model year vehicles, even if they are Toyota Genuine floor mats.
- Only use floor mats designed for the driver's seat.
- Always install the floor mat securely using the retaining hooks (clips) provided.
- Do not use two or more floor mats on top of each other.
- Do not place the floor mat bottom-side up or upside-down.

■ Before driving

- Check that the floor mat is securely fixed in the correct place with all the provided retaining hooks (clips). Be especially careful to perform this check after cleaning the floor.
- With the engine stopped and the shift lever in P, fully depress each pedal to the floor to make sure it does not interfere with the floor mat.

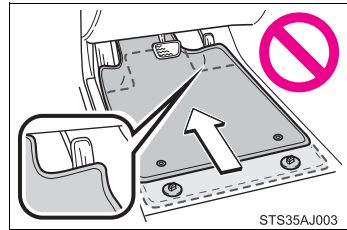

For safety drive

For safe driving, adjust the seat and mirror to an appropriate position before driving.

Correct driving posture

- ① Adjust the angle of the seat-back so that you are sitting straight up and so that you do not have to lean forward to steer. (→P. 113)
- ② Adjust the seat so that you can depress the pedals fully and so that your arms bend slightly at the elbow when gripping the steering wheel. (→P. 113)
- ③ Lock the head restraint in place with the center of the head restraint closest to the top of your ears. (→P. 122)
- ④ Wear the seat belt correctly. (→P. 32)

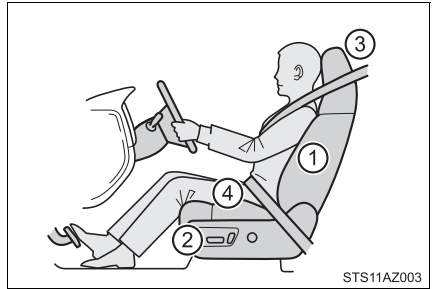

Correct use of the seat belts

Make sure that all occupants are wearing their seat belts before driving the vehicle. (→P. 32)

Use a child restraint system appropriate for the child until the child becomes large enough to properly wear the vehicle's seat belt. (→P. 56)

Adjusting the mirrors

Make sure that you can see backward clearly by adjusting the inside and outside rear view mirrors properly. (→P. 129, 132)

 CAUTION

Observe the following precautions.

Failure to do so may result in death or serious injury.

- Do not adjust the position of the driver's seat while driving.
Doing so could cause the driver to lose control of the vehicle.
- Do not place a cushion between the driver or passenger and the seatback.
A cushion may prevent correct posture from being achieved, and reduce the effectiveness of the seat belt and head restraint.
- Do not place anything under the front seats.
Objects placed under the front seats may become jammed in the seat tracks and stop the seat from locking in place. This may lead to an accident and the adjustment mechanism may also be damaged.
- When driving over long distances, take regular breaks before you start to feel tired.
Also, if you feel tired or sleepy while driving, do not force yourself to continue driving and take a break immediately.

Seat belts

Make sure that all occupants are wearing their seat belts before driving the vehicle.

Correct use of the seat belts

- Extend the shoulder belt so that it comes fully over the shoulder, but does not come into contact with the neck or slide off the shoulder.
- Position the lap belt as low as possible over the hips.
- Adjust the position of the seat-back. Sit up straight and well back in the seat.
- Do not twist the seat belt.

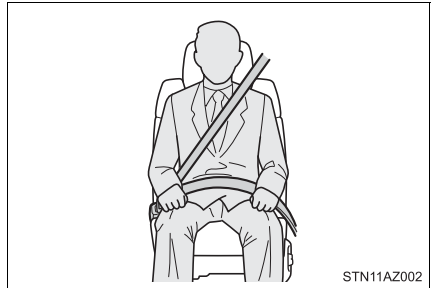

Fastening and releasing the seat belt

- ① To fasten the seat belt, push the plate into the buckle until a click sound is heard.
- ② To release the seat belt, press the release button.

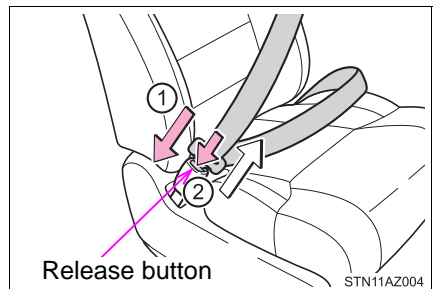

Using the front seat belt (Regular Cab models)

Raise the front seat belt hanger until it locks.

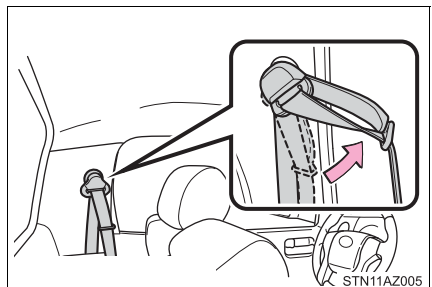

Adjusting the seat belt shoulder anchor height (Double Cab and CrewMax models)

- ① Push the seat belt shoulder anchor down while pressing the release button.
 - ② Push the seat belt shoulder anchor up.
- Move the height adjuster up and down as needed until you hear a click.

► Front seats

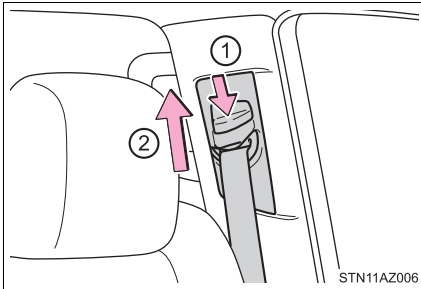

► Rear seats (CrewMax models)

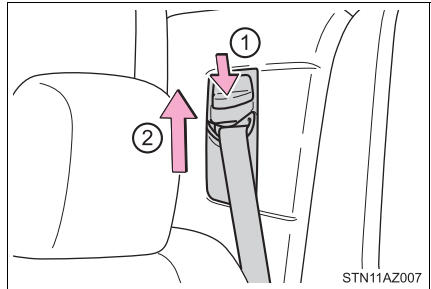

Seat belt pretensioners (front seats)

The pretensioners help the seat belts to quickly restrain the occupants by retracting the seat belts when the vehicle is subjected to certain types of severe frontal or side collision or a vehicle rollover.

The pretensioners do not activate in the event of a minor frontal impact, a minor side impact or a rear impact.

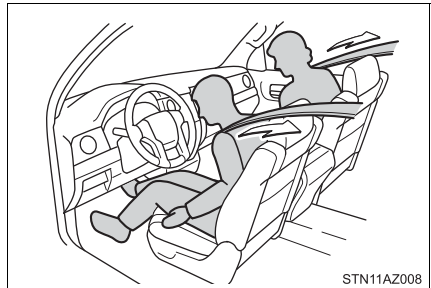

■ Emergency locking retractor (ELR)

The retractor will lock the belt during a sudden stop or on impact. It may also lock if you lean forward too quickly. A slow, easy motion will allow the belt to extend so that you can move around fully.

■ Automatic locking retractor (ALR)

When a passenger's shoulder belt is completely extended and then retracted even slightly, the belt is locked in that position and cannot be extended. This feature is used to hold the child restraint system (CRS) firmly. To free the belt again, fully retract the belt and then pull the belt out once more. (→P. 60)

■ Child seat belt usage

The seat belts of your vehicle were principally designed for persons of adult size.

- Use a child restraint system appropriate for the child, until the child becomes large enough to properly wear the vehicle's seat belt. (→P. 56)
- When the child becomes large enough to properly wear the vehicle's seat belt, follow the instructions regarding seat belt usage. (→P. 32)

■ Replacing the belt after the pretensioner has been activated

If the vehicle is involved in multiple collisions, the pretensioner will activate for the first collision, but will not activate for the second or subsequent collisions.

■ Seat belt extender

If your seat belts cannot be fastened securely because they are not long enough, a personalized seat belt extender is available from your Toyota dealer free of charge.

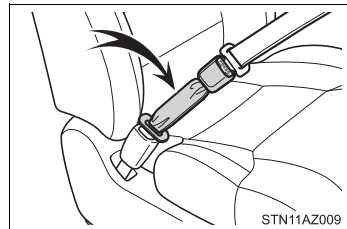

⚠ CAUTION

Observe the following precautions to reduce the risk of injury in the event of sudden braking, sudden swerving or an accident.
Failure to do so may cause death or serious injury.

■ Wearing a seat belt

- Ensure that all passengers wear a seat belt.
- Always wear a seat belt properly.
- Each seat belt should be used by one person only. Do not use a seat belt for more than one person at once, including children.
- Toyota recommends that children be seated in the rear seat and always use a seat belt and/or an appropriate child restraint system.
- To achieve a proper seating position, do not recline the seat more than necessary. The seat belt is most effective when the occupants are sitting up straight and well back in the seats.
- Do not wear the shoulder belt under your arm.
- Always wear your seat belt low and snug across your hips.

■ Pregnant women

Obtain medical advice and wear the seat belt in the proper way. (→P. 32)

Women who are pregnant should position the lap belt as low as possible over the hips in the same manner as other occupants, extending the shoulder belt completely over the shoulder and avoiding belt contact with the rounding of the abdominal area.

If the seat belt is not worn properly, not only the pregnant woman, but also the fetus could suffer death or serious injury as a result of sudden braking or a collision.

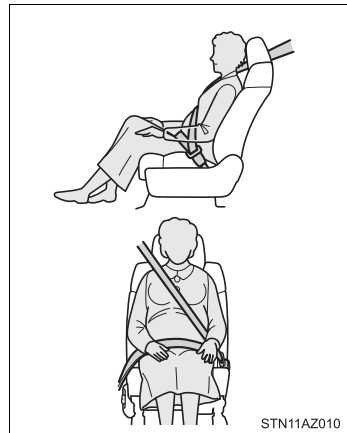

STN11AZ010

■ People suffering illness

Obtain medical advice and wear the seat belt in the proper way. (→P. 32)

 **CAUTION****■ When children are in the vehicle**

Do not allow children to play with the seat belt. If the seat belt becomes twisted around a child's neck, it may lead to choking or other serious injuries that could result in death.

If this occurs and the buckle cannot be unfastened, scissors should be used to cut the belt.

■ Seat belt pretensioners

● Do not place anything, such as a cushion, on the front passenger's seat. Doing so will disperse the passenger's weight, which prevents the sensor from detecting the passenger's weight properly. As a result, the seat belt pretensioner for the front passenger's seat may not activate in the event of a collision.

● If the pretensioner has activated, the SRS warning light will come on. In that case, the seat belt cannot be used again and must be replaced at your Toyota dealer.

■ Adjustable shoulder anchor (Double Cab and CrewMax models)

Always make sure the shoulder belt is positioned across the center of your shoulder. The belt should be kept away from your neck, but not falling off your shoulder. Failure to do so could reduce the amount of protection in an accident and cause death or serious injuries in the event of a sudden stop, sudden swerve or an accident. (→P. 33)

■ Seat belt damage and wear

● Do not damage the seat belts by allowing the belt, plate, or buckle to be jammed in the door.

● Inspect the seat belt system periodically. Check for cuts, fraying, and loose parts. Do not use a damaged seat belt until it is replaced. Damaged seat belts cannot protect an occupant from death or serious injury.

● Ensure that the belt and plate are locked and the belt is not twisted. If the seat belt does not function correctly, immediately contact your Toyota dealer.

● Replace the seat assembly, including the belts, if your vehicle has been involved in a serious accident, even if there is no obvious damage.

● Do not attempt to install, remove, modify, disassemble or dispose of the seat belts. Have any necessary repairs carried out by your Toyota dealer. Inappropriate handling of the pretensioner may prevent it from operating properly, resulting in death or serious injury.

**CAUTION****■ Before using a front seat belt (Regular Cab models)**

Make sure the seat belt hanger is secured in the raised position before you fasten the seat belt.

■ Using a seat belt extender

- Do not wear the seat belt extender if you can fasten the seat belt without the extender.
- Do not use the seat belt extender when installing a child restraint system because the belt will not securely hold the child restraint system, increasing the risk of death or serious injury in the event of an accident.
- The personalized extender may not be safe on another vehicle, when used by another person, or at a different seating position other than the one originally intended.

**NOTICE****■ When using a seat belt extender**

When releasing the seat belt, press on the buckle release button on the extender, not on the seat belt.

This helps prevent damage to the vehicle interior and the extender itself.

SRS airbags

The SRS airbags inflate when the vehicle is subjected to certain types of severe impacts that may cause significant injury to the occupants. They work together with the seat belts to help reduce the risk of death or serious injury.

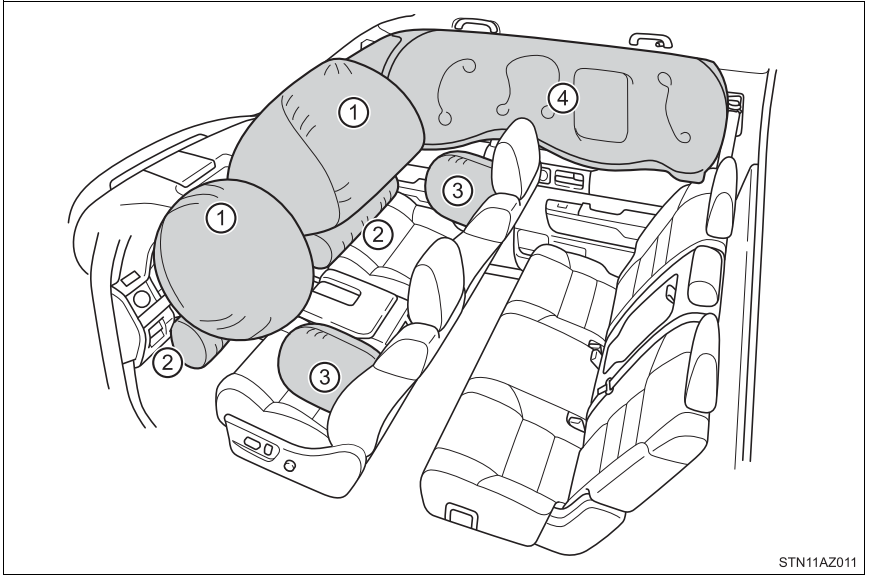

STN11AZ011

◆ SRS front airbags

- ① SRS driver airbag/front passenger airbag
Can help protect the head and chest of the driver and right front passenger from impact with interior components
- ② SRS knee airbags
Can help provide driver and front passenger protection

◆ SRS side and curtain shield airbags

- ③ SRS side airbags
Can help protect the torso of the front seat occupants
- ④ SRS curtain shield airbags
 - Can help protect primarily the head of occupants in the outer seats
 - Can prevent the occupants from being thrown from the vehicle in the event of vehicle rollover

SRS airbag system components

► Regular Cab models

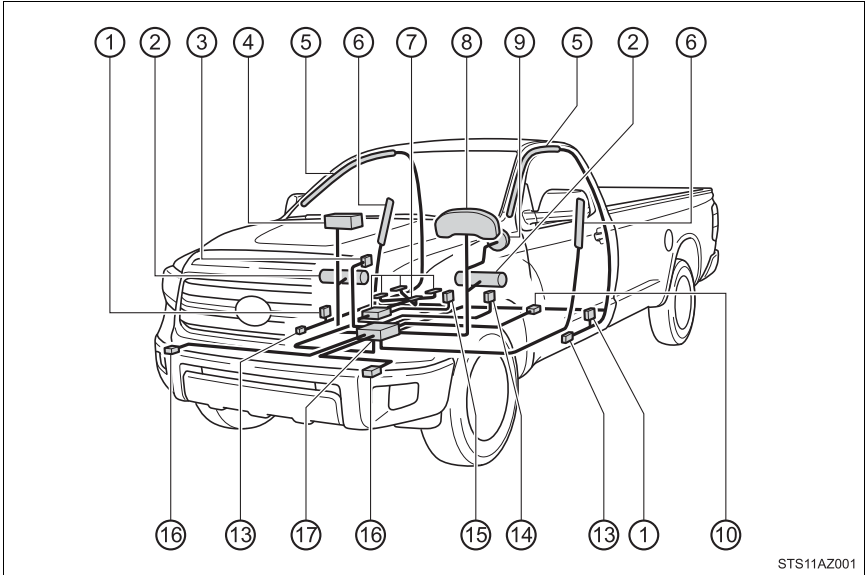

► Double Cab and CrewMax models

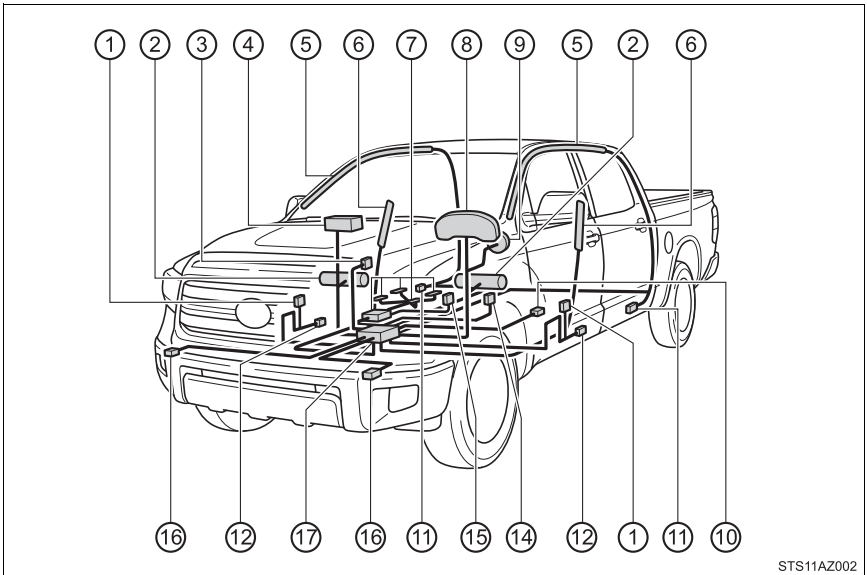

- ① Seat belt pretensioners
- ② Knee airbags
- ③ “AIR BAG ON” and “AIR BAG OFF” indicator lights
- ④ Front passenger airbag
- ⑤ Curtain shield airbags
- ⑥ Side airbags (front seats)
- ⑦ Front passenger occupant classification system (ECU and sensors)
- ⑧ SRS warning light
- ⑨ Driver airbag
- ⑩ Driver’s seat position sensor
- ⑪ Side impact sensors (rear) (Double Cab and CrewMax models)
- ⑫ Side impact sensors (front door) (Double Cab and CrewMax models)
- ⑬ Side impact sensors (front) (Regular Cab models)
- ⑭ Driver’s seat belt buckle switch
- ⑮ Front passenger’s seat belt buckle switch
- ⑯ Front impact sensors
- ⑰ Airbag sensor assembly

Your vehicle is equipped with ADVANCED AIRBAGS designed based on the US motor vehicle safety standards (FMVSS208). The airbag sensor assembly (ECU) controls airbag deployment based on information obtained from the sensors etc. shown in the system components diagram above. This information includes crash severity and occupant information. As the airbags deploy, a chemical reaction in the inflators quickly fills the airbags with non-toxic gas to help restrain the motion of the occupants.

Front bench type seat: The SRS airbags are designed to protect the driver and right front passenger, and they are not designed to protect an occupant in the front center seating position.

⚠ CAUTION

■ SRS airbag precautions

Observe the following precautions regarding the SRS airbags. Failure to do so may cause death or serious injury.

- The driver and all passengers in the vehicle must wear their seat belts properly.

The SRS airbags are supplemental devices to be used with the seat belts.

- The SRS driver airbag deploys with considerable force, and can cause death or serious injury especially if the driver is very close to the airbag. The National Highway Traffic Safety Administration (NHTSA) advises:

Since the risk zone for the driver's airbag is the first 2 - 3 in. (50 - 75 mm) of inflation, placing yourself 10 in. (250 mm) from your driver airbag provides you with a clear margin of safety. This distance is measured from the center of the steering wheel to your breastbone. If you sit less than 10 in. (250 mm) away now, you can change your driving position in several ways:

- Move your seat to the rear as far as you can while still reaching the pedals comfortably.
- Slightly recline the back of the seat. Although vehicle designs vary, many drivers can achieve the 10 in. (250 mm) distance, even with the driver seat all the way forward, simply by reclining the back of the seat somewhat. If reclining the back of your seat makes it hard to see the road, raise yourself by using a firm, non-slippery cushion, or raise the seat if your vehicle has that feature.
- If your steering wheel is adjustable, tilt it downward. This points the airbag toward your chest instead of your head and neck.

The seat should be adjusted as recommended by NHTSA above, while still maintaining control of the foot pedals, steering wheel, and your view of the instrument panel controls.

- If the seat belt extender has been connected to the front seat belt buckles but the seat belt extender has not also been fastened to the latch plate of the seat belt, the SRS front airbags will judge that the driver and front passenger are wearing the seat belt even though the seat belt has not been connected. In this case, the SRS front airbags may not activate correctly in a collision, resulting in death or serious injury in the event of a collision. Be sure to wear the seat belt with the seat belt extender.

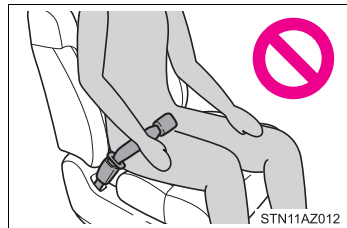

CAUTION

SRS airbag precautions

- The SRS front passenger airbag also deploys with considerable force, and can cause death or serious injury especially if the front passenger is very close to the airbag. The front passenger seat should be as far from the airbag as possible with the seatback adjusted, so the front passenger sits upright.
- Improperly seated and/or restrained infants and children can be killed or seriously injured by a deploying airbag. An infant or child who is too small to use a seat belt should be properly secured using a child restraint system. Toyota strongly recommends that all infants and children be placed in the rear seats of the vehicle and properly restrained. The rear seats are safer for infants and children than the front passenger seat. (→P. 56)
- Do not sit on the edge of the seat or lean against the dashboard.

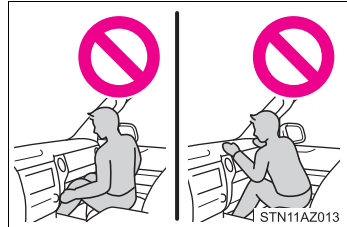

- Do not allow a child to stand in front of the SRS front passenger airbag unit or sit on the knees of a front passenger.
- Do not allow the front seat occupants to hold items on their knees.

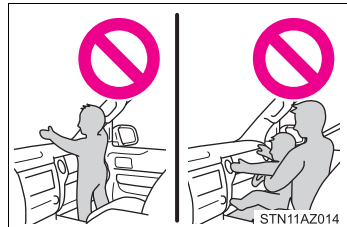

- Do not lean against the door, the roof side rail or the front, side and rear pillars.



CAUTION

SRS airbag precautions

- Do not allow anyone to kneel on the passenger seats toward the door or put their head or hands outside the vehicle.

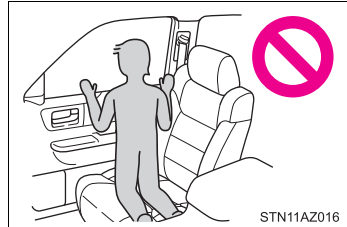

- Do not attach anything to or lean anything against areas such as the dashboard, steering wheel pad and lower portion of the instrument panel. These items can become projectiles when the SRS driver, front passenger and knee airbags deploy.

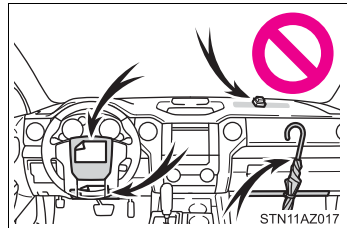

- Do not attach anything to areas such as a door, windshield glass, side door glass, front or rear pillar, roof side rail and assist grip.

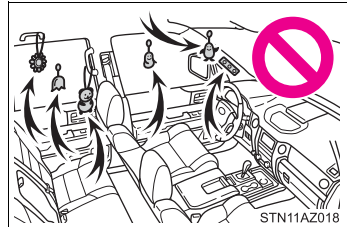

- Do not attach any heavy, sharp or hard objects such as keys and accessories to the key. The objects may restrict the SRS knee airbag inflation or be thrust into the driver's seat area by the force of the deploying airbag, thus causing a danger.

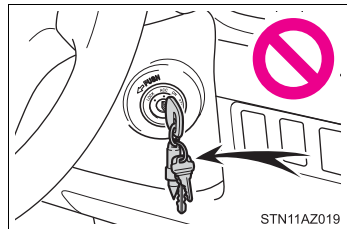

- Do not hang coat hangers or other hard objects on the coat hooks. All of these items could become projectiles and may cause death or serious injury, should the SRS curtain shield airbags deploy.
- If a vinyl cover is put on the area where the SRS knee airbag will deploy, be sure to remove it.

 CAUTION**■ SRS airbag precautions**

- Do not use seat accessories which cover the parts where the SRS side airbags inflate as they may interfere with inflation of the airbags. Such accessories may prevent the side airbags from activating correctly, disable the system or cause the side airbags to inflate accidentally, resulting in death or serious injury.
- Do not strike or apply significant levels of force to the area of the SRS airbag components.
Doing so can cause the SRS airbags to malfunction.
- Do not touch any of the component parts immediately after the SRS airbags have deployed (inflated) as they may be hot.
- If breathing becomes difficult after the SRS airbags have deployed, open a door or window to allow fresh air in, or leave the vehicle if it is safe to do so. Wash off any residue as soon as possible to prevent skin irritation.
- If the areas where the SRS airbags are stored, such as the steering wheel pad and front and rear pillar garnishes, are damaged or cracked, have them replaced by your Toyota dealer.
- Do not place anything, such as a cushion, on the front passenger's seat. Doing so will disperse the passenger's weight, which prevents the sensor from detecting the passenger's weight properly. As a result, the SRS front airbags for the front passenger may not deploy in the event of a collision.

■ Modification and disposal of SRS airbag system components

Do not dispose of your vehicle or perform any of the following modifications without consulting your Toyota dealer. The SRS airbags may malfunction or deploy (inflate) accidentally, causing death or serious injury.

- Installation, removal, disassembly and repair of the SRS airbags
- Repairs, modifications, removal or replacement of the steering wheel, instrument panel, dashboard, seats or seat upholstery, front, side and rear pillars or roof side rails
- Repairs or modifications of the front fender, front bumper, or side of the occupant compartment
- Installation of a grille guard (bull bars, kangaroo bar, etc.), snow plows, winches or roof luggage carrier
- Modifications to the vehicle's suspension system
- Installation of electronic devices such as mobile two-way radios and CD players
- Modifications to your vehicle for a person with a physical disability

■ If the SRS airbags deploy (inflate)

- Bruising and slight abrasions may result from contact with a deploying (inflating) SRS airbag.
- A loud noise and white powder will be emitted.
- Parts of the airbag module (steering wheel hub, airbag cover and inflator) as well as the front seats, parts of the front and rear pillars and roof side rails, may be hot for several minutes. The airbag itself may also be hot.
- The windshield may crack.

■ SRS airbag deployment conditions (SRS front airbags)

- The SRS front airbags will deploy in the event of an impact that exceeds the set threshold level (the level of force corresponding to an approximately 12 - 18 mph [20 - 30 km/h] frontal collision with a fixed wall that does not move or deform).

However, this threshold velocity will be considerably higher in the following situations:

- If the vehicle strikes an object, such as a parked vehicle or sign pole, which can move or deform on impact
- If the vehicle is involved in an underride collision, such as a collision in which the front of the vehicle “underrides”, or goes under, the bed of a truck
- Depending on the type of collision, it is possible that only the seat belt pretensioners will activate.
- The SRS front airbags for the front passenger will not activate if there is no passenger sitting in the right front passenger seat. However, the SRS front airbags for the front passenger may deploy if luggage is put in the seat, even if the seat is unoccupied. (→P. 50)

■ SRS airbag deployment conditions (SRS side and curtain shield airbags)

- The SRS side and curtain shield airbags will deploy in the event of an impact that exceeds the set threshold level (the level of force corresponding to the impact force produced by an approximately 3300 lb. [1500 kg] vehicle colliding with the vehicle cabin from a direction perpendicular to the vehicle orientation at an approximate speed of 12 - 18 mph [20 - 30 km/h]).
- The SRS curtain shield airbags will deploy in the event of vehicle rollover.
- The SRS curtain shield airbags may also deploy in the event of a severe frontal collision.

■ Conditions under which the SRS airbags may deploy (inflate), other than a collision

The SRS front airbags and SRS curtain shield airbags may also deploy if a serious impact occurs to the underside of your vehicle. Some examples are shown in the illustration.

- Hitting a curb, edge of pavement or hard surface
- Falling into or jumping over a deep hole
- Landing hard or vehicle falling

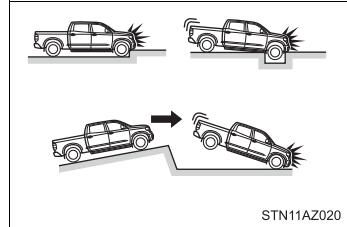

The SRS curtain shield airbags may also deploy under the situation shown in the illustration.

- The angle of vehicle tip-up is marginal.
- The vehicle skids and hits a curb stone.

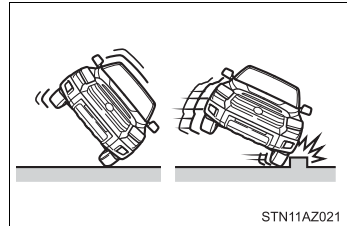

■ Types of collisions that may not deploy the SRS airbags (SRS front airbags)

The SRS front airbags do not generally inflate if the vehicle is involved in a side or rear collision, if it rolls over, or if it is involved in a low-speed frontal collision. But, whenever a collision of any type causes sufficient forward deceleration of the vehicle, deployment of the SRS front airbags may occur.

- Collision from the side
- Collision from the rear
- Vehicle rollover

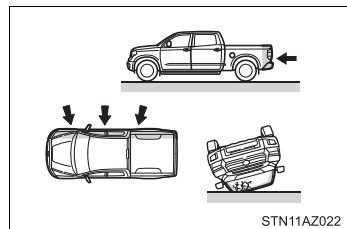

■ Types of collisions that may not deploy the SRS airbags (SRS side and curtain shield airbags)

The SRS side and curtain shield airbags may not activate if the vehicle is subjected to a collision from the side at certain angles, or a collision to the side of the vehicle body other than the passenger compartment.

- Collision from the side to the vehicle body other than the passenger compartment
- Collision from the side at an angle

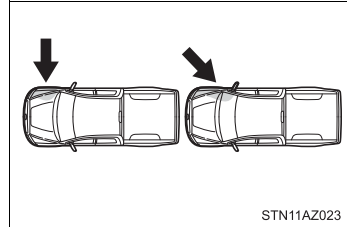

The SRS side airbags do not generally inflate if the vehicle is involved in a frontal or rear collision, if it rolls over, or if it is involved in a low-speed side collision.

- Collision from the front
- Collision from the rear
- Vehicle rollover

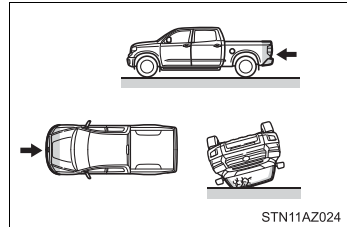

The SRS curtain shield airbags do not generally inflate if the vehicle is involved in a rear collision, if it pitches end over end, or if it is involved in a low-speed side or low-speed frontal collision.

- Collision from the rear
- Pitching end over end

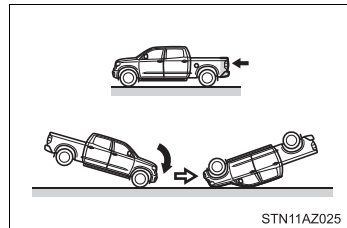

■ When to contact your Toyota dealer

In the following cases, the vehicle will require inspection and/or repair. Contact your Toyota dealer as soon as possible.

- Any of the SRS airbags have been inflated.
- The front of the vehicle is damaged or deformed, or was involved in an accident that was not severe enough to cause the SRS front airbags to inflate.

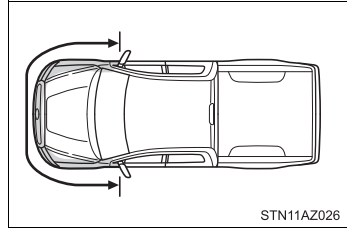

- A portion of a door or its surrounding area is damaged or deformed, or the vehicle was involved in an accident that was not severe enough to cause the SRS side and curtain shield airbags to inflate.

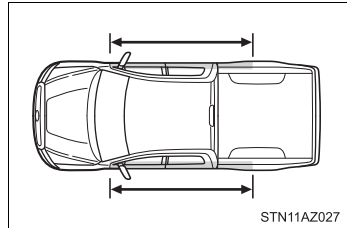

- The pad section of the steering wheel, dashboard near the front passenger airbag or lower portion of the instrument panel is scratched, cracked, or otherwise damaged.

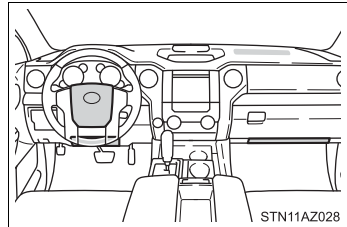

- The surface of the seats with the side airbag is scratched, cracked, or otherwise damaged.

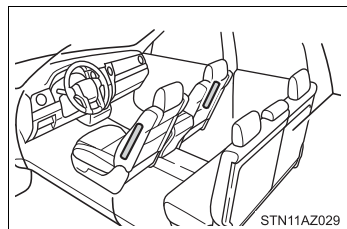

- The portion of the front pillars, rear pillars or roof side rail garnishes (padding) containing the curtain shield airbags inside is scratched, cracked, or otherwise damaged.

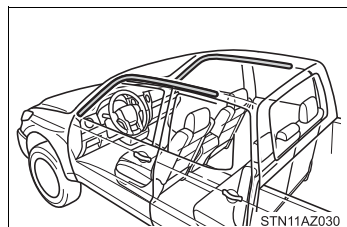

Front passenger occupant classification system

Your vehicle is equipped with a front passenger occupant classification system. This system detects the conditions of the front passenger seat and activates or deactivates the devices for the front passenger.

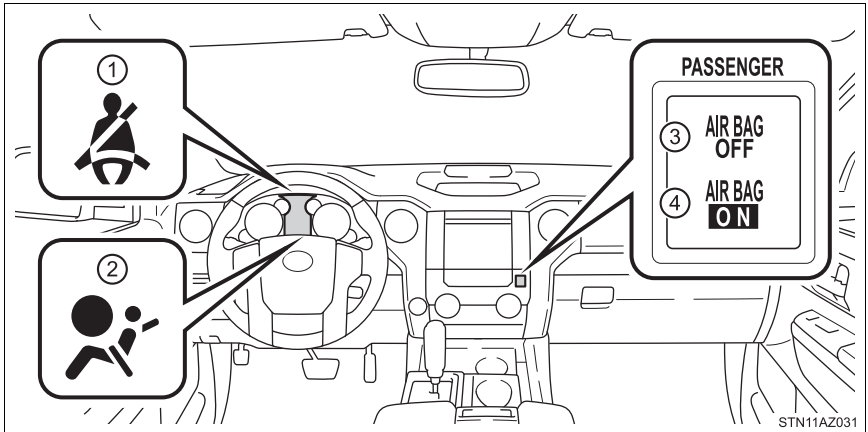

- ① Seat belt reminder light
- ② SRS warning light
- ③ "AIR BAG OFF" indicator light
- ④ "AIR BAG ON" indicator light

Condition and operation in the front passenger occupant classification system

■ Adult*1

| | | |
|-----------------------------|--|--------------|
| Indicator/ warning light | “AIR BAG ON” and “AIR BAG OFF” indicator lights | “AIR BAG ON” |
| | SRS warning light | Off |
| | Front passenger’s seat belt reminder light | Flashing*2 |
| Devices | Front passenger airbag | Activated |
| | Front passenger knee airbag | |
| | Side airbag on the front passenger seat | |
| | Curtain shield airbag in the front passenger side | |
| | Front passenger’s seat belt pretensioner | |

■ Child*3 or child restraint system*4

| | | |
|-----------------------------|--|--------------------|
| Indicator/ warning light | “AIR BAG ON” and “AIR BAG OFF” indicator lights | “AIR BAG OFF”*5 |
| | SRS warning light | Off |
| | Front passenger’s seat belt reminder light | Flashing*2 |
| Devices | Front passenger airbag | Deactivated |
| | Front passenger knee airbag | |
| | Side airbag on the front passenger seat | Activated |
| | Curtain shield airbag in the front passenger side | |
| | Front passenger’s seat belt pretensioner | |

■ Unoccupied

| | | |
|-----------------------------|--|--|
| Indicator/ warning light | “AIR BAG ON” and “AIR BAG OFF” indicator lights | Not illuminated |
| | SRS warning light | Off |
| | Front passenger’s seat belt reminder light | |
| Devices | Front passenger airbag | Deactivated |
| | Front passenger knee airbag | |
| | Side airbag on the front passenger seat | Activated |
| | Curtain shield airbag in the front passenger side | |
| | Front passenger’s seat belt pretensioner | Deactivated* ⁶ or activated* ⁷ |

■ There is a malfunction in the system

| | | |
|-----------------------------|--|---------------|
| Indicator/ warning light | “AIR BAG ON” and “AIR BAG OFF” indicator lights | “AIR BAG OFF” |
| | SRS warning light | On |
| | Front passenger’s seat belt reminder light | Off |
| Devices | Front passenger airbag | Deactivated |
| | Front passenger knee airbag | |
| | Side airbag on the front passenger seat | Activated |
| | Curtain shield airbag in the front passenger side | |
| | Front passenger’s seat belt pretensioner | |

- *1: The system judges a person of adult size as an adult. When a smaller adult sits in the front passenger seat, the system may recognize him/her as a child depending on his/her physique and posture.
- *2: In the event the front passenger does not wear a seat belt
- *3: When a larger child who has outgrown a child restraint system sits in the front passenger seat, the system may recognize him/her as an adult depending on his/her physique or posture.
- *4: Never install a rear-facing child restraint system on the front passenger seat. A forward-facing child restraint system should only be installed on the front passenger seat when it is unavoidable. (→P. 56)
- *5: In case the indicator light is not illuminated, consult this manual on how to install the child restraint system properly. (→P. 60)
- *6: In the event of a frontal collision or rollover.
- *7: In the event of a side collision.



CAUTION

■ Front passenger occupant classification system precautions

Observe the following precautions regarding the front passenger occupant classification system.

Failure to do so may cause death or serious injury.

- Wear the seat belt properly.
- Make sure the front passenger's seat belt plate has not been left inserted into the buckle before someone sits in the front passenger seat.
- Make sure the "AIR BAG OFF" indicator light is not illuminated when using the seat belt extender for the right front passenger seat. If the "AIR BAG OFF" indicator light is illuminated, disconnect the extender tongue from the seat belt buckle, and reconnect the seat belt. Reconnect the seat belt extender after making sure the "AIR BAG ON" indicator light is illuminated. If you use the seat belt extender while the "AIR BAG OFF" indicator light is illuminated, the SRS airbags for the front passenger will not activate, which could cause death or serious injury in the event of a collision.
- Do not apply a heavy load to the front passenger seat or equipment (e.g. seatback pockets).
- Double Cab and CrewMax models: Do not put weight on the front passenger seat by putting your hands or feet on the front passenger seat seatback from the rear passenger seat.
- Double Cab and CrewMax models: Do not let a rear passenger lift the front passenger seat with their feet or press on the seatback with their legs.
- Do not put objects under the front passenger seat.

 CAUTION**■ Front passenger occupant classification system precautions**

- Do not recline the front passenger seatback so far that it touches a rear seat or a back wall. This may cause the “AIR BAG OFF” indicator light to be illuminated, which indicates that the SRS airbags for the front passenger will not activate in the event of a severe accident. If the seatback touches the rear seat or back wall, return the seatback to a position where it does not touch the rear seat or back wall. Keep the front passenger seatback as upright as possible when the vehicle is moving. Reclining the seatback excessively may lessen the effectiveness of the seat belt system.
- If an adult sits in the front passenger seat, the “AIR BAG ON” indicator light is illuminated. If the “AIR BAG OFF” indicator is illuminated, ask the passenger to sit up straight, well back in the seat, feet on the floor, and with the seat belt worn correctly. If the “AIR BAG OFF” indicator still remains illuminated, either ask the passenger to move to the rear seat, or if that is not possible, move the front passenger seat fully rearward.
- When it is unavoidable to install a forward-facing child restraint system on the front passenger seat, install the child restraint system on the front passenger seat in the proper order. (→P. 60)
- Do not modify or remove the front seats.
- Do not kick the front passenger seat or subject it to severe impact. Otherwise, the SRS warning light may come on to indicate a malfunction of the front passenger occupant classification system. In this case, contact your Toyota dealer immediately.
- Double Cab and CrewMax models: Child restraint systems installed on the rear seat should not contact the front seatbacks.
- Do not use a seat accessory, such as a cushion and seat cover, that covers the seat cushion surface.
- Do not attach a commercial seatback table or other heavy item to the back of the front passenger seat.
- Do not modify or replace the upholstery of the front seat.

Safety information for children

Observe the following precautions when children are in the vehicle.

Use a child restraint system appropriate for the child, until the child becomes large enough to properly wear the vehicle's seat belt.

- Double Cab and CrewMax models: It is recommended that children sit in the rear seats to avoid accidental contact with the shift lever, wiper switch, etc.
- Use the rear door child-protector lock (Double Cab and CrewMax models) or the window lock switch (if equipped) to avoid children opening the door while driving or operating the power window accidentally.
- Do not let small children operate equipment which may catch or pinch body parts, such as the power window, hood, tailgate, seats, etc.

CAUTION

Never leave children unattended in the vehicle, and never allow children to have or use the key.

Children may be able to start the vehicle or shift the vehicle into neutral. There is also a danger that children may injure themselves by playing with the windows, the moon roof or other features of the vehicle. In addition, heat build-up or extremely cold temperatures inside the vehicle can be fatal to children.

Child restraint systems

A child restraint system for a small child or baby must itself be properly restrained on the seat with the lap portion of the lap/shoulder belt.

The laws of all 50 states of the U.S.A. and Canada now require the use of child restraint systems.

Points to remember

Studies have shown that installing a child restraint on a rear seat is much safer than installing one on the front passenger seat.

- Choose a child restraint system that suits your vehicle and is appropriate to the age and size of the child.
- For installation details, follow the instructions provided with the child restraint system.

General installation instructions are provided in this manual.

(→P. 60)

Types of child restraints

Child restraint systems are classified into the following 3 types according to the age and size of the child:

- ▶ Rear facing — Infant seat/convertible seat
- ▶ Forward facing — Convertible seat

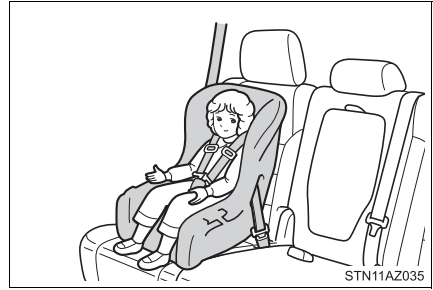
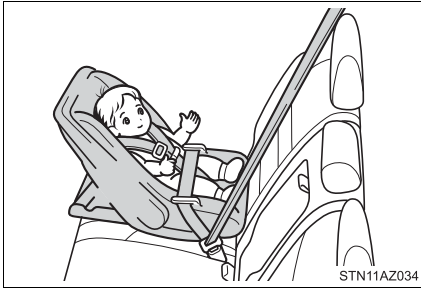

- ▶ Booster seat

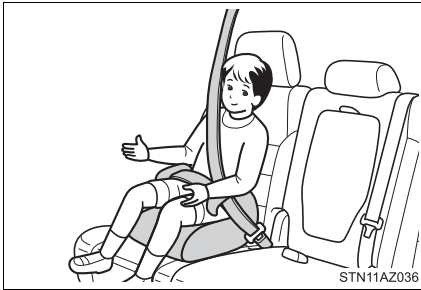

■ Selecting an appropriate child restraint system

- Use a child restraint system appropriate for the child until the child becomes large enough to properly wear the vehicle's seat belt.
- If the child is too large for a child restraint system, sit the child on a rear seat and use the vehicle's seat belt. (→P. 32)

**CAUTION****■ Child restraint precautions**

- For effective protection in automobile accidents and sudden stops, a child must be properly restrained, using a seat belt or child restraint system depending on the age and size of the child. Holding a child in your arms is not a substitute for a child restraint system. In an accident, the child can be crushed against the windshield, or between you and the vehicle's interior.
- Regular Cab models: Toyota strongly urges the use of a proper child restraint system that conforms to the size of the child.
- Double Cab and CrewMax models: Toyota strongly urges the use of a proper child restraint system that conforms to the size of the child, installed on the rear seat. According to accident statistics, the child is safer when properly restrained in the rear seat than in the front seat.
- Never install a rear-facing child restraint system on the front passenger seat even if the "AIR BAG OFF" indicator light is illuminated.
In the event of an accident, the force of the rapid inflation of the front passenger airbag can cause death or serious injury to the child if the rear-facing child restraint system is installed on the front passenger seat.
- Regular Cab models: A forward-facing child restraint system may be installed on the front passenger seat only when it is unavoidable. Adjust the seatback as upright as possible and always move the seat as far back as possible even if the "AIR BAG OFF" indicator light is illuminated, because the front passenger airbag could inflate with considerable speed and force. Otherwise, the child may be killed or seriously injured.
- Double Cab and CrewMax models: A forward-facing child restraint system may be installed on the front passenger seat only when it is unavoidable. A child restraint system that requires a top tether strap should not be used in the front passenger seat since there is no top tether strap anchor for the front passenger seat. Adjust the seatback as upright as possible and always move the seat as far back as possible even if the "AIR BAG OFF" indicator light is illuminated, because the front passenger airbag could inflate with considerable speed and force. Otherwise, the child may be killed or seriously injured.
- Regular Cab models: Do not install a child restraint system on the center seat if it interferes with driving operations such as changing the shift lever position. In this case, install the child restraint system on the right passenger seat.

**CAUTION****■ Child restraint precautions**

- Do not use the seat belt extender when installing a child restraint system on the front or rear passenger seat. If installing a child restraint system with the seat belt extender connected to the seat belt, the seat belt will not securely hold the child restraint system, which could cause death or serious injury to the child or other passengers in the event of an accident.
- Do not allow the child to lean his/her head or any part of his/her body against the door or the area of the seat, front and rear pillars or roof side rails from which the SRS side airbags or SRS curtain shield airbags deploy even if the child is seated in the child restraint system. It is dangerous if the SRS side airbags and curtain shield airbags inflate, and the impact could cause death or serious injury to the child.
- Make sure you have complied with all installation instructions provided by the child restraint manufacturer and that the system is properly secured. If it is not secured properly, it may cause death or serious injury to the child in the event of a sudden stop or an accident.

■ When children are in the vehicle

Do not allow children to play with the seat belt. If the seat belt becomes twisted around a child's neck, it may lead to choking or other serious injuries that could result in death.

If this occurs and the buckle cannot be unfastened, scissors should be used to cut the belt.

■ When the child restraint system is not in use

- Keep the child restraint system properly secured on the seat even if it is not in use. Do not store the child restraint system unsecured in the passenger compartment.
- If it is necessary to detach the child restraint system, remove it from the vehicle. This will prevent it from injuring passengers in the event of a sudden stop or an accident.

Installing child restraints

Follow the child restraint system manufacturer's instructions. Firmly secure child restraints to the seats using the LATCH anchors or a seat belt. Attach the top tether strap when installing a child restraint.

The lap/shoulder belt can be used if your child restraint system is not compatible with the LATCH (Lower Anchors and Tethers for Children) system.

► Regular Cab models

Seat belts equipped with a child restraint locking mechanism (ALR/ELR belts except driver's seat belt) (→P. 34)



Anchor brackets (for top tether strap)

Anchor brackets are provided for all passenger seats.

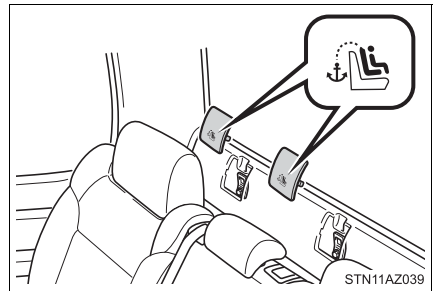

► Double Cab models

Child restraint LATCH anchors

LATCH anchors are provided for the outer rear seats. (Buttons displaying the location of the anchors are attached to the seats.)

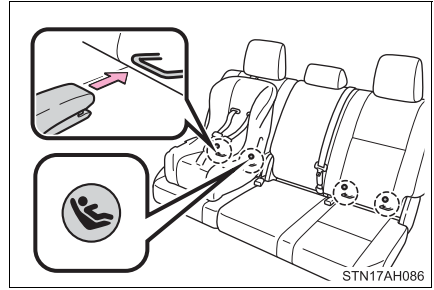

Seat belts equipped with a child restraint locking mechanism (ALR/ELR belts except driver's seat belt) (→P. 34)

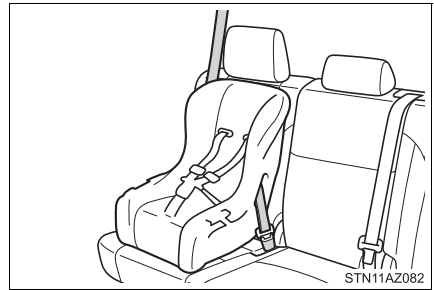

Anchor bracket (for top tether strap)

An anchor bracket is provided for each rear seat.

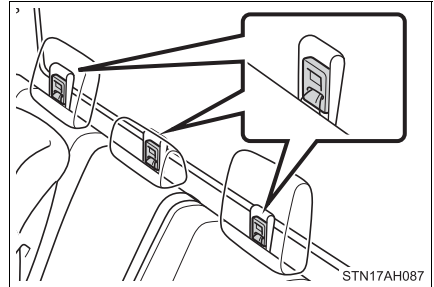

► CrewMax models

Child restraint LATCH anchors

LATCH anchors are provided for the outer rear seats. (Buttons displaying the location of the anchors are attached to the seats.)

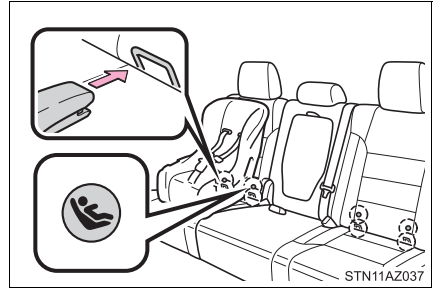

Seat belts equipped with a child restraint locking mechanism (ALR/ELR belts except driver's seat belt) (→P. 34)

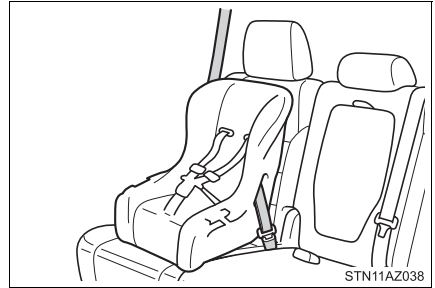

Anchor bracket (for top tether strap)

An anchor bracket is provided for each rear seat.

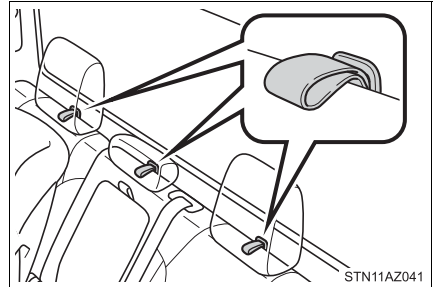

Installation with LATCH system (Double Cab models)

► Type A

- 1 Widen the gap between the seat cushion and seatback slightly.
- 2 Latch the hooks of the lower straps onto the LATCH anchors. If the child restraint has a top tether strap, the top tether strap should be latched onto the top tether strap anchor.

For owners in Canada:

The symbol on a child restraint system indicates the presence of a lower connector system.

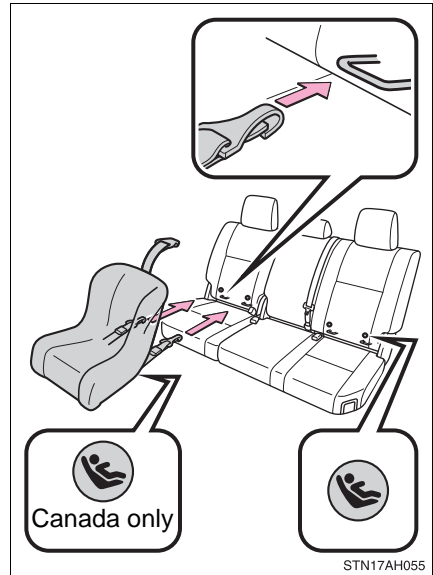

► Type B

- 1 Widen the gap between the seat cushion and seatback slightly.
- 2 Latch the buckles onto the LATCH anchors. If the child restraint has a top tether strap, the top tether strap should be latched onto the top tether strap anchor.

For owners in Canada:

The symbol on a child restraint system indicates the presence of a lower connector system.

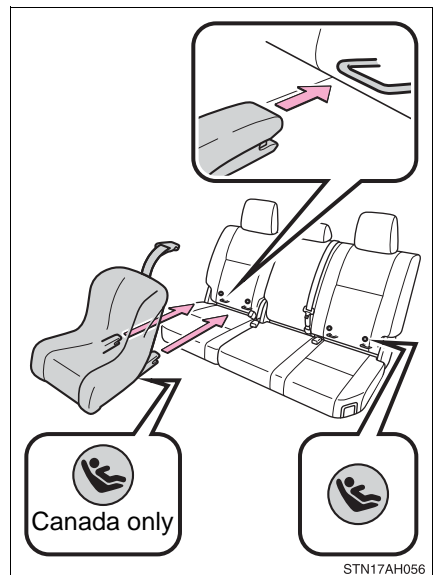

Installation with LATCH system (CrewMax models)

► Type A

- 1 Widen the gap between the seat cushion and seatback slightly.
- 2 Latch the hooks of the lower straps onto the LATCH anchors. If the child restraint has a top tether strap, the top tether strap should be latched onto the top tether strap anchor.

For owners in Canada:

The symbol on a child restraint system indicates the presence of a lower connector system.

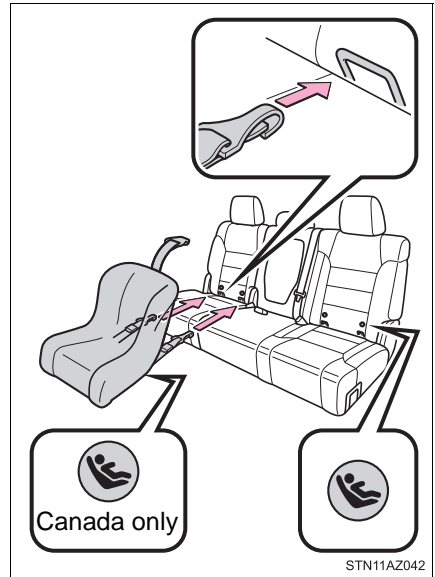

► Type B

- 1 Widen the gap between the seat cushion and seatback slightly.
- 2 Latch the buckles onto the LATCH anchors. If the child restraint has a top tether strap, the top tether strap should be latched onto the top tether strap anchor.

For owners in Canada:

The symbol on a child restraint system indicates the presence of a lower connector system.

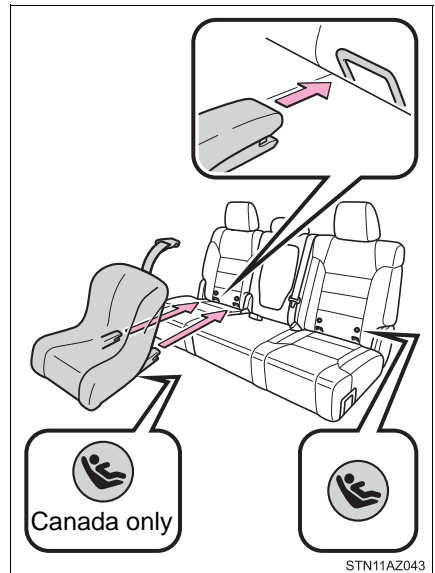

Installing child restraints using a seat belt (child restraint lock function belt)

■ Rear-facing (Regular Cab models) — Infant seat/convertible seat

Never install a rear-facing child restraint. Your vehicle is not designed to carry an infant.

■ Rear-facing (Double Cab and CrewMax models) — Infant seat/convertible seat

- 1 Place the child restraint system on the seat facing the rear of the vehicle.

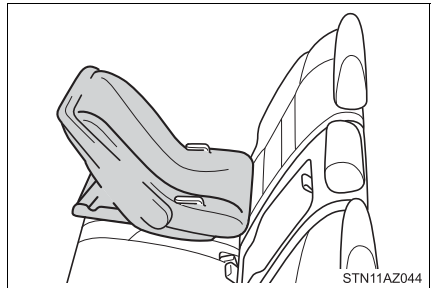

- 2 Run the seat belt through the child restraint system and insert the plate into the buckle. Make sure that the belt is not twisted.

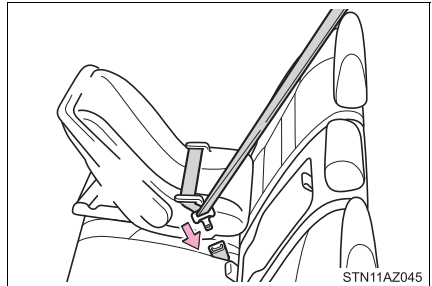

- 3 Fully extend the shoulder belt and allow it to retract to put it in lock mode. In lock mode, the belt cannot be extended.

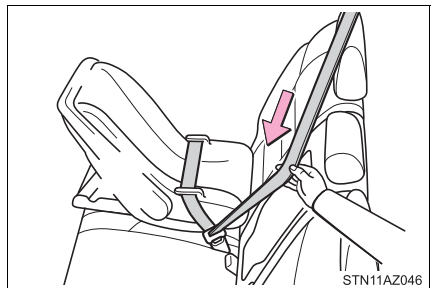

- 4 While pushing the child restraint system down into the rear seat, allow the shoulder belt to retract until the child restraint system is securely in place.

After the shoulder belt has retracted to a point where there is no slack in the belt, pull the belt to check that it cannot be extended.

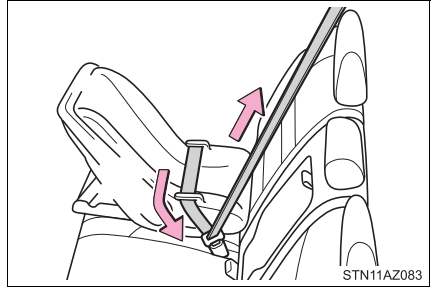

■ Forward-facing — Convertible seat

- 1 Place the child restraint system on the seat facing the front of the vehicle.

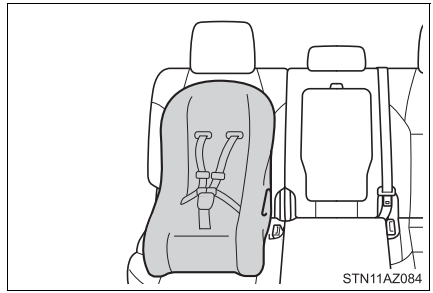

- 2 Run the seat belt through the child restraint system and insert the plate into the buckle. Make sure that the belt is not twisted.

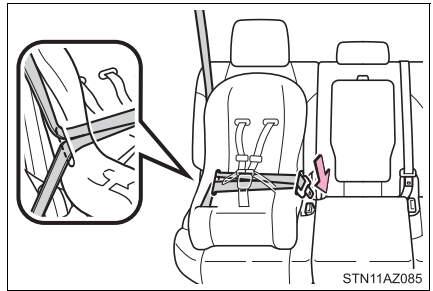

- 3 Fully extend the shoulder belt and allow it to retract to put it in lock mode. In lock mode, the belt cannot be extended.

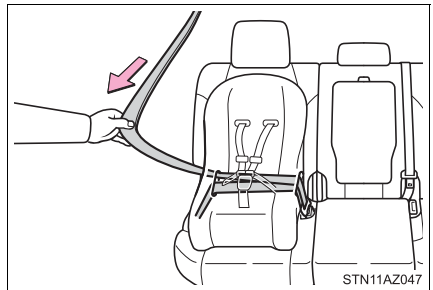

- 4 While pushing the child restraint system into the rear seat, allow the shoulder belt to retract until the child restraint system is securely in place.

After the shoulder belt has retracted to a point where there is no slack in the belt, pull the belt to check that it cannot be extended.

- 5 If the child restraint has a top tether strap, the top tether strap should be latched onto the top tether strap anchor.
(→P. 68, 69, 72)

■ Booster seat

- 1 Place the child restraint system on the seat facing the front of the vehicle.

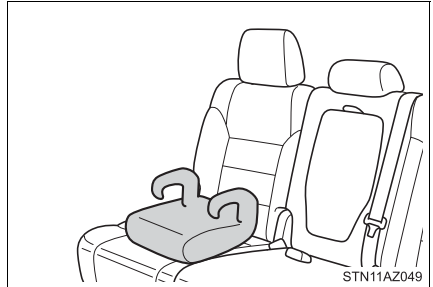
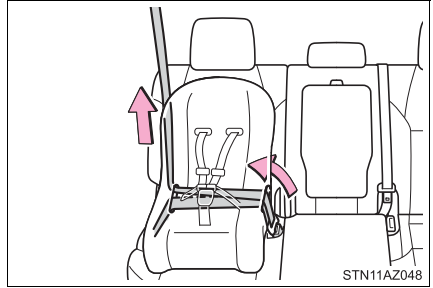

- 2 Sit the child in the child restraint system. Fit the seat belt to the child restraint system according to the manufacturer's instructions and insert the plate into the buckle. Make sure that the belt is not twisted.

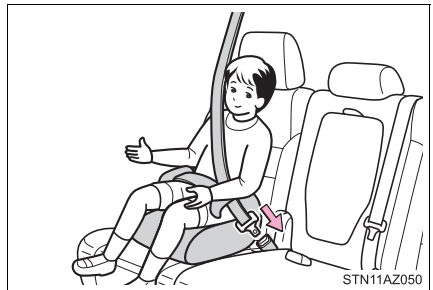

Check that the shoulder belt is correctly positioned over the child's shoulder and that the lap belt is as low as possible. (→P. 32)

Removing a child restraint installed with a seat belt

Push the buckle release button and fully retract the seat belt.

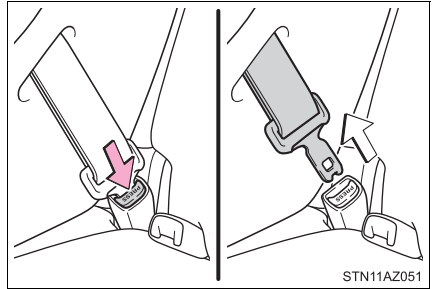

Child restraint systems with a top tether strap (Regular Cab models)

1 Secure the child restraint system using a seat belt.

2 Remove the head restraint.
(→P. 123)

Installing position:

- ① Right side passenger seat
- ② Center passenger seat

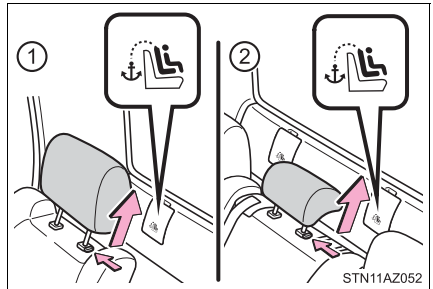

3 Remove the anchor bracket cover.

Installing position:

- ① Right side passenger seat
- ② Center passenger seat

Store the removed cover in a safe place such as the glove box.

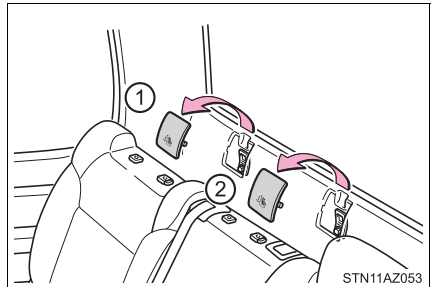

- 4 Latch the hook onto the anchor bracket and tighten the top tether strap.

Make sure the top tether strap is securely latched.

▶ Right side passenger seat

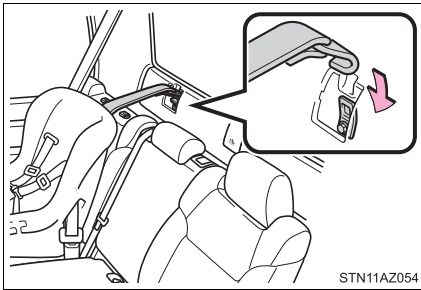

▶ Center passenger seat

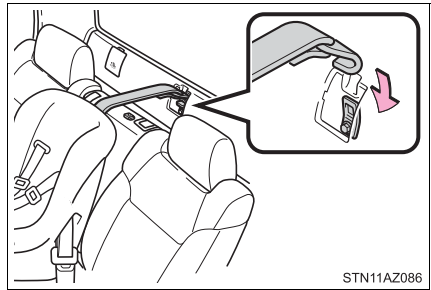

- 5 Replace the head restraint.
(→P. 124)

Installing position:

- ① Right side passenger seat
- ② Center passenger seat

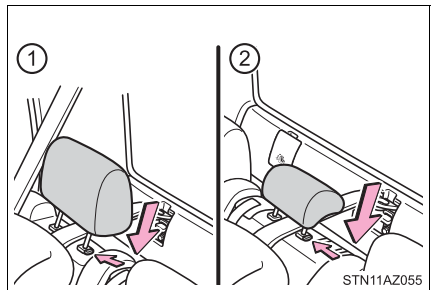

Child restraint systems with a top tether strap (Double Cab models)

■ Right rear seat or center rear seat

- 1 Secure the child restraint system using a seat belt or the lower anchors.
- 2 Remove the head restraints of right and center rear seats.
(→P. 123)

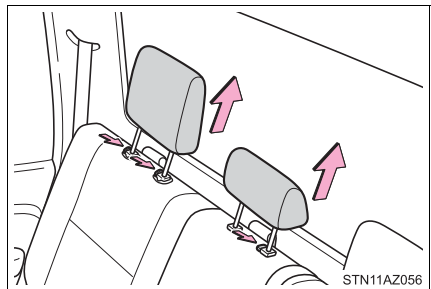

- 3** Pull up the straps of right and center seats.

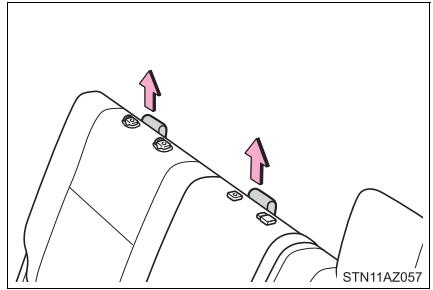

- 4** Route the top tether strap through the anchor strap router as shown in the illustration.

Make sure the top tether strap is not twisted.

- ① Anchor strap router

► Right rear seat

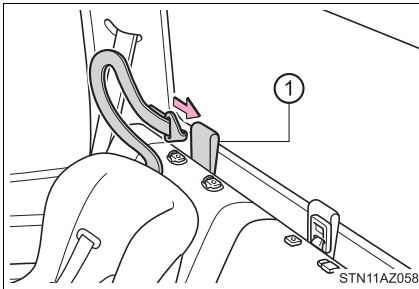

► Center rear seat

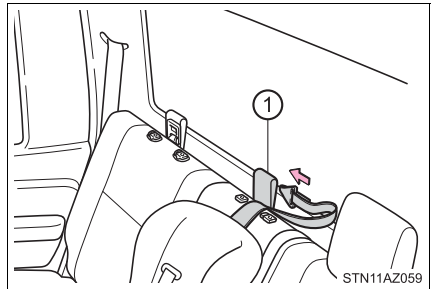

- 5** Latch the hook onto the anchor strap ring and tighten the top tether strap.

Make sure the top tether strap is securely latched.

- ① Anchor strap ring

► Right rear seat

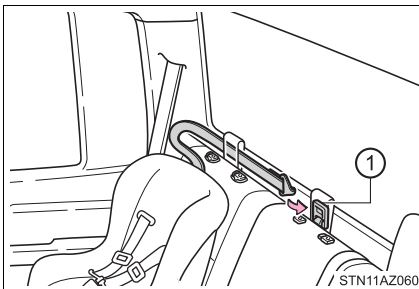

► Center rear seat

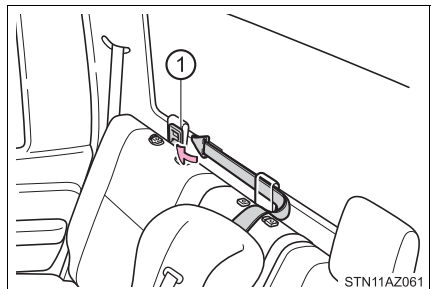

- 6 Replace the head restraints of right and center rear seats. (→P. 124)

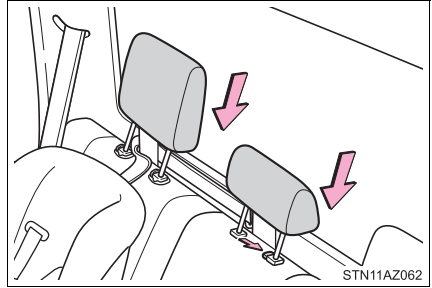

■ Left rear seat

- 1 Secure the child restraint system using a seat belt or the lower anchors.
- 2 Remove the head restraints of center and left rear seats. (→P. 123)

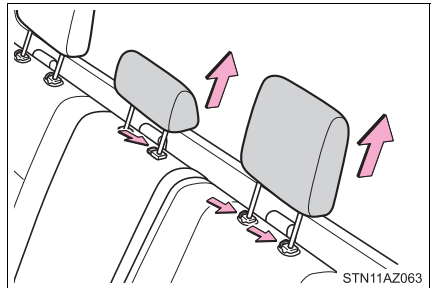

- 3 Pull up the straps of center and left seats.

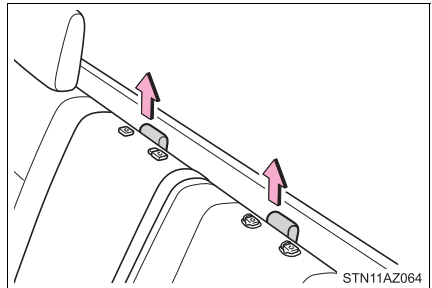

- 4 Route the top tether strap through the anchor strap router as shown in the illustration.

Make sure the top tether strap is not twisted.

- ① Anchor strap router

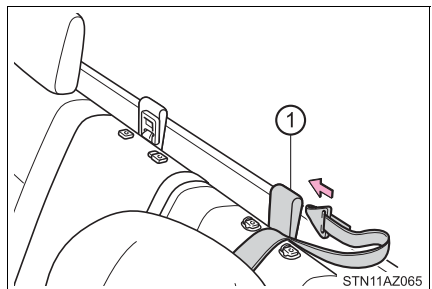

- 5 Latch the hook onto the anchor strap ring and tighten the top tether strap.

Make sure the top tether strap is securely latched.

- ① Anchor strap ring

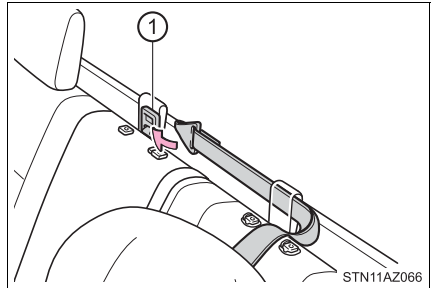

- 6 Replace the head restraints of center and left seats. (→P. 124)

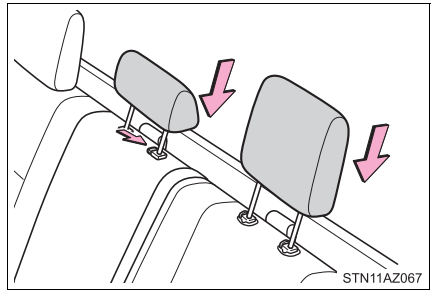

Child restraint systems with a top tether strap (CrewMax models)

■ Right rear seat or center rear seat

- 1 Secure the child restraint system using a seat belt or the lower anchors.
- 2 Remove the head restraints of the right and center rear seats. (→P. 123)

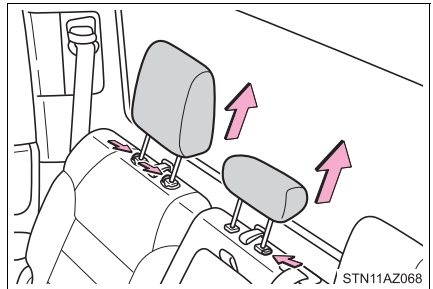

- 3** Route the top tether strap through the anchor strap belt as shown in the illustration.

Make sure the top tether strap is not twisted.

- ① Anchor strap belt

▶ Right rear seat

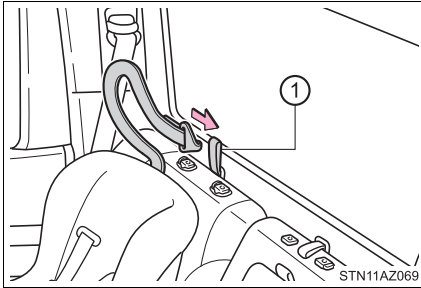

▶ Center rear seat

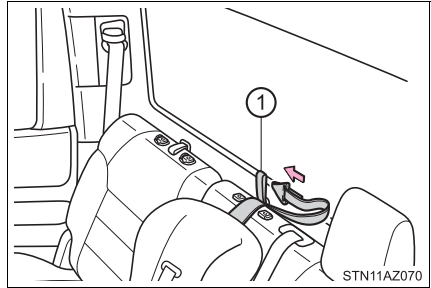

- 4** Latch the hook onto the anchor strap belt and tighten the top tether strap.

Make sure the top tether strap is securely latched.

- ① Anchor strap belt

▶ Right rear seat

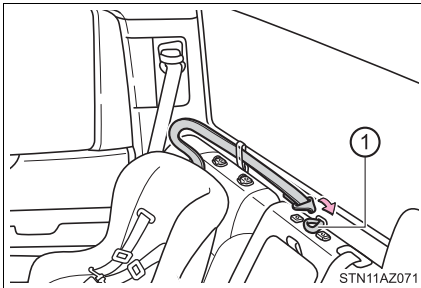

▶ Center rear seat

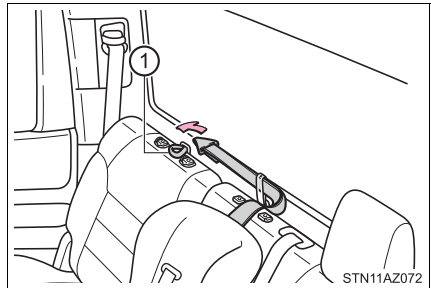

- 5** Replace the head restraints of right and center rear seats. (→P. 124)

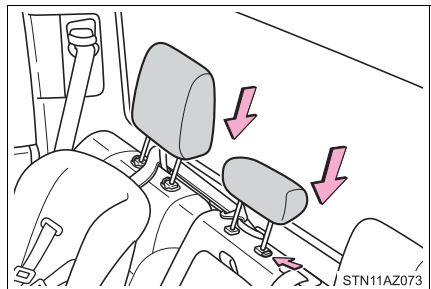

■ Left seat

- 1 Secure the child restraint system using a seat belt or the lower anchors.

- 2 Remove the head restraints of the center and left rear seats. (→P. 123)

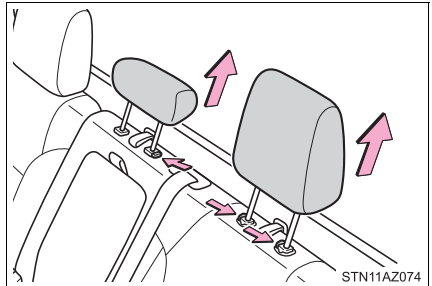

- 3 Route the top tether strap through the anchor strap belt as shown in the illustration.

Make sure the top tether strap is not twisted.

- ① Anchor strap belt

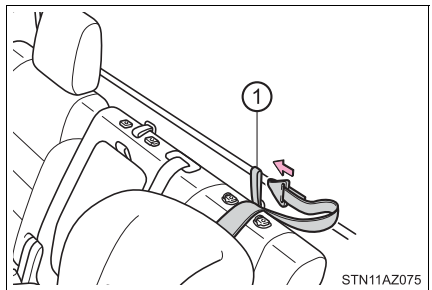

- 4 Latch the hook onto the anchor strap belt and tighten the top tether strap.

Make sure the top tether strap is securely latched.

- ① Anchor strap belt

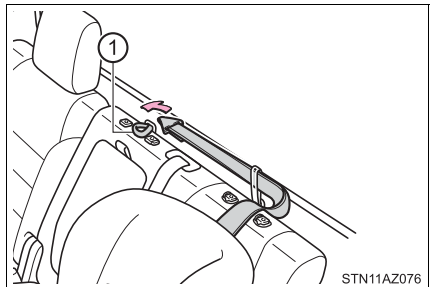

- 5 Replace the head restraints of center and left rear seats. (→P. 124)

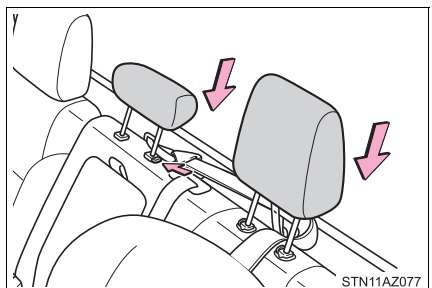

■ Laws and regulations pertaining to anchorages

The LATCH system conforms to FMVSS225 or CMVSS210.2.

Child restraint systems conforming to FMVSS213 or CMVSS213 specifications can be used.

This vehicle is designed to conform to the SAE J1819.

⚠ CAUTION

■ When installing a booster seat

To prevent the belt from going into ALR lock mode, do not fully extend the shoulder belt. ALR mode causes the belt to tighten only. This could cause injury or discomfort to the child. (→P. 34)

■ When installing a child restraint system

Follow the directions given in the child restraint system installation manual and fix the child restraint system securely in place.

If the child restraint system is not correctly fixed in place, the child or other passengers may be seriously injured or even killed in the event of a sudden braking or an accident.

- Double Cab and CrewMax models: If the driver's seat interferes with the child restraint system and prevents it from being attached correctly, attach the child restraint system to the right-hand rear seat.

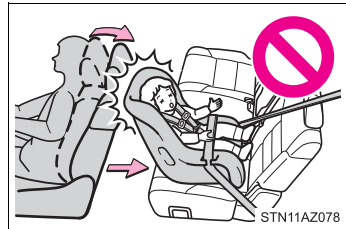

- Double Cab and CrewMax models: Adjust the front passenger seat so that it does not interfere with the child restraint system.

- Only put a forward-facing child restraint system on the front seat when unavoidable. When installing a forward-facing child restraint system on the front passenger seat, move the seat as far back as possible even if the "AIR BAG OFF" indicator light is illuminated. Failure to do so may result in death or serious injury if the airbags deploy (inflate).

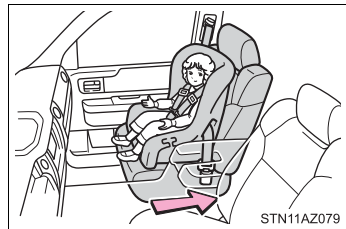

CAUTION

■ When installing a child restraint system

- Regular Cab models: In order to firmly secure the child restraint system, align the seatback angle and seat position of the right passenger seat to match the center passenger seat. Otherwise, it could cause death or injury in an accident.

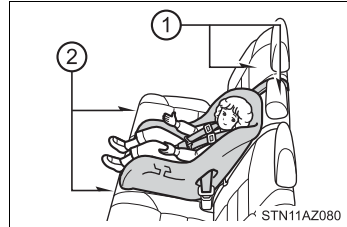

- ① Same angle
- ② Same position

- When a booster seat is installed, always ensure that the shoulder belt is positioned across the center of the child's shoulder. The belt should be kept away from the child's neck, but not so that it could fall off the child's shoulder. Failure to do so may result in death or serious injury in the event of an accident or a sudden braking.
- Ensure that the belt and plate are securely locked and the seat belt is not twisted.
- Shake the child restraint system left and right, and forward and backward to ensure that it has been securely installed.
- After securing a child restraint system, never adjust the seat.
- Follow all installation instructions provided by the child restraint system manufacturer.

■ Do not use a seat belt extender

If a seat belt extender is used when installing a child restraint system, the seat belt will not securely hold the child restraint system, which could cause death or serious injury to the child or other passengers in the event of a sudden braking, sudden swerving or an accident.

■ To correctly attach a child restraint system to the anchors (Double Cab and CrewMax models)

When using the LATCH anchors, be sure that there are no foreign objects around the anchors and that the seat belt is not caught behind the child restraint system. Make sure the child restraint system is securely attached, or it may cause death or serious injury to the child or other passengers in the event of a sudden braking or an accident.

Exhaust gas precautions

Harmful substance to the human body is included in exhaust gases if inhaled.

CAUTION

Exhaust gases include harmful carbon monoxide (CO), which is colorless and odorless. Observe the following precautions.

Failure to do so may cause exhaust gases to enter the vehicle and may lead to an accident caused by light-headedness, or may lead to death or a serious health hazard.

■ Important points while driving

- Double Cab and CrewMax models: Keep the back window closed.
- Double Cab and CrewMax models: If you smell exhaust gases in the vehicle even when the back window is closed, open the windows and have the vehicle inspected at your Toyota dealer as soon as possible.
- Toyota does not recommend occupying the rear cargo area when it is fitted with a slide-in camper, camper shell or other type cover while the engine is running. This caution applies to both driving and stopped or parked situations with the engine running. Particular care should be taken to prevent exhaust gases from entering camper bodies, trailers or other enclosures on or around your vehicle. If exhaust fumes are detected, open all windows and thoroughly ventilate the area.

■ When parking

- If the vehicle is in a poorly ventilated area or a closed area, such as a garage, stop the engine.
- Do not leave the vehicle with the engine on for a long time. If such a situation cannot be avoided, park the vehicle in an open space and ensure that exhaust fumes do not enter the vehicle interior.
- Do not leave the engine running in an area with snow build-up, or where it is snowing. If snowbanks build up around the vehicle while the engine is running, exhaust gases may collect and enter the vehicle.

■ Exhaust pipe

The exhaust system needs to be checked periodically. If there is a hole or crack caused by corrosion, damage to a joint or abnormal exhaust noise, be sure to have the vehicle inspected and repaired by your Toyota dealer.

Engine immobilizer system*

The vehicle's keys have built-in transponder chips that prevent the engine from starting if a key has not been previously registered in the vehicle's on-board computer.

Never leave the keys inside the vehicle when you leave the vehicle.

This system is designed to help prevent vehicle theft but does not guarantee absolute security against all vehicle thefts.

The indicator light flashes after the key has been removed from the engine switch to indicate that the system is operating.

The indicator light stops flashing after the registered key has been inserted into the engine switch to indicate that the system has been canceled.

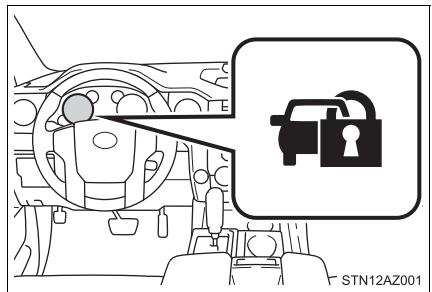

■ System maintenance

The vehicle has a maintenance-free type engine immobilizer system.

■ Conditions that may cause the system to malfunction

- If the grip portion of the key is in contact with a metallic object
- If the key is in close proximity to or touching a key to the security system (key with a built-in transponder chip) of another vehicle

■ Certifications for the engine immobilizer system

- ▶ For vehicles sold in the U.S.A.

FCC ID: MOZRI-21BTY

This device complies with Part 15 of the FCC Rules. Operation is subject to the following two conditions: (1) this device may not cause harmful interference, and (2) this device must accept any interference received, including interference that may cause undesired operation.

- ▶ For vehicles sold in Canada

This device complied with RSS-210 of Industry Canada.

Operation is subject to the following two conditions: (1) this device may not cause interference, and (2) this device must accept any interference, including interference that may cause undesired operation of the device.

CAUTION

■ Certifications for the immobilizer system

Changes or modifications not expressly approved by the party responsible for compliance could void the user's authority to operate the equipment.

NOTICE

■ To ensure the system operates correctly

Do not modify or remove the system. If modified or removed, the proper operation of the system cannot be guaranteed.

Alarm*

The alarm

The alarm uses light and sound to give an alert when an intrusion is detected.

The alarm is triggered in the following situations when the alarm is set:

- A locked door is unlocked or opened in any way other than using a key or wireless remote control. (The doors will lock again automatically.)
- The hood is opened.
- Vehicles with the glass breakage sensor: The side windows are tapped or broken.

Setting the alarm system

Close the doors and hood, and lock all the doors. The system will be set automatically after 30 seconds.

The indicator light changes from being on to flashing when the system is set.

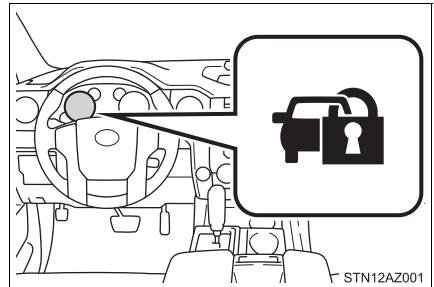

Deactivating or stopping the alarm

Do one of the following to deactivate or stop the alarms:

- Unlock the doors.
- Turn the engine switch to the “ACC” or “ON” position, or start the engine. (The alarm will be deactivated or stopped after a few seconds.)

■ System maintenance

The vehicle has a maintenance-free type alarm system.

■ Items to check before locking the vehicle

To prevent unexpected triggering of the alarm and vehicle theft, make sure of the following:

- Nobody is in the vehicle.
- The windows and moon roof (if equipped) are closed before the alarm is set.
- No valuables or other personal items are left in the vehicle.

■ Triggering of the alarm

The alarm may be triggered in the following situations:
(Stopping the alarm deactivates the alarm system.)

- A person inside the vehicle opens a door or hood.



- The battery is recharged or replaced when the vehicle is locked.

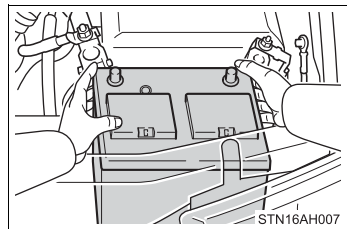

■ Alarm-operated door lock

- When the alarm is operating, the doors are locked automatically to prevent intruders.
- Do not leave the key inside the vehicle when the alarm is operating, and make sure the key is not inside the vehicle when recharging or replacing the battery.

⚠ NOTICE

■ To ensure the system operates correctly

Do not modify or remove the system. If modified or removed, the proper operation of the system cannot be guaranteed.

Instrument cluster

2

2. Instrument cluster

| | |
|-------------------------------------|----|
| Warning lights and indicators | 84 |
| Gauges and meters | 88 |
| Trip information display | 91 |
| Multi-information display | 93 |

Warning lights and indicators

The warning lights and indicators on the instrument cluster and center panel inform the driver of the status of the vehicle's various systems.

For the purpose of explanation, the following illustration displays all warning lights and indicators illuminated.

► Vehicles without multi-information display

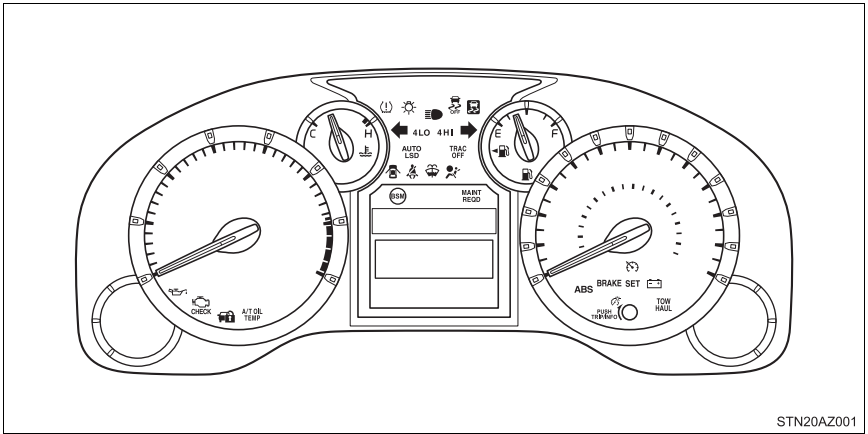



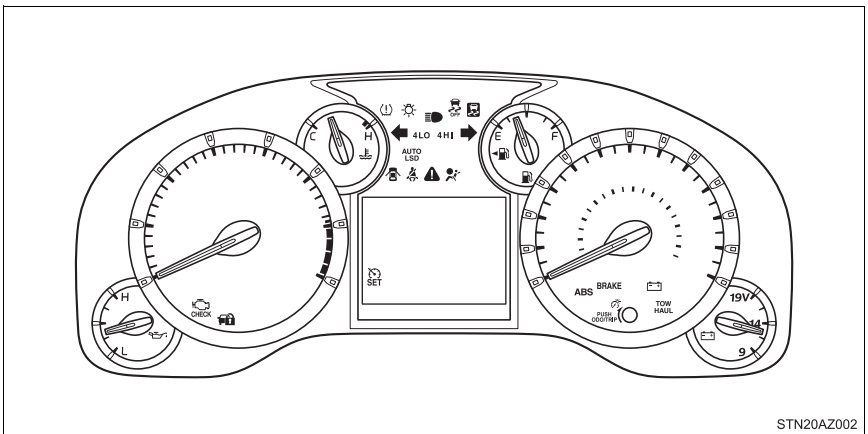















► Vehicles with multi-information display



Warning lights

Warning lights inform the driver of malfunctions in the indicated vehicle's systems.

| | | | |
|---|--|---|---|
| <p>*1</p>  <p>(U.S.A.)</p> | <p>Brake system warning light (→P. 464)</p> | <p>*1, 2</p>  <p>(If equipped)</p> | <p>BSM warning light (→P. 465)</p> |
| <p>*1</p>  <p>(Canada)</p> | <p>Brake system warning light (→P. 464)</p> | <p>*1, 2</p>  | <p>Automatic transmission fluid temperature warning light (→P. 466)</p> |
| <p>*1</p>  | <p>Charging system warning light (→P. 464)</p> |  | <p>Open door warning light (→P. 466)</p> |
| <p>*1, 2</p>  | <p>Low engine oil pressure warning light (→P. 464)</p> |  | <p>Low fuel level warning light (→P. 466)</p> |
| <p>*1</p>  <p>CHECK</p> | <p>Malfunction indicator lamp (→P. 464)</p> |  | <p>Seat belt reminder light (→P. 466)</p> |
| <p>*1</p>  | <p>SRS warning light (→P. 465)</p> | <p>*1, 4</p>  | <p>Master warning light (→P. 466)</p> |
| <p>*1</p>  <p>(U.S.A.)</p> | <p>ABS warning light (→P. 465)</p> | <p>*1</p>  | <p>Tire pressure warning light (→P. 467)</p> |
| <p>*1</p>  <p>(Canada)</p> | <p>ABS warning light (→P. 465)</p> | <p>*1, 2</p>  | <p>Low washer fluid warning light (→P. 467)</p> |
| <p>*1, 3</p>  | <p>Slip indicator (→P. 465)</p> | <p>*1, 2</p>  <p>(U.S.A.)</p> | <p>Maintenance required reminder light (→P. 467)</p> |
| <p>(Flashes)</p>  | <p>Cruise control indicator light (→P. 465)</p> | | |

- *1: These lights turn on when the engine switch is turned to the “ON” position to indicate that a system check is being performed. They will turn off after the engine is started, or after a few seconds. There may be a malfunction in a system if a lights does not come on, or if the lights do not turn off. Have the vehicle inspected by your Toyota dealer for details.
- *2: Vehicles without multi-information display
- *3: The light comes on to indicate a malfunction.
- *4: Vehicles with multi-information display

Indicators

The indicators inform the driver of the operating state of the vehicle's various systems.



Turn signal indicator
(→P. 186)

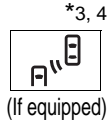

BSM outside rear view mirror indicator
(→P. 218)



(U.S.A.)

Headlight indicator
(→P. 189)



(If equipped)

Security indicator
(→P. 78, 80)



(Canada)

Tail light indicator
(→P. 189)



“AUTO LSD” indicator
(→P. 229, 232)



Headlight high beam indicator (→P. 190)

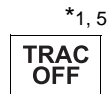

“TRAC OFF” indicator
(→P. 232, 234, 236)



Cruise control indicator
(→P. 200)



“AIR BAG ON” and
“AIR BAG OFF”
indicators (→P. 50)



Cruise control “SET” indicator (→P. 200)



Slip indicator
(→P. 230, 232)



(4WD models)

“4HI” indicator (→P. 226)



VSC off indicator
(→P. 229, 232, 234, 236)

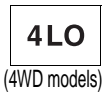

(4WD models)

“4LO” indicator (→P. 226)



(If equipped)

“TOW HAUL” indicator
(→P. 184)

- *1: These lights turn on when the engine switch is turned to the “ON” position to indicate that a system check is being performed. They will turn off after the engine is started, or after a few seconds. There may be a malfunction in a system if a light does not come on, or if the lights do not turn off. Have the vehicle inspected by your Toyota dealer for details.
- *2: The light flashes to indicate that the system is operating.
- *3: In order to confirm operation, the BSM outside rear view mirror indicators illuminate in the following situations:
 - When the engine switch is turned to the “ON” position while the BSM main switch is set to ON.
 - When the BSM main switch is set to ON while the engine switch is in the “ON” position.

If the system is functioning correctly, the BSM outside rear view mirror indicators will turn off after a few seconds.
If the BSM outside rear view mirror indicators do not illuminate or do not turn off, there may be a malfunction with the system.
If this occurs, have the vehicle inspected by your Toyota dealer.
- *4: The light illuminates on the outside rear view mirrors.
- *5: Vehicles without multi-information display
- *6: The light illuminates on the center panel.

**CAUTION****■ If a safety system warning light does not come on**

Should a safety system light such as the ABS and SRS warning light not come on when you start the engine, this could mean that these systems are not available to help protect you in an accident, which could result in death or serious injury. Have the vehicle inspected by your Toyota dealer immediately if this occurs.

Gauges and meters

► Vehicles without multi-information display

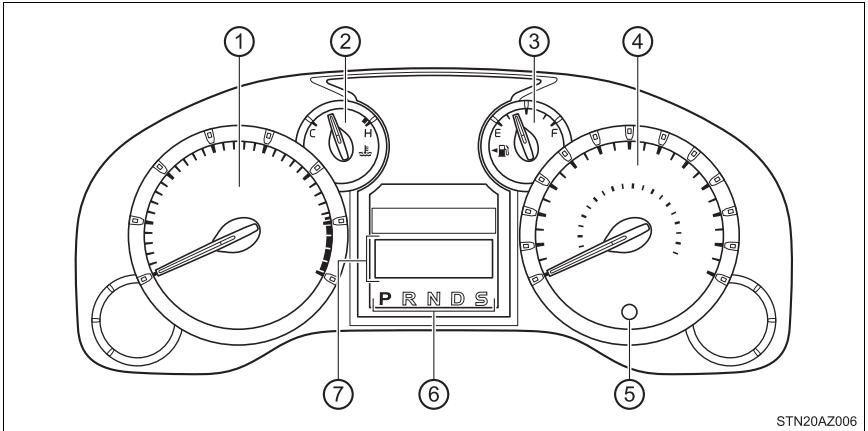

STN20AZ006

- ① **Tachometer**
Displays the engine speed in revolutions per minute
- ② **Engine coolant temperature gauge**
Displays the engine coolant temperature
- ③ **Fuel gauge**
Displays the quantity of fuel remaining in the tank
- ④ **Speedometer**
Displays the vehicle speed
- ⑤ **“TRIP/INFO” and instrument panel light control button**
→P. 90, 91
- ⑥ **Shift position**
Displays the selected shift position (→P. 181)
- ⑦ **Trip information display**
Presents the driver with a variety of driving-related data (→P. 91)

► Vehicles with multi-information display

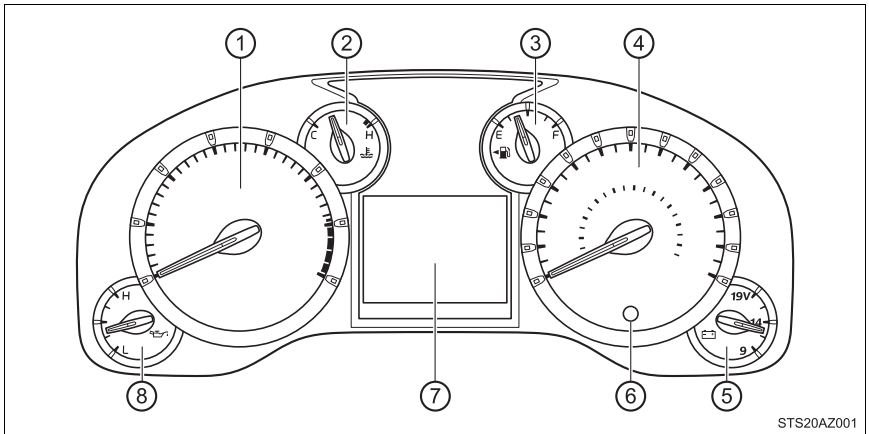

- ① **Tachometer**
Displays the engine speed in revolutions per minute
- ② **Engine coolant temperature gauge**
Displays the engine coolant temperature
- ③ **Fuel gauge**
Displays the quantity of fuel remaining in the tank
- ④ **Speedometer**
Displays the vehicle speed
- ⑤ **Voltmeter**
Displays the charge state
- ⑥ **“ODO/TRIP” and instrument panel light control button**
→P. 90, 93
- ⑦ **Multi-information display**
Presents the driver with a variety of driving-related data (→P. 93)
- ⑧ **Engine oil pressure gauge**
Displays the engine oil pressure

Instrument panel light control

The brightness of the instrument panel lights can be adjusted by turning the “TRIP/INFO” button (vehicles without multi-information display) or “ODO/TRIP” button (vehicles with multi-information display).

- ① Darker
- ② Brighter

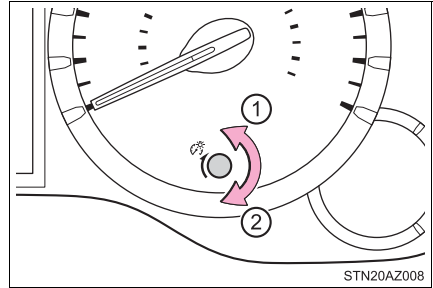

■ The meters and display illuminate when

The engine switch is in the “ON” position.

NOTICE

■ To prevent damage to the engine and its components

- Do not let the indicator needle of the tachometer enter the red zone, which indicates the maximum engine speed.
- The engine may be overheating if the engine coolant temperature gauge is in the red zone (H). In this case, immediately stop the vehicle in a safe place, and check the engine after it has cooled completely. (→P. 496)

Trip information display*

Display contents

The trip information display presents the driver with a variety of driving-related data including the current outside air temperature.

- Trip information (→P. 91)

Displays trip meters, fuel consumption, driving range and outside temperature

- Odometer

Displays the total distance the vehicle has been driven.

- Shift range

Displays the selected shift range.
(→P. 181)

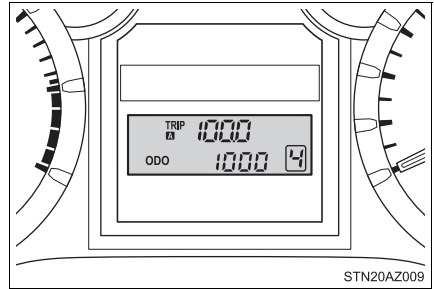

Trip information

- Switching the display

Items displayed can be switched by pushing the “TRIP/INFO” button.

Push and hold the “TRIP/INFO” button to change the units to US (ENGLISH) or METRIC.
(→P. 92)

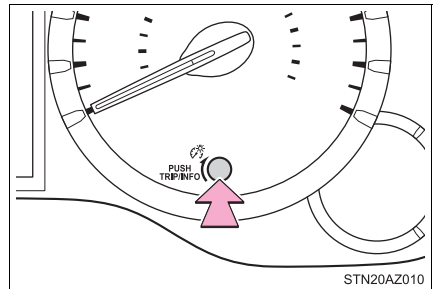

- Trip meters “A” and “B”

Displays the distance the vehicle has been driven since the meter was last reset. Trip meters “A” and “B” can be used to record and display different distances independently.

Pushing and holding the “TRIP/INFO” button will reset the trip meter that is currently displayed.

■ Average fuel consumption

Displays the average fuel consumption since the function was reset

- The function can be reset by pushing the “TRIP/INFO” button for longer than 1 second when the average fuel consumption is displayed.
- Use the displayed average fuel consumption as a reference.

■ Driving range

Displays the estimated approximate distance that can be driven with the quantity of fuel remaining

- This distance is computed based on your average fuel consumption. As a result, the actual distance that can be driven may differ from that displayed.
- When only a small amount of fuel is added to the tank, the display may not be updated.
When refueling, turn the engine switch off. If the vehicle is refueled without turning the engine switch off, the display may not be updated.

■ Outside temperature

→P. 376

■ When disconnecting and reconnecting battery terminals

The following information data will be reset:

- Trip meters “A” and “B”
- Average fuel consumption
- Driving range

■ Liquid crystal display

Small spots or light spots may appear on the display. This phenomenon is characteristic of liquid crystal displays, and there is no problem continuing to use the display.

■ To select the US (ENGLISH) or METRIC

| Information | US (ENGLISH) | METRIC |
|-----------------------------|--------------|----------|
| Average fuel consumption | MPG | L/100 km |
| Driving range | miles | km |
| Outside temperature display | °F | °C |



NOTICE

■ The trip information display at low temperatures

Allow the interior of the vehicle to warm up before using the liquid crystal information display. At extremely low temperatures, the information display monitor may respond slowly, and display changes may be delayed.

Multi-information display*

Display contents

The multi-information display presents the driver with a variety of driving-related data including the current outside air temperature.

- Trip information (→P. 94)

Displays fuel consumption, driving range, outside temperature and other cruising related information.

- Shift position and shift range

Displays the selected shift position and shift range. (→P. 181)

- Odometer and trip meter display (→P. 93)

- Turn-by-turn navigation (vehicles with navigation system) (→P. 97)

- Intuitive parking assist display (if equipped) (→P. 203)

Automatically displayed when the system is used. Display can be switched by pressing the “DISP” button on the steering wheel. (→P. 94)

- Warning messages (→P. 472)

Automatically displayed when a malfunction occurs in one of the vehicle's systems. Display can be switched by pressing the “DISP” button on the steering wheel. (→P. 94)

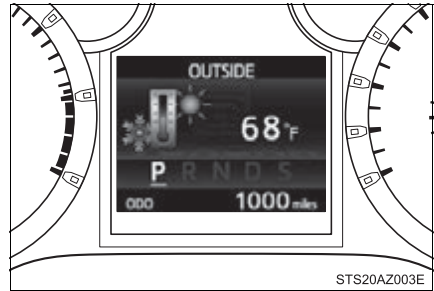

Odometer and trip meters

- Switching the display

Items displayed can be switched by pushing the “ODO/TRIP” button.

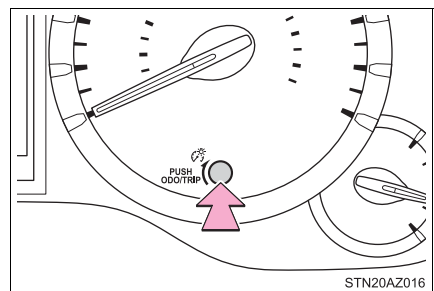

■ Odometer

Displays the total distance the vehicle has been driven

■ Trip meters “A” and “B”

Displays the distance the vehicle has been driven since the meter was last reset. Trip meters “A” and “B” can be used to record and display different distances independently.

Pushing and holding the “ODO/TRIP” button will reset the trip meter that is currently displayed.

Trip information

■ Switching the display

Items displayed can be switched by pressing the “DISP” button.

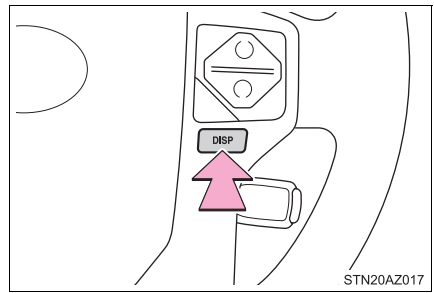

■ Average fuel consumption

Displays the average fuel consumption since the function was reset

- The function can be reset by pressing the “DISP” button for longer than 1 second when the average fuel consumption is displayed.
- Use the displayed average fuel consumption as a reference.

■ Current fuel consumption

Displays the current rate of fuel consumption

■ Driving range

Displays the estimated approximate distance that can be driven with the quantity of fuel remaining

- This distance is computed based on your average fuel consumption. As a result, the actual distance that can be driven may differ from that displayed.
- When only a small amount of fuel is added to the tank, the display may not be updated.
When refueling, turn the engine switch off. If the vehicle is refueled without turning the engine switch off, the display may not be updated.
- The display shows “LOW FUEL” instead of “0 miles” at very low fuel levels.

■ Elapsed time

Displays the elapsed time since the engine was started

■ Average vehicle speed

Displays the average vehicle speed since the engine was started

■ Outside temperature

→P. 376

■ Settings display

→P. 95

■ Display off

A blank screen is displayed

Setting up the displays

■ Before setting

- 1 Press the “DISP” button until the “SETTINGS” screen appears.

This can only be done while the vehicle is stopped.

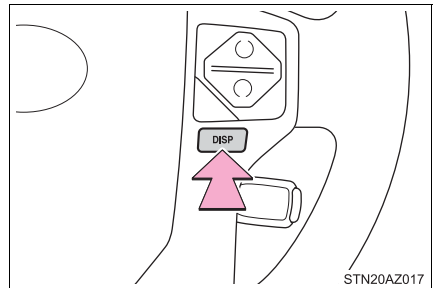

- 2 Press and hold the “DISP” button until the screen changes.



- 3 Press and hold the “DISP” button after selecting the desired setting item (“TURN BY TURN NAVI”, “LANGUAGE” or “UNITS”) by pressing the “DISP” button.



■ Setting the turn-by-turn navigation (vehicles with navigation system)

- 1 Selecting “TURN BY TURN NAVI” on the menu screen.
- 2 Select the turn-by-turn navigation system on or off.

Press and hold the “DISP” button to input your choice.



■ Selecting the language

- 1 Selecting “LANGUAGE” on the menu screen.
- 2 Select the desired language.

Press and hold the “DISP” button to input your choice.



■ Selecting the units

- 1 Selecting “UNITS” on the menu screen.
- 2 Select the desired item on the unit screen. (→P. 98)

Press and hold the “DISP” button to input your choice.



■ Returning the previous screen

Press and hold the “DISP” button after selecting the “EXIT” by pressing the “DISP” button.



■ Turn-by-turn navigation (vehicles with navigation system)

The turn-by-turn navigation appears only while route guidance of the navigation system is being performed. When a turn approaches, the distance to the turn and the turn direction are displayed.

- The image shown may differ from the actual intersection.
- The turn-by-turn navigation can be set to on or off using the customization feature. (→P. 95)

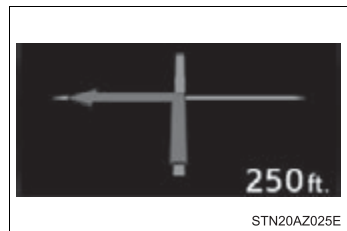

■ When disconnecting and reconnecting battery terminals

The following information data will be reset:

- Trip meters “A” and “B”
- Average fuel consumption
- Driving range
- Elapsed time
- Average vehicle speed

■ Liquid crystal display

Small spots or light spots may appear on the display. This phenomenon is characteristic of liquid crystal displays, and there is no problem continuing to use the display.

■ To select the units

| Information | miles (MPG US) | km (L/100km) |
|-----------------------------|----------------|--------------|
| Average fuel consumption | MPG | L/100km |
| Driving range | miles | km |
| Outside temperature display | °F | °C |

**NOTICE****■ The multi-information display at low temperatures**

Allow the interior of the vehicle to warm up before using the liquid crystal information display. At extremely low temperatures, the information display monitor may respond slowly, and display changes may be delayed.

Operation of each component

3

- | | |
|--|---|
| <p>3-1. Key information Keys 100</p> <p>3-2. Opening, closing and locking the doors Side doors 102 Tailgate 108</p> <p>3-3. Adjusting the seats Front seats 113 Rear seats (Double Cab and CrewMax models) 116 Driving position memory (driver's seat) 118 Head restraints 122</p> <p>3-4. Adjusting the steering wheel and mirrors Steering wheel 126 Inside rear view mirror 129 Outside rear view mirrors 132</p> | <p>3-5. Opening, closing the windows and moon roof Power windows 136 Back window 139 Power back window 140 Moon roof 142</p> |
|--|---|

Keys

The keys

The following keys are provided with the vehicle.

▶ Vehicles without engine immobilizer system

- ① Keys
- ② Key number plate

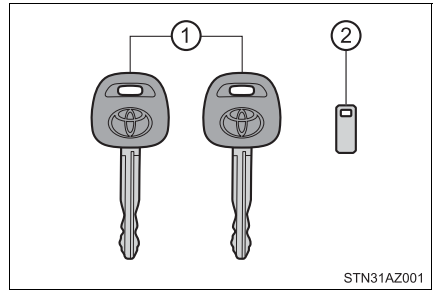

▶ Vehicles with engine immobilizer system

- ① Keys
- ② Key number plate

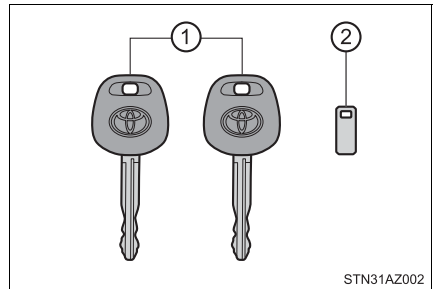

■ If you lose your keys

New genuine key can be made by your Toyota dealer using the other key and the key number stamped on your key number plate.

Keep the plate in a safe place such as your wallet, not in the vehicle.

**NOTICE****■ To prevent key damage (vehicles with engine immobilizer system)**

- Do not drop the keys, subject them to strong shocks or bend them.
- Do not expose the keys to high temperatures for long periods of time.
- Do not get the keys wet or wash them in an ultrasonic washer, etc.
- Do not attach metallic or magnetic materials to the keys or place the keys close to such materials.
- Do not place the keys near objects that produce magnetic fields, such as TVs, audio systems and induction cookers, or medical electrical equipment, such as low-frequency therapy equipment.

Side doors

Unlocking and locking the doors from the outside

◆ Key

► Vehicles without power door lock system

- ① Locks the door
- ② Unlocks the door

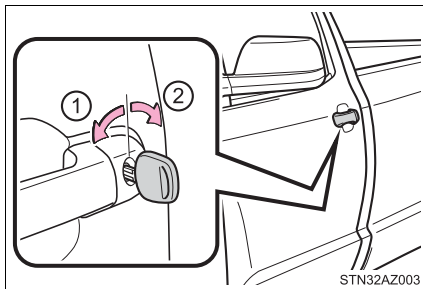

► Vehicles with power door lock system

- ① Locks all the doors
- ② Unlocks all the doors

Turning the key unlocks the driver's door. Turning the key again unlocks the other doors.

Vehicles with moon roof:

- ③ Closes the moon roof (turn and hold)
- ④ Opens the moon roof (turn and hold)

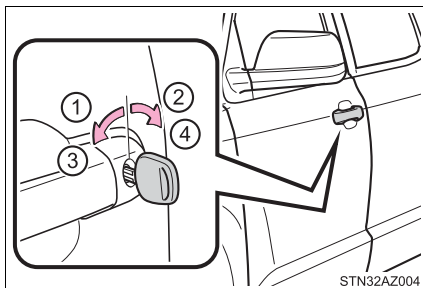

◆ Wireless remote control (if equipped)

- ① Locks all the doors
- ② Unlocks all the doors

Pressing the button unlocks the driver's door. Pressing the button again within 3 seconds unlocks the other doors.

- ③ Sounds the alarm
(press and hold) (→P. 103)

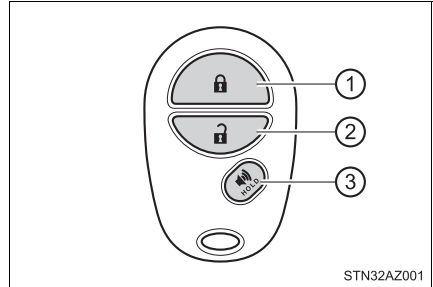

■ Operation signals (vehicles with wireless remote control)

A buzzer sounds and the emergency flashers flash to indicate that the doors have been locked/unlocked. (Locked: once; Unlocked: twice)

■ Door lock buzzer (vehicles with wireless remote control)

If an attempt to lock the doors is made when a door is not fully closed, a buzzer sounds continuously for 5 seconds. Fully close the door to stop the buzzer, and lock the vehicle once more.

■ Panic mode (vehicles with wireless remote control)

When  is pressed for longer than about 1 second, an alarm will sound intermittently and the vehicle lights will flash to deter any person from trying to break into or damage your vehicle.

To stop the alarm, press any button on the wireless remote control.



■ Security feature (vehicles with wireless remote control)

If a door is not opened within approximately 60 seconds after the vehicle is unlocked, the security feature automatically locks the vehicle again.

■ Alarm (if equipped)

Using the wireless remote control to lock the doors will set the alarm system. (→P. 80)

■ Conditions affecting operation (vehicles with wireless remote control)

The wireless remote control function may not operate normally in the following situations.

- Near a TV tower, radio station, electric power plant, airport or other facility that generates strong radio waves
- When carrying a portable radio, cellular phone or other wireless communication device
- When multiple wireless keys are in the vicinity
- When the wireless key has come into contact with, or is covered by a metallic object
- When a wireless key (that emits radio waves) is being used nearby
- When the wireless key has been left near an electrical appliance such as a personal computer

■ Wireless remote control battery depletion (vehicles with wireless remote control)

If the wireless remote control function does not operate, the battery may be depleted. Replace the battery when necessary. (→P. 434)

■ When riding in an aircraft (vehicles with wireless remote control)

When bringing a wireless key onto an aircraft, make sure you do not press any buttons on the wireless key while inside the aircraft cabin. If you are carrying a wireless key in your bag, etc., ensure that the buttons are not likely to be pressed accidentally. Pressing a button may cause the wireless key to emit radio waves that could interfere with the operation of the aircraft.

■ Certification for wireless remote control (vehicles with wireless remote control)

- ▶ For vehicles sold in the U.S.A.

NOTE:

This device complies with part 15 of the FCC Rules. Operation is subject to the following two conditions: (1) this device may not cause harmful interference, and (2) this device must accept any interference received, including interference that may cause undesired operation.

- ▶ For vehicles sold in Canada

NOTE:

Operation is subject to the following two conditions: (1) This device may not cause interference, and (2) this device must accept any interference, including interference that may cause undesired operation of the device.

Unlocking and locking the doors from the inside

■ Door lock switch (if equipped)

- ① Locks all the doors
- ② Unlocks all the doors

▶ Driver's door lock switch

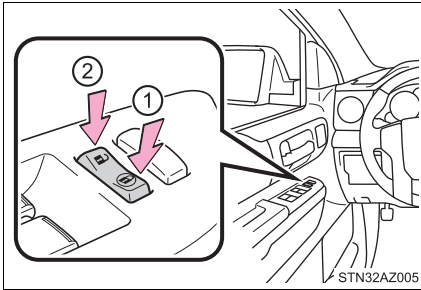

▶ Passenger's door lock switch

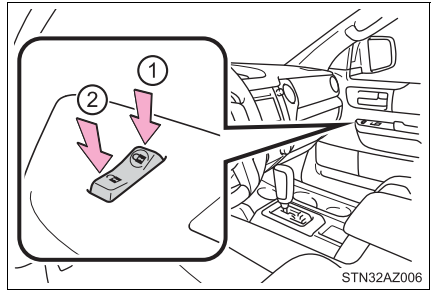

■ Inside lock buttons

- ① Locks the door
- ② Unlocks the door

The front doors can be opened even if the lock buttons are in the lock position.

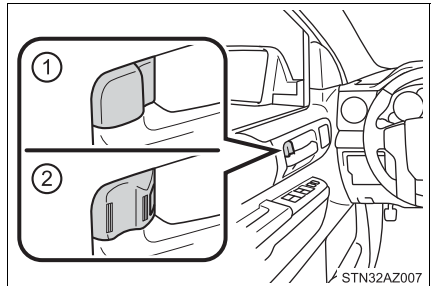

Locking the front doors from the outside without a key

- 1 Move the inside lock button to the lock position.
- 2 Close the door.

Vehicles with power door lock system:

The door cannot be locked if either of the front doors is open and the key is in the engine switch.

Rear door child-protector lock (Double Cab and CrewMax models)

The door cannot be opened from inside the vehicle when the lock is set.

- ① Unlock
- ② Lock

These locks can be set to prevent children from opening the rear doors. Push down on each rear door switch to lock both rear doors.

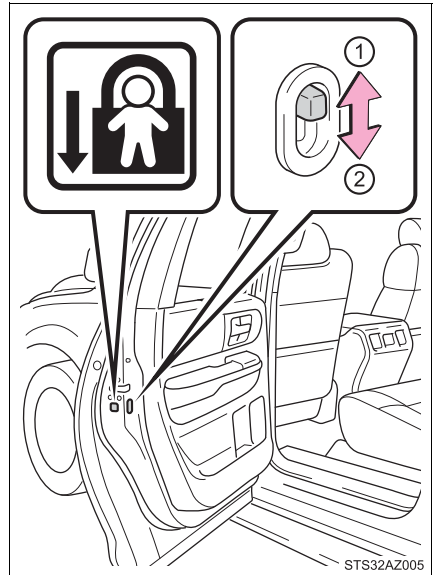

Automatic door locking and unlocking systems (vehicles with power door lock system)

The following functions can be set or canceled:

| Function | Operation |
|---|---|
| Shift position linked door locking function | Shifting the shift lever out of P locks all the doors. |
| Shift position linked door unlocking function | Shifting the shift lever to P unlocks all the doors. |
| Speed linked door locking function | All the doors are locked when the vehicle speed is approximately 12 mph (20 km/h) or higher. |
| Driver's door linked door unlocking function | All the doors are unlocked when the driver's door is opened within 10 seconds after turning the engine switch to the "LOCK" position. |

■ Customization that can be configured at Toyota dealer

Settings (e.g. unlocking function using a key) can be changed.
(Customizable features: →P. 530)

⚠ CAUTION**■ To prevent an accident**

Observe the following precautions while driving the vehicle.

Failure to do so may result in a door opening and an occupant throwing out of the vehicle, resulting in death or serious injury.

- Ensure that all doors are properly closed and locked.
- Do not pull the inside handle of the doors while driving.
Be especially careful for the front doors, as the doors may be opened even if the inside lock buttons are in locked position.
- Double Cab and CrewMax models: Set the rear door child-protector locks when children are seated in the rear seats.

Tailgate

The tailgate can be opened using the tailgate handle. The tailgate can be locked/unlocked using a key.

Locking/unlocking the tailgate

- ① Unlock the tailgate
- ② Lock the tailgate

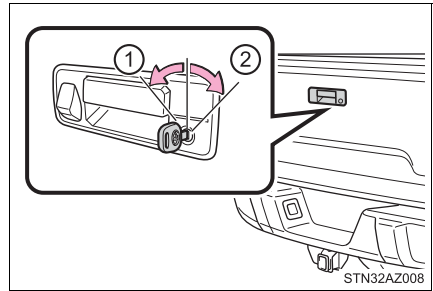

Opening/closing the tailgate

- ① Pull the handle
- ② Open the tailgate slowly
The support cables will hold the tailgate horizontal.
- ③ Lift and closing the tailgate
After closing the tailgate, try pulling it toward you to make sure it is securely locked.

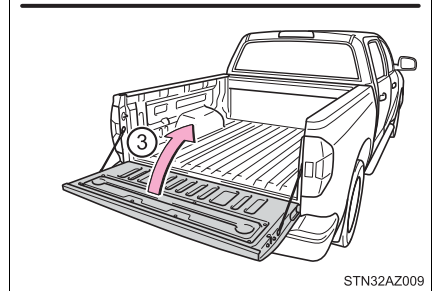
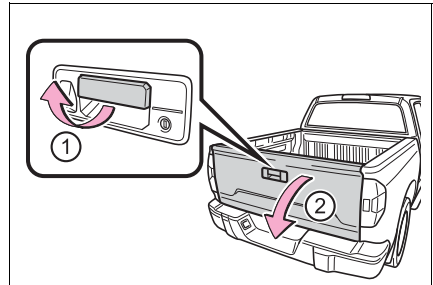

Removing the tailgate

■ Before removing the tailgate

These connector covers are used when removing the tailgate, to prevent the back-up camera wire harness connectors from being contaminated.

- (A) Connector cover (Gray)
- (B) Connector cover (White)

Store the connector covers in the glove box in a plastic bag when not using.

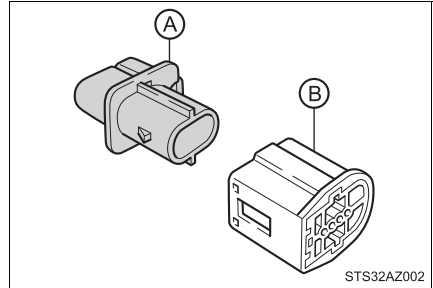

- 1 To disconnect the wire harness connectors (1) and (2), depress small plastic tab on connector (1) and pull apart from connector (2).

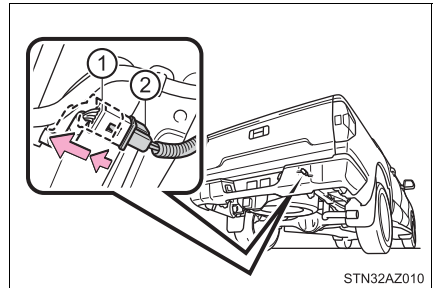

- (1) Tailgate wire harness connector (White)
- (2) Frame wire harness connector (Gray)

- 2 Attach the connector cover (White) to the frame wire harness connector (Gray).

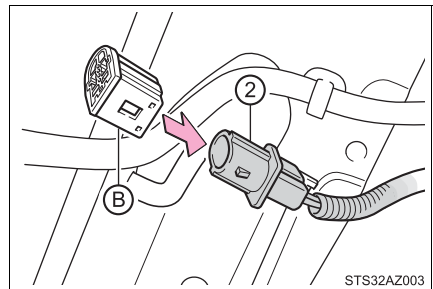

- (B) Connector cover (White)
- (2) Frame wire harness connector (Gray)

- 3 Open the tailgate.

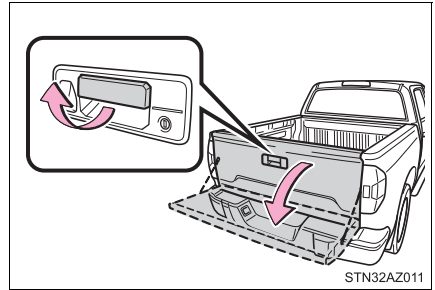

- 4 Pull out the plastic wire protector located in the vehicle bed by pressing the tabs and pulling the protector.

Ⓒ Plastic wire protector

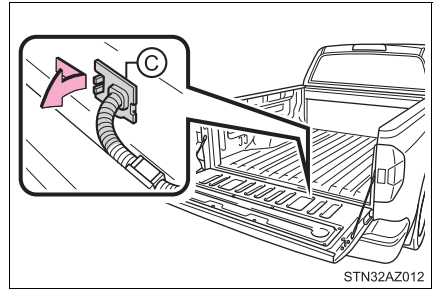

- 5 Pull out the wire harness from the vehicle bed.

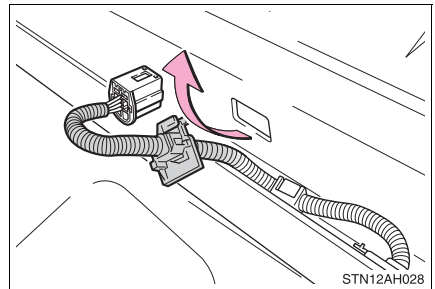

- 6 Attach the connector cover (Gray) to the tailgate wire harness connector (White).

① Tailgate wire harness connector (White)

Ⓐ Connector cover (Gray)

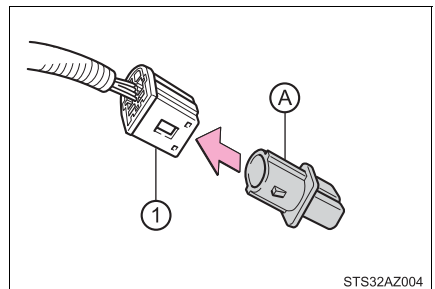

■ Removing the tailgate

- 1 Open the tailgate to the angle where you can release the brackets on the support cables from the lugs on both sides. Lift the support cable bracket up and slide it off.

To unhook the support cable bracket, keep pulling up the clip on the bracket and unhook the bracket.

- ① Support cable bracket
- ② Clip

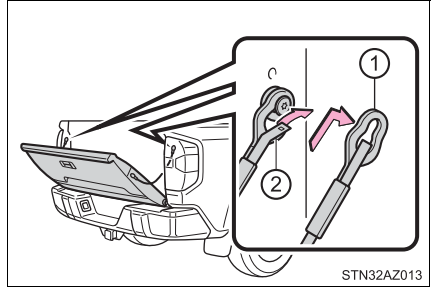

STN32AZ013

- 2 Tilt the tailgate to about 45° from vertical and pull up the right side of the tailgate to unhook the right side.

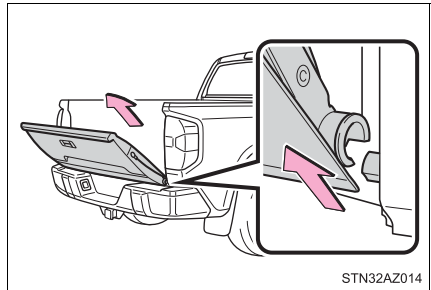

STN32AZ014

- 3 Tilt the tailgate up to 15°.

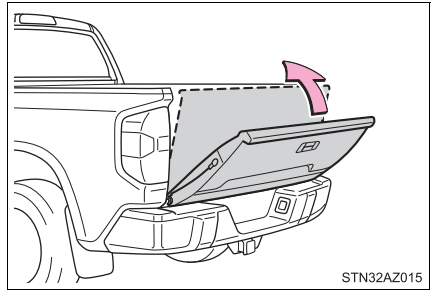

STN32AZ015

- 4 Slide the tailgate a little to the right to unhook the left side.

To attach the tailgate, follow the removal procedure in reverse order.

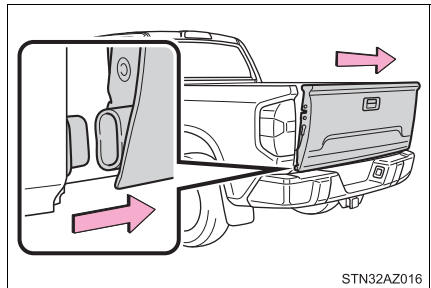

STN32AZ016

Rear step bumper

For rear end protection and easier step-up loading.

To get on the rear step bumper, use the shaded area in the illustration.

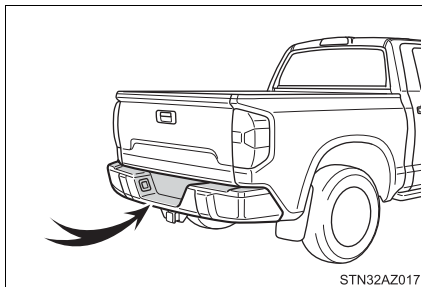

CAUTION

■ Before removing the tailgate

Disconnect the wire harness between the back-up camera and the vehicle. Failure to do so may result in serious personal injury or damage to the vehicle components.

■ Caution while driving

Observe the following precautions.

Failure to do so may result in death or serious personal injury.

- Do not drive with the tailgate open.
- Do not allow others to get on the rear step bumper.

NOTICE

■ To prevent damage to the tailgate wire harness

Do not pull out all of the tailgate wire harness before opening the tailgate.

■ To prevent damage to the camera lens

Store the removed tailgate with the back-up camera lens facing upward.

■ After closing the tailgate

Try pulling it toward you to make sure it is securely locked.

■ To prevent damage to the rear step bumper

Do not allow more than one person to get on the rear step bumper at a time.

Front seats

Adjustment procedure (separated type seats)

■ Driver's seat

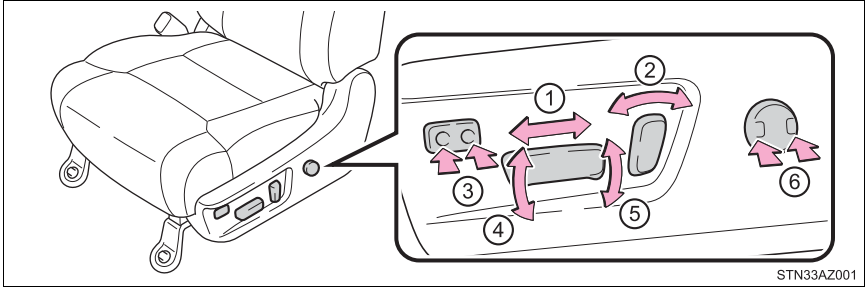

- | | |
|---|--|
| ① Seat position adjustment switch | ④ Seat cushion (front) angle adjustment switch |
| ② Seatback angle adjustment switch | ⑤ Seat vertical height adjustment switch |
| ③ Seat cushion length adjustment switch (if equipped) | ⑥ Seat lumbar support adjustment switch |

■ Passenger's seat

► Manual seat

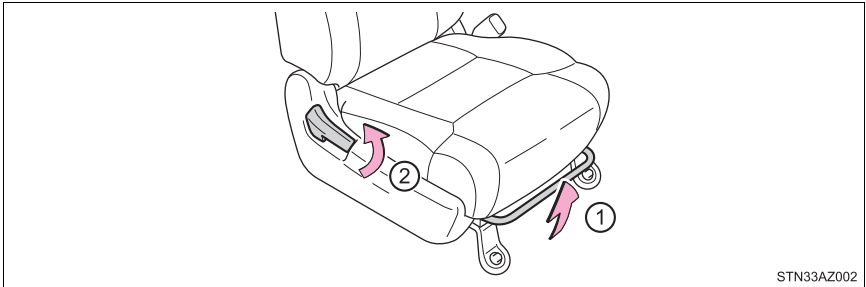

- | | |
|----------------------------------|-----------------------------------|
| ① Seat position adjustment lever | ② Seatback angle adjustment lever |
|----------------------------------|-----------------------------------|

► Power seat

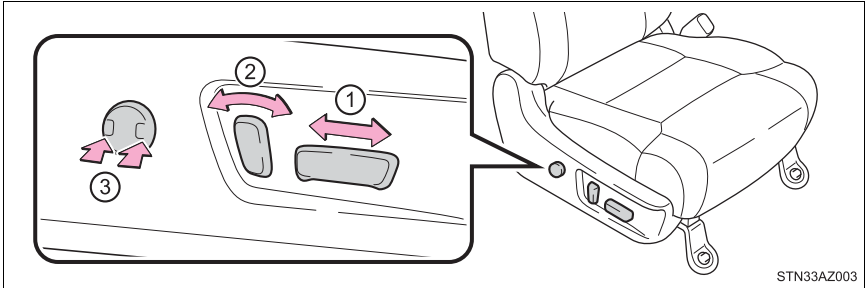

STN33AZ003

- ① Seat position adjustment switch ③ Seat lumbar support adjustment switch
- ② Seatback angle adjustment switch

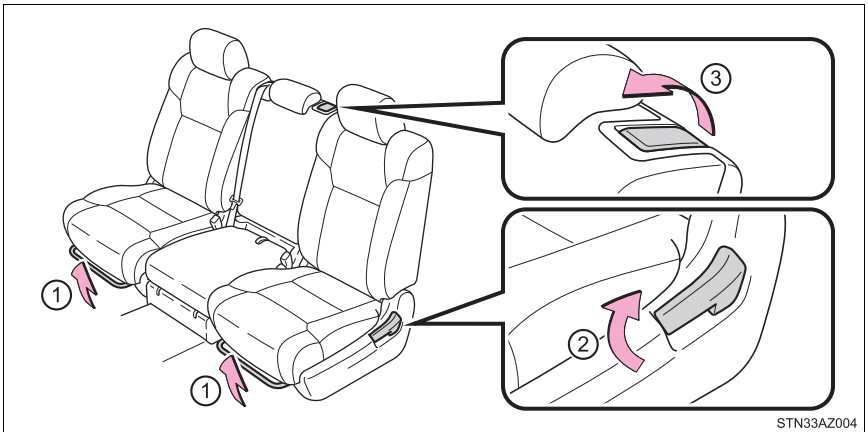
Adjustment procedure (bench type seats)

STN33AZ004

- ① Seat position adjustment levers ③ Center seat seatback angle adjustment lever
- ② Seatback angle adjustment levers

■ Power easy access system (vehicles with driving position memory)

The driver's seat and steering wheel move in accordance with engine switch position and the driver's seat belt condition. (→P. 118)

▲ CAUTION**■ When adjusting the seat position**

- Take care when adjusting the seat position to ensure that other passengers are not injured by the moving seat.
- Do not put your hands under the seat or near the moving parts to avoid injury.
Fingers or hands may become jammed in the seat mechanism.

■ Seat adjustment

- To reduce the risk of sliding under the lap belt during a collision, do not recline the seat more than necessary.
If the seat is too reclined, the lap belt may slide past the hips and apply restraint forces directly to the abdomen, or your neck may contact the shoulder belt, increasing the risk of death or serious injury in the event of an accident.
Adjustments should not be made while driving as the seat may unexpectedly move and cause the driver to lose control of the vehicle.
- Manual seat type only: After adjusting the seat, make sure that the seat is locked in position.

■ When adjusting the seat positions

Make sure to leave enough space around the feet so they do not get stuck.

Rear seats (Double Cab and CrewMax models)

Raising the bottom cushion

- 1 Use the seat belt hangers to prevent the belts from being tangled.

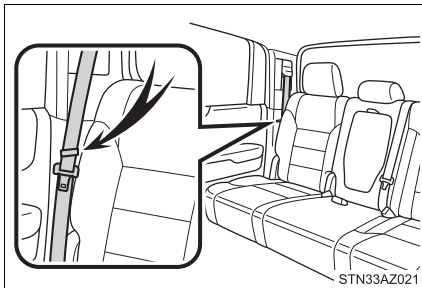

- 2 Pull and release the lever to unlock while raising the bottom cushion until it locks.

When returning the bottom cushion to its original position, pull and release the lever, then carefully lower the bottom cushion using your other hand.

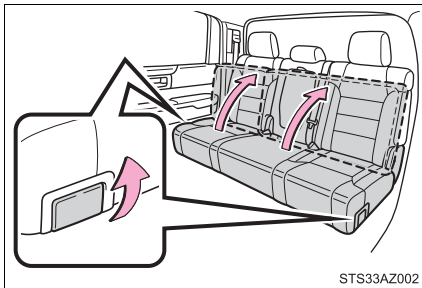

**CAUTION****■ When raising the bottom cushion**

Observe the following precautions.

Failure to do so may result in death or serious injury.

- Do not raise the bottom cushion while driving.
- Stop the vehicle on level ground, set the parking brake and shift the shift lever to P.

■ When bottom cushion is raised

Do not allow passengers to sit on raised bottom cushion or place anything on storage box (Double Cab models) while driving.

■ When returning the seats to their original position

Observe the following precautions.

Failure to do so may result in death or serious injury.

- Be careful not to get your hands or feet pinched in the seat.
- Make sure the bottom cushions are securely locked.
- Check that the seat belts are not twisted or caught in the seat.
- Arrange the seat belts in the proper positions for ready use.
- Make sure that there are no objects under the seat cushion or on the loading floor.

**NOTICE****■ Before raising the bottom cushion**

- Make sure that there are no objects, such as cushions, on the seat cushion.
- The seat belts must be stowed.

Driving position memory (driver's seat)*

This feature automatically adjusts the driver's seat, steering wheel and outside rear view mirrors to make entering and exiting the vehicle easier or to suit your preferences.

Power easy access system

The driver's and steering wheel are automatically adjusted to allow the driver to enter and exit the vehicle easily.

When all of the following have been performed, the driver's seat and steering wheel are automatically adjusted to a position that allows driver to enter and exit the vehicle easily.

- The shift lever has been shifted to P.
- The key has been removed from the engine switch.
- The driver's seat belt has been unfastened.

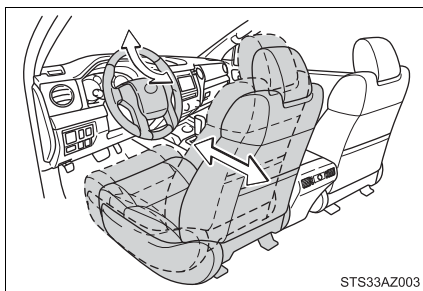

When any of the following has been performed, the driver's seat and steering wheel automatically return to their original positions.

- The key has been inserted into the engine switch.
- The driver's seat belt has been fastened.

■ Operation of the power easy access system

When exiting the vehicle, the power easy access system may not operate if the seat is already close to the rearmost position, etc.

■ Customization

The seat movement amount settings of the power easy access system can be customized. (Customizable features: →P. 530)

Driving position memory

Your preferred driving position (the position of the driver's seat, steering wheel and outside rear view mirrors) can be recorded and recalled by pressing a button.

Two different driving positions can be recorded into memory.

■ Recording procedure

- 1 Check that the shift lever is in P.
- 2 Turn the engine switch to the "ON" position.
- 3 Adjust the driver's seat, steering wheel, and outside rear view mirrors to the desired positions.
- 4 While pressing the "SET" button, or within 3 seconds after the "SET" button is pressed, press button "1" or "2" until the buzzer sounds.

If the selected button has already been preset, the previously recorded position will be overwritten.

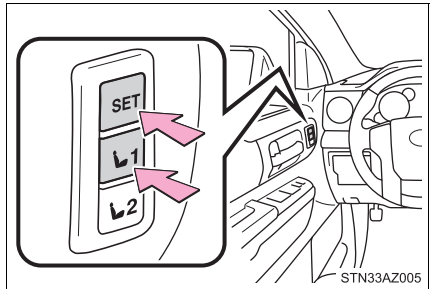

■ Recall procedure

- 1 Check that the shift lever is in P.
- 2 Turn the engine switch to the "ON" position.
- 3 Press one of the buttons for the driving position you want to recall until the buzzer sounds.

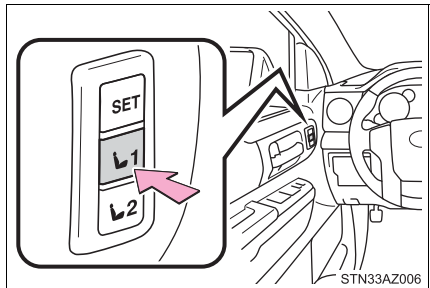

■ To stop the position recall operation part-way through

Perform any of the following:

- Press the "SET" button.
- Press button "1" or "2".
- Operate any of the seat adjustment switches (only cancels seat position recall).
- Operate the tilt and telescopic steering control switch (only cancels steering wheel position recall).

■ Seat positions that can be memorized (→P. 113)

The adjusted positions other than the position adjusted by lumbar support switch can be recorded.

■ Operating the driving position memory after the key is removed from the engine switch

Recorded seat positions (except the steering wheel position) can be activated up to 30 seconds after the driver's door is opened, even if the key is removed from the engine switch.

■ In order to correctly use the driving position memory function

If a seat position is already in the furthest possible position and the seat is operated in the same direction, the recorded position may be slightly different when it is recalled.

Memory recall function

A desired driving position can be recalled linked with the unlocking of the door.

■ Registering procedure

Record your driving position to button “1” or “2” before performing the following:

- 1 Turn the engine switch off and close the driver's door.
- 2 While pressing the button “1” or “2”, press  on the wireless remote control until the signal beeps.

The driving position is recalled when the driver's door is unlocked using the wireless remote control and the driver's door is opened.

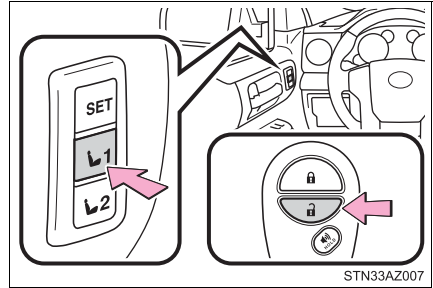

To prevent unintended triggering of the alarm, open and close a door once after a driving position has been recorded. (If a door is not opened within 60 seconds after  is pressed, the doors will be locked again and the alarm will automatically be set.)

In case that the alarm is triggered, immediately stop the alarm. (→P. 80)

■ Cancellation procedure

- 1 Turn the engine switch off and close the driver's door.
- 2 While pressing the “SET” button, press  on the wireless remote control until you hear 2 beeps.

■ If the battery is disconnected

The recorded seat positions are erased when the battery is disconnected.

⚠ CAUTION

■ Seat adjustment caution

Take care during seat adjustment so that the seat does not strike the rear passenger or squeeze your body against the steering wheel.

Head restraints

Head restraints are provided for all seats.

Front seats

① Up

Pull the head restraints up.

② Down

Push the head restraint down while pressing the lock release button.

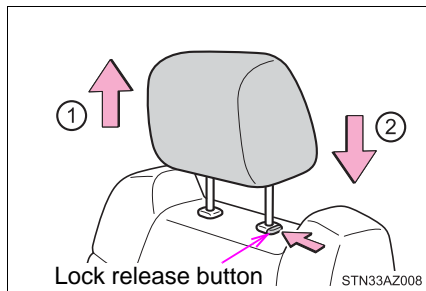

Rear seats

■ Center seat

① Up

Pull the head restraints up.

② Down

Push the head restraint down while pressing the lock release button.

▶ Double Cab models

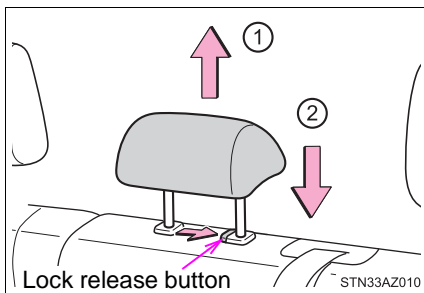

▶ CrewMax models

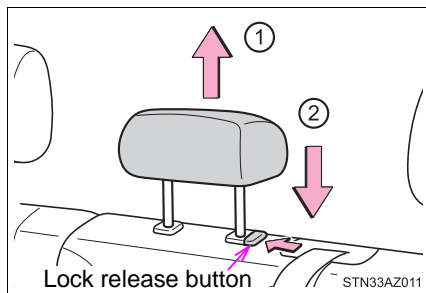

■ Outer seat

① To use

Lift up the head restraint back to the neutral position and then push the head restraint down.

② To fold

Lift up the head restraint while pressing the right lock release button, and fold it forward.

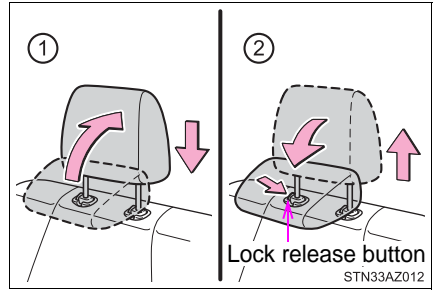

■ Removing the head restraints

▶ Front seats and center rear seat (CrewMax models)

Pull the head restraint up while pressing the lock release button.

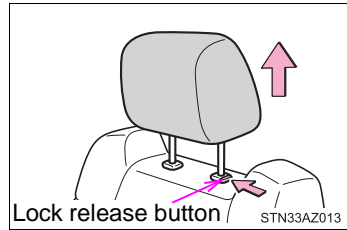

▶ Center rear seat (Double Cab models)

Pull the head restraint up while pressing the lock release button.

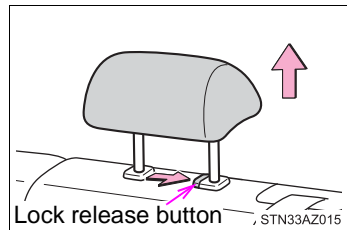

▶ Outer rear seat (Double Cab and CrewMax models)

Pull the head restraint up while pressing both lock release buttons.

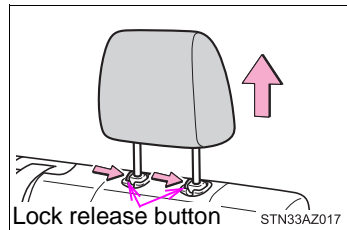

■ Installing the head restraints

▶ Front seats and center rear seat (CrewMax models)

Align the head restraint with the installation holes and push it down to the lock position. Press and hold the lock release button when lowering the head restraint.

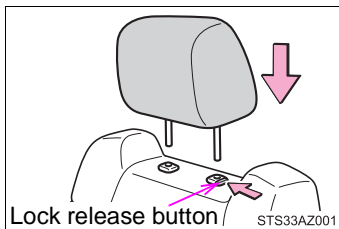

▶ Center rear seat (Double Cab models)

Align the head restraint with the installation holes and push it down to the lock position. Press and hold the lock release button when lowering the head restraint.

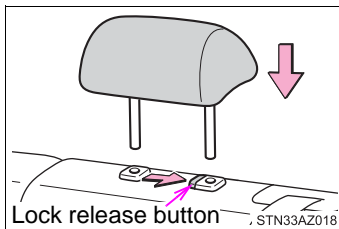

▶ Outer rear seat (Double Cab and CrewMax models)

Align the head restraint with the installation holes and push it down to the lock position.

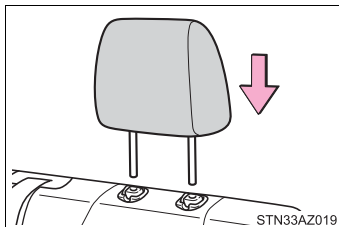

■ Adjusting the height of the head restraints (front seats)

Make sure that the head restraints are adjusted so that the center of the head restraint is closest to the top of your ears.

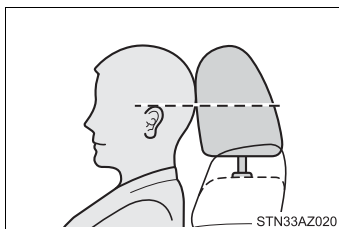

■ Adjusting the front center seat (bench type seat) and rear center seat head restraints (Double Cab and CrewMax models)

Always raise the head restraint one level from the stowed position when using.

 CAUTION**■ Head restraint precautions**

Observe the following precautions regarding the head restraints. Failure to do so may result in death or serious injury.

- Use the head restraints designed for each respective seat.
- Adjust the head restraints to the correct position at all times.
- After adjusting the head restraints, push down on them and make sure they are locked in position.
- Do not drive with the head restraints removed.

Steering wheel

Adjustment procedure (manually adjustable type)

- 1 Hold the steering wheel and push the lever down.

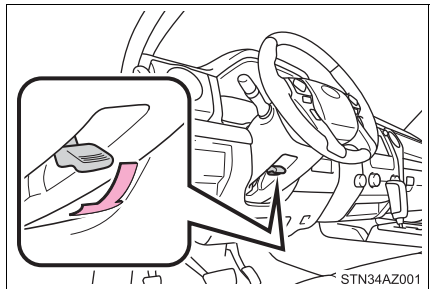

- ▶ Vehicles with front bench type seat

- 2 Adjust to the ideal position by moving the steering wheel.
After adjustment, pull the lever up to secure the steering wheel.

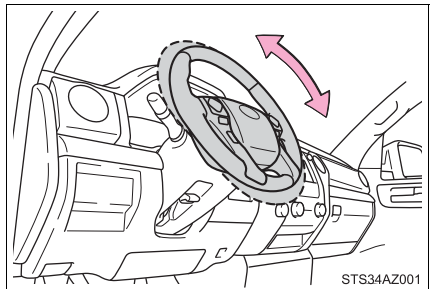

- ▶ Vehicles with front separate type seats

- 2 Adjust to the ideal position by moving the steering wheel horizontally and vertically.
After adjustment, pull the lever up to secure the steering wheel.

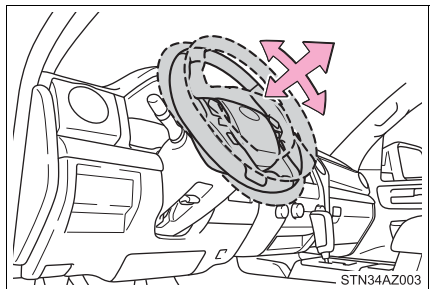

Adjustment procedure (power-adjustable type)

Operating the switch moves the steering wheel in the following directions:

- ① Up
- ② Down
- ③ Toward the driver
- ④ Away from the driver

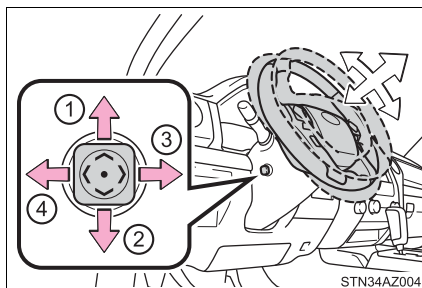

Auto tilt away (power-adjustable type)

When the key is removed from the engine switch, the steering wheel returns to its stowed position by moving up and away to enable easier driver enter and exit.

Inserting the key into the engine switch returns the steering wheel to its original position.

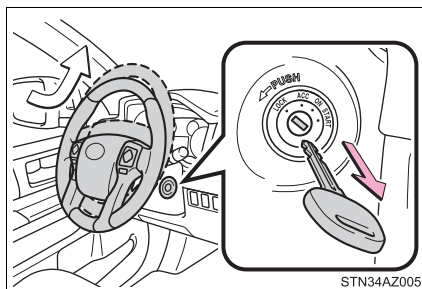

■ The steering wheel can be adjusted when (power adjustable type)

The engine switch is in the "ON" position.

■ Automatic adjustment of the steering position (power adjustable type)

A desired steering position can be entered to memory and recalled automatically by the driving position memory system. (→P. 118)

■ Power easy access system (vehicles with driving position memory)

The steering wheel and driver's seat move in accordance with engine switch position and the driver's seat belt condition. (→P. 118)

**CAUTION****■ Caution while driving**

Do not adjust the steering wheel while driving.

Doing so may cause the driver to mishandle the vehicle and cause an accident, resulting in death or serious injury.

■ After adjusting the steering wheel (manually adjustable type)

Make sure that the steering wheel is securely locked.

Otherwise, the steering wheel may move suddenly, possibly causing an accident and resulting in death or serious injury.

Inside rear view mirror

The rear view mirror's position can be adjusted to enable sufficient confirmation of the rear view.

Adjusting the height of rear view mirror

The height of the rear view mirror can be adjusted to suit your driving posture.

Adjust the height of the rear view mirror by moving it up and down.

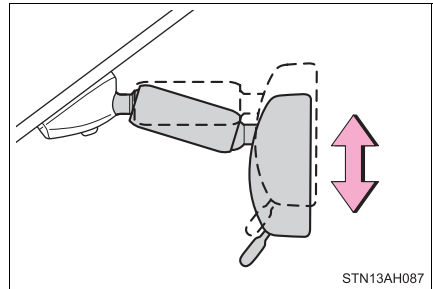

Anti-glare function

► Manual anti-glare inside rear view mirror

Reflected light from the headlights of vehicles behind can be reduced by operating the lever.

- ① Normal position
- ② Anti-glare position

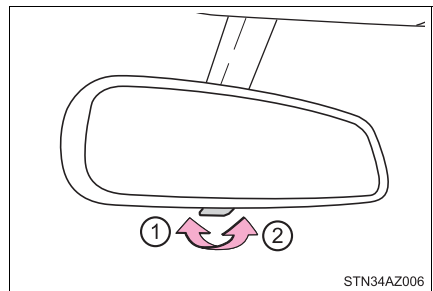

▶ Auto anti-glare inside rear view mirror

Responding to the level of brightness of the headlights of vehicles behind, the reflected light is automatically reduced.

Changing automatic anti-glare function mode

ON/OFF

When the automatic anti-glare function is in ON mode, the indicator illuminates.

The function will set to ON mode each time the engine switch is turned to the "ON" position.

Pressing the button turns the function to OFF mode. (The indicator also turns off.)

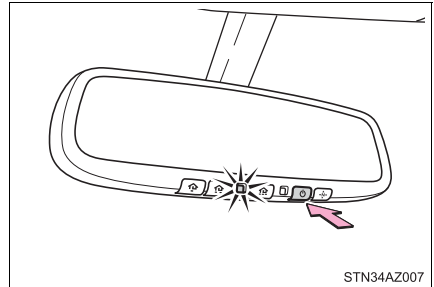

■ To prevent sensor error (vehicles with auto anti-glare inside rear view mirror)

To ensure that the sensors operate properly, do not touch or cover them.

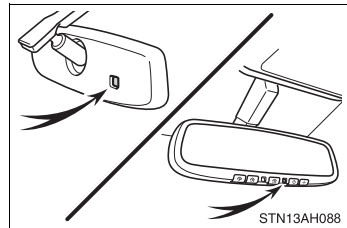

■ If a sun visor interferes with the mirror

Hold and rotate the mirror to adjust the support.

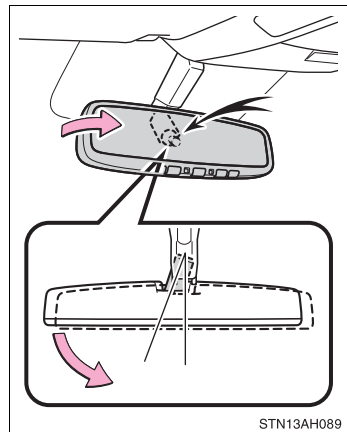

 CAUTION

Do not adjust the position of the mirror while driving.
Doing so may lead to mishandling of the vehicle and cause an accident,
resulting in death or serious injury.

Outside rear view mirrors

Adjustment procedure

► Manually adjustable type

Adjust the mirror up and down, in or out by pushing the mirror surface.

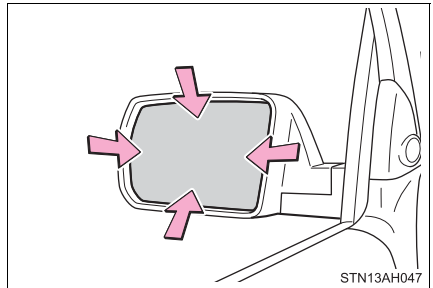

► Power-adjustable type (type A)

1 To select a mirror to adjust, press the switch.

- ① Left
- ② Right

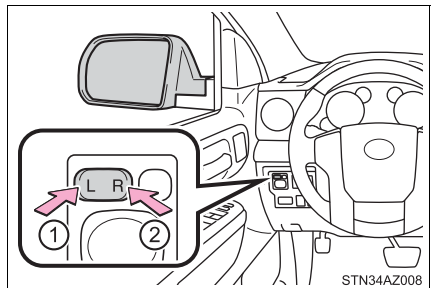

2 To adjust the mirror, press the switch.

- ① Up
- ② Right
- ③ Down
- ④ Left

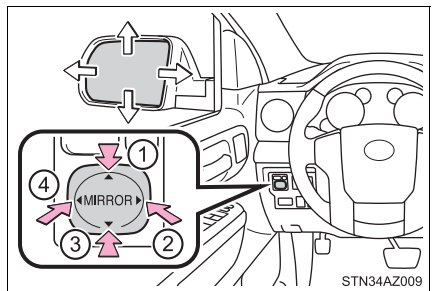

► Power-adjustable type (type B)

Upper part mirror:

- 1 To select a mirror to adjust, press the switch.
 - ① Left
 - ② Right

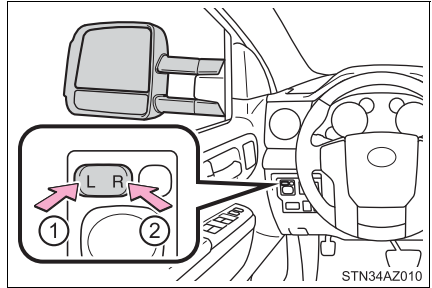

- 2 To adjust the mirror, press the switch.
 - ① Up
 - ② Right
 - ③ Down
 - ④ Left

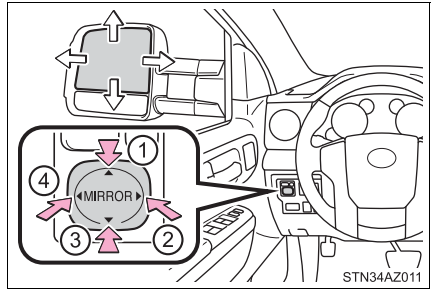

Lower part mirror:

Adjust the mirror up and down, in or out by pushing the mirror surface.

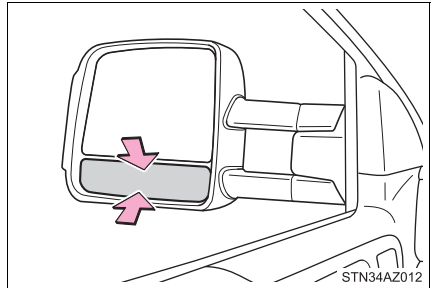

Folding the mirrors

► From outside

Push the mirror back in the direction of the vehicle's rear.

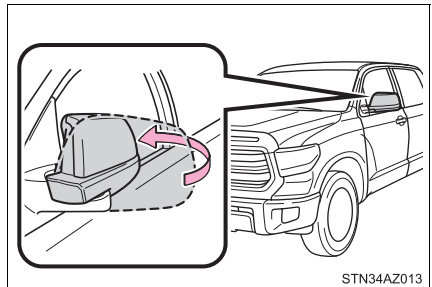

► From inside (if equipped)

Press the switch to fold the mirrors.

Press it again to extend them to the original position.

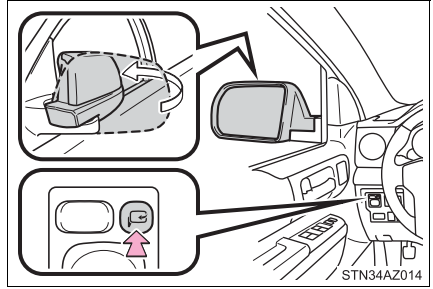

Extending the mirrors (if equipped)

The mirrors can be manually slid outward to improve visibility around wide trailers.

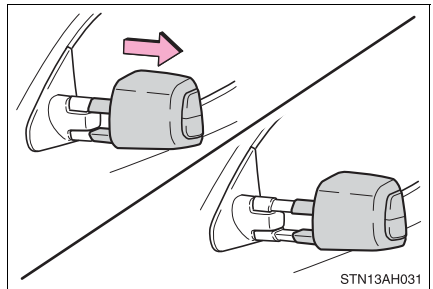

■ Recommended mirror angle when towing a trailer (vehicles with extending mirrors)

- ① Power adjust the upper part of the mirror until an appropriate view is obtained. It is recommended that the outer 2/3 of the upper mirror be filled with images other than the vehicle and trailer.
- ② Manually adjust the lower part of the mirror until an appropriate view of the towed object is obtained. It is recommended that the outer 2/3 of the lower mirror be filled with images other than the trailer.

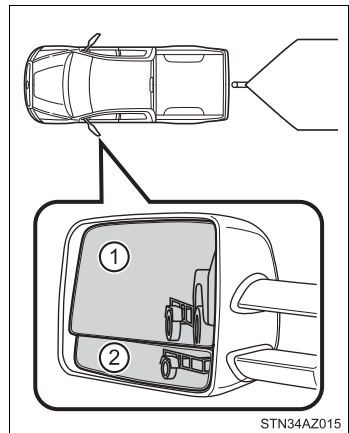

■ Mirror operating conditions (power-adjustable type)

The engine switch is in the “ACC” or “ON” position.

■ When the mirrors are fogged up (vehicles with outside rear view mirror defoggers)

Turn on the mirror defoggers to defog the mirrors. (→P. 338, 345)

■ Automatic adjustment of the mirror angle (vehicles with driving position memory)

A desired mirror face angle can be entered to memory and recalled automatically by the driving position memory. (→P. 118)

■ Auto anti-glare function (if equipped)

When the anti-glare inside rear view mirror is set to automatic mode, the outside rear view mirrors will activate in conjunction with the anti-glare inside rear view mirror to reduce reflected light. (→P. 130)

▲ CAUTION**■ Important points while driving**

Observe the following precautions while driving.

Failure to do so may result in loss of control of the vehicle and cause an accident, resulting in death or serious injury.

- Do not adjust the mirrors while driving.
- Do not drive with the mirrors folded.
- Both the driver and passenger side mirrors must be extended and properly adjusted before driving.

■ When a mirror is moving (power-adjustable type)

To avoid personal injury and mirror malfunction, be careful not to get your hand caught by the moving mirror.

■ When the mirror defoggers are operating (vehicles with outside rear view mirror defoggers)

Do not touch the rear view mirror surfaces, as they can become very hot and burn you.

Power windows*

Opening and closing procedures

The power windows can be opened and closed using the switches.

Operating the switch moves the windows as follows:

► Type A

- ① Closing
- ② Opening
- ③ One-touch opening* (driver's window only)

*: To stop the window partway, operate the switch in the opposite direction.

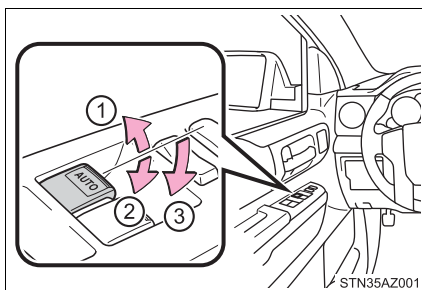

► Type B

- ① Closing
- ② One-touch closing* (front seat windows)
- ③ Opening
- ④ One-touch opening* (front seat windows)

*: To stop the window partway, operate the switch in the opposite direction.

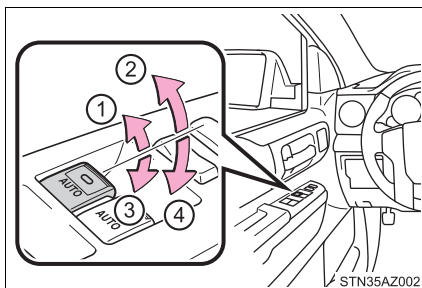

Window lock switch

Press the switch down to lock the passenger window switches.

Use this switch to prevent children from accidentally opening or closing a passenger window.

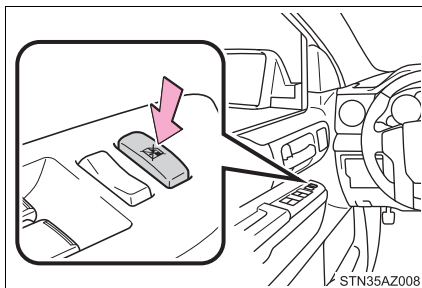

*: If equipped

■ The power windows can be operated when

The engine switch is in the "ON" position.

■ Operating the power windows after turning the engine off

The power windows can be operated for approximately 43 seconds after the engine switch is turned to the "ACC" or "LOCK" position. They cannot, however, be operated once either front door is opened.

■ Jam protection function (type B only)

If an object becomes caught between the window and the window frame, window travel is stopped and the window is opened slightly.

■ When the power window does not close normally (type B only)

If the jam protection function is operating abnormally and a window cannot be closed, perform the following operations using the power window switch on the relevant door.

- After stopping the vehicle, the window can be closed by holding the power window switch in the one-touch closing position while the engine switch is turned to the "ON" position.
- If the window still cannot be closed even by carrying out the operation as explained above, initialize the function by performing the following procedure.
 - 1 Hold the power window switch in the one-touch closing position. Continue holding the switch for a further 6 seconds after the window has closed.
 - 2 Hold the power window switch in the one-touch opening position. Continue holding the switch for a further 2 seconds after the window has opened completely.
 - 3 Hold the power window switch in the one-touch closing position once again. Continue holding the switch for a further 2 seconds after the window has closed.

If you release the switch while the window is moving, start again from the beginning.

If the window continues to close but then re-open slightly even after performing the above procedure correctly, have the vehicle inspected by your Toyota dealer.

**CAUTION**

Observe the following precautions.

Failure to do so may result in death or serious injury.

■ Closing the windows

- Check to make sure that all passengers do not have any part of their body in a position where it could be caught when a window is being operated.
- Do not allow children to operate the power windows.
Closing a power window on someone can cause serious injury, and in some instances, even death.

■ Jam protection function (type B only)

- Never use any part of your body to intentionally activate the jam protection function.
- The jam protection function may not work if something gets caught just before the window fully closes.

Back window*

Opening and closing

Open/close

Push the lock release lever and slide the back window.

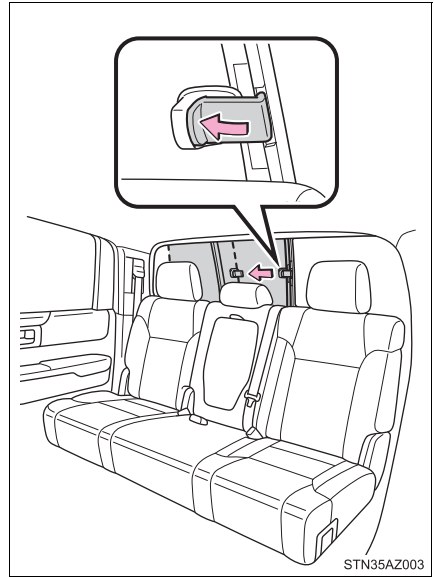

■ Closing the back window

Make sure that the back window is securely closed after closing it.

▲ CAUTION

■ Caution while driving

Keep the back window closed.

This not only keeps personal belongings from being thrown out, but also prevents exhaust gases from entering the vehicle.

Power back window*

Opening and closing

► Double Cab models

- ① Opening
- ② Closing

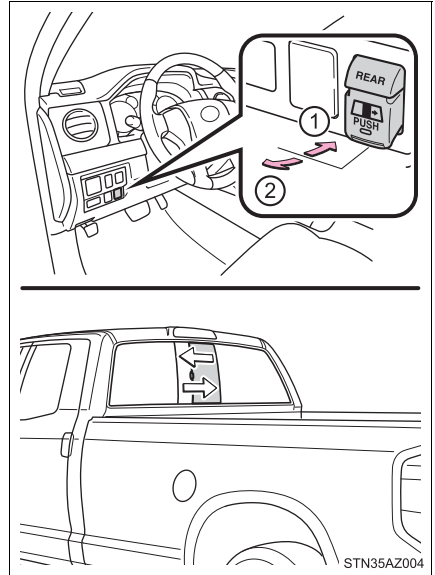

*: If equipped

► CrewMax models

- ① Opening
- ② Closing

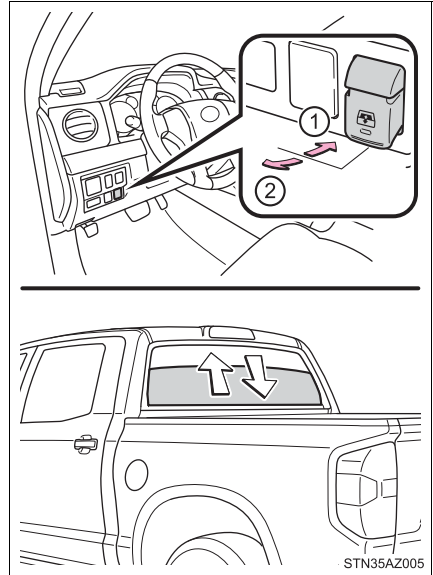

■ **The power back window can be operated when**

The engine switch is in the “ON” position.

■ **Operating the power back windows after turning the engine off**

The power back windows can be operated for approximately 43 seconds after the engine switch is turned to the “ACC” or “LOCK” position. They cannot, however, be operated once either front door is opened.

⚠ CAUTION

■ **Closing the back window**

Observe the following precautions.

Failure to do so may result in death or serious injury.

- Check to make sure that all passengers do not have any part of their body in a position where it could be caught when a window is being operated.
- Do not allow children to operate the power back window.
Closing a back window on someone can cause serious injury, and in some instances, even death.

■ **Caution while driving**

Keep the back window closed.

This not only keeps personal belongings from being thrown out, but also prevents exhaust gases from entering the vehicle.

Moon roof*

Use the overhead switches to open and close the moon roof and tilt it up and down.

Opening and closing

- ① Opens the moon roof*
- ② Closes the moon roof*

*: Lightly press either way of the moon roof switch to stop the moon roof partway.

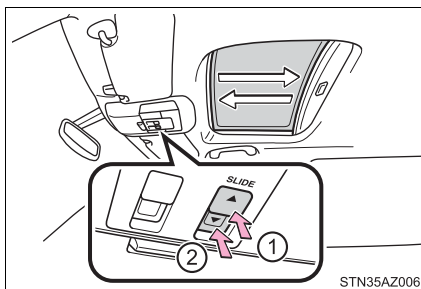

Tilting up and down

- ① Tilts the moon roof up*
- ② Tilts the moon roof down*

*: Lightly press either way of the moon roof switch to stop the moon roof partway.

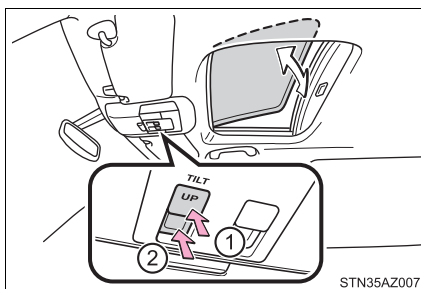

■ The moon roof can be operated when

The engine switch in the "ON" position.

■ Operating the moon roof after turning the engine off

The moon roof can be operated for approximately 43 seconds after the engine switch is turned to the "ACC" or "LOCK" position. It cannot, however, be operated once either front door is opened.

■ Jam protection function

If an object is detected between the moon roof and the frame while the moon roof is closing or tilting down, travel is stopped and the moon roof opens slightly.

■ Sunshade

The sunshade can be opened and closed manually. However, the sunshade will open automatically when the moon roof is opened.

■ Door lock linked moon roof operation

The moon roof can be opened and closed using the key. (→P. 102)

■ When the moon roof does not close normally

Perform the following procedure:

- If the moon roof closes but then re-opens slightly

- 1 Stop the vehicle.
- 2 Press and hold the “▼” (sliding close) switch.*1
The moon roof will close, reopen and pause for approximately 10 seconds.*2 Then it will close again, tilt up and pause for approximately 1 second. Finally, it will tilt down, open and close.
- 3 Check to make sure that the moon roof is completely closed and then release the switch.

- If the moon roof tilts down but then tilts back up

- 1 Stop the vehicle.
- 2 Press and hold the “UP” (tilt up) switch*1 until the moon roof moves into the tilt up position and stops.
- 3 Release the “UP” (tilt up) switch once and then press and hold the “UP” (tilt up) switch again.*1
The moon roof will pause for approximately 10 seconds in the tilt up position.*2 Then it will adjust slightly and pause for approximately 1 second. Finally, it will tilt down, open and close.
- 4 Check to make sure that the moon roof is completely closed and then release the switch.

*1: If the switch is released at the incorrect time, the procedure will have to be performed again from the beginning.

*2: If the switch is released after the above mentioned 10 seconds pause, automatic operation will be disabled. In that case, press and hold the “▼” (sliding close) or “UP” (tilt up) switch, and the moon roof will tilt up and pause for approximately 1 second. Then it will tilt down, open and close. Check to make sure that the moon roof is completely closed and then release the switch.

If the moon roof does not fully close even after performing the above procedure correctly, have the vehicle inspected by your Toyota dealer.

■ Moon roof open reminder function

The buzzer sounds when the engine switch is turned to the “LOCK” position and the driver’s door is opened with the moon roof open.

■ When the battery is disconnected

The moon roof must be initialized in order to ensure proper operation.

- 1 Push and hold the switch toward the “UP” (tilt up) side or “ ▼ ” (sliding close) side.
- 2 After the moon roof will tilt up and down, release the switch.
- 3 To ensure the initialization is complete, make sure automatic opening and closing functions work properly.

■ Customization that can be configured at Toyota dealer

Settings (e.g. linked door lock operation) can be changed.
(Customizable features: →P. 530)

**CAUTION**

Observe the following precautions.

Failure to do so may cause death or serious injury.

■ Opening the moon roof

- Do not allow any passengers to put their hands or heads outside the vehicle while it is moving.
- Do not sit on top of the moon roof.

■ Closing the moon roof

- Check to make sure that all passengers do not have any part of their body in a position where it could be caught when the moon roof is being operated.
- Do not allow children to operate the moon roof.
Closing the moon roof on someone can cause death or serious injury.

■ Jam protection function

- Never use any part of your body to intentionally activate the jam protection function.
- The jam protection function may not work if something gets caught just before the moon roof fully closes.

Driving

4

- 4-1. Before driving**
 - Driving the vehicle..... 146
 - Cargo and luggage 153
 - Vehicle load limits 156
 - Trailer towing..... 158
 - Dinghy towing 178
- 4-2. Driving procedures**
 - Engine (ignition) switch 179
 - Automatic transmission 181
 - Turn signal lever..... 186
 - Parking brake 187
 - Horn 188
- 4-3. Operating the lights and wipers**
 - Headlight switch..... 189
 - Fog light switch 192
 - Windshield wipers and washer 193
- 4-4. Refueling**
 - Opening the fuel tank cap 196
- 4-5. Using the driving support systems**
 - Cruise control..... 200
 - Intuitive parking assist..... 203
 - Rear view monitor system 209
 - BSM (Blind Spot Monitor) 218
 - Four-wheel drive system ... 226
 - AUTO LSD system..... 229
 - Driving assist systems 231
- 4-6. Driving tips**
 - Winter driving tips 240
 - Off-road precautions 244

Driving the vehicle

The following procedures should be observed to ensure safe driving:

Starting the engine

→P. 179

Driving

- 1 With the brake pedal depressed, shift the shift lever to D. (→P. 181)
- 2 Release the parking brake. (→P. 187)
- 3 Gradually release the brake pedal and gently depress the accelerator pedal to accelerate the vehicle.

Stopping

- 1 With the shift lever in D, depress the brake pedal.
- 2 If necessary, set the parking brake.
If the vehicle is to be stopped for an extended period of time, shift the shift lever to P or N. (→P. 181)

Parking the vehicle

- 1 With the shift lever in D, depress the brake pedal.
- 2 Set the parking brake. (→P. 187)
- 3 Shift the shift lever to P. (→P. 181)
- 4 Turn the engine switch to the "LOCK" position to stop the engine.
- 5 Lock the door, making sure that you have the key on your person.
If parking on a hill, block the wheels as needed.

Starting off on a steep uphill

- 1 Make sure that the parking brake is set and shift the shift lever to D.
- 2 Gently depress the accelerator pedal.
- 3 Release the parking brake.

■ Driving in the rain

- Drive carefully when it is raining, because visibility will be reduced, the windows may become fogged-up, and the road will be slippery.
- Drive carefully when it starts to rain, because the road surface will be especially slippery.
- Refrain from high speeds when driving on an expressway in the rain, because there may be a layer of water between the tires and the road surface, preventing the steering and brakes from operating properly.

■ Engine speed while driving

In the following conditions, the engine speed may become high while driving. This is due to automatic up-shifting control or down-shifting implementation to meet driving conditions. It does not indicate sudden acceleration.

- The vehicle is judged to be driving uphill or downhill
- When the accelerator pedal is released
- When the brake pedal is depressed while TOW/HAIL mode is selected (if equipped)

■ Breaking in your new Toyota

To extend the life of the vehicle, observing the following precautions is recommended:

- For the first 200 miles (300 km):
Avoid sudden stops.
- For the first 500 miles (800 km):
Do not tow a trailer.
- For the first 1000 miles (1600 km):
 - Do not drive at extremely high speeds.
 - Avoid sudden acceleration.
 - Do not drive continuously in low gears.
 - Do not drive at a constant speed for extended periods.

■ Drum-in-disc type parking brake system

Your vehicle has a drum-in-disc type parking brake system. This type of brake system needs bedding-down of the brake shoes periodically or whenever the parking brake shoes and/or drum are replaced. Have your Toyota dealer perform the bedding down operation.

■ Operating your vehicle in a foreign country

Comply with the relevant vehicle registration laws and confirm the availability of the correct fuel. (→P. 516)

■ When turning off the engine

The emission system operating sounds may continue for a short time after the engine is turned off. This is not a malfunction, and helps to ensure optimal performance of the emission system.

 **CAUTION**

Observe the following precautions.

Failure to do so may result in death or serious injury.

■ When starting the vehicle

Always keep your foot on the brake pedal while stopped with the engine running. This prevents the vehicle from creeping.

■ When driving the vehicle

- Do not drive if you are unfamiliar with the location of the brake and accelerator pedals to avoid depressing the wrong pedal.
 - Accidentally depressing the accelerator pedal instead of the brake pedal will result in sudden acceleration that may lead to an accident.
 - When backing up, you may twist your body around, leading to difficulty in operating the pedals. Make sure to operate the pedals properly.
 - Make sure to keep a correct driving posture even when moving the vehicle only slightly. This allows you to depress the brake and accelerator pedals properly.
 - Depress the brake pedal using your right foot. Depressing the brake pedal using your left foot may delay response in an emergency, resulting in an accident.
- Do not drive the vehicle over or stop the vehicle near flammable materials. The exhaust system and exhaust gases can be extremely hot. These hot parts may cause a fire if there is any flammable material nearby.
- During normal driving, do not turn off the engine. Turning the engine off while driving will not cause loss of steering or braking control, but the power assist to these systems will be lost. This will make it more difficult to steer and brake, so you should pull over and stop the vehicle as soon as it is safe to do so.

However, in the event of an emergency, such as if it becomes impossible to stop the vehicle in the normal way: →P. 457
- Use engine braking (downshift) to maintain a safe speed when driving down a steep hill.

Using the brakes continuously may cause the brakes to overheat and lose effectiveness. (→P. 181)
- Do not adjust the positions of the steering wheel, the seat, or the inside or outside rear view mirrors while driving.

Doing so may result in a loss of vehicle control.
- Always check that all passengers' arms, heads or other parts of their body are not outside the vehicle.

**CAUTION**

Observe the following precautions.
Failure to do so may result in death or serious injury.

■ When driving the vehicle

- Do not drive in excess of the speed limit. Even if the legal speed limit permits it, do not drive over 85 mph (140 km/h) unless your vehicle has high-speed capability tires. Driving over 85 mph (140 km/h) may result in tire failure, loss of control and possible injury. Be sure to consult a tire dealer to determine whether the tires on your vehicle are high-speed capability tires or not before driving at such speeds.

■ When driving on slippery road surfaces

- Sudden braking, acceleration and steering may cause tire slippage and reduce your ability to control the vehicle.
- Sudden acceleration, engine braking due to shift changing, or changes in engine speed could cause the vehicle to skid.
- After driving through a puddle, lightly depress the brake pedal to make sure that the brakes are functioning properly. Wet brake pads may prevent the brakes from functioning properly. If the brakes on only one side are wet and not functioning properly, steering control may be affected.

■ When shifting the shift lever

- Do not let the vehicle roll backward while the shift lever is in a driving position, or roll forward while the shift lever is in R.
Doing so may cause the engine to stall or lead to poor brake and steering performance, resulting in an accident or damage to the vehicle.
- Do not shift the shift lever to P while the vehicle is moving.
Doing so can damage the transmission and may result in a loss of vehicle control.
- Do not shift the shift lever to R while the vehicle is moving forward.
Doing so can damage the transmission and may result in a loss of vehicle control.
- Do not shift the shift lever to D while the vehicle is moving backward.
Doing so can damage the transmission and may result in a loss of vehicle control.
- Moving the shift lever to N while the vehicle is moving will disengage the engine from the transmission. Engine braking is not available when N is selected.
- Be careful not to shift the shift lever with the accelerator pedal depressed.
Shifting the shift lever to a gear other than P or N may lead to unexpected rapid acceleration of the vehicle that may cause an accident.

**CAUTION****■ If you hear a squealing or scraping noise (brake pad wear limit indicators)**

Have the brake pads checked and replaced by your Toyota dealer as soon as possible.

Rotor damage may result if the pads are not replaced when needed.

It is dangerous to drive the vehicle when the wear limits of the brake pads and/or those of the brake discs are exceeded.

■ When the vehicle is stopped

- Do not race the engine.

If the vehicle is in any gear other than P or N, the vehicle may accelerate suddenly and unexpectedly, causing an accident.

- In order to prevent accidents due to the vehicle rolling away, always keep depressing the brake pedal while the engine is running, and apply the parking brake as necessary.

- If the vehicle is stopped on an incline, in order to prevent accidents caused by the vehicle rolling forward or backward, always depress the brake pedal and securely apply the parking brake as needed.

- Avoid revving or racing the engine.

Running the engine at high speed while the vehicle is stopped may cause the exhaust system to overheat, which could result in a fire if combustible material is nearby.

■ When the vehicle is parked

- Do not leave glasses, cigarette lighters, spray cans, or soft drink cans in the vehicle when it is in the sun.

Doing so may result in the following:

- Gas may leak from a cigarette lighter or spray can, and may lead to a fire.
 - The temperature inside the vehicle may cause the plastic lenses and plastic material of glasses to deform or crack.
 - Soft drink cans may rupture, causing the contents to spray over the interior of the vehicle, and may also cause a short circuit in the vehicle's electrical components.
- Do not leave cigarette lighters in the vehicle. If a cigarette lighter is in a place such as the glove box or on the floor, it may be lit accidentally when luggage is loaded or the seat is adjusted, causing a fire.
 - Do not attach adhesive discs to the windshield or windows. Do not place containers such as air fresheners on the instrument panel or dashboard. Adhesive discs or containers may act as lenses, causing a fire in the vehicle.

 **CAUTION**

- Do not leave a door or window open if the curved glass is coated with a metallized film such as a silver-colored one. Reflected sunlight may cause the glass to act as a lens, causing a fire.
- Always apply the parking brake, shift the shift lever to P, stop the engine and lock the vehicle.
Do not leave the vehicle unattended while the engine is running.
- Do not touch the exhaust pipes while the engine is running or immediately after turning the engine off.
Doing so may cause burns.
- 4WD models: If the shift lever is moved before the “4LO” indicator turns on/off, the transfer mode may not be shifted completely. The transfer mode disengages both the front and rear driveshafts from the powertrain and allows the vehicle to move regardless of the shift position. (At this time, the indicator blinks and the buzzer sounds.)
Therefore, the vehicle is free to roll even if the automatic transmission is in P. You or someone else could be seriously injured. You must complete the shifting of the transfer mode. (→P. 226)

■ When taking a nap in the vehicle

Always turn the engine off. Otherwise, if you accidentally move the shift lever or depress the accelerator pedal, this could cause an accident or fire due to engine overheating. Additionally, if the vehicle is parked in a poorly ventilated area, exhaust gases may collect and enter the vehicle, leading to death or a serious health hazard.

■ When braking

- When the brakes are wet, drive more cautiously.
Braking distance increases when the brakes are wet, and this may cause one side of the vehicle to brake differently than the other side. Also, the parking brake may not securely hold the vehicle.
- If the power brake assist function does not operate, do not follow other vehicles closely and avoid hills or sharp turns that require braking.
In this case, braking is still possible, but the brake pedal should be depressed more firmly than usual. Also, the braking distance will increase. Have your brakes fixed immediately.
- Do not pump the brake pedal if the engine stalls.
Each push on the brake pedal uses up the reserve for the power-assisted brakes.
- The brake system consists of 2 individual hydraulic systems; if one of the systems fails, the other will still operate. In this case, the brake pedal should be depressed more firmly than usual and the braking distance will increase. Have your brakes fixed immediately.

**NOTICE****■ When driving the vehicle**

- Do not depress the accelerator and brake pedals at the same time during driving, as this may restrain driving torque.
- Do not use the accelerator pedal or depress the accelerator and brake pedals at the same time to hold the vehicle on a hill.

■ When parking the vehicle

Always shift the shift lever to P. Failure to do so may cause the vehicle to move or the vehicle may accelerate suddenly if the accelerator pedal is accidentally depressed.

■ Avoiding damage to vehicle parts

- Do not turn the steering wheel fully in either direction and hold it there for an extended period of time.
Doing so may damage the power steering pump.
- When driving over bumps in the road, drive as slowly as possible to avoid damaging the wheels, underside of the vehicle, etc.

■ If you get a flat tire while driving

A flat or damaged tire may cause the following situations. Hold the steering wheel firmly and gradually depress the brake pedal to slow down the vehicle.

- It may be difficult to control your vehicle.
- The vehicle will make abnormal sounds or vibrations.
- The vehicle will lean abnormally.

Information on what to do in case of a flat tire (→P. 475)

■ When encountering flooded roads

Do not drive on a road that has flooded after heavy rain, etc. Doing so may cause the following serious damage to the vehicle:

- Engine stalling
- Short in electrical components
- Engine damage caused by water immersion

In the event that you drive on a flooded road and the vehicle is flooded, be sure to have your Toyota dealer check the following:

- Brake function
- Changes in quantity and quality of oil and fluid used for the engine, transmission, transfer (4WD models) differentials, etc.
- Lubricant condition for the propeller shaft, bearings and suspension joints (where possible), and the function of all joints, bearings, etc.

Cargo and luggage

Take notice of the following information about storage precautions, cargo capacity and load:

Capacity and distribution

Cargo capacity depends on the total weight of the occupants.

(Cargo capacity) = (Total load capacity) – (Total weight of occupants)

Steps for Determining Correct Load Limit —

- (1) Locate the statement “The combined weight of occupants and cargo should never exceed XXX kg or XXX lbs.” on your vehicle’s placard.
- (2) Determine the combined weight of the driver and passengers that will be riding in your vehicle.
- (3) Subtract the combined weight of the driver and passengers from XXX kg or XXX lbs.
- (4) The resulting figure equals the available amount of cargo and luggage load capacity.

For example, if the “XXX” amount equals 1400 lbs. and there will be five 150 lb passengers in your vehicle, the amount of available cargo and luggage load capacity is 650 lbs. (1400 – 750 (5 × 150) = 650 lbs.)

- (5) Determine the combined weight of luggage and cargo being loaded on the vehicle. That weight may not safely exceed the available cargo and luggage load capacity calculated in Step 4.
- (6) If your vehicle will be towing a trailer, load from your trailer will be transferred to your vehicle. Consult this manual to determine how this reduces the available cargo and luggage load capacity of your vehicle. (→P. 156)

Calculation formula for your vehicle

- ① Cargo capacity
- ② Total load capacity (vehicle capacity weight) (→P. 502)

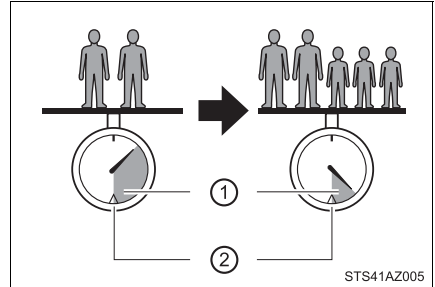

When 2 people with the combined weight of A lb. (kg) are riding in your vehicle, which has a total load capacity (vehicle capacity weight) of B lb. (kg), the available amount of cargo and luggage load capacity will be C lb. (kg) as follows:

$$B^{*2} \text{ lb. (kg)} - A^{*1} \text{ lb. (kg)} = C^{*3} \text{ lb. (kg)}$$

*1: A = Weight of people

*2: B = Total load capacity

*3: C = Available cargo and luggage load

In this condition, if 3 more passengers with the combined weight of D lb. (kg) get on, the available cargo and luggage load will be reduced E lb. (kg) as follows:

$$C \text{ lb. (kg)} - D^{*4} \text{ lb. (kg)} = E^{*5} \text{ lb. (kg)}$$

*4: D = Additional weight of people

*5: E = Available cargo and luggage load

As shown in the above example, if the number of occupants increases, the cargo and luggage load will be reduced by an amount that equals the increased weight due to the additional occupants. In other words, if an increase in the number of occupants causes an excess of the total load capacity (combined weight of occupants plus cargo and luggage load), you must reduce the cargo and luggage on your vehicle.

**CAUTION****■ Things that must not be carried in the luggage compartment**

The following things may cause a fire if loaded in the luggage compartment:

- Receptacles containing gasoline
- Aerosol cans

■ Storage precautions

Observe the following precautions.

Failure to do so may prevent the pedals from being depressed properly, may block the driver's vision, or may result in items hitting the driver or passengers, possibly causing an accident.

- Do not stack anything behind the front seats higher than the seat-backs.
 - Do not place cargo or luggage in or on the following locations.
 - At the feet of the driver
 - On the front passenger or rear seats (when stacking items)
 - On the instrument panel
 - On the dashboard
 - On the auxiliary box or tray that has no lid
 - Secure all items in the occupant compartment.
 - Never allow anyone to ride in the rear deck. It is not designed for passengers. They should ride in their seats with their seat belts properly fastened. Otherwise, they are much more likely to suffer death or serious bodily injury, in the event of sudden braking, sudden swerving or an accident.
- Capacity and distribution**
- Do not exceed the maximum axle weight rating or the total vehicle weight rating.
 - Even if the total load of occupant's weight and the cargo load is less than the total load capacity, do not apply the load unevenly. Improper loading may cause deterioration of steering or braking control which may cause death or serious injury.

Vehicle load limits

Vehicle load limits include total load capacity, seating capacity, TWR (Trailer Weight Rating) and cargo capacity.

◆ **Total load capacity (vehicle capacity weight): →P. 502**

Total load capacity means the combined weight of occupants, cargo and luggage.

◆ **Seating capacity**

- ▶ Regular Cab models
3 occupants
- ▶ Double Cab and CrewMax models
Vehicles with front separated type seats —
5 occupants (Front 2, Rear 3)
Vehicles with front bench type seat —
6 occupants (Front 3, Rear 3)

Seating capacity means the maximum number of occupants whose estimated average weight is 150 lb. (68 kg) per person.

Even if the number of occupants are within the seating capacity, do not exceed the total load capacity.

◆ **TWR (Trailer Weight Rating): →P. 162**

TWR means the maximum gross trailer weight (trailer weight plus its cargo weight) that your vehicle is able to tow.

◆ **Cargo capacity**

Cargo capacity may increase or decrease depending on the weight and the number of occupants.

■ **Total load capacity and seating capacity**

These details are also described on the tire and loading information label. (→P. 425)

**CAUTION****■ Overloading the vehicle**

Do not overload the vehicle.

It may not only cause damage to the tires, but also degrade steering and braking ability, resulting in an accident.

Trailer towing

Your vehicle is designed primarily as a passenger-and-load-carrying vehicle. Towing a trailer can have an adverse impact on handling, performance, braking, durability, and fuel consumption. For your safety and the safety of others, you must not overload your vehicle or trailer. You must also ensure that you are using appropriate towing equipment, that the towing equipment has been installed correctly and used properly, and that you employ the requisite driving habits.

Vehicle-trailer stability and braking performance are affected by trailer stability, brake performance and setting, trailer brakes, the hitch and hitch systems (if equipped).

To tow a trailer safely, use extreme care and drive the vehicle in accordance with your trailer's characteristics and operating conditions.

Toyota warranties do not apply to damage or malfunction caused by towing a trailer for commercial purposes.

Contact your Toyota dealer for further information about additional requirements such as a towing kits, etc.

Towing related terms

■ GCWR (Gross Combination Weight Rating)

The maximum allowable gross combination weight. The gross combination weight is the sum of the total vehicle weight (including the occupants, cargo and any optional equipment installed on the vehicle) and the weight of the trailer being towed (including the cargo in the trailer).

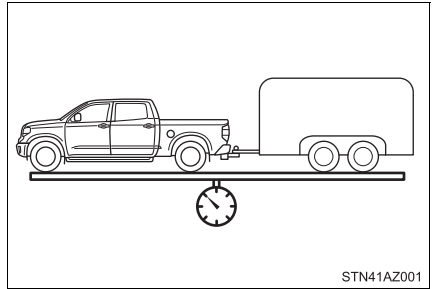

■ GVWR (Gross Vehicle Weight Rating)

The maximum allowable gross vehicle weight. The gross vehicle weight is the total weight of the vehicle. When towing a trailer, it is the sum of the vehicle weight (including the occupants, cargo and any optional equipment installed on the vehicle) and the tongue weight.

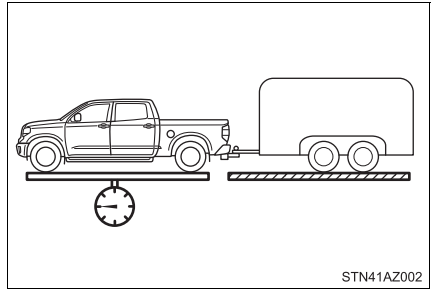

■ GAWR (Gross Axle Weight Rating)

The maximum allowable gross axle weight. The gross axle weight is the load placed on each axle (front and rear).

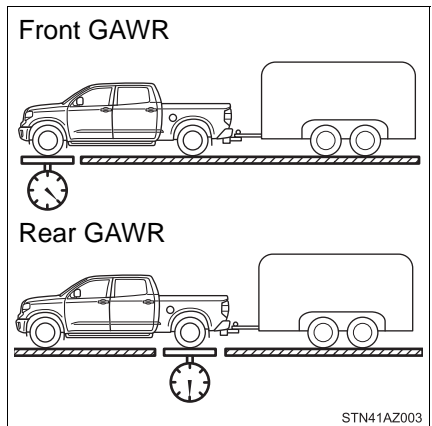

■ TWR (Trailer Weight Rating)

The maximum allowable gross trailer weight. The gross trailer weight is the sum of the trailer weight and the weight of the cargo in the trailer.

TWR is calculated assuming base vehicle with one driver, one front passenger, towing package (if available), hitch and hitch systems (if required).

Additional optional equipment, passengers and cargo in the vehicle will reduce the trailer weight rating so as not to exceed GCWR, GVWR and GAWR.

If the gross trailer weight exceeds 3000 lb. (1360 kg), it is recommended to use a trailer with 2 or more axles.

■ Unbraked TWR (Unbraked Trailer Weight Rating)

The trailer weight rating for towing a trailer without a trailer service brake system.

■ Tongue Weight

The load placed on the trailer hitch ball. (→P. 167)

(With brakes)

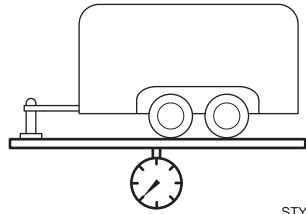

STYOT00135

(Without brakes)

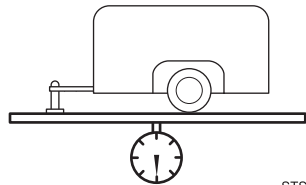

STSOT00046

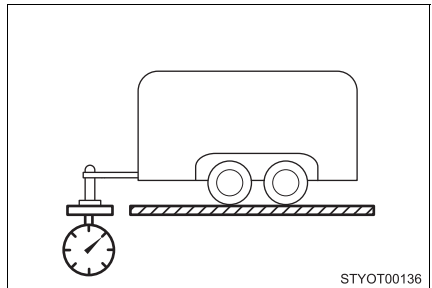

STYOT00136

■ Kingpin Weight

The load placed on the 5th wheel mount or the gooseneck ball. (→P. 168)

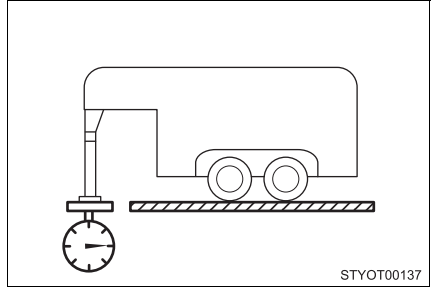

Weight limits

- The gross trailer weight must never exceed the TWR described in the table. (→P. 162)
- The gross combination weight must never exceed the GCWR described in the table. (→P. 162)
- The gross vehicle weight must never exceed the GVWR indicated on the Certification Label.
- The gross axle weight on each axle must never exceed the GAWR indicated on the Certification Label.

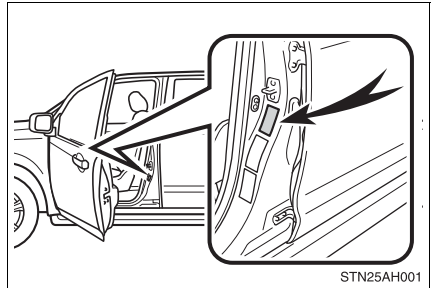

- If the gross trailer weight is over the unbraked TWR, trailer service brakes are required.
- If the gross trailer weight is over 2000 lb. (907 kg), a sway control device with sufficient capacity is required.
- If the gross trailer weight is over 5000 lb. (2268 kg), a weight distributing hitch with sufficient capacity is required.

GCWR, TWR, Unbraked TWR, Fifth wheel and Gooseneck towing TWR

Confirm that the gross trailer weight, gross combination weight, gross vehicle weight, gross axle weight and tongue weight are all within the limits.

■ GCWR*4 and TWR*4

► Regular Cab models

| Model code*1 | Engine | Driving system | Bed type | GCWR | TWR |
|---------------|----------------|----------------|--------------------------|--------------------------|--------------------------|
| GSK51L-THASKA | 1GR-FE engine | 2WD | Long | 10000 lb. (4535 kg) | 4800 lb. (2175 kg) |
| USK51L-THTSKA | 3UR-FE engine | | | 14000 lb. (6350 kg)*2 | 8500 lb. (3855 kg)*2 |
| | | | | 16000 lb. (7255 kg)*3 | 10500 lb. (4760 kg)*3 |
| USK56L-THTSKA | 3UR-FBE engine | 4WD | | 14000 lb. (6350 kg)*2 | 8200 lb. (3715 kg)*2 |
| USK56L-THTSGA | | | | 16000 lb. (7255 kg)*3 | 10200 lb. (4625 kg)*3 |
| | | | | 14000 lb. (6350 kg)*2 | 8200 lb. (3715 kg)*2 |
| | | | 16000 lb. (7255 kg)*3 | 10200 lb. (4625 kg)*3 | |

*1: The model code is indicated on the Certification Label. (→P. 506)

*2: Vehicles without towing package

*3: Vehicles with towing package

*4: These models meet the tow-vehicle trailering requirement of SAE International per SAE J2807.

► Double Cab models

| Model code*1 | Engine | Driving system | Bed type | GCWR | TWR |
|--------------------------|---------------|----------------|--------------------------|--------------------------|--------------------------|
| GSK51L-CRASKA | 1GR-FE engine | 2WD | Standard | 10000 lb. (4535 kg) | 4500 lb. (2040 kg) |
| UPK51L-CRTSKA | 1UR-FE engine | | | 12500 lb. (5670 kg) | 6800 lb. (3080 kg) |
| UPK56L-CRTSKA | | 4WD | | 12500 lb. (5670 kg) | 6500 lb. (2945 kg) |
| USK51L-CRTSKA | 3UR-FE engine | 2WD | Standard | 14000 lb. (6350 kg)*2 | 8200 lb. (3715 kg)*2 |
| USK51L-CRTLKA | | | | 16000 lb. (7255 kg)*3 | 10200 lb. (4625 kg)*3 |
| | | | | 14000 lb. (6350 kg)*2 | 8200 lb. (3715 kg)*2 |
| USK52L-CHTSKA | | | | 16000 lb. (7255 kg)*3 | 10200 lb. (4625 kg)*3 |
| | | | Long | 14000 lb. (6350 kg)*2 | 8100 lb. (3670 kg)*2 |
| 16000 lb. (7255 kg)*3 | | | | 10100 lb. (4580 kg)*3 | |
| USK56L-CRTSKA | | 4WD | Standard | 14000 lb. (6350 kg)*2 | 7900 lb. (3580 kg)*2 |
| USK56L-CRTLKA | | | | 16000 lb. (7255 kg)*3 | 9900 lb. (4490 kg)*3 |
| | | | | 14000 lb. (6350 kg)*2 | 7900 lb. (3580 kg)*2 |
| USK57L-CHTSKA | | | | 16000 lb. (7255 kg)*3 | 9900 lb. (4490 kg)*3 |
| | Long | | 14000 lb. (6350 kg)*2 | 7800 lb. (3535 kg)*2 | |
| 16000 lb. (7255 kg)*3 | | | 9800 lb. (4445 kg)*3 | | |

| Model code *1 | Engine | Driving system | Bed type | GCWR | TWR |
|---------------|----------------|----------------|----------|--------------------------------------|-------------------------------------|
| USK56L-CRTSGA | 3UR-FBE engine | 4WD | Standard | 14000 lb. (6350 kg) ^{*2} | 7900 lb. (3580 kg) ^{*2} |
| | | | | 16000 lb. (7255 kg) ^{*3} | 9900 lb. (4490 kg) ^{*3} |
| USK56L-CRTLGA | | | | 14000 lb. (6350 kg) ^{*2} | 7900 lb. (3580 kg) ^{*2} |
| | | | | 16000 lb. (7255 kg) ^{*3} | 9900 lb. (4490 kg) ^{*3} |
| USK57L-CHTSGA | | | Long | 14000 lb. (6350 kg) ^{*2} | 7800 lb. (3535 kg) ^{*2} |
| | | | | 16000 lb. (7255 kg) ^{*3} | 9800 lb. (4445 kg) ^{*3} |

*1: The model code is indicated on the Certification Label. (→P. 506)

*2: Vehicles without towing package

*3: Vehicles with towing package

► CrewMax models

| Model code* ¹ | Engine | Driving system | Bed type | GCWR | TWR | | | | | | | |
|--------------------------------------|---------------|----------------|---------------|--------------------------------------|--------------------------------------|--------------------------------------|--------------------------------------|--------------------------------------|--------------------------------------|-------------------------------------|--------------------------------------|-------------------------------------|
| UPK51L-PSTSKA | 1UR-FE engine | 2WD | Short | 12500 lb. (5670 kg) | 6600 lb. (2990 kg) | | | | | | | |
| UPK56L-PSTSKA | | 4WD | | 12500 lb. (5670 kg) | 6300 lb. (2855 kg) | | | | | | | |
| USK51L-PSTSKA | 3UR-FE engine | 2WD | | 14000 lb. (6350 kg) ^{*2} | 8100 lb. (3670 kg) ^{*2} | | | | | | | |
| | | | | 16000 lb. (7255 kg) ^{*3} | 10100 lb. (4580 kg) ^{*3} | | | | | | | |
| 14000 lb. (6350 kg) ^{*2} | | | | 8000 lb. (3625 kg) ^{*2} | | | | | | | | |
| 16000 lb. (7255 kg) ^{*3} | | | | 10000 lb. (4535 kg) ^{*3} | | | | | | | | |
| USK51L-PSTLKA | | | | 3UR-FE engine | 2WD | 14000 lb. (6350 kg) ^{*2} | 8000 lb. (3625 kg) ^{*2} | | | | | |
| | | | | | | 16000 lb. (7255 kg) ^{*3} | 10000 lb. (4535 kg) ^{*3} | | | | | |
| USK51L-PSTZKA | | | | | | 3UR-FE engine | 2WD | 14000 lb. (6350 kg) ^{*2} | 8000 lb. (3625 kg) ^{*2} | | | |
| | | | | | | | | 16000 lb. (7255 kg) ^{*3} | 10000 lb. (4535 kg) ^{*3} | | | |
| USK56L-PSTSKA | | | 3UR-FE engine | | | | | 4WD | 14000 lb. (6350 kg) ^{*2} | 7800 lb. (3535 kg) ^{*2} | | |
| | | | | | | | | | 16000 lb. (7255 kg) ^{*3} | 9800 lb. (4445 kg) ^{*3} | | |
| USK56L-PSTLKA | 3UR-FE engine | 4WD | | | | | | | 14000 lb. (6350 kg) ^{*2} | 7700 lb. (3490 kg) ^{*2} | | |
| | | | | | | | | | 15900 lb. (7210 kg) ^{*3} | 9600 lb. (4350 kg) ^{*3} | | |
| USK56L-PSTZKA | | | | | | | | | 3UR-FE engine | 4WD | 14000 lb. (6350 kg) ^{*2} | 7700 lb. (3490 kg) ^{*2} |
| | | | | | | | | | | | 15800 lb. (7165 kg) ^{*3} | 9500 lb. (4305 kg) ^{*3} |

| Model code *1 | Engine | Driving system | Bed type | GCWR | TWR |
|-----------------------------------|-----------------------------------|----------------------------------|----------|-----------------------------------|----------------------------------|
| USK56L-PSTSGA | 3UR-FBE engine | 4WD | Short | 14000 lb. (6350 kg) ^{*2} | 7800 lb. (3535 kg) ^{*2} |
| | | | | 16000 lb. (7255 kg) ^{*3} | 9800 lb. (4445 kg) ^{*3} |
| 14000 lb. (6350 kg) ^{*2} | | | | 7700 lb. (3490 kg) ^{*2} | |
| 15900 lb. (7210 kg) ^{*3} | | | | 9600 lb. (4350 kg) ^{*3} | |
| USK56L-PSTLGA | | | | 14000 lb. (6350 kg) ^{*2} | 7700 lb. (3490 kg) ^{*2} |
| | | | | 15800 lb. (7165 kg) ^{*3} | 9500 lb. (4305 kg) ^{*3} |
| USK56L-PSTZGA | 14000 lb. (6350 kg) ^{*2} | 7700 lb. (3490 kg) ^{*2} | | | |
| | 15800 lb. (7165 kg) ^{*3} | 9500 lb. (4305 kg) ^{*3} | | | |

*1: The model code is indicated on the Certification Label. (→P. 506)

*2: Vehicles without towing package

*3: Vehicles with towing package

■ **Unbraked TWR^{*4}**

1000 lb. (453 kg)

*4: These models meet the tow-vehicle trailering requirement of SAE International per SAE J2807.

Trailer Tongue Weight and Trailer Kingpin Weight

- A recommended tongue weight or kingpin weight varies in accordance with the types of trailers or towing as described below.
- To ensure the recommended values shown below, the trailer must be loaded by referring to the following instructions.

1. Conventional Towing

The gross trailer weight should be distributed so that the tongue weight is 9% to 11%. (Tongue Weight/Gross trailer weight x 100 = 9% to 11%)

- ① Gross trailer weight
- ② Tongue Weight

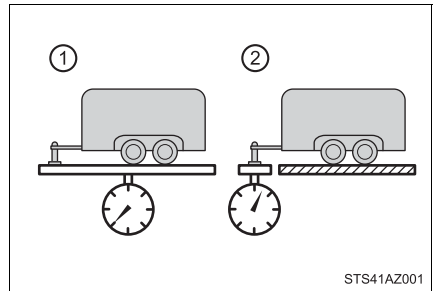

If using a weight distributing hitch when towing, return the front axle to the same weight as before the trailer connection.

If front axle weight cannot be measured directly, measure the front fender height above the front axle before connection. Adjust weight distributing hitch torque until front fender is returned to the same height as before connection.

Do not reduce front fender height below original measurement.

The gross trailer weight, gross axle weight and tongue weight can be measured with platform scales found at a highway weighing station, building supply company, trucking company, junk yard, etc.

2. Fifth wheel Towing or Gooseneck Towing

The gross trailer weight should be distributed so that the kingpin weight is 19% to 21%. (Kingpin weight/Gross trailer weight x 100 = 19% to 21%)

- ① Gross trailer weight
- ② Kingpin weight

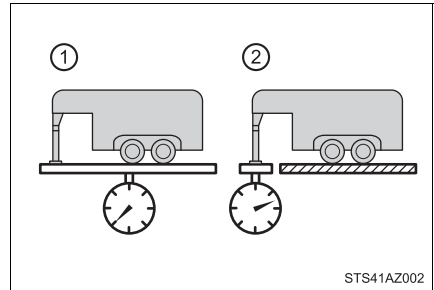

The gross trailer weight and kingpin weight can be measured with platform scales found at a highway weighing station, building supply company, trucking company, junk yard, etc.

CrewMax models: Current fifth wheel trailer designs are not compatible with short bed.

Hitch

Trailer hitch assemblies have different weight capacities. Toyota recommends the use of Toyota hitch/bracket for your vehicle. For details, contact your Toyota dealer.

- If you wish to install a trailer hitch, contact your Toyota dealer.
- Use only a hitch that conforms to the gross trailer weight requirement of your vehicle.
- Follow the directions supplied by the hitch manufacturer.
- Lubricate the hitch ball and kingpin with a light coating of grease.
- Remove the trailer hitch whenever you are not towing a trailer. After removing the hitch, seal any mounting hole in the vehicle body to prevent entry of any substances into the vehicle.

Bumper towing (vehicles with steel bumper only)

The rear bumper of your vehicle is equipped with a hole to install a trailer ball. If you have any questions, contact your Toyota dealer.

The gross trailer weight (trailer weight plus cargo weight) when towing with the bumper must never exceed the TWR (→P. 162) or 5000 lb. (2268 kg) whichever is lower.

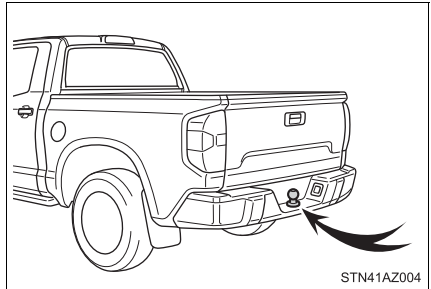

Selecting trailer ball

Use the correct trailer ball for your application.

① Trailer ball load rating

Matches or exceeds the gross trailer weight rating of the trailer.

② Ball diameter

Matches the size of the trailer coupler. Most couplers are stamped with the required trailer ball size.

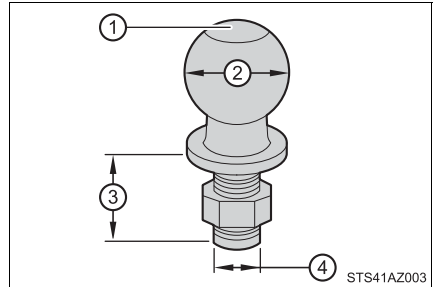

| | | | |
|---------------------------|------------|------------|-----------|
| Trailer class | IV | II and III | I |
| Typical trailer ball size | 2 5/16 in. | 2 in. | 1 7/8 in. |

③ Shank length

Protrudes beyond the bottom of the lock washer and nut by at least 2 threads.

④ Shank diameter

Matches the ball mount hole diameter size.

Positions for towing hitch receiver

- ① Hitch receiver pin hole position:
46.4 in. (1179 mm)

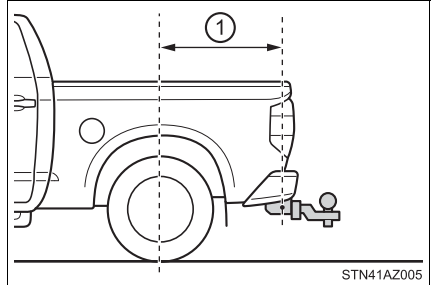

Connecting trailer lights

Use the wire harness stored in the rear end of the vehicle.

- Vehicles without towing package ► Vehicles with towing package age

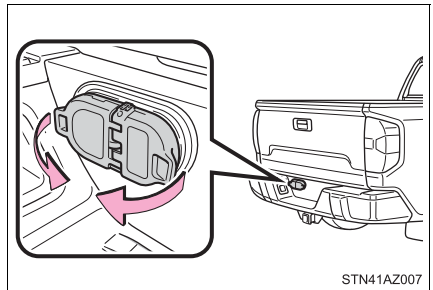
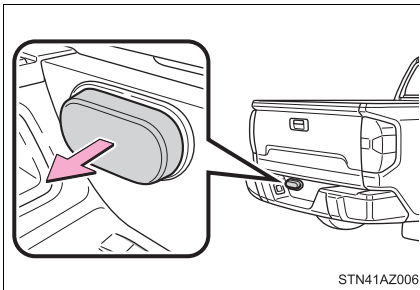

Service connector for towing brake controller (if equipped)

Your vehicle is equipped with a service connector for the trailer brake controller as shown.

Access the service connector.

- ① Remove the scuff plate.
- ② Remove the clip (screw type) and trim board.
- ③ Remove the connector cover.

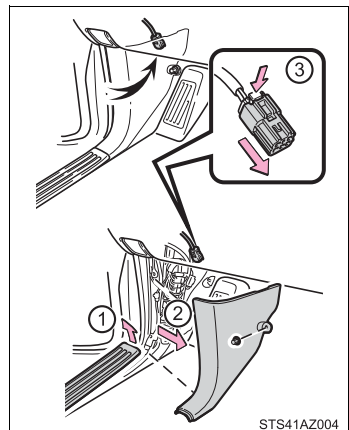

Trailer towing tips

Your vehicle will handle differently when towing a trailer. Help to avoid an accident, death or serious injury, keep the following in mind when towing:

- Speed limits for towing a trailer vary by state or province. Do not exceed the posted towing speed limit.
- Toyota recommends that the vehicle-trailer speed limit is 65 mph (104 km/h) on a flat, straight, dry road. Do not exceed this limit, the posted towing speed limit or the speed limit for your trailer as set forth in your trailer owner's manual, whichever is lowest. Instability of the towing vehicle-trailer combination (trailer sway) increases as speed increases. Exceeding speed limits may cause loss of control.
- Before starting out, check the trailer lights, tires and the vehicle-trailer connections. Recheck after driving a short distance.
- Practice turning, stopping and reversing with the trailer attached in an area away from traffic until you become accustomed to the feel of the vehicle-trailer combination.
- Reversing with a trailer attached is difficult and requires practice. Grip the bottom of the steering wheel and move your hand to the left to move the trailer to the left. Move your hand to the right to move the trailer to the right. (This is generally opposite to reversing without a trailer attached.) Avoid sharp or prolonged turning. Have someone guide you when reversing to reduce the risk of an accident.
- As stopping distance is increased when towing a trailer, vehicle-to-vehicle distance should be increased. For each 10 mph (16 km/h) of speed, allow at least one vehicle and trailer length.

- Avoid sudden braking as you may skid, resulting in the trailer jackknifing and a loss of vehicle control. This is especially true on wet or slippery surfaces.
- Avoid jerky starts or sudden acceleration.
- Avoid jerky steering and sharp turns, and slow down before making a turn.
- Note that when making a turn, the trailer wheels will be closer than the vehicle wheels to the inside of the turn. Compensate by making a wider than normal turning radius.
- Slow down before making a turn, in crosswinds, on wet or slippery surfaces, etc.
Increasing vehicle speed can destabilize the trailer.
- Take care when passing other vehicles. Passing requires considerable distance. After passing a vehicle, do not forget the length of your trailer, and be sure you have plenty of room before changing lanes.
- To maintain engine braking efficiency and charging system performance when using engine braking, do not use the transmission in D.
Transmission shift range position must be in 4 in the S mode.
- Instability happens more frequently when descending steep or long downhill grades. Before descending, slow down and downshift. Do not make sudden downshifts while descending steep or long downhill grades.
- Avoid holding the brake pedal down too long or applying the brakes too frequently. This could cause the brakes to overheat and result in reduced braking efficiency.
- Due to the added load of the trailer, your vehicle's engine may overheat on hot days (at temperatures over 85°F [30°C]) when driving up a long or steep grade. If the engine coolant temperature gauge indicates overheating, immediately turn off the air conditioning (if in use), pull your vehicle off the road and stop in a safe spot.
(→P. 496)

- Always place wheel blocks under both the vehicle's and the trailer's wheels when parking. Apply the parking brake firmly, and put the transmission in P. Avoid parking on a slope, but if unavoidable, do so only after performing the following:
 - 1 Apply the brakes and keep them applied.
 - 2 Have someone place wheel blocks under both the vehicle's and trailer's wheels.
 - 3 When the wheel blocks are in place, release the brakes slowly until the blocks absorb the load.
 - 4 Apply the parking brake firmly.
 - 5 Shift into P and turn off the engine.
- When restarting after parking on a slope:
 - 1 With the transmission in P, start the engine. Be sure to keep the brake pedal pressed.
 - 2 Shift into D or R (if reversing).
 - 3 Release the parking brake and brake pedal, and slowly pull or back away from the wheel blocks. Stop and apply the brakes.
 - 4 Have someone retrieve the blocks.

■ Matching trailer ball height to trailer coupler height

No matter which class of tow hitch applies, for a more safe trailer hookup, the trailer ball setup must be the proper height for the coupler on the trailer.

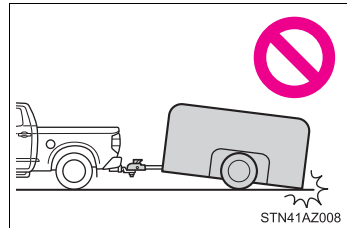

- 1 Coupler
- 2 Trailer ball

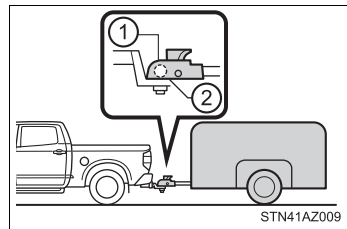

■ Before towing

Check that the following conditions are met:

- Ensure that your vehicle's tires are properly inflated. (→P. 513)
- Trailer tires are inflated according to the trailer manufacturer's recommendation.
- All trailer lights work as required by law.
- All lights work each time you connect them.
- The trailer ball is set at the proper height for the coupler on the trailer.
- The trailer is level when it is hitched.
Do not drive if the trailer is not level, and check for improper tongue weight, overloading, worn suspension, or other possible causes.
- The trailer cargo is securely loaded.
- The rear view mirrors conform to all applicable federal, state/provincial or local regulations. If they do not, install rear view mirrors appropriate for towing purposes.
- Depress TOW/HAUL button (if equipped). (→P. 184)
- The manual headlight leveling dial is correctly adjusted. (if equipped) (→P. 190)

■ Break-in schedule

If your vehicle is new or equipped with any new power train components (such as an engine, transmission, differential or wheel bearing), Toyota recommends that you do not tow a trailer until the vehicle has been driven for over 500 miles (800 km).

After the vehicle has been driven for over 500 miles (800 km), you can start towing. However, for the next 500 miles (800 km), drive the vehicle at a speed of less than 50 mph (80 km/h) when towing a trailer, and avoid full throttle acceleration.

■ Maintenance

- If you tow a trailer, your vehicle will require more frequent maintenance due to the additional load. (See "Owner's Warranty Information Booklet" or "Scheduled Maintenance Guide"/"Owner's Manual Supplement".)
- Retighten the fixing bolts of the towing ball and bracket after approximately 600 miles (1000 km) of trailer towing.

■ If trailer sway occurs

One or more factors (crosswinds, passing vehicles, rough roads, etc.) can adversely affect handling of your vehicle and trailer, causing instability.

● If trailer swaying occurs:

- Firmly grip the steering wheel. Steer straight ahead.
Do not try to control trailer swaying by turning the steering wheel.
- Begin releasing the accelerator pedal immediately but very gradually to reduce speed.
Do not increase speed. Do not apply vehicle brakes.

If you make no extreme correction with the steering or brakes, your vehicle and trailer should stabilize. (if enabled, Trailer Sway Control can also help to stabilize the vehicle and trailer.)

● After the trailer swaying has stopped:

- Stop in a safe place. Get all occupants out of the vehicle.
- Check the tires of the vehicle and the trailer.
- Check the load in the trailer.
Make sure the load has not shifted.
Make sure the tongue weight is appropriate, if possible.
- Check the load in the vehicle.
Make sure the vehicle is not overloaded after occupants get in.

If you cannot find any problems, the speed at which trailer swaying occurred is beyond the limit of your particular vehicle-trailer combination.

Drive at a lower speed to prevent instability. Remember that swaying of the towing vehicle-trailer increases as speed increases.

CAUTION

■ Trailer towing precautions

To tow a trailer safely, use extreme care and drive the vehicle in accordance with the trailer's characteristics and operating conditions. Failure to do so could cause an accident resulting in death or serious injury. Vehicle stability and braking performance are affected by trailer stability, brake setting and performance, and the hitch. Your vehicle will handle differently when towing a trailer.

**CAUTION****■ To avoid accident or injury**

- Do not exceed the TWR, unbraked TWR, GCWR, GVWR or GAWR.
- If the gross trailer weight is over 2000 lb. (907 kg), a sway control device with sufficient capacity is required.
- If the gross trailer weight is over 5000 lb. (2268 kg), a weight distributing hitch with sufficient capacity is required.
- Adjust the tongue weight within the appropriate range. Place heavier loads as close to the trailer axle as possible.
- Do not exceed 65 mph (104 km/h), the posted towing speed limit or the speed limit for your trailer as set forth in your trailer owner's manual, whichever is lowest. Slow down sufficiently before making a turn, in crosswinds, on wet or slippery surface, etc., to help avoid an accident. If you experience a vehicle-trailer instability from reducing a certain speed, slow down and make sure you keep your vehicle speed under the speed of which you experience the instability.
- Do not make jerky, abrupt or sharp turns.
- Do not apply the brakes suddenly as you may skid, resulting in jackknifing and loss of vehicle control. This is especially true on wet or slippery surfaces.
- Do not exceed the trailer hitch assembly weight, gross vehicle weight, gross axle weight and trailer tongue weight capacities.
- Do not use cruise control when towing.
- Slow down and downshift before descending steep or long downhill grades. Do not make sudden downshifts while descending steep or long downhill grades.
- Vehicle-trailer instability is more likely on steep long downhills. Before descending steep or long downhill grades, slow down and downshift. Do not make sudden downshifts when descending steep or long downhill grades. Avoid holding the brake pedal down too long or applying the brakes too frequently. This could cause the brakes to overheat and result in reduced braking efficiency.
- Do not tow a trailer when the temporary spare tire is installed on your vehicle.

 **CAUTION**

Hitch

Trailer hitch assemblies have different weight capacities established by the hitch manufacturer. Even though the vehicle may be physically capable of towing a higher weight, the operator must determine the maximum weight rating of the particular hitch assembly and never exceed the maximum weight rating specified for the trailer-hitch. Exceeding the maximum weight rating set by the trailer-hitch manufacturer can cause an accident resulting in death or serious personal injuries.

When towing a trailer

Toyota recommends trailers with brakes that conform to any applicable federal and state/provincial regulations.

- If the gross trailer weight exceeds unbraked TWR, trailer brakes are required. Toyota recommends trailers with brakes that conform to all applicable federal and state/provincial regulations.
- Never tap into your vehicle's hydraulic system, as this will lower the vehicle's braking effectiveness.
- Never tow a trailer without using a safety chain securely attached to both the trailer and the vehicle. If damage occurs to the coupling unit or hitch ball, there is danger of the trailer wandering into another lane.

 **NOTICE**

When installing a trailer hitch

Use only the position recommended by your Toyota dealer. Do not install the trailer hitch on the bumper; this may cause body damage.

Do not directly splice trailer lights

Do not directly splice trailer lights. Directly splicing trailer lights may damage your vehicle's electrical system and cause a malfunction.

When towing a fifth wheel trailer

Be careful not to hit the cabin or bed with the trailer while making a sharp turn.

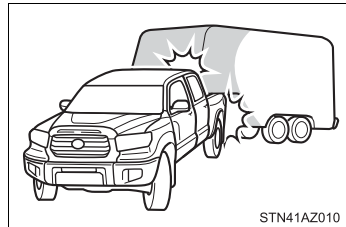

STN41AZ010

Dinghy towing

Your vehicle is not designed to be dinghy towed (with 4 wheels on the ground) behind a motor home.

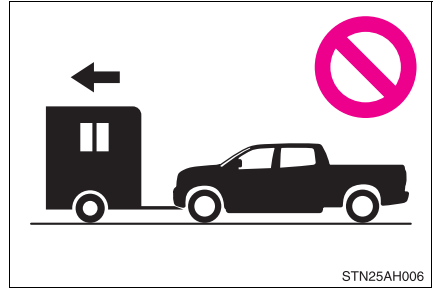

NOTICE

■ To avoid serious damage to your vehicle

Do not tow your vehicle with the four wheels on the ground.

Engine (ignition) switch

Starting the engine

- 1 Check that the parking brake is set.
- 2 Check that the shift lever is set in P.
- 3 Firmly depress the brake pedal.
- 4 Turn the engine switch to the “START” position to start the engine.

Changing the engine switch positions

① “LOCK”

The steering wheel is locked and the key can be removed. (The key can be removed only when the shift lever is in P.)

② “ACC”

Some electrical components such as the audio system can be used.

③ “ON”

All electrical components can be used.

④ “START”

For starting the engine.

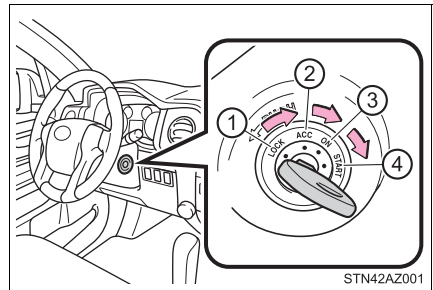

■ Turning the key from “ACC” to “LOCK”

- 1 Shift the shift lever to P.
- 2 Push in the key and turn it to the “LOCK” position.

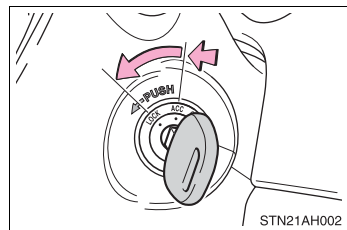

■ If the engine does not start (vehicles with engine immobilizer system)

The engine immobilizer system may not have been deactivated. (→P. 78)
Contact your Toyota dealer.

■ When the steering lock cannot be released

When starting the engine, the engine switch may seem stuck in the “LOCK” position. To free it, turn the key while turning the steering wheel slightly left and right.

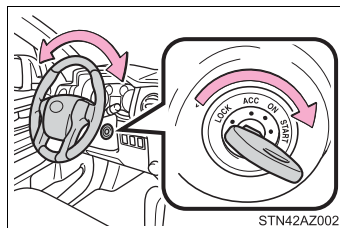

■ Key reminder function

A buzzer sounds if the driver's door is opened while the engine switch is in the “ACC” or “LOCK” position to remind you to remove the key.

⚠ CAUTION

■ When starting the engine

Always start the engine while sitting in the driver's seat. Do not depress the accelerator pedal while starting the engine under any circumstances. Doing so may cause an accident resulting in death or serious injury.

■ Caution while driving

Do not turn the engine switch to the “LOCK” position while driving. If, in an emergency, you must turn the engine off while the vehicle is moving, turn the engine switch only to the “ACC” position to stop the engine. An accident may result if the engine is stopped while driving. (→P. 457)

⚠ NOTICE

■ To prevent battery discharge

Do not leave the engine switch in the “ACC” or “ON” position for long periods of time without the engine running.

■ When starting the engine

- Do not crank the engine for more than 30 seconds at a time. This may overheat the starter and wiring system.
- Do not race a cold engine.
- If the engine becomes difficult to start or stalls frequently, have your vehicle checked by your Toyota dealer immediately.

Automatic transmission

Shifting the shift lever

► Floor shift type

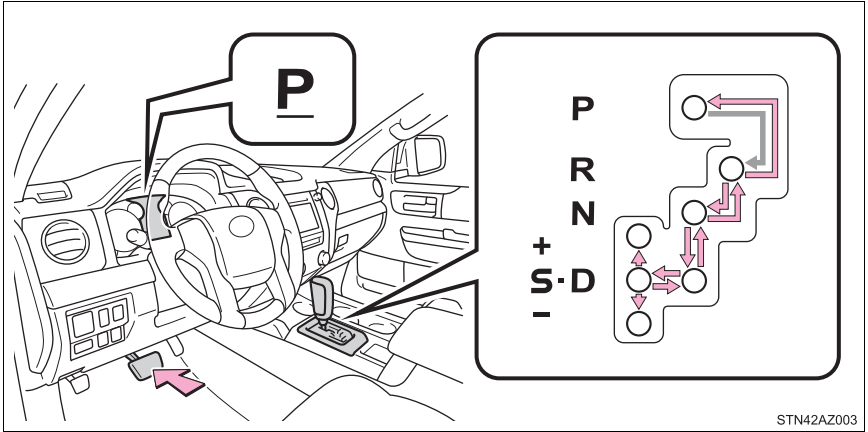

← While the engine switch is in the “ON” position, move the shift lever with the brake pedal depressed.

When shifting the shift lever between P and D, make sure that the vehicle is completely stopped.

► Column shift type

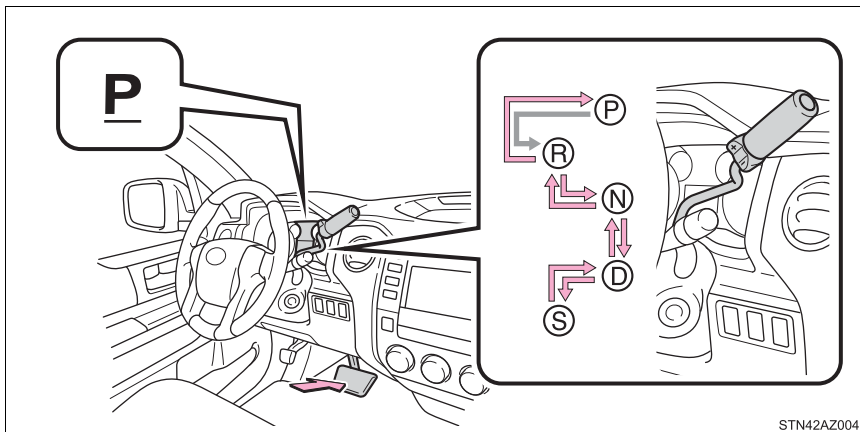

STN42AZ004

← While the engine switch is in the “ON” position, move the shift lever with the brake pedal depressed.

When shifting the shift lever between P and D, make sure that the vehicle is completely stopped.

Shift position purpose

| Shift position | Function |
|----------------|---|
| P | Parking the vehicle/starting the engine |
| R | Reversing |
| N | Neutral |
| D | Normal driving*1 |
| S | S mode driving*2 (→P. 183) |

*1: To improve fuel efficiency and reduce noises, set the shift lever in the D position for normal driving.

*2: Selecting shift ranges using S mode restricts the upper limit of the possible gear ranges, controls engine braking forces, and prevents unnecessary upshifting.

Selecting shift ranges in the S position

To enter S mode, shift the shift lever to S. Shift ranges can be selected by operating the shift lever, allowing you to drive in the shift range of your choosing. The shift range can be selected by the shift lever.

▶ Floor shift type

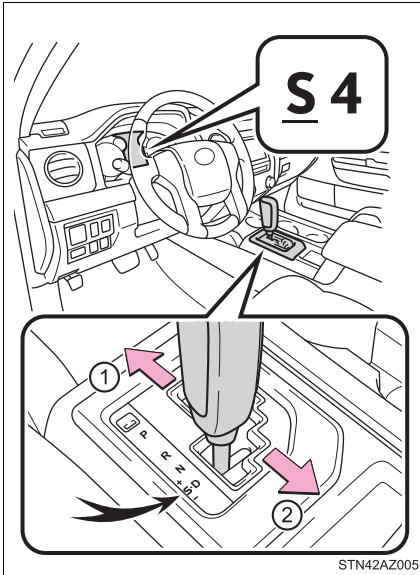

▶ Column shift type

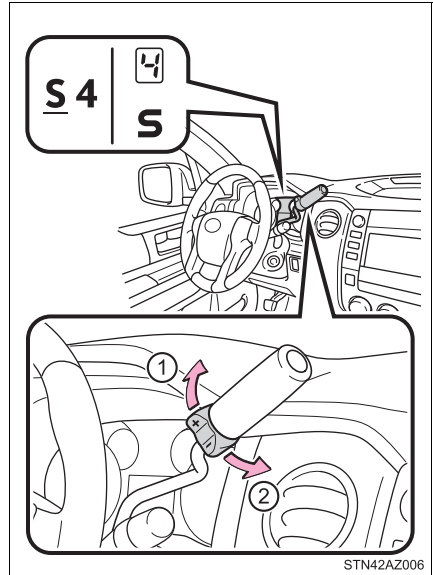

- ① Upshifting
- ② Downshifting

The selected shift range, from 1 to 6 (6-speed models) or 1 to 5 (5-speed models), will be displayed in the meter.

The initial shift range in S mode is set automatically to 5 or 4 (6-speed models) or 4 (5-speed models) according to vehicle speed. However, the initial shift range may be set to 3 or 2 (6-speed models) or 3 (5-speed models) if the AI-SHIFT (→P. 185) has operated while the shift lever was in the D position.

■ Shift ranges and their functions

- Automatically selecting gears between 1 and 6 (6-speed models) or 1 and 5 (5-speed models) according to vehicle speed and driving conditions.
- You can choose from 6 levels (6-speed models) or 5 levels (5-speed models) of accelerating force and engine braking force.
- A lower shift range will provide greater accelerating force and engine braking force than a higher shift range, and the engine revolutions will also increase.

TOW/HAUL switch (vehicles with towing package)

Use TOW/HAUL mode when pulling a trailer or hauling a heavy load.

Press the TOW/HAUL switch. The indicator will come on.

Press the switch once more to cancel the mode.

▶ Floor shift type

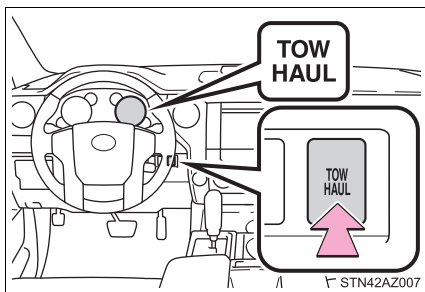

▶ Column shift type

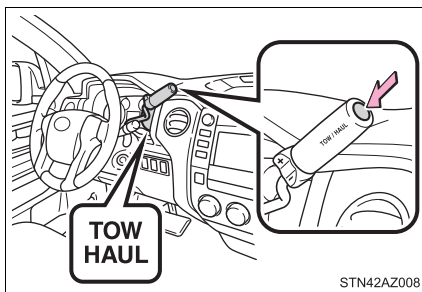

■ AI-SHIFT

AI-SHIFT automatically selects the suitable gear according to the driver performance and driving conditions.

AI-SHIFT automatically operates when the shift lever is in the D position. (Shifting the shift lever to the S position cancels the function.)

■ When driving with cruise control activated (if equipped)

Even when performing the following actions with the intent of enabling engine braking, engine braking will not activate while driving in S mode and downshifting to 5 or 4 (6-speed models) or 4 (5-speed models) because cruise control will not be canceled. (→P. 200)

■ If the shift lever cannot be shift from P

→P. 491

■ If the “S” indicator does not come on even after shifting the shift lever to S

This may indicate a malfunction in the automatic transmission system. Have the vehicle inspected by your Toyota dealer, immediately.

(In this situation, the transmission will operate in the same manner as when the shift lever is in D.)

■ Downshifting restrictions warning buzzer (S mode)

To help ensure safety and driving performance, downshifting operation may sometimes be restricted. In some circumstances, downshifting may not be possible even when the shift lever is operated. (A buzzer will sound twice.)

▲ CAUTION**■ When driving on slippery road surfaces**

Do not accelerate or shift gears suddenly.

Sudden changes in engine braking may cause the vehicle to spin or skid, resulting in an accident.

Turn signal lever

Operating instructions

- ① Right turn
- ② Lane change to the right (push and hold the lever partway)
The right hand signals will flash until you release the lever.
- ③ Lane change to the left (push and hold the lever partway)
The left hand signals will flash until you release the lever.
- ④ Left turn

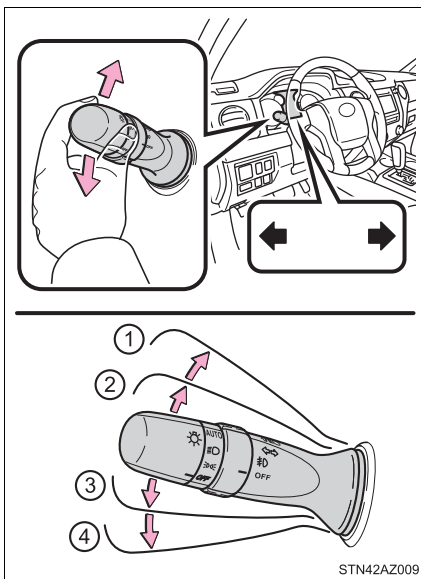

■ Turn signals can be operated when

The engine switch is in the "ON" position.

■ If the indicator flashes faster than usual

Check that a light bulb in the front or rear turn signal lights has not burned out.

Parking brake

To set the parking brake, fully depress the parking brake pedal with your left foot while depressing the brake pedal with your right foot.

(Depressing the pedal again releases the parking brake.)

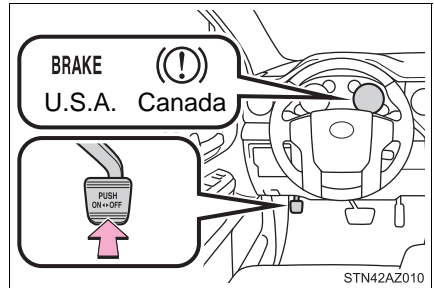

■ Usage in winter time

→P. 241

NOTICE

■ Before driving

Fully release the parking brake.

Driving the vehicle with the parking brake set will lead to brake components overheating, which may affect braking performance and increase brake wear.

Horn

To sound the horn, press on or close to the  mark.

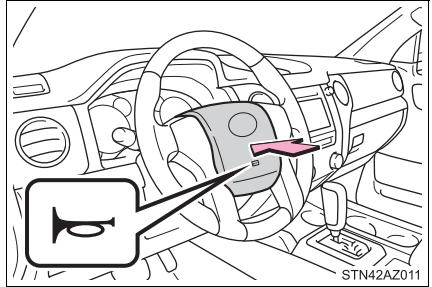

■ After adjusting the steering wheel (manual adjustable type)

Make sure that the steering wheel is securely locked.

The horn may not sound if the steering wheel is not securely locked.

(→P. 126)

Headlight switch

The headlights can be operated manually or automatically.

Operating instructions

Turning the end of the lever turns on the lights as follows:

- ① OFF (U.S.A.) or ○ (Canada)

Off

Vehicles with the daytime running light system: The daytime running lights turn on.

- ②  The side marker, parking, tail, license plate, daytime running lights (if equipped) and instrument panel lights turn on.

- ③  The headlights and all lights listed above (except daytime running lights) turn on.

- ④ AUTO (If equipped)

The headlights, daytime running lights (if equipped) and all the lights listed above turn on and off automatically. (When the engine switch is in the "ON" position.)

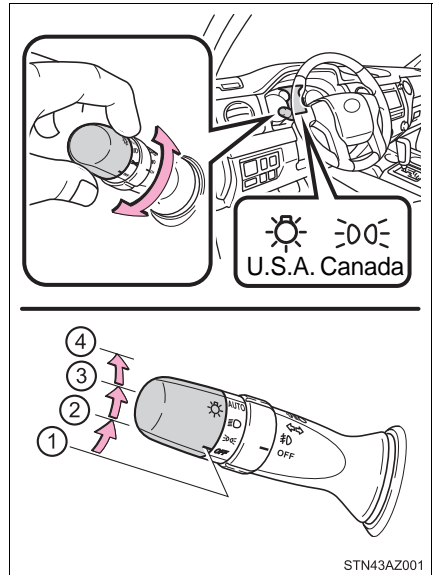

Turning on the high beam headlights

- ① With the headlights on, push the lever away from you to turn on the high beams.
Pull the lever toward you to the center position to turn the high beams off.
- ② Pull the lever toward you and release it to flash the high beams once.

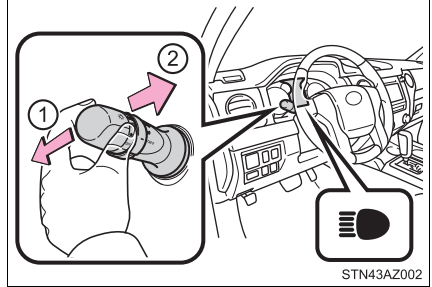

You can flash the high beams with the headlights on or off.

Manual headlight leveling dial (if equipped)

The level of the headlights can be adjusted according to the number of passengers and the loading condition of the vehicle.

- ① Raises the level of the headlights
- ② Lowers the level of the headlights

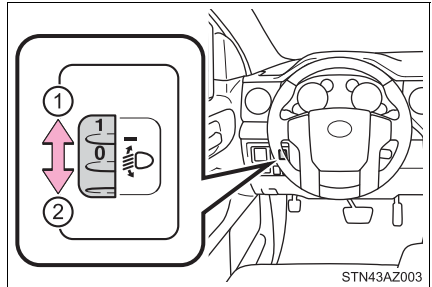

■ Guide to dial settings

| Loading condition | | Control switch position | | | |
|----------------------------------|--------------|-------------------------|------------|------|---------|
| Towing Hitch (Towing package) | Payload | Regular Cab | Double Cab | | CrewMax |
| | | Long | Standard | Long | Short |
| None | None | 0 | 0 | 0 | 0 |
| None | Maximum load | 2.5 | 2.5 | 2 | 2.5 |
| Maximum load | None | 4 | 3.5 | 3 | 3.5 |

■ Daytime running light system (if equipped)

- To make your vehicle more visible to other drivers, the daytime running lights turn on automatically whenever the engine is started and the parking brake is released. Daytime running lights are not designed for use at night.
- Compared to turning on the headlights, the daytime running light system offers greater durability and consumes less electricity, so it can help improve fuel economy.

■ Headlight control sensor (vehicles with automatic headlight system)

The sensor may not function properly if an object is placed on the sensor, or anything that blocks the sensor is affixed to the windshield.

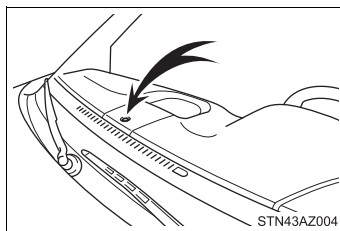

Doing so interferes with the sensor detecting the level of ambient light and may cause the automatic headlight system to malfunction.



■ Automatic light off system

- When the headlights come on: The headlights and tail lights turn off 30 seconds after a door is opened and closed if the engine switch is turned to the “ACC” or “LOCK” position. (The lights turn off immediately if the  button on the key is pressed after all the doors are locked.)
- When only the tail lights come on: The tail lights turn off automatically if the engine switch is tuned to the “ACC” or “LOCK” position and the driver’s door is opened.

Vehicles with automatic headlight system: If any of the doors is kept open, the lights automatically turn off after 20 minutes.

To turn the lights on again, turn the engine switch to the “ON” position, or turn the light switch off once and then back to  or .

■ Light reminder buzzer

A buzzer sounds when the key is removed from the engine switch and the driver’s door is opened while the lights are turned on.

■ Customization that can be configured at Toyota dealer

Settings (automatic light off system) can be changed.
(Customizable features: →P. 530)

NOTICE

■ To prevent battery discharge

Do not leave the lights on longer than necessary when the engine is not running.

Fog light switch*

The fog lights secure excellent visibility in difficult driving conditions, such as in rain and fog.

- ① OFF (U.S.A.) or ○ (Canada)
Turns the front fog lights off
- ② Ⓜ Turns the front fog lights on

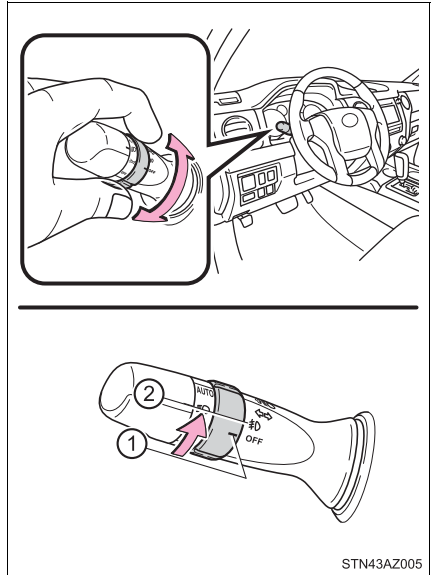

STN43AZ005

■ Fog lights can be used when

The headlights are on in low beam.

*: If equipped

Windshield wipers and washer

Operating the wiper lever

Operate the lever as follows to operate the wipers.

► Vehicles without intermittent type

- ① OFF (U.S.A.) or ○ (Canada)
Off
- ② LO (U.S.A.) or ▼ (Canada)
Low speed windshield
wiper operation
- ③ HI (U.S.A.) or ▼ (Canada)
High speed windshield
wiper operation
- ④ MIST (U.S.A.) or ▲ (Canada)
Temporary operation

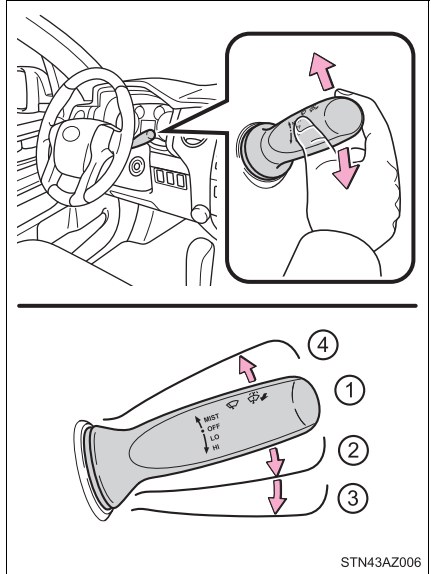

- ⑤ Washer operation

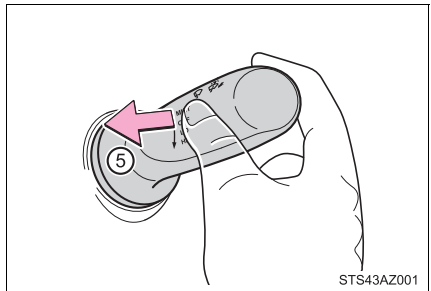

► Vehicles with intermittent type

- ① OFF (U.S.A.) or ○ (Canada)
Off
- ② INT (U.S.A.) or  (Canada)
Intermittent windshield wiper operation
- ③ LO (U.S.A.) or ▼ (Canada)
Low speed windshield wiper operation
- ④ HI (U.S.A.) or ▼ (Canada)
High speed windshield wiper operation
- ⑤ MIST (U.S.A.) or ▲ (Canada)
Temporary operation

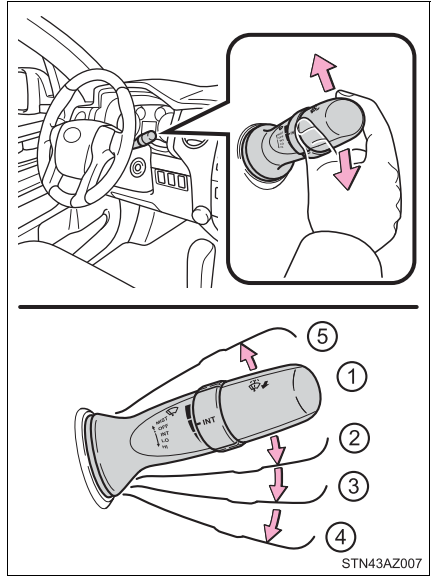

Wiper intervals can be adjusted when intermittent operation is selected.

- ⑥ Increases the intermittent windshield wiper frequency
- ⑦ Decreases the intermittent windshield wiper frequency

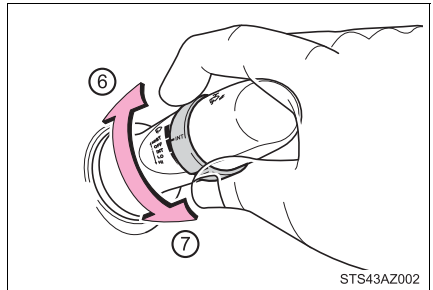

- ⑧ Washer/wiper dual operation
Wipers will automatically operate a couple of times after the washer squirts.

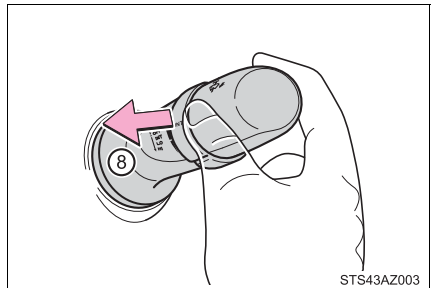

■ The windshield wipers and washer can be operated when

The engine switch is in the "ON" position.

■ If no windshield washer fluid sprays

Check that the washer nozzles are not blocked if there is washer fluid in the windshield washer fluid reservoir.

**CAUTION****■ Caution regarding the use of washer fluid**

When it is cold, do not use the washer fluid until the windshield becomes warm. The fluid may freeze on the windshield and cause low visibility. This may lead to an accident, resulting in death or serious injury.

**NOTICE****■ When the windshield is dry**

Do not use the wipers, as they may damage the windshield.

■ When the washer fluid tank is empty

Do not operate the switch continually as the washer fluid pump may over-heat.

■ When a nozzle becomes blocked

In this case, contact your Toyota dealer.

Do not try to clear it with a pin or other object. The nozzle will be damaged.

Opening the fuel tank cap

Perform the following steps to open the fuel tank cap:

Before refueling the vehicle

- Close all the doors and windows, and turn the engine switch to the “LOCK” position.
- Confirm the type of fuel.

Fuel types

- ▶ Gasoline vehicles

Unleaded gasoline (Octane rating 87 [Research Octane Number 91] or higher)

- ▶ Flex-fuel vehicles

Unleaded gasoline (Octane rating 87 [Research Octane Number 91] or higher), E85 or a blend of these two fuels. (→P. 516)

Identifying flex-fuel vehicles

Flex-fuel vehicles can be identified by the fuel tank cap, which is marked “FLEX-FUEL E85/GASOLINE”.

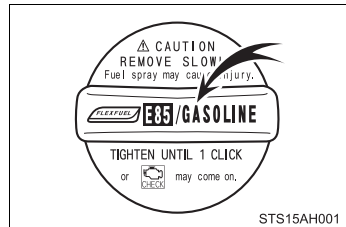

E85 Fueling Stations (Flex-fuel vehicles)

E85 fueling stations and fuel pumps can be identified by the indication “E85 85% Ethanol”. For more information about fueling stations, please refer to the U.S. Department of Energy Web site.

<http://www.afdc.energy.gov/afdc/locator/stations/>

■ Refueling (Flex-fuel vehicles)

Observe the following precautions when switching fuels, in order to maintain starting and driving performance.

- Do not change fuels when the fuel level is 1/4 or less.
- Always add at least 2.6 gal. (10 L) of fuel.
- After filling up with fuel, warm up the engine or drive the vehicle for at least 5 minutes or 7 miles (11 km).
- Do not accelerate rapidly immediately after refueling.

CAUTION

■ When refueling the vehicle

Observe the following precautions while refueling the vehicle.
Failure to do so may result in death or serious injury.

- After exiting the vehicle and before opening the fuel door, touch an unpainted metal surface to discharge any static electricity. It is important to discharge static electricity before refueling because sparks resulting from static electricity can cause fuel vapors to ignite while refueling.
- Always hold the grips on the fuel tank cap and turn it slowly to remove it. A whooshing sound may be heard when the fuel tank cap is loosened. Wait until the sound cannot be heard before fully removing the cap. In hot weather, pressurized fuel may spray out the filler neck and cause injury.
- Do not allow anyone that has not discharged static electricity from their body to come close to an open fuel tank.
- Do not inhale vaporized fuel.
Fuel contains substances that are harmful if inhaled.
- Do not smoke while refueling the vehicle.
Doing so may cause the fuel to ignite and cause a fire.
- Do not return to the vehicle or touch any person or object that is statically charged.
This may cause static electricity to build up, resulting in a possible ignition hazard.

■ When refueling

Observe the following precautions to prevent fuel overflowing from the fuel tank:

- Securely insert the fuel nozzle into the fuel filler neck.
- Stop filling the tank after the fuel nozzle automatically clicks off.
- Do not top off the fuel tank.

 NOTICE**Refueling**

Do not spill fuel during refueling.

Doing so may damage the vehicle, such as causing the emission control system to operate abnormally, or damaging fuel system components or the vehicle's painted surface.

E85 fuel

E85 fuel can be used only in flex-fuel vehicles. Do not add E85 fuel to a gasoline-engine vehicle.

Failure a gasoline-engine vehicle with E85 will have a negative impact on starting and driving performance and will cause damage to the fuel system components.

Opening the fuel tank cap

- 1 Open the fuel filler door.

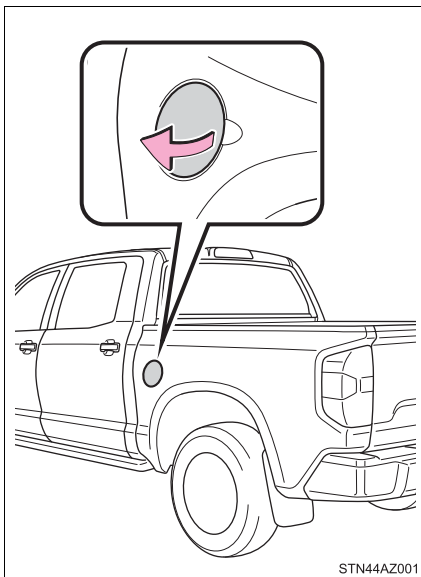

- 2 Turn the fuel tank cap slowly open, and hang the fuel tank cap on the back of the fuel filler door.

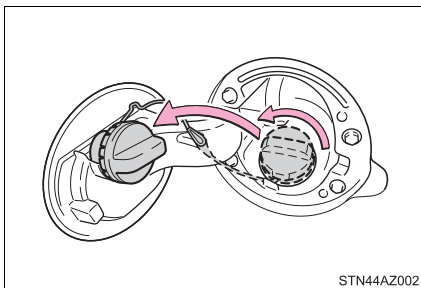

Closing the fuel tank cap

After refueling, turn the fuel tank cap until you hear a click. Once the cap is released, it will turn slightly in the opposite direction.

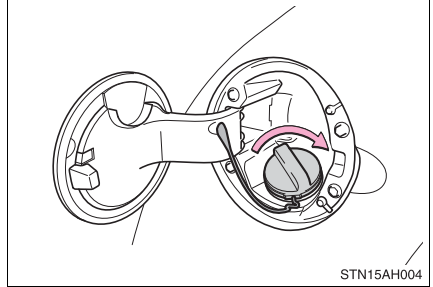

CAUTION

■ When replacing the fuel tank cap

Do not use anything but a genuine Toyota fuel tank cap designed for your vehicle. Doing so may cause a fire or other incident which may result in death or serious injury.

Cruise control*

Summary of functions

Use the cruise control to maintain a set speed without depressing the accelerator pedal.

- ① Indicators
- ② Cruise control switch

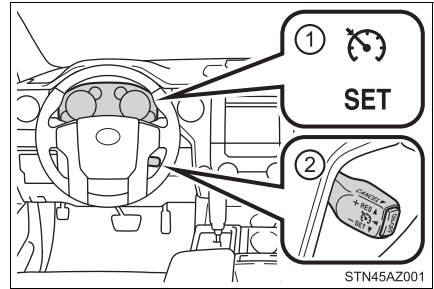

Setting the vehicle speed

- 1 Press the “ON-OFF” button to activate the cruise control.
Cruise control indicator will come on.
Press the button again to deactivate the cruise control.

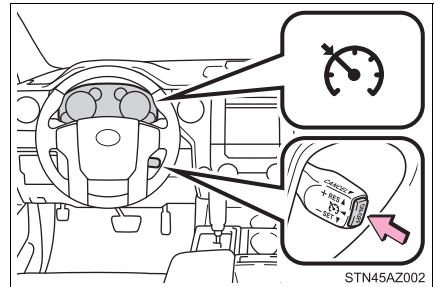

- 2 Accelerate or decelerate the vehicle to the desired speed, and push the lever down to set the speed.
“SET” indicator will come on.
The vehicle speed at the moment the lever is released becomes the set speed.

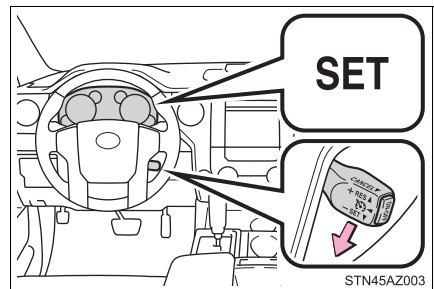

*: If equipped

Adjusting the set speed

To change the set speed, operate the lever until the desired set speed is obtained.

- ① Increases the speed
- ② Decreases the speed

Fine adjustment: Momentarily move the lever in the desired direction.

Large adjustment: Hold the lever in the desired direction.

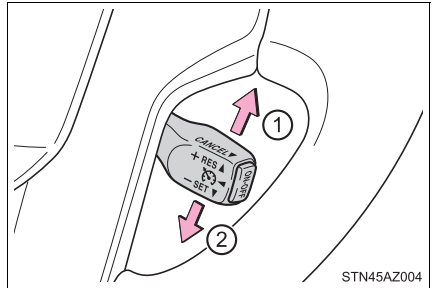

The set speed will be increased or decreased as follows:

Fine adjustment: By approximately 1 mph (1.6 km/h) each time the lever is operated.

Large adjustment: The set speed can be increased or decreased continually until the lever is released.

Canceling and resuming the constant speed control

- ① Pulling the lever toward you cancels the constant speed control.

The speed setting is also canceled when the brakes are applied.

- ② Pushing the lever up resumes the constant speed control.

Resuming is available when the vehicle speed is more than approximately 25 mph (40 km/h).

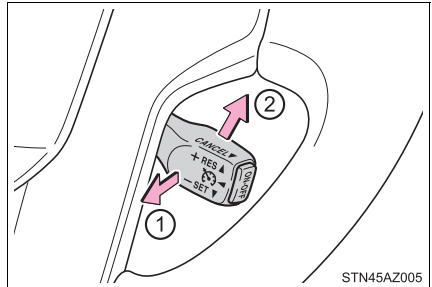

■ Cruise control can be set when

- The shift lever is in D or range 4 or higher of S has been selected.
- Vehicle speed is above approximately 25 mph (40 km/h).

■ Accelerating after setting the vehicle speed

- The vehicle can be accelerated normally. After acceleration, the set speed resumes.
- Even without canceling the cruise control, the set speed can be increased by first accelerating the vehicle to the desired speed and then pushing the lever down to set the new speed.

■ Automatic cruise control cancelation

Cruise control will stop maintaining the vehicle speed in any of the following situations.

- Actual vehicle speed falls more than approximately 10 mph (16 km/h) below the preset vehicle speed.
At this time, the memorized set speed is not retained.
- Actual vehicle speed is below approximately 25 mph (40 km/h).
- VSC is activated.
- 4WD models: The operation cannot be switched for 5 seconds or more after operating the front-wheel drive control switch.

■ If the cruise control indicator light flashes

Press the “ON-OFF” button once to deactivate the system, and then press the button again to reactivate the system.

If the cruise control speed cannot be set or if the cruise control cancels immediately after being activated, there may be a malfunction in the cruise control system. Have the vehicle inspected by your Toyota dealer.



CAUTION

■ To avoid operating the cruise control by mistake

Switch the cruise control off using the “ON-OFF” button when not in use.

■ Situations unsuitable for cruise control

Do not use cruise control in any of the following situations.

Doing so may result in loss of control and could cause an accident resulting in death or serious injury.

- In heavy traffic
- On roads with sharp bends
- On winding roads
- On slippery roads, such as those covered with rain, ice or snow
- On steep hills
Vehicle speed may exceed the set speed when driving down a steep hill.
- When your vehicle is towing a trailer or during emergency towing

Intuitive parking assist*

The distance from your vehicle to nearby obstacles when parallel parking or maneuvering into a garage is measured by the sensors and communicated via the multi-information display and buzzer. Always check the surrounding area when using this system.

■ Types of sensors

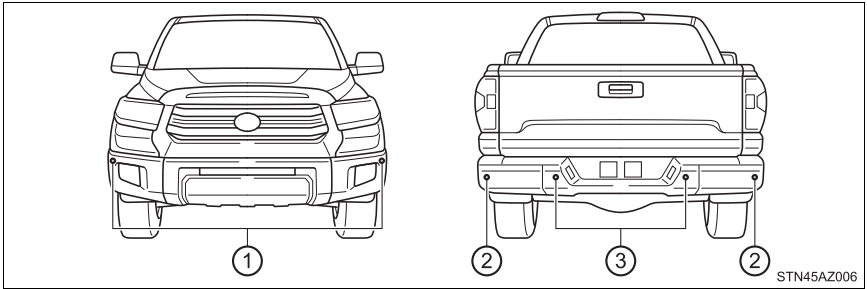

- ① Front corner sensors
- ② Rear corner sensors
- ③ Rear center sensors

■ Intuitive parking assist switch

Turns the intuitive parking assist on/off

When on, the indicator light comes on to inform the driver that the system is operational.

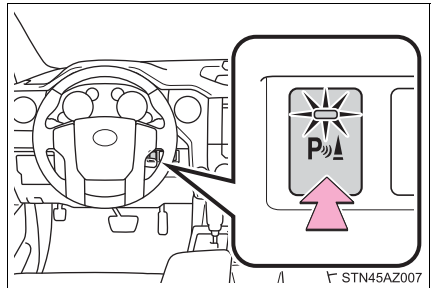

The distance display and buzzer

When the sensor detects an obstacle, the direction of and the approximate distance to the obstacle are displayed and the buzzer sounds.

■ Intuitive parking assist display

- ① Front corner sensor operation
- ② Rear corner sensor operation
- ③ Rear center sensor operation

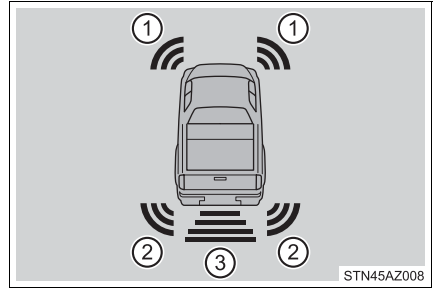

■ Sensor operation and distance to an obstacle

The system operates when the vehicle approaches an obstacle, as shown by the following table.

When 2 or more obstacles are detected simultaneously, the buzzer system responds to the nearest zone.

▶ Front corner sensors

| Approximate distance to obstacle | Display and buzzer |
|------------------------------------|--------------------|
| 2.0 ft. (60 cm) to 1.5 ft. (45 cm) | Intermittent |
| 1.5 ft. (45 cm) to 1.0 ft. (30 cm) | Fast intermittent |
| Less than 1.0 ft. (30 cm) | Continuously |

▶ Rear corner sensors

| Approximate distance to obstacle | Display and buzzer |
|------------------------------------|--------------------|
| 2.8 ft. (85 cm) to 2.0 ft. (60 cm) | Intermittent |
| 2.0 ft. (60 cm) to 1.3 ft. (40 cm) | Fast intermittent |
| Less than 1.3 ft. (40 cm) | Continuously |

► Rear center sensor

| Approximate distance to obstacle | Display and buzzer |
|--------------------------------------|------------------------|
| 5.9 ft. (180 cm) to 3.3 ft. (100 cm) | Intermittent |
| 3.3 ft. (100 cm) to 2.5 ft. (75 cm) | Fast intermittent |
| 2.5 ft. (75 cm) to 1.6 ft. (50 cm) | Very fast intermittent |
| Less than 1.6 ft. (50 cm) | Continuously |

■ **When multiple obstacles are detected in front and behind the vehicle at the same time**

The buzzer will change in the following manner.

- If an obstacle has been detected within 1.5 ft. (45 cm) of the front or 2.8 ft. (85 cm) in rear of the vehicle (a continuous buzzer is sounding), and a new obstacle is detected at the other end of the vehicle, the buzzer will sound 7 times then 1 continuous buzzer.
- If an obstacle has been detected within 1.5 ft. (45 cm) of the front or 2.8 ft. (85 cm) in rear of the vehicle (a continuous buzzer is sounding), and a new obstacle is detected in the same way at the other end of the vehicle, the buzzer will sound 3 times then 1 continuous buzzer.

■ **Detection range of the sensors**

- ① Approximately 5.9 ft. (180 cm)
- ② Approximately 2.0 ft. (60 cm)
- ③ Approximately 2.8 ft. (85 cm)

The diagram shows the detection range of the sensors. Note that the sensors may not be able to detect obstacles that are extremely close to the vehicle.

The range of the sensors may change depending on the shape of the object, etc.

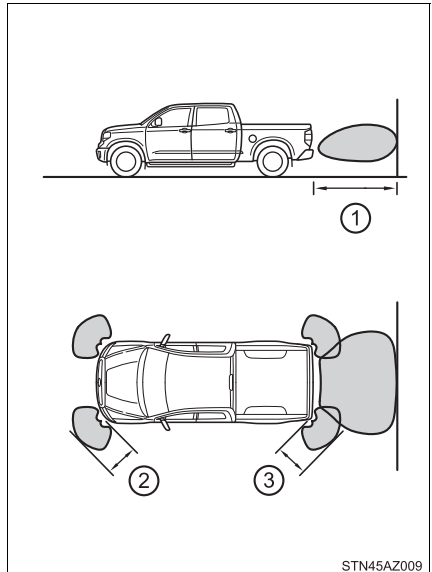

STN45AZ009

■ The intuitive parking assist can be operated when

- Front corner sensors:
 - The engine switch is in the “ON” position.
 - The shift lever is in R.
 - The shift lever is not in P or R and vehicle speed is less than about 6 mph (10 km/h).
- Rear corner and rear center sensors:
 - The engine switch is in the “ON” position.
 - The shift lever is in R.

■ Sensor detection information

- The sensor’s detection areas are limited to the areas around the vehicle’s front corner and rear bumpers.
- Certain vehicle conditions and the surrounding environment may affect the ability of the sensor to correctly detect obstacles. Particular instances where this may occur are listed below.
 - There is dirt, snow or ice on the sensor. (Wiping the sensors will resolve this problem.)
 - The sensor is frozen. (Thawing the area will resolve this problem.)
 - The sensor is covered in any way.
 - The vehicle is leaning considerably to one side.
 - On an extremely bumpy road, on an incline, on gravel, or on grass.
 - The vicinity of the vehicle is noisy due to vehicle horns, motorcycle engines, air brakes of large vehicles, or other loud noises producing ultrasonic waves.
 - There is another vehicle equipped with parking assist sensors in the vicinity.
 - The sensor is coated with a sheet of spray or heavy rain.
 - The vehicle is equipped with a fender pole or radio antenna.
 - The bumper or sensor receives a strong impact.
 - The vehicle is approaching a tall or curved curb.
 - In harsh sunlight or intense cold weather.
 - The area directly under the bumpers is not detected.
 - If obstacles draw too close to the sensor.
 - A non-genuine Toyota suspension (lowered suspension, etc.) is installed.
 - People may not be detected if they are wearing certain types of clothing.

In addition to the examples above, there are instances in which, because of their shape, signs and other objects may be judged by the sensor to be closer than they are.

- The shape of the obstacle may prevent the sensor from detecting it. Pay particular attention to the following obstacles:
 - Wires, fences, ropes, etc.
 - Cotton, snow and other materials that absorb sound waves
 - Sharply-angled objects
 - Low obstacles
 - Tall obstacles with upper sections projecting outwards in the direction of your vehicle
- The following situations may occur during use.
 - Depending on the shape of the obstacle and other factors, the detection distance may shorten, or detection may be impossible.
 - Obstacles may not be detected if they are too close to the sensor.
 - There will be a short delay between obstacle detection and display. Even at slow speeds, there is a possibility that the obstacle will come within the sensor's detection areas before the display is shown and the warning beep sounds.
 - Thin posts or objects lower than the sensor may not be detected for collision when approached, even if they have been detected once.
 - It might be difficult to hear beeps due to the volume of audio system or air flow noise of air conditioning system.

■ **If the display flashes and a message is displayed**

→P. 472, 474

■ **Certification (Canada only)**

This ISM device complies with Canadian ICES-001.

 **CAUTION**

■ **When using the intuitive parking assist**

Observe the following precautions.

Failure to do so may result in the vehicle being unable to be driven safely and possibly cause an accident.

- Do not use the sensor at speeds in excess of 6 mph (10 km/h).
- The sensors' detection areas and reaction times are limited. When moving forward or reversing, check the areas surrounding the vehicle (especially the sides of the vehicle) for safety, and drive slowly, using the brake to control the vehicle's speed.
- Do not install accessories within the sensors' detection areas.

**NOTICE****■ When using intuitive parking assist-sensor**

In the following situations, the system may not function correctly due to a sensor malfunction, etc. Have the vehicle checked by your Toyota dealer.

- A beep does not sound when you turn the main switch on.
- The intuitive parking assist operation display flashes, and a beep sounds when no obstacles are detected.
- If the area around a sensor collides with something, or is subjected to strong impact.
- If the bumper collides with something.
- If the display shows continuously without a beep.
- If a display error occurs, first check the sensor.
If the error occurs even if there is no ice, snow or mud on the sensor, it is likely that the sensor is malfunctioning.

■ Notes when washing the vehicle

Do not apply intensive bursts of water or steam to the sensor area. Doing so may result in the sensor malfunctioning.

Rear view monitor system

The rear view monitor system assists the driver by displaying guide lines and an image of the view behind the vehicle while backing up, for example while parking.

The screen illustrations used in this text are intended as examples, and may differ from the image that is actually displayed on the screen.

- ▶ Vehicles with Entune Audio Plus or Entune Premium Audio (Multimedia system types: →P. 250)

Refer to the “NAVIGATION SYSTEM OWNER’S MANUAL”.

- ▶ Vehicles with Entune Audio (Multimedia system types: →P. 250)

The rear view image is displayed when the shift position is in R and the engine switch is in the “ON” position.

The rear view monitor system will be deactivated when the shift lever is in any position other than R.

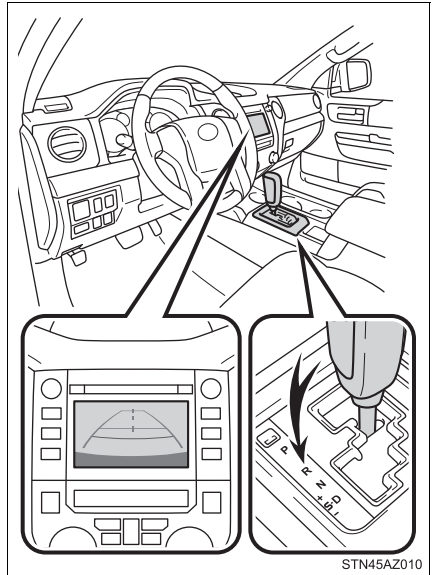

Using the rear view monitor system

■ Screen description

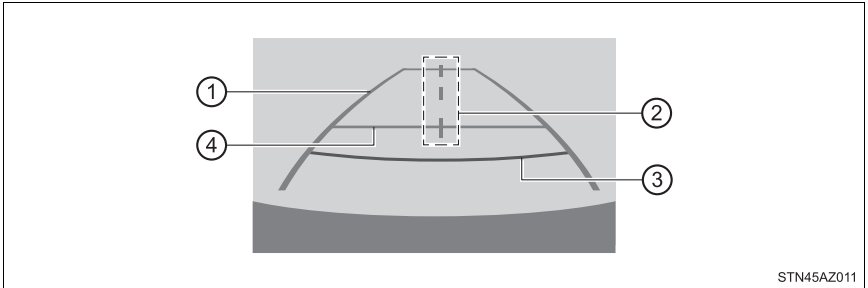

① Vehicle width guide lines

The line indicates a guide path when the vehicle is being backed straight up.

The displayed width is wider than the actual vehicle width.

② Vehicle center guide lines

These lines indicate the estimated vehicle center on the ground.

③ Distance guide line

The line shows points approximately 1.5 ft. (0.5 m) (red) from the center of the edge of the bumper.

④ Distance guide line

The line shows distance behind the vehicle, a point approximately 3 ft. (1 m) (blue) from the edge of the bumper.

Rear view monitor system precautions

■ Area displayed on screen

The rear view monitor system displays an image of the view from the bumper of the rear area of the vehicle.

To adjust the image on the rear view monitor system screen.
(→P. 260)

- The area displayed on the screen may vary according to vehicle orientation conditions.
- Objects which are close to either corner of the bumper or under the bumper cannot be seen on the screen.
- The camera uses a special lens. The distance of the image that appears on the screen differs from the actual distance.
- Items which are located higher than the camera may not be displayed by the monitor.

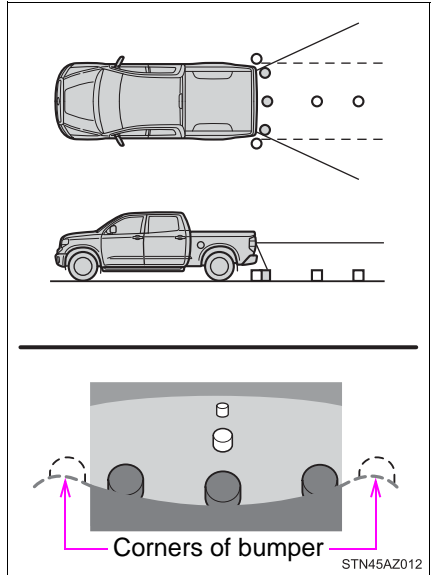

■ Rear view monitor system camera

The camera for the rear view monitor system is located as shown in the illustration.

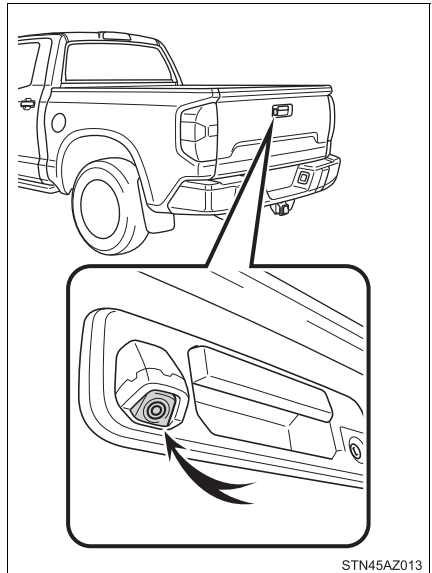

- Using the camera

If the camera lens becomes dirty, it cannot transmit a clear image. If water droplets, snow or mud adhere to the lens, rinse it with water and wipe with a soft cloth. If the lens is extremely dirty, wash it with a mild cleanser and rinse.

- Differences between the screen and the actual road

The distance guide lines and the vehicle width guide lines may not actually be parallel with the dividing lines of the parking space, even when they appear to be so. Be sure to check visually.

The distances between the vehicle width guide lines and the left and right dividing lines of the parking space may not be equal, even when they appear to be so. Be sure to check visually.

The distance guide lines give a distance guide for flat road surfaces. In any of the following situations, there is a margin of error between the fixed guide lines on the screen and the actual distance/course on the road.

- When the ground behind the vehicle slopes up sharply

The distance guide lines will appear to be closer to the vehicle than the actual distance. Because of this, objects will appear to be farther away than they actually are. In the same way, there will be a margin of error between the guidelines and the actual distance/course on the road.

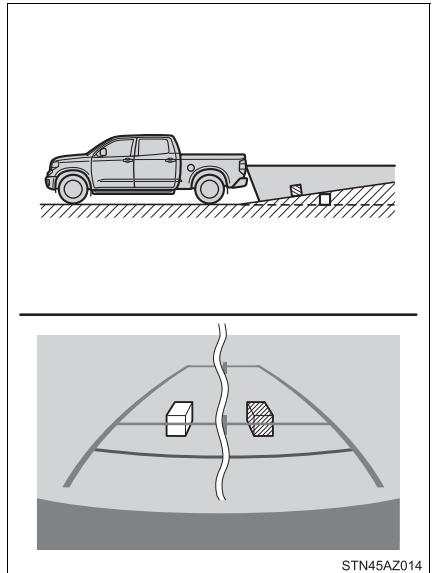

STN45AZ014

- When the ground behind the vehicle slopes down sharply

The distance guide lines will appear to be further from the vehicle than the actual distance. Because of this, objects will appear to be closer than they actually are. In the same way, there will be a margin of error between the guidelines and the actual distance/course on the road.

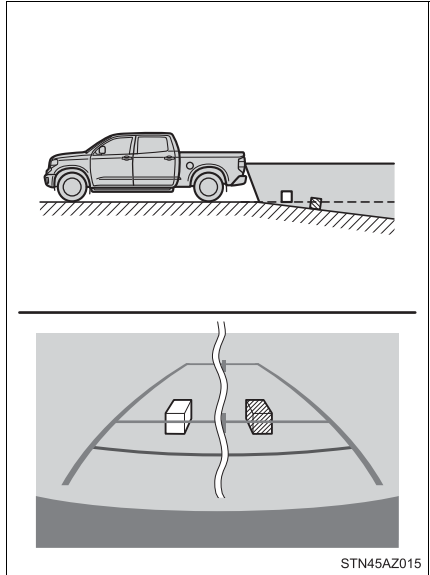

- When any part of the vehicle sags

When any part of the vehicle sags due to the number of passengers or the distribution of the load, there is a margin of error between the fixed guide lines on the screen and the actual distance/course on the road.

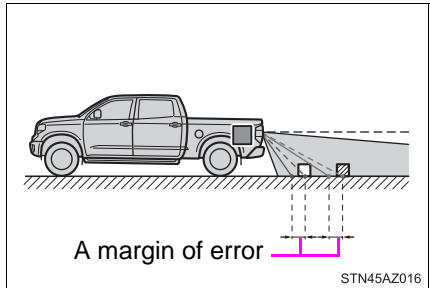

- When approaching three-dimensional objects

The distance guide lines are displayed according to flat surfaced objects (such as the road). It is not possible to determine the position of three-dimensional objects (such as vehicles) using the distance guide lines. When approaching a three-dimensional object that extends outward (such as the flatbed of a truck), be careful of the following.

● Distance guidelines

Visually check the surroundings and the area behind the vehicle. On the screen, it appears that a truck is parked at point ②. However, in reality if you back up to point ①, you will hit the truck. On the screen, it appears that ① is closest and ③ is furthest away. However, in reality, the distance to ① and ③ is the same, and ② is farther than ① and ③.

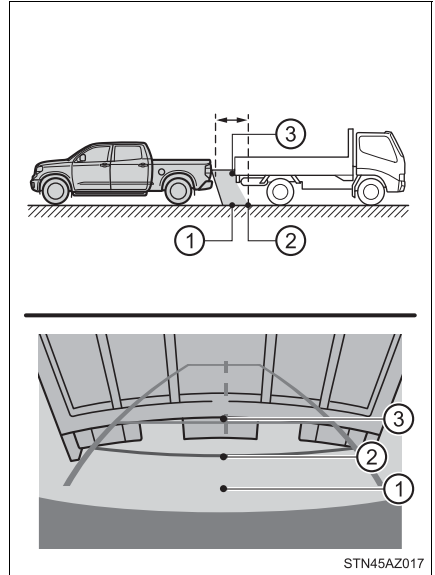

■ Vehicle width guide lines

Visually check the surroundings and the area behind the vehicle. In the case shown below, the truck appears to be outside of the vehicle width guide lines and the vehicle does not look as if it hits the truck. However, the rear body of the truck may actually cross over the vehicle width guide lines. In reality if you back up as guided by the vehicle width guide lines, the vehicle may hit the truck.

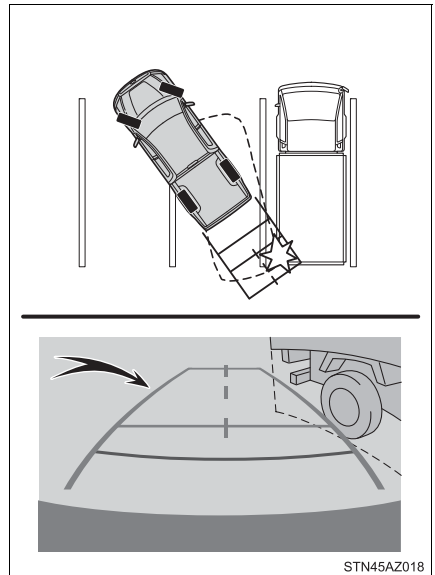

Things you should know

■ If you notice any symptoms

If you notice any of the following symptoms, refer to the likely cause and the solution, and re-check.

If the symptom is not resolved by the solution, have the vehicle inspected by your Toyota dealer.

| Likely cause | Solution |
|--|--|
| <input type="checkbox"/> The image is difficult to see | |
| <ul style="list-style-type: none"> • The vehicle is in a dark area • The temperature around the lens is either high or low • The outside temperature is low • There are water droplets on the camera • It is raining or humid • Foreign matter (mud, etc.) is adhering to the camera • There are scratches on the camera • Sunlight or headlights are shining directly into the camera • The vehicle is under fluorescent lights, sodium lights, mercury lights, etc. | <p>If this happens due to these causes, it does not indicate a malfunction. Back up while visually checking the vehicle's surroundings. (Use the monitor again once conditions have been improved.)</p> <p>To adjust the image on the rear view monitor system screen. (→P. 260)</p> |
| <input type="checkbox"/> The image is blurry | |
| Dirt or foreign matter (such as water droplets, snow, mud, etc.) is adhering to the camera. | Rinse the camera lens with water and wipe it clean with a soft cloth. Wash with a mild soap if the dirt is stubborn. |
| <input type="checkbox"/> The image is out of alignment | |
| The camera or surrounding area has received a strong impact. | Have the vehicle inspected by your Toyota dealer. |
| <input type="checkbox"/> The fixation guide lines are very far out of alignment | |
| <ul style="list-style-type: none"> • The vehicle is tilted (there is a heavy load on the vehicle, tire pressure is low due to a tire puncture, etc.) • The vehicle is used on an incline. | <p>If this happens due to these causes, it does not indicate a malfunction/ Back up while visually checking the vehicle's surroundings.</p> |
| The camera position is out of alignment. | Have the vehicle inspected by your Toyota dealer. |

**CAUTION****■ When using the rear view monitor system**

The rear view monitor system is a supplemental device intended to assist the driver when backing up. When backing up, be sure to check visually behind and all around the vehicle before proceeding.

Observe the following precautions to avoid an accident that could result in death or serious injuries.

- Never depend on the rear view monitor system entirely when backing up. The image and the position of the guide lines displayed on the screen may differ from the actual state. Use caution, just as you would when backing up any vehicle.
- Be sure to back up slowly, depressing the brake pedal to control vehicle speed.
- The instructions given are only guidelines. When and how much to turn the steering wheel will vary according to traffic conditions, road surface conditions, vehicle condition, etc., when parking. It is necessary to be fully aware of this before using the rear view monitor system.
- When parking, be sure to check that the parking space will accommodate your vehicle before maneuvering into it.
- Do not use the rear view monitor system in the following cases:
 - On icy or slick road surfaces, or in snow
 - When using tire chains or the compact spare tire
 - When the tailgate is not closed completely
 - On roads that are not flat or straight, such as curves or slopes.
- In low temperatures, the screen may darken or the image may become faint. The image could distort when the vehicle is moving, or you may become unable to see the image on the screen. Be sure to directly check visually and with the mirrors all around the vehicle before proceeding.
- If the tire sizes are changed, the position of the fixed guide lines displayed on the screen may change.
- The camera uses a special lens. The distances between objects and pedestrians that appear in the image displayed on the screen will differ from the actual distances. (→P. 212)

**NOTICE****■ How to use the camera**

- The rear view monitor system may not operate properly in the following cases.
 - If the back of the vehicle is hit, the position and mounting angle of the camera may change.
 - As the camera has a water proof construction, do not detach, disassemble or modify it. This may cause incorrect operation.
 - Do not strongly rub the camera lens. If the camera lens is scratched, it cannot transmit a clear image.
 - Do not allow organic solvent, car wax, window cleaner or glass coat to adhere to the camera. If this happens, wipe it off as soon as possible.
 - If the temperature changes rapidly, such as when hot water is poured on the vehicle in cold weather, the system may not operate normally.
 - When washing the vehicle, do not apply intensive bursts of water to the camera or camera area. Doing so may result in the camera malfunctioning.
 - When the camera is used under fluorescent lights, sodium light or mercury light, etc., the lights and the illuminated areas may appear to flicker.
- Do not expose the camera to strong impact as this could cause a malfunction. If this happens, have the vehicle inspected by your Toyota dealer as soon as possible.

BSM (Blind Spot Monitor)*

Summary of the Blind Spot Monitor

The Blind Spot Monitor is a system that has 2 functions;

- The Blind Spot Monitor function
Assists the driver in making the decision when changing lanes
- The Rear Cross Traffic Alert function
Assists the driver when backing up

These functions use same sensors.

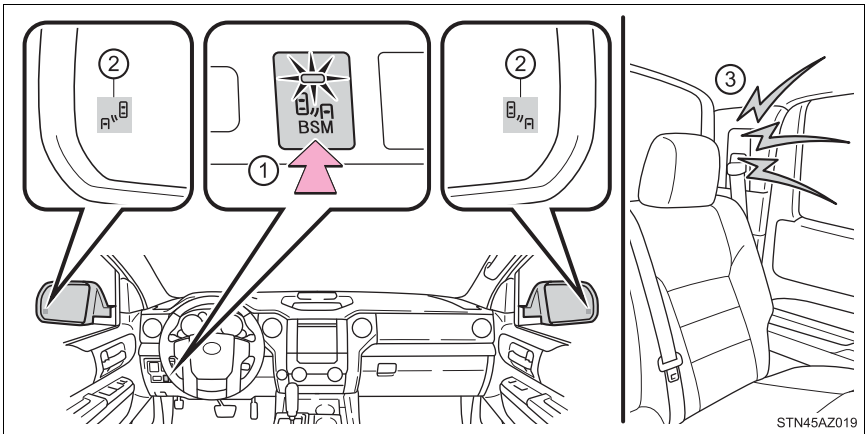

① BSM main switch

Pressing the switch turns the system on or off. When the switch is set to on, the switch's indicator illuminates and the buzzer sounds. Common switch for Blind Spot Monitor function and Rear Cross Traffic Alert function.

② Outside rear view mirror indicators

Blind Spot Monitor function:

When a vehicle is detected in the blind spot, the outside rear view mirror indicator comes on while the turn signal lever is not operated and the outside rear view mirror indicator flashes while the turn signal lever is operated.

Rear Cross Traffic Alert function:

When a vehicle approaching from the right or left rear of the vehicle is detected, the outside rear view mirror indicators flash.

*: If equipped

③ Rear Cross Traffic Alert buzzer (Rear Cross Traffic Alert function only)

When a vehicle approaching from the right or left rear of the vehicle is detected, a buzzer sounds from behind the left-hand rear pillar.

■ The outside rear view mirror indicators visibility

When under strong sunlight, the outside rear view mirror indicator may be difficult to see.

■ Rear Cross Traffic Alert buzzer hearing

Rear Cross Traffic Alert function may be difficult to hear over noises such as high audio volume.

■ When there is a malfunction in the Blind Spot Monitor system

If a system malfunction is detected due to any of the following reasons, BSM warning light will come on (vehicles without multi-information display) or warning messages will be displayed (vehicles with multi-information display): (→P. 465, 473, 474)

- There is a malfunction with the sensors
- The sensors have become dirty
- The outside temperature is extremely high or low
- The sensor voltage has become abnormal

■ Certification for the Blind Spot Monitor system

- ▶ For vehicles sold in the U.S.A.

FCC ID: OAYSRR2A

This device complies with part 15 of the FCC Rules. Operation is subject to the following three conditions:

- (1) This device may not cause harmful interference, and
- (2) this device must accept any interference received, including interference that may cause undesired operation.

FCC Warning

Changes or modifications not expressly approved by the party responsible for compliance could void the user's authority to operate the equipment.

- ▶ For vehicles sold in Canada

Applicable law: Canada 310

This device complies with Industry Canada licence-exempt RSS standard(s). Operation is subject to the following two conditions: (1) this device may not cause interference, and (2) this device must accept any interference, including interference that may cause undesired operation of the device.

Frequency bands: 24.05 – 24.25 GHz

Output power: less than 20 milliwatts

⚠ CAUTION**■ Handling the radar sensor**

One Blind Spot Monitor sensor installed inside the left and right side of the vehicle rear bumper respectively. Observe the following to ensure the Blind Spot Monitor system can function correctly.

- Keep the sensor and its surrounding area on the bumper clean at all times.

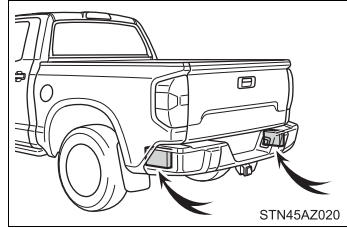

- Do not subject the sensor or surrounding area on the bumper to a strong impact. If the sensor moves even slightly off position, the system may malfunction and vehicles that enter the detection area may not be detected. If the sensor or surrounding area is subject to a strong impact, always have the area inspected by your Toyota dealer.
- Do not disassemble the sensor.
- Do not attach accessories or stickers to the sensor or surrounding area on the bumper.
- Do not modify the sensor or surrounding area on the bumper.
- Do not paint the sensor or surrounding area on the bumper.

The Blind Spot Monitor function

The Blind Spot Monitor function uses radar sensors to detect vehicles that are traveling in an adjacent lane in the area that is not reflected in the outside rear view mirror (the blind spot), and advises the driver of the vehicles existence via the outside rear view mirror indicator.

The Blind Spot Monitor function detection areas

The areas that vehicles can be detected in are outlined below.

The range of the detection area extends to:

- ① Approximately 11.5 ft. (3.5 m) from the side of the vehicle
The first 1.6 ft. (0.5 m) from the side of the vehicle is not in the detection area
- ② Approximately 9.8 ft. (3 m) from the rear bumper
- ③ Approximately 3.3 ft. (1 m) forward of the rear bumper

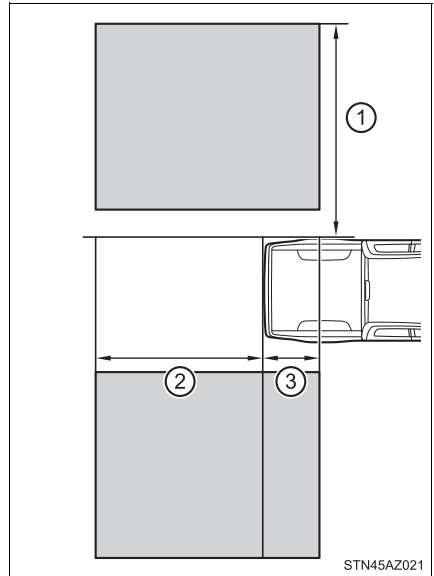

⚠ CAUTION

■ Cautions regarding the use of the system

The driver is solely responsible for safe driving. Always drive safely, taking care to observe your surroundings.

The Blind Spot Monitor function is a supplementary function which alerts the driver that a vehicle is present in the blind spot. Do not overly rely on the Blind Spot Monitor function. The function cannot judge if it is safe to change lanes, therefore over reliance could cause an accident resulting in death or serious injury.

According to conditions, the system may not function correctly. Therefore the driver's own visual confirmation of safety is necessary.

■ **The Blind Spot Monitor function is operational when**

- The BSM main switch is set to on.
- Vehicle speed is greater than approximately 25 mph (40 km/h).

■ **The Blind Spot Monitor function will detect a vehicle when**

- A vehicle in an adjacent lane overtakes the vehicle.
- Another vehicle enters the detection area when it changes lanes.

■ **Conditions under which the Blind Spot Monitor function will not detect a vehicle**

The Blind Spot Monitor function is not designed to detect the following types of vehicles and/or objects:

- Small motorcycles, bicycles, pedestrians, etc.*
- Vehicles traveling in the opposite direction
- Guardrails, walls, signs, parked vehicles and similar stationary objects*
- Following vehicles that are in the same lane*
- Vehicles driving 2 lanes across from your vehicle*

*: Depending on conditions, detection of a vehicle and/or object may occur

■ **Conditions under which the Blind Spot Monitor function may not function correctly**

- The Blind Spot Monitor function may not detect vehicles correctly in the following conditions:
 - During bad weather such as heavy rain, fog, snow, etc.
 - When ice or mud, etc., is attached to the rear bumper
 - When driving on a road surface that is wet due to rain, standing water, etc.
 - When there is a significant difference in speed between your vehicle and the vehicle that enters the detection area
 - When a vehicle is in the detection area from a stop and remains in the detection area as your vehicle accelerates
 - When driving up or down consecutive steep inclines, such as hills, a dip in the road, etc.
 - When multiple vehicles approach with only a small gap between each vehicle
 - When vehicle lanes are wide, and the vehicle in the next lane is too far away from your vehicle
 - When the vehicle that enters the detection area is traveling at about the same speed as your vehicle
 - When towing anything such as trailer, boat, etc.
 - When there is a significant difference in height between your vehicle and the vehicle that enters the detection area
 - Directly after the BSM main switch is set to on
 - When towing a trailer
 - When items such as a bicycle carrier are installed on the rear of the vehicle

- Instances of the Blind Spot Monitor function unnecessarily detecting a vehicle and/or object may increase under the following conditions:
 - When there is only a short distance between your vehicle and a guardrail, wall, etc.
 - When there is only a short distance between your vehicle and a following vehicle
 - When vehicle lanes are narrow and a vehicle driving 2 lanes across from your vehicle enters the detection area
 - When items such as a bicycle carrier are installed on the rear of the vehicle

The Rear Cross Traffic Alert function

The Rear Cross Traffic Alert functions when your vehicle is in reverse. It can detect other vehicles approaching from the right or left rear of the vehicle. It uses radar sensors to alert the driver of the other vehicle's existence through flashing the outside rear view mirror indicators and sounding a buzzer.

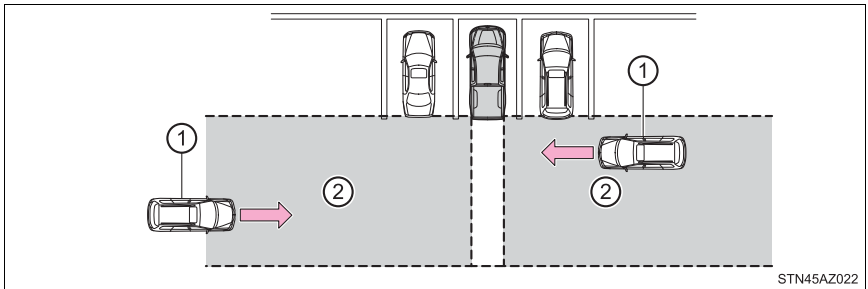

① Approaching vehicles

② Detection areas

⚠ CAUTION

■ Cautions regarding the use of the system

The driver is solely responsible for safe driving. Always drive safely, taking care to observe your surroundings.

The Rear Cross Traffic Alert function is only an assist and is not a replacement for careful driving. Driver must be careful when backing up, even when using Rear Cross Traffic Alert function. The driver's own visual confirmation of behind you and your vehicle is necessary and be sure there are no pedestrians, other vehicles, etc., before backing up. Failure to do so could cause death or serious injury.

According to conditions, the system may not function correctly. Therefore the driver's own visual confirmation of safety is necessary.

The Rear Cross Traffic Alert function detection areas

The areas that vehicles can be detected in are outlined below.

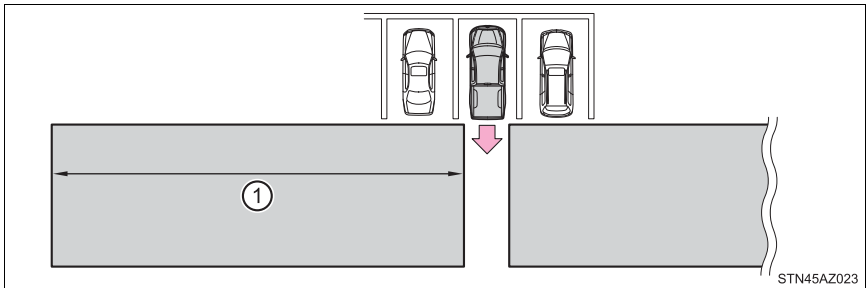

To give the driver a more consistent time to react, the buzzer can alert for faster vehicles from farther away.

Example:

| Approaching vehicle | Speed | ① Approximate alert distance |
|---------------------|------------------|------------------------------|
| Fast | 18 mph (28 km/h) | 65 ft. (20 m) |
| Slow | 5 mph (8 km/h) | 18 ft. (5.5 m) |

■ The Rear Cross Traffic Alert function is operational when

- The BSM main switch is set to on.
- The shift lever is in R.
- Vehicle speed is less than approximately 5 mph (8 km/h).
- Approaching vehicle speed is between approximately 5 mph (8 km/h) and 18 mph (28 km/h).

■ Conditions under which the Rear Cross Traffic Alert function will not detect a vehicle

The Rear Cross Traffic Alert function is not designed to detect the following types of vehicles and/or objects.

- Small motorcycles, bicycles, pedestrians, etc.*
- Vehicles approaching from directly behind
- Guardrails, walls, signs, parked vehicles and similar stationary objects*
- Vehicles moving away from your vehicle
- Vehicles approaching from the parking spaces next to your vehicle*
- Vehicles backing up in the parking space next to your vehicle*

*: Depending on conditions, detection of a vehicle and/or object may occur.

■ Conditions under which the Rear Cross Traffic Alert function may not function correctly

The Rear Cross Traffic Alert function may not detect vehicles correctly in the following conditions.

- When ice or mud, etc., is attached to the rear bumper
- During bad weather such as heavy rain, fog, snow, etc.
- When multiple vehicles approach continuously
- Shallow angle parking
- When a vehicle is approaching at high speed
- When parking on a steep incline, such as hills, a dip in the road, etc.
- Directly after the BSM main switch is set to on
- Directly after the engine is started with the BSM main switch on
- When towing a trailer
- Vehicles that the sensors cannot detect because of obstacles

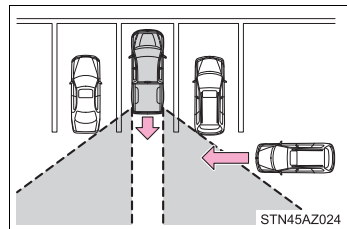

Four-wheel drive system*

Summary of functions

Use the front-wheel drive control switch to select the following transfer modes:

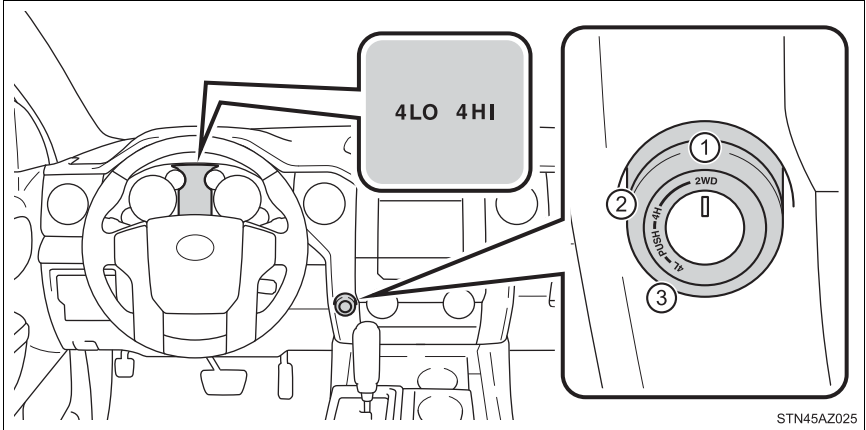

① "2WD" (high speed position, two-wheel drive)

Use this for normal driving on dry hard-surfaced roads. This position gives greater economy, quietest ride and least wear.

② "4H" (high speed position, four-wheel drive)

Use this for driving only on tracks that permit the tires slide, like off-road, icy or snow-covered roads. This position provides greater traction than two-wheel drive.

The "4HI" indicator will come on.

③ "4L" (low speed position, four-wheel drive)

Use this for maximum power and traction. Use "4L" for climbing or descending steep hills, off-road driving, and hard pulling in sand, mud or deep snow.

The "4LO" indicator will come on.

Shifting between “2WD” and “4H”**■ Shifting from “2WD” to “4H”**

- 1 Reduce vehicle speed to less than 62 mph (100 km/h).
- 2 Turn the front-wheel drive control switch to “4H”.

The “4HI” indicator will come on.

■ Shifting from “4H” to “2WD”

- 1 Reduce vehicle speed to less than 62 mph (100 km/h).
- 2 Turn the front-wheel drive control switch to “2WD”.

The “4HI” indicator will go off.

Shifting between “4H” and “4L”**■ Shifting from “4H” to “4L”**

- 1 Stop the vehicle completely and continue to depress the brake pedal.
- 2 Shift the shift lever to N.
- 3 Push and turn the front-wheel drive control switch to “4L”.

The “4LO” indicator will come on.

■ Shifting from “4L” to “4H”

- 1 Stop the vehicle completely and continue to depress the brake pedal.
- 2 Shift the shift lever to N.
- 3 Push and turn the front-wheel drive control switch to “4H”.

The “4LO” indicator will go off.

■ When the front-wheel drive control switch is shifted to “4L”

VSC is automatically turned off.

■ If the “4HI” indicator flashes

The transfer mode may not successfully change. Drive straight ahead while accelerating or decelerating, or drive in reverse.

■ If the “4LO” indicator continues to flash

The transfer mode may not successfully change. Operate the front-wheel drive control switch again.

■ If the “4LO” indicator continues to flash and a buzzer sounds

The shift lever is not in N and/or the vehicle is moving. Stop the vehicle completely, shift the shift lever to N and make sure that the indicator stops flashing.

■ If the “4HI” or “4LO” indicator flashes rapidly

There may be a malfunction in the four-wheel drive system. Have the vehicle inspected by your Toyota dealer immediately.

■ Four-wheel drive usage frequency

You should drive in four-wheel drive for at least 10 miles (16 km) each month. This will assure that the front drive components are lubricated.

**CAUTION****■ Shifting the front-wheel drive control switch from “2WD” to “4H” while driving**

Never operate the front-wheel drive control switch if the wheels are slipping. Stop the slipping or spinning before shifting.

■ When the vehicle is parked

If the shift lever is moved before the “4LO” indicator turns on/off, the transfer mode may not be shifted completely. The transfer mode disengages both the front and rear driveshafts from the powertrain and allows the vehicle to move regardless of the shift position. (At this time, the indicator blinks and the buzzer sounds.)

Therefore, the vehicle is free to roll even if the automatic transmission is in P. You or someone else could be seriously injured. You must complete the shifting of the transfer mode before placing transmission in P.

AUTO LSD system

The AUTO LSD system aids traction by using the traction control system to control engine performance and braking when one of the rear wheels begins to spin.

The system should be used only when one of the rear wheels spinning occurs in a ditch or rough surface.

System operation

The system can be used on 2WD models and in 2WD mode on 4WD models.

The system is activated when driving at a speed under 62 mph (100 km/h).

The AUTO LSD system will be activated with the following two procedures.

Press the VSC off switch briefly.

The “AUTO LSD” indicator will come on.

To turn off the system, push the switch again.

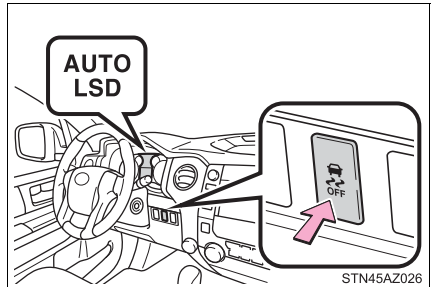

Stop the vehicle completely, and press the VSC off switch for more than 3 seconds.

The VSC off and “AUTO LSD” indicators will come on.

To turn off the system, push the switch again.

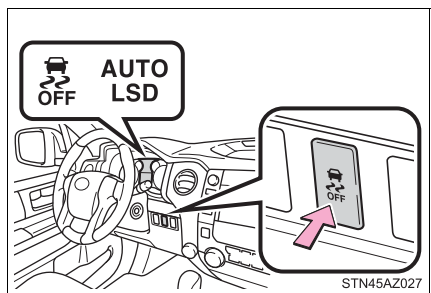

When the AUTO LSD system is operating

If the rear wheels spin, the slip indicator flashes to indicate that the AUTO LSD system has controlled the spinning of the rear wheels.

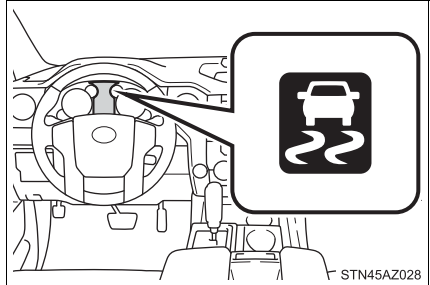

■ If the engine is turned off and restarted

The AUTO LSD system and the indicators are automatically turned off.

■ If the brake system overheats

The AUTO LSD system will cease operation, and the slip indicator will change from flashing to being on continuously to alert the driver. Stop the vehicle in a safe place. (There is no problem with continuing normal driving.) The system will be automatically restored after a short time.

⚠ CAUTION

■ To avoid an accident

- Do not use the AUTO LSD system in conditions other than the above. A much greater steering effort and more careful cornering control will be required.
- Do not drive with the AUTO LSD system continuously turned on.

Driving assist systems

To help enhance driving safety and performance, the following systems operate automatically in response to various driving situations. Be aware, however, that these systems are supplementary and should not be relied upon too heavily when operating the vehicle.

◆ ABS (Anti-lock Brake System)

Helps to prevent wheel lock when the brakes are applied suddenly, or if the brakes are applied while driving on a slippery road surface

◆ Brake assist

Generates an increased level of braking force after the brake pedal is depressed when the system detects a panic stop situation

◆ VSC (Vehicle Stability Control)

Helps the driver to control skidding when swerving suddenly or turning on slippery road surfaces

◆ Trailer Sway Control

Helps the driver to control trailer sway by selectively applying brake pressure for individual wheels and reducing engine torque when trailer sway is detected.

Trailer Sway Control is part of the VSC system and will not operate if VSC system is turned off or experiences a malfunction.

◆ TRAC (Traction Control) for 2WD models and 2WD mode on 4WD models

Helps to maintain drive power and prevent the drive wheels from spinning when starting the vehicle or accelerating on slippery roads

◆ A-TRAC (Active Traction Control) for 4WD mode on 4WD models

Maintains drive power and prevents all wheels from spinning when starting the vehicle or accelerating on slippery roads.

When the TRAC/VSC/A-TRAC/Trailer Sway Control systems are operating

The slip indicator light will flash while the TRAC/VSC/A-TRAC/Trailer Sway Control systems are operating.

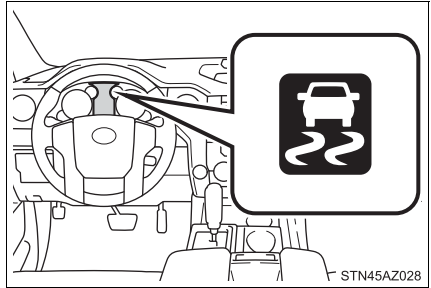

Disabling the VSC/Trailer Sway Control/TRAC systems (2WD models and 2WD mode on 4WD models)

If the vehicle gets stuck in fresh snow or mud, VSC/Trailer Sway Control/TRAC systems may reduce power from the engine to the wheels. You may need to turn the system off to enable you to rock the vehicle in order to free it.

■ TRAC off mode

Press the VSC off switch.

The "AUTO LSD" indicator will come on.

The system is in TRAC off and AUTO LSD, VSC, Trailer Sway Control on mode.

Press the switch again to turn the system back on.

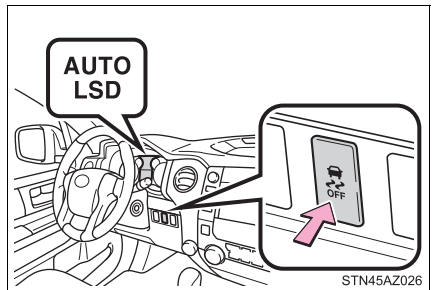

■ AUTO LSD mode

Stop the vehicle completely, and press the VSC off switch for more than 3 seconds, when the system is in the TRAC OFF mode.

The VSC off and “AUTO LSD” indicators will come on.

The system is in TRAC, VSC, Trailer Sway Control off and AUTO LSD on mode.

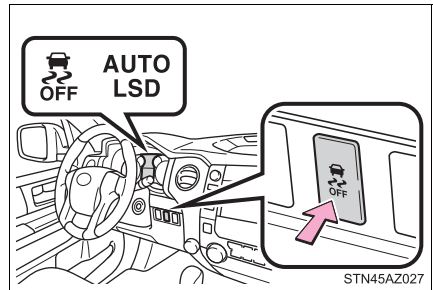

■ VSC off mode

Stop the vehicle completely, and press the VSC off switch for more than 3 seconds, when the system is in the AUTO LSD mode.

Vehicles without multi-information display: The VSC off and “TRAC OFF” indicators will come on.

Vehicles with multi-information display: The VSC off indicator will come on and the “TRACTION CONTROL OFF” will be shown on the display.

The system is all off mode.

- ▶ Vehicles without multi-information display

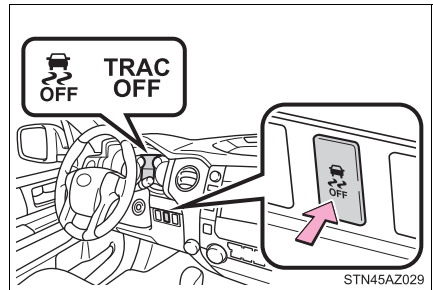

- ▶ Vehicles with multi-information display

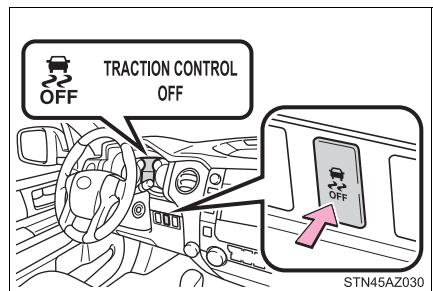

Disabling the VSC/Trailer Sway Control/A-TRAC systems (4H mode on 4WD models)

If the vehicle gets stuck in fresh snow or mud, VSC/Trailer Sway Control/A-TRAC systems may reduce power from the engine to the wheels. You may need to turn the system off to enable you to rock the vehicle in order to free it.

■ A-TRAC off mode

Press the VSC off switch.

Vehicles without multi-information display: The “TRAC OFF” indicator will come on.

Vehicles with multi-information display: The “TRACTION CONTROL OFF” will be shown on the display.

The system is in A-TRAC off and VSC, Trailer Sway Control on mode.

Press the switch again to turn the system back on.

- ▶ Vehicles without multi-information display

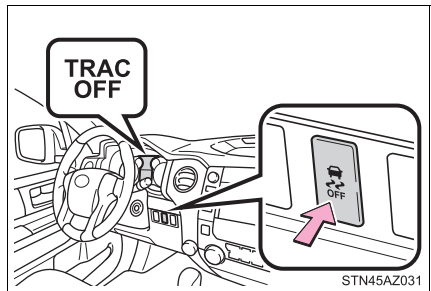

- ▶ Vehicles with multi-information display

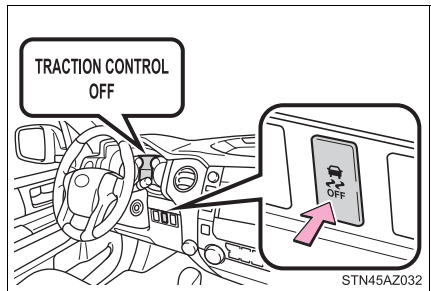

■ VSC off mode

Stop the vehicle completely, and press the VSC off switch for more than 3 seconds.

Vehicles without multi-information display: The VSC off and “TRAC OFF” indicators will come on.

Vehicles with multi-information display: The VSC off indicator will come on and the “TRAC-TION CONTROL OFF” will be shown on the display.

The system is all off mode. Press the switch again to turn the system back on.

- ▶ Vehicles without multi-information display

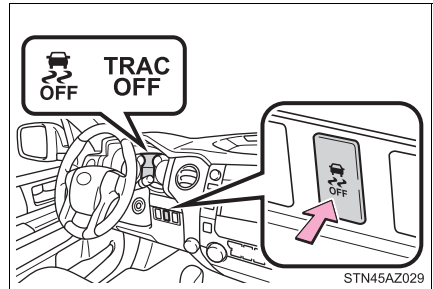

- ▶ Vehicles with multi-information display

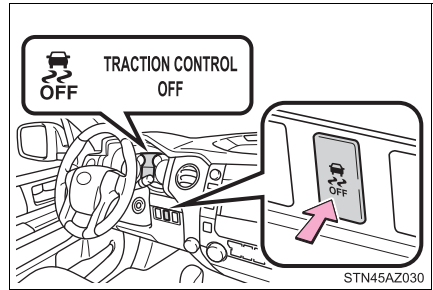

Disabling the A-TRAC system (4L mode on 4WD models)

If the vehicle gets stuck in fresh snow or mud, A-TRAC system may reduce power from the engine to the wheels. You may need to turn the system off to enable you to rock the vehicle in order to free it.

Stop the vehicle completely, and press the VSC off switch for more than 3 seconds.

Vehicles without multi-information display: The "TRAC OFF" indicator will come on.

Vehicles with multi-information display: The "TRACTION CONTROL OFF" will be shown on the display.

Press the switch again to turn the system back on.

► Vehicles without multi-information display

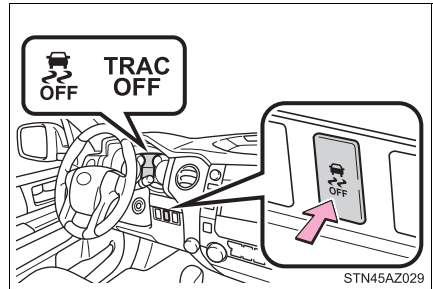

► Vehicles with multi-information display

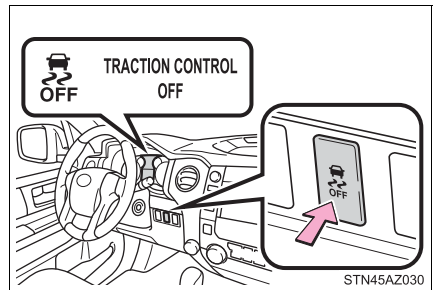

- **When the “TRAC OFF” indicator light comes on or the message is displayed on the multi-information display showing that “TRACTION CONTROL OFF” has been disabled even if the VSC off switch has not been pressed**

TRAC cannot be operated. Contact your Toyota dealer.

- **Sounds and vibrations caused by the ABS, brake assist, VSC, TRAC, A-TRAC and Trailer Sway Control systems**

- A sound may be heard from the engine compartment when the brake pedal is depressed repeatedly, when the engine is started or just after the vehicle begins to move. This sound does not indicate that a malfunction has occurred in any of these systems.

- Any of the following conditions may occur when the above systems are operating. None of these indicates that a malfunction has occurred.

- Vibrations may be felt through the vehicle body and steering.
- A motor sound may be heard after the vehicle comes to a stop.
- The brake pedal may pulsate slightly after the ABS is activated.
- The brake pedal may move down slightly after the ABS is activated.

- **Reactivation of the TRAC/VSC/A-TRAC/Trailer Sway Control systems**

Even after the TRAC/VSC/A-TRAC/Trailer Sway Control systems have been turned off, turning the engine switch off and then on again will automatically reactivate the TRAC/VSC/A-TRAC/Trailer Sway Control systems.

- **Reactivation of the TRAC system linked to vehicle speed**

When only the TRAC system is turned off, the TRAC system will turn on when vehicle speed increases. However, when both TRAC/VSC systems are turned off, the systems will not turn on even when vehicle speed increases.

- **If the brake system overheats**

TRAC or A-TRAC will cease operation, and the slip indicator will change from flashing to being on continuously to alert the driver. Stop the vehicle in a safe place. (There is no problem with continuing normal driving.)

- **Shifting to “4L”**

VSC and Trailer Sway Control are automatically turned off.

 **CAUTION****■ The ABS does not operate effectively when**

- The limits of tire gripping performance have been exceeded (such as excessively worn tires on a snow covered road).
- The vehicle hydroplanes while driving at high speed on wet or slick roads.

■ Stopping distance when the ABS is operating may exceed that of normal conditions

The ABS is not designed to shorten the vehicle's stopping distance. Always maintain a safe distance from the vehicle in front of you, especially in the following situations:

- When driving on dirt, gravel or snow-covered roads
- When driving with tire chains
- When driving over bumps in the road
- When driving over roads with potholes or uneven surfaces

■ TRAC or A-TRAC may not operate effectively when

Directional control and power may not be achievable while driving on slippery road surfaces, even if the TRAC or A-TRAC system is operating.

Drive the vehicle carefully in conditions where stability and power may be lost.

■ When the VSC and Trailer Sway Control are activated

The slip indicator light flashes. Always drive carefully. Reckless driving may cause an accident. Exercise particular care when the indicator light flashes.

■ When the TRAC/VSC/A-TRAC/Trailer Sway Control systems are turned off

Be especially careful and drive at a speed appropriate to the road conditions. As these are the systems to ensure vehicle stability and driving force, do not turn the TRAC/VSC/A-TRAC/Trailer Sway Control systems off unless necessary.

 **CAUTION****■ Replacing tires**

Make sure that all tires are of the specified size, brand, tread pattern and total load capacity. In addition, make sure that the tires are inflated to the recommended tire inflation pressure level.

The ABS, TRAC, A-TRAC, VSC and Trailer Sway Control systems will not function correctly if different tires are installed on the vehicle.

Contact your Toyota dealer for further information when replacing tires or wheels.

■ Handling of tires and the suspension

Using tires with any kind of problem or modifying the suspension will affect the driving assist systems, and may cause a system to malfunction.

■ Trailer Sway Control precaution

The Trailer Sway Control system is not able to reduce trailer sway in all situations. Depending on many factors such as the conditions of the vehicle, trailer, road surface, and driving environment, the Trailer Sway Control system may not be effective. Refer to your trailer owner's manual for information on how to tow your trailer properly.

■ If trailer sway occurs

Observe the following precautions.

Failure to do so may cause death or serious injury.

- Firmly grip the steering wheel. Steer straight ahead.
Do not try to control trailer swaying by turning the steering wheel.
- Begin releasing the accelerator pedal immediately but very gradually to reduce speed.
Do not increase speed. Do not apply vehicle brakes.

If you make no extreme correction with the steering or brakes, your vehicle and trailer should stabilize. (→P. 175)

Winter driving tips

Carry out the necessary preparations and inspections before driving the vehicle in winter. Always drive the vehicle in a manner appropriate to the prevailing weather conditions.

Preparation for winter

- Use fluids that are appropriate to the prevailing outside temperatures.
 - Engine oil
 - Engine coolant
 - Washer fluid
- Have a service technician inspect the condition of the battery.
- Have the vehicle fitted with four snow tires or purchase a set of tire chains for the rear tires.

Ensure that all tires are the same size and brand, and that chains match the size of the tires.

Before driving the vehicle

Perform the following according to the driving conditions:

- Do not try to forcibly open a window or move a wiper that is frozen. Pour warm water over the frozen area to melt the ice. Wipe away the water immediately to prevent it from freezing.
- To ensure proper operation of the climate control system fan, remove any snow that has accumulated on the air inlet vents in front of the windshield.
- Check for and remove any excess ice or snow that may have accumulated on the exterior lights, vehicle's roof, chassis, around the tires or on the brakes.
- Remove any snow or mud from the bottom of your shoes before getting in the vehicle.

When driving the vehicle

Accelerate the vehicle slowly, keep a safe distance between you and the vehicle ahead, and drive at a reduced speed suitable to road conditions.

When parking the vehicle

Park the vehicle and move the shift lever to P without setting the parking brake. The parking brake may freeze up, preventing it from being released. If necessary, block the wheels to prevent inadvertent sliding or creeping.

Refueling (Flex-fuel vehicles)

Observe the following precautions when switching fuels, in order to maintain starting and driving performance.

- Do not change fuels when the fuel level is 1/4 or less.
- Always add at least 2.6 gal. (10 L) of fuel.
- After filling up with fuel, warm up the engine or drive the vehicle for at least 5 minutes or 7 miles (11 km).
- Do not accelerate rapidly immediately after refueling.

Selecting tire chains

Use the correct tire chain size when mounting the tire chains. Chain size is regulated for each tire size.

- ① Side chain
(0.2 in. [5 mm] in diameter)
- ② Cross chain
(0.25 in. [6.3 mm] in diameter)

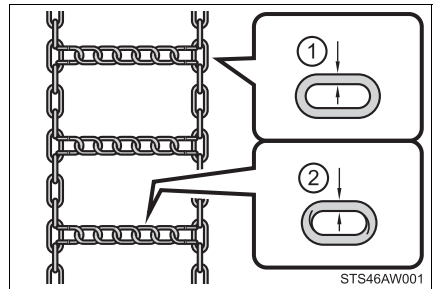

Regulations on the use of tire chains

Regulations regarding the use of tire chains vary depending on location and type of road. Always check local regulations before installing chains.

■ Tire chain installation

Observe the following precautions when installing and removing chains:

- Install and remove tire chains in a safe location.
- Install tire chains on the rear tires. Do not install tire chains on the front tires.
- Install tire chains on rear tires as tightly as possible. Retighten chains after driving 1/4 — 1/2 mile (0.5 — 1.0 km).
- Install tire chains following the instructions provided with the tire chains.



CAUTION

■ Driving with snow tires

Observe the following precautions to reduce the risk of accidents. Failure to do so may result in a loss of vehicle control and cause death or serious injury.

- Use tires of the specified size.
- Maintain the recommended level of air pressure.
- Do not drive in excess of 75 mph (120 km/h), regardless of the type of snow tires being used.
- Use snow tires on all, not just some wheels.
- 4WD models: Do not mix tires of different makes, models, tread patterns or treadwear.

■ Driving with tire chains

Observe the following precautions to reduce the risk of accidents. Failure to do so may result in the vehicle being unable to be driven safely, and may cause death or serious injury.

- Do not drive in excess of the speed limit specified for the tire chains being used, or 30 mph (50 km/h), whichever is lower.
- Avoid driving on bumpy road surfaces or over potholes.
- Avoid sudden acceleration, abrupt steering, sudden braking and shifting operations that cause sudden engine braking.
- Slow down sufficiently before entering a curve to ensure that vehicle control is maintained.

**NOTICE****■ Repairing or replacing snow tires**

Request repairs or replacement of snow tires from Toyota dealers or legitimate tire retailers.

This is because the removal and attachment of snow tires affects the operation of the tire pressure warning valves and transmitters.

■ Fitting tire chains

The tire pressure warning valves and transmitters may not function correctly when tire chains are fitted.

Off-road precautions

This vehicle belongs to the utility vehicle class, which has higher ground clearance and narrower tread in relation to the height of its center of gravity to make it capable of performing in a wide variety of off-road applications.

Off-road vehicle features

- Specific design characteristics give it a higher center of gravity than ordinary passenger cars. This vehicle design feature causes this type of vehicle to be more likely to rollover. And, utility vehicles have a significantly higher rollover rate than other types of vehicles.
- An advantage of the higher ground clearance is a better view of the road allowing you to anticipate problems.
- It is not designed for cornering at the same speeds as ordinary passenger cars any more than low-slung sports cars are designed to perform satisfactorily under off-road conditions. Therefore, sharp turns at excessive speeds may cause the vehicle to rollover.

**CAUTION****Off-road vehicle precautions**

Always observe the following precautions to minimize the risk of death, serious injury or damage to your vehicle:

- In a rollover crash, an unbelted person is significantly more likely to die than a person wearing a seat belt. Therefore, the driver and all passengers should fasten their seat belts whenever the vehicle is moving.
- Avoid sharp turns or abrupt maneuvers, if at all possible. Failure to operate this vehicle correctly may result in loss of control or vehicle rollover causing death or serious injury.
- Avoid loading any items on the roof that will raise the vehicle's center of gravity.
- Always slow down in gusty crosswinds. Because of its profile and higher center of gravity, your vehicle is more sensitive to side winds than an ordinary passenger car. Slowing down will allow you to have better control.
- When driving off-road or in rugged terrain, do not drive at excessive speeds, jump, make sharp turns, strike objects, etc. This may cause loss of control or vehicle rollover causing death or serious injury. You are also risking expensive damage to your vehicle's suspension and chassis.
- Do not drive horizontally across steep slopes. Driving straight up or straight down is preferred. Your vehicle (or any similar off-road vehicle) can tip over sideways much more easily than forward or backward.

Off-road driving

When driving your vehicle off-road, please observe the following precautions to ensure your driving enjoyment and to help prevent the closure of areas to off-road vehicles.

- Drive your vehicle only in areas where off-road vehicles are permitted to travel.
- Respect private property. Get owner's permission before entering private property.
- Do not enter areas that are closed. Honor gates, barriers and signs that restrict travel.
- Stay on established roads. When conditions are wet, driving techniques should be changed or travel delayed to prevent damage to roads.

■ Additional information for off-road driving

► For owners in U.S. mainland, Hawaii and Puerto Rico:

To obtain additional information pertaining to driving your vehicle off-road, consult the following organizations.

- State and Local Parks and Recreation Departments
- State Motor Vehicle Bureau
- Recreational Vehicle Clubs
- U.S. Forest Service and Bureau of Land Management

**CAUTION****■ Off-road driving precautions**

Always observe the following precautions to minimize the risk of death, serious injury or damage to your vehicle:

- Drive carefully when off the road. Do not take unnecessary risks by driving in dangerous places.
- Do not grip the steering wheel spokes when driving off-road. A bad bump could jerk the wheel and injure your hands. Keep both hands and especially your thumbs on the outside of the rim.
- Always check your brakes for effectiveness immediately after driving in sand, mud, water or snow.
- After driving through tall grass, mud, rock, sand, rivers, etc., check that there is no grass, bush, paper, rags, stone, sand, etc., adhering or trapped on the underbody. Clear off any such matter from the underbody. If the vehicle is used with these materials trapped or adhering to the underbody, a breakdown or fire could occur.
- In a rollover crash, an unbelted person is significantly more likely to die than a person wearing a seat belt. Therefore, the driver and all passengers should fasten their seat belts whenever the vehicle is moving.
- When driving off-road or in rugged terrain, do not drive at excessive speeds, jump, make sharp turns, strike objects, etc. This may cause loss of control or vehicle rollover causing death or serious injury. You are also risking expensive damage to your vehicle's suspension and chassis.

**NOTICE****■ To prevent the water damage**

Take all necessary safety measures to ensure that water damage to the engine or other components does not occur.

- Water entering the engine air intake will cause severe engine damage.
- Water entering the automatic transmission will cause deterioration in shift quality, locking up of your transmission accompanied by vibration, and ultimately damage.
- Water can wash the grease from wheel bearings, causing rusting and premature failure, and may also enter the differentials, transmission and transfer case, reducing the gear oil's lubricating qualities.

■ When you drive through water

If driving through water, such as when crossing shallow streams, first check the depth of the water and the bottom of the river bed for firmness. Drive slowly and avoid deep water.

■ Inspection after off-road driving

- Sand and mud that has accumulated in brake drums and around brake discs may affect braking efficiency and may damage brake system components.
- Always perform a maintenance inspection after each day of off-road driving that has taken you through rough terrain, sand, mud, or water. For scheduled maintenance information, refer to the "Scheduled Maintenance Guide" or "Owner's Manual Supplement".

Multimedia

5

5-1. Basic Operations

- Multimedia system types... 250
- Entune Audio 252
- USB Port/AUX Port 255

5-2. Setup

- Setup menu..... 256
- General settings..... 257
- Audio settings 259
- Display settings..... 260
- Voice settings..... 261

5-3. Using the audio system

- Basic audio operations..... 262
- Selecting the audio
source 263
- List screen operation..... 264
- Sound settings 266

5-4. Using the radio

- Radio operation..... 267

5-5. Playing an audio CD and MP3/WMA/AAC discs

- CD player operation 269

Multimedia

5

- 5-6. Using an external device**
 - Listening to an iPod 274
 - Listening to a USB
memory device..... 278
 - Using the AUX port 282
- 5-7. Connecting Bluetooth®**
 - Preparations to use
wireless
communication..... 283
 - Registering a Bluetooth®
audio player
for the first time 287
 - Registering a Bluetooth®
phone for the first time ... 288
 - Registering a Bluetooth®
device..... 289
 - Connecting a Bluetooth®
device..... 291
 - Displaying a Bluetooth®
device details 293
 - Detailed Bluetooth®
system settings 294
- 5-8. Bluetooth® audio**
 - Listening to Bluetooth®
audio 295
- 5-9. Bluetooth® phone**
 - Using a Bluetooth®
phone..... 296
 - Making a call 298
 - Receiving a call..... 301
 - Speaking on the phone 302
 - Bluetooth® phone
message function..... 305
 - Using the steering wheel
switches 309
 - Bluetooth® phone
settings 310
 - Contact/Call History
Settings..... 312
 - What to do if..
(Troubleshooting)..... 321
- 5-10. Using the voice command system**
 - Voice command system.... 325
- 5-11. Bluetooth®**
 - Bluetooth® 327
- 5-12. Antenna**
 - Antenna..... 332

Multimedia system types

▶ Entune Audio

→P. 252

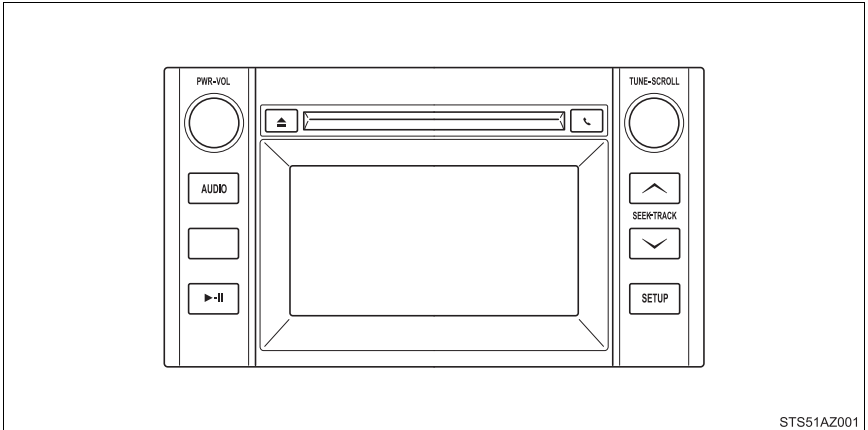

▶ Entune Audio Plus

Refer to the “NAVIGATION SYSTEM OWNER’S MANUAL”.

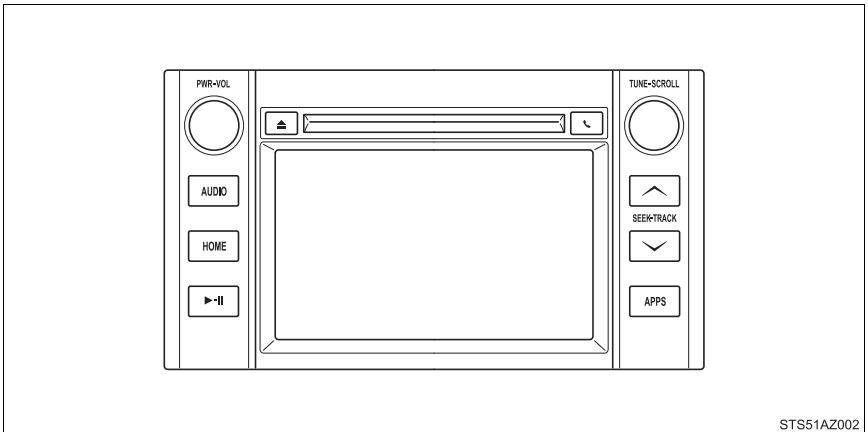

► Entune Premium Audio

Refer to the “NAVIGATION SYSTEM OWNER’S MANUAL”.

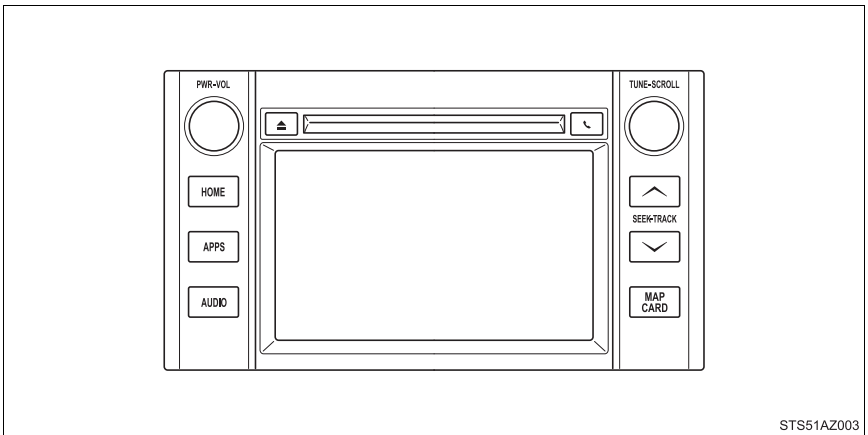

Entune Audio

Operations such as listening to audio, using the hands-free phone, confirming vehicle information and changing multimedia system settings are started by using the following buttons.

Multimedia system operation buttons

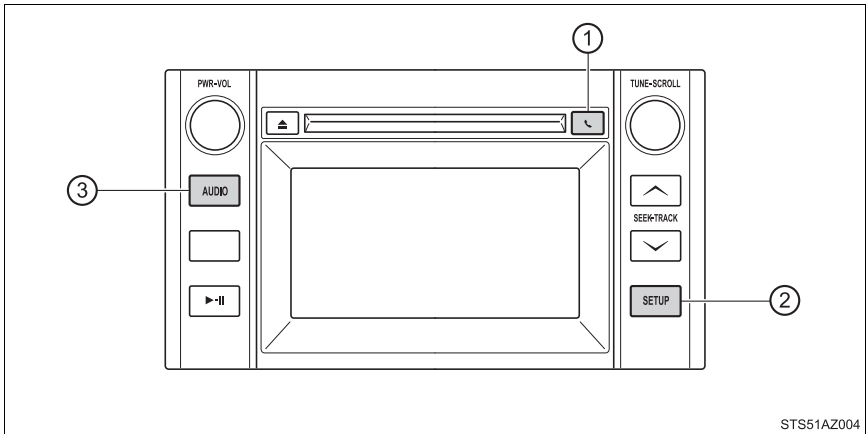

STS51AZ004

①  button

Press this button to access the Bluetooth[®] hands-free system. (→P. 296)

② “SETUP” button

Press this button to customize the function settings. (→P. 256)

③ “AUDIO” button

Display the “Select Audio Source” screen or audio control screen. (→P. 263)

Operating the touch screen

By touching the screen with your finger, you can control the Audio system, hands-free system, etc.

■ Drag*

Touch the screen with your finger and move the screen to the desired position.

- Scrolling the lists
- Using scroll bar in lists

■ Flick*

Touch the screen with your finger and then quickly move the screen.

- Scrolling the main screen page
- Returning to the menu screen from the sub-menu screen (screen one level below)

*: The above operations may not be performed on all screens.

■ When using the touch screen

- If the screen is cold, the display may be dark, or the system may seem to be operating slightly slower than normal.
- The screen may seem dark and hard to see when viewed through sunglasses. Change your angle of viewing, adjust the display on the "Display Settings" screen (→P. 260) or remove your sunglasses.

■ Using cellular phones

Interference may be heard through the multimedia system's speakers if a cellular phone is being used inside or close to the vehicle while the multimedia system is operating.

**CAUTION****■ Laser product**

THIS PRODUCT IS A CLASS 1 LASER PRODUCT. USE OF CONTROLS OR ADJUSTMENTS OR PERFORMANCE OF PROCEDURES OTHER THAN THOSE SPECIFIED HEREIN MAY RESULT IN HAZARDOUS RADIATION EXPOSURE. DO NOT OPEN COVERS AND DO NOT REPAIR BY YOURSELF. REFER SERVING TO QUALIFIED PERSONNEL.

**NOTICE****■ To avoid damaging the touch screen**

- To prevent damaging the screen, lightly touch the screen buttons with your finger.
- Do not use objects other than your finger to touch the screen.
- Wipe off fingerprints using a glass cleaning cloth. Do not use chemical cleaners to clean the screen, as they may damage the touch screen.

■ To prevent battery discharge

Do not leave the multimedia system on longer than necessary when the engine is off.

■ To avoid damaging the multimedia system

Take care not to spill drinks or other fluids on the multimedia system.

USB Port/AUX Port

Connect an iPod, USB memory device or portable audio player to the USB/AUX port as indicated below. Select “iPod”, “USB” or “AUX” on the “Select Audio Source” screen and the device can be operated via multimedia system.

Connecting using the USB/AUX port

■ iPod

Open the cover and connect an iPod using an iPod cable.

Turn on the power of the iPod if it is not turned on.

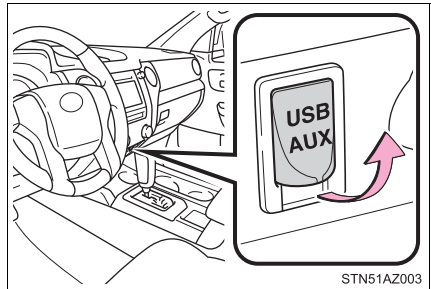

■ USB memory

Open the cover and connect the USB memory device.

Turn on the power of the USB memory device if it is not turned on.

■ Portable audio player

Open the cover and connect the portable audio player.

Turn on the power of the portable audio player if it is not turned on.

⚠ CAUTION

■ While driving

Do not connect a device or operate the device controls.

Setup menu

You can adjust the multimedia system to your desired settings.

Display “Setup” screen

Press the “SETUP” button to display the “Setup” screen.

- ① Select to adjust the settings for operation sounds, screen animation, etc. (→P. 257)
- ② Select to set the voice settings. (→P. 261)
- ③ Select to adjust the settings for contrast and brightness of the screen. (→P. 260)
- ④ Select to adjust the settings for registering, removing, connecting and disconnecting Bluetooth® devices. (→P. 286, 291)
- ⑤ Select to adjust the settings for phone sound, contact, etc. (→P. 310)
- ⑥ Select to set radio and external media settings. (→P. 259)
- ⑦ Select to turn the screen off.
- ⑧ Select to set the vehicle customization. (→P. 530)

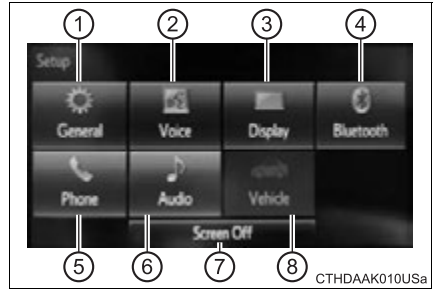

General settings

Settings are available for adjusting the operation sounds, screen animation, etc.

Screen for general settings

- 1 Press the “SETUP” button.
- 2 Select “General” on the “Setup” screen.

- ① Select to adjust the clock. (→P. 258)
- ② “English”, “Français” or “Español” can be selected.
- ③ On/off can be selected to sound beeps.

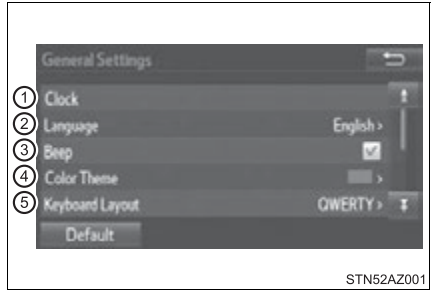

- ④ Select to change the screen color.
- ⑤ Select to change the keyboard layout.
- ⑥ The animation effect for the screen can be set to on/off.
- ⑦ Select to delete personal data (→P. 258)

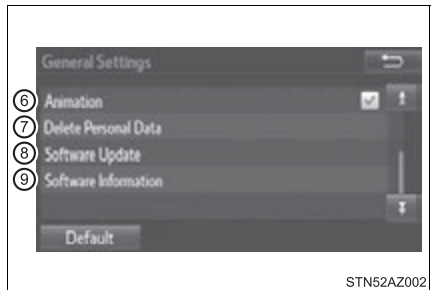

- ⑧ Select to update program versions. For details, contact your Toyota dealer.
- ⑨ Select to display the software information. Notices related to third party software used in this product are enlisted. (This includes instructions for obtaining such software, where applicable.)

■ To return to the default settings

Select “Default”, and then “Yes”.

Setting the clock

- 1 Select “Clock” on the “General Settings” screen.
- 2 Adjust the time, then select “OK”.

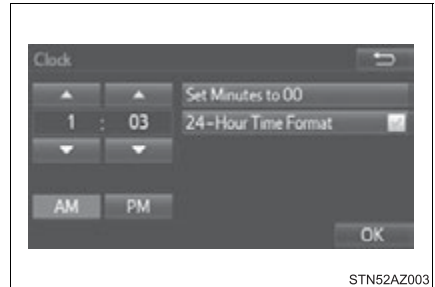

Delete personal data

- 1 Select “Delete Personal Data” on the “General Settings” screen.
- 2 Select “Delete”.
- 3 A confirmation screen will be displayed. Select “Yes”.

Check carefully beforehand, as data cannot be retrieved once deleted.

The following personal data will be deleted or changed to its default settings.

- General settings
- Audio settings
- Phone settings

Audio settings

Settings are available for adjusting the radio operation, cover art, etc.

Screen for audio settings

- 1 Press the “SETUP” button.
- 2 Select “Audio” on the “Setup” screen.
 - ① Select the number of radio preset stations.
 - ② Select to display the cover art.
 - ③ Select “High”, “Middle”, “Low” or “Off”.

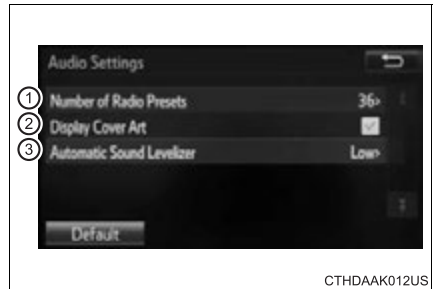

■ About Automatic Sound Leveliser (ASL)

ASL automatically adjusts the volume and tone quality according to the vehicle speed.

Display settings

Settings are available for adjusting the contrast and brightness of the screen.

Screen for display settings

- 1 Press the “SETUP” button.
- 2 Select “Display” on the “Setup” screen.
 - 1 Adjust general screen contrast/brightness
 - 2 Adjust camera screen contrast/brightness
 - 3 Changes to day mode.

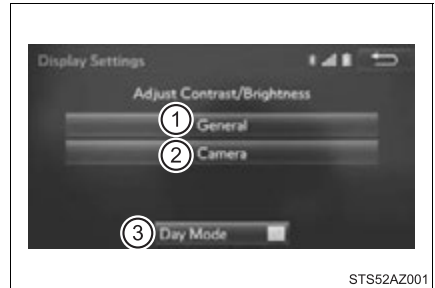

Adjusting the screen contrast/brightness

- 1 Select “General” or “Camera” on the “Display Settings” screen.
- 2 Adjust the display as desired by selecting “+” or “-”.

Day mode

When the headlights are turned on, the screen dims. However, the screen can be switched to day mode by selecting “Day Mode”.

The screen will stay in day mode when the headlights are turned on until “Day Mode” is selected again.

Voice settings

This screen is used for guidance for voice command systems setting.

- ① Adjust the voice guidance volume setting.
- ② Set the voice recognition prompts “High”, “Low” or “Off”.
- ③ Set the train voice recognition.
- ④ Set the voice prompt interrupt on/off.
- ⑤ Voice recognition tutorial



Basic audio operations

Basic audio operations and functions common to each mode are explained in this section.

Operating the multimedia system



STS53AZ002

- ① Turn this knob to select radio station bands, tracks and files. Also the knob can be used to select items in the list display.
- ② Press the “^” or “v” button to seek up or down for a radio station, or to access a desired track or file.
- ③ Press to pause or resume playing music.
- ④ Press this knob to turn the multimedia system on and off, and turn it to adjust the volume.
- ⑤ Press this button to eject a disc
- ⑥ Insert a disc into the disc slot
- ⑦ “Select Audio Source” screen appears (→P. 263)
- ⑧ Setting the Sound (→P. 266)
- ⑨ Pause or resume playing music
- ⑩ Select to enable repeat play
- ⑪ Select to enable random playback

Selecting the audio source

Switching between audio sources such as radio and CD are explained in this section.

Selecting the audio source

- 1 Press the “AUDIO” button.
- 2 Select “Source” on the audio control screen or press the “AUDIO” button again.
- 3 Select the desired audio source.

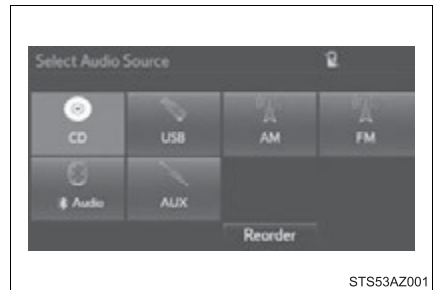



Reordering the audio source



- 1 Select “Reorder”.
- 2 Select the desired audio source then **<<** or **>>** to reorder.
- 3 Select “OK”.

List screen operation

When a list style screen is displayed, use the appropriate buttons to scroll through the list.

How to scroll

  : Select to scroll to the next or previous page.

 : If  appears to the right of titles, the complete titles are too long for the display. Select this button to scroll the title.

Turn the “TUNE·SCROLL” knob to move the cursor box to select a desired item from the list, and press the “TUNE·SCROLL” knob to play it. The track that is being played is highlighted.

To return to the top screen, select “Now Playing” on the list screen.



Selecting, fast-forwarding and reversing tracks/files/songs

■ Selecting a track/file/song

Press the “^” or “v” button on “SEEK/TRACK” or turn the “TUNE-SCROLL” knob to select the desired track/file/song number.

To fast-forward or reverse, press and hold the “^” or “v” button on “SEEK/TRACK”.

■ Selecting a track/file/song from the track/file/song list

- 1 Select “Browse” or cover art.
- 2 Select the desired track/file/song.



When an MP3/WMA/AAC disc or USB memory device is being used, the folder can be selected. When a Bluetooth® device or iPod is being used, the album can be selected.

According to the audio device, the following is displayed.

| Audio source | List name |
|-----------------------|--------------|
| Audio CD | Track |
| MP3/WMA/AAC disc, USB | Folder, File |
| Bluetooth® | Album, Track |
| iPod | Album, Song |

Sound settings

On the “Sound Settings” screen, sound quality (Treble/Mid/Bass), volume balance can be adjusted.

Tone and balance

Select “Sound” on the audio control screen to adjust the sound settings.

- ① ② ③ Select “-” or “+” to adjust the treble, mid or bass to a level between -5 and 5.
- ④ ⑤ Select “Front” or “Rear” to adjust the front/rear audio balance.
- ⑥ ⑦ Select “L” or “R” to adjust the left/right audio balance.

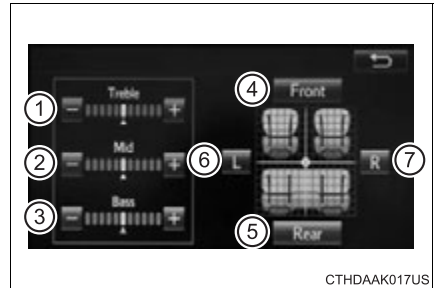

■ The sound quality level is adjusted individually

The treble, mid and bass levels can be adjusted for each audio mode separately.

Radio operation

Select “AM” or “FM” on the “Select Audio Source” screen to begin listening to the radio.

Audio control screen

- ① “Select Audio Source” screen appears
- ② Preset stations
- ③ Select to display RBDS text message
- ④ Scanning for receivable station
- ⑤ Select to display a list of receivable stations
- ⑥ Setting the sound (→P. 266)

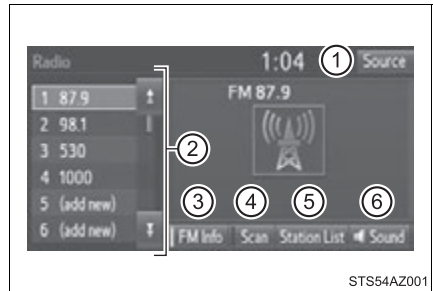

Selecting a station

Tune in to the desired station using one of the following methods.

■ Seek tuning

Press the “∧” or “∨” button on “SEEK/TRACK”.

The radio will begin seeking up or down for a station of the nearest frequency and will stop when a station is found.

■ Manual tuning

Turn the “TUNE·SCROLL” knob.

■ Preset stations

Select the desired preset station.

Setting station presets

- 1 Search for desired stations by turning the “TUNE·SCROLL” knob or pressing the “^” or “v” button on “SEEK/TRACK”.
- 2 Select “(add new)”
To change the preset station to a different one, select and hold the preset station.
- 3 Select “Yes”.
- 4 Select “OK” after setting the new preset station.

■ Refreshing the station list

- 1 Select “Refresh” on the “Station List” screen.
To cancel the refresh, select “Cancel Refresh”.

■ Reception sensitivity

Maintaining perfect radio reception at all times is difficult due to the continually changing position of the antenna, differences in signal strength and surrounding objects, such as trains, transmitters, etc.

CD player operation

Insert disc or select “CD” on the “Select Audio Source” screen to begin listening to a CD.

Audio control screen

- ① “Select Audio Source” screen appears
- ② Audio CD:
Displaying the track list
(→P. 265)
MP3/WMA/AAC:
Displaying the folder list
(→P. 265)
- ③ Random playback
- ④ Repeat play
- ⑤ Pause
Select  to resume play
- ⑥ Setting the sound (→P. 266)

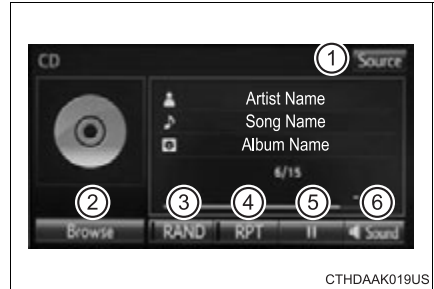

■ Displaying the title and artist name

If a CD-TEXT disc is inserted, the title of the disc and track will be displayed.

■ Error messages

If an error message is displayed, refer to the following table and take the appropriate measures. If the problem is not rectified, take the vehicle to your Toyota dealer.

| Message | Cause | Correction procedures |
|-------------------------|---|--|
| “Check DISC” | <ul style="list-style-type: none"> • The disc is dirty or damaged. • The disc is inserted upside down. • The disc is not playable with the player. | <ul style="list-style-type: none"> • Clean the disc. • Insert the disc correctly. • Confirm the disc is playable with the player. |
| “Disc Error” | There is a malfunction within the system. | Eject the disc. |
| “No music files found.” | No playable data is included on the disc. | Eject the disc. |

■ Discs that can be used

Discs with the marks shown below can be used.

Playback may not be possible depending on recording format or disc features, or due to scratches, dirt or deterioration.



CDs with copy-protection features may not play correctly.

■ CD player protection feature

To protect the internal components, playback is automatically stopped when a problem is detected.

■ If a disc is left inside the CD player or in the ejected position for extended periods

Disc may be damaged and may not play properly.

■ Lens cleaners

Do not use lens cleaners. Doing so may damage the CD player.

■ MP3, WMA and AAC files

MP3 (MPEG Audio LAYER3) is a standard audio compression format.

Files can be compressed to approximately 1/10 of their original size by using MP3 compression.

WMA (Windows Media Audio) is a Microsoft audio compression format.

This format compresses audio data to a size smaller than that of the MP3 format.

AAC is short for Advanced Audio Coding and refers to an audio compression technology standard used with MPEG2 and MPEG4.

MP3, WMA and AAC file and media/formats compatibility are limited.

● MP3 file compatibility

- Compatible standards
MP3 (MPEG1 LAYER3, MPEG2 LSF LAYER3)
- Compatible sampling frequencies
MPEG1 LAYER3: 32, 44.1, 48 (kHz)
MPEG2 LSF LAYER3: 16, 22.05, 24 (kHz)
- Compatible bit rates (compatible with VBR)
MPEG1 LAYER3: 32-320 (kbps)
MPEG2 LSF LAYER3: 8-160 (kbps)
- Compatible channel modes: stereo, joint stereo, dual channel and monaural

- WMA file compatibility

- Compatible standards
WMA Ver. 7, 8, 9
- Compatible sampling frequencies
32, 44.1, 48 (kHz)
- Compatible bit rates (only compatible with 2-channel playback)
Ver. 7, 8: CBR 48-192 (kbps)
Ver. 9: CBR 48-320 (kbps)

- AAC file compatibility

- Compatible standards
MPEG4/AAC-LC
- Compatible sampling frequencies
11.025/12/16/22.05/24/32/44.1/48 (kHz)
- Compatible bit rates
16-320 (kbps)

- Compatible media

Media that can be used for MP3, WMA and AAC playback are CD-Rs and CD-RWs.

Playback in some instances may not be possible if the CD-R or CD-RW is not finalized. Playback may not be possible or the audio may jump if the disc is scratched or marked with fingerprints.

- Compatible disc formats

The following disc formats can be used.

- Disc formats: CD-ROM Mode 1 and Mode 2
CD-ROM XA Mode 2, Form 1 and Form 2
- File formats: ISO9660 Level 1, Level 2, (Romeo, Joliet)
UDF (2.01 or lower)

MP3, WMA and AAC files written in any format other than those listed above may not play correctly, and their file names and folder names may not be displayed correctly.

Items related to standards and limitations are as follows.

- Maximum directory hierarchy: 8 levels (including the root)
- Maximum length of folder names/file names: 32 characters
- Maximum number of folders: 192 (including the root)
- Maximum number of files per disc: 255

- File names

The only files that can be recognized as MP3/WMA/AAC and played are those with the extension .mp3, .wma or .m4a.

- Discs containing multi-session recordings

As the multimedia system is compatible with multi session discs, it is possible to play discs that contain MP3, WMA and AAC files. However, only the first session can be played.

- ID3, WMA and AAC tags

ID3 tags can be added to MP3 files, making it possible to record the track title, artist name, etc.

The system is compatible with ID3 Ver. 1.0, 1.1, and Ver. 2.2, 2.3 ID3 tags. (The number of characters is based on ID3 Ver. 1.0 and 1.1.)

WMA tags can be added to WMA files, making it possible to record the track title and artist name in the same way as with ID3 tags.

AAC tags can be added to AAC files, making it possible to record the track title and artist name in the same way as with ID3 tags.

- MP3, WMA and AAC playback

When a disc containing MP3, WMA or AAC files is inserted, all files on the disc are first checked. Once the file check is finished, the first MP3, WMA or AAC file is played. To make the file check finish more quickly, we recommend you do not write any files to the disc other than MP3, WMA or AAC files or create any unnecessary folders.

Discs that contain a mixture of music data and MP3, WMA or AAC format data cannot be played.

- Extensions

If the file extensions .mp3, .wma and .m4a are used for files other than MP3, WMA and AAC files, they may be mistakenly recognized and played as MP3, WMA and AAC files. This may result in large amounts of interference and damage to the speakers.

- Playback

- To play MP3 files with steady sound quality, we recommend a fixed bit rate of at least 128 kbps and a sampling frequency of 44.1 kHz.
- CD-R or CD-RW playback may not be possible in some instances, depending on the characteristics of the disc.
- There is a wide variety of freeware and other encoding software for MP3, WMA and AAC files on the market, and depending on the status of the encoding and the file format, poor sound quality or noise at the start of playback may result. In some cases, playback may not be possible at all.
- When files other than MP3, WMA or AAC files are recorded on a disc, it may take more time to recognize the disc and in some cases, playback may not be possible at all.
- Microsoft, Windows, and Windows Media are the registered trademarks of Microsoft Corporation in the U.S.A. and other countries.
- This system can playback AAC files encoded by iTunes.

 NOTICE

Discs and adapters that cannot be used

Do not use the following types of CDs.

Also, do not use 3 in. (8 cm) CD adapters, Dual Discs or printable discs.

Doing so may damage the CD player and/or the CD insert/eject function.

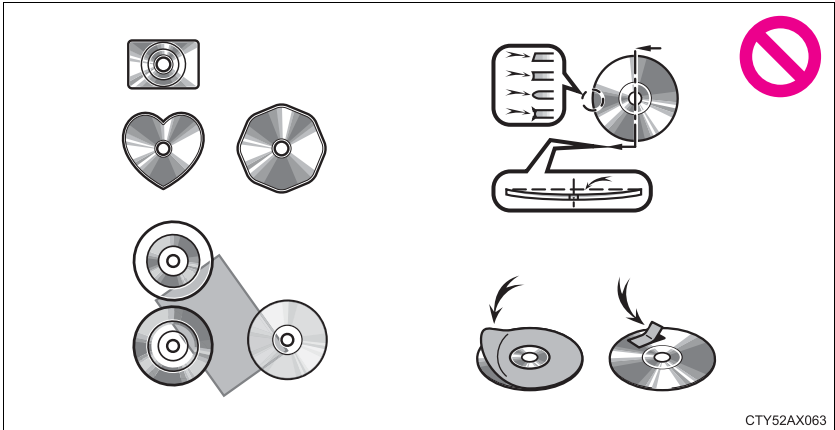

- Discs that have a diameter that is not 4.7 in. (12 cm).
- Low-quality or deformed discs.
- Discs with a transparent or translucent recording area.
- Discs that have tape, stickers or CD-R labels attached to them, or that have had the label peeled off.

Player precautions

Failure to follow the precautions below may result in damage to the discs or the player itself.

- Do not insert anything other than discs into the disc slot.
- Do not apply oil to the player.
- Store discs away from direct sunlight.
- Never try to disassemble any part of the player.

Listening to an iPod

Connecting an iPod enables you to enjoy music from the vehicle speakers.

Select “iPod” on the “Select Audio Source” screen.

When the iPod connected to the system includes iPod video, the system can only output the sound by selecting the browse screen.

Connecting an iPod

→P. 255

Audio control screen

- ① “Select Audio Source” screen appears
- ② Displays cover art
- ③ Selecting the play mode
- ④ Shuffle play
- ⑤ Repeat play
- ⑥ Pause
Select  to resume playback
- ⑦ Setting the sound (→P. 266)

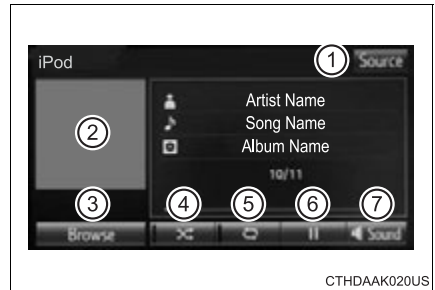

Selecting a play mode

- 1 Select “Browse” on the “iPod” screen.
- 2 Select the desired play mode by selecting the “Playlists”, “Artists”, “Albums”, “Songs”, “Podcasts”, “Audio books”, “Genres”, “Composers” or “Video”. Then select a song to begin using the selected play mode.

■ About iPod



- “Made for iPod”, “Made for iPhone” and “Made for iPad” mean that an electronic accessory has been designed to connect specifically to iPod or iPhone, or iPad, respectively, and has been certified by the developer to meet Apple performance standards.
- Apple is not responsible for the operation of this device or its compliance with safety and regulatory standards. Please note that the use of this accessory with iPod, iPhone or iPad may affect wireless performance.
- iPad, iPhone, iPod, iPod classic, iPod nano, and iPod touch are trademarks of Apple Inc., registered in the U.S. and other countries. Lightning is a trademark of Apple Inc.

■ iPod cover art

- Depending on the iPod and songs in the iPod, iPod cover art may be displayed.
- This function can be changed to on/off. (→P. 259)
- It may take time to display iPod cover art, and the iPod may not be operated while the cover art display is in process.
- Only iPod cover art that is saved in JPEG format can be displayed.

■ iPod functions

- When an iPod is connected and the audio source is changed to iPod mode, the iPod will resume play from the same point in which it was last used.
- Depending on the iPod that is connected to the system, certain functions may not be available. If a function is unavailable due to a malfunction (as opposed to a system specification), disconnecting the device and reconnecting it may resolve the problem.
- While connected to the system, the iPod cannot be operated with its own controls. It is necessary to use the controls of the vehicle’s multimedia system instead.
- When the battery level of an iPod is very low, the iPod may not operate. If so, charge the iPod before use.
- Compatible models (→P. 277)

■ iPod problems

To resolve most problems encountered when using your iPod, disconnect your iPod from the vehicle iPod connection and reset it. For instructions on how to reset your iPod, refer to your iPod Owner's Manual.

■ Error messages

| Message | Cause/Correction procedures |
|---|---|
| "Connection error. Please consult your Owner's Manual for instructions on how to connect the iPod." | This indicates a problem in the iPod or its connection. |
| "No music files found." | This indicates that there is no music data in the iPod. |
| "There are no songs available for playback. Please add compatible files to your iPod." | This indicates that songs are not found in a selected playlist. |
| "Please check the iPod firmware version." | This indicates that the software version is not compatible. Please check the compatible models. (→P. 277) |
| "iPod authorization unsuccessful." | This indicates that the display multimedia system failed to authorize the iPod. Please check your iPod. |

■ Compatible models

The following iPod®, iPod nano®, iPod classic®, iPod touch® and iPhone® devices can be used with this system.

● Made for

- iPod touch (5th generation)
- iPod touch (4th generation)
- iPod touch (3rd generation)
- iPod touch (2nd generation)
- iPod touch (1st generation)
- iPod classic
- iPod with video
- iPod nano (7th generation)
- iPod nano (6th generation)
- iPod nano (5th generation)
- iPod nano (4th generation)
- iPod nano (3rd generation)
- iPod nano (2nd generation)
- iPod nano (1st generation)
- iPhone 5
- iPhone 4S
- iPhone 4
- iPhone 3GS
- iPhone 3G
- iPhone

Depending on differences between models or software versions etc., some models might be incompatible with this system.

CAUTION

■ While driving

Do not connect an iPod or operate the controls.

NOTICE

■ To prevent damage to the iPod or its terminals

- Do not leave the iPod in the vehicle. The temperature inside the vehicle may become high, resulting in damage to the iPod.
- Do not push down on or apply unnecessary pressure to the iPod while it is connected.
- Do not insert foreign objects into the port.

Listening to a USB memory device

Connecting a USB memory device enables you to enjoy music from the vehicle speakers.

Select “USB” on the “Select Audio Source” screen.

Connecting a USB memory device

→P. 255

Audio control screen

- ① “Select Audio Source” screen appears
- ② Displaying the folder list (→P. 265)
- ③ Random playback
- ④ Repeat play
- ⑤ Pause
Select  to resume playback
- ⑥ Setting the sound (→P. 266)



■ USB memory functions

- Depending on the USB memory device that is connected to the system, the device itself may not be operable and certain functions may not be available. If the device is inoperable or a function is unavailable due to a malfunction (as opposed to a system specification), disconnecting the device and reconnecting it may resolve the problem.
- If the USB memory device still does not begin operation after being disconnected and reconnected, format the memory.

■ Error messages for USB memory

| Message | Cause/Correction procedures |
|--|---|
| “Connection error. Please consult your Owner’s Manual for instruction on how to connect the USB device.” | This indicates a problem with the USB memory device or its connection. |
| “There are no file available for playback. Please add compatible file to your USB device.” | This indicates that no MP3/WMA/AAC files are included on the USB memory device. |

■ USB memory

● Compatible devices

USB memory device that can be used for MP3, WMA and AAC playback.

● Compatible device formats

The following device format can be used:

- USB communication format: USB2.0 FS (12 Mbps), USB2.0 HS (480 Mbps)
 - File system format: FAT16/32 (Windows)
 - Correspondence class: Mass storage class
- MP3, WMA and AAC files written to a device with any format other than those listed above may not play correctly, and their file names and folder names may not be displayed correctly.

Items related to standards and limitations are as follows:

- Maximum directory hierarchy: 8 levels
- Maximum number of folders in a device: 3000 (including the root)
- Maximum number of files in a device: 9999
- Maximum number of files per folder: 255

● MP3, WMA and AAC files

MP3 (MPEG Audio LAYER 3) is a standard audio compression format.

Files can be compressed to approximately 1/10 of their original size using MP3 compression.

WMA (Windows Media Audio) is a Microsoft audio compression format. This format compresses audio data to a size smaller than that of the MP3 format.

AAC is short for Advanced Audio Coding and refers to an audio compression technology standard used with MPEG2 and MPEG4.

MP3, WMA and AAC file and media/formats compatibility are limited.

● MP3 file compatibility

- Compatible standards
MP3 (MPEG1 AUDIO LAYER3, MPEG2 AUDIO LAYER3)
- Compatible sampling frequencies
MPEG1 AUDIO LAYER3: 32, 44.1, 48 (kHz)
MPEG2 AUDIO LAYER3: 16, 22.05, 24 (kHz)
- Compatible bit rates (compatible with VBR)
MPEG1 AUDIO LAYER3: 32-320 (kbps)
MPEG2 AUDIO LAYER3: 8-160 (kbps)
- Compatible channel modes: stereo, joint stereo, dual channel and monaural

● WMA file compatibility

- Compatible standards
WMA Ver. 7, 8, 9
- Compatible sampling frequencies
HIGH PROFILE 32, 44.1, 48 (kHz)
- Compatible bit rates
HIGH PROFILE 48-320 (kbps, VBR)

- AAC file compatibility

- Compatible standards
MPEG4/AAC-LC
- Compatible sampling frequencies
11.025/12/16/22.05/24/32/44.1/48 (kHz)
- Compatible bit rates
16-320 (kbps)
- Compatible channel modes: 1 ch and 2 ch

- File names

The only files that can be recognized as MP3/WMA/AAC and played are those with the extension .mp3 or .wma.

- ID3, WMA and AAC tags

ID3 tags can be added to MP3 files, making it possible to record the track title, artist name, etc.

The system is compatible with ID3 Ver. 1.0, 1.1, and Ver. 2.2, 2.3 ID3 tags. (The number of characters is based on ID3 Ver. 1.0 and 1.1.)

WMA tags can be added to WMA files, making it possible to record the track title and artist name in the same way as with ID3 tags.

AAC tags can be added to AAC files, making it possible to record the track title and artist name in the same way as with ID3 tags.

- MP3, WMA and AAC playback

- When a device containing MP3, WMA and AAC files is connected, all files in the USB memory device are checked. Once the file check is finished, the first MP3, WMA and AAC file is played. To make the file check finish more quickly, we recommend that you do not include any files other than MP3, WMA and AAC files or create any unnecessary folders.
- When a USB memory device is connected and the audio source is changed to USB memory mode, the USB memory device will start playing the first file in the first folder. If the same device is removed and reconnected (and the contents have not been changed), the USB memory device will resume play from the same point in which it was last used.

- Extensions

If the file extensions .mp3, .wma and .m4a are used for files other than MP3, WMA and AAC files, they will be skipped (not played).

- Playback

- To play MP3 files with steady sound quality, we recommend a fixed bit rate of at least 128 kbps and a sampling frequency of 44.1 kHz.
- There is a wide variety of freeware and other encoding software for MP3, WMA and AAC files on the market, and depending on the status of the encoding and the file format, poor sound quality or noise at the start of playback may result. In some cases, playback may not be possible at all.
- Microsoft, Windows, and Windows Media are the registered trademarks of Microsoft Corporation in the U.S.A. and other countries.

**CAUTION****■ While driving**

Do not connect a USB memory device or operate the device controls.

**NOTICE****■ To prevent damage to the USB memory device or its terminals**

- Do not leave the USB memory device in the vehicle. The temperature inside the vehicle may become high, resulting in damage to the USB memory device.
- Do not push down on or apply unnecessary pressure to the USB memory device while it is connected.
- Do not insert foreign objects into the port.

Using the AUX port

To use the AUX port, connect a portable player, then select “AUX” on the “Select Audio Source” screen.

Connecting a portable audio player

→P. 255

■ Operating portable audio players connected to the multimedia system

The volume can be adjusted using the vehicle's audio controls. All other adjustments must be made on the portable audio player itself.

■ When using a portable audio player connected to the power outlet

Noise may occur during playback. Use the power source of the portable audio player.



CAUTION

■ While driving

Do not connect a portable audio player or operate the device controls.

Preparations to use wireless communication

The following can be performed using Bluetooth® wireless communication:

- A portable audio player can be operated and listened to via multimedia system
- Hands-free phone calls can be made via a cellular phone

In order to use wireless communication, register and connect a Bluetooth® device by performing the following procedures.

■ About Bluetooth®

The Bluetooth® word mark and logos are registered trademarks owned Bluetooth SIG, Inc. and any use of such marks by Panasonic Corporation is under license. Other trademarks and trade names are those of their respective owners.



■ Certification

FCC ID: ACJ932YEAP01A446

IC: 216J-YEAP01A466

- ▶ For vehicles sold in the U.S.A.

This device complies with Part 15 of the FCC Rules. Operation is subject to the following two conditions: (1) this device may not cause harmful interference, and (2) this device must accept any interference received, including interference that may cause undesired operation.

- ▶ For vehicles sold in Canada

This device complies with Industry Canada licence-exempt RSS standard(s). Operation is subject to the following two conditions: (1) this device may not cause interference, and (2) this device must accept any interference, including interference that may cause undesired operation of the device.

This radio transmitter (identify the device by certification number, or model number if Category II) has been approved by Industry Canada to operate with the antenna types listed below with the maximum permissible gain and required antenna impedance for each antenna type indicated. Antenna types not included in this list, having a gain greater than the maximum gain indicated for that type, are strictly prohibited for use with this device.

The latest original “DECLARATION of CONFORMITY” (DoC) is available at the address stated.

<http://www.ptc.panasonic.de/>



| |
|--|
| <p>C настоящето, Panasonic Corporation, декларира, че YEAP01A446/YEAP01A473 е в съответствие със съществените изисквания и другите приложими разпоредби на Директива 1999/5/EC.</p> <p>Panasonic Corporation timto proklamuje, ze tento YEAP01A446/YEAP01A473 je ve shodě se základními požadavky a dalšími příslušnými ustanoveními směrnice 1999/5/ES.</p> <p>Undertegnede Panasonic Corporation erklærer herved, at følgende udstyr YEAP01A446/YEAP01A473 overholder de væsentlige krav og øvrige relevante krav i direktiv 1999/5/EF.</p> <p>Hierbij verklaart Panasonic Corporation dat het toestel YEAP01A446/YEAP01A473 in overeenstemming is met de essentiële eisen en de andere relevante bepalingen van richtlijn 1999/5/EG.</p> <p>Hereby, Panasonic Corporation, declares that this YEAP01A446/YEAP01A473 is in compliance with the essential requirements and other relevant provisions of Directive 1999/5/EC.</p> <p>Käesolevaga kinnitab Panasonic Corporation seadme YEAP01A446/YEAP01A473 vastavust direktiivi 1999/5/EÜ põhinõuetele ja nimetatud direktiivist tulenevatele teistele asjakohastele sätetele.</p> <p>Panasonic Corporation vakuuttaa täten että YEAP01A446/YEAP01A473 tyyppinen laite on direktiivin 1999/5/EY oleellisten vaatimusten ja sitä koskevien direktiivin muiden ehtojen mukainen.</p> <p>Par la présente Panasonic Corporation déclare que l'appareil YEAP01A446/YEAP01A473 est conforme aux exigences essentielles et aux autres dispositions pertinentes de la directive 1999/5/CE.</p> <p>Hiermit erklärt Panasonic Corporation, dass sich das Gerät YEAP01A446/YEAP01A473 in Übereinstimmung mit den grundlegenden Anforderungen und den übrigen einschlägigen Bestimmungen der Richtlinie 1999/5/EG befindet.</p> <p>ΜΕ ΤΗΝ ΠΑΡΟΥΣΑ Panasonic Corporation ΔΗΛΩΝΕΙ ΟΤΙ YEAP01A446/YEAP01A473 ΣΥΜΜΟΡΦΩΝΕΤΑΙ ΠΡΟΣ ΤΙΣ ΟΥΣΙΩΔΕΙΣ ΑΠΑΙΤΗΣΕΙΣ ΚΑΙ ΤΙΣ ΛΟΙΠΕΣ ΣΧΕΤΙΚΕΣ ΔΙΑΤΑΞΕΙΣ ΤΗΣ ΟΔΗΓΙΑΣ 1999/5/ΕΚ.</p> <p>Alulirolet, Panasonic Corporation nyilatkozum, hogy a YEAP01A446/YEAP01A473 megfelel a vonatkozó alapvető követelményeknek és az 1999/5/EC irányelv egyéb elírásainak.</p> <p>Con la presente Panasonic Corporation dichiara che questo YEAP01A446/YEAP01A473 è conforme ai requisiti essenziali ed alle altre disposizioni pertinenti stabilite dalla direttiva 1999/5/CE.</p> <p>Ar šo Panasonic Corporation deklarē, ka YEAP01A446/YEAP01A473 atbilst Direktīvas 1999/5/EK būtiskajām prasībām un citiem ar to saistītajiem noteikumiem.</p> <p>Suo Panasonic Corporation deklaruoja, kad šis YEAP01A446/YEAP01A473 atitinka esminius reikalavimus ir kitas 1999/5/EB Direktivos nuostatas.</p> <p>Hämeenhekk, Panasonic Corporation, jiddikjara li dan YEAP01A446/YEAP01A473 jikkonforma mal-ħigijiet essenzjali u ma provvedimenti oħrajn relevanti li hemm fid-Direttiva 1999/5/EC.</p> <p>Niniejszym Panasonic Corporation oświadczca, że YEAP01A446/YEAP01A473 jest zgodny z zasadniczymi wymogami oraz pozostałymi stosownymi postanowieniami Dyrektywy 1999/5/EC.</p> <p>Panasonic Corporation declara que este YEAP01A446/YEAP01A473 está conforme con os requisitos essenciais e outras disposições da Directiva 1999/5/CE.</p> <p>Prin prezenta, Panasonic Corporation, declară că aparatul YEAP01A446/YEAP01A473 este în conformitate cu cerințele esențiale și cu alte prevederi pertinente ale Directivei 1999/5/CE.</p> <p>Panasonic Corporation tímto vyhlásuje, že YEAP01A446/YEAP01A473 splňa základné požiadavky a všetky príslušné ustanovenia Smernice 1999/5/ES.</p> <p>Panasonic Corporation izjavlja, da je ta YEAP01A446/YEAP01A473 v skladu s bistvenimi zahtevami in ostalimi relevantnimi določili direktive 1999/5/ES.</p> <p>Por medio de la presente Panasonic Corporation declara que el YEAP01A446/YEAP01A473 cumple con los requisitos esenciales y cualesquiera otras disposiciones aplicables o exigibles de la Directiva 1999/5/CE.</p> <p>Härmed intygar Panasonic Corporation att denna YEAP01A446/YEAP01A473 står i överensstämmelse med de väsentliga egenskapskrav och övriga relevanta bestämmelser som framgår av direktiv 1999/5/EG.</p> <p>Hér með lýsir Panasonic Corporation yfir því að YEAP01A446/YEAP01A473 er í samræmi við grunnkröfur og aðrar kröfur, sem gerðar eru í tilskilin 1999/5/EG.</p> <p>Panasonic Corporation erklærer herved at udstyret YEAP01A446/YEAP01A473 er i samvæg med de grundlæggende krav og øvrige relevante krav i direktiv 1999/5/EF.</p> <p>Ovim , Panasonic Corporation, izjavlja da ovaj YEAP01A446/YEAP01A473 je usklađen sa bitnim zahtjevima i drugim relevantnim odredbama Direktive 1999/5/EC.</p> <p>Nepemjet kesaj, Panasonic Corporation, deklarajo qe ky YEAP01A446/YEAP01A473 eshte ne pajtim me kerkesat thebesore dhe dispozitat e tjera perkatese te Direktives 1999/5/EC.</p> <p>Ovim Panasonic Corporation, izjavlja da je YEAP01A446/YEAP01A473 u skladu s bitnim zahtjevima drugim relevantnim odredbama Direktive 1999/5/EC.</p> |
|--|

 **CAUTION**
FCC WARNING

Changes or modifications not expressly approved by the party responsible for compliance could void the user's authority to operate the equipment.

Radio frequency radiation exposure information:

This equipment complies with FCC radiation exposure limits set forth for an uncontrolled environment.

This equipment should be installed and operated with minimum distance of 7.9 in. (20 cm) between the radiator and your body.

Co-location:

This transmitter must not be co-located or operating in conjunction with any other antenna or transmitter.

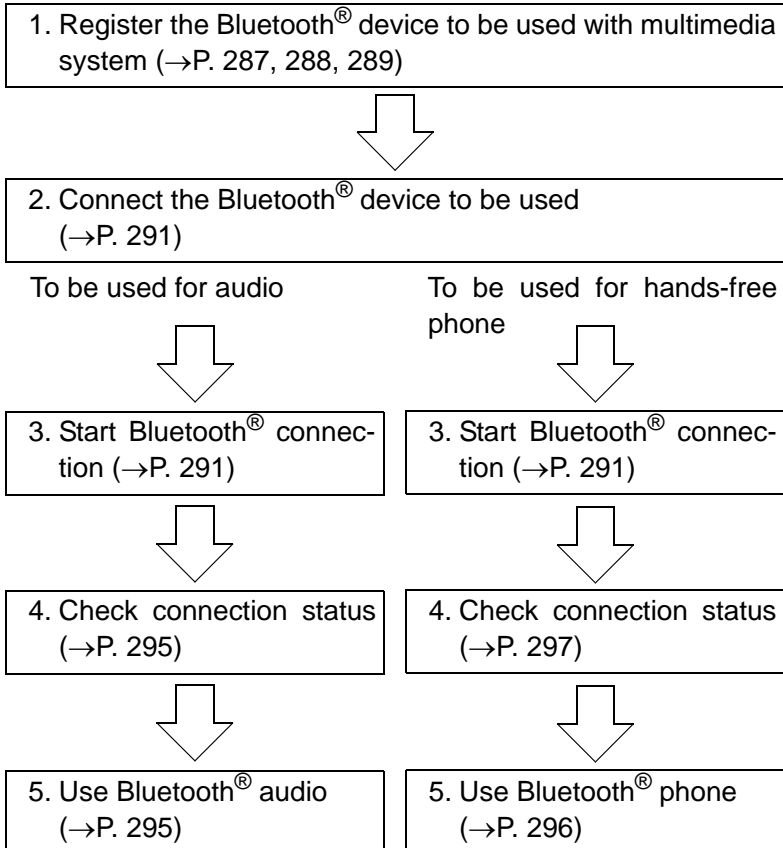
Device registration/connection flow

Registering and connecting from the “Bluetooth Setup” screen

To display the screen shown below, press the “SETUP” button and select “Bluetooth” on the “Setup” screen.

- ① Select to connect the device to be used with multimedia system. (→P. 291)
- ② Select to register a Bluetooth® device to be used with multimedia system. (→P. 289)
- ③ Select to set detailed Bluetooth® system settings. (→P. 294)
- ④ Select to delete registered devices. (→P. 290)

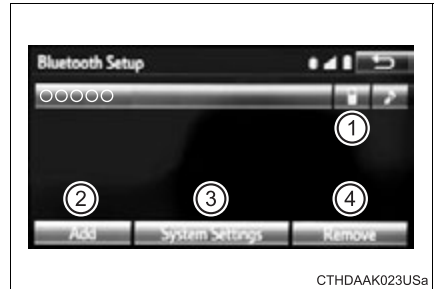

Registering a Bluetooth® audio player for the first time

To use the Bluetooth® Audio, it is necessary to register an audio player with the system.

Once the player has been registered, it is possible to use the Bluetooth® Audio.

This operation cannot be performed while driving.

For details about registering a Bluetooth® device (→P. 289)

- 1 Turn the Bluetooth® connection setting of your audio player on.
This function is not available when the Bluetooth® connection setting of your audio player is set to off.
- 2 Press the “AUDIO” button.
- 3 Select “ Audio” on the “Select Audio Source” screen.
- 4 Select “Select Device”.
- 5 Follow the steps in “How to registering a Bluetooth® device” from “STEP 2”. (→P. 289)

Registering a Bluetooth® phone for the first time

To use the hands-free system, it is necessary to register a Bluetooth® phone with the system.

Once the phone has been registered, it is possible to use the hands-free system.

For details about registering a Bluetooth® device (→P. 289)

- 1 Turn the Bluetooth® connection setting of your cellular phone on.
- 2 Press the  button.
- 3 Select “OK” to register a phone.
- 4 Follow the steps in “How to registering a Bluetooth® device” from “STEP 2” (→P. 289)

Registering a Bluetooth® device

Bluetooth® compatible phones (HFP) and portable audio players (AVP) can be registered simultaneously. You can register up to 5 Bluetooth® devices.

How to register a Bluetooth® device

- 1 Display the “Bluetooth Setup” screen. (→P. 286)
- 2 Select “Add”.
- 3 When this screen is displayed, search for the device name displayed on this screen on the screen of your Bluetooth® device.

For details about operating the Bluetooth® device, see the manual that comes with it.

To cancel the registration, select “Cancel”.

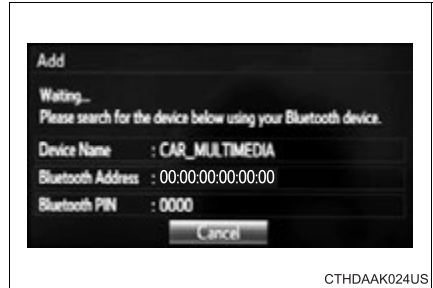

CTHDAAK024US

- 4 Register the Bluetooth® device using your Bluetooth® device.

A PIN-code is not required for SSP (Secure Simple Pairing) compatible Bluetooth® devices. Depending on the type of Bluetooth® device being connected, a message confirming registration may be displayed on the Bluetooth® device’s screen. Respond and operate the Bluetooth® device according to the confirmation message.

- 5 Check that this screen is displayed when registration is complete.



CTHDAAK050US

- 6 Select "OK" when the connection status changes from "Connecting..." to "Connected".

If an error message is displayed, follow the guidance on the screen to try again.

Registration can be performed from screens other than the "Bluetooth Setup" screen.

■ When registering from the "Bluetooth Audio" screen

- 1 Display the "Bluetooth Audio" screen. (→P. 295)
- 2 Select "Select Device".
- 3 Follow the steps in "How to registering a Bluetooth® device" from "STEP 2" (→P. 289)

Deleting a Bluetooth® device

- 1 Display the "Bluetooth Setup" screen. (→P. 286)
- 2 Select "Remove".
- 3 Select the desired device.
- 4 A confirmation message will be displayed, select "Yes" to delete the device.
- 5 Check that a confirmation screen is displayed when the operation is complete.

Connecting a Bluetooth® device

Up to 5 Bluetooth® devices (Phones (HFP) and audio players (AVP)) can be registered.

If more than 1 Bluetooth® device has been registered, select which device to connect to.

- 1 Press the “SETUP” button.
- 2 Select “Bluetooth” on the “Setup” screen.
- 3 Select the device to be connected.

Supported profile icons will be displayed.

① Phone

② Audio player

Supported profile icons for currently connected devices will illuminate.

Dimmed icons can be selected to connect to the function directly.



CTHDAAK025USa

Auto connection

To turn auto connection mode on, set “Bluetooth Power” to on. (→P. 294)

When you register a phone, auto connection will be activated. Always set it to this mode and leave the Bluetooth® phone in a place where a connection can be established.

When the engine switch is turned to the “ACC” or “ON” position, the system will search for a nearby cellular phone you have registered.

Next, the system automatically connects with the most recent of the phones connected to in the past. Then, the connection result is displayed.

Manual connection

When auto connection has failed or “Bluetooth Power” is turned off, you must connect the Bluetooth® device manually.

Follow the steps in “Connecting a Bluetooth® device” from “STEP 1”. (→P. 291)

Connecting a Bluetooth® audio player

▶ Registering an additional device

- 1 Select “Select Device” on the “Bluetooth Audio” screen.
- 2 For more information: →P. 289

▶ Selecting a registered device

- 1 Select “Select Device” on the “Bluetooth Audio” screen.
- 2 For more information: →P. 291

■ Reconnecting a Bluetooth® phone

If the system cannot connect due to poor signal strength with the engine switch in the “ACC” or “ON” position, the system will automatically attempt to reconnect.

If the phone is turned off, the system will not attempt to reconnect. In this case, the connection must be made manually, or the phone must be reselected.

Displaying a Bluetooth® device details

You can confirm and change the registered device details.

Bluetooth® device registration status

- 1 Display the “Bluetooth Setup” screen. (→P. 286)
- 2 Select the device.
- 3 Select “Device Info”.
- 4 Following screen is displayed:

- ① Device name
- ② Change connection method (→P. 293)
- ③ Bluetooth® address
- ④ Display your telephone number

The number may not be displayed depending on the model of phone.

- ⑤ Compatibility profile of the device
- ⑥ Restore default settings

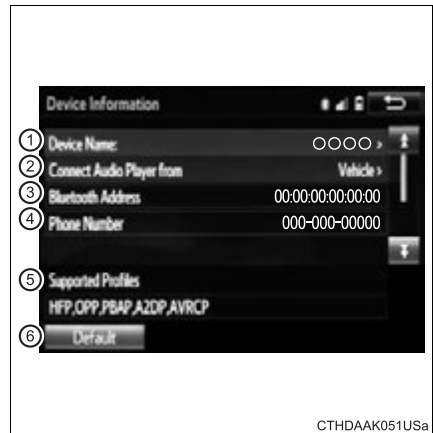

Changing connection method

- 1 Select “Connect Audio Player from”.
- 2 Select “Vehicle” or “Device”.

“Vehicle”: Connect the multimedia system to the portable audio player.

“Device”: Connect the portable audio player to the multimedia system.

Detailed Bluetooth® system settings

You can confirm and change the detailed Bluetooth® settings.

How to check and change detailed Bluetooth® settings

- 1 Display the “Bluetooth Setup” screen. (→P. 286)
- 2 Select “System Settings”.
- 3 The following screen is displayed:

1 Bluetooth® power on/off

You can change Bluetooth® function on/off

2 Bluetooth® name

3 Change PIN-code (→P. 294)

4 Bluetooth® address

5 Display phone status

You can set the system to show the status confirmation display when connecting a telephone

6 Display audio player status

You can set the system to show the status confirmation display when connecting an audio player

7 Compatibility profile of the system

8 Restore default settings



Editing the Bluetooth® PIN

You can change the PIN-code that is used to register your Bluetooth® devices in the system.

- 1 Select “Bluetooth PIN”.
- 2 Input a PIN-code, and select “OK”.

Listening to Bluetooth® audio

The Bluetooth® audio system enables the user to enjoy music played on a portable player from the vehicle speakers via wireless communication.

Select “ Audio” on the “Select Audio Source” screen.

When a Bluetooth® device cannot be connected, check the connection status on the “Bluetooth Audio” screen. If the device is not connected, either register or reconnect the device. (→P. 286, 291)





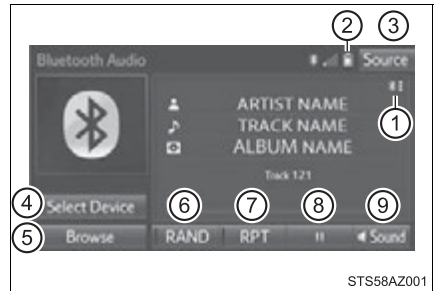

Audio control screen

Some titles and controls may not be displayed depending on the type of portable audio player used.

- ① Connection status
- ② Battery charge
- ③ “Select Audio Source” screen appears
- ④ Selecting a Bluetooth® device
- ⑤ Select to display the play mode selection screen
- ⑥ Random playback
- ⑦ Repeat play
- ⑧ Pause
Select  to resume play
- ⑨ Setting the sound (→P. 266)



STS58AZ001

| Indicators | Conditions |
|-------------------|--|
| Connection status | Good ←————→ Not connected    |
| Battery charge | Full ←————→ Empty    |

Using a Bluetooth® phone



The hands-free system is a function that allows you to use your cellular phone without touching it.

This system supports Bluetooth®. Bluetooth® is a wireless data system that allows the cellular phone to wirelessly connect to the hands-free system and make/receive calls.

Before making a phone call, check the connection status, battery charge, call area and signal strength. (→P. 297)

If a Bluetooth® device cannot be connected, check the connection status on the phone screen. If the device is not connected, either register or reconnect it. (→P. 286, 291)

Phone screen

To display the screen shown below, press the  switch on the steering wheel or press the  button.

Several functions are available to operate on each screen that is displayed by selecting the 4 tabs.

- ① Device name
- ② Bluetooth® connection status



■ Microphone

The vehicle's built in microphone is used when talking on the phone.

The person you are speaking to can be heard from the front speakers.

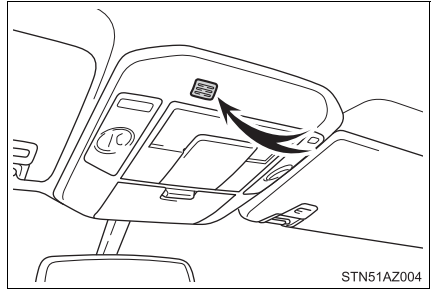

STN51AZ004

To use the hands-free system, you must register your Bluetooth® phone in the system. (→P. 289)







Status display

You can check indicators such as signal strength and battery charge on any screen.

- ① Connection status
- ② Signal strength
- ③ Battery charge





CTHDAAK033USa

| Indicators | Conditions |
|-------------------|---|
| Connection status | Good (Blue)  ↔  Not connected |
| Battery charge | Full  ↔  Empty |
| Call area | "Rm": Roaming area |
| Signal strength | Excellent  ↔  Poor |

Making a call



Once a Bluetooth® phone is registered, you can make a call using the following procedure:

Dialing

- 1 Display the phone screen. (→P. 296)
- 2 Select the “Dial Pad” tab and enter a phone number.
To delete the input phone number, select .
For the first digit, you can enter “+” by selecting “*” for a while.
- 3 Press the  switch on the steering wheel or select .

Dialing from the contacts list

You can dial a number from the contact data imported from your cellular phone. The system has one contact for each registered phone. Up to 2500 contacts may be stored in each contact. (→P. 298)

- 1 Display the phone screen. (→P. 296)
- 2 Select “Contacts” tab.
- 3 Choose the desired contact to call from the list.
- 4 Choose the number and then press the  switch on the steering wheel or select .

When the contact is empty

You can transfer the phone numbers in a Bluetooth® phone to the system.

Operation methods differ between PBAP (Phone Book Access Profile) compatible and PBAP incompatible Bluetooth® phones. If the cellular phone does not support either PBAP or OPP (Object Push Profile) service, you cannot transfer contacts.

■ For PBAP compatible Bluetooth® phones

- ▶ When “Automatic Contact/History Transfer” is set to on (→P. 312)
 - 1 Select the “Contacts” tab.
 - 2 Check that a confirmation screen is displayed when the operation is complete.

Transfer the contact data to the system using a Bluetooth® phone.

► When “Automatic Contact/History Transfer” is set to off

- 1 Select the “Contacts” tab.
- 2 Select the desired item.
 - 1 Select to transfer new contacts from a cellular phone, select “Always” and then enable “Automatic Transfer”.
 - 2 Select to transfer all the contacts from a connected cellular phone only once.
 - 3 Select to cancel transferring.



- 3 Check that a confirmation screen is displayed when the operation is complete.

■ For PBAP incompatible but OPP compatible Bluetooth® phones

- 1 Select the “Contacts” tab.
- 2 Follow the steps in “Update contacts from phone” from “STEP2”. (→P. 313)

Calling using favorites list

You can make a call using numbers registered in the contact.

- 1 Display the phone screen. (→P. 296)
- 2 Select “Favorites” tab.
- 3 Select the desired number to make a call.



Dialing from call history

You can make a call using the call history, which has the 3 functions below.

: calls which you missed

: calls which you received

: calls which you made

- 1 Display the phone top screen. (→P. 296)
- 2 Select “Call History” tab.
- 3 Select  or the desired entry from the list.
 - ▶ When  is selected
- 4 Check that the “Call” screen is displayed.
 - ▶ When the desired contact is selected
- 4 Select the desired number.
- 5 Check that the “Call” screen is displayed.

■ Call history list

- If you make a call to or receive a call from a number registered in the contact, the name is displayed in the call history.
- If you make multiple calls to the same number, only the last call made is displayed in the call history.



■ International calls

You may not be able to make international calls, depending on the mobile phone in use.

Receiving a call



When a call is received, the following screen is displayed together with a sound.

To answer the phone

Press the  switch on the steering wheel or select .



To refuse a call

Press the  switch on the steering wheel or select .

To adjust the incoming call volume

Turn the “PWR·VOL” knob.

■ International calls

Received international calls may not be displayed correctly depending on the cellular phone in use.

Speaking on the phone

The following screen is displayed when speaking on the phone.



To adjust the call volume

Select “-” or “+”. You can also adjust the volume using the volume knob.

To prevent the other party from hearing your voice

Select “Mute”.

Inputting tones

When using phone services such as an answering service or a bank, you can store phone numbers and code numbers in the contact.

- 1 Select “0-9”.
- 2 Input the number.

■ Release Tones

“Release Tones” appear when a continuous tone signal(s) containing a “w” is registered in the contact list.

- 1 Select “Release Tones”.

■ Release Tones

- A continuous tone signal is a character string that consists of numbers and the characters “p” or “w”. (e.g.056133w0123p#1*)
- When the “p” pause tone is used, the tone data up until the next pause tone will be automatically sent after 2 seconds have elapsed. When the “w” pause tone is used, the tone data up until the next pause tone will be automatically sent after a user operation is performed.
- Release tones can be used when automated operation of a phone based service such as an answering machine or bank phone service is desired. A phone number with continuous tone signals can be registered in the contact list.
- Tone data after a “w” pause tone can be operated on voice command during a call.

To transfer a call



Select “Handset Mode” to change from a hands-free call to a cellular phone call.

Select “Handset Mode” to off from a cellular phone call to a hands-free call.

Transmit volume setting

- 1 Select “Transmit Volume”.
- 2 Select the desired level for the transmit volume.
- 3 Select “OK”.



To hang up

Press the  switch on the steering wheel or select .



Call waiting

When a call is interrupted by a third party while talking, an incoming call message will be displayed.



To talk with the other party:

Press the  switch on the steering wheel or select .

To refuse the call:

Press the  switch on the steering wheel or select .



Every time you press the  switch on the steering wheel or select  during call waiting, you will be switched to the other party.

■ Transferring calls

- If you transfer from the cellular phone to hands-free, the hands-free screen will be displayed, and you can operate the system using the screen.
- Transfer method and operation may vary according to the cellular phone used.
- For operation of the cellular phone in use, see the phone's manual.

■ Call waiting operation

Call waiting operation may differ depending on your phone company and cellular phone.



Bluetooth® phone message function

Received messages can be forwarded from the connected Bluetooth® phone, enabling checking and replying using the multimedia system.

Depending on the type of Bluetooth® phone connected, received messages may not be transferred to the message inbox.

If the phone does not support the message function, this function cannot be used.

Displaying “Message Inbox” screen

- 1 Press the  switch on the steering wheel or press the  button.
- 2 Select  on the phone screen.
- 3 Check that the “Message Inbox” screen is displayed.

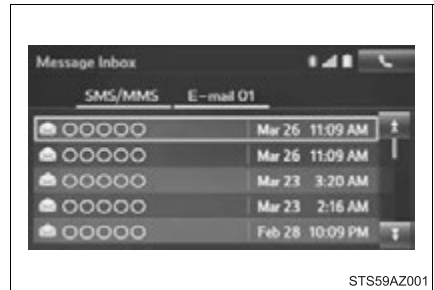

Receiving a message

When an e-mail/SMS/MMS is received, the incoming message screen pops up with sound and is ready to be operated on the screen.

- ① E-mail: Select to check the message.
- ② Select to refuse the message.
- ③ Select to call the message sender.



■ Receiving a message

- Depending on the cellular phone used for receiving messages, or its registration status with the navigation system, some information may not be displayed.
- The pop up screen is separately available for incoming e-mail and SMS/MMS messages under the following conditions:

E-mail:

- “Incoming E-mail Display” is set to “Full Screen”. (→P. 319)
- “E-mail Notification Popup” is set to on. (→P. 319)

SMS/MMS:

- “Incoming SMS/MMS Display” is set to “Full screen”. (→P. 319)
- “SMS/MMS Notification Popup” is set to on. (→P. 319)

Checking the messages

- 1 Display the “Message Inbox” screen. (→P. 305)
- 2 Select the desired message from the list.
- 3 Check that the message is displayed.

- ① E-mails: Select “Mark Unread” or “Mark Read” to mark mail unread or read on the “Message Inbox” screen.

This function is available when “Update Message Read Status on Phone” is set to on (→P. 319)

- ② Select to make a call to the sender.
- ③ Select to have messages read out. To cancel this function, select “Stop”.
- ④ Select to display the previous or next message.
- ⑤ Select to reply the message.

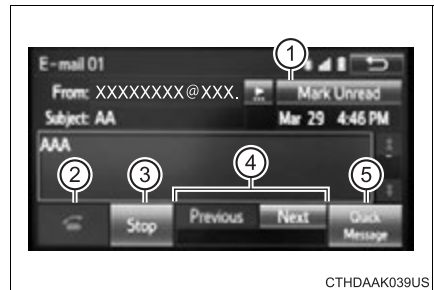

■ Check the messages

- Depending on the type of Bluetooth® phone being connected, it may be necessary to perform additional steps on the phone.
- Messages are displayed in the appropriate connected Bluetooth® phone's registered mail address folder.
Select the tab of the desired folder to be displayed.
- Only received messages on the connected Bluetooth® phone can be displayed.
- The text of the message is not displayed while driving.
- When "Automatic Message Readout" is set to on, messages will be automatically read out. (→P. 319)
- Turn the "PWR·VOL" knob to adjust the message read out volume.
- The message read out function is available even while driving.

Replying to a message

- 1 Display the "Message Inbox" screen. (→P. 305)
- 2 Select the desired message from the list.
- 3 Select "Quick Message".
- 4 Select the desired message.
- 5 Select "Send".

■ Editing quick reply message

This operation cannot be performed while driving.

- 1 Select "Quick Message".
- 2 Select  corresponding to the desired message to edit.
- 3 Select "OK" when editing is completed.

Calling the message sender

Calls can be made to an e-mail/SMS/MMS message sender's phone number.

- 1 Display the "Message Inbox" screen. (→P. 305)
- 2 Select the desired message.
- 3 Select .
- 4 Check that the "Call" screen is displayed.

■ Calling from a number within a message

Calls can be made to a number identified in a message's text area.

- 1 Display the "Message Inbox" screen. (→P. 305)
- 2 Select the desired message.
- 3 Select the text area.
- 4 Select  corresponding to the desired number.
- 5 Check that the "Call" screen is displayed.

■ Calling from the incoming message screen

→P. 304

Using the steering wheel switches*

The steering wheel switches can be used to operate a connected cellular phone.

Operating a telephone using the steering wheel switches

- ① Off hook switch
 - Make a call
 - Receive a call
 - Display “Phone” screen
- ② On hook switch
 - End a call
 - Refuse a call

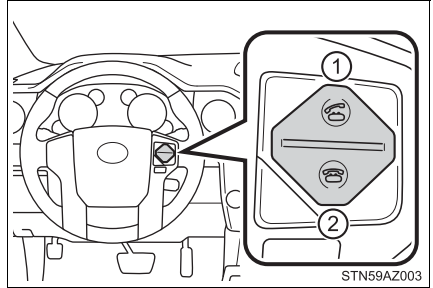

Bluetooth® phone settings

You can adjust the hands-free system to your desired settings.

“Phone/Message Settings” screen

To display the screen shown below, press the “SETUP” button, and select “Phone” on the “Setup” screen.

- ① Set the phone connection
(→P. 291)
- ② Sound Settings (→P. 311)
- ③ Contact/Call History Settings
(→P. 312)
- ④ Messaging Settings (→P. 319)
- ⑤ Phone Display Settings
(→P. 320)

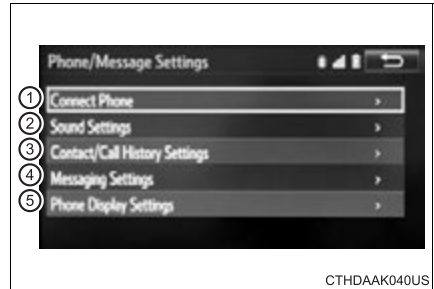

Sound setting

- 1 Display the “Phone/Message Settings” screen. (→P. 310)
- 2 Select “Sound Settings” on the “Phone/Message Settings” screen.
 - ① Set the desired ringtone.
 - ② Adjust the ringtone volume.
 - ③ Adjust the message readout volume.
 - ④ Set the desired incoming SMS/MMS tone.
 - ⑤ Adjust the incoming SMS/MMS tone volume.
 - ⑥ Set the incoming e-mail tone.
 - ⑦ Adjust the incoming e-mail tone volume.
 - ⑧ Adjust the default volume of the other party’s voice.



■ To return to the default settings

Select “Default”, and then “Yes”.

Contact/Call History Settings

The contact can be transferred from a Bluetooth® phone to the system. The contact also can be added, edited and deleted.

The call history can be deleted and contact and favorites can be changed.

- 1 Display the “Phone/Message Settings” screen. (→P. 310)
- 2 Select “Contact/Call History Settings”.
- 3 Select the desired item to be set.

① For PBAP compatible Bluetooth® phones, select to set automatic contact/history transfer on/off. When set to on, the phone’s contact data and history are automatically transferred.

② Select to update contacts from the connected phone. (→P. 313)

③ Select to sort contacts by the first name or last name field.

④ Select to add contacts to the favorites list. (→P. 316)

⑤ Select to delete contacts from the favorites list. (→P. 318)

⑥ Select to display contact images.

⑦ Select to clear contacts from the call history.

⑧ Select to add new contacts to the contact list.* (→P. 314)

⑨ Select to edit contacts in the contact list.* (→P. 315)

⑩ Select to delete contacts from the contact list.* (→P. 316)

⑪ Select to reset all setup items.*

*: For PBAP compatible Bluetooth® phones only, this function is available when “Automatic Contact/History Transfer” is set to off. (→P. 312)



Update contacts from phone

Operation methods differ between PBAP compatible and PBAP incompatible but OPP compatible Bluetooth® phones.

If your cellular phone is neither PBAP nor OPP compatible, the contacts cannot be transferred.

■ For PBAP Compatible Bluetooth® Phones

- 1 Select “Update Contacts from Phone”.
- 2 Check that a confirmation screen is displayed when the operation is complete.

This operation may be unnecessary depending on the type of cellular phone.

Depending on the type of cellular phone, OBEX authentication may be required when transferring contact data. Enter “1234” into the Bluetooth® phone.

If another Bluetooth® device is connected when transferring contact data, depending on the phone, the connected Bluetooth® device may need to be disconnected.

Depending on the type of Bluetooth® phone being connected, it may be necessary to perform additional steps on the phone.

■ For PBAP Incompatible Bluetooth® Phones

- 1 Select “Update Contacts from Phone”.
- 2 Transfer the contact data to the system using a Bluetooth® phone.

This operation may be unnecessary depending on the type of cellular phone.

Depending on the type of cellular phone, OBEX authentication may be required when transferring contact data. Enter “1234” into the Bluetooth® phone.

To cancel this function, select “Cancel”.

- 3 Select “Done” when it appears on the screen.
- 4 Check that a confirmation screen is displayed when the operation is complete.

■ **Updating the contacts in a different way (From the “Call History” screen)**

For PBAP compatible Bluetooth® phones, this function is available when “Automatic Contact/History Transfer” is set to off. (→P. 312)

- 1 Display the phone screen. (→P. 296)
- 2 Select the “Call History” tab and select a contact not yet registered in the contact list.
- 3 Select “Update Contact”.
- 4 Select the desired contact.
- 5 Select a phone type for the phone number.

Registering a new contact to the contact list

New contact data can be registered. Up to 4 numbers per person can be registered. For PBAP compatible Bluetooth® phones, this function is available when “Automatic Contact/History Transfer” is set to off. (→P. 312)

- 1 Select “New Contact”.
- 2 Enter the name and select “OK”.
- 3 Enter the phone number and select “OK”.
- 4 Select the phone type for the phone number.
- 5 To add another number to this contact, select “Yes”.

■ **Registering a new contact in a different way (From the “Call History” screen)**

- 1 Display the phone screen. (→P. 296)
- 2 Select the “Call History” tab and select a contact not yet registered in the contact list.
- 3 Select “Add to Contacts”.
- 4 Follow the steps in “Registering a new contact to the contacts list” from “STEP 3”. (→P. 314)

Editing the contact data

For PBAP compatible Bluetooth® phones, this function is available when “Automatic Contact/History Transfer” is set to off. (→P. 312)

- 1 Select “Edit Contact”.
- 2 Select the desired contact.
- 3 Select  icon corresponding to the desired name or number.
 - ▶ For editing the name
- 4 Follow the steps in “Registering a new contact to the contact list” from “STEP 3”. (→P. 314)
 - ▶ For editing the number
- 4 Follow the steps in “Registering a new contact to the contact list” from “STEP 4”. (→P. 314)

■ Editing the contacts in a different way (From the “Contact Details” screen)

- 1 Display the phone screen. (→P. 296)
- 2 Select the “Contacts”, “Call history” tab or the “Favorites” tab and select the desired contact.
- 3 Select “Edit Contact”.

“E-mail Addresses”: Select to display all registered e-mail addresses for the contact.
- 4 Follow the steps in “Editing the contact data” from “STEP 4”. (→P. 315)

Deleting the contact data

For PBAP compatible Bluetooth® phones, this function is available when “Automatic Contact/History Transfer” is set to off. (→P. 312)

- 1 Select “Delete Contacts”.
- 2 Select the desired contact and select “Delete”.
- 3 Select “Yes” when the confirmation screen appears.

■ Deleting the contact in a different way (From the “Contact Details” screen)

- 1 Display the phone screen. (→P. 296)
- 2 Select the “Contacts”, “Call history” tab or the “Favorites” tab and select the desired contact.
- 3 Select “Edit Contact”.
- 4 Select “Yes” when the confirmation screen appears.

Favorites list setting

Up to 15 contacts (maximum of 4 numbers per contact) can be registered in the favorites list.

■ Registering the contacts in the favorites list

- 1 Select “Add Favorite”.
- 2 Select the desired contact to add to the favorites list.
Dimmed contacts are already stored as a favorite.
- 3 Check that a confirmation screen is displayed when the operation is complete.

- ▶ When 15 contacts have already been registered to the favorites list
 - 1 When 15 contacts have already been registered to the favorites list, a registered contact needs to be replaced.
Select “Yes” when the confirmation screen appears to replace a contact.
 - 2 Select the contact to be replaced.
 - 3 Check that a confirmation screen is displayed when the operation is complete.
- ▶ Registering contacts in the favorites list in a different way (from the “Contacts” screen)
 - 1 Display the phone screen. (→P. 296)
 - 2 Select the “Contacts” tab.
 - 3 Select ☆ at the beginning of the desired contact list name to be registered in the favorites list.
When selected, ☆ is changed to ★ , and the contact is registered in the favorites list.
- ▶ Registering contacts in the favorites list in a different way (from the “Contact Details” screen)
 - 1 Display the phone screen. (→P. 296)
 - 2 Select the “Contacts” tab or the “Call History” tab and select the desired contact.
 - 3 Select “Add Favorite”.
 - 4 Check that a confirmation screen is displayed when the operation is complete.

■ Deleting the contacts in the favorites list

- 1 Select “Remove Favorite”.
 - 2 Select the desired contacts and select “Remove”.
 - 3 Select “Yes” when the confirmation screen appears.
 - 4 Check that a confirmation screen is displayed when the operation is complete.
- ▶ Deleting contacts in the favorites list in a different way (from the “Contacts” screen)
- 1 Display the phone screen. (→P. 296)
 - 2 Select the “Contacts” tab.
 - 3 Select ★ at the beginning of the contact list name to be deleted from the favorites. list.
When selected, ★ is changed to ☆, and the data is deleted from the list.
- ▶ Deleting contacts in the favorites list in a different way (from the “Contact Details” screen)
- 1 Display the phone screen. (→P. 296)
 - 2 Select the “Contacts”, “Call history” tab or the “Favorites” tab and select the desired contact to delete.
 - 3 Select “Remove Favorite”.
 - 4 Select “Yes” when the confirmation screen appears.
 - 5 Check that a confirmation screen is displayed when the operation is complete.

Message Settings

- 1 Display the “Phone/Message Settings” screen. (→P. 310)
- 2 Select “Messaging Settings”.
- 3 Select the desired item to be set.
 - 1 Set automatic message transfer on/off.
 - 2 Set automatic message readout on/off.
 - 3 Set the SMS/MMS notification popup on/off.
 - 4 Set the e-mail notification popup on/off.
 - 5 Set adding the vehicle signature to outgoing messages on/off.



CTHDAAK043US

- 6 Set updating message read status on phone on/off.
- 7 Change the incoming SMS/MMS display.

“Full Screen”: When an SMS/MMS message is received, the incoming SMS/MMS display screen is displayed and can be operated on the screen.

“Drop-Down”: When an SMS/MMS message is received, a message is displayed on the upper side of the screen.

- 8 Change the incoming e-mail display.

“Full Screen”: When an e-mail is received, the incoming e-mail display screen is the displayed and can be operated on the screen.

“Drop-Down”: When an e-mail is received, a message is displayed on the upper side of the screen.

- 9 Set display of messaging account names on the inbox tab on/off.

When set to on, messaging account names used on the cellular phone will be displayed.

■ To return to the default settings

Select “Default”, and then “Yes”.

■ Displaying the “Messaging Settings” screen in a different way

- 1 Display the phone screen. (→P. 296)
- 2 Select .
- 3 Select “Settings”.

Phone Display Settings

- 1 Display the “Phone/Message Settings” screen. (→P. 310)
- 2 Select “Phone Display Settings”.
- 3 Select the desired item to be set.
 - ① Change the incoming call display.

“Full Screen”: When a call is received, the hands-free screen is displayed and can be operated on the screen.

“Drop-Down”: A message is displayed on the upper side of the screen.



- ② Set display of the contact/ history transfer completion message on/off.

What to do if... (Troubleshooting)

If there is a problem with the hands-free system or a Bluetooth® device, first check the table below.

- ▶ When using the hands-free system with a Bluetooth® device

The hands-free system or Bluetooth® device does not work.

The connected device may not be a compatible Bluetooth® cellular phone.
→ **For a list of specific devices which operation has been confirmed on this system, check with your Toyota dealer or the following web-site: <http://www.toyota.com/bluetooth>**

The Bluetooth version of the connected cellular phone may be older than the specified version.

→ **Use a cellular phone with Bluetooth version 2.0 or higher (recommended: Ver. 3.0 with EDR or higher). (→P. 329)**

► When registering/connecting a cellular phone

A cellular phone cannot be registered.

An incorrect passcode was entered on the cellular phone.

→ **Enter the correct passcode on the cellular phone.**

The registration operation has not been completed on the cellular phone side.

→ **Complete the registration operation on the cellular phone (approve registration on the phone).**

Old registration information remains on either this system or the cellular phone.

→ **Delete the existing registration information from both this system and the cellular phone, then register the cellular phone you wish to connect to this system. (→P. 290)**

A Bluetooth® connection cannot be made.

Another Bluetooth® device is already connected.

→ **Manually connect the cellular phone you wish to use to this system. (→P. 292)**

Bluetooth® function is not enabled on the cellular phone.

→ **Enable the Bluetooth® function on the cellular phone.**

“Please check your device settings.” message is displayed.

Bluetooth® function is not enabled on the cellular phone.

→ **Enable the Bluetooth® function on the cellular phone.**

Old registration information remains on either this system or the cellular phone.

→ **Delete the existing registration information from both this system and the cellular phone, then register the cellular phone you wish to connect to this system. (→P. 290)**

► When making/receiving a call

A call cannot be made/received.

Your vehicle is in a out of cellular service area.

→ **Move to where “Out of cellular service area. Please try again later.” no longer appears on the display.**

► When using the contacts

Contact data cannot be transferred manually/automatically.

The profile version of the connected cellular phone may not be compatible with transferring contact data.

→ **For a list of specific devices which operation has been confirmed on this system, check with your Toyota dealer or the following web-site: <http://www.toyota.com/bluetooth>**

Automatic contact transfer function on this system is set to off.

→ **Set automatic contact transfer function on this system to on.**
(→P. 312)

Passcode has not been entered on the cellular phone.

→ **Enter the passcode on the cellular phone if requested (default passcode: 1234).**

Transfer operation on the cellular phone has not completed.

→ **Complete transfer operation on the cellular phone (approve transfer operation on the phone).**

Contact data cannot be edited.

Automatic contact transfer function on this system is set to on.

→ **Set automatic contact transfer function on this system to off.**
(→P. 312)

► When using the Bluetooth® message function

Messages cannot be viewed.

Message transfer is not enabled on the cellular phone.

→ **Enable message transfer on the cellular phone (approve message transfer on the phone).**

Automatic transfer function on this system is set to off.

→ **Set automatic transfer function on this system to on. (→P. 319)**

New message notifications are not displayed.

Notification of SMS/MMS/E-mail reception on this system is set to off.

→ **Set notification of SMS/MMS/E-mail reception on this system to on.**
(→P. 319)

Automatic message transfer function is not enabled on the cellular phone.

→ **Enable automatic transfer function on the cellular phone.**

► In other situations

Even though all conceivable measures have been taken, the symptom status does not change.

The cellular phone is not close enough to this system.

→ **Bring the cellular phone closer to this system.**

The cellular phone is the most likely cause of the symptom.

→ **Turn the cellular phone off, remove and reinstall the battery pack, and then restart the cellular phone.**

→ **Enable the cellular phone's Bluetooth® connection.**

→ **Stop the cellular phone's security software and close all applications.**

→ **Before using an application installed on the cellular phone, carefully check its source and how its operation might affect this system.**

Voice command system

The voice command system enables the hands-free system to be operated using voice commands.

Operations of the voice command system can be performed by selecting the menu corresponding to each function on the screen. Even if any menu is selected, commands displayed on all menus can be operated.

Using the voice command system

- 1 Press the talk switch.

To cancel the voice command system, press and hold the talk switch.

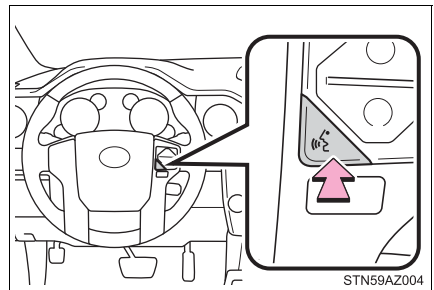

- 2 After a beep sounds, say the desired command.

On the list screen, you can select the desired command.

■ Microphone

→P. 297

■ When using the microphone

- It is unnecessary to speak directly into the microphone when giving a command.
- It is not necessary to wait for the confirmation beep before speaking a command.
- Voice commands may not be recognized if:
 - Spoken too quickly.
 - Spoken at a low or high volume.
 - The roof or windows are open.
 - Passengers are talking while voice commands are spoken.
 - The air conditioning speed is set high.
 - The air conditioning vents are turned towards the microphone.
- In the following conditions, the system may not recognize the command properly and using voice commands may not be possible:
 - The command is incorrect or unclear. Note that certain words, accents or speech patterns may be difficult for the system to recognize.
 - There is excessive background noise, such as wind noise.

Casual speech recognition

Due to natural language speech recognition technology, this system enables recognition of a command when spoken naturally. However, the system cannot recognize every variation of each command.

In some situations, it is possible to omit the command for the procedure and directly state the desired operation.

Not all voice commands are displayed in the short cut menu.

This function is available in English, Spanish and French.

■ Expression examples for each function

| Command | Expression examples |
|-------------------------|---|
| “Call <name> <type>” | Get me <Robert Brown>. I need to call <Robert Brown> at <Work> right away. |
| “Dial <number>” | Please dial the number <3334445555>. Ring <3334445555>. |

Bluetooth®

■ When using the Bluetooth® audio system

- In the following conditions, the system may not function.
 - If the portable audio player is turned off
 - If the portable audio player is not connected
 - If the portable audio player's battery is low
- There may be a delay if a cellular phone connection is made during Bluetooth® audio play.
- Depending on the type of portable audio player that is connected to the system, operation may differ slightly and certain functions may not be available.

■ When using the hands-free system

- The multimedia system is muted when making a call.
- If both parties speak at the same time, it may be difficult to hear.
- If the received call volume is overly loud, an echo may be heard.
If the Bluetooth® phone is too close to the system, quality of the sound may deteriorate and connection status may deteriorate.
- In the following circumstances, it may be difficult to hear the other party:
 - When driving on unpaved roads
 - When driving at high speeds
 - If a window is open
 - If the air conditioning is blowing directly on the microphone
 - If there is interference from the network of the cellular phone

■ Conditions under which the system will not operate

- If using a cellular phone that does not support Bluetooth®
- If the cellular phone is turned off
- If you are outside of cellular phone service coverage
- If the cellular phone is not connected
- If the cellular phone's battery is low
- When outgoing calls are controlled, due to heavy traffic on telephone lines, etc.
- When the cellular phone itself cannot be used
- When transferring contact data from the cellular phone

■ Bluetooth® antenna

The antenna is built into the display.

If the portable audio player is behind the seat or in the glove box or console box, or is touching or covered by metal objects, the connection status may deteriorate.

If the cellular phone is behind the seat or in the console box, or touching or covered by metal objects, the connection status may deteriorate.

■ Battery charge/signal status

- This display may not correspond exactly with the portable audio player or cellular phone itself.
- This system does not have a charging function.
- The portable audio player or cellular phone battery will be depleted quickly when the device is connected to Bluetooth®.

■ When using the Bluetooth® audio and hands-free system at the same time

The following problems may occur.

- The Bluetooth® audio connection may be interrupted.
- Noise may be heard during Bluetooth® audio playback.

■ About the contact in this system

The following data is stored for every registered cellular phone. When another phone is connecting, you cannot read the registered data.

- Contact data
- Call history
- Favorite
- Message

When removing a Bluetooth® phone from the system, the above-mentioned data is also deleted.

■ Compatible models

The Bluetooth® audio system supports portable audio players with the following specifications

● Bluetooth® specifications:

Ver. 2.0, or higher (Recommended: Ver. 3.0+EDR or higher)

● Profiles:

- A2DP (Advanced Audio Distribution Profile) Ver. 1.0, or higher (Recommended: Ver. 1.2 or higher)

This is a profile to transmit stereo audio or high quality sound to the multimedia system.

- AVRCP (Audio/Video Remote Control Profile) Ver. 1.0 or higher (Recommended: Ver. 1.4 or higher)

This is a profile to allow remote control the A/V equipment.

However, please note that some functions may be limited depending on the type of portable audio player connected.

The hands-free system supports cellular phones with the following specifications.

● Bluetooth® specification:

Ver. 2.0 or higher (Recommended: Ver. 3.0+EDR or higher)

● Profiles:

- HFP (Hands Free Profile) Ver. 1.0 or higher (Recommended: Ver. 1.6 or higher)

This is a profile to allow hands-free phone calls using a cellular phone or head set. It has outgoing and incoming call functions.

- OPP (Object Push Profile) Ver. 1.1 or higher (Recommended: Ver. 1.2)

This is a profile to transfer contact data. When a Bluetooth® compatible cellular phone has both PBAP and OPP, OPP cannot be used.

- PBAP (Phone Book Access Profile) Ver. 1.0 or higher (Recommended: Ver. 1.1)

This is a profile to transfer contact data.

If the cellular phone does not support HFP, you cannot register it with the hands-free system. OPP, PBAP services must be selected individually.

■ Reconnecting the portable audio player

If the portable audio player is disconnected due to poor reception when the engine switch is in the “ACC” or “ON” position, the system automatically reconnects the portable audio player.

If you have switched off the portable audio player yourself, follow the instructions below to reconnect:

- Select the portable audio player again
- Enter the portable audio player

■ When you sell your car

Be sure to delete your personal data. (→P. 258)

**CAUTION****■ While driving**

Do not use the portable audio player, cellular phone or connect a device to the Bluetooth® system.

■ Caution regarding interference with electronic devices

- Your audio unit is fitted with Bluetooth® antennas. People with implantable cardiac pacemakers, cardiac resynchronization therapy-pacemakers or implantable cardioverter defibrillators should maintain a reasonable distance between themselves and the Bluetooth® antennas. The radio waves may affect the operation of such devices.
- Before using Bluetooth® devices, users of any electrical medical device other than implantable cardiac pacemakers, cardiac resynchronization therapy-pacemakers or implantable cardioverter defibrillators should consult the manufacturer of the device for information about its operation under the influence of radio waves. Radio waves could have unexpected effects on the operation of such medical devices.

**NOTICE****■ When leaving the vehicle**

Do not leave your portable audio player or cellular phone in the vehicle. The inside of the vehicle may become hot, causing damage to the portable audio player or cellular phone.

Antenna

Removing the antenna

- 1 Place the included wrench around the antenna.

When not in use, the wrench is stored in glove box.

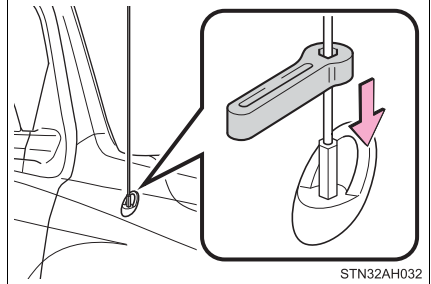

- 2 Loosen the antenna with the wrench and remove it.

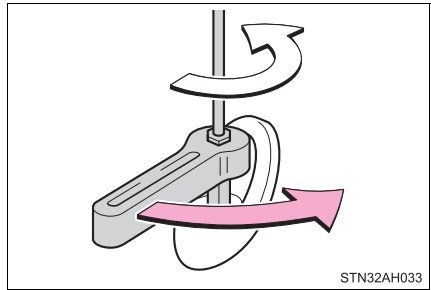

Installing the antenna

- 1 Tighten the antenna by one hand until it will not turn any more.

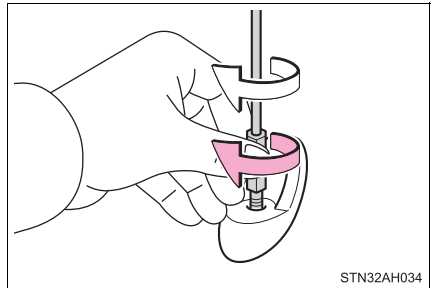

- 2 Using the wrench, tighten the antenna an additional 1/8th turn (20 to 45 degrees) to secure it in place.

After tightening the antenna, remove the wrench.

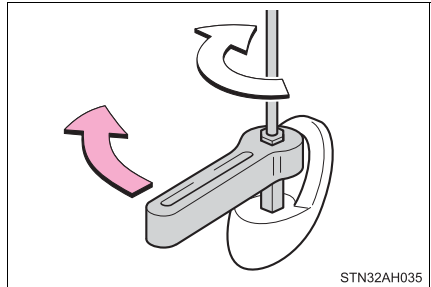

■ About the wrench

After using the included wrench, store it in the glove box for safekeeping.



NOTICE

■ To avoid damaging the antenna

Remove the antenna in the following situations.

- When using an automatic carwash.
- When the antenna will touch the ceiling of a garage, etc.
- When covering the vehicle with a car cover.

■ Removing the antenna

- For normal driving, make sure the antenna is installed.
- When removing the antenna to use an automatic carwash, etc., be careful not to lose the antenna. Also, make sure to reinstall the antenna before driving the vehicle.

■ Using the wrench

- When installing or removing the antenna, use the included wrench.
- Be careful not to scratch or damage the vehicle body with the wrench.
- Do not over-tighten the antenna.
Over-tightening may damage the antenna.
- Do not use any tools other than the included wrench to install or remove the antenna.
Otherwise damage may result on the antenna's finish.

Interior features

6

6-1. Using the air conditioning system

| | |
|--|-----|
| Manual air conditioning system..... | 336 |
| Automatic air conditioning system..... | 343 |
| Seat heaters/ seat ventilators..... | 350 |

6-2. Using the interior lights

| | |
|---|-----|
| Interior lights list | 353 |
| • Personal/interior lights main switch | 354 |
| • Personal/interior lights | 354 |
| • Cargo lamp main switch..... | 355 |

6-3. Using the storage features

| | |
|--|-----|
| List of storage features | 356 |
| • Glove box..... | 358 |
| • Console box (front separated type seat) | 359 |
| • Card holder | 360 |
| • Map holder (front bench type seat) | 362 |
| • Pen holder | 363 |
| • Tissue pocket..... | 364 |
| • Overhead console..... | 365 |
| • Cup holders | 366 |
| • Bottle holders..... | 368 |
| • Auxiliary boxes (front bench type seat) | 369 |
| • Storage box | 371 |
| Luggage compartment features..... | 373 |

6-4. Other interior features

| | |
|---------------------------------------|-----|
| Other interior features | 374 |
| • Sun visors | 374 |
| • Vanity mirrors..... | 374 |
| • Clock..... | 375 |
| • Outside temperature display..... | 376 |
| • Power outlets | 377 |
| • Armrest | 379 |
| • Assist grips | 380 |
| Garage door opener..... | 381 |
| Compass..... | 387 |

Manual air conditioning system*

Air conditioning controls

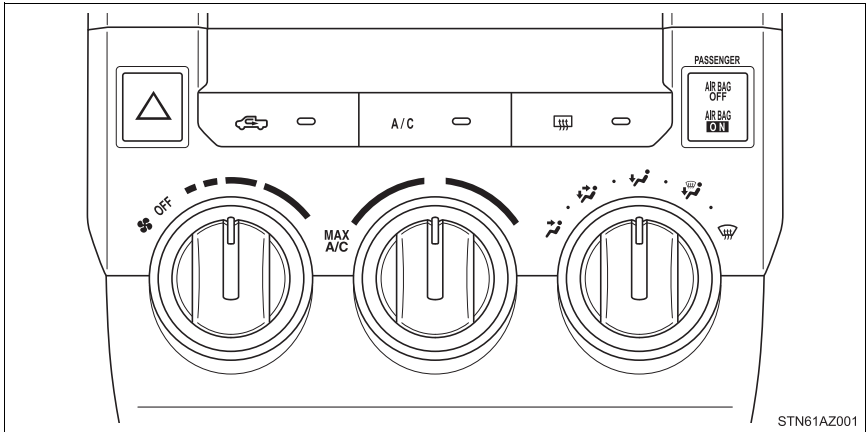

STN61AZ001

■ Adjusting the temperature setting

To adjust the temperature setting, turn the temperature control dial clockwise (warm) or counterclockwise (cool).

If  is not pressed, the system will blow ambient temperature air or heated air. For quick cooling, turn the temperature control dial to the "MAX A/C" position.

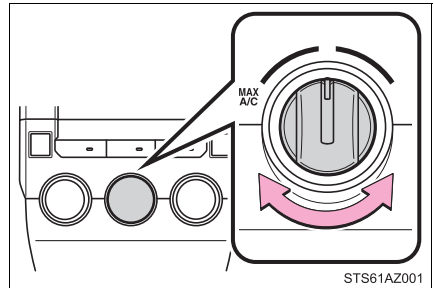

STS61AZ001

The air conditioning will automatically turn on and the air intake selector will be set to recirculated air mode.

*: If equipped

■ Fan speed setting

To adjust the fan speed, turn the fan speed control dial clockwise (increase) or counterclockwise (decrease).

Turning the dial to “OFF” turns off the fan.

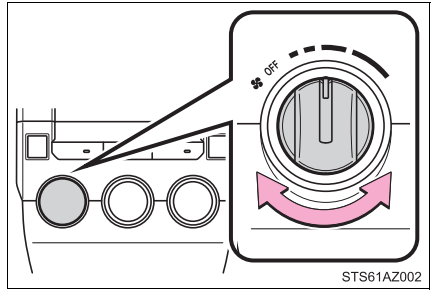

■ Change the airflow mode

To select the airflow, set the air outlet selector dial to the desired position.

The positions between the air outlet selections shown below can also be selected for more delicate adjustment.

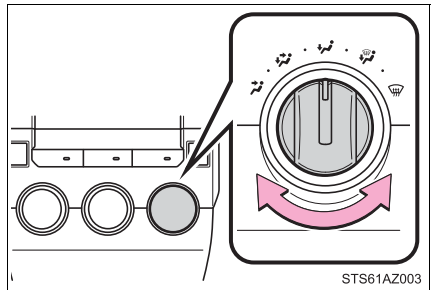

■ Other functions

- Switching between outside air and recirculated air modes (→P. 338)
- Defogging the windshield (→P. 338)
- Defogging the back window (CrewMax models) (→P. 338)
- Defogging the outside rear view mirrors (if equipped) (→P. 338)
- Windshield wiper de-icer (if equipped) (→P. 339)

Other functions

■ Switching between outside air and recirculated air modes

Press .

The mode switches between outside air mode (introduces air from outside the vehicle) (indicator off) and recirculated air mode (recycles air inside the vehicle) (indicator on) each time the button is pressed.

■ Defogging the windshield

Defoggers are used to defog the windshield and front side windows.

Set the air outlet selector dial to  position.

Set the outside/recirculated air mode button to outside air mode if the recirculated air mode is used. (It may switch automatically.)

To defog the windshield and the side windows early, turn the air flow and temperature up.

■ Defogging the back window (CrewMax models)

Defogger is used to defog the back window.

Press .

The defogger will automatically turn off after approximately 15 minutes.

■ Defogging the outside rear view mirrors (if equipped)

Defogger is used to defog to remove raindrops, dew and frost from the outside rear view mirrors.

Press  or .

The defogger will automatically turn off after approximately 15 minutes.

CrewMax models: Turning the back window defogger on will turn the outside rear view mirror defoggers on.

■ Windshield wiper de-icer (if equipped)

This feature is used to prevent ice from building up on the windshield and wiper blades.

Press  or .

The defogger will automatically turn off after approximately 15 minutes.

Regular Cab and Double Cab models: Turning the outside rear view mirror defoggers on will turn the windshield wiper de-icer on.

CrewMax models: Turning the back window defogger on will turn the windshield wiper de-icer on.

Air outlets

■ Location of air outlets

Air outlets and air volume changes according to the selected airflow mode.

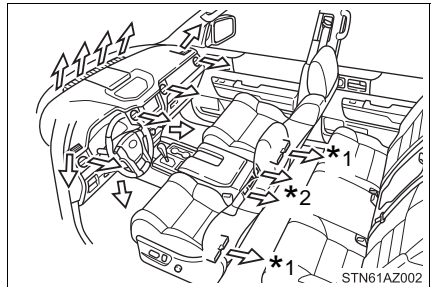

*1: Double Cab and CrewMax models

*2: CrewMax models

■ Adjusting the position and opening and closing the air outlets

► Front

Direct air flow to the left or right, up or down.

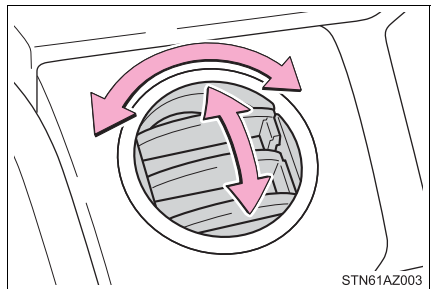

- ① Open the vent
- ② Close the vent

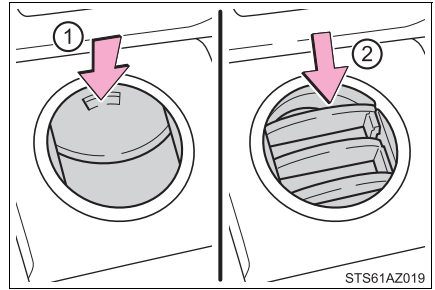

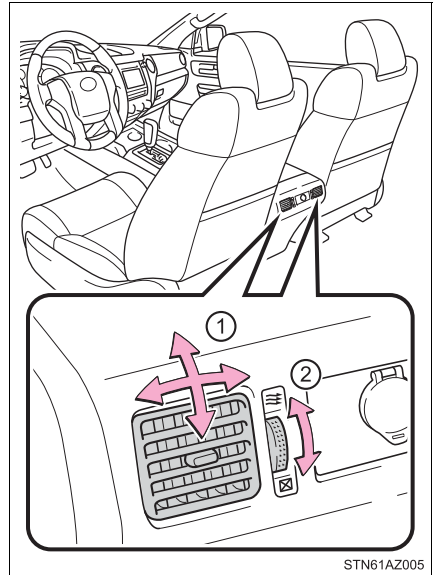

► Rear (CrewMax models)

- ① Direct air flow to the left or right, up or down.
- ② Turn the knob to open or close the vent.



■ Fogging up of the windows

- The windows will easily fog up when the humidity in the vehicle is high.
Turning  on will dehumidify the air from the outlets and defog the windshield effectively.
- If you turn  off, the windows may fog up more easily.
- The windows may fog up if the recirculated air mode is used.

■ Outside/recirculated air mode

When driving on dusty roads such as tunnels or in heavy traffic, set the outside/recirculated air mode button to the recirculated air mode. This is effective in preventing outside air from entering the vehicle interior. During cooling operation, setting the recirculated air mode will also cool the vehicle interior effectively.

■ When the outside temperature exceeds 75°F (24°C) and air conditioning system is on

- In order to reduce the air conditioning power consumption, the air conditioning system may switch to recirculated air mode automatically. This may also reduce fuel consumption.
- Recirculated air mode is selected as a default mode when the engine switch is in the “ON” position.
- It is possible to switch to outside air mode at any time by pressing .

■ When the outside temperature falls to nearly 32°F (0°C)

The dehumidification function may not operate even when  is pressed.

■ Air conditioning odors

- During use, various odors from inside and outside the vehicle may enter into and accumulate in the air conditioning system. This may then cause odor to be emitted from the vents.
- To reduce potential odors from occurring:
It is recommended that the air conditioning system be set to outside air mode prior to turning the vehicle off.

■ Air conditioning filter

→P. 431

⚠ CAUTION**■ To prevent the windshield from fogging up**

- Do not use  during cool air operation in extremely humid weather. The difference between the temperature of the outside air and that of the windshield can cause the outer surface of the windshield to fog up, blocking your vision.
- Do not place anything on the instrument panel which may cover the air outlets. Otherwise, air flow may be obstructed, preventing the windshield defoggers to defog.

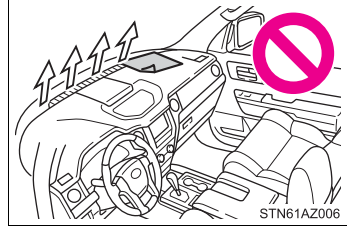
**■ To prevent burns (vehicles with rear view mirror defoggers and windshield wiper de-icer)**

- Do not touch the rear view mirror surfaces when the outside rear view mirror defoggers are on.
- Do not touch the glass at lower part of the windshield or to the side of the front pillars, when the windshield wiper de-icer is on.

⚠ NOTICE**■ To prevent battery discharge**

Do not leave the air conditioning system on longer than necessary when the engine is stopped.

Automatic air conditioning system*

Air outlets and fan speed are automatically adjusted according to the temperature setting.

Air conditioning controls

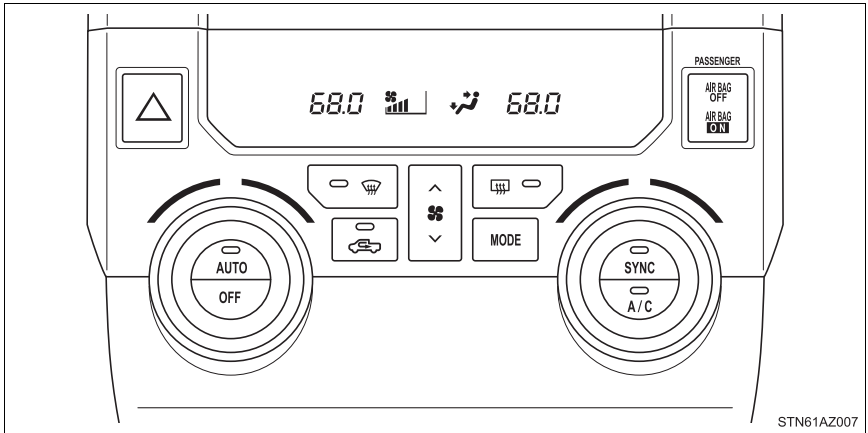

STN61AZ007

■ Adjusting the temperature setting

To adjust the temperature setting, turn the temperature control dial clockwise (warm) or counterclockwise (cool).

The air conditioning system switches between individual and simultaneous mode each time the  is pressed. (→P. 344)

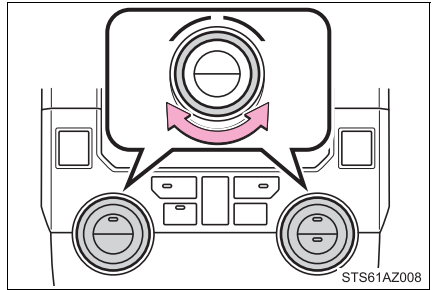

STS61AZ008

■ Fan speed setting

To adjust the fan speed, press “^” on  to increase the fan speed and “v” to decrease the fan speed.

Press  to turn the fan off.

■ Change the airflow mode

To change the airflow, press .

Air outlets are adjusted each time the button is pressed.

■ Other functions

- Switching between outside air and recirculated air modes (→P. 345)
- Defogging the windshield (→P. 345)
- Defogging the back window (CrewMax models) (→P. 345)
- Defogging the outside rear view mirrors (if equipped) (→P. 345)
- Windshield wiper de-icer (if equipped) (→P. 346)

Using by automatic mode

1 Press .

2 Adjust the temperature setting.

3 To stop the operation, press .

■ If the system is operated manually in automatic mode

If the fan speed setting or air flow modes are operated, the automatic mode indicator goes off. However, automatic mode for functions other than that operated are maintained.

■ Adjusting the temperature for driver and passenger seats separately (“SYNC” mode)

The air conditioning system switches between individual and simultaneous mode each time  is pressed.

Simultaneous mode (the indicator on  is on):

The driver's side temperature control dial can be used to adjust the temperature for driver's and front passenger's side. At this time, operate the front passenger's side temperature control dial to enter individual mode.

Individual mode (the indicator on  is off):

The temperature for the driver's and front passenger's side can be adjusted separately.

Other functions

■ Switching between outside air and recirculated air modes

Press .

The mode switches between outside air mode (introduces air from outside the vehicle) (indicator off) and recirculated air mode (recycles air inside the vehicle) (indicator on) each time the button is pressed.

■ Defogging the windshield

Defoggers are used to defog the windshield and front side windows.

Press .

Set the outside/recirculated air mode button to outside air mode if the recirculated air mode is used. (It may switch automatically.) To defog the windshield and the side windows early, turn the air flow and temperature up. To return to the previous mode, press again when the windshield is defogged.

■ Defogging the back window (CrewMax models)

Defogger is used to defog the back window.

Press .

The defogger will automatically turn off after approximately 15 minutes.

■ Defogging the outside rear view mirrors (if equipped)

Defogger is used to defog to remove raindrops, dew and frost from the outside rear view mirrors.

Press  or .

The defogger will automatically turn off after approximately 15 minutes.
CrewMax models: Turning the back window defogger on will turn the outside rear view mirror defoggers on.

■ Windshield wiper de-icer (if equipped)

This feature is used to prevent ice from building up on the windshield and wiper blades.

Press  or .

The defogger will automatically turn off after approximately 15 minutes.

Regular Cab and Double Cab models: Turning the outside rear view mirror defoggers on will turn the windshield wiper de-icer on.

CrewMax models: Turning the back window defogger on will turn the windshield wiper de-icer on.

Air outlets

■ Location of air outlets

Air outlets and air volume changes according to the selected airflow mode.

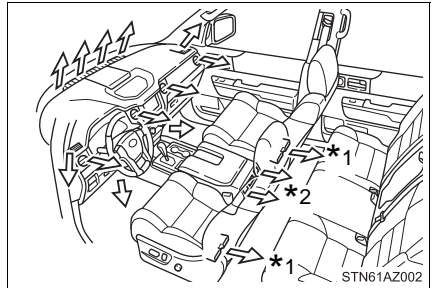

*1: Double Cab and CrewMax models

*2: CrewMax models

■ Adjusting the position of and opening and closing the air outlets

► Front

Direct air flow to the left or right, up or down.

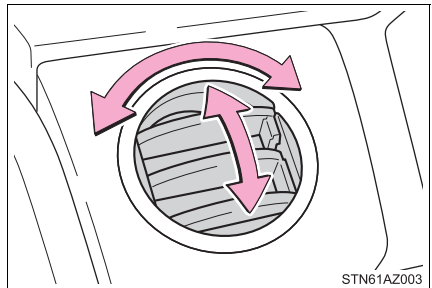

- ① Open the vent
- ② Close the vent

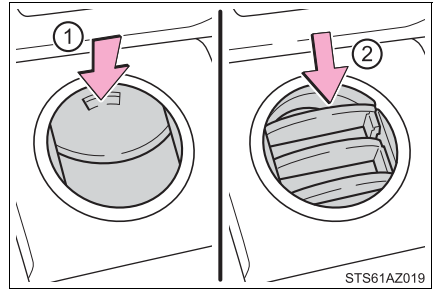

► Rear (CrewMax models)

- ① Direct air flow to the left or right, up or down.
- ② Turn the knob to open or close the vent.

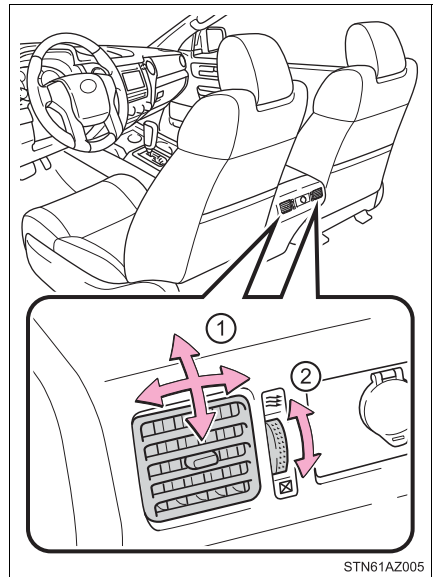

■ Using automatic mode

Fan speed is adjusted automatically according to the temperature setting and the ambient conditions.

Therefore, the fan may stop for a while until warm or cool air is ready to flow immediately after  is pressed.

■ Fogging up of the windows

- The windows will easily fog up when the humidity in the vehicle is high.

Turning  on will dehumidify the air from the outlets and defog the windshield effectively.

- If you turn  off, the windows may fog up more easily.
- The windows may fog up if the recirculated air mode is used.

■ Outside/recirculated air mode

- When driving on dusty roads such as tunnels or in heavy traffic, set the outside/recirculated air mode button to the recirculated air mode. This is effective in preventing outside air from entering the vehicle interior. During cooling operation, setting the recirculated air mode will also cool the vehicle interior effectively.

- Outside/recirculated air mode may automatically switch depending on the temperature setting or the inside temperature.

■ When the outside temperature exceeds 75°F (24°C) and the air conditioning system is on

- In order to reduce the air conditioning power consumption, the air conditioning system may switch to recirculated air mode automatically. This may also reduce fuel consumption.
- Recirculated air mode is selected as a default mode when the engine switch is in the "ON" position.

- It is possible to switch to outside air mode at any time by pressing  .

■ When the outside temperature falls to nearly 32°F (0°C)

The dehumidification function may not operate even when  is selected.

■ Air conditioning odors

- During use, various odors from inside and outside the vehicle may enter into and accumulate in the air conditioning system. This may then cause odor to be emitted from the vents.

- To reduce potential odors from occurring:

- It is recommended that the air conditioning system be set to outside air mode prior to turning the vehicle off.
- The start timing of the blower may be delayed for a short period of time immediately after the air conditioning system is started in automatic mode.

■ Air conditioning filter

→P. 431

⚠ CAUTION**■ To prevent the windshield from fogging up**

- Do not use  during cool air operation in extremely humid weather. The difference between the temperature of the outside air and that of the windshield can cause the outer surface of the windshield to fog up, blocking your vision.
- Do not place anything on the instrument panel which may cover the air outlets. Otherwise, air flow may be obstructed, preventing the windshield defoggers to defog.

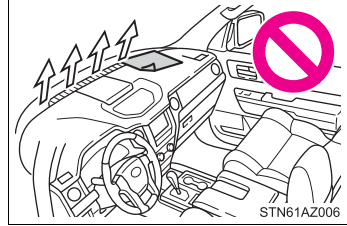
**■ To prevent burns (vehicles with rear view mirror defoggers and windshield wiper de-icer)**

- Do not touch the rear view mirror surfaces when the outside rear view mirror defoggers are on.
- Do not touch the glass at lower part of the windshield or to the side of the front pillars, when the windshield wiper de-icer is on.

⚠ NOTICE**■ To prevent battery discharge**

Do not leave the air conditioning system on longer than necessary when the engine is stopped.

Seat heaters*/seat ventilators*

The seat heaters and ventilators heat the seats and maintain good airflow by blowing air from the seats.

Seat heaters

Turns the seat heater on

- ① Hi
- ② Mid
- ③ Lo
- ④ Off

The level indicator lights come on. Press the “^” on the button to up and “v” to down, and off.

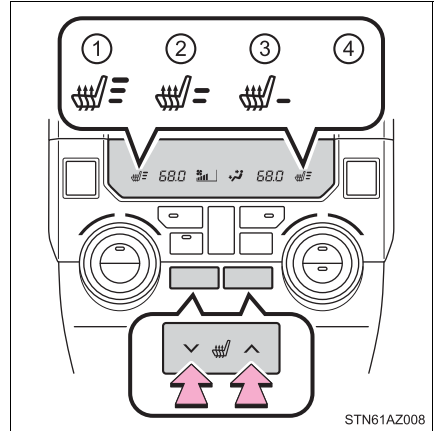

Seat ventilators

■ Seat heater

Turns the seat heater on

- ① Hi
- ② Mid
- ③ Lo
- ④ Off

The level indicator lights come on. Pressing the button changes modes in the following:
Hi→Mid→Lo→Off

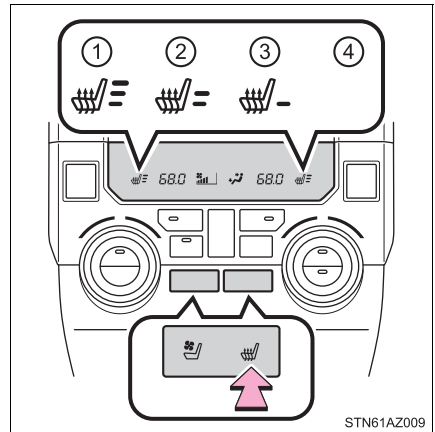

*: If equipped

■ Seat ventilators

Blows air from the seat

- ① Hi
- ② Mid
- ③ Lo
- ④ Off

The level indicator lights come on.
Pressing the button changes
modes in the following:
Hi→Mid→Lo→Off

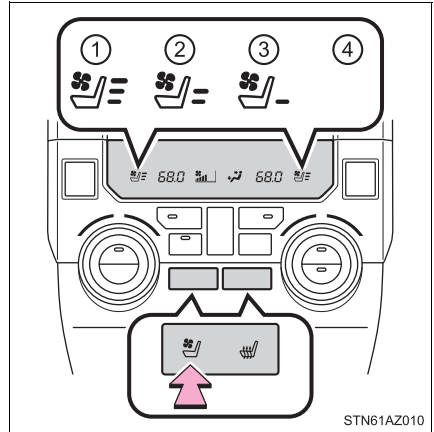

STN61AZ010

■ The seat heaters/seat ventilators can be used when

The engine switch is in the “ON” position.

■ Passenger seat ventilator timer (vehicles with seat ventilators)

- The ventilator operates on for 5 minutes after the button is pressed.
- When the passenger is not detected, the automatically turns off the ventilator after 5 minutes.

■ When not in use

Turn the seat heaters or seat ventilators off by pressing the button. The indicator light turns off.

⚠ CAUTION

■ Burns

- Use caution when seating the following persons in a seat with the seat heater on to avoid the possibility of burns:
 - Babies, small children, the elderly, the sick and the physically challenged
 - Persons with sensitive skin
 - Persons who are fatigued
 - Persons who have taken alcohol or drugs that induce sleep (sleeping drugs, cold remedies, etc.)
- Do not cover the seat with anything when using the seat heater. Using the seat heater with a blanket or cushion increases the temperature of the seat and may lead to overheating.
- Do not use seat heater more than necessary. Doing so may cause minor burns or overheating.

**NOTICE****■ To prevent damage to the seat heaters/seat ventilators**

Do not put heavy objects that have an uneven surface on the seat and do not stick sharp objects (needles, nails, etc.) into the seat.

■ To prevent battery discharge

Turn the seat heaters/seat ventilators off when the engine is not running.

Interior lights list

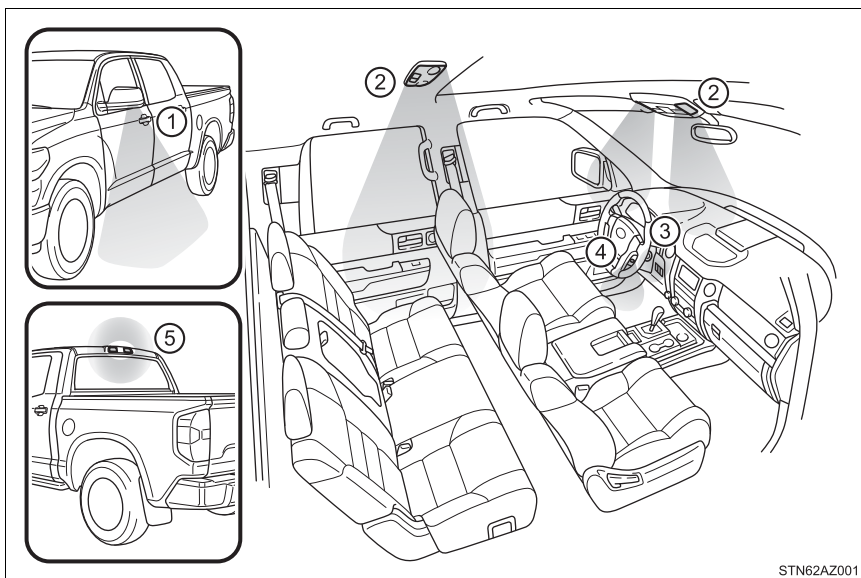

- ① Outer foot lights (if equipped)
- ② Personal/interior lights
(→P. 354)
- ③ Engine switch light (if equipped)
- ④ Foot well lighting (if equipped)
- ⑤ Cargo lamp (→P. 355)

Personal/interior lights main switch

① “OFF”

The personal/interior lights can be individually turned on or off.

② “DOOR”

The personal/interior lights come on when a door is opened. They turn off when the doors are closed.

③ “ON”

The personal/interior lights cannot be individually turned off.

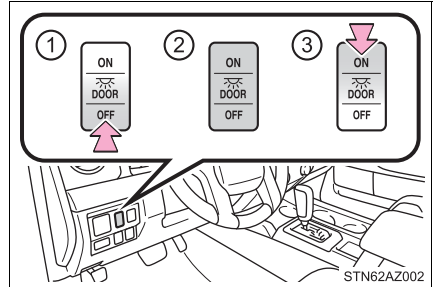

Personal/interior lights

■ Front

On/off

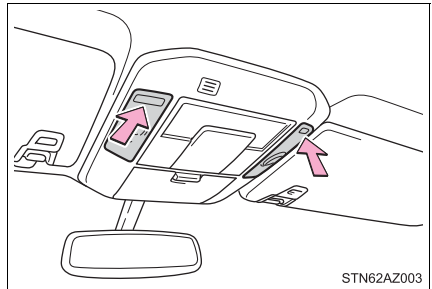

■ Rear

▶ Type A

On/off

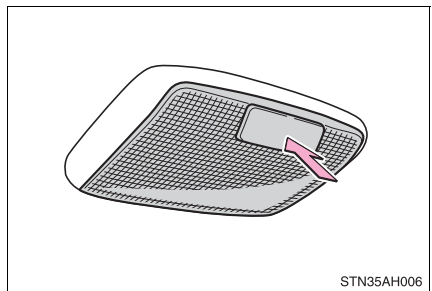

▶ Type B

On/off

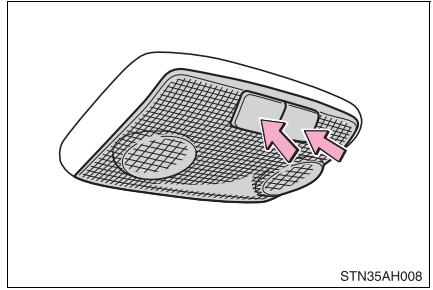

STN35AH008

Cargo lamp main switch

① “OFF”

The cargo lamp can be individually turned on or off.

② “DOOR”

The cargo lamp comes on when a door is opened. They turn off when the doors are closed.

③ “ON”

The cargo lamp cannot be individually turned off.

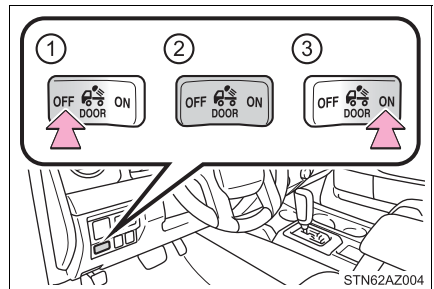

STN62AZ004

■ Illuminated entry system

The lights automatically turn on/off according to the engine switch position, whether the doors are locked/unlocked, and whether the doors are opened/closed.

■ To prevent battery discharge

If the following lights remain on when the door is not fully closed and the main switch is in the “DOOR” position, the lights will go off automatically after 20 minutes:

- Personal lights
- Interior lights
- Cargo lamp

■ Customization that can be configured at Toyota dealer

Settings (e.g. the time elapsed before lights turn off) can be changed.
(Customizable features: →P. 530)

List of storage features

► Front separated type seats

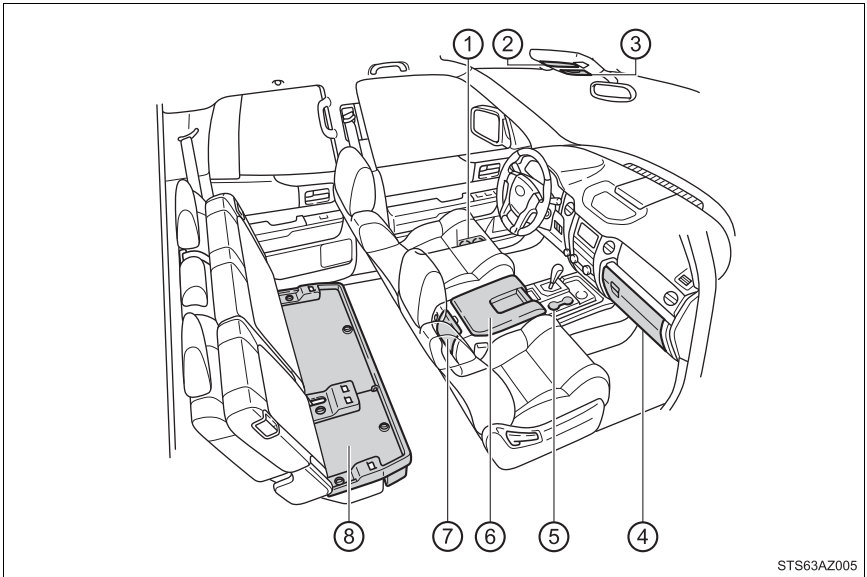

STS63AZ005

- | | | | |
|---------------------|-----------|----------------------------------|-----------|
| ① Bottle holders | (→P. 368) | ⑥ Console box | (→P. 359) |
| ② Card holder | (→P. 360) | • Card holder | (→P. 360) |
| ③ Overhead console | (→P. 365) | • Pen holder | (→P. 363) |
| ④ Glove box | (→P. 358) | • Tissue pocket | (→P. 364) |
| ⑤ Front cup holders | (→P. 366) | ⑦ Rear cup holders (if equipped) | (→P. 367) |
| | | ⑧ Storage box (if equipped) | (→P. 371) |

► Front bench type seat

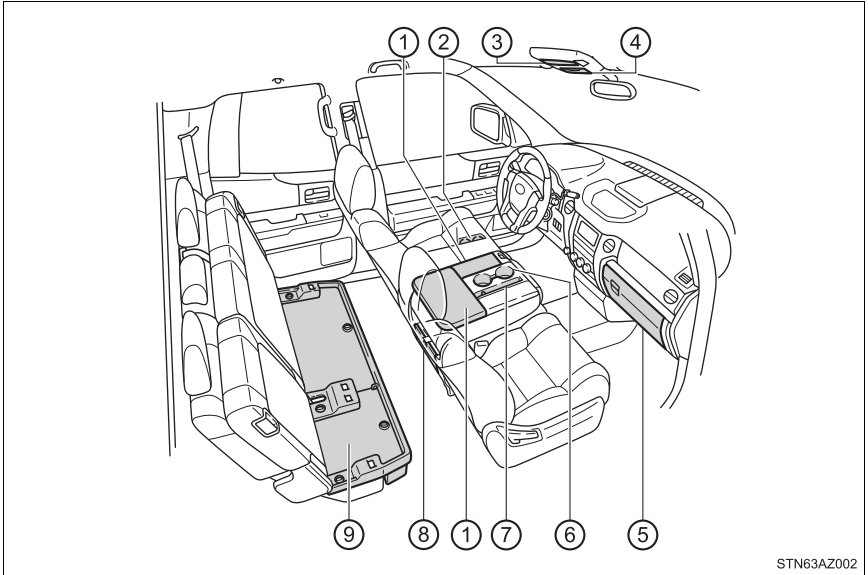

- | | |
|------------------------------|--|
| ① Auxiliary boxes (→P. 369) | ⑤ Glove box (→P. 358) |
| • Card holder (→P. 360) | ⑥ Front cup holders (→P. 366) |
| • Map holder (→P. 362) | ⑦ Pen holder (→P. 363) |
| • Tissue pocket (→P. 364) | ⑧ Rear cup holders (if equipped) (→P. 367) |
| ② Bottle holders (→P. 368) | |
| ③ Card holder (→P. 360) | ⑨ Storage box (if equipped) (→P. 371) |
| ④ Overhead console (→P. 365) | |

⚠ CAUTION**■ Items that should not be left in the storage spaces**

Do not leave glasses, lighters or spray cans in the storage spaces, as this may result in the following when cabin temperature becomes high:

- Glasses may be deformed by heat or cracked if they come into contact with other stored items.
- Lighters or spray cans may explode. If they come into contact with other stored items, the lighter may catch fire or the spray can may release gas, causing a fire hazard.

■ When driving or when the storage compartments are not in use

Keep the lids closed.

In the event of sudden braking or sudden swerving, an accident may occur due to an occupant being struck by an open lid or the items stored inside.

Glove box

- ① Open (pull the lever up)
- ② Lock
- ③ Unlock

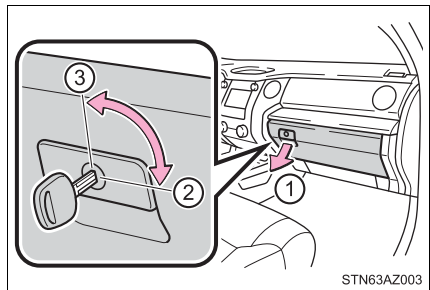

Console box (front separated type seat)

Pull the knob up and lift the lid

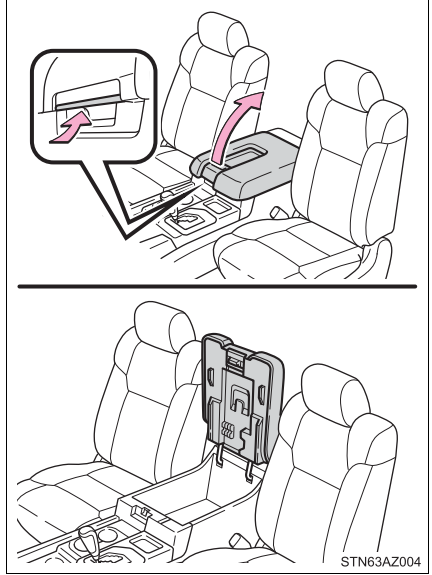
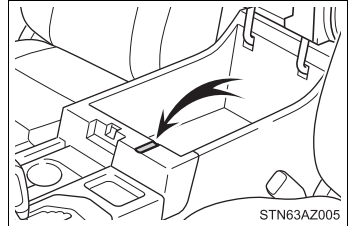
**■ Passing a cable from the console box**

Card holder

■ Overhead console

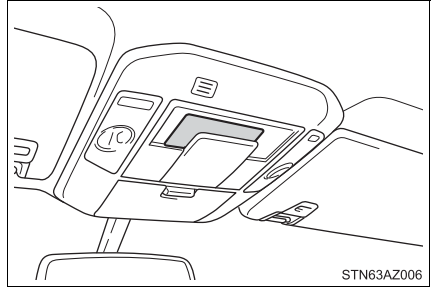

■ Console box (front separated type seats)

Pull the knob up and lift the lid

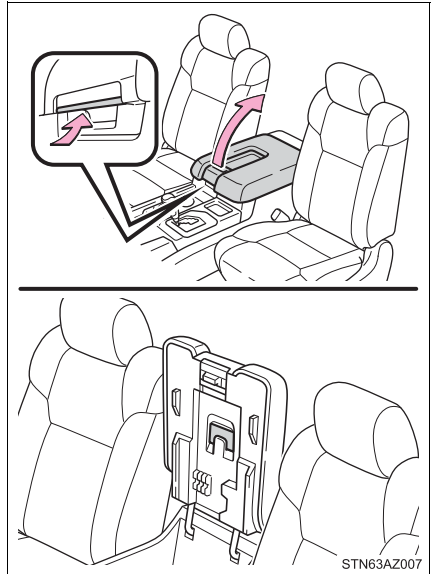

■ Back of the front center seatback (front bench type seat)

- 1 Pull the lever up and fold down the seatback

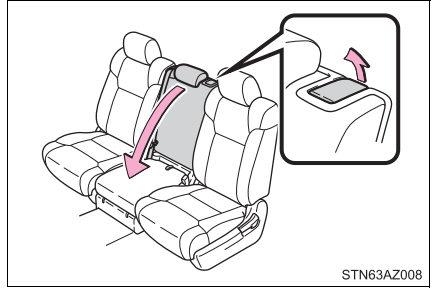

- 2 Push the knob and lift the lid

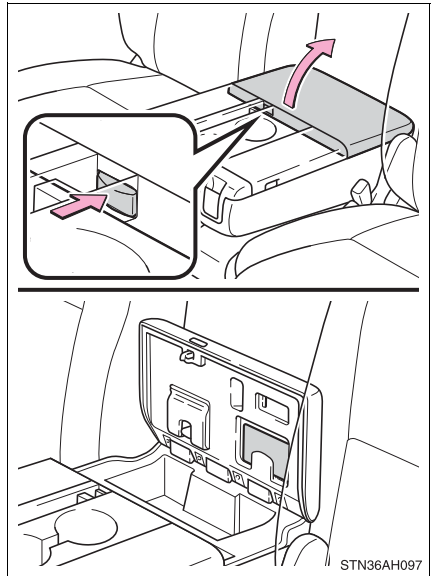

Map holder (front bench type seat)

- 1 Pull the lever up and fold down the seatback

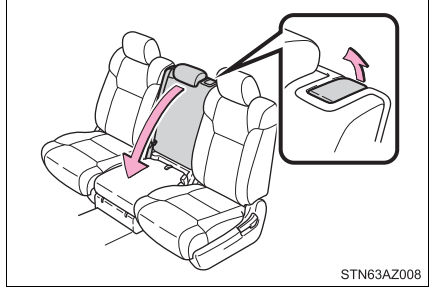

- 2 Push the knob and lift the lid

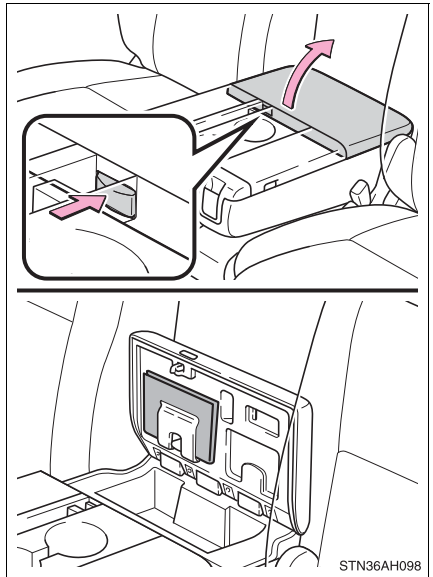

Pen holder

▶ Front separated type seats

Pull the knob up and lift the lid

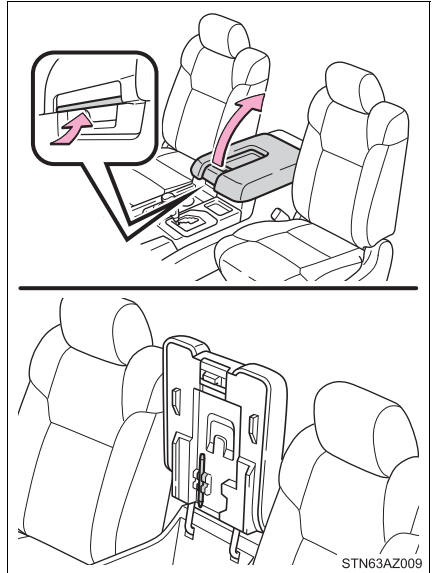

▶ Front bench type seat

Pull the lever up and fold down the seatback

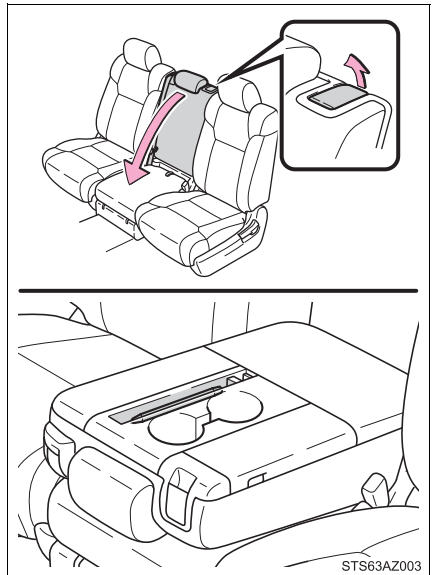

Tissue pocket

▶ Front separated type seats

Pull the knob up and lift the lid

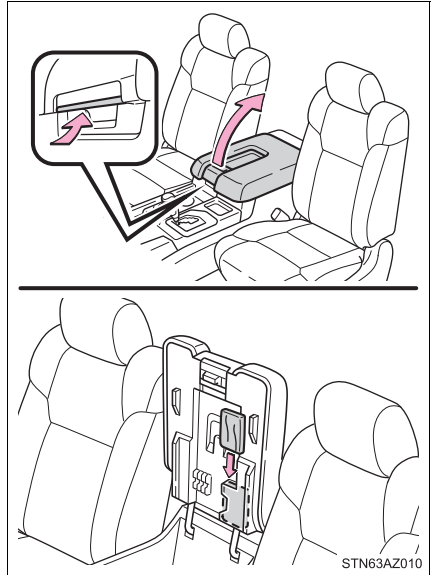

▶ Front bench type seat

- 1 Pull the lever up and fold down the seatback

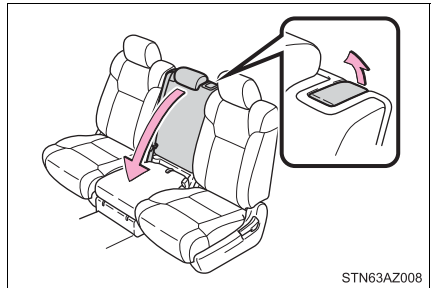

- 2 Push the knob and lift the lid

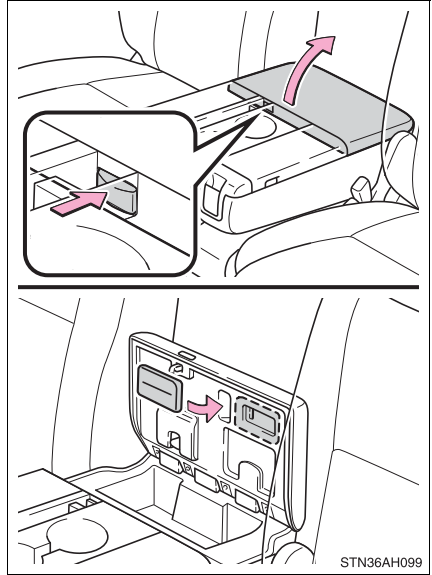

Overhead console

The overhead console is useful for temporarily storing sunglasses and similar small items.

Push the knob forward to open the console

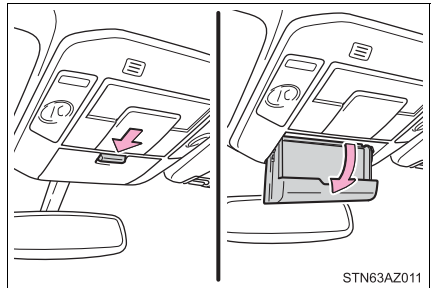

Cup holders

■ Front

▶ Separated type seats

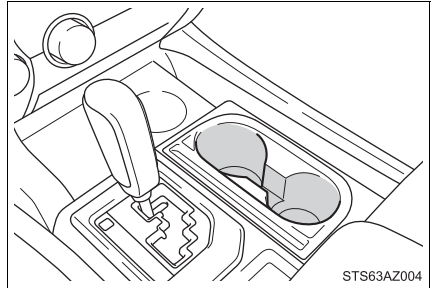

▶ Bench type seat

Pull the lever up and fold down the seatback

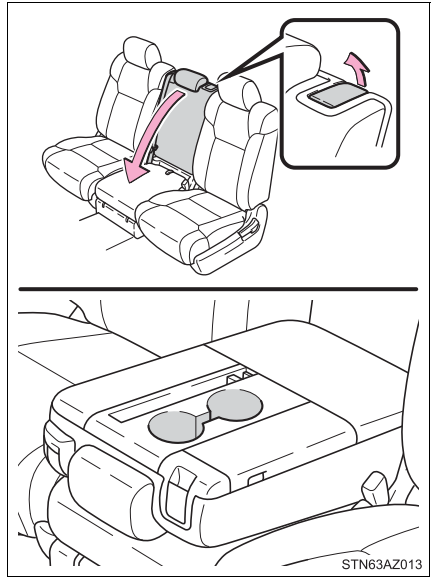

■ Rear

▶ Double Cab models with front separated type seats

Pull the lid down

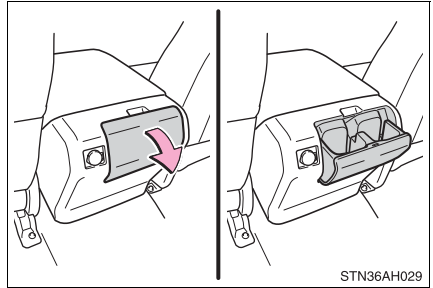

▶ Double Cab models with front bench type seat

Pull the lid down

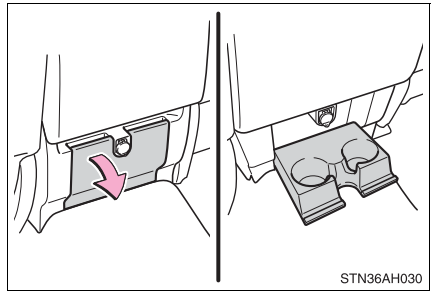

▶ CrewMax models

Pull the armrest down

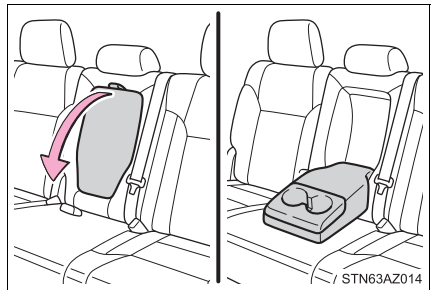

⚠ CAUTION

■ Items unsuitable for the cup holder

Do not place anything other than cups or beverage cans in the cup holders. Other items may be thrown out of the holders in the event of an accident or sudden braking and cause injury. If possible, cover hot drinks to prevent burns.

Bottle holders

▶ Front door

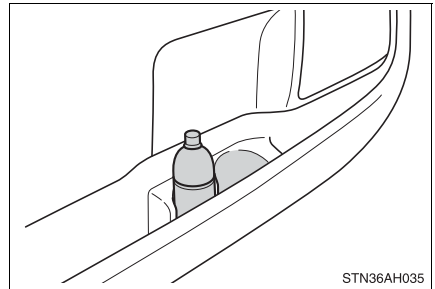

▶ Rear door (CrewMax models)

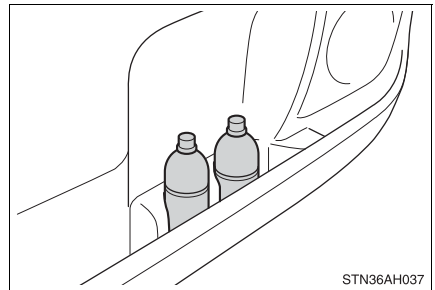
**⚠ CAUTION****■ Items unsuitable for the bottle holders**

Do not place anything other than a bottle in the bottle holders. Other items may be thrown out of the holders in the event of an accident or sudden braking and cause injury.

⚠ NOTICE**■ Items that should not be stowed in the bottle holders**

Put the cap on before stowing a bottle. Do not place open bottles in the bottle holders, or glasses and paper cups containing liquid. The contents may spill and glasses may break.

Auxiliary boxes (front bench type seat)

► Type A

Pull the strap

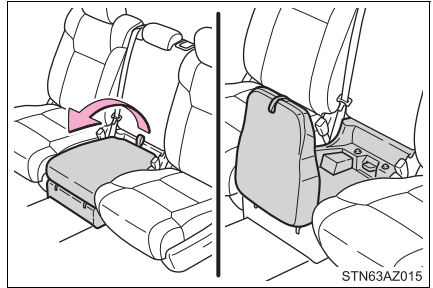

► Type B

- 1 Pull the lever up and fold down the seatback

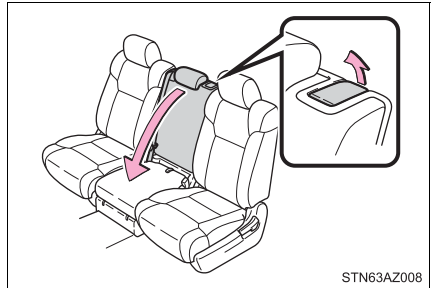

- 2 Push the knob and lift the lid

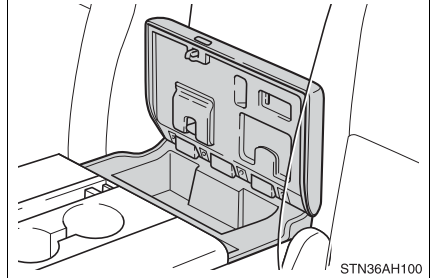
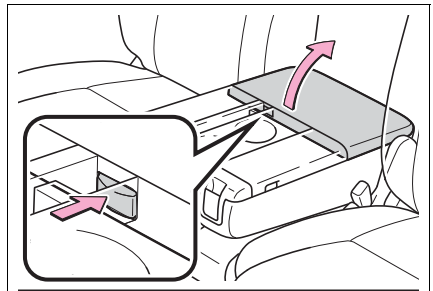

▶ Type C

- 1 Pull the lever up and fold down the seatback

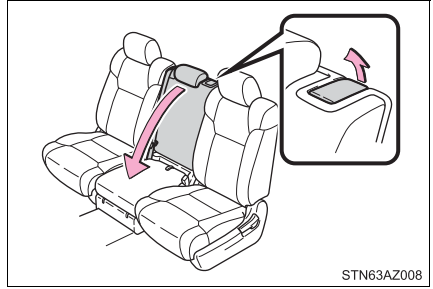

- 2 Push the knob and lift the lid

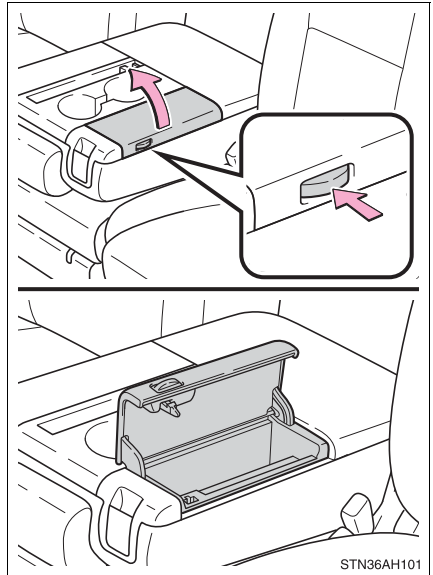

Storage box (if equipped)

■ Using the storage box

- 1 Pull the lever up and raise the rear seat cushion

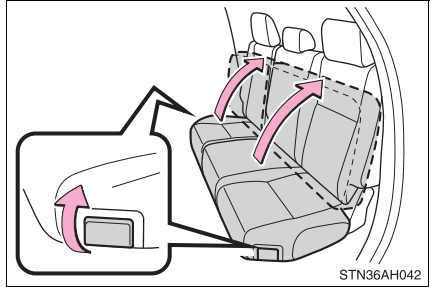

- 2 Open the lid
 - ① Turn the knob in the "OPEN" direction
 - ② Lift the lid

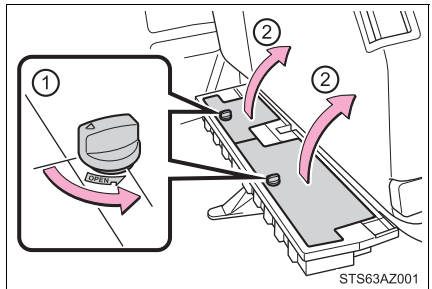

■ Remove the storage box

- 1 Pull the lever up and raise the rear seat cushion

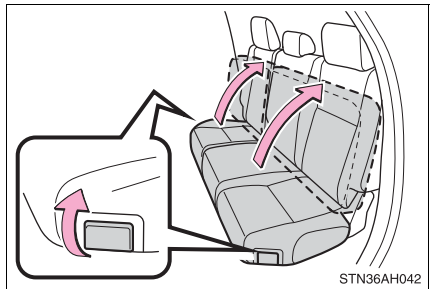

- 2 Open the lid
 - ① Turn the knob in the "OPEN" direction
 - ② Lift the lid

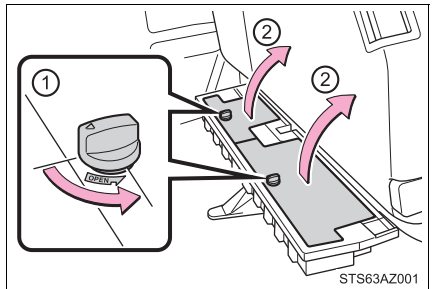

- 3 Remove the storage box
 - ① Remove the lids
 - ② Turn the knobs counterclockwise
 - ③ Remove the storage box

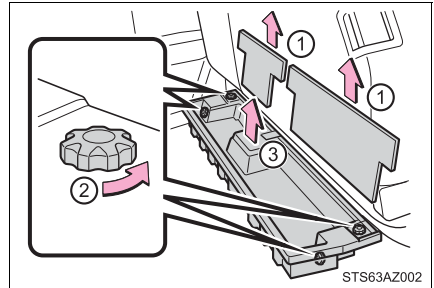

⚠ CAUTION

- **To prevent damage to the storage box**
Do not put heavy loads on the lids.

Luggage compartment features

Deck hooks

Deck hooks are provided for securing loose items.

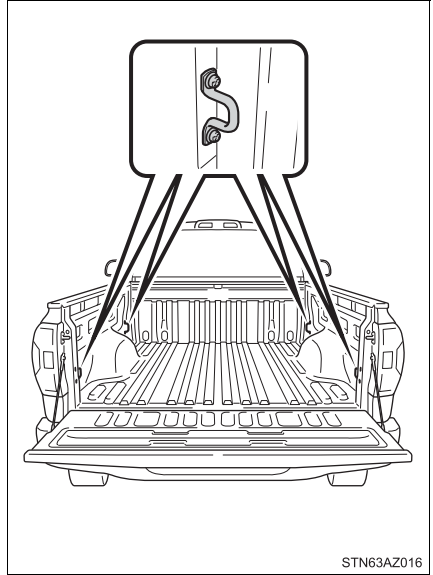

STN63AZ016

Other interior features

Sun visors

- ① To set the visor in the forward position, flip it down.
- ② To set the visor in the side position, flip down, unhook, and swing it to the side.
- ③ To use the side extender, place the visor in the side position, then slide it backward.

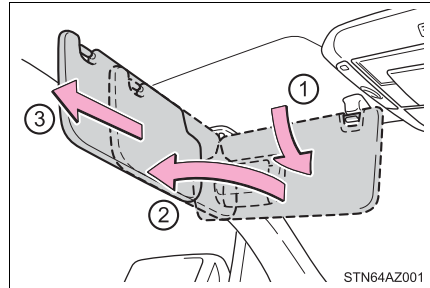

Vanity mirrors (if equipped)

Open the cover

The light turns on when the cover is opened.

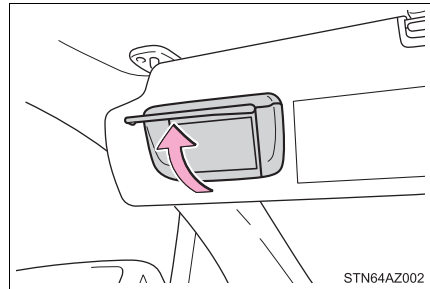

NOTICE

Do not leave the vanity lights on for extended periods while the engine is stopped.

Clock

The clock is displayed on the screen.

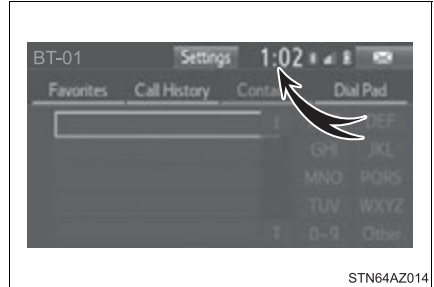

■ Setting the clock

- ▶ Vehicles with Entune Audio (Multimedia system types: →P. 250)
→P. 258
- ▶ Vehicles with Entune Audio Plus or Entune Premium Audio
(Multimedia system types: →P. 250)
Refer to the “NAVIGATION SYSTEM OWNER’S MANUAL”.

■ The clock is displayed when

The engine switch is in the “ACC” or “ON” position.

■ When disconnecting and reconnecting battery terminals

The clock data will be reset.

Outside temperature display

The temperature display shows temperature within the range of -40°F (-40°C) to 122°F (50°C).

▶ Vehicles without multi-information display

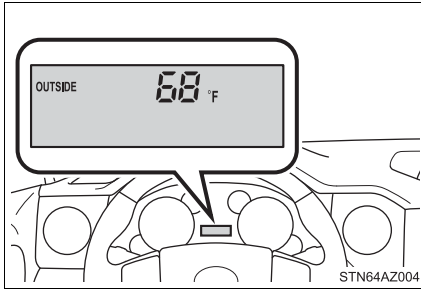

▶ Vehicles with multi-information display

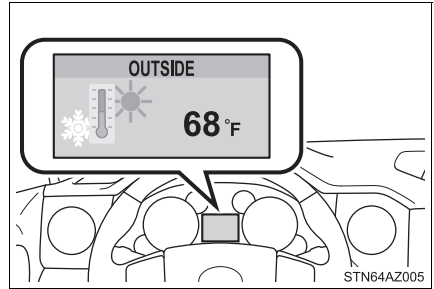

■ The outside temperature is displayed when

The engine switch is in the “ON” position.

■ Display

In the following situations, the correct outside temperature may not be displayed, or the display may take longer than normal to change:

- When the vehicle is stopped, or moving at low speeds (less than 12 mph [20 km/h])
- When the outside temperature has changed suddenly (at the entrance/exit of a garage, tunnel, etc.)

■ When “- -” is displayed

The system may be malfunctioning. Take your vehicle to your Toyota dealer.

■ Changing display units

▶ Vehicles without multi-information display

Press and hold the “TRIP/INFO” button to change the unit of measurement.

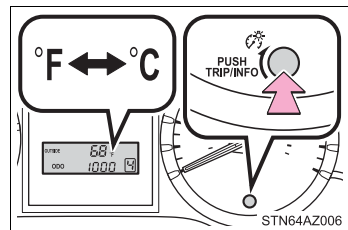

▶ Vehicles with multi-information display

The unit of measurement can be changed using the multi-information display customization. (→P. 95)

Power outlets

Please use as a power supply for electronic goods that use less than 12 VDC/10 A (power consumption of 120 W).

When using electronic goods, make sure that the power consumption of all the connected power outlets is less than 120 W.

► Type A (instrument panel)

Open the lid.

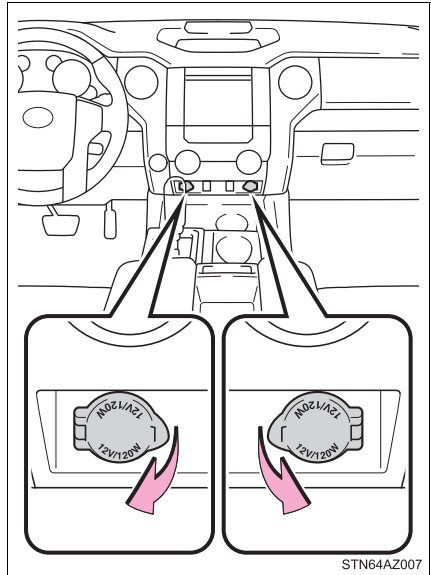

► Type B (back of the front center seatback)

Open the lid.

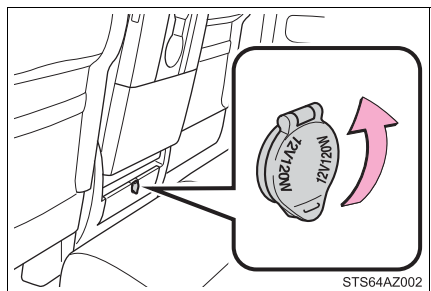

► Type C (back of the front center seatback)

Open the lid.

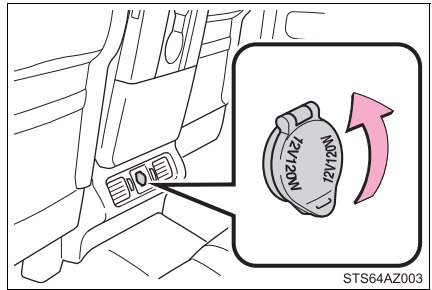

► Type D (inside of the console box)

Pull the knob up and lift the lid, and open the lid.

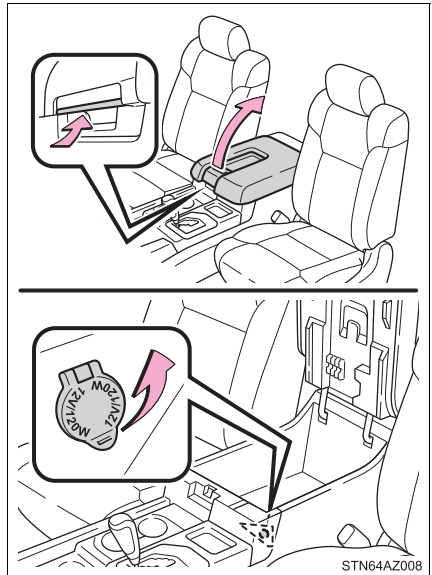

► Type E (back of the console box)

Open the lid.

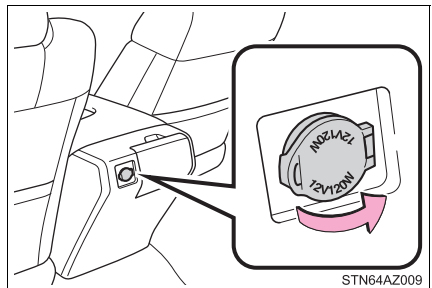

► Type F (back of the console box)

Open the lid.

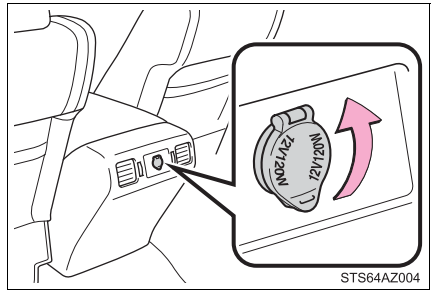

■ **The power outlets can be used when**

The engine switch is in the “ACC” or “ON” position.

■ **Passing a cable from the console box (type D)**

→P. 359



NOTICE

- Close the power outlet lids when the power outlets are not in use. Foreign objects or liquids that enter the power outlets may cause a short circuit.
- Do not use the power outlets longer than necessary when the engine is not running.

Armrest (CrewMax models)

Fold down the armrest for use.

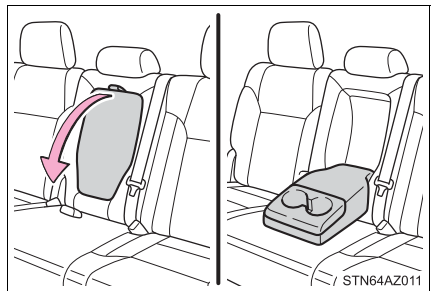

NOTICE

Do not apply too much load on the armrest.

Assist grips

An assist grip (type A) installed on the ceiling can be used to support your body while sitting on the seat.

An assist grip (type B) installed on the pillar can be used when getting in or out of the vehicle and others.

- ① Assist grip (type A)
- ② Assist grip (type B)

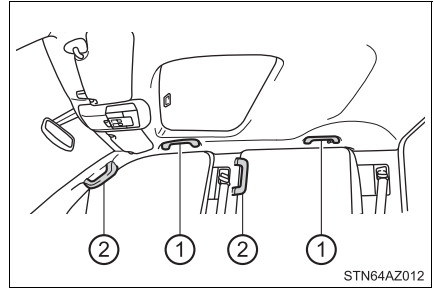

⚠ CAUTION

■ Assist grip (type A)

Do not use the assist grip when getting in or out of the vehicle or rising from your seat.

Doing so could damage the assist grip, or could cause you to injure yourself by falling over.

⚠ NOTICE

Do not hang any heavy object or put a heavy load on the assist grip.

Garage door opener*

The garage door opener can be programmed to operate garage doors, gates, entry doors, door locks, home lighting systems, security systems, and other devices.

The garage door opener (HomeLink® Universal Transceiver) is manufactured under license from HomeLink®.

Programming the HomeLink® (for U.S.A. owners)

The HomeLink® compatible transceiver in your vehicle has 3 buttons which can be programmed to operate 3 different devices. Refer to the programming method below appropriate for the device.

- ① Indicator light
- ② Buttons

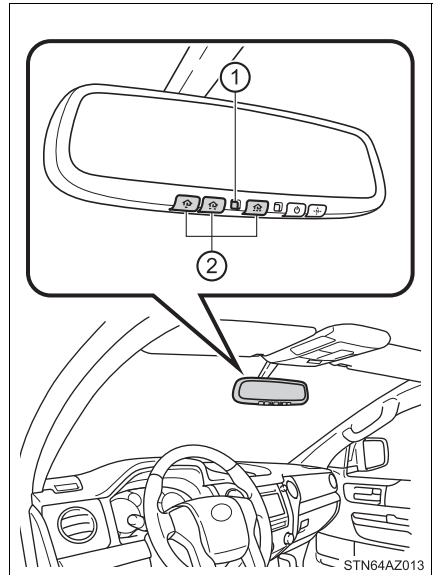

*: If equipped

■ Programming HomeLink®

- 1 Point the remote control transmitter for the device 1 to 3 in. (25 to 75 mm) from the HomeLink® buttons.

Keep the HomeLink® indicator light in view while programming.

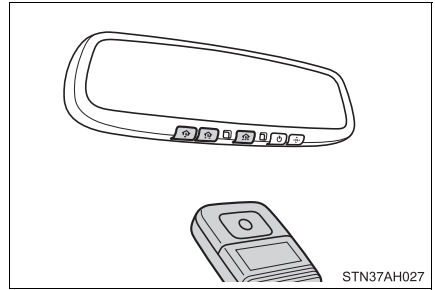

- 2 Press and hold one of the HomeLink® buttons and the transmitter button. When the HomeLink® indicator light changes from a slow to a rapid flash, you can release both buttons.

If the HomeLink® indicator light comes on but does not flash, or flashes rapidly for 2 seconds and remains lit, the HomeLink® button is already programmed. Use the other buttons or follow the “Reprogramming a HomeLink® button” instructions. (→P. 385)

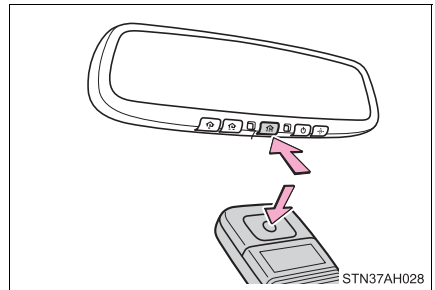

- 3 Test the HomeLink® operation by pressing the newly programmed button.

If a HomeLink® button has been programmed for a garage door, check to see if the garage door opens and closes. If the garage door does not operate, see if your garage transmitter is of the rolling code type. Press and hold the programmed HomeLink® button. The remote control transmitter is of the rolling code type if the HomeLink® indicator light flashes rapidly for 2 seconds and then remains lit. If your transmitter is the rolling code type, proceed to the heading “Programming a rolling code system”.

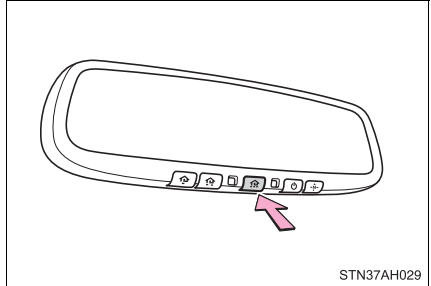

- 4 Repeat the steps above to program another device for any of the remaining HomeLink® buttons.

■ Programming a rolling code system (for U.S.A. owners)

If your device is rolling code equipped, follow the steps under the heading “Programming HomeLink®” before proceeding with the steps listed below.

- 1 Locate the training button on the ceiling mounted garage door opener motor. The exact location and color of the button may vary by brand of garage door opener motor.

Refer to the operation manual supplied with the garage door opener for the location of the training button.

- 2 Press the training button.

Following this step, you have 30 seconds in which to initiate step 3 below.

- 3 Press and hold the vehicle's programmed HomeLink[®] button for 2 seconds and release it. Repeat this step once again. The garage door may open.

If the garage door opens, the programming process is complete. If the door does not open, press and release the button a third time. This third press and release will complete the programming process by opening the garage door.

The ceiling mounted garage door opener motor should now recognize the HomeLink[®] signal and operate the garage door.

- 4 Repeat the steps above to program another rolling code system for any of the remaining HomeLink[®] buttons.

■ **Programming an entry gate (for U.S.A. owners)/Programming a devices in the Canadian market**

- 1 Place the remote control transmitter 1 to 3 in. (25 to 75 mm) away from the HomeLink[®] buttons.

Keep the HomeLink[®] indicator light in view while programming.

- 2 Press and hold the selected HomeLink[®] button.
- 3 Repeatedly press and release (cycle) the remote control transmitter for 2 seconds each until step 4 is completed.
- 4 When the HomeLink[®] indicator light starts to flash rapidly, release the buttons.
- 5 Test the HomeLink[®] operation by pressing the newly programmed button. Check to see if the gate/device operates correctly.
- 6 Repeat the steps above to program another device for any of the remaining HomeLink[®] buttons.

■ **Programming other devices**

To program other devices such as home security systems, home door locks and lighting, contact your Toyota dealer for assistance.

■ **Reprogramming a button**

The individual HomeLink[®] buttons cannot be erased but can be reprogrammed. To reprogram a button, follow the "Reprogramming a HomeLink[®] button" instructions.

Operating HomeLink®

Press the appropriate HomeLink® button. The HomeLink® indicator light should come on.

The HomeLink® compatible transceiver in your vehicle continues to send a signal for up to 20 seconds as long as the button is pressed.

Reprogramming a HomeLink® button

Press and hold the desired HomeLink® button. After 20 seconds, the HomeLink® indicator light will start flashing slowly. Keep pressing the HomeLink® button and press and hold the transmitter button until the HomeLink® indicator light changes from a slow to a rapid flash. Release the buttons.

Erasing the entire HomeLink® memory (all three programs)

Press and hold the 2 outside buttons for 10 seconds until the indicator light flashes.

If you sell your vehicle, be sure to erase the programs stored in the HomeLink® memory.

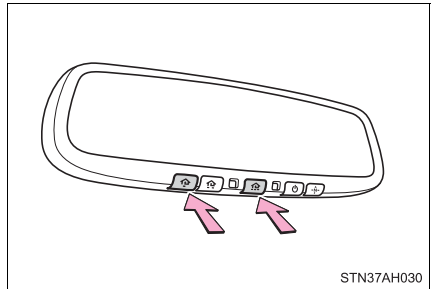

■ Before programming

- Install a new battery in the remote control transmitter.
- The battery side of the remote control transmitter must be pointed away from the HomeLink[®] button.

■ Certification for the garage door opener

- ▶ For vehicles sold in the U.S.A.

FCC ID: NZLWZLHL4

NOTE:

This device complies with Part 15 of the FCC Rules. Operation is subject to the following two conditions: (1) this device may not cause harmful interference, and (2) this device must accept any interference received, including interference that may cause undesired operation.

FCC WARNING:

Changes or modifications not expressly approved by the party responsible for compliance could void the user's authority to operate the equipment.

- ▶ For vehicles sold in Canada

NOTE:

Operation is subject to the following two conditions: (1) this device may not cause interference, and (2) this device must accept any interference, including interference that may cause undesired operation of the device.

■ When support is necessary

Visit on the web at www.homelink.com or call 1-800-355-3515.

⚠ CAUTION**■ When programming a garage door or other remote control device**

The garage door or other device may operate, so ensure people and objects are out of danger to prevent potential harm.

■ Conforming to federal safety standards

Do not use the HomeLink[®] compatible transceiver with any garage door opener or device that lacks safety stop and reverse features as required by federal safety standards.

This includes any garage door that cannot detect an interfering object. A door or device without these features increases the risk of death or serious injury.

Compass*

The compass on the inside rear view mirror indicates the direction in which the vehicle is heading.

Operation

To turn the compass on or off, press the switch.

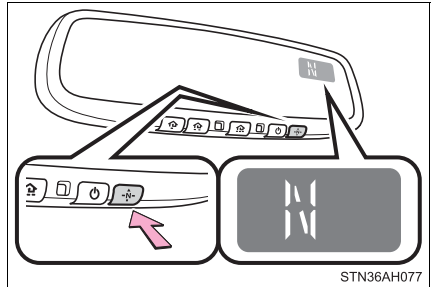

Displays and directions

| Display | Direction |
|---------|-----------|
| N | North |
| NE | Northeast |
| E | East |
| SE | Southeast |
| S | South |
| SW | Southwest |
| W | West |
| NW | Northwest |

Calibrating the compass

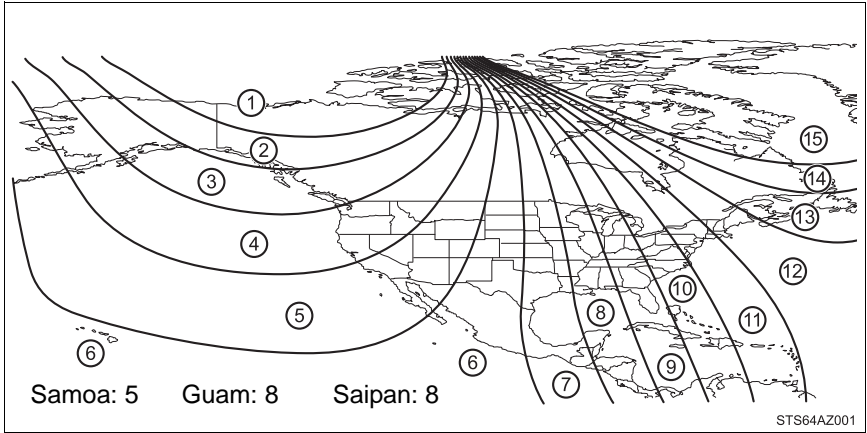

The direction display deviates from the true direction determined by the earth's magnetic field. The amount of deviation varies according to the geographic position of the vehicle.

If you cross over a map boundary shown in illustration, the compass will deviate.

To obtain higher precision of accurate calibration, refer to the following.

■ Deviation calibration

- 1 Stop the vehicle where it is safe to drive in a circle.
- 2 Press the switch until a number (1 to 15) appears on the compass display.

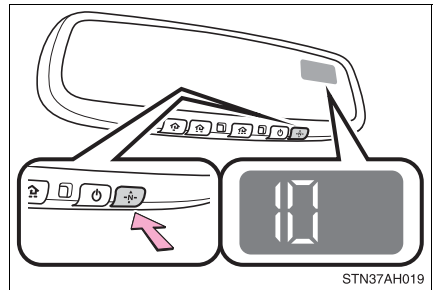

- 3 Press the switch, and referring to the map above, select the number of the zone where you are.

If the direction is displayed several seconds after adjustment, the calibration is complete.

■ Circling calibration

When “C” appears on the display, drive the vehicle at 5 mph (8 km/h) or less in a circle until a direction is displayed.

If there is not enough space to drive in a circle, drive around the block until the direction is displayed.

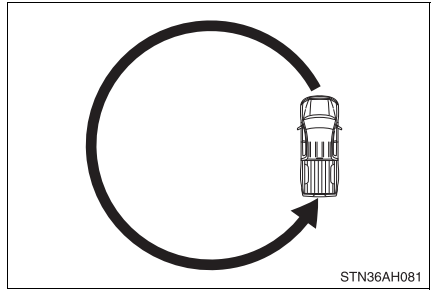

■ Conditions unfavorable to correct operation

The compass may not show the correct direction in the following conditions:

- The vehicle is stopped immediately after turning.
- The vehicle is on an inclined surface.
- The vehicle is in a place where the earth's magnetic field is subject to interference by artificial magnetic fields (underground car park/parking lot, under a steel tower, between buildings, roof car park/parking lot, near an intersection, near a large vehicle, etc.).
- The vehicle has become magnetized.
(There is a magnet or metal object near the inside rear view mirror.)
- The battery has been disconnected.
- A door is open.

⚠ CAUTION

■ When driving the vehicle

Do not adjust the display. Be sure to adjust the display only when the vehicle is stopped.

■ When doing the circling calibration

Be sure to secure a wide space, and watch out for people and vehicles in the neighborhood. Do not violate any local traffic rules while performing circling calibration.

**NOTICE****■ To avoid the compass malfunctions**

Do not place magnets or any metal objects near the inside rear view mirror. Doing this may cause a malfunction of the compass sensor.

■ To ensure normal operation of the compass

- Do not perform circling calibration of the compass in a place where the earth's magnetic field is subject to interference by artificial magnetic fields.
- During calibration, do not operate electric systems (moon roof, power windows, etc.) as they may interfere with the calibration.

Maintenance and care

7

7-1. Maintenance and care

Cleaning and protecting
the vehicle exterior 392

Cleaning and protecting
the vehicle interior 394

7-2. Maintenance

Maintenance
requirements 397

General maintenance 399

Emission inspection
and maintenance (I/M)
programs 402

7-3. Do-it-yourself maintenance

Do-it-yourself service
precautions 403

Hood 405

Engine compartment 406

Tires 417

Tire inflation pressure 425

Wheels 428

Air conditioning filter 431

Wireless remote control
battery 434

Checking and replacing
fuses 436

Light bulbs 439

Cleaning and protecting the vehicle exterior

Perform the following to protect the vehicle and maintain it in prime condition:

- Working from top to bottom, liberally apply water to the vehicle body, wheel wells and underside of the vehicle to remove any dirt and dust.
- Wash the vehicle body using a sponge or soft cloth, such as a chamois.
- For hard-to-remove marks, use car wash soap and rinse thoroughly with water.
- Wipe away any water.
- Wax the vehicle when the waterproof coating deteriorates.
If water does not bead on a clean surface, apply wax when the vehicle body is cool.

■ Automatic car washes

- Fold the mirrors and remove the antenna before washing the vehicle. Start washing from the front of the vehicle. Make sure to re-install the antenna and extend the mirrors before driving.
- Brushes used in automatic car washes may scratch the vehicle surface and harm your vehicle's paint.

■ High pressure car washes

- Do not allow the nozzles of the car wash to come within close proximity of the windows.
- Before using the car wash, check that the fuel filler door on your vehicle is closed properly.

■ Aluminum wheels (if equipped)

- Remove any dirt immediately by using a neutral detergent. Do not use hard brushes or abrasive cleaners. Do not use strong or harsh chemical cleaners.
Use the same mild detergent and wax as used on the paint.
- Do not use detergent on the wheels when they are hot, for example after driving for long distance in the hot weather.
- Wash detergent from the wheels immediately after use.

■ Bumpers

Do not scrub with abrasive cleaners.

 CAUTION**■ When washing the vehicle**

Do not apply water to the inside of the engine compartment. Doing so may cause the electrical components, etc., to catch fire.

■ Precautions regarding the exhaust pipe

Exhaust gases cause the exhaust pipe to become quite hot.

When washing the vehicle, be careful not to touch the pipe until it has cooled sufficiently, as touching hot exhaust pipe can cause burns.

 NOTICE**■ To prevent paint deterioration and corrosion on the body and components (aluminum wheels, etc.)**

● Wash the vehicle immediately in the following cases:

- After driving near the sea coast
- After driving on salted roads
- If coal tar or tree sap is present on the paint surface
- If dead insects, insect droppings or bird droppings are present on the paint surface
- After driving in an area contaminated with soot, oily smoke, mine dust, iron powder or chemical substances
- If the vehicle becomes heavily soiled with dust or mud
- If liquids such as benzene and gasoline are spilled on the paint surface

● If the paint is chipped or scratched, have it repaired immediately.

● To prevent the wheels from corroding, remove any dirt and store in a place with low humidity when storing the wheels.

■ Cleaning the exterior lights

● Wash carefully. Do not use organic substances or scrub with a hard brush. This may damage the surfaces of the lights.

● Do not apply wax to the surfaces of the lights. Wax may cause damage to the lenses.

■ Antenna installation and removal precautions

● Before driving, ensure that the antenna is installed.

● When the antenna is removed, such as before entering an automatic car wash, make sure to store it in a suitable place so as not to lose it. Also, before driving, make sure to reinstall the antenna in its original position.

Cleaning and protecting the vehicle interior

The following procedures will help protect your vehicle's interior and keep it in top condition:

Protecting the vehicle interior

Remove dirt and dust using a vacuum cleaner. Wipe dirty surfaces with a cloth dampened with lukewarm water.

Cleaning the leather areas

- Remove dirt and dust using a vacuum cleaner.
- Wipe off any excess dirt and dust with a soft cloth dampened with diluted detergent.
Use a diluted water solution of approximately 5% neutral wool detergent.
- Wring out any excess water from the cloth and thoroughly wipe off all remaining traces of detergent.
- Wipe the surface with a dry, soft cloth to remove any remaining moisture. Allow the leather to dry in a shaded and ventilated area.

Cleaning the synthetic leather areas

- Remove loose dirt using a vacuum cleaner.
- Apply a mild soap solution to the synthetic leather using a sponge or soft cloth.
- Allow the solution to soak in for a few minutes. Remove the dirt and wipe off the solution with a clean, damp cloth.

■ Caring for leather areas

Toyota recommends cleaning the interior of the vehicle at least twice a year to maintain the quality of the vehicle's interior.

■ Shampooing the carpets

There are several commercial foaming-type cleaners available. Use a sponge or brush to apply the foam. Rub in overlapping circles. Do not use water. Wipe dirty surfaces and let them dry. Excellent results are obtained by keeping the carpet as dry as possible.

■ Seat belts

Clean with mild soap and lukewarm water using a cloth or sponge. Also check the belts periodically for excessive wear, fraying or cuts.

■ When cleaning the carpeted portions of the console box, etc.

If a strong adhesive tape is used, there is a possibility that the surface of the carpet could be damaged.

▲ CAUTION**■ Water in the vehicle**

- Do not splash or spill liquid in the vehicle.
Doing so may cause electrical components, etc., to malfunction or catch fire.
- Do not get any of the SRS components or wiring in the vehicle interior wet. (→P. 40)
An electrical malfunction may cause the airbags to deploy or not function properly, resulting in death or serious injury.

■ Cleaning the interior (especially instrument panel)

Do not use polish wax or polish cleaner. The instrument panel may reflect off the windshield, obstructing the driver's view and leading to an accident, resulting in death or serious injury.

**NOTICE****■ Cleaning detergents**

- Do not use the following types of detergent, as they may discolor the vehicle interior or cause streaks or damage to painted surfaces:
 - Non-seat portions: Organic substances such as benzene or gasoline, alkaline or acidic solutions, dye, and bleach
 - Seats: Alkaline or acidic solutions, such as thinner, benzene, and alcohol
- Do not use polish wax or polish cleaner. The instrument panel's or other interior part's painted surface may be damaged.

■ Preventing damage to leather surfaces

Observe the following precautions to avoid damage to and deterioration of leather surfaces:

- Remove any dust or dirt from leather surfaces immediately.
- Do not expose the vehicle to direct sunlight for extended periods of time. Park the vehicle in the shade, especially during summer.
- Do not place items made of vinyl, plastic, or containing wax on the upholstery, as they may stick to the leather surface if the vehicle interior heats up significantly.

■ Water on the floor

Do not wash the vehicle floor with water.

Vehicle systems such as the audio system may be damaged if water comes into contact with electrical components such as the audio system above or under the floor of the vehicle. Water may also cause the body to rust.

■ Cleaning the inside of the back window

- Do not use glass cleaner to clean the back window, as this may cause damage to the back window defogger heater wires. Use a cloth dampened with lukewarm water to gently wipe the window clean. Wipe the window in strokes running parallel to the heater wires.
- Be careful not to scratch or damage the heater wires.

Maintenance requirements

To ensure safe and economical driving, day-to-day care and regular maintenance are essential. It is the owner's responsibility to perform regular checks. Toyota recommends the following maintenance:

General maintenance

General maintenance should be performed on a daily basis. This can be done by yourself or by a Toyota dealer.

Scheduled maintenance

Scheduled maintenance should be performed at specified intervals according to the maintenance schedule.

For details about maintenance items and schedules, refer to the "Scheduled Maintenance Guide" or "Owner's Manual Supplement".

Do-it-yourself maintenance

You can perform some maintenance procedures by yourself. Please be aware that do-it-yourself maintenance may affect warranty coverage.

The use of Toyota Repair Manuals is recommended.

For details about warranty coverage, see the separate "Owner's Warranty Information Booklet" or "Owner's Manual Supplement".

■ Repair and replacement

It is recommended that genuine Toyota parts be used for repairs to ensure performance of each system. If non-Toyota parts are used in replacement or if a repair shop other than a Toyota dealer performs repairs, confirm the warranty coverage.

■ Reset the maintenance data (U.S.A. only)

After the required maintenance is performed according to the maintenance schedule, please reset the maintenance data.

To reset the data, follow the procedure described below:

- 1 Turn the engine switch off with the trip meter “A” reading shown.
- 2 While pressing the “TRIP/INFO” button (→P. 88) or the “ODO/TRIP” button (→P. 89), turn the engine switch on.
 - ▶ Vehicles without multi-information display
- 3 Continue to press and hold the button until the trip meter displays “000000”.
 - ▶ Vehicles with multi-information display
- 3 Continue to press and hold the button until “RESETTING MAINTENANCE DATA” appears on the multi-information display.

■ Allow inspection and repairs to be performed by a Toyota dealer

- Toyota technicians are well-trained specialists and are kept up to date with the latest service information. They are well informed about the operations of all systems on your vehicle.
- Keep a copy of the repair order. It proves that the maintenance that has been performed is under warranty coverage. If any problem should arise while your vehicle is under warranty, your Toyota dealer will promptly take care of it.

**CAUTION****■ If your vehicle is not properly maintained**

Improper maintenance could result in serious damage to the vehicle and possible death or serious injury.

■ Handling of the battery

- Engine exhaust, some of its constituents, and a wide variety of automobile components contain or emit chemicals known to the State of California to cause cancer and birth defects and other reproductive harm. Work in a well ventilated area.
- Oils, fuels and fluids contained in vehicles as well as waste produced by component wear contain or emit chemicals known to the State of California to cause cancer and birth defects or other reproductive harm. Avoid exposure and wash any affected area immediately.
- Battery posts, terminals and related accessories contain lead and lead compounds which are known to cause brain damage. Wash your hands after handling. (→P. 414)

General maintenance

Listed below are the general maintenance items that should be performed at the intervals specified in the “Owner’s Warranty Information Booklet” or “Owner’s Manual Supplement/Scheduled Maintenance Guide”. It is recommended that any problem you notice should be brought to the attention of your Toyota dealer or qualified service shop for advice.

Engine compartment

| Items | Check points |
|----------------------|--|
| Battery | Check the connections. (→P. 414) |
| Brake fluid | Is the brake fluid at the correct level? (→P. 412) |
| Engine coolant | Is the engine coolant at the correct level?(→P. 410) |
| Engine oil | Is the engine oil at the correct level? (→P. 408) |
| Exhaust system | There should not be any fumes or strange sounds. |
| Power steering fluid | Is the power steering fluid at correct level? (→P. 413) |
| Radiator/condenser | The radiator and condenser should be free from foreign objects. (→P. 412) |
| Washer fluid | Is there sufficient washer fluid? (→P. 416) |

Vehicle interior

| Items | Check points |
|---|--|
| Accelerator pedal | <ul style="list-style-type: none"> The accelerator pedal should move smoothly (without uneven pedal effort or catching). |
| Automatic transmission "Park" mechanism | <ul style="list-style-type: none"> When parked on a slope and the shift lever is in P, is the vehicle securely stopped? |
| Brake pedal | <ul style="list-style-type: none"> Does the brake pedal move smoothly? Does the brake pedal have appropriate clearance from the floor? (→P. 513) Does the brake pedal have the correct amount of free play? (→P. 513) |
| Brakes | <ul style="list-style-type: none"> The vehicle should not pull to one side when the brakes are applied. The brakes should work effectively. The brake pedal should not feel spongy. The brake pedal should not get too close to the floor when the brakes are applied. |
| Head restraints | <ul style="list-style-type: none"> Do the head restraints move smoothly and lock securely? |
| Indicators/buzzers | <ul style="list-style-type: none"> Do the indicators and buzzers function properly? |
| Parking brake | <ul style="list-style-type: none"> Does the parking brake pedal move smoothly? When parked on a slope and the parking brake is on, is the vehicle securely stopped? |
| Seat belts | <ul style="list-style-type: none"> Do the seat belts operate smoothly? The seat belts should not be damaged. |
| Seats | <ul style="list-style-type: none"> Do the seat controls operate properly? |
| Steering wheel | <ul style="list-style-type: none"> Does the steering wheel rotate smoothly? Does the steering wheel have the correct amount of free play? There should not be any strange sounds coming from the steering wheel. |

Vehicle exterior

| Items | Check points |
|-------------------|--|
| Doors | <ul style="list-style-type: none"> • Do the doors operate smoothly? |
| Engine hood | <ul style="list-style-type: none"> • Does the engine hood lock system work properly? |
| Fluid leaks | <ul style="list-style-type: none"> • There should not be any signs of fluid leakage after the vehicle has been parked. |
| Tires | <ul style="list-style-type: none"> • Is the tire inflation pressure correct? • The tires should not be damaged or excessively worn. • Have the tires been rotated according to the maintenance schedule? • The wheel nuts should not be loose. |
| Lights | <ul style="list-style-type: none"> • Do all the lights come on? |
| Windshield wipers | <ul style="list-style-type: none"> • The wiper blades should not show any signs of cracking, splitting, wear, contamination or deformation. • The wiper blades should clear the windshield without streaking or skipping. |

CAUTION

■ If the engine is running

Turn the engine off and ensure that there is adequate ventilation before performing maintenance checks.

Emission inspection and maintenance (I/M) programs

Some states have vehicle emission inspection programs which include OBD (On Board Diagnostics) checks. The OBD system monitors the operation of the emission control system.

If the malfunction indicator lamp comes on

The OBD system determines that a problem exists somewhere in the emission control system. Your vehicle may not pass the I/M test and may need to be repaired. Contact your Toyota dealer to service the vehicle.

Your vehicle may not pass the I/M test in the following situations:

- When the battery is disconnected or discharged
Readiness codes that are set during ordinary driving are erased. Also, depending on your driving habits, the readiness codes may not be completely set.
- When the fuel tank cap is loose
The malfunction indicator lamp comes on indicating a temporary malfunction and your vehicle may not pass the I/M test.

When the malfunction indicator lamp still remains on after several driving trips

The error code in the OBD system will not be cleared unless the vehicle is driven 40 or more times.

If your vehicle does not pass the I/M test

Contact your Toyota dealer to prepare the vehicle for re-testing.

Do-it-yourself service precautions

If you perform maintenance by yourself, be sure to follow the correct procedure as given in these sections.

| Items | Parts and tools |
|---|---|
| Battery condition (→P. 414) | <ul style="list-style-type: none"> • Warm water • Baking soda • Grease • Conventional wrench (for terminal clamp bolts) |
| Brake fluid level (→P. 412) | <ul style="list-style-type: none"> • FMVSS No.116 DOT 3 or SAE J1703 brake fluid • Rag or paper towel • Funnel (used only for adding brake fluid) |
| Engine coolant level (→P. 410) | <ul style="list-style-type: none"> • “Toyota Super Long Life Coolant” or a similar high quality ethylene glycol-based non-silicate, non-amine, non-nitrite and non-borate coolant with long-life hybrid organic acid technology For the U.S.A.: “Toyota Super Long Life Coolant” is pre-mixed with 50% coolant and 50% deionized water. For Canada: “Toyota Super Long Life Coolant” is pre-mixed with 55% coolant and 45% deionized water. • Funnel (used only for adding coolant) |
| Engine oil level (→P. 408) | <ul style="list-style-type: none"> • “Toyota Genuine Motor Oil” or equivalent • Rag or paper towel • Funnel (used only for adding engine oil) |
| Fuses (→P. 436) | <ul style="list-style-type: none"> • Fuse with same amperage rating as original |
| Light bulbs (→P. 439) | <ul style="list-style-type: none"> • Bulb with same number and wattage rating as original • Phillips-head screwdriver • Flathead screwdriver • Wrench |
| Power steering fluid level (→P. 413) | <ul style="list-style-type: none"> • Automatic transmission fluid DEXRON[®] II or III • Rag or paper towel • Funnel (used only for adding power steering fluid) |
| Radiator and condenser (→P. 412) | — |
| Tire inflation pressure (→P. 425) | <ul style="list-style-type: none"> • Tire pressure gauge • Compressed air source |
| Washer fluid (→P. 416) | <ul style="list-style-type: none"> • Water or washer fluid containing antifreeze (for winter use) • Funnel (used only for adding water or washer fluid) |

 **CAUTION**

The engine compartment contains many mechanisms and fluids that may move suddenly, become hot, or become electrically energized. To avoid death or serious injury, observe the following precautions.

■ When working on the engine compartment

- Keep hands, clothing and tools away from the moving fan and engine drive belt.
- Be careful not to touch the engine, radiator, exhaust manifold, etc., right after driving as they may be hot. Oil and other fluids may also be hot.
- Do not leave anything that may burn easily, such as paper and rags, in the engine compartment.
- Do not smoke, cause sparks or expose an open flame to fuel or the battery. Fuel and battery fumes are flammable.
- Be extremely cautious when working on the battery. It contains poisonous and corrosive sulfuric acid.

■ When working near the electric cooling fan or radiator grille

Be sure the engine switch is off.

With the engine switch in the "ON" position, the electric cooling fan may automatically start to run if the air conditioning is on and/or the coolant temperature is high. (→P. 412)

■ Safety glasses

Wear safety glasses to prevent flying or falling material, fluid spray, etc., from getting in your eyes.

 **NOTICE****■ If you remove the air cleaner filter**

Driving with the air cleaner filter removed may cause excessive engine wear due to dirt in the air.

Hood

Release the lock from the inside of the vehicle to open the hood.

- 1 Pull the hood lock release lever.
The hood will pop up slightly.

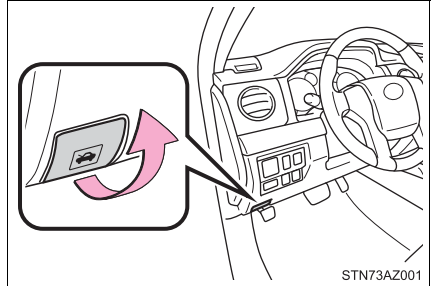

- 2 Pull up the auxiliary catch lever and lift the hood.

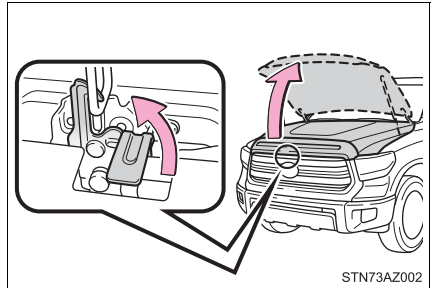

CAUTION

Pre-driving check

Check that the hood is fully closed and locked.

If the hood is not locked properly, it may open while the vehicle is in motion and cause an accident, which may result in death or serious injury.

Engine compartment

► 1GR-FE engine

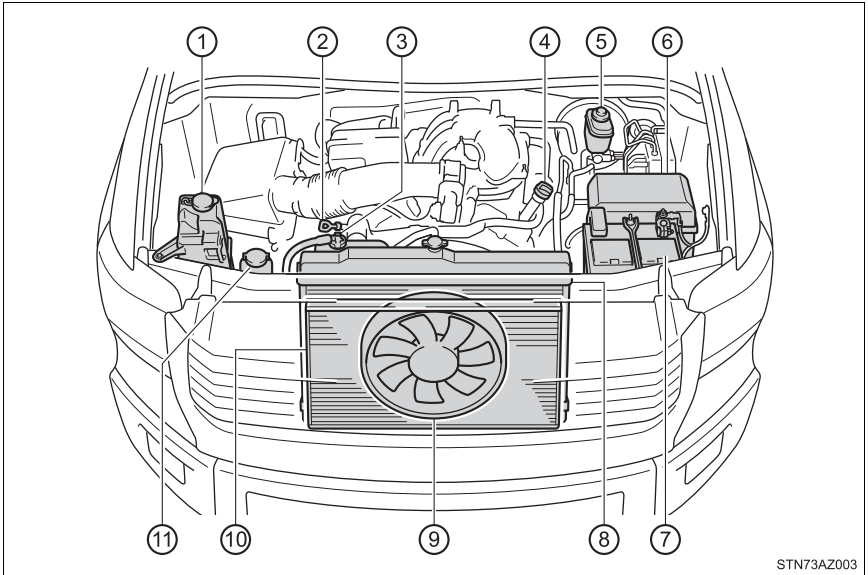

STN73AZ003

- | | |
|---------------------------------------|--|
| ① Washer fluid tank (→P. 416) | ⑥ Fuse box (→P. 436) |
| ② Engine oil level dipstick (→P. 408) | ⑦ Battery (→P. 414) |
| ③ Engine coolant reservoir (→P. 410) | ⑧ Radiator (→P. 412) |
| ④ Engine oil filler cap (→P. 409) | ⑨ Cooling fan |
| ⑤ Brake fluid reservoir (→P. 412) | ⑩ Condenser (→P. 412) |
| | ⑪ Power steering fluid reservoir (→P. 413) |

► 1UR-FE, 3UR-FE and 3UR-FBE engines

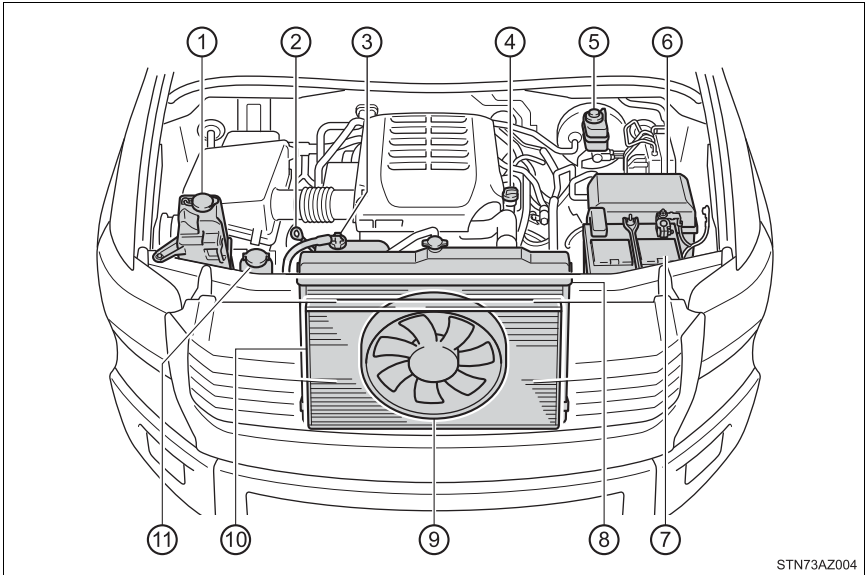

STN73AZ004

- | | |
|---------------------------------------|--|
| ① Washer fluid tank (→P. 416) | ⑥ Fuse box (→P. 436) |
| ② Engine oil level dipstick (→P. 408) | ⑦ Battery (→P. 414) |
| ③ Engine coolant reservoir (→P. 410) | ⑧ Radiator (→P. 412) |
| ④ Engine oil filler cap (→P. 409) | ⑨ Cooling fan |
| ⑤ Brake fluid reservoir (→P. 412) | ⑩ Condenser (→P. 412) |
| | ⑪ Power steering fluid reservoir (→P. 413) |

Engine oil

With the engine at operating temperature and turned off, check the oil level on the dipstick.

■ Checking the engine oil

- 1 Park the vehicle on level ground. After warming up the engine and turning it off, wait more than 5 minutes for the oil to drain back into the bottom of the engine.

- 2 Holding a rag under the end, pull the dipstick out.

▶ 1GR-FE engine

▶ 1UR-FE, 3UR-FE and 3UR-FBE engines

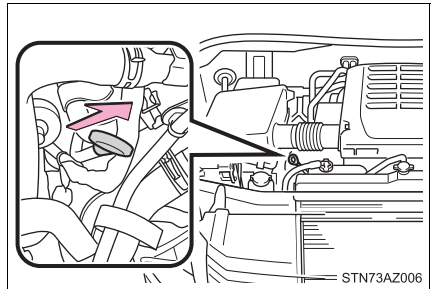
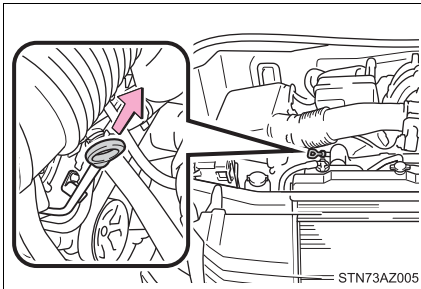

- 3 Wipe the dipstick clean.
- 4 Reinsert the dipstick fully.
- 5 Holding a rag under the end, pull the dipstick out and check the oil level.

- ① Low
- ② Normal
- ③ Excessive

The shape of the dipstick may differ depending on the type of vehicle or engine.

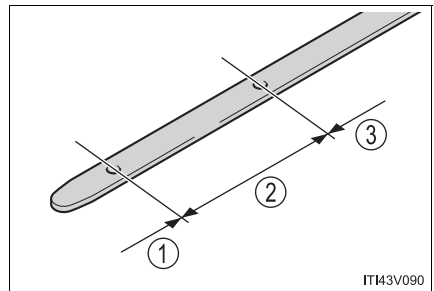

- 6 Wipe the dipstick and reinsert it fully.

■ Adding engine oil

If the oil level is below or near the low level mark, add engine oil of the same type as that already in the engine.

▶ 1GR-FE engine

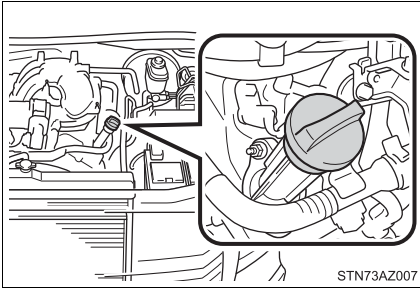

▶ 1UR-FE, 3UR-FE and 3UR-FBE engines

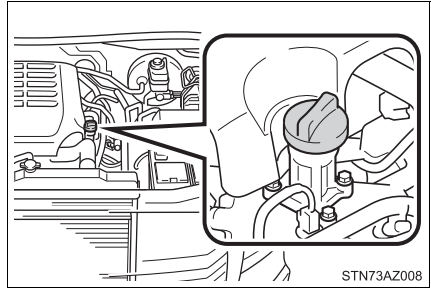

Make sure to check the oil type and prepare the items needed before adding oil.

| | |
|------------------------------|------------------------------|
| Engine oil selection | →P. 509 |
| Oil quantity (Low → Full) | 1.6 qt. (1.5 L, 1.3 Imp.qt.) |
| Items | Clean funnel |

- 1 Remove the oil filler cap by turning it counterclockwise.
- 2 Add engine oil slowly, checking the dipstick.
- 3 Install the oil filler cap by turning it clockwise.

■ Engine oil consumption

A certain amount of engine oil will be consumed while driving. In the following situations, oil consumption may increase, and engine oil may need to be refilled in between oil maintenance intervals.

- When the engine is new, for example directly after purchasing the vehicle or after replacing the engine
- If low quality oil or oil of an inappropriate viscosity is used
- When driving at high engine speeds or with a heavy load, when towing, or when driving while accelerating or decelerating frequently
- When leaving the engine idling for a long time, or when driving frequently through heavy traffic

CAUTION

■ Used engine oil

- Used engine oil contains potentially harmful contaminants which may cause skin disorders such as inflammation and skin cancer, so care should be taken to avoid prolonged and repeated contact. To remove used engine oil from your skin, wash thoroughly with soap and water.
- Dispose of used oil and filters only in a safe and acceptable manner. Do not dispose of used oil and filters in household trash, in sewers or onto the ground.
Call your Toyota dealer, service station or auto parts store for information concerning recycling or disposal.
- Do not leave used engine oil within the reach of children.

NOTICE

■ To prevent serious engine damage

Check the oil level on a regular basis.

■ When replacing the engine oil

- Be careful not to spill engine oil on the vehicle components.
- Avoid overfilling, or the engine could be damaged.
- Check the oil level on the dipstick every time you refill the vehicle.
- Be sure the engine oil filler cap is properly tightened.

Engine coolant

The coolant level is satisfactory if it is between the “FULL” and “LOW” lines on the reservoir when the engine is cold.

- ① Reservoir cap
- ② “FULL” line
- ③ “LOW” line

If the level is on or below the “LOW” line, add coolant up to the “FULL” line. (→P. 496)

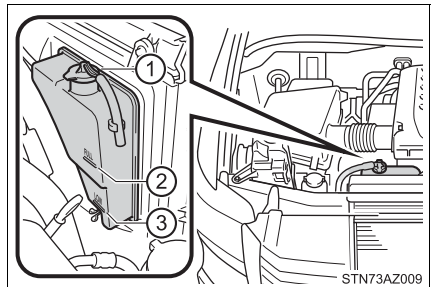

■ Coolant selection

Only use “Toyota Super Long Life Coolant” or a similar high quality ethylene glycol based non-silicate, non-amine, non-nitrite, and non-borate coolant with long-life hybrid organic acid technology.

U.S.A.:

“Toyota Super Long Life Coolant” is a mixture of 50% coolant and 50% deionized water. (Minimum temperature: -31°F [-35°C])

Canada:

“Toyota Super Long Life Coolant” is a mixture of 55% coolant and 45% deionized water. (Minimum temperature: -44°F [-42°C])

For more details about coolant, contact your Toyota dealer.

■ If the coolant level drops within a short time of replenishing

Visually check the radiator, hoses, engine coolant reservoir cap, drain cock and water pump.

If you cannot find a leak, have your Toyota dealer test the cap and check for leaks in the cooling system.



CAUTION

■ When the engine is hot

Do not remove the radiator cap.(→P. 496)

The cooling system may be under pressure and may spray hot coolant if the cap is removed, causing serious injuries, such as burns.



NOTICE

■ When adding coolant

Coolant is neither plain water nor straight antifreeze. The correct mixture of water and antifreeze must be used to provide proper lubrication, corrosion protection and cooling. Be sure to read the antifreeze or coolant label.

■ If you spill coolant

Be sure to wash it off with water to prevent it from damaging parts or paint.

Radiator and condenser

Check the radiator and condenser and clear away any foreign objects. If either of the above parts is extremely dirty or you are not sure of their condition, have your vehicle inspected by your Toyota dealer.

⚠ CAUTION

■ When the engine is hot

Do not touch the radiator or condenser as they may be hot and cause serious injuries, such as burns.

Brake fluid

■ Checking fluid level

The brake fluid level should be between the “MAX” and “MIN” lines on the tank.

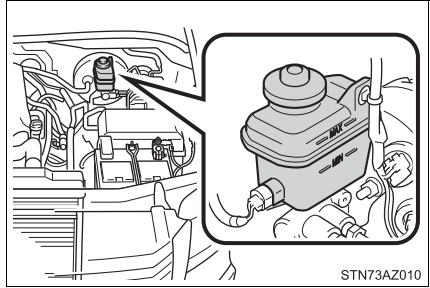

STN73AZ010

■ Adding fluid

Make sure to check the fluid type and prepare the necessary item.

| | |
|------------|---|
| Fluid type | FMVSS No.116 DOT 3 or SAE J1703 brake fluid |
| Items | Clean funnel |

■ Brake fluid can absorb moisture from the air

Excess moisture in the brake fluid can cause a dangerous loss of braking efficiency. Use only newly opened brake fluid.

CAUTION

■ When filling the reservoir

Take care as brake fluid can harm your hands and eyes and damage painted surfaces.

If fluid gets on your hands or in your eyes, flush the affected area with clean water immediately.

If you still experience discomfort, see a doctor.

NOTICE

■ If the fluid level is low or high

It is normal for the brake fluid level to go down slightly as the brake pads wear out or when the fluid level in the accumulator is high.

If the reservoir needs frequent refilling, there may be a serious problem.

Power steering fluid

■ Fluid level

The fluid level should be within the appropriate range.

- ① Full (when cold)
- ② Add fluid (when cold)
- ③ Full (when hot)
- ④ Add fluid (when hot)

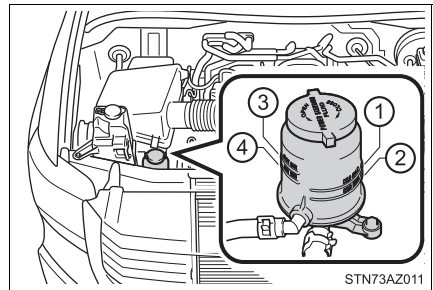

Hot: Vehicle has been driven around 50 mph (80 km/h) for 20 minutes, or slightly longer in frigid temperatures. (Fluid temperature, 140°F - 175°F [60°C - 80°C])

Cold: Engine has not been run for about 5 hours. (Room temperature, 50°F - 85°F [10°C - 30°C])

■ Checking the fluid level

Make sure to check the fluid type and prepare the necessary items.

| | |
|------------|--|
| Fluid type | Automatic transmission fluid DEXRON® II or III |
| Items | Rag or paper, clean funnel (only for adding fluid) |

- 1 Clean all dirt off the reservoir.
- 2 Remove the cap by turning it counterclockwise.
- 3 Wipe the dipstick clean.
- 4 Reinstall the cap and remove it again.
- 5 Check the fluid level.

⚠ CAUTION

■ Checking the fluid level

Take care, as the reservoir may be hot.

⚠ NOTICE

■ When adding fluid

Avoid overfilling, or the power steering may be damaged.

■ After replacing the reservoir cap

Check the steering box case, vane pump and hose connections for leaks or damage.

Battery

Check the battery as follows:

■ Battery exterior

Make sure that the battery terminals are not corroded and that there are no loose connections, cracks, or loose clamps.

- 1 Terminals
- 2 Hold-down clamp

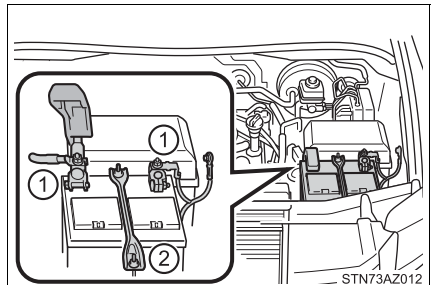

■ Before recharging

When recharging, the battery produces hydrogen gas which is flammable and explosive. Therefore, observe the following before recharging:

- If recharging with the battery installed on the vehicle, be sure to disconnect the ground cable.
- Make sure the power switch on the charger is off when connecting and disconnecting the charger cables to the battery.

⚠ CAUTION

■ Chemicals in the battery

Batteries contain poisonous and corrosive sulfuric acid and may produce hydrogen gas which is flammable and explosive. To reduce the risk of death or serious injury, take the following precautions while working on or near battery:

- Do not cause sparks by touching the battery terminals with tools.
- Do not smoke or light a match near the battery.
- Avoid contact with eyes, skin and clothes.
- Never inhale or swallow electrolyte.
- Wear protective safety glasses when working near the battery.
- Keep children away from the battery.

■ Where to safely charge the battery

Always charge the battery in an open area. Do not charge the battery in a garage or closed room where there is insufficient ventilation.

■ How to recharge the battery

Only perform a slow charge (5 A or less). The battery may explode if charged at a quicker rate.

■ Emergency measures regarding electrolyte

- If electrolyte gets in your eyes
Flush your eyes with clean water for at least 15 minutes and get immediate medical attention. If possible, continue to apply water with a sponge or cloth while traveling to the nearest medical facility.
- If electrolyte gets on your skin
Wash the affected area thoroughly. If you feel pain or burning, get medical attention immediately.
- If electrolyte gets on your clothes
It can soak through clothing on to your skin. Immediately take off the clothing and follow the procedure above if necessary.
- If you accidentally swallow electrolyte
Drink a large quantity of water or milk. Get emergency medical attention immediately.

 NOTICE**When recharging the battery**

Never recharge the battery while the engine is running. Also, be sure all accessories are turned off.

Washer fluid

Add washer fluid in the following situations:

- A washer does not work.
- Vehicles without multi-information display: The low washer fluid warning light comes on.
- Vehicles with multi-information display: The warning message appears on the display.

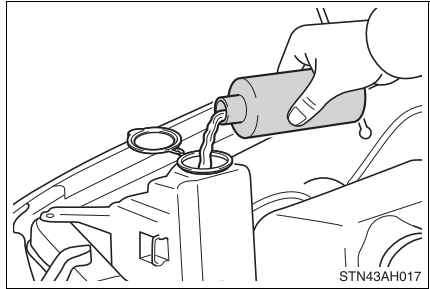
 CAUTION**When adding washer fluid**

Do not add washer fluid when the engine is hot or running as washer fluid contains alcohol and may catch fire if spilled on the engine, etc.

 NOTICE**Do not use any fluid other than washer fluid**

Do not use soapy water or engine antifreeze instead of washer fluid. Doing so may cause streaking on the vehicle's painted surfaces.

Diluting washer fluid

Dilute washer fluid with water as necessary. Refer to the freezing temperatures listed on the label of the washer fluid bottle.

Tires

Replace or rotate tires in accordance with maintenance schedules and treadwear.

Checking tires

- ① New tread
- ② Treadwear indicator
- ③ Worn tread

The location of treadwear indicators is shown by the “TWI” or “Δ” marks, etc., molded on the side-wall of each tire.

Check spare tire condition and pressure if not rotated.

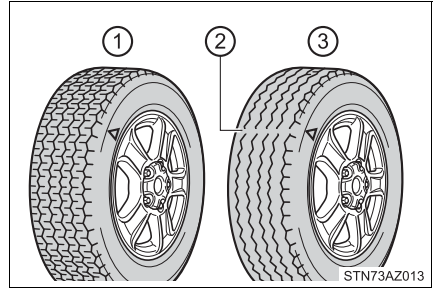

Tire rotation

Rotate the tires in the order shown.

To equalize tire wear and extend tire life, Toyota recommends that tire rotation is carried out at the same interval as tire inspection.

Do not fail to initialize the tire pressure warning system after tire rotation.

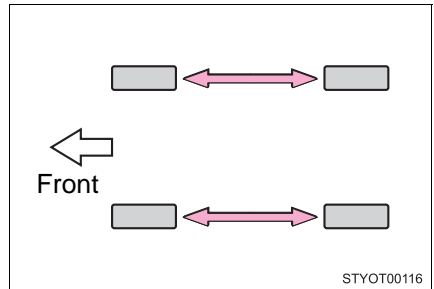

Tire pressure warning system

Your vehicle is equipped with a tire pressure warning system that uses tire pressure warning valves and transmitters to detect low tire inflation pressure before serious problems arise. (→P. 467)

◆ Installing tire pressure warning valves and transmitters

When replacing tires or wheels, tire pressure warning valves and transmitters must also be installed.

When new tire pressure warning valves and transmitters are installed, new ID codes must be registered in the tire pressure warning computer and the tire pressure warning system must be initialized. Have tire pressure warning valve and transmitter ID codes registered by your Toyota dealer. (→P. 419)

◆ Initializing the tire pressure warning system

■ The tire pressure warning system must be initialized in the following circumstances:

- When rotating the tires.
- When changing the tire size.

When the tire pressure warning system is initialized, the current tire inflation pressure is set as the benchmark pressure.

■ How to initialize the tire pressure warning system

- 1 Park the vehicle in a safe place and turn the engine switch off.

Initialization cannot be performed while the vehicle is moving.

- 2 Adjust the tire inflation pressure to the specified cold tire inflation pressure level. (→P. 513)

Make sure to adjust the tire pressure to the specified cold tire inflation pressure level. The tire pressure warning system will operate based on this pressure level.

- 3 Turn the engine switch to the “ON” position.

- 4 Press and hold the tire pressure warning reset switch until the tire pressure warning light blinks slowly 3 times.

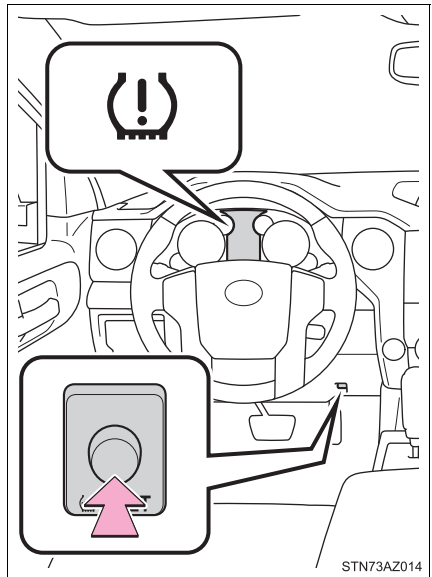

- 5 Wait for a few minutes with the engine switch in the “ON” position and then turn the engine switch to the “LOCK” position.

◆ Registering ID codes

The tire pressure warning valve and transmitter is equipped with a unique ID code. When replacing a tire pressure warning valve and transmitter, it is necessary to register the ID code. Have the ID code registered by your Toyota dealer.

■ When to replace your vehicle's tires

Tires should be replaced if:

- You have tire damage such as cuts, splits, cracks deep enough to expose the fabric, and bulges indicating internal damage
- A tire goes flat repeatedly or cannot be properly repaired due to the size or location of a cut or other damage

If you are not sure, consult with your Toyota dealer.

■ Replacing tires and wheels

If the ID code of the tire pressure warning valve and transmitter is not registered, the tire pressure warning system will not work properly. After driving for about 20 minutes, the tire pressure warning light blinks for 1 minute and stays on to indicate a system malfunction.

■ Tire life

Any tire over 6 years old must be checked by a qualified technician even if it has seldom or never been used or damage is not obvious.

■ Routine tire inflation pressure checks

The tire pressure warning system does not replace routine tire inflation pressure checks. Make sure to check tire inflation pressure as part of your routine of daily vehicle checks.

■ Maximum load of tire

Check that the number given by dividing the maximum load by 1.10 of the replacement tire is greater than 1/2 of the Gross Axle Weight Ratings (GAWR) of either the front axle or the rear axle, whichever is greater.

For the GAWR, see the Certification Label. For the maximum load of the tire, see the load limit at maximum cold tire inflation pressure mentioned on the sidewall of the tire. (→P. 520)

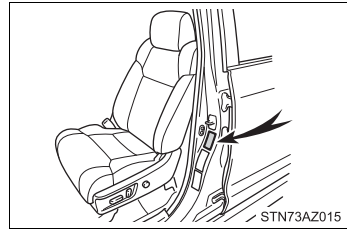

■ Tire types

● Summer tires

Summer tires are high-speed performance tires best suited to highway driving under dry conditions. Since summer tires do not have the same traction performance as snow tires, summer tires are inadequate for driving on snow-covered or icy roads. For driving on snow-covered roads or icy roads, the use of snow tires is recommended. When installing snow tires, be sure to replace all four tires.

● All season tires

All season tires are designed to provide better traction in snow and to be adequate for driving in most winter conditions as well as for use year-round. All season tires, however, do not have adequate traction performance compared with snow tires in heavy or loose snow. Also, all season tires fall short in acceleration and handling performance compared with summer tires in highway driving.

● Snow tires

For driving on snow-covered roads or icy roads, we recommend using snow tires. If you need snow tires, select tires of the same size, construction and load capacity as the originally installed tires. Since your vehicle has radial tires as original equipment, make sure your snow tires also have radial construction. Do not install studded tires without first checking local regulations for possible restrictions. Snow tires should be installed on all wheels. (→P. 240)

■ If the tread on snow tires wears down below 0.16 in. (4 mm)

The effectiveness of the tires as snow tires is lost.

■ Situations in which the tire pressure warning system may not operate properly

● In the following cases, the tire pressure warning system may not operate properly.

- If non-genuine Toyota wheels are used.
- A tire has been replaced with a tire that is not an OE (Original Equipment) tire.
- A tire has been replaced with a tire that is not of the specified size.
- Tire chains, etc., are equipped.
- Lock nuts are equipped.
- An auxiliary-supported run-flat tire is equipped.
- If a window tint that affects the radio wave signals is installed.
- If there is a lot of snow or ice on the vehicle, particularly around the wheels or wheel housings.
- If the tire inflation pressure is extremely higher than the specified level.

- Performance may be affected in the following situations.
 - Near a TV tower, electric power plant, gas station, radio station, large display, airport or other facility that generates strong radio waves or electrical noise
 - When carrying a portable radio, cellular phone, cordless phone or other wireless communication device
 - If a radio set at similar frequencies is in use in the vehicle
- When the vehicle is parked, the time taken for the warning to start or go off could be extended.
- When tire inflation pressure declines rapidly for example when a tire has burst, the warning may not function.

■ The initialization operation

- Make sure to carry out initialization after adjusting the tire inflation pressure.
Also, make sure the tires are cold before carrying out initialization or tire inflation pressure adjustment.
- If you have accidentally turned the engine switch off during initialization, it is not necessary to press the reset switch again as initialization will restart automatically when the engine switch has been turned to the "ON" position for the next time.
- If you accidentally press the reset switch when initialization is not necessary, adjust the tire inflation pressure to the specified level when the tires are cold, and conduct initialization again.

■ When initialization of the tire pressure warning system has failed

Initialization can be completed in a few minutes. However, in the following cases, the settings have not been recorded and the system will not operate properly. If repeated attempts to record tire inflation pressure settings are unsuccessful, have the vehicle inspected by your Toyota dealer.

- When operating the tire pressure warning reset switch, the tire pressure warning light does not blink 3 times.
- After carrying out the initialization procedure, the tire pressure warning light blinks for 1 minute then stays on after driving for about 20 minutes.

■ Tire pressure warning system certification

FCC ID: GQ4-45T

FCC ID: GQ4-37R

► For vehicles sold in the U.S.A.

NOTE:

This device complies with Part 15 of the FCC Rules. Operation is subject to the following two conditions: (1) This device may not cause harmful interference, and (2) this device must accept any interference received, including interference that may cause undesired operation.

FCC WARNING:

Changes or modifications not expressly approved by the party responsible for compliance could void the user's authority to operate the equipment.

► For vehicles sold in Canada

NOTE:

Operation is subject to the following two conditions: (1) this device may not cause interference, and (2) this device must accept any interference, including interference that may cause undesired operation of the device.

CAUTION

■ When inspecting or replacing tires

Observe the following precautions to prevent accidents.

Failure to do so may cause damage to parts of the drive train as well as dangerous handling characteristics, which may lead to an accident resulting in death or serious injury.

- Do not mix tires of different makes, models or tread patterns.
Also, do not mix tires of remarkably different treadwear.
- Do not use tire sizes other than those recommended by Toyota.
- Do not mix differently constructed tires (radial, bias-belted or bias-ply tires).
- Do not mix summer, all season and snow tires.
- Do not use tires that have been used on another vehicle.
Do not use tires if you do not know how they were used previously.

■ When initializing the tire pressure warning system

Do not operate the tire pressure warning reset switch without first adjusting the tire inflation pressure to the specified level. Otherwise, the tire pressure warning light may not come on even if the tire inflation pressure is low, or it may come on when the tire inflation pressure is actually normal.

**NOTICE****■ Repairing or replacing tires, wheels, tire pressure warning valves, transmitters and tire valve caps**

- When removing or fitting the wheels, tires or the tire pressure warning valves and transmitters, contact your Toyota dealer as the tire pressure warning valves and transmitters may be damaged if not handled correctly.
- Make sure to install the tire valve caps. If the tire valve caps are not installed, water could enter the tire pressure warning valves and the tire pressure warning valves could be bound.
- When replacing tire valve caps, do not use tire valve caps other than those specified. The cap may become stuck.

■ To avoid damage to the tire pressure warning valves and transmitters

When a tire is repaired with liquid sealants, the tire pressure warning valve and transmitter may not operate properly. If a liquid sealant is used, contact your Toyota dealer or other qualified service shop as soon as possible. Make sure to replace the tire pressure warning valve and transmitter when replacing the tire. (→P. 418)

■ Driving on rough roads

Take particular care when driving on roads with loose surfaces or pot-holes.

These conditions may cause losses in tire inflation pressure, reducing the cushioning ability of the tires. In addition, driving on rough roads may cause damage to the tires themselves, as well as the vehicle's wheels and body.

■ If tire inflation pressure of each tire becomes low while driving

Do not continue driving, or your tires and/or wheels may be ruined.

Tire inflation pressure

Tire inflation pressure

The recommended cold tire inflation pressure and tire size are displayed on the tire and loading information label. (→P. 513)

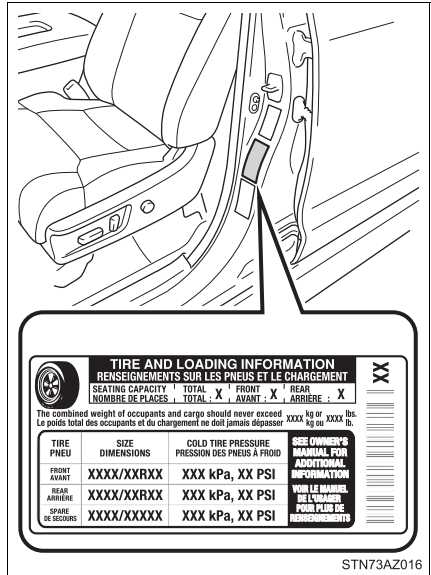

Inspection and adjustment procedure

- ① Tire valve
- ② Tire pressure gauge

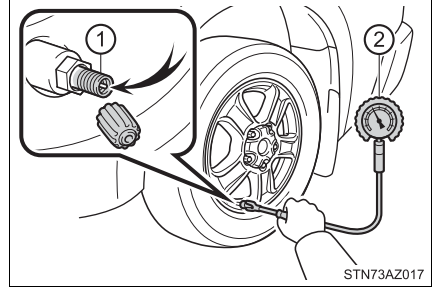

- 1 Remove the tire valve cap.
- 2 Press the tip of the tire pressure gauge onto the tire valve.
- 3 Read the pressure using the gauge gradations.
- 4 If the tire inflation pressure is not at the recommended level, adjust the pressure.
If you add too much air, press the center of the valve to deflate.
- 5 After completing the tire inflation pressure measurement and adjustment, apply soapy water to the valve and check for leakage.
- 6 Put the tire valve cap back on.

■ Tire inflation pressure check interval

You should check tire inflation pressure every two weeks, or at least once a month.

Do not forget to check the spare.

■ Effects of incorrect tire inflation pressure

Driving with incorrect tire inflation pressure may result in the following:

- Reduced fuel efficiency
- Reduced driving comfort and tire life
- Reduced safety
- Damage to the drive train

If a tire needs frequent inflating, have it checked by your Toyota dealer.

■ Instructions for checking tire inflation pressure

When checking tire inflation pressure, observe the following:

- Check only when the tires are cold.
If your vehicle has been parked for at least 3 hours or has not been driven for more than 1 mile or 1.5 km, you will get an accurate cold tire inflation pressure reading.
- Always use a tire pressure gauge.
The appearance of the tire can be misleading. In addition, tire inflation pressure that is even just a few pounds off can affect ride quality and handling.
- Do not reduce tire inflation pressure after driving. It is normal for tire inflation pressure to be higher after driving.
- Never exceed the vehicle capacity weight.
Passengers and luggage weight should be placed so that the vehicle is balanced.

CAUTION

■ Proper inflation is critical to save tire performance

Keep your tires properly inflated. Otherwise, the following conditions may occur and result in an accident causing death or serious injury:

- Excessive wear
- Uneven wear
- Poor handling
- Possibility of blowouts resulting from overheated tires
- Poor sealing of the tire bead
- Wheel deformation and/or tire separation
- A greater possibility of tire damage from road hazards

NOTICE

■ When inspecting and adjusting tire inflation pressure

Be sure to put the tire valve caps back on. Without the valve caps, dirt or moisture could get into the valve and cause air leakage, which could result in an accident. If the caps are lost, replace them as soon as possible.

Wheels

If a wheel is bent, cracked or heavily corroded, it should be replaced. Otherwise, the tire may separate from the wheel or cause a loss of handling control.

Wheel selection

When replacing wheels, care should be taken to ensure that they are equivalent to those removed in load capacity, diameter, rim width and inset*.

Replacement wheels are available at your Toyota dealer.

*: Conventionally referred to as “offset”.

Toyota does not recommend using the following:

- Wheels of different sizes or types
- Used wheels
- Bent wheels that have been straightened

Aluminum wheel precautions (if equipped)

- Use only Toyota wheel nuts and wrenches designed for use with your aluminum wheels.
- When rotating, repairing or changing your tires, check that the wheel nuts are still tight after driving 1000 miles (1600 km).
- Be careful not to damage the aluminum wheels when using tire chains.
- Use only Toyota genuine balance weights or equivalent and a plastic or rubber hammer when balancing your wheels.

■ When replacing wheels

The wheels of your vehicle are equipped with tire pressure warning valves and transmitters that allow the tire pressure warning system to provide advance warning in the event of a loss in tire inflation pressure. Whenever wheels are replaced, tire pressure warning valves and transmitters must be installed. (→P. 418)

■ When installing the wheel ornament (on some models)

Align the notch of the wheel and ornament.

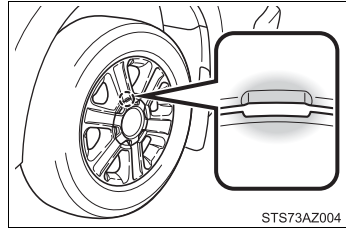

⚠ CAUTION

■ When replacing wheels

- Do not use wheels that are a different size from those recommended in the Owner's Manual, as this may result in a loss of handling control.
- Never use an inner tube in a leaking wheel which is designed for a tubeless tire. Doing so may result in an accident, causing death or serious injury.

■ When installing the wheel nuts

- Be sure to install the wheel nuts with the tapered ends facing inward. Installing the nuts with the tapered ends facing outward can cause the wheel to break and eventually cause the wheel to come off while driving, which could lead to an accident resulting in death or serious injury.

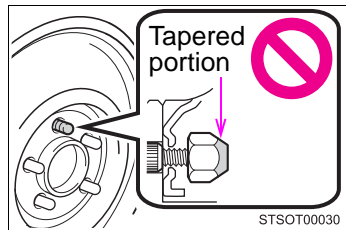

- Never use oil or grease on the wheel bolts or wheel nuts. Oil and grease may cause the wheel nuts to be excessively tightened, leading to bolt or disc wheel damage. In addition, the oil or grease can cause the wheel nuts to loosen and the wheel may fall off, causing an accident and resulting in death or serious injury. Remove any oil or grease from the wheel bolts or wheel nuts.

**NOTICE****■ Replacing tire pressure warning valves and transmitters**

- Because tire repair or replacement may affect the tire pressure warning valves and transmitters, make sure to have tires serviced by your Toyota dealer or other qualified service shop. In addition, make sure to purchase your tire pressure warning valves and transmitters at your Toyota dealer.
- Ensure that only genuine Toyota wheels are used on your vehicle. Tire pressure warning valves and transmitters may not work properly with non-genuine wheels.

Air conditioning filter

The air conditioning filter must be changed regularly to maintain air conditioning efficiency.

Removal method

- 1 Turn the engine switch off.
- 2 Open the glove box.

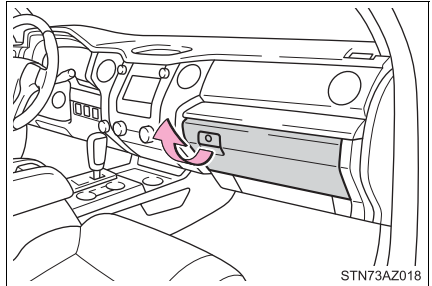

- 3 Remove the tray.

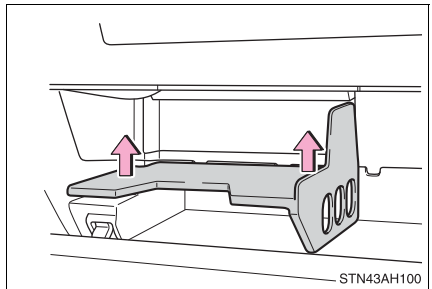

- 4 Remove the cover by sliding up while pulling toward you.

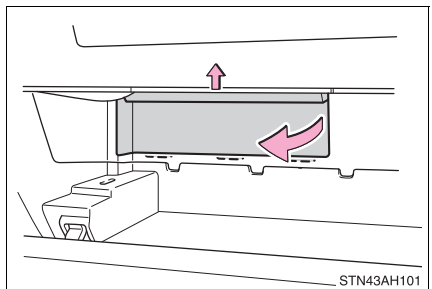

- 5 Remove the filter cover.

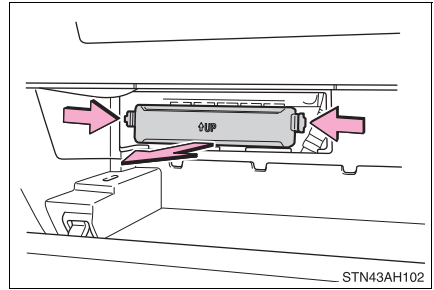

- 6 Pull the filter out of the filter outlet.

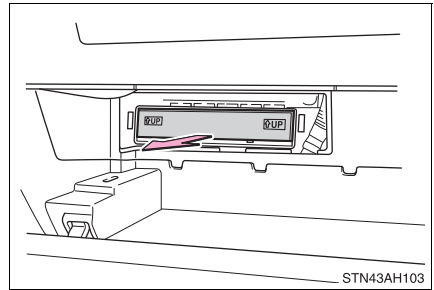

Replacement method

Remove the air conditioning filter and replace it with a new one.

The “↑UP” marks shown on the filter should be pointing up.

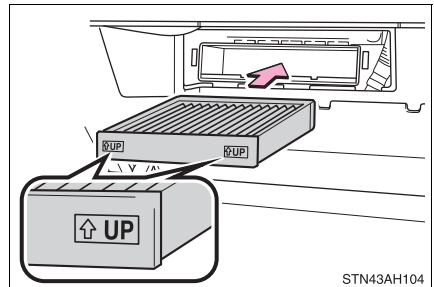

■ Checking interval

Inspect and replace the air conditioning filter according to the maintenance schedule. In dusty areas or areas with heavy traffic flow, early replacement may be required. (For scheduled maintenance information, please refer to the “Scheduled Maintenance Guide” or “Owner’s Manual Supplement”.)

■ If air flow from the vents decreases dramatically

The filter may be clogged. Check the filter and replace if necessary.

**NOTICE****■ When using the air conditioning system**

Make sure that a filter is always installed.

Using the air conditioning system without a filter may cause damage to the system.

Wireless remote control battery*

Replace the battery with a new one if it is depleted.

You will need the following items:

Lithium battery CR2032

Replacing the battery

- 1 Remove the cover using a coin protected with tape, etc.

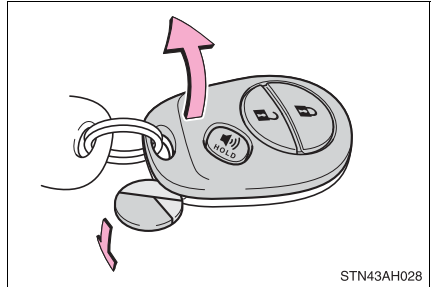

- 2 Remove the depleted battery.
Insert a new battery with the “+” terminal facing up.

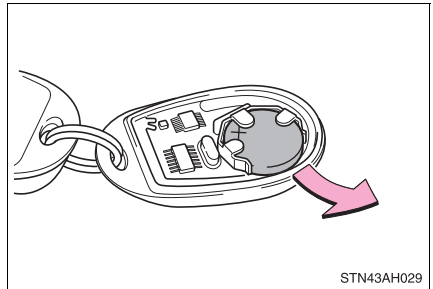

*: If equipped

■ Use a CR2032 lithium battery

- Batteries can be purchased at your Toyota dealer, local electrical appliance shops or camera stores.
- Replace only with the same or equivalent type recommended by the manufacturer.
- Dispose of used batteries according to local laws.

■ If the key battery is depleted

The following symptoms may occur:

- The wireless remote control will not function properly.
- The operational range will be reduced.

**CAUTION****■ Removed battery and other parts**

Keep away from children. These parts are small and if swallowed by a child, they can cause choking. Failure to do so could result in death or serious injury.

**NOTICE****■ For normal operation after replacing the battery**

Observe the following precautions to prevent accidents:

- Always work with dry hands.
Moisture may cause the battery to rust.
- Do not touch or move any other component inside the remote control.
- Do not bend either of the battery terminals.

Checking and replacing fuses

If any of the electrical components do not operate, a fuse may have blown. If this happens, check and replace the fuses as necessary.

- 1 Turn the engine switch off.
- 2 Open the fuse box cover.

► Engine compartment

Push the tab in and lift the cover off.

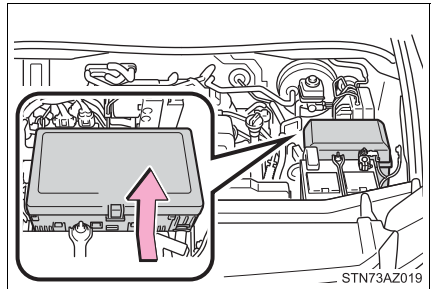

► Under the instrument panel

Remove the cover.

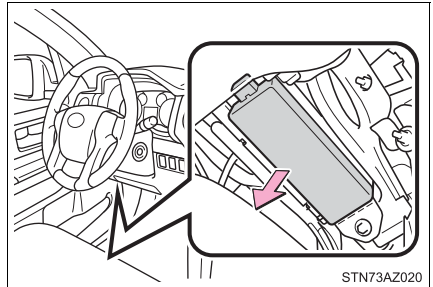

- 3 Remove the fuse with the pull-out tool.

Only type A fuse can be removed using the pullout tool.

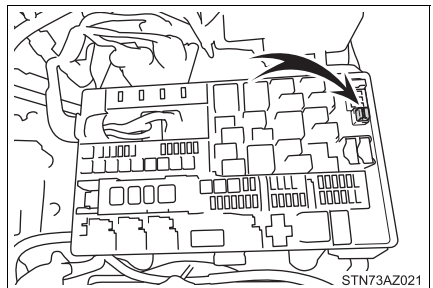

4 Check if the fuse is blown.

① Normal fuse

② Blown fuse

Type A and B:

Replace the blown fuse with a new fuse of an appropriate amperage rating. The amperage rating can be found on the fuse box cover.

Type C:

Contact your Toyota dealer.

► Type A

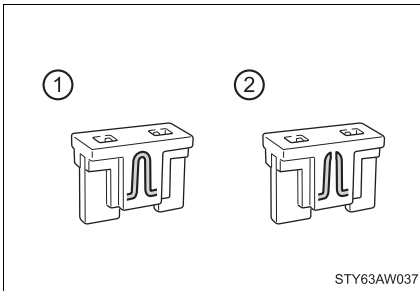

► Type B

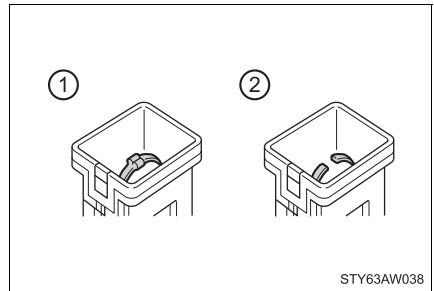

► Type C

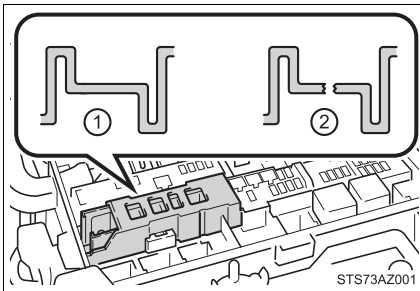

■ **After a fuse is replaced**

- If the lights do not turn on even after the fuse has been replaced, a bulb may need replacement. (→P. 439)
- If the replaced fuse blows again, have the vehicle inspected by your Toyota dealer.

■ **If there is an overload in a circuit**

The fuses are designed to blow, protecting the wiring harness from damage.

**CAUTION****■ To prevent system breakdowns and vehicle fire**

Observe the following precautions.

Failure to do so may cause damage to the vehicle, and possibly a fire or injury.

- Never use a fuse of a higher amperage rating than that indicated, or use any other object in place of a fuse.
- Always use a genuine Toyota fuse or equivalent.
Never replace a fuse with a wire, even as a temporary fix.
- Do not modify the fuses or fuse boxes.

**NOTICE****■ Before replacing fuses**

Have the cause of electrical overload determined and repaired by your Toyota dealer as soon as possible.

Light bulbs

You may replace the following bulbs by yourself. The difficulty level of replacement varies depending on the bulb. If necessary bulb replacement seems difficult to perform, contact your Toyota dealer.

For more information about replacing other light bulbs, contact your Toyota dealer.

Preparing for light bulb replacement

Check the wattage of the light bulb to be replaced. (→P. 515)

Bulb locations

■ Front

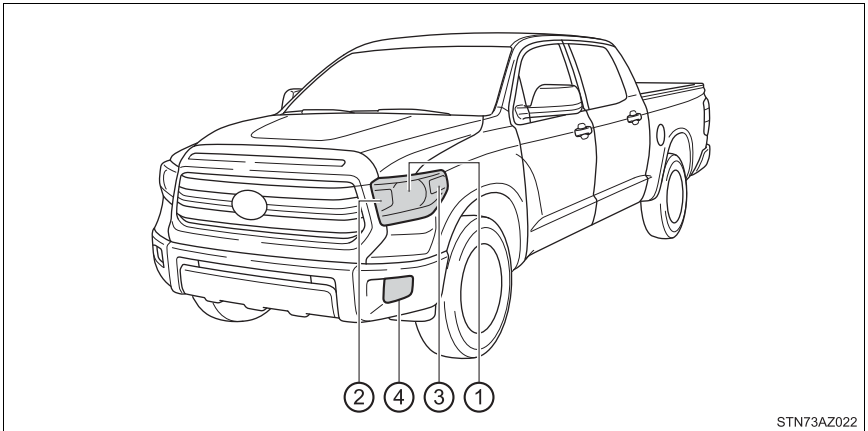

- ① Headlights
- ② Front turn signal lights/parking lights (bulb type)/daytime running lights (if equipped on bulb type)
- ③ Front side marker lights
- ④ Fog lights (if equipped)

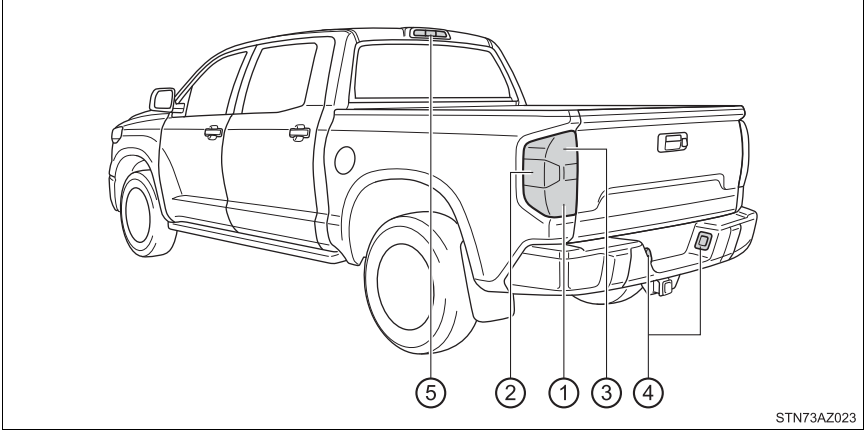
■ Rear

STN73AZ023

- ① Stop/tail and rear side marker lights
- ② Back up lights
- ③ Rear turn signal lights
- ④ License plate lights
- ⑤ High mounted stoplight and cargo lamps

Replacing light bulbs

■ Headlights

- 1 To allow enough working space, turn the steering wheel to the opposite side of the bulb to be replaced. Remove the screws and fender liner clips.

Turn the steering wheel to the left when replacing the right side light bulb, and turn the steering wheel to the right when replacing the left side light bulb.

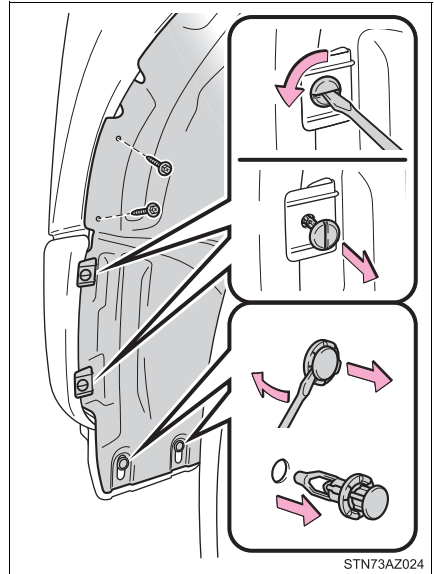

- 2 Open the fender liner and unplug the connector.



- 3 Remove the rubber cover.

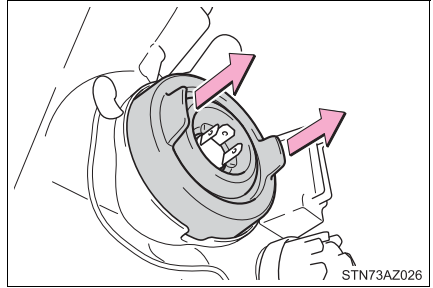

- 4 Release the bulb retaining spring.

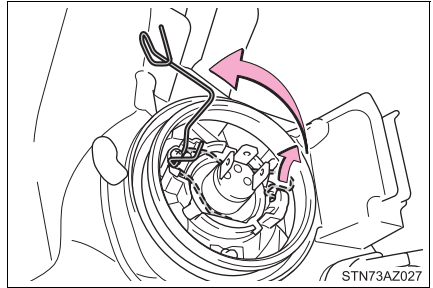

- 5 Remove the bulb.

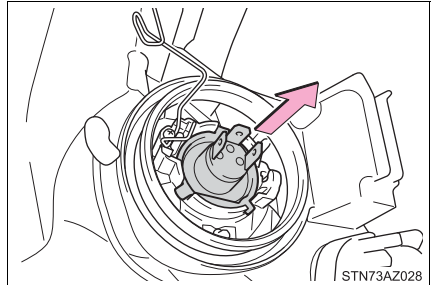

- 6 Set the new light bulb.

To install a new bulb, align tabs of the bulb with the cutouts of the mounting hole.

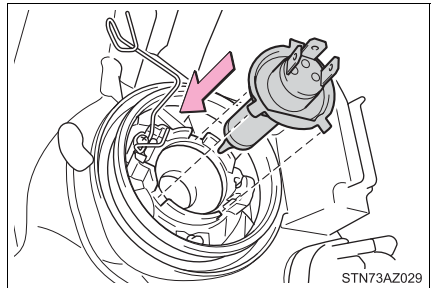

- 7 Install the bulb retaining spring.

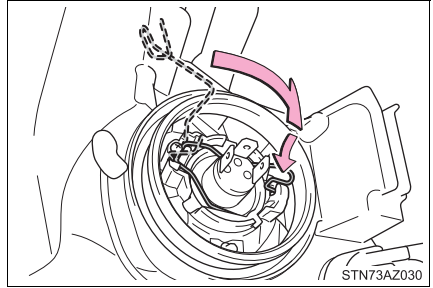

- 8 Install the rubber cover.
When installing the rubber cover: →P. 453

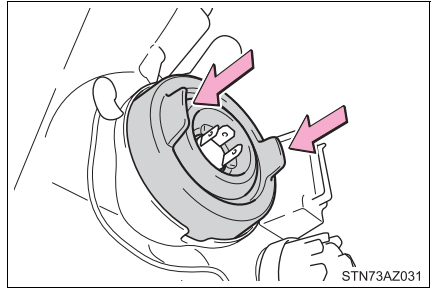

- 9 Install the connector.

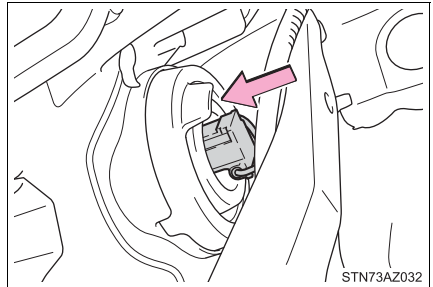

- 10 Reinstall the fender liner and install the screws and clips.

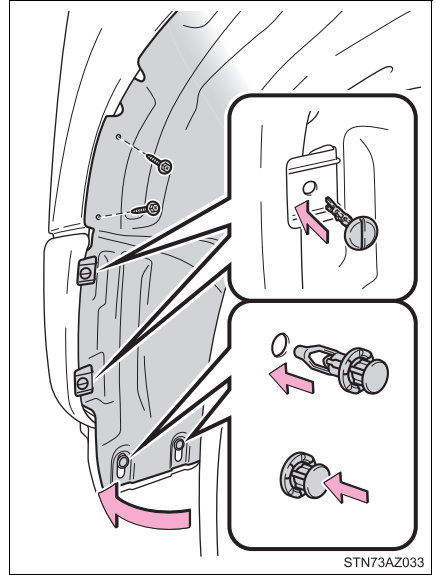

■ Front turn signal/parking lights (bulb type)/daytime running lights (if equipped on bulb type)

- 1 Turn the bulb base counter-clockwise.

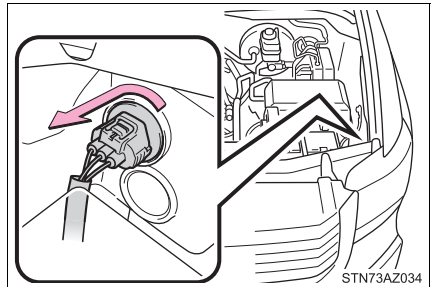

- 2 Remove the light bulb.

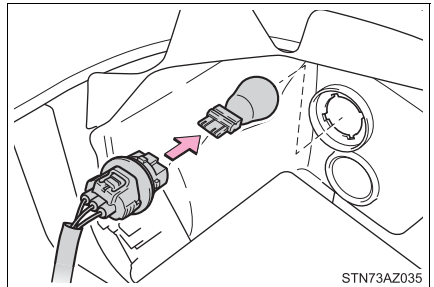

■ Front side marker lights

- 1 To allow enough working space, turn the steering wheel to the opposite side of the bulb to be replaced. Remove the screws and fender liner clips.

Turn the steering wheel to the left when replacing the right side light bulb, and turn the steering wheel to the right when replacing the left side light bulb.

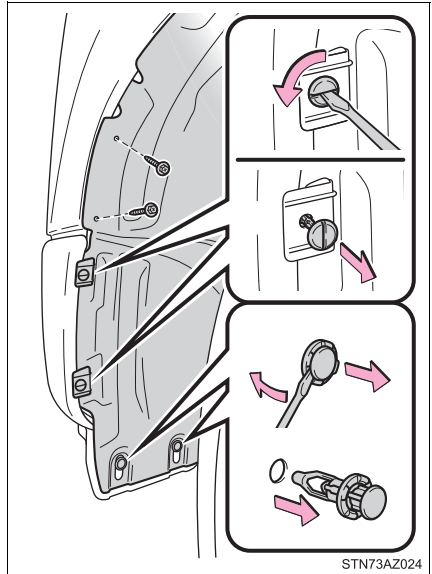

STN73AZ024

- 2 Open the fender liner and turn the bulb base counter-clockwise.

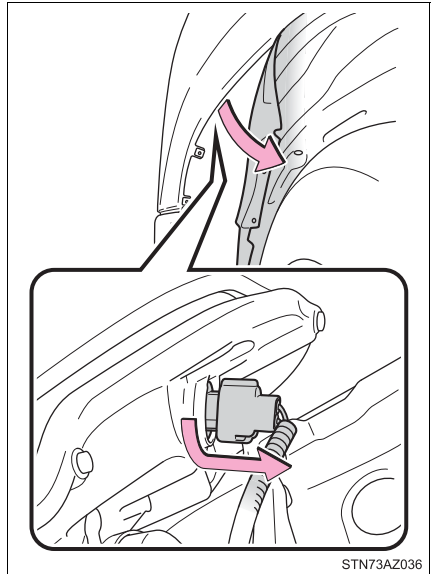

STN73AZ036

- 3 Remove the light bulb.

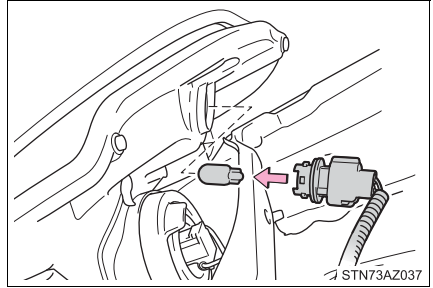

- 4 Reinstall the fender liner and install the screws and clips.

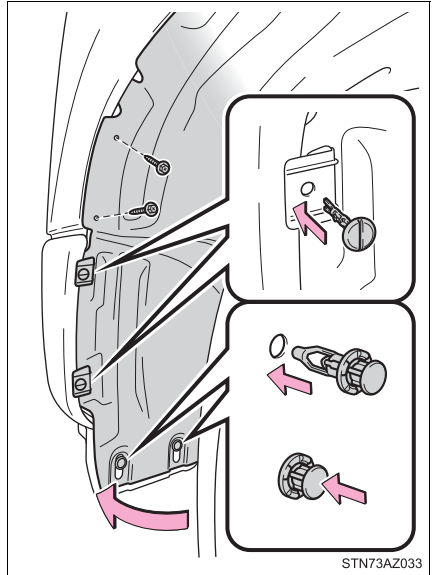

■ Front fog lights (if equipped)

- 1 To allow enough working space, turn the steering wheel to the opposite side of the bulb to be replaced. Remove the fender liner clips.

Turn the steering wheel to the left when replacing the right side light bulb, and turn the steering wheel to the right when replacing the left side light bulb.

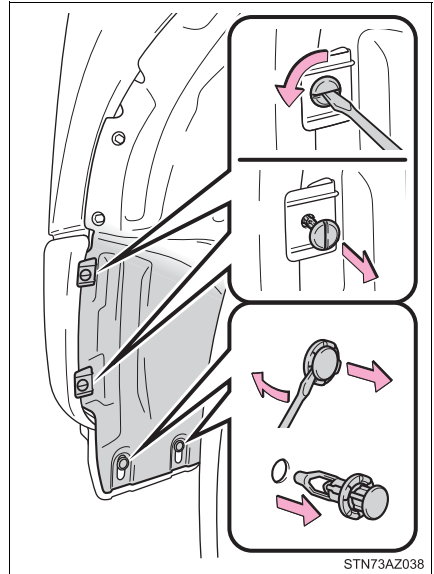

- 2 Open the fender liner and unplug the connector while depressing the lock release.

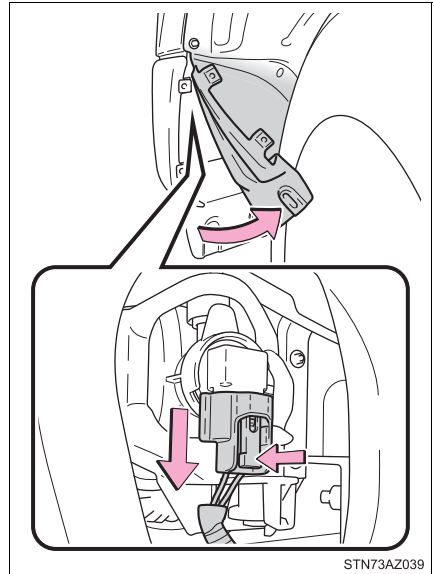

- 3** Turn the bulb counterclockwise.

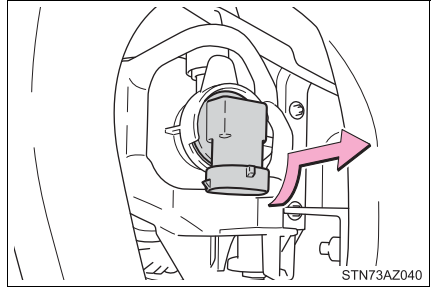

- 4** Set the new light bulb.

Align the 3 tabs on the light bulb with the mounting, and insert. Turn it clockwise to set.

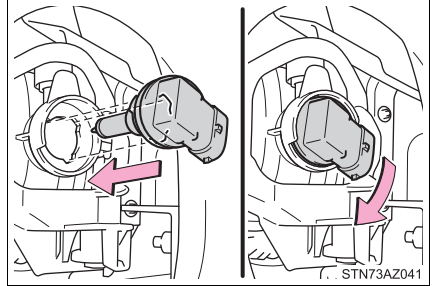

- 5** Install the connector.

Shake the bulb base gently to check that it is not loose, turn the fog lights, on once and visually confirm that no light is leaking through the mounting.

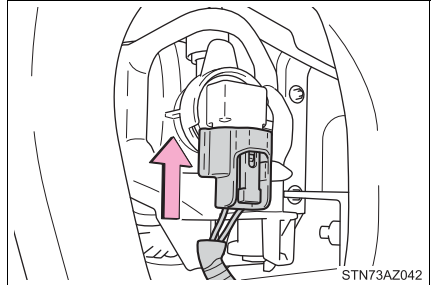

- 6 Reinstall the fender liner and install the clips.

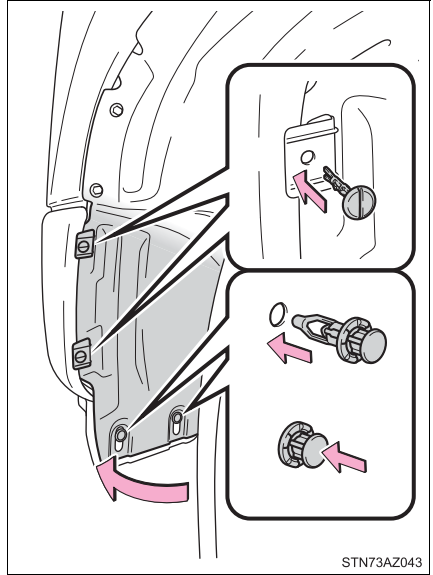

■ Stop/tail and rear side marker lights, back-up lights and rear turn signal lights

- 1 Remove the bolts and rear combination assembly.

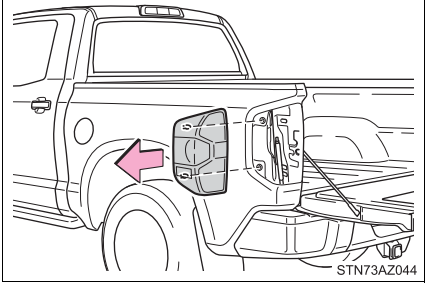
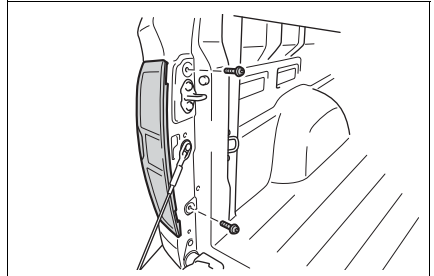

- 2 Turn the bulb bases counter-clockwise.

- ① Rear turn signal light
- ② Back-up light
- ③ Stop/tail and rear side marker light

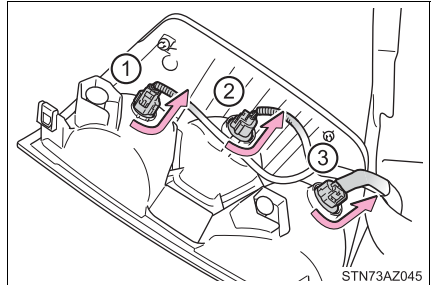

- 3 Remove the light bulb.

- ① Rear turn signal light
- ② Back-up light
- ③ Stop/tail and rear side marker light

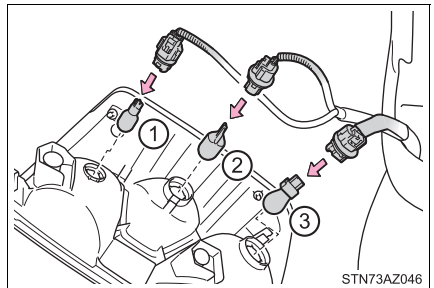

■ License plate lights

- 1 Turn the bulb base counter-clockwise.

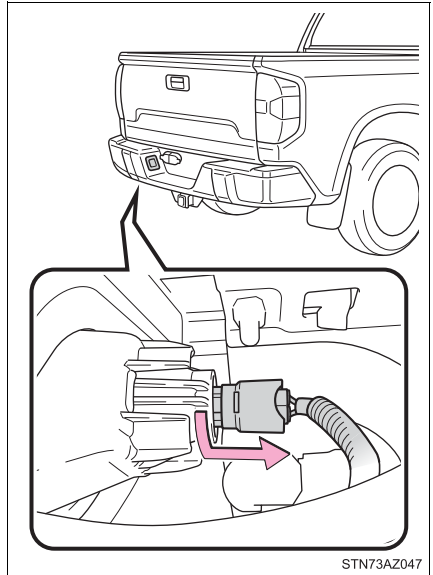

- 2 Remove the light bulb.

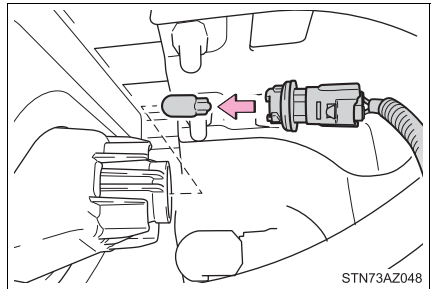

■ High mounted stoplight and cargo lamps

- 1 Remove the screws and cover.

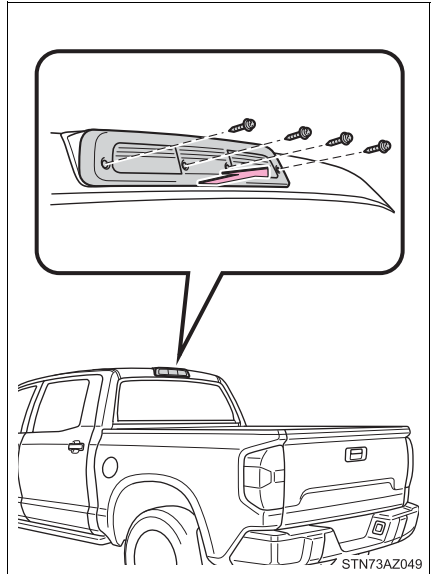

- 2 Remove the light bulb.

- ① High mounted stoplight
- ② Cargo lamps

When reinstalling the outer lens, confirm that the packing is properly seated in the groove on the housing.

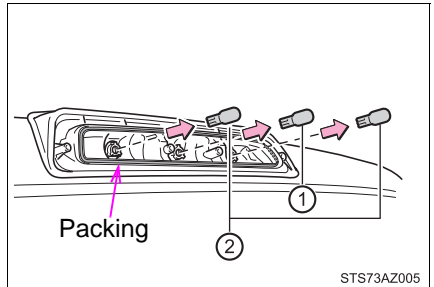

■ Replacing the following bulbs

If any of the lights listed below has burnt out, have it replaced by your Toyota dealer.

- Parking lights (LED type)
- Daytime running lights (LED type)
- Side turn signal lights (if equipped)
- Outer foot lights (if equipped)

■ When installing the rubber cover of the headlight

Ensure the rubber cover is securely attached.

- ① Fit the rubber cover outer circumference in firmly.
- ② Fit the rubber cover around the light bulb in until the light bulb plug can be seen.

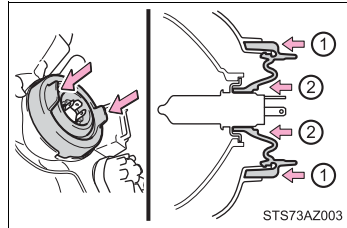

■ When replacing the light bulbs

Confirm that they are properly engaged with the bulb base and that there is no light leakage.

■ LED Lights

The parking lights (LED type), daytime running light (LED type) and side turn signal lights consist of a number of LEDs. If any of the LEDs burn out, take your vehicle to your Toyota dealer to have the light replaced.

■ Condensation build-up on the inside of the lens

Temporary condensation build-up on the inside of the headlight lens does not indicate a malfunction. Contact your Toyota dealer for more information in the following situations:

- Large drops of water have built up on the inside of the lens.
- Water has built up inside the headlight.

**CAUTION****■ Replacing light bulbs**

- Turn off the lights. Do not attempt to replace the bulb immediately after turning off the lights.
The bulbs become very hot and may cause burns.
- Do not touch the glass portion of the light bulb with bare hands. When it is unavoidable to hold the glass portion, use and hold with a clean dry cloth to avoid getting moisture and oils on the bulb.
Also, if the bulb is scratched or dropped, it may blow out or crack.
- Fully install light bulbs and any parts used to secure them. Failure to do so may result in heat damage, fire, or water entering the headlight unit. This may damage the lights or cause condensation to build up on the lens.
- Do not attempt to repair or disassemble the bulb, bulb base, electrical wiring, or subcomponents.
Doing so could result in electric shock and serious injury.

■ To prevent damage or fire

- Make sure bulbs are fully seated and locked.
- Check the wattage of the bulb before installing to prevent heat damage.

When trouble arises

8

8-1. Essential information

| | |
|---|-----|
| Emergency flashers | 456 |
| If your vehicle has to be stopped in an emergency | 457 |

8-2. Steps to take in an emergency

| | |
|--|-----|
| If your vehicle needs to be towed | 458 |
| If you think something is wrong | 462 |
| Fuel pump shut off system | 463 |
| If a warning light turns on or a warning buzzer sounds | 464 |
| If a warning message is displayed (vehicles with multi-information display) | 472 |
| If you have a flat tire..... | 475 |
| If the engine will not start..... | 490 |
| If the shift lever cannot be shifted from P..... | 491 |
| If the vehicle battery is discharged | 493 |
| If your vehicle overheats ... | 496 |
| If the vehicle becomes stuck | 498 |

Emergency flashers

The emergency flashers are used to warn other drivers when the vehicle has to be stopped in the road due to a breakdown, etc.

Press the switch.

All the turn signal lights will flash.
To turn them off, press the switch
once again.

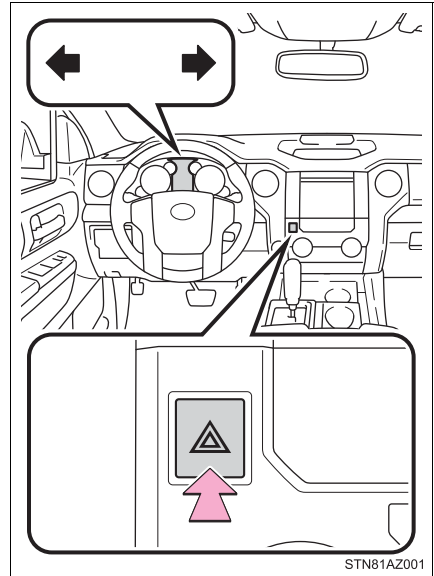

■ Emergency flashers

If the emergency flashers are used for a long time while the engine is not operating, the battery may discharge.

If your vehicle has to be stopped in an emergency

Only in an emergency, such as if it becomes impossible to stop the vehicle in the normal way, stop the vehicle using the following procedure:

- 1 Steadily step on the brake pedal with both feet and firmly depress it.
Do not pump the brake pedal repeatedly as this will increase the effort required to slow the vehicle.
- 2 Shift the shift lever to N.
 - ▶ If the shift lever is shifted to N
- 3 After slowing down, stop the vehicle in a safe place by the road.
- 4 Stop the engine.
 - ▶ If the shift lever cannot be shifted to N
- 3 Keep depressing the brake pedal with both feet to reduce vehicle speed as much as possible.
- 4 Stop the engine by turning the engine switch to the “ACC” position.

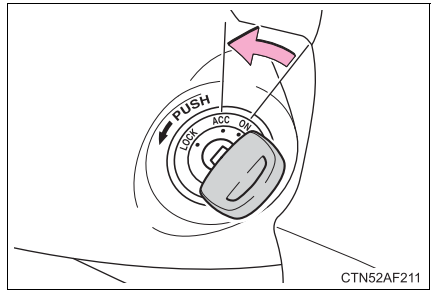

- 5 Stop the vehicle in a safe place by the road.

CAUTION

■ If the engine has to be turned off while driving

- Power assist for the brakes and steering wheel will be lost, making the brake pedal harder to depress and the steering wheel heavier to turn. Decelerate as much as possible before turning off the engine.
- Never attempt to remove the key, as doing so will lock the steering wheel.

If your vehicle needs to be towed

If towing is necessary, we recommend having your vehicle towed by your Toyota dealer or a commercial towing service, using a lift-type truck or flat bed truck.

Use a safety chain system for all towing, and abide by all state/provincial and local laws.

The wheels and axle on the ground must be in good condition. If they are damaged, use a towing dolly or flat bed truck.

Before towing

The following may indicate a problem with your transmission. Contact your Toyota dealer before towing.

- The engine is running but the vehicle will not move.
- The vehicle makes an abnormal sound.

Emergency towing

If a tow truck is not available in an emergency, your vehicle may be temporarily towed using a cable or chain secured to the emergency towing eyelets. This should only be attempted on hard surfaced roads for short distances at low speeds.

A driver must be in the vehicle to steer and operate the brakes. The vehicle's wheels, drive train, axles, steering and brakes must be in good condition.

► Type A

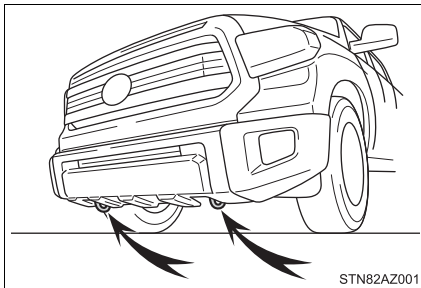

► Type B

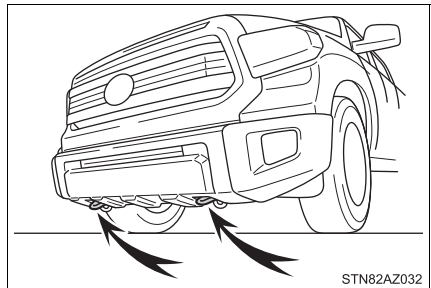

Towing with a sling-type truck

Do not tow with a sling-type truck to prevent body damage.

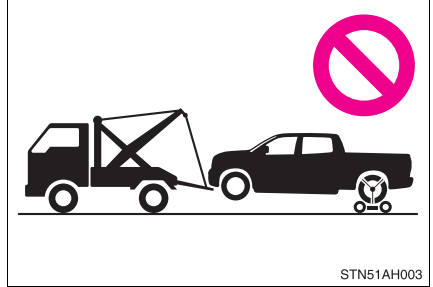

Towing with a wheel-lift type truck

- From the front

Use a towing dolly under the rear wheels.

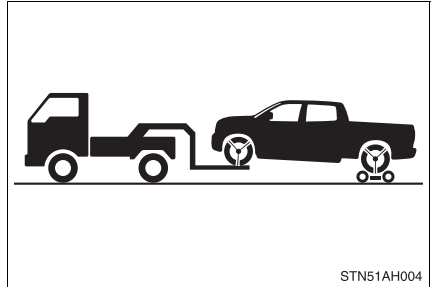

- From the rear (2WD models)

Turn the engine switch to the "ACC" position so that the steering wheel is unlocked.

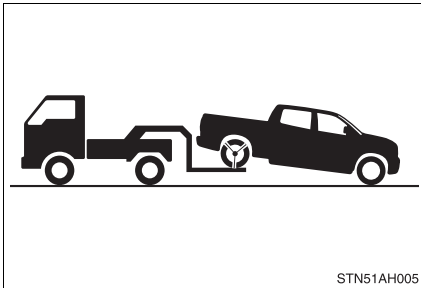

- From the rear (4WD models)

Use a towing dolly under the front wheels.

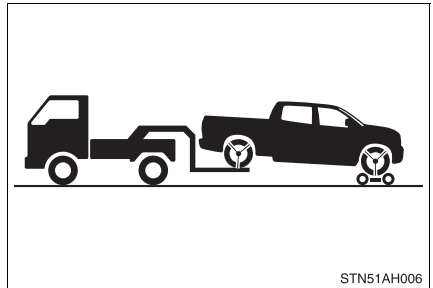

Using a flat bed truck

If you use chains or cables to tie down your vehicle, the angles shaded in black must be 45°.

Do not overly tighten the tie downs or the vehicle may be damaged.

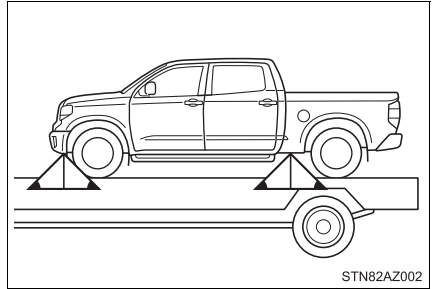

■ Before emergency towing

- 1 Release the parking brake.
- 2 4WD models: Put the front-wheel drive control switch in “2WD”.
- 3 Shift the shift lever to N.
- 4 Turn the engine switch to the “ACC” (engine off) or the “ON” (engine running) position.

▲ CAUTION

Observe the following precautions.
Failure to do so may result in death or serious injury.

■ Caution while towing

- Use extreme caution when towing the vehicle.
Avoid sudden starts or erratic driving maneuvers which place excessive stress on the emergency towing eyelets and the cables or chains. Always be cautious of the surroundings and other vehicles while towing.
- If the engine is not running, the power assist for the brakes and steering will not function, making steering and braking more difficult.

 NOTICE**■ To prevent causing serious damage to the transmission and transfer (4WD models) when towing using a wheel-lift type truck**

2WD models: Never tow this vehicle from the front with the rear wheels on the ground.

4WD models: Never tow this vehicle with any of the wheels in contact with the ground.

■ To prevent damage to the vehicle when towing using a wheel-lift type truck

- Do not tow the vehicle from the rear when the engine switch is in the "LOCK" position or the key is removed. The steering lock mechanism is not strong enough to hold the front wheels straight.

- When raising the vehicle from the rear, ensure adequate ground clearance for towing at the opposite end of the raised vehicle. Without adequate clearance, the vehicle could be damaged while being towed from the rear.

■ To prevent body damage when towing with a sling-type truck

Do not tow with a sling-type truck, either from the front or rear.

■ To prevent causing serious damage to the transmission and transfer in emergency towing (4WD models)

Never tow a vehicle from the rear with four wheels on the ground. This may cause serious damage to the transmission and transfer.

■ Emergency towing eyelet precautions

- Before emergency towing, check that the eyelet is not broken or damaged and that the installation bolts are not loose.

- Fasten the towing cable or chain securely to the eyelet.

- Do not jerk the eyelet. Apply steady and even force.

- To avoid damaging the eyelet, do not pull from the side or at a vertical angle. Always pull straight ahead.

If you think something is wrong

If you notice any of the following symptoms, your vehicle probably needs adjustment or repair. Contact your Toyota dealer as soon as possible.

Visible symptoms

- Fluid leaks under the vehicle.
(Water dripping from the air conditioning after use is normal.)
- Flat-looking tires or uneven tire wear
- Engine coolant temperature gauge needle continually points higher than normal.
- Voltmeter continually points higher or lower than normal
(if equipped)
- Engine oil pressure gauge continually points lower than normal
(if equipped)
- Vehicles without multi-information display:
Automatic transmission fluid temperature warning light comes on
Vehicles with multi-information display:
Automatic transmission fluid temperature warning message is displayed

Audible symptoms

- Changes in exhaust sound
- Excessive tire squeal when cornering
- Strange noises related to the suspension system
- Pinging or other noises related to the engine

Operational symptoms

- Engine misses, stumbling or running roughly
- Appreciable loss of power
- Vehicle pulls heavily to one side when braking
- Vehicle pulls heavily to one side when driving on a level road
- Loss of brake effectiveness, spongy feeling, pedal almost touches the floor

Fuel pump shut off system

To minimize the risk of fuel leakage when the engine stalls or when an airbag inflates upon collision, the fuel pump shut off system stops supply of fuel to the engine.

Follow the procedure below to restart the engine after the system is activated.

- 1 Turn the engine switch to the “ACC” or “LOCK” position.
- 2 Restart the engine.



NOTICE

■ Before starting the engine





Inspect the ground under the vehicle.







If you find that fuel has leaked onto the ground, the fuel system has been damaged and is in need of repair. Do not restart the engine.





If a warning light turns on or a warning buzzer sounds



Calmly perform the following actions if any of the warning lights comes on or flashes. If a light comes on or flashes, but then goes off, this does not necessarily indicate a malfunction in the system. However, if this continues to occur, have the vehicle inspected by your Toyota dealer.

Warning light and warning buzzer list

| Warning light | Warning light/Details/Actions |
|---|---|
|  <p>(U.S.A.)</p>  <p>(Canada)</p> | <p>Brake system warning light (warning buzzer)*¹</p> <ul style="list-style-type: none"> • Low brake fluid • Malfunction in the brake system <p>This light also comes on when the parking brake is not released. If the light turns off after the parking brake is fully released the system is operating normally.</p> <p>→ Immediately stop the vehicle in a safe place and contact your Toyota dealer.</p> |
|  | <p>Charging system warning light</p> <p>Indicates a malfunction in the vehicle's charging system</p> <p>→ Immediately stop the vehicle in a safe place and contact your Toyota dealer.</p> |
|  <p>(If equipped)</p> | <p>Low engine oil pressure warning light</p> <p>Indicates that the engine oil pressure is too low*².</p> <p>→ Immediately stop the vehicle in a safe place and contact your Toyota dealer.</p> |
|  | <p>Malfunction indicator lamp</p> <p>Indicates a malfunction in:</p> <ul style="list-style-type: none"> • The electronic engine control system; • The electronic throttle control system; or • The electronic automatic transmission control system. <p>→ Have the vehicle inspected by your Toyota dealer immediately.</p> |

| Warning light | Warning light/Details/Actions |
|---|--|
|  | <p>SRS warning light</p> <p>Indicates a malfunction in:</p> <ul style="list-style-type: none"> • The SRS airbag system; • The front passenger occupant classification system; or • The seat belt pretensioner system <p>→ Have the vehicle inspected by your Toyota dealer immediately.</p> |
|  <p>(U.S.A.)</p>  <p>(Canada)</p> | <p>ABS warning light</p> <p>Indicates a malfunction in:</p> <ul style="list-style-type: none"> • The ABS; or • The brake assist system <p>→ Have the vehicle inspected by your Toyota dealer immediately.</p> |
|  | <p>Slip indicator light</p> <p>Indicates a malfunction in:</p> <ul style="list-style-type: none"> • The VSC; • The TRAC; • The A-TRAC; or • The AUTO LSD system. <p>→ Have the vehicle inspected by your Toyota dealer immediately.</p> |
|  <p>(Flashes)</p> | <p>Cruise control indicator light</p> <p>Indicates a malfunction in the cruise control system.</p> <p>→ Have the vehicle inspected by your Toyota dealer immediately.</p> |
|  <p>(If equipped)</p> | <p>BSM warning light</p> <p>Indicates a malfunction in the Blind Spot Monitor.</p> <p>→ Have the vehicle inspected by your Toyota dealer immediately.</p> |

| Warning light | Warning light/Details/Actions |
|--|--|
|  <p>(If equipped)</p> | <p>Automatic transmission fluid temperature warning light</p> <p>Comes on: Indicates that the automatic transmission fluid temperature is too high. → Stop the vehicle in a safe place, shift the shift lever to P and wait until the light goes off. If the light goes off, you may start the vehicle again. If the light does not go off, contact your Toyota dealer.</p> <p>Flashes: Indicates a malfunction in the automatic transmission system. → Have the vehicle inspected by your Toyota dealer immediately.</p> |
|  | <p>Open door warning light (warning buzzer)*³ Indicates that one or more of the doors is not fully closed. → Check that all the doors are closed.</p> |
|  | <p>Low fuel level warning light Indicates remaining fuel is approximately 4.0 gal. (15 L, 3.3 Imp.gal.) or less → Refuel the vehicle.</p> |
|  | <p>Seat belt reminder light (warning buzzer)*⁴ Warns the driver and/or front passenger to fasten their seat belts → Fasten the seat belt. If the front passenger's seat is occupied, the front passenger's seat belt also needs to be fastened to make the warning light (warning buzzer) turn off.</p> |
|  <p>(If equipped)</p> | <p>Master warning light A buzzer sounds and the warning light comes on and flashes to indicate that the master warning system has detected a malfunction. → P. 472</p> |

| Warning light | Warning light/Details/Actions |
|--|--|
|  | <p>Tire pressure warning light</p> |
| | <p>When the light comes on: Low tire inflation pressure such as</p> <ul style="list-style-type: none"> • Natural causes (→P. 469) • Flat tire (→P. 475) <p>→ Adjust the tire inflation pressure to the specified level. The light will turn off after a few minutes. In case the light does not turn off even if the tire inflation pressure is adjusted, have the system checked by your Toyota dealer.</p> |
| | <p>When the light comes on after blinking for 1 minute: Malfunction in the tire pressure warning system. → Have the system checked by your Toyota dealer.</p> |
|  <p>(If equipped)</p> | <p>Low windshield washer fluid warning light Low level of washer fluid → Fill the tank.</p> |
|  | <p>Maintenance required reminder light Indicates that maintenance is required according to the driven distance on the maintenance schedule.*5</p> |
| | <p>Illuminates for about 3 seconds and then flashes for about 15 seconds approximately 4500 miles (7200 km) after the maintenance data has been reset. → If necessary, perform maintenance.</p> |
| | <p>Comes on and remains on if the distance driven exceeds 5000 miles (8000 km) after the maintenance data has been reset. (The indicator will not work properly unless the maintenance data has been reset.) → Perform the necessary maintenance. Please reset the maintenance data after the maintenance is performed. (→P. 398)</p> |

*1: Parking brake engaged warning buzzer:

A buzzer will sound if the vehicle is driven at a speed of approximately 3 mph (5 km/h) or more.

*2: The light may come on when the oil level is extremely low. It is not designed to indicate low oil level, and the oil level must be checked using the engine oil level dipstick.

*3. Open door warning buzzer:

A buzzer will sound if the vehicle reaches a speed of 3 mph (5 km/h) or more with any door open.

*4. Driver's seat belt buzzer:

The driver's seat belt buzzer sounds to alert the driver that his or her seat belt is not fastened. Once the engine switch is turned to the "ON" or "START" position mode, the buzzer sounds for 6 seconds. If the vehicle reaches a speed of 12 mph (20 km/h), the buzzer sounds once. If the seat belt is still unfastened after 30 seconds, the buzzer will sound intermittently for 10 seconds. Then, if the seat belt is still unfastened, the buzzer will sound in a different tone for 20 more seconds.

Front passenger's seat belt buzzer:

The front passenger's seat belt buzzer sounds to alert the front passenger that his or her seat belt is not fastened. The buzzer sounds once if the vehicle reaches a speed of 12 mph (20 km/h). If the seat belt is still unfastened after 30 seconds, the buzzer will sound intermittently for 10 seconds. Then, if the seat belt is still unfastened, the buzzer will sound in a different tone for 20 more seconds.

*5. Refer to the separate "Scheduled Maintenance Guide" or "Owner's Manual Supplement" for the maintenance interval applicable to your vehicle.

■ SRS warning light

This warning light system monitors the airbag sensor assembly, front impact sensors, side impact sensors (front door), side impact sensors (front), side impact sensors (rear), driver's seat position sensor, driver's seat belt buckle switch, front passenger occupant classification system (ECU and sensors), "AIR BAG ON" indicator light, "AIR BAG OFF" indicator light, front passenger's seat belt buckle switch, seat belt pretensioners assemblies, airbags, interconnecting wiring and power sources. (→P. 40)

■ Front passenger detection sensor, seat belt reminder and warning buzzer

- If luggage is placed on the front passenger seat, the front passenger detection sensor may cause the warning light to flash and the warning buzzer to sound even if a passenger is not sitting in the seat.
- If a cushion is placed on the seat, the sensor may not detect a passenger, and the warning light may not operate properly.

■ If the malfunction indicator lamp comes on while driving

First check the following:

- Is the fuel tank empty?
If it is, fill the fuel tank immediately.
- Is the fuel tank cap loose?
If it is, tighten it securely.

The light will go off after several driving trips.

If the light does not go off even after several trips, contact your Toyota dealer as soon as possible.

■ When the tire pressure warning light comes on

Check the tire inflation pressure and adjust to the appropriate level. Pushing the tire pressure warning reset switch will not turn off the tire pressure warning light.

■ The tire pressure warning light may come on due to natural causes

The tire pressure warning light may come on due to natural causes such as natural air leaks and tire inflation pressure changes caused by temperature. In this case, adjusting the tire inflation pressure will turn off the warning light (after several minutes).

■ When a tire is replaced with a spare tire

The temporary spare tire is not equipped with a tire pressure warning valve and transmitter. If a tire goes flat, the tire pressure warning light will not turn off even though the flat tire has been replaced with the temporary spare tire. Replace the temporary spare tire with the repaired tire and adjust the tire inflation pressure. The tire pressure warning light will go off after several minutes.

■ Conditions that the tire pressure warning system may not function properly

→P. 421

■ If the tire pressure warning light frequently comes on after blinking for 1 minute

If the tire pressure warning light frequently comes on after blinking for 1 minute when the engine switch is turned to "ON" position, have it checked by your Toyota dealer.

■ Warning buzzer

In some cases, the buzzer may not be heard because of noisy place or an audio sound.

**CAUTION****■ If both the ABS and the brake system warning lights remain on**

Stop your vehicle in a safe place immediately and contact your Toyota dealer. The vehicle will become extremely unstable during braking, and the ABS system may fail, which could cause an accident resulting in death or serious injury.

■ If the tire pressure warning light comes on

Be sure to observe the following precautions. Failure to do so could cause a loss of vehicle control and result in death or serious injury.

- Stop your vehicle in a safe place as soon as possible. Adjust the tire inflation pressure immediately.
- If the tire pressure warning light comes on even after tire inflation pressure adjustment, it is probable that you have a flat tire. Check the tires. If a tire is flat, change it with the spare tire and have the flat tire repaired by the nearest Toyota dealer.
- Avoid abrupt maneuvering and braking. If the vehicle tires deteriorate, you could lose control of the steering wheel or the brakes.

■ If a blowout or sudden air leakage should occur

The tire pressure warning system may not activate immediately.

■ Maintenance of the tires

Each tire, including the spare (if provided), should be checked monthly when cold and inflated to the inflation pressure recommended by the vehicle manufacturer on the vehicle placard or tire inflation pressure label (tire and load information label). (If your vehicle has tires of a different size than the size indicated on the vehicle placard or tire inflation pressure label [tire and load information label], you should determine the proper tire inflation pressure for those tires.)

As an added safety feature, your vehicle has been equipped with a tire pressure monitoring system (TPMS-tire pressure warning system) that illuminates a low tire pressure telltale (tire pressure warning light) when one or more of your tires is significantly under-inflated. Accordingly, when the low tire pressure telltale (tire pressure warning light) illuminates, you should stop and check your tires as soon as possible, and inflate them to the proper pressure. Driving on a significantly under-inflated tire causes the tire to overheat and can lead to tire failure. Under-inflation also reduces fuel efficiency and tire tread life, and may affect the vehicle's handling and stopping ability.

 CAUTION

Please note that the TPMS (tire pressure warning system) is not a substitute for proper tire maintenance, and it is the driver's responsibility to maintain correct tire pressure, even if under-inflation has not reached the level to trigger illumination of the TPMS low tire pressure telltale (tire pressure warning light).

Your vehicle has also been equipped with a TPMS (tire pressure warning system) malfunction indicator to indicate when the system is not operating properly. The TPMS (tire pressure warning system) malfunction indicator is combined with the low tire pressure telltale (tire pressure warning light). When the system detects a malfunction, the telltale will flash for approximately one minute and then remain continuously illuminated. This sequence will continue upon subsequent vehicle start-ups as long as the malfunction exists. When the malfunction indicator is illuminated, the system may not be able to detect or signal low tire pressure as intended.

TPMS (tire pressure warning system) malfunctions may occur for a variety of reasons, including the installation of replacement or alternate tires or wheels on the vehicle that prevent the TPMS (tire pressure warning system) from functioning properly. Always check the TPMS (tire pressure warning system) malfunction telltale after replacing one or more tires or wheels on your vehicle to ensure that the replacement or alternate tires and wheels allow the TPMS (tire pressure warning system) to continue to function properly.

 NOTICE**■ Precaution when installing a different tire**

When differently constructed tires or tires of different makers, models or tread patterns are installed, the tire pressure warning system may not operate properly.

If a warning message is displayed (vehicles with multi-information display)

If a warning is shown on the multi-information display, stay calm and perform the following actions:

① Master warning light



The master warning light also comes on or flashes in order to indicate that a message is currently being displayed on the multi-information display.

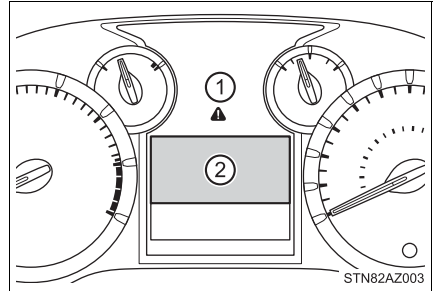







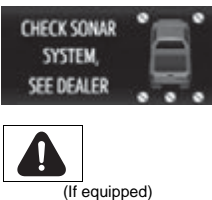

② Multi-information display



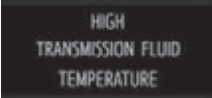







If any of the warning light comes on again after the following actions have been performed, contact your Toyota dealer.

Warning message and warning buzzer list

| Warning message | Details/Actions |
|---|--|
|  <p>ENGINE COOLANT OVERTEMP</p> <p>! (Warning Light)</p> | <p>Indicates that the engine coolant temperature is too high</p> <p>A buzzer also sounds.</p> <p>→ Immediately stop the vehicle in a safe place and contact your Toyota dealer.</p> |
|  <p>CHECK TRANSMISSION SYSTEM, SEE DEALER</p> <p>! (Warning Light)</p> | <p>Indicates a malfunction in the automatic transmission system</p> <p>A buzzer also sounds.</p> <p>→ Have the vehicle inspected by your Toyota dealer immediately.</p> |
|  <p>CHECK SONAR SYSTEM, SEE DEALER</p> <p>! (Warning Light)</p> <p>(If equipped)</p> | <p>Indicates a malfunction in the intuitive parking assist</p> <p>The malfunctioning assist-sensor is flashing.</p> <p>→ Have the vehicle inspected by your Toyota dealer immediately.</p> |

| Warning message | Details/Actions |
|--|---|
|   (If equipped) | <p>Indicates a malfunction in the Blind Spot Monitor</p> <p>A buzzer also sounds.</p> <p>→ Have the vehicle inspected by your Toyota dealer immediately.</p> |
|   | <p>Indicates that one or more of the doors is not fully closed</p> <p>The system also indicates which doors are not fully closed.</p> <p>If the vehicle reaches a speed of 3 mph (5 km/h),  flashes and a buzzer sounds to indicate that the door(s) are not yet fully closed.</p> <p>→ Make sure that all the doors are closed.</p> |
|   | <p>Indicates that the automatic transmission fluid temperature is too high</p> <p>A buzzer also sounds.</p> <p>→ Stop the vehicle in a safe place, shift the shift lever to P and wait until the light goes off.</p> <p>If the light goes off, you may start the vehicle again. If the light does not go off, contact your Toyota dealer.</p> |
|   BRAKE (U.S.A.) (Canada) | <p>Indicates that the parking brake is still engaged</p> <p>If the vehicle reaches a speed of 3 mph (5 km/h),  flashes and a buzzer sounds to indicate that the parking brake is still engaged.</p> <p>→ Release the parking brake.</p> |
|  | <p>Indicates that the washer fluid level is low</p> <p>→ Add washer fluid.</p> |

| Warning message | Details/Actions |
|---|---|
|   (If equipped) | <p>Indicates that intuitive parking assist is dirty or covered with ice → Clean the sensor.</p> |
|   (If equipped) | <p>Indicates that the Blind Spot Monitor sensors or the surrounding area on the bumper is dirty or covered with ice A buzzer also sounds. → Clean the sensor and its surrounding area on the bumper.</p> |
|   | <p>Indicates remaining fuel is approximately 4.0 gal. (15 L, 3.3 Imp.gal.) or less A buzzer also sounds. → Refuel the vehicle.</p> |
|  (U.S.A.) | <p>Indicates that all maintenance according to the driven distance on the maintenance schedule* should be performed soon. Comes on approximately 4500 miles (7200 km) after the maintenance data has been reset. → If necessary, perform maintenance.</p> |
|  (U.S.A.) | <p>Indicates that all maintenance is required to correspond to the driven distance on the maintenance schedule*. Comes on approximately 5000 miles (8000 km) after the maintenance data has been reset. (The indicator will not work properly unless the maintenance data has been reset.) → Perform the necessary maintenance. Please reset the maintenance data after the maintenance is performed. (→P. 398)</p> |

*: Refer to the separate “Scheduled Maintenance Guide” or “Owner’s Manual Supplement” for the maintenance interval applicable to your vehicle.

If you have a flat tire

Remove the flat tire and replace it with the spare tire provided.

For details about tires: →P. 417

CAUTION

■ If you have a flat tire

Do not continue driving with a flat tire.

Driving even a short distance with a flat tire can damage the tire and the wheel beyond repair, which could result in an accident.

Before jacking up the vehicle

- Stop the vehicle on a hard, flat surface.
- Set the parking brake.
- Shift the shift lever to P.
- Stop the engine.
- Turn on the emergency flashers. (→P. 456)

Location of the spare tire, jack and tools

■ Spare tire

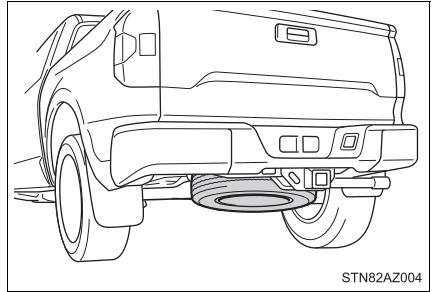

■ Jack and tools

- ① Jack
- ② Tool bag

▶ Regular Cab models

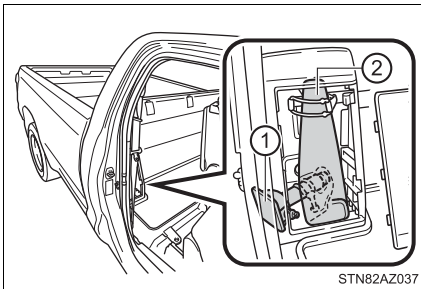

▶ Double Cab models without storage box

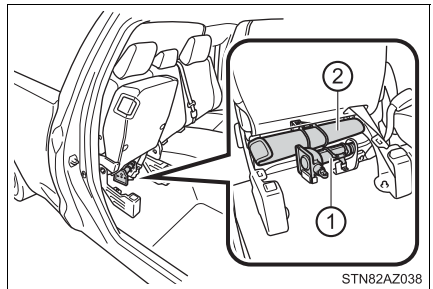

▶ Double Cab models with storage box

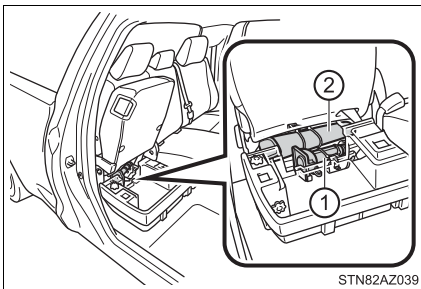

▶ CrewMax models

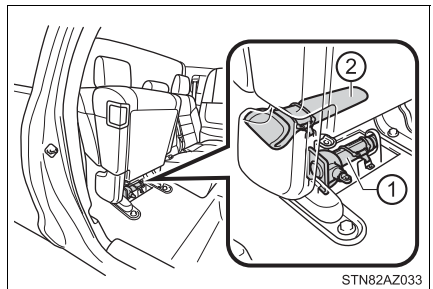

 **CAUTION****■ Using the tire jack**

Observe the following precautions.

Improper use of the tire jack may cause the vehicle to suddenly fall off the jack, leading to death or serious injury.

- Do not use the tire jack for any purpose other than replacing tires or installing and removing tire chains.
- Only use the tire jack that comes with this vehicle for replacing a flat tire.
Do not use it on other vehicles, and do not use other tire jacks for replacing tires on this vehicle.
- Put the jack properly in its jack point.
- Do not put any part of your body under the vehicle while it is supported by the jack.
- Do not start the engine or drive the vehicle while the vehicle is supported by the jack.
- Do not raise the vehicle while someone is inside.
- When raising the vehicle, do not put an object on or under the jack.
- Do not raise the vehicle to a height greater than that required to replace the tire.
- Use a jack stand if it is necessary to get under the vehicle.
- When lowering the vehicle, make sure that there is no-one near the vehicle. If there are people nearby, warn them vocally before lowering.

■ Using the jack handle

Insert the square head securely until you hear a click to prevent the extension parts from coming apart unexpectedly.

Taking out the jack and tool bag (Regular Cab models)

- 1 Pull the lever and fold down the seatback.

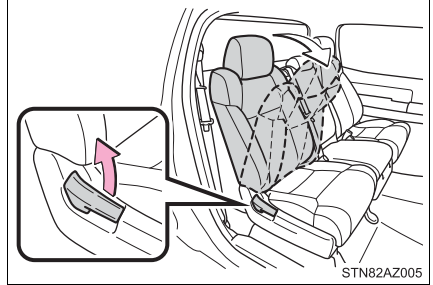

- 2 Remove the cover.

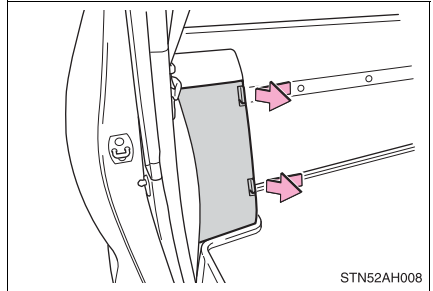

- 3 Unhook the rubber band and remove the tool bag.

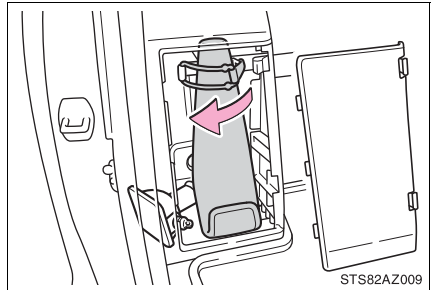

- 4 Unhook the rubber band and take out the jack.

- ① For loosening
- ② For tightening

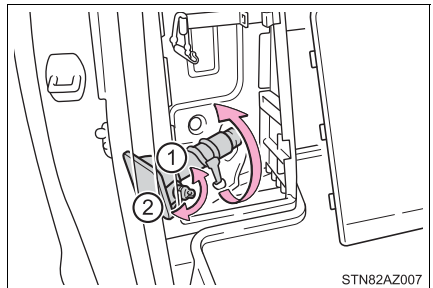

Taking out the jack and tool bag (Double Cab models)

- 1 Pull up the lever and raise the bottom cushion up.

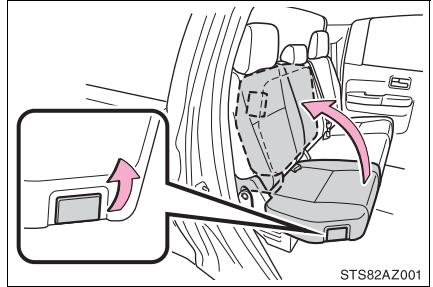

- 2 On vehicles with storage box, turn the knob to the "OPEN" direction and remove the lid.

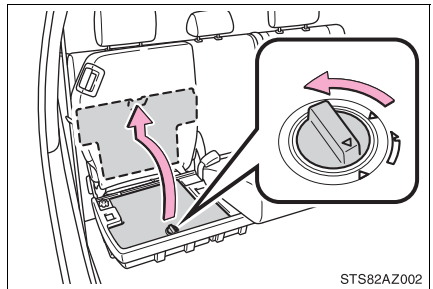

- 3 On vehicles with storage box, remove the jack cover panel.

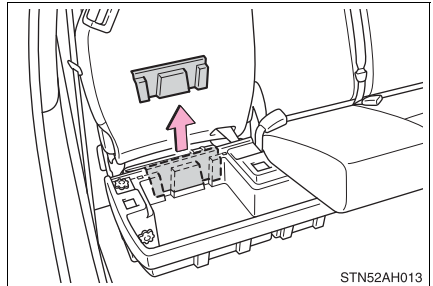

- 4 Unhook the rubber band and take out the jack.

- ① For loosening
- ② For tightening

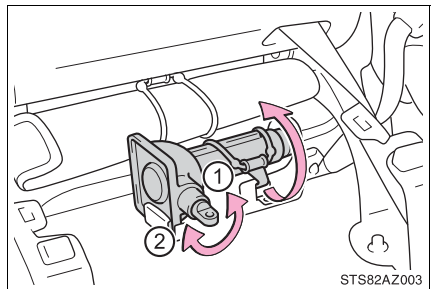

- 5 Unhook the rubber band and remove the tool bag.

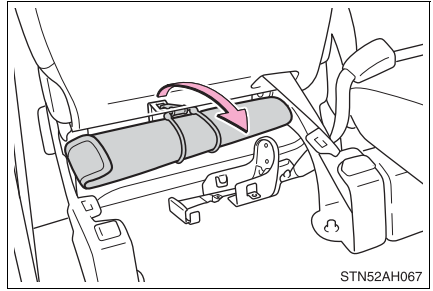

Taking out the jack and tool bag (CrewMax models)

- 1 Pull the lever and raise the bottom cushion up.

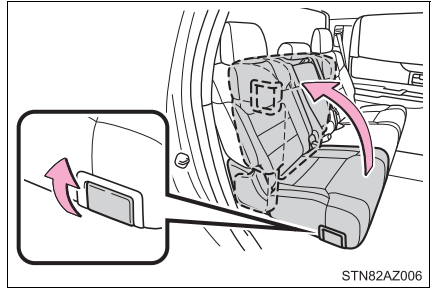

- 2 Unhook the rubber band and take out the jack.
- ① For loosening
 - ② For tightening

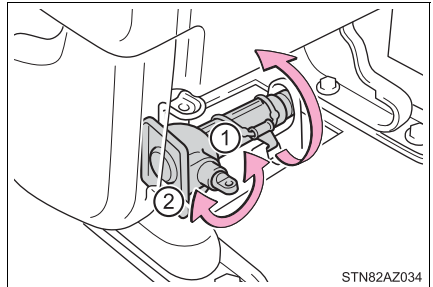

- 3 Unhook the rubber band and remove the tool bag.

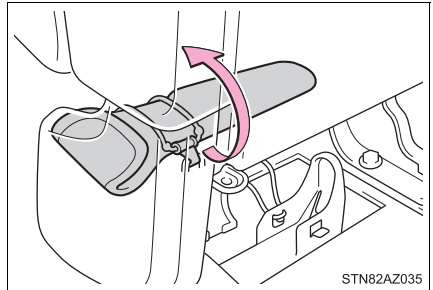

Taking out the spare tire

- 1 Assemble the jack handle extension as shown.

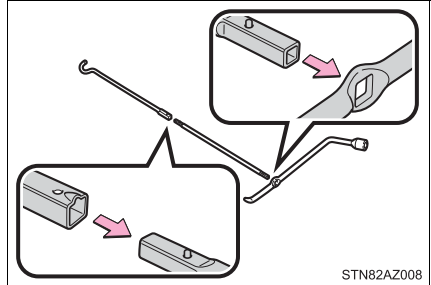

- 2 Insert the end of the jack handle extension into the lowering screw and turn it counterclockwise.

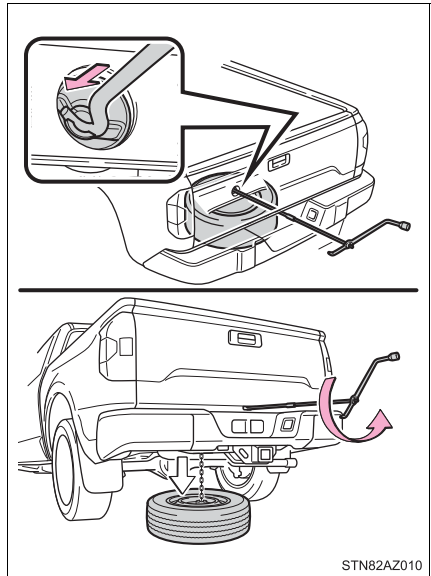

- 3 After the tire is lowered completely to the ground, remove the holding bracket.

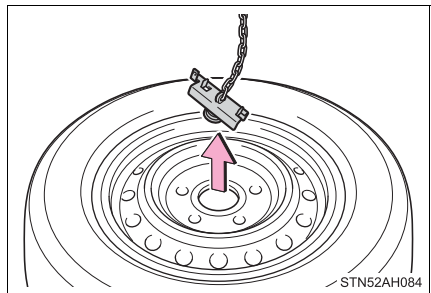

Replacing a flat tire

- 1 Chock the tires.

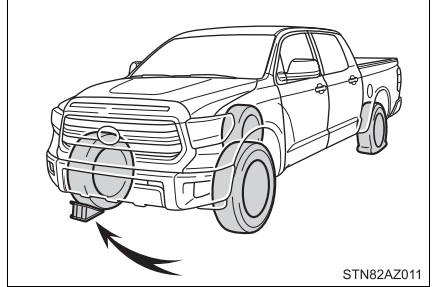

| Flat tire | | Wheel chock positions |
|-----------|-----------------|--|
| Front | Left-hand side | Behind the rear right-hand side tire |
| | Right-hand side | Behind the rear left-hand side tire |
| Rear | Left-hand side | In front of the front right-hand side tire |
| | Right-hand side | In front of the front left-hand side tire |

- 2 On some models, remove the wheel ornament using the wheel nut wrench as shown.

To protect the wheel and wheel ornament, place a rag between the wrench and the wheel ornament, as shown in the illustration.

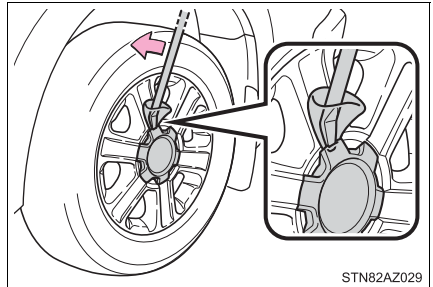

- 3 Slightly loosen the wheel nuts (one turn).

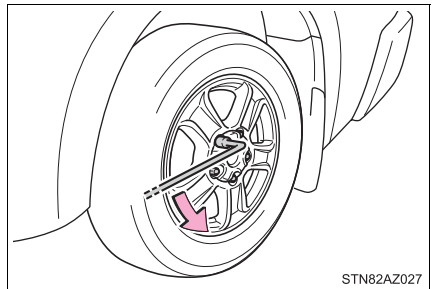

- 4 Assemble the jack handle extension as shown.

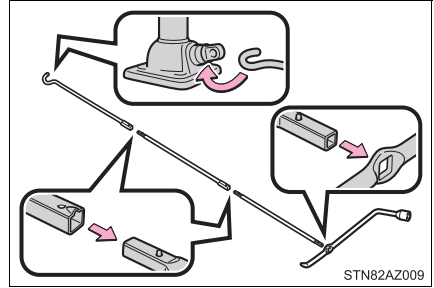

- 5 Position the jack at the correct jack point as shown.

- ① Front
- ② Rear

Make sure the jack is positioned on a level and solid place.

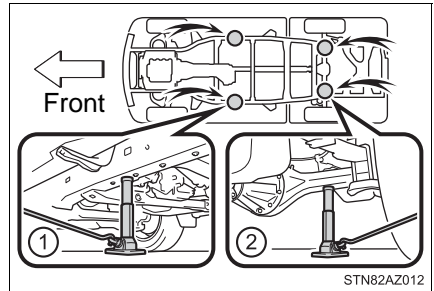

- 6 Raise the vehicle until the tire is slightly raised off the ground.

When positioning the jack under the rear axle housing, make sure the groove on the top of the jack fits with the rear axle housing.

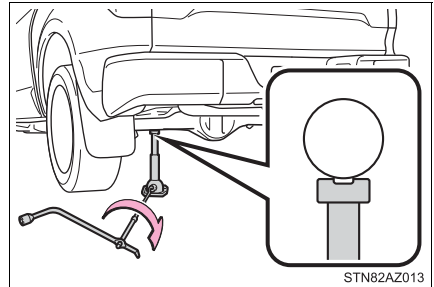

- 7 Remove all the wheel nuts and the tire.

When resting the tire on the ground, place the tire so that the wheel design faces up to avoid scratching the wheel surface.

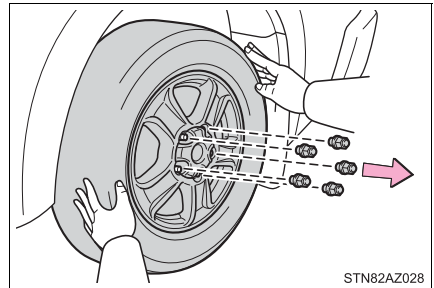

CAUTION

■ Replacing a flat tire

- Observe the following precautions.
Failure to do so may result in serious injury:
 - Lower the spare tire completely to the ground before removing it from under the vehicle.
 - Do not try to remove the wheel ornament by hand. Take due care in handling the ornament to avoid unexpected personal injury.
 - Do not touch the disc wheels or the area around the brakes immediately after the vehicle has been driven.
After the vehicle has been driven the disc wheels and the area around the brakes will be extremely hot. Touching these areas with hands, feet or other body parts while changing a tire, etc., may result in burns.
- Failure to follow these precautions could cause the wheel nuts to loosen and the tire to fall off, resulting in death or serious injury.
 - Have the wheel nuts tightened with a torque wrench as soon as possible after changing wheels.
Steel wheel: 154 ft·lbf (209 N·m, 21.3 kgf·m)
Aluminum wheel: 97 ft·lbf (131 N·m, 13.4 kgf·m)
 - When installing a tire, only use wheel nuts that have been specifically designed for that wheel.
 - Retighten the wheel nuts within 100 miles (160 km) of driving.
 - If there are any cracks or deformations in the bolt screws, nut threads or bolt holes of the wheel, have the vehicle inspected by your Toyota dealer.
 - Do not attach a heavily damaged wheel ornament, as it may fly off the wheel while the vehicle is moving.
 - When installing the wheel nuts, be sure to install them with the tapered ends facing inward. (→P. 429)

■ Installing the spare tire

- 1 Remove any dirt or foreign matter from the wheel contact surface.

If foreign matter is on the wheel contact surface, the wheel nuts may loosen while the vehicle is in motion, causing the tire to come off.

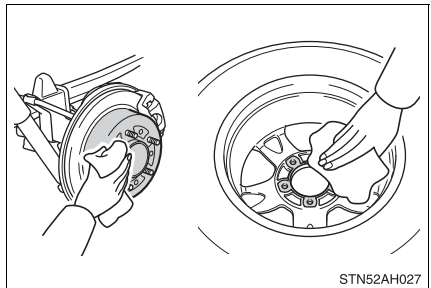

STN52AH027

- 2 Install the spare tire and loosely tighten each wheel nut by hand by approximately the same amount.

Tighten the nuts until the tapered portion comes into loose contact with the disc wheel seat.

- ▶ Replacing a steel wheel with a steel wheel ▶ Replacing an aluminum wheel with a steel wheel

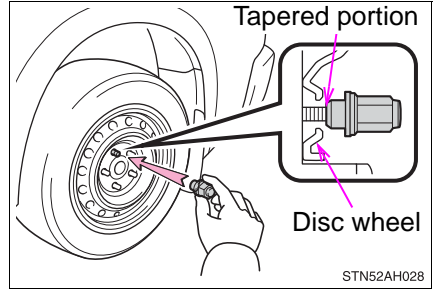
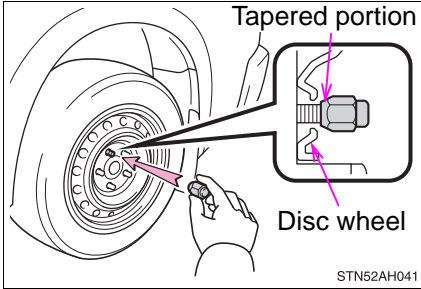

- 3 Lower the vehicle.

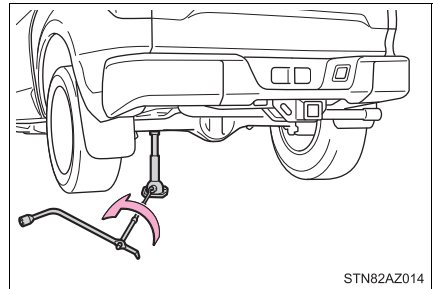

- 4 Firmly tighten each nut two or three times in the order shown in the illustration.

Tightening torque:
154 ft·lbf (209 N·m, 21.3 kgf·m)

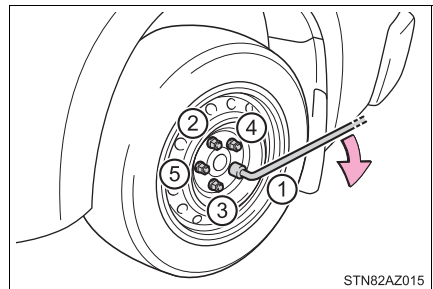

⚠ CAUTION

■ Stowing the flat tire

Failure to follow steps listed under stowing the tire may result in damage to the spare tire carrier and loss of the tire, which could result in serious injury or death.

Stowing the flat tire, jack and all tools

1 Vehicles with aluminum wheels: Remove the center wheel ornament by pushing from the reverse side.

2 Lay down the tire with the valve stem facing up and install the holding bracket centered in the wheel opening. Turn the jack handle extension clockwise to take up slack in the cable.

Check to ensure the holding bracket is centered in the wheel opening.

While raising, secure the tire, taking care that the tire goes straight up without catching on any surrounding part to prevent it from flying forward during a collision or sudden braking.

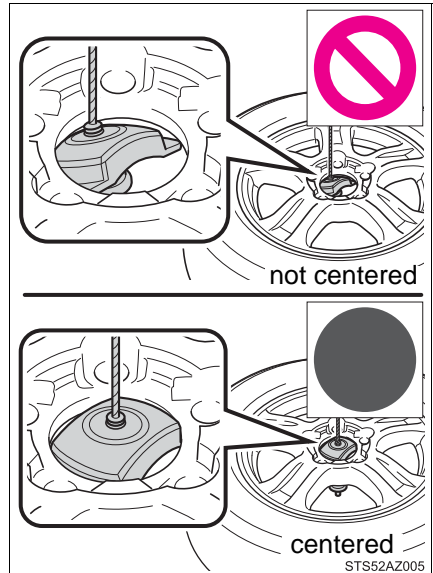

- 3 Keep winding until three clicks are heard. It is not possible to overtighten.

To confirm it is not loose after tightening:

- 1 Push and pull the tire
- 2 Try rotating

Visually check to ensure tire is not hung on surrounding parts.

If looseness or misassembly exists, repeat step 2 and step 3.

- 4 Repeat step 3, any time the tire is lowered or disturbed.
- 5 Stow the tools and jack securely.

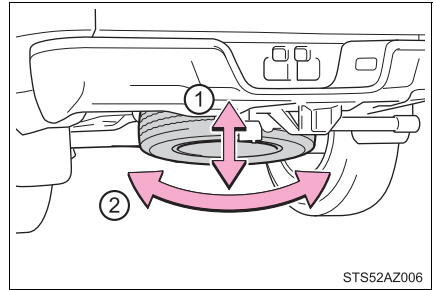

■ The temporary spare tire

- The temporary spare tire is identified by the label “TEMPORARY USE ONLY” on the disc wheel. Use the temporary spare tire temporarily, and only in an emergency.
- Make sure to check the tire inflation pressure of the temporary spare tire. (→P. 513)

■ After completing the tire change

The tire pressure warning system must be reset. (→P. 419)

■ When reinstalling the wheel ornament (on some models)

→P. 429

■ When using the temporary spare tire

As the temporary spare tire is not equipped with the tire pressure warning valve and transmitter, low inflation pressure of the spare tire will not be indicated by the tire pressure warning system. Also, if you replace the temporary spare tire after the tire pressure warning light comes on, the light remains on.

■ If you have a flat rear tire on a road covered with snow or ice

Install the temporary spare tire on one of the front wheels of the vehicle. Perform the following steps and fit tire chains to the rear tires:

- 1 Replace a front tire with the temporary spare tire.
- 2 Replace the flat rear tire with the tire removed from the front of the vehicle.
- 3 Fit tire chains to the rear tires.

**CAUTION****■ When using the temporary spare tire**

- Remember that the temporary spare tire provided is specifically designed for use with your vehicle. Do not use your temporary spare tire on another vehicle.
- Do not use more than one temporary spare tires simultaneously.
- Replace the temporary spare tire with a standard tire as soon as possible.
- Avoid sudden acceleration, abrupt steering, sudden braking and shifting operations that cause sudden engine braking.

■ When the spare tire is attached

The vehicle speed may not be correctly detected, and the following systems may not operate correctly:

- ABS & Brake assist
- VSC
- TRAC
- A-TRAC
- AUTO LSD
- Cruise control (if equipped)
- Navigation system (if equipped)

Also, not only can the following system not be utilized fully, but it may even negatively affect the drive-train components:

- 4WD system

■ Speed limit when using the temporary spare tire

Do not drive at speeds in excess of 50 mph (80 km/h) when a temporary spare tire is installed on the vehicle.

The temporary spare tire is not designed for driving at high speeds. Failure to observe this precaution may lead to an accident causing death or serious injury.

**NOTICE****■ Do not drive the vehicle with a flat tire**

Do not continue driving with a flat tire.

Driving even a short distance with a flat tire can damage the tire and the wheel beyond repair.

■ Driving with tire chains and the temporary spare tire

Do not fit tire chains to the temporary spare tire.

Tire chains may damage the vehicle body and adversely affect driving performance.

■ When replacing the tires

When removing or fitting the wheels, tires or the tire pressure warning valve and transmitter, contact your Toyota dealer as the tire pressure warning valve and transmitter may be damaged if not handled correctly.

■ To avoid damage to the tire pressure warning valves and transmitters

When a tire is repaired with liquid sealants, the tire pressure warning valve and transmitter may not operate properly. If a liquid sealant is used, contact your Toyota dealer or other qualified service shop as soon as possible. Make sure to replace the tire pressure warning valve and transmitter when replacing the tire. (→P. 418)

If the engine will not start

If the engine will not start even though correct starting procedures are being followed (→P. 179), consider each of the following points.

The engine will not start even though the starter motor operates normally.

One of the following may be the cause of the problem:

- There may not be sufficient fuel in the vehicle's tank.

Refuel the vehicle.

Flex-fuel vehicles: The type of fuel may be different. When refueling, add the same type of fuel, if available.

After adding a different type of fuel, the engine may run roughly and driving performance may be reduced for a while when the engine is first started. In this case, wait until the engine runs normally.

- The engine may be flooded.

Try to restart the engine again following correct starting procedures. (→P. 179)

- There may be a malfunction in the engine immobilizer system. (if equipped) (→P. 78)

The starter motor turns over slowly, the interior lights and headlights are dim, or the horn does not sound or sounds at a low volume.

One of the following may be the cause of the problem:

- The battery may be discharged. (→P. 493)
- The battery terminal connections may be loose or corroded.

The starter motor does not turn over, the interior lights and headlights do not turn on, or the horn does not sound.

One of the following may be the cause of the problem:

- One or both of the battery terminals may be disconnected.
- The battery may be discharged. (→P. 493)

Contact your Toyota dealer if the problem cannot be repaired, or if repair procedures are unknown.

If the shift lever cannot be shifted from P

If the shift lever cannot be shifted with your foot on the brake pedal, there may be a problem with the shift lock system (a system to prevent accidental operation of the shift lever). Have the vehicle inspected by your Toyota dealer immediately.

The following steps may be used as an emergency measure to ensure that the shift lever can be shifted:

- 1 Set the parking brake.
- 2 Turn the engine switch to the "ACC" position.
- 3 Depress the brake pedal.
- 4 Pry the cover up with a flathead screwdriver or equivalent tool.

To prevent damage to the cover, cover the tip of the screwdriver with a rag.

► Floor shift type

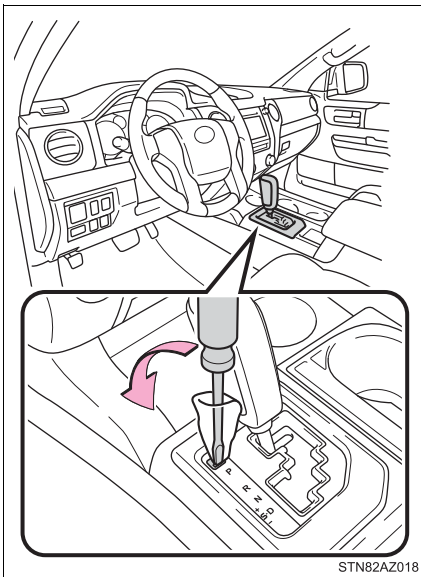

► Column-shift type

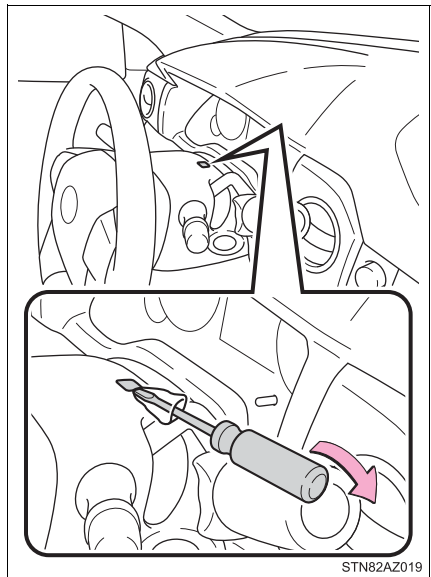

5 Press the shift lock override button.

The shift lever can be shifted while the button is pressed.

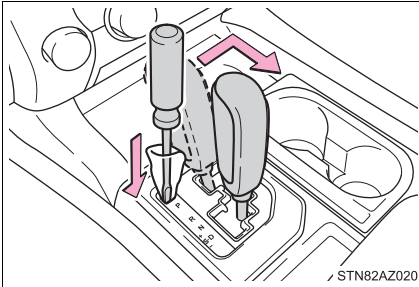
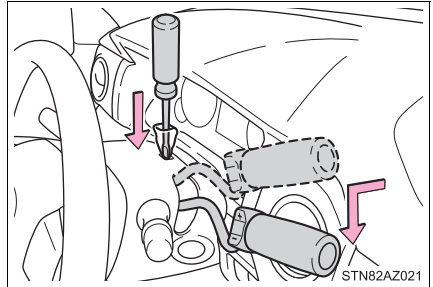
▶ Floor shift type**▶ Column-shift type**

If the vehicle battery is discharged

The following procedures may be used to start the engine if the vehicle's battery is discharged.

You can also call your Toyota dealer or a qualified repair shop.

If you have a set of jumper (or booster) cables and a second vehicle with a 12-volt battery, you can jump start your vehicle by following the steps below.

- 1 Open the hood. (→P. 405)
- 2 Connect the jumper cables according to the following procedure:
 - ▶ 1GR-FE engine

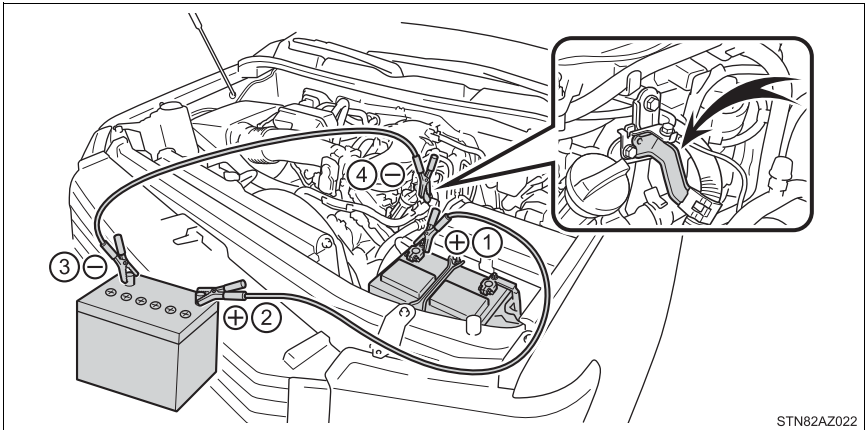

- ▶ 1UR-FE, 3UR-FE and 3UR-FBE engines

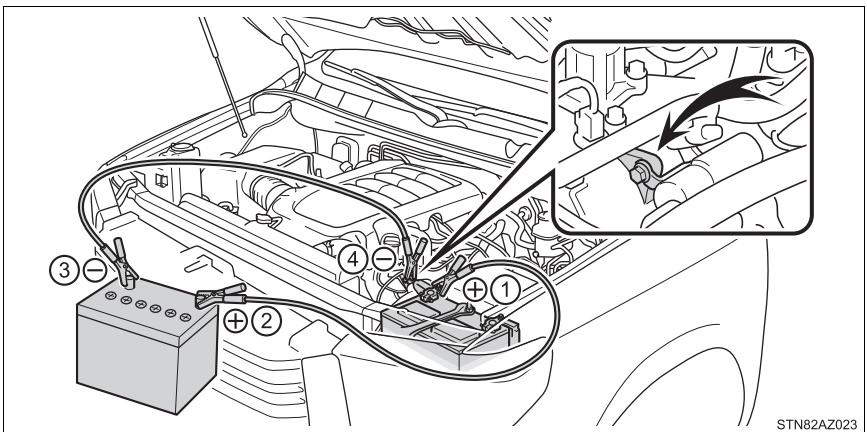

- ① Connect a positive jumper cable clamp to the positive (+) battery terminal on your vehicle.
 - ② Connect the clamp on the other end of the positive cable to the positive (+) battery terminal on the second vehicle.
 - ③ Connect a negative cable clamp to the negative (-) battery terminal on the second vehicle.
 - ④ Connect the clamp at the other end of the negative cable to a solid, stationary, unpainted metallic point away from the battery and any moving parts, as shown in the illustration.
- 3 Start the engine of the second vehicle. Increase the engine speed slightly and maintain at that level for approximately 5 minutes to recharge the battery of your vehicle.
 - 4 Maintain the engine speed of the second vehicle and start the engine of your vehicle.
 - 5 Once the vehicle's engine has started, remove the jumper cables in the exact reverse order from which they were connected.

Once the engine starts, have the vehicle inspected at your Toyota dealer as soon as possible.

■ Starting the engine when the battery is discharged

The engine cannot be started by push-starting.

■ To prevent battery discharge

- Turn off the headlights and the audio system while the engine is off.
- Turn off any unnecessary electrical components when the vehicle is running at a low speed for an extended period, such as in heavy traffic.

■ When the battery is removed or discharged

- The moon roof must be initialized. (→P. 144)
- Flex-fuel vehicles: The information recorded in the computer will be cleared, which may cause the engine to run roughly and reduce driving performance for a while when the engine is first started. In this case, wait until the engine runs normally.

If the vehicle is running on E85, the engine may stall.

In this case, restart the engine, repeatedly if necessary.

- Vehicles with alarm: Make sure that the key is not inside the vehicle when recharging or replacing the battery. The key may be locked in the vehicle if the alarm is activated. (→P. 81)

■ Charging the battery

The electricity stored in the battery will discharge gradually even when the vehicle is not in use, due to natural discharge and the draining effects of certain electrical appliances. If the vehicle is left for a long time, the battery may discharge, and the engine may be unable to start. (The battery recharges automatically during driving.)



CAUTION

■ Avoiding battery fires or explosions

Observe the following precautions to prevent accidentally igniting the flammable gas that may be emitted from the battery:

- Make sure each jumper cable is connected to the correct terminal and that it is not unintentionally in contact with any other than the intended terminal.
- Do not allow the + and - clamps of the jumper cables to come into contact with each other.
- Do not smoke, use matches, cigarette lighters or allow open flame near the battery.

■ Battery precautions

The battery contains poisonous and corrosive acidic electrolyte, while related parts contain lead and lead compounds. Observe the following precautions when handling the battery:

- When working with the battery, always wear safety glasses and take care not to allow any battery fluids (acid) to come into contact with skin, clothing or the vehicle body.
- Do not lean over the battery.
- In the event that battery fluid comes into contact with the skin or eyes, immediately wash the affected area with water and seek medical attention. Place a wet sponge or cloth over the affected area until medical attention can be received.
- Always wash your hands after handling the battery support, terminals, and other battery-related parts.
- Do not allow children near the battery.



NOTICE

■ When handling jumper cables

When connecting the jumper cables, ensure that they do not become entangled in the cooling fan or belt.

If your vehicle overheats

The following may indicate that your vehicle is overheating:

- The needle of the engine coolant temperature gauge (→P. 88) enters the red zone or a loss of engine power is experienced. (For example, the vehicle speed does not increase.)
- “ENGINE COOLANT OVERTEMP” is shown on the multi-information display. (vehicles with multi-information display)
- Steam comes out from under the hood.

Correction procedures

- 1 Stop the vehicle in a safe place and turn off the air conditioning system, and then stop the engine.
- 2 If you see steam:
Carefully lift the hood after the steam subsides.

If you do not see steam:
Carefully lift the hood.

- 3 After the engine has cooled down sufficiently, inspect the hoses and radiator core (radiator) for any leaks.

- ① Radiator
- ② Cooling fan

If a large amount of coolant leaks, immediately contact your Toyota dealer.

- 4 The coolant level is satisfactory if it is between the “FULL” and “LOW” lines on the reservoir.

- ① Reservoir
- ② “FULL”
- ③ “LOW”
- ④ Radiator cap

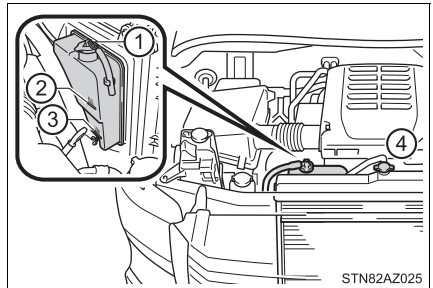
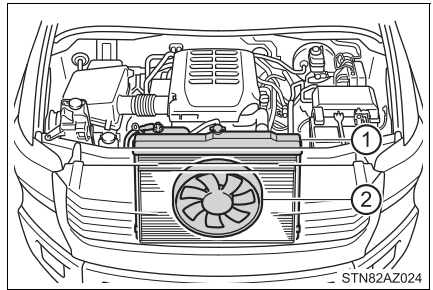

5 Add coolant if necessary.

Water can be used in an emergency if coolant is unavailable.

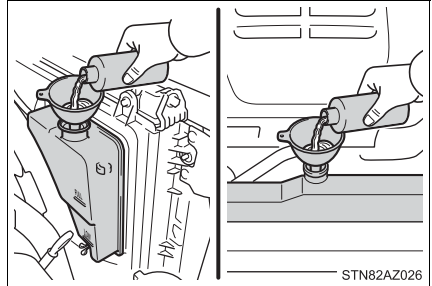
**6** Start the engine and check that the radiator cooling fan operates and to check for coolant leaks from the radiator or hoses.**7** If the fan is not operating:

Stop the engine immediately and contact your Toyota dealer.

If the fan is operating:

Have the vehicle inspected at the nearest Toyota dealer.

⚠ CAUTION

■ When inspecting under the hood of your vehicle

Observe the following precautions.

Failure to do so may result in serious injury such as burns.

- If steam is seen coming from under the hood, do not open the hood until the steam has subsided. The engine compartment may be very hot.
- Keep hands and clothing away from the fans, etc., while the engine is running.
- Do not loosen the radiator cap and the coolant reservoir cap while the engine and radiator are hot. High temperature steam or coolant could spray out.

⚠ NOTICE

■ When adding engine coolant

Add coolant slowly after the engine has cooled down sufficiently. Adding cool coolant to a hot engine too quickly can cause damage to the engine.

■ To prevent damage to the cooling system

Observe the following precautions:

- Avoid contaminating the coolant with foreign matter (such as sand or dust, etc.).
- Do not use any coolant additives.

If the vehicle becomes stuck

Carry out the following procedures if the tires spin or the vehicle becomes stuck in mud, dirt or snow:

- 1 Stop the engine. Set the parking brake and shift the shift lever to P.
- 2 Remove the mud, snow or sand from around the rear wheels.
- 3 Place wood, stones or some other material to help provide traction under the rear wheels.
- 4 Restart the engine.
- 5 Shift the shift lever to D or R and release the parking brake. Then, while exercising caution, depress the accelerator pedal.

■ When it is difficult to free the vehicle

Press  to turn off TRAC/A-TRAC.

Turn off TRAC/A-TRAC and/or VSC if these functions are hampering your attempts to free the vehicle. (→P. 232, 234, 236)

CAUTION

■ When attempting to free a stuck vehicle

If you choose to push the vehicle back and forth to free it, make sure the surrounding area is clear to avoid striking other vehicles, objects or people. The vehicle may also lunge forward or lunge back suddenly as it becomes free. Use extreme caution.

■ When shifting the shift lever

Be careful not to shift the shift lever with the accelerator pedal depressed. This may lead to unexpected rapid acceleration of the vehicle that may cause an accident resulting in death or serious injury.

NOTICE

■ To avoid damage to the transmission and other components

- Avoid spinning the rear wheels and depressing the accelerator pedal more than necessary.
- If the vehicle remains stuck even after these procedures are performed, the vehicle may require towing to be freed.

Vehicle specifications

9

9-1. Specifications

| | |
|---|-----|
| Maintenance data (fuel, oil level, etc.) | 500 |
| Fuel information | 516 |
| Tire information | 520 |

9-2. Customization

| | |
|-----------------------------|-----|
| Customizable features | 530 |
|-----------------------------|-----|

9-3. Items to initialize

| | |
|---------------------------|-----|
| Items to initialize | 535 |
|---------------------------|-----|

Maintenance data (fuel, oil level, etc.)

Dimensions

► 2WD models

| Cab type | Regular Cab | Double Cab | | CrewMax |
|------------------------------|----------------------------------|-------------------------------------|-------------------------------------|---------------------|
| Bed type | Long | Standard | Long | Short |
| Overall length | 228.9 in. (5815 mm) | | 247.8 in. (6295 mm) | 228.9 in. (5815 mm) |
| Overall width | 79.9 in. (2030 mm) | | | |
| Overall height* ¹ | 75.7 in. (1925 mm)* ² | 75.9 in. (1930 mm)* ² | 75.7 in. (1925 mm)* ² | |
| | 75.5 in. (1920 mm)* ³ | 75.7 in. (1925 mm)* ^{3,*4} | 75.5 in. (1920 mm)* ^{3,*4} | |
| Wheelbase | 145.6 in. (3700 mm) | | 164.5 in. (4180 mm) | 145.6 in. (3700 mm) |
| Front tread | 67.9 in. (1725 mm) | | | |
| Rear tread | 67.9 in. (1725 mm) | | | |

*1: Unladen vehicle

*2: P255/70R18 tires

*3: P275/65R18 tires

*4: P275/55R20 tires

► 4WD models

| Cab type | Regular Cab | Double Cab | | CrewMax |
|------------------------------|----------------------------------|-------------------------------------|-------------------------------------|---------------------|
| Bed type | Long | Standard | Long | Short |
| Overall length | 228.9 in. (5815 mm) | | 247.8 in. (6295 mm) | 228.9 in. (5815 mm) |
| Overall width | 79.9 in. (2030 mm) | | | |
| Overall height ^{*1} | 76.1 in. (1935 mm) ^{*2} | 76.3 in. (1940 mm) ^{*2} | 76.1 in. (1935 mm) ^{*2} | |
| | 75.9 in. (1930 mm) ^{*3} | 76.1 in. (1935 mm) ^{*3,*4} | 75.9 in. (1930 mm) ^{*3,*4} | |
| Wheelbase | 145.6 in. (3700 mm) | | 164.5 in. (4180 mm) | 145.6 in. (3700 mm) |
| Front tread | 67.9 in. (1725 mm) | | | |
| Rear tread | 67.9 in. (1725 mm) | | | |

*1: Unladen vehicle

*2: P255/70R18 tires

*3: P275/65R18 tires

*4: P275/55R20 tires

Vehicle capacity weight

► Regular Cab models

| Model code ^{*1} | Engine | Driving system | Bed type | Vehicle capacity weight (Occupants + luggage) |
|--------------------------|----------------|----------------|----------|--|
| GSK51L-THASKA | 1GR-FE engine | 2WD | Long | 1630 lb. (735 kg) |
| USK51L-THTSKA | 3UR-FE engine | 2WD | | 1970 lb. (890 kg) |
| | | | | 1895 lb. (855 kg) ^{*2} |
| | | | | 2040 lb. (925 kg) ^{*3} |
| USK56L-THTSKA | | 4WD | | 1910 lb. (865 kg) |
| | | | | 1835 lb. (830 kg) ^{*2} |
| USK56L-THTSGA | 3UR-FBE engine | 4WD | | 1910 lb. (865 kg) |
| | | | | 1835 lb. (830 kg) ^{*2} |

*1: The model code is indicated on the Certification Label. (→P. 506)

*2: Vehicles with towing package

*3: Vehicles without option

► Double Cab models

| Model code *1 | Engine | Driving system | Bed type | Vehicle capacity weight (Occupants + luggage) | |
|---------------|----------------|----------------------|----------------------|---|----------------------|
| GSK51L-CRASKA | 1GR-FE engine | 2WD | Standard | 1340 lb. (605 kg) | |
| UPK51L-CRTSKA | 1UR-FE engine | 2WD | Standard | 1410 lb. (635 kg) | |
| UPK56L-CRTSKA | | 4WD | | 1320 lb. (595 kg) | |
| USK51L-CRTSKA | 3UR-FE engine | 2WD | Standard | 1595 lb. (720 kg) | |
| | | | | 1520 lb. (685 kg) *2 | |
| USK51L-CRTLKA | | | | 1565 lb. (705 kg) | |
| | | | | 1490 lb. (675 kg) *2 | |
| USK52L-CHTSKA | | | Long | 1565 lb. (705 kg) | |
| | | | | 1490 lb. (675 kg) *2 | |
| USK56L-CRTSKA | | 4WD | Standard | 1500 lb. (680 kg) | |
| | | | | 1430 lb. (645 kg) *2 | |
| USK56L-CRTLKA | | | | 1495 lb. (675 kg) | |
| | | | | 1420 lb. (640 kg) *2 | |
| USK57L-CHTSKA | Long | | 1480 lb. (670 kg) | | |
| | | | 1410 lb. (635 kg) *2 | | |
| USK56L-CRTSGA | 3UR-FBE engine | | 4WD | Standard | 1500 lb. (680 kg) |
| | | | | | 1430 lb. (645 kg) *2 |
| USK56L-CRTLGA | | 1495 lb. (675 kg) | | | |
| | | 1420 lb. (640 kg) *2 | | | |
| USK57L-CHTSGA | | Long | 1480 lb. (670 kg) | | |
| | | | 1410 lb. (635 kg) *2 | | |

*1: The model code is indicated on the Certification Label. (→P. 506)

*2: Vehicles with towing package

► CrewMax models

| Model code *1 | Engine | Driving system | Bed type | Vehicle capacity weight (Occupants + luggage) |
|---------------|---------------|----------------------|----------|--|
| UPK51L-PSTSKA | 1UR-FE engine | 2WD | Short | 1355 lb. (610 kg) |
| | | | | 1325 lb. (600 kg) *2 |
| 4WD | | 1255 lb. (565 kg) | | |
| | | 1225 lb. (555 kg) *2 | | |
| USK51L-PSTSKA | 3UR-FE engine | 2WD | | 1520 lb. (685 kg) |
| | | | | 1485 lb. (670 kg) *2 |
| | | | | 1435 lb. (650 kg) *3 |
| | | | | 1410 lb. (635 kg) *4 |
| USK51L-PSTLKA | | 3UR-FE engine | 2WD | 1505 lb. (680 kg) |
| | | | | 1470 lb. (665 kg) *2 |
| | | | | 1425 lb. (645 kg) *3 |
| | | | | 1395 lb. (630 kg) *4 |
| USK51L-PSTZKA | 3UR-FE engine | | 2WD | 1505 lb. (680 kg) |
| | | | | 1470 lb. (665 kg) *2 |
| | | | | 1425 lb. (645 kg) *3 |
| | | | | 1395 lb. (630 kg) *4 |
| USK56L-PSTSKA | | 3UR-FE engine | 4WD | 1440 lb. (650 kg) |
| | | | | 1410 lb. (635 kg) *2 |
| | | | | 1360 lb. (615 kg) *3 |
| | | | | 1330 lb. (600 kg) *4 |
| USK56L-PSTLKA | 3UR-FE engine | | 4WD | 1410 lb. (635 kg) |
| | | | | 1375 lb. (620 kg) *2 |
| | | | | 1335 lb. (605 kg) *3 |
| | | | | 1305 lb. (590 kg) *4 |

| Model code *1 | Engine | Driving system | Bed type | Vehicle capacity weight (Occupants + luggage) |
|---------------|----------------------|----------------|----------|--|
| USK56L-PSTZKA | 3UR-FE engine | 4WD | Short | 1415 lb. (640 kg) |
| | | | | 1380 lb. (625 kg) *2 |
| | | | | 1335 lb. (605 kg) *3 |
| | | | | 1305 lb. (590 kg) *4 |
| USK56L-PSTSGA | 3UR-FBE engine | 4WD | | 1440 lb. (650 kg) |
| | | | | 1410 lb. (635 kg) *2 |
| | | | | 1360 lb. (615 kg) *3 |
| | | | | 1330 lb. (600 kg) *4 |
| USK56L-PSTLGA | | | | 1410 lb. (635 kg) |
| | | | | 1375 lb. (620 kg) *2 |
| | | | | 1335 lb. (605 kg) *3 |
| | | | | 1305 lb. (590 kg) *4 |
| USK56L-PSTZGA | 1415 lb. (640 kg) | | | |
| | 1380 lb. (625 kg) *2 | | | |
| | 1335 lb. (605 kg) *3 | | | |
| | 1305 lb. (590 kg) *4 | | | |

*1: The model code is indicated on the Certification Label. (→P. 506)

*2: Vehicles with electric moon roof

*3: Vehicles with towing package

*4: Vehicles with towing package and electric moon roof

Vehicle identification

■ Vehicle identification number

The vehicle identification number (VIN) is the legal identifier for your vehicle. This is the primary identification number for your Toyota. It is used in registering the ownership of your vehicle.

This number is stamped on the top left of the instrument panel.

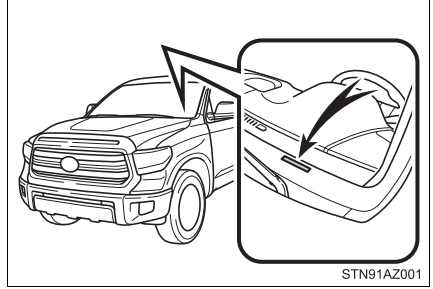

This number is also on the Certification Label.

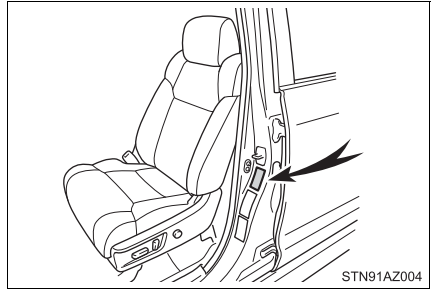

■ Engine number

The engine number is stamped on the engine block as shown.

▶ 1GR-FE engine

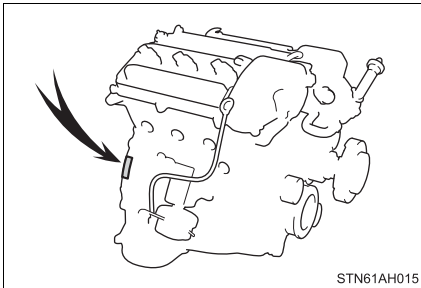

▶ 1UR-FE engine

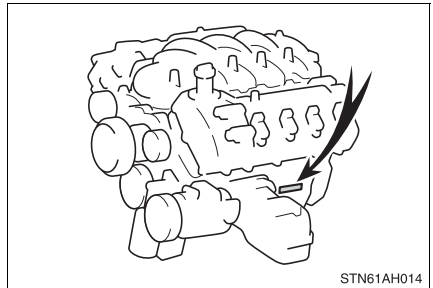

► 3UR-FE and 3UR-FBE engines

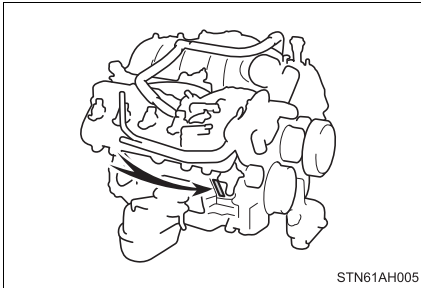

Engine

► 1GR-FE engine

| | |
|-------------------------------|--------------------------------------|
| Model | 1GR-FE |
| Type | 6-cylinder V-type, 4-cycle, gasoline |
| Bore and stroke | 3.70 × 3.74 in. (94.0 × 95.0 mm) |
| Displacement | 241.4 cu.in. (3956 cm ³) |
| Drive belt tension | Automatic adjustment |
| Valve clearance (engine cold) | Automatic adjustment |

► 1UR-FE, 3UR-FE and 3UR-FBE engines

| | |
|-------------------------------|--|
| Model | 1UR-FE, 3UR-FE, 3UR-FBE |
| Type | 8-cylinder V-type, 4-cycle, gasoline |
| Bore and stroke | <p>► 1UR-FE engine 3.70 × 3.27 in. (94.0 × 83.0 mm)</p> <p>► 3UR-FE and 3UR-FBE engines 3.70 × 4.02 in. (94.0 × 102.0 mm)</p> |
| Displacement | <p>► 1UR-FE engine 281.2 cu.in. (4608 cm³)</p> <p>► 3UR-FE and 3UR-FBE engines 345.6 cu.in. (5663 cm³)</p> |
| Drive belt tension | Automatic adjustment |
| Valve clearance (engine cold) | Automatic adjustment |

Fuel

| Engine | Gasoline engine | Flex-fuel engine |
|-----------------------------------|--|---|
| Fuel type | Unleaded gasoline only | Unleaded gasoline, E85, or a blend of the two fuels |
| Octane rating (Unleaded gasoline) | 87 (Research octane number 91) or higher | |
| Ethanol percentage (E85) | — | 85% or less |
| Fuel tank capacity (Reference) | 26.4 gal. (100.0 L, 22.0 Imp.gal.) | |

Lubrication system

| | |
|--|---|
| Oil capacity (Drain and refill - reference*) | |
| With filter | <ul style="list-style-type: none"> ▶ 1GR-FE engine 6.4 qt. (6.1 L, 5.4 Imp.qt.) ▶ 1UR-FE, 3UR-FE and 3UR-FBE engines 7.9 qt. (7.5 L, 6.6 Imp.qt.) |
| Without filter | <ul style="list-style-type: none"> ▶ 1GR-FE engine 5.9 qt. (5.6 L, 4.9 Imp.qt.) ▶ 1UR-FE, 3UR-FE and 3UR-FBE engines 7.5 qt. (7.1 L, 6.2 Imp.qt.) |

*: The engine oil capacity is a reference quantity to be used when changing the engine oil. Warm up and turn off the engine, wait more than 5 minutes, and check the oil level on the dipstick.

■ Engine oil selection

“Toyota Genuine Motor Oil” is used in your Toyota vehicle. Use Toyota approved “Toyota Genuine Motor Oil” or equivalent to satisfy the following grade and viscosity.

Oil grade: ILSAC GF-5 multigrade engine oil

Recommended viscosity: SAE 0W-20

SAE 0W-20 is the best choice for good fuel economy and good starting in cold weather.

If SAE 0W-20 is not available, SAE 5W-20 oil may be used. However, it must be replaced with SAE 0W-20 at the next oil change.

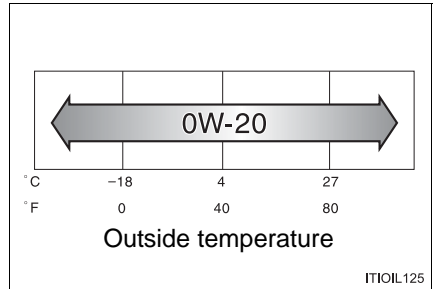

Oil viscosity (0W-20 is explained here as an example):

- The 0W in 0W-20 indicates the characteristic of the oil which allows cold startability. Oils with a lower value before the W allow for easier starting of the engine in cold weather.
- The 20 in 0W-20 indicates the viscosity characteristic of the oil when the oil is at high temperature. An oil with a higher viscosity (one with a higher value) may be better suited if the vehicle is operated at high speeds, or under extreme load conditions.

How to read oil container label:

The International Lubricant Specification Advisory Committee (ILSAC) Certification Mark is added to some oil containers to help you select the oil you should use.

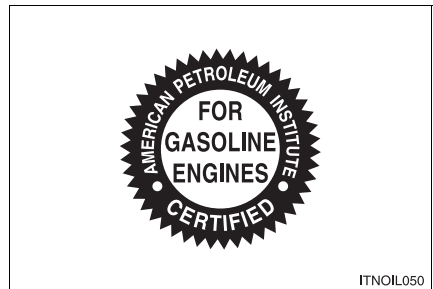

Cooling system

| | | |
|--------------|--|--|
| Capacity | 1GR-FE engine | 11.3 qt. (10.7 L, 9.4 Imp.qt.) |
| | 1UR-FE engine | <ul style="list-style-type: none"> ▶ Vehicles without towing package 11.4 qt. (10.8 L, 9.5 Imp.qt.) ▶ Vehicles with towing package 12.6 qt. (11.9 L, 10.5 Imp.qt.) |
| | 3UR-FE, 3UR-FBE engines | <ul style="list-style-type: none"> ▶ Vehicles without towing package 11.4 qt. (10.8 L, 9.5 Imp.qt.) ▶ Vehicles with towing package 12.4 qt. (11.7 L, 10.3 Imp.qt.) |
| Coolant type | <p>Use either of the following.</p> <ul style="list-style-type: none"> • “Toyota Super Long Life Coolant” • Similar high-quality ethylene glycol-based non-silicate, non-amine, non-nitrite, and non-borate coolant with long-life hybrid organic acid technology <p>Do not use plain water alone.</p> | |

Ignition system

| | |
|------------|---|
| Spark plug | |
| Make | <ul style="list-style-type: none"> ▶ 1GR-FE engine DENSO SK16HR11 ▶ 1UR-FE, 3UR-FE and 3UR-FBE engines DENSO SK20HR11 |
| Gap | 0.043 in. (1.1 mm) |

NOTICE

■ Iridium-tipped spark plugs

Use only iridium-tipped spark plugs. Do not adjust the spark plug gap.

Electrical system

| | |
|---|--|
| Battery Open voltage at 68°F (20°C): | 12.6 — 12.8 V Fully charged 12.2 — 12.4 V Half charged 11.8 — 12.0 V Discharged (Voltage is checked 20 minutes after the engine and all lights are turned off.) |
| Charging rates | 5 A max. |

Differential

| | | | | |
|-------------------------|--------------------|----------------------------|---|--|
| Oil capacity | Front (4WD models) | | 2.2 qt. (2.05 L, 1.8 Imp.qt.) | |
| | Rear | 1GR-FE and 1UR-FE engines | | 4.9 qt. (4.60 L, 4.0 Imp.qt.) |
| | | 3UR-FE and 3UR-FBE engines | Regular Cab models | 3.8 qt. (3.60 L, 3.2 Imp.qt.) |
| | | | Double Cab models | ▶ With standard bed 3.8 qt. (3.60 L, 3.2 Imp.qt.) ▶ With long bed 4.0 qt. (3.75 L, 3.3 Imp.qt.) |
| | | | CrewMax models | ▶ 2WD models 4.0 qt. (3.75 L, 3.3 Imp.qt.) ▶ 4WD models 3.8 qt. (3.60 L, 3.2 Imp.qt.) |
| Oil type and viscosity* | | | Toyota Genuine Differential Gear Oil LT 75W-85 GL-5 or equivalent | |

*: Your Toyota vehicle is filled with “Toyota Genuine Differential Gear Oil” at the factory. Use Toyota approved “Toyota Genuine Differential Gear Oil” or an equivalent oil of matching quality to satisfy the above specification. Please contact your Toyota dealer for further details.

Automatic transmission

| | | | |
|-----------------|----------------------------|---------------------------------|--|
| Fluid capacity* | 1GR-FE engine | | 11.1 qt. (10.5 L, 9.2 Imp.qt.) |
| | 1UR-FE engine | | ▶ 2WD models 11.6 qt. (11.0 L, 9.7 Imp.qt.) ▶ 4WD models 11.3 qt. (10.7 L, 9.4 Imp.qt.) |
| | 3UR-FE and 3UR-FBE engines | Vehicles without towing package | 11.7 qt. (11.1 L, 9.8 Imp.qt.) |
| | | Vehicles with towing package | 12.3 qt. (11.6 L, 10.2 Imp.qt.) |
| Fluid type | | | Toyota Genuine ATF WS |

*: The fluid capacity is the quantity of reference.

If replacement is necessary, contact your Toyota dealer.



NOTICE

■ Transmission fluid type

Using transmission fluid other than “Toyota Genuine ATF WS” may cause deterioration in shift quality, locking up of the transmission accompanied by vibration and, ultimately, damage to the vehicle’s transmission.

Transfer (4WD models)

| | |
|---------------------------|---|
| Oil capacity | 1.6 qt. (1.5 L, 1.3 Imp.qt.) |
| Oil type | Toyota Genuine Transfer Gear oil LF or equivalent |
| Recommended oil viscosity | SAE 75W |

Brakes

| | |
|--|----------------------------------|
| Pedal clearance* ¹ | 4.1 in. (104 mm) Min. |
| Pedal free play | 0.04 — 0.24 in. (1 — 6 mm) |
| Brake pad wear limit | 0.04 in. (1.0 mm) |
| Parking brake lining wear limit | 0.04 in. (1.0 mm) |
| Parking brake pedal travel* ² | 6 — 9 clicks |
| Fluid type | FMVSS No. 116 DOT 3 or SAE J1703 |

*¹: Minimum pedal clearance when depressed with a force of 110 lbf (490 N, 50 kgf) with the engine running.

*²: Parking brake pedal travel when depressed with a force of 67.1 lbf (300 N, 30.6 kgf).

Chassis lubrication (4WD models)

| | |
|------------------------|--|
| Propeller shaftsSpider | Lithium base chassis grease, NLGI No.2 |
|------------------------|--|

Steering

| | |
|---------------------------|--|
| Free play | Less than 1.2 in. (30 mm) |
| Power steering fluid type | Automatic transmission fluid DEXRON [®] II or III |

Tires and wheels

► Type A

| | |
|--|--|
| Tire size | P255/70R18 112T |
| Tire inflation pressure (Recommended cold tire inflation pressure) | Front tires: 30 psi (210 kPa, 2.1 kgf/cm ² or bar) Rear tires: 33 psi (230 kPa, 2.3 kgf/cm ² or bar) Spare tire: 33 psi (230 kPa, 2.3 kgf/cm ² or bar) |
| Wheel size | 18 × 8J |
| Wheel nut torque | Steel wheels: 154 ft·lbf (209 N·m, 21.3 kgf·m) Aluminum wheels: 97 ft·lbf (131 N·m, 13.4 kgf·m) |

► Type B

| | |
|--|--|
| Tire size | P275/65R18 114T |
| Tire inflation pressure (Recommended cold tire inflation pressure) | Front tires: 30 psi (210 kPa, 2.1 kgf/cm ² or bar) Rear tires: 33 psi (230 kPa, 2.3 kgf/cm ² or bar) Spare tire: 33 psi (230 kPa, 2.3 kgf/cm ² or bar) |
| Wheel size | 18 × 8J |
| Wheel nut torque | Steel wheels: 154 ft·lbf (209 N·m, 21.3 kgf·m) Aluminum wheels: 97 ft·lbf (131 N·m, 13.4 kgf·m) |

► Type C

| | |
|--|--|
| Tire size | P275/55R20 111H, P255/70R18 112T (spare tire) |
| Tire inflation pressure (Recommended cold tire inflation pressure) | Front tires: 30 psi (210 kPa, 2.1 kgf/cm ² or bar) Rear tires: 33 psi (230 kPa, 2.3 kgf/cm ² or bar) Spare tire: 33 psi (230 kPa, 2.3 kgf/cm ² or bar) |
| Wheel size | 20 × 8J, 18 × 8J (spare wheel) |
| Wheel nut torque | Steel wheels: 154 ft·lbf (209 N·m, 21.3 kgf·m) Aluminum wheels: 97 ft·lbf (131 N·m, 13.4 kgf·m) |

Light bulbs

| | Light Bulbs | Bulb No. | W | Type |
|--------------------|--|----------|-------|------|
| Exterior | Headlights | HB2 | 60/55 | A |
| | Front fog lights* ¹ | H16 | 19 | B |
| | Front side marker lights | W5W | 5 | D |
| | Front turn signal lights/ parking lights* ² / daytime running lights* ^{1, 2} | 4157NAK | 28/8 | C |
| | Rear turn signal lights | 921 | 16 | D |
| | Stop/tail and rear side marker lights | 3157KX | 27/8 | D |
| | Back-up lights | 7440 | 21 | D |
| | License plate lights | W5W | 5 | D |
| | High mounted stoplight and cargo lamp | 921 | 16 | D |
| | Outer foot light | — | 5 | D |
| Interior | Vanity lights | 7065 | 5 | E |
| | Personal/interior lights | | | |
| | Front | W5W | 5 | D |
| | Rear | W5W | 5 | D |
| Foot well lighting | — | 1.4 | D | |

*1: If equipped

*2: Bulb type only

A: HB2 halogen bulbs

B: H16 halogen bulbs

C: Wedge base bulbs (amber)

D: Wedge base bulbs (clear)

E: Double end bulbs

Fuel information

► Gasoline engine

You must only use unleaded gasoline in your vehicle.

Select octane rating 87 (Research Octane Number 91) or higher. Use of unleaded gasoline with an octane rating lower than 87 may result in engine knocking. Persistent knocking can lead to engine damage.

At minimum, the gasoline you use should meet the specifications of ASTM D4814 in the U.S.A. and CGSB3.5-M93 in Canada.

► Flex-fuel engine

You must only use unleaded gasoline in your vehicle, E85, or a blend of the two fuels.

Unleaded gasoline (Octane rating 87 [Research Octane Number 91] or higher), E85, or a blend of these two fuels is required for optimum engine performance.

The use of unleaded gasoline with an octane rating lower than 87 may result in engine knocking. Persistent knocking can lead to engine damage.

The use of fuel with an ethanol concentration in excess of 85% will have a negative impact on driving performance and can cause damage to the fuel system components.

At minimum, the gasoline you use should meet the specifications of ASTM D4814 in the U.S.A. and CGSB3.5-M93 in Canada.

At minimum, the E85 you use should meet the specifications of ASTM D5798 in the U.S.A.

■ Fuel tank opening for unleaded gasoline

To help prevent incorrect fueling, your vehicle has a fuel tank opening that only accommodates the special nozzle on unleaded fuel pumps.

■ Fuel quality

In very few cases, driveability problems may be caused by the brand of fuel you are using. If driveability problems persist, try changing the brand of fuel. If this does not correct the problem, consult your Toyota dealer.

■ Gasoline quality standards

- Automotive manufacturers in the U.S.A., Europe and Japan have developed a specification for fuel quality called the World-Wide Fuel Charter (WWFC), which is expected to be applied worldwide.
- The WWFC consists of four categories that are based on required emission levels. In the U.S., category 4 has been adopted.
- The WWFC improves air quality by lowering emissions in vehicle fleets, and improves customer satisfaction through better performance.

■ E85 fuel (Flex-fuel vehicles)

- E85 fuel is a blend of 85% ethanol and 15% gasoline. However, E85 does not necessarily contain 85% ethanol. For example, in cold climates the ethanol content of E85 may be reduced during the winter months to maintain cold weather starting performance.
- E85 has less energy per gallon than gasoline, so you will need to fill your fuel tank more frequently when using E85.
- The number of fuel stations that sell E85 fuel is limited. For more information about fueling stations, please refer to the U.S. Department of Energy Web site.
<http://www.afdc.energy.gov/afdc/locator/stations/>

■ Recommendation of the use of gasoline containing detergent additives

- Toyota recommends the use of gasoline detergent additives to avoid build-up of engine deposits.
- All gasoline sold in the U.S.A. contains minimum detergent additives to clean and/or keep clean intake systems, per EPA's lowest additives concentration program.
- Toyota strongly recommends the use of Top Tier Detergent Gasoline. For more information on Top Tier Detergent Gasoline and a list of marketers, please go to the official website www.toptiergas.com.

■ Recommendation of the use of cleaner burning gasoline

Cleaner burning gasoline, including reformulated gasoline that contains oxygenates such as ethanol or MTBE (Methyl Tertiary Butyl Ether) is available in many areas.

Toyota recommends the use of cleaner burning gasoline and appropriately blended reformulated gasoline. These types of gasoline provide excellent vehicle performance, reduce vehicle emissions and improve air quality.

■ Non-recommendation of the use of blended gasoline (gasoline engine)

- Use only gasoline containing a maximum of 10% ethanol.
DO NOT use any flex-fuel or gasoline that could contain more than 10% ethanol, including from any pump labeled E15, E30, E50, E85 (which are only some examples of fuel containing more than 10% ethanol).

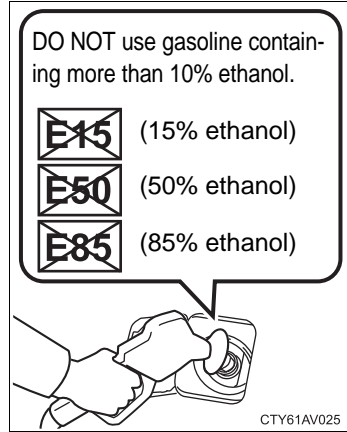

- If you use gasohol in your vehicle, be sure that it has an octane rating no lower than 87.
- Toyota does not recommend the use of gasoline containing methanol.

■ Non-recommendation of the use of gasoline containing MMT

Some gasoline contains an octane enhancing additive called MMT (Methylcyclopentadienyl Manganese Tricarbonyl).

Toyota does not recommend the use of gasoline that contains MMT. If fuel containing MMT is used, your emission control system may be adversely affected.

The malfunction indicator lamp on the instrument cluster may come on. If this happens, contact your Toyota dealer for service.

■ Toyota does not recommend blended gasoline (Flex-fuel engine)

Do not use non-specified fuels such as the following.

- Fuels containing methanol.
- Fuels with more than 85% ethanol.

■ Toyota does not recommend the use of after-market fuel additives (Flex-fuel engine)

Do not use any after-market fuel additives when repeatedly refueling with E85, as some after-market fuel additives are not compatible with E85.

■ If your engine knocks

- Consult your Toyota dealer.
- You may occasionally notice light knocking for a short time while accelerating or driving uphill. This is normal and there is no need for concern.

**NOTICE****■ Notice on fuel quality**

- Do not use improper fuels. If improper fuels are used, the engine will be damaged.
- Do not use leaded gasoline.
Leaded gasoline can cause damage to your vehicle's three-way catalytic converters causing the emission control system to malfunction.
- Gasoline engine: Do not use gasohol other than the type previously stated.
Other gasohol may cause fuel system damage or vehicle performance problems.
- Using unleaded gasoline with an octane number or rating lower than the level previously stated will cause persistent heavy knocking.
At worst, this will lead to engine damage.

■ When use of non-specified fuels (Flex-fuel engine)

The use of non-specified fuels will have a negative impact on starting and driving performance, and will cause damage to the fuel system components. Therefore, do not add fuels such as the following.

- Fuels containing methanol
- Fuels with more than 85% ethanol

■ Fuel-related poor driveability

If poor driveability is encountered after using a different type of fuel (poor hot starting, vaporization, engine knocking, etc.), discontinue the use of that type of fuel.

■ When refueling with gasohol

Take care not to spill gasohol. It can damage your vehicle's paint.

Tire information

Typical tire symbols

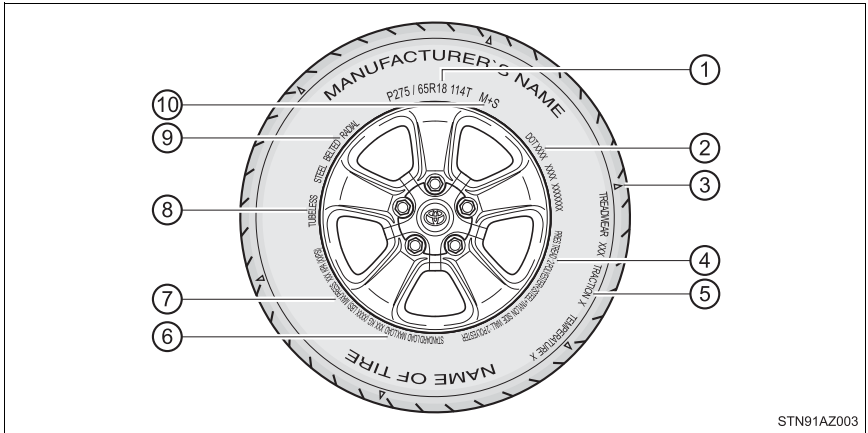

STN91AZ003

- ① Tire size (→P. 521)
- ② DOT and Tire Identification Number (TIN) (→P. 521)
- ③ Location of treadwear indicators (→P. 417)
- ④ Tire ply composition and materials

Ply is a layer of rubber-coated parallel cords. Cords are the strands which form the plies in a tire.

- ⑤ Uniform tire quality grading
- ⑥ Load limit at maximum cold tire inflation pressure (→P. 525)
- ⑦ Maximum cold tire inflation pressure (→P. 525)

This means the pressure to which a tire may be inflated.

- ⑧ TUBELESS or TUBE TYPE

A tubeless tire does not have a tube and air is directly put into the tire. A tube type tire has a tube inside the tire and the tube maintains the air pressure.

- ⑨ Radial tires or bias-ply tires

A radial tire has "RADIAL" on the sidewall. A tire not marked "RADIAL" is a bias-ply tire.

- ⑩ Summer tire or all season tire (→P. 421)

An all season tire has "M+S" on the sidewall. A tire not marked "M+S" is a summer tire.

Typical DOT and Tire Identification Number (TIN)

- ① DOT symbol*
- ② Tire Identification Number (TIN)
- ③ Tire manufacturer's identification mark
- ④ Tire size code
- ⑤ Manufacturer's optional tire type code (3 or 4 letters)
- ⑥ Manufacturing week
- ⑦ Manufacturing year

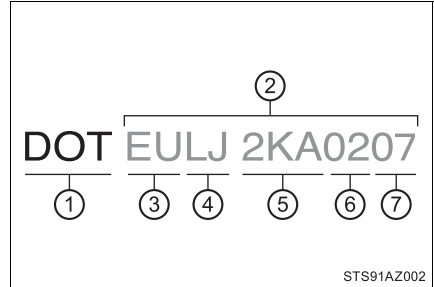

*: The DOT symbol certifies that the tire conforms to applicable Federal Motor Vehicle Safety Standards.

Tire size

■ Typical tire size information

The illustration indicates typical tire size.

- ① Tire use
(P = Passenger car,
T = Temporary use)
- ② Section width (millimeters)
- ③ Aspect ratio
(tire height to section width)
- ④ Tire construction code
(R = Radial, D = Diagonal)
- ⑤ Wheel diameter (inches)
- ⑥ Load index
(2 digits or 3 digits)
- ⑦ Speed symbol
(alphabet with one letter)

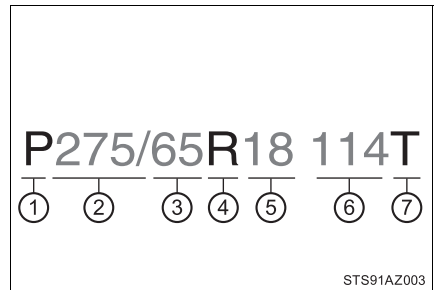

■ Tire dimensions

- ① Section width
- ② Tire height
- ③ Wheel diameter

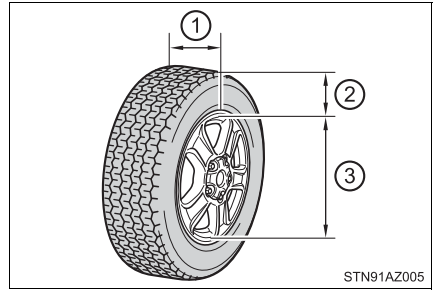

Tire section names

- ① Bead
- ② Sidewall
- ③ Shoulder
- ④ Tread
- ⑤ Belt
- ⑥ Inner liner
- ⑦ Reinforcing rubber
- ⑧ Carcass
- ⑨ Rim lines
- ⑩ Bead wires
- ⑪ Chafer

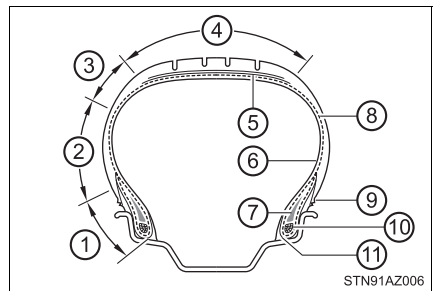

Uniform Tire Quality Grading

This information has been prepared in accordance with regulations issued by the National Highway Traffic Safety Administration of the U.S. Department of Transportation.

It provides the purchasers and/or prospective purchasers of Toyota vehicles with information on uniform tire quality grading.

Your Toyota dealer will help answer any questions you may have as you read this information.

■ DOT quality grades

All passenger vehicle tires must conform to Federal Safety Requirements in addition to these grades. Quality grades can be found where applicable on the tire sidewall between tread shoulder and maximum section width.

For example: Treadwear 200 Traction AA Temperature A

■ Treadwear

The treadwear grade is a comparative rating based on the wear rate of the tire when tested under controlled conditions on a specified government test course.

For example, a tire graded 150 would wear one and a half (1 - 1/2) times as well on the government course as a tire graded 100.

The relative performance of tires depends upon the actual conditions of their use. Performance may differ significantly from the norm due to variations in driving habits, service practices and differences in road characteristics and climate.

■ Traction AA, A, B, C

The traction grades, from highest to lowest, are AA, A, B and C, and they represent the tire's ability to stop on wet pavement as measured under controlled conditions on specified government test surfaces of asphalt and concrete.

A tire marked C may have poor traction performance.

Warning: The traction grade assigned to this tire is based on braking (straight ahead) traction tests and does not include cornering (turning) traction.

■ Temperature A, B, C

The temperature grades are A (the highest), B, and C, representing the tire's resistance to the generation of heat and its ability to dissipate heat when tested under controlled conditions on a specified indoor laboratory test wheel.

Sustained high temperature can cause the material of the tire to degenerate and reduce tire life, and excessive temperature can lead to sudden tire failure.

Grade C corresponds to a level of performance which all passenger car tires must meet under the Federal Motor Vehicle Safety Standard No. 109.

Grades B and A represent higher levels of performance on the laboratory test wheel than the minimum required by law.

Warning: The temperature grades of a tire assume that it is properly inflated and not overloaded.

Excessive speed, underinflation, or excessive loading, either separately or in combination, can cause heat buildup and possible tire failure.

Glossary of tire terminology

| Tire related term | Meaning |
|--------------------------------|--|
| Cold tire inflation pressure | Tire pressure when the vehicle has been parked for three hours or more, or has not been driven more than 1 mile or 1.5 km under that condition |
| Maximum inflation pressure | The maximum cold inflated pressure to which a tire may be inflated, shown on the sidewall of the tire |
| Recommended inflation pressure | Cold tire inflation pressure recommended by a manufacturer |
| Accessory weight | The combined weight (in excess of those standard items which may be replaced) of automatic transmission, power steering, power brakes, power windows, power seats, radio and heater, to the extent that these items are available as factory-installed equipment (whether installed or not) |
| Curb weight | The weight of a motor vehicle with standard equipment, including the maximum capacity of fuel, oil and coolant, and if so equipped, air conditioning and additional weight optional engine |
| Maximum loaded vehicle weight | The sum of: (a) Curb weight (b) Accessory weight (c) Vehicle capacity weight (d) Production options weight |
| Normal occupant weight | 150 lb. (68 kg) times the number of occupants specified in the second column of Table 1* that follows |
| Occupant distribution | Distribution of occupants in a vehicle as specified in the third column of Table 1* below |
| Production options weight | The combined weight of installed regular production options weighing over 5 lb. (2.3 kg) in excess of the standard items which they replace, not previously considered in curb weight or accessory weight, including heavy duty brakes, ride levelers, roof rack, heavy duty battery, and special trim |

| Tire related term | Meaning |
|---|--|
| Rim | A metal support for a tire or a tire and tube assembly upon which the tire beads are seated |
| Rim diameter (Wheel diameter) | Nominal diameter of the bead seat |
| Rim size designation | Rim diameter and width |
| Rim type designation | The industry manufacturer's designation for a rim by style or code |
| Rim width | Nominal distance between rim flanges |
| Vehicle capacity weight (Total load capacity) | The rated cargo and luggage load plus 150 lb. (68 kg) times the vehicle's designated seating capacity |
| Vehicle maximum load on the tire | The load on an individual tire that is determined by distributing to each axle its share of the maximum loaded vehicle weight, and dividing by two |
| Vehicle normal load on the tire | The load on an individual tire that is determined by distributing to each axle its share of curb weight, accessory weight, and normal occupant weight (distributed in accordance with Table 1* below), and dividing by two |
| Weather side | The surface area of the rim not covered by the inflated tire |
| Bead | The part of the tire that is made of steel wires, wrapped or reinforced by ply cords and that is shaped to fit the rim |
| Bead separation | A breakdown of the bond between components in the bead |
| Bias ply tire | A pneumatic tire in which the ply cords that extend to the beads are laid at alternate angles substantially less than 90 degrees to the centerline of the tread |
| Carcass | The tire structure, except tread and sidewall rubber which, when inflated, bears the load |
| Chunking | The breaking away of pieces of the tread or sidewall |
| Cord | The strands forming the plies in the tire |

| Tire related term | Meaning |
|--|---|
| Cord separation | The parting of cords from adjacent rubber compounds |
| Cracking | Any parting within the tread, sidewall, or innerliner of the tire extending to cord material |
| CT | A pneumatic tire with an inverted flange tire and rim system in which the rim is designed with rim flanges pointed radially inward and the tire is designed to fit on the underside of the rim in a manner that encloses the rim flanges inside the air cavity of the tire |
| Extra load tire | A tire designed to operate at higher loads and at higher inflation pressures than the corresponding standard tire |
| Groove | The space between two adjacent tread ribs |
| Innerliner | The layer(s) forming the inside surface of a tubeless tire that contains the inflating medium within the tire |
| Innerliner separation | The parting of the innerliner from cord material in the carcass |
| Intended outboard sidewall | (a) The sidewall that contains a whitewall, bears white lettering, or bears manufacturer, brand, and/or model name molding that is higher or deeper than the same molding on the other sidewall of the tire, or (b) The outward facing sidewall of an asymmetrical tire that has a particular side that must always face outward when mounted on a vehicle |
| Light truck (LT) tire | A tire designated by its manufacturer as primarily intended for use on lightweight trucks or multipurpose passenger vehicles |
| Load rating | The maximum load that a tire is rated to carry for a given inflation pressure |
| Maximum load rating | The load rating for a tire at the maximum permissible inflation pressure for that tire |
| Maximum permissible inflation pressure | The maximum cold inflation pressure to which a tire may be inflated |
| Measuring rim | The rim on which a tire is fitted for physical dimension requirements |

| Tire related term | Meaning |
|---------------------|---|
| Open splice | Any parting at any junction of tread, sidewall, or innerliner that extends to cord material |
| Outer diameter | The overall diameter of an inflated new tire |
| Overall width | The linear distance between the exteriors of the sidewalls of an inflated tire, including elevations due to labeling, decorations, or protective bands or ribs |
| Passenger car tire | A tire intended for use on passenger cars, multipurpose passenger vehicles, and trucks, that have a gross vehicle weight rating (GVWR) of 10,000 lb. or less. |
| Ply | A layer of rubber-coated parallel cords |
| Ply separation | A parting of rubber compound between adjacent plies |
| Pneumatic tire | A mechanical device made of rubber, chemicals, fabric and steel or other materials, that, when mounted on an automotive wheel, provides the traction and contains the gas or fluid that sustains the load |
| Radial ply tire | A pneumatic tire in which the ply cords that extend to the beads are laid at substantially 90 degrees to the centerline of the tread |
| Reinforced tire | A tire designed to operate at higher loads and at higher inflation pressures than the corresponding standard tire |
| Section width | The linear distance between the exteriors of the sidewalls of an inflated tire, excluding elevations due to labeling, decoration, or protective bands |
| Sidewall | That portion of a tire between the tread and bead |
| Sidewall separation | The parting of the rubber compound from the cord material in the sidewall |

| Tire related term | Meaning |
|----------------------------|---|
| Snow tire | A tire that attains a traction index equal to or greater than 110, compared to the ASTM E-1136 Standard Reference Test Tire, when using the snow traction test as described in ASTM F-1805-00, Standard Test Method for Single Wheel Driving Traction in a Straight Line on Snow-and Ice-Covered Surfaces, and which is marked with an Alpine Symbol () on at least one sidewall |
| Test rim | The rim on which a tire is fitted for testing, and may be any rim listed as appropriate for use with that tire |
| Tread | That portion of a tire that comes into contact with the road |
| Tread rib | A tread section running circumferentially around a tire |
| Tread separation | Pulling away of the tread from the tire carcass |
| Treadwear indicators (TWI) | The projections within the principal grooves designed to give a visual indication of the degrees of wear of the tread |
| Wheel-holding fixture | The fixture used to hold the wheel and tire assembly securely during testing |

*: Table 1 — Occupant loading and distribution for vehicle normal load for various designated seating capacities

| Designated seating capacity, Number of occupants | Vehicle normal load, Number of occupants | Occupant distribution in a normally loaded vehicle |
|--|--|---|
| 2 through 4 | 2 | 2 in front |
| 5 through 10 | 3 | 2 in front, 1 in second seat |
| 11 through 15 | 5 | 2 in front, 1 in second seat, 1 in third seat, 1 in fourth seat |
| 16 through 20 | 7 | 2 in front, 2 in second seat, 2 in third seat, 1 in fourth seat |

Customizable features

Your vehicle includes a variety of electronic features that can be personalized to your preferences. Programming these preferences requires specialized equipment and may be performed by your Toyota dealer.

Customizing vehicle features

■ Changing by using the multimedia system

- 1 Press the “SETUP” or “APPS” button.

▶ Entune Audio

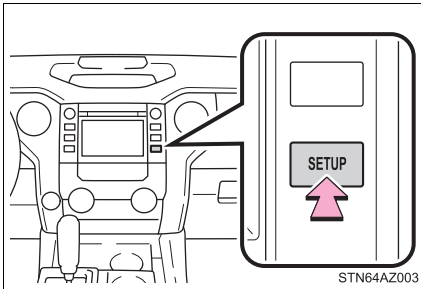

▶ Entune Audio Plus

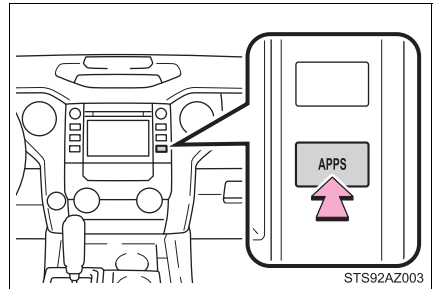

▶ Entune Premium Audio

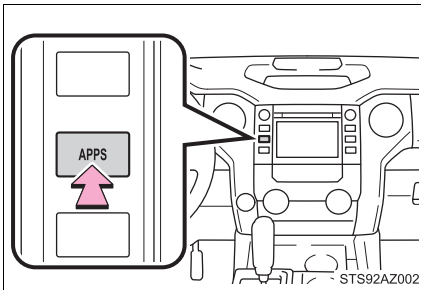

- 2 Entune Audio Plus or Entune Premium Audio:
Select “Setup” on the “Apps” screen.
- 3 Select “Vehicle” on the “Setup” screen.
- 4 Select “Vehicle Customization” on the “Vehicle Settings” screen.
“Vehicle Customization” screen will appear.
- 5 Choose a category displayed on the screen to display the settings.

- 6 Select the setting to be changed. Change each setting.

For items that can be enabled/disabled, and for items with an operating time that can be changed, select “On” or “Off”, or select the desired operating time.

For items with sensor sensitivity that can be changed, select “+” or “-” to choose the desired level, then select “OK”.

- 7 A message indicating that the settings are being saved will appear. Do not perform any other operations while this message is displayed.

■ Changing by using the multi-information display

→P. 95

Customizable features

Some function settings are changed simultaneously with other functions being customized. Contact your Toyota dealer for further details.

- ① Settings that can be changed using the multi-information display.
- ② Settings that can be changed using the multimedia system.
- ③ Settings that can be changed by your Toyota dealer.

Definition of symbols: O = Available, — = Not available

■ Door lock* (→P. 102)

| Function | Default setting | Customized setting | ① | ② | ③ |
|---|---|--------------------------------|---|---|---|
| Unlocking using a key | Driver's door unlocked in one step, all doors unlocked in two steps | All doors unlocked in one step | — | — | O |
| Speed-detecting automatic door lock function | On | Off | — | O | O |
| Shifting gears to position other than P locks all doors | Off | On | — | O | O |
| Shifting gears to P unlocks all doors | On | Off | — | O | O |
| Opening the driver's door unlocks all doors | Off | On | — | O | O |

*: If equipped

■ Wireless remote control* (→P. 103)

| Function | Default setting | Customized setting | ① | ② | ③ |
|--|---|--------------------------------|---|---|---|
| Wireless remote control | On | Off | — | — | ○ |
| Unlocking operation | Driver's door unlocked in one step, all doors unlocked in two steps | All doors unlocked in one step | — | ○ | ○ |
| Automatic door lock function to be activated if door is not opened after being unlocked | On | Off | — | — | ○ |
| Time elapsed before automatic door lock function is activated if door is not opened after being unlocked | 60 seconds | 0 seconds | — | ○ | ○ |
| | | 30 seconds | | | |
| | | 120 seconds | | | |
| Operation signal (Emergency flashers) | On | Off | — | ○ | ○ |
| Operation signal (Buzzer) | On | Off | — | — | ○ |
| Panic function | On | Off | — | — | ○ |
| Open door reminder buzzer (When locking the vehicle) | On | Off | — | — | ○ |

*: If equipped

■ Moon roof* (→P. 142)

| Function | Default setting | Customized setting | ① | ② | ③ |
|--|-----------------|--------------------|---|---|---|
| Door key linked operation | Open and close | Open only | — | — | ○ |
| | | Close only | | | |
| | | Off | | | |
| Linked operation of components when door key is used | Slide only | Tilt only | — | — | ○ |

*: If equipped

■ Automatic light off system* (→P. 189)

| Function | Default setting | Customized setting | ① | ② | ③ |
|--|-----------------|--------------------|---|---|---|
| Light sensor sensitivity | Level 3 | Level 1 to 5 | — | ○ | ○ |
| Time elapsed before headlights automatically turn off after doors are closed | 30 seconds | 0 seconds | — | ○ | ○ |
| | | 60 seconds | | | |
| | | 90 seconds | | | |

*: If equipped

■ Multi-information display*¹ (→P. 95)

| Function | Default setting | Customized setting | ① | ② | ③ |
|---------------------------------------|-----------------|--------------------|---|---|---|
| Turn by Turn navigation* ² | On | Off | ○ | ○ | ○ |
| Language | English | French | ○ | ○ | ○ |
| | | Spanish | | | |
| Units | miles (MPG US) | km (L/100 km) | ○ | ○ | ○ |

*¹: If equipped

*²: Vehicles with navigation system

■ Illumination (→P. 353)

| Function | Default setting | Customized setting | ① | ② | ③ |
|---------------------------------------|-----------------|--------------------|---|---|---|
| Time elapsed before lights turn off | 15 seconds | 7.5 seconds | — | ○ | ○ |
| | | 30 seconds | | | |
| Operation after the engine is off | On | Off | — | — | ○ |
| Operation when the doors are unlocked | On | Off | — | — | ○ |

■ Seat Belt Reminder Buzzer (→P. 466)

| Function | Default setting | Customized setting | ① | ② | ③ |
|--|-----------------|--------------------|---|---|---|
| Vehicle speed linked seat belt reminder buzzer | On | Off | — | — | ○ |

■ Vehicle customization

- When the speed-detecting automatic door lock function and shift position linked door locking function (shifting gears to a position other than P locks all doors) are both on, the door lock operates as follows.
 - When shifting the shift lever to any position other than P, all the doors will be locked.
 - If the vehicle is started with all the doors locked, the speed-detecting automatic door lock function would not operate.
 - If the vehicle is started with any the door unlocked, the speed-detecting automatic door lock function will operate.
- When the doors remain closed after unlocking the doors and the automatic door lock function (Time elapsed before the automatic door lock function is activated if a door is not opened after being unlocked) activates, the signals will be generated in accordance with operation signal (buzzers) and the operation signal (emergency flashers) settings.

**CAUTION****■ During customization**

As the engine needs to be running during customization, ensure that the vehicle is parked in a place with adequate ventilation. In a closed area such as a garage, exhaust gases including harmful carbon monoxide (CO) may collect and enter the vehicle. This may lead to death or serious health hazard.

**NOTICE****■ During customization**

To prevent battery discharge, ensure that the engine is running while customizing features.

Items to initialize

The following items must be initialized for normal system operation after such cases as the battery being reconnected, or maintenance being performed on the vehicle:

| Item | When to initialize | Reference |
|------------------------------|---|-----------|
| Moon roof | <ul style="list-style-type: none"> • After reconnecting or changing the battery • After changing a fuse | P. 144 |
| Maintenance data | <ul style="list-style-type: none"> • After the maintenance is performed | P. 398 |
| Tire pressure warning system | <ul style="list-style-type: none"> • When rotating the tires. • When changing the tire size. | P. 419 |

For owners**10**

| | |
|---|-----|
| Reporting safety defects for U.S. owners..... | 538 |
| Seat belt instructions for Canadian owners (in French) | 539 |
| SRS airbag instructions for Canadian owners (in French) | 541 |
| Camper information | 550 |

Reporting safety defects for U.S. owners

If you believe that your vehicle has a defect which could cause a crash or could cause injury or death, you should immediately inform the National Highway Traffic Safety Administration (NHTSA) in addition to notifying Toyota Motor Sales, U.S.A., Inc. (Toll-free: 1-800-331-4331).

If NHTSA receives similar complaints, it may open an investigation, and if it finds that a safety defect exists in a group of vehicles, it may order a recall and remedy campaign. However, NHTSA cannot become involved in individual problems between you, your dealer, or Toyota Motor Sales, U.S.A., Inc.

To contact NHTSA, you may call the Vehicle Safety Hotline toll-free at 1-888-327-4236 (TTY: 1-800-424-9153); go to <http://www.safercar.gov>; or write to: Administrator, NHTSA, 1200 New Jersey Ave, S.E., Washington, DC 20590. You can also obtain other information about motor vehicle safety from <http://www.safercar.gov>.

Seat belt instructions for Canadian owners (in French)

The following is a French explanation of seat belt instructions extracted from the seat belt section in this manual.

See the seat belt section for more detailed seat belt instructions in English.

Utilisation adéquate des ceintures de sécurité

- Tirez sur la ceinture épaulière jusqu'à ce qu'elle recouvre entièrement l'épaule; elle ne doit cependant pas toucher le cou ni glisser de l'épaule.
- Placez la sangle abdominale de la ceinture de sécurité le plus bas possible sur les hanches.
- Réglez la position du dossier du siège. Asseyez-vous le dos le plus droit possible et calez-vous bien dans le siège.
- Ne pas vriller la ceinture de sécurité.

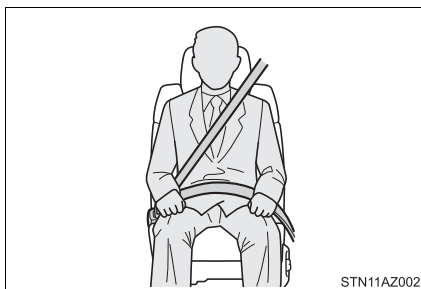

Entretien et soin

■ Ceintures de sécurité

Nettoyez avec un chiffon ou une éponge humectée d'eau savonneuse tiède. Par ailleurs, vérifiez régulièrement que les ceintures ne sont pas effilochées, entaillées, ou ne paraissent pas exagérément usées.

**ATTENTION****■ Dommages et usure de la ceinture de sécurité**

Inspectez les ceintures de sécurité périodiquement. Contrôlez qu'elles ne sont pas entaillées, effilochées, et que leurs ancrages ne sont pas desserrés. Ne pas utiliser une ceinture de sécurité défectueuse avant qu'elle ne soit remplacée. Une ceinture de sécurité défectueuse n'apporte aucune garantie de protection de l'occupant contre des blessures graves, voire mortelles.

SRS airbag instructions for Canadian owners (in French)

The following is a French explanation of SRS airbag instructions extracted from the SRS airbag section in this manual.

See the SRS airbag section for more detailed SRS airbag instructions in English.

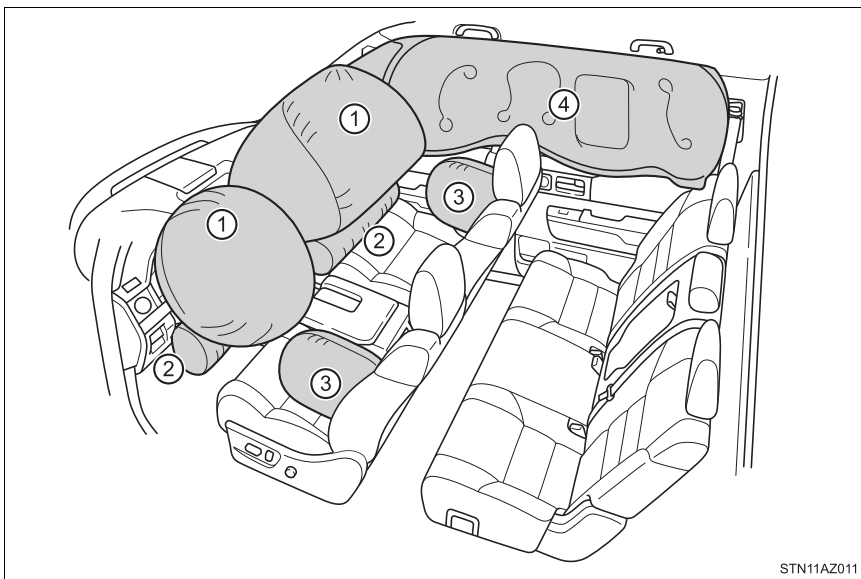

STN11AZ011

◆ Coussins gonflables SRS frontaux

- ① Coussins gonflables SRS conducteur/passager avant
Participent à la protection de la tête et du thorax du conducteur et du passager avant contre les chocs avec les éléments de l'habitacle
- ② Coussins gonflables SRS de genoux
Participent à la protection du conducteur et du passager avant

◆ Coussins gonflables SRS latéraux et rideau

- ③ Coussins gonflables SRS latéraux
Participent à la protection du haut du corps des occupants des sièges avant
- ④ Coussins gonflables SRS rideau
 - Participent principalement à la protection de la tête des occupants assis dans les sièges des places extérieures
 - Peuvent empêcher les occupants d'être éjectés du véhicule en cas de retournement de celui-ci

Composition du système de coussins gonflables SRS

► Modèles à Simple Cabine

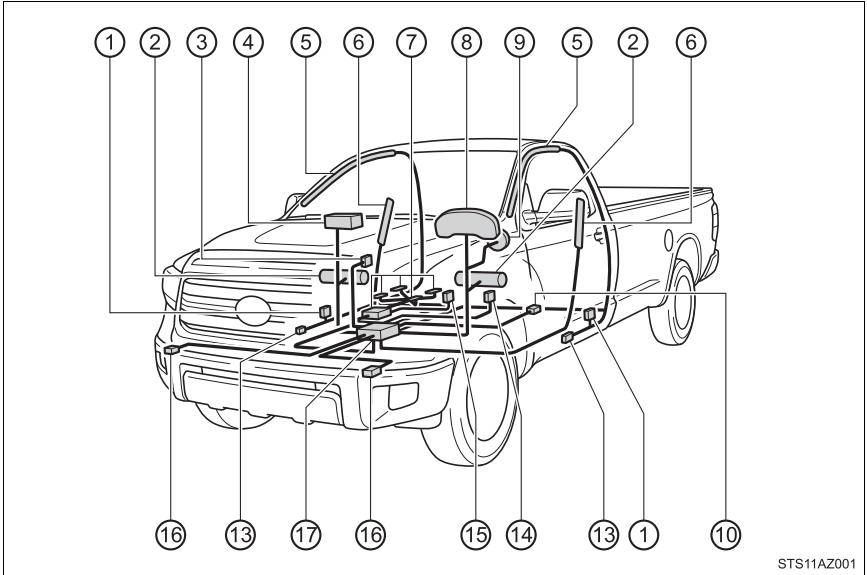

► Modèles à Double Cabine et CrewMax

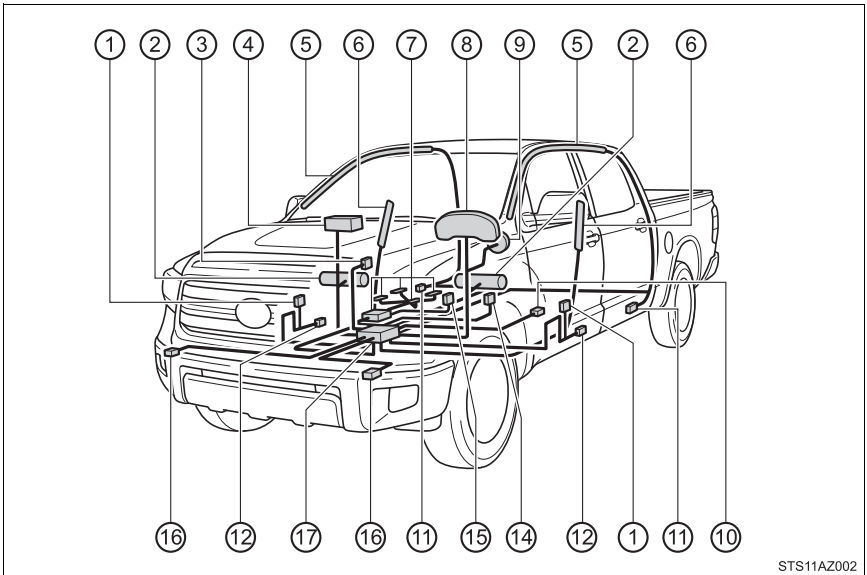

- | | |
|--|--|
| ① Prétensionneurs de ceintures de sécurité | ⑪ Capteurs d'impact latéral (arrière) (modèles à Double Cabine et CrewMax) |
| ② Coussins gonflables de genoux | ⑫ Capteurs d'impact latéral (porte avant) (modèles à Double Cabine et CrewMax) |
| ③ Témoins indicateurs "AIR BAG ON" et "AIR BAG OFF" | ⑬ Capteurs d'impact latéral (avant) (modèles à Simple Cabine) |
| ④ Coussin gonflable passager avant | ⑭ Contacteur de boucle de ceinture de sécurité conducteur |
| ⑤ Coussins gonflables rideau | ⑮ Contacteur de boucle de ceinture de sécurité passager avant |
| ⑥ Coussins gonflables latéraux (sièges avant) | ⑯ Capteurs d'impact avant |
| ⑦ Système de classification d'occupant du siège passager avant (ECU et capteurs) | ⑰ Boîtier électronique de coussins gonflables |
| ⑧ Témoin d'alerte SRS | |
| ⑨ Coussin gonflable conducteur | |
| ⑩ Capteur de position du siège conducteur | |

Votre véhicule est équipé de COUSSINS GONFLABLES ÉVOLUÉS, dont la conception est basée sur les normes de sécurité des véhicules automobiles américains (FMVSS208). Le boîtier électronique de coussins gonflables (ECU) utilise les informations reçues des capteurs, etc. détaillés dans le schéma ci-dessus de composition du système pour commander le déploiement des coussins gonflables. Ces informations comprennent des informations sur la gravité de la collision et les occupants. Le déploiement rapide des coussins gonflables est obtenu au moyen d'une réaction chimique dans les dispositifs pyrotechniques, qui produit un gaz inoffensif permettant d'amortir le mouvement des occupants.

Siège avant de type banquette: Les coussins gonflables SRS sont conçus pour protéger le conducteur et le passager avant droit, et en aucun cas une personne assise à la place centrale avant.

 ATTENTION

■ Précautions avec les coussins gonflables SRS

Respectez les précautions suivantes concernant les coussins gonflables SRS.

À défaut, des blessures graves, voire mortelles, pourraient s'ensuivre.

- Le conducteur et tous les passagers à bord du véhicule doivent porter leur ceinture de sécurité correctement.

Les coussins gonflables SRS sont des dispositifs de protection complémentaires aux ceintures de sécurité.

- Le coussin gonflable SRS conducteur se déploie avec une puissance considérable et peut occasionner des blessures graves, voire mortelles, notamment lorsque le conducteur se trouve très près du coussin gonflable. Conseils de la National Highway Traffic Safety Administration (NHTSA):

Sachant que la zone de danger pour le coussin gonflable conducteur se trouve dans les premiers 2 - 3 in. (50 - 75 mm) du déploiement, placez-vous à 10 in. (250 mm) du coussin gonflable conducteur pour garantir une marge de sécurité suffisante. Cette distance est à mesurer entre le moyeu du volant de direction et le sternum. Si vous êtes assis à moins de 10 in. (250 mm), vous pouvez changer votre position de conduite de plusieurs façons:

- Reculez votre siège le plus possible, tout en continuant à pouvoir atteindre confortablement les pédales.
- Inclinez légèrement le dossier du siège.
Bien que les véhicules puissent être différents les uns des autres, la plupart des conducteurs peuvent s'asseoir à une distance de 10 in. (250 mm), même avec le siège conducteur complètement avancé, simplement en inclinant un peu le dossier de siège. Si vous avez des difficultés à voir la route après avoir incliné votre siège, utilisez un coussin ferme et antidérapant pour vous rehausser ou, si votre véhicule est équipé du réglage en hauteur du siège, remontez-le.
- Si votre volant de direction est réglable, inclinez-le vers le bas. Cela vous permet d'orienter le coussin gonflable vers votre buste plutôt que vers la tête et le cou.

Le siège doit être réglé selon les recommandations de la NHTSA ci-dessus, tout en conservant le contrôle des pédales et du volant, et la vue des commandes au tableau de bord.

⚠ ATTENTION

■ Précautions avec les coussins gonflables SRS

● Si vous attachez une rallonge de ceinture de sécurité aux boucles des ceintures de sièges avant, mais pas au pêne de la ceinture de sécurité proprement dite, les coussins gonflables SRS frontaux déterminent que le conducteur et le passager avant portent leur ceinture de sécurité, alors même qu'elle n'est pas attachée. Dans ce cas, les coussins gonflables SRS frontaux risquent de ne pas se déployer correctement en cas de collision, causant des blessures graves, voire mortelles. Veillez à porter la ceinture de sécurité avec la rallonge de ceinture de sécurité.

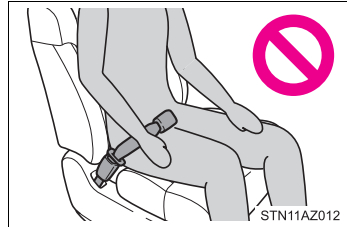

- Le coussin gonflable SRS passager avant se déploie également avec une puissance considérable et peut occasionner des blessures graves, voire mortelles, notamment lorsque le passager avant se trouve très près du coussin gonflable. Le siège du passager avant doit se trouver le plus loin possible du coussin gonflable et le dossier doit être réglé de manière à ce que le passager avant soit assis bien droit.
- Le déploiement d'un coussin gonflable risque d'infliger des blessures graves, voire mortelles, aux bébés et aux enfants mal assis et/ou mal attachés. Installez dans un siège de sécurité enfant les enfants trop jeunes pour pouvoir utiliser la ceinture de sécurité. Toyota recommande vivement que tous les nourrissons et enfants soient installés dans les sièges arrière du véhicule et convenablement attachés. Les sièges arrière sont plus sûrs pour les nourrissons et les enfants que le siège passager avant.
- N'installez jamais un siège de sécurité enfant type dos à la route sur le siège passager avant, même si le voyant "AIR BAG OFF" est allumé. En cas d'accident, la force exercée par le déploiement rapide du coussin gonflable passager peut causer des blessures graves, voire mortelles à un enfant, si le siège de sécurité enfant type dos à la route est installé sur le siège passager avant.

⚠ ATTENTION

■ Précautions avec les coussins gonflables SRS

- Ne pas s'asseoir sur le bord du siège et ne pas s'appuyer contre la planche de bord.

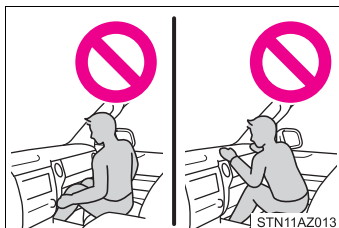

- Ne laissez pas un enfant debout face au coussin gonflable SRS passager avant ni assis sur les genoux d'un passager avant.
- Ne pas laisser les occupants des sièges avant voyager avec un objet sur les genoux.

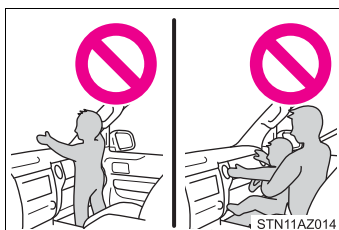

- Ne pas s'appuyer contre la porte, contre le rail latéral de toit ou contre les montants avant, latéraux et arrière.



- Ne laissez personne s'agenouiller face à la portière sur les sièges du passager ou sortir la tête ou les mains à l'extérieur du véhicule.

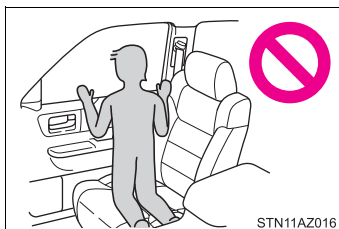

- Ne fixez ni ne posez aucun objet sur la planche de bord, la garniture centrale du volant de direction et la partie inférieure du tableau de bord. Lors du déploiement des coussins gonflables SRS conducteur, passager avant et de genoux, tout objet risque de se transformer en projectile.

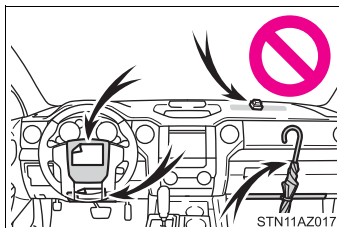

ATTENTION

■ Précautions avec les coussins gonflables SRS

- Ne rien fixer aux portes, à la vitre de pare-brise, aux vitres latérales, aux montants avant et arrière, au rail latéral de toit et à la poignée de maintien.

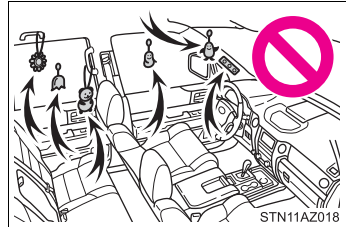

- Ne pas attacher à la clé des objets lourds, pointus ou très durs, comme d'autres clés par exemple. Ces objets risquent d'entraver le déploiement du coussin gonflable SRS de genoux ou d'être projetés en direction du siège conducteur par la force de déploiement, constituant ainsi un danger potentiel.

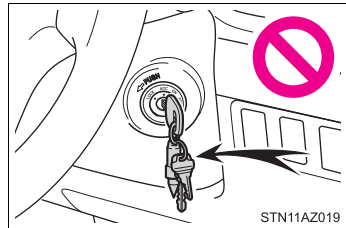

- Ne suspendez aux crochets à vêtements aucun cintre nu ni aucun objet dur. En cas de déploiement des coussins gonflables SRS rideau, tous ces objets pourraient se transformer en projectiles et causer des blessures graves, voire mortelles.
- Si une housse en vinyle recouvre la partie où le coussin gonflable SRS de genoux se déploie, veillez à l'enlever.
- N'utilisez aucun accessoire de siège venant recouvrir les zones de déploiement des coussins gonflables SRS latéraux, car il risquerait d'en gêner le déploiement. De tels accessoires peuvent empêcher les coussins gonflables latéraux de fonctionner correctement, désactiver le dispositif ou entraîner le déploiement accidentel des coussins latéraux, entraînant la mort ou des blessures graves.
- Évitez de faire subir des chocs ou des pressions excessives aux zones renfermant les composants des coussins gonflables SRS. En effet, cela pourrait entraîner un mauvais fonctionnement des coussins gonflables SRS.
- Ne touchez à aucun composant des coussins gonflables SRS immédiatement après leur déploiement (gonflage), car ils pourraient être chauds.

 **ATTENTION**
■ Précautions avec les coussins gonflables SRS

- Si vous avez des difficultés à respirer après le déploiement des coussins gonflables SRS, ouvrez une porte ou une vitre pour faire entrer de l'air frais, ou bien descendez du véhicule si cela ne présente pas de danger. Retirez tout résidu dès que possible afin d'éviter d'éventuelles irritations de la peau.
- Si les parties renfermant les coussins gonflables SRS, telles que la garniture centrale du volant de direction et les garnitures de montants avant et arrière, apparaissent abîmées ou craquelées, faites-les remplacer par votre concessionnaire Toyota.
- Ne placez aucun objet, par exemple un coussin, sur le siège du passager avant. Cela a pour conséquence de répartir le poids du passager sur toute la surface du siège, ce qui empêche le capteur de détecter normalement le poids du passager. En conséquence, les coussins gonflables SRS frontaux du passager avant peuvent ne pas se déployer en cas de collision.

■ Modification et élimination en fin de vie des éléments du système de coussins gonflables SRS

Consultez impérativement votre concessionnaire Toyota si vous avez besoin d'intervenir sur votre véhicule ou de procéder à l'une des modifications suivantes. Les coussins gonflables SRS peuvent ne pas fonctionner correctement ou se déployer (gonfler) accidentellement, provoquant ainsi des blessures graves, voire mortelles.

- Installation, dépose, démontage et réparations des coussins gonflables SRS
- Réparations, modifications, démontage ou remplacement du volant, du tableau de bord, de la planche de bord, des sièges ou de leur garnissage, des montants avant, latéraux et arrière ou des rails latéraux de toit
- Réparation ou modification des ailes avant, du bouclier avant, ou des flancs de l'habitacle
- Installation d'un équipement de protection sur la calandre (pare-buffle, pare-kangourou, etc.), d'un chasse-neige, de treuils ou d'une galerie de toit
- Modification des suspensions du véhicule
- Installation d'appareils électroniques, tels qu'un émetteur/récepteur radio ou lecteur de CD
- Aménagements du véhicule visant à permettre sa conduite par une personne atteinte d'un handicap physique

Camper information

This information has been prepared in accordance with regulation issued by the National Highway Traffic Safety Administration of the U.S. Department of Transportation. It provides the purchasers and/or prospective purchasers of Toyota vehicles with information on truck-camper loading. Your Toyota dealer will help answer any questions you may have as you read this information.

Center of gravity location

The figures given in the illustration indicate the recommended center of gravity zone.

- ① Recommended location for cargo center of gravity for cargo weight rating
- ② Rear end of truck bed
 - ▶ Regular Cab models
 - ▶ Double Cab models with standard bed

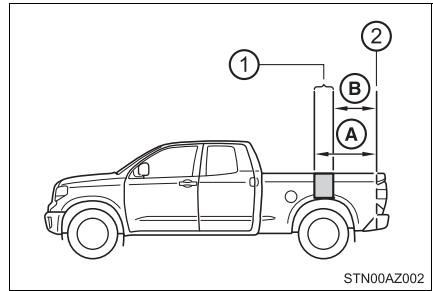
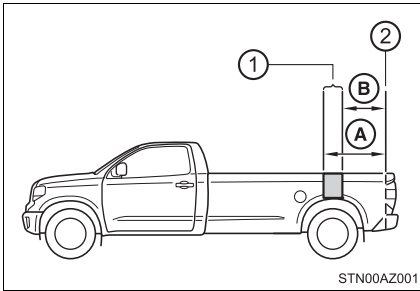

- ▶ Double Cab models with long bed
- ▶ CrewMax models

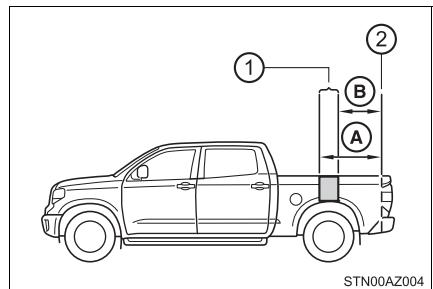
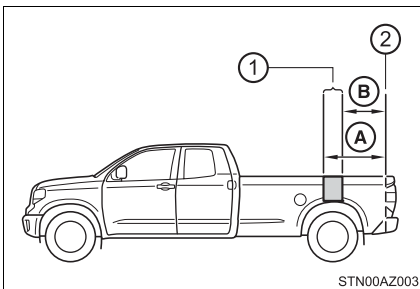

| | (A) | (B) |
|--------------------|-------------------|-------------------|
| Regular Cab models | 42.6 in. (1082mm) | 37.6 in. (955 mm) |
| Double Cab models | | |
| CrewMax models | | |

⚠ CAUTION

■ Loading precaution

If a load is too far back, it can cause dangerous handling. If it is too far forward, the front axle may be overloaded.

Cargo weight rating and proper matching

When the truck is used to carry a slide-in camper, the total cargo load of the truck consists of the manufacturer's camper weight figure, the weight of installed additional camper equipment not included in the manufacturer's camper weight figure, the weight of camper cargo, and the weight of passengers in the camper.

The total cargo load should not exceed the truck's cargo weight rating and the camper's center of gravity should fall within the truck's recommended center of gravity zone when installed.

- ① Camper center of gravity
- ② Recommended center of gravity location zone

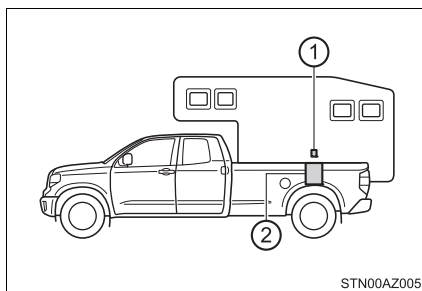

■ Cargo weight rating

CWR: Cargo Weight Rating

| Engine | Drive | Cab | Bed | Grade | Passenger number | C.W.R | |
|------------------|-------|----------|----------|-----------|------------------|-------|------|
| | | | | | | (lbs) | (kg) |
| 1GR-FE | 2WD | Regular | Long | SR5 | 3 | 1180 | 535 |
| 3UR-FE | | | | | 3 | 1445 | 655 |
| 3UR-FE & 3UR-FBE | 4WD | | | | 3 | 1385 | 628 |
| 1GR-FE | 2WD | Double | Standard | SR5 | 6 | 440 | 200 |
| 1UR-FE | 2WD | | Standard | SR5 | 6 | 510 | 231 |
| | 4WD | | | SR5 | 6 | 420 | 191 |
| 3UR-FE | 2WD | | Standard | SR5 | 6 | 620 | 281 |
| | | | | LTD | 5 | 740 | 336 |
| 3UR-FE & 3UR-FBE | 4WD | | Standard | SR5 | 6 | 530 | 240 |
| | | | | LTD | 5 | 670 | 304 |
| Long | SR5 | | 6 | 510 | 231 | | |
| | | | | | | SR5 | 6 |
| 1UR-FE | 2WD | Crew Max | Short | SR5 | 6 | 425 | 193 |
| | 4WD | | | SR5 | 6 | 325 | 147 |
| 3UR-FE | 2WD | | | SR5 | 6 | 510 | 231 |
| | | | | LTD | 5 | 645 | 293 |
| 3UR-FE & 3UR-FBE | 4WD | | | Plati-num | 5 | 645 | 293 |
| | | | | SR5 | 6 | 430 | 195 |
| | | | | LTD | 5 | 555 | 252 |
| Plati-num | 5 | | | 555 | 252 | | |

CAUTION

Overloading

Be careful — overloading can cause dangerous braking and handling problems, and can damage your vehicle and its tires.

Gross axle and vehicle weight ratings

Secure loose items to prevent weight shifts that could affect the balance of your vehicle. When the truck camper is loaded, drive to a scale and weigh on the front and on the rear wheels separately to determine axle loads. Individual axle loads should not exceed either of the Gross Axle Weight Ratings (GAWR). The total of the axle loads should not exceed the Gross Vehicle Weight Rating (GVWR). These ratings are given on the vehicle certification label which is located on the door latch post on the left side of the vehicle. (→P. 506) If weight ratings are exceeded, move or remove items to bring all weights below the ratings.

► Gross axle weight rating

- ① Front GAWR
- ② Rear GAWR

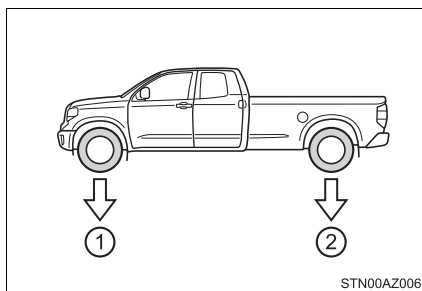

► Gross vehicle weight rating

- ① Not exceed GVWR

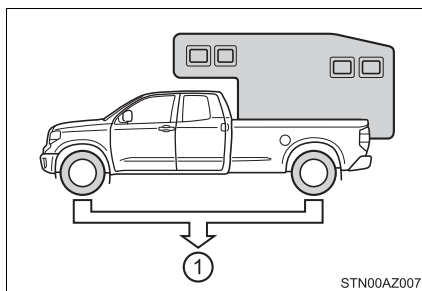

■ GAWR and GVWR

► Regular Cab models

| Model code * | Engine | Driving system | Bed type | GAWR | | GVWR |
|---------------|---------|----------------|----------|-----------------------|-----------------------|-----------------------|
| | | | | Front | Rear | |
| GSK51L-THASKA | 1GR-FE | 2WD | Long | 3900 lb. (1765 kg) | 3800 lb. (1720 kg) | 6400 lb. (2900 kg) |
| USK51L-THTSKA | 3UR-FE | 2WD | | 3900 lb. (1765 kg) | 4150 lb. (1880 kg) | 7000 lb. (3175 kg) |
| USK56L-THTSKA | | 4WD | | 4000 lb. (1810 kg) | 4150 lb. (1880 kg) | 7200 lb. (3265 kg) |
| USK56L-THTSGA | 3UR-FBE | 4WD | | 4000 lb. (1810 kg) | 4150 lb. (1880 kg) | 7200 lb. (3265 kg) |

*: The model code is indicated on the Certification Label. (→P. 506)

► Double Cab models

| Model code* | Engine | Driving system | Bed type | GAWR | | GVWR | |
|---------------|---------|----------------|-----------------------|-----------------------|-----------------------|-----------------------|-----------------------|
| | | | | Front | Rear | | |
| GSK51L-CRASKA | 1GR-FE | 2WD | Standard | 3900 lb. (1765 kg) | 3800 lb. (1720 kg) | 6400 lb. (2900 kg) | |
| UPK51L-CRTSKA | 1UR-FE | 2WD | Standard | 3900 lb. (1765 kg) | 4000 lb. (1810 kg) | 6700 lb. (3035 kg) | |
| UPK56L-CRTSKA | | 4WD | | 4000 lb. (1810 kg) | 4100 lb. (1855 kg) | 6900 lb. (3125 kg) | |
| USK51L-CRTSKA | 3UR-FE | 2WD | Standard | 3900 lb. (1765 kg) | 4100 lb. (1855 kg) | 6900 lb. (3125 kg) | |
| USK51L-CRTLKA | | | | | Long | 4150 lb. (1880 kg) | 7000 lb. (3175 kg) |
| USK52L-CHTSKA | | | 4WD | | | Standard | 4000 lb. (1810 kg) |
| USK56L-CRTSKA | | Long | | 7200 lb. (3265 kg) | | | |
| USK56L-CRTLKA | | | | 3UR-FBE | 4WD | Standard | |
| USK57L-CHTSKA | | Long | 7200 lb. (3265 kg) | | | | |
| USK56L-CRTSGA | 3UR-FBE | | 4WD | | | Standard | 4000 lb. (1810 kg) |
| USK56L-CRTLGA | | Long | | 7200 lb. (3265 kg) | | | |
| USK57L-CHTSGA | | | | | | | |

*: The model code is indicated on the Certification Label. (→P. 506)

► CrewMax models

| Model code* | Engine | Driving system | Bed type | GAWR | | GVWR |
|---------------|---------|----------------|----------|-----------------------|-----------------------|-----------------------|
| | | | | Front | Rear | |
| UPK51L-PSTSKA | 1UR-FE | 2WD | Short | 3900 lb. (1765 kg) | 4050 lb. (1835 kg) | 6800 lb. (3080 kg) |
| UPK56L-PSTSKA | | 4WD | | 4000 lb. (1810 kg) | 4150 lb. (1880 kg) | 7000 lb. (3175 kg) |
| USK51L-PSTSKA | 3UR-FE | 2WD | | 3900 lb. (1765 kg) | 4150 lb. (1880 kg) | 7000 lb. (3175 kg) |
| USK51L-PSTLKA | | | | | | |
| USK51L-PSTZKA | | | | | | |
| USK56L-PSTSKA | | 4WD | | 4000 lb. (1810 kg) | 7200 lb. (3265 kg) | |
| USK56L-PSTLKA | | | | | | |
| USK56L-PSTZKA | | | | | | |
| USK56L-PSTSGA | | | | | | |
| USK56L-PSTLGA | 3UR-FBE | 4WD | | 4000 lb. (1810 kg) | 4150 lb. (1880 kg) | 7200 lb. (3265 kg) |
| USK56L-PSTZGA | | | | | | |

*: The model code is indicated on the Certification Label. (→P. 506)

Index

| | |
|---|-----|
| What to do if... (Troubleshooting) | 558 |
| Alphabetical index | 561 |

For vehicles with Entune Audio Plus or Entune Premium Audio, refer to the "NAVIGATION SYSTEM OWNER'S MANUAL" for information regarding the multimedia system.

Multimedia system types: →P. 250

What to do if... (Troubleshooting)

If you have a problem, check the following before contacting your Toyota dealer.

The doors cannot be locked, unlocked, opened or closed



You lose your keys

- If you lose your keys, new genuine keys can be made by your Toyota dealer. (→P. 100)



The doors cannot be locked or unlocked

- Is the wireless key battery weak or depleted? (→P. 434)
- The function may not operate properly due to the condition of the radio wave. (→P. 104)



The rear door cannot be opened

- Is the child-protector lock set?
The rear door cannot be opened from inside the vehicle when the lock is set. Open the rear door from outside and then unlock the child-protector lock. (→P. 106)

If you think something is wrong



The engine does not start

- Is the shift lever in P? (→P. 179)
- Is the battery discharged? (→P. 493)



The shift lever cannot be shifted from P even if you depress the brake pedal

- Is the engine switch in the "ON" position?
If you cannot release the shift lever by depressing the brake pedal with the engine switch in the "ON" position. (→P. 491)



The steering wheel cannot be turned after the engine is stopped

- It is locked to prevent theft of the vehicle if the key is removed from the engine switch. (→P. 180)



The windows do not open or close by operating the power window switches

- Is the window lock switch pressed?
The power window except for the one at the driver's seat cannot be operated if the window lock switch is pressed. (→P. 136)



A warning buzzer sounds during driving

- The seat belt reminder light is flashing
Are the driver and the front passenger wearing the seat belts? (→P. 466)
 - The parking brake indicator is on
Is the parking brake released? (→P. 187)
- Depending on the situation, other types of warning buzzer may also sound. (→P. 464, 472)



An alarm is activated and the horn sounds

- Did anyone inside the vehicle open a door during setting the alarm?
The sensor detects it and the alarm sounds. (→P. 80)
- To stop the alarm, turn the engine switch to the "ACC" or "ON" position, or start the engine.



A warning light turns on or a warning message is displayed

- When a warning light turns on or a warning message is displayed, refer to P. 464, 472.

When a problem has occurred**If you have a flat tire**

- Stop the vehicle in a safe place and replace the flat tire with the spare tire. (→P. 475)

**The vehicle becomes stuck**

- Try the procedure for when the vehicle becomes stuck in mud, dirt, or snow. (→P. 498)

Alphabetical index

A

A/C 336, 343
 Air conditioning filter 431
 Automatic air conditioning
 system 343
 Manual air conditioning
 system 336

ABS (Anti-lock Brake System) 231
 Function 231
 Warning light 465

Air conditioning filter 431

Air conditioning system 336, 343
 Air conditioning filter 431
 Automatic air conditioning
 system 343
 Manual air conditioning
 system 336

Airbags 38
 Airbag operating conditions 46
 Airbag precautions
 for your child 42
 Airbag warning light 465
 Correct driving posture 30
 Curtain shield airbag
 operating conditions 46
 Curtain shield airbag
 precautions 43
 Front passenger occupant
 classification system 50
 General airbag precautions 42
 Locations of airbags 38
 Modification and disposal
 of airbags 45
 Side airbag operating
 conditions 46

Side airbag precautions 43
 Side and curtain shield
 airbags operating
 conditions 46
 Side and curtain shield
 airbags precautions 43
 SRS airbags 38

Alarm
 Alarm 80
 Warning buzzer 464, 472

Anchor brackets 60

Anti-lock Brake System (ABS) 231
 Function 231
 Warning light 465

Armrest 379

Assist grips 380

Audio input 255, 274, 278, 282

Audio remote control switches*

Audio system 250
 Antenna 332
 Audio input 255, 274, 278, 282
 Audio settings 259
 AUX port/
 USB port 255, 274, 278, 282
 Bluetooth® audio 289, 295
 CD player 269
 Display settings 260
 General settings 257
 iPod 255, 274
 MP3/WMA disc 269
 Portable music
 player 255, 274, 278, 282
 Radio 267
 Setup menu 256
 USB memory 255, 278

*: Refer to "NAVIGATION SYSTEM OWNER'S MANUAL".

| | |
|---|-----------------|
| AUTO LSD system | 229 |
| Automatic light control system | 189 |
| Automatic transmission | |
| Automatic transmission..... | 181 |
| If the shift lever cannot be shifted from P | 491 |
| TOW/HAUL switch..... | 184 |
| AUX port | 255, 282 |
| Auxiliary boxes | 369 |

B

| | |
|--|------------|
| Back window | |
| Back window..... | 139 |
| Power back window | 140 |
| Back-up lights | |
| Replacing light bulbs..... | 450 |
| Wattage | 515 |
| Battery | 414 |
| If the vehicle battery is discharged..... | 493 |
| Preparing and checking before winter..... | 240 |
| Warning light..... | 464 |
| Blind Spot Monitor (BSM) | 218 |
| Bluetooth® | |
| Audio system | 289, 295 |
| Hands-free system (for cellular phone) | 289, 296 |
| Bottle holders | 368 |
| Brake | |
| Fluid..... | 412 |
| Parking brake..... | 187 |
| Warning buzzer..... | 464 |
| Warning light..... | 464 |
| Brake assist | 231 |
| Break-in tips | 147 |

Brightness control

| | |
|--|------------|
| Instrument panel light control | 90 |
| BSM (Blind Spot Monitor) | 218 |
| Blind Spot Monitor function..... | 220 |
| Rear Cross Traffic Alert function..... | 223 |

C

| | |
|--|-----------------|
| Camper information | 550 |
| Card holder | 360 |
| Care | 392, 394 |
| Aluminum wheels | 392 |
| Exterior | 392 |
| Interior | 394 |
| Seat belts..... | 395 |
| Cargo capacity | 156 |
| Cargo lamp | |
| Light switch..... | 355 |
| Replacing light bulbs | 452 |
| Wattage | 515 |
| CD player | 269 |
| Certification label | 161, 506 |
| Chains | 241 |
| Child restraint system | 56 |
| Booster seats, definition | 57 |
| Booster seats, installation..... | 67 |
| Convertible seats, definition ... | 57 |
| Convertible seats, installation | 65, 66 |
| Front passenger occupant classification system | 50 |
| Infant seats, definition..... | 57 |
| Infant seats, installation..... | 65 |
| Installing CRS with LATCH anchors | 63 |
| Installing CRS with seat belts..... | 65 |
| Installing CRS with top tether strap..... | 68 |

| | |
|---|-----------------|
| Child safety | 55 |
| Airbag precautions | 42 |
| Battery precautions | 495 |
| Child restraint system | 56 |
| How your child should wear the seat belt | 34 |
| Installing child restraints | 60 |
| Moon roof precautions | 144 |
| Power back window precautions | 141 |
| Power window lock switch | 136 |
| Power window precautions ... | 138 |
| Rear door child-protector | 106 |
| Removed wireless remote control battery precautions | 435 |
| Seat belt extender precautions | 37 |
| Seat belt precautions | 59 |
| Seat heater precautions | 351 |
| Child-protectors | 106 |
| Cleaning | 392, 394 |
| Aluminum wheels | 392 |
| Exterior | 392 |
| Interior | 394 |
| Seat belts | 395 |
| Clock | 375 |
| Compass | 387 |
| Condenser | 412 |
| Console box | 359 |
| Consumption screen | 92, 94 |
| Coolant | 410 |
| Capacity | 510 |
| Checking | 410 |
| Preparing and checking before winter | 240 |
| Cooling system | 410 |
| Engine overheating | 496 |

| | |
|-------------------------------------|------------|
| CRS | 56 |
| Cruise control | 200 |
| Cup holders | 366 |
| Curtain shield airbags | 39 |
| Customizable features | 530 |

D

| | |
|--|------------|
| Daytime running light system | 191 |
| Deck hooks | 373 |
| Defogger | |
| Back window | 338, 345 |
| Outside rear view mirrors | 338, 345 |
| Windshield | 338, 345 |
| Differential | 511 |
| Dimensions | 500 |
| Dinghy towing | 178 |
| Display | |
| Multi-information display | 93 |
| Trip information | 91, 94 |
| Warning message | 472 |
| Do-it-yourself maintenance | 403 |
| Doors | 102 |
| Automatic door locking and unlocking system | 106 |
| Door glasses | 136 |
| Door lock | 105 |
| Open door warning light | 466 |
| Open door warning message | 473 |
| Outside rear view mirrors | 132 |
| Rear door child-protector | 106 |
| Side doors | 102 |
| Driver's seat position | |
| memory | 118 |
| Driving | 146 |
| Break-in tips | 147 |
| Correct driving posture | 30 |
| Driving assist system | 231 |
| Procedures | 146 |
| Winter drive tips | 240 |

E

| | |
|---------------------------------------|------------|
| EDR (Event data recorder)..... | 10 |
| Emergency, in case of | |
| If the engine will not start..... | 490 |
| If the shift lever | |
| cannot be shifted from P | 491 |
| If the vehicle has discharged | |
| battery | 493 |
| If the warning buzzer | |
| sounds..... | 464 |
| If the warning light turns | |
| on | 464 |
| If the warning message | |
| is displayed..... | 472 |
| If you have a flat tire | 475 |
| If you lose your keys | 100 |
| If you think something | |
| is wrong..... | 462 |
| If your vehicle becomes | |
| stuck..... | 498 |
| If your vehicle has to be | |
| stopped in an emergency ... | 457 |
| If your vehicle needs | |
| to be towed..... | 458 |
| If your vehicle overheats..... | 496 |
| Emergency flashers | 456 |

Engine

| | |
|--|------------|
| “ACC” position | 179 |
| Compartment..... | 406 |
| Engine switch | 179 |
| Hood..... | 405 |
| How to start the engine..... | 179 |
| Identification number | 506 |
| If the engine will not start..... | 490 |
| Ignition switch | |
| (engine switch) | 179 |
| Immobilizer system..... | 78 |
| Overheating | 496 |
| Engine coolant..... | 410 |
| Capacity..... | 510 |
| Checking..... | 410 |
| Preparing and checking | |
| before winter | 240 |
| Engine coolant temperature | |
| gauge | 88 |
| Engine immobilizer system | 78 |
| Engine oil | 408 |
| Capacity..... | 508 |
| Checking..... | 408 |
| Oil pressure warning light..... | 464 |
| Preparing and checking | |
| before winter | 240 |
| Engine oil maintenance | |
| data..... | 398 |
| Engine switch | |
| (ignition switch) | 179 |
| Engine switch light | |
| (ignition switch light)..... | 353 |
| Event data recorder (EDR)..... | 10 |

F

| | |
|---|-----------------|
| FFV | 196, 516 |
| Flat tire | 475 |
| Flex-fuel | 196, 516 |
| Flexible fuel vehicle | 196, 516 |
| Floor mats | 28 |
| Fluid | |
| Automatic transmission..... | 512 |
| Brake | 513 |
| Washer | 416 |
| Fog lights | 192 |
| Replacing light bulbs..... | 447 |
| Switch | 192 |
| Wattage | 515 |
| Foot well light | 353 |
| Four-wheel drive system | 226 |
| Front passenger occupant classification system | 50 |
| Front personal lights | 354 |
| Front seats | 113 |
| Adjustment..... | 113 |
| Cleaning..... | 394 |
| Correct driving posture | 30 |
| Driving position memory | 118 |
| Head restraints | 122 |
| Power easy access system..... | 118 |
| Seat heaters | 350 |
| Seat position memory | 118 |
| Seat ventilators | 350 |
| Front side marker lights | |
| Light switch | 189 |
| Replacing light bulbs..... | 445 |
| Wattage | 515 |

Front turn signal lights

| | |
|--|------------|
| Replacing light bulbs | 444 |
| Turn signal lever | 186 |
| Wattage | 515 |
| Fuel | 508 |
| Capacity..... | 508 |
| Fuel gauge..... | 88 |
| Fuel pump shut off system ... | 463 |
| Gas station information..... | 576 |
| Information..... | 516 |
| Refueling | 196 |
| Type..... | 196, 508 |
| Warning light..... | 466 |
| Warning message..... | 474 |
| Fuel consumption | |
| Average fuel consumption..... | 92, 94 |
| Current fuel consumption | 94 |
| Fuel filler door | 198 |
| Fuel pump shut off system | 463 |
| Fuses | 436 |

G

| | |
|--------------------------------------|------------|
| Garage door opener | 381 |
| Gas station information | 576 |
| Gauges | 88 |
| Glove box | 358 |

H

| | |
|---|----------|
| Hands-free system (for cellular phone)..... | 289, 296 |
| Head restraints | 122 |
| Headlights | 189 |
| Light switch | 189 |
| Replacing light bulbs..... | 441 |
| Wattage | 515 |
| Heaters | |
| Automatic air conditioning system | 343 |
| Manual air conditioning system | 336 |
| Seat heaters | 350 |
| Outside rear view mirrors | 338, 345 |
| High mounted stoplight | |
| Replacing..... | 452 |
| Wattage | 515 |
| Hood | 405 |
| Hooks | |
| Deck hooks | 373 |
| Retaining hooks (floor mat)..... | 28 |
| Horn | 188 |

I

| | |
|---|----------|
| I/M test | 402 |
| Identification | |
| Engine | 506 |
| Tire | 521 |
| Vehicle..... | 506 |
| Ignition switch (engine switch)..... | 179 |
| Ignition switch light (engine switch light) | 353 |
| Illuminated entry system | 355 |
| Immobilizer system | 78 |
| Indicators | 86 |
| Initialization | |
| Maintenance | 398 |
| Moon roof | 144 |
| Tire pressure warning system | 419 |
| Inside rear view mirror | 129 |
| Instrument panel light control..... | 90 |
| Interior lights | 353 |
| Personal lights | 354 |
| Switches | 354 |
| Wattage | 515 |
| Intuitive parking assist | 203 |
| Function..... | 203 |
| Warning message..... | 472, 474 |

J**Jack**

- Positioning the jack..... 483
- Vehicle-equipped jack..... 476

Jack handle 481**Jam protection function**

- Moon roof..... 142
- Power windows..... 137

K**Keyless entry 103**

- Wireless remote control 103

Keys 100

- Engine switch..... 179
- If you lose your keys 100
- Ignition switch 179
- Key number plate..... 100
- Keyless entry 103
- Replacing the battery..... 434
- Wireless remote control 103

Knee airbags 39**L****Language**

- (multi-information display)..... 95

LATCH anchors 63, 64**Lever**

- Auxiliary catch lever..... 405
- Hood lock release lever 405
- Shift lever..... 181
- Turn signal lever 186
- Wiper lever..... 193

License plate lights

- Light switch..... 189
- Replacing light bulbs 451
- Wattage 515

Light bulbs

- Replacing..... 441
- Wattage 515

Lights

- Cargo lamp switch 355
- Engine switch light
(ignition switch light)..... 353
- Fog light switch..... 192
- Headlight switch 189
- Illuminated entry system..... 355
- Interior lights 354
- Interior lights list..... 353
- Outer foot light 353
- Personal lights 354
- Replacing light bulbs 439
- Turn signal lever..... 186
- Vanity lights 374
- Wattage 515

Load capacity 156**Luggage compartment**

- features 373

Luggage storage box 371

M**Maintenance**

- Do-it-yourself maintenance... 403
- General maintenance 399
- Maintenance data 500
- Maintenance requirements ... 397
- Reset the maintenance
 - data 398

Malfunction indicator lamp..... 464**Manual headlight leveling**

- dial 190

Map holder 362**Master warning light..... 466, 472****Meter**

- Indicators 86
- Instrument panel light
 - control..... 90
- Meters..... 88
- Multi-information display..... 93
- Trip information display..... 91
- Warning lights 85

Mirrors

- Inside rear view mirror 129
- Outside rear view
 - mirror defoggers..... 338, 345
- Outside rear view mirrors..... 132
- Vanity mirrors..... 374

Moon roof 142

- Door lock linked
 - moon roof operation 143
- Jam protection function..... 142
- Operation 142

MP3 disc..... 269**Multi-information display..... 93**

- Settings..... 95
- Switching the display 91
- Trip information..... 94
- Warning message..... 472

N**Noise from under vehicle 8****O****Odometer 91, 93****Off-road precautions..... 244****Oil**

- Engine oil..... 508
- Differential oil..... 511
- Transfer oil..... 512

Opener

- Hood..... 405

Outer foot lights

- Location 353
- Replacing light bulbs 452
- Wattage 515

Outside rear view mirrors..... 132

- Adjusting and folding 132
- Blind spot monitor..... 218
- Mirror position memory..... 118
- Outside rear view
 - mirror defoggers..... 338, 345

Outside temperature

- display..... 376

Overhead console 365**Overheating 496**

P

| | |
|--------------------------------------|----------|
| Parking assist sensors | |
| (intuitive parking assist)..... | 203 |
| Parking brake | 187 |
| Operation | 187 |
| Parking brake engaged | |
| warning buzzer | 464 |
| Parking brake engaged | |
| warning message | 473 |
| Parking lights | 189 |
| Light switch | 189 |
| Replacing light bulbs..... | 444, 452 |
| Wattage | 515 |
| Pen holder | 363 |
| Personal lights | 354 |
| Light switch | 354 |
| Wattage | 515 |
| Power back window | 140 |
| Power easy access system | 118 |
| Power outlets | 377 |
| Power steering fluid | 413 |
| Power windows | 136 |
| Jam protection function..... | 137 |
| Operation | 136 |
| Window lock switch..... | 136 |

R

| | |
|---------------------------------------|-----|
| Radiator | 412 |
| Radio | 267 |
| Rear personal lights | 354 |
| Rear seat | |
| Adjustment precautions | 117 |
| Child seats/child restraint | |
| system installation..... | 60 |
| Cleaning | 394 |
| Head restraints | 122 |
| Raising the bottom | |
| cushion..... | 116 |
| Rear side marker lights | 189 |
| Light switch..... | 189 |
| Replacing light bulbs | 450 |
| Wattage | 515 |
| Rear step bumper | 112 |
| Rear turn signal lights | 186 |
| Replacing light bulbs | 450 |
| Turn signal lever..... | 186 |
| Wattage | 515 |
| Rear view mirror | |
| Inside rear view mirror | 129 |
| Outside rear view mirrors | 132 |
| Rear view monitor system | 209 |
| Refueling | 196 |
| Capacity..... | 508 |
| Fuel types..... | 508 |
| Opening the fuel tank cap..... | 198 |
| Replacing | |
| Fuses..... | 436 |
| Light bulbs | 439 |
| Tires..... | 475 |
| Wireless remote control | |
| battery | 434 |
| Reporting safety defects | |
| for U.S. owners..... | 538 |
| Reset the maintenance data ... | 398 |

S

- Seat belts..... 32**
 - Adjusting the seat belt 33
 - Automatic Locking
 - Retractor..... 34
 - Child restraint system
 - installation 60
 - Cleaning and maintaining
 - the seat belt..... 395
 - Emergency Locking
 - Retractor..... 34
 - How to wear your seat belt 32
 - How your child should wear
 - the seat belt..... 34
 - Pregnant women, proper
 - seat belt use 35
 - Reminder light and buzzer.... 466
 - Seat belt extender..... 34
 - Seat belt pretensioners..... 33
 - SRS warning light 465
- Seat heaters 350**
- Seat position memory 118**
- Seat ventilators..... 350**
- Seating capacity 156**
- Seats, Front..... 113**
 - Adjustment..... 113
 - Adjustment precautions 115
 - Child seats/child restraint
 - system installation 60
 - Cleaning..... 394
 - Driving position memory 118
 - Head restraints 122
 - Power easy access
 - system 118
 - Properly sitting in the seat 30
 - Seat heaters 350
 - Seat position memory 118
 - Seat ventilators 350
- Seats, Rear 116**
 - Adjustment precautions 117
 - Child seats/child restraint
 - system installation..... 60
 - Cleaning 394
 - Head restraints 122
 - Raising the bottom
 - cushion..... 116
- Sensor**
 - Automatic headlight
 - system..... 191
 - Inside rear view mirror 130
 - Intuitive parking assist 203
- Service reminder indicators 84**
- Shift lever 181**
 - Automatic transmission 181
 - If the shift lever
 - cannot be shifted from P 491
- Shift lock system..... 491**
- Side airbags 39**
- Side doors..... 102**
- Side marker lights 189**
 - Light switch..... 189
 - Replacing light bulbs 445, 450
 - Wattage 515
- Side mirrors 132**
 - Adjusting and folding 132
 - BSM (Blind spot monitor)..... 218
 - Mirror position memory..... 118
- Side turn signal lights..... 186**
 - Replacing light bulbs 445, 450
 - Turn signal lever..... 186
 - Wattage 515
- Snow tires 242**
- Spare tire..... 475**
 - Inflation pressure 513
 - Replacing..... 475
 - Storage location..... 476

- Spark plug** 510
- Specifications** 500
- Speedometer** 88
- Steering**
 - Column lock release 180
- Steering wheel**
 - Adjustment..... 126, 127
 - Steering wheel
 - position memory 118
- Steering wheel audio switches***
- Stop lights**
 - Replacing light bulbs..... 450
 - Wattage 515
- Storage box**..... 371
- Storage feature** 356
- Stuck**
 - If the vehicle becomes
 - stuck 498
- Sun visors** 374
- Switches**
 - Back window defogger
 - switch 338, 345
 - BSM (Blind spot monitor)
 - main switch..... 218
 - Cargo lamp main switch 355
 - Cruise control switch..... 200
 - “DISP” button 94
 - Door lock switch..... 105
 - Driving position memory
 - switches..... 118
 - Emergency flashers switch ... 456
 - Engine switch..... 179
 - Fog light switch 192
 - Front-wheel drive control
 - switch 226
 - Garage door opener
 - switches 381
 - Ignition switch..... 179
 - Intuitive parking assist 203
 - Light switches 189
 - Moon roof switches..... 142
 - Outside rear view mirror
 - defoggers switch 338, 345
 - Outside rear view mirror
 - switches 132
 - Personal/interior lights
 - main switch 354
 - Power back window
 - switch 140
 - Power door lock switch..... 105
 - Power window switches..... 136
 - Seat heater switches 350
 - Seat ventilator switches..... 350
 - Tilt and telescopic
 - steering control switch..... 127
 - Tire pressure warning reset
 - switch 419
 - TOW/HAUL switch..... 184
 - Turn signal lights 186
 - VSC off
 - switch 229, 232, 234, 236
 - Window lock switch 136
 - Windshield wiper
 - de-icer switch 339, 346
 - Windshield wipers
 - and washer switch..... 193

*: Refer to “NAVIGATION SYSTEM OWNER’S MANUAL”.

T

- Tachometer** 88
- Tail lights**..... 189
 - Light switch 189
 - Replacing light bulbs..... 450
 - Wattage 515
- Tailgate**
 - Removing the tailgate 109
 - Tailgate 108
- Talk switch** 325
- Telephone switches** 309
- Theft deterrent system**
 - Alarm 80
 - Engine immobilizer system 78
- Tire inflation pressure**..... 425
 - Maintenance data 513
 - Warning light..... 467
- Tire information** 520
 - Glossary..... 525
 - Size..... 521
 - Tire identification number 521
 - Uniform Tire Quality Grading..... 523
- Tire pressure warning system**..... 418
 - Initializing..... 419
 - Installing tire pressure warning valves and transmitters..... 418
 - Registering ID codes 419
 - Tire pressure warning reset switch 419
 - Warning light..... 467
- Tires**..... 417
 - Chains 241
 - Checking..... 417
 - If you have a flat tire 475
 - Inflation pressure 513
 - Information..... 520
 - Replacing..... 475
 - Rotating tires 417
 - Size..... 513
 - Snow tires..... 242
 - Spare tire 476
 - Tire pressure warning system..... 418
 - Warning light..... 467
- Tissue pocket** 364
- Tools**..... 476
- Top tether strap** 68, 69, 72
- Total load capacity** 156, 502
- TOW/HAUL switch**..... 184
- Towing**
 - Bumper towing..... 169
 - Dinghy towing 178
 - Emergency towing 458
 - Fifth wheel trailer 168
 - Trailer towing 158
- TRAC (Traction Control)**..... 231
- Transmission** 181
 - Automatic transmission 181
 - If the shift lever cannot be shifted from P 491
 - S mode 183
- Trip information display** 91
- Trip meters**..... 91, 93
- Turn signal lights** 186
 - Replacing light bulbs..... 444, 450, 452
 - Turn signal lever 186
 - Wattage 515

U

USB port..... 255, 274, 278

V**Vanity lights**

Vanity lights 374

Wattage 515

Vanity mirrors 374

Vehicle data recordings 9

Vehicle identification

number 506

Vehicle Stability Control

(VSC) 231

Ventilators

(seat ventilators) 350

Voice command system..... 325

VSC

(Vehicle Stability Control) 231

W**Warning buzzers**

Brake system 464, 473

Downshifting 185

Intuitive parking assist 204

Key reminder 180

Light reminder 191

Open door 466, 473

Open moon roof 144

Seat belt reminder 466

Warning lights..... 85

ABS 465

Automatic transmission

fluid temperature 466

Brake system 464

BSM (Blind Spot Monitor) 465

Charging system 464

Cruise control 465

Low engine oil pressure 464

Low fuel level 466

Low windshield washer

fluid 467

Malfunction indicator lamp 464

Master warning light 466

Maintenance 467

Open door 466

Seat belt reminder light 466

Slip indicator 465

SRS 465

Tire pressure 467

Warning messages..... 472

Washer 193

Checking 416

Low windshield washer fluid

warning light 467

Low windshield washer fluid

warning message 473

Preparing and checking

before winter 240

Switch 193

Washing and waxing..... 392

Weight

Cargo capacity 156

Cargo weight rating 552

Gross axle weight rating 554

Gross combination

weight rating 162

Gross vehicle weight

rating 554

Load limits 156

Towing capacity 156, 162

Trailer Weight

Rating 156, 162

TWR 156, 162

Vehicle capacity

weight 156, 502

Wheels

Replacing wheels..... 429

Size..... 513

Window glasses..... 136**Window lock switch 136****Windows..... 136**

Back window..... 139

Back window

defogger 338, 345

Power back window 140

Power windows..... 136

Windshield wiper**de-icer 339, 346****Windshield wipers 193****Winter driving tips 240****Wireless remote control key**

Locking/Unlocking..... 103

Replacing the battery..... 434

WMA disc 269



GAS STATION INFORMATION

Auxiliary catch lever

P. 405

Fuel filler door

P. 198

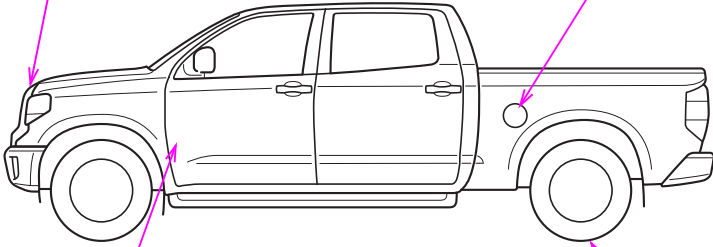

Hood lock release lever

P. 405

Tire inflation pressure

P. 513

STNPIAZ010

| | | | |
|--|------------------------------------|------------------------------------|------------------------------------|
| Fuel tank capacity (Reference) | | 26.4 gal. (100.0 L, 22.0 Imp.gal.) | |
| Fuel type | | P. 196, 508 | |
| Cold tire inflation pressure | | P. 513 | |
| Engine oil capacity (Drain and refill — reference) | 1GR-FE engine | With filter | qt. (L, Imp.qt.) 6.4 (6.1, 5.4) |
| | | Without filter | 5.9 (5.6, 4.9) |
| | 1UR-FE, 3UR-FE and 3UR-FBE engines | With filter | qt. (L, Imp.qt.) 7.9 (7.5, 6.6) |
| | | Without filter | 7.5 (7.1, 6.2) |
| Engine oil type | | P. 509 | |