



Operator's Manual
C-Class Sedan



Mercedes-Benz



2 0 3 5 8 4 3 4 7 1

Order No. 6515 0183 13 Part No. 203 584 34 71 USA Edition A, 2007

C-Class Sedan

C 230

C 230 Sport

C 280

C 280 4MATIC

C 350

C 350 4MATIC

C 350 Sport

Our company and staff congratulate you on the purchase of your new Mercedes-Benz.

Your selection of our product is a demonstration of your trust in our company name. Furthermore, it exemplifies your desire to own an automobile that will be as easy as possible to operate and provide years of service.

Your Mercedes-Benz represents the efforts of many skilled engineers and craftsmen. To help assure your driving pleasure, and also the safety of you and your passengers, we ask you to make a small investment of time:

- Please read this manual carefully, then return it to your vehicle where it will be handy for your reference.
- Please follow the recommendations contained in this manual. They are designed to acquaint you with the operation of your Mercedes-Benz.
- Please pay attention to the warnings and cautions contained in this manual. They are designed to help improve the safety of the vehicle operator and occupants.

We extend our best wishes for many miles of safe, pleasurable driving.

Mercedes-Benz USA, LLC
A DaimlerChrysler Company

Introduction	9
Product information	9
Operator's Manual	10
Service and warranty information ..	10
Important notice for California retail buyers and lessees of Mercedes-Benz automobiles	11
Maintenance	12
Roadside Assistance	12
Change of address or ownership....	12
Operating your vehicle outside the USA or Canada	13
Where to find it	14
Symbols	15
Operating safety	16
Proper use of the vehicle	16
Problems with your vehicle	17
Reporting safety defects	18
Reporting Safety Defects	18
Vehicle data recording	19
Information regarding electronic recording devices	19

At a glance	21
Cockpit	22
Instrument cluster	24
Multifunction steering wheel	26
Center console	27
Upper part	27
Lower part	28
Overhead control panel	29
Door control panel	30

Getting started	31
Unlocking	32
Unlocking with the SmartKey	32
Starter switch positions	32
Adjusting	34
Seats	34
Steering wheel	38
Mirrors	41
Driving	43
Fastening the seat belt	43
Starting the engine	46
Parking brake	48
Driving	48
Switching on headlamps	50
Turn signals	50
Windshield wipers	51
Problems while driving	53
Parking and locking	54
Parking brake	54
Switching off headlamps	55
Turning off engine	55
Releasing seat belts	56
Locking	56

Safety and Security	57	Controls in detail	91	Lighting	109
Occupant safety.....	58	Locking and unlocking.....	92	Exterior lamp switch	109
Air bags	59	SmartKey	92	Combination switch	113
Occupant Classification System.....	64	Checking the batteries.....	95	Corner-illuminating front	
Seat belts.....	69	Loss of SmartKey		fog lamps* (C 230 (Canada only),	
Active head restraint	73	or mechanical key.....	95	C 280, C 350 and models	
Children in the vehicle.....	74	Opening the doors from the inside.	96	with 4MATIC: with	
Blocking of		Opening the trunk.....	96	Bi-Xenon* headlamps)	113
rear door window operation	80	Closing the trunk.....	97	Hazard warning flasher	115
Panic alarm*	81	Trunk emergency release	98	Interior lighting	116
Activating	81	Valet locking	99	Door entry lamps	117
Deactivating	81	Automatic central locking	99	Trunk lamp.....	117
Driving safety systems.....	82	Locking and unlocking		Instrument cluster	118
ABS	82	from the inside.....	100	Adjusting	
BAS	84	Seats	101	instrument cluster illumination	118
ESP®.....	85	Front seat active head restraints .	101	Coolant temperature gauge	119
Four wheel electronic traction		Rear seat head restraints.....	101	Resetting trip odometer.....	119
system (4MATIC) with the ESP®.....	88	Lumbar support.....	105	Tachometer.....	120
Anti-theft systems.....	89	Multicontour seats*		Outside temperature indicator.....	120
Immobilizer.....	89	(Canada only).....	105	Control system	121
Anti-theft alarm system*	89	Seat heating*	106	Multifunction display.....	121
		Memory function*	107	Multifunction steering wheel.....	122
		Storing positions into memory	108	Menus.....	124
		Recalling positions from memory.	108	Standard display menu	126
				AUDIO menu	127
				NAV* menu.....	129

Vehicle status message memory menu	130	Climate control.....	164	Charcoal filter	183
Settings menu.....	131	Deactivating the climate control system	167	Air conditioning	184
Trip computer menu.....	144	Operating the climate control system in automatic mode.....	167	Residual heat and ventilation (Canada only).....	185
TEL menu*	146	Setting the temperature.....	168	Rear passenger compartment adjustable air vents	186
Manual transmission	149	Adjusting air distribution and volume	168	Audio system.....	187
Shifting into reverse.....	150	Adjusting air volume	169	Audio and telephone, operation....	187
Automatic transmission*	151	Front defroster.....	169	Operating safety	187
Gear selector lever.....	151	Air recirculation mode	170	Operating and display elements ...	188
Shifting procedure	152	Air conditioning.....	172	Button and soft key operation	190
Gear selector lever positions	153	Rear passenger compartment adjustable air vents.....	173	Operation.....	190
Driving tips.....	155	Automatic climate control	174	Radio operation	194
Gear ranges	156	Deactivating the automatic climate control system	177	Introduction to satellite radio* (USA only).....	197
Automatic shift program	157	Operating the automatic climate control system	177	CD mode.....	201
One-touch gearshifting.....	158	in automatic mode.....	177	GSM network phones	208
Emergency operation (Limp-Home Mode)	159	Setting the temperature.....	178	TDMA or CDMA network phones ..	214
Good visibility	160	Adjusting air distribution.....	178	Emergency calls "911"	219
Headlamp cleaning system*	160	Adjusting air volume	179	Power windows	221
Rear view mirrors.....	160	Front defroster.....	179	Opening and closing the windows	221
Sun visors	161	Maximum cooling MAXCOOL	180	Synchronizing power windows.....	222
Rear window sunshade*	162	Air recirculation mode	181	Summer opening feature	223
Rear window defroster	163			Convenience closing feature.....	223

Contents

Power tilt/sliding sunroof* 224		At the gas station 271
Opening and closing		Refueling..... 271
the power tilt/sliding sunroof 224		Check regularly
Synchronizing		and before a long trip..... 273
the power tilt/sliding sunroof 226		Engine compartment 274
Driving systems 227		Hood 274
Cruise control..... 227		Engine oil 276
Loading..... 230		Transmission fluid level..... 277
Roof rack* 230		Coolant level..... 278
Ski sack* (Canada only) 230		Battery 279
Split rear bench seat* 233		Windshield washer system
Loading instructions..... 235		and headlamp cleaning system* .. 280
Cargo tie-down rings* 236		Tires and wheels..... 281
Useful features 237		Important guidelines 281
Storage compartments..... 237		Tire care and maintenance..... 282
Cup holders..... 239		Direction of rotation..... 284
Ashtrays 241		Loading the vehicle 284
Cigarette lighter 242		Recommended
Power outlet..... 243		tire inflation pressure..... 289
Telephone* 244		Checking tire inflation pressure ... 290
Tele Aid* 247		MOExtended system* 294
Garage door opener* 253		Tire labeling 295
		Load identification 299
		DOT, Tire Identification Number
		(TIN)..... 299
		Maximum tire load 301
	Operation 259	
	The first 1000 miles (1500 km)..... 260	
	Driving instructions..... 261	
	Drive sensibly – save fuel..... 261	
	Drinking and driving 261	
	Pedals 261	
	Power assistance 262	
	Brakes..... 262	
	Driving off 263	
	Parking..... 264	
	Tires 264	
	Hydroplaning..... 265	
	Tire traction..... 265	
	Tire speed rating 266	
	Winter driving instructions 267	
	Standing water..... 268	
	Passenger compartment 268	
	Driving abroad..... 268	
	Control and operation	
	of radio transmitters 268	
	Catalytic converter..... 269	
	Emission control 270	
	Coolant temperature..... 270	

Maximum tire inflation pressure ..	301		
Uniform Tire Quality Grading Standards (U.S. vehicles)	302		
Tire ply material	304		
Tire and loading terminology	304		
Rotating tires	307		
Winter driving	308		
Winter tires	308		
Block heater (Canada only)	309		
Snow chains.....	309		
Maintenance.....	310		
Maintenance service indicator message.....	310		
Calling up the maintenance service indicator display.....	312		
Resetting the maintenance service indicator	312		
Vehicle care.....	313		
Cleaning and care of the vehicle ..	313		
		Practical hints	321
		What to do if	322
		Lamps in instrument cluster	322
		Lamp in center console.....	331
		Vehicle status messages in the multifunction display.....	333
		Where will I find ...?	356
		First aid kit.....	356
		Vehicle tool kit.....	356
		Minispare wheel.....	359
		Spare wheel bolts	360
		Unlocking/locking in an emergency... ..	361
		Unlocking the vehicle.....	361
		Locking the vehicle	362
		Manually unlocking the transmission gear selector lever... ..	363
		Opening/closing in an emergency	364
		Power tilt/sliding sunroof*	364
		Resetting activated head restraints....	365
		Resetting activated head restraints	365
		Replacing SmartKey batteries	366
		SmartKey	366
		Replacing bulbs.....	367
		Bulbs.....	368
		Replacing bulbs for front lamps	370
		Replacing bulbs for rear lamps	373
		Replacing wiper blades	375
		Removing and installing wiper blades	375
		Flat tire.....	377
		Preparing the vehicle	377
		Mounting the Minispare wheel.....	377
		MOExtended system*	382
		Battery	383
		Disconnecting the battery	384
		Removing the battery	384
		Charging and reinstalling the battery.....	385
		Reconnecting the battery	385
		Jump starting.....	386
		Towing the vehicle.....	388
		Installing towing eye bolt.....	390
		Fuses.....	391
		Main fuse box in passenger compartment.....	392
		Fuse box in engine compartment.....	392
		Fuse box in trunk	394

Contents

Technical data	395	Fuels, coolants, lubricants, etc.	409	Index	419
Parts service	396	Capacities	409		
Warranty coverage.....	397	Engine oils.....	412		
Loss of Service and Warranty		Engine oil additives	412		
Information Booklet.....	397	Air conditioning refrigerant	412		
Identification labels.....	398	Brake fluid.....	412		
Layout of poly-V-belt drive	400	Premium unleaded gasoline	413		
Engine.....	401	Gasoline additives.....	413		
Rims and Tires	403	Fuel requirements	414		
Same size tires.....	404	Flexible Fuel Vehicles			
Mixed size tires	405	(C 230/C 230 Sport only).....	414		
Minispare wheel	406	Coolants.....	416		
Electrical system.....	407	Windshield washer and			
Main dimensions and weights.....	408	headlamp cleaning system*	418		
Main dimensions	408				
Weights	408				

▼ Product information

Please observe the following in your own best interest:

We recommend using Genuine Mercedes-Benz parts as well as conversion parts and accessories explicitly approved by us for your vehicle model.

We have tested these parts to determine their reliability, safety and special suitability for Mercedes-Benz vehicles.

We are unable to make an assessment for other products and therefore cannot be held responsible for them, even if in individual cases an official approval or authorization by governmental or other agencies should exist. Use of such parts and accessories could adversely affect the safety, performance or reliability of your vehicle. Please do not use them.

Genuine Mercedes-Benz parts as well as conversion parts and accessories approved by us are available at your authorized Mercedes-Benz Center where you will receive comprehensive information, also on permissible technical modifications, and where proper installation will be performed.

This Operator's Manual contains a great deal of useful information. We urge you to read it carefully and familiarize yourself with the vehicle before driving.

For your own safety and longer service life of the vehicle, we urge you to follow the instructions and warnings contained in this manual. Ignoring them could result in damage to the vehicle or personal injury to you or others. Vehicle damage caused by failure to follow instructions is not covered by the Mercedes-Benz Limited Warranty.

Your vehicle may have some or all of the equipment described in this manual. Therefore, you may find explanations for optional equipment not installed in your vehicle. If you have any questions about the operation of any equipment, your authorized Mercedes-Benz Center will be glad to demonstrate the proper procedures.

We continuously strive to improve our product, and ask for your understanding that we reserve the right to make changes in design and equipment. Therefore, information, illustrations and descriptions in this Operator's Manual might differ from your vehicle.

Optional equipment is also described in this manual, including operating instructions wherever necessary. Since they are special-order items, the descriptions and illustrations herein may vary slightly from the actual equipment of your vehicle.

If there are any equipment details that are not shown or described in this Operator's Manual, your authorized Mercedes-Benz Center will be glad to inform you of correct care and operating procedures.

The Operator's Manual and Maintenance Booklet are important documents and should be kept with the vehicle.

Service and warranty information

The Service and Warranty Information Booklet contains detailed information about the warranties covering your Mercedes-Benz, including:

- New Vehicle Limited Warranty
- Emission System Warranty
- Emission Performance Warranty
- California, Maine, Massachusetts, and Vermont Emission Control System Warranty (California, Maine, Massachusetts, and Vermont only)
- State Warranty Enforcement Laws (Lemon Laws)

Important notice for California retail buyers and lessees of Mercedes-Benz automobiles

Under California law you may be entitled to a replacement of your vehicle or a refund of the purchase price or lease price, if Mercedes-Benz USA, LLC and/or its authorized repair or service facilities fail to fix one or more substantial defects or malfunctions in the vehicle that are covered by its express warranty after a reasonable number of repair attempts. During the period of 18 months from original delivery of the vehicle or the accumulation of 18 000 miles (approximately 29 000 km) on the odometer of the vehicle, whichever occurs first, a reasonable number of repair attempts is presumed for a retail buyer or lessee if one or more of the following occurs:

- (1) the same substantial defect or malfunction results in a condition that is likely to cause death or serious bodily injury if the vehicle is driven, that defect or malfunction has been subject to repair two or more times, and you have directly notified Mercedes-Benz USA, LLC in writing of the need for its repair,
- (2) the same substantial defect or malfunction of a less serious nature than category (1) has been subject to repair four or more times and you have directly notified us in writing of the need for its repair, or
- (3) the vehicle is out of service by reason of repair of the same or different substantial defects or malfunctions for a cumulative total of more than 30 calendar days.

Written notification should not be sent to a dealer, it should be addressed to Mercedes-Benz USA, LLC Customer Assistance Center One Mercedes Drive Montvale, NJ 07645-0350

Maintenance

The Maintenance Booklet describes all the necessary maintenance work which should be performed at regular intervals.

Always have the Maintenance Booklet with you when you take the vehicle to your authorized Mercedes-Benz Center for service. The service advisor will record each service in the booklet for you.

Roadside Assistance

The Mercedes-Benz Roadside Assistance Program provides factory-trained technical help in the event of a breakdown. Calls to the toll-free Roadside Assistance number

1-800-FOR-MERCEdes (in the USA)
1-800-387-0100 (in Canada)

will be answered by Mercedes-Benz Customer Assistance Representatives 24 hours a day, 365 days a year.

For additional information refer to the Mercedes-Benz Roadside Assistance Program Brochure in your vehicle literature portfolio.

Change of address or ownership

If you change your address, be sure to send in the "Change of Address Notice" found in the Service and Warranty Information Booklet, or simply call the Mercedes-Benz Customer Assistance Center (in the USA) at 1-800-FOR-MERCEdes, or Customer Service (in Canada) at 1-800-387-0100. It is in your own interest that we can contact you should the need arise.

If you sell your Mercedes, please leave all literature with the vehicle to make it available to the next operator.

If you bought this vehicle used, be sure to send in the "Notice of Purchase of Used Car" found in the Service and Warranty Information Booklet, or call the Mercedes-Benz Customer Assistance Center (in the USA) at 1-800-FOR-MERCEdes, or Customer Service (in Canada) at 1-800-387-0100.

Operating your vehicle outside the USA or Canada

If you plan to operate your vehicle in foreign countries, please be aware that

- service facilities or replacement parts may not be readily available,
- unleaded gasoline for vehicles with catalytic converters may not be available; the use of leaded fuels will damage the catalysts,
- gasoline may have a considerably lower octane rating, and improper fuel can cause engine damage.

Certain Mercedes-Benz models are available for delivery in Europe under our European Delivery Program. For details, consult an authorized Mercedes-Benz Center or write to:

In the USA:

Mercedes-Benz USA, LLC
European Delivery Department
One Mercedes Drive
Montvale, NJ 07645-0350

In Canada:

Mercedes-Benz Canada, Inc.
European Delivery Department
98 Vanderhoof Avenue
Toronto, Ontario M4G 4C9

Where to find it

This Operator's Manual is designed to provide comprehensive support information for you, the vehicle operator. Each section has its own reference color.

At a glance

Here you will find an overview of all the controls that can be operated from the driver's seat.

Getting started

Here you will find all the information you need for your first drive. You should read this section first if this is your first Mercedes-Benz vehicle or if you are renting or borrowing this vehicle.

Safety and Security

Here you will find descriptions of the safety and security features of your vehicle.

Controls in detail

Here you will find detailed information about the equipment installed in your vehicle. This section expands on the "Getting started" section and also describes technical innovations. If you are already familiar with the basic functions of your vehicle, this section will be of particular interest to you.

Operation

Here you will find all the information you need for the proper operation of your vehicle.

Practical hints

This section provides fast assistance for dealing with problems you may encounter.

Technical data

All important technical data for your vehicle can be found in this section.

Indexes

The table of contents and the index are designed to help you find information quickly and easily.

The following publications are part of your vehicle documentation:

- this Operator's Manual
- the Maintenance Booklet

Separate operating instructions will be provided as required depending on the equipment options installed in your vehicle.

▼ Symbols

Trademarks:

- ESP® is a registered trademark of DaimlerChrysler.
- HomeLink® is a registered trademark of Prince, a Johnson Controls Company.
- SIRIUS and related marks are trademarks of SIRIUS Satellite Radio Inc.

The following symbols are found in this Operator's Manual:

- * Optional equipment is identified with an asterisk. Since standard equipment varies between models, the descriptions and illustrations in this manual may differ slightly from the actual equipment of your vehicle.

Warning!



Warning notices draw your attention to hazards that may endanger your health or life, or the health or life of others.

 *Highlights hazards that may result in damage to your vehicle.*

 *Helpful hints or further information you may find useful.*

- ▶ This symbol points to instructions for you to follow.
- ▶ A number of these symbols appearing in succession indicates a multiple-step procedure.
- ▷ Page This symbol tells you where to look for further information on a topic.
- ▷▷ This continuation symbol marks a procedure which is continued on the next page.
- ▷▷ This continuation symbol marks a warning which is continued on the next page.
- > This symbol is used to indicate cross-references to term definitions.
- Display Words appearing in the multi-function display and audio display are printed in the type shown here.

Warning!



Work improperly carried out on electronic components and associated software could cause them to cease functioning. Because the vehicle's electronic components are interconnected, any modifications made may produce an undesired effect on other systems. Electronic malfunctions could seriously impair the operating safety of your vehicle.

See an authorized Mercedes-Benz Center for repairs or modifications to electronic components.

Other improper work or modifications on the vehicle could also have a negative impact on the operating safety of the vehicle.

Some safety systems only function while the engine is running. You should therefore never turn off the engine while driving.

Warning!



Heavy blows against the vehicle underbody or tires/wheels, for example when running over an obstacle, road debris or a pothole, may cause serious damage and impair the operating safety of your vehicle. If you feel a sudden significant vibration or ride disturbance, or you suspect that damage to your vehicle has occurred, you should turn on your hazard warning flashers, carefully slow down, and drive with caution to an area which is a safe distance from the road.

Inspect the vehicle underbody and tires/wheels for possible damage. If the vehicle appears unsafe, have it towed to the nearest authorized Mercedes-Benz Center or other qualified maintenance or repair facility for further inspection or repairs.

Proper use of the vehicle

Proper use of the vehicle requires that you are familiar with the following information and rules:

- the safety precautions in this manual
- the “Technical data” section in this manual
- traffic rules and regulations
- motor vehicle laws and safety standards

Warning!



Various warning labels are attached to your vehicle. These warning labels are intended to make you and others aware of various risks. You should not remove any of these warning labels unless explicitly instructed to do so by information on the label itself. Removal of any of these labels may cause you and others to be unaware of certain risks which may result in an accident and/or personal injury.

▼ Problems with your vehicle

If you should experience a problem with your vehicle, particularly one that you believe may affect its safe operation, we urge you to immediately contact an authorized Mercedes-Benz Center to have the problem diagnosed and corrected if required. If the matter is not handled to your satisfaction, please discuss the problem with the Mercedes-Benz Center management, or if necessary contact us at one of the following addresses:

In the USA:

Customer Assistance Center
Mercedes-Benz USA, LLC
One Mercedes Drive
Montvale, NJ 07645-0350

In Canada:

Customer Relations Department
Mercedes-Benz Canada, Inc.
98 Vanderhoof Avenue
Toronto, Ontario, M4G 4C9

Reporting safety defects

For the USA only:

The following text is published as required of manufacturers under Title 49, Code of U.S. Federal Regulations, Part 575 pursuant to the “National Traffic and Motor Vehicle Safety Act of 1966”.

Reporting Safety Defects

If you believe that your vehicle has a defect which could cause a crash or could cause injury or death, you should immediately inform the National Highway Traffic Safety Administration (NHTSA) in addition to notifying Mercedes-Benz USA, LLC.

If NHTSA receives similar complaints, it may open an investigation, and if it finds that a safety defect exists in a group of vehicles, it may order a recall and remedy campaign. However, NHTSA cannot become involved in individual problems between you, your dealer, or Mercedes-Benz USA, LLC.

To contact NHTSA, you may either call the Auto Safety Hotline toll-free at 1-888-327-4236 (TTY: 1-800-424-9153); go to <http://www.safercar.gov>; or write to: Administrator, NHTSA, 400 Seventh Street, SW., Washington, D.C. 20590. You can also obtain other information about motor vehicle safety from <http://www.safercar.gov>.

▼ Vehicle data recording

Information regarding electronic recording devices

(Including notice pursuant to California Code § 9951)

Please note that your vehicle is equipped with devices that can record vehicle systems data and, if equipped with the Tele Aid system, may transmit some data in certain accidents.

This information helps, for example, to diagnose vehicle systems after a collision and to continuously improve vehicle safety. DaimlerChrysler may access the information and share it with others

- for safety research or vehicle diagnosis purposes
- with the consent of the vehicle owner or lessee
- in response to an official request by law enforcement or other government agency
- for use in dispute resolution involving DaimlerChrysler, its affiliates or sales/service organization and/or
- as otherwise required or permitted by law.

Please check the Tele Aid subscription service agreement for details regarding the information that may be recorded or transmitted via that system.

Cockpit

Instrument cluster

Multifunction steering wheel

Center console

Overhead control panel

Door control panel



Cockpit

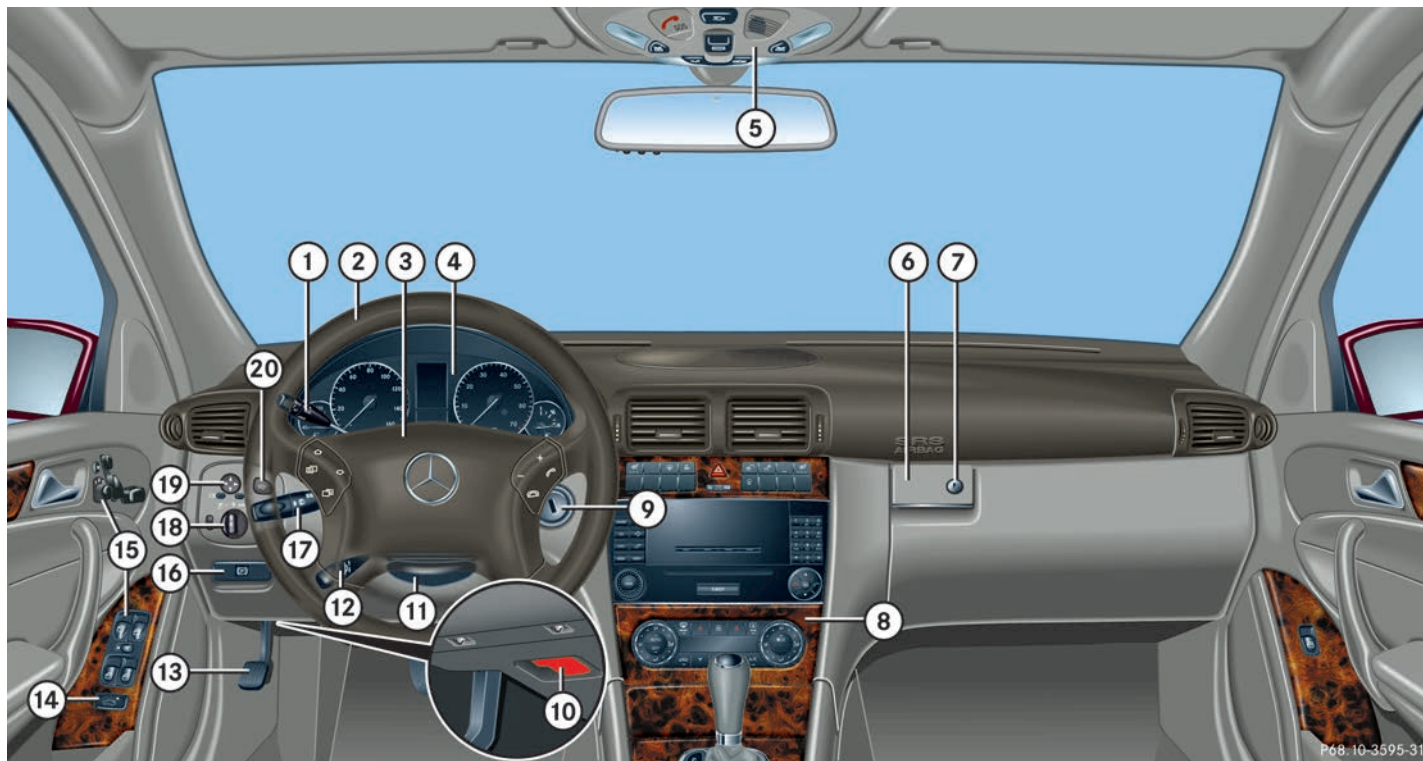

Item	Page
① Cruise control lever	227
② Multifunction steering wheel	26, 122
③ Horn	
④ Instrument cluster	24, 118
⑤ Overhead control panel	29
⑥ Glove box lid release	237
⑦ Glove box lock	237
⑧ Center console	27
⑨ Starter switch	32





Item	Page
⑩ Hood lock release	274
⑪ Steering wheel release handle (manual)	39
⑫ Steering wheel adjustment stalk (electrical)*	40
⑬ Parking brake pedal	48, 54
⑭ Remote trunk opening switch	97
⑮ Door control panel	30
⑯ Parking brake release	48





Item	Page
⑰ Combination switch	
• Turn signals	50
• Windshield wipers	51
• High beam	50
⑱ Exterior lamp switch	50, 109
⑲ Exterior rear view mirror adjustment	42, 160
⑳ Headlamp washer button*	160



Instrument cluster



P54.32-3565-31

Item	Page
① Speedometer with:	
 Electronic Stability Program (ESP®) warning lamp	85, 327
 Brake warning lamp, USA only	48, 54, 324
 Brake warning lamp, Canada only	48, 54, 324
 Low beam headlamp indicator lamp	50, 109
②  Left turn signal indicator lamp	50
③ Multifunction display with:	121
• Trip odometer	119
• Main odometer	121
• Gear selector lever position*	47, 121, 153

Item	Page
• Program mode*	157
• Status indicator (outside temperature/digital speedometer)	120, 135
• Digital clock	121
④  Right turn signal indicator lamp	50
⑤ Tachometer with:	120
 Antilock Brake System (ABS) indicator lamp	82, 322
 Engine malfunction indicator lamp, USA only	325, 326
 Engine malfunction indicator lamp, Canada only	325, 326
 Supplemental Restraint System (SRS) indicator lamp	58, 330

Item	Page
 Seat belt telltale	69, 328
 High beam headlamp indicator lamp	50, 113
⑥ Fuel gauge with:	
Fuel reserve warning lamp	328
 The arrow indicates that the fuel filler cap is on the rear right-hand side.	
⑦ Coolant temperature gauge	119
⑧ Button for:	
• Resetting trip odometer	119
• Resetting all settings	131
• Instrument cluster illumination	118

Multifunction steering wheel

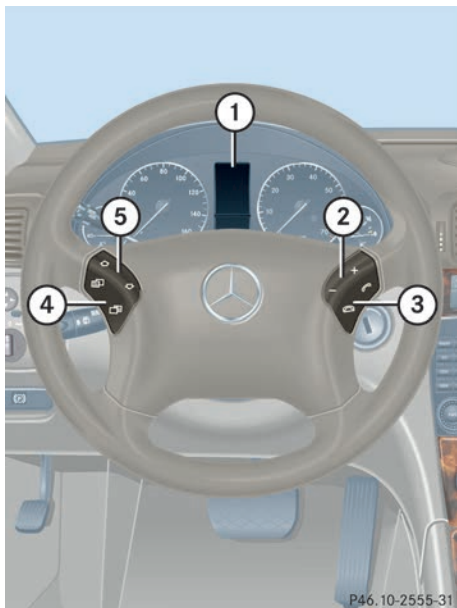

P46.10-2555-31

	Item	Page
①	Multifunction display	121
	Operating control system	122
②	Selecting the submenu or setting the volume: Press button	
	up/to increase	
	down/to decrease	
③	Telephone*: Press button	
	to take a call to dial a call	
	to end a call to reject an incoming call	

	Item	Page
④	Menu systems: Press button	
	for next menu	
	for previous menu	
⑤	Moving within a menu: Press button	
	for next display	
	for previous display	

i C 230 Sport and C 350 Sport:
Steering wheel in these vehicles will vary from steering wheel shown. However, multifunction steering wheel symbols and feature description apply to Sport models as well.

▼ Center console

Upper part

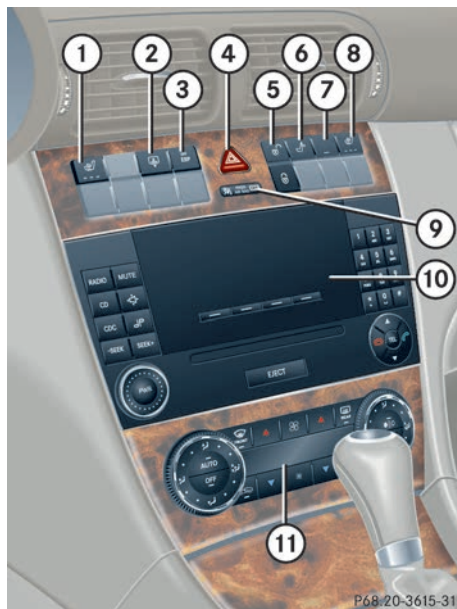

P68:20-3615-31

Item	Page
① Seat heating*, driver's side	106
② Rear window sunshade switch*	162
③ ESP® control switch	85
④ Hazard warning flasher switch – switching on/off	115
⑤ Central locking switch	100
Central unlocking switch	100
⑥ Switch for folding back rear seat head restraints	103
⑦ Anti-theft alarm system indicator lamp*	90

Item	Page
⑧ Seat heating*, passenger side	106
⑨ Front passenger front air bag off indicator lamp	68, 332, 339
⑩ Audio system, or COMAND* (see separate operating instructions)	187
⑪ Automatic climate control*	174
Climate control	164
Rear window defroster	163

Center console

Lower part

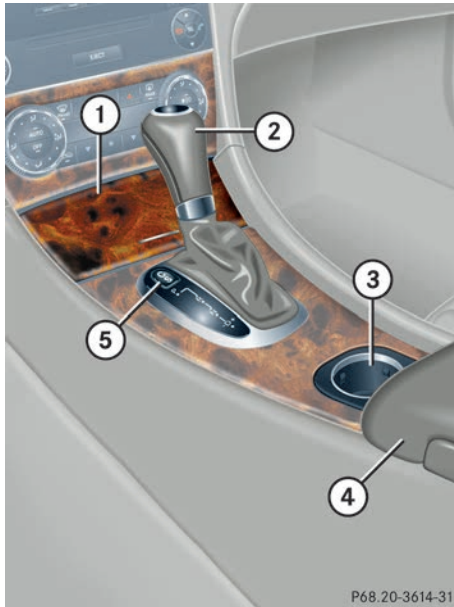

	Item	Page
①	Ashtray	241
	Cigarette lighter	242
②	Gear selector lever for automatic transmission*	47, 153
	Gearshift lever for manual transmission	46, 149
③	Cup holder	239
④	Storage compartment/telephone* compartment under the center armrest	238
⑤	Program mode selector switch for automatic transmission*	157

▼ Overhead control panel

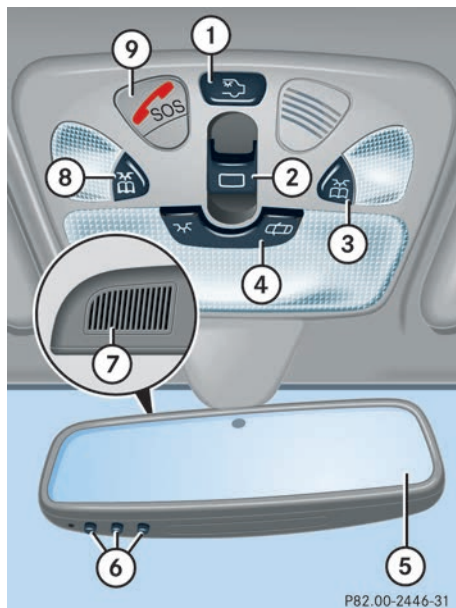

Item	Page
① Rear interior lighting on/off	117
② Power tilt/sliding sunroof*	224
③ Right reading lamp on/off	117
④ Interior lighting control	116
⑤ Interior rear view mirror	42, 160
⑥ Garage door opener*	253
⑦ Hands-free microphone for Tele Aid* (emergency call system) and telephone*	146, 208, 247
⑧ Left reading lamp on/off	117
⑨ Tele Aid* (emergency call system) button	247

Door control panel

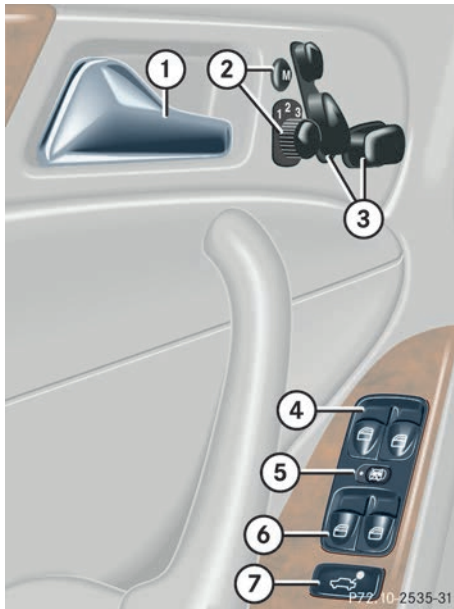

	Item	Page
①	Inside door handle	96
②	Memory function* (for storing seat, exterior mirror and steering wheel settings)	107
③	Switches for seat adjustment*	34, 101
④	Switches for opening/closing front door windows	221
⑤	Rear door window override switch	80
⑥	Switches for opening/closing rear door windows	221
⑦	Remote trunk lid switch	97

Unlocking

Adjusting

Driving

Parking and locking



Unlocking





The “Getting started” section provides an overview of the vehicle’s most basic functions. First-time Mercedes-Benz owners should pay special attention to the information given here.

If you are already familiar with the basic functions described here, the “Controls in detail” section (▷ page 92) will provide you with further information. The corresponding page references are located at the end of each segment.

Unlocking with the SmartKey



SmartKey with remote control

- ①  Lock button
- ②  Opening button for trunk
- ③  Unlock button
- ④  Panic button* (▷ page 81)

i *Canada only:*
Only vehicles equipped with an anti-theft alarm system* have SmartKeys with integrated panic button* ④.

- ▶ Press unlock button  on the SmartKey.

All turn signal lamps flash once. The locking knobs in the doors move up. The anti-theft alarm system* is disarmed.

- ▶ Get in the vehicle and insert the SmartKey in the starter switch.

For more information, see “Locking and unlocking” (▷ page 92).

Starter switch positions

Warning!



When leaving the vehicle, always remove the SmartKey from the starter switch, take it with you, and lock the vehicle. Do not leave children unattended in the vehicle, or with access to an unlocked vehicle. A child’s unsupervised access to a vehicle could result in an accident and/or serious personal injury.

SmartKey

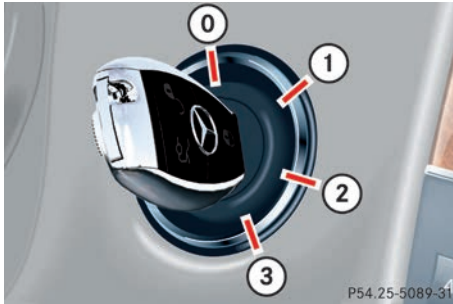

Starter switch

- 0** For removing SmartKey
The steering is locked when the SmartKey is removed from the starter switch.
- 1** Power supply for some electrical consumers, such as seat adjustment

- 2** Ignition (power supply for all electrical consumers) and driving position.
All lamps (except low beam headlamp indicator lamp, high beam headlamp indicator lamp, and turn signal indicator lamps unless activated) in the instrument cluster come on. If a lamp in the instrument cluster fails to come on when the ignition is switched on, have it checked and replaced if necessary. If a lamp in the instrument cluster remains on after starting the engine or comes on while driving, refer to “Lamps in instrument cluster” (▷ page 322).

3 Starting position

- i** When you switch on ignition, the indicator and warning lamps (except low beam headlamp indicator lamp, high beam headlamp indicator lamp, and turn signal indicator lamps unless activated) in the instrument cluster come on. The indicator and warning lamps (except low beam headlamp indicator lamp, high beam headlamp indicator lamp, and turn signal indicator lamps if activated) will go out when the engine is running. This indicates that the respective systems are operational.

- i** Vehicles with automatic transmission*: The SmartKey can only be removed from the starter switch with the gear selector lever in position **P**.

- i** If the SmartKey is left in starter switch position **0** for an extended period of time, it can no longer be turned in the switch. In this case, the steering is locked. To unlock, remove SmartKey from starter switch and reinsert.

- !** If the SmartKey cannot be turned in the starter switch, the battery may not be sufficiently charged.

- Check the battery and charge it if necessary (▷ page 383).
- Get a jump start (▷ page 386).

To prevent accelerated vehicle battery discharge or a completely discharged battery, always remove the SmartKey from the starter switch when the engine is not in operation.

Adjusting

Warning!



All seat, head restraint, steering wheel, and rear view mirror adjustments, as well as fastening of seat belts, must be done before the vehicle is put into motion.

Seats

The seats can be adjusted either manually or electrically, depending on the vehicle's equipment.

For more information, see "Seats" (▷ page 101).

Warning!



Do not adjust the driver's seat while driving. Adjusting the seat while driving could cause the driver to lose control of the vehicle.

Never ride in a moving vehicle with the seat back in an excessively reclined position as this can be dangerous. You could slide under the seat belt in a collision. If you slide under it, the belt would apply force at the abdomen or neck. That could cause serious or fatal injuries. The seat back and seat belts provide the best restraint when the wearer is in a nearly upright position and belts are properly positioned on the body. Your seat must be adjusted so that you can correctly fasten your seat belt (▷ page 43).

Never place hands under the seat or near any moving parts while a seat is being adjusted.

Warning!



When leaving the vehicle, always remove the SmartKey from the starter switch, take it with you, and lock the vehicle.

Even with the SmartKey removed from the starter switch, the power seats* can be operated when the respective door is open. Therefore, do not leave children unattended in the vehicle, or with access to an unlocked vehicle. Unsupervised use of vehicle equipment may cause an accident and/or serious personal injury.

Warning!

According to accident statistics, children are safer when properly restrained in the rear seating positions than in the front seating position. Thus, we strongly recommend that children be placed in the rear seats whenever possible. Regardless of seating position, children 12 years old and under must be seated and properly secured in an appropriate infant, or toddler restraint, or booster seat recommended for the size and weight of the child. For additional information, see “Children in the vehicle” (▷ page 74).

A child’s risk of serious or fatal injuries is significantly increased if the child restraints are not properly secured in the vehicle and/or the child is not properly secured in the child restraint.

! *When moving the seats, make sure that there are no items in the footwell or behind the seat. Otherwise you could damage the seats.*

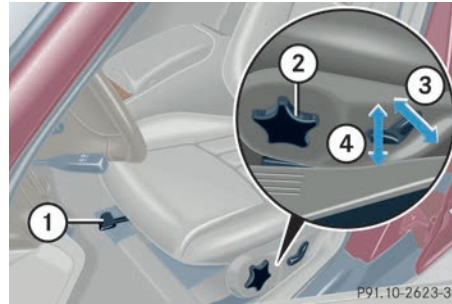
Manual seat adjustment

- ① Seat fore and aft adjustment
- ② Seat cushion tilt
- ③ Seat backrest tilt
- ④ Seat height

Seat fore and aft adjustment

- ▶ Lift handle ①.
- ▶ Slide seat to the desired position.

Adjust seat to a comfortable seating position that still allows you to reach the accelerator/brake pedal safely. The position should be as far rearward as possible, consistent with ability to properly operate controls.

- ▶ Allow handle ① to reengage with an audible click.
- ▶ Check for proper engagement before driving.

Seat cushion tilt

- ▶ Turn handwheel ② forward or backward until your upper legs are lightly supported.

Seat backrest tilt

- ▶ Switch on the ignition (▷ page 32).
- ▶ Press switch ③ in direction of arrow until your arms are slightly angled when holding the steering wheel.

Seat height

- ▶ Switch on the ignition (▷ page 32).
- ▶ Press switch ④ in direction of arrow until your legs are lightly supported.

Adjusting

Head restraint height

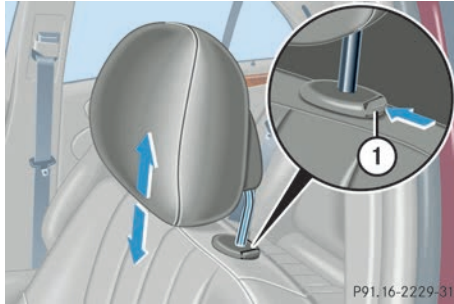

- ① Release button

Raising:

- ▶ Manually adjust the height of the head restraint by pulling it upward.

Lowering:

- ▶ To lower the head restraint, push release button ① and push down on the head restraint.

i Adjust the head restraint in such a way that it is as close to the head as possible.

Warning!



For your protection, drive only with properly positioned head restraints.

Adjust head restraint so that the head restraint supports the back of the head at eye level. This will reduce the potential for injury to the head and neck in the event of an accident or similar situation.

Do not drive the vehicle without the seat head restraints. Head restraints are intended to help reduce injuries during an accident.

Head restraint adjusting

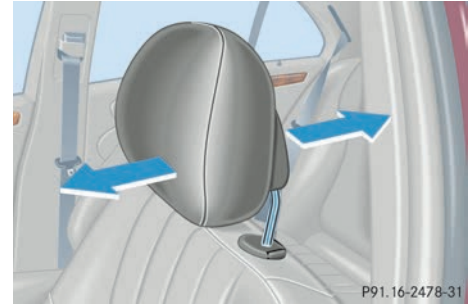

Manually adjust the head restraint.

- ▶ Push or pull the head restraint cushion to the desired position.

i Adjust the head restraint in such a way that it is as close to the head as possible.

For more information, see “Seats” (▷ page 101).

Power seat* adjustment

The seat adjustment switches are located on the respective front door.

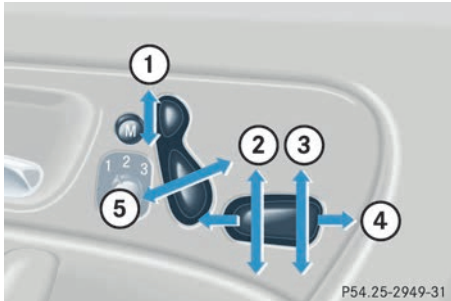

- ① Head restraint height
- ② Seat height
- ③ Seat cushion tilt
- ④ Seat fore and aft adjustment
- ⑤ Seat backrest tilt

► Switch on the ignition (▷ page 32).

or

► Open the respective door.

i The memory function* (▷ page 107) lets you store the settings for the power seat*, the steering wheel adjustment (electrical*) and the exterior rear view mirrors.

Seat fore and aft adjustment

- Press switch forward or backward in direction of arrow ④.

Adjust seat to a comfortable seating position that still allows you to reach the accelerator/brake pedal safely. The position should be as far rearward as possible, consistent with ability to properly operate controls.

Seat cushion tilt

- Press switch up or down in direction of arrow ③ until your upper legs are lightly supported.

Seat backrest tilt

- Press switch forward or backward in direction of arrow ⑤ until your arms are slightly angled when holding the steering wheel.

Seat height

- Press switch up or down in direction of arrow ②.

Head restraint height

- Press switch up or down in direction of arrow ①.

i Adjust the head restraint in such a way that it is as close to the head as possible.

Adjusting

Warning!



For your protection, drive only with properly positioned head restraints.

Adjust head restraint so that the head restraint supports the back of the head at eye level. This will reduce the potential for injury to the head and neck in the event of an accident or similar situation.

Do not drive the vehicle without the seat head restraints. Head restraints are intended to help reduce injuries during an accident.

Head restraint adjusting

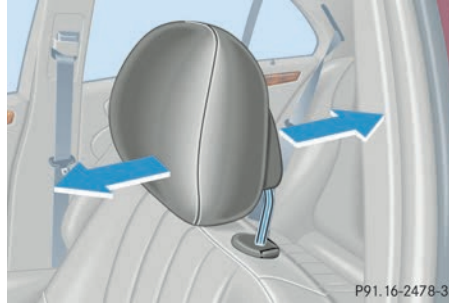

Manually adjust the head restraint.

- ▶ Push or pull the head restraint cushion to the desired position.

i *Adjust the head restraint in such a way that it is as close to the head as possible.*

For more information, see “Seats” (▷ page 101).

Steering wheel

Warning!



Do not adjust the steering wheel while driving. Adjusting the steering wheel while driving, or driving without the steering wheel adjustment feature locked could cause the driver to lose control of the vehicle.

When leaving the vehicle, always remove the SmartKey from the starter switch, take it with you, and lock the vehicle.

Even with the SmartKey removed from the starter switch, the electrical steering wheel adjustment feature* can be operated when the driver's door is open. Therefore, do not leave children unattended in the vehicle, or with access to an unlocked vehicle. Unsupervised use of vehicle equipment may cause an accident and/or serious personal injury.

Steering wheel adjustment, manual

Warning!



Only adjust the steering wheel with the vehicle at a standstill and make sure the steering column is securely locked in place before driving off.

Driving without the steering column locked may cause an unexpected steering wheel movement which could cause the driver to lose control of the vehicle. Make sure the steering column is securely locked by trying to move it up and down, and in and out before driving off.

The handle for steering wheel adjustment is located below the steering column.

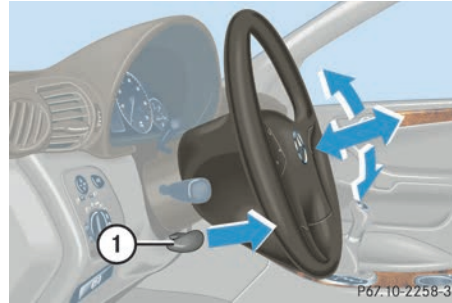

① Steering wheel adjustment release handle

- ▶ To unlock the steering column, pull handle ① out to its stop limit.
- ▶ Move steering wheel to the desired position.

Make sure your legs can move freely and that all the displays (including malfunction and indicator lamps) on the instrument cluster are clearly visible.

- ▶ To lock the steering column, push handle ① all the way in until it engages.

The steering wheel is locked into position again.

- ▶ Make sure the steering wheel is securely locked by trying to move it up and down, and in and out before driving off.

! Do not drive the vehicle until you have properly locked the steering column.

Adjusting

Steering wheel adjustment, electrical*

The stalk for the electrical steering wheel adjustment is located on the lower left of the steering column.

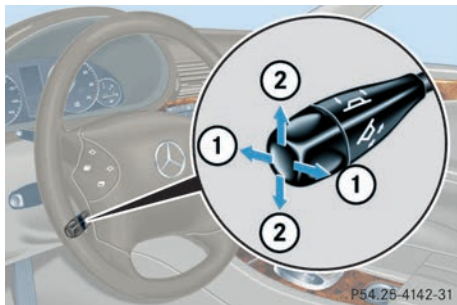

- ① Adjusting steering column, in or out
- ② Adjusting steering column, up or down

► Switch on the ignition (▷ page 32).

or

► Open the driver's door.

i *The memory function* (▷ page 107) lets you store the settings for the power seat*, the steering wheel adjustment (electrical*) and the exterior rear view mirrors.*

Adjusting steering column in or out

► Move the stalk in direction of arrows ① until a comfortable steering wheel position is reached with your arms slightly bent at the elbow.

Adjusting steering column up or down

► Move the stalk in direction of arrows ②.

Make sure your legs can move freely and that all the displays (including malfunction and indicator lamps) on the instrument cluster are clearly visible.

Easy-entry/exit feature*

This feature allows for easier entry into and exit from the vehicle. When entering and exiting the vehicle, the steering wheel is in its uppermost position.

The easy-entry/exit feature can be activated or deactivated in the Convenience sub-menu of the control system (▷ page 144).

Warning!



You must make sure no one can become trapped or injured by the moving steering wheel when the easy-entry/exit feature is activated.

To stop steering wheel movement, do one of the following:

- Move steering wheel adjustment stalk* (▷ page 40).
- Press memory position switch* (▷ page 108).

Do not leave children unattended in the vehicle, or with access to an unlocked vehicle. Children could open the driver's door and unintentionally activate the easy-entry/exit feature, which could result in an accident and/or serious personal injury.

With the easy-entry/exit feature activated, the steering wheel will return to its last set position when you:

- close the driver's door with the ignition switched on,
or
- insert the SmartKey into the starter switch with the driver's door closed.

i *The last set steering wheel position is stored when*

- *the ignition is switched off*
- *the position is stored in memory*
(▷ *page 107*)

With the easy-entry/exit feature activated, the steering wheel tilts upwards when you:

- remove the SmartKey from the starter switch,
or
- open the driver's door with the SmartKey in starter switch position **0** or **1**.

i *If the current position for the steering wheel is in the uppermost tilt position, the steering wheel will no longer be able to move upward when the easy-entry/exit feature is activated.*

The adjustment procedure is briefly interrupted when the engine is started.

Warning!



Let the system complete the adjustment procedure before setting the vehicle in motion. All steering wheel adjustments must be completed before setting the vehicle in motion. Driving off with the steering wheel still adjusting could cause the driver to lose control of the vehicle.

Mirrors

Adjust the interior and exterior rear view mirrors before driving so that you have a good view of the road and traffic conditions.

Warning!



In case of an accident, liquid electrolyte may escape the mirror housing if the mirror glass breaks.

Electrolyte has an irritating effect. Do not allow the liquid to come into contact with eyes, skin, clothing, or respiratory system. In case it does, immediately flush affected area with water, and seek medical help if necessary.

! *Electrolyte drops coming into contact with the vehicle paint finish can only be completely removed while in their liquid state and by applying plenty of water.*

Adjusting

Interior rear view mirror

- ▶ Manually adjust the interior rear view mirror.

For more information, see “Rear view mirrors” (▷ page 160).

Exterior rear view mirrors

Warning!



Exercise care when using the passenger-side exterior rear view mirror. The mirror surface is convex (outwardly curved surface for a wider field of view). Objects in mirror are closer than they appear. Check your interior rear view mirror or glance over your shoulder before changing lanes.

The buttons are located above the exterior lamp switch.

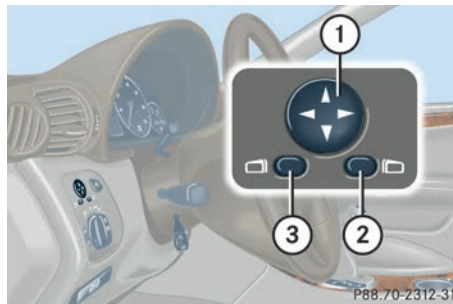

- ① Adjustment button
 - ② Passenger-side exterior rear view mirror button
 - ③ Driver's side exterior rear view mirror button
- ▶ Switch on the ignition (▷ page 32).
 - ▶ Press button ③ for the driver's side exterior rear view mirror or button ② for passenger-side exterior rear view mirror.
 - ▶ Push adjustment button ① up, down, left, or right according to the desired setting.

! If an exterior rear view mirror was forcibly pushed forward (hit from the rear) or forcibly pushed rearward (hit from the front), reposition it by applying firm pressure until it snaps into place. The mirror housing is now properly positioned and you can adjust the mirror in the usual manner.

i At low ambient temperatures, the exterior rear view mirrors will be heated automatically.

i The memory function* (▷ page 107) lets you store the settings for the exterior rear view mirrors together with the settings for the steering wheel and the driver's seat position.

For more information, see “Rear view mirrors” (▷ page 160).

▼ Driving

Warning!



Make sure that absolutely no objects are obstructing the pedals' range of movement. Keep the driver's footwell clear of all obstacles. If there are any floor mats or carpets in the footwell, make sure that the pedals still have sufficient clearance.

During sudden driving or braking maneuvers, the objects could get caught between or beneath the pedals. You could then no longer brake or accelerate. This could lead to accidents and injury.

Fastening the seat belt

Warning!



Always fasten your seat belt before driving off. Always make sure your passengers are properly restrained, even those sitting in the rear.

Failure to wear and properly fasten and position your seat belt greatly increases your risk of injuries and their likely severity in an accident. You and your passengers should always wear seat belts.

If you are ever in an accident, your injuries can be considerably more severe without your seat belt properly buckled. Without your seat belt buckled, you are much more likely to hit the interior of the vehicle or be ejected from it. You can be seriously injured or killed.

In the same crash, the possibility of injury or death is lessened if you are wearing your seat belt. The air bags can only provide the protection they were designed to afford if the occupants are using their seat belts (▷ page 69).

Warning!



According to accident statistics, children are safer when properly restrained in the rear seating positions than in the front seating position. Thus, we strongly recommend that children be placed in the rear seats. Regardless of seating position, children 12 years old and under must be seated and properly secured in an appropriate infant or toddler restraint, or booster seat recommended for the size and weight of the child. For additional information, see "Children in the vehicle" (▷ page 74).

A child's risk of serious or fatal injuries is significantly increased if the child restraints are not properly secured in the vehicle and/or the child is not properly secured in the child restraint.

Driving

Warning!



Never let more people ride in the vehicle than there are seat belts available. Be sure everyone riding in the vehicle is correctly restrained with a separate seat belt. Never use a seat belt for more than one person at a time.

Warning!



Never ride in a moving vehicle with the seat backrest in an excessively reclined position as this can be dangerous. You could slide under the seat belt in a collision. If you slide under it, the belt would apply force at the abdomen or neck. That could cause serious or even fatal injuries. The seat backrest and seat belt provide the best restraint when the wearer is in a nearly upright position and the belt is properly positioned on the body.

Warning!



Read and observe the additional warning notices printed in the “Safety and Security” section (▷ page 62) and (▷ page 69).

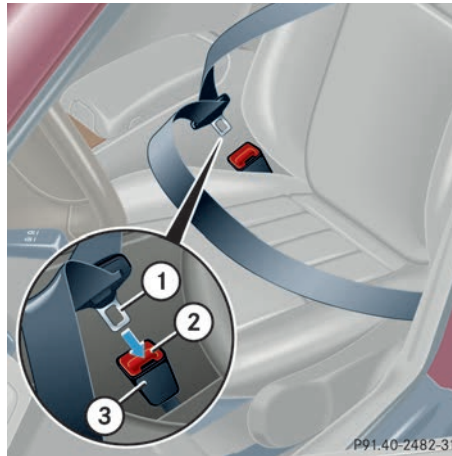

- ① Latch plate
- ② Release button
- ③ Buckle

- ▶ With a smooth motion, pull the belt from the belt outlet.
- ▶ Place the shoulder portion of the belt across the top of your shoulder and the lap portion across your hips.
- ▶ Push latch plate ① into buckle ③ until it engages.
- ▶ If necessary, tighten the lap portion to a snug fit by pulling shoulder portion up.

Belt outlet height adjustment

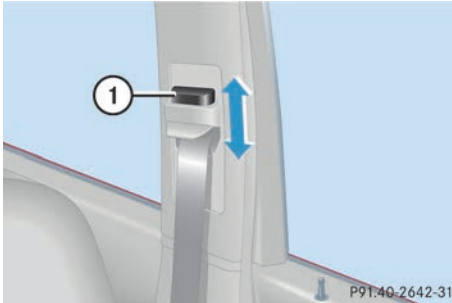

① Release button

- ▶ Press release button ① and move the seat belt height adjuster upward or downward.

Proper use of seat belts

- Do not twist the seat belt when fastening.
- Adjust seat belt so that the shoulder portion is located as close as possible to the middle of the shoulder (it should not touch the neck). Never pass the

shoulder portion of the belt under your arm. For this purpose, you can adjust the height of the belt outlet.

- Position the lap belt as low as possible on your hips (over hip joint) and not across the abdomen.
- Place the seat backrest in a nearly upright position.
- Never use a seat belt for more than one person at a time.
- Do not fasten a seat belt around a person and another object at the same time.
- When using a seat belt to secure infant or toddler restraints or children in booster seats, always follow the child seat manufacturer's instructions.
- Check your seat belt during travel to make sure that it is properly positioned.
- Make sure that the seat belt is always fitted snugly. Take special care of this when wearing loose clothing.

Warning!



Do not pass belts over sharp edges. They could tear.

Do not allow the belt to get caught in the door or in the seat adjustment mechanism. This could damage the belt.

Never attempt to make modifications to seat belts. This could impair the effectiveness of the belts.

Do not bleach or dye seat belts as this may severely weaken them. In a crash, they may not be able to provide adequate protection.

Damaged seat belts or belts that were highly stressed in an accident must be replaced. Contact an authorized Mercedes-Benz Center.

Starting the engine

Warning!



Inhalation of exhaust gas is hazardous to your health. All exhaust gas contains carbon monoxide (CO), and inhaling it can cause unconsciousness and possible death.

Do not run the engine in confined areas (such as garage) which are not properly ventilated. If you think that exhaust gas fumes are entering the vehicle while driving, have the cause determined and corrected immediately. If you must drive under these conditions, drive only with at least one window fully open.

Manual transmission

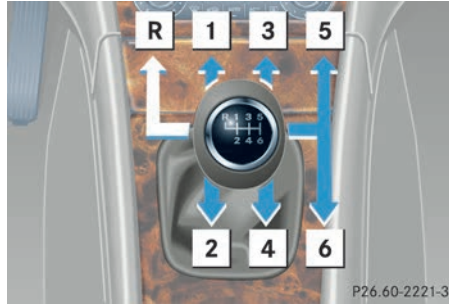

Gearshift pattern for manual transmission

For more information, see “Manual transmission” (▷ page 149).

Starting

- ▶ Depress brake pedal.
- ▶ Make sure the gearshift lever is in neutral position (no gear selected).
- ▶ Fully depress clutch pedal.
Otherwise the engine cannot be started due to the integrated safety interlock.
- ▶ Do not depress the accelerator.
- ▶ Turn the SmartKey in the starter switch to position **3** (▷ page 32) and hold until the engine starts.

For information on turning off the engine, see “Turning off engine” (▷ page 55).

Automatic transmission*



Gearshift pattern for automatic transmission

- P** Park position with gear selector lever lock
- R** Reverse gear
- N** Neutral position
- D** Drive position

For more information, see “Automatic transmission*” (▷ page 151).

Starting

- ▶ Place the gear selector lever in position **P**.
- ▶ Do not depress the accelerator.
- ▶ Turn the SmartKey in the starter switch to position **3** (▷ page 32) and release it again immediately. The engine then starts automatically.

For information on turning off the engine, see “Turning off engine” (▷ page 55).

Starting difficulties

If the SmartKey is left in starter switch position **0** for an extended period of time, it can no longer be turned in the switch. In this case, the steering is locked.

- ▶ To unlock, remove SmartKey from starter switch and reinsert.

If the engine does not start as described, carry out the following steps:

- ▶ Turn the SmartKey in starter switch to position **0** and repeat the starting procedure (▷ page 46).

Remember that extended starting attempts can drain the vehicle battery.

- ▶ Get a jump start (▷ page 386).

If the engine does not start after several starting attempts, there could be a malfunction in the engine electronics or in the fuel supply system.

- ▶ Notify an authorized Mercedes-Benz Center.

Parking brake

Warning!



When leaving the vehicle, always remove the SmartKey from the starter switch, take it with you, and lock the vehicle. Do not leave children unattended in the vehicle, or with access to an unlocked vehicle. Children could release the parking brake, which could result in an accident and/or serious personal injury.

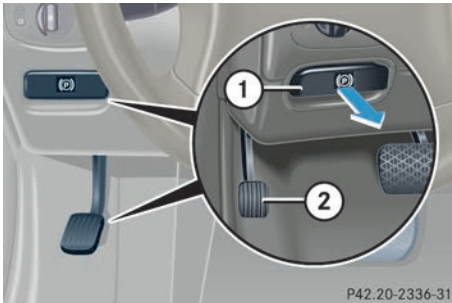

P42.20-2336-31

- ① Release handle
- ② Parking brake pedal

- ▶ Release parking brake by pulling on handle ①.

The warning lamp **BRAKE** (USA only) or **(P)** (Canada only) in the instrument cluster goes out.

Driving

Warning!



On slippery road surfaces, never downshift in order to obtain braking action. This could result in drive wheel slip and reduced vehicle control. Your vehicle's ABS will not prevent this type of loss of control.

- ❗ *If you hear a warning signal and the message **Release parking brake** appears in the multifunction display when driving off, you have forgotten to release the parking brake.*

Release the parking brake (▷ page 48).

- ℹ *At vehicle speeds of approximately 9 mph (15 km/h), the automatic central locking system engages and the locking knobs drop down.*

The automatic door lock feature can be deactivated (▷ page 143).

You can open a locked door from the inside. Open door only when conditions are safe to do so.

- ❗ *Simultaneously depressing the accelerator pedal and applying the brake reduces engine performance and causes premature brake and drivetrain wear.*

- ❗ *Do not run cold engine at high engine speeds. Running a cold engine at high engine speeds may shorten the service life of the engine.*

Manual transmission

- ▶ Depress the brake pedal.
- ▶ Fully depress the clutch pedal.

! *In order to avoid damage to the transmission, place the gearshift lever to reverse gear only when the vehicle is stopped.*

- ▶ Move gearshift lever to first gear to drive forward, or to reverse gear to drive rearward.
- ▶ Simultaneously release the brake pedal and slowly the clutch pedal.
- ▶ Carefully depress the accelerator pedal.

Automatic transmission*

! *Wait for the gear selection process to complete before setting the vehicle in motion.*

- ▶ Depress the brake pedal.
- ▶ Move gear selector lever to position **D** to drive forward, or to position **R** to drive rearward.

! *Place the gear selector lever in position **P** or **R** only when the vehicle is stopped in order to avoid damaging the transmission.*

- ▶ Release the brake pedal.
- ▶ Carefully depress the accelerator pedal.

Warning!



It is dangerous to shift the gear selector lever out of **P** or **N** if the engine speed is higher than idle speed. If your foot is not firmly on the brake pedal, the vehicle could accelerate quickly forward or in reverse. You could lose control of the vehicle and hit someone or something. Only shift into gear when the engine is idling normally and when your right foot is firmly on the brake pedal.

Switching on headlamps

Low beam headlamps

The exterior lamp switch is located on the dashboard to the left of the steering wheel.

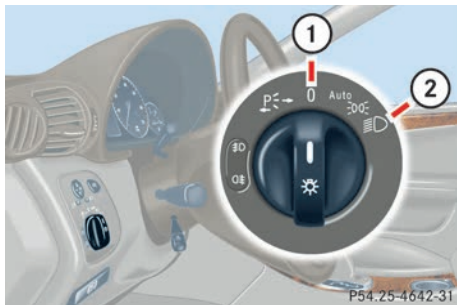

Exterior lamp switch

- ① Off
- ② Low beam headlamps on

- ▶ Turn the exterior lamp switch to position .

The low beam headlamps and the low beam headlamp indicator lamp  in the instrument cluster comes on (▷ page 24).

High beam

The combination switch is located on the left of the steering column.

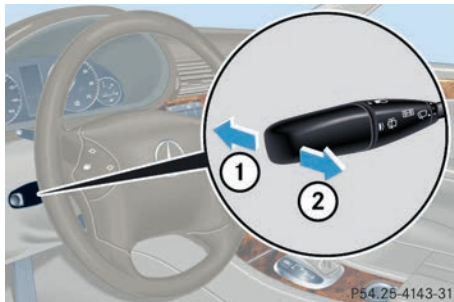

Combination switch

- ① High beam
- ② High beam flasher

- ▶ Push the combination switch in direction of arrow ①.

The high beam headlamps and the high beam headlamp indicator lamp  in the instrument cluster comes on (▷ page 24).

For more information on headlamps, see “Lighting” (▷ page 109).

Turn signals

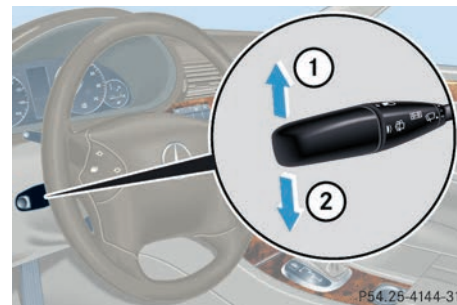

The combination switch is located on the left of the steering column.



Combination switch

- ① Turn signals, right
- ② Turn signals, left

- ▶ Press the combination switch in direction of arrow ① or ②.

The corresponding turn signal indicator lamp  or  in the instrument cluster flashes (▷ page 24).

The combination switch resets automatically after major steering wheel movements.

i If the combination switch is pressed to the point of resistance and released, the corresponding turn signals will flash three times.

Windshield wipers

The combination switch is located on the left of the steering column.

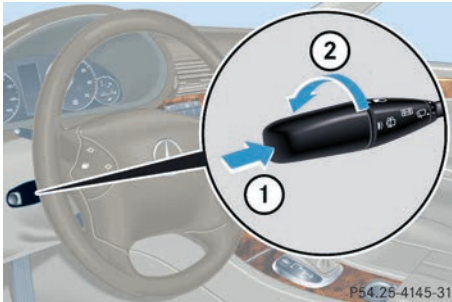

Combination switch

- ① Single wipe
Wiping with windshield washer fluid
 - ② Switching on windshield wipers
- ▶ Switch on the ignition (▷ page 32).

! Do not operate the windshield wipers when the windshield is dry. Dust that accumulates on a windshield might scratch the glass and/or damage the wiper blades when wiping occurs on a dry windshield. If it is necessary to operate the windshield wipers in dry weather conditions, always operate the windshield wipers with windshield washer fluid (▷ page 52).

Switching on windshield wipers

- ▶ Turn the combination switch to the desired position depending on the intensity of the rain.
 - 0 Windshield wipers off
 - I Intermittent wiping
 - II Normal wiper speed
 - III Fast wiper speed

Intermittent wiping

! Vehicles with rain sensor*: Do not leave windshield wipers in intermittent setting when the vehicle is taken to an automatic car wash or during windshield cleaning. Windshield wipers will operate in the presence of water sprayed on the windshield, and windshield wipers may be damaged as a result.

! Vehicles with rain sensor*: If you have set intermittent wiping, dirt on the surface of the rain sensor or optical effects may cause the windshield wipers to wipe in an undesired fashion. This could then damage the windshield wiper blades or scratch the windows. You should therefore switch off the windshield wipers when weather conditions are dry.

Vehicles with rain sensor*: Intermittent wiping interval is dependent on wetness of windshield.

- ▶ Turn the combination switch to position I.

Vehicles with rain sensor*: After the initial wipe, pauses between wipes are automatically controlled by the rain sensor.

Driving

i Intermittent wiping is interrupted when the vehicle is at a standstill and a front door is opened. This protects persons getting into or out of the vehicle from being sprayed.

Intermittent wiping will be continued when

- all doors are closed

and

- the clutch pedal is depressed (vehicles with manual transmission)
or
- the gear selector lever is in position **D** or **R** (vehicles with automatic transmission*)
or
- the wiper setting is changed using the combination switch

Single wipe

- ▶ Press the combination switch briefly in direction of arrow ① to the resistance point.

The windshield wipers wipe one time without washer fluid.

Wiping with windshield washer fluid

- ▶ Press the combination switch in direction of arrow ① past the resistance point.

The windshield wipers operate with washer fluid.

i To prevent smears on the windshield, or noisy/chattering wiper blades, wipe with windshield washer fluid every now and then even when it is raining.

For information on filling up the washer reservoir, see “Windshield washer system and headlamp cleaning system*” (▷ page 280).

! If anything blocks the windshield wipers (leaves, snow, etc.), switch them off immediately.

- For safety reasons, stop the vehicle in a safe location and remove SmartKey from starter switch before attempting to remove any blockage.
- Remove blockage.
- Turn the windshield wipers on again.

If the windshield wipers fail to function at all with combination switch in position **I**,

- set the combination switch to the next higher wiper speed
- have the windshield wipers checked at the nearest authorized Mercedes-Benz Center

Problems while driving

The engine runs erratically and misfires

- An ignition cable may be damaged.
- The engine electronics may not be operating properly.
- Unburned gasoline may have entered the catalytic converter and damaged it.
- ▶ Give very little gas.
- ▶ Have the problem repaired by an authorized Mercedes-Benz Center as soon as possible.

The coolant temperature is above 248°F (120°C)

The coolant is too hot and is no longer cooling the engine.

- ▶ Stop the vehicle in a safe location as soon as possible and turn off the engine. Allow engine and coolant to cool off.
- ▶ Check the coolant level and add coolant if necessary (▷ page 278).

In case of accident

If the vehicle is leaking gasoline:

- ▶ Do not start the engine under any circumstances.
- ▶ Notify local fire and/or police authorities.

If the extent of the damage cannot be determined:

- ▶ Notify an authorized Mercedes-Benz Center.

If no damage can be determined on the

- Major assemblies
- Fuel system
- Engine mount
- ▶ Start the engine in the usual manner.

Parking and locking

You have now completed your first drive. You have properly stopped and parked your vehicle. End your drive as follows.

Warning!



Vehicles with manual transmission: Wait until the vehicle is stationary before removing the SmartKey from the starter switch. The vehicle cannot be steered when the SmartKey is removed.

Warning!



With the engine not running, there is no power assistance for the brake and steering system. In this case, it is important to keep in mind that a considerably higher degree of effort is necessary to brake and steer the vehicle.

Warning!



Do not park this vehicle in areas where combustible materials such as grass, hay or leaves can come into contact with the hot exhaust system, as these materials could be ignited and cause a vehicle fire.

To reduce the risk of personal injury, or damage to the vehicle or the vehicle drivetrain, as a result of vehicle movement, always do the following before turning off the engine and leaving the vehicle:

- Keep right foot on brake pedal.
- Manual transmission: Move the gear-shift lever into neutral position (no gear is selected).
- Firmly depress parking brake pedal.
- Manual transmission: Move the gear-shift lever into first or reverse gear.
- Automatic transmission*: Move the gear selector lever to position **P**.
- Slowly release brake pedal.

- When parked on an incline, always turn the front wheels towards the road curb.
- Turn the SmartKey in the starter switch to position **0** and remove.
- Take the SmartKey with you and lock the vehicle when leaving, which could endanger other road users when you engage the parking brake.

Parking brake

Warning!



Do not engage the parking brake while the vehicle is in motion. Doing so can cause the rear wheels to lock up. You could lose control of the vehicle and cause an accident. In addition, the vehicle's brake lights do not light up when the parking brake is engaged, which could endanger other road users.

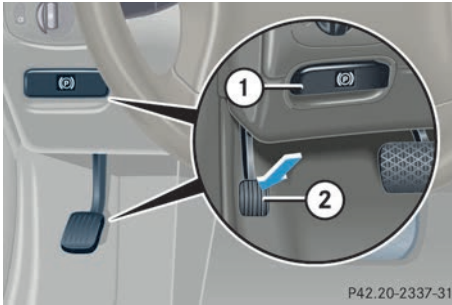

- ① Release handle
- ② Parking brake pedal

- ▶ Step firmly on parking brake pedal ②.

When the engine is running, the brake warning lamp **BRAKE** (USA only) or **(P)** (Canada only) in the instrument cluster comes on.

Warning!



When leaving the vehicle, always remove the SmartKey from the starter switch, take it with you, and lock the vehicle. Do not leave children unattended in the vehicle, or with

access to an unlocked vehicle. Children could release the parking brake and/or move the gear selector lever* from position **P**, either of which could result in an accident and/or serious personal injury.

Position **P** alone may not prevent your vehicle from moving, possibly hitting people or objects. Always set the parking brake in addition to shifting to position **P** (▷ page 153) (manual transmission: first or reverse gear (▷ page 149)).

When parked on an incline, turn front wheel towards the road curb.

Getting out of your vehicle without taking the above measurements to secure it is dangerous.

Switching off headlamps

- ▶ Turn the exterior lamp switch to **0** (▷ page 50).

For more information, see “Lighting” (▷ page 109).

Turning off engine

- ▶ Manual transmission: Move the gear-shift lever into first or reverse gear.
- ▶ Automatic transmission*: Place the gear selector lever in position **P**.
- ▶ Apply the parking brake (▷ page 54).

i Always set the parking brake in addition to shifting to position **P** (manual transmission: first or reverse gear).

On slopes, turn the front wheels towards the road curb.

- ▶ Turn the SmartKey in the starter switch to position **0** (▷ page 32).
- ▶ Remove the SmartKey from the starter switch. The immobilizer is activated.

i Vehicles with automatic transmission: The SmartKey can only be removed from the starter switch with the gear selector lever in position **P**.

Parking and locking

Releasing seat belts

- ▶ Press the seat belt release button (▷ page 44).

Allow the retractor to completely rewind the seat belt by guiding the latch plate.

! *Make sure the seat belt retracts fully so that the seat belt and/or latch plate cannot get caught or pinched in the door or in the seat mechanism. This can damage the seat belt and impair the effectiveness of the seat belt, and/or cause damage to the door and/or door trim panel. Such damage is not covered by the Mercedes-Benz Limited Warranty.*

Damaged seat belts must be replaced. Contact an authorized Mercedes-Benz Center.

Locking

Warning!



To prevent possible personal injury, always keep hands and fingers away from the door openings when closing the doors. Be especially careful when small children are around.

Before closing doors, make sure there is no possibility of someone getting caught in a door during closing.

Warning!



When leaving the vehicle, always remove the SmartKey from the starter switch, take it with you, and lock the vehicle. Do not leave children unattended in the vehicle, or with access to an unlocked vehicle. A child's unsupervised access to a vehicle could result in an accident and/or serious personal injury.

i *If you hear a warning signal you have forgotten to switch off the headlamps before opening the driver's door.*

In addition the message Switch off lights appears in the multifunction display.

Switch off the headlamps.

- ▶ Exit the vehicle and close all doors and the trunk.
- ▶ Press lock button  on the SmartKey (▷ page 32).
 - All turn signal lamps flash three times.
 - An acoustic signal sounds three times. For more information, see “Factory setting” (▷ page 93).
 - The locking knobs in the doors move down.
 - The anti-theft alarm system* is armed.

For more information, see “Locking and unlocking” (▷ page 92).

Occupant safety

Panic alarm*

Driving safety systems

Anti-theft systems



Occupant safety

In this section you will learn the most important facts about the restraint system components of the vehicle.

- Seat belts (▷ page 69)
- Child restraints (▷ page 77)
- Lower Anchors and Tethers for Children (LATCH) (▷ page 79)

Additional protection potential provide

- Supplemental Restraint System (SRS) with
 - Air bags (▷ page 59)
 - Air bag control unit (with crash sensors)
 - Emergency tensioning device (ETD) for seat belts (▷ page 72)
- Active head restraints (▷ page 73)

Air bag system components with

- Front passenger front air bag off indicator lamp (▷ page 68)
- Front passenger seat with Occupant Classification System (OCS) (▷ page 64)

Although independent systems, their protective effects work in conjunction with each other.

i For information on infants and children traveling with you in the vehicle and restraint systems for infants and children, see “Children in the vehicle” (▷ page 74).

The SRS system conducts a self-test when the ignition is switched on and in regular intervals while the engine is running. This facilitates detection of system malfunctions. The **SRS** indicator lamp in the instrument cluster comes on when the ignition is switched on and goes out no later than a few seconds after the engine has been started.

The SRS components are in operational readiness if the **SRS** indicator lamp is not lit when the engine is running.

A malfunction in the system has been detected if the **SRS** indicator lamp:

- fails to go out after approximately 4 seconds after the engine was started
- does not come on at all
- comes on after the engine was started or while driving.

Warning!



Modifications to or work improperly conducted on restraint systems (such as seat belts and anchors, emergency tensioning devices, seat belt force limiters or air bags) or their wiring, as well as tampering with interconnected electronic systems, can lead to the restraint systems no longer functioning as intended.

Air bags or emergency tensioning devices, for example, could deploy inadvertently or fail to deploy in accidents although the deceleration threshold for air bag deployment is exceeded. Therefore, never modify the restraint systems. Do not tamper with electronic components or their software.

Warning!



In the event that the **SRS** indicator lamp comes on during driving or does not come on at all, the SRS self-check has detected a malfunction. For your safety, we strongly recommend that you visit an authorized Mercedes-Benz Center immediately to have the system checked; otherwise the SRS may not deploy when needed in an accident, which could result in serious or fatal injury, or it might deploy unexpectedly and unnecessarily which could also result in injury.

In addition, improper repair work on the SRS creates a risk of rendering the SRS inoperative or causing unintended air bag deployment. Work on the SRS must therefore only be performed by qualified technicians. Contact an authorized Mercedes-Benz Center.

If it is necessary to modify an air bag system to accommodate a person with disabilities, contact your local authorized Mercedes-Benz Center or call our Customer Assistance Center at 1-800-FOR-MERCEdes (1-800-367-6372) for details.

Air bags

Warning!



Air bags are designed to reduce the potential of injury and fatality in certain frontal impacts (front air bags) or side impacts (front side impact air bags, rear side impact air bags* and window curtain air bags). However, no system available today can totally eliminate injuries and fatalities.

The deployment of the air bags temporarily releases a small amount of dust from the air bags. This dust, however, is neither injurious to your health, nor does it indicate a fire in the vehicle. The dust might cause some temporary breathing difficulty for people with asthma or other breathing trouble. To avoid this, you may wish to get out of the vehicle as soon as it is safe to do so. If you have any breathing difficulty but cannot get out of the vehicle after the air bag inflates, then get fresh air by opening a window or door.

Occupant safety

Warning!



To reduce the risk of injury when the front air bags inflate, it is very important for the driver and front passenger to always be in a properly seated position and to wear their respective seat belts.

For maximum protection in the event of a collision always be in normal seated position with your back against the backrest. Fasten your seat belt and make sure that it is properly positioned on your body.

Since the air bag inflates with considerable speed and force, a proper seating and hands on steering wheel position will help to keep you at a safe distance from the air bag. Occupants who are unbelted, out of position or too close to the air bag can be seriously injured or killed by an air bag as it inflates with great force in the blink of an eye:

- Sit properly belted in a nearly upright position with your back against the seat backrest.

- Adjust the driver's seat as far as possible rearward, still permitting proper operation of vehicle controls. The distance from the center of the driver's breastbone to the center of the air bag cover on the steering wheel must be at least 10 in (25 cm) or more. You should be able to accomplish this by a combination of adjustments to the seat and steering wheel. If you have any problems, please see an authorized Mercedes-Benz Center.
- Do not lean your head or chest close to the steering wheel or dashboard.
- Keep hands on the outside of steering wheel rim. Placing hands and arms inside the rim can increase the risk and potential severity of hand/arm injury when driver front air bag inflates.
- Adjust the front passenger seat as far as possible rearward from the dashboard when the seat is occupied.

- Occupants, especially children, should always sit nearly upright, properly use the seat belts and use an appropriately sized infant or toddler restraint or booster seat recommended for the size and weight of the child.

Failure to follow these instructions can result in severe injuries to you or other occupants.

If you sell your vehicle, it is important that you make the buyer aware of this safety information. Be sure to give the buyer this Operator's Manual.

Warning!

Accident research shows that the safest place for children in an automobile is in the rear seat.

There is a possibility for a side impact air bag related injury if occupants, especially children, are not properly seated or restrained when next to a front side impact air bag and/or rear side impact air bag* which needs to deploy rapidly in a side impact in order to do its job.

To help avoid the possibility of injury, please follow these guidelines:

- (1) Occupants, especially children, should never place their bodies or lean their heads in the area of the door where the front side impact air bag and/or the rear side impact air bag* inflates. This could result in serious injuries or death should the front side impact air bag and/or the rear side impact air bag* be deployed.

- (2) Always sit as upright as possible, properly use the seat belts, and for children 12 years old and under, use an appropriately sized infant or toddler restraint or booster seat recommended for the size and weight of the child.

- (3) Always wear seat belts properly.

If you believe that, even with the use of these guidelines, it would be safer for your rear seat occupants to have the rear mounted side impact air bags* deactivated, then deactivation can be accomplished upon your written request to do so at an authorized Mercedes-Benz Center at an additional cost.

Please contact your local authorized Mercedes-Benz Center or call our Customer Assistance Center at 1-800-FOR-MERCEdes (1-800-367-6372) for details.

i *Air bags are designed to deploy only in certain frontal impacts (front air bags) and in side impacts (front side impact air bags, rear side impact air bags* and window curtain air bags) which exceed preset thresholds. Only during these events will they provide their supplemental protection.*

The driver and passengers should always wear their seat belts. Otherwise it is not possible for the air bags to provide their supplemental protection.

In case of other types of impacts and impacts below air bag deployment thresholds, air bags will not deploy. The driver and passenger will then be protected to the extent possible by a properly fastened seat belt. A properly fastened seat belt is also needed to provide the best possible protection in a rollover.

We caution you not to rely on the presence of the air bags in order to avoid wearing your seat belt.

It is important to your safety and that of your passengers that you replace deployed air bags and repair any malfunctioning air bags to make sure that the vehicle will continue to provide supplemental crash protection for occupants.

Occupant safety

Safety guidelines for the seat belt, emergency tensioning device and air bag

Warning!



- Damaged seat belts or belts that were highly stressed in an accident must be replaced and their anchoring points must also be checked. Only use belts installed or supplied by an authorized Mercedes-Benz Center.
- Air bags and emergency tensioning devices (ETDs) are designed to function on a one-time-only basis. An air bag or ETD that is deployed must be replaced.
- Do not pass belts over sharp edges. They could tear.
- Do not make any modification that could change the effectiveness of the belts.
- Do not bleach or dye seat belts as this may severely weaken them. In a crash they may not be able to provide adequate protection.

- No modifications of any kind may be made to any components or wiring of the SRS. This includes changing or removing any component or part of the SRS, the installation of additional trim material, badges, etc. over the steering wheel hub, front passenger front air bag cover, outboard sides of the front seat backrests, door trim panels, or door frame trims, and installation of additional electrical/electronic equipment on or near SRS components and wiring. Keep area between air bags and occupants free from objects (e.g. packages, purses, umbrellas, etc.).
- Do not hang items such as coat hangers from the coat hooks or handles over the door. These items may turn into projectiles and cause head and other injuries when the window curtain air bag is deployed.
- Air bag system components will be hot after an air bag has inflated. Do not touch.

- Never place your feet on the instrument panel, dashboard, or on the seat. Always keep both feet on the floor in front of the seat.
- In addition, improper repair work on the SRS creates a risk of rendering the SRS inoperative or causing unintended air bag deployment. Work on the SRS must therefore only be performed by qualified technicians. Contact an authorized Mercedes-Benz Center.
- For your protection and the protection of others, when scrapping the air bag unit or emergency tensioning device, our safety instructions must be followed. These instructions are available from your authorized Mercedes-Benz Center.
- Given the considerable deployment speed, required inflation volume, and the textile structure of the air bags, there is the possibility of abrasions or other, potentially more serious injuries resulting from air bag deployment.

When you sell your vehicle we strongly urge you to give notice to the subsequent owner that it is equipped with an SRS by alerting them to the applicable section in the Operator's Manual.

Front air bags

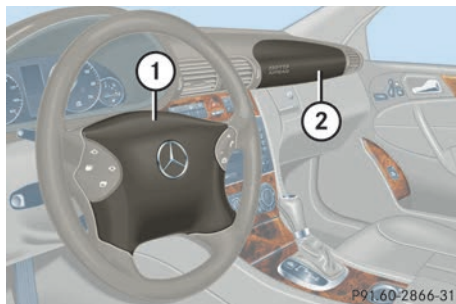

- ① Driver air bag
- ② Passenger air bag

Driver and front passenger front air bags are deployed:

- in the event of certain frontal impacts
- if impact exceeds a preset deployment threshold
- independently of the front side impact air bags and/or the rear side impact air bags*

i *The front air bags in this vehicle have been designed to inflate in two stages. This allows the air bag to have different rates of inflation that are based on the rate of relevant vehicle deceleration as assessed by the air bag control unit.*

On the front passenger side, the front air bag deployment is additionally influenced by the passenger's weight category as identified by the Occupant Classification System (OCS) (▷ page 64).

The lighter the front passenger side occupant, the higher the vehicle deceleration rate required for the second stage inflation of the air bag.

The air bags will not deploy in impacts which do not exceed the system's deployment thresholds. You will then be protected by the fastened seat belts.

The front passenger front air bag will only be deployed if:

- the system, based on OCS weight sensor readings, senses that the front passenger seat is occupied
- the  indicator lamp in the center console is not lit (▷ page 68)
- the impact exceeds a preset deployment threshold

Occupant safety

Front side impact air bags, rear side impact air bags*, window curtain air bags

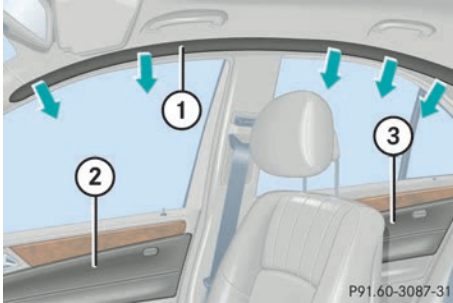

- ① Window curtain air bag
- ② Front side impact air bag
- ③ Rear side impact air bag*

The front side impact air bags, the rear side impact air bags*, and the window curtain air bags are deployed:

- on the impacted side of the vehicle
- in impacts exceeding a preset deployment threshold
- independently of the front air bags

The front side impact air bags, the rear side impact air bags*, and the window curtain air bags are not deployed in impacts which do not exceed the system's deployment threshold.

Occupant Classification System



The Occupant Classification System (OCS) automatically turns the front passenger front air bag on or off based on the classified occupant weight category determined by weight sensor readings from the front passenger seat.

i *The system does not deactivate the front passenger side impact air bag, the window curtain air bag and the emergency tensioning device.*

Occupants must sit properly belted in a position that is as upright as possible with their back against the seat backrest and feet on the floor to be correctly classified. If the occupant's weight is transferred to another object in the vehicle (e.g. by leaning on armrests), the OCS may not be able to properly approximate the occupant's weight category.





i If your seat, including your trim cover and cushion needs to be serviced in any way, take the vehicle to an authorized Mercedes-Benz Center.

Only seat accessories approved by Mercedes-Benz may be used.

Both driver and the front passenger should always use the   indicator lamp as an indication of whether or not the front passenger is properly positioned.



Warning!











If the   indicator lamp illuminates when an adult or someone larger than a small individual is in the front passenger seat, have the front passenger re-position himself or herself in the seat until the   indicator lamp goes out.



More information about air bag display messages (▷ page 332).

In the event of a collision, the air bag control unit will not allow front passenger front air bag deployment when the OCS classified the front passenger seat occupant as being up to or less than the weight of a typical 12-month-old child in a standard child restraint or if the front passenger seat is sensed as being empty.

When the OCS senses that the front passenger seat occupant is classified as being up to or less than the weight of a typical 12-month-old child in a standard child restraint, the   indicator lamp will illuminate when the engine is started and remain illuminated, indicating that the front passenger front air bag is deactivated.

When the OCS senses that the front passenger seat is classified as being empty, the   indicator lamp will illuminate when the engine is started and remain illuminated, indicating that the front passenger front air bag is deactivated.

When the OCS senses that the front passenger seat occupant is classified as being heavier than the weight of a typical 12-month-old child seated in a standard child restraint or as being a small individual (such as a young teenager or a small adult), the   indicator lamp will illuminate for approximately 6 seconds when the engine is started and then, depending on occupant weight sensor readings from the seat, remain illuminated or go out. With the   indicator lamp illuminated, the front passenger front air bag is deactivated. With the   indicator lamp out, the front passenger front air bag is activated.

When the OCS senses that the front passenger seat occupant is classified as an adult or someone larger than a small individual, the   indicator lamp will illuminate for approximately 6 seconds when the engine is started and then go out, indicating that the front passenger front air bag is activated.



Occupant safety



If the  indicator lamp is illuminated, the front passenger front air bag is deactivated and will not be deployed.

If the  indicator lamp is not illuminated, the front passenger front air bag is activated and will be deployed:

- in the event of certain frontal impacts
- if impact exceeds a preset deployment threshold
- independently of the front side impact air bags and/or rear side impact air bags*.

If the front passenger front air bag is deployed, the rate of inflation will be influenced by:

- the rate of vehicle deceleration as assessed by the air bag control unit
- front passenger's weight category as identified by the Occupant Classification System (OCS).

Warning!







According to accident statistics, children are safer when properly restrained in the rear seating positions than in the front seating position. Thus, we strongly recommend that children be placed in the rear seats whenever possible. Regardless of seating position, children 12 years old and under must be seated and properly secured in an appropriate infant or child restraint recommended for the size and weight of the child.

The infant or child restraint must be properly secured with the vehicle's seat belt, the seat belt and top tether strap, or lower anchors and top tether strap, fully in accordance with the child seat manufacturer's instructions.

Children can be killed or seriously injured by an inflating air bag. Note the following important information when circumstances require you to place a child in the front passenger seat:

- Your vehicle is equipped with air bag technology designed to turn off the front passenger front air bag in your vehicle when the system senses the weight of a typical 12-month-old child or less along with the weight of a standard appropriate child restraint on the front passenger seat.
- A child in a rear-facing child restraint on the front passenger seat will be seriously injured or even killed if the front passenger front air bag inflates in a collision which could occur under some circumstances, even with the air bag technology installed in your vehicle. The only means to completely eliminate this risk is to never place a child in a rear-facing child restraint in the front seat. We therefore strongly recommend that you always place a child in a rear-facing child restraint in the back seat.

- If you must install a rear-facing child restraint on the front passenger seat because circumstances require you to do so, make sure that the  indicator lamp is illuminated, indicating that the front passenger front air bag is deactivated. Should the  indicator lamp not illuminate or go out while the restraint is installed, please check installation. Periodically check the  indicator lamp while driving to make sure the  indicator lamp is illuminated. If the  indicator lamp goes out or remains out, do not transport a child on the front passenger seat until the system has been repaired. A child in a rear-facing child restraint on the front passenger seat will be seriously injured or even killed if the front passenger front air bag inflates.



- If you have to place a child in a forward-facing child restraint on the front passenger seat, move the seat as far back as possible, use the proper child restraint recommended for the age, size and weight of the child, and secure child restraint with the vehicle's seat belt according to the child seat manufacturer's instructions. For children larger than the typical 12-month-old child, the front passenger front air bag may or may not be activated (▷ page 65).

 *Deployment of the driver front air bag does not mean that the front passenger front air bag also should have deployed.*

The Occupant Classification System (▷ page 64) may have determined:



- *that the seat was empty or occupied by the weight up to or less than that of a typical 12-month-old child seated in a standard child restraint - both instances where the system suppresses deployment of the front passenger front air bag even though the impact met the criteria and was of sufficient severity to deploy the driver front air bag.*
- *that the seat was occupied by a small individual (such as a young teenager or a small adult) or a child weighing more than the weight of a typical 12-month-old child in a standard child restraint - instances where the system may suppress deployment of the front passenger front air bag even though the impact met the criteria and was of sufficient severity to deploy the driver front air bag.*

Occupant safety

The   indicator lamp is located in the center console.







① Front passenger front air bag off indicator lamp

The   indicator lamp ① will be illuminated, except with the SmartKey removed from the starter switch or with the starter switch in position 0.

Warning!







If the   indicator lamp and the   indicator lamp are lit at the same time, there is a malfunction in the Occupant Classification System. The front passenger front air bag will be deactivated in this case.



In order to ensure proper operation of the air bag system and OCS:

- Have the system checked as soon as possible by qualified technicians. Contact an authorized Mercedes-Benz Center.
- Sit properly belted in a nearly upright position with your back against the seat backrest.
- Do not lean on the armrests or lift yourself from the seat by using the handle over the door as this may cause the OCS to be unable to correctly approximate the occupant weight category.

- Only have the seat repaired or replaced by an authorized Mercedes-Benz Center.
- Read and observe all warnings in this chapter.

Self-test Occupant Classification System

After turning the SmartKey in the starter switch to position 1 or 2, the   indicator lamp located in the center console illuminates. If an adult occupant is properly sitting on the front passenger seat and the system senses the occupant as being an adult, the   indicator lamp will illuminate and go out after approximately 6 seconds.

If the seat is not occupied and the system senses the front passenger seat as being empty, the   indicator lamp will illuminate and not go out.

Warning!

If the  indicator lamp should not illuminate, the system is not functioning. You must see an authorized Mercedes-Benz Center before seating any child on the front passenger seat.

More information can be found in the “Practical hints” section (▷ page 332).

Warning!

Never place anything between seat cushion and child seat (e.g. pillow), since it reduces the effectiveness of the Occupant Classification System. The bottom of the child seat must make full contact with the passenger seat cushion. An incorrectly mounted child seat could cause injuries to the child in case of an accident, instead of increasing protection for the child.

Follow the manufacturer’s instructions for installation of child seats.

Seat belts

The use of seat belts and infant and child restraint systems is required by law in all 50 states, the District of Columbia, the U.S. territories and all Canadian provinces.

Even where this is not the case, all vehicle occupants should have their seat belts fastened whenever the vehicle is in motion.

For more information, see “Fastening the seat belt” (▷ page 43).

 *For information on infants and children traveling with you in the vehicle and restraint systems for infants and children, see “Children in the vehicle” (▷ page 74).*

Warning!

Always fasten your seat belt before driving off. Always make sure all of your passengers are properly restrained, including those sitting in the rear.

Failure to wear and properly fasten and position your seat belt greatly increases your risk of injuries and their likely severity in an accident. You and your passengers should always wear seat belts.

If you are ever in an accident, your injuries can be considerably more severe without your seat belt properly buckled. Without your seat belt buckled, you are much more likely to hit the interior of the vehicle or be ejected from it. You can be seriously injured or killed.

In the same crash, the possibility of injury or death is lessened if you are properly wearing your seat belt. Air bags can only protect as they are designed if the occupants are properly wearing their seat belts.

Occupant safety

Warning!



Never ride in a moving vehicle with the seat backrest in an excessively reclined position as this can be dangerous. You could slide under the seat belt in a collision. If you slide under it, the belt would apply force at the abdomen or neck. That could cause serious or even fatal injuries. The seat backrest and seat belt provide the best restraint when the wearer is in a nearly upright position and the belt is properly positioned on the body.

Warning!



Never let more people ride in the vehicle than there are seat belts available. Make sure everyone riding in the vehicle is correctly restrained with a separate seat belt. Never use a seat belt for more than one person at a time.

Warning!



Damaged seat belts or belts that were highly stressed in an accident must be replaced and their anchoring points must also be checked.

Only use seat belts which have been approved by Mercedes-Benz.

Do not make any modifications to the seat belts. This can lead to unintended activation of the ETDs or to their failure to activate when necessary.

Do not bleach or dye seat belts as this may severely weaken them. In a crash they may not be able to provide adequate protection.

Have all work carried out only by qualified technicians. Contact an authorized Mercedes-Benz Center.

Warning!



USE SEAT BELTS PROPERLY

- Seat belts can only work when used properly. Never wear seat belts in any other way than as described in this section, as that could result in serious injuries in case of an accident.
- Each occupant should wear their seat belt at all times, because seat belts help reduce the likelihood of and potential severity of injuries in accidents, including rollovers. The integrated restraint system includes SRS (driver air bag, passenger front air bag, front side impact air bags, rear side impact air bags*, window curtain air bags for side windows), ETD (seat belt emergency tensioning device), and front seat knee bolsters. The system is designed to enhance the protection offered to properly belted occupants in certain frontal (front air bags and ETD)

and side (front side impact air bags, rear side impact air bags*, window curtain air bags and ETD) impacts which exceed preset deployment thresholds.

- Never wear the shoulder belt under your arm, against your neck or off your shoulder. In a frontal crash, your body would move too far forward. That would increase the chance of head and neck injuries. The belt would also apply too much force to the ribs or abdomen, which could severely injure internal organs such as your liver or spleen.
- Never wear belts over rigid or breakable objects in or on your clothing, such as eyeglasses, pens, keys, etc., as these might cause injuries.
- Position the lap belt as low as possible on your hips and not across the abdomen. If the belt is positioned across your abdomen, it could cause serious injuries in a crash.
- Never use a seat belt for more than one person at a time. Do not fasten a seat belt around a person and another person or other objects.



- Belts should not be worn twisted. In a crash, you wouldn't have the full width of the belt to distribute impact forces. The twisted belt against your body could cause injuries.
- Pregnant women should also always use a lap-shoulder belt. The lap belt portion should be positioned as low as possible on the hips to avoid any possible pressure on the abdomen.
- Never place your feet on the instrument panel, dashboard, or on the seat. Always keep both feet on the floor in front of the seat.
- When using a seat belt to secure infant or toddler restraints or children in booster seats, always follow the child seat manufacturer's instructions.

Enhanced seat belt reminder system

When the engine is started, the seat belt telltale  will always illuminate for 6 seconds to remind you and your passengers to fasten your seat belts.

If the driver's seat belt is not fastened when the engine is started, an additional warning chime will also sound for a maximum of 6 seconds or until the driver's seat belt is fastened.

If after these 6 seconds the driver's or the front passenger's seat belt (with the front passenger seat occupied) is not fastened with front doors closed,

- the seat belt telltale  remains illuminated for as long as either the driver's or front passenger's seat belt is not fastened.
- and if the vehicle speed once exceeds 15 mph (25 km/h), the seat belt telltale  starts flashing and a warning chime sounds with increasing

Occupant safety

intensity for a maximum of 60 seconds or until the driver's and the front passenger's seat belt are fastened.

If you and/or your passenger release the seat belt during driving, the seat belt telltale  starts flashing and a warning chime sounds as described before.

If the driver's or the front passenger's seat belt remains unfastened after 60 seconds, the warning chime stops sounding, the seat belt telltale  stops flashing but continues to be illuminated.

After a vehicle standstill the warning chime is reactivated and the seat belt telltale  is flashing again if the vehicle speed once exceeds 15 mph (25 km/h).

The seat belt telltale  will only go out if both the driver's and the front passenger's seat belt (with the front passenger seat occupied) are fastened, or the vehicle is standing still and a front door is opened.

For more information, see "Practical hints" (▷ page 328).

Emergency tensioning device (ETD), seat belt force limiter

The seat belts for the front and rear outer seats are equipped with emergency tensioning devices and belt force limiters.

The ETD is designed to activate in the following cases:

- in frontal or rear-end impacts exceeding the system deployment threshold.
- if the restraint systems are operational and functioning correctly, see  indicator lamp (▷ page 58).

 *The ETDs for the front seats will only activate if the respective front seat belt is fastened (latch plate properly inserted into buckle).*

The ETDs for the rear outer seats will activate with or without the respective seat belt fastened.

When activated, emergency tensioning devices remove slack from the belts. Belt force limiters reduce the force exerted by the seat belts on occupants during a crash.

Warning!



An emergency tensioning device (ETD) that was activated must be replaced.

When disposing the emergency tensioning device, our safety instructions must be followed. These are available at your authorized Mercedes-Benz Center.

Active head restraint

The active front seat head restraints are intended to offer the driver and front passenger increased protection from whiplash type injuries in rear-end collisions. In the event of a rear-end collision exceeding the systems' deployment threshold, the active head restraints on the driver's and front passenger's seats are designed to move forward in the direction of travel, providing the head with increased support earlier on in the collision sequence. The active head restraints activate whether the seat is occupied or not.

Warning!



For your protection, drive only with properly positioned head restraints.

Adjust the head restraint so that it is as close to the head as possible and the center of the head restraint supports the back of the head at eye level. This will reduce the

potential for injury to the head and neck in the event of an accident or similar situation.

Do not drive the vehicle without the seat head restraints. Head restraints are intended to help reduce injuries during an accident.

Warning!



Only use seat or head restraint covers which have been tested and approved by Mercedes-Benz for your vehicle model. Using other seat or head restraint covers may interfere with or prevent the activation of the active head restraints. Contact an authorized Mercedes-Benz Center for availability.

Do not attach any objects (e.g. hangers) to the head restraint posts. Otherwise, the active head restraints may not be able to function properly or offer the intended degree of protection in the event of an accident.

You cannot remove the active head restraints on the driver's and front passenger's seat.

For removal of the active head restraints we recommend that you contact an authorized Mercedes-Benz Center.

For information on head restraint adjustment, see "Seats" (▷ page 34).

For information on resetting the activated active head restraints, see "Resetting activated head restraints" (▷ page 365).

Occupant safety

Children in the vehicle

If an infant or child is traveling with you in the vehicle:

- ▶ Secure the child using an infant or child restraint appropriate to the age and size of the child.
- ▶ Make sure that the infant or child is properly secured at all times while the vehicle is in motion.

Warning!



Do not leave children unattended in the vehicle, even if they are secured in a child restraint system. The children could

- injure themselves on parts of the vehicle
- be seriously or fatally injured through excessive exposure to extreme heat or cold

If children open a door, they could

- injure other persons
- get out of the car and injure themselves or be injured by oncoming traffic

Do not expose the child restraint system to direct sunlight. The child restraint system's metal parts, for example, could become very hot, and the child could be burned on these parts.

Do not carry heavy or hard objects in the passenger compartment or trunk unless they are firmly secured in place. For more information, see “Loading” (▷ page 230), and see “Useful features” (▷ page 237) in the “Controls in detail” chapter.

Unsecured or improperly positioned cargo increases a child's risk of injury in the event of

- strong braking maneuvers
- sudden changes of direction
- an accident

Infant and child restraint systems

We recommend all infants and children be properly restrained at all times while the vehicle is in motion.

All lap-shoulder belts except the driver's seat belt have special seat belt retractors for secure fastening of child restraints.

To fasten a child restraint, follow child restraint instructions for mounting. Then pull the shoulder belt out completely and let it retract. During seat belt retraction, a ratcheting sound can be heard to indicate that the special seat belt retractor is activated. The belt is now locked. Push down on child restraint to take up any slack.

To deactivate, release seat belt buckle and let seat belt retract completely. The seat belt can again be used in the usual manner.

Warning!

Never release the seat belt buckle while the vehicle is in motion, since the special seat belt retractor will be deactivated.

i Information on child seats with anchor fittings for tether anchorages (▷ page 77).

For information on LATCH-type child seat anchors (▷ page 79).

! The use of infant or child restraints is required by law in all 50 states, the District of Columbia, the U.S. territories, and all Canadian provinces.

Infants and small children should be seated in an appropriate infant or child restraint system properly secured in accordance with the manufacturer's instructions for the child restraint, that complies with U.S. Federal Motor Vehicle Safety Standards 213 and 225 and Canadian Motor Vehicle Safety Standards 213 and 210.2.

! A statement by the child restraint manufacturer of compliance with these standards can be found on the instruction label on the restraint and in the instruction manual provided with the restraint.

When using any infant, or toddler restraint, or booster seat, be sure to carefully read and follow all manufacturer's instructions for installation and use.

Please read and observe warning labels affixed to the inside of the vehicle and to infant or child restraints.

Warning!

According to accident statistics, children are safer when properly restrained in the rear seating positions than in the front seating position. Thus, we strongly recommend that children be placed in the rear seats whenever possible. Regardless of seating position, children 12 years old and under must be seated and properly secured in an appropriate infant or child restraint recommended for the size and weight of the child.

The infant or child restraint must be properly secured with the vehicle's seat belt, the seat belt and top tether strap, or lower anchors and top tether strap, fully in accordance with the child seat manufacturer's instructions.

Occupants, especially children, should never place their bodies or lean their heads in the area of the door where the front side impact air bag and/or the rear side impact air bag* inflates. This could result in serious injuries or



Occupant safety







death should the air bag be triggered. Always sit nearly upright, properly use the seat belts and use an appropriately sized infant or toddler restraint or booster seat recommended for the size and weight of the child.

Children can be killed or seriously injured by an inflating air bag. Note the following important information when circumstances require you to place a child in the front passenger seat:

- Your vehicle is equipped with air bag technology designed to turn off the front passenger front air bag in your vehicle when the OCS senses the weight of a typical 12-month-old child or less along with the weight of a standard appropriate child restraint on the front passenger seat.
- A child in a rear-facing child restraint on the front passenger seat will be seriously injured or even killed if the front passenger front air bag inflates in a collision which could occur under some circumstances, even with the

air bag technology installed in your vehicle. The only means to completely eliminate this risk is to never place a child in a rear-facing child restraint in the front seat. We therefore strongly recommend that you always place a child in a rear-facing child restraint in the back seat.

- If you must install a rear-facing child restraint on the front passenger seat because circumstances require you to do so, make sure that the  indicator lamp is illuminated, indicating that the front passenger front air bag is deactivated. Should the  indicator lamp not illuminate or go out while the restraint is installed, please check installation. Periodically check the  indicator lamp while driving to make sure the  indicator lamp is illuminated. If the  indicator lamp goes out or remains out,

do not transport a child on the front passenger seat until the system has been repaired. A child in a rear-facing child restraint on the front passenger seat will be seriously injured or even killed if the front passenger front air bag inflates.

- If you have to place a child in a forward-facing child restraint on the front passenger seat, move the seat as far back as possible, use the proper child restraint recommended for the age, size and weight of the child, and secure child restraint with the vehicle's seat belt according to the child seat manufacturer's instructions. For children larger than the typical 12-month-old child, the front passenger front air bag may or may not be activated (> page 65).

Warning!

Infants and small children should never share a seat belt with another occupant. During an accident, they could be crushed between the occupant and seat belt.

A child's risk of serious or fatal injuries is significantly increased if the child restraints are not properly secured in the vehicle and/or the child is not properly secured in the child restraint.

Children too big for a toddler restraint must ride in seats using regular seat belts. Position shoulder belt across chest and shoulder, not face or neck. A booster seat may be necessary to achieve proper belt positioning for children from 41 lbs until they reach a height where a lap/shoulder belt fits properly without a booster.

When the child restraint is not in use, remove it from the vehicle or secure it with the seat belt to prevent the child restraint from becoming a projectile in the event of an accident.

Do not leave children unattended in the vehicle, even if the children are secured in a child restraint system. Unsupervised children in a child restraint system may use vehicle equipment and may cause an accident and/or serious personal injury.

Installation of infant and child restraint systems

This vehicle is equipped with tether anchorages for a top tether strap at each of the rear seating positions.

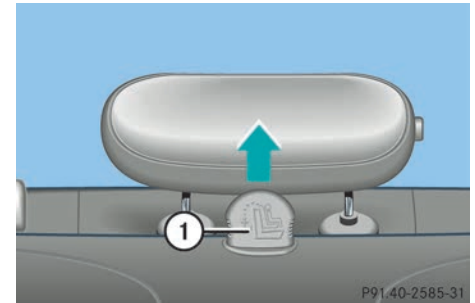

- ① Cover of top anchorage ring
- ▶ Make sure the rear backrest is locked in its upright position (▷ page 235). ▷▷

Occupant safety



Warning!



Always lock backrest in its upright position when rear seat bench is occupied by passengers, or the extended cargo area is not in use. Check for secure locking by pushing and pulling on the backrest.

- ▶ Remove cover ① from anchorage ring ③.

- ▶ Guide tether strap between head restraint and top of seat back.

Head restraint must be installed and positioned such that the top tether strap can pass freely between the head restraint and top of seat back.

Make sure the tether strap is not twisted.

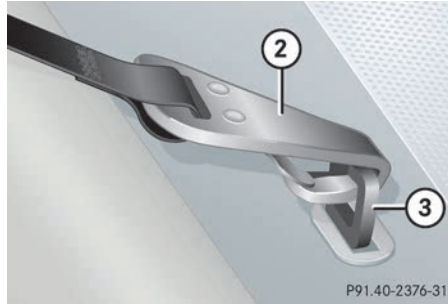

② Hook

③ Anchorage ring

- ▶ Securely fasten hook ②, which is part of the tether strap, to anchorage ring ③.

i For safety, make sure the hook ② has attached to the anchorage ring ③ beyond the safety catch, as illustrated.

Once the top tether anchorage hook is attached, the child restraint itself can be secured. Secure the child restraint and tighten the top tether strap according to the child restraint manufacturer's instructions.

- ▶ Reinstall cover ① after removing the tether strap.

Child seat anchors – LATCH-type

This vehicle is equipped with two LATCH- (Lower Anchors and Tethers for Children) type anchors (at each of the outer rear seats) for the installation of a LATCH-type child seat with the matching mounting fittings.

Warning!



Children too big for a toddler restraint must ride in seats using regular seat belts. Position shoulder belt across chest and shoulder, not face or neck.

A booster seat may be necessary to achieve proper belt positioning for children over 41 lbs until they reach a height where a lap/shoulder belt fits properly without a booster.

Install child seat according to manufacturer's instructions.

The child seat must be firmly attached to the right and left side anchors ①.

An incorrectly mounted child seat may come loose during an accident which could result in serious injury or death to the child.

Damaged or impact damaged child seats or child seat anchor fittings must be replaced.

Do not leave children unattended in the vehicle, even if the children are secured in a child restraint system.

i With a child seat installed in the left rear seat, the seat belt for the center seat occupied by a passenger must operate freely. Guide seat belt between its seat cushion mount and backrest mount along outside of right side child seat anchor.

i Non-LATCH-type child seats may also be used and can be installed using the vehicle's seat belt system. Install child seat according to the manufacturer's instructions.

LATCH-type anchors

The LATCH-type anchors are located between the seat cushion and the backrest.

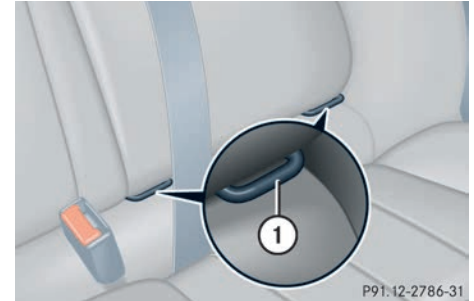

① Anchors

► Install child seat according to the manufacturer's instructions.

Occupant safety

Blocking of rear door window operation

You can block the rear door window operation (for instance when you have children riding in the rear passenger compartment).

The override switch is located on the door control panel of the driver's door.

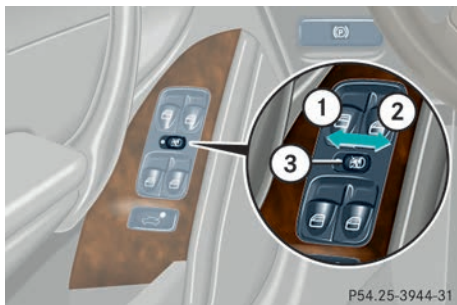

- ① Deactivating override switch
- ② Activating override switch
- ③ Override switch

Warning!



Activate the override switch when children are riding in the back seats of the vehicle. The children may otherwise injure themselves, e.g. by becoming trapped in the window opening.

When leaving the vehicle, always remove the SmartKey from the starter switch, take it with you, and lock the vehicle. Do not leave children unattended in the vehicle, or with access to an unlocked vehicle. A child's unsupervised access to a vehicle could result in an accident and/or serious personal injury.

Activating override switch

- ▶ Slide override switch ③ to the right in direction ②.

The rear door windows can no longer be operated using the respective switch located in the rear doors.

i Operation of the rear door windows with the switches located on the door control panel of the driver's door is still possible.

Deactivating override switch

- ▶ Slide override switch ③ to the left in direction ①.

The rear door windows can be operated again using the respective switch located in the rear doors.

For more information, see "Power windows" (▷ page 221).

▼ Panic alarm*



① **PANIC** button

i *Canada only:*

Only vehicles equipped with an anti-theft alarm system have SmartKeys with integrated panic button ①.*

i *USA only:*

This device complies with Part 15 of the FCC Rules. Operation is subject to the following two conditions:

- (1) This device may not cause harmful interference, and*
- (2) this device must accept any interference received, including interference that may cause undesired operation.*

Any unauthorized modification to this device could void the user's authority to operate the equipment.

i *Canada only:*

This device complies with RSS-210 of Industry Canada. Operation is subject to the following two conditions:

- (1) This device may not cause interference, and*
- (2) this device must accept any interference received, including interference that may cause undesired operation of the device.*

Any unauthorized modification to this device could void the user's authority to operate the equipment.

Activating

- ▶ Press and hold button **PANIC** for at least 1 second.

An audible alarm and flashing exterior lamps will operate briefly.

Deactivating

- ▶ Press button **PANIC** again.

or

- ▶ Insert SmartKey in starter switch.

Driving safety systems

In this section you will find information on the following driving safety systems:

- ABS (Antilock Brake System)
- BAS (Brake Assist System)
- ESP® (Electronic Stability Program)
- 4MATIC (Four Wheel Electronic Traction System)

Warning!



The following factors increase the risk of accidents:

- Excessive speed, especially in turns
- Wet and slippery road surfaces
- Following another vehicle too closely

The ABS, BAS, ESP®, and 4MATIC (if so equipped) cannot reduce this risk.

Always adjust your driving style to the prevailing road and weather conditions.

i *In winter operation, the maximum effectiveness of the ABS, ESP®, and 4MATIC (if so equipped) is only achieved with winter tires (▷ page 308), or snow chains as required.*

ABS

Warning!



Do not pump the brake pedal. Use firm, steady brake pedal pressure instead. Pumping the brake pedal defeats the purpose of the ABS and significantly reduces braking effectiveness.

The Antilock Brake System (ABS) regulates the brake pressure so that the wheels do not lock during braking. This allows you to maintain the ability to steer your vehicle.

The ABS is functional above a speed of approximately 5 mph (8 km/h) independent of road surface conditions.

On slippery road surfaces, the ABS will respond even to light brake pressure.

The  indicator lamp in the instrument cluster (▷ page 24) comes on when you switch on the ignition. It goes out when the engine is running.

Braking

At the instant one of the wheels is about to lock up, a slight pulsation can be felt in the brake pedal, indicating that the ABS is in the regulating mode.

- ▶ Keep firm and steady pressure on the brake pedal while experiencing the pulsation.

Continuous steady brake pedal pressure yields the advantages provided by the ABS, namely braking power and ability to steer the vehicle.

The pulsating brake pedal can be an indication of hazardous road conditions and functions as a reminder to take extra care while driving.

Emergency brake maneuver

- ▶ Keep continuous full pressure on the brake pedal.

Warning!



When the ABS is malfunctioning, the BAS and the ESP[®] are also switched off. The basic driving and braking functions are still available

When the ABS is malfunctioning, the wheels may lock during hard braking, reducing steering capability and extending the braking distance.

Warning!



The ABS cannot prevent the natural laws of physics from acting on the vehicle, nor can it increase braking or steering efficiency beyond that afforded by the condition of the vehicle brakes and tires or the traction available on the road surface. The ABS cannot prevent accidents, including those resulting from excessive speed in turns, following another vehicle too closely, or hydroplaning. Only a safe, attentive, and skillful driver can prevent accidents. The capabilities of an ABS equipped vehicle must never be exploited in a reckless or dangerous manner which could jeopardize the user's safety or the safety of others.

For more information, see the “Practical hints” section (▷ page 322).

Driving safety systems

BAS

The Brake Assist System (BAS) operates in emergency situations. If you apply the brakes very quickly, the BAS automatically provides full brake boost, thereby potentially reducing the braking distance.

- ▶ Apply continuous full braking pressure until the emergency braking situation is over.

The ABS will prevent the wheels from locking.

When you release the brake pedal, the brakes function again as normal. The BAS is then deactivated.

Warning!



If the BAS is malfunctioning, the brake system is still functioning normally, but without the additional brake boost available that BAS would normally provide in an emergency braking maneuver. Therefore, the braking distance may increase.

Warning!





The BAS cannot prevent the natural laws of physics from acting on the vehicle, nor can it increase braking efficiency beyond that afforded by the condition of the vehicle brakes and tires or the traction. The BAS cannot prevent accidents, including those resulting from excessive speed in turns, following another vehicle too closely, or hydroplaning. Only a safe, attentive, and skillful driver can prevent accidents. The capabilities of a BAS equipped vehicle must never be exploited in a reckless or dangerous manner which could jeopardize the user's safety or the safety of others.

ESP®

The Electronic Stability Program (ESP®) is operational as soon as the engine is running and monitors the vehicle's traction (force of adhesive friction between the tires and the road surface) and handling.

The ESP® recognizes when a wheel is spinning or if the vehicle starts to skid. By applying the brakes to the appropriate wheel and by limiting the engine output, the ESP® works to stabilize the vehicle. The ESP® is especially useful while driving off and on wet or slippery road surfaces. The ESP® also stabilizes the vehicle during braking and steering maneuvers.

The ESP® warning lamp  in the instrument cluster flashes when the ESP® is engaged.

The ESP® warning lamp  in the instrument cluster comes on when you switch on the ignition. It goes out when the engine is running.

Warning!



Never switch off the ESP® when you see the ESP® warning lamp  flashing in the instrument cluster. In this case, proceed as follows:

- While driving off, apply as little throttle as possible.
- While driving, ease up on the accelerator.
- Adapt your speed and driving style to the prevailing road conditions.

Failure to observe these guidelines could cause the vehicle to skid.

The ESP® cannot prevent accidents resulting from excessive speed.

Warning!



The ESP® cannot prevent the natural laws of physics from acting on the vehicle, nor can it increase the traction afforded by the existing road and tire conditions. The ESP® cannot prevent accidents, including those resulting from excessive speed in turns or hydroplaning. Only a safe, attentive, and skillful driver can prevent accidents. The capabilities of an ESP® equipped vehicle must never be exploited in a reckless or dangerous manner which could jeopardize the user's safety or the safety of others.

Driving safety systems

! *Vehicles without 4MATIC:*
Because the ESP® operates automatically, the engine must be turned off (SmartKey in starter switch position **0** or **1**) when

- the parking brake is being tested on a brake test dynamometer
- the vehicle is being towed with the front axle raised

Active braking action through the ESP® may otherwise seriously damage the brake system.

For information on vehicles with 4MATIC, see “Four wheel electronic traction system (4MATIC) with the ESP® ” (▷ page 88).

i The ESP® will only function properly if you use wheels of the recommended tire size (▷ page 403).

For more information, see the “Practical hints” section (▷ page 327) and (▷ page 335).

Electronic traction system

The electronic traction system is a component of ESP®.

The electronic traction system improves the vehicle’s ability to utilize available traction, especially under slippery road conditions by applying the brakes to a spinning wheel.

When you switch off the ESP®, the electronic traction system is still enabled.

Warning!



If you are driving too fast, the electronic traction system cannot reduce the risk of an accident.

The electronic traction system cannot prevent the natural laws of physics from acting on the vehicle.

Switching off the ESP®

Warning!



The ESP® should not be switched off during normal driving other than in the circumstances described below. Disabling of the system will reduce vehicle stability in standard driving maneuvers.

Do not switch off the ESP® when a Minispare wheel is mounted.

To improve the vehicle’s traction, turn off the ESP® in driving situations where it would be advantageous to have the drive wheels spin and thus cut into surfaces for better grip such as:

- when driving with snow chains
- in deep snow
- in sand or gravel

! *Switch on the ESP® immediately if the aforementioned circumstances do not apply anymore.*

When you switch off the ESP®

- the ESP® does not stabilize the vehicle
- the engine output is not limited, which allows the drive wheels to spin and thus cut into surfaces for better grip
- the traction control will still apply the brakes to a spinning wheel
- the ESP® continues to operate when you are braking
- you cannot activate the cruise control
- the cruise control switches off if currently activated

i When the ESP® is switched off and one or more drive wheels are spinning, the ESP® warning lamp  in the instrument cluster flashes. However, the ESP® will then not stabilize the vehicle.

The ESP® switch is located on the center console.



① ESP® switch

- ▶ With the engine running, press ESP® switch ① until the ESP® warning lamp  in the instrument cluster comes on.

The ESP® is switched off.

Warning!



When the ESP® warning lamp  is illuminated continuously, the ESP® is switched off or is not operational due to a malfunction. Vehicle stability in standard driving maneuvers reduces.

Adapt your speed and driving to the prevailing road conditions and to the non-operating status of the ESP®.

! Avoid spinning of a drive wheel for an extended period with the ESP® switched off. This may cause serious damage to the drivetrain which is not covered by the Mercedes-Benz Limited Warranty.

Switching on the ESP®

- ▶ Press ESP® switch ① until the ESP® warning lamp  in the instrument cluster goes out.

You are now again in normal driving mode with ESP® switched on.

Driving safety systems

Four wheel electronic traction system (4MATIC) with the ESP®

Models with all-wheel-drive only.

The 4MATIC improves vehicle's ability to use available traction, e.g. during winter operation in mountains under snowy conditions, by applying power to all four wheels.

Warning!



If you see the ESP® warning lamp  flashing in the instrument cluster, proceed as follows:

- While driving off, apply as little throttle as possible
- While driving, ease up on the accelerator
- Adapt your speed and driving style to the prevailing road conditions

Failure to observe these guidelines could cause the vehicle to skid.

The ESP® cannot prevent accidents resulting from excessive speed.

 Do not tow with one axle raised.

Otherwise the transfer case can be damaged, which is not covered by the Mercedes-Benz Limited Warranty.



 Performance testing must only be conducted on a two-axle dynamometer.

Otherwise the transfer case can be damaged, which is not covered by the Mercedes-Benz Limited Warranty.

 Because the ESP® operates automatically, the engine must be shut off (SmartKey in starter switch position **0** or **1**) when the parking brake is being tested on a brake test dynamometer.

Active braking action through the ESP® may otherwise seriously damage the front or rear axle brake system.

Operational tests with the engine running can only be conducted on a two-axle dynamometer.

 At highly demanding operating conditions, the electronic traction system may temporarily switch off to prevent overheating of the drive wheel brakes. The message unavailable See Operator's Manual will then appear in the multifunction display while the ESP® warning lamp  is flashing. The ESP® is still functioning normally.

▼ Anti-theft systems

Immobilizer

The immobilizer prevents unauthorized persons from starting your vehicle.

Activating

- ▶ Remove the SmartKey from the starter switch.

Deactivating

- ▶ Switch on the ignition (▷ page 32).

i Starting the engine will also deactivate the immobilizer.

In case the engine cannot be started (yet the vehicle's battery is charged), the system is not operational. Contact an authorized Mercedes-Benz Center or call 1-800-FOR-MERCEdes (in the USA), or 1-800-387-0100 (in Canada).

Anti-theft alarm system*

Once the alarm system has been armed, a visual and audible alarm is triggered when someone opens

- a door
- the trunk
- the hood

The alarm will stay on even if the activating element (e. g. a door) is immediately closed.

The alarm system will also be triggered when

- opening the vehicle with the mechanical key
- someone opens a door from the inside
- someone opens the trunk with the emergency release button

i *If the alarm stays on for more than 30 seconds, a call to the Response Center is initiated automatically by the Tele Aid system* (▷ page 247) provided Tele Aid service was subscribed to and properly activated, and that necessary cellular service and GPS coverage are available.*

Anti-theft systems

Arming the alarm system

The indicator lamp is in the center console.

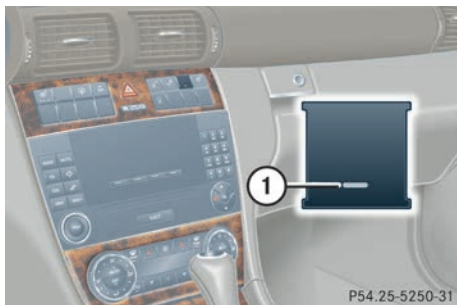

① Indicator lamp

- ▶ Lock the vehicle with the SmartKey.

The turn signal lamps flash three times and an acoustic signal sounds three times, to indicate that the alarm system is armed.

Indicator lamp ① begins to flash after approximately 30 seconds after arming the alarm system.

i If the turn signal lamps do not flash three times, one of the following elements may not be properly closed:

- a door
- the trunk

Close the respective element and lock the vehicle again.

Disarming the alarm system



- ▶ Unlock the vehicle with the SmartKey.

The turn signal lamps flash once and an acoustic signal sounds once, to indicate that the alarm system is disarmed.

i The alarm system will rearm automatically after approximately 40 seconds if neither a door nor the trunk lid was opened.

Canceling the alarm

To cancel the alarm:

- ▶ Press the  or  button on the SmartKey.

or

- ▶ Insert the SmartKey in the starter switch.

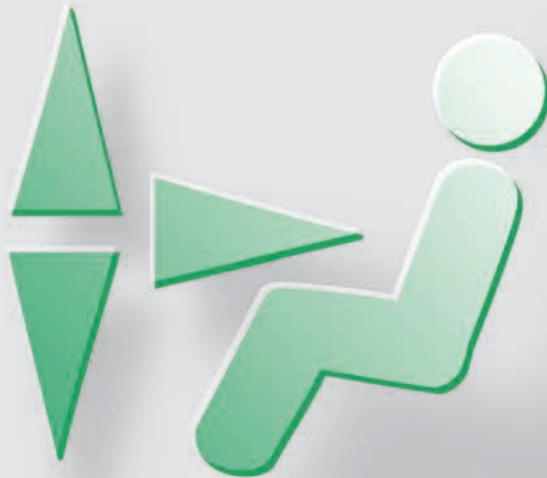

Locking and unlocking

Seats

Memory function*

Lighting

Instrument cluster

Control system

Manual transmission

Automatic transmission*

Good visibility

Climate control

Automatic climate control

Audio system

Power windows

Power tilt/sliding sunroof*

Driving systems

Loading

Useful features

Locking and unlocking

In the “Controls in detail” section you will find detailed information on how to operate the equipment installed on your vehicle. If you are already familiar with the basic functions of your vehicle, this section will be of particular interest to you.

To quickly familiarize yourself with the basic functions of the vehicle, refer to the “Getting started” section of this manual. The corresponding page numbers are given at the beginning of each segment.

For more information on locking and unlocking, see “Getting started” (▷ page 32) and (▷ page 54).

SmartKey

Your vehicle comes supplied with two SmartKeys, each with remote control and a removable mechanical key.

The locking tabs for the mechanical key portion of the two SmartKeys are a different color to help distinguish each SmartKey unit.

The SmartKey provides an extended operating range. To prevent theft, however, it is advisable to only unlock the vehicle when you are in close proximity to it.

The SmartKey centrally locks and unlocks:

- the doors
- the trunk
- the fuel filler flap



P80.35-2282-31

SmartKey with remote control

- ① Lock button
- ② Opening button for trunk (▷ page 95)
- ③ Mechanical key locking tab
- ④ Unlock button
- ⑤ Battery check lamp
- ⑥ Panic button* (▷ page 81)

Canada only:

Only vehicles equipped with an anti-theft alarm system have SmartKeys with integrated panic button ⑥.*

To prevent possible malfunction, avoid exposing the SmartKey to high levels of electromagnetic radiation.

Warning!



When leaving the vehicle, always remove the SmartKey from the starter switch, take it with you, and lock the vehicle. Do not leave children unattended in the vehicle, or with access to an unlocked vehicle. It is possible for children to open a locked door from the inside, which could result in an accident and/or serious personal injury.

i USA only:

This device complies with Part 15 of the FCC Rules. Operation is subject to the following two conditions:

- (1) *This device may not cause harmful interference, and*
- (2) *this device must accept any interference received, including interference that may cause undesired operation.*

Any unauthorized modification to this device could void the user's authority to operate the equipment.

i Canada only:

This device complies with RSS-210 of Industry Canada. Operation is subject to the following two conditions:

- (1) *This device may not cause interference, and*
- (2) *this device must accept any interference received, including interference that may cause undesired operation of the device.*

Any unauthorized modification to this device could void the user's authority to operate the equipment.

i You can also open or close the windows and the tilt/sliding sunroof* using the SmartKey (▷ page 223).

! If you can no longer lock or unlock the vehicle with the SmartKey, then either the batteries in the SmartKey are discharged, the SmartKey is malfunctioning or the vehicle battery is drained.

- Try second SmartKey.
- Check the batteries in the SmartKey (▷ page 95) and replace them if necessary (▷ page 366).
- Use the mechanical key to unlock the driver's door (▷ page 361) and the trunk (▷ page 362).

- Use the mechanical key to lock the driver's door (▷ page 362) and the trunk (▷ page 99).
- Have the vehicle battery and the battery connections checked (▷ page 383).

If the SmartKey is malfunctioning, contact Roadside Assistance or an authorized Mercedes-Benz Center.

Factory setting

i When unlocking or locking the vehicle with the SmartKey an acoustic signal sounds. The acoustic signal is activated at the factory. If you wish to deactivate the feature, or adjust its signal volume, contact an authorized Mercedes-Benz Center.

Global unlocking

▶ Press button .

- All turn signal lamps flash once.
- An acoustic signal sounds once.
- The locking knobs in the doors move up.
- The anti-theft alarm system* is disarmed.

Locking and unlocking

The vehicle will lock again automatically and rearm the anti-theft alarm system* within approximately 40 seconds of unlocking if:



- neither door nor trunk is opened
- the SmartKey is not inserted in the starter switch
- the central locking switch is not activated

Global locking

- ▶ Press button .
- All turn signal lamps flash three times.
- An acoustic signal sounds three times.
- The locking knobs in the doors move down.
- The anti-theft alarm system* is armed.

Selective setting

If you frequently travel alone, you may wish to reprogram the SmartKey so that pressing button  only unlocks the driver's door and the fuel filler flap.

- ▶ Press and hold buttons  and  simultaneously for about 5 seconds until battery check lamp ⑤ (> page 92) flashes twice.

The SmartKey will then function as follows:

Unlocking driver's door and fuel filler flap

- ▶ Press button  once.
 - All turn signal lamps flash once.
 - An acoustic signal sounds once.
 - The locking knob in the driver's door moves up.
 - The anti-theft alarm system* is disarmed.



Global unlocking

- ▶ Press button  twice.
 - All turn signal lamps flash once.
 - An acoustic signal sounds once.
 - The locking knobs in the doors move up.
 - The anti-theft alarm system* is disarmed.

Global locking

- ▶ Press button .
- With the trunk and all doors closed:
- All turn signal lamps flash three times.
 - An acoustic signal sounds three times.
 - The locking knobs in the doors move down.
 - The anti-theft alarm system* is armed.

Restoring to factory setting

- ▶ Press and hold buttons  and  simultaneously for about 5 seconds until Battery check lamp  (▷ page 92) flashes twice.

Unlocking and opening the trunk

You can unlock and open the trunk separately.

A minimum height clearance of 5.71 ft (1.74 m) is required to open the trunk lid.



- ▶ Press button  until trunk lid unlocks and begins to open.

! *The trunk lid swings open upwards automatically. Always make sure there is sufficient overhead clearance.*

i *If the trunk does not open, it is still locked separately (▷ page 99).*

The trunk can also be opened from its inside in an emergency, see “Trunk emergency release” (▷ page 98).

Checking the batteries



- ▶ Press button  or .

Battery check lamp (▷ page 92) comes on briefly to indicate that the SmartKey batteries are in order.

! *If the battery check lamp does not come on briefly during check, then the SmartKey batteries are discharged.*

Replace the batteries (▷ page 366).

You can obtain the required batteries at any authorized Mercedes-Benz Center.

i *If the batteries are checked within signal range of the vehicle, pressing the  or  button will lock or unlock the vehicle accordingly.*

Loss of SmartKey or mechanical key

If you lose a SmartKey or mechanical key, you should do the following:

- ▶ Have the SmartKey deactivated by an authorized Mercedes-Benz Center.
- ▶ Report the loss of the SmartKey or the mechanical key immediately to your car insurance company.
- ▶ Have the mechanical lock replaced if necessary.

Your authorized Mercedes-Benz Center will be glad to supply you with a replacement.

Locking and unlocking

Opening the doors from the inside

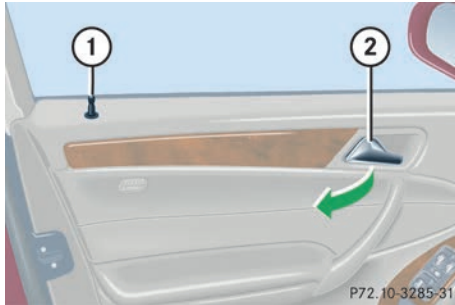

You can open a locked door from the inside. Open door only when conditions are safe to do so.



- ① Locking knob
- ② Inside door handle

i If the vehicle has previously been locked with the SmartKey, opening a door from the inside will trigger the anti-theft alarm system*.

To cancel the alarm, do one of the following:

- Insert the SmartKey in the starter switch.
- Press button  or  on the SmartKey.

Front doors

- ▶ Pull on door handle ② on the respective front door to open door.

If door was locked, locking knob ① will move up.

i If you hear a warning signal you have forgotten to switch off the headlamps before opening the driver's door.

In addition the message Switch off lights appears in the multifunction display.

Switch off the headlamps.

Rear doors

- ▶ Pull up locking knob ① on the respective rear door to unlock door.
- ▶ Pull on door handle ② on the respective rear door to open door.

Opening the trunk

Warning!



Only drive with the trunk closed as, among other dangers such as blocked visibility, exhaust fumes may enter the vehicle interior.

You can open the trunk if the vehicle is stationary.

A minimum height clearance of 5.71 ft (1.74 m) is required to open the trunk lid.

! The trunk lid swings open upwards automatically. Always make sure there is sufficient overhead clearance.

Opening the trunk from the outside

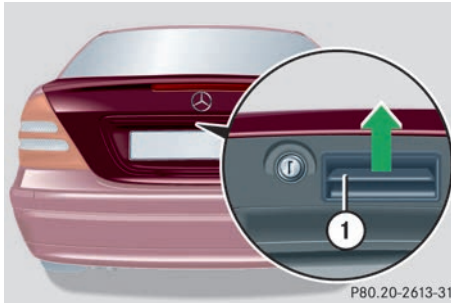

① Handle

- ▶ Press and hold button  on the SmartKey until trunk unlocks and begins to open.

or

- ▶ Pull on handle ①.

The vehicle must be unlocked.

i If the trunk does not open, it is still locked separately (▷ page 99).

i The trunk can also be opened from its inside in an emergency, see “Trunk emergency release” (▷ page 98).

Opening the trunk from the inside

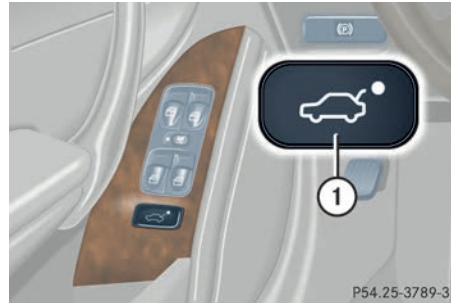

① Remote trunk opening switch

- ▶ Press remote trunk opening switch ① until the trunk begins to open.

The trunk opens. The indicator lamp in remote trunk opening switch ① comes on and remains lit until the trunk is closed.

i If the trunk does not open, it is still locked separately (▷ page 99).

i The trunk can also be opened by opening using button  on the SmartKey or from its inside in an emergency, see “Trunk emergency release” (▷ page 98).

Closing the trunk

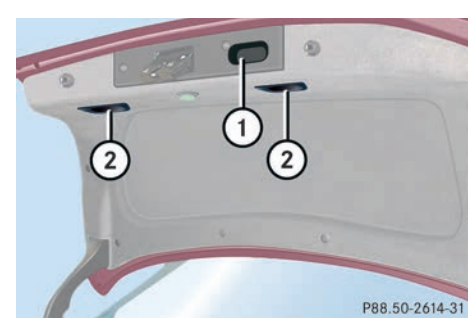

- ① Handle
- ② Handles

- ▶ Lower trunk lid by pulling firmly on handle ① or handles ②.
- ▶ Close trunk lid with hands placed flat on the trunk lid.

Warning!



To prevent possible personal injury, always keep hands and fingers away from the trunk opening when closing the trunk.



Locking and unlocking

▷▷ Be especially careful when small children are around.

When leaving the vehicle, always remove the SmartKey from the starter switch, take it with you, and lock the vehicle. Do not leave children unattended in the vehicle, or with access to an unlocked vehicle. A child's unsupervised access to a vehicle could result in an accident and/or serious personal injury.

Warning!



Only drive with the trunk closed as, among other dangers such as a blocked visibility, exhaust fumes may enter the vehicle interior.

i Do not place the SmartKey in the open trunk. You may lock yourself out.

i If the vehicle was previously centrally locked, the trunk will lock automatically after closing it. The turn signals will flash three times to confirm locking.

Trunk emergency release

With the emergency release button, the trunk can be opened from inside the trunk.

The emergency release button is located on the inside of the trunk lid.

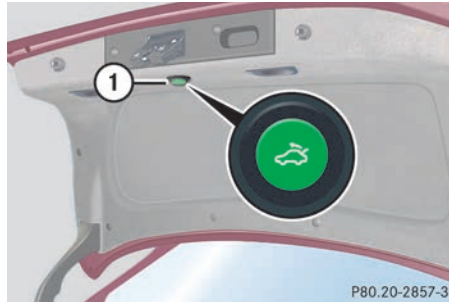

① Emergency release button

▶ Briefly press emergency release button ①.

The trunk unlocks and the trunk lid opens.

! The trunk lid swings open upwards automatically.

Illumination of the emergency release button:



- The button flashes 30 minutes after opening the trunk.
- The button flashes 60 minutes after closing the trunk.

i The emergency release button unlocks and opens the trunk while the vehicle is standing still or in motion.

i The emergency release button does not open the trunk lid if the vehicle battery is discharged or disconnected.

i If the vehicle has previously been locked with the SmartKey, opening the trunk from the inside using the emergency release button will trigger the anti-theft alarm system*.

To cancel the alarm, do one of the following:

- Press button  or  on the SmartKey.
- Insert the SmartKey in the starter switch.

Valet locking

i To deny any unauthorized person access to the trunk, lock it separately with the mechanical key. Leave only the SmartKey less its mechanical key with the vehicle.

The lock is located next to the handle above the rear license plate recess.

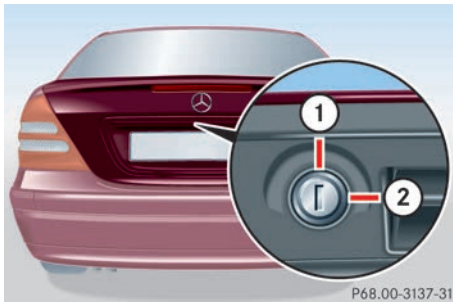

P68.00-3137-31

① Neutral position

② Locked

- ▶ Close the trunk (▷ page 97).
- ▶ Pull the mechanical key out of the SmartKey (▷ page 361).
- ▶ Insert the mechanical key in the trunk lid lock.

- ▶ Turn the mechanical key clockwise to position ② and remove the mechanical key in that position to lock the trunk.

The trunk remains locked even when the vehicle is centrally unlocked.

i You can only cancel the separate trunk locking mode by means of the mechanical key.

- ▶ Insert the mechanical key in the trunk lid lock.
- ▶ Turn the mechanical key counterclockwise to neutral position ① and remove the mechanical key in that position to unlock the trunk.

You can now open the trunk (▷ page 96).

Automatic central locking

The doors and the trunk automatically lock when the ignition is switched on and the wheels are turning at vehicle speeds of approximately 9 mph (15 km/h) or more.

You can open a locked door from the inside. Open door only when conditions are safe to do so.

i The doors unlock automatically after an accident if the force of the impact exceeds a preset threshold.

To prevent the vehicle door locks from locking, deactivate the automatic central locking when the vehicle

- is pushed or towed
- is on a test stand

You can deactivate the automatic locking mode using the control system, see “Setting automatic locking” (▷ page 143).

Locking and unlocking

Locking and unlocking from the inside

You can lock or unlock the doors and the trunk from inside using the central locking or unlocking switch. This can be useful, for example, if you want to lock the vehicle before starting to drive.

You cannot lock or unlock the fuel filler flap with the central locking or unlocking switch.

Warning!



When leaving the vehicle, always remove the SmartKey from the starter switch, take it with you, and lock the vehicle. Do not leave children unattended in the vehicle, or with access to an unlocked vehicle. A child's unsupervised access to a vehicle could result in an accident and/or serious personal injury.

The switches are located in the center console.

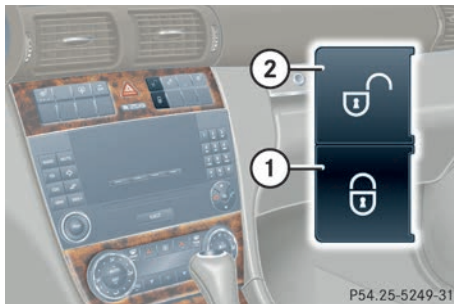

- ① Central locking switch
- ② Central unlocking switch

i You can open a locked door from the inside. Open door only when conditions are safe to do so.

If the vehicle was previously centrally locked using the SmartKey, it will not unlock using the central unlocking switch ②.

If the vehicle was previously locked with the central locking switch ①

- *while in the selective remote control mode, only the door opened from the inside is unlocked.*
- *while in the global remote control mode, the complete vehicle is unlocked when a door is opened from the inside.*

Locking

- ▶ Press central locking switch ①.

If all doors are closed, the vehicle locks.

Unlocking

- ▶ Press central unlocking switch ②.

The vehicle unlocks.

▼ Seats

For information on seat adjustment, see “Adjusting” (▷ page 34).

Front seat active head restraints

Warning!



For your protection, drive only with properly positioned head restraints.

Adjust the head restraint so that it is as close to the head as possible and the center of the head restraint supports the back of the head at eye level. This will reduce the potential for injury to the head and neck in the event of an accident or similar situation.

You cannot remove the active head restraints on the driver’s and front passenger’s seat.

For removal of the active head restraints we recommend that you contact an authorized Mercedes-Benz Center.

 *Adjust the head restraint in such a way that it is as close to the head as possible.*

For information on head restraint adjustment, see “Seats” (▷ page 34).

For information on active head restraints, see “Active head restraint” (▷ page 73).

Rear seat head restraints

Warning!



For safety reasons, always drive with the rear head restraints in the upright position when the rear seats are occupied.

Keep the area around head restraints clear of articles (e.g. clothing) to not obstruct the folding operation of the head restraints.

Seats

Head restraint height (rear outer seats)

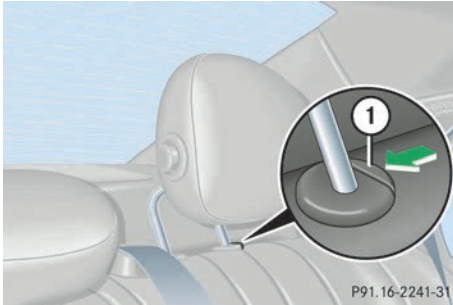

① Release button

Warning!



For your protection, drive only with properly positioned head restraints.

Adjust head restraint so that the head restraint supports the back of the head at eye level. This will reduce the potential for injury to the head and neck in the event of an accident or similar situation.

Do not drive the vehicle without the seat head restraints. Head restraints are intended to help reduce injuries during an accident.

i Adjust the head restraint in such a way that it is as close to the head as possible.

Raising

- ▶ Manually adjust the height of the head restraint by pulling it upward.

If the head restraint is fully retracted, push release button ① and pull the head restraint up.

Lowering

- ▶ To lower the head restraint, push release button ① and push down on the head restraint.

Folding head restraints back with release button

The rear seat head restraints can be folded backward for increased visibility.

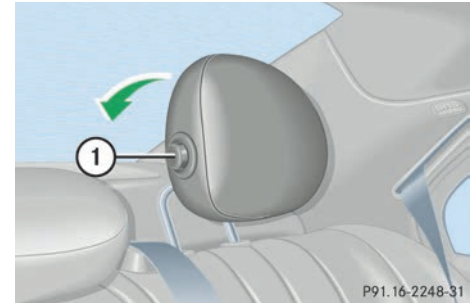

① Release button

- ▶ Push release button ①.

The head restraint will fold backward.

i You can also fold the rear outer seat head restraints back using the switch in the center console.

Folding head restraints back with switch in the center console

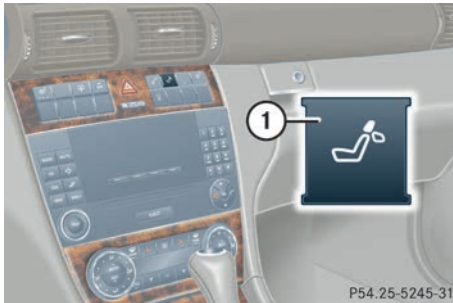

- ① Switch for rear seat head restraints
- ▶ Start the engine (▷ page 46).
- ▶ Press switch ①.

The rear seat head restraints will fold backward.

Placing head restraints upright

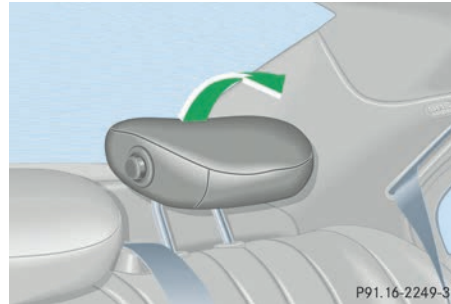

- ▶ Pull the head restraint forward until it locks into position.

Warning!



Make sure the head restraints engage when placing them upright. Otherwise their protective function cannot be assured.

Head restraint tilt (rear outer seats)

Two different head restraint angle positions are available:

- ▶ Press the release button (▷ page 102) and tilt the head restraint to the desired position.
- ⓘ *Adjust the head restraint in such a way that it is as close to the head as possible.*

Seats

Removing and installing rear seat head restraints (rear outer seats)

i The rear center seat head restraint cannot be removed.

Warning!



For your protection, drive only with properly positioned head restraints.

Adjust head restraint so that the head restraint supports the back of the head at eye level. This will reduce the potential for injury to the head and neck in the event of an accident or similar situation.

Do not drive the vehicle without the seat head restraints. Head restraints are intended to help reduce injuries during an accident.

Do not interchange head restraints from front and rear seat.

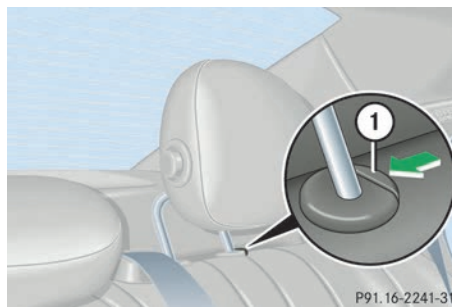

① Release button

Removing rear seat head restraints

- ▶ Fold back head restraint (▷ page 102).
- ▶ Pull head restraint to its highest position.
- ▶ Push release button ① and pull out head restraint.

Installing rear seat head restraints

- ▶ Insert head restraint and push it down until it engages.
- ▶ Push release button ① and adjust head restraint to desired position.

i Adjust the head restraint in such a way that it is as close to the head as possible.

Lumbar support

The curvature of the front seats can be adjusted to help enhance lower back support and seating comfort.

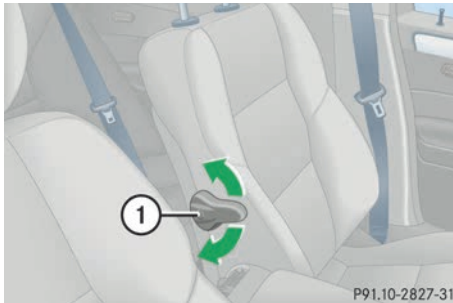

① Adjustment lever

- ▶ Move adjustment lever ① in direction of arrows until you have reached a comfortable seating position.

Multicontour seats* (Canada only)

This driver's multicontour seat has a movable seat cushion and inflatable air cushions built into the backrest to provide additional lumbar and side support.

The seat cushion movement, backrest cushion height and curvature can be continuously varied with switches on the side of the seat after switching on ignition.

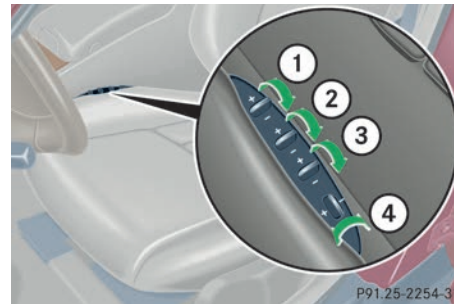

- ① Seat cushion depth
- ② Backrest bottom
- ③ Backrest center
- ④ Backrest side bolster adjustment

- ▶ Switch on the ignition (▷ page 32).

Seat cushion depth

- ▶ Adjust the seat cushion depth to the length of your upper leg using switch ①.

Backrest contour

- ▶ Adjust the contour of the backrest to the desired position using switches ② and ③.

Backrest side bolsters

- ▶ Adjust the backrest side bolsters so that they provide good lateral support using switch ④.

i If, after a period of time, the seat no longer provides the desired contour, then repeat the adjustment procedure.

Seats

Seat heating*

Both switches for the front seats are located in the center console. The red indicator lamps in the switch come on to show heating level you have selected.

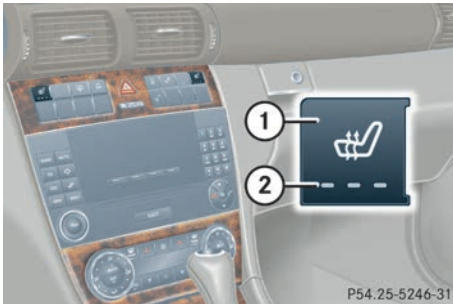

- ① Seat heating switch
- ② Indicator lamps

▶ Switch on the ignition (▷ page 32).

Level	
3	Three indicator lamps on (highest level). After approximately 5 minutes, seat heating is automatically switched to level 2.
2	Two indicator lamps on. After approximately 10 minutes, seat heating is automatically switched to level 1.
1	One indicator lamp on (lowest level). After approximately 20 minutes, seat heating is automatically switched off.
off	No indicator lamp on.

Switching on seat heating

- ▶ Press switch ① once.
Three red indicator lamps ② in the switch come on.
- ▶ Continue pressing switch ① until desired seat heating level is reached.

Switching off seat heating

- ▶ Press switch ① repeatedly until all indicator lamps ② go out.

i If one or more of the indicator lamps ② on the seat heating switch are flashing, there is insufficient voltage due to too many electrical consumers are turned on. The seat heating switches off automatically.

The seat heating will switch back on again automatically as soon as sufficient voltage is available.

▼ Memory function*

Prior to operating the vehicle, the driver should check and adjust the seat height, seat position fore and aft, and seat backrest angle if necessary, to ensure adequate control, reach and comfort. The head restraint should also be adjusted for proper height. See also the section on air bags (▷ page 59) for proper seat positioning.

In addition, adjust the steering wheel to ensure adequate control, reach, operation and comfort. Both the interior and exterior rear view mirrors should be adjusted for adequate rear vision.

Fasten seat belts. Infants and small children should be seated in a properly secured restraint system that complies with U.S. Federal Motor Vehicle Safety Standards 213 and 225 and Canadian Motor Vehicle Safety Standards 213 and 210.2.

With the memory function you can store up to three different settings.

The following settings are stored for the driver's seat when using the buttons on the driver's door:

- Driver's seat, backrest and head restraint position
- Steering wheel position
- Exterior rear view mirrors

Warning!



Do not activate the memory function while driving. Activating the memory function while driving could cause the driver to lose control of the vehicle.

The following settings are stored for the front passenger seat when using the buttons (if so equipped depending on vehicle equipment configuration) on the passenger door:

- Front passenger seat, backrest and head restraint position

Memory function*

The memory button and memory position switch are located on the door.

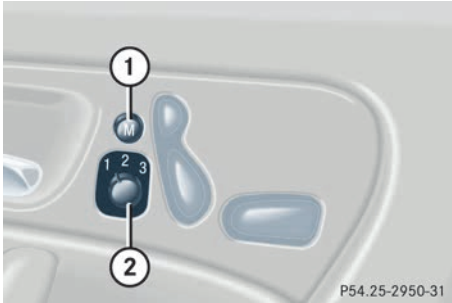

① Memory button

② Memory position switch

- ▶ Switch on the ignition (▷ page 32).

or

- ▶ Open the respective door.

Storing positions into memory

- ▶ Adjust the seat, steering wheel and exterior rear view mirrors to the desired position (▷ page 34).
- ▶ Turn memory position switch ② to the desired memory position.
- ▶ Press memory button ①.
- ▶ Release memory button ① and press memory position switch ② within 3 seconds.

All settings are stored to the selected position.

Recalling positions from memory

! Do not operate the power seats using the memory button if the seat backrest is in an excessively reclined position. Doing so could cause damage to front or rear seats.

- ▶ Turn memory position switch ② to the desired memory position.
- ▶ Press and hold memory position switch ② until the seat, steering wheel and exterior rear view mirrors have completely moved to the stored positions.

i Releasing the memory position switch stops movement to the stored positions immediately.

▼ Lighting

For information on how to switch on the headlamps and use the turn signals, see “Switching on headlamps” (▷ page 50) and “Turn signals” (▷ page 50).

i *If you drive in countries where vehicles drive on the other side of the road than the country where the vehicle is registered, you must have the headlamps modified for symmetrical low beams. Relevant information can be obtained at your authorized Mercedes-Benz Center.*

Exterior lamp switch

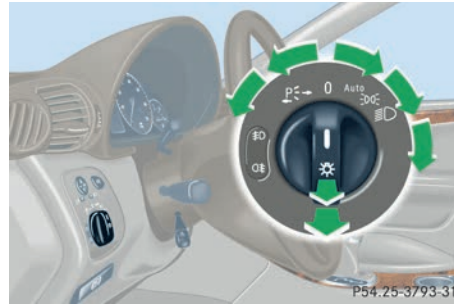

Exterior lamp switch

- 0** Off
Daytime running lamp mode
(▷ page 111)
- AUTO** Automatic headlamp mode
Daytime running lamp mode
(▷ page 111)
- PB** Parking lamps (also tail lamps,
license plate lamps, side marker
lamps, instrument panel lamps)

D Low beam headlamps or high beam headlamps when the combination switch is pushed forward. The tail lamps, license plate lamps, side marker lamps, parking lamps and instrument panel lamps also come on.

P↔ Standing lamps, right (turn left one stop)

↔P Standing lamps, left (turn left two stops)

FO Indicator lamp for front fog lamps

0F Indicator lamp for rear fog lamp

i *If you hear a warning signal you have forgotten to switch off the headlamps before opening the driver's door.*

In addition the message Switch off lights appears in the multifunction display.

Switch off the headlamps.

Lighting

Manual headlamp mode

The low beam headlamps and the parking lamps can be switched on and off with the exterior lamp switch.

- ▶ Turn the exterior lamp switch to position .

Automatic headlamp mode

The following lamps switch on and off automatically depending on the brightness of the ambient light:

- Low beam headlamps
- Tail and parking lamps
- License plate lamps
- Side marker lamps



Warning!



If the exterior lamp switch is set to **AUTO**,

- the headlamps may switch off unexpectedly when the system senses bright ambient light, for example light from oncoming traffic.
- the headlamps will not be automatically switched on under foggy conditions.

To minimize risk to you and to others, activate headlamps by turning exterior lamp switch to  when driving or when traffic and/or ambient lighting conditions require you to do so.

In low ambient lighting conditions, only switch from position **AUTO** to  with the vehicle at a standstill in a safe location. Switching from **AUTO** to  will briefly switch off the headlamps. Doing so while driving in low ambient lighting conditions may result in an accident.

The automatic headlamp feature is only an aid to the driver. The driver is responsible for the operation of the vehicle's lights at all times.

- ▶ Turn the exterior lamp switch to position **AUTO**.

With the SmartKey in starter switch position **1**, only the parking lamps and the side marker lamps will switch on and off automatically.

When the engine is running, the low beam headlamps, the tail and parking lamps, the license plate lamps, and the side marker lamps will switch on and off automatically.

 *USA only:*

With the automatic headlamp mode activated you can switch on the high beam headlamps in low ambient lighting conditions.

Daytime running lamp mode

- ▶ Turn the exterior lamp switch to position **0** or **AUTO**.

When the engine is running, the low beam headlamps are switched on.

In low ambient light conditions, the following lamps will switch on additionally:

- Tail and parking lamps
- License plate lamps
- Side marker lamps

i With the daytime running lamp mode activated and the engine running, you cannot switch off the low beam headlamps manually.

Canada only:

The daytime running lamp mode is mandatory and therefore in a constant mode.

i With the exterior lamp switch in position **0** or **AUTO**, you cannot switch on the high beam headlamps.



The high beam flasher is available at all times.

For nighttime driving turn the exterior lamp switch to position  to permit activation of the high beam headlamps.

Vehicles with automatic transmission*:

When the engine is running, and you shift from a driving position to position **N** or **P**, the low beam headlamps will switch off with a three-minute delay.

When the engine is running, and you

- turn the exterior lamp switch to position , the parking lamps and the side marker lamps switch on additionally.
- turn the exterior lamp switch to position , the manual headlamp mode has priority over the daytime running lamp mode.

The corresponding exterior lamps switch on (▷ page 109).



USA only:

By default, the daytime running lamp mode is deactivated. Activate the daytime running lamp mode using the control system, see “Setting daytime running lamp mode (USA only)” (▷ page 139).

i With the daytime running lamp mode activated and the exterior lamp switch in position **0**, you cannot switch on the high beam headlamps.

The high beam flasher is available at all times.

*For nighttime driving turn the exterior lamp switch to position  or **AUTO** to permit activation of the high beam headlamps.*

When the engine is running, and you turn the exterior lamp switch to position  or , the manual headlamp mode has priority over the daytime running lamp mode.

The corresponding exterior lamps switch on (▷ page 109).

Lighting



Locator lighting and night security illumination

The locator lighting and the night security illumination are described in the “Control system” section, see “Setting locator lighting” (▷ page 140) and “Setting night security illumination” (▷ page 141).



Fog lamps

Warning!



In low ambient lighting or foggy conditions, only switch from position **AUTO** to  with the vehicle at a standstill in a safe location. Switching from **AUTO** to  will briefly switch off the headlamps. Doing so while driving in low ambient lighting conditions may result in an accident.

 *Fog lamps will operate with the parking lamps and/or the low beam headlamps on. Fog lamps should only be used in conjunction with low beam headlamps. Consult your State or Province Motor Vehicle Regulations regarding permissible lamp operation.*

 *Fog lamps cannot be switched on with the exterior lamp switch in position **AUTO**. To switch on the fog lamps, turn the exterior lamp switch to position  first.*

Front fog lamps

- ▶ Switch on the low beam headlamps  (▷ page 109).
- ▶ Pull out the exterior lamp switch to first stop.

The front fog lamps switch on.

The green indicator lamp  in the exterior lamp switch comes on (▷ page 109).

- ▶ Push in the exterior lamp switch.

The front fog lamps switch off.

The green indicator lamp  in the exterior lamp switch goes out.

Rear fog lamp (driver's side only)

- ▶ Switch on the low beam headlamps  (▷ page 109).
- ▶ Pull out the exterior lamp switch to second stop.

The front fog lamps and the rear fog lamp switch on.

The yellow indicator lamp  in the exterior lamp switch comes on (▷ page 109).

- ▶ Push in the exterior lamp switch to first stop.

The rear fog lamp switches off.

The yellow indicator lamp  in the exterior lamp switch goes out. The front fog lamps remain lit.

Combination switch

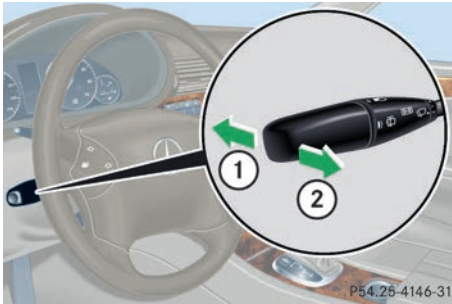

Combination switch

- ① High beam
- ② High beam flasher

High beam

- ▶ Turn the exterior lamp switch to position  (▷ page 109).
- ▶ Push the combination switch in direction of arrow ① to switch on the high beam.

The high beam headlamp indicator lamp  in the instrument cluster comes on (▷ page 24).

- ▶ Pull the combination switch in direction of arrow ② to its original position to switch off the high beam.

The high beam headlamp indicator lamp  in the instrument cluster goes out.

High beam flasher

- ▶ Pull the combination switch briefly in direction of arrow ②.

Corner-illuminating front fog lamps* (C 230 (Canada only), C 280, C 350 and models with 4MATIC: with Bi-Xenon* headlamps)

The corner-illuminating front fog lamps improve illumination of the area in the direction into which you are turning.

The corner-illuminating front fog lamps will operate with the engine running and with

- the exterior lamp switch in position  (▷ page 109) or
- the exterior lamp switch in position **AUTO** (▷ page 109) or
- the daytime running lamp mode activated (▷ page 111)

i With the automatic headlamp mode activated: The corner-illuminating front fog lamps will only come on in low ambient lighting conditions.

i If you are driving faster than 25 mph (40 km/h) or have the front fog lamps switched on, the corner-illuminating front fog lamps function is not available.

Lighting

Driving forward

Switching on corner-illuminating front fog lamps

- ▶ Switch on the left or right turn signal (▷ page 50), depending on whether you are turning left or right.

The respective front fog lamp comes on and illuminates the area in the direction into which you are turning.

or

- ▶ Turning steering wheel in desired direction.

The front fog lamp on the side of your steering direction comes on.

i *If you have switched on the turn signal for one side but turn the steering wheel in the opposite direction, the corner-illuminating front fog lamp comes on for the side indicated by the turn signal.*

The corner-illuminating front fog lamp remains lit for a maximum of three minutes. Afterward, it goes out even if the turn signal is still switched on.

i *The corner-illuminating front fog lamps temporarily come on, on both sides of the vehicle if you turn the steering wheel in one direction and then again in the other direction shortly thereafter.*

i *The corner-illuminating front fog lamps will come on automatically depending on the steering angle, even if you did not switch on either turn signal.*

If the corner-illuminating front fog lamps came on automatically, they will also go out automatically depending on the steering angle.

Switching off corner-illuminating front fog lamps

The combination switch for the turn signal resets automatically after major steering wheel movements. This will switch off the corner-illuminating front fog lamps if they were activated by switching on the left or right turn signal.

If the turn signal should stay on after making the turn, the turn signal and the corner-illuminating front fog lamp can be switched off by returning the combination switch to its original position.

i *There may be a brief delay before the corner-illuminating front fog lamps switch off.*

Driving in reverse

Switching on corner-illuminating front fog lamps

- ▶ Place the gear selector lever (manual transmission: gearshift lever) in position **R**.

The corner-illuminating front fog lamp opposite to your steering direction comes on.

Switching off corner-illuminating front fog lamps

- ▶ Place the gear selector lever (manual transmission: gearshift lever) out of position **R**.

The respective front fog lamp goes out.

Hazard warning flasher

The hazard warning flasher can be switched on at all times, even with the SmartKey removed from the starter switch.

The hazard warning flasher switches on automatically when an air bag deploys.

The hazard warning flasher switch is located on the center console.



① Hazard warning flasher switch

Switching on hazard warning flasher

- ▶ Press hazard warning flasher switch ①.

All turn signal lamps are flashing.

i *With the hazard warning flasher activated and the combination switch set for either left or right turn, only the respective left or right turn signals will operate when the ignition is switched on (▷ page 32).*

Switching off hazard warning flasher

- ▶ Press hazard warning flasher switch ① again.

i *If the hazard warning flasher has been activated automatically, press hazard warning flasher switch ① once to switch it off.*

Lighting

Interior lighting

The controls are located in the overhead control panel.



- ① Rear interior lighting on/off
- ② Right front reading lamp on/off
- ③ Rocker switch for automatic control system
- ④ Left front reading lamp on/off

! An interior lamp switched on manually does not go out automatically.

Leaving an interior lamp switch in the ON position for extended periods of time with the engine turned off could result in a discharged battery.

Deactivating automatic control

i The interior lighting is factory-set to automatic mode.

- ▶ Press the  symbol on rocker switch ③.

The interior lighting remains switched off in darkness, even when you

- unlock the vehicle
- remove the SmartKey from the starter switch
- open a door
- open the trunk

Activating automatic control

- ▶ Press rocker switch ③ to center position.

The interior lighting switch on in darkness, when you

- unlock the vehicle
- remove the SmartKey from the starter switch
- open a door
- open the trunk

The interior lighting switches off after approximately 10 seconds, see “Setting interior lighting delayed shut-off” (▷ page 142).



i If a door remains open, the interior lighting switches off automatically after approximately 5 minutes.

Manual control



Switching front interior lighting on and off

- ▶ Press the  symbol on rocker switch ③.
The front interior lighting comes on.
- ▶ Press rocker switch ③ to center position to activate the automatic control.

Switching rear interior lighting on and off

- ▶ Press button .
The lighting in the rear passenger compartment comes on.
- ▶ Press button  again.
The lighting in the rear passenger compartment goes out.

Switching front reading lamps on and off

- ▶ Press the left or right button  to switch on the desired front reading lamp.
- ▶ Press the left or right button  again to switch off the respective front reading lamp.

Door entry lamps

For better orientation in the dark, the corresponding door entry lamps will switch on in darkness when you open a door and the automatic control is activated.

The door entry lamps will switch off when the corresponding door is closed.

i If you turn the SmartKey in the starter switch to position **0** and switch off the exterior headlamps, the door entry lamps will remain lit for approximately 5 minutes.

Trunk lamp

The trunk lamp switches on if the trunk is opened.

If the trunk lid remains open, the trunk lamp switches off automatically after approximately 10 minutes.

Instrument cluster

For a full view illustration of the instrument cluster, see “At a glance” (▷ page 24).



① Reset button

The instrument cluster is activated when you

- open a door
- switch on ignition (▷ page 32)
- press reset button ①
- switch on the exterior lighting

You can change the instrument cluster settings in the Instrument cluster submenu of the control system (▷ page 134).

Warning!



No messages will be displayed if either the instrument cluster or the multifunction display is inoperative.

As a result, you will not be able to see information about your driving conditions, such as speed or outside temperature, warning/indicator lamps, malfunction/warning messages or the failure of any systems. Driving characteristics may be impaired.

If you must continue to drive, please do so with added caution. Visit an authorized Mercedes-Benz Center as soon as possible.

Adjusting instrument cluster illumination

Use reset button ① to adjust the illumination brightness for the instrument cluster.

i *The instrument cluster illumination is dimmed or brightened automatically to suit ambient light conditions.*

The instrument cluster illumination will also be adjusted automatically when you switch on the vehicle's exterior lamps.

To brighten illumination

- ▶ Turn reset button ① clockwise.

The instrument cluster illumination will brighten.

To dim illumination

- ▶ Turn reset button ① counterclockwise.

The instrument cluster illumination will dim.

Coolant temperature gauge

The coolant temperature gauge is on the left side in the instrument cluster (▷ page 24).

Warning!



- Driving when your engine is badly overheated can cause some fluids which may have leaked into the engine compartment to catch fire. You could be seriously burned.
- Steam from an overheated engine can cause serious burns and can occur just by opening the hood. Stay away from the engine if you see or hear steam coming from it.



Turn off the engine, get out of the vehicle and do not stand near the vehicle until the engine has cooled down.

! Excessive coolant temperature triggers a warning in the multifunction display (▷ page 346).

The engine should not be operated with the coolant temperature above 248°F (120°C). Doing so may cause serious engine damage which is not covered by the Mercedes-Benz Limited Warranty.

i During severe operating conditions, e.g. stop-and-go traffic, the coolant temperature may rise close to 248°F (120°C).

Resetting trip odometer

- ▶ Make sure you are viewing the trip odometer and main odometer in the multifunction display (▷ page 121).
- ▶ If it is not displayed, press button  or  on the multifunction steering wheel (▷ page 122) until the trip odometer appears in the multifunction display.
- ▶ Press and hold the reset button in the instrument cluster (▷ page 118) until the trip odometer is reset.

Tachometer

The red marking on the tachometer (▷ page 24) denotes excessive engine speed.

! *Avoid driving at excessive engine speeds, as it may result in serious engine damage that is not covered by the Mercedes-Benz Limited Warranty.*

To help protect the engine, the fuel supply is interrupted if the engine is operated within the red marking.

Outside temperature indicator

Warning!



The outside temperature indicator is not designed to serve as an ice-warning device and is therefore unsuitable for that purpose.

Indicated temperatures just above the freezing point do not guarantee that the road surface is free of ice. The road may still be icy, especially in wooded areas or on bridges.

The outside temperature is indicated in the multifunction display (▷ page 121).

The temperature sensor is located in the front bumper area. Due to its location, the sensor can be affected by road or engine heat during idling or slow driving. Therefore, the accuracy of the displayed temperature can only be verified by comparison to a thermometer placed next to the sensor, not by comparison to external displays (e.g. bank signs, etc.).

When moving the vehicle into colder ambient temperatures (e.g. when leaving your garage), you will notice a delay before the lower temperature is displayed.

A delay also occurs when ambient temperatures rise. This prevents inaccurate temperature indications caused by heat radiated from the engine during idling or slow driving.

▼ Control system

The control system is activated as soon as the SmartKey in the starter switch is turned to position **1**. The control system enables you to

- call up information about your vehicle
- change vehicle settings

For example, you can use the control system to find out when your vehicle is next due for service, to set the language for messages in the instrument cluster display, and much more.

i *The displays for the audio systems (radio, CD player) will appear in English, regardless of the language selected.*

Warning!



A driver's attention to the road and traffic conditions must always be his/her primary focus when driving.

For your safety and the safety of others, selecting features through the multifunction steering wheel should only be done by the driver when traffic and road conditions permit it to be done safely.

Bear in mind that at a speed of just 30 mph (approximately 50 km/h), your vehicle is covering a distance of 44 feet (approximately 14 m) every second.

The control system relays information to the multifunction display.

Multifunction display



- ① Trip odometer
- ② Main odometer
- ③ Current program mode (automatic transmission*)
- ④ Current gear selector lever position/gear range (automatic transmission*)
- ⑤ Digital clock
- ⑥ Status indicator (outside temperature/digital speedometer)

Control system

Multifunction steering wheel

The displays in the multifunction display and the settings in the control system are controlled by the buttons on the multifunction steering wheel.

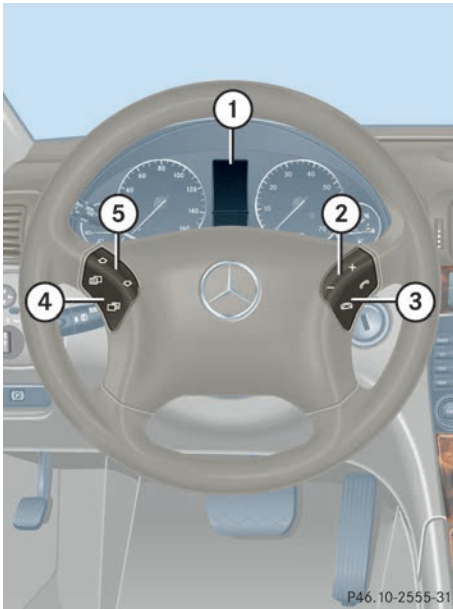

P46.10-2555-31

① Multifunction display

Operating the control system

② Selecting the submenu or setting the volume:

Press button

+ up/to increase

- down/to decrease

③ Telephone*:

Press button

 to take a call
to dial
to redial

 to end a call
to reject an incoming call

④ Menu systems:

Press button

 for next menu

 for previous menu

⑤ Moving within a menu:

Press button

 for next display

 for previous display





Depending on the selected menu (▷ page 125), pressing the buttons on the multifunction steering wheel will alter what is shown in the multifunction display.

The information available in the multifunction display is arranged in menus, each containing a number of functions or sub-menus.

The individual functions are then found within the relevant menu (radio or CD operations under AUDIO, for example). These functions serve to call up relevant information or to customize the settings for your vehicle.

i *C 230 Sport and C 350 Sport:*
Steering wheel in these vehicles will vary from steering wheel shown. However, multifunction steering wheel symbols and feature description apply to Sport models as well.

It is helpful to think of the menus, and the functions within each menu, as being arranged in a circular pattern.

- If you press button  or  repeatedly, you will pass through each menu one after the other.
- If you press button  or  repeatedly, you will pass through each function display, one after the other, in the current menu.

In the Settings menu, instead of functions you will find a number of submenus for calling up and changing settings. For instructions on using these submenus, see “Submenus in the Settings menu” (▷ page 132).

The number of menus available in the system depends on which optional equipment is installed in your vehicle.

i *The headings used in the menu table are designed to facilitate navigation within the system and are not necessarily identical to those shown in the control system displays.*

The first function displayed in each menu will automatically show you which part of the system you are in.

Control system

Menus

This is what you will see when you scroll through the menus.

The table on the next page provides an overview of the individual menus.

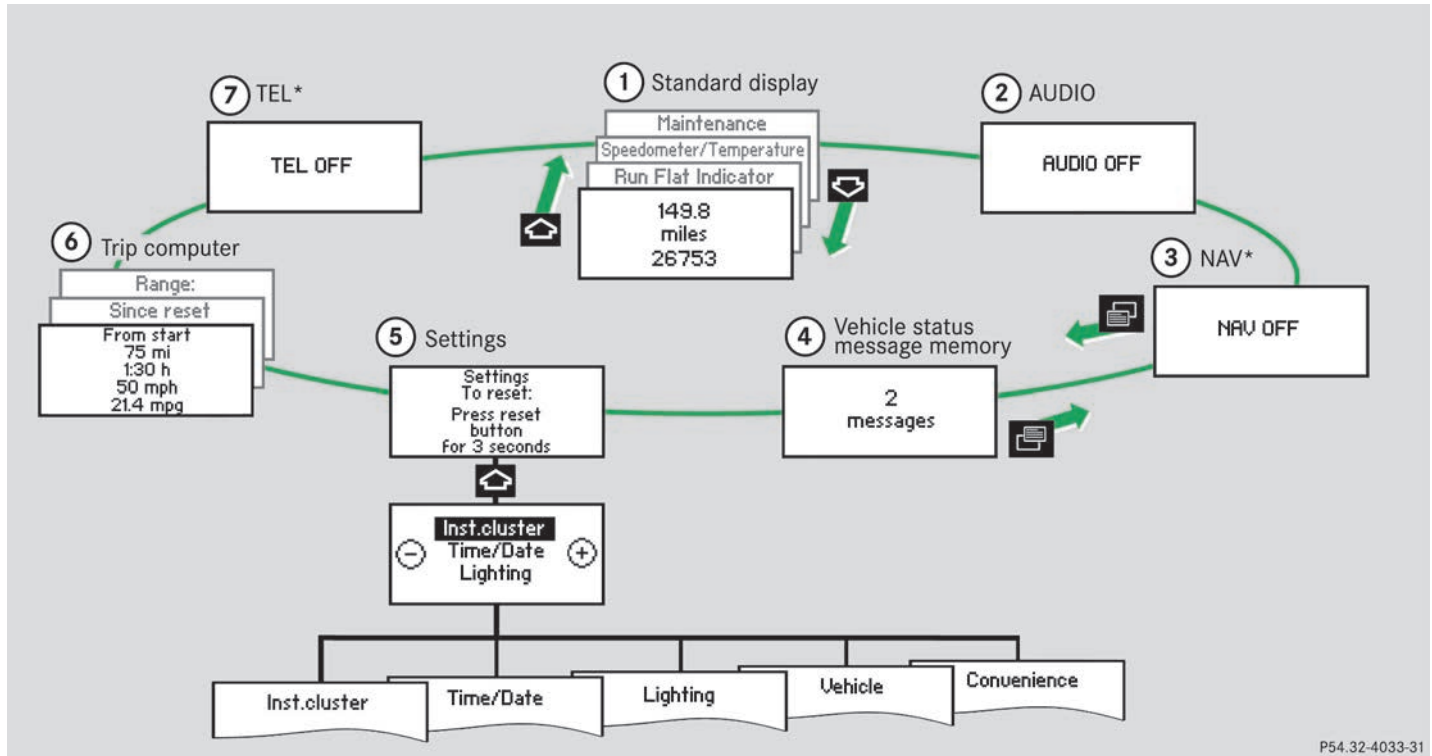

P54.32-4033-31

Menus, submenus and functions

	Menu ① Standard display (▷ page 126)	Menu ② AUDIO (▷ page 127)	Menu ③ NAV* (▷ page 129)	Menu ④ Vehicle status message memory (▷ page 130)	Menu ⑤ Settings (▷ page 131)	Menu ⑥ Trip computer (▷ page 144)	Menu ⑦ TEL* (▷ page 146)
Commands/submenus	Run Flat Indicator* (Canada only)	Selecting radio station	Show route guidance instructions, current direction traveled	Call up vehicle malfunction, warning and system status messages stored in memory ¹	Reset to factory settings	Fuel consumption statistics from start	Load phone book
	Digital speedometer or outside temperature	Selecting satellite radio station* (USA only)			Instrument cluster submenu	Fuel consumption statistics since the last reset	Search for name in phone book
	Call up maintenance service display	Operating CD player*			Time/Date submenu Lighting submenu Vehicle submenu Convenience submenu	Distance to empty	

¹ The vehicle status message memory menu is only displayed if there is a message stored.

Control system



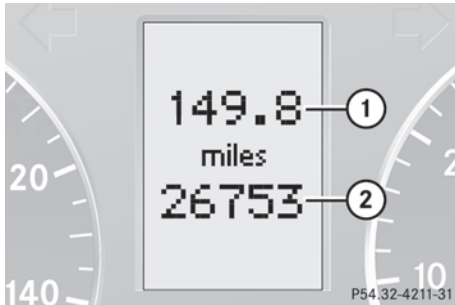

Standard display menu

In the standard display, the main odometer and the trip odometer are shown in the multifunction display.



- ① Trip odometer
- ② Main odometer



If another display is shown instead of the standard display:

- ▶ Press button  or  repeatedly until you see the standard display.
- ▶ Press button  or  to select the functions in the standard display menu.

The following functions are available:

Function	Page
Run Flat Indicator* (Canada only)	291
Call up digital speedometer or outside temperature	126
Call up maintenance service display	310

Call up digital speedometer or outside temperature

- ▶ Press button  or  repeatedly until the digital speedometer or the outside temperature appears in the multifunction display.

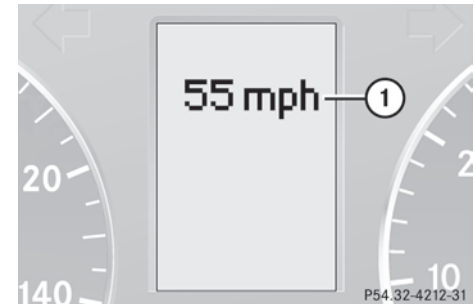

Example illustration

- ① Digital speedometer

i You can select whether the digital speedometer or the outside temperature is to be displayed, see “Select display (digital speedometer or outside temperature) for status indicator” (▷ page 135).

AUDIO menu



The functions in the AUDIO menu operate the audio equipment which you currently have turned on.

If no audio equipment is currently turned on, the message AUDIO OFF appears in the multifunction display.

The following functions are available:



Function	Page
Selecting radio station	127
Selecting satellite radio station* (USA only)	127
Operating CD player*	128

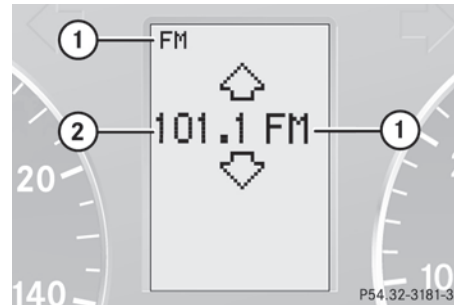

Selecting radio station

- ▶ Turn on the radio (▷ page 190) and select radio. Vehicles with COMAND*: Refer to separate operating instructions.
- ▶ Press button  or  repeatedly until the currently tuned station appears in the multifunction display.



- ① Waveband setting
- ② Station frequency

- ▶ Press button  or  repeatedly until the desired station or the desired stored station is found.

The station search depends on the selected setting in the Vehicle submenu of the control system (▷ page 142). Pressing button  or  will either start a frequency scan or select the next stored radio station.

 You can only store new stations using the corresponding feature on the radio (▷ page 196).

Vehicles with COMAND*: Refer to separate operating instructions.

You can also operate the radio in the usual manner.

Selecting satellite radio station* (USA only)

The satellite radio is treated as a radio application.



- ▶ Select satellite radio with the corresponding soft key (SAT) in the radio menu.

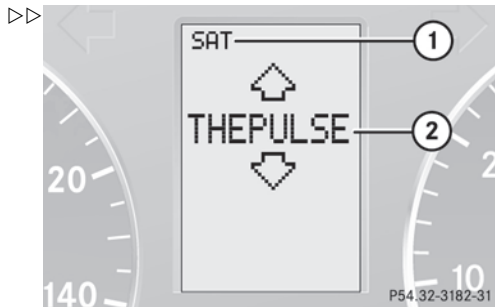

Control system



- ① SAT mode and preset number
- ② Channel name or number

▶ Press button  or  repeatedly until the desired channel is found.



i For more information on satellite radio operation, see “Introduction to satellite radio* (USA only)” (▷ page 197).

Vehicles with COMAND*:
Refer to separate operating instructions.

Operating the CD player*

i The COMAND* system and the CD changer* can play audio CDs as well as CDs with MP3 files.

Selecting CD track

- ▶ Turn on the radio and select CD or CD changer* (▷ page 205).
Vehicles with COMAND*:
Refer to separate operating instructions.
- ▶ Press button  or  repeatedly until the settings for the CD currently being played appear in the multifunction display.

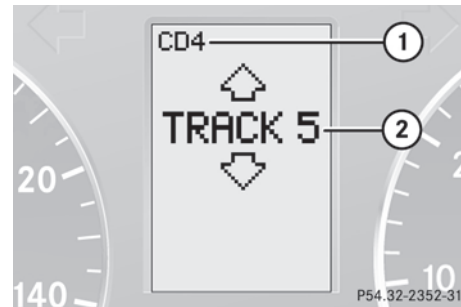

- ① Current CD (with additional number from 1 to 6 when running from CD changer*)
- ② Current track

▶ Press button  or  repeatedly until the desired track is selected.



i To select a CD from the CD changer* magazine, press a number on the audio system or the COMAND* system key pad located in the center console.

For more information on CD operation, see “CD mode” (▷ page 201) and for the CD changer*, see (▷ page 204).

Selecting CD MP3-track (vehicles with COMAND* and/or CD changer*)

- ▶ Turn on the radio and select the CD changer* (▷ page 205) or turn on COMAND* and select CD or CD changer*. Vehicles with COMAND*: Refer to separate operating instructions.

i A CD with MP3 files insert in the CD changer* is handled by the audio/COMAND* system like an audio CD. Information contained on the CD with MP3 files will not shown in the multifunction display or in the audio/COMAND* display.

- ▶ Press button  or  repeatedly until the settings for the CD currently being played appear in the multifunction display.

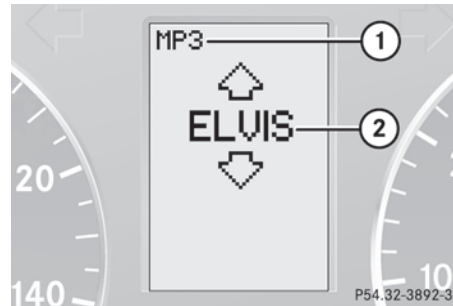

- ① MP3 mode (vehicles with COMAND*)
- ② Current track

- ▶ Press button  or  repeatedly until the desired track is selected.



i Level of information displayed will vary depending on the information contained on the CD with MP3 files insert in the single CD player of the COMAND* system.

To select a CD from the CD changer* magazine, press a number on the audio system or the COMAND* system key pad located in the center console.

For more information on MP3, see “MP3 notes” (▷ page 202), and for operating, see “MP3 playback” (▷ page 204).

NAV* menu

The NAV menu contains the functions needed to operate your navigation system.

- ▶ Press button  or  repeatedly until the message NAV appears in the multifunction display.
 - If COMAND* is switched off, the message NAV OFF appears in the multifunction display.
 - With COMAND* switched on but route guidance not activated, the direction of travel and, if available, the name of the street currently traveled on appear in the multifunction display.
 - With COMAND* switched on and route guidance activated, the direction of travel and maneuver instructions appear in the multifunction display.

Please refer to the COMAND* manual for instructions on how to activate the route guidance system*.

Control system

Vehicle status message memory menu

Use the vehicle status message memory menu to scan malfunction and warning messages that may be stored in the system. Such messages appear in the multifunction display and are based on conditions or system status the vehicle's system has recorded.



The vehicle status message memory menu only appears if there are any messages stored.

Warning!



Malfunction and warning messages are only indicated for certain systems and are intentionally not very detailed. The malfunction and warning messages are simply a reminder with respect to the operation of certain systems and do not replace the owner's and/or driver's responsibility to maintain the vehicle's operating safety by having all required maintenance and

safety checks performed on the vehicle and by bringing the vehicle to an authorized Mercedes-Benz Center to address the malfunction and warning messages (▷ page 333).

- ▶ Press button  or  repeatedly until the vehicle status message memory appears in the multifunction display.

If the vehicle status message memory menu does not appear, then there are no messages stored.

Vehicle status messages have been recorded

If conditions have occurred causing status messages to be recorded, the number of messages appears in the multifunction display:

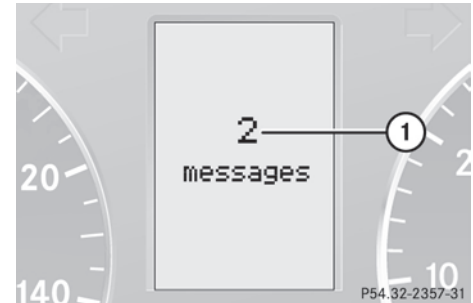

- ① Number of messages

- ▶ Press button  or .



The stored messages will now be displayed in the order in which they have occurred. For malfunction and warning messages, see “Vehicle status messages in the multifunction display” (▷ page 333).

Should the vehicle's system record any conditions while driving, the number of messages will reappear in the multifunction display when the SmartKey in the starter switch is turned to position **0** or removed from the starter switch.

i *The vehicle status message memory will be cleared when you turn the SmartKey in the starter switch to position **1** or **2**. You will then only see high-priority messages in the multifunction display (▷ page 333).*

Settings menu

In the Settings menu there are two functions:

- The function **Reset to factory settings**, with which you can reset all the settings to the original factory settings.
 - A collection of submenus with which you can make individual settings for your vehicle.
- ▶ Press button  or  repeatedly until the Settings menu appears in the multifunction display.

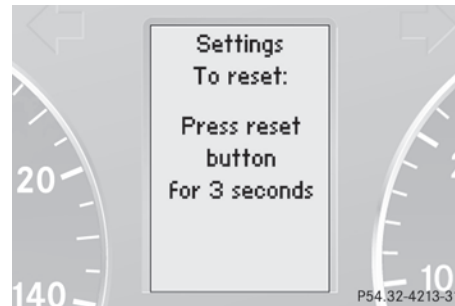

Resetting all settings

You can reset all the functions of all submenus to the factory settings.

- ▶ Press the reset button in the instrument cluster (▷ page 118) for approximately 3 seconds.

The request to press the reset button once more to confirm appears in the multifunction display.

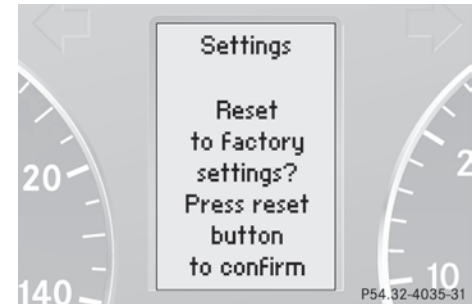

- ▶ Press the reset button once more.

The functions of all the submenus will reset to factory settings.

Control system

i The settings you have changed will not be reset unless you confirm the action by pressing the reset button a second time. After approximately 5 seconds, the Settings menu reappears in the multifunction display.

For safety reasons, the following function are not reset while driving:

- the Headlamp mode function in the Lighting submenu

Submenus in the Settings menu



- ▶ Press button .

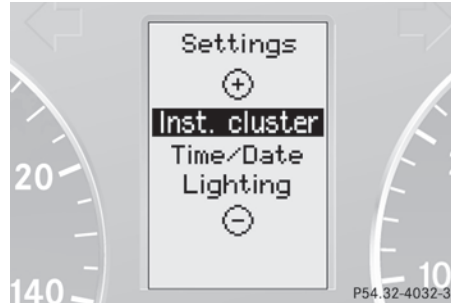



The collection of the submenus appears in the multifunction display.



- ▶ Press button .

The selection marker moves to the next submenu.

The submenus are arranged by hierarchy. Scroll down with button , scroll up with button .

With the selection marker on the desired submenu, use the button  to access the individual functions within that submenu. Once within the submenu, you can use the button  to move to the next function or the button  to move to the previous function within that submenu. The settings themselves are made with button  or .

The table below shows what settings can be changed within the various menus.

Detailed instructions on making individual settings can be found on the following pages.

Instrument cluster (▷ page 134)	Time/Date (▷ page 136)	Lighting (▷ page 139)	Vehicle (▷ page 142)	Convenience (▷ page 143)
Select speedometer display mode Select language Select display (speed display or outside temperature) for status indicator	Time synchronization with head unit* Set the time (hours) Set the time (minutes) Select automatic time change (Daylight Saving Time (DST) summer/Standard time winter) Set the date (month) Set the date (day) Set the date (year)	Setting daytime running lamp mode (USA only) Setting locator lighting Setting night security illumination Setting interior lighting delayed shut-off	Set automatic locking	Activate easy-entry/exit feature*

Control system

Instrument cluster submenu

Access the `Inst.cluster` submenu via the `Settings` menu. Use the `Inst.cluster` submenu to change the instrument cluster display settings.

The following functions are available:

Function	Page
Select speedometer display mode	134
Select language	134
Select display (speed display or outside temperature) for status indicator	135

Select speedometer display mode

- ▶ Move the selection marker with button **+** or **-** to the `Inst.cluster` submenu.
- ▶ Press button **▲** or **▼** repeatedly until the message `Disp.Unit Speed-/odom.` appears in the multifunction display.

The selection marker is on the current setting.

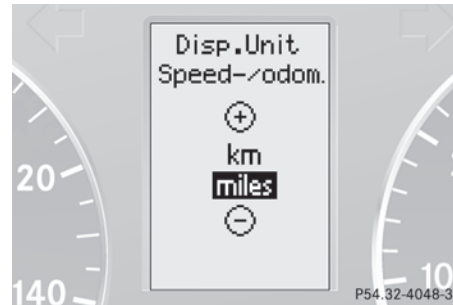

- ▶ Press button **+** or **-** to set speedometer unit to km or miles.

Select language

- ▶ Move the selection marker with button **+** or **-** to the `Inst.cluster` submenu.
- ▶ Press button **▲** or **▼** repeatedly until the message `Language` appears in the multifunction display.

The selection marker is on the current setting.



- ▶ Press button **+** or **-** to select the language to be used for the multifunction display messages.

Available languages:

- German
- English
- French
- Italian
- Spanish
- Dutch
- Danish
- Swedish
- Portuguese
- Turkish
- Russian (Canada only)

Select display (digital speedometer or outside temperature) for status indicator

- ▶ Move the selection marker with button **+** or **-** to the Inst.cluster submenu.
- ▶ Press button **▲** or **▼** repeatedly until the message Status line display appears in the multifunction display.

The selection marker is on the current setting.

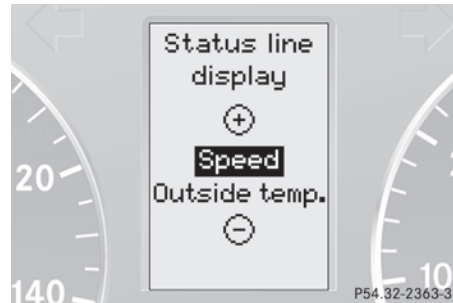

- ▶ Press button **+** or **-** to select the desired setting.

The selected display is then shown continuously in the lower display.

The other display now appears in the menu of the standard display:

- Digital speedometer
or
- Outside temperature

Control system

Time/Date submenu

Access the Time/Date submenu via the Settings menu. Use the Time/Date submenu to change the instrument cluster display settings.

The following functions are available:

Function	Page
Time synchronization with head unit*	136
Set the time (hours)	136
Set the time (minutes)	137
Select automatic time change (Daylight Saving Time (DST) summer/Standard time winter)	137
Set the date (month)	138
Set the date (day)	138
Set the date (year)	138

Time synchronization with head unit*

This function can only be seen on vehicles with COMAND* and navigation module*.

- ▶ Move the selection marker with button **+** or **-** to the Time/Date submenu.
- ▶ Press button **▲** or **▼** repeatedly until the message **Time synchro. w/Head Unit** appears in the multifunction display.

The selection marker is on the current setting.

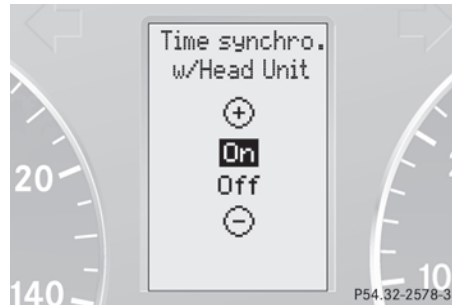

- ▶ Press button **+** or **-** to select the desired setting.

Set the time (hours)

This function can be seen in vehicles with audio system, or in vehicles with COMAND* if the time synchronization with head unit* feature was set to Off.

i *Vehicles with COMAND*:
For information on setting the time, refer to the separate COMAND operating instructions.*

- ▶ Move the selection marker with button **+** or **-** to the Time/Date submenu.
- ▶ Press button **▲** or **▼** repeatedly until the message **Time Hours** appears in the multifunction display.

The selection marker is on the hour setting.

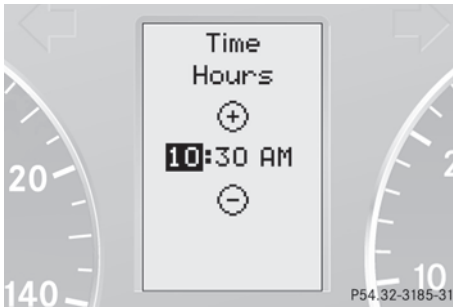

- ▶ Press button **+** or **-** to set the hour.

Set the time (minutes)

This function can be seen in vehicles with audio system, or in vehicles with COMAND* if the time synchronization with head unit* feature was set to Off.

i Vehicles with COMAND*:
For information on setting the time, refer to the separate COMAND operating instructions.

- ▶ Move the selection marker with button **+** or **-** to the Time/Date submenu.

- ▶ Press button **▲** or **▼** repeatedly until the message Time Minutes appears in the multifunction display.

The selection marker is on the minute setting.

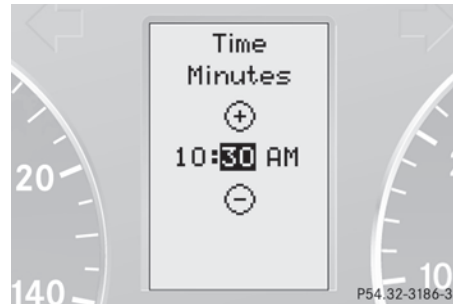

- ▶ Press button **+** or **-** to set the minutes.

Select automatic time change (Daylight Saving Time (DST) summer/Standard time winter)

This function can be seen in vehicles with audio system, or in vehicles with COMAND* if the time synchronization with head unit* feature was set to Off.

- ▶ Move the selection marker with button **+** or **-** to the Time/Date submenu.

- ▶ Press button **▲** or **▼** repeatedly until the message Daylight sav. Summer / Winter time appears in the multifunction display.

The selection marker is on the current setting.

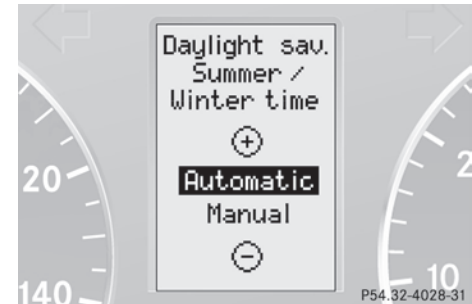

- ▶ Press button **+** or **-** to select if the changeover between summer and winter time should be automatic or manual.

Control system

Set the date (month)

This function can be seen in vehicles with audio system, or in vehicles with COMAND* if the time synchronization with head unit* feature was set to Off.

i Vehicles with COMAND*:

For information on setting the date, refer to the separate COMAND operating instructions.

- ▶ Move the selection marker with button **+** or **-** to the Time/Date submenu.
- ▶ Press button **↶** or **↷** repeatedly until the message Date Set month appears in the multifunction display.

The selection marker is on the month setting.

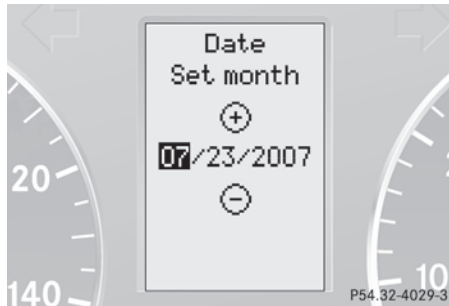

- ▶ Press button **+** or **-** to set the month.

Set the date (day)

This function can be seen in vehicles with audio system, or in vehicles with COMAND* if the time synchronization with head unit* feature was set to Off.

i Vehicles with COMAND*:

For information on setting the date, refer to the separate COMAND operating instructions.

- ▶ Move the selection marker with button **+** or **-** to the Time/Date submenu.

- ▶ Press button **↶** or **↷** repeatedly until the message Date Set day appears in the multifunction display.

The selection marker is on the day setting.

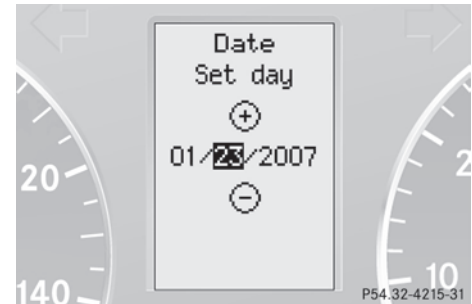

- ▶ Press button **+** or **-** to set the day.

Set the date (year)

This function can be seen in vehicles with audio system, or in vehicles with COMAND* if the time synchronization with head unit* feature was set to Off.

i *Vehicles with COMAND*:*
For information on setting the date, refer to the separate COMAND operating instructions.

- ▶ Move the selection marker with button **+** or **-** to the Time/Date submenu.
- ▶ Press button **↕** or **↓** repeatedly until the message **Date Set year** appears in the multifunction display.

The selection marker is on the year setting.



- ▶ Press button **+** or **-** to set the year.

Lighting submenu

Access the Lighting submenu via the Settings menu. Use the Lighting submenu to change the lamp and lighting settings on your vehicle.

The following functions are available:

Function	Page
Setting daytime running lamp mode (USA only)	139
Setting locator lighting	140
Setting night security illumination	141
Setting interior lighting delayed shut-off	142

Setting daytime running lamp mode (USA only)

i *This function is not available in countries where the daytime running lamp mode is mandatory and therefore in a constant mode.*

- ▶ Move the selection marker with button **+** or **-** to the Lighting submenu.
- ▶ Press button **↕** or **↓** repeatedly until the message **Headlamp mode** appears in the multifunction display.

The selection marker is on the current setting.

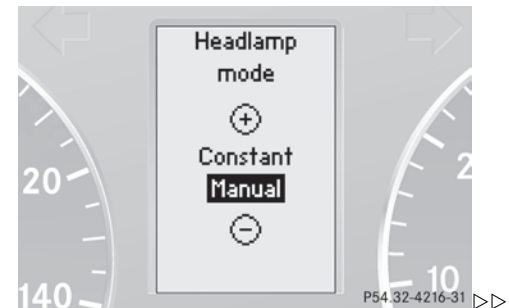

Control system

- ▷▷▶ Press button **+** or **-** to select manual operation (Manual) or daytime running lamp mode (Constant).

With daytime running lamp mode activated and the exterior lamp switch in position **0** or **AUTO**, the low beam headlamps are switched on when the engine is running.

In low ambient light conditions the following lamps will switch on additionally:

- Parking lamps
- Tail lamps
- License plate lamps
- Side marker lamps

For more information on the daytime running lamp mode, see “Lighting” (▷ page 109).

i For safety reasons, resetting the Lighting submenu to factory settings (▷ page 131) while driving will not deactivate the daytime running lamp mode.

The following message appears in the multifunction display:

Lighting - Cannot be completely reset to factory settings while driving.

Setting locator lighting

With the locator lighting feature activated and the exterior lamp switch in position **AUTO**, the following lamps will switch on during darkness when the vehicle is unlocked with the SmartKey:

- Parking lamps
- Tail lamps
- License plate lamps
- Side marker lamps
- Front fog lamps

The locator lighting switches off when the driver's door is opened.

If you do not open a door after unlocking the vehicle with the SmartKey, the lamps will switch off automatically after approximately 40 seconds.

- ▶ Move the selection marker with button **+** or **-** to the Lighting submenu.
- ▶ Press button **↶** or **↷** repeatedly until the message Surround lighting appears in the multifunction display.

The selection marker is on the current setting.

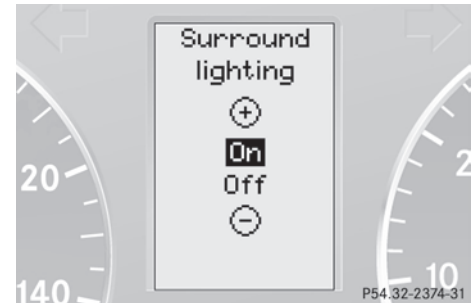

- ▶ Press button **+** or **-** to switch the locator lighting function On or Off.

- ▶ Turn the exterior lamp switch to position **AUTO** when exiting the vehicle. The locator lighting feature is activated.

Setting night security illumination (Headlamps delayed shut-off feature)

Use this function to set whether you would like the exterior lamps to remain on for 15 seconds during darkness after exiting the vehicle and closing all doors.

With the headlamps delayed shut-off feature activated and the exterior lamp switch in position **AUTO** before the engine is turned off, the following lamps will switch on when the engine is turned off:

- Parking lamps
- Tail lamps
- License plate lamps
- Side marker lamps
- Front fog lamps

If after turning off the engine you do not open a door or do not close an opened door, the lamps will automatically switch off after 60 seconds.

- ▶ Move the selection marker with button **+** or **-** to the Lighting submenu.
- ▶ Press button **▲** or **▼** repeatedly until the message **Headl. delayed shut-off** appears in the multifunction display.

The selection marker is on the current setting.

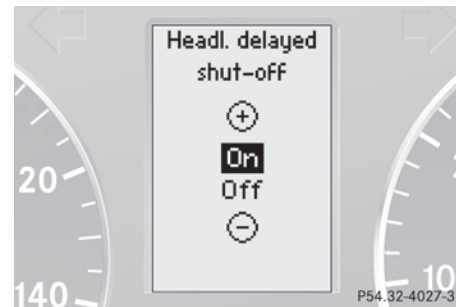

- ▶ Press button **+** or **-** to switch the headlamps delayed shut-off feature On or Off.
- ▶ Turn the exterior lamp switch to position **AUTO** before turning off the engine.

The headlamps delayed shut-off feature is activated.

You can temporarily deactivate the headlamp delayed shut-off feature:

- ▶ Before exiting the vehicle, turn the SmartKey in the starter switch to position **0**.
- ▶ Then turn it to position **2** and back to position **0**.

The headlamps delayed shut-off feature is deactivated. It will reactivate as soon as you reinsert the SmartKey in the starter switch.

Control system

Setting interior lighting delayed shut-off

Use this function to set whether you would like the interior lighting to remain on for 10 seconds during darkness after you have removed the SmartKey from the starter switch.

- ▶ Move the selection marker with button **+** or **-** to the Lighting submenu.
- ▶ Press button **↶** or **↷** repeatedly until the message Interior light. delay. sw.off appears in the multifunction display.

The selection marker is on the current setting.

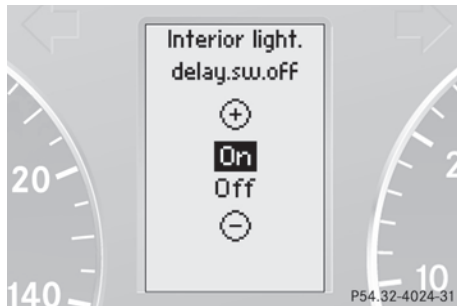

- ▶ Press button **+** or **-** to switch the interior lighting delayed shut-off feature Off or On.

Vehicle submenu

Access the Vehicle submenu via the Settings menu. Use the Vehicle submenu to make general vehicle settings.

The following function is available:

Function	Page
Selecting audio search function	142
Setting automatic locking	143

Selecting audio search function

Use of the Audio search function to select a radio station (▷ page 127) will enable you to start a frequency scan (Frequency) or select a radio station stored in memory (Memory).

- ▶ Move the selection marker with button **+** or **-** to the Vehicle submenu.

- ▶ Press button **↶** or **↷** repeatedly until the message Audio search appears in the multifunction display.

The selection marker is on the current setting.

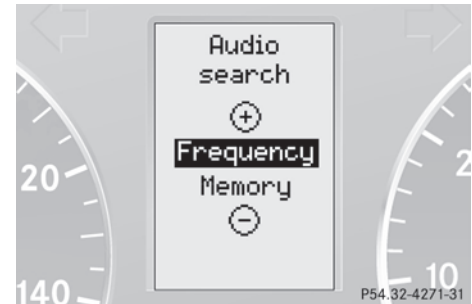

- ▶ Press button **+** or **-** to set the audio search function to Frequency or Memory.

To select a radio station, see “Selecting radio station” (▷ page 127).

Setting automatic locking

Use this function to activate or deactivate the automatic central locking. With the automatic central locking system activated, the vehicle is centrally locked at vehicle speeds of approximately 9 mph (15 km/h).

- ▶ Move the selection marker with button **+** or **-** to the Vehicle submenu.
- ▶ Press button **↶** or **↷** repeatedly until the message *Automatic door lock* appears in the multifunction display.

The selection marker is on the current setting.

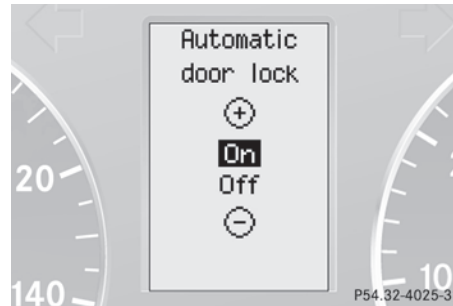

- ▶ Press button **+** or **-** to switch the automatic central locking On or Off.

Convenience submenu

Access the Convenience submenu via the Settings menu. Use the Convenience submenu to change the settings for a number of convenience features.

The following functions are available:

Function	Page
Activate easy-entry/exit feature*	144

Control system

Activate easy-entry/exit feature*

Use this function to activate and deactivate the easy-entry/exit feature (▷ page 40).

Warning!



You must make sure no one can become trapped or injured by the moving steering wheel when the easy-entry/exit feature is activated.

To stop steering wheel movement, do one of the following:

- Move steering wheel adjustment stalk* (▷ page 40).
- Press memory position switch* (▷ page 108).

Do not leave children unattended in the vehicle, or with access to an unlocked vehicle. Children could open the driver's door and unintentionally activate the easy-entry/exit feature, which could result in an accident and/or serious personal injury.

- ▶ Move the selection marker with button **+** or **-** to the Convenience submenu.
- ▶ Press button **↶** or **↷** repeatedly until the message *Easy-entry feature* appears in the multifunction display.

The selection marker is on the current setting.

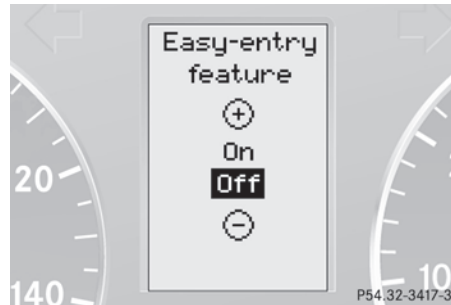

- ▶ Press button **+** or **-** to switch the easy-entry feature On or Off.

Trip computer menu

Use the trip computer menu to call up statistical data on your vehicle.

The following information is available:

Function	Page
Fuel consumption statistics from start	144
Fuel consumption statistics since last reset	145
Distance to empty	146

Fuel consumption statistics from start

- ▶ Press button **☰** or **☷** repeatedly until the first function of the trip computer menu appears in the multifunction display.
- ▶ Press button **↶** or **↷** repeatedly until the message *From start* appears in the multifunction display.

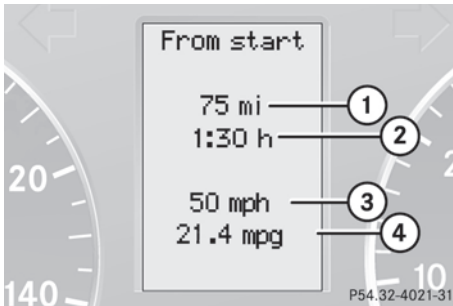

- ① Distance driven since start
- ② Time elapsed since start
- ③ Average speed since start
- ④ Average fuel consumption since start

i All statistics stored since the last engine start will be reset approximately 4 hours after the SmartKey in the starter switch is turned to position 0 or removed from the starter switch.

Resetting will not occur if you turn the SmartKey back to position 1 or 2 within this time period.

Fuel consumption since last reset

- ▶ Press button or repeatedly until the first function of the trip computer menu appears in the multifunction display.
- ▶ Press button or repeatedly until the message **Since reset** appears in the multifunction display.

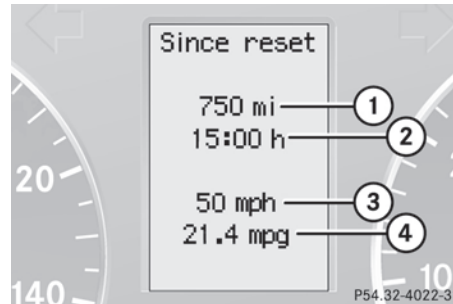





- ① Distance driven since last reset
- ② Time elapsed since last reset
- ③ Average speed since last reset
- ④ Average fuel consumption since last reset

Resetting fuel consumption statistics

- ▶ Press button or repeatedly until the first function of the trip computer menu appears in the multifunction display.
- ▶ Press button or repeatedly until the reading that you want to reset appears in the multifunction display.
- ▶ Press and hold the reset button in the instrument cluster (▷ page 118) until the value is reset to 0.

Control system

Distance to empty

- ▶ Switch on the ignition (▷ page 32).
- ▶ Press button  or  repeatedly until the first function of the trip computer menu appears in the multifunction display.
- ▶ Press button  or  repeatedly until the message **Range:** appears in the multifunction display.

The calculated remaining driving range based on the current fuel tank level appears in the multifunction display.

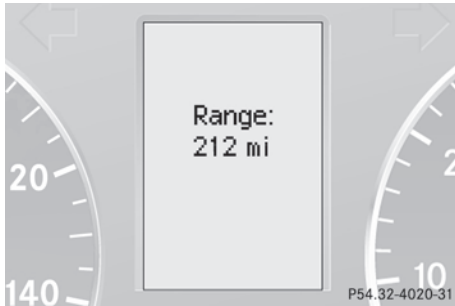

TEL menu*

Warning!





A driver's attention to the road must always be his/her primary focus when driving. For your safety and the safety of others, we recommend that you pull over to a safe location and stop before placing or taking a telephone call. If you choose to use the telephone while driving, please use the hands-free device and only use the telephone when weather, road and traffic conditions permit.

Some jurisdictions prohibit the driver from using a cellular telephone while driving a vehicle.

Bear in mind that at a speed of just 30 mph (approximately 50 km/h), your vehicle is covering a distance of 44 feet (approximately 14 m) every second.

Never operate radio transmitters equipped with a built-in or attached antenna (i.e. without being connected to an external antenna) from inside the vehicle while the engine is running. Doing so could lead to a malfunction of the vehicle's electronic system, possibly resulting in an accident and personal injury.

You can use the functions in the TEL menu to operate your telephone, provided it is connected to a hands-free system and switched on.

- ▶ Switch on the telephone and Audio or COMAND*.
- ▶ Press button  or  on the steering wheel repeatedly until the message **TEL** appears in the multifunction display.

Which messages will appear in the multifunction display depends on whether your telephone is switched on or off:

- If the telephone is off, the message `Phone off` appears in the multifunction display.
- If the telephone is on:

The telephone will then search for a network. During this time the multifunction display is empty.

As soon as the telephone has found a network, the message `READY` appears in the multifunction display.



This standby message indicates that your telephone is ready for use and you can operate it using the control system.

Answering a call

When your telephone is ready to receive calls, you can answer a call at any time. In the multifunction display you will see the message, or if available, the caller ID (name and number):



- ▶ Press button .





You have answered the call. The duration of the call appears in the multifunction display.

Ending a call or rejecting an incoming call

- ▶ Press button .



Dialing a number from the phone book

If your telephone is ready to receive calls, you may select and dial a number from the phone book at any time.

- ▶ Press button  or  repeatedly until the message `TEL` appears in the multifunction display.
- ▶ Press button  or .

The control system reads the phone book which is stored in the telephone. This may take several minutes. The message `Please wait` appears in the multifunction display.

When the message `Please wait` disappears, the phone book has been loaded.

- ▶ Press button  or  repeatedly until the desired name appears in the multifunction display.



The stored names are displayed in ascending or descending alphabetical order.



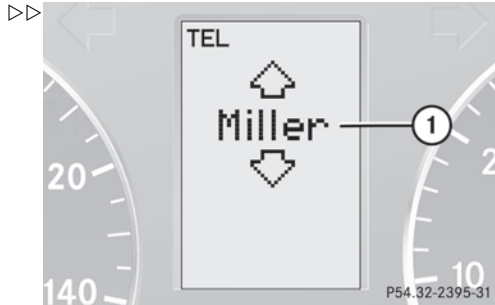

Control system



① Name from the phone book

i If you press and hold button  or  for longer than 1 second, the system scrolls rapidly through the list of names until you release the button again.

Cancel the quick search mode by pressing button .

▶ Press button .

The system dials the selected phone number.

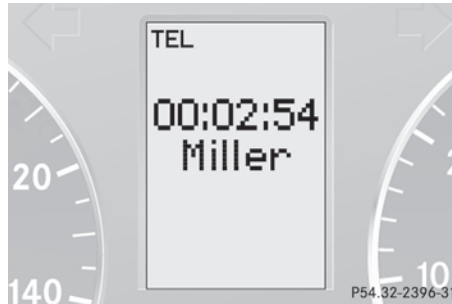

- If the connection is successful and this feature is supported by your network provider, the name of the party you are calling (if stored in your phone book) and the duration of the call will appear in the multifunction display.



- If no connection is made, the control system stores the dialed number in the redial memory.



Redialing

The control system stores the most recently dialed phone numbers. This eliminates the need to search through your entire phone book.

▶ Press button  or  repeatedly until the message TEL appears in the multifunction display.

▶ Press button .

The first number in the redial memory appears in the multifunction display.

▶ Press button  or  repeatedly until the desired name appears in the multifunction display.

▶ Press button .

The control system dials the selected phone number.

▼ Manual transmission

Manual transmission is standard equipment on select models and not available on all models.

For information on driving with a manual transmission, see “Manual transmission” (▷ page 46).

Warning!



For vehicles equipped with a manual transmission, getting out of your vehicle with the gearshift lever not engaged in first or reverse gear and parking brake engaged is dangerous.

Also, when parked on an incline, an engaged first or reverse gear alone may not prevent your vehicle from moving, possibly hitting people or objects.

Always set the parking brake in addition to engaging first or reverse gear (▷ page 54).

When parked on an incline, turn front wheels towards the road curb.

Do not park this vehicle in areas where combustible materials such as grass, hay or leaves can come into contact with the hot exhaust system, as these materials could be ignited and cause a vehicle fire.

Warning!



When leaving the vehicle, always remove the SmartKey from the starter switch, take it with you, and lock the vehicle. Do not leave children unattended in the vehicle, or with access to an unlocked vehicle. Children could move the gearshift lever, which could result in an accident and/or serious personal injury.

Warning!



On slippery road surfaces, never downshift in order to obtain braking action. This could result in drive wheel slip and reduced vehicle control. Your vehicle's ABS will not prevent this type of loss of control.

Warning!



Make sure that absolutely no objects are obstructing the pedals' range of movement. Keep the driver's footwell clear of all obstacles. If there are any floor mats or carpets in the footwell, make sure that the pedals still have sufficient clearance.

During sudden driving or braking maneuvers the objects could get caught between or beneath the pedals. You could then no longer brake or accelerate. This could lead to accidents and injury.

Manual transmission

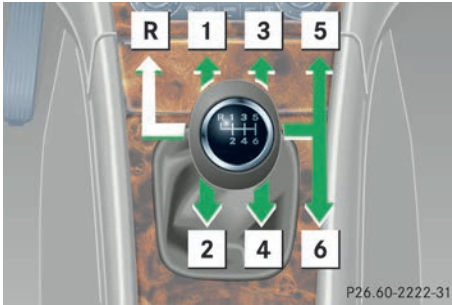

Gearshift pattern for manual transmission

! When you are shifting into the **5th** or **6th** gear, make sure that you press the gearshift lever to the right. Otherwise, you could accidentally shift into the **3th** or **4th** gear and damage the transmission.

Downshifting gears leading to overrevving the engine can result in engine damage that is not covered by the Mercedes-Benz Limited Warranty.

Never hold the vehicle stopped on a hill by using the clutch pedal. The clutch may be damaged which is not covered by the Mercedes-Benz Limited Warranty.

Do not exceed the engine speed limits. Refer to tachometer (▷ page 120) for engine speeds.

Shifting into reverse

! Only shift into reverse gear **R** when the vehicle is stationary, as the transmission could otherwise be damaged.

- ▶ Stop the vehicle completely.
- ▶ Fully depress clutch pedal.
- ▶ Move the gearshift lever to neutral position (no gear selected).
- ▶ Move the gearshift lever to the left until you feel a certain resistance.
- ▶ Push the gearshift lever past this resistance.
- ▶ Then move the gearshift lever forward into position **R**.

▼ Automatic transmission*

Automatic transmission is standard equipment on select models and available as optional equipment on select other models.

For more information on driving with an automatic transmission, see “Automatic transmission*” (▷ page 47).

Your vehicle’s transmission adapts its gear shifting process to your individual driving style by continually adjusting the shift points up or down. These shift point adjustments are performed based on current operating and driving conditions.

If the operating conditions change, the automatic transmission reacts by adjusting its shift program.

i *During the brief warm-up, transmission upshifting is delayed. This allows the catalytic converter to heat up more quickly to operating temperature.*

Warning!



Make sure that absolutely no objects are obstructing the pedals’ range of movement. Keep the driver’s footwell clear of all obstacles. If there are any floor mats or carpets in the footwell, make sure that the pedals still have sufficient clearance.

During sudden driving or braking maneuvers the objects could get caught between or beneath the pedals. You could then no longer brake or accelerate. This could lead to accidents and injury.

Gear selector lever

The gear selector lever is located on the lower part of the center console.



Gearshift pattern for automatic transmission

- P** Park position
- R** Reverse gear
- N** Neutral
- D** Drive position

i *The current gear selector lever position **P**, **R**, **N** or **D** appears in the multifunction display (▷ page 153).*

Automatic transmission*

Warning!



It is dangerous to shift the gear selector lever out of park position **P** or neutral position **N** if the engine speed is higher than idle speed. If your foot is not firmly on the brake pedal, the vehicle could accelerate quickly forward or reverse. You could lose control of the vehicle and hit someone or something. Only shift into gear when the engine is idling normally and when your right foot is firmly on the brake pedal.

An additional indication of the current gear selector lever position can be found on the cover of the shifting-gate.

The indicators come on when you activate a switch (e.g. unlocking the vehicle or opening a door) and go out after approximately 15 minutes.

Shifting procedure

The automatic transmission selects individual gears automatically, depending on:

- gear selector lever position **D**
(▷ page 153) with gear ranges
(▷ page 156)
- the selected program mode (**C/S**)
(▷ page 157)
- the position of the accelerator pedal
(▷ page 155)
- the vehicle speed

! Allow engine to warm up under low load use. Do not place full load on the engine until the operating temperature has been reached.

Shift into reverse gear **R** or park position **P** only when the vehicle is stopped.

Avoid spinning of a drive wheel when driving off on slippery road surfaces. This may cause serious damage to the drivetrain which is not covered by the Mercedes-Benz Limited Warranty.

When the gear selector lever is in drive position **D**, you can influence transmission shifting by:

- limiting the gear range
- changing gears manually

Gear selector lever positions

The current gear selector lever position appears in the multifunction display.



① Current gear selector lever position

	Effect
P	<p>Park position</p> <p>Gear selector lever position when the vehicle is parked. Place gear selector lever in park position P only when vehicle is stopped. The park position is not intended to serve as a brake when the vehicle is parked.</p>

	Effect
	<p>Rather, the driver should always set the parking brake in addition to placing the gear selector lever in park position P to secure the vehicle.</p> <p>The SmartKey can only be removed from the starter switch with the gear selector lever in park position P. With the SmartKey removed, the gear selector lever is locked in park position P.</p> <p>If the vehicle's electrical system is malfunctioning, the gear selector lever could remain locked in park position P (▷ page 363).</p>
R	<p>Reverse gear</p> <p>Place gear selector lever in position R only when vehicle is stopped.</p>

	Effect
N	<p>Neutral</p> <p>No power is transmitted from the engine to the drive axle. When the brakes are released, the vehicle can be moved freely (pushed or towed).</p> <p>To avoid damage to the transmission, never engage neutral position N while driving.</p> <p>If the ESP® is deactivated or malfunctioning: Move gear selector lever to neutral position N only if the vehicle is in danger of skidding, e.g. on icy roads.</p>
D	<p>Drive</p> <p>The transmission shifts automatically. All forward gears are available.</p>

Automatic transmission*

! *Coasting the vehicle, or driving for any other reason with gear selector lever in neutral position **N** can result in transmission damage that is not covered by the Mercedes-Benz Limited Warranty.*

Warning!



Position **P** alone is not intended to or capable of preventing your vehicle from moving, possibly hitting people or objects. Always set the parking brake in addition to shifting to park position **P** (▷ page 54).

When parked on an incline, turn the front wheels towards the road curb.

Do not park this vehicle in areas where combustible materials such as grass, hay or leaves can come into contact with the hot exhaust system, as these materials could be ignited and cause a vehicle fire.

Warning!



When leaving the vehicle, always remove the SmartKey from the starter switch, take it with you, and lock the vehicle. Do not leave children unattended in the vehicle, or with access to an unlocked vehicle. Children could move the gear selector lever from park position **P**, which could result in an accident and/or serious personal injury.

Getting out of your vehicle without taking the above measurements to secure it is dangerous.

Driving tips

Accelerator position

Your driving style influences the transmission's shifting behavior:

Less throttle	Earlier upshifting
More throttle	Later upshifting

Kickdown

Use kickdown when you want maximum acceleration.

- ▶ Press the accelerator past the point of resistance.
Depending on the engine speed the transmission shifts into a lower gear.
- ▶ Ease on the accelerator when you have reached the desired speed.
The transmission shifts up again.

Stopping

When you stop briefly, e.g. at traffic lights:

- ▶ Leave the transmission in gear.
- ▶ Hold the vehicle with the brake.

When you stop for a longer period of time with the engine idling and/or on a hill:

- ▶ Set the parking brake.
- ▶ Move the gear selector lever to park position **P**.

Maneuvering

When you maneuver in tight areas, e.g. when pulling into a parking space:

- ▶ Control the vehicle speed by gradually releasing the brakes.
- ▶ Accelerate gently.
- ▶ Never abruptly step on the accelerator.

Working on the vehicle

Warning!



When working on the vehicle, set the parking brake and move gear selector lever to park position **P**. Otherwise the vehicle could roll away.

Automatic transmission*

Gear ranges

With the gear selector lever in drive position **D**, you can select a gear range for the automatic transmission to operate within.

You can limit the gear range by pressing the gear selector lever to the left (**D-**), and reverse the gear range limit by pressing the gear selector lever to the right (**D+**) (▷ page 158).

The selected gear range appears in the multifunction display.



① Current gear range

Effect

- 6** The transmission shifts through sixth gear only (applies to vehicles with 7-speed automatic transmission only).
- 5** The transmission shifts through fifth gear only (applies to vehicles with 7-speed automatic transmission only).
- 4** The transmission shifts through fourth gear only.
- 3** The transmission shifts through third gear only.
With this selection you can use the braking effect of the engine.

Effect

- 2** The transmission shifts through second gear only.
Allows the use of engine's braking power when driving
 - on steep downgrades
 - in mountainous regions
 - under extreme operating conditions
- 1** The transmission operates in first gear only.
For maximum use of engine's braking effect on very steep or lengthy downgrades.

Automatic shift program

The program mode selector switch is located on the lower part of the center console.



Program mode selector switch

- | | |
|------------------|----------------------|
| C Comfort | For comfort driving |
| S Sport | For standard driving |

The selected program mode appears in the multifunction display.



① Selected program mode (comfort or sport)

! *Never change the program mode when the gear selector lever is out of park position **P**. This could result in a change of driving characteristics for which you may not be prepared.*

i *The last selected program mode (**C** or **S**) is switched on when the engine is restarted.*

► Press program mode selector switch repeatedly until the letter of the desired program mode appears in the multifunction display.

Select **C** for comfort driving:

- The vehicle starts out in second gear (both forward and reverse) for gentler starts. This does not apply if full throttle is applied or gear range **1** is selected.

- Traction and driving stability are improved on icy roads.

- Upshifts occur earlier even when you give more gas. The engine then operates at lower rpms and the wheels are less likely to spin.

Select **S** for standard driving:

- The vehicle starts out in first gear.
- Upshifts occur later.

Automatic transmission*

One-touch gearshifting

With the gear selector lever in drive position **D**, you can limit or extend the gear range.

! *Allow engine to warm up under low load use. Do not place full load on the engine until the operating temperature has been reached.*

*Shift into reverse gear **R** or park position **P** only when the vehicle is stopped.*

Avoid spinning of a drive wheel when driving off on slippery road surfaces. This may cause serious damage to the drivetrain which is not covered by the Mercedes-Benz Limited Warranty.

Limiting gear range

Warning!



On slippery road surfaces, never downshift in order to obtain braking action. This could result in drive wheel slip and reduced vehicle control. Your vehicle's ABS will not prevent this type of loss of control.

- ▶ Briefly press the gear selector lever to the left in the **D-** direction.

The transmission will shift to the next lower gear as permitted by the shift program. This action simultaneously limits the gear range of the transmission (▷ page 156).

i *To avoid overrevving the engine when downshifting, the transmission will not shift to a lower gear if the engine's max. speed would be exceeded.*

Extending gear range

- ▶ Briefly press the gear selector lever to the right in the **D+** direction.

The transmission will shift to the next higher gear as permitted by the shift program. This action simultaneously extends the gear range of the transmission.

i *If you press on the accelerator when the engine has reached its rpm limit, the transmission will upshift beyond any gear range limit selected.*

Canceling gear range limit

- ▶ Press and hold the gear selector lever in the **D+** direction until **D** reappears in the multifunction display (> page 153).

The transmission will shift from the current gear range directly to gear range **D**.

Shifting into optimal gear range

- ▶ Press and hold the gear selector lever in the **D-** direction.

The transmission will automatically select the gear range suited for optimal acceleration and deceleration. This will involve shifting down one or more gears.

Emergency operation (Limp-Home Mode)

If vehicle acceleration becomes less responsive or sluggish or the transmission no longer shifts, the transmission is most likely operating in limp-home (emergency operation) mode. In this mode only second gear and reverse gear can be selected.

- ▶ Stop the vehicle in a safe location.
- ▶ Move the gear selector lever to park position **P**.
- ▶ Turn off the engine.
- ▶ Wait at least 10 seconds before restarting.
- ▶ Restart the engine.
- ▶ Move the gear selector lever to position **D** (for second gear) or position **R**.
- ▶ Have the transmission checked at an authorized Mercedes-Benz Center as soon as possible.

Good visibility

For information on the windshield wipers, see “Windshield wipers” (▷ page 51).

Headlamp cleaning system*

The button is located on the left side of the dashboard.

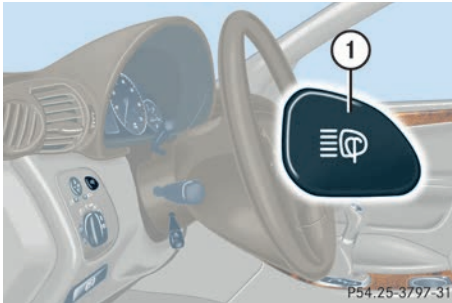

① Headlamp washer button

- ▶ Switch on the ignition (▷ page 32).
- ▶ Press button ①.

The headlamps are cleaned with a high-pressure water jet.

i The headlamps will automatically be cleaned when you have

- switched on the headlamps and
- operated the windshield wipers with windshield washer fluid fifteen times

When you switch off the ignition, the counter resets.

For information on filling up the washer reservoir, see “Windshield washer system and headlamp cleaning system*” (▷ page 280).

Rear view mirrors

For more information on setting the rear view mirrors, see “Mirrors” (▷ page 41).

Interior rear view mirror, antiglare position

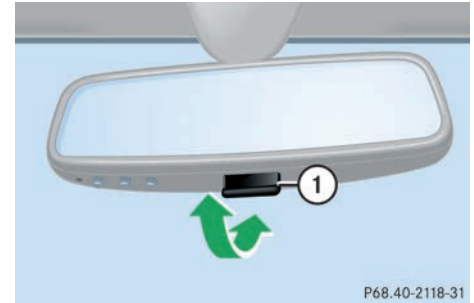

① Lever

- ▶ Tilt the mirror to the antiglare position by moving lever ① towards the windshield.

The interior rear view mirror is dimmed.

Auto-dimming rear view mirrors*

The reflection brightness of the exterior rear view mirror on the driver's side and the interior rear view mirror will respond automatically to glare when

- the ignition is switched on and
- incoming light from headlamps falls on the sensor in the interior rear view mirror.

The rear view mirror will not react if

- reverse gear **R** is engaged
- the interior lighting is turned on

Warning!



The auto-dimming function does not react if incoming light is not aimed directly at sensors in the interior rear view mirror.

The interior rear view mirror and the exterior rear view mirror on the driver's side do not

react, for example, if the rear window sunshade* is in raised position.

Light hitting the mirror(s) at certain angles (incident light) could blind you. As a result, you may not be able to observe traffic conditions and could cause an accident.

Warning!



In the case of an accident, liquid electrolyte may escape from the mirror housing if the mirror glass breaks.

Electrolyte has an irritating effect. Do not allow the liquid to come into contact with eyes, skin, clothing, or respiratory system. In case it does, immediately flush affected area with water, and seek medical help if necessary.

! *Electrolyte drops coming into contact with the vehicle paint finish can be completely removed only while in the liquid state and by applying plenty of water.*

Warning!



Exercise care when using the passenger-side exterior rear view mirror. The mirror surface is convex (outwardly curved surface for a wider field of view). Objects in mirror are closer than they appear. Check your interior rear view mirror or glance over your shoulder before changing lanes.

Sun visors

The sun visors protect you from sun glare while driving.

Warning!



Do not use the vanity mirror while driving.

Keep the vanity mirrors in the sun visors closed while vehicle is in motion. Reflected glare can endanger you and others.

Good visibility

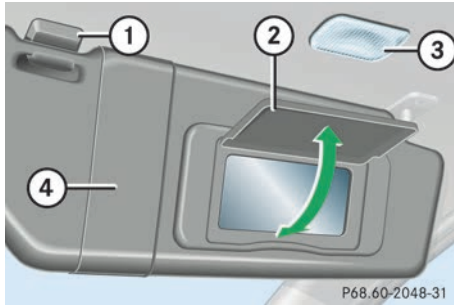

- ① Mounting
- ② Vanity mirror cover
- ③ Vanity mirror lamp
- ④ Sun visor

- ▶ Swing sun visor ④ down when you experience glare.
- ▶ To use illuminated vanity mirror, lift up vanity mirror cover ②.

i If sun visor ④ is disengaged from mounting ① with vanity mirror cover ② open, vanity mirror lamp ③ will switch off.

i If sunlight enters through a side window, close vanity mirror cover ② (if open), disengage sun visor ④ from mounting ① and pivot to the side.

Rear window sunshade*

Warning!



When operating the rear window sunshade, make sure there is no danger of anyone being harmed by the raising or lowering procedure.

The raising or lowering procedure can be immediately halted by briefly pressing the switch.

Briefly press switch again to raise or lower the rear window sunshade completely.

Warning!



When leaving the vehicle, always remove the SmartKey from the starter switch, take it with you, and lock the vehicle. Do not leave children unattended in the vehicle, or with access to an unlocked vehicle. A child's unsupervised access to a vehicle could result in an accident and/or serious personal injury.

The switch is located in the center console.

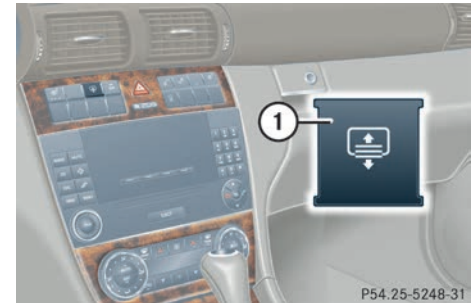

- ① Rear window sunshade switch

! Make sure that the movement of the rear window sunshade is not restricted by objects on the rear window shelf. Otherwise, the sunshade or the objects could be damaged.

- ▶ Switch on the ignition (▷ page 32).

Always raise or lower the sunshade fully for its support against the window frame.

Raising or lowering the sunshade

- ▶ Press switch ① briefly.

The sunshade is raised or lowered completely.

Stopping the raising or lowering procedure

- ▶ Press switch ① again.

The sunshade stops.

Rear window defroster

The rear window defroster uses a large amount of power. To keep the battery drain to a minimum, switch off the defroster as soon as the rear window is clear.

The defroster is automatically deactivated after approximately 6 to 17 minutes of operation depending on the outside temperature.



Warning!



Any accumulation of snow and ice should be removed from the rear window before driving. Visibility could otherwise be impaired, endangering you and others.

- ▶ Switch on the ignition (▷ page 32).

Activating

- ▶ Press button  or  in the climate control panel (▷ page 165) or automatic climate control panel* (▷ page 175).

The indicator lamp on the button comes on.

Deactivating

- ▶ Press button  or  again.

The indicator lamp on the button goes out.

! If the rear window defroster switches off too soon and the indicator lamp starts flashing, this means that too many electrical consumers are operating simultaneously and there is insufficient voltage in the battery. The system responds automatically by deactivating the rear window defroster.

As soon as the battery has sufficient voltage, the rear window defroster automatically turns itself back on.

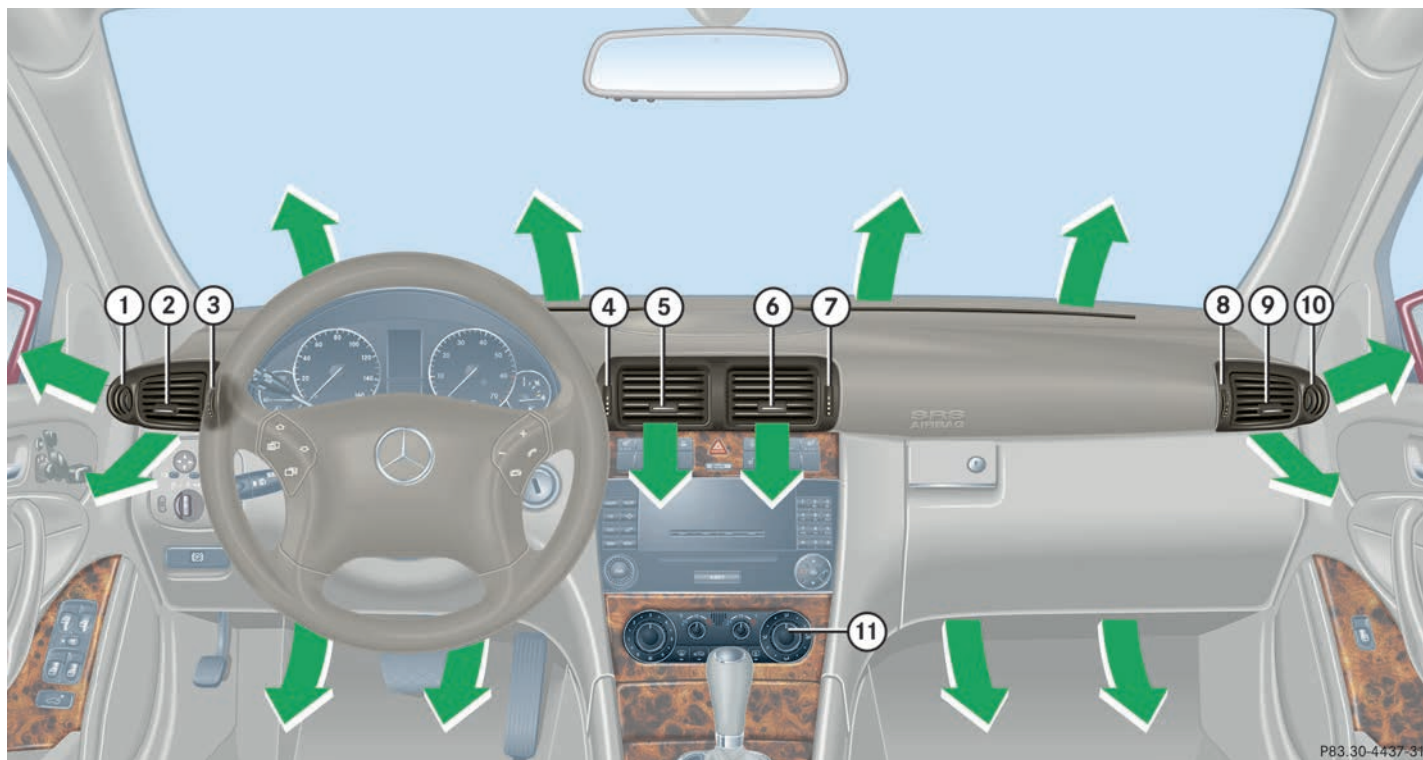

P83.30-4437-31

USA standard equipped with climate control, depending on vehicle production date. Canada standard equipped with climate control.

Item
① Left side defroster vent, fixed
② Left side air vent, adjustable
③ Thumbwheel for air volume control for left side air vent
④ Thumbwheel for air volume control for left center air vent
⑤ Left center air vent, adjustable
⑥ Right center air vent, adjustable
⑦ Thumbwheel for air volume control for right center air vent
⑧ Thumbwheel for air volume control for right side air vent
⑨ Right side air vent, adjustable
⑩ Right side defroster vent, fixed
⑪ Climate control panel

i For draft-free ventilation, move the sliders for the center air vents and side air vents to the middle position.



USA only (depending on vehicle production date)

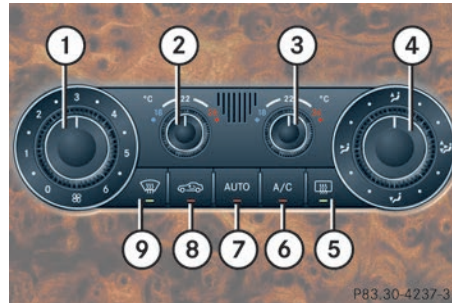

Canada only

Item
① Air volume control
② Left side temperature control
③ Right side temperature control
④ Air distribution control
⑤ Rear window defroster
⑥ AC cooling on/off
⑦ Air distribution and air volume (automatic mode)
⑧ Air recirculation
⑨ Front defroster

Climate control

The climate control is operational whenever the engine is running. You can operate the climate control system in either the automatic or manual mode. The system cools or heats the interior depending on the selected interior temperature and the current outside temperature.

Warning!



When operating the climate control, the air that enters the passenger compartment through the air vents can be very hot or very cold (depending on the set temperature). This may cause burns or frostbite on unprotected skin in the immediate area of the air vents. Always keep sufficient distance between unprotected parts of the body and the air vents. If necessary, use the air distribution control (> page 168) to direct the air to air vents in the vehicle interior that are not in the immediate area of unprotected skin.

Nearly all dust particles, pollutants and odors are filtered out before outside air enters the passenger compartment through the air distribution system.

The air conditioning will not engage (no cooling) if the **A/C** mode is deactivated (> page 172).

Warning!



Follow the recommended settings for heating and cooling given on the following pages. Otherwise the windows could fog up, impairing visibility and endangering you and others.

i Severe conditions (e.g. strong air pollution) may require replacement of the filter before its scheduled interval. A clogged filter will reduce the air volume to the interior.

If the vehicle interior is hot, ventilate the interior before driving off, see “Summer opening feature” (> page 223). The climate control will then adjust the interior temperature to the set value much faster.

Keep the air intake grille in front of the windshield free of snow and debris.

Do not obstruct air flow by placing objects on the air flow-through exhaust slots below the rear window.

Deactivating the climate control system

Warning!



When the climate control is switched off, the outside air supply and circulation are also switched off. Only choose this setting for a short time. Otherwise the windows could fog up, impairing visibility and endangering you and others.

Deactivating

- ▶ Set air volume control ① (▷ page 165) to position **0**.

Reactivating

- ▶ Make sure the ignition is switched on.
- ▶ Set air volume control ① (▷ page 165) to any speed.

The previous settings are once again in effect.

Operating the climate control system in automatic mode

i When operating the climate control system in automatic mode, you will only rarely need to adjust the temperature, air volume and air distribution.

*In automatic mode, the dehumidify function is switched on when the system is cooling. If necessary, this function can be switched off by pushing the **A/C** button.*

Activating

- ▶ Press button **AUTO** (▷ page 165) while the engine is running.

The indicator lamp on the button comes on. The air volume and air distribution are adjusted automatically.

- ▶ Use temperature controls ② and ③ (▷ page 165) to separately adjust the air temperature on each side of the passenger compartment.

The temperature of the vehicle interior is adjusted automatically.

Deactivating

- ▶ Press button **AUTO** (▷ page 165) again.

The indicator lamp on the button goes out. The automatic operation of air volume and air distribution switches off.

Climate control

Setting the temperature

Use temperature controls ② and ③ (▷ page 165) to separately adjust the air temperature on each side of the passenger compartment. You should raise or lower the temperature setting in small increments, preferably starting at 72°F (22°C). The climate control will adjust to the set temperature as fast as possible.

Increasing

- ▶ Turn temperature control ② and/or ③ (▷ page 165) slightly clockwise.

The climate control system will correspondingly adjust the interior air temperature.

i *If you turn the temperature control fully clockwise for one side of the vehicle, you are increasing the temperature for the other side of the vehicle as well.*

Decreasing





- ▶ Turn temperature control ② and/or ③ (▷ page 165) slightly counterclockwise.

The climate control system will correspondingly adjust the interior air temperature.

i *If you turn the temperature control fully counterclockwise for one side of the vehicle, you are decreasing the temperature for the other side of the vehicle as well.*

Adjusting air distribution and volume

Use air distribution control ④ (▷ page 165) to adjust the air distribution. The following symbols are located on the controls:

Symbol	Function
	Directs air through the center, side and rear passenger compartment air vents
	Directs air to the windshield and the side defroster vents
	Directs air into the entire vehicle interior
	Directs air to the footwells

- ▶ Press button **AUTO** (▷ page 165).

The indicator lamp on the button goes out. The automatic air distribution is switched off. The air distribution is controlled according to the selected control setting.

- ▶ Turn air distribution control ④ (▷ page 165) to the desired symbol.

Opening center and side air vents

- ▶ Turn thumbwheels ③, ④, ⑦ and ⑧ (▷ page 164) upward.

The center air vents ⑤ and ⑥ and side air vents ② and ⑨ are open.

Closing center and side air vents

- ▶ Turn thumbwheels ③, ④, ⑦ and ⑧ (▷ page 164) downward.

The center air vents ⑤ and ⑥ and side air vents ② and ⑨ are closed.

Adjusting air volume

Six blower speeds are available.

- ▶ Press button **AUTO** (▷ page 165).

The indicator lamp in the button goes out. The automatic air volume control is switched off. The air volume is adjusted according to the currently selected setting.



- ▶ Use the air volume control ① (▷ page 165) to adjust the air volume.

Front defroster

You can use this setting to defrost the windshield, for example if it is iced up. You can also defog the windshield and the side windows.

 *Keep this setting selected only until the windshield or the side windows are clear again.*

Activating

- ▶ Press button  or  (▷ page 165).

The indicator lamp on the button comes on.



The air conditioning switches automatically to the following functions:

- maximum blowing and heating power
- air flows onto the windshield and the front side windows
- the air recirculation mode is switched off

Climate control

i If you have switched on the defrost function using the  or  button, you cannot make any other settings.

Deactivating

- ▶ Press button  or  (> page 165) again.

The indicator lamp on the button goes out. Defrosting is turned off.

i The cooling remains switched on.

Windshield fogged on the outside

i Keep this setting selected only until the windshield is clear again.

- ▶ Switch the windshield wipers on (> page 51).

If the automatic mode of the climate control is switched off:



- ▶ Turn air distribution control ④ to  or  (> page 165).

Air recirculation mode

Switch to air recirculation mode to prevent unpleasant odors from entering the vehicle from the outside (e.g. before driving through a tunnel). This setting cuts off the intake of outside air and recirculates the air in the passenger compartment.

Warning!



Fogged windows impair visibility, endangering you and others. If the windows begin to fog on the inside, switching off the air recirculation mode immediately should clear interior window fogging. If interior window fogging persists, make sure the air conditioning (> page 172) is activated, or press button  or .

Activating

- ▶ Press button  (> page 165).

The indicator lamp on the button comes on.

i The air recirculation mode is activated automatically at high outside temperatures.

The indicator lamp on button  is not lit when the air recirculation mode is automatically switched on.

A quantity of outside air is added after approximately 30 minutes.

Deactivating

- ▶ Press button  (> page 165).

The indicator lamp on the button goes out.

 *The air recirculation mode is deactivated automatically:*

- *after 5 minutes if the outside temperature is below approximately 41 °F (5 °C)*
- *after 5 minutes if the air conditioning is turned off*
- *after 30 minutes if the outside temperature is above approximately 41 °F (5 °C)*

Air recirculation mode with convenience closing or opening feature

Warning!



Never operate the side windows and the tilt/sliding sunroof* if there is the possibility of anyone being harmed by the closing procedure.

When using the air recirculation mode with convenience closing feature, should the upward movement of a window be blocked by some obstructions including but not limited to arms, hands, fingers. etc., the automatic reversal feature will not operate.

In the event that the closing procedure causes potential danger, the closing of the side windows can be immediately halted by pressing or pulling the respective window switch. The closing of the tilt/sliding sunroof* can be immediately halted by moving the tilt/sliding sunroof* switch in the overhead control panel in any direction.

The closing of the side windows and tilt/sliding sunroof* can be reversed by again pressing and holding the  button.

Convenience closing

- ▶ Press button  (> page 165) for approximately 2 seconds.



The windows and tilt/sliding sunroof* will close. You can release button  once the closing procedure has begun. The windows and tilt/sliding sunroof* continue closing until they are fully closed. The indicator lamp on the button comes on. The air recirculation mode is activated.

Convenience opening

- ▶ Press button  for approximately 2 seconds.

The windows and tilt/sliding sunroof* will return to their previous position. You can release button  once the opening procedure has begun. The windows and tilt/sliding sunroof continue opening until they have reached their previous position. The indicator lamp on the button goes out. The air recirculation mode is deactivated.

Climate control

i A side window or tilt/sliding sunroof* will only return to its previous position if it has not been moved to another position using the respective side window switch or tilt/sliding sunroof* switch after it was closed with button . A side window or tilt/sliding sunroof* that was moved will remain in its current position if button  is used to re-open the remaining side windows or tilt/sliding sunroof*.

Air conditioning

The cooling function, only operational when the engine is running, cools the vehicle interior down to the selected temperature. The cooling function also dehumidifies the air in the vehicle interior, thus preventing the windows from fogging up.

i Condensation may drip out from underneath the vehicle. This is normal and not an indication of a malfunction.

Warning!



If you turn off the cooling function, the vehicle will not be cooled when weather conditions are warm. The windows can fog up more quickly. Window fogging may impair visibility and endanger you and others.

Deactivating

It is possible to deactivate the air conditioning (cooling) function of the climate control system. The air in the vehicle will then no longer be cooled or dehumidified.

- ▶ Press button  (▷ page 165).

The indicator lamp on the button goes out.

The cooling function switches off after a short delay.

Activating

Moist air can fog up the windows. You can dehumidify the air with the air conditioning.

- ▶ Press button  (▷ page 165).

The indicator lamp on the button comes on.

The air conditioning uses the refrigerant R134a. This refrigerant is free of CFCs which are harmful to the ozone layer.

! If the air conditioning cannot be turned on again, this indicates that the air conditioning is losing refrigerant. The compressor has turned itself off.

Have the air conditioning checked at the nearest authorized Mercedes-Benz Center.

Rear passenger compartment adjustable air vents

The air conditioning for the rear passenger compartment is controlled via the climate control panel (> page 165).

i The temperature at the center air vents ① and ③ for the rear passenger compartment is the same as at the dashboard center air vents.

The air vents for the rear passenger compartment are located in the rear center console.



- ① Left center air vent
- ② Thumbwheel for air volume control for center air vents
- ③ Right center air vent

Adjusting air distribution

- ▶ Push the slide for the left center vent ① or right center vent ③ to the left, right, up, or down.

The air flow is directed in the corresponding direction.

i For draft-free ventilation, move the sliders for the center air vents ① and ③ upward.

Adjusting air volume

- ▶ Turn thumbwheel ② up or down.

The air volume is increased or decreased.

Automatic climate control

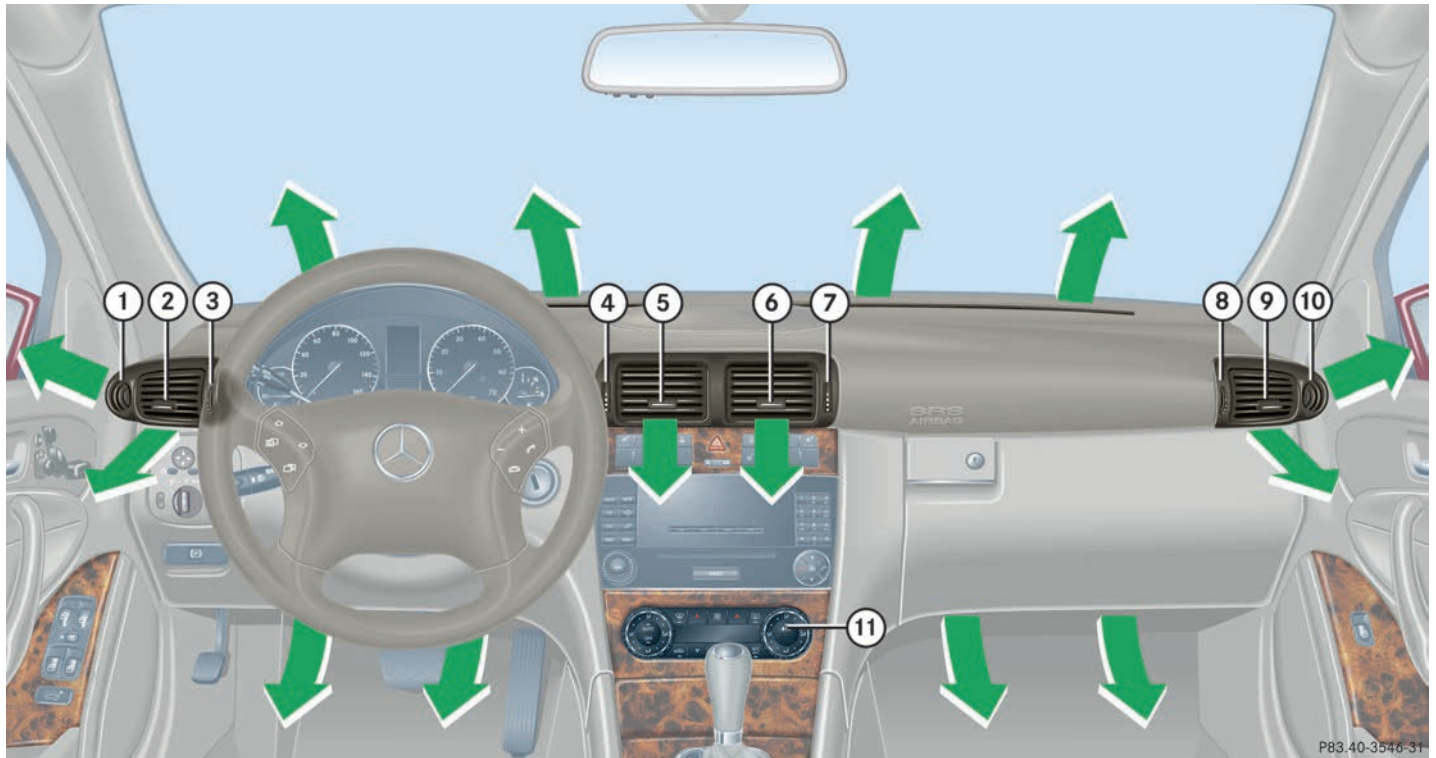

P83.40-3546-31

USA standard equipped with automatic climate control, depending on vehicle production date.
Automatic climate control* optional for Canada.

Automatic climate control

Item
① Left side defroster vent, fixed
② Left side air vent, adjustable
③ Thumbwheel for air volume control for left side air vent
④ Thumbwheel for air volume control for left center air vent
⑤ Left center air vent, adjustable
⑥ Right center air vent, adjustable
⑦ Thumbwheel for air volume control for right center air vent
⑧ Thumbwheel for air volume control for right side air vent
⑨ Right side air vent, adjustable
⑩ Right side defroster vent, fixed
⑪ Automatic climate control panel

i For draft-free ventilation, move the sliders for the center air vents and side air vents to the middle position.

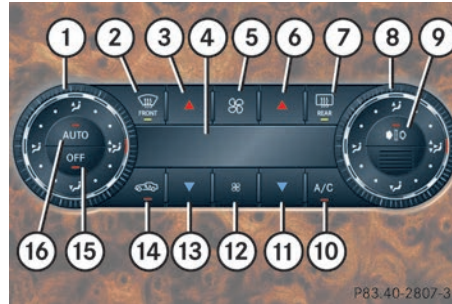

USA only (depending on vehicle production date)

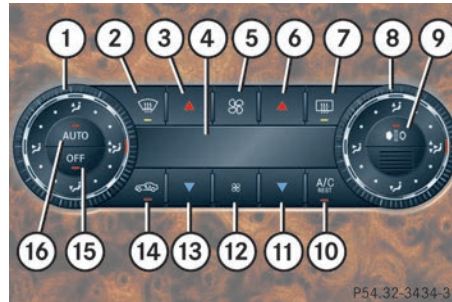

Canada only

Item
① Left side air distribution control
② Front defroster
③ Temperature control, left, raising
④ Display
⑤ Air volume control, raising
⑥ Temperature control, right, raising
⑦ Rear window defroster
⑧ Right side air distribution control
⑨ Charcoal filter
⑩ AC cooling on/off Residual heat/ventilation
⑪ Temperature control, right, lowering
⑫ Air volume control, lowering
⑬ Temperature control, left, lowering
⑭ Air recirculation
⑮ Automatic climate control on/off (complete system)
⑯ Air distribution and air volume (automatic mode)

Automatic climate control

The automatic climate control is operational whenever the engine is running. You can operate the automatic climate control system in either the automatic or manual mode. The system cools or heats the interior depending on the selected interior temperature and the current outside temperature.

Warning!



When operating the automatic climate control, the air that enters the passenger compartment through the air vents can be very hot or very cold (depending on the set temperature). This may cause burns or frostbite on unprotected skin in the immediate area of the air vents. Always keep sufficient distance between unprotected parts of the body and the air vents. If necessary, use the air distribution control (▷ page 178) to direct the air to air vents in the vehicle interior that are not in the immediate area of unprotected skin.

Nearly all dust particles, pollutants and odors are filtered out before outside air enters the passenger compartment through the air distribution system.

The air conditioning will not engage (no cooling) if the **A/C** mode is deactivated (▷ page 184).

Warning!



Follow the recommended settings for heating and cooling given on the following pages. Otherwise the windows could fog up, impairing visibility and endangering you and others.

i Severe conditions (e.g. strong air pollution) may require replacement of the filter before its scheduled interval. A clogged filter will reduce the air volume to the interior.

If the vehicle interior is hot, ventilate the interior before driving off, see “Summer opening feature” (▷ page 223). The automatic climate control will then adjust the interior temperature to the set value much faster.

Keep the air intake grille in front of the windshield free of snow and debris.

Do not obstruct air flow by placing objects on the air flow-through exhaust slots below the rear window.

Automatic climate control

Deactivating the automatic climate control system

Warning!



When the automatic climate control is switched off, the outside air supply and circulation are also switched off. Only choose this setting for a short time. Otherwise the windows could fog up, impairing visibility and endangering you and others.

Deactivating

- ▶ Press button **OFF** (▷ page 175).
The indicator lamp on the button comes on.

Reactivating

- ▶ Press button **OFF** (▷ page 175).
The indicator lamp on the button goes out. The previous settings are once again in effect.

Operating the automatic climate control system in automatic mode

i When operating the automatic climate control system in automatic mode, you will only rarely need to adjust the temperature, air volume and air distribution.

*In automatic mode, the dehumidify function is switched on when the system is cooling. If necessary, this function can be switched off by pushing the button **A/C** or **A/C BEST** (▷ page 175).*

i You can switch the automatic climate control system on and off for each side of the passenger compartment as desired.

Activating

- ▶ Press button **AUTO** (▷ page 175) while the engine is running.
The indicator lamp on the button comes on. The air volume and air distribution are adjusted automatically.

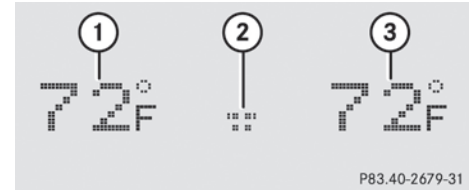

- ① Temperature, left
- ② Blower speed
- ③ Temperature, right

- ▶ Use temperature controls ③ and ⑬ or ⑥ and ⑪ (▷ page 175) to separately adjust the air temperature on each side of the passenger compartment.

The temperature of the vehicle interior is adjusted automatically.

Deactivating

- ▶ Press button **AUTO** (▷ page 175) again.
The indicator lamp on the button goes out. The automatic operation of air volume and air distribution switches off.

Automatic climate control

Setting the temperature

Use temperature controls ③ and ⑬ for the left side or ⑥ and ⑪ for the right side (▷ page 175) to separately adjust the air temperature on each side of the passenger compartment. You should raise or lower the temperature setting in small increments, preferably starting at 72°F (22°C). The automatic climate control will adjust to the set temperature as fast as possible.

Increasing

- ▶ Press temperature button ③ and/or ⑥ (▷ page 175) until the desired temperature appears in the display ④ (▷ page 175).

The automatic climate control system will correspondingly adjust the interior air temperature.

i If you increase the temperature for one side of the vehicle to the highest adjustable value then you will see the message HI in the display. This also increases the temperature for the other side of the vehicle.

Decreasing





- ▶ Press temperature button ⑪ and/or ⑬ (▷ page 175) until the desired temperature appears in the display ④ (▷ page 175).

The automatic climate control system will correspondingly adjust the interior air temperature.

i If you decrease the temperature for one side of the vehicle to the lowest adjustable value then you will see the message LO in the display. This also decreases the temperature for the other side of the vehicle.

Adjusting air distribution

Use air distribution controls ① and ⑧ (▷ page 175) to separately adjust the air distribution on each side of the passenger compartment. The following symbols are found on the controls:

Symbol	Function
	Directs air through the center, side and rear passenger compartment air vents
	Directs air to the windshield and the side defroster vents
	Directs air into the entire vehicle interior
	Directs air to the footwells

- ▶ Turn air distribution control ① or ⑧ (▷ page 175) to the desired symbol.

The indicator lamp on the button **AUTO** (▷ page 175) goes out.

The automatic air distribution is switched off. The air distribution is controlled according to the selected control setting.

i You can also turn the air distribution control to a position between two symbols.

Opening center and side air vents

- ▶ Turn thumbwheels ③, ④, ⑦ and ⑧ (▷ page 174) upward.



The center air vents ⑤ and ⑥ and side air vents ② and ⑨ (▷ page 175) are open.

Closing center and side air vents



- ▶ Turn thumbwheels ③, ④, ⑦ and ⑧ (▷ page 174) downward.

The center air vents ⑤ and ⑥ and side air vents ② and ⑨ (▷ page 174) are closed.

Adjusting air volume

Use button **AUTO** (▷ page 175) for automatic mode or air volume controls  or  (▷ page 175) to adjust air volume manually.

Seven blower speeds are available.

- ▶ Press button  to decrease or  (▷ page 175) to increase air volume to the desired level.

The indicator lamp on the button **AUTO** goes out.



The automatic air distribution remains switched on.

Front defroster

You can use this setting to defrost the windshield, for example if it is iced up. You can also defog the windshield and the side windows.

i Keep this setting selected only until the windshield or the side windows are clear again.

Activating

- ▶ Press button  or  (▷ page 175).

The indicator lamp on the button comes on.



The air conditioning switches automatically to the following functions:

- cooling on to dehumidify
- maximum blowing and heating power
- air flows onto the windshield and the front side windows
- the air recirculation mode is switched off

Automatic climate control

i If you have switched on the defrost function using the  or  button, you cannot make any other settings.

Deactivating

- ▶ Press button  or  (▷ page 175) again.

The indicator lamp on the button goes out.

The previous settings are once again in effect.



i The cooling remains switched on.

Windshield fogged on the outside

i Keep this setting selected only until the windshield is clear again.

- ▶ Switch the windshield wipers on (▷ page 51).

If the automatic mode of the automatic climate control is switched off:

- ▶ Turn air distribution control ① or ⑧ to  or  (▷ page 175).

Maximum cooling MAXCOOL

If the left and right air distribution controls as well as the airflow volume control are set to **AUTO** (▷ page 175) and there is a high need for cooling, the display “MAXCOOL” appears.



This provides the fastest possible cooling of the vehicle interior (when side windows and tilt/sliding sunroof* are closed).

Air recirculation mode

Switch to air recirculation mode to prevent unpleasant odors from entering the vehicle from the outside (e.g. before driving through a tunnel). This setting cuts off the intake of outside air and recirculates the air in the passenger compartment.

Warning!





Fogged windows impair visibility, endangering you and others. If the windows begin to fog on the inside, switching off the air recirculation mode immediately should clear interior window fogging. If interior window fogging persists, make sure the air conditioning (> page 175) is activated, or press button  or .

Activating

▶ Press button  (> page 175).

The indicator lamp on the button comes on.

 *The air recirculation mode is activated automatically at high outside temperatures.*

The indicator lamp on the button  is not lit when the air recirculation mode is automatically switched on.

A quantity of outside air is added after approximately 30 minutes.

Deactivating

▶ Press button  (> page 175) again.

The indicator lamp on the button goes out.

 *The air recirculation mode is deactivated automatically:*

- *after 5 minutes if the outside temperature is below approximately 41 °F (5 °C)*
- *after 5 minutes if the air conditioning is turned off*
- *after 30 minutes if the outside temperature is above approximately 41 °F (5 °C)*

Automatic climate control

Air recirculation mode with convenience closing or opening feature

Warning!



Never operate the side windows and the tilt/sliding sunroof* if there is the possibility of anyone being harmed by the closing procedure.

When using the air recirculation mode with convenience closing feature, should the upward movement of a window be blocked by some obstructions including but not limited to arms, hands, fingers. etc., the automatic reversal feature will not operate.

In the event that the closing procedure causes potential danger, the closing of the side windows can be immediately halted by pressing or pulling the respective window switch. The closing of the tilt/sliding sunroof* can be immediately halted by moving the tilt/sliding sunroof* switch in the overhead control panel in any direction.

The closing of the side windows and tilt/sliding sunroof* can be reversed by again pressing and holding the  button.

Convenience closing



- ▶ Press button  (▷ page 165) for approximately 2 seconds.

The windows and tilt/sliding sunroof* will close. You can release button  once the closing procedure has begun. The windows and tilt/sliding sunroof* continue closing until they are fully closed. The indicator lamp on the button comes on. The air recirculation mode is activated.

Convenience opening

- ▶ Press button  for approximately 2 seconds.

The windows and tilt/sliding sunroof* will return to their previous position. You can release button  once the opening procedure has begun. The windows and tilt/sliding sunroof continue opening until they have reached their previous position. The indicator lamp on the button goes out. The air recirculation mode is deactivated.



i A side window or tilt/sliding sunroof* will only return to its previous position if it has not been moved to another position using the respective side window switch or tilt/sliding sunroof* switch after it was closed with button . A side window or tilt/sliding sunroof* that was moved will remain in its current position if button  is used to re-open the remaining side windows or tilt/sliding sunroof*.

Charcoal filter

An activated charcoal filter markedly reduces bad odors and removes pollutants from air entering the passenger compartment. The charcoal filter can be activated or deactivated.

The system switches automatically to the air recirculation mode, if the

- charcoal filter is switched on
- carbon monoxide (CO) or nitrogen oxide (NO_x) concentration of the outside air increases beyond a predetermined level

i *The automatic air recirculation mode does not function if the **A/C** mode is deactivated (indicator lamp on button  or  not lit), or if the outside temperature has fallen below 41 °F (5 °C).*

Activating

▶ Press button  (> page 175).

The indicator lamp on the button comes on.

i *If you press and hold button , the side windows and tilt/sliding sunroof* will close.*

i *The activated charcoal filter should be switched off when windows fog up on the inside, or if the passenger compartment needs to be quickly heated or cooled down.*

Warning!



Never operate the side windows and the tilt/sliding sunroof* if there is the possibility of anyone being harmed by the closing procedure.

When using the charcoal filter with convenience closing feature, should the upward movement of a window be blocked by some obstructions including but not limited to arms, hands, fingers. etc., the automatic reversal feature will not operate.

In the event that the closing procedure causes potential danger, the closing of the side windows can be immediately halted by pressing or pulling the respective window switch. The closing of the tilt/sliding sunroof* can be immediately halted by moving the tilt/sliding sunroof* switch in the overhead control panel in any direction.



The closing of the side windows and tilt/sliding sunroof* can be reversed by again pressing and holding the button .



Automatic climate control

Deactivating

- ▶ Press button  (> page 175).

The indicator lamp on the button goes out.

i Press and hold button  for approx. 2 seconds. The side windows and or tilt/sliding sunroof* will return to their previous position. You can release button  once the opening procedure has begun. The windows and tilt/sliding sunroof* continue opening until they have reached their previous position.

A window or tilt/sliding sunroof* will only return to its previous position if it has not been moved to another position using the respective window switch or tilt/sliding sunroof* switch after it was closed with button . A window or tilt/sliding sunroof* that was moved will remain in its current position if button  is used to re-open the remaining windows or tilt/sliding sunroof*.

Air conditioning

The cooling function, only operational when the engine is running, cools the vehicle interior down to the selected temperature. The cooling function also dehumidifies the air in the vehicle interior, thus preventing the windows from fogging up.

i Condensation may drip out from underneath the vehicle. This is normal and not an indication of a malfunction.



Warning!



If you turn off the cooling function, the vehicle will not be cooled when weather conditions are warm. The windows can fog up more quickly. Window fogging may impair visibility and endanger you and others.

Deactivating

It is possible to deactivate the air conditioning (cooling) function of the automatic climate control system. The air in the vehicle will then no longer be cooled or dehumidified.



- ▶ Press button  or  (> page 175).

The indicator lamp on the button goes out.

The cooling function switches off after a short delay.

Activating

Moist air can fog up the windows. You can dehumidify the air with the air conditioning.

- ▶ Press button  or  (▷ page 175) again.

The indicator lamp on the button comes on.

The air conditioning uses the refrigerant R134a. This refrigerant is free of CFCs which are harmful to the ozone layer.

! *If the air conditioning cannot be turned on again, this indicates that the air conditioning is losing refrigerant. The compressor has turned itself off.*

Have the air conditioning checked at the nearest authorized Mercedes-Benz Center.

Residual heat and ventilation (Canada only)

With the engine switched off, it is possible to continue to heat or ventilate the interior for up to 30 minutes. This feature makes use of the residual heat produced by the engine.

i *How long the system will provide heating depends on*

- *the coolant temperature*
- *the temperature set by the operator*

The blower will run at speed setting 1 regardless of the air distribution control setting.

Activating

- ▶ Switch off the ignition (▷ page 32).
- ▶ Press button  (▷ page 175).

The indicator lamp on the button comes on.

Deactivating

- ▶ Press button  (▷ page 175).

The indicator lamp on the button goes out.

The residual heat is automatically turned off:

- when the ignition is switched on
- after about 30 minutes
- if the battery voltage drops

Automatic climate control

Rear passenger compartment adjustable air vents

The air conditioning for the rear passenger compartment is controlled via the automatic climate control panel (▷ page 175).

i The temperature at the center air vents ① and ③ for the rear passenger compartment is the same as at the dashboard center air vents.

The air vents for the rear passenger compartment are located in the rear center console.

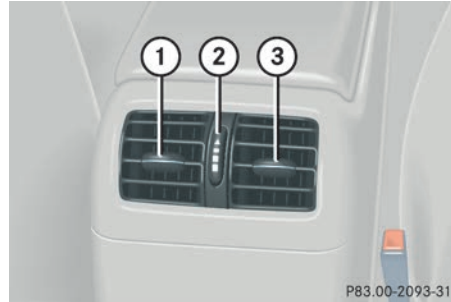

- ① Left center air vent
- ② Thumbwheel for air volume control for center air vents
- ③ Right center air vent

Adjusting air distribution

- ▶ Push the slide for the left center vent ① or right center vent ③ to the left, right, up, or down.

The air flow is directed in the corresponding direction.

i For draft-free ventilation, move the sliders for the center air vents ① and ③ upward.

Adjusting air volume

- ▶ Turn thumbwheel ② up or down.

The air volume is increased or decreased.

▼ Audio system

Audio and telephone, operation

These instructions are intended to help you become familiar with your Mercedes-Benz audio system. They contain useful tips and a detailed description of the user functions.

Warning!



In order to avoid distraction which could lead to an accident, the driver should enter system settings with the vehicle at a standstill and operate the system only when road and traffic conditions permit. Always pay full attention to traffic conditions first before operating system controls while driving.

Bear in mind that at a speed of just 30 mph (approximately 50 km/h), your car is covering a distance of 44 feet (approximately 14 m) every second.

Operating safety

Warning!



Any alterations made to electronic components can cause malfunctions.

The radio, amplifier, CD changer*, satellite radio*, and telephone* are interconnected. When one of the components is not operational or has not been removed/replaced properly, the function of other components may be impaired.

This condition might seriously impair the operating safety of your vehicle.

We recommend that you have any service work on electronic components carried out by an authorized Mercedes-Benz Center.

Audio system

Operating and display elements

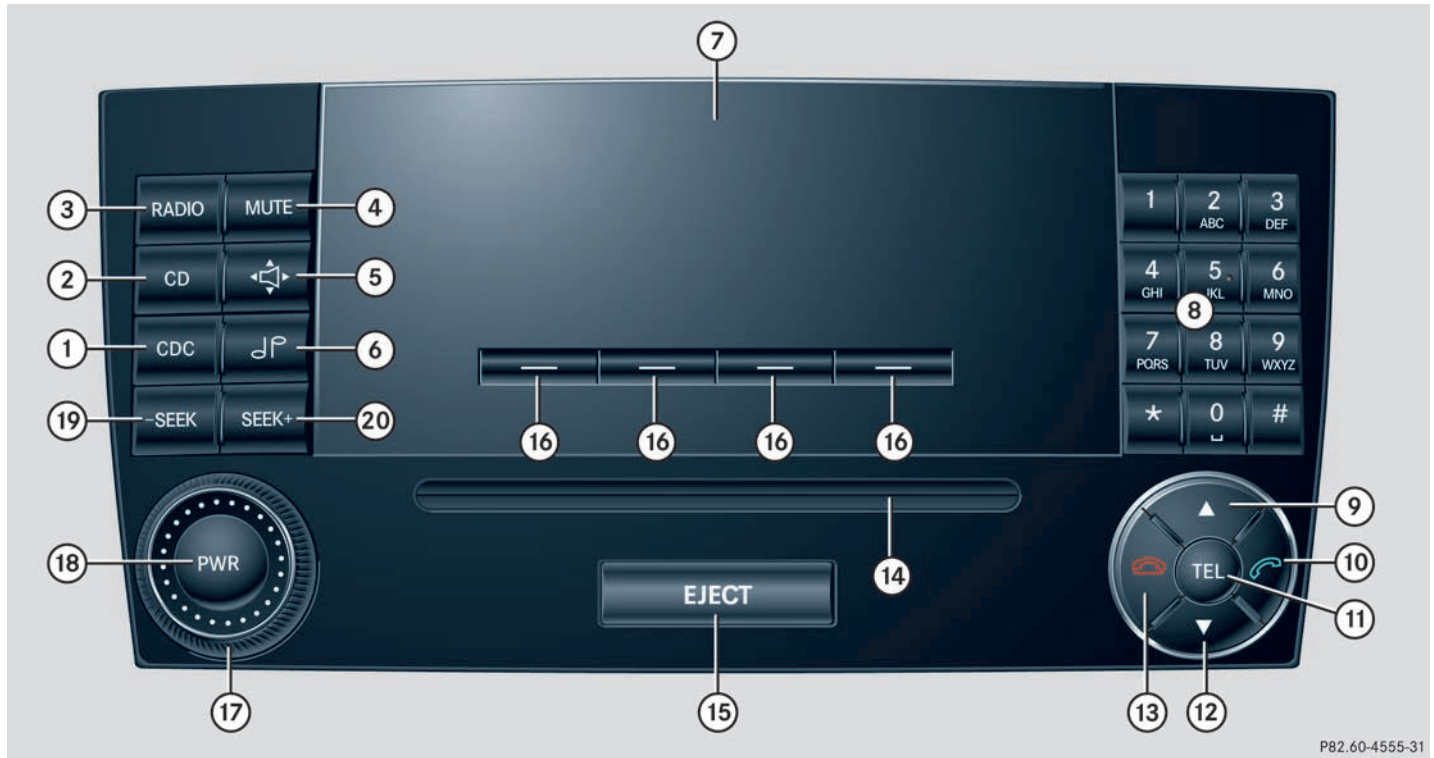

P82.60-4555-31

Item	Page
① CD changer mode selector	201
AUX mode selector	193
② Single CD mode selector	204
③ Radio mode selector	
④ Mute function (radio)	196
Pause (CD)	208
⑤ Volume distribution	192
⑥ Sound settings	191
⑦ Display	
⑧ Alphanumeric keypad	

Item	Page
⑨ Speed dialing memory (telephone) in descending order	
⑩ Accepting a call (telephone)	212
⑪ Telephone mode selector	208
⑫ Speed dialing memory (telephone) in ascending order	210
⑬ Terminating a call (telephone)	213
⑭ CD slot	
⑮ CD ejection	204

Item	Page
⑯ Soft keys	190
⑰ Volume	190
⑱ Switching on/off	190
⑲ Manual tuning/seek tuning (radio)	195
Track search, reverse (CD)	207
⑳ Manual tuning/seek tuning (radio)	195
Track search, fast forward (CD)	207

Audio system

Button and soft key operation

In these instructions, the alphanumeric keypad (right side of radio panel) and the function buttons (left side of radio panel) are referred to as “buttons”. The four keys below the display panel are referred to as “soft keys”.

! Do not press directly in the display face. Otherwise, the display will be damaged.

Operation

Switching the unit on/off

Switching on

- ▶ Turn the SmartKey in the starter switch to position **1** or **2**.
- ▶ If the audio system was on as you removed the SmartKey from the starter switch, the audio system will automatically come back on as you turn the SmartKey to position **1** or **2**.

or

- ▶ Press  button.

i If the radio is switched on without the SmartKey in the starter switch, it will automatically switch off again after approx. 30 minutes.

If your vehicle is equipped with a telephone, the display may prompt you to enter your PIN (GSM network) or code (TDMA or CDMA network).

Switching off

- ▶ Remove SmartKey from starter switch.
- or
- ▶ Press  button.

i Should excessively high temperatures occur while the audio system is being operated, the display will dim. If temperatures continue to rise, HIGH TEMP will appear in the display, after which the audio system will be switched off for a cooling-down period.

Adjusting the volume

- ▶ Turn rotary control of  button.

The volume will increase or decrease depending on the direction turned.

i If your vehicle equipment includes a Mercedes-Benz specified mobile telephone*, you can adjust its volume separately from the volume of the audio system while the telephone is being used.

Adjusting sound functions

The bass and treble functions are called up by pressing the **⏮** button.

Settings for bass and treble are stored separately for the AM and FM wavebands, weather band, CD mode and telephone mode.

Bass

- ▶ Press **⏮** button repeatedly until BASS appears in the display.



- ▶ Press + or - soft key to increase or decrease tone level accordingly.

or

- ▶ Press RES soft key briefly to reset bass tones to their center level.

The radio switches back to the standard radio menu 8 seconds after the last soft key is pressed.

Adjusting treble

- ▶ Press **⏮** button repeatedly until TREBLE appears in the display.



- ▶ Press + or - soft key to increase or decrease tone level accordingly.

or

- ▶ Press RES soft key briefly to reset treble tones to their center level.

The radio switches back to the standard radio menu 8 seconds after the last soft key is pressed.

Sound system*

You can either program the sound settings manually (▷ page 191) or choose settings via preset sound characteristics.

You can select from among the following settings:

- STANDARD: conventional stereo sound.
- SURROUND: the sound is set for better three-dimensional acoustic characteristics.
- SPEECH: the sound is optimized for the spoken word.

- ▶ Press **⏮** button repeatedly until STANDARD, SURROUND, or SPEECH appears in the display.

- ▶ Press <<< or >>> soft key repeatedly until the desired sound setting has been reached.

The sound is set accordingly.

or

▷▷

Audio system

- ▷▷▶ Press RES soft key briefly.

The sound setting is reset depending on the sound source activated.

- Radio mode: STANDARD
- CD/AUX mode: SURROUND
- Telephone: SPEECH

The radio switches back to the standard radio menu 8 seconds after the last soft key is pressed.

Returning sound functions to factory settings

- ▶ Press  button to call up settings menu in the display.



- ▶ Press RES soft key briefly; the respective sound function is reset to its center level.

or

- ▶ Press and hold RES soft key until RESET appears in the display.

The sound settings for bass and treble are returned to their center level and the volume is set to a predefined level.

Vehicles with sound system*:

The sound setting is reset depending on the sound source activated.

- Radio mode: STANDARD
- CD/AUX mode: SURROUND
- Telephone: SPEECH

The radio switches back to the standard radio menu 4 seconds after the last soft key is pressed.



Adjusting volume distribution

Call up fader and balance functions by pressing the  button.

Fader

- ▶ Press  button repeatedly until FADER appears in the display.



- ▶ Press  or  soft key.

The volume is distributed accordingly between the front and rear of the vehicle.

or

- ▶ Press RES soft key briefly.

The fader is reset to its center level.

The radio switches back to the standard radio menu 8 seconds after the last soft key is pressed.

Adjusting balance

- ▶ Press  button repeatedly until BALANCE appears in the display.



P82.60-4453-31

- ▶ Press <<< or >>> soft key.

The volume is distributed between the left and right sides of the vehicle.

or

- ▶ Press RES soft key briefly.

The balance is reset to its center level.

The radio switches back to the standard radio menu 8 seconds after the last button is pressed.

Returning volume distribution to factory settings

- ▶ Press  button to call up settings menu in the display.



P82.60-4452-31

- ▶ Press RES soft key briefly; the respective volume distribution is reset to its center (flat) level.

or

- ▶ Press and hold RES soft key until RESET appears in the display.

The volume distribution settings for fader and balance are set to their center level.

The radio switches back to the standard radio menu 4 seconds after the last soft key is pressed.

Telephone* muting

If your vehicle equipment includes a Mercedes-Benz specified mobile telephone*, you can adjust its volume separately from the volume of the audio system while the telephone is being used.

Connecting an external audio source (AUX) to the radio*

An optional dealer-installed cinch-connector* for connecting an external audio source may become available for your vehicle model. Feature description is based on preliminary information at time of printing. Contact an authorized Mercedes-Benz Center for availability.

You can adjust the volume (▶ page 190), the sound settings (▶ page 191) and the volume distribution (▶ page 192) for the AUX input.

Calling up AUX mode

- ▶ Press and hold  button until AUX appears in the display.

Audio system

Canceling AUX mode

- ▶ Press any audio source button.

Radio operation

Selecting radio mode

- ▶ Press **RADIO** button.

Calling up wavebands

You can choose from among the FM, AM, and WB wavebands.

Weather band (▷ page 196).

i FM waveband: 87.7.....107.9 MHz

AM waveband: 530.....1710 KHz

Calling up wavebands for radios without SAT

- ▶ Press FM or AM soft key to switch between FM and AM.

The FM and AM wavebands are called up one after another.

or

- ▶ Press WB soft key.

The weather band menu is called up.

The waveband currently selected appears in the upper left-hand corner of the display.

Calling up wavebands for radios with SAT

- ▶ Press FM, AM, or WB soft key repeatedly until desired waveband has been selected.

The FM, AM, and WB wavebands are called up one after another.

The waveband currently selected appears in the upper left-hand corner of the display.

Selecting a station

The following options are available for selecting a station:

- Direct frequency input (▷ page 194)
- Manual tuning (▷ page 195)

- Automatic seek tuning (▷ page 195)
- Scan search (▷ page 195)
- Station memory (▷ page 195)
- Automatic station memory (Autostore) (▷ page 196)

The station search proceeds in the following frequency increments:

- 200 kHz in FM range
- 10 kHz in AM range

Direct frequency input

- ▶ Select desired waveband.



- ▶ Press ***** button.

- ▶ Enter desired frequency with buttons **1** to **0**.

i You can only enter frequencies within the respective waveband.

If a button is not pressed within 4 seconds, the radio will return to the last station tuned.

Manual tuning

- ▶ Select desired waveband.
- ▶ Press **SEEK+** or **-SEEK** button for approx. 3 seconds.
- ▶ Press button repeatedly until desired frequency has been reached.

Step-by-step station tuning takes place in ascending or descending order. Each time the button is pressed, the radio tunes further by 0.2 MHz. During manual tuning, the radio is muted.

Automatic seek tuning

- ▶ Select desired waveband.
- ▶ Press **SEEK+** or **-SEEK** button briefly.

The radio will tune to the next highest or next lowest receivable frequency.

i If no station is received after two consecutive scans of the complete frequency range, then the scan stops at the frequency from which it began.

Scan search

- Starting scan search
 - ▶ Select desired waveband.



- ▶ Press **SC** soft key.
 - SC will appear in the display. The radio briefly tunes in all receivable stations on the waveband selected.
- Ending scan search
 - ▶ Press **SC** soft key or **SEEK+** or **-SEEK**.

The station last played will be selected and **SC** disappears from the display.

Station memory

You can store ten AM and ten FM stations in the memory.

- Storing stations
 - ▶ Tune in desired station.
 - ▶ Press and hold desired station button **1** to **0** until a brief signal tone is heard.

The frequency is stored on the selected station button.
- Calling up stations
 - ▶ Press desired station button **1** to **0** briefly.

Audio system

Autostore – automatic station memory

The Autostore memory function provides an additional memory level. The station memory for manually stored stations is not overwritten.

- Calling up Autostore memory level and storing stations



- ▶ Press AS soft key briefly.

The radio switches to the Autostore memory level. AS and SEARCH appear in the display and the radio finds the ten stations with the strongest signals. These stations are stored on the station buttons **1** to **0** in order of signal strength.

- Calling up stations
 - ▶ Press desired station button **1** to **0**.
- Leaving the Autostore memory level
 - ▶ Press FM or AM soft key briefly.

Interrupting radio mode

The radio mode is interrupted by an incoming call on the telephone* (▷ page 212).

- Mute on
 - ▶ Press **MUTE** button.
 - The radio mode is interrupted and MUTED appears in the display.
- Mute off
 - ▶ Press **MUTE** button.
 - The radio mode is again active.

Weather band



- ▶ Press WB soft key.

The weather band station last received is tuned in.

Selecting a weather band station directly

- ▶ Select desired weather band station with buttons **1** to **7 PORS**.

If a station cannot be tuned in, a search is automatically started.

Search

- ▶ Press **SEEK+** or **-SEEK** button to tune in the next receivable weather band station.

i If no weather band station is received after three consecutive scans of the complete frequency range, then the scan stops at the channel with which it began and **NO WB FOUND** appears in the display.

If this happens, switch back to standard radio mode.

Scan search

- Starting scan search
 - ▶ Press **SC** soft key.

SC will appear in the display. The radio briefly tunes in all receivable weather band stations.
- Ending scan search
 - ▶ Press **SC** soft key or **SEEK+** or **-SEEK**.

The weather band station last played will be selected and **SC** disappears from the display.

Introduction to satellite radio* (USA only)

SIRIUS satellite radio provides 100 channels of digital-quality radio, among others music, sports, news, and entertainment, free of commercials. SIRIUS satellite radio uses a fleet of high-power satellites to broadcast 24 hours per day, coast to coast, in the contiguous U.S.

This diverse, satellite-delivered programming is available for a monthly subscription fee.

For more information and service availability call the SIRIUS Service Center (▶ page 201), or contact www.siriusradio.com.

i Additional satellite radio equipment and a subscription to a satellite radio service provider are required for the satellite radio operation described here.

Contact an authorized Mercedes-Benz Center for details and availability for your vehicle.

Note that categories and channels shown in illustrations are dependent on programming content delivered by the service provider. Programming content is subject to change. Therefore, channels and categories shown in illustrations and descriptions contained in this manual may differ from the channels and categories delivered by the service provider.

i Satellite radio service may be unavailable or interrupted from time to time for a variety of reasons, such as environmental or topographic conditions and other things beyond the service provider's or our control. Service might also not be available in certain places (e.g., in tunnels, parking garages, or within or next to buildings) or near other technologies.

Audio system

Program categories

The channels are categorized. Categories allow you to tune to stations broadcasting a certain type of program (category mode) (▷ page 199).

Calling up the SAT main menu

- ▶ Press SAT soft key.

SAT is displayed in the upper left-hand corner of the display.

Prior to activation of the satellite radio service (▷ page 198).

After activation of satellite radio service (▷ page 198).

Prior to activation of the satellite radio service



The telephone number of the SIRIUS Service Center (888-539-7474) is displayed.

- ▶ Press ESN soft key.

The twelve-digit electronic serial number (ESN) of the SAT tuner* installed in your vehicle is displayed.

This information is required to call the SIRIUS Service Center for an activation request.

i Credit card information may also be required for your application.

The activation process takes approximately 5 to 10 minutes after calling the SIRIUS Service Center.

After activation of the satellite radio service

The satellite radio main menu appears. The radio station selected last is audible, provided it can be received.

i The system will tune to a default station if no station had been selected previously.



The first channel 001 is called up and the PTY system changes to All categories.

If no station can be received, ACQUIRING appears in the display.

If the Satellite radio service is not activated, ACQUIRING will also appear in the radio display and NO SAT will appear in the multifunction display.

Selecting a station

The following options are available:

- Selecting a station using the selected category (▷ page 199).
- Tuning via station presets (▷ page 199).
- Tuning via scan search (▷ page 200).
- Tuning via manual channel input (▷ page 199).
- Tuning via the program category list (▷ page 199).

Tuning via station presets

Ten satellite radio station presets are available.

You can access the presets via number keys.

Accessing via number keys

- ▶ Enter number of preset you wish to select, e.g. **1**.

The radio plays the station stored under this number and the PTY function changes to the category corresponding to the station.

Tuning via manual channel input



Example: tuning in channel 16

- ▶ Press ***** button.

Input line appears in the main radio menu.

- ▶ Use number keys to enter desired channel within 8 seconds, e.g. **1**

6
MNO

The system tunes to channel 16.

The station you have selected begins to play.

i You can only enter available channel numbers.

Tuning via the program category list

The category list contains all currently receivable categories of programs. It is arranged alphabetically.

- Selecting a category
 - ▶ Press PTY soft key.



The current PTY category of the station is displayed.

▷▷

Audio system

- ▷▷ ▶ Press <<< or >>> soft key.

This switches between the individual categories.

When changing the category, the channel selected last in the new category becomes audible.

The system will automatically switch to a station of the selected category if the currently selected station is not of the selected category. Otherwise, the currently selected station remains tuned.

- Tuning a station within the selected category

The channels identified for the currently selected category are arranged numerically. Only one entry is visible at a time.

- ▶ Press **SEEK+** or **-SEEK** button briefly.

The next station within the category is started.

- ▶ Press and hold **SEEK+** or **-SEEK** button for approx. 3 seconds until desired station has been reached.

Tuning via scan search

Scan search is characterized as follows:

- Scan search plays a channel for approx. 8 seconds and then skips to the next channel within the current category.
 - Scan search can be terminated manually.
- ▶ Press **SC** soft key.

The search starts. **SC** appears in the display.

- ▶ Press **SC** soft key again.

The search stops.

Obtaining additional text information

Additional text information (artist, title) related to the current channel can be displayed.

- ▶ Press **INF** soft key.

The title being played is displayed.

- ▶ Press **INF** soft key again.

The name of the artist performing the title being played is displayed.

i *If a button is not pressed within 4 seconds, the radio will return to the standard display.*

Storing stations

- ▶ Tune in desired station.

- ▶ Press and hold desired station button **1** to **0** until a brief signal tone is heard.

The frequency is stored on the selected station button.

or

The radio saves the current station at the memory preset selected. The memory preset selected appears in the status line, e.g. S3.

 *There are ten presets available.*

An existing entry is overwritten in the memory list when a new entry is given.

Calling up the ESN information menu

- ▶ Press INF soft key.
- ▶ Press ESN soft key.

The twelve-digit electronic serial number (ESN) of the SAT tuner* installed in your vehicle is displayed.

- ▶ Press RET soft key to exit the menu.

CD mode

Safety precautions

Warning!



The single CD player and the CD changer* are Class 1 laser products. There is a danger of invisible laser radiation if the housing is opened or damaged.

Do not open the housing. The single CD player and the CD changer* do not contain any parts that can be serviced by the user. For safety reasons, have any service work which may be necessary performed only by qualified personnel.

Warning!



In order to avoid distraction which could lead to an accident, the driver should insert CDs with the vehicle at a standstill and operate the audio system only if permitted by road, weather and traffic conditions. Bear in mind that at a speed of just 30 mph (approximately 50 km/h), your car covers a distance of 44 feet (approximately 14 m) every second.

General notes

The system may not be able to play audio CDs with copy protection.

Playing copied CDs may cause malfunctions during playback.

! *If you affix stickers to the CDs, they can become warped due to the heat that develops in the CD drive or CD changer*. In certain situations, the CDs can then no longer be ejected and cause damage to the drive. Such damage is not covered by the Mercedes-Benz Limited Warranty.*

Audio system

! Your CD drive or CD changer* has been designed to play CDs which correspond to the EN 60908 standard. You can therefore only use CDs with a maximum thickness of 1.3 mm.

If you insert thicker data carriers, e.g. ones that have data on both sides (one side with DVD data, the other side with audio data), they cannot be ejected and will damage the drive.

Do not use CDs with an 8 cm diameter, not even with a CD adapter. Attempting to play CDs with an 8 cm diameter or playing such CDs with an adapter may cause damage to the CD drive. Such damage is not covered by the Mercedes-Benz Limited Warranty.

Should excessively high or low temperatures occur while in CD changer mode*, CD ERROR will appear in the display, and the CD will be muted until the temperature has reached an acceptable level for the system to continue operation.

The single CD player play audio CDs, the CD changer* can play audio CDs as well as CDs with MP3 files.

Tips on handling CDs

- Handle CDs carefully to prevent interference during playback.
- Avoid scratches, fingerprints and dust on the CDs.
- Do not write on CDs or apply any labels or other material to them.
- Clean CDs from time to time with a commercially available cleaning cloth. Never wipe the CD in a circular motion; instead, wipe it in a straight line starting in the center and moving outward. Do not use solvents, anti-static sprays, etc. for cleaning.
- Replace the CD in its case after use.
- Protect CDs from heat and direct sunlight.

MP3 notes

The CD changer* can play audio CDs as well as CDs with MP3 files.

Information on MP3 data carriers

i CD media, CD burning software and CD writers are available in great variety. Due to this variety, it cannot be guaranteed that the CD changer will be able to play every user-written CD.

The burning process can lead to data errors and aging of the medium may result in data loss. Therefore, the CD changer may be restricted in its ability to play MP3 data carriers; it may play them with reduced sound quality, or it may not be able to play them at all.

Problems may be encountered during playback of user-written CDs with a storage capacity of more than 700 MB. These CDs do not meet valid standards as of this printing.

Compatible MP3 data carriers

The CD changer can read the following data carriers in MP3 mode:

- CD-DA
- CD-R
- CD-RW

Compatible file systems and compression methods

Use Romeo or Joliet. Depending on file format used, up to 128 characters are possible.

The following compression methods are compatible:

- MP3
- WMA
- WAV

Compatible bit and sampling rates

Fixed and variable bit rates of up to 320 kBit/s are possible.

The following table lists possible sampling rates:

MPEG1 Audio Layer3	44.1 KHz, 48 KHz, 32 KHz
MPEG2 Audio Layer3	22.5 KHz, 24 KHz, 16 KHz
MPEG2.5 Audio Layer3	11.025 KHz, 12 KHz, 8 KHz
WMA	32 KHz, 44.1 KHz, 48 KHz

i Only use MP3 tracks with a bit rate of 128 kBit/s or higher and with the specified sampling rates.

The use of rates other than those specified may lead to noticeably inferior sound quality.

Information on copyright

The music tracks that you create for use in MP3 mode or that you play in MP3 mode are subject to copyright laws under applicable international and national regulations.

In many countries, the reproduction of copyrighted materials is not permitted, even if only for personal use, without the express prior consent of the copyright holder.

Please check the current copyright laws for your country and comply with them.

These restrictions do not apply, for example, to your own compositions and recordings, or for recordings for which authorization has been obtained from the copyright holder.

Audio system

MP3 playback

You can play an MP3 CD on the CD changer* as you would any standard audio CD. All of the functions described for the CD changer also apply for the playback of MP3 CDs. Keep in mind that the single CD player in the audio system unit is not able to read MP3 CDs.

The first 99 tracks on the CD, including tracks in subdirectories, are recognized and played. Any additional tracks will not be played.

i Due to the branched data structure, playback of the first track may be delayed slightly.

Operating the single CD player in the audio system unit

Loading a CD

The single CD player in the audio system unit has capacity for one CD. The CD slot for loading the drive is located underneath the soft keys.

i Keep in mind that the single CD player in the audio system unit is not able to play CDs with MP3 files.

- ▶ Make sure the system is switched on.
- ▶ Insert CD into CD slot. The label side of the CD must face upwards.

The system automatically pulls the CD into the CD slot. The audio CD begins to play.

! If a CD is already loaded, it must be ejected before inserting a new CD. Inserting a second CD in the slot with another CD still loaded will cause damage to the CD drive not covered by the Mercedes-Benz Limited Warranty.

i If a CD has been inserted incorrectly or cannot be read, **WRONG CD ERROR** will appear in the display.

Ejecting a CD

- ▶ Make sure the system is switched on.
- ▶ Press **EJECT** button.

The system ejects the CD. **NO CD** will appear in the display.

- ▶ Remove CD from slot.

i If you do not take the CD out of the CD slot within approx. 15 seconds, the system automatically pulls the CD back in and plays it.

If a CD is pulled back in, press **EJECT** button for 5 seconds; the CD will then be ejected.

Operational readiness of CD changer*

If a CD changer* has been installed in the vehicle, it can be operated from the front control panel of the audio system. A loaded magazine must be installed to play CDs.

The CD changer* is located in the glove box.

Loading/unloading the CD magazine

i The CD changer* may not be able to play audio CDs with copy protection.

- ▶ Slide changer door to the right and press  button.
- ▶ Magazine will be ejected.

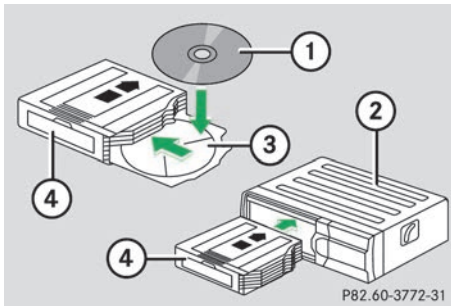

- ① CD
- ② CD changer
- ③ CD tray
- ④ CD magazine

- ▶ Remove magazine ④ and pull CD tray ③ fully out.
- ▶ Place CD ① in recess of tray, label side up.
- ▶ Push tray into magazine in direction of arrow.

i CDs which have been inserted improperly or are unreadable will not be played.

- ▶ Push magazine into CD changer* ② in direction of arrow and close sliding door.

Playing CDs

Single CD player in the audio unit

- ▶ Press **CD** button.
CD 0 will appear in the upper left-hand corner of the display.

The CD will resume playback at the point where it was switched off.

CD changer*

- ▶ Press **CDC** button.
CD and the selected magazine slot number appear in the upper left-hand corner of the display.

If you have not removed a CD since the last time the CD audio source was activated, the last CD listened to will begin to play at the point where it was switched off.

After the last track on a CD has finished, the next CD is automatically played.

Playing tracks

You have the following options:

- Audio system with CD changer*: selecting CDs
- Direct track entry
- Track skip forward/reverse
- Fast forward/reverse
- Scan
- Random tracks
- Repeat track

Audio system

Selecting CDs in the audio unit with CD changer*



- ▶ You can select from among the inserted CDs with buttons **0** to **6** .
0 = CD player in the audio unit
1 to **6** = CDs in the CD changer*

The magazine slot number of the selected CD appears next to CD in the display, and the number of the currently played track appears next to TRACK.

i If there is no CD in the selected magazine slot, NO CD appears in the display with the corresponding slot number.

Direct track entry



You can make a direct selection from among the tracks on a CD.

- ▶ Press ***** button.
- ▶ Enter track number using buttons **1** to **0** .

The number of the track being played appears next to TRACK in the display.

You can only enter available track numbers.

Skipping tracks forward/backward

- Skipping tracks forward
 - ▶ Press **SEEK+** button briefly.
The next track will be played.
- Skipping tracks backward
 - ▶ Press **-SEEK** button briefly.

If the track has been playing for more than 10 seconds, the unit skips back to the beginning of the track currently playing. If less than 10 seconds have been played, the unit skips back to the beginning of the previous track.

Pressing the **-SEEK** or **SEEK+** button repeatedly will result in multiple tracks being skipped.

Fast forward/reverse

- Fast forward
 - ▶ Press and hold **SEEK+** button until desired point has been reached.
- Reverse
 - ▶ Press and hold **-SEEK** button until desired point has been reached.

i *The track number and the relative time of the track is shown in the display during the search.*

Scan

- Starting scan
 - ▶ Press **SC** soft key.
SC will appear in the display.
Each track on the current CD will be played for approx. 8 seconds in ascending order.
- Ending scan
 - ▶ Press **SC** soft key or **-SEEK** or **SEEK+**.

Random play

The random function (RDM) plays the tracks of the current CD in random order.

i *When you start the RDM function, the RPT function is automatically switched off.*

- Switching on random
 - ▶ Press RDM soft key.
RDM appears in the display.
A randomly selected track is played.
- Switching off random
 - ▶ Press RDM soft key again.

Repeat

The track being played is repeated until the repeat function is switched off.

i *When you start the RPT function, the RDM function is automatically switched off.*

- Switching on repeat
 - ▶ Press RPT soft key.
RPT appears in the display.
- Switching off repeat
 - ▶ Press RPT soft key again.

Audio system

Pause function

The CD changer mode is interrupted by an incoming call on the telephone* (▷ page 212).

- Switching on pause function



- ▶ Press **MUTE** button.

The CD changer mode is interrupted and PAUSE appears in the display.

- Switching off pause function

- ▶ Press **MUTE** button.

The CD changer mode is active again.

Track and time display



- ▶ Press T soft key.

The number of the track being played and the elapsed playing time appear in the display.

- ▶ Press T soft key again.

The total number of tracks and the total playing time of the CD appear in the display.

- ▶ Press T soft key.

The standard CD playback menu appears in the display.

GSM network phones

Using your Mercedes-Benz specified mobile telephone*, a number of functions and operating steps can be performed and displayed in the audio system display.

Further operating instructions not covered here can be found in the operating instructions for the multifunction steering wheel and the cellular telephone*.

If your audio system is set up for telephone operation, the  symbol will appear in the display.

When you insert your Mercedes-Benz specified mobile telephone* into the telephone cradle, you will be prompted to enter your PIN for 30 seconds (▷ page 209). This display disappears when you press any button.

When your mobile telephone is inserted into the telephone cradle, you will see the reception strength in the upper right-hand corner of the display.

Switching on the telephone

Switching on the telephone

- ▶ Press **TEL** button.

If the telephone was previously switched off, PROCESSING appears in the display and you will then be prompted to enter your PIN.

Switching off the telephone

- ▶ Press **TEL** button for approx. 3 seconds.

PROCESSING appears in the display until the telephone is off. Afterward, PHONE OFF appears in the display.

PIN entry



- ▶ Enter PIN number using buttons **1** to **0**.
- ▶ If necessary, correct number entered with the CLR soft key. Press soft key briefly to delete the last digit entered; press soft key and hold to delete the complete number.
- ▶ Press OK soft key after entering correct PIN.
- ▶ READY or ROAMING will appear in the display.

i If the PIN is entered incorrectly three times, NEED PUK will appear in the display. Enter PUK via your telephone. Please refer to the separate telephone operating instructions for more information.

Adjusting the volume

- ▶ Turn rotary control of **☎** button during a telephone call.

The volume will increase or decrease depending on the direction turned.

i The volume can be adjusted separately for telephone mode and audio mode.

Adjusting sound

- ▶ Adjust sound during a telephone call. Sound adjustment (▷ page 191).

Audio system

Placing a call

Entering a telephone number and starting the dialing process



- ▶ Enter desired telephone number using buttons **1** to **0**.

The number can have up to 32 digits, but only twelve of these are visible in the display.

- ▶ If necessary, correct number entered with the CLR soft key. Press soft key briefly to delete the last digit entered; press soft key and hold to delete the complete number.
- ▶ After correct telephone number has been entered, press  button.

i If the telephone number has been saved together with a name in the telephone book, the name will appear in the display.

Phone book

The numbers stored in the phone book of the telephone can be called up either by name or number.





In addition, incoming calls are stored in the phone book.

i This is only possible, however, when the call information transmitted includes the number of the person calling. If the telephone number is not transmitted, NO NUMBER will be stored in the phone book.

- Searching and calling up telephone book entries by name



You can access your mobile telephone's phone book using the audio system. You can access both the main entries and the sub-entries of your phone book.





- ▶ Press MEM soft key or press button  or .
- ▶ Press desired numerical key  to .

The stored entries are selected according to the alphabetical order of the initial letters (e.g. for S-Smith, press button  four times).



or

- ▶ Press and hold button  or .

The system jumps from one initial letter to the next in ascending or descending order.

- ▶ Press and hold button  or  until desired initial letter has been reached.

or

- ▶ Press button  or  repeatedly until desired entry has been reached.

The stored entries are selected in alphabetical order with the sub-entries.

i Several sub-entries can be stored for each main entry (name). These entries are marked by a corresponding abbreviation that appears in the upper left-hand corner of the display. The following abbreviations for sub-entries are possible:

CEL = Mobile phone
 HOM = Home
 WOR = Work
 FAX = Fax
 PAG = Pager
 TEL = Main

- ▶ When you have selected a number, press  button.

The call will be made.

- Viewing the telephone number of a telephone book entry



- ▶ Search for desired entry.

- ▶ Press NUM soft key.

The telephone number of the phone book entry appears in the display.

- Returning calls received



- ▶ Press MEM soft key or press button  or .

- ▶ Press RCV soft key (received calls).

The number of received calls and then the call last received appear briefly in the display.

- ▶ Select desired telephone number with button  or .

The letter R and the number of the memory position appear in the upper left-hand corner of the display. The numbers are stored in the order of the calls received.

- ▶ When you have selected a number, press  button.

The call will be made.

Audio system

- Speed dial

If you have stored telephone numbers as speed dial numbers in your telephone, you can also enter these with buttons **1** to **0** on the radio head unit.

- ▶ Press desired button **1** to **0** briefly.
- ▶ Press  button.
The call will be made.

- Turbo dial

If you have stored telephone numbers as turbo dial numbers in your telephone, you can also enter these with buttons **1** to **0** on the radio head unit.

- ▶ Press desired button **1** to **0** until the call is made.

Redial

If the number you have dialed is busy, you can again place calls to the last ten telephone numbers dialed using the redial function.

 *If you have activated the automatic redial function on your telephone, the number of the person being called is automatically redialed after a short waiting period if there is a busy signal. Refer to the separate operating instructions for the mobile telephone.*

- Manual redial



- ▶ Press  button.

The telephone number last dialed will appear in the display.

- ▶ Select desired telephone number with button  or .

The letter L and the number of the memory position appears in the left-hand corner of the display. The numbers are stored in the order of the calls received.

- ▶ When you have selected a number, press  button.

The call will be made.

Accepting an incoming call

If the telephone is active in the background (reception symbol is visible in the display), the audio source is muted when an incoming call is received. A ringing tone can be heard and the caller's telephone number, or the name under which the telephone number has been saved in the phone book, appears in the display. If the caller's number is not transmitted with the call, CALL will appear in the display.

- ▶ Press  button.

The call is accepted.

Muting a call

It is possible to mute a call; the caller is then no longer able to hear you.

- Mute on
 - ▶ Press MUT soft key.
 - ▶ MIC MUTE will appear in the display.
- Mute off
 - ▶ Press MUT soft key again.

Terminating a call

- ▶ Press  button.

The current call is terminated and the muted audio source becomes active again.

Talking with two callers at the same time

If you wish to receive or place another call during an already active call, you can accept or place the second call and switch between the callers or combine them into one call. Note that the features described here are depending on availability from your mobile phone service provider.

- Placing/accepting a second call
 - ▶ Place new call by entering telephone number manually.
 - ▶ Press  button.



You are connected to the second caller; the first caller is kept on hold.

or



- ▶ Press  button to accept a second call.

 You will be notified of the second call acoustically, but you will not see this in the display.

You are connected with the second caller; the first caller is kept on hold.

- Switching between calls
 - ▶ Press  and  buttons.

This switches between the calls. The non-active call is kept on hold.
- Terminating a call
 - ▶ Press  button.

The current call is terminated. You are again connected with the caller previously placed on hold.
- Combining two calls
 - ▶ Press  and  buttons.

The calls are combined into one call.
- Terminating a combined call
 - ▶ Press  button.

The connection to both callers is terminated.

Audio system

TDMA or CDMA network phones

Using your Mercedes-Benz specified mobile telephone*, a number of functions and operating steps can be performed and displayed in the audio system display.

Further operating instructions not covered here can be found in the operating instructions for the multifunction steering wheel and the mobile telephone*.

If your audio system is set up for telephone operation, the  symbol will appear in the display.

When you insert your Mercedes-Benz specified mobile telephone* into the telephone cradle, you will be prompted to enter your PIN for 30 seconds (▷ page 209). This display disappears when you press any button.

When your mobile telephone is inserted into the telephone cradle, you will see the reception strength in the upper right-hand corner of the display.

Switching on the telephone

Switching on the telephone

- ▶ Press **TEL** button.

If you have programmed an unlock code for the telephone, you must now enter the code.



- ▶ Enter code using buttons **1** to **0**.
- ▶ If necessary, correct number entered with the CLR soft key. Press soft key briefly to delete the last digit entered; press soft key and hold to delete the complete number.

- ▶ Press OK soft key after entering correct code.

The telephone is unlocked. If you have entered an incorrect code, you must enter the correct code.

Switching off the telephone

- ▶ Press **TEL** button for approx. 3 seconds.

PROCESSING appears in the display until the telephone is off. Afterward, PHONE OFF appears in the display.

Adjusting the volume

- ▶ Turn rotary control of  button during a telephone call.

The volume will increase or decrease depending on the direction turned.

 *The volume can be adjusted separately for telephone mode and audio mode.*

Adjusting sound

- ▶ Adjust sound during a telephone call. Sound adjustment (▷ page 191).

Placing a call

Entering a telephone number and starting the dialing process

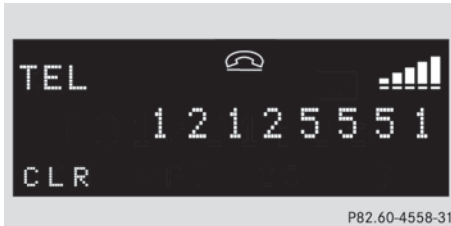

- ▶ Enter desired telephone number using buttons **1** to **0**.

The number can have up to 32 digits, but only twelve of these are visible in the display.

- ▶ If necessary, correct number entered with the CLR soft key. Press soft key briefly to delete the last digit entered; press soft key and hold to delete the complete number.
- ▶ After correct telephone number has been entered, press  button.

i If the telephone number has been saved together with a name in the phone book, the name will appear in the display.

Phone book

The numbers stored in the phone book of the mobile telephone can be called up either by name or number.





In addition, incoming calls are stored in the phone book.

i This is only possible, however, when the call information transmitted includes the number of the person calling. If the telephone number is not transmitted, NO NUMBER will be stored in the phone book.

- Searching and calling up phone book entries by name

You can access your mobile telephone's phone book with the audio system. You can access both the main entries and the sub-entries of your phone book.





- ▶ Press MEM soft key or press button  or .
- ▶ Press desired numerical key  to .

The stored entries are selected according to the alphabetical order of the initial letters (e.g. for S -Schneider, press button  four times).



or

▷▷



Audio system

- ▷▷ ▶ Press and hold button  or .

The system jumps from one initial letter to the next in ascending or descending order.

- ▶ Press and hold button  or  until desired initial letter has been reached.

or

- ▶ Press button  or  repeatedly until desired entry has been reached.

The stored entries are selected in alphabetical order with the sub-entries.

 Several sub-entries can be stored for each main entry (name). These entries are marked by a corresponding abbreviation that appears in the upper left-hand corner of the display. The following abbreviations for sub-entries are possible:

CEL = Mobile phone

HOM = Home

WOR = Work

FAX = Fax

PAG = Pager

TEL = Main





- ▶ When you have selected a number, press  button.

The call will be made.

- Viewing the telephone number of a phone book entry
 - ▶ Search for desired entry.
 - ▶ Press NUM soft key.

The telephone number of the phone book entry appears in the display.
- Returning calls received



- ▶ Press MEM soft key or press button  or .
- ▶ Press RCV soft key (received calls). The number of received calls and then the call last received appear briefly in the display.
- ▶ Select desired telephone number with button  or .
- The letter R and the number of the memory position appear in the upper left-hand corner of the display. The numbers are stored in the order of the calls received.
- ▶ When you have selected a number, press  button. The call will be made.

- Speed dial

If you have stored telephone numbers as speed dial numbers in your telephone, you can also enter these with buttons **1** to **0** on the radio unit.

- ▶ Press desired button **1** to **0** briefly.

- ▶ Press  button.

The call will be made.

- Turbo dial

If you have stored telephone numbers as turbo dial numbers in your telephone, you can also enter these with buttons **1** to **0** on the radio unit.

- ▶ Press desired button **1** to **0** until the call is made.

Redial

If the number you have dialed is busy, you can again place calls to the last ten telephone numbers dialed using the redial function.

 *If you have activated the automatic redial function on your mobile telephone, the number of the person being called is automatically redialed after a short waiting period if there is a busy signal.*

Refer to the separate operating instructions for the mobile telephone.

- Manual redial



- ▶ Press  button.

The telephone number last dialed will appear in the display.

- ▶ Select desired telephone number with button  or .

The letter L and the number of the memory position appears in the left-hand corner of the display. The numbers are stored in the order of the calls received.

- ▶ When you have selected a number, press  button.

The call will be made.

Accepting an incoming call

If the telephone is active in the background (reception symbol is visible in the display), the audio source is muted when an incoming call is received. A ringing tone can be heard and the caller's telephone number, or the name under which the telephone number has been saved in the telephone book, appears in the display. If the caller's number is not relayed, CALL will appear in the display.

- ▶ Press  button.

The call is accepted.

Audio system

Muting a call

It is possible to mute a call; the caller is then no longer able to hear you.

- Mute on
 - ▶ Press MUT soft key.
 - ▶ MIC MUTE will appear in the display.
- Mute off
 - ▶ Press MUT soft key again.

Terminating a call

- ▶ Press  button.

The current call is terminated and the muted audio source becomes active again.

Accepting a second incoming call

If you receive another call during an already active call, you can accept the second call and switch between the two.

- Accepting a second call
 - ▶ Place new call by entering telephone number manually.

 *You will be notified of the second call acoustically, but you will not see this in the display.*

You are connected to the second caller; the first caller is kept on hold.

- Switching between calls
 - ▶ Press  button.

This switches between the calls. The non-active call is kept on hold.
- Terminating a call
 - ▶ Press  button.

The current call is terminated. The connection to the caller previously kept on hold is also interrupted; however, reconnection is indicated by an acoustic signal.



Placing a second call

If you wish to place another call during an already active call, you can place the second call and switch between the callers or combine them into one call. Note that this feature is dependent on availability from your mobile phone service provider.

- Placing a second call
 - ▶ Place a new call by entering telephone number manually.
 - ▶ Press  button.

You are connected to the second caller; the first caller is kept on hold.
- Terminating a call
 - ▶ Press  button.

The current call is terminated. The connection to the caller previously kept on hold is also interrupted; however, reconnection is indicated by an acoustic signal.

- Combining two calls
 - ▶ Press  button.
The calls are combined into one call.
- Terminating a combined call
 - ▶ Press  button.
The connection to both callers is terminated.

Emergency calls “911”

The following describes how to dial a “911” emergency call using the audio system head unit when a Mercedes-Benz specified mobile phone* is inserted in the phone cradle*. Unless otherwise specified, the descriptions refer to the audio system head unit.

Consult the separate telephone operating instructions that came with your mobile phone* for information on how to place a “911” emergency call on the mobile phone*.

Warning!



The “911” emergency call system is a public service. Using it without due cause is a criminal offense.

The following conditions must be met for a “911” emergency call:

- Telephone must be switched on.
- The corresponding mobile communications network must be available.

 *Emergency calls may not be possible with all telephone networks or if certain network services and/or telephone functions are active. Check with your local service providers.*

If you cannot make an emergency call, you will have to initiate rescue measures yourself.

GSM network phones

Placing a “911” emergency call using audio head unit with the phone locked

- ▶ Press  button to switch to telephone operation.
PIN? appears in the audio display.
- ▶ Enter 911 using the number keypad on the audio head unit. ▷▷

Audio system

- ▷▷ Press OK soft key or  button for dialing to begin.

DIALING appears in the audio display while the telephone establishes the connection.

- ▶ Wait until the emergency call center answers, then describe the emergency.

Placing a “911” emergency call using audio head unit with the phone unlocked

- ▶ Press **TEL** button to switch to telephone operation.
- ▶ Enter 911 using the number keypad on the audio head unit.
- ▶ Press  button for dialing to begin.

DIALING appears in the audio display while the telephone establishes the connection.

- ▶ Wait until the emergency call center answers, then describe the emergency.

 *If no SIM card is in the mobile phone, NO SERVICE appears in the audio display. In that case, you only can make an emergency call on the mobile phone itself, without the use of the head unit.*

TDMA/CDMA network phones

Placing a “911” emergency call using audio head unit with the phone locked

- ▶ Press **TEL** button to switch to telephone operation.
CODE? appears in the audio display.
- ▶ Enter 911 using the number keypad on the audio head unit.
- ▶ Press OK soft key or  button for dialing to begin.

DIALING appears in the audio display while the telephone establishes the connection.

- ▶ Wait until the emergency call center answers, then describe the emergency.

Placing a “911” emergency call using audio head unit with the phone unlocked

- ▶ Press **TEL** button to switch to telephone operation.
- ▶ Enter 911 using the number keypad on the audio head unit.
- ▶ Press  button for dialing to begin.

DIALING appears in the audio display while the telephone establishes the connection.

- ▶ Wait until the emergency call center answers, then describe the emergency.

▼ Power windows

Opening and closing the windows

The side windows are opened and closed electrically. The switches for all the side windows are on the driver's door. The switches for the respective windows are on the front passenger door and the rear doors.

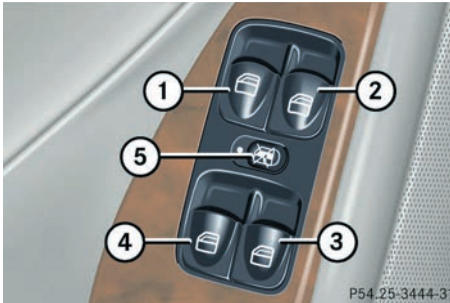

- ① Left front window
- ② Right front window
- ③ Right rear window
- ④ Left rear window
- ⑤ Rear window override switch
(▷ page 80)



Warning!



When closing the power windows, make sure there is no danger of anyone being harmed by the closing procedure.



The closing of the door windows can be immediately halted by releasing the switch or, if switch was pulled past the resistance point and released, by either pressing or pulling the respective switch.

If the window encounters an obstruction that blocks its path in a circumstance where you pulled the switch past the resistance point and released it to close the window, the automatic reversal function will stop the window and open it slightly.

If the window encounters an obstruction that blocks its path in a circumstance where you are closing the window by pulling and holding the switch, by pressing and holding button  on the SmartKey, or by pressing and holding button  or  on the climate control panel, the automatic reversal function will not operate.

When leaving the vehicle, always remove the SmartKey from the starter switch, take it with you, and lock the vehicle. Do not leave children unattended in the vehicle, or with access to an unlocked vehicle. A child's unsupervised access to a vehicle could result in an accident and/or serious personal injury.

i You can also open or close the power windows using the SmartKey, see "Summer opening feature" (▷ page 223) and "Convenience closing feature" (▷ page 223).

Depending on current position, the windows may also open or close when the air recirculation button  in the control panel of the climate control (▷ page 165) or automatic climate control* (Canada only) (▷ page 175), or the charcoal filter button  in the control panel of the automatic climate control* (Canada only) (▷ page 183) is pressed and held.

▶ Switch on the ignition (▷ page 32).

Power windows

Opening the windows

- ▶ Press switch ① to ④ to the resistance point.

The corresponding window will move downwards until you release the switch.

Closing the windows

- ▶ Pull switch ① to ④ to the resistance point.

The corresponding window will move upwards until you release the switch.

Warning!



If you pull and hold the switch up when closing the window, and upward movement of the window is blocked by some obstruction including but not limited to arms, hands, fingers, etc., the automatic reversal will not operate.

Fully opening the windows (Express-open)

- ▶ Press switch ① to ④ past the resistance point and release.

The corresponding window opens completely.

Fully closing the windows (Express-close)

- ▶ Pull switch ① to ④ past the resistance point and release.

The corresponding window closes completely.

! *If the upward movement of the window is blocked during the closing procedure, the window will stop and open slightly.*

Remove the obstruction, pull the switch again past the resistance point and release.

If the window still does not close when there is no obstruction, then pull and hold the switch again. The side window will then close without the obstruction sensor function.

Warning!



Driver's door only:

If within 5 seconds you again pull the switch past the resistance point and release, the automatic reversal will not function.

Stopping windows

- ▶ Press or pull respective switch again.

Synchronizing power windows

The power windows must be resynchronized each time

- after the battery has been disconnected or discharged.
- if the power windows cannot be fully opened (Express-open) or closed (Express-close).
- ▶ Switch on the ignition (▷ page 32).

- ▶ Pull the power window switches until the side windows are closed.

Hold the switches for approximately 1 second.



The power windows are synchronized.

Summer opening feature

If the weather is warm, you can ventilate the vehicle before driving off by simultaneously:

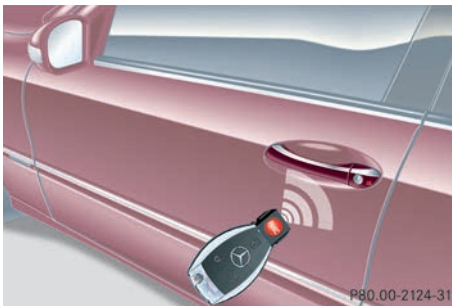
- opening the side windows
- opening the tilt/sliding sunroof*



- ▶ Aim transmitter eye at the driver's door handle. The SmartKey must be in close proximity to the door handle.
- ▶ Press and hold button  until the windows and the tilt/sliding sunroof* have reached the desired position.
- ▶ Release button  to interrupt procedure.



Convenience closing feature



Warning!



When closing the windows and the tilt/sliding sunroof*, make sure that there is no danger of anyone being harmed by the closing procedure.

If potential danger exists, proceed as follows:

- Release button  to stop the closing procedure. To open, press and hold button . To continue the closing procedure after making sure that there is no danger of anyone being harmed by the closing procedure, press and hold button .

- ▶ Aim transmitter eye at the driver's door handle. The SmartKey must be in close proximity to the door handle.
- ▶ Press and hold button  until the windows and the tilt/sliding sunroof* are completely closed.
- ▶ Release the  button to stop procedure.

Make sure all windows and the tilt/sliding sunroof* are properly closed before leaving the vehicle.

Power tilt/sliding sunroof*

Opening and closing the power tilt/sliding sunroof

The tilt/sliding sunroof can be opened and closed electrically. The switch for the tilt/sliding sunroof is on the overhead control panel.

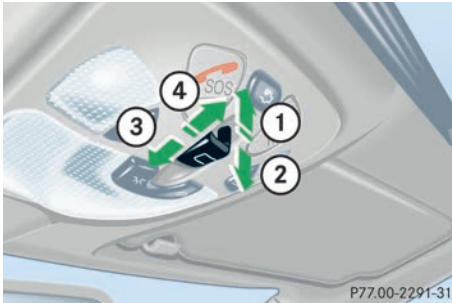

Sunroof switch

- ① Push up to raise sunroof at rear
- ② Pull down to lower sunroof at rear
- ③ Push forward to slide sunroof closed
- ④ Push back to slide sunroof open

With the sunroof closed or tilted open, a screen can be slid into the roof opening to guard against sun rays. When sliding the sunroof open, the screen will also retract.

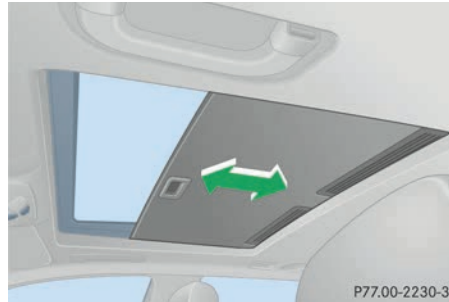

Screen

Warning!



When closing the tilt/sliding sunroof, make sure there is no danger of anyone being harmed by the closing procedure.

The opening/closing procedure of the tilt/sliding sunroof can be immediately halted by releasing the switch or, if the switch was moved past the resistance point and released, by moving the switch in any direction.

The tilt/sliding sunroof is made out of glass. In the event of an accident, the glass may shatter. This may result in an opening in the roof.

In a vehicle rollover, occupants not wearing their seat belts or not wearing them properly may be thrown out of the opening. Such an opening also presents a potential for injury for occupants wearing their seat belts properly as entire body parts or portions of them may protrude from the passenger compartment.

Power tilt/sliding sunroof*

When leaving the vehicle, always remove the SmartKey from the starter switch, take it with you, and lock the vehicle. Do not leave children unattended in the vehicle, or with access to an unlocked vehicle. A child's unsupervised access to a vehicle could result in an accident and/or serious personal injury.



! To avoid damaging the seals, do not transport any objects with sharp edges which can stick out of the tilt/sliding sunroof.

Do not open the tilt/sliding sunroof if there is snow or ice on the roof, as this could result in malfunctions.

The tilt/sliding sunroof can be opened or closed manually should an electrical malfunction occur (▷ page 364).

i When the tilt/sliding sunroof is open, resonance noises may result in addition to the usual wind noises. They are caused by minimal pressure changes in the passenger compartment. To reduce or eliminate these noises, change the position of the tilt/sliding sunroof or open a side window slightly.

i You can also open or close the tilt/sliding sunroof using the SmartKey, see "Summer opening feature" (▷ page 223) and "Convenience closing feature" (▷ page 223).

Depending on current position, the tilt/sliding sunroof may also open or close when the air recirculation button  in the control panel of the climate control (▷ page 165) or automatic climate control* (Canada only) (▷ page 181), or the charcoal filter button  in the control panel of the automatic climate control* (Canada only) (▷ page 183) is pressed and held.

▶ Switch on the ignition (▷ page 32).

Opening and closing the power tilt/sliding sunroof

▶ To open, close, raise, or lower the tilt/sliding sunroof, move the sunroof switch to resistance point in the required direction of arrows ① to ④.

Release the sunroof switch when the tilt/sliding sunroof has reached the desired position.

Fully opening (Express-open) and closing (Express-close) the power tilt/sliding sunroof

▶ To open or close the tilt/sliding sunroof, move the sunroof switch past the resistance point in the required direction of arrow ① to ④ and release.

The tilt/sliding sunroof opens or closes completely.

Power tilt/sliding sunroof*

Stopping the power tilt/sliding sunroof during Express-operation

- ▶ Move the sunroof switch in any direction.

i *If the movement of the tilt/sliding sunroof is blocked during the closing procedure, the tilt/sliding sunroof will stop and reopen slightly.*

Synchronizing the power tilt/sliding sunroof

The tilt/sliding sunroof must be synchronized

- after the battery has been disconnected or discharged
- after the tilt/sliding sunroof has been closed manually (▷ page 364)
- after a malfunction
- if the tilt/sliding sunroof does not open smoothly

- ▶ Switch on the ignition (▷ page 32).
- ▶ Move and hold the sunroof switch in direction of arrow ① (▷ page 224) until the tilt/sliding sunroof is fully raised at the rear.

Hold the sunroof switch for approximately 1 second.

- ▶ Check the Express-open feature (▷ page 225).

If the tilt/sliding sunroof opens completely, the tilt/sliding sunroof is synchronized. Otherwise repeat the above steps.

▼ Driving systems

The driving system of your vehicle is described on the following pages:

- Cruise control, with which the vehicle can maintain a preset speed.

For information on the BAS, ABS and ESP®, see “Driving safety systems” (▷ page 82).

Cruise control

The cruise control automatically maintains the speed you set for your vehicle.

The use of cruise control is recommended for driving at a constant speed for extended periods of time. You can set or resume cruise control at any speed over 20 mph (30 km/h).

The cruise control function is operated by means of the cruise control lever.

The cruise control lever is the uppermost lever on the left-hand side of the steering column (▷ page 22).

Warning!



The cruise control is a convenience system designed to assist the driver during vehicle operation. The driver is and must always remain responsible for the vehicle's speed and for safe brake operation.

Only use cruise control if the road, traffic and weather conditions make it advisable to travel at a steady speed.

- The use of cruise control can be dangerous on winding roads or in heavy traffic because conditions do not allow safe driving at a steady speed.
- The use of cruise control can be dangerous on slippery roads. Rapid changes in tire traction can result in wheel spin and loss of control.
- Deactivate cruise control when driving in fog.

The “Resume” function should only be operated if the driver is fully aware of the previously set speed and wishes to resume this particular preset speed.

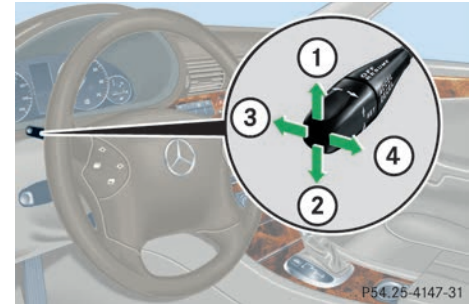

- ① Sets current or higher speed
- ② Sets current or lower speed
- ③ Cancels cruise control
- ④ Resumes at last set speed

Setting current speed

- ▶ Accelerate or decelerate to the desired speed.
- ▶ Briefly lift ① or depress ② the cruise control lever.

The current speed is set.

- ▶ Remove your foot from the accelerator pedal.

Cruise control is activated.

Driving systems

i On uphill or downhill grades, cruise control may not be able to maintain the set speed. Once the grade eases, the set speed will be resumed.

Canceling cruise control

There are several ways to cancel cruise control:

- ▶ Step on the brake pedal.

Cruise control is canceled. The last speed set is stored for later use.

or

- ▶ Briefly push the cruise control lever to position ③.

Cruise control is canceled. The last speed set is stored for later use.

! Vehicles with automatic transmission*: Moving the gear selector lever to position **N** while driving also cancels cruise control. However, the gear selector lever should not be moved to position **N** while driving, except to coast when the vehicle is in danger of skidding (e.g. on icy roads).

i Vehicles with manual transmission: The set cruise controlled speed is switched off when de-clutching exceeds 4 seconds during shifting a new gear.

i The last stored speed is canceled when you turn off the engine.

Setting a higher speed

- ▶ Lift cruise control lever to position ① and hold it up until the desired speed is reached.

- ▶ Release cruise control lever.

The new speed is set.

i Depressing the accelerator pedal does not deactivate cruise control. After brief acceleration (e.g. for passing), cruise control will resume the last speed set.

Setting a lower speed

- ▶ Depress cruise control lever to position ② and hold it down until the desired speed is reached.
- ▶ Release cruise control lever.
The new speed is set.

i *Vehicles with automatic transmission*:
When you use the cruise control lever to decelerate, the transmission will automatically downshift if the engine's braking power does not brake the vehicle sufficiently.*

Fine adjustment in 1 mph (Canada: 1 km/h) increments

Faster

- ▶ Briefly tip cruise control lever in direction of arrow ①.

Slower

- ▶ Briefly tip cruise control lever in direction of arrow ②.

Setting to last stored speed “Resume” function)

Warning!



The speed stored in memory should only be set again if prevailing road conditions permit. Possible acceleration or deceleration differences arising from returning to preset speed could cause an accident and/or serious injury to you and others.

- ▶ Briefly push cruise control lever to position ④.
The cruise control resumes the last set speed.
- ▶ Remove your foot from the accelerator pedal.

Loading

Roof rack*

Warning!



Only use roof racks approved by Mercedes-Benz for your vehicle model to avoid damage to the vehicle.

Follow the manufacturer's installation instructions. Otherwise, an improperly attached roof rack system or its load could become detached from the vehicle.

Do not exceed the maximum roof load of 220 lbs (100 kg).

Take into consideration that when the roof rack is loaded, the handling characteristics are different from those when operating the vehicles without the roof rack loaded.

! Load the roof rack in such a way that the vehicle cannot be damaged while driving.

Make sure

- you can fully raise the tilt/sliding sunroof*.
- you can fully open the trunk.

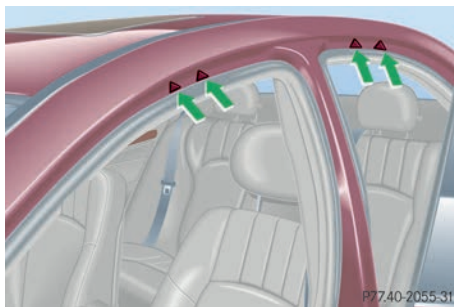

- ▶ Mount the roof rack only between the fastening points (see arrows).
- ▶ Secure the roof rack according to manufacturer's instructions for installation.

Ski sack* (Canada only)

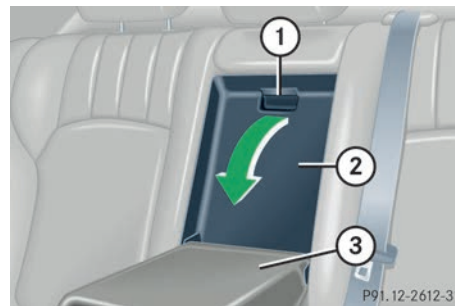

- ① Handle
- ② Cover
- ③ Armrest

Unfolding and loading

- ▶ Fold armrest ③ down (arrow).

! Do not sit on or lean your body weight against the armrest when it is folded down, as you could otherwise damage it.

- ▶ Pull handle ① and swing cover ② down.

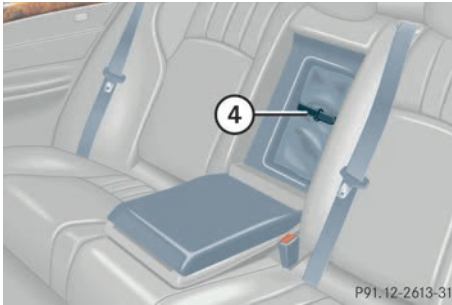

④ Hook and loop fastener

- ▶ Unfasten hook and loop fastener ④.
- ▶ Pull ski sack into passenger compartment and unfold.

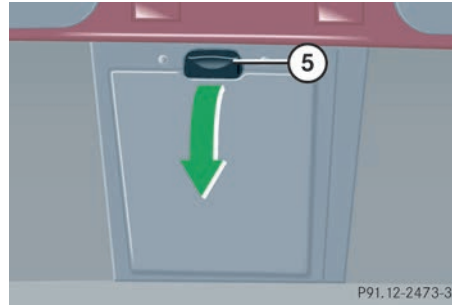

⑤ Button

- ▶ Open trunk lid.
 - ▶ Press button ⑤.
- The flap opens downward.

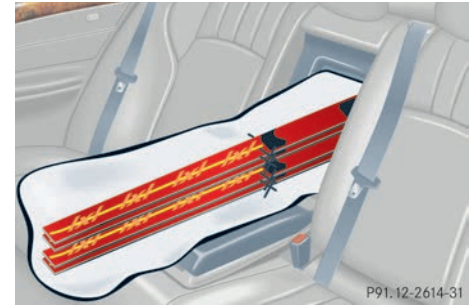

- ▶ From trunk, slide skis into ski sack.

Warning!



The ski sack is designed for up to four pairs of skis. Do not load the ski sack with other objects.

Always fasten the ski sack securely. In an accident, an unfastened ski sack can cause injury to vehicle occupants.



Loading



⑥ Strap

- ▶ Tighten strap ⑥ by pulling at the loose end (arrow) until the skis in the ski sack are tightly secured.

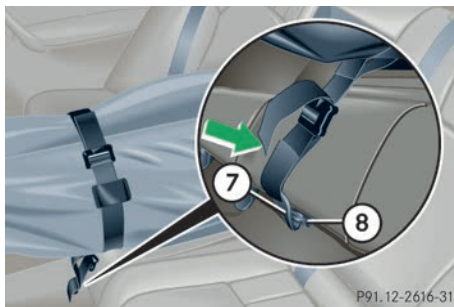

⑦ Hook

⑧ Eye

- ▶ Connect hook ⑦ to eye ⑧.

Tighten strap by pulling at the loose end (arrow).

Unloading and folding

- ▶ Loosen the straps.
- ▶ Disconnect hook ⑦ from eye ⑧.
- ▶ Unload skis.
- ▶ Close flap in trunk.
- ▶ Fold and flatten ski sack lengthwise.
- ▶ Place folded ski sack inside recess of backrest.
- ▶ Fasten hook and loop fastener.
- ▶ Close ski sack compartment cover.

Removing the ski sack

You can remove the ski sack for cleaning or drying.

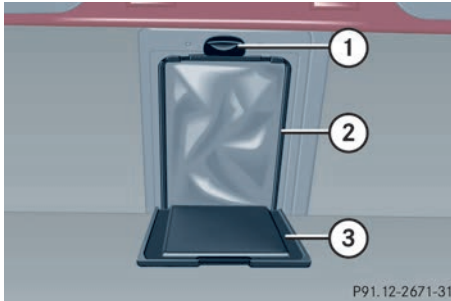

- ① Button
- ② Ski sack frame
- ③ Flap

- ▶ Open trunk lid.
- ▶ Press button ①.

The flap ③ opens downward.

- ▶ Press button ① firmly until ski sack frame ② is released.
- ▶ Pull ski sack frame ② with ski sack out.

Warning!



Never drive vehicle with trunk open while the ski sack is removed. Deadly carbon monoxide (CO) gases may enter vehicle interior, resulting in unconsciousness and death.

i To prevent unauthorized persons from accessing the trunk, always close the flap.

Installing the ski sack

Install the ski sack in the reverse order.

- ▶ Push ski sack frame ② with ski sack inward until the ski sack frame snaps into place.
- ▶ Close flap ③.
- ▶ Close trunk lid.

Split rear bench seat*

To expand the cargo area, you can fold down the left and right rear seat backrests.

The two sections can be folded down separately.

Warning!



When expanding the luggage area, always fold the seat cushions fully forward.

Unless you are transporting cargo, the backrests must remain properly locked in the upright position.

In an accident, during hard braking or sudden maneuvers, loose items will be thrown around inside the vehicle, and cause injury to vehicle occupants unless the items are securely fastened in the vehicle.

Always use the cargo tie down rings* (▷ page 236).

Loading

Folding the backrest forward

The release handle ① is located in the trunk.

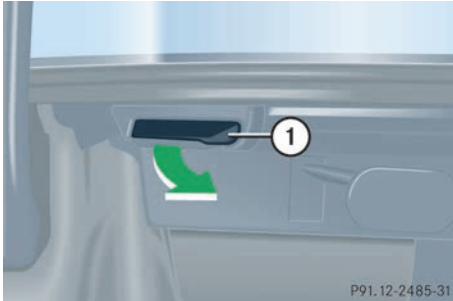

- ▶ Pull release handle ①.
- ▶ Fully retract and fold rearward head restraints (> page 103).

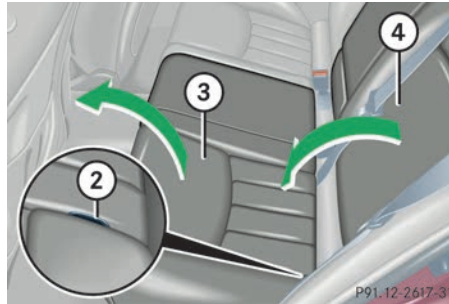

- ▶ Pull release handle ②.
- ▶ Fold seat cushion ③ forward.
- ▶ Fold backrest ④ forward.

! Always release the seat cushion and fold it forward before folding the seat backrests forward. Otherwise, the backrest covering may be damaged.

Returning the backrest to original position

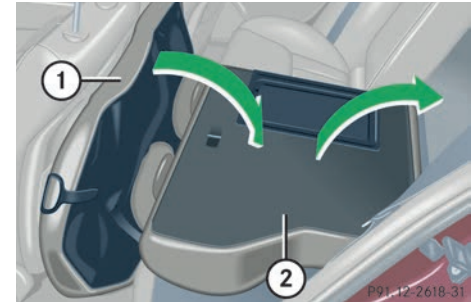

- ▶ Fold backrest ② rearward until it engages.
- ▶ Fold seat cushion ① rearward until it locks into position.

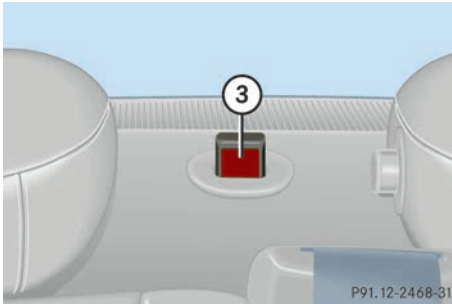

If the backrest is not locked into position, a red indicator ③ will be visible.

- ▶ Check for secure locking by pushing and pulling on the backrest.

Warning!



If a red indicator is visible with the backrest up, then the backrest is not properly locked into position.

Always lock backrest in its upright position when rear seat bench is occupied, cargo is being carried in the trunk, or the extended cargo compartment is not in use. Check for secure locking by pushing and pulling on the backrest.

In an accident, during hard braking or sudden maneuvers, loose items will be thrown around inside the vehicle, and cause injury to vehicle occupants unless the items are securely fastened in the vehicle.

To help avoid personal injury during a collision or sudden maneuver, exercise care when transporting cargo.

i To prevent unauthorized persons from access to the trunk, always lock backrest in its upright position.

Loading instructions

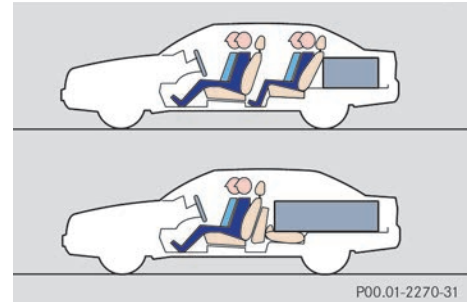

The total load weight including vehicle occupants and luggage/cargo should not exceed the load limit indicated on the corresponding placard located on the driver's door B-pillar.

The handling characteristics of a fully loaded vehicle depend greatly on the load distribution. It is therefore recommended to load the vehicle according to the illustrations shown, with the heaviest items being placed towards the front of the vehicle.

Loading

Always place items being carried against front or rear seat backrests, and fasten them as securely as possible.

The heaviest portion of the cargo should always be kept as low as possible since it influences the handling characteristics of the vehicle.

Warning!



Always fasten items being carried as securely as possible using cargo tie-down rings and fastening materials appropriate for the weight and size of the load.

In an accident, during hard braking or sudden maneuvers, loose items will be thrown around inside the vehicle and can cause injury to vehicle occupants unless the items are securely fastened in the vehicle.

To help avoid personal injury during a collision or sudden maneuver, exercise care when transporting cargo.

Never drive vehicle with trunk open. Deadly carbon monoxide (CO) gases may enter vehicle interior resulting in unconsciousness and death.

i *The trunk is the preferred place to carry objects.*

The enlarged cargo area should only be used for items which do not fit in the trunk alone.

Cargo tie-down rings*

The four cargo tie-down rings are located in the trunk.

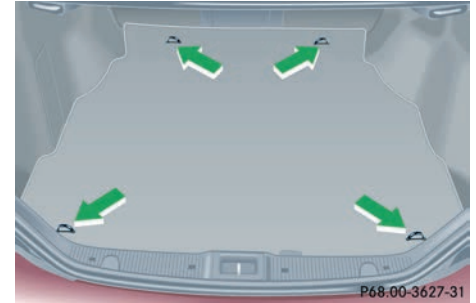

Cargo tie-down rings

- ▶ Carefully secure cargo by applying even load on all rings with rope sufficient strength to hold down the cargo.

Always follow loading instructions (▷ page 235).

▼ Useful features

Storage compartments

Warning!



Do not store any flammable substances inside the vehicle or in the trunk. Otherwise the flammable substances could ignite and start a fire inside the vehicle.

To help avoid personal injury during a collision or sudden maneuver, exercise care when storing objects in the vehicle. Put luggage or cargo in the trunk if possible. Do not pile luggage or cargo higher than the seat backs. Do not place anything on the shelf below the rear window.

Luggage nets cannot secure hard or heavy objects.

Keep compartment lids closed. This will help to prevent stored objects from being thrown about and injuring vehicle occupants during an accident.

Glove box

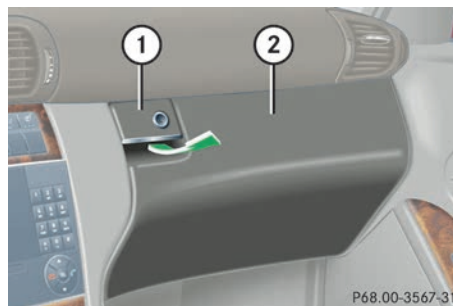

- ① Glove box lid release
- ② Glove box lid

Opening glove box

- ▶ Pull glove box lid release ①.
- The glove box lid ② opens downward.

Closing glove box

- ▶ Push glove box lid ② up to close.

i *Audio system/COMAND* with CD changer*: The CD changer* is located in the glove box.*

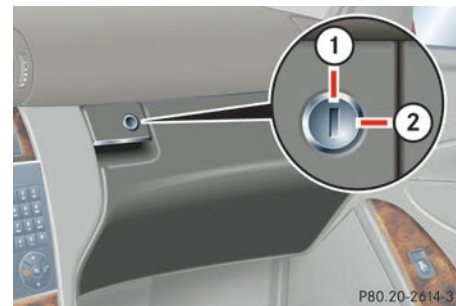

- ① Unlocking
- ② Locking

Locking glove box

- ▶ Insert mechanical key (▷ page 361) into the glove box lock and turn it to position ②.

Unlocking glove box

- ▶ Turn mechanical key in the glove box lock to position ①.

Useful features

Storage compartment/telephone* tray under front center armrest

A flat storage tray with a deeper storage compartment underneath is located below the front center armrest. Both can be opened separately.

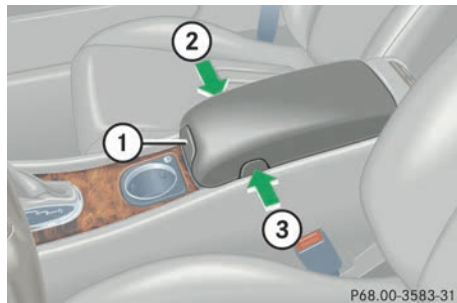

- ① Handle to open storage compartment
- ② Button to open storage tray/telephone* tray, passenger side
- ③ Button to open storage tray/telephone* tray, driver's side

Opening storage compartment

- ▶ Pull handle ① and lift armrest.

Closing storage compartment



- ▶ Press armrest down until it engages into place.

Opening the storage tray/telephone* tray

- ▶ Press button ③ on driver's side or button ② on passenger side and lift armrest.

Closing the storage tray/telephone* tray

- ▶ Press armrest down until it engages into place.

i The mobile phone cradle (▷ page 245), the Roadside Assistance button  (▷ page 250) and the Information button  (▷ page 251) are located in the storage tray (if equipped).

Armrest in the rear passenger compartment



- ▶ Pull the top of the armrest out and fold it down.

! Do not sit on or lean your body weight against the armrest when it is folded down, as you could otherwise damage it.

Parcel net in front passenger footwell (all models, except C 280 4MATIC and C 350 4MATIC)

A small convenience parcel net is located in the front passenger footwell. It is for small and light items, such as road maps, mail, etc.

Warning!



The parcel net is intended for storing light-weight items only.

Heavy objects, objects with sharp edges or fragile objects may not be transported in the parcel net. In an accident, during hard braking, or sudden maneuvers, they could be thrown around inside the vehicle and cause injury to vehicle occupants.

The parcel net cannot protect transported goods in the event of an accident.

Cup holders

Warning!



In order to help prevent spilling liquids on vehicle occupants and/or vehicle equipment, only use containers that fit into the cup holder. Use lids on open containers and do not fill containers to a height where the contents, especially hot liquids, could spill during braking, vehicle maneuvers, or an accident. Liquids spilled on vehicle occupants may cause serious personal injury. Liquids spilled on vehicle equipment may cause damage not covered by the Mercedes-Benz Limited Warranty.

When not in use, keep the cup holder closed. An open cup holder may cause injury to you or others when contacted during braking, vehicle maneuvers, or in an accident.

Keep in mind that objects placed in the cup holder may come loose during braking, vehicle maneuvers, or in an accident and be thrown around in the vehicle interior.

Objects thrown around in the vehicle interior may cause an accident and/or serious personal injury.

Cup holders in front of seat armrest

Underneath the swiveling cup holder is another stationary cup holder. You can only use this when the swiveling cup holder is pulled out and completely turned outward.

Useful features

Sliding out swiveling cup holder

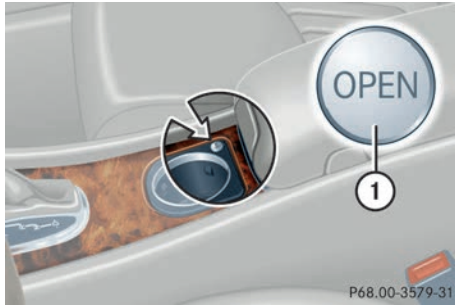

- ▶ Push button ①.

The cup holder slides upward.

! No objects should be in the swiveling cup holder when the swiveling cup holder is slid upward. Otherwise the swiveling cup holder or the objects could be damaged.

Turning swiveling cup holder outward



- ▶ Turn the cup holder in direction of arrow ② until it engages.
You can now use both cup holders.

Turning swiveling cup holder inward and sliding it in

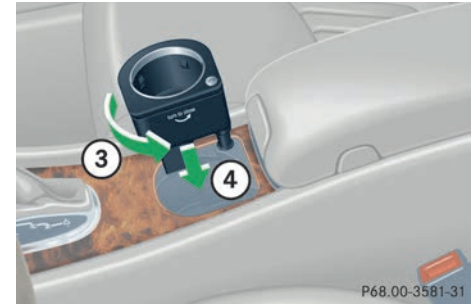

- ▶ Turn the cup holder in direction of arrow ③ until it engages.
- ▶ Press the cup holder in direction of arrow ④ until it engages.

! No objects should be in the stationary cup holder when the swiveling cup holder is turned inward and pushed in. Otherwise the swiveling cup holder or the objects could be damaged.

Cup holder in rear seat armrest

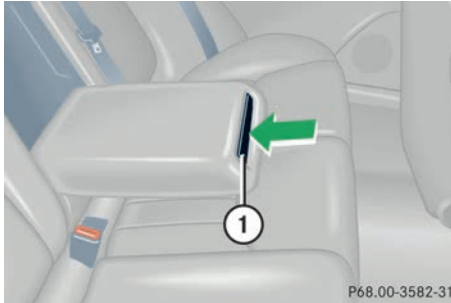

- ① Cup holder

Opening cup holder

- ▶ Briefly press the front of cup holder ①.
The cup holder slides out slightly.
- ▶ Pull out the cup holder until it stops.

Closing cup holder

- ▶ Slide cup holder back until it engages.

! Do not sit on or lean your body weight against the armrest when it is folded down, as you could otherwise damage it.

Ashtrays

Center console ashtray

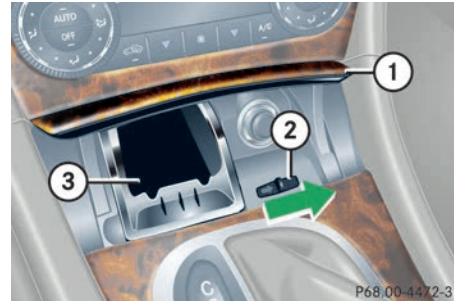

- ① Cover plate
- ② Sliding button
- ③ Ashtray insert
- ▶ Briefly press the bottom of cover plate ①.
The cover plate opens automatically.

Removing ashtray insert

Warning!



Remove front ashtray only with vehicle standing still. Set the parking brake to secure vehicle from movement. Move gear selector lever to position **N** (manual transmission: second gear). With gear selector lever in position **N** (manual transmission: second gear) turn off the engine.

- ▶ Secure vehicle from movement by setting the parking brake.
- ▶ Move the gear selector lever to position **N** (manual transmission: second gear).
Now you have more room to take out the ashtray insert.
- ▶ Push sliding button ② to the right.
The ashtray insert ③ slides out slightly.
- ▶ Remove the ashtray insert.

Useful features

Reinstalling ashtray insert

- ▶ Push the ashtray insert ③ down into the retainer until it engages.
- ▶ Push down cover plate ① to close ashtray.

The cover plate engages.

Rear seat ashtray

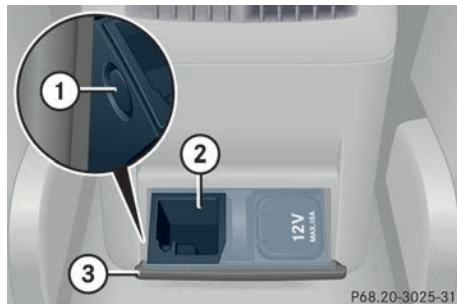

- ① Button
- ② Ashtray insert
- ③ Cover

- ▶ Pull at top of cover ③.

Removing ashtray insert

- ▶ Push button ① to disengage ashtray insert ② and remove it.

Reinstalling ashtray insert

- ▶ Push the ashtray insert ② down into the retainer until it engages.
- ▶ Push at top of cover ③ to close ashtray.

Cigarette lighter

Warning!



Never touch the heating element or sides of the lighter; they are extremely hot. Hold the knob only.

Make sure that any children traveling with you do not injure themselves or start a fire with the hot cigarette lighter.

When leaving the vehicle, always remove the SmartKey from the starter switch, take it with you, and lock the vehicle. Do not leave children unattended in the vehicle, or with access to an unlocked vehicle. A child's unsupervised access to a vehicle could result in an accident and/or serious personal injury.

- ▶ Switch on the ignition (▷ page 32).



- ① Cover plate
- ② Cigarette lighter

- ▶ Briefly press the bottom of cover plate ①.

The cover plate opens automatically.

- ▶ Push in cigarette lighter ②.

The cigarette lighter will pop out automatically when hot.

! The lighter socket can be used to accommodate 12V DC electrical accessories (up to a maximum of 85 W) designed for use with the standard “cigarette lighter” plug type. Keep in mind, however, that connecting accessories to the lighter socket (for example extensive connecting and disconnecting, or using plugs that do not fit properly) can damage the lighter socket. With the socket damaged, the lighter may no longer be able to be placed in the heating (pushed-in) position, or the lighter may pop out too early with the lighter not hot enough.

To help avoid damaging the cigarette lighter socket, we recommend connecting 12V DC electrical accessories designed for use with the standard “cigarette lighter” plug type to the 12V power outlets (▷ page 243) in your vehicle whenever possible.

- ▶ Push down cover plate ① to close ashtray.

The cover plate engages.

Power outlet

The power outlet is located in the rear passenger compartment.

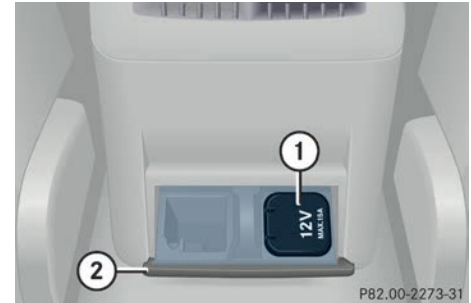

- ① Power outlet
- ② Cover

- ▶ Switch on the ignition (▷ page 32).
- ▶ Pull at top of cover ②.
- ▶ Flip cover ① to the left and insert electrical plug (cigarette lighter type).

i The power outlet can be used to accommodate 12V DC electrical accessories (e.g. air pump, auxiliary lamps) up to a maximum of 180 W.

Telephone*

Warning!



Never operate radio transmitters equipped with a built-in or attached antenna (i.e. without being connected to an external antenna) from inside the vehicle while the engine is running. Doing so could lead to a malfunction of the vehicle's electronic system, possibly resulting in an accident and/or serious personal injury.

Radio transmitters, such as a portable telephone or a citizens band unit, should only be used inside the vehicle if they are connected to an antenna that is installed on the outside of the vehicle.

The external antenna must be approved by Mercedes-Benz. Please contact an authorized Mercedes-Benz Center for information on the installation of an approved external antenna. Refer to the radio transmitter operation instructions regarding use of an external antenna.

Warning!



Please do not forget that your primary responsibility is to drive the vehicle. A driver's attention to the road must always be his/her primary focus when driving. For your safety and the safety of others, we recommend that you pull over to a safe location and stop before placing or taking a telephone call.

If you choose to use the telephone¹ while driving, please use the hands-free device and only use the telephone when road, weather and traffic conditions permit. Some jurisdictions prohibit the driver from using a mobile telephone while driving a vehicle.

Only operate the COMAND*¹ if road, weather and traffic conditions permit.



Bear in mind that at a speed of just 30 mph (approximately 50 km/h), your vehicle is covering a distance of 44 feet (approximately 14 m) every second.

¹ Observe all legal requirements.

i Various mobile phone cradles can be installed in the front center armrest, see separate installation instructions for the mobile phone cradle. These mobile phone cradles can be obtained from an authorized Mercedes-Benz Center.

The functions and services available to you while using the mobile phone depend on your service provider and the type of mobile phone you are using. See also separate operating manual for instructions on how to use your mobile phone.

When the mobile phone is inserted in the cradle, you can operate the telephone using the following devices:

- mobile phone keypad
- COMAND* (see separate operating instructions)
- buttons  and  on the multifunction steering wheel (▷ page 122)
- audio system (▷ page 208)

Please note that these functions are only available with Mercedes-Benz approved mobile phones. Please contact an authorized Mercedes-Benz Center for information on features available for your mobile phone of choice.

The cradle is located in the front center armrest.

- ▶ Open telephone tray (▷ page 238).

Inserting mobile phone in mobile phone cradle

Once the mobile phone has been inserted in the mobile phone cradle, you have to use the hands-free device to respond during phone calls.

! Do not try to remove the mobile phone along with the cradle. You could otherwise damage the mobile phone cradle.

- ▶ If applicable, remove the cover for the external antenna connection from the back of the mobile phone and store it in a safe place. Be sure to comply with the mobile phone's operating instructions as well.



Example illustration

- ① Insert the mobile phone
 - ② Connector contact
 - ③ Mobile phone cradle
- ▶ Slide the lower end of the mobile phone into connector contact ② on cradle ③.

- ▶ Push the top of the mobile phone in direction of arrow ①, until the lug on the mobile phone release button engages.

The mobile phone is connected to the network via the external antenna.

The mobile phone is linked to the hands-free device and the multifunction steering wheel.

The battery is charged depending on its charge status and the position of the SmartKey in the starter switch. The charge procedure will be indicated in the mobile phone's display.

You can place or receive phone calls. You can control other functions of the mobile phone via the control system (▷ page 146), audio system (▷ page 208), COMAND* (see separate operating instructions).

i When you take the SmartKey out of the starter switch, the mobile phone remains switched on for approx. 10 minutes. If you place or receive a call during this time, the mobile phone switches off 10 minutes after the call has been completed.

Useful features

Removing mobile phone from mobile phone cradle



Example illustration

- ① Release catch for mobile phone
- ② Mobile phone cradle

i When using a flip-style mobile phone, open flip top before removing from the cradle while a call is connected. Otherwise, the call will be disconnected.

- ▶ Press release catch in direction of arrow ① and take mobile phone out of mobile phone cradle ②.

Changing mobile phone cradle

If you require a different cradle for your mobile phone, remove the present cradle before installing a new one.

Removing an existing mobile phone cradle



Example illustration

- ① To release the mobile phone cradle
 - ② To remove the mobile phone cradle
 - ③ Mobile phone cradle
- ▶ Press release button in direction of arrow ① and take mobile phone cradle ③ out in direction of arrow ②.

Installing a different mobile phone cradle

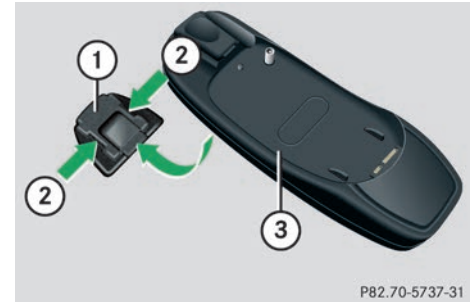

Example illustration

- ① Contact plate
 - ② Recesses
 - ③ Mobile phone cradle
- ▶ Insert mobile phone cradle ③ into recesses ② of contact plate ①.
 - ▶ Push mobile phone cradle ③ forward until it engages.

Tele Aid*

! *The initial activation of the Tele Aid system may only be performed by completing the subscriber agreement and placing an acquaintance call using the  button. Failure to complete either of these steps will result in a system that is not activated.*

If you have any questions regarding activation, please call the Response Center at 1-800-756-9018 (in the USA) or 1-888-923-8367 (in Canada).

Shortly after the completion of your Tele Aid acquaintance call, you will receive a user ID and password. By visiting www.mbusa.com and selecting “Tele Aid” (USA only), you will have access to account information, remote door unlock and more.

The Tele Aid system

(Telematic Alarm Identification on Demand)



The Tele Aid system consists of three types of response:

- automatic and manual emergency
- roadside assistance
- information



The Tele Aid system is operational providing that the vehicle’s battery is charged, properly connected, not damaged and cellular and GPS coverage is available.

The speaker volume of a Tele Aid call can be adjusted when using the volume control on the audio system or COMAND* System or on the multifunction steering wheel. To raise, turn the rotary volume control on audio system or COMAND* System clockwise or press button  on the multifunction steering wheel. To lower, turn the rotary volume control on audio

system or COMAND* System control counterclockwise or press button  on the multifunction steering wheel.

- ▶ To activate, press the SOS button, the Roadside Assistance button  or the Information button , depending on the type of response required.

i *The SOS button is located in the overhead control panel (▷ page 249).*



The Roadside Assistance button  and the Information button  are located in the arm-rest storage compartment (▷ page 238).

! *The Tele Aid system utilizes the cellular network for communication and the GPS (Global Positioning System) satellites for vehicle location. If either of these signals are unavailable, the Tele Aid system may not function and if this occurs, assistance must be summoned by other means.*

Useful features

i When a Tele Aid call has been initiated, the audio system or COMAND* System unit is muted and the selected mode (radio, tape or CD) pauses. The optional cellular phone (if installed) and inserted in cradle switches off. If you must use this phone, we recommend that you use it only with the vehicle at a standstill in a safe location. Remove the phone from the cradle and place the call. The navigation* system (if engaged) will continue to run. The multifunction display in the instrument cluster is available for use, and spoken commands are only available by pressing the RPT button on audio system or COMAND* System unit. A pop-up window will appear in the audio system or COMAND* System unit display to indicate that a Tele Aid call is in progress. After the TeleAid call has ended, the optional cellular phone switches on again. A PIN entry might be necessary.

System self-check

Initially, after switching on ignition, malfunctions are detected and indicated (the indicator lamps in the SOS button, the Roadside Assistance button  and the Information button  stay on longer

than 10 seconds or do not come on). The message malfunction Visit workshop appears in the multifunction display.

Warning!



If the indicator lamps on the SOS button, on the Roadside Assistance button, and/or on the Information button remain illuminated continuously in red and/or the message malfunction Visit workshop is displayed in the multifunction display after the system self-check, a malfunction in the system has been detected.

If a malfunction is indicated as outlined above, the system may not operate as expected. Have the system checked at the nearest Mercedes-Benz Center as soon as possible.

Emergency calls

An emergency call is initiated automatically following an accident in which the emergency tensioning devices (ETDs) or air bags deploy.

An emergency call can also be initiated manually by opening the cover next to the interior rear view mirror labeled SOS, then briefly pressing the button located under the cover. See (▷ page 249) for instructions on initiating an emergency call manually.

Once the emergency call is in progress, the indicator lamp on the SOS button will begin to flash. The message Connecting Call appears in the multifunction display. When the connection is established, the message Call connected appears in the multifunction display. All information relevant to the emergency, such as the location of the vehicle (determined by the GPS satellite location system), vehicle model, identification number and color are generated.

A voice connection between the Response Center and the occupants of the vehicle will be established automatically soon after the emergency call has been initiated. The Response Center will attempt to determine more precisely the nature of the accident provided they can speak to an occupant of the vehicle.

The Tele Aid system is available if

- it has been activated and is operational. Activation requires a subscription for monitoring services, connection and cellular air time
- the relevant cellular phone network and GPS signals are available and pass the information on to the response center

i Location of the vehicle on a map is only possible if the vehicle is able to receive signals from the GPS satellite network and pass the information on to the Response Center.

Warning!



If the indicator lamp in the SOS button is flashing continuously and there was no voice connection to the Response Center established, then the Tele Aid system could not initiate an emergency call (e.g. the relevant cellular phone network is not available). The message *Call failed* appears in the multifunction display for approximately 10 seconds.

Should this occur, assistance must be summoned by other means.

Initiating an emergency call manually



- ① Cover
- ② SOS button

- ▶ Briefly press on cover ①.

The cover will open.

- ▶ Press SOS button ② briefly.

The indicator lamp in SOS button ② will flash until the emergency call is concluded.



Useful features

- ▷▷ Wait for a voice connection to the Response Center.
- ▶ Close cover ① after the emergency call is concluded.

Warning!



If you feel at any way in jeopardy when in the vehicle (e.g. smoke or fire in the vehicle, vehicle in a dangerous road location), please do not wait for voice contact after you have pressed the emergency button. Carefully leave the vehicle and move to a safe location. The Response Center will automatically contact local emergency officials with the vehicle's approximate location if they receive an automatic SOS signal and cannot make voice contact with the vehicle occupants.

Roadside Assistance button

The Roadside Assistance button  is located below the center armrest cover.

- ▶ Open the storage compartment under the center armrest (▷ page 238).
- ▶ Press and hold button (for longer than 2 seconds).

A call to a Mercedes-Benz Roadside Assistance dispatcher will be initiated. The button will flash while the call is in progress. The message *Connecting call* will appear in the multifunction display.

When the connection is established, the message *Call connected* appears in the multifunction display. The Tele Aid system will transmit data generating the vehicle identification number, model, color and location (subject to availability of cellular and GPS signals).

 *While the call is connected you can change to the navigation menu by pressing NAVI button on the audio system or COMAND* System unit.*



A voice connection between the Roadside Assistance dispatcher and the occupants of the vehicle will be established.

- ▶ Describe the nature of the need for assistance.

The Mercedes-Benz Roadside Assistance dispatcher will either dispatch a qualified Mercedes-Benz technician or arrange to tow your vehicle to the nearest Mercedes-Benz Center. For services such as labor and/or towing, charges may apply. Refer to the Roadside Assistance Manual for more information.

These programs are only available in the USA:

- Sign and Drive services: Services such as jump start, a few gallons of fuel or the replacement of a flat tire with the vehicle spare tire are obtainable.

i The indicator lamp on the Roadside Assistance button  remains illuminated in red for approximately 10 seconds during the system self-check after switching on the ignition (together with the SOS button and the Information button .

See system self-check (▷ page 248) if the indicator lamp does not come on in red or stays on longer than approximately 10 seconds.

If the indicator lamp on the Roadside Assistance button  is flashing continuously and there was no voice connection to the Response Center established, then the Tele Aid system could not initiate a Roadside Assistance call (e.g. the relevant cellular phone network was not available). The message **Call failed** appears in the multifunction display.

Roadside Assistance calls can be terminated using the  button on the multifunction steering wheel or the **END Button** on the audio system or **COMAND*** System.

Information button

The Information button  is located below the center armrest cover.

- ▶ Open the storage compartment under the center armrest (▷ page 238).
- ▶ Press and hold button (for longer than 2 seconds).



A call to the Customer Assistance Center will be initiated. The button will flash while the call is in progress. The message **Connecting call** will appear in the multifunction display.

When the connection is established, the message **Call connected** appears in the multifunction display. The Tele Aid system will transmit data generating the vehicle identification number, model, color and location (subject to availability of cellular and GPS signals).

i While the call is connected, you can change to the navigation menu by pressing **NAVI** button on the audio system or **COMAND*** System.

A voice connection between the Customer Assistance Center representative and the occupants of the vehicle will be established. Information regarding the operation of your vehicle, the nearest Mercedes-Benz Center or Mercedes-Benz USA products and services is available to you.

For more details concerning the Tele Aid system, please visit www.mbusa.com and use your ID and password (sent to you separately) to learn more (USA only).

i The indicator lamp in the Information button  remains illuminated in red for approximately 10 seconds during the system self-check after switching on the ignition (together with the SOS button and the Roadside Assistance button .

See system self-check (▷ page 248) if the indicator lamp does not come on in red or stays on longer than approximately 10 seconds.

Useful features

If the indicator lamp in the Information button  is flashing continuously and there was no voice connection to the Response Center established, then the Tele Aid system could not initiate an Information call (e.g. the relevant cellular phone network is not available). The message **Call failed** appears in the multifunction display.

Information calls can be terminated using the  button on the multifunction steering wheel or the END Button on the audio system or COMAND* System.

! If the indicator lamps do not start flashing after pressing one of the buttons or remain illuminated (in red) at any time, the Tele Aid system has detected a malfunction or the service is not currently active, and may not initiate a call. Visit your authorized Mercedes-Benz Center and have the system checked or contact the Response Center at 1-800-756-9018 (in the USA) or 1-888-923-8367 (in Canada) as soon as possible.

Call priority

If other service calls such as a Roadside Assistance call or Information call are active, an Emergency call is still possible. In this case, the Emergency call will take priority and override all other active calls.

i The indicator lamp in the respective button flashes until the call is concluded. Emergency calls can only be terminated by a Response Center or Customer Assistance Center representative, whereas Roadside Assistance and Information calls can also be terminated by pressing button  on the multifunction steering wheel or using the END button on the audio system or COMAND* System.

! If the indicator lamp continues to flash or the system does not reset, contact the Response Center at 1-800-756-9018 (in the USA) or 1-888-923-8367 (in Canada), or Mercedes-Benz Customer Assistance at 1-800-FOR-MERCEdes (1-800-367-6372) in the USA or Customer Service at 1-800-387-0100 in Canada.

Remote door unlock

In case you have locked your vehicle unintentionally (e.g. SmartKey inside vehicle), and the reserve SmartKey is not handy:

▶ Contact the Mercedes-Benz Response Center at 1-800-756-9018 (in the USA) or 1-888-923-8367 (in Canada).

You will be asked to provide your password which you provided when you completed the subscriber agreement.

▶ Then return to your vehicle and pull the trunk recessed handle for a minimum of 20 seconds until the SOS button is flashing.

The message **Connecting call** appears in the multifunction display.

As an alternative, you may unlock the vehicle via Internet using the ID and password sent to you shortly after the completion of your acquaintance call.

The Response Center will then unlock your vehicle with the remote door unlocking feature.

i *The remote door unlock feature is available if the relevant cellular phone network is available.*

The SOS button will flash and the message Connecting call will appear in the multifunction display to indicate receipt of the door unlock command.

Once the vehicle is unlocked, a Response Center specialist may attempt to establish voice contact with the vehicle occupants.

If the tailgate recessed handle was pulled for more than 20 seconds before door unlock authorization was received by the Response Center, you must wait 15 minutes before pulling the tailgate recessed handle again.

Stolen Vehicle Recovery services

In the event your vehicle was stolen:

- ▶ Report the incident to the police.
The police will issue a numbered incident report.
- ▶ Pass this number on to the Mercedes-Benz Response Center along with your password issued to you when you subscribed to the service.

The Response Center will then attempt to covertly contact the vehicle's Tele Aid system. Once the vehicle is located, the Response Center will contact the local law enforcement and you. The vehicle's location will only be provided to law enforcement.

i *When the anti-theft alarm* stays on for more than 30 seconds, a call is initiated automatically to the Response Center. See "Anti-theft alarm system*" (▷ page 89).*

Garage door opener*

The integrated remote control is capable of operating up to three separately controlled devices. It provides a convenient way to replace up to three hand-held remote controls used to operate devices such as garage door openers, gate openers, or other devices compatible with HomeLink® or some other systems.

Before the integrated remote control can be used, it must be programmed to the garage door opener, gate operator or other device you wish to operate. See the following instructions for programming information.

Useful features

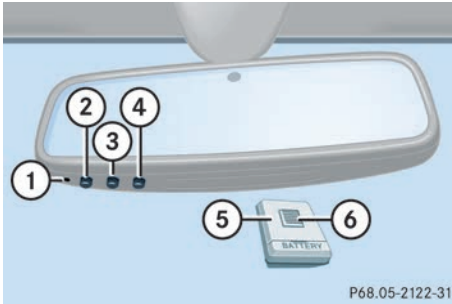

Interior rear view mirror with integrated remote control

- ① Indicator lamp
- ② ③ ④ Signal transmitter button

Needed for programming (not part of vehicle equipment):

- ⑤ Hand-held remote control of garage door opener, gate operator or other device
- ⑥ Hand-held remote control button

Warning!



Before programming the integrated remote control to a garage door opener or gate operator, make sure people and objects are out of the way of the device to prevent potential harm or damage. When programming a garage door opener, the door moves up or down. When programming a gate operator, the gate opens or closes.

Do not use the integrated remote control with any garage door opener that lacks safety stop and reverse features as required by U.S. federal safety standards (this includes any garage door opener model manufactured before April 1, 1982). A garage door that cannot detect an object - signaling the door to stop and reverse - does not meet current U.S. federal safety standards.

When programming a garage door opener, park outside the garage.

Do not run the engine while programming the integrated remote control. Inhalation of exhaust gas is hazardous to your health. All exhaust gas contains carbon monoxide (CO), and inhaling it can cause unconsciousness and possible death.

Programming the integrated remote control

Step 1:

- ▶ Switch on the ignition (▷ page 32).

Step 2:

- ▶ If you have previously programmed a signal transmitter button and wish to retain its programming, proceed to step 3.

If you are programming the integrated remote control for the first time, press and hold the two outer signal transmitter buttons ② and ④ and release them only when indicator lamp ① be-

gins to flash after approximately 20 seconds (do not hold the button for longer than 30 seconds). This procedure erases any previous settings for all three channels and initializes the memory.

If you later wish to program a second and/or third hand-held transmitter to the remaining two signal transmitter buttons, do not repeat this step and begin directly with step 3.

Step 3:

- ▶ Hold the end of hand-held remote control ⑤ of the device you wish to train approximately 2 to 5 in (5 to 12 cm) away from the signal transmitter button (②, ③ or ④) to be programmed, while keeping indicator lamp ① in view.

Step 4:

- ▶ Using both hands, simultaneously press hand-held remote control button ⑥ and the desired signal trans-

mitter button (②, ③ or ④). Do not release the buttons until step 5 is completed.

Indicator lamp ① will flash, first slowly and then rapidly.

i Indicator lamp ① flashes immediately the first time the signal transmitter button is programmed. If this button has already been programmed, the indicator lamp will only start flashing after 20 seconds.

Step 5:

- ▶ After indicator lamp ① changes from a slow to a rapidly flashing light, release the hand-held remote control button and the signal transmitter button.

Step 6:

- ▶ Press and hold the just-trained signal transmitter button (②, ③ or ④) and observe indicator lamp ①.

If indicator lamp ① stays on constantly, programming is complete and your device should activate when the respective signal transmitter button (②, ③ or ④) is pressed and released.

i If indicator lamp ① flashes rapidly for about 2 seconds and then turns to a constant light, continue with programming steps 8 through 12 as your garage door opener may be equipped with the “rolling code” feature.

Step 7:

- ▶ To program the remaining two signal transmitter buttons, repeat the steps above starting with step 3.

Rolling code programming

To train a garage door opener (or other rolling code devices) with the rolling code feature, follow these instructions after completing the “Programming” portion (steps 1 through 6) of this text. (A second person may make the following training procedures quicker and easier.)

Useful features

Step 8:

- ▶ Locate “training” button on the garage door opener motor head unit.

Exact location and color of the button may vary by garage door opener brand. Depending on manufacturer, the “training” button may also be referred to as “learn” or “smart” button. If there is difficulty locating the transmitting button, refer to the garage door opener Operator’s Manual.

Step 9:

- ▶ Press the “training” button on the garage door opener motor head unit.

The “training light” is activated.

You have 30 seconds to initiate the following step.

Step 10:

- ▶ Return to the vehicle and firmly press, hold for 2 seconds and release the programmed signal transmitter button (②, ③ or ④).

Step 11:

- ▶ Press, hold for 2 seconds and release same signal transmitter button a second time to complete the training process.

i *Some garage door openers (or other rolling code equipped devices) may require you to press, hold for 2 seconds and release the same signal transmitter button a third time to complete the training process.*

Step 12:

- ▶ Confirm the garage door operation by pressing the programmed signal transmitter button (②, ③ or ④).

Step 13:

- ▶ To program the remaining two signal transmitter buttons, repeat the steps above starting with step 3.

Gate operator/Canadian programming

Canadian radio-frequency laws require transmitter signals to “time-out” (or quit) after several seconds of transmission which may not be long enough for the integrated signal transmitter to pick up the signal during programming. Similar to this Canadian law, some U.S. gate operators are designed to “time-out” in the same manner.

If you live in Canada or if you are having difficulties programming a gate operator (regardless of where you live) by using the programming procedures, replace step 4 with the following:

Step 4:

- ▶ Press and hold the signal transmitter button (②, ③ or ④). Do not release this button until it has been successfully trained.
- ▶ While still holding down the signal transmitter button (②, ③ or ④), “cycle” your hand-held remote control button ⑥ as follows: Press and hold

button ⑥ for 2 seconds, then release it for 2 seconds, and again press and hold it for 2 seconds. Repeat this sequence on the hand-held remote control until the frequency signal has been learned. Upon successful training, indicator lamp ① will flash slowly and then rapidly after several seconds.

- ▶ Proceed with programming step 5 and step 6 to complete.

i Upon completion of programming the integrated remote control, make sure you retain the hand-held remote control that came with the garage door opener, gate operator or other device. You may need it for use in other vehicles, for future programming of an integrated remote control, or simply for continued use as a hand-held remote control to operate the respective device in other situations.

Reprogramming a single signal transmitter button

To program a device using a signal transmitter button previously trained, follow these steps:

- ▶ Switch on the ignition (▷ page 32).
- ▶ Press and hold the desired signal transmitter button (②, ③ or ④). Do not release the button.
- ▶ Indicator lamp ① will begin to flash after 20 seconds. Without releasing the signal transmitter button, proceed with programming starting with step 3.

Operation of integrated remote control

- ▶ Switch on the ignition (▷ page 32).
- ▶ Select and press the appropriate integrated signal transmitter button (②, ③ or ④) to activate the remote controlled device.

The integrated remote control transmitter continues to send the signal as long as the button is pressed – up to 20 seconds.

Erasing the integrated remote control memory

- ▶ Switch on the ignition (▷ page 32).
- ▶ Simultaneously press and hold outer signal transmitter buttons ② and ④, for approximately 20 seconds, until indicator lamp ① flashes rapidly. Do not hold for longer than 30 seconds.

The codes of all three channels are erased.

i If you sell your vehicle, erase the codes of all three channels.

Useful features

Programming tips

If you are having difficulty programming the integrated remote control, here are some helpful tips:

- Check the frequency of hand-held remote control ⑤ (typically located on the reverse side of the remote). The integrated remote control is compatible with radio-frequency devices operating between 280-390 MHz.
- Put a new battery in hand-held remote control ⑤. This will increase the likelihood of the hand-held remote control sending a faster and more accurate signal to the integrated remote control.
- While performing step 3, hold hand-held remote control ⑤ at different lengths and angles from the signal transmitter button (②, ③ or ④) you are programming. Attempt varying angles at the distance of 2 to 5 inches (5 to 12 cm) away or the same angle at varying distances.

- If another hand-held remote control is available for the same device, try the programming steps again using that other hand-held remote control. Make sure new batteries are in the hand-held remote control before beginning the procedure.
- Straighten the antenna wire from the garage door opener assembly. This may help improve transmitting and/or receiving signals.

i Certain types of garage door openers are incompatible with the integrated remote control. If you should experience further difficulties with programming the integrated remote control, contact an authorized Mercedes-Benz Center, or call Mercedes-Benz Customer Assistance Center (in the USA only) at 1-800-FOR-MERCEdes, or Customer Service (in Canada) at 1-800-387-0100.

i USA only:

This device complies with Part 15 of the FCC Rules. Operation is subject to the following two conditions:

- (1) *This device may not cause harmful interference, and*
- (2) *this device must accept any interference received, including interference that may cause undesired operation.*

Any unauthorized modification to this device could void the user's authority to operate the equipment.

i Canada only:

This device complies with RSS-210 of Industry Canada. Operation is subject to the following two conditions:

- (1) *This device may not cause interference, and*
- (2) *this device must accept any interference received, including interference that may cause undesired operation of the device.*

Any unauthorized modification to this device could void the user's authority to operate the equipment.



The first 1000 miles (1500 km)

Driving instructions

At the gas station

Engine compartment

Tires and wheels

Winter driving

Maintenance

Vehicle care

The first 1 000 miles (1 500 km)

In the “Operation” section you will find detailed information on operating, maintaining and caring for your vehicle.

The more cautiously you treat your vehicle during the break-in period, the more satisfied you will be with its performance later on.

- Drive your vehicle during the first 1 000 miles (1 500 km) at varying but moderate vehicle and engine speeds.
- During this period, avoid heavy loads (full throttle driving) and excessive engine speeds (no more than $\frac{2}{3}$ of maximum rpm in each gear).
- Shift gears in a timely manner.
- Avoid accelerating by kick-down.
- Do not attempt to slow the vehicle down by shifting to a lower gear using the gear selector lever.
- Select positions **3**, **2** or **1** only when driving at moderate speeds (for hill driving).
- Select **C** as the preferred shift program (▷ page 157) for the first 1 000 miles (1 500 km).

After 1 000 miles (1 500 km) you may gradually increase vehicle and engine speeds to the permissible maximum.

All of the above instructions, as may apply to your vehicle type, also apply when driving the first 1 000 miles (1 500 km) after the engine or the rear differential has been replaced.

 *Always obey applicable speed limits.*

▼ Driving instructions

Drive sensibly – save fuel

Fuel consumption, to a great extent, depends on driving habits and operating conditions.

To save fuel you should:

- Keep tires at the recommended tire inflation pressures.
- Remove unnecessary loads.
- Remove roof rack when not in use.
- Allow engine to warm up under low load use.
- Avoid frequent acceleration and deceleration.
- Have all maintenance work performed at the intervals specified in the Maintenance Booklet and as required by the maintenance service display. Contact an authorized Mercedes-Benz Center.

Fuel consumption is also increased by driving in cold weather, in stop-and-go traffic, on short trips and in hilly area.

Drinking and driving

Warning!



Drinking and driving and/or taking drugs and driving are very dangerous combinations. Even a small amount of alcohol or drugs can affect your reflexes, perceptions and judgment.

The possibility of a serious or even fatal accident are greatly increased when you drink or take drugs and drive.

Do not drink or take drugs and drive or allow anyone to drive who has been drinking or taking drugs.

Pedals

Warning!



Make sure that absolutely no objects are obstructing the pedals' range of movement. Keep the driver's footwell clear of all obstacles. If there are any floor mats or carpets in the footwell, make sure that the pedals still have sufficient clearance.

During sudden driving or braking maneuvers, the objects could get caught between or beneath the pedals. You could then no longer brake or accelerate. This could lead to accidents and injury.

Driving instructions

Power assistance

Warning!



With the engine not running, there is no power assistance for the brake and steering systems. In this case, it is important to keep in mind that a considerably higher degree of effort is necessary to brake and steer the vehicle.

Brakes

Warning!



After driving in heavy rain for some time without applying the brakes or through water deep enough to wet brake components, the first braking action may be somewhat reduced and increased pedal pressure may be necessary to obtain expected braking effect. Maintain a safe distance from vehicles in front.

Resting your foot on the brake pedal will cause excessive and premature wear of the brake pads.

It can also result in the brakes overheating, thereby significantly reducing their effectiveness. It may not be possible to stop the vehicle in sufficient time to avoid an accident.

! *Vehicles without 4MATIC:*
Because the ESP[®] operates automatically, the engine must be turned off (SmartKey in starter switch position **0** or **1**) when

- the parking brake is being tested on a brake test dynamometer
- the vehicle is being towed with the front axle raised

Active braking action through the ESP[®] may otherwise seriously damage the brake system.

For information on vehicles with 4MATIC, see “Four wheel electronic traction system (4MATIC) with the ESP[®]” (▷ page 88).

To help prevent brake disk corrosion after driving on wet road surfaces (particularly salted roads), it is advisable to brake the vehicle with considerable force prior to parking. The heat generated serves to dry the brakes.

If your brake system is normally only subject to moderate loads, you should occasionally test the effectiveness of the brakes by applying above-normal braking pressure at higher speeds. This will also enhance the grip of the brake pads.

Warning!

Make sure not to endanger any other road users when carrying out these braking maneuvers.

Refer to the description of the Brake Assist System (BAS) (▷ page 84).

Brake pad wear or a leak in the system may be the reason for low brake fluid level in the reservoir.

The brake fluid level in the reservoir may be too low if the brake warning lamp in the instrument cluster comes on and an acoustic warning sounds although the parking brake is released (▷ page 324). Observe additional messages in the multi-function display that may appear (▷ page 344).

Have the brake system inspected immediately. Contact an authorized Mercedes-Benz Center.

All checks and service work on the brake system should be carried out by qualified technicians only. Contact an authorized Mercedes-Benz Center.

Only install brake pads and brake fluid recommended by Mercedes-Benz.

Warning!

If other than recommended brake pads are installed, or other than recommended brake fluid is used, the braking properties of the vehicle can be degraded to an extent that safe braking is substantially impaired. This could result in an accident.

! *When driving down long and steep grades, relieve the load on the brakes by shifting into a lower gear to use the engine's braking power. This helps prevent overheating of the brakes and reduces brake pad wear.*

After hard braking, it is advisable to drive on for some time, rather than immediately park, so that the air stream will cool down the brakes faster.

Driving off

Apply the brakes to test them briefly after driving off. Perform this procedure only when the road is clear of other traffic.

Warm up the engine smoothly. Do not place full load on the engine until the operating temperature has been reached.

! *When starting off on a slippery surface, do not allow a drive wheel to spin for an extended period with the ESP[®] switched off. Doing so may cause serious damage to the drivetrain which is not covered by the Mercedes-Benz Limited Warranty.*

! *Simultaneously depressing the accelerator pedal and applying the brake reduces engine performance and causes premature brake and drivetrain wear.*

Driving instructions

Parking

Warning!



Do not park this vehicle in areas where combustible materials such as grass, hay or leaves can come into contact with the hot exhaust system, as these materials could be ignited and cause a vehicle fire.

To reduce the risk of personal injury, or damage to the vehicle or the vehicle drivetrain, as a result of vehicle movement, always do the following before turning off the engine and leaving the vehicle:

- Keep right foot on brake pedal.
- Manual transmission: Move the gear-shift lever to neutral position (no gear selected).
- Firmly depress parking brake pedal.
- Manual transmission: Move the gear-shift lever into first or reverse gear.

- Automatic transmission*: Move the gear selector lever to position **P**.
- Slowly release brake pedal.
- When parked on an incline, always turn the front wheels towards the road curb.
- Turn the SmartKey in the starter switch to position **0** and remove.
- Take the SmartKey with you and lock the vehicle when leaving.

Tires

Warning!



If you feel a sudden significant vibration or ride disturbance, or you suspect that possible damage to your vehicle has occurred, you should turn on the hazard warning flashers, carefully slow down, and drive with caution to an area which is a safe distance from the road.

Inspect the tires and the vehicle underbody for possible damage. If the vehicle or tires appear unsafe, have the vehicle towed to the nearest Mercedes-Benz Center or tire dealer for repairs.

Treadwear indicators (TWI) are required by law. These indicators are located in six places on the tread circumference and become visible at a tread depth of approximately $\frac{1}{16}$ in (1.6 mm), at which point the tire is considered worn and should be replaced.

The treadwear indicator appears as a solid band across the tread.

Warning!

Although the applicable federal motor vehicle safety laws consider a tire to be worn when the treadwear indicators (TWI) become visible at approximately $\frac{1}{16}$ in (1.6 mm), we recommend that you do not allow your tires to wear down to that level. As tread depth approaches $\frac{1}{8}$ in (3 mm), the adhesion properties on a wet road are sharply reduced.

Depending upon the weather and/or road surface (conditions), the tire traction varies widely.

Specified tire inflation pressures must be maintained. This applies particularly if the tires are subjected to high loads (e.g. high speeds, heavy loads, high ambient temperatures).

Warning!

Do not drive with a flat tire. A flat tire affects the ability to steer or brake the vehicle. You may lose control of the vehicle. Continued driving with a flat tire or driving at high speed with a flat tire will cause excessive heat build-up and possibly a fire.

For more information, see “Tires and wheels” (▷ page 281).

Hydroplaning

Depending on the depth of the water layer on the road, hydroplaning may occur, even at low speeds and with new tires. Reduce vehicle speed, avoid track grooves in the road and apply brakes cautiously in the rain.

Tire traction

The safe speed on a wet, snow covered or icy road is always lower than on a dry road.

You should pay particular attention to the condition of the road whenever the outside temperatures are close to the freezing point.

Warning!

If ice has formed on the road, tire traction will be substantially reduced. Under such weather conditions, drive, steer and brake with extreme caution.

Driving instructions

Mercedes-Benz recommends winter tires (▷ page 308) with a minimum tread depth of approximately $\frac{1}{6}$ in (4 mm) on all four wheels for the winter season to ensure normal balanced handling characteristics. On packed snow, they can reduce your stopping distance compared to summer tires. Stopping distance, however, is still considerably greater than when the road is not covered with snow or ice. Exercise appropriate caution.

! *Avoid spinning of a drive wheel. This may cause serious damage to the drivetrain which is not covered by the Mercedes-Benz Limited Warranty.*

Tire speed rating

Regardless of the tire speed rating, local speed limits should be obeyed. Use prudent driving speeds appropriate to prevailing conditions.

Warning!



Even when permitted by law, never operate a vehicle at speeds greater than the maximum speed rating of the tires.

Exceeding the maximum speed for which tires are rated can lead to sudden tire failure, causing loss of vehicle control and possibly resulting in an accident and/or personal injury and possible death, for you and for others.

An electronic speed limiter prevents your vehicle from exceeding a speed of 130 mph (210 km/h).

The factory equipped tires on your vehicle may have a tire speed rating above the maximum speed permitted by the electronic speed limiter.

Make sure your tires have the required tire speed rating as specified for your vehicle in the "Technical data" section (▷ page 403), for example when purchasing new tires.

For Information on how to identify the tire speed rating on a tire's sidewall, see "Tire size designation, load and speed rating" (▷ page 295).

If you are uncertain about the correct reading of the information given on a tire's sidewall, any authorized Mercedes-Benz Center will be glad to assist you.

i *For information on speed rating for winter tires, see "Winter tires" (▷ page 308).*

For additional general information on tire speed markings on tire sidewall, see "Tire speed rating" (▷ page 297).

Winter driving instructions

The most important rule for slippery or icy roads is to drive sensibly and to avoid abrupt acceleration, braking and steering maneuvers. Do not use the cruise control system under such conditions.

When the vehicle is in danger of skidding, move gear selector lever to position **N** or in case of manual transmission declutch. Try to keep the vehicle under control by corrective steering action.

 For information on driving with snow chains, see “Snow chains” (▷ page 309).

Warning!



On slippery road surfaces, never downshift in order to obtain braking action. This could result in drive wheel slip and reduced vehicle control. Your vehicle’s ABS will not prevent this type of control loss.

Road salts and chemicals can adversely affect braking efficiency. Increased pedal force may become necessary to produce the normal braking effect.

Depressing the brake pedal periodically when traveling at length on salt-strewn roads can bring road-salt-impaired braking efficiency back to normal.

If the vehicle is parked after being driven on salt-treated roads, the braking efficiency should be tested as soon as possible after driving is resumed.

Warning!



Make sure not to endanger any other road users when carrying out these braking maneuvers.

Warning!



If the vehicle becomes stuck in snow, make sure snow is kept clear of the exhaust pipe and from around the vehicle with the engine running. Otherwise, deadly carbon monoxide (CO) gases may enter vehicle interior resulting in unconsciousness and death.

To assure sufficient fresh air ventilation, open a window slightly on the side of the vehicle not facing the wind.

Warning!



The outside temperature indicator is not designed to serve as an ice-warning device and is therefore unsuitable for that purpose. Indicated temperatures just above the freezing point do not guarantee that the road surface is free of ice.

For more information, see “Winter driving” (▷ page 308).

Driving instructions

Standing water

! Do not drive through flooded areas or water of unknown depth. Before driving through water, determine its depth. Never accelerate before driving into water. The bow wave could force water into the engine and auxiliary equipment, thus damaging them.

If you must drive through standing water, drive slowly to prevent water from entering the passenger compartment or the engine compartment. Water in these areas could cause damage to electrical components or wiring of the engine or transmission, or could result in water being ingested by the engine through the air intake causing severe internal engine damage. Any such damage is not covered by the Mercedes-Benz Limited Warranty.

Passenger compartment

Warning!



Always fasten items being carried as securely as possible.

In an accident, during hard braking or sudden maneuvers, loose items will be thrown around inside the vehicle, and cause injury to vehicle occupants unless the items are securely fastened in the vehicle.

The trunk is the preferred place to carry objects.

Driving abroad

Abroad, there is an extensive Mercedes-Benz service network at your disposal. If you plan to drive into areas which are not listed in the index of your Mercedes-Benz Center directory, you should request pertinent information from an authorized Mercedes-Benz Center.

Control and operation of radio transmitters

COMAND*, radio and telephone*

Warning!



Please do not forget that your primary responsibility is to drive the vehicle safely. Only operate the COMAND (Cockpit Management and Data System), radio or telephone¹ if road, weather and traffic conditions permit.

Bear in mind that at a speed of just 30 mph (approximately 50 km/h), your vehicle is covering a distance of 44 feet (approximately 14 m) every second.

¹ Observe all legal requirements.

Telephones* and two-way radios

Warning!



Never operate radio transmitters equipped with a built-in or attached antenna (i.e. without being connected to an external antenna) from inside the vehicle while the engine is running. Doing so could lead to a malfunction of the vehicle's electronic system, possibly resulting in an accident and personal injury.

Radio transmitters, such as a portable telephone or a citizens band unit should only be used inside the vehicle if they are connected to an antenna that is installed on the outside of the vehicle.

Refer to the radio transmitter operation instructions regarding use of an external antenna.

Catalytic converter

Your Mercedes-Benz is equipped with monolithic-type catalytic converters, an important element in conjunction with the oxygen sensors to achieve substantial control of the pollutants in the exhaust emissions. Keep your vehicle in proper operating condition by following our recommended maintenance instructions as outlined in your Maintenance Booklet.

! *To prevent damage to the catalytic converters, only use premium unleaded gasoline in this vehicle.*

Any noticeable irregularities in engine operation should be repaired promptly. Otherwise, excessive unburned fuel may reach the catalytic converter, causing it to overheat and potentially start a fire.

Warning!



As with any vehicle, do not idle, park or operate this vehicle in areas where combustible materials such as grass, hay or leaves can come into contact with the hot exhaust system, as these materials could be ignited and cause a vehicle fire.

Driving instructions

Emission control

Certain systems of the engine serve to keep the toxic components of the exhaust gases within permissible limits required by law.

These systems, of course, will function properly only when maintained strictly according to factory specifications. Any adjustments on the engine should, therefore, be carried out only by qualified Mercedes-Benz Center authorized technicians. Engine adjustments should not be altered in any way. Moreover, the specified service jobs must be carried out regularly according to Mercedes-Benz servicing requirements. For details refer to the Maintenance Booklet.

Warning!



Inhalation of exhaust gas is hazardous to your health. All exhaust gas contains carbon monoxide (CO), and inhaling it can cause unconsciousness and possible death.

Do not run the engine in confined areas (such as a garage) which are not properly ventilated. If you think that exhaust gas fumes are entering the vehicle while driving, have the cause determined and corrected immediately. If you must drive under these conditions, drive only with at least one window fully open at all times.

Coolant temperature

During severe operating conditions and stop-and-go city traffic, the coolant temperature may rise close to approximately 248°F (120°C).

The engine should not be operated with the coolant temperature over 248°F (120°C). Doing so may cause serious engine damage which is not covered by the Mercedes-Benz Limited Warranty.

Warning!



- Driving when your engine is badly overheated can cause some fluids, which may have leaked into the engine compartment, to catch fire. You could be seriously burned.
- Steam from an overheated engine can cause serious burns and can occur just by opening the hood. Stay away from the engine if you see or hear steam coming from it.

Turn off the engine, get out of the vehicle and do not stand near the vehicle until the engine has cooled down.

▼ At the gas station

Refueling

Warning!



Gasoline is highly flammable and poisonous. It burns violently and can cause serious personal injury.

Never allow sparks, flame or smoking materials near gasoline!

Turn off the engine before refueling

Whenever you are around gasoline, avoid inhaling fumes and skin or clothing contact, extinguish all smoking materials.

Direct skin contact with fuels and the inhalation of fuel vapors can damage to your health.

Warning!



C 230/C 230 Sport:
Flexible Fuel Vehicles (identified by a label reading **Premium gasoline or E85 only!** on fuel filler flap):

Ethanol fuel (E85) and its vapors are highly flammable, poisonous and burn easily. Ethanol fuel can cause serious injuries if ignited or if you come into contact with it or inhale fumes of it. Avoid inhalation of ethanol fumes and skin contact with ethanol. Extinguish all open flames before refueling. Never smoke or create sparks close to ethanol.

The fuel filler flap is located on the right-hand side of the vehicle towards the rear. Locking/unlocking the vehicle with the SmartKey automatically locks/unlocks the fuel filler flap.

i In case that the central locking system does not release the fuel filler flap, or the opening mechanism is clamping, notify Roadside Assistance or an authorized Mercedes-Benz Center.

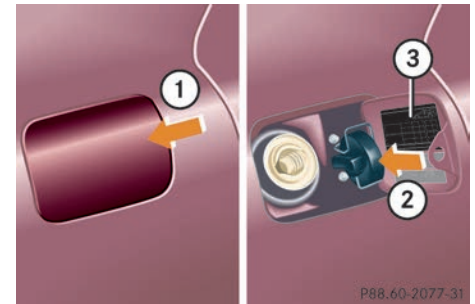

- ① To open the fuel filler flap
- ② To insert the fuel filler cap
- ③ Supplemental tire inflation pressure information

At the gas station

i Only use premium unleaded gasoline with a minimum Posted Octane Rating of 91 (average of 96 RON/86 MON). Information on gasoline quality can normally be found on the fuel pump.

C 230/C 230 Sport:

Flexible Fuel Vehicles are identified by a label reading **Premium gasoline or E85 only!** on the fuel filler flap.

For more information on gasoline or E85, see “Premium unleaded gasoline” (▷ page 413) or the Factory Approved Service Products pamphlet.

- ▶ Turn the engine off by turning the SmartKey to position **0**.
- ▶ Remove the SmartKey from the starter switch.
- ▶ Open the fuel filler flap by pushing at the point indicated by arrow ①. The fuel filler flap springs open.
- ▶ Turn fuel cap counterclockwise and hold on to it until possible pressure is released.
- ▶ Take off cap and set it in direction of arrow ② in the recess on the fuel filler flap.
To prevent fuel vapors from escaping into open air, fully insert filler nozzle unit.
- ▶ Only fill your tank until the filler nozzle unit cuts out – **do not top up or overflow**.

Warning!





Overfilling of the fuel tank may create pressure in the system which could cause a gas discharge. This could cause the gas to spray back out when removing the fuel pump nozzle, which could cause personal injury.

- ▶ Replace fuel cap by turning it clockwise until it audibly engages.

i Make sure to close the fuel filler flap before locking your vehicle as the flap locking pin prevents closing after you have locked the vehicle.

- ▶ Close fuel filler flap.

i Leaving the engine running and the fuel cap open can cause the yellow fuel tank reserve warning lamp to flash and the  malfunction indicator lamp (USA only) or the  malfunction indicator lamp (Canada only) to illuminate.

For more information, see “Practical hints” (▷ page 325) and (▷ page 326).

Check regularly and before a long trip

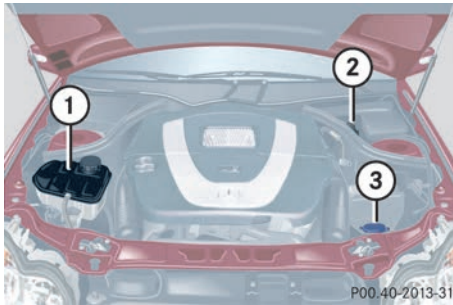

- ① Coolant
- ② Brake fluid (fuse box cover removed)
- ③ Windshield washer and headlamp cleaning system*

i Opening the hood, see (▷ page 274).

Coolant

For normal replenishing, use water (potable water quality). For more information, see “Coolant level” (▷ page 278) and see “Fuels, coolants, lubricants, etc.” (▷ page 409).

Brake fluid

! If you find that the brake fluid in the brake fluid reservoir has fallen to the minimum mark or below, have the brake system checked for brake pad thickness and leaks immediately. Notify an authorized Mercedes-Benz Center immediately. Do not add brake fluid as this will not solve the problem. For more information, see “Practical hints” (▷ page 324).

Removing fuse box cover (▷ page 392).

Windshield washer and headlamp cleaning system*

For more information on filling up the washer reservoir, see “Windshield washer system and headlamp cleaning system*” (▷ page 280).

Engine oil level

For more information on engine oil level, see “Engine oil” (▷ page 276).

Vehicle lighting

Check function and cleanliness. For more information on replacing light bulbs, see “Replacing bulbs” (▷ page 367).

Exterior lamp switch (▷ page 109).

Tire inflation pressure

More information on tire inflation pressure (▷ page 290).

Engine compartment

Hood

Warning!



Do not pull the release lever while the vehicle is in motion. Otherwise the hood could be forced open by passing air flow.

This could cause the hood to come loose and injure you and/or others.

Opening

Warning!



If you see flames or smoke coming from the engine compartment, or if the coolant temperature gauge indicates that the engine is overheated, do not open the hood. Move away from vehicle and do not open the hood until the engine has cooled. If necessary, call the fire department.

Warning!



You could be injured when the hood is open - even when the engine is turned off.

Parts of the engine can become very hot. To prevent burns, only touch owner serviceable components described in the Operator's Manual and comply with all relevant safety precautions.

Warning!



To help prevent personal injury, stay clear of moving parts when the hood is open and the engine is running.

The radiator fan may continue to run for approximately 30 seconds or even restart after the engine has been turned off. Stay clear of fan blades.

Warning!



The engine is equipped with a transistorized ignition system. Because of the high voltage it is dangerous to touch any components (ignition coils, spark plug sockets, diagnostic socket) of the ignition system

- with the engine running
- while starting the engine
- if ignition is "on" and the engine is turned manually

The hood lock release lever is located to the left of the steering wheel under the dashboard.



① Hood lock release lever

- ▶ Pull lever ① downwards.

The hood is unlocked and handle ② will extend out of the radiator grille.

! To avoid damage to the windshield wipers or hood, never open the hood if the wiper arms are folded forward away from the windshield.

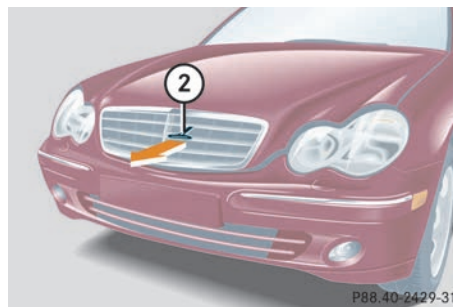

② Handle for opening the hood

- ▶ Pull handle ② to its stop out of radiator grille.
- ▶ Pull up on the hood (do not pull up on the handle) and then release it.

The hood will be automatically held open at shoulder height by gas-filled struts.

Closing

Warning!



When closing the hood, use extreme caution not to catch hands or fingers.

Be careful that you do not close the hood on anyone.

Make sure that the hood is securely engaged before driving off. Do not continue driving if the hood can no longer engage after an accident, for example. The hood could otherwise come loose while the vehicle is in motion and injure you and/or others.

- ▶ Let the hood drop from a height of approximately 1 ft (30 cm).
The hood will lock audibly.
- ▶ Check to make sure the hood is fully closed.

If you can raise the hood at a point above the headlamps, then it is not properly closed. Open it again and let it drop with somewhat greater force.

Engine compartment

Engine oil

The amount of oil your engine needs will depend on a number of factors, including driving style. Higher oil consumption can occur when

- the vehicle is new
- the vehicle is driven frequently at higher engine speeds

Engine oil consumption checks should only be made after the vehicle break-in period.

i Do not use any special lubricant additives, as these may damage the drive assemblies. Using special additives not approved by Mercedes-Benz may cause damage not covered by the Mercedes-Benz Limited Warranty. More information on this subject is available at any Mercedes-Benz Center.

Checking engine oil level

When checking the oil level

- the vehicle must be parked on level ground

- with the engine at operating temperature, the vehicle must have been stationary for at least 5 minutes with the engine turned off
- with the engine not at operating temperature yet, the vehicle must have been stationary for at least 30 minutes with the engine turned off

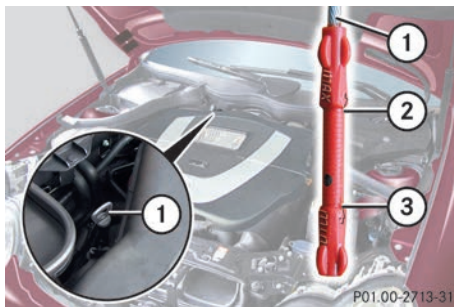

- ① Oil dipstick
- ② Upper (max) mark
- ③ Lower (min) mark

To check the engine oil level with the oil dipstick, do the following:

- ▶ Open the hood (> page 274).

- ▶ Pull out oil dipstick ①.
- ▶ Wipe oil dipstick ① clean.
- ▶ Fully insert oil dipstick ① into the dipstick guide tube.
- ▶ Pull out oil dipstick ① again after approximately 3 seconds to obtain accurate reading.

The oil level is correct when it is between the lower (min) mark ③ and upper (max) mark ② of oil dipstick ①.

i The filling quantity between the upper and lower marks on the oil dipstick is approximately 2.1 US qt. (2.0 l).

- ▶ If necessary, add engine oil.

For adding engine oil, see “Adding engine oil” (> page 277).

For more information on engine oil, see “Fuels, coolants, lubricants, etc.” (> page 409).

For more information on messages in the multifunction display concerning engine oil, see the “Practical hints” section (▷ page 348).

Adding engine oil

! Only use approved engine oils and oil filters required for vehicles with Maintenance System (U.S. vehicles) or FSS (Canada vehicles). For a listing of approved engine oils and oil filters, refer to the Factory Approved Service Products pamphlet in your vehicle literature portfolio, or contact an authorized Mercedes-Benz Center.

Using engine oils and oil filters of specification other than those expressly required for the Maintenance System (U.S. vehicles) or FSS (Canada vehicles), or changing of oil and oil filter at change intervals longer than those called for by the Maintenance System (U.S. vehicles) or FSS (Canada Vehicles) will result in engine or emission control system damage not covered by the Mercedes-Benz Limited Warranty.

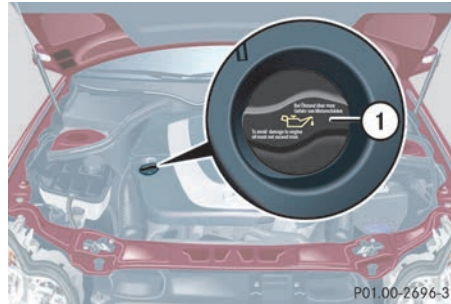

① Filler cap

- ▶ Unscrew filler cap ① from filler neck.
- ▶ Add engine oil as required. Be careful not to overfill with oil.

Be careful not to spill any oil when adding. Avoid environmental damage caused by oil entering the ground or water.

! Excess oil must be siphoned or drained off. It could cause damage to the engine and emission control system not covered by the Mercedes-Benz Limited Warranty.

- ▶ Screw filler cap ① back on filler neck.

For more information on engine oil, see the “Technical data” section (▷ page 409) and (▷ page 412).

Transmission fluid level

The transmission fluid level does not need to be checked. If you notice transmission fluid loss or gear shifting malfunctions, have an authorized Mercedes-Benz Center check the transmission.

Engine compartment

Coolant level

The engine coolant is a mixture of water and anticorrosion/antifreeze. To check the coolant level, the vehicle must be parked on level ground and the engine must be cool.

Warning!



In order to avoid any potentially serious burns:

- Use extreme caution when opening the hood if there are any signs of steam or coolant leaking from the cooling system, or if the coolant temperature gauge indicates that the coolant is overheated.
- Do not remove pressure cap on coolant reservoir if coolant temperature is above 158°F (70°C). Allow engine to cool down before removing cap. The coolant reservoir contains hot fluid and is under pressure.

- Using a rag, slowly open the cap approximately $1/2$ turn to relieve excess pressure. If opened immediately, scalding hot fluid and steam will be blown out under pressure.
- Do not spill antifreeze on hot engine parts. Antifreeze contains ethylene glycol which may burn if it comes into contact with hot engine parts.

The coolant expansion tank is located on the passenger side of the engine compartment.

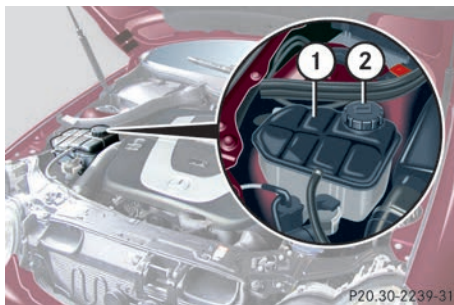

- ① Coolant expansion tank
- ② Cap

- ▶ Using a rag, turn cap ② slowly approximately one half turn counterclockwise to release any excess pressure.
- ▶ Continue turning the cap counterclockwise and remove it.

The coolant level is correct if the level

- for cold coolant: reaches the black top part of the reservoir
- for warm coolant: is approx. 0.6 in (1.5 cm) higher

- ▶ Add coolant as required.
- ▶ Replace and tighten cap.

For more information on coolant, see “Coolants” (▷ page 416).

Battery

Your vehicle's battery is located in the engine compartment on the right hand side (> page 383).

The battery should always be sufficiently charged in order to achieve its rated service life. Refer to Maintenance Booklet for battery maintenance intervals.

If you use your vehicle mostly for short-distance trips, you will need to have the battery charge checked more frequently.

When replacing the battery, always use batteries approved by Mercedes-Benz.

If you do not intend to operate your vehicle for an extended period of time, consult an authorized Mercedes-Benz Center about steps you need to observe.

Warning!



Observe all safety instructions and precautions when handling automotive batteries.



Risk of explosion.



Fire, open flames and smoking are prohibited when handling batteries. Avoid creating sparks.



Battery acid is caustic. Do not allow it to come into contact with skin, eyes or clothing.

Wear suitable protective clothing, especially gloves, apron and faceguard.



Wear eye protection.

Rinse any acid spills immediately with clear water. Contact a physician if necessary.



Keep children away.



Follow the instructions in this Operator's Manual.

Batteries contain materials that can harm the environment if disposed of improperly. Recycling of batteries is the preferred method of disposal. Many states require sellers of batteries to accept old batteries for recycling.

Engine compartment

Windshield washer system and headlamp cleaning system*

The windshield washer reservoir is located in the engine compartment.

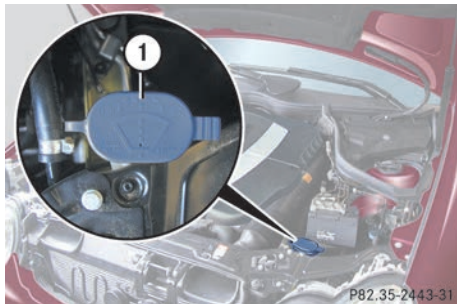

① Washer fluid reservoir

Fluid for the windshield washer system and the headlamp cleaning system* is supplied from the windshield washer reservoir. It has a capacity of:

- 3.2 US qt (3.0 l) in vehicles without headlamp cleaning system
- 6.4 US qt (6.0 l) in vehicles with headlamp cleaning system

During all seasons, add MB Windshield Washer Concentrate “MB SummerFit” to water. Premix the windshield washer fluid in a suitable container.

Warning!



Washer solvent/antifreeze is highly flammable. Do not spill washer solvent/antifreeze on hot engine parts, because it may ignite and burn. You could be seriously burned.

- ▶ Refill the reservoir with MB Windshield Washer Concentrate and water (or commercially available premixed windshield washer solvent/antifreeze, depending on ambient temperatures).

! Always use washer solvent/antifreeze where temperatures may fall below the freezing point. Failure to do so could result in damage to the washer system/reservoir.

! Only use washer fluid which is suitable for plastic lenses. Improper washer fluid can damage the plastic lenses of the headlamps.

For more information, see “Windshield washer and headlamp cleaning system*” (▷ page 418).

▼ Tires and wheels

See an authorized Mercedes-Benz Center for information on tested and recommended rims and tires for summer and winter operation. They can also offer advice concerning tire service and purchase.

Warning!



Replace rims or tires with the same designation, manufacturer and type as shown on the original part. See an authorized Mercedes-Benz Center for further information. If incorrectly sized rims and tires are mounted:

- The wheel brakes or suspension components can be damaged.
- The operating clearance of the wheels and the tires may no longer be correct.

Warning!



Worn, old tires can cause accidents. If the tire tread is badly worn, or if the tires have sustained damage, replace them.

When replacing rims, only use genuine Mercedes-Benz wheel bolts specified for the particular rim type. Failure to do so can result in the bolts loosening and possibly an accident.

Retreaded tires are not tested or recommended by Mercedes-Benz, since previous damage cannot always be recognized on re-treads. The operating safety of the vehicle cannot be assured when such tires are used.

Important guidelines

- Only use sets of tires and rims of the same type and make.
- Tires must be of the correct size for the rim.
- Break in new tires for approximately 60 miles (100 km) at moderate speeds.
- Regularly check the tires and rims for damage. Dented or bent rims can cause tire inflation pressure loss and damage to the tire beads.
- If vehicle is heavily loaded, check tire inflation pressure and correct as required.
- Do not allow your tires to wear down too far. Adhesion properties on wet roads are sharply reduced at tread depths under $\frac{1}{8}$ in (3 mm).
- When replacing individual tires, you should mount new tires on the front wheels first (on vehicles with same-sized wheels all around).

Tires and wheels

Tire care and maintenance

Warning!



Regularly check the tires for damage. Damaged tires can cause tire inflation pressure loss. As a result, you could lose control of your vehicle.

Worn, old tires can cause accidents. If the tire tread is badly worn, or if the tires have sustained damage, replace them.

Regularly check your tire inflation pressure at least once a month. For more information on checking tire inflation pressure see “Recommended tire inflation pressure” (▷ page 289).

Tire inspection

Every time you check your tire inflation pressure, you should also inspect your tires for wear and damage for the following:

- excessive treadwear (▷ page 283)
- cord or fabric showing through the tire’s rubber
- bumps, bulges, cuts, cracks, or splits in the tread or side of the tire

Replace the tire if you find any of the above conditions.

Make sure you also inspect the spare tire periodically for condition and tire inflation pressure. Spare tires will age and become worn over time even if never used, and thus should be inspected and replaced when necessary.

Life of tire

The service life of a tire is dependent upon varying factors including but not limited to:

- Driving style
- Tire inflation pressure
- Distance driven

Warning!



Tires and spare tire should be replaced after 6 years, regardless of the remaining tread.

Tread depth

Do not allow your tires to wear down too far. Adhesion properties on wet roads are sharply reduced at tread depths under $\frac{1}{8}$ in (3 mm).

Treadwear indicators (TWI) are required by law. These indicators are located in six places on the tread circumference and become visible at a tread depth of approximately $\frac{1}{16}$ in (1.6 mm), at which point the tire is considered worn and should be replaced.

Recommended minimum tire tread depth:

- Summer tires $\frac{1}{8}$ in (3 mm)
- Winter tires $\frac{1}{6}$ in (4 mm)

Warning!



Although the applicable federal motor safety laws consider a tire to be worn when the treadwear indicators (TWI) become visible at approximately $\frac{1}{16}$ in (1.6 mm), we recommend that you do not allow your tires

to wear down to that level. As tread depth approaches $\frac{1}{8}$ in (3 mm), the adhesion properties on a wet road are sharply reduced.

Depending upon the weather and/or road surface (conditions), the tire traction varies widely.

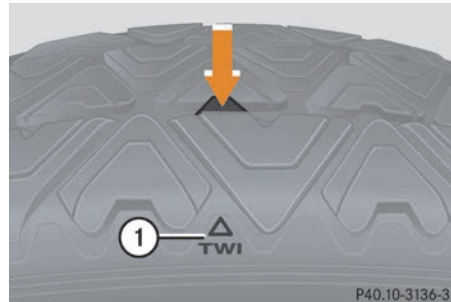

① TWI (Tread Wear Indicator)

The treadwear indicator appears as a solid band across the tread.

Storing tires

! *Keep unmounted tires in a cool, dry place with as little exposure to light as possible. Protect tires from contact with oil, grease and gasoline.*

Cleaning tires

! *Never use a round nozzle to power wash tires. The intense jet of water can result in damage to the tire.*

Always replace a damaged tire.

Tires and wheels

Direction of rotation

Unidirectional tires offer added advantages, such as better hydroplaning performance. To benefit, however, you must make sure the tires rotate in the direction specified.

An arrow on the sidewall indicates the intended direction of rotation (spinning) of the tire.

i *Spare wheels may be mounted against the direction of rotation (spinning) even with a unidirectional tire for temporary use only until the regular drive wheel has been repaired or replaced. Always observe and follow applicable temporary use restrictions and speed limitations indicated on the spare wheel.*

Loading the vehicle

A label on your vehicle shows how much weight it may properly carry.

- The Tire and Loading Information placard can be found on the driver's door B-pillar. This placard tells you important information about the number of people that can be in the vehicle and the total weight that can be carried in the vehicle. It also contains information on the proper size and recommended tire inflation pressures for the original equipment tires on your vehicle.
- The certification label found on the driver's door B-pillar tells you about the gross weight capacity of your vehicle, called the Gross Vehicle Weight Rating (GVWR). The GVWR includes the weight of the vehicle, all occupants, fuel and cargo. The certification label also tells you about the front and rear axle weight capacity, called the Gross Axle Weight Rating (GAWR). The GAWR is the total allowable weight that can be

carried by a single axle (front or rear). Never exceed the GVWR or GAWR for either the front axle or rear axle.

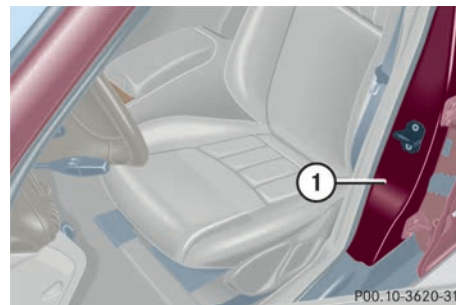

① Driver's door B-pillar

Following is a discussion on how to work with the information contained on the placard with regards to loading your vehicle.

Tire and Loading Information

Warning!



Do not overload the tires by exceeding the specified load limit as indicated on the placard on the driver's door B-pillar. Overloading the tires can overheat them, possibly causing a blowout. Overloading the tires can also result in handling or steering problems, or brake failure.

Your vehicle is equipped with a Tire and Loading Information placard.

i Data shown on placard example are for illustration purposes only. Load limit data are specific to each vehicle and may vary from data shown in the illustration below. Refer to placard on vehicle for actual data specific to your vehicle.

Placard

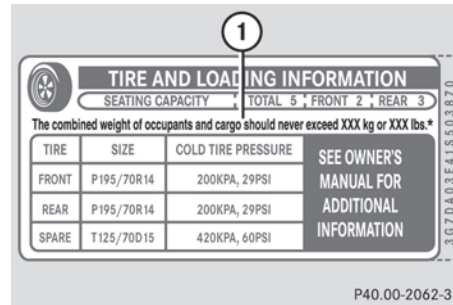

① Load limit information on the Tire and Loading Information placard

The placard showing the load limit information is located on the driver's door B-pillar. Locate the statement "The combined weight of occupants and cargo should never exceed XXX kilograms or XXX lbs." on this placard. The combined weight of all occupants, cargo / luggage and trailer tongue load (if applicable) should never exceed the weight referenced in that statement.

Seating capacity

The seating capacity gives you important information on the number of occupants that can be in the vehicle. Observe front and rear seating capacity. The placard showing the seating capacity is located on the driver's door B-pillar (▷ page 284).

i Data shown on placard example are for illustration purposes only. Seating data are specific to each vehicle and may vary from data shown in the illustration below. Refer to placard on vehicle for actual data specific to your vehicle.

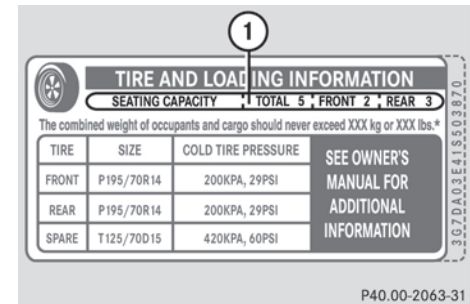

① Seating capacity information on the Tire and Loading Information placard.

Tires and wheels

Steps for determining correct load limit

The following steps have been developed as required of all manufacturers under Title 49, Code of U.S. Federal Regulations, Part 575 pursuant to the “National Traffic and Motor Vehicle Safety Act of 1966”.

Step 1

- ▶ Locate the statement “The combined weight of occupants and cargo should never exceed XXX kg or XXX lbs.” on your vehicle’s placard.

Step 2

- ▶ Determine the combined weight of the driver and passengers that will be riding in your vehicle.

Step 3

- ▶ Subtract the combined weight of the driver and passengers from XXX kilograms or XXX lbs.

Step 4

- ▶ The resulting figure equals the available amount of cargo and luggage load capacity. For example, if the “XXX” amount equals 1400 lbs and there will be five 150 lbs passengers in your vehicle, the amount of available cargo and luggage load capacity is 650 lbs ($1400 - 750 (5 \times 150) = 650$ lbs).

Step 5

- ▶ Determine the combined weight of luggage and cargo being loaded on the vehicle. That weight may not safely exceed the available cargo and luggage load capacity calculated in step 4.

Step 6 (if applicable)

- ▶ If your vehicle will be towing a trailer, load from your trailer will be transferred to your vehicle. Consult this manual to determine how this reduces the available cargo and luggage load capacity of your vehicle (▷ page 288).

The following table shows examples on how to calculate total and cargo load capacities with varying seating configurations and number and size of occupants. The following examples use a load limit of 1500 lbs. **This is for illustration purposes only.** Make sure you are using the actual load limit for your vehicle stated on the vehicle’s placard (▷ page 285).

Example	Combined weight limit of occupants and cargo from placard	Number of occupants (driver and passengers)	Seating configuration	Occupants weight	Combined weight of all occupants	Available cargo/luggage and trailer tongue weight (total load limit from placard minus combined weight of all occupants)
1	1500 lbs	5	front: 2 rear: 3	Occupant 1: 150 lbs Occupant 2: 180 lbs Occupant 3: 160 lbs Occupant 4: 140 lbs Occupant 5: 120 lbs	750 lbs	1500 lbs - 750 lbs = 750 lbs
2	1500 lbs	3	front: 1 rear: 2	Occupant 1: 200 lbs Occupant 2: 190 lbs Occupant 3: 150 lbs	540 lbs	1500 lbs - 540 lbs = 960 lbs
3	1500 lbs	1	front:1	Occupant 1: 150 lbs	150 lbs	1500 lbs - 150 lbs = 1350 lbs

The higher the weight of all occupants, the less cargo and luggage load capacity is available.

For more information, see “Trailer tongue load” (> page 288).

Tires and wheels

Certification label

Even after careful determination of the combined weight of all occupants, cargo and the trailer tongue load (if applicable) (▷ page 288) as to not exceed the permissible load limit, you must make sure that your vehicle never exceeds the Gross Vehicle Weight Rating (GVWR) and the Gross Axle Weight Rating (GAWR) for either the front or rear axle. You can obtain the GVWR and GAWR from the certification label. The certification label can be found on the driver's door B-pillar, see "Technical data" (▷ page 398).

Gross Vehicle Weight Rating (GVWR): The total weight of the vehicle, all occupants, all cargo, and the trailer tongue load (▷ page 288) must never exceed the GVWR.

Gross Axle Weight Rating (GAWR): The total allowable weight that can be carried by a single axle (front or rear).

To assure that your vehicle does not exceed the maximum permissible weight limits (GVWR and GAWR for front and rear axle), have the loaded vehicle (including driver, passengers and all cargo and, if applicable, trailer fully loaded) weighed on a suitable commercial scale.

Trailer tongue load

The tongue load of any trailer is an important weight to measure because it affects the load you can carry in your vehicle. If a trailer is towed, the tongue load must be added to the weight of all occupants riding and any cargo you are carrying in the vehicle. The tongue load typically is ten percent of the trailer weight and everything loaded in it.

Your Mercedes-Benz has been designed primarily to carry passengers and their cargo. Mercedes-Benz does not recommend trailer towing with your vehicle.

Recommended tire inflation pressure

Warning!



Follow recommended tire inflation pressures.

Do not underinflate tires. Underinflated tires wear excessively and / or unevenly, adversely affect handling and fuel economy, and are more likely to fail from being overheated.

Do not overinflate tires. Overinflated tires can adversely affect handling and ride comfort, wear unevenly, increase stopping distance, and result in sudden deflation (blowout) because they are more likely to become punctured or damaged by road debris, potholes etc.

Your vehicle is equipped with a Tire and Loading Information placard located on the driver's door B-pillar (▷ page 284).

The tire inflation pressure should be checked regularly and should only be adjusted on cold tires. The tires can be considered cold if the vehicle has been parked for at least three hours or driven less than one mile (1.6 km).

Follow recommended cold tire inflation pressures listed on placard.

Keeping the tires properly inflated provides the best handling, tread life and riding comfort.

In addition to the tire placard on the driver's door B-pillar, also consult the fuel filler flap for any additional information pertaining to special driving situations. For more information, see "Important notes on tire inflation pressure" (▷ page 290).

i Data shown on placard example are for illustration purposes only. Tire data are specific to each vehicle and may vary from data shown in the illustration below. Refer to placard on vehicle for actual data specific to your vehicle.

Placard

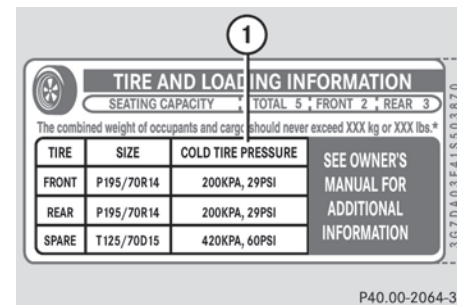

① Tire and Loading Information placard with recommended cold tire inflation pressures

The placard lists the recommended cold tire inflation pressures for maximum loaded vehicle weight. The tire inflation pressures listed apply to the tires installed as original equipment.

Tires and wheels

Important notes on tire inflation pressure

Warning!



If the tire inflation pressure repeatedly drops:

- Check the tires for punctures from foreign objects.
- Check to see whether air is leaking from the valves or from around the rim.

Tire temperature and tire inflation pressure are also increased while driving, depending on the driving speed and the tire load.

If you will be driving your vehicle at high speeds of 100 mph (160 km/h) or higher, where it is legal and conditions allow, consult the placard on the inside of the fuel filler flap on how to adjust the cold tire inflation pressure. If you do not adjust the tire inflation pressure, excessive heat can build up and result in sudden tire failure.

Be sure to readjust the tire inflation pressure for normal driving speeds. You should wait until the tires are cold before adjusting the tire inflation pressure.

i *Driving comfort may be reduced when the tire inflation pressure is adjusted to the value for speeds above 100 mph (160 km/h) as specified on the placard located on the inside of the fuel filler flap.*

Some vehicles may have supplemental tire inflation pressure information for vehicle loads less than the maximum loaded vehicle condition. If such information is provided, it can be found on the placard located on the inside of the fuel filler flap.

Tire inflation pressure changes by approximately 1.5 psi (0.1 bar) per 18°F (10°C) of air temperature change. Keep this in mind when checking tire inflation pressure where the temperature is different from the outside temperature.

Checking tire inflation pressure

Regularly check your tire inflation pressure at least once a month.

Check and adjust the tire inflation pressure when the tires are cold. The tires can be considered cold if the vehicle has been parked for at least three hours or driven less than one mile (1.6 km).

If you check the tire inflation pressure when the tires are warm (the vehicle has been driven for several miles or sitting less than three hours), the reading will be approximately 4 psi (0.3 bar) higher than the cold reading. This is normal. Do not let air out to match the specified cold tire inflation pressure. Otherwise, the tire will be underinflated.

Warning!

Follow recommended tire inflation pressures.

Do not overinflate tires. Overinflating tires can result in sudden deflation (blowout) because they are more likely to become punctured or damaged by road debris, potholes, etc.

Do not underinflate tires. Underinflated tires wear unevenly, adversely affect handling and fuel economy, and are more likely to fail from being overheated.

Do not overload the tires by exceeding the specified load limit as indicated on the placard on the driver's door B-pillar. Overloading the tires can overheat them, possibly causing a blowout.

Checking tire inflation pressure manually

Follow the steps below to achieve correct tire inflation pressure:

- ▶ Remove the cap from the valve on one tire.
- ▶ Firmly press a tire gauge onto the valve.
- ▶ Read tire inflation pressure on tire gauge and check against the recommended tire inflation pressure on the placard on the driver's door B-pillar (▷ page 289). If necessary, add air to achieve the recommended tire inflation pressure.

i *If you have overfilled the tire, release tire inflation pressure by pushing the metal stem of the valve with e.g. a tip of a pen. Then recheck the tire inflation pressure with the tire gauge.*

- ▶ Install the valve cap.
- ▶ Repeat this procedure for each tire.

Run Flat Indicator*

U.S. vehicles: The Run Flat Indicator is only available in conjunction with the MOExtended* system (▷ page 294).

While the vehicle is being driven, the Run Flat Indicator monitors the set tire inflation pressures by evaluating each wheel's rotational speed. This allows the system to detect a significant loss of pressure in a tire. If a wheel's rotational speed changes due to falling tire inflation pressure, you will see a corresponding warning message in the multifunction display.

Tires and wheels

The Run Flat Indicator* may function in a restricted manner or with a delay if:

- snow chains are mounted to the vehicle
- winter road conditions prevail in presence of ice and snow
- you are driving on a loose surface (e.g. sand or gravel)
- you are driving in a very sporty manner (involving rapid acceleration or high speeds in curves)

Warning!



When the multifunction display shows the message **Tire pressure Check tires**, one or more of your tires is significantly under-inflated. You should stop and check your tires as soon as possible, and inflate them to the proper tire inflation pressure as indicated on the vehicle's tire information placard. Driving on a significantly under-inflated tire causes the tire to overheat and can lead to tire failure. Under-inflation also reduces fuel efficiency and tire tread life, and may affect the vehicle's handling and stopping ability. Each tire, including the spare, should be checked monthly when cold and set to the recommended tire inflation pressure as specified in the vehicle placard and owner's manual.

Warning!



The Run Flat Indicator* does not provide a warning for wrongly selected tire inflation pressures. Always adjust tire inflation pressure according to the placard on the driver's door B-pillar or fuel filler flap.

The Run Flat Indicator* does not replace regular checks of the tire inflation pressures since a gradual pressure loss in more than one tires cannot be detected by the Run Flat Indicator*.

The Run Flat Indicator* is not able to issue a warning due to a sudden dramatic loss of tire inflation pressure (e.g. tire blowout caused by a foreign object). In this case bring the vehicle to a halt by carefully applying the brakes and avoiding abrupt steering maneuvers.

i *The recommended tire inflation pressures for your vehicle can be found on the tire placard located on the driver's door B-pillar (▷ page 289). The tire inflation pressures are not listed in the owner's manual.*

Reactivating the Run Flat Indicator*

The tire inflation pressure monitor must be reactivated in the following situations:



- If you have changed the tire inflation pressure
- If you have replaced the wheels or tires
- If you have installed new wheels or tires
- ▶ Using the tire placard on the driver’s door B-pillar or, if available, the inside of the fuel filler flap, make sure the tire inflation pressure of all four tires is correct.

Warning!



The Run Flat Indicator* can only warn you in a reliable manner if you have set the correct tire inflation pressures for each tire.

If an incorrect tire inflation pressure was set, the system will monitor the pressure according to the incorrect value.

- ▶ Switch on the ignition (▷ page 32).
The standard display menu appears in the multifunction display (▷ page 126).
- ▶ Press button  or  repeatedly until the following message appears in the multifunction display:

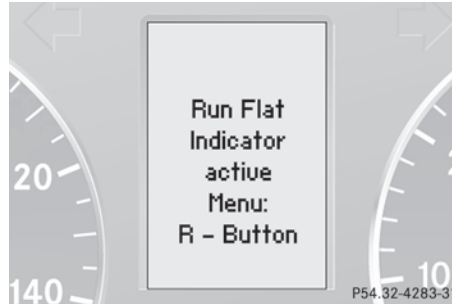

- ▶ Press the reset button in the instrument cluster (▷ page 311).
The following message will appear in the multifunction display:
Restart
Run Flat
Indicator?
Yes
Cancel

If you wish to confirm activation:

- ▶ Press button .

The following message will appear in the multifunction display:

Run Flat
Indicator
restarted

After a certain “learning phase”, the Run Flat Indicator checks the set pressure values for all four tires.

If you wish to cancel activation:

- ▶ Press button .

or

- ▶ Wait until the message
Restart
Run Flat
Indicator?
Yes
Cancel
disappears.

Tires and wheels

Potential problems associated with underinflated and overinflated tires

Underinflated tires

Underinflated tires can:

- cause excessive and uneven tire wear
- adversely affect fuel economy
- lead to tire failure from being overheated
- adversely affect handling characteristics

Warning!



Follow recommended tire inflation pressures.

Do not underinflate tires. Underinflated tires wear excessively and / or unevenly, adversely affect handling and fuel economy, and are more likely to fail from being overheated.

Overinflated tires

Overinflated tires can:

- adversely affect handling characteristics
- cause uneven tire wear
- be more prone to damage from road hazards
- adversely affect ride comfort
- increase stopping distance

Warning!



Follow recommended tire inflation pressures.

Do not overinflate tires. Overinflated tires can adversely affect handling and ride comfort, wear unevenly, increase stopping distance, and result in sudden deflation (blowout) because they are more likely to become punctured or damaged by road debris, potholes etc.

*MOExtended system**

The *MOExtended* system allows you to continue driving your vehicle even if there is a total loss of pressure in one or more tires.

You may only use the *MOExtended* system in conjunction with the Run Flat Indicator* (▷ page 291).

For information on driving in case of pressure loss in one or more tires (emergency mode), see the “Practical hints” section (▷ page 382).

Tire labeling

Besides tire name (sales designation) and manufacturer name, a number of markings can be found on a tire.

Following are some explanations for the markings on your vehicle's tires:

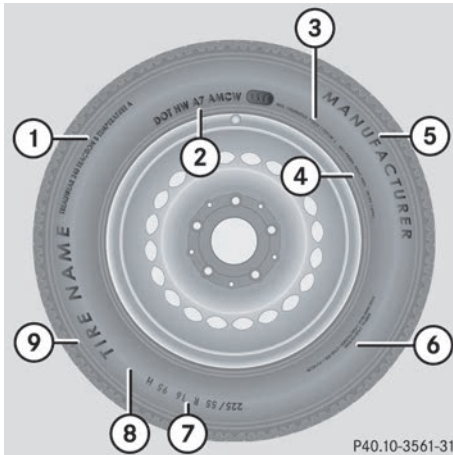

- ① Uniform Quality Grading Standards (▷ page 302)
- ② DOT, Tire Identification Number (TIN) (▷ page 299)
- ③ Maximum tire load (▷ page 301)
- ④ Maximum tire inflation pressure (▷ page 301)
- ⑤ Manufacturer
- ⑥ Tire ply material (▷ page 304)
- ⑦ Tire size designation, load and speed rating (▷ page 295)
- ⑧ Load identification (▷ page 299)
- ⑨ Tire name

i For illustration purposes only. Actual data on tires is specific to each vehicle and may vary from data shown in above illustration.

For more information, see “Rims and Tires” (▷ page 403).

Tire size designation, load and speed rating

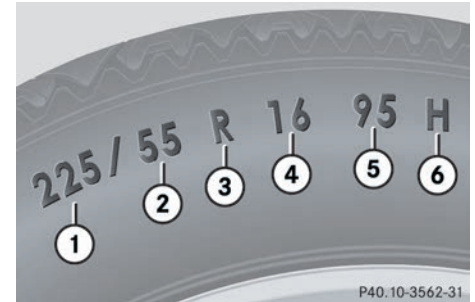

- ① Tire width
- ② Aspect ratio in %
- ③ Radial tire code
- ④ Rim diameter
- ⑤ Tire load rating
- ⑥ Tire speed rating

i For illustration purposes only. Actual data on tires is specific to each vehicle and may vary from data shown in above illustration.

Tires and wheels

General:

Depending on the design standards used, the tire size molded into the sidewall may have no letter or a letter preceding the tire size designation.

No letter preceding the size designation (as illustrated above): Passenger car tire based on European design standards.

Letter “P” preceding the size designation: Passenger car tire based on U.S. design standards.

Letter “LT” preceding the size designation: Light Truck tire based on U.S. design standards.

Letter “T” preceding the size designation: Temporary spare tires which are high pressure compact spares designed for temporary emergency use only.

Tire width

The tire width ① (▷ page 295) indicates the nominal tire width in mm.

Aspect ratio

The aspect ratio ② (▷ page 295) is the dimensional relationship between tire section height and section width and is expressed in percentage. The aspect ratio is arrived at by dividing section height by section width.

Tire code

The tire code ③ (▷ page 295) indicates the tire construction type. The “R” stands for radial tire type. Letter “D” means diagonal or bias ply construction; letter “B” means belted-bias ply construction.

At the tire manufacturer’s option, any tire with a speed capability above 149 mph (240 km/h) can include a “ZR” in the size designation (for example: 245/40 ZR 18). For additional information, see “Tire speed rating” (▷ page 297).

Rim diameter

The rim diameter ④ (▷ page 295) is the diameter of the bead seat, not the diameter of the rim edge. Rim diameter is indicated in inches (in).

Tire load rating

The tire load rating ⑤ (▷ page 295) is a numerical code associated with the maximum load a tire can support.

For example, a load rating of 91 corresponds to a maximum load of 1356 lbs (615 kg) the tire is designed to support. See also “Maximum tire load” (▷ page 301) where the maximum load associated with the load index is indicated in kilograms and lbs.

Summer tires

Index	Speed rating
Q	up to 100 mph (160 km/h)
R	up to 106 mph (170 km/h)
S	up to 112 mph (180 km/h)
T	up to 118 mph (190 km/h)
H	up to 130 mph (210 km/h)
V	up to 149 mph (240 km/h)
W	up to 168 mph (270 km/h)
Y	up to 186 mph (300 km/h)
(Y)	above 186 mph (300 km/h)
ZR	above 149 mph (240 km/h)

Warning!



The tire load rating must always be at least half of the GAWR (▷ page 305) of your vehicle. Otherwise, tire failure may be the result which may cause an accident and/or serious personal injury to you or others.

Always replace rims and tires with the same designation, manufacturer and type as shown on the original part.

i Tire load rating ⑤ (▷ page 295) and Tire speed rating ⑥ (▷ page 295) are also referred to as “service description”.

Tire speed rating

The tire speed rating ⑥ (▷ page 295) indicates the approved maximum speed for the tire.

Warning!



Even when permitted by law, never operate a vehicle at speeds greater than the maximum speed rating of the tires.

Exceeding the maximum speed for which tires are rated can lead to sudden tire failure, causing loss of vehicle control and possibly resulting in an accident and/or personal injury and possible death, for you and for others.

i Tire load rating ⑤ (▷ page 295) and Tire speed rating ⑥ (▷ page 295) are also referred to as “service description”.

Warning!



Do not overload the tires by exceeding the specified load limit as indicated on the placard located on the driver’s door B-pillar. Overloading the tires can overheat them, possibly causing a blowout. Overloading the tires can also result in handling or steering problems, or brake failure.

For additional information on tire load rating, see “Load identification” (▷ page 299).

Tires and wheels

- At the tire manufacturer's option, any tire with a speed capability above 149 mph (240 km/h) can include a "ZR" in the size designation (for example: 245/40 ZR18). To determine the maximum speed capability of the tire, the service description for the tire must be referred to. The service description is comprised of the tire load rating ⑤ (▷ page 295) and the tire speed rating ⑥ (▷ page 295).

If your tire includes "ZR" in the size designation and no service description ⑤ and ⑥ (▷ page 295) is given, the tire manufacturer must be consulted for the maximum speed capability.



If a service description ⑤ and ⑥ (▷ page 295) is given, the speed capability is limited by the speed symbol in the service description.
 Example: 245/40 ZR18 97Y.
 In this example, "97Y" is the service description. The letter "Y" designates the speed rating and the speed capability of the tire is limited to 186 mph (300 km/h).

- Any tire with a speed capability above 186 mph (300 km/h) must include a "ZR" in the size designation AND the service description must be placed in parenthesis. Example: 275/40 ZR 18 (99Y). The "(Y)" speed rating in parenthesis designates the maximum speed capability of the tire as being above 186 mph (300 km/h). Consult the tire manufacturer for the actual maximum permissible speed of the tire.

All-season and winter tires

Index	Speed rating
Q M+S ¹	up to 100 mph (160 km/h)
T M+S ¹	up to 118 mph (190 km/h)
H M+S ¹	up to 130 mph (210 km/h)
V M+S ¹	up to 149 mph (240 km/h)

¹ or M+S  for winter tires

 *Not all M+S rated tires provide special winter performance. Make sure the tires you use show M+S and the mountain/snowflake  marking on the tire sidewall. These tires meet specific snow traction performance requirements of the Rubber Manufacturers Association (RMA) and the Rubber Association of Canada (RAC) and have been designed specifically for use in snow conditions.*

Load identification



① Load identification

i For illustration purposes only. Actual data on tires is specific to each vehicle and may vary from data shown in above illustration.

In addition to tire load rating, special load information may be molded into the tire sidewall following the letter designating the tire speed rating (⑥ ▷ page 295).

No specification given: absence of any text (like in above example) indicates a standard load (SL) tire.

XL or Extra Load: designates an extra load (or reinforced) tire.

Light Load: designates a light load tire.

C, D, E: designates load range associated with the maximum load a tire can carry at a specified pressure.

DOT, Tire Identification Number (TIN)

U.S. tire regulations require each new tire manufacturer or tire retreader to mold a TIN into or onto a sidewall of each tire produced.

The TIN is a unique identifier which facilitates efforts by tire manufactures to notify purchasers in recall situations or other safety matters concerning tires and gives purchasers the means to easily identify such tires.

The TIN is comprised of “Manufacturer’s identification mark”, “Tire size”, “Tire type code”, and “Date of manufacture”.

Tires and wheels

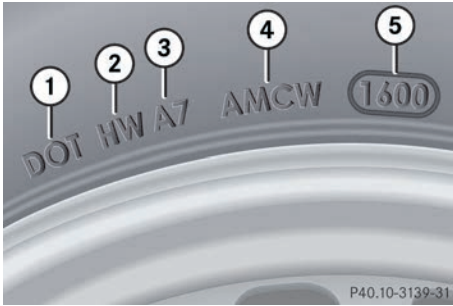

- ① DOT
- ② Manufacturer's identification mark
- ③ Tire size
- ④ Tire type code (at the option of the tire manufacturer)
- ⑤ Date of manufacture

i For illustration purposes only. Actual data on tires is specific to each vehicle and may vary from data shown in above illustration.

DOT (Department of Transportation)

A tire branding symbol ① (▷ page 300) which denotes the tire meets requirements of the U.S. Department of Transportation.

Manufacturer's identification mark

The manufacturer's identification mark ② (▷ page 300) denotes the tire manufacturer.

New tires have a mark with two symbols.

Retreaded tires have a mark with four symbols. For more information on retreaded tires, see (▷ page 281).

Tire size

The code ③ (▷ page 300) indicates the tire size.

Tire type code

The code ④ (▷ page 300) may, at the option of the manufacturer, be used as a descriptive code for identifying significant characteristics of the tire.

Date of manufacture

The date of manufacture ⑤ (▷ page 300) identifies the week and year of manufacture.

The first two figures identify the week, starting with "01" to represent the first full week of the calendar year. The second two figures represent the year.

For example, "3202" represents the 32nd week of 2002.

Maximum tire load

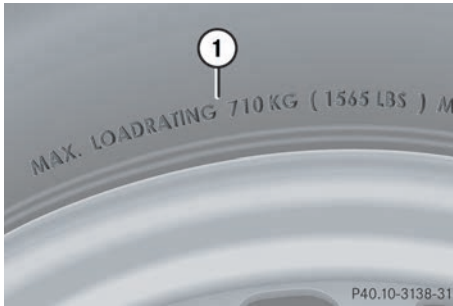

① Maximum tire load rating

i For illustration purposes only. Actual data on tires is specific to each vehicle and may vary from data shown in above illustration.

The maximum tire load is the maximum weight the tires are designed to support.

Warning!



Do not overload the tires by exceeding the specified load limit as indicated on the placard located on the driver's door B-pillar. Overloading the tires can overheat them, possibly causing a blowout. Overloading the tires can also result in handling or steering problems, or brake failure.

For more information on tire load rating (▷ page 296).

For information on calculating total and cargo load capacities (▷ page 286).

Maximum tire inflation pressure



① Maximum permissible tire inflation pressure

i For illustration purposes only. Actual data on tires is specific to each vehicle and may vary from data shown in above illustration.

This is the maximum permissible tire inflation pressure for the tire.

Tires and wheels

Always follow the recommended tire inflation pressure (▷ page 289) for proper tire inflation.

Warning!



Never exceed the max. tire inflation pressure. Follow recommended tire inflation pressures.

Do not underinflate tires. Underinflated tires wear excessively and / or unevenly, adversely affect handling and fuel economy, and are more likely to fail from being overheated.

Do not overinflate tires. Overinflated tires can adversely affect handling and ride comfort, wear unevenly, increase stopping distance, and result in sudden deflation (blowout) because they are more likely to become punctured or damaged by road debris, potholes etc.

Uniform Tire Quality Grading Standards (U.S. vehicles)

Tire manufacturers are required to grade tires based on three performance factors: treadwear, traction, and temperature resistance.

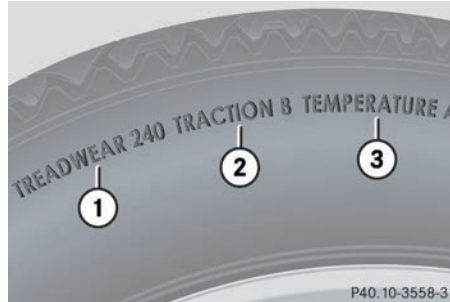

- ① Treadwear
- ② Traction
- ③ Temperature resistance

i For illustration purposes only. Actual data on tires is specific to each vehicle and may vary from data shown in above illustration.

Quality grades can be found, where applicable, on the tire sidewall between tread shoulder and maximum section width. For example:

Treadwear	Traction	Temperature
200	AA	A

All passenger car tires must conform to federal safety requirements in addition to these grades.

Treadwear

The treadwear grade is a comparative rating based on the wear rate of the tire when tested under controlled conditions on a specified government test course. For example, a tire graded 150 would wear one and one-half (1 1/2) times as well on the government course as a tire graded 100. The relative performance of tires depends upon the actual conditions of their use, however, and may depart significantly

from the norm due to variations in driving habits, service practices and differences in road characteristics and climate.

Traction

The traction grades, from highest to lowest, are AA, A, B, and C. Those grades represent the tire's ability to stop on wet pavement as measured under controlled conditions on specified government test surfaces of asphalt and concrete. A tire marked C may have poor traction performance.

Warning!



The traction grade assigned to this tire is based on straight-ahead braking traction tests, and does not include acceleration, cornering, hydroplaning, or peak traction characteristics.

Temperature

The temperature grades are A (the highest), B, and C, representing the tire's resistance to the generation of heat and its ability to dissipate heat when tested under controlled conditions on a specified indoor laboratory test wheel. Sustained high temperature can cause the material of the tire to degenerate and reduce tire life, and excessive temperature can lead to sudden tire failure. The grade C corresponds to a level of performance which all passenger car tires must meet under the Federal Motor Vehicle Safety Standard No. 109. Grades B and A represent higher levels of performance on the laboratory test wheel than the minimum required by law.

Warning!



The temperature grade for this tire is established for a tire that is properly inflated and not overloaded. Excessive speed, underinflation, or excessive loading, either separately or in combination, can cause excessive heat build-up and possible tire failure.

Tires and wheels

Tire ply material

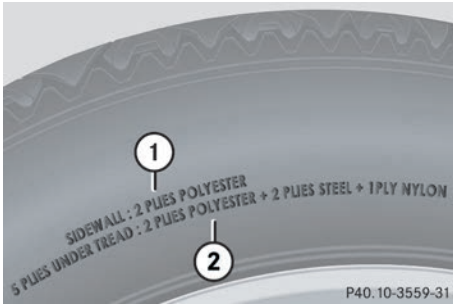

- ① Plies in sidewall
- ② Plies under tread

i For illustration purposes only. Actual data on tires is specific to each vehicle and may vary from data shown in above illustration.

This marking tells you about the type of cord and number of plies in the sidewall and under the tread.

Tire and loading terminology

Accessory weight

The combined weight (in excess of those standard items which may be replaced) of automatic transmission, power steering, power brakes, power windows, power seats, radio, and heater, to the extent that these items are available as factory-installed equipment (whether installed or not).

Air pressure

The amount of air inside the tire pressing outward on each square inch of the tire. Air pressure is expressed in pounds per square inch (psi), or kilopascal (kPa) or bars.

Aspect ratio

Dimensional relationship between tire section height and section width expressed in percentage.

Bar

Another metric unit for air pressure. There are 14.5038 pounds per square inch (psi) to 1 bar; there are 100 kilopascals (kPa) to 1 bar.

Bead

The tire bead contains steel wires wrapped by steel cords that hold the tire onto the rim.

Cold tire inflation pressure

Tire inflation pressure when your vehicle has been sitting for at least three hours or driven no more than one mile (1.6 km).

Curb weight

The weight of a motor vehicle with standard equipment including the maximum capacity of fuel, oil, and coolant, and, if so equipped, air conditioning and additional optional equipment, but without passengers and cargo.

DOT (Department of Transportation)

A tire branding symbol which denotes the tire meets requirements of the U.S. Department of Transportation.

GAWR (Gross Axle Weight Rating)

The GAWR is the maximum permissible axle weight. The gross vehicle weight on each axle must never exceed the GAWR for the front and rear axle indicated on the certification label located on the driver's door B-pillar.

GVW (Gross Vehicle Weight)

The GVW comprises the weight of the vehicle including fuel, tools, spare wheel, installed accessories, passengers and cargo and, if applicable, trailer tongue load. The GVW must never exceed the GVWR indicated on the certification label located on the driver's door B-pillar.

GVWR (Gross Vehicle Weight Rating)

This is the maximum permissible vehicle weight of the fully loaded vehicle (weight of the vehicle including all options, passengers, fuel, and cargo and, if applicable, trailer tongue load). It is indicated on certification label located on the driver's door B-pillar.

Kilopascal (kPa)

The metric unit for air pressure. There are 6.9 kPa to 1 psi; another metric unit for air pressure is bars. There are 100 kilopascals (kPa) to 1 bar.

Maximum load rating

The maximum load in kilograms and pounds that can be carried by the tire.

Maximum loaded vehicle weight

The sum of curb weight, accessory weight, total load weight, and production options weight.

Maximum tire inflation pressure

This number is the greatest amount of air pressure that should ever be put in the tire under normal driving conditions.

Normal occupant weight

The number of occupants the vehicle is designed to seat, multiplied by 68 kilograms (150 lbs).

Occupant distribution

The distribution of occupants in a vehicle at their designated seating positions.

Production options weight

The combined weight of those installed regular production options weighing over 5 lbs (2.3 kilograms) in excess of those standard items which they replace, not previously considered in curb weight or accessory weight, including heavy duty brakes, ride levelers, roof rack, heavy duty battery, and special trim.

Tires and wheels

PSI (Pounds per square inch)

A standard unit of measure for air pressure
-> bar, kilopascal (kPa).

Recommended tire inflation pressure

Recommended tire inflation pressure listed on placard located on driver's door B-pillar for normal driving conditions. Provides best handling, tread life and riding comfort.

Rim

A metal support for a tire or a tire and tube assembly upon which the tire beads are seated.

Sidewall

The portion of a tire between the tread and the bead.

TIN (Tire Identification Number)

Unique identifier which facilitates efforts by tire manufacturers to notify purchasers in recall situations or other safety matters concerning tires and gives purchases the means to easily identify such tires. The TIN is comprised of "Manufacturer's identification mark", "Tire size", "Tire type code" and "Date of manufacture".

Tire load rating

Numerical code associated with the maximum load a tire can support.

Tire ply composition and material used

This indicates the number of plies or the number of layers of rubber-coated fabric in the tire tread and sidewall. Tire manufacturers also must indicate the ply materials in the tire and sidewall, which include steel, nylon, polyester, and others.

Tire speed rating

Part of tire designation; indicates the speed range for which a tire is approved.

Traction

Force exerted by the vehicle on the road via the tires. The amount of grip provided.

Tread

The portion of a tire that comes into contact with the road.

Treadwear indicators

Narrow bands, sometimes called "wear bars" that show across the tread of a tire when only $\frac{1}{16}$ in (1.6 mm) of tread remains.

Uniform Tire Quality Grading Standards

A tire information system that provides consumers with ratings for a tire's traction, temperature and treadwear. Ratings are determined by tire manufacturers using government testing procedures. The ratings are molded into the sidewall of the tire.

Vehicle maximum load on the tire

Load on an individual tire that is determined by distributing to each axle its share of the maximum loaded vehicle weight and dividing it by two.

Rotating tires

Warning!



Rotate front and rear wheels only if the tires are of the same dimension.

If your vehicle is equipped with mixed-size tires (different tire dimensions front vs. rear), tire rotation is not possible.

Tire rotation can be performed on vehicles with tires of the same dimension all around. If your vehicle is equipped with tires of the same dimension all around, tires can be rotated, observing a front-to-rear rotation pattern that will maintain the intended rotation (spinning) direction of the tire (▷ page 284).

In some cases, such as when your vehicle is equipped with mixed-size tires (different tire dimension front vs. rear), tire rotation is not possible.

If applicable to your vehicle's tire configuration, tires can be rotated according to the tire manufacturer's recommended intervals in the tire manufacturer's warranty pamphlet located in your vehicle literature portfolio. If none is available, tires should be rotated every 3000 to 6000 miles (5000 to 10000 km), or sooner if necessary, according to the degree of tire wear. The same rotation (spinning) direction must be maintained (▷ page 284).

Rotate tires before the characteristic tire wear pattern becomes visible (shoulder wear on front tires and tread center wear on rear tires).

Thoroughly clean the mounting face of wheels and brake disks, i.e. the inner side of the wheels/tires, during each rotation. Check for and ensure proper tire inflation pressure.

Warning!



Have the tightening torque checked after changing a wheel. Wheels could become loose if not tightened with a torque of 80 lb-ft (110 Nm).

Only use genuine Mercedes-Benz wheel bolts specified for your vehicle's rims.

For information on wheel change, see the "Practical hints" section (▷ page 356) and (▷ page 377).

Winter driving

Before the onset of winter, have your vehicle winterized at an authorized Mercedes-Benz Center. This service includes:

- Check of anticorrosion and antifreeze concentration.
- Addition of cleaning concentrate to the water of the windshield and headlamp cleaning system. Add MB Concentrate “MB SummerFit” to a premixed windshield washer solvent/antifreeze which is formulated for below freezing temperatures (▷ page 418).
- Battery test. Battery capacity drops with decreasing ambient temperature. A well charged battery helps to make sure that the engine can be started, even at low ambient temperatures.
- Tire change.

Winter tires

Always use winter tires at temperatures below 45°F (7°C) and whenever wintry road conditions prevail. Not all M+S rated tires provide special winter performance. Make sure the tires you use show M+S and the mountain/snowflake  marking on the tire sidewall. These tires meet specific snow traction performance requirements of the Rubber Manufacturers Association (RMA) and the Rubber Association of Canada (RAC) and have been designed specifically for use in snow conditions. Use of winter tires is the only way to achieve the maximum effectiveness of the ABS, ESP®, and 4MATIC in winter operation.

For safe handling, make sure that all mounted winter tires are of the same make and have the same tread design.

Warning!



Winter tires with a tread depth of less than $\frac{1}{6}$ in (4 mm) must be replaced. They are no longer suitable for winter operation.

Always observe the speed rating of the winter tires installed on your vehicle. If the maximum speed for which your tires are rated is below the speed rating of your vehicle, you must place a notice to this effect where it will be seen by the driver. Such notices are available from your tire dealer or from any authorized Mercedes-Benz Center.

Warning!

If you use your spare tire when winter tires are fitted on the other wheels, be aware that the difference in tire characteristics may very well impair turning stability and that overall driving stability may be reduced.

Adapt your driving style accordingly.

Have the spare tire replaced with a winter tire at the nearest authorized Mercedes-Benz Center.

Block heater (Canada only)

The engine is equipped with a block heater.

The electrical cable may be installed at an authorized Mercedes-Benz Center.

Snow chains

! Some tire sizes do not leave adequate clearance for snow chains. To help avoid serious damage to your vehicle or tires, make sure that the use of snow chains is permissible as specified in the "Technical data" section of this Operator's Manual, see "Rims and Tires" (▷ page 403).

Snow chains should only be driven on snow-covered roads at speeds not higher than 30 mph (50 km/h). Remove chains as soon as possible when driving on roads without snow.

Please observe the following guidelines when using snow chains:

- Using snow chains is not permissible with all wheel/tire combinations (▷ page 403).
- Use snow chains in pairs and on rear wheels only. Follow the manufacturer's mounting instructions.

! If snow chains are mounted to the front wheels, they may scrape against the body or axle components. The tires or the vehicle could be damaged as a result.

- Only use snow chains that are approved by Mercedes-Benz. Any authorized Mercedes-Benz Center will be glad to advise you on this subject.
- Use of snow chains may be prohibited depending on location. Always check local and state laws before installing snow chains.
- Do not use snow chains on the spare wheel (▷ page 406).

i When driving with snow chains, you may wish to deactivate the ESP® (▷ page 86) before setting the vehicle in motion. This will improve the vehicle's traction.

We strongly recommend that you have your vehicle serviced by an authorized Mercedes-Benz Center, in accordance with the Maintenance Booklet at the times called for by the maintenance service indicator display.

Failure to have the vehicle maintained in accordance with the Maintenance Booklet and maintenance service indicator at the designated times/mileage will result in vehicle damage not covered by the Mercedes-Benz Limited Warranty.

Maintenance service indicator message

The maintenance service indicator will notify you when your next maintenance service is due.

Starting approximately 1 month before your next maintenance service is due, one of the following messages will appear in the multifunction display while you are driving or when you switch on the ignition (example service A):

Service A in XXXXX miles (km)

Service A in XXX Days

Service A due now

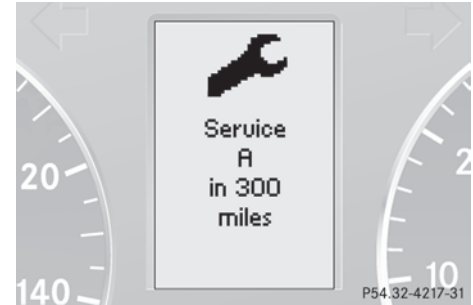

The type of maintenance service due is indicated in the multifunction display:



Basic service (A)



Extended service (B)

i Vehicles equipped with Maintenance System (U.S. vehicles. Canada vehicles, depending on vehicle production date):

The Maintenance System in your vehicle tracks distance driven and the time elapsed since your last maintenance service and calculates other maintenance service work required.

i Vehicles equipped with FSS (Flexible Service System) only (Canada vehicles, depending on vehicle production date):

- FSS evaluates engine temperature, oil level, vehicle speed, engine speed, distance driven and the time elapsed since your last service and calculates other maintenance service work required.
- The interval between maintenance services depends on your driving habits. A gentle driving style, moderate engine speeds and the avoidance of short-distance trips will lengthen the interval between services.

Clearing the maintenance service indicator message

The maintenance service indicator is automatically cleared

- after approximately 10 seconds when you switch on the ignition or when reaching the maintenance service threshold while driving
- after approximately 30 seconds, once the suggested maintenance service term has passed

You can also clear it yourself.



① Reset button

- ▶ Press reset button ① on the instrument cluster.

The maintenance service indicator message is cleared and the standard display appears in the multifunction display (▷ page 126).

Maintenance service term exceeded







If you have exceeded the suggested maintenance service term, you will see the following message in the multifunction display:

Service A exceeded by XXXX miles (km)
Service A exceeded by XXX Days

In addition, a signal sounds when the message appears.

Any authorized Mercedes-Benz Center will reset the maintenance service indicator following a completed maintenance service.

Calling up the maintenance service indicator display

- ▶ Switch on the ignition (▷ page 32).
- ▶ Press button  or  on the multifunction steering wheel repeatedly until the standard display appears in the multifunction display (▷ page 121).
- ▶ Press button  or  until the maintenance service indicator display with the service symbol  or  and the service deadline appears in the multifunction display.

i *If the battery is disconnected, the days of disconnection will not be included in the count shown by the maintenance service indicator. To arrive at the true maintenance service deadline, you will need to subtract these days from the days shown in the maintenance service indicator message or maintenance service indicator display.*

Do not confuse the maintenance service indicator with the engine oil level indicator .

Resetting the maintenance service indicator

In the event that the maintenance service on your vehicle is not carried out by an authorized Mercedes-Benz Center, you can have the maintenance service indicator reset. The automotive maintenance facility carrying out the maintenance service will find the information for resetting the maintenance service indicator in the maintenance-relevant information for your vehicle. Such information is available from either your authorized Mercedes-Benz Center or directly from Mercedes-Benz.

i *If the maintenance service indicator was inadvertently reset, have an authorized Mercedes-Benz Center correct it.*

Only reset if the proper maintenance service has been performed. Resetting the system without performing the proper service as called for by the maintenance service indicator will result in engine damage and/or other vehicle damage not covered by the Mercedes-Benz Limited Warranty.

▼ Vehicle care

Cleaning and care of the vehicle

Regular and proper care will help to maintain the value of your vehicle. The best way to protect your vehicle from harmful environmental influences is to wash it and use protective treatments regularly.

Warning!



Many cleaning products can be hazardous. Some are poisonous, others are flammable. Always follow the instructions on the particular container. Always open your vehicle's doors or windows when cleaning the inside.

Never use fluids or solvents that are not designed for cleaning your vehicle.

Always lock away cleaning products and keep them out of reach of children.

While in operation, even while parked, your vehicle is subjected to varying external influences which, if gone unchecked, can attack the paintwork as well as the vehicle underbody and cause lasting damage.

Such damage is caused not only by extreme and varying climatic conditions, but also by:

- Air pollution
- Road salt
- Tar
- Gravel and stone chipping

To avoid paint damage, you should immediately remove:

- Grease and oil
- Fuel
- Coolant
- Brake fluid
- Bird droppings
- Insects
- Tree resins, etc.

Frequent washing reduces and/or eliminates the aggressiveness and potency of the above adverse influences.

More frequent washings are necessary to deal with unfavorable conditions:

- near the ocean
- in industrial areas (smoke, exhaust emissions)
- during winter operation

You should check your vehicle from time to time for stone chipping or other damage. Any damage should be repaired as soon as possible to prevent corrosion.

In doing so, do not neglect the underbody of the vehicle. A prerequisite for a thorough check is a washing of the underbody followed by a thorough inspection. Damaged areas need to be re-undercoated.

Your vehicle has been treated at the factory with a wax-base rustproofing in the body cavities which will last for the lifetime of the vehicle. Post-production treatment is neither necessary nor recommended by Mercedes-Benz because of the possibility of incompatibility between materials used in the production process and others applied later.

We have selected car-care products and compiled recommendations which are specially matched to our vehicles and which always reflect the latest technology. You can obtain Mercedes-Benz approved car-care products at an authorized Mercedes-Benz Center.

Scratches, corrosive deposits, corrosion or damage due to negligent or incorrect care cannot always be removed or repaired with the car-care products recommended here. In such cases it is best to seek aid at an authorized Mercedes-Benz Center.

The following topics deal with the cleaning and care of your vehicle and give important “how-to” information as well as references to Mercedes-Benz approved car-care products.

Power washer

! *Follow the instructions provided by the power washer manufacturer on maintaining a distance between the vehicle and the nozzle of the power washer.*

Never use a round nozzle to power-wash tires. The intense jet of water can result in damage to the tire.

Always replace a damaged tire.

Always keep the jet of water moving across the surface. Do not aim directly at electrical parts, electrical connectors, seals, or other rubber parts.

Tar stains

Quickly remove tar stains before they dry and become more difficult to remove. A tar remover is recommended.

Paintwork, painted body components

! *Affixing stickers, magnets, adhesive tape or similar materials to painted body components may damage the paintwork.*

Mercedes-Benz approved Paint Care should be applied when water drops on the paint surface do not “bead up”. This should normally be done every 3 to 5 months, depending on the climate and washing detergent used.

Mercedes-Benz approved Paint Cleaner should be applied if the paint surface shows signs of embedded dirt (i.e. loss of gloss).

Do not apply any of these products or wax if your vehicle is parked in the sun or if the hood is still hot.

- ▶ Use the appropriate MB-Touch-Up Stick for quick and provisional repairs of minor paint damage (i.e. chips from stones, vehicle doors, etc.).

Engine cleaning

Prior to cleaning the engine compartment, make sure to protect electrical components and connectors from contact with water and cleaning agents.

Corrosion protection, such as MB Anticorrosion Wax, should be applied to the engine compartment after every engine cleaning. Before applying, all control linkage bushings and joints should be lubricated. The poly-V-belt and all pulleys should be protected from any wax.

Vehicle washing

In the winter, thoroughly remove all traces of road salt as soon as possible.

When washing the vehicle underbody, do not forget to clean the inner sides of the wheels.

Hand-wash

Do not use hot water or wash your vehicle in direct sunlight.

- ▶ Only use a mild car wash detergent, such as Mercedes-Benz approved Car Shampoo.
- ▶ Thoroughly spray the vehicle with a diffused jet of water.

Direct only a very weak spray towards the ventilation intake.

- ▶ Use plenty of water and rinse the sponge and chamois frequently.
- ▶ Rinse with clean water and thoroughly dry with a chamois.

Do not allow cleaning agents to dry on the finish.

! *Do not use scouring agents on these parts. Never apply strong force and only use a soft, non-scratching cloth when cleaning the vehicle. Do not attempt to wipe the surface with a dry cloth or sponge.*

Otherwise you may scratch or damage the paint.

Automatic car wash

You can have your car washed in an automatic car wash from the start. Automatic car washes without brushes are preferable.

- ▶ To protect the filter system, switch the climate control or automatic climate control to air recirculation mode, see “Air recirculation” (▷ page 165) for climate control or (▷ page 175) for automatic climate control.

! *Do not clean your vehicle in an automatic touchless car wash which uses caustic spray. Otherwise the caustic spray will damage the paint or ornamental moldings.*

If the vehicle is very dirty, prewash it before running it through the automatic car wash.

! *Make sure that the windshield wiper switch is set to 0 (▷ page 51). Otherwise, e.g. the rain sensor could activate and cause the wipers to move unintentionally. This may lead to vehicle damage.*

Due to the width of the vehicle, fold in exterior rear view mirrors prior to running the vehicle through an automatic car wash to prevent damage to the mirrors.

i *After running the vehicle through an automatic car wash, wipe any wax off of the windshield (▷ page 317). This will prevent smears and reduce wiping noise which can be caused by residual wax on the windshield.*

When leaving the car wash, make sure that the mirrors are folded out. Otherwise they may vibrate.

Ornamental moldings

For regular cleaning and care of ornamental moldings, use a damp cloth.

! *Do not use chrome cleaner on ornamental moldings. Although ornamental moldings may have chrome appearance, they could be made of anodized aluminum that will be damaged when cleaned with chrome cleaner. Instead, use a damp cloth to clean those ornamental moldings.*

For very dirty ornamental moldings of which you are sure are chrome-plated, use a chrome cleaner. If in doubt whether an ornamental molding is chrome-plated, contact an authorized Mercedes-Benz Center.

Headlamps, tail lamps, side markers, turn signal lenses

▶ Use a mild car wash detergent, such as Mercedes-Benz approved Car Shampoo, with plenty of water.

! *Only use window cleaning solutions that are suitable for plastic lamp lenses. Window cleaning solutions which are not suitable may damage the plastic lamp lenses of the headlamps. Therefore, do not use abrasives, solvents or cleaners that contain solvents.*

Never apply strong force and only use a soft, non-scratching cloth when cleaning the lenses. Do not attempt to wipe dirty lenses with a dry cloth or sponge.

Otherwise you may scratch or damage the lens surface.

Cleaning the windows and the wiper blades

! *Never open the hood when the wiper arms are folded forward.*

- ▶ Make sure the hood is fully closed.
- ▶ Switch off the ignition (▷ page 32).

Warning!



For safety reasons, switch off wipers and remove SmartKey from starter switch before cleaning the windshield and/or the wiper blades. Otherwise, the wiper motor could suddenly turn on and cause injury.

- ▶ Fold the wiper arms forward until they snap into place.
- !** *Do not pull on the wiper blade inserts. They could tear.*
- ▶ Clean the wiper blade inserts with a clean cloth and detergent solution.

- ▶ Use a soft, clean cloth and a mild window cleaning solution on all outside and inside glass surfaces.

An automotive glass cleaner is recommended.

! *Fold the windshield wiper arms back onto the windshield before turning the SmartKey in the starter switch.*

Hold on to the wiper when folding the wiper arm back. If released, the force of the impact from the tensioning spring could crack the windshield.

! *To clean the window interior, do not use a dry cloth, abrasives, solvents or cleaners containing solvents. Do not touch the inside of the front, rear or side windows with hard objects such as an ice scraper or ring. Doing so may damage the windows.*

Light alloy wheels

If possible, clean wheels once a week.

- ▶ Use Mercedes-Benz approved Wheel Care, a soft bristle brush and a strong spray of water for cleaning the light alloy wheels.

! *Only use acid-free cleaning materials. Acid may cause corrosion or damage the clear coat.*

! *The vehicle should not be parked for an extended period of time immediately after it has been cleaned, especially not after the wheel rims have been cleaned with wheel rim cleaner. Wheel rim cleaners can lead to increased corrosion of the brake disks and brake pads. Non-approved wheel cleaners may also damage the wheel paint if the car is not driven after cleaning. Therefore, the vehicle's brake system should always be warmed-up before it is parked after cleaning. To do so, please drive your vehicle for several minutes to allow the brakes to dry.*

When applying Mercedes-Benz approved Tire Care and Mercedes-Benz approved Wheel Care products, take care not to spray them on the brake disks.

Vehicle care

Plastic and rubber parts

- ▶ Use a gentle dishwashing detergent or mild detergent for delicate fabrics as a washing solution.
- ▶ Wipe with a cloth moistened in a lukewarm solution.

The surface may temporarily change color. If this is the case, wait for it to dry.

Warning!



Do not use cleaners or cockpit care sprays containing solvents to clean the cockpit or the steering wheel. Cleaners containing solvents will make the surface porous and vehicle occupants could suffer serious injuries from plastic parts coming loose in the event of air bag deployment.

! Do not use oil, wax or scouring agents on these parts.

Never apply strong force and only use a soft, non-scratching cloth when cleaning the surface. Do not attempt to wipe the surface with a dry cloth or sponge.

Otherwise you may scratch or damage the surface.

Hard plastic trim items

- ▶ Use Mercedes-Benz approved Interior Care, a soft, lint-free cloth and apply with light pressure.

! Never apply strong force and only use a soft, non-scratching cloth when cleaning the surface. Do not attempt to wipe the surface with a dry cloth or sponge.

Otherwise you may scratch or damage the surface.

Steering wheel and gear selector lever

- ▶ Wipe with a damp cloth and dry thoroughly or clean with Mercedes-Benz approved Leather Care.

Carpets

- ▶ Use Mercedes-Benz approved Carpet and Fabric Care for cleaning the carpets.

Headliner and shelf below rear window

- ▶ Use a soft bristle brush or a dry-shampoo cleaner in case of excessive dirt.

Seat belts

- ▶ Only use clear, lukewarm water and soap.

! *The seat belts must not be treated with chemical cleaning agents. Do not dry the seat belts at temperatures above 176 °F (80 °C) or in direct sunlight.*

Warning!

Do not bleach or dye seat belts as this may severely weaken them. In a crash they may not be able to provide adequate protection.

Upholstery

Using aftermarket seat covers or wearing clothing that have the tendency to give off coloring (e.g. when wet, etc.) may cause the upholstery to become permanently discolored. By lining the seats with a proper intermediate cover, contact-discoloration will be prevented.

Warning!



Only use seat or head restraint covers which have been tested and approved by Mercedes-Benz for your vehicle model. Using other seat or head restraint covers may interfere with or prevent the activation of the active head restraints. Contact an authorized Mercedes-Benz Center for availability.

Leather upholstery

Please note that leather upholstery is a natural product and is therefore subject to a natural aging process. Leather upholstery may also react to certain ambient influences such as high humidity or high temperature by showing wrinkles for example.

- ▶ Wipe leather upholstery with a damp cloth and dry thoroughly or clean with Mercedes-Benz approved Leather Care.

! *Wipe with light pressure to avoid damage to the upholstery.*

Exercise particular care when cleaning perforated leather as its underside should not become wet.

MB Tex upholstery

- ▶ Use Mercedes-Benz approved Interior Care onto a soft, lint-free cloth and apply with light pressure for cleaning the upholstery.

Wood trims

- ▶ Dampen cloth using water and use damp cloth to clean wood trims in your vehicle.

! *Do not use solvents like tar remover or wheel cleaner nor polishes or waxes as these may be abrasive.*



What to do if ...

Where will I find ...?

Unlocking/locking in an emergency

Opening/closing in an emergency

Resetting activated head restraints

Replacing SmartKey batteries

Replacing bulbs

Replacing wiper blades

Flat tire

Battery

Jump starting

Towing the vehicle

Fuses

What to do if ...

Lamps in instrument cluster

General information:



If any of the following lamps in the instrument cluster fails to come on during the

bulb self-check when switching on the ignition, have the respective bulb checked and replaced if necessary.

Problem	Possible cause/consequence	Suggested solution
 <p>The yellow ABS indicator lamp comes on while the engine is running.</p>	<p>The ABS has detected a malfunction and has switched off. The BAS and the ESP® are also switched off (see messages in the multifunction display).</p> <p>The brake system is still functioning normally but without the systems specified above.</p> <p>If the ABS control unit is malfunctioning, other systems such as the navigation system* or the automatic transmission may also be malfunctioning.</p> <p>The charging voltage has fallen below 10 volts. The ABS has switched off.</p> <p>The battery might not be charged sufficiently.</p>	<ul style="list-style-type: none"> ▶ Continue driving with added caution. Wheels may lock during hard braking, reducing steering capability. ▶ Read and observe messages in the multifunction display (▷ page 333). ▶ Have the system checked at an authorized Mercedes-Benz Center as soon as possible. <p>Failure to follow these instructions increases the risk of an accident.</p> <ul style="list-style-type: none"> ▶ Switch off electrical consumers that are currently not needed, e.g. seat heating*. ▶ If necessary, have the generator and battery checked. <p>When the voltage is above this value again, the ABS is operational again.</p>

Problem	Possible cause/consequence	Suggested solution
 <p>The yellow ABS indicator lamp comes on while the engine is running.</p>	<p>The ABS is temporarily not available. The ESP® and the BAS are also unavailable.</p> <p>The system's self-diagnosis may not be completed yet.</p> <p>The brake system is still functioning normally but without the systems specified above.</p>	<ul style="list-style-type: none"> ▶ Drive a short distance with added caution at a vehicle speed of above 12 mph (20 km/h). When the ABS indicator lamp goes out, the ABS, the ESP®, and the BAS are available again. <p>If the ABS indicator lamp does not go out:</p> <ul style="list-style-type: none"> ▶ Continue driving with added caution. ▶ Have the system checked at an authorized Mercedes-Benz Center as soon as possible. <p>Failure to follow these instructions increases the risk of an accident.</p>

What to do if ...



Problem	Possible cause/consequence	Suggested solution
BRAKE (USA only)  (Canada only) The red brake warning lamp comes on while driving and you hear a warning sound.	You are driving with the parking brake set.	► Release the parking brake (▷ page 48).
BRAKE (USA only)  (Canada only) The red brake warning lamp comes on while driving.	There is insufficient brake fluid in the reservoir.	► Risk of accident! Carefully stop the vehicle and notify an authorized Mercedes-Benz Center. Do not add brake fluid! This will not solve the problem.

Warning!





Driving with the brake warning lamp illuminated can result in an accident. Have your brake system checked immediately if the brake warning lamp stays on. Don't add brake fluid before checking the brake system. Overfilling the brake fluid reservoir can result in spilling brake fluid on hot engine parts and the brake fluid catching fire. You could be seriously burned.



! *If you find that the brake fluid in the brake fluid reservoir has fallen to the minimum mark or below, have the brake system checked for brake pad thickness and leaks.*

Problem	Possible cause/consequence	Suggested solution
<p> (USA only)</p> <p> (Canada only)</p> <p>The yellow engine malfunction indicator lamp comes on while driving.</p>	<p>There is a malfunction in:</p> <ul style="list-style-type: none"> • The fuel management system • The ignition system • The emission control system • Systems which affect emissions <p>Such malfunctions may result in excessive emissions values and may switch the engine to its limp-home (emergency operation) mode.</p>	<p>► Have the vehicle checked as soon as possible by an authorized Mercedes-Benz Center.</p> <p>An on-board diagnostic connector is used by the service station to link the vehicle to the shop diagnostics system. It allows the accurate identification of system malfunctions through the readout of diagnostic trouble codes. It is located in the front left area of the footwell next to the parking brake pedal.</p>



 *Some states may by law require you to visit a workshop immediately as soon as the engine malfunction indicator lamp comes on. Check local requirements.*

What to do if ...

Problem	Possible cause/consequence	Suggested solution
<p> (USA only)</p> <p> (Canada only)</p> <p>The yellow engine malfunction indicator lamp comes on while driving.</p>	<p>Your fuel tank is empty.</p> <p>A loss of pressure has been detected in the fuel system. The fuel cap may not be closed properly or the fuel system may be leaky.</p>	<p>▶ After refuelling start, turn off and restart the engine three or four times in succession.</p> <p>The limp-home mode is canceled. You do not need to have your vehicle checked.</p> <p>▶ Check the fuel cap (▷ page 27 1).</p> <p>If it is not closed properly:</p> <p>▶ Close the fuel cap.</p> <p>If it is closed properly:</p> <p>▶ Have the fuel system checked by an authorized Mercedes-Benz Center.</p>

Problem	Possible cause/consequence	Suggested solution
<p> The yellow ESP® warning lamp comes on while the engine is running.</p>	<p>The ESP® has been switched off with the ESP® switch or has been switched off due to a malfunction.</p> <p>Risk of accident!</p> <p>When the ESP® is switched off it will not stabilize the vehicle if the system recognizes that the vehicle starts to skid or that a wheel is spinning.</p> <p>The cruise control is deactivated and cannot be switched on.</p>	<ul style="list-style-type: none"> ▶ Switch the ESP® back on (▷ page 87). Exceptions: (▷ page 85). ▶ If leaving the ESP® switched off, adapt your speed and driving to the prevailing road, weather and traffic conditions. <p>If the ESP® cannot be switched on:</p> <ul style="list-style-type: none"> ▶ Continue driving with added caution. ▶ Observe additional messages that may appear in the multifunction display (▷ page 335). ▶ Have the system checked at an authorized Mercedes-Benz Center as soon as possible.
<p> The yellow ESP® warning lamp flashes while driving.</p>	<p>The ESP® or traction control has come into operation because of detected traction loss in at least one tire.</p> <p>The cruise control is deactivated</p>	<ul style="list-style-type: none"> ▶ When driving off, apply as little throttle as possible. ▶ While driving, ease up on the accelerator. ▶ Adapt your speed and driving to the prevailing road, weather and traffic conditions. ▶ Do not deactivate the ESP®. Exceptions: (▷ page 85). <p>Failure to follow these instructions increases the risk of an accident.</p>

What to do if ...

Problem	Possible cause/consequence	Suggested solution
The yellow fuel tank reserve warning lamp in the fuel gauge (▷ page 24) comes on while driving.	The fuel level has gone below the reserve mark.	▶ Refuel at the next gas station (▷ page 271).
 The red seat belt telltale comes on for a maximum of 6 seconds after starting the engine.	The seat belt telltale reminds you and your passengers to fasten your seat belts before driving off.	▶ Fasten your seat belts. Regardless of whether the seat belts are fastened or not, the seat belt telltale always comes on and remains lit for 6 seconds after starting the engine.
 You hear a warning chime for a maximum of 6 seconds after starting the engine.	You have forgotten to fasten your seat belt.	▶ Fasten your seat belt. The warning chime stops sounding.
 The red seat belt telltale comes on while the vehicle is standing still and the engine is running or during driving.	You and/or your front passenger have forgotten to fasten your seat belts.	▶ Fasten your seat belts. The seat belt telltale goes out.
	There are items placed on the front passenger seat and therefore the system senses the front passenger seat as being occupied.	▶ Remove the items from the front passenger seat and put them in a safe place. The seat belt telltale goes out.

Problem	Possible cause/consequence	Suggested solution
 <p>During driving the red seat belt telltale flashes and you additionally hear an intermittent warning chime with increasing intensity.</p>	<p>The vehicle's speed once exceeded 15 mph (25 km/h) and you and/or your front passenger have forgotten to fasten your seat belts.</p>	<p>► Fasten your seat belts.</p> <p>The seat belt telltale goes out and the warning chime stops sounding.</p>
	<p>There are items placed on the front passenger seat and therefore the system senses the front passenger seat as being occupied.</p>	<p>► Remove the items from the front passenger seat and put them in a safe place.</p> <p>The seat belt telltale goes out and the warning chime stops sounding.</p>

i After 60 seconds with an unfastened seat belt the warning chime stops sounding and the seat belt telltale illuminates continuously. The seat belt telltale will only go out if both, the driver's and the front passenger's seat belt are fastened, or the vehicle is standing still and a front door is opened.

What to do if ...

Problem	Possible cause/consequence	Suggested solution
SRS The red SRS indicator lamp comes on while driving.	There is a malfunction in the restraint systems. The air bags or emergency tensioning devices (ETDs) could deploy unexpectedly or fail to deploy in an accident.	▶ Drive with added caution to the nearest authorized Mercedes-Benz Center.

Warning!



In the event a malfunction of the SRS is indicated as outlined above, the SRS may not be operational. For your safety, we strongly recommend that you visit an authorized Mercedes-Benz Center immediately to have the system checked; otherwise the SRS may not be deployed when needed in an accident, which could result in serious or fatal injury, or it might deploy unexpectedly and unnecessarily which could also result in an accident and/or injury to you or to others.

Lamp in center console

Problem	Possible cause/consequence	Suggested solution
 <p>The front passenger front air bag off indicator lamp illuminates and remains illuminated with the weight of a typical adult or someone larger than a small individual on the front passenger seat.</p>	<p>The system is malfunctioning.</p>	<ul style="list-style-type: none"> ▶ Have the system checked as soon as possible by an authorized Mercedes-Benz Center. ▶ Also note any messages in the multifunction display and follow corrective steps (▷ page 333).

Warning!



If the  indicator lamp illuminates and remains illuminated with the weight of a typical adult or someone larger than a small individual on the front passenger seat, do not have any passenger use the front passenger seat until the system has been repaired.

What to do if ...

Problem	Possible cause/consequence	Suggested solution
 <p>The front passenger front air bag off indicator lamp does not illuminate and/or does not remain illuminated with the weight of a typical 12-month-old child in a standard child restraint or less on the front passenger seat.</p>	<p>The system is malfunctioning.</p>	<ul style="list-style-type: none"> ▶ Make sure there is nothing between seat cushion and child seat and check installation of the child seat. ▶ Make sure that no objects applying supplemental weight onto the seat are present. ▶ If the front passenger front air bag off indicator lamp remains out, have the system checked as soon as possible by an authorized Mercedes-Benz Center. Do not transport a child on the front passenger seat until the system has been repaired. ▶ Also note any messages in the multifunction display and follow corrective steps (▷ page 337).

Warning!



If the  indicator lamp does not illuminate or remains out with the weight of a typical 12-month-old child in a standard child restraint or less on the front passenger seat, do not transport a child on the front passenger seat until the system has been repaired.

Vehicle status messages in the multifunction display





Warning and malfunction messages appear in the multifunction display located in the instrument cluster.





Certain warning and malfunction messages are accompanied by an audible signal.

Address these messages accordingly and follow the additional instructions given in this Operator's Manual.

Selecting the vehicle status message memory menu in the control system (▷ page 130) displays both cleared and uncleared messages.

High-priority messages appear in the multifunction display in red color.

Certain messages of high priority cannot be cleared from the multifunction display using the reset button (▷ page 118) or button , , , or  on the steering wheel.

Other messages of high priority and messages of less immediate priority can be cleared from the multifunction display using the reset button (▷ page 118) or button , , , or  on the steering wheel. They are then stored in the vehicle status message memory (▷ page 130). Remember that clearing a message will only make the message disappear. Clearing a message will not correct the condition that caused the message to appear.

Warning!



All categories of messages contain important information which should be taken note of and, where a malfunction is indicated, addressed as soon as possible at an authorized Mercedes-Benz Center.

Failure to repair condition noted may cause damage not covered by the Mercedes-Benz Limited Warranty, or result in property damage or personal injury.

What to do if ...

Warning!



No messages will be displayed if either the instrument cluster or the multifunction display is inoperative.

As a result, you will not be able to see information about your driving conditions, such as speed or outside temperature, warning/indicator lamps, malfunction/warning messages or the failure of any systems. Driving characteristics may be impaired.

If you must continue to drive, please do so with added caution. Visit an authorized Mercedes-Benz Center as soon as possible.

i *Switching on the ignition causes all instrument cluster lamps (except low beam headlamp indicator lamp, high beam headlamp indicator lamp, and turn signal indicator lamps unless activated) as well as the multifunction display to come on. Make sure the lamps and multifunction display are in working order before starting your journey.*

On the pages that follow, you will find a compilation of the most important warning and malfunction messages that may appear in the multifunction display.

For your convenience the messages are divided into two sections:

- Text messages (▷ page 335)
- Symbol messages (▷ page 343)

Text messages



Display message	Possible cause/consequence	Possible solution
<p>ABS</p> <p>ABS, ESP inoperative</p> <p>See Operator's Manual</p>	<p>The ABS and ESP® are not available due to a malfunction.</p> <p>The BAS is also deactivated.</p> <p>The brake system is still functioning normally but without but without the systems specified above.</p>	<ul style="list-style-type: none"> ▶ Continue driving with added caution. Wheels will lock during hard braking, reducing steering capability. ▶ Have the system checked at an authorized Mercedes-Benz Center as soon as possible. <p>Failure to follow these instructions increases the risk of an accident.</p>
<p>Cruise cont. and SPEED-TRONIC</p> <p>inoperative</p>	<p>Cruise control is malfunctioning.</p>	<p>Have the cruise control checked by an authorized Mercedes-Benz Center.</p>
<p>ESP</p> <p>inoperative</p> <p>See Operator's Manual</p>	<p>The ESP® has switched off due to a malfunction.</p> <p>The ABS and the BAS might not be operational.</p> <p>The brake system is still functioning normally but without the systems specified above.</p>	<ul style="list-style-type: none"> ▶ Continue driving with added caution. ▶ Contact an authorized Mercedes-Benz Center as soon as possible. <p>Failure to follow these instructions increases the risk of an accident.</p>

What to do if ...

Display message	Possible cause/consequence	Possible solution
<p>ESP unavailab le See Operator's Manual</p>	<p>The ESP is temporarily not available.</p> <p>The system's self-diagnosis may not be completed yet.</p> <p>The ABS and the BAS might not be operational.</p> <p>The brake system is still functioning normally but without the systems specified above.</p> <hr/> <p>The charging voltage has fallen below 10 volts. The ESP® has switched off. The BAS may be switched off, too. The battery may not be charged. The battery or the generator may be malfunctioning.</p> <p>The ABS might not be operational.</p> <p>The brake system is still functioning normally but without the systems specified above.</p>	<p>▶ Drive a short distance with added caution at a vehicle speed of above 12 mph (20 km/h). When the message disappears, the ESP® is available again.</p> <p>If the message does not disappear:</p> <p>▶ Continue driving with added caution.</p> <p>▶ Have the system checked at an authorized Mercedes-Benz Center as soon as possible.</p> <p>Failure to follow these instructions increases the risk of an accident.</p> <hr/> <p>▶ Continue driving with added caution. When the voltage is above this value again, the ESP® is operational again.</p> <p>▶ Have the system checked at an authorized Mercedes-Benz Center as soon as possible.</p>

Display message	Possible cause/consequence	Possible solution
Front-pass. airbag enabled See Operator's Manual	Front passenger front air bag is activated while driving even though a child, small individual, or object below the system's weight threshold is on the front passenger seat, or the front passenger seat is empty. Objects on the seat or forces acting on the seat may make the system sense supplemental weight.	<p>Stop the vehicle in a safe location as soon as possible and check the front passenger seat for the following:</p> <ul style="list-style-type: none">▶ Switch off the ignition (▷ page 32).▶ Remove child and child restraint from front passenger seat and properly secure the child in rear seat employing the child restraint if necessary.▶ Make sure that no objects applying supplemental weight onto the seat are present. The system may recognize such supplemental weight and sense that an occupant on the front passenger seat is of a greater weight than actually present.▶ Keep the seat unoccupied, close the front passenger door and switch on the ignition (▷ page 32). <p>(Continued on next page)</p>

What to do if ...

Display message	Possible cause/ consequence	Possible solution
		<p>Monitor the  indicator lamp on the center console (▷ page 27) and the multifunction display in the instrument cluster (▷ page 24) for the following:</p> <p>With the seat unoccupied and the ignition turned on,</p> <ul style="list-style-type: none"> the  indicator lamp on the center console should illuminate and remain illuminated, indicating that the OCS (▷ page 64) has deactivated the air bag. the message Front-pass. airbag enabled See Operator's Manual or the message Front-pass. airbag disabled See Operator's Manual should not appear in the multifunction display at any time the seat is unoccupied. Wait at last 60 seconds for the system to complete the necessary check cycles and to make sure neither message appears in the multifunction display. <p>If above conditions are met, you can occupy the front passenger seat again. Depending on the front passenger classification sensed by the OCS (▷ page 64), the  indicator lamp will remain illuminated or go out.</p> <p>If above conditions are not met, the system is not working properly. Have the system checked as soon as possible by an authorized Mercedes-Benz Center.</p>

Warning!





If the  indicator lamp remains

out even after performing the above corrective steps, do not have any children 12 years old and under and other small individuals

use the front passenger seat until the system has been repaired.

Display message	Possible cause/consequence	Possible solution
Front-pass. airbag disabled See Operator's Manual	Front passenger front air bag is deactivated while driving even though an adult or someone larger than a small individual is occupying the front passenger seat. Forces acting on the seat may make the system sense a decrease in weight.	Stop the vehicle in a safe location as soon as possible and check the front passenger seat for the following: <ul style="list-style-type: none">▶ Switch off the ignition (▷ page 32).▶ Have the front passenger vacate the seat and exit the vehicle.▶ Keep the seat unoccupied, close the front passenger door and switch on the ignition (▷ page 32). (Continued on next page)

What to do if ...

Display message	Possible cause/ consequence	Possible solution
		<p>Monitor the  indicator lamp on the center console (▷ page 27) and the multifunction display in the instrument cluster (▷ page 24) for the following:</p> <p>With the seat unoccupied and the ignition turned on,</p> <ul style="list-style-type: none"> • the  indicator lamp on the center console should illuminate and remain illuminated, indicating that the OCS (▷ page 64) has deactivated the air bag. • the message Front-pass. airbag enabled See Operator's Manual or the message Front-pass. airbag disabled See Operator's Manual should not appear in the multifunction display at any time the seat is unoccupied. Wait at last 60 seconds for the system to complete the necessary check cycles and to make sure neither message appears in the multifunction display. <p>If above conditions are met, you can occupy the front passenger seat again. Depending on the front passenger classification sensed by the OCS (▷ page 64), the  indicator lamp will remain illuminated or go out.</p> <p>If above conditions are not met, the system is not working properly. Have the system checked as soon as possible by an authorized Mercedes-Benz Center.</p>

Warning!



If the  indicator lamp remains

illuminated with an adult occupant on the front passenger seat even after performing the above corrective steps, do not have any

passenger use the front passenger seat until the system has been repaired.

Display message	Possible cause/consequence	Possible solution
Run Flat Indicator inoperative	The Run Flat Indicator* is malfunctioning or has been switched off due to an error.	▶ Have the Run Flat Indicator* checked by an authorized Mercedes-Benz Center.
Check tires Then restart Run Flat Indicator	There was a warning message about a loss in tire inflation pressure and the Run Flat Indicator* has not been reactivated yet.	▶ Make sure that the correct tire inflation pressure is set for each tire. ▶ Then reactivate the Run Flat Indicator*.
Tire pressure Check tires	The Run Flat Indicator* indicates that the pressure is too low in one or more tires.	▶ Carefully bring the vehicle to a halt, avoiding abrupt steering and braking maneuvers. Observe the traffic situation around you. ▶ Check and adjust the tire inflation pressure as required (▷ page 290). ▶ If necessary, change the wheel (▷ page 377). ▶ Reactivate the Run Flat Indicator* after adjusting the tire inflation pressure values (▷ page 293).

Warning!



Do not drive with a flat tire. A flat tire affects the ability to steer or brake the vehicle.

You may lose control of the vehicle. Continued driving with a flat tire will cause excessive heat build-up and possibly a fire.

What to do if ...

Display message	Possible cause/consequence	Possible solution
SRS Restraint system malfunction Visit workshop	The system is malfunctioning.	► Drive with added caution to the nearest authorized Mercedes-Benz Center.

Warning!







In the event a malfunction of the SRS is indicated as outlined above, the SRS may not be operational.

For your safety, we strongly recommend that you visit an authorized Mercedes-Benz Center immediately to have the system checked; otherwise the SRS may not be deployed when needed in an accident, which could result in serious or fatal injury, or it might deploy unexpectedly and unnecessarily which could also result in injury.

Symbol messages

Display symbol	Display message	Possible cause/consequence	Possible solution
		<p>The battery is no longer charging. Possible causes:</p> <ul style="list-style-type: none"> • broken poly-V-belt • alternator malfunctioning 	<p>▶ Stop immediately and check the poly-V-belt in a safe location or as soon as it is safe to do so.</p> <p>If it is broken:</p> <ul style="list-style-type: none"> ▶ Do not continue to drive. Otherwise the engine will overheat due to an inoperative water pump which may result in damage to the engine. Notify an authorized Mercedes-Benz Center. <p>If it is intact:</p> <ul style="list-style-type: none"> ▶ Drive immediately to the nearest authorized Mercedes-Benz Center.
	Low voltage Charge battery	The battery has insufficient voltage.	▶ Start the engine (▷ page 46).
	Low voltage Switch off Consumers	The battery has insufficient voltage.	▶ Turn off unnecessary electrical consumers.

What to do if ...

Display symbol	Display message	Possible cause/consequence	Possible solution
 (USA only)  (Canada only)	Release parking brake	You are driving with the parking brake set.	► Release the parking brake (▷ page 48).
	Brake wear	The brake pads have reached their wear limit.	► Have the brake pads replaced as soon as possible.
 (USA only)  (Canada only)	Check brake fluid level	There is insufficient brake fluid in the reservoir.	► Risk of accident! Stop the vehicle and notify an authorized Mercedes-Benz Center. Do not add brake fluid! This will not solve the problem.

Warning!



Driving with the message **Check brake fluid level** displayed can result in an accident. Have your brake system checked immediately. Do not add brake fluid before checking the brake system. Overfilling the brake fluid reservoir can result in spilling brake fluid on hot engine parts and the brake fluid catching fire. You could be seriously burned.

! If you find that the brake fluid in the brake fluid reservoir has fallen to the minimum mark or below, have the brake system checked for brake pad thickness and leaks.

! Brake pad thickness must be visually inspected by a qualified technician at the intervals specified in the Maintenance Booklet.

Display symbol	Display message	Possible cause/consequence	Possible solution
	Top up coolant See Operator's Manual	The coolant level is too low.	<ul style="list-style-type: none"> ▶ Add coolant (▷ page 278). ▶ If you have to add coolant frequently, have the cooling system checked by an authorized Mercedes-Benz Center.

Warning!





Do not spill antifreeze on hot engine parts. Antifreeze contains ethylene glycol which may burn if it comes into contact with hot engine parts. You could be seriously burned.

! Do not ignore the low engine coolant level warning. Extended driving with the message and symbol displayed may cause serious engine damage not covered by the Mercedes-Benz Limited Warranty.

Do not drive without sufficient amount of coolant in the cooling system. The engine will overheat causing major engine damage.

What to do if ...

Display symbol	Display message	Possible cause/consequence	Possible solution
	Coolant Stop, turn engine off	The coolant is too hot. Among other possible causes, the poly-V-belt could be broken.	<ul style="list-style-type: none"> ▶ Stop the vehicle in a safe location or as soon as it is safe to do so. ▶ Apply the parking brake (▷ page 54). ▶ Turn off the engine. ▶ Check the poly-V-belt. <p>If it is broken:</p> <ul style="list-style-type: none"> ▶ Do not continue to drive. Otherwise the engine will overheat due to an inoperative water pump which may result in damage to the engine. Contact an authorized Mercedes-Benz Center. <p>If it is intact:</p> <ul style="list-style-type: none"> ▶ Wait for the message to disappear before restarting the engine. <p>Doing otherwise could result in serious engine damage that is not covered by the Mercedes-Benz Limited Warranty.</p> <p>(Continued on next page)</p>

Display symbol	Display message	Possible cause/consequence	Possible solution
			<ul style="list-style-type: none"> ▶ Observe the coolant temperature gauge in the instrument cluster (▷ page 24). If the temperature rises again: <ul style="list-style-type: none"> ▶ Contact an authorized Mercedes-Benz Center immediately.
		The cooling fan for the coolant is malfunctioning.	<ul style="list-style-type: none"> ▶ Observe the coolant temperature gauge in the instrument cluster (▷ page 24). ▶ Have the fan replaced as soon as possible.

Warning!



Driving when your engine is overheated can cause some fluids which may have leaked into the engine compartment to catch fire. You could be seriously burned.



Steam from an overheated engine can cause serious burns and can occur just by opening the hood. Stay away from the engine if you see or hear steam coming from it.

Turn off the engine, get out of the vehicle and do not stand near the vehicle until the engine has cooled down.

During severe operating conditions and stop-and-go city traffic, the coolant temperature may rise close to 248°F (120°C).

! *The engine should not be operated with the coolant temperature above 248°F (120°C). Doing so may cause serious engine damage which is not covered by the Mercedes-Benz Limited Warranty.*

What to do if ...



Display symbol	Display message	Possible cause/consequence	Possible solution
		<p>Certain electronic systems are unable to relay information to the control system. The following systems may have failed:</p> <ul style="list-style-type: none"> • Coolant temperature display • Tachometer • Cruise control display 	<ul style="list-style-type: none"> ▶ Have the electronic systems checked by an authorized Mercedes-Benz Center.
	Check oil level at next gas station	The engine oil has dropped to a critical level.	<ul style="list-style-type: none"> ▶ Check the engine oil level (▷ page 276) and add oil as required (▷ page 277). ▶ If you must add engine oil frequently, have the engine checked for possible leaks.

When the message *Check oil level at next gas station* appears while the engine is running and at operating temperature, the engine oil level has dropped to approximately the minimum level.

When this occurs, the warning will first come on intermittently and then stay on if the oil level drops further.

Visually check for oil leaks. If no obvious oil leaks are noted, drive to the nearest service station where the engine oil should be topped to the required level with an approved oil specified in the Factory Approved Service Products pamphlet.

! *The engine oil level warnings should not be ignored. Extended driving with the symbol displayed could result in serious engine damage that is not covered by the Mercedes-Benz Limited Warranty.*

Display symbol	Display message	Possible cause/consequence	Possible solution
	Gas cap is open	A loss of pressure has been detected in the fuel system. The fuel cap may not be closed properly or the fuel system may be leaky.	<ul style="list-style-type: none"> ▶ Check the fuel cap (▷ page 271). If it is not closed properly: <ul style="list-style-type: none"> ▶ Close the fuel cap. If it is closed properly: <ul style="list-style-type: none"> ▶ Have the fuel system checked by an authorized Mercedes-Benz Center.
	Remove key	You have forgotten to remove the SmartKey.	▶ Remove the SmartKey from the starter switch.
	Get a new key	No additional code available for SmartKey.	▶ Change the SmartKey.
	3rd brake lamp	The high mounted brake lamp is malfunctioning.	▶ Contact an authorized Mercedes-Benz Center as soon as possible.
	AUTO-Light inoperative	The light sensor is malfunctioning. The headlamps switch on automatically.	<ul style="list-style-type: none"> ▶ In the control system, set lamp operation to manual mode (▷ page 139). ▶ Switch on the headlamps using the exterior lamp switch. ▶ Contact an authorized Mercedes-Benz Center as soon as possible.

What to do if ...

Display symbol	Display message	Possible cause/consequence	Possible solution
	Brake lamp left	The left brake lamp is malfunctioning.	► Replace the bulb as soon as possible (▷ page 373).
	Brake lamp right	The right brake lamp is malfunctioning.	► Replace the bulb as soon as possible (▷ page 373).
	Front foglamp left	The left front fog lamp is malfunctioning.	► Contact an authorized Mercedes-Benz Center as soon as possible.
	Front foglamp right	The right front fog lamp is malfunctioning.	► Contact an authorized Mercedes-Benz Center as soon as possible.
	Front left side marker lamp	The left front side marker lamp is malfunctioning.	► Contact an authorized Mercedes-Benz Center as soon as possible.
	Front right side marker lamp	The right front side marker lamp is malfunctioning.	► Contact an authorized Mercedes-Benz Center as soon as possible.
	High beam left	The left high beam lamp is malfunctioning.	► Replace the bulb as soon as possible (▷ page 371).
	High beam right	The right high beam lamp is malfunctioning.	► Replace the bulb as soon as possible (▷ page 371).

Display symbol	Display message	Possible cause/consequence	Possible solution
	License plate lamp, left	The left license plate lamp is malfunctioning.	▶ Replace the bulb as soon as possible (▷ page 374).
	License plate lamp, right	The right license plate lamp is malfunctioning.	▶ Replace the bulb as soon as possible (▷ page 374).
	Low beam left	The left low beam lamp is malfunctioning.	Halogen headlamp: ▶ Replace the bulb as soon as possible (▷ page 370). Bi-Xenon* headlamp: ▶ Contact an authorized Mercedes-Benz Center as soon as possible.
	Low beam right	The right low beam lamp is malfunctioning.	Halogen headlamp: ▶ Replace the bulb as soon as possible (▷ page 370). Bi-Xenon* headlamp: ▶ Contact an authorized Mercedes-Benz Center as soon as possible.
	Parking lamp front left	The left front parking lamp is malfunctioning.	▶ Replace the bulb as soon as possible (▷ page 371).
	Parking lamp front right	The right front parking lamp is malfunctioning.	▶ Replace the bulb as soon as possible (▷ page 371).

What to do if ...

Display symbol	Display message	Possible cause/consequence	Possible solution
	Rear fog lamp Auxiliary bulb on	The rear fog lamp is malfunctioning. A substitute bulb is being used.	► Replace the bulb as soon as possible (▷ page 373).
	Reverse lamp left	The left backup lamp is malfunctioning.	► Replace the bulb as soon as possible (▷ page 373).
	Reverse lamp right	The right backup lamp is malfunctioning.	► Replace the bulb as soon as possible (▷ page 373).
	Switch off lights	You have removed the SmartKey from the starter switch, opened the driver's door and left the headlamps on.	► Switch off the headlamps.
	Tail lamp left Auxiliary bulb on	The left tail lamp is malfunctioning. A substitute bulb is being used.	► Replace the bulb as soon as possible (▷ page 373).
	Tail lamp right Auxiliary bulb on	The right tail lamp is malfunctioning. A substitute bulb is being used.	► Replace the bulb as soon as possible (▷ page 373).

Display symbol	Display message	Possible cause/consequence	Possible solution
	Turn signal front left	The left front turn signal lamp is malfunctioning.	► Replace the bulb as soon as possible (▷ page 371).
	Turn signal front right	The right front turn signal lamp is malfunctioning.	► Replace the bulb as soon as possible (▷ page 371).
	Turn signal left side mirror	The turn signal in the left exterior rear view mirror is malfunctioning. This message will only appear if a critical number of LEDs have stopped working.	► Contact an authorized Mercedes-Benz Center as soon as possible.
	Turn signal right side mirror	The turn signal in the right exterior rear view mirror is malfunctioning. This message will only appear if a critical number of LEDs have stopped working.	► Contact an authorized Mercedes-Benz Center as soon as possible.
	Turn signal rear left Auxiliary bulb on	The left rear turn signal lamp is malfunctioning. A substitute bulb is being used	► Replace the bulb as soon as possible (▷ page 373).
	Turn signal rear right Auxiliary bulb on	The right rear turn signal lamp is malfunctioning. A substitute bulb is being used.	► Replace the bulb as soon as possible (▷ page 373).

What to do if ...

Display symbol	Display message	Possible cause/consequence	Possible solution
	Steering oil Visit workshop	The steering gear oil level is too low. There is a danger of steering gear damage.	► Have the system checked by an authorized Mercedes-Benz Center.





Warning!



If the level of steering gear oil in reservoir is too low, the steering power assistance could fail. Much greater effort will then be needed to turn the steering wheel.

Do not add steering oil without checking the steering system.

Do not drive the vehicle. Have the system checked at an authorized Mercedes-Benz Center as soon as possible.

Display symbol	Display message	Possible cause/consequence	Possible solution
	Tele Aid malfunction. Drive to workshop	One or more main functions of the Tele Aid system* are malfunctioning.	▶ Have the Tele Aid system* checked by an authorized Mercedes-Benz Center.
	Function unavailable	This display appears if button  or  on the multifunction steering wheel is pressed and the vehicle is not equipped with a telephone*.	
	Top up washer fluid	The fluid level has dropped to about $\frac{1}{3}$ of total reservoir capacity.	▶ Add washer fluid (▷ page 280).

Where will I find ...?

First aid kit

The first aid kit is located in the trunk on the left side secured by a hook and loop fastener.

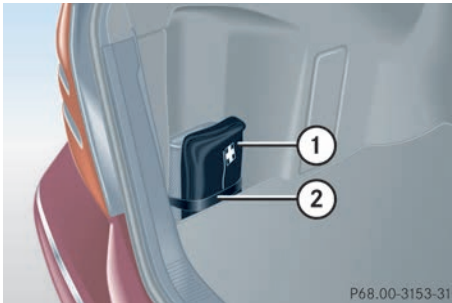

- ① First aid kit
- ② Hook and loop fastener

- ▶ Unfasten hook and loop fastener ②.
- ▶ Remove first aid kit ①.

i Check expiration dates and contents for completeness at least once a year and replace missing/expired items.

Vehicle tool kit

The vehicle tool kit is located in the storage compartment underneath the trunk floor.

The following is included:

- Towing eye bolt
- Wheel wrench
- Alignment bolt
- Vehicle jack
- Spare fuses
- Collapsible wheel chock
- A pair of gloves

Removing the vehicle tool kit

- ▶ Lift up trunk floor cover and engage trunk floor handle in upper edge of trunk.

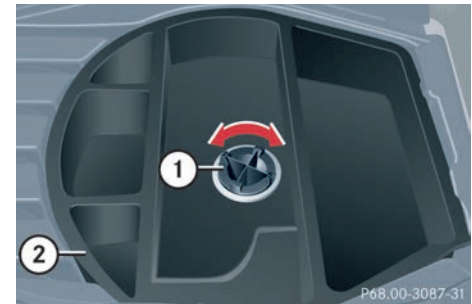

- ① Retaining screw
- ② Storage well casing

- ▶ Loosen retaining screw ① by turning it counterclockwise.
- ▶ Remove storage well casing ②.

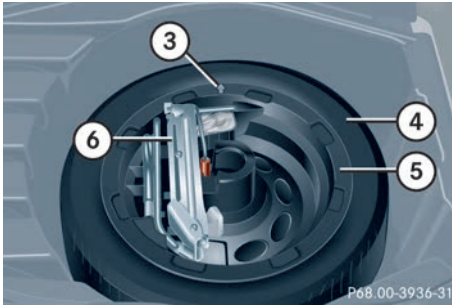

- ③ Arrow
 - ④ Minispare wheel with spare wheel bolts in container on wheel rim
 - ⑤ Vehicle tool kit storage well casing
 - ⑥ Vehicle tool kit
- ▶ Remove vehicle tool kit ⑥.

Storing the vehicle tool kit

- ▶ Place vehicle tool kit ⑥ in vehicle tool kit storage well casing ⑤.
- ▶ Place storage well casing ② over the vehicle tool kit storage well casing ⑤ and turn retaining screw ① clockwise as far it will go to secure the Minispare wheel.

i Arrow ③ on vehicle tool kit storage well casing ⑤ must point in the direction of travel. Otherwise you cannot place the storage well casing ② on top and secure the Minispare wheel with retaining screw ①.

! To prevent damage, always disengage trunk floor handle from upper edge of trunk and lower trunk floor before closing the trunk.

Vehicle jack

Warning!



The jack is designed exclusively for jacking up the vehicle at the jack take-up brackets built into both sides of the vehicle. To help avoid personal injury, use the jack only to lift the vehicle during a wheel change. Never get beneath the vehicle while it is supported by the jack. Keep hands and feet away from the area under the lifted vehicle. Always firmly set parking brake and block wheels before raising vehicle with jack.

Do not disengage parking brake while the vehicle is raised. Be certain that the jack is always vertical (plumb line) when in use, especially on hills. Always try to use the jack on level surface. Make sure the jack arm is fully seated in the jack take-up bracket. Always lower the vehicle onto sufficient capacity jackstands before working under the vehicle.

Where will I find ...?

The vehicle jack is located in the storage compartment underneath the trunk floor.

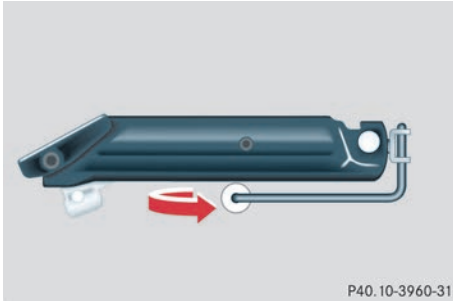

Storage position

- ▶ Turn crank handle in direction of arrow as far as it will go.
- ▶ Push crank handle up.

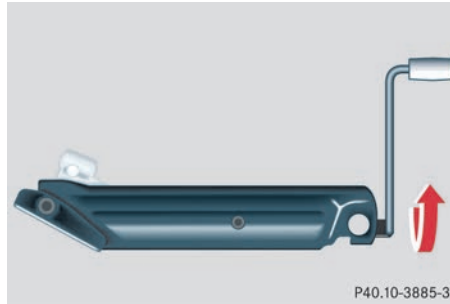

Operational position

- ▶ Turn crank handle clockwise.

Before storing the vehicle jack in its compartment:

- It should be fully collapsed.
- The handle must be folded in (storage position).

Setting up the collapsible wheel chock

The collapsible wheel chock serves to additionally secure the vehicle, e.g. while changing the wheel.

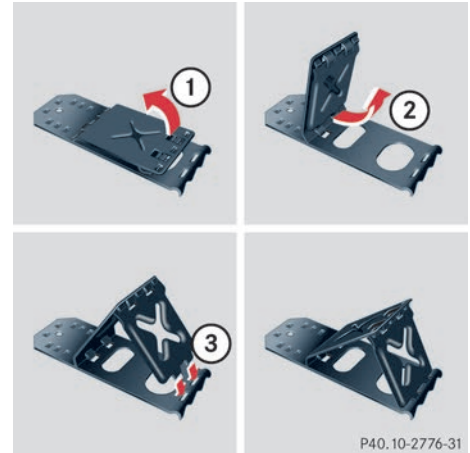

- ① Tilt the plate upward
- ② Fold the lower plate outward
- ③ Insert the plate

- ▶ Tilt both plates upward ①.
- ▶ Fold the lower plate outward ②.
- ▶ Guide the tabs of the lower plate all the way into the openings of the base plate ③.

For information on where to place wheel chocks when changing a wheel, see “Lifting the vehicle” (▷ page 378).

Minispare wheel

The Minispare wheel is located in the storage compartment underneath the trunk floor.

Removing the Minispare wheel

- ▶ Lift up trunk floor cover and engage trunk floor handle in upper edge of trunk.
- ▶ Loosen the retaining screw (▷ page 356) in the middle of storage well casing.
- ▶ Remove the storage well casing (▷ page 356).

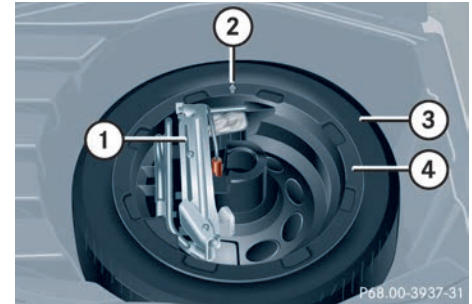

- ① Vehicle tool kit
 - ② Arrow
 - ③ Minispare wheel with spare wheel bolts in container on wheel rim
 - ④ Vehicle tool kit storage well casing
- ▶ Remove vehicle tool kit storage well casing ④.
 - ▶ Remove Minispare wheel ③.

Where will I find ...?

Storing the Minispare wheel

- ▶ Place Minispare wheel ③ in wheel well.
- ▶ Place vehicle tool kit storage well casing ④ over the Minispare wheel.
Make sure arrow ② on vehicle tool kit storage well casing ④ points in the direction of travel.
- ▶ Place storage well casing (▷ page 356) over vehicle tool kit storage well casing ④ and turn the retaining screw (▷ page 356) clockwise as far it will go to secure the Minispare wheel.

i Arrow ② on vehicle tool kit storage well casing ④ must point in the direction of travel. Otherwise you cannot place the storage well casing (▷ page 356) on top and secure the Minispare wheel with the retaining screw (▷ page 356).

! To prevent damage, always disengage trunk floor handle from upper edge of trunk and lower trunk floor before closing the trunk lid.

Warning!



The dimensions of the Minispare wheel are different from those of the road wheels. As a result, the vehicle handling characteristics change when driving with a Minispare wheel mounted.

The Minispare wheel should only be used temporarily, and should be replaced with a regular road wheel as quickly as possible.

In case of a flat tire, you may temporarily use the Minispare wheel when observing the following restrictions:

- Do not exceed a vehicle speed of 50 mph (80 km/h).
- Drive to the nearest tire repair facility to have the flat tire repaired or replaced as appropriate.
- Do not operate vehicle with more than one Minispare wheel mounted.

For more information, see “Rims and Tires” (▷ page 403).

Spare wheel bolts

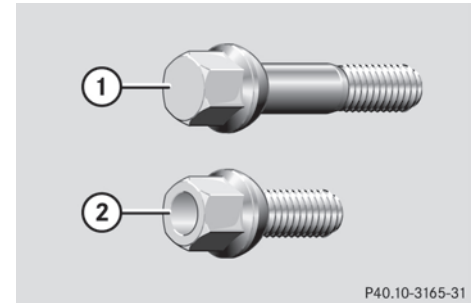

- ① Wheel bolt for light alloy rims
- ② Wheel bolt for Minispare wheel (located in trunk with spare wheel)

! Wheel bolts ② must be used when mounting the Minispare wheel. The use of any wheel bolts other than wheel bolts ② for the Minispare wheel will physically damage the vehicle's brakes.

Warning!



Make sure to use the original length wheel bolts when remounting the original wheel after it has been repaired.

Unlocking/locking in an emergency



▼ **Unlocking/locking in an emergency**

Unlocking the vehicle

If you are unable to unlock the vehicle with the SmartKey, open the driver's door and the trunk using the mechanical key.

i *Unlocking and opening the driver's door and/or the trunk with the mechanical key will trigger the anti-theft alarm system*.*

To cancel the alarm, do one of the following:

- Press button  or  on the SmartKey.
- Insert the SmartKey in the starter switch.

Removing the mechanical key

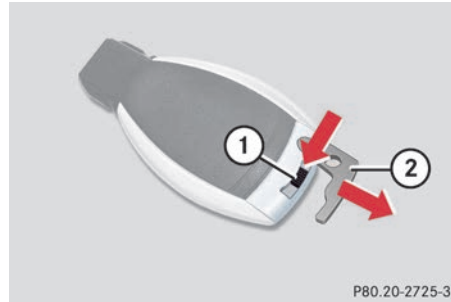

- ① Mechanical key locking tab
 - ② Mechanical key
- ▶ Move locking tab ① in direction of arrow.
 - ▶ Slide mechanical key ② out of the housing.

Unlocking the driver's door

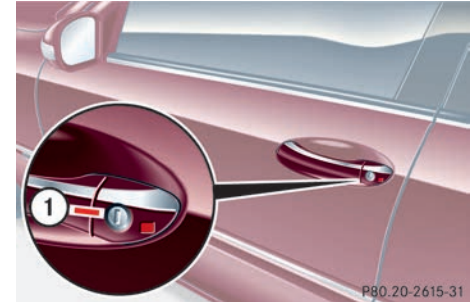

- ① Unlocking
- ▶ Insert the mechanical key into the driver's door lock until it stops.
 - ▶ Turn the mechanical key counterclockwise to position ① until the locking knob moves up.
The driver's door is unlocked.
 - ▶ Pull the door handle to open the driver's door.

Unlocking/locking in an emergency

Unlocking and opening the trunk

A minimum height clearance of 5.71 ft (1.74 m) is required to open the trunk lid.

The trunk lid lock is located next to the handle above the rear license plate recess.

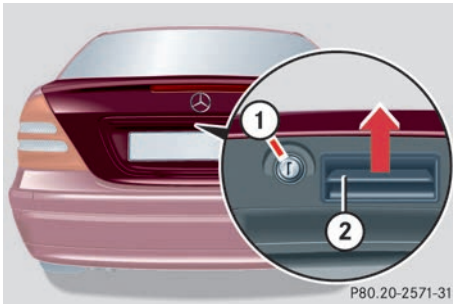

- ① Unlocking in an emergency
- ② Handle

▶ Insert the mechanical key into the trunk lid lock until it stops.

▶ Turn the mechanical key counterclockwise to position ①.

The trunk lid unlocks.

▶ Pull on handle ②.

The trunk opens.

! *The trunk lid swings open upwards automatically. Always make sure there is sufficient overhead clearance.*

▶ Turn the mechanical key back and remove it from the trunk lid lock.

Locking the vehicle

If you can not lock the vehicle with the SmartKey, do the following:

▶ Close the passenger door, the rear doors and the trunk.

▶ Press the central locking switch in the center console (▷ page 100).

▶ Check to see whether the locking knobs on the doors have moved down.

▶ If necessary push them down manually.

▶ Remove the mechanical key out of the SmartKey (▷ page 361).

▶ Check whether the trunk is locked.

▶ If necessary, lock the trunk with the mechanical key (▷ page 99).

▶ Close the driver's door.

Except for the driver's door, the vehicle should now be locked.

Unlocking/locking in an emergency

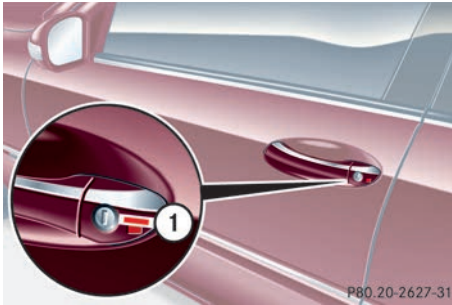

① Locking

- ▶ Insert the mechanical key into the driver's door lock until it stops.
- ▶ Turn the mechanical key clockwise to position ①.

The driver's door is locked.

i This procedure does not arm the anti-theft alarm system, nor does it lock the fuel filler flap.

Manually unlocking the transmission gear selector lever

In case of power failure, the transmission gear selector lever can be manually unlocked, e.g. to tow the vehicle.

- ▶ Slide out the swiveling cup holder (▷ page 240).

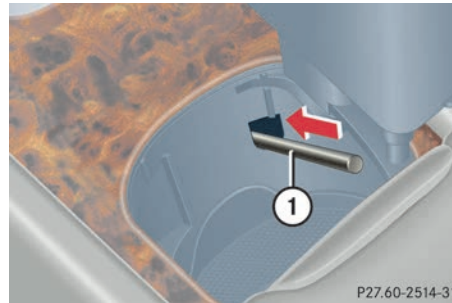

① Tool

- ▶ Insert a tool ① (e.g. flat blade screw driver) into the opening.
- ▶ Perform the following two steps simultaneously:
 - ▶ Press tool ① forward in direction of the arrow.
 - ▶ Move gear selector lever from position **P**.
- ▶ Remove tool ① from the opening.

i The gear selector lever is locked again when moving it to position **P**.

Opening/closing in an emergency

Power tilt/sliding sunroof*

You can open or close the tilt/sliding sunroof manually should an electrical malfunction occur.

The tilt/sliding sunroof drive is located behind the lens ① of the interior overhead light.



① Lens

- ▶ Remove SmartKey from the starter switch.
- ▶ Pry off lens ① using a flat blade screwdriver.



② Locking tabs

- ▶ Slide both locking tabs ② in direction of the arrows.
- ▶ Lower the rear of the cover.
- ▶ Remove the cover.

i Do not disconnect electrical connectors.

- ▶ Take the crank ③ out of the Mercedes-Benz vehicle literature pouch.

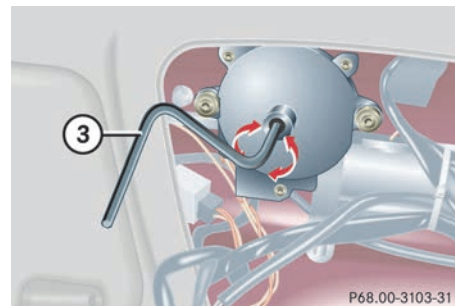

③ Crank

- ▶ Insert crank ③ through hole on the left side.
- ▶ Turn crank ③ clockwise to:
 - slide sunroof closed
 - raise sunroof at the rear
- ▶ Turn crank ③ counterclockwise to:
 - slide sunroof open
 - lower sunroof at the rear

i Turn crank ③ slowly and smoothly.

The tilt/sliding sunroof must be synchronized after being operated manually (▷ page 226).

Resetting activated head restraints

▼ Resetting activated head restraints

Resetting activated head restraints

If the active head restraints have been triggered in a rear-end collision, the active head restraints must be reset. Otherwise, the active head restraint cannot offer any additional protection in the event of another rear-end collision.

You can tell that the head restraints have been triggered when they have been moved forward and cannot be adjusted.

i For your convenience, we recommend that you have this work carried out by an authorized Mercedes-Benz Center.

You will find the reset tool for manually operating the active head restraints in the Mercedes-Benz vehicle literature pouch.

Warning!



For safety reasons, have the active head restraints checked by an authorized Mercedes-Benz Center after a rear-end collision.

Warning!



When pushing back the head restraint cushion, take care that your fingers do not become caught between the head restraint cushion and the cover. Failing to do so may lead to injury.

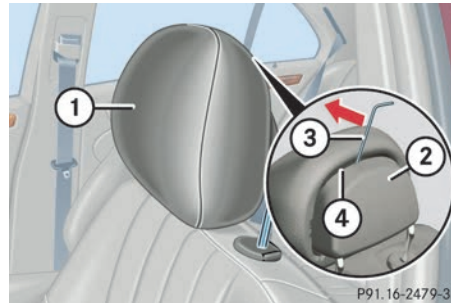

- ① Head restraint cushion
- ② Head restraint cover
- ③ Reset tool
- ④ Hole

▶ Take the reset tool ③ out of the Mercedes-Benz vehicle literature pouch.

▶ Guide reset tool ③ into the hole ④ between the rear head restraint cover ② and the head restraint cushion ①.

! Be careful not to damage upholstery.

▶ Press the reset tool ③ forward in direction of the arrow.

▶ Press the reset tool ③ downward until you hear the head restraint release mechanism audibly engage.

▶ Pull out reset tool ③.

▶ Firmly press the head restraint cushion ① back toward the rear head restraint cover ② until it engages.

▶ Repeat this procedure on the active head restraint for the second front seat.

For information on active head restraints, see “Active head restraint” (▶ page 73).

For information on head restraint adjustment, see “Seats” (▶ page 34).

Replacing SmartKey batteries

If the batteries in the SmartKey are discharged, the vehicle can no longer be locked or unlocked. It is recommended to have the batteries replaced at an authorized Mercedes-Benz Center.

Warning!



Keep the batteries out of reach of children.
If a battery is swallowed, seek medical help immediately.

Batteries contain materials that can harm the environment if disposed of improperly. Recycling of batteries is the preferred method of disposal. Many states require sellers of batteries to accept old batteries for recycling.

i When inserting the batteries, make sure they are clean and free of lint.

i When replacing batteries, always replace both batteries of both SmartKeys.

The required replacement batteries are available at any Mercedes-Benz Center.

SmartKey

Replacement batteries: Lithium, type CR 2025 or equivalent.

- ▶ Remove the mechanical key from the SmartKey (▶ page 361).

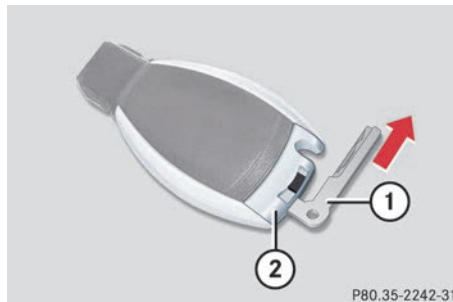

- ① Mechanical key
- ② Battery compartment

- ▶ Insert mechanical key ① into the opening.
- ▶ Press mechanical key ① in direction of arrow.

The battery compartment ② is unlatched.

- ▶ Pull battery compartment ② out of the housing.

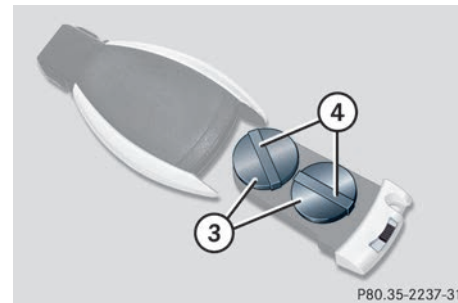

- ③ Batteries
- ④ Contact spring

- ▶ Remove the batteries ③.
- ▶ Using a lint-free cloth, insert new batteries ③ under the contact springs ④ with the positive terminal (+) side facing up.
- ▶ Return battery compartment ② into housing until it locks into place.
- ▶ Slide mechanical key ① back into the SmartKey.
- ▶ Check the operation of the SmartKey.

▼ Replacing bulbs

Safe vehicle operation depends on proper exterior lighting and signaling. It is therefore essential that all bulbs and lamp assemblies are in good working order at all times.

Correct headlamp adjustment is extremely important. Have headlamps checked and readjusted at regular intervals and when a bulb has been replaced. See an authorized Mercedes-Benz Center for headlamp adjustment.

i *If the headlamps or front fog lamps are fogged up on the inside as a result of high humidity, driving the vehicle a distance with the lights on should clear up the fogging.*

i *Substitute bulbs will be brought into use when lamps malfunction. Read and observe the messages in the multifunction display (▷ page 349).*

Replacing bulbs

Bulbs

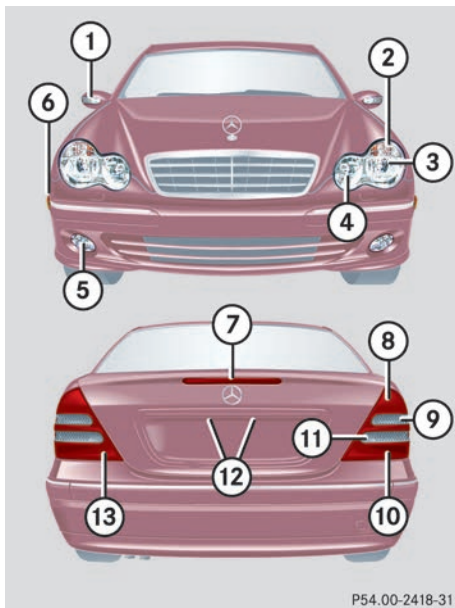

Front lamps

	Lamp	Type
①	Additional turn signal lamp	LED
②	Halogen headlamp: Turn signal lamp Bi-Xenon* headlamp: Turn signal lamp	1156 A 2357 A
③	Halogen headlamp: Low beam Bi-Xenon* headlamp: Low and high beam ¹	H7 (55 W) D2S-35 W
④	Halogen headlamp: High beam/high beam flasher	H7 (55 W)
	Bi-Xenon* headlamp: High beam flasher	H7 (55 W)
	Parking and standing lamp	W 5 W

¹ Vehicles with Bi-Xenon* headlamps: Low beam and high beam use the same D2S-35W lamp. Do not replace the Xenon bulbs yourself. Contact an authorized Mercedes-Benz Center.

	Lamp	Type
⑤	Front fog lamp	HB4 (51 W)
	Corner-illuminating front fog lamps*	H7 (55 W)
⑥	Side marker lamp	W 5 W

Rear lamps

	Lamp	Type
⑦	High mounted brake lamp	LED
⑧	Brake lamp	P 21 W
⑨	Turn signal lamp	PY 21 W
⑩	Parking and side marker lamp	P 21/5 W
⑪	Backup lamp	P 21 W
⑫	License plate lamps	C 5 W
⑬	Rear fog lamp (driver's side only), tail and standing lamp	P 21/4 W

Warning!

Bulbs and bulb sockets can be very hot. Allow the lamp to cool down before changing a bulb.

Keep bulbs out of reach of children.

Halogen lamps contain pressurized gas. A bulb can explode if you

- touch or move it when hot
- drop the bulb
- scratch the bulb

Wear eye and hand protection.

Because of high voltage in Xenon lamps, it is dangerous to replace the bulb or repair the lamp and its components. We recommend that you have such work done by a qualified technician.

Notes on bulb replacement

- Only use 12 volt bulbs of the same type and with the specified watt rating.
- Switch lights off before changing a bulb to prevent short circuits.
- Always use a clean lint-free cloth when handling bulbs.
- Your hands should be dry and free of oil and grease.
- If the newly installed bulb does not come on, visit an authorized Mercedes-Benz Center.

Have the LEDs and bulbs for the following lamps replaced by an authorized Mercedes-Benz Center:

- Additional turn signals in the exterior rear view mirrors
- High mounted brake lamp
- Xenon* lamps
- Front fog lamps
- Front side marker lamps

! Do not replace the LEDs yourself. You could otherwise damage the LEDs or parts of the vehicle. Only have the LEDs replaced by an authorized Mercedes-Benz Center.

Replacing bulbs

Replacing bulbs for front lamps

Before you start to replace a bulb for a front lamp, do the following first:

- ▶ Turn the exterior lamp switch to position **0** (▷ page 109).
- ▶ Open the hood (▷ page 274).

Halogen headlamp

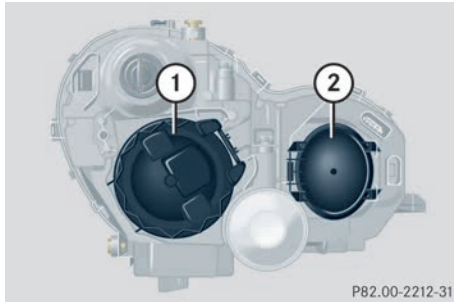

- ① Housing cover for low beam headlamp
- ② Housing cover for high beam headlamp, parking and standing lamp

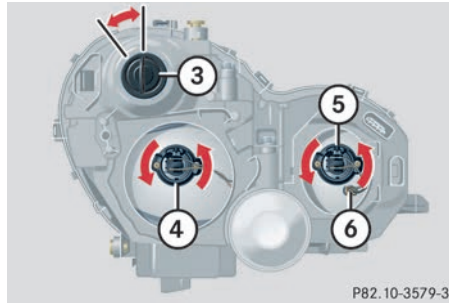

- ③ Bulb socket for turn signal lamp bulb
- ④ Bulb socket for low beam bulb
- ⑤ Bulb socket for high beam bulb
- ⑥ Bulb socket for parking and standing lamp bulb

Low beam bulb

- ▶ Press the clamp on housing cover ① and remove it.
- ▶ Pull the electrical connector off.
- ▶ Turn bulb socket ④ counterclockwise and take out the bulb.
- ▶ Insert the new bulb so that its socket locates in the recess of the lamp housing.
- ▶ Turn bulb socket ④ clockwise until it engages.
- ▶ Plug the electrical connector onto the bulb.
- ▶ Align housing cover ① and press until it engages.

High beam bulb

- ▶ Press the clamp on housing cover ② and remove it.
- ▶ Pull the electrical connector off.
- ▶ Turn bulb socket ⑤ counterclockwise and take out the bulb.
- ▶ Insert the new bulb so that its socket locates in the recess of the lamp housing.
- ▶ Turn bulb socket ⑤ clockwise until it engages.
- ▶ Plug the electrical connector onto the bulb.
- ▶ Align housing cover ② and press until it engages.

Front turn signal lamp bulb

- ▶ Turn bulb socket ③ with the bulb counterclockwise and remove it.
- ▶ Press gently onto the bulb and turn it counterclockwise out of bulb socket ③.
- ▶ Press new bulb gently into bulb socket ③ and turn clockwise until it engages.
- ▶ Place bulb socket ③ back into the lamp and turn it clockwise.

Parking and standing lamp bulb

- ▶ Press the clamp on housing cover ② and remove it.
- ▶ Pull out bulb socket ⑥ with the bulb.
- ▶ Pull the bulb out of bulb socket ⑥.
- ▶ Press the new bulb into bulb socket ⑥.
- ▶ Press bulb socket ⑥ back into the lamp.
- ▶ Align housing cover ② and press until it engages.

Replacing bulbs

Bi-Xenon* headlamp

Warning!



Do not remove the cover ① for the Bi-Xenon headlamp. Because of high voltage in Bi-Xenon lamps, it is dangerous to replace the bulb or repair the lamp and its components. We recommend that you have such work done by a qualified technician.

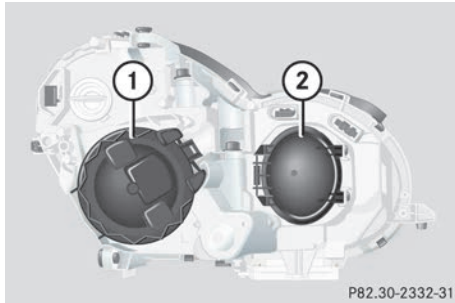

- ① Housing cover for Bi-Xenon headlamp
- ② Housing cover for high beam flasher, parking and standing lamp

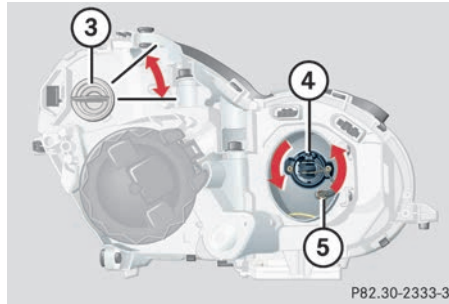

- ③ Bulb socket for turn signal lamp bulb
- ④ Bulb socket for high beam flasher bulb
- ⑤ Bulb socket for parking and standing lamp bulb

High beam flasher bulb

- ▶ Press the clamp on housing cover ② and remove it.
- ▶ Pull the electrical connector off.
- ▶ Turn bulb socket ④ counterclockwise and take out the bulb.
- ▶ Insert the new bulb so that its socket locates in the recess of the lamp housing.
- ▶ Turn bulb socket ④ clockwise until it engages.
- ▶ Plug the electrical connector onto the bulb.
- ▶ Align housing cover ② and press until it engages.

Front turn signal lamp bulb

- ▶ Turn bulb socket ③ with the bulb counterclockwise and remove it.
- ▶ Press gently onto the bulb and turn it counterclockwise out of bulb socket ③.
- ▶ Press new bulb gently into bulb socket ③ and turn clockwise until it engages.
- ▶ Place bulb socket ③ back into the lamp and turn it clockwise.

Parking and standing lamp bulb

- ▶ Press the clamp on housing cover ② and remove it.
- ▶ Pull out bulb socket ⑤ with the bulb.
- ▶ Pull the bulb out of bulb socket ⑤.
- ▶ Press the new bulb into bulb socket ⑤.
- ▶ Press bulb socket ⑤ back into the lamp.
- ▶ Align housing cover ② and press until it engages.

Additional turn signal lamp bulbs

The additional turn signal lamps in the exterior rear view mirrors have LEDs.

If a malfunction occurs or LEDs fail to function, the entire turn signal unit must be replaced. Have the turn signal unit replaced by an authorized Mercedes-Benz Center.

Front side marker lamp bulbs

Since replacing the side marker lamp bulbs is a technically highly demanding process, we recommend you have the side marker lamp bulbs replaced by an authorized Mercedes-Benz Center.

Replacing bulbs for rear lamps

Before you start to replace a bulb for a rear lamp, do the following first:

- ▶ Turn the exterior lamp switch to position **0** (▷ page 109).
- ▶ Open the trunk (▷ page 96).

Tail lamp unit



① Latch



Replacing bulbs

- ▷▷ Fold the corresponding trim panel to the side.
- ▶ Turn latch ① to vertical position and remove the bulb carrier.

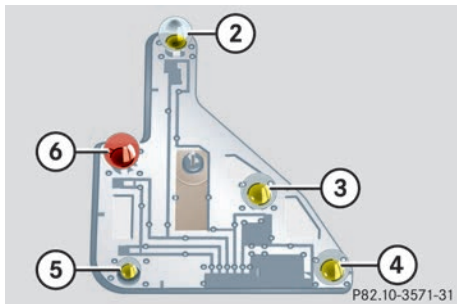

Bulb carrier

- ② Brake lamp bulb
- ③ Backup lamp bulb
- ④ Rear fog lamp (driver's side only), tail and standing lamp bulb
- ⑤ Parking and side marker lamp bulb
- ⑥ Turn signal lamp bulb

- ▶ Press gently onto the respective bulb and turn counterclockwise out of its bulb socket.
- ▶ Press the new bulb gently into its bulb socket and turn clockwise until it engages.
- ▶ Reinstall the bulb carrier and lock it again with latch ①.
- ▶ Reinstall the trim panel.

License plate lamp

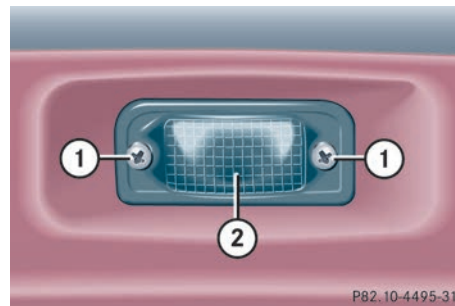

- ① Screw
- ② License plate lamp
- ▶ Loosen both screws ①.
- ▶ Remove the license plate lamp ②.
- ▶ Replace the bulb.
- ▶ Reinstall the license plate lamp ②.
- ▶ Retighten screws ①.

Replacing wiper blades

▼ Replacing wiper blades

Removing and installing wiper blades

Warning!



For safety reasons, switch off wipers and remove SmartKey from starter switch before replacing a wiper blade. Otherwise, the wiper motor could suddenly turn on and cause injury.

Warning!



Wiper blades are components that are subject to wear and tear. Change the wiper blades twice a year, preferably in the spring and fall. Otherwise the windows will not be properly wiped. As a result, you may not be able to observe surrounding traffic conditions and could cause an accident.

❗ *Never open the hood when the wiper arms are folded forward.*

For your convenience, we recommend that you have this work carried out by an authorized Mercedes-Benz Center.

▶ Remove SmartKey from starter switch.

Removing wiper blades

❗ *Do not pull on the wiper blade inserts. They could tear.*

- ▶ Pull the tab ② in direction of arrow ①. The wiper blade is unlocked.
- ▶ Lift up the wiper arm as far as you need to remove the wiper blade.

❗ *Hold on to the wiper arm. If released, the force of the impact from the tensioning spring could crack the windshield.*

- ▶ Carefully fold the wiper arm back to rest on the windshield.

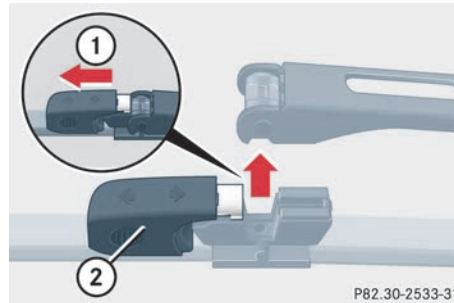

- ① Unlocking
- ② Tab

Replacing wiper blades

Installing wiper blades

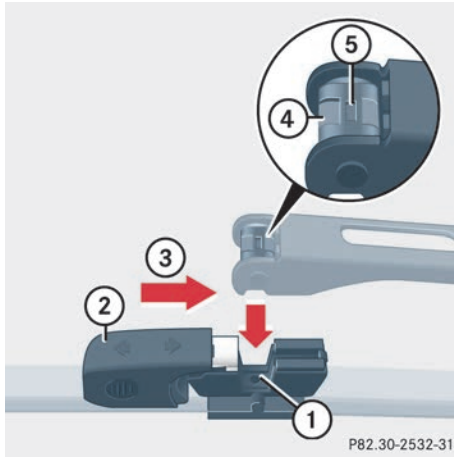

P82.30-2532-31

- ① Recess
- ② Tab
- ③ Locking
- ④ Taper piece
- ⑤ Square recess

- ▶ Lift up the wiper arm as far as you need to position the wiper blade under the wiper arm and hold it.

! Hold on to the wiper arm. If released, the force of the impact from the tensioning spring could crack the windshield.

- ▶ Carefully fold the wiper arm back and make sure that the taper piece ④ slides into the recess ① at the wiper blade.

! Make certain that the square recess ⑤ on the taper piece ④ is on the top, otherwise the taper piece ④ cannot slide into the recess ① at the wiper blade. If the square recess ⑤ is not at the top turn the taper piece ④ around to bring the square recess ⑤ to the top.

- ▶ Slide the tab ② back in direction of arrow ③ until it audibly engages.

The wiper blade is locked.

! Make certain that the wiper blades are properly installed. Improperly installed wiper blades may cause windshield damage.

▼ Flat tire

Warning!

The dimensions of the Minispare wheel are different from those of the road wheels. As a result, the vehicle handling characteristics change when driving with a Minispare wheel mounted. Adapt your driving style accordingly.

The Minispare wheel is for temporary use only. When driving with Minispare wheel mounted, ensure proper tire inflation pressure and do not exceed a vehicle speed of 50 mph (80 km/h).

Drive to the nearest Mercedes-Benz Center as soon as possible to have the Minispare wheel replaced with a regular road wheel.

Never operate the vehicle with more than one Minispare wheel mounted.

Do not switch off the ESP® when a Minispare wheel is mounted.

Preparing the vehicle

- ▶ Park the vehicle in a safe distance from moving traffic on a hard, flat surface when possible.
- ▶ Turn on the hazard warning flasher (▷ page 115).
- ▶ Turn the steering wheel so that the front wheels are in a straight ahead position.
- ▶ Set the parking brake (▷ page 54).
- ▶ Move the gear selector lever to **P** (manual transmission: to first or reverse gear).
- ▶ Turn off the engine (▷ page 55).
- ▶ Remove the SmartKey from the starter switch.
- ▶ Have any passenger exit the vehicle at a safe distance from the roadway.

 *Open doors only when conditions are safe to do so.*

Mounting the Minispare wheel**Preparing the vehicle**

Prepare the vehicle as described (▷ page 377).

- ▶ Take the wheel wrench, alignment bolt, collapsible wheel chock, and the jack out of the trunk (▷ page 356).
- ▶ Take the Minispare wheel and wheel bolts out of the trunk (▷ page 359).

Flat tire

Lifting the vehicle

- ▶ Prevent the vehicle from rolling away by blocking wheels with wheel chocks or other sizable objects.

One wheel chock is included with the vehicle tool kit (▷ page 356).

When changing wheel on a level surface:

- ▶ Place the wheel chock in front of and another sizable object behind the wheel that is diagonally opposite to the wheel being changed.

Always try lifting the vehicle using the jack on a level surface. However, should circumstances require you to do so on a hill, place the wheel chock and the other sizeable object as follows:

- ▶ Place wheel chocks and another sizeable object on the downhill side blocking both wheels of the axle not being worked on.

Warning!



The jack is designed exclusively for jacking up the vehicle at the jack take-up brackets built into both sides of the vehicle. To help avoid personal injury, use the jack only to lift the vehicle during a wheel change. Never get beneath the vehicle while it is supported by the jack. Keep hands and feet away from the area under the lifted vehicle. Always firmly set parking brake and block wheels before raising vehicle with jack.

Do not disengage parking brake while the vehicle is raised. Be certain that the jack is always vertical (plumb line) when in use, especially on hills. Always try to use the jack on level surface. Make sure the jack arm is fully seated in the jack take-up bracket. Always lower the vehicle onto sufficient capacity jackstands before working under the vehicle.

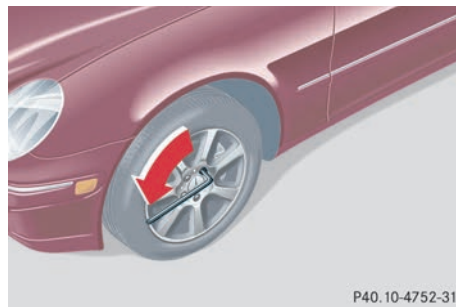

P40.10-4752-31

- ▶ On wheel to be changed, loosen but do not yet remove the wheel bolts (approximately one full turn with wrench).

The jack take-up brackets are located directly behind the front wheel housings and in front of the rear wheel housings.

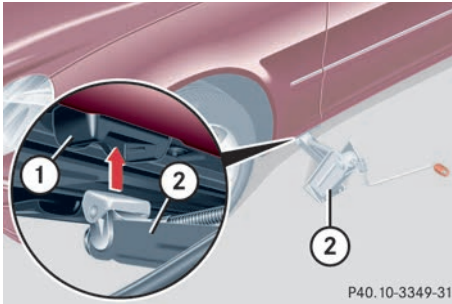

P40.10-3349-31

① Take-up bracket

② Jack

- ▶ Place jack ② on firm ground.
- ▶ Position jack ② under take-up bracket ① so that it is always vertical (plumb-line) as seen from the side, even if the vehicle is parked on an incline.

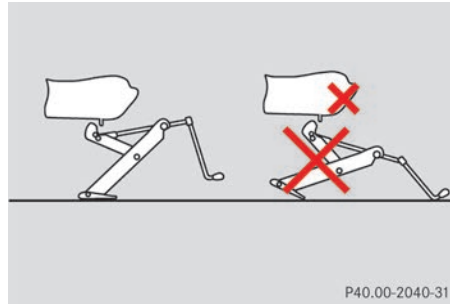

P40.00-2040-31

- ▶ Jack up the vehicle until the wheel is a maximum of 1.2 in (3 cm) from the ground. Never start engine while vehicle is raised.

Warning!



The jack is intended only for lifting the vehicle briefly for wheel changes. It is not suited for performing maintenance work under the vehicle.

- Never start the engine when the vehicle is raised.
- Never lie down under the raised vehicle.

Removing the wheel

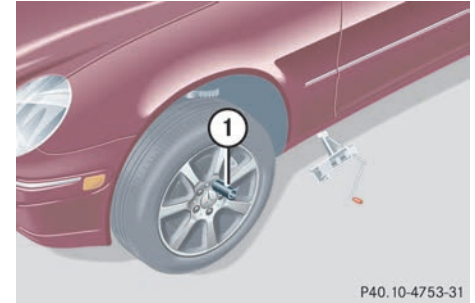

P40.10-4753-31

① Alignment bolt

- ▶ Unscrew upper-most wheel bolt and remove.
- ▶ Replace this wheel bolt with alignment bolt ① supplied in the tool kit.
- ▶ Remove the remaining bolts.

! Do not place wheel bolts in sand or dirt. This could result in damage to the bolts and wheel hub threads.

- ▶ Remove the wheel.

Flat tire

Mounting the spare wheel

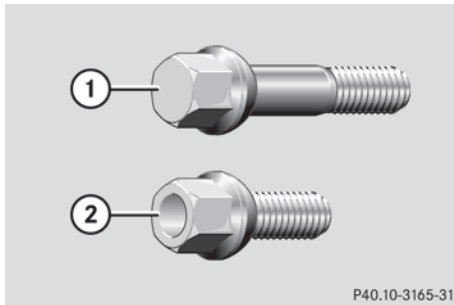

- ① Wheel bolt for light alloy rims
- ② Wheel bolt for Minispare wheel (located in trunk with spare wheel)

! Wheel bolts ② must be used when mounting the Minispare wheel. The use of any wheel bolts other than wheel bolts ② for the Minispare wheel will physically damage the vehicle's brakes.

- ▶ Clean contact surfaces of wheel and wheel hub.

! To avoid paint damage, place wheel flat against hub and hold it there while installing first wheel bolt.

Warning!



Always replace wheel bolts that are damaged or rusted.

Never apply oil or grease to wheel bolts.

Damaged wheel hub threads should be repaired immediately. Do not continue to drive under these circumstances! Contact an authorized Mercedes-Benz Center or call Roadside Assistance.

Incorrect wheel bolts or improperly tightened wheel bolts can cause the wheel to come off. This could cause an accident. Make sure to use the correct wheel bolts.

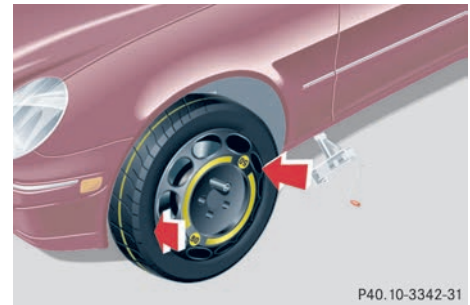

P40.10-3342-31

- ▶ Guide spare wheel onto the alignment bolt and push it on.
- ▶ Insert wheel bolts and tighten them slightly.

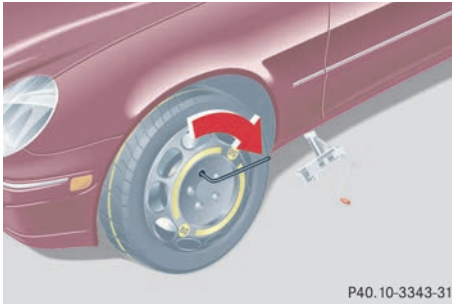

P40.10-3343-31

- ▶ Unscrew the alignment bolt, install last wheel bolt and tighten slightly.

Warning!



Only use genuine equipment Mercedes-Benz wheel bolts. Other wheel bolts may come loose.

Do not tighten the wheel bolts when the vehicle is raised. Otherwise the vehicle could fall off the jack.

Lowering the vehicle

- ▶ Lower vehicle by turning crank counterclockwise until vehicle is resting fully on its own weight.
- ▶ Remove the jack.

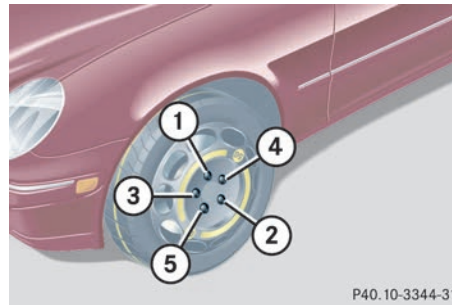

P40.10-3344-31

① - ⑤ Wheel bolts

- ▶ Tighten the five wheel bolts evenly, following the diagonal sequence illustrated (① to ⑤), until all bolts are tight. Observe a tightening torque of 80 lb-ft (110 Nm).

Warning!



Have the tightening torque checked after changing a wheel. The wheels could come loose if they are not tightened to a torque of 80 lb-ft (110 Nm).

Before storing the jack, it should be fully collapsed, with handle folded in (storage position) (▷ page 358).

- ▶ Store the jack and the other vehicle tools in the trunk.

Flat tire

MOExtended system*

The MOExtended system allows you to continue driving your vehicle even if there is a total loss of pressure in one or more tires.

You may only use the MOExtended system in conjunction with the Run Flat Indicator*.

! *The maximum distance in emergency mode depends on the vehicle's load. It is 30 miles (50 km) if the vehicle is partially loaded and 18 miles (30 km) if the vehicle is fully loaded.*

The point at which the maximum driving distance begins in emergency mode is when the warning message appears in the multifunction display indicating that there is a loss of tire inflation pressure.

Do not exceed the maximum speed of 50 mph (80 km/h).

Warning!



In emergency mode, your vehicle's driving characteristics are diminished in such situations as:

- driving around curves
- while braking
- while accelerating rapidly

Therefore, your driving style must be adapted accordingly. Avoid abrupt steering and driving maneuvers, as well as driving over obstacles (road curbs, potholes, or off-road areas). This is especially important if the vehicle is heavily loaded.

The emergency driving distance that can be achieved greatly depends on the demands placed on the vehicle. Depending on speed, load, driving maneuvers, road conditions, outside temperature, etc., the distance can be significantly shorter or, if the vehicle is driven cautiously, somewhat longer.

Do not continue driving in emergency mode if

- you notice knocking sounds
- the vehicle starts to shake
- smoke develops and you smell rubber
- ESP® is intervening continuously
- you notice tears on the tire sidewalls

After driving in emergency mode, you must have the rims inspected by an authorized Mercedes-Benz Center to check if they are suitable for further use. The failed tire must be replaced in any case.

i *When replacing individual or all tires on the vehicle, make sure only matching tires marked with "MOExtended" are mounted in the size specified for your vehicle (▷ page 403).*

▼ Battery

The battery is located in the engine compartment on the right hand side.

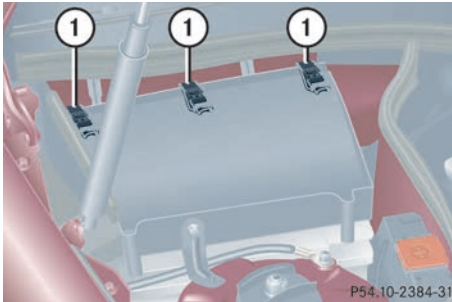

① Clamps

Removing filter box:

- ▶ Release clamps ①.
- ▶ Remove filter box.

Installing filter box:

- ▶ Insert filter box properly.
- ▶ Secure it with clamps ①.

Warning!



Failure to follow these instructions can result in severe injury or death.

Observe all safety instructions and precautions when handling automotive batteries (▷ page 279).

Never lean over batteries while connecting, you might get injured.

Battery fluid contains sulfuric acid. Do not allow this fluid to come in contact with eyes, skin or clothing. In case it does, immediately flush affected area with water and seek medical help if necessary.

A battery will also produce hydrogen gas, which is flammable and explosive. Keep flames or sparks away from battery, avoid improper connection of jumper cables, smoking, etc.

Warning!



Do not place metal objects on the battery as this could result in a short circuit.

Use leak-proof battery only to avoid the risk of acid burns in the event of an accident.

! *Never loosen or detach battery terminal clamps while the engine is running or the SmartKey is in the starter switch. Otherwise the alternator and other electronic components could be severely damaged.*

Have the battery checked regularly by an authorized Mercedes-Benz Center.

Refer to Maintenance Booklet for maintenance intervals or contact an authorized Mercedes-Benz Center for further information.

Battery

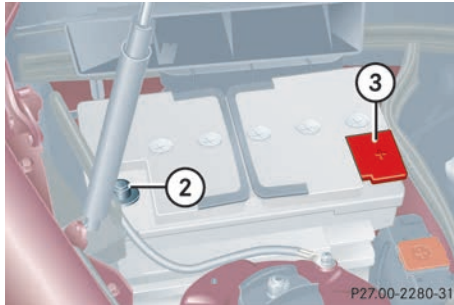

- ② Negative terminal
- ③ Positive terminal cover

Disconnecting the battery

Warning!



With a disconnected battery

- you will no longer be able to turn the SmartKey in the starter switch
- automatic transmission*: the gear selector lever will remain locked in position **P**

! Always disconnect the battery in the order described below. Otherwise the vehicle's electronics can be damaged.

- ▶ Apply the parking brake (▷ page 54).
- ▶ Make sure the gear selector lever* is set to position **P** (▷ page 153) (manual transmission: to Neutral (▷ page 149)).
- ▶ Turn off all electrical consumers.
- ▶ Remove SmartKey from starter switch.
- ▶ Open the hood (▷ page 274).
- ▶ Remove the filter box (▷ page 383).

- ▶ Read and observe safety instructions and precautions (▷ page 279) and (▷ page 383).
- ▶ Disconnect the battery negative lead from negative terminal ②.
- ▶ Remove cover ③ from the positive terminal.
- ▶ Disconnect the battery positive lead.

Removing the battery

- ▶ Remove the screw-nuts securing the battery.
- ▶ Remove the battery bracket.
- ▶ Pull out the battery ventilation hose from the battery (depending on battery arrangement in your vehicle model, the ventilation hose is located either on the left or right side of the battery).
- ▶ Take out the battery.

Charging and reinstalling the battery

Warning!



Never charge a battery while still installed in the vehicle unless the accessory battery charge unit approved by Mercedes-Benz is being used. Gases may escape during charging and cause explosions that may result in paint damage, corrosion or personal injury.

An accessory battery charge unit specially adapted for Mercedes-Benz vehicles and tested and approved by Mercedes-Benz is available, permitting the charging of the battery in its installed position. Contact an authorized Mercedes-Benz Center for information and availability. Charge battery in accordance with the separate instructions for the accessory battery charger.

- ▶ Charge battery in accordance with the instructions of the battery charger manufacturer.
- ▶ Reinstall the charged battery. Follow the previously described steps in reverse order.

! *The battery, its filler caps and the battery ventilation hose must always be securely installed when the vehicle is in operation.*

Reconnecting the battery

! *Always connect the battery in the order described below. Otherwise the vehicle's electronics can be damaged.*

- ▶ Turn off all electrical consumers.
- ▶ Remove SmartKey from starter switch.
- !** *Never invert the terminal connections!*
- ▶ Connect the battery positive lead and fasten its cover ③ (▷ page 384).
- ▶ Connect the battery negative lead ② (▷ page 384).
- ▶ Reinstall the filter box (▷ page 383).

i *The following procedures must be carried out following any interruption of battery power (e.g. due to reconnection):*

- *Set the clock (▷ page 136). Vehicles with COMAND*: See COMAND operator's manual.*
- *Synchronize side windows (▷ page 222).*
- *Synchronize tilt/sliding sunroof* (▷ page 226).*

Batteries contain materials that can harm the environment if disposed of improperly. Large 12 volt storage batteries contain lead. Recycling of batteries is the preferred method of disposal. Many states require sellers of batteries to accept old batteries for recycling.

Jump starting

Warning!



Failure to follow these directions will cause damage to the electronic components, and can lead to a battery explosion and severe injury or death.

Never lean over batteries while connecting or jump starting, you might get injured.

Battery fluid contains sulfuric acid. Do not allow this fluid to come in contact with eyes, skin or clothing. In case it does, immediately flush affected area with water, and seek medical help if necessary.

A battery will also produce hydrogen gas, which is flammable and very explosive. Keep flames or sparks away from battery, avoid improper connection of jumper cables, smoking, etc.

Attempting to jump start a frozen battery can result in it exploding, causing personal injury.

Read all instructions before proceeding.

! *Vehicles with automatic transmission and/or 4MATIC:
Do not tow-start the vehicle.*

! *Avoid repeated and lengthy starting attempts.*

Do not attempt to start the engine using a battery quick charge unit.

If engine does not run after several unsuccessful starting attempts, have it checked at the nearest authorized Mercedes-Benz Center.

Excessive unburned fuel generated by repeated failed starting attempts may damage the catalytic converter and may present a fire risk.

Make sure the jumper cables do not have loose or missing insulation.

Make sure the cable clamps do not touch any other metal part while the other end is still attached to a battery.

If the battery is discharged, the engine can be started with jumper cables and the battery of another vehicle. Observe the following:

- Jump starting should only be performed when the engine and catalytic converter are cold.

- Do not start the engine if the battery is frozen. Let the battery thaw out first.
- Only jump start from batteries with the same voltage rating (12V). Jump starting with a higher voltage battery could damage the vehicle's electrical system, which will not be covered by the Mercedes-Benz Limited Warranty.
- Only use jumper cables with sufficient cross-section and insulated terminal clamps.
- Always make sure the jumper cables are not on or near pulleys, fans, or other parts that move when an engine is started or running.

Warning!



Keep flames or sparks away from battery. Do not smoke.

Observe all safety instructions and precautions when handling automotive batteries (▷ page 279).

The battery is located in the engine compartment on the right hand side. The terminals for jump starting are located in front of the battery.

- ▶ Make sure the two vehicles do not touch.
- ▶ Turn off all electrical consumers.
- ▶ Apply the parking brake (▷ page 54).
- ▶ Make sure the gear selector lever* is set to position **P** (▷ page 153) (manual transmission: to Neutral (▷ page 149)).
- ▶ Open the hood (▷ page 274).
- ▶ Flip up cover from the positive under hood terminal ② in front of the filter box (▷ page 383).

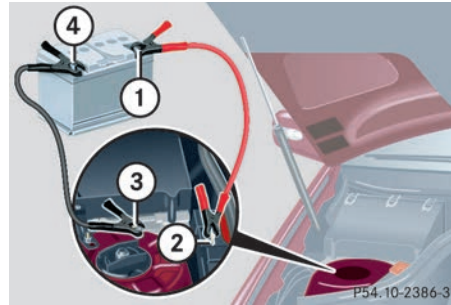

- ① Positive terminal of charged battery
- ② Positive under hood terminal in front of discharged battery
- ③ Negative under hood terminal in front of discharged battery
- ④ Negative terminal of charged battery

! Never invert the terminal connections!

- ▶ Connect positive terminal ① of the charged battery with positive under hood terminal ② in front of the filter box with the jumper cable. Clamp cable to charged battery ① first.
- ▶ Start engine of the vehicle with the charged battery and run at idle speed.

- ▶ Connect the negative terminal ④ of the charged battery with the negative under hood terminal ③ in front of the filter box with the second jumper cable. Clamp cable to charged battery ④ first.
- ▶ Start the engine of the disabled vehicle.

You can now turn on the electrical consumers. Do not switch on the headlamps under any circumstances.

- ▶ Remove the jumper cables first from the negative terminals ③ and ④ and then from the positive terminals ② and ①.

You can now switch on the headlamps.

- ▶ Have the battery checked at the nearest authorized Mercedes-Benz Center.

Towing the vehicle

Mercedes-Benz recommends that the vehicle be transported with all wheels off the ground using flatbed or appropriate wheel lift/dolly equipment. This method is preferable to other types of towing.

! *Vehicles with automatic transmission* and/or 4MATIC:
Do not tow-start the vehicle.*

! *Use flatbed or wheel lift/dolly equipment with the SmartKey in the starter switch turned to position **0**.*

Do not tow with sling-type equipment. Towing with sling-type equipment over bumpy roads will damage radiator and supports.

To prevent damage during transport, do not tie down vehicle by its chassis or suspension parts.

*Switch off the automatic central locking
(▷ page 143).*

When circumstances do not permit the recommended towing methods, the vehicle may be towed with all wheels on the ground or front wheels raised (except vehicles with 4MATIC) only so far as necessary to have the vehicle moved to a safe location where the recommended towing methods can be employed.

! *Vehicles with 4MATIC:
Do not tow with one axle raised. Doing so could damage the transfer case, which is not covered by the Mercedes-Benz Limited Warranty.*

All wheels must be on or off the ground. Observe instructions for towing the vehicle with all wheels on the ground.

! *If the vehicle is towed with the front axle raised (not permissible for vehicles with 4MATIC), the gear selector lever* must be in position **N** (manual transmission: gear shift lever in neutral position) and the engine must be shut off (SmartKey in starter switch position **0** or **1**). Otherwise the ESP® will immediately be engaged and will apply the rear wheel brakes.*

When towing the vehicle with all wheels on the ground, the gear selector lever must be in position **N** (manual transmission: gears disengaged) and the SmartKey must be in starter switch position **2**.*

When towing the vehicle with all wheels on the ground or the front axle raised, the vehicle may be towed only for distances up to 30 miles (50 km) and at a speed not to exceed 30 mph (50 km/h).

Warning!

If circumstances require towing the vehicle with all wheels on the ground, always tow with a tow bar if:

- the engine will not run
- there is a malfunction in the power supply or in the vehicle's electrical system

as that will be necessary to adequately control the towed vehicle.

Prior to towing the vehicle with all wheels on the ground, make sure the SmartKey is in starter switch position **2**.

If the SmartKey is left in starter switch position **0** for an extended period of time, it can no longer be turned in the switch. In this case, the steering is locked. To unlock, remove SmartKey from starter switch and reinsert.

i To signal turns while being towed with the hazard warning flasher in use, switch on the ignition and activate the combination switch for the left or right turn signal in the usual manner – only the selected turn signal will operate.

Upon canceling the turn signal, the hazard warning flasher will operate again.

Warning!

With the engine not running, there is no power assistance for the brake and steering systems. In this case, it is important to keep in mind that a considerably higher degree of effort is necessary to brake and steer the vehicle. Adapt your driving accordingly.

! When towing the vehicle with all wheels on the ground, please note the following:

With the automatic central locking activated and the SmartKey in starter switch position **2**, the vehicle doors lock if the left front wheel as well as the right rear wheel are turning at vehicle speeds of approx. 9 mph (15 km/h) or more.

To prevent the vehicle doors from locking, deactivate the automatic central locking (▷ page 143).

Towing of the vehicle should only be done using the properly installed towing eye bolt. Never attach tow cable, tow rope or tow rod to vehicle chassis, frame or suspension parts.

i If the battery is disconnected or discharged

- the SmartKey will not turn in the starter switch. For more information, see “Battery” (▷ page 383) and “Jump starting” (▷ page 386).
- the gear selector lever will remain locked in position **P**. For information on manually unlocking the transmission gear selector lever see (▷ page 363).

Towing the vehicle

Installing towing eye bolt

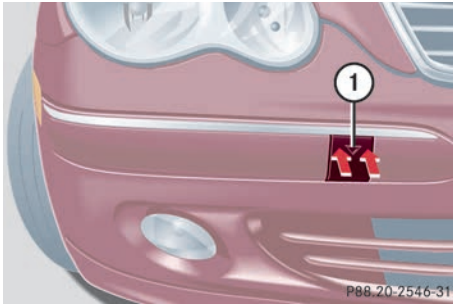

① Cover on right side of front bumper

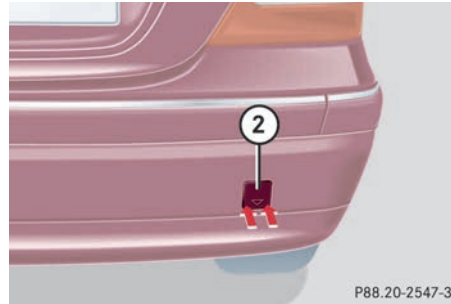

② Cover on right side of rear bumper

Removing cover

- ▶ Press mark on cover ① or ② in direction of arrows.
- ▶ Lift cover off to reveal the threaded hole for towing eye bolt.

The towing eye bolt is supplied with the tool kit (located in the compartment underneath the trunk floor).

- ▶ Screw towing eye bolt in to its stop and tighten with lug wrench.

Reinstalling cover

- ▶ Fit cover ① or ② and snap into place.

▼ Fuses

The electrical fuses in your vehicle serve to switch off malfunctioning power circuits.

If a fuse is blown, the components and systems secured by that fuse will stop operating.

Warning!



Only use fuses approved by Mercedes-Benz with the specified amperage for the system in question and do not attempt to repair or bridge a blown fuse. Using other than approved fuses or using repaired or bridged fuses may cause an overload leading to a fire, and/or cause damage to electrical components and/or systems. Have the cause determined and remedied by an authorized Mercedes-Benz Center

i A blown fuse must be replaced by an appropriate spare fuse (recognizable by its color or the fuse rating given on the fuse) of the amperage recommended in the fuse chart. Any Mercedes-Benz Center will be glad to advise you on this subject.

If a newly inserted fuse blows again, have the cause determined and rectified by an authorized Mercedes-Benz Center.

The following aids are available to help you replace fuses.

- Fuse chart

The fuse chart is located in the main fuse box in the passenger compartment (▷ page 392). The fuse chart explains the fuse allocation and fuse amperages.

- Spare fuses

Spare fuses are located in the vehicle tool kit in the spare wheel well (▷ page 356).

- Fuse extractor

The fuse extractor is located in the cover of the auxiliary fuse box in the trunk (▷ page 394).

The electrical fuses are located in different fuse boxes:

- in the passenger compartment on the driver's side (▷ page 392)
- on the driver's side of the engine compartment (▷ page 392)
- in the trunk (▷ page 394)

Before replacing fuses:

- ▶ Apply the parking brake (▷ page 54).
- ▶ Make sure the gear selector lever* is set to position **P** (▷ page 153) (manual transmission: to Neutral (▷ page 149)).
- ▶ Turn off all electrical consumers.
- ▶ Turn off the engine (▷ page 55).
- ▶ Remove the SmartKey from the starter switch.

Fuses

Main fuse box in passenger compartment

The main fuse box is located in the passenger compartment on the driver's side of the cockpit.

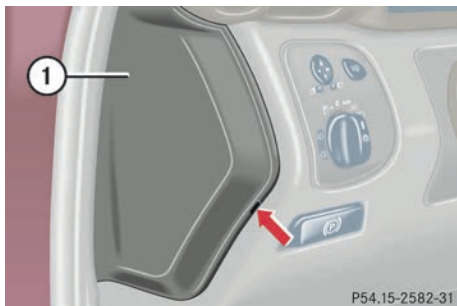

① Main fuse box cover

Opening fuse box

- ▶ Open the driver's door.
- ▶ Pull fuse box cover ① open with a screw driver or similar tool (see arrow).
- ▶ Remove fuse box cover ① rearward.

Closing fuse box

- ▶ Attach fuse box cover ① in the front.
- ▶ Fold fuse box cover ① in until it engages.

Fuse box in engine compartment

The fuse box is located in the engine compartment on the driver's side.

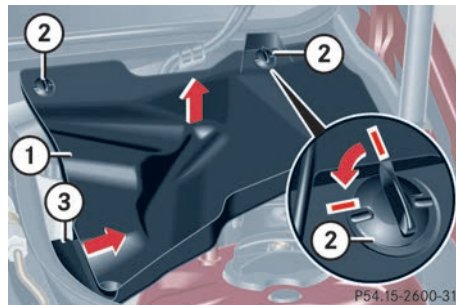

- ① Cover
- ② Screws
- ③ Retainer

Removing cover

- ▶ Twist screws ② 90° counterclockwise.
- ▶ Lift the rear of cover ①.
- ▶ Slide out retainer ③ and remove cover ① by pulling towards front.

Opening fuse box

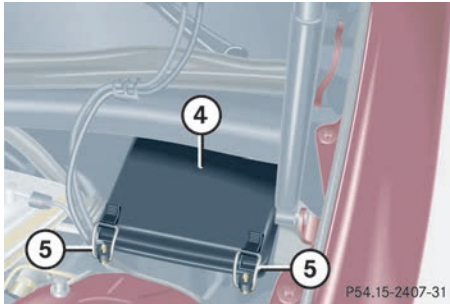

④ Fuse box cover

⑤ Clamps

- ▶ With a dry cloth, remove any moisture from the fuse box.
- ▶ Release clamps ⑤.
- ▶ Remove fuse box cover ④.

Closing fuse box

- ▶ Make sure that the sealing rubber is properly positioned.
- ▶ Press fuse box cover ④ down and secure with clamps ⑤.

! *The fuse box cover ④ must be properly positioned as described to prevent moisture or dirt from entering the fuse box and possibly impairing fuse operation.*

Installing cover

- ▶ Insert cover ① sideways into retainer ③.
- ▶ Twist screws ② 90° clockwise.

Fuses

Fuse box in trunk

The fuse box is located in the trunk behind the left-hand trim panel.

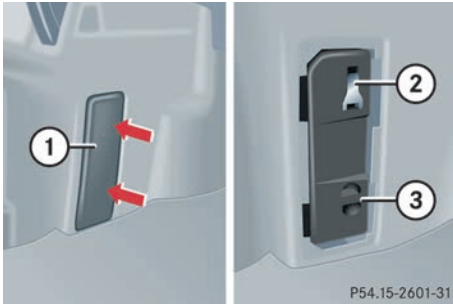

- ① Trim panel
- ② Fuse extractor
- ③ Fuse box cover

Opening fuse box

- ▶ Pull away trim panel ①.
- ▶ Remove fuse box cover ③.

Closing fuse box

- ▶ Insert fuse box cover ③.
- ▶ Insert trim panel ①.



Parts service

Warranty coverage

Identification labels

Layout of poly-V-belt drive

Engine

Rims and Tires

Electrical system

Main dimensions and weights

Weights

Fuels, coolants, lubricants, etc.

The “Technical data” section provides the necessary technical data for your vehicle.

All authorized Mercedes-Benz Centers maintain a stock of Genuine Mercedes-Benz parts required for maintenance and repair work. In addition, strategically located parts distribution centers provide quick and reliable parts service.

More than 300 000 different parts for Mercedes-Benz models are available.

Genuine Mercedes-Benz parts are subject to stringent quality inspections. Each part has been specifically developed, manufactured or selected for and adapted to Mercedes-Benz vehicles.

Therefore, Genuine Mercedes-Benz parts should be installed.

! *The use of non-genuine Mercedes-Benz parts and accessories not authorized by Mercedes-Benz could damage the vehicle, which is not covered by the Mercedes-Benz Limited Warranty, or could compromise the vehicle's durability or safety.*

▼ Warranty coverage

Your vehicle is covered under the terms of the warranties printed in the Service and Warranty Information booklet. Your authorized Mercedes-Benz Center will exchange or repair any defective parts originally installed in the vehicle in accordance with the terms of the following warranties:

- New Vehicle Limited Warranty
- Emission System Warranty
- Emission Performance Warranty
- California, Maine, Massachusetts, and Vermont Emission Control Systems Warranty

Replacement parts and accessories are covered by the Mercedes-Benz Parts and Accessories warranties, copies of which are available at any Mercedes-Benz Center.

Loss of Service and Warranty Information Booklet

Should you lose your Service and Warranty Information booklet, have an authorized Mercedes-Benz Center arrange for a replacement. It will be mailed to you.

Identification labels

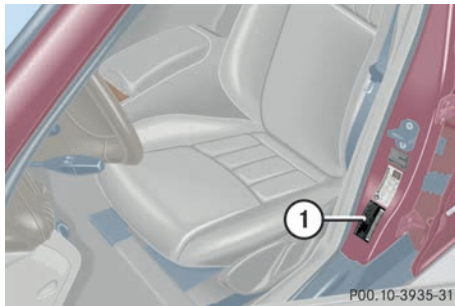

① Certification label (on driver's B-pillar)

The VehicIdentification Number (VIN) can be found in the following locations:

- on the certification label.
- embossed underneath the carpet in front of the front passenger seat (▷ page 399).
- on the lower edge of the windshield (▷ page 399).

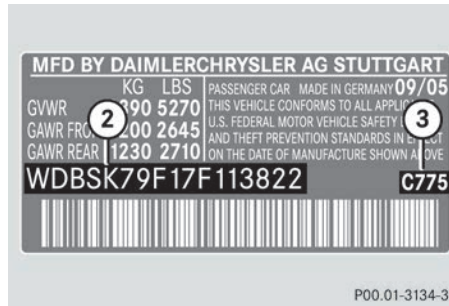

Example certification label (U.S. vehicles)

- ② VIN
- ③ Paintwork code

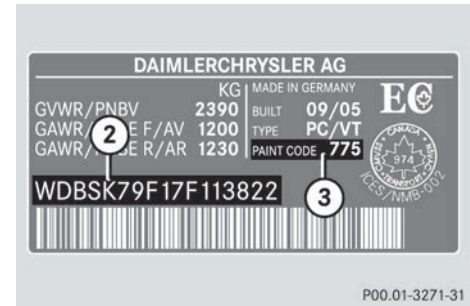

Example certification label (Canada vehicles)

- ② VIN
- ③ Paintwork code

i Data shown on certification label are for illustration purpose only. These data are specific to each vehicle and may vary from data shown in the illustration. Refer to certification label on vehicle for actual data specific to your vehicle.

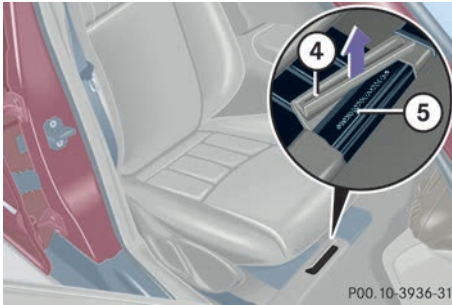

- ④ Carpet
- ⑤ VIN

- ▶ Move the front passenger seat to the rear as far as possible.
- ▶ Fold carpet ④ in direction of arrow. VIN ⑤ is visible.

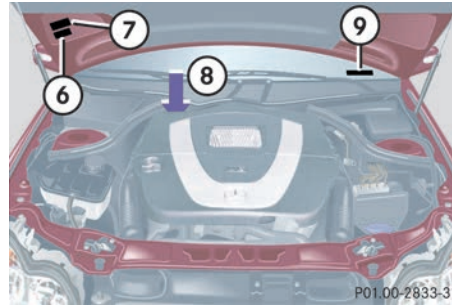

- ⑥ Emission control information label, includes both federal and California certification exhaust emission standards
- ⑦ Vacuum line routing diagram label
- ⑧ Engine number (engraved on engine)
- ⑨ VIN (lower edge of windshield)

i When ordering parts, please specify vehicle identification and engine numbers.

Layout of poly-V-belt drive

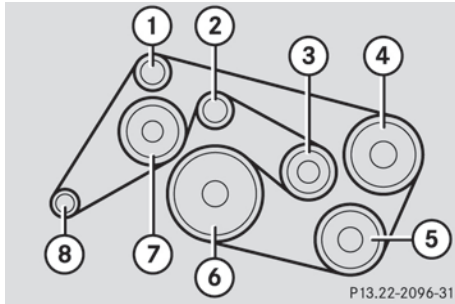

All models

- ① Idler pulley
- ② Idler pulley
- ③ Automatic belt tensioner
- ④ Power steering pump
- ⑤ Air conditioning compressor
- ⑥ Crankshaft
- ⑦ Coolant pump
- ⑧ Generator (alternator)

▼ Engine

Model	C 230 (203.052) ¹ C 230 Sport (203.052) ¹	C 280 (203.054) ¹ C 280 4MATIC (203.092) ¹
Engine	272	272
Mode of operation	4-stroke engine, gasoline injection	4-stroke engine, gasoline injection
No. of cylinders	6	6
Bore	3.46 in (88.00 mm)	3.46 in (88.00 mm)
Stroke	2.69 in (68.40 mm)	3.23 in (82.10 mm)
Total piston displacement	152.3 cu in (2496 cm ³)	182.8 cu in (2996 cm ³)
Compression ratio	11.2:1	11.3:1
Output acc. to SAE J 1349	201 hp/6200 rpm ² (150 kW/6200 rpm)	228 hp/6000 rpm ² (170 kW/6000 rpm)
Maximum torque acc. to SAE J 1349	181 lb-ft/2700 – 5500 rpm (245 Nm/2700 – 5500 rpm)	221 lb-ft/2700 – 5000 rpm (300 Nm/2700 – 5000 rpm)
Maximum engine speed	6500 rpm	6500 rpm
Firing order	1-4-3-6-2-5	1-4-3-6-2-5
Poly-V-belt	2404 mm	2404 mm

¹ The quoted data apply only to the standard vehicle. See an authorized Mercedes-Benz Center for the corresponding data of all special bodies and special equipment.

² Premium fuel required. Performance may vary with fuel octane rating.

Engine

Model	C 350 (203.056) ¹ C 350 Sport (203.056) ¹ C 350 4MATIC (203.087) ¹
Engine	272
Mode of operation	4-stroke engine, gasoline injection
No. of cylinders	6
Bore	3.65 in (92.90 mm)
Stroke	3.38 in (86.00 mm)
Total piston displacement	213.5 cu in (3498 cm ³)
Compression ratio	10.7:1
Output acc. to SAE J 1349	268 hp/6000 rpm ² (200 kW/6000 rpm)
Maximum torque acc. to SAE J 1349	258 lb-ft/2400 – 5000 rpm (350 Nm/2400 – 5000 rpm)
Maximum engine speed	6500 rpm
Firing order	1-4-3-6-2-5
Poly-V-belt	2404 mm

¹ The quoted data apply only to the standard vehicle. See an authorized Mercedes-Benz Center for the corresponding data of all special bodies and special equipment.

² Premium fuel required. Performance may vary with fuel octane rating.

▼ Rims and Tires

! Only use tires which have been tested and approved for your vehicle by Mercedes-Benz. Tires approved by Mercedes-Benz are developed to provide best possible performance in conjunction with the driving safety systems on your vehicle such as ABS or ESP®. Tires specially developed for your vehicle and tested and approved by Mercedes-Benz can be identified by finding the following on the tire's sidewall:

- MO = Mercedes-Benz Original equipment tires
- MOE = Mercedes-Benz Original Extended (tires with limited run-flat characteristics) original equipment tires. Using tires other than those approved by Mercedes-Benz may result in damage that is not covered by the Mercedes-Benz Limited Warranty.

i For information on driving with MOExtended tires, see "MOExtended system*" (▷ page 382).

! Using tires other than those approved by Mercedes-Benz can have detrimental effects, such as

- poor handling characteristics
- increased noise
- increased fuel consumption

Moreover, tires and rims not approved by Mercedes-Benz may, under load, exhibit dimensional variations and different tire deformation characteristics that could cause them to come into contact with the vehicle body or axle parts. Damage to the tires or the vehicle may be the result.

i Further information on tires and rims is available at any authorized Mercedes-Benz Center. A placard with the recommended tire inflation pressures is located on the driver's door B-pillar. Some vehicles may have supplemental tire inflation pressure information for driving at high speeds (▷ page 290) or for vehicle loads less than the maximum loaded vehicle condition (▷ page 290).



If such information is provided, it can be found on the placard located on the inside of the fuel filler flap. The tire inflation pressure should be checked regularly and should only be adjusted on cold tires. Follow tire manufacturer's maintenance recommendation included with vehicle.

i The following pages also list the approved wheel rim and tire sizes for equipping your vehicles with winter tires. Winter tires are not available as standard or optional factory equipment, but can be purchased from an authorized Mercedes-Benz Center.

Depending on vehicle model and the standard or optional factory-equipped wheel rim/tire configuration on your vehicle (Appearance Package, Sport Package etc.), equipping your vehicle with winter tires approved for your vehicle model may also require the purchase of two or four wheel rims of the recommended size for use with these winter tires. See an authorized Mercedes-Benz Center for more information.

Rims and Tires

Same size tires

Model	C 230 C 280 C 280 4MATIC C 350 C 350 4MATIC	C 230 Sport C 350 Sport
Rims (light alloy)	7 J x 16 H2	7.5 J x 17 H2
Wheel offset	1.22 in (31 mm)	1.42 in (36 mm)
All-season tires ¹	205/55 R16 91H M+S	-
Winter tires ^{1,2}	205/55 R16 91H M+S 	225/45 R17 91H M+S  or 225/45 R17 91H M+S  MOExtended ³

¹ Radial-ply tires

² Not available as factory equipment.

³ Must be used in conjunction with Run Flat Indicator* only.

Mixed size tires

Model	C 230 Sport C 350 Sport
--------------	--

Front axle:

Rims (light alloy)	7.5 J x 17 H2
Wheel offset	1.42 in (36 mm)
Summer tires¹	225/45 R17 91W or 225/45 R17 91W MOExtended ²

Rear axle:

Rims	8.5 J x 17 H2
Wheel offset	1.18 in (30 mm)
Summer tires^{1,3}	245/40 R17 91W or 245/40 R17 91W MOExtended ²

¹ Radial-ply tires

² Must be used in conjunction with Run Flat Indicator* only.

³ Must not be used with snow chains.

Rims and Tires

Minispare wheel

Model	C 230 C 280 C 280 4MATIC C 350 C 350 4MATIC	C 230 Sport C 350 Sport
Rim (steel)	3.5 B x 16 H2	3.5 B x 17 H2
Wheel offset	0.67 in (17 mm)	0.67 in (17 mm)
Tire¹	T 125/90 R16 98M	T 125/80 R17 99M

¹ Must not be used with snow chains.

! Please compare the recommended tire inflation pressure for your vehicle with the tire inflation pressure on the yellow label located on the spare wheel rim.

If the tire inflation pressure on the yellow label on the spare wheel rim differs from the values given in this Operator's Manual, inflate the Minispare wheel to the recommended tire inflation pressure given on the yellow label on the spare wheel rim.

i Please note that the tire inflation pressure of the Minispare differs from the tire inflation pressure of the road tires.

Inflate the Minispare wheel to approximately 61 psi (4.2 bar).

▼ **Electrical system**

Model	all models
Generator (alternator)	14 V/150 A
Starter motor	12 V/1.4 kW
Battery	12 V/100 Ah
Spark plugs	Bosch Platin Y 7 MPP 33 NGK PLKR 6A
Electrode gap	0.031 in (0.8 mm)
Tightening torque	18 – 22 lb-ft (25 – 30 Nm)

Main dimensions and weights

Main dimensions

Model	C 230 C 230 Sport	C 280 C 350	C 280 4MATIC C 350 4MATIC	C 350 Sport
Overall vehicle length	178.4 in (4532 mm)	178.4 in (4532 mm)	178.4 in (4532 mm)	178.4 in (4532 mm)
Overall vehicle width (exterior rear view mirrors folded out)	77.8 in (1977 mm)	77.8 in (1977 mm)	77.8 in (1977 mm)	77.8 in (1977 mm)
Overall vehicle height	55.6 in (1413 mm)	56.1 in (1426 mm)	56.3 in (1429 mm)	55.5 in (1410 mm)
Wheelbase	106.9 in (2715 mm)	106.9 in (2715 mm)	106.9 in (2715 mm)	106.9 in (2715 mm)
Track, front	59.3 in (1505 mm)	59.3 in (1505 mm)	59.3 in (1505 mm)	59.3 in (1505 mm)
Track, rear	58.1 in (1476 mm)	58.1 in (1476 mm)	58.1 in (1476 mm)	58.1 in (1476 mm)

Weights

Roof load max.	220 lb (100 kg)
Trunk load max.	220 lb (100 kg)

Fuels, coolants, lubricants, etc.

▼ **Fuels, coolants, lubricants, etc.**

Capacities

Vehicle components and their respective lubricants must match. Therefore only use products tested and approved by Mercedes-Benz.

Please refer to the Factory Approved Service Products pamphlet, or inquire at your Mercedes-Benz Center.

Warning!



Comply with all valid regulations with respect to handling, storing, and disposing of service fluids. Otherwise you could endanger persons or the environment.

Keep service fluids out of the reach of children.

For health reasons, you should prevent service fluids from coming into direct contact with your eyes or any open wounds.

If a service fluid is swallowed, contact a physician immediately.

	Model	Capacity	Fuels, coolants, lubricants, etc.
Engine with oil filter		8.5 US qt (8.0 l)	Approved engine oils
Automatic transmission	C 230 (all models)	9.0 US qt (8.5 l)	MB Automatic Transmission Fluid
	C 280	9.0 US qt (8.5 l)	
	C 350 (all models)	9.0 US qt (8.5 l)	
	C 280 4MATIC	8.3 US qt (7.8 l)	
	C 350 4MATIC	8.3 US qt (7.8 l)	
Manual transmission	C 230 Sport	1.3 US qt (1.2 l)	MB Manual Transmission Oil
	C 350 Sport	1.6 US qt (1.5 l)	

Fuels, coolants, lubricants, etc.

	Model	Capacity	Fuels, coolants, lubricants, etc.
Rear axle	C 230 (all models) C 280 (all models) C 350 C 350 Sport C 350 4MATIC	1.0 US qt (1.0 l) 1.2 US qt (1.1 l) 1.2 US qt (1.1 l) 1.2 US qt (1.1 l) 1.0 US qt (1.0 l)	Hypoid gear oil SAE 85 W 90
Front axle	C 280 4MATIC C 350 4MATIC	0.5 US qt (0.46 l)	Hypoid gear oil SAE 85 W 90
Transfer case	C 280 4MATIC C 350 4MATIC	approx. 0.62 US qt (0.59 l)	MB Transfer case fluid
Power steering		approx. 1.1 US qt (1.0 l)	MB Power Steering Fluid (Pentosin CHF 11S)
Front wheel hubs		approx. 2.1 oz (60 g) each	High temperature roller bearing grease
Brake system		0.5 US qt (0.5 l)	MB Brake Fluid (DOT 4+)
Cooling system		approx. 7.8 US qt (7.4 l)	MB 325.0 Anticorrosion/antifreeze agent

Fuels, coolants, lubricants, etc.

	Model	Capacity	Fuels, coolants, lubricants, etc.
Fuel tank including a reserve of		16.4 US gal (62.0 l)	Premium unleaded gasoline: Minimum Posted Octane 91 (Avg. of 96 RON/86 MON)
		2.1 US gal (8.0 l)	C 230/C 230 Sport: Flexible Fuel Vehicle (identified by a label reading Premium gasoline or E85 only! on fuel filler flap): Alternative fuel: Ethanol fuel (E85)
Air conditioning system			R-134a refrigerant and special PAG lubricant oil (never R-12)
Windshield washer		3.2 US qt (3.0 l)	MB Windshield Washer Concentrate ¹
Windshield washer and headlamp cleaning system*		6.4 US qt (6.0 l)	

¹ Use MB Windshield Washer Concentrate “MB SummerFit” and water for temperatures above freezing point or MB Windshield Washer Concentrate “MB SummerFit” and commercially available premixed windshield washer solvent/antifreeze for temperatures below freezing point. Follow suggested mixing ratios (> page 418).

Fuels, coolants, lubricants, etc.

Engine oils

Engine oils are specifically tested for their suitability in our engines and durability for our service intervals. Therefore, only use approved engine oils and oil filters required for vehicles with Maintenance System (U.S. vehicles) or FSS (Canada vehicles). For a listing of approved engine oils and oil filters, refer to the Factory Approved Service Products pamphlet, or contact an authorized Mercedes-Benz Center.

! *Using engine oils and oil filters of specification other than those expressly required for the Maintenance System (U.S. vehicles) or FSS (Canada vehicles), or changing of oil and oil filter at change intervals longer than those called for by the Maintenance System (U.S. vehicles) or FSS (Canada Vehicles) will result in engine or emission control system damage not covered by the Mercedes-Benz Limited Warranty.*

Please follow Maintenance System (U.S. vehicles) or FSS (Canada vehicles) recommendations for scheduled oil changes. Failure to do so will result in engine or emission control system damage not covered by the Mercedes-Benz Limited Warranty.

Engine oil additives

Do not blend oil additives with engine oil. They may damage the engine.

Damage or malfunctions resulting from blending oil additives are not covered by the Mercedes-Benz Limited Warranty.

Air conditioning refrigerant

R-134a (HFC) refrigerant and special PAG lubricating oil are used in the air conditioning system.

Never use R-12 (CFC) or mineral-based lubricating oil. Otherwise damage to the system will occur.

Brake fluid

During vehicle operation, the boiling point of the brake fluid is continuously reduced through the absorption of moisture from the atmosphere.

Warning!



Under extremely strenuous operating conditions, this moisture content can lead to the formation of bubbles in the system, thus reducing the system's efficiency.

Therefore, the brake fluid must be replaced regularly. Refer to your vehicle's Maintenance Booklet for replacement interval.

Only brake fluid approved by Mercedes-Benz is recommended. An authorized Mercedes-Benz Center will provide you with additional information.

Premium unleaded gasoline

Warning!



Gasoline is highly flammable and poisonous. It burns violently and can cause serious personal injury.

Never allow sparks, flame or smoking materials near gasoline!

Turn off the engine before refueling

Whenever you are around gasoline, avoid inhaling fumes and skin or clothing contact, extinguish all smoking materials.

Direct skin contact with fuels and the inhalation of fuel vapors can be damaging to your health.

! *To maintain the engine's durability and performance, premium unleaded gasoline must be used. If premium unleaded is not available and low octane fuel is used, follow these precautions:*

- *Have the fuel tank only partially filled with unleaded regular and fill up with premium unleaded as soon as possible.*
- *Avoid full throttle driving and abrupt acceleration.*
- *Do not exceed an engine speed of 3000 rpm if the vehicle is loaded with a light load such as two persons and no luggage.*
- *Do not exceed $\frac{2}{3}$ of maximum accelerator pedal position if the vehicle is fully loaded or operating in mountainous terrain.*

Gasoline additives

A major concern among engine manufacturers is carbon build-up caused by gasoline. Mercedes-Benz recommends only the use of quality gasoline containing additives that prevent the build-up of carbon deposits.

After an extended period of using fuels without such additives, carbon deposits can build up especially on the intake valves and in the combustion area, leading to engine performance problems such as:

- Warm-up hesitation
- Unstable idle
- Knocking/pinging
- Misfire
- Power loss

Fuels, coolants, lubricants, etc.

In areas where carbon deposits may be encountered due to lack of availability of gasolines which contain these additives, Mercedes-Benz recommends the use of additives approved by us for use on Mercedes-Benz vehicles. Refer to Factory Approved Service Products pamphlet for a listing of approved product(s). Follow directions on product label.

Do not blend other fuel additives with fuel. This only results in unnecessary cost and may be harmful to engine operation.

Damage or malfunction resulting from poor fuel quality or from blending additional fuel additives other than those tested and approved by us for use on Mercedes-Benz vehicles listed in the Factory Approved Service Products pamphlet are not covered by the Mercedes-Benz Limited Warranty.

Fuel requirements

Only use premium unleaded fuel:

- The octane number (posted at the pump) must be 91 min. It is an average of both the Research (R) octane number and the Motor (M) octane number: $(R+M)/2$. This is also known as the ANTI-KNOCK INDEX.

Unleaded gasoline containing oxygenates such as ethanol, IPA, IBA and TBA can be used provided the ratio of any one of these oxygenates to gasoline does not exceed 10%; MTBE must not exceed 15%.

The ratio of methanol to gasoline must not exceed 3% plus additional cosolvents.

Using mixtures of ethanol and methanol is not allowed. Gasohol, which contains 10% ethanol and 90% unleaded gasoline, can be used.

These blends must also meet all other fuel requirements, such as resistance to spark knock, boiling range, vapor pressure, etc.

Flexible Fuel Vehicles (C 230/C 230 Sport only)

Flexible Fuel Vehicles are identified by a label reading **Premium gasoline or E85 only!** on fuel filler flap).

These vehicles are designed to operate on premium unleaded gasoline or Ethanol fuel (E85), or on any mixture of these two.

Ethanol fuel (E85) is a mixture of approximately 85% Ethanol and 15% unleaded gasoline.

Warning!



Ethanol fuel (E85) and its fumes are highly flammable, poisonous and burn easily. Ethanol fuel can cause serious injuries if ignited or if you come into contact with it or inhale fumes of it. Avoid inhalation of Ethanol fumes and skin contact with Ethanol. Extinguish all open flames before fueling. Never smoke or create sparks close to Ethanol.

Fuels, coolants, lubricants, etc.**Switching fuels**

For best performance and driveability it is recommended to use either one or the other fuel. A refueling pattern that alternates between the two different fuels should be avoided if possible.

When switching fuels, make sure:

- Fuel level is below half full.
- Fuel level is above reserve (reserve warning lamp is not lit).
- Amount of added fuel is more than 5 gallons (20 liters).
- Ignition is off during refill.
- Immediately after refueling engine is started and operated for at least five minutes.

These precautions and recommendations are supposed to prevent any difficulties when starting and operating the engine which otherwise may be experienced before the engine has fully adapted to the different fuel.

If in spite of these recommendations the engine does not perform properly, adding more gasoline (at least 3 gallons [12 liters]) to the fuel may improve the engine behavior.

Cruising range

E85 fuel contains less energy per gallon than gasoline. To ensure that engine performance with Ethanol fuel is similar to that when using gasoline, the engine must burn more Ethanol fuel. As a result, it is to be expected that the fuel consumption will increase when using E85 compared to gasoline operation.

 *Use of E85 may reduce your driving range.*

Maintenance

Please inform your authorized Mercedes-Benz Center if you use or have used E85 fuel when your vehicle is delivered for maintenance or repairs.

Cold weather performance

It is possible that starting times will significantly increase at temperatures below 32°F (0°C). At low temperatures the use of a block heater is recommended (see an authorized Mercedes-Benz Center for further information). Rough idling may also be experienced at such temperatures before the engine is fully warmed up.

 *E85 fuel is unsuitable for use when ambient temperatures fall below 14°F (-10°C).*

Hot weather performance

At ambient temperatures above 95°F (35°C) start times may increase and be accompanied by a rough idle following the start.

Fuels, coolants, lubricants, etc.

Coolants

The engine coolant is a mixture of water and anticorrosion/antifreeze, which provides:

- Corrosion protection
- Freeze protection
- Boiling protection (by increasing the boiling point)

The cooling system was filled at the factory with a coolant providing freeze protection to approximately -22°F (-30°C) and corrosion protection.

! *Add premixed coolant solution only. Adding water and MB 325.0 Anticorrosion/Antifreeze separately from each other, could cause engine damage not covered by the Mercedes-Benz Limited Warranty*

If the antifreeze mixture is effective to -22°F (-30°C), the boiling point of the coolant in the pressurized cooling system is reached at approx. 266°F (130°C).

The coolant solution must be used year-round to provide the necessary corrosion protection and increase boil-over protection. Refer to Maintenance Booklet for replacement interval.

Coolant system design and coolant used determine the replacement interval. The replacement interval published in the Maintenance Booklet is only applicable if MB 325.0 anticorrosion/antifreeze solution or other Mercedes-Benz approved products of equal specification (see Factory Approved Service Products pamphlet) are used to renew the coolant concentration or bring it back up to the proper level.

To provide important corrosion protection, the solution must be at least 45% anticorrosion/antifreeze [equivalent to freeze protection to approx. -22°F (-30°C)].

If you use a solution that is more than 55% anticorrosion/antifreeze [freeze protection to approx. -49°F (-45°C)], the engine temperature will increase due to the lower heat transfer capability of the solution. Therefore, do not use more than this amount of anticorrosion/antifreeze.

If the coolant level is low, water and MB 325.0 anticorrosion/antifreeze should be used to bring it up to the proper level (have cooling system checked for signs of leakage). Please make sure the mixture is in accordance with label instructions.

The water in the cooling system must meet minimum requirements, which are usually satisfied by normal drinking water. If you are not sure about the water quality, consult an authorized Mercedes-Benz Center.

Fuels, coolants, lubricants, etc.

Anticorrosion/antifreeze

Your vehicle contains a number of aluminum parts. The use of aluminum components in motor vehicle engines necessitates that anticorrosion/antifreeze coolant used in such engines be specifically formulated to protect the aluminum parts.

Failure to use such anticorrosion/antifreeze coolant will result in a significantly shortened service life.

Therefore, the following product is strongly recommended for use in your vehicle:

Mercedes-Benz 325.0

Anticorrosion/Antifreeze Agent.

Before the start of the winter season (or once a year in hot southern regions), you should have the anticorrosion/antifreeze concentration checked. The coolant is also regularly checked each time you bring your vehicle to an authorized Mercedes-Benz Center for service.

Anticorrosion/antifreeze quantity

Model	Approx. freeze protection	
	-35°F (-37°C)	-49°F (-45°C)
all models	3.8 US qt (3.6 l)	4.1 US qt (3.9 l)

Fuels, coolants, lubricants, etc.

Windshield washer and headlamp cleaning system*

Both the windshield washer and headlamp cleaning system* are supplied from the windshield washer fluid reservoir.

The washer fluid reservoir has a capacity of approx.:

- 3.2 US qt (3.0 l) in vehicles without headlamp cleaning system*
- 6.4 US qt (6.0 l) in vehicles with headlamp cleaning system*

- ▶ Refill the reservoir with MB Windshield Washer Concentrate “MB SummerFit” and water (or concentrate and commercially available premixed windshield washer solvent/antifreeze, depending on ambient temperatures).

Warning!



Washer solvent/antifreeze is highly flammable. Do not spill washer solvent/antifreeze on hot engine parts, because it may ignite and burn. You could be seriously burned.

Windshield and headlamp washer fluid mixing ratio

For temperatures above freezing point, use MB Windshield Washer Concentrate “MB SummerFit” and water:

- 1 part “MB SummerFit” to 100 parts water

(1.34 fl oz [40 ml] “MB SummerFit” to 1 gallon [4.0 l] water)

For temperatures below freezing point, use MB Windshield Washer Concentrate “MB SummerFit” and commercially available premixed windshield washer solvent/antifreeze:

- 1 part “MB SummerFit” to 100 parts solvent

(1.34 fl oz [40 ml] “MB SummerFit” to 1 gallon [4.0 l] solvent)

- A**
- ABS 25, 82
 - Malfunction indicator lamp 322, 323
 - Messages in display 335
 - Accelerator position,
 - automatic transmission 155
 - Accessory weight 304
 - Accident
 - In case of 53
 - Active head restraints
 - see Head restraints
 - Additional turn signals 368
 - Air bags 59
 - Children 75
 - Front passenger front air bag off indicator lamp 27, 68, 331
 - Front, Driver 63
 - Front, Passenger 63
 - Passenger 63
 - Safety guidelines 62
 - Side impact (front and rear*) 64
 - Window curtain 64
 - Air conditioning refrigerant 412
 - Air conditioning system
 - Automatic climate control* 174
 - Climate control 164
 - Air conditioning, Cooling
 - Automatic climate control* 184
 - Climate control 172
 - Air distribution
 - Automatic climate control* 178
 - Climate control 168
 - Air pressure see Tire inflation pressure
 - Air recirculation mode
 - Automatic climate control* 181
 - Climate control 170
 - Air vents, Front
 - Automatic climate control* 175
 - Climate control 165
 - Air vents, Rear
 - Automatic climate control* 186
 - Climate control 173
 - Air volume
 - Automatic climate control* 179
 - Climate control 168
 - Alignment bolt (vehicle tool kit) 379
 - Anticorrosion/antifreeze 417
 - Antiglare, Rear view mirror 160
 - Anti-theft systems 89
 - Anti-theft alarm system* 89
 - Immobilizer 89
 - Aquaplaning see Hydroplaning
 - Armrest 238
 - Ashtrays 241
 - Aspect ratio 304
 - ATF (Automatic transmission fluid) 277
 - AUDIO menu
 - Search function 142
 - AUDIO menu (Control system) 127

- Audio system 187
 - Audio and telephone, operation 187
 - Button and soft key operation 190
 - CD changer* with MP3 202
 - CD operation 201
 - Operating and display elements 188
 - Operating audio system 190
 - Operating safety 187
 - Radio operation 194
 - Telephone* operation 208
 - Auto-dimming mirror* 161
 - Automatic central locking
 - Activating/deactivating (Control system) 143
 - Automatic climate control* 174
 - Control panel 175
 - Defrosting, front 179
 - Rear window defroster 163
 - Automatic headlamp mode 110
 - Automatic locking when driving 99
 - Automatic shift program 157
 - Automatic time change (Standard time, Daylight Saving time) 137
 - Automatic transmission 151
 - Accelerator position 155
 - Automatic shift program 157
 - Emergency operation (limp-home mode) 159
 - Gear ranges 156
 - Gear selector lever 151
 - Gear selector lever positions 153
 - Gear shifting malfunctions 159
 - Kickdown 155
 - One-touch gearshifting 158
 - Program mode selector switch 157
 - Shifting procedure 152
 - Automatic transmission*
 - Fluid level (ATF) 277
 - Starting engine 47
- ## B
- Backrest
 - Driver's multicontour seat* (Canada only) 105
 - Rear seat, folding 234
 - Seat, manual 35
 - Seat, power* 37
 - Backup lamps
 - Messages in display 352
 - Replacing bulbs 368
 - Bar 304
 - BAS 84
 - Batteries, SmartKey
 - Changing 366
 - Checking battery condition 95
 - Battery, Vehicle 279, 383
 - Charging 385
 - Disconnecting and connecting 384
 - Jump starting 386
 - Removing and installing 384
 - Bead 304
 - Block heater (Canada only) 309
 - Bolts, Spare wheel 360

- Brake fluid 412
 - Checking 273
 - Message in display 344
- Brake lamps
 - Cleaning lenses 316
 - Replacing bulbs 373
- Brake pads
 - Message in display 344
- Brakes 262
 - Warning lamp 25, 324
- Break-in period 260
- Bulbs, replacing see Replacing bulbs

- C**
- California retail buyers and lessees,
 - important notice 11
- Cargo area see Trunk
- Cargo tie-down rings* 236
- Carpets, cleaning 319
- Catalytic converter 269
- CD changer* 201
- CD player* 128, 201
- Centigrade see
 - Temperature display mode 133
- Central locking
 - Automatic 99, 143
 - From inside 100
 - Locking/unlocking from inside 100
 - Switch 100
- Certification label 398
- Certification label, examples 398
- Charcoal filter
 - Automatic climate control* 183

- Children in the vehicle 74
 - Air bags 60
 - Blocking rear
 - door window operation 80
 - Indicator lamp, front
 - passenger air bag 68, 331
 - Infant and child restraint systems 74
 - LATCH-type child seat anchors 79
 - Occupant Classification System (OCS) 64
- Cigarette lighter 242
- Climate control system 164
 - Control panel,
 - Automatic climate control 175
 - Control panel,
 - Climate control 165
 - Defrosting, Front 169
 - Rear window defroster 163
- Clock 25, 121
 - Setting time 136, 137
- Cockpit 22
- Cold tire inflation pressure 304
- Cold weather performance 415
- Collapsible wheel chock 358

- COMAND* see separate COMAND
 - operating instructions
 - Combination switch 50, 113
 - Control system 121
 - Multifunction display 121
 - Multifunction steering wheel 122
 - Resetting to factory default 131
 - Control system menu 121
 - AUDIO 127
 - Menus overview 124
 - NAV* 129
 - Settings 131
 - Standard display 126
 - TEL* 146
 - Trip computer 144
 - Vehicle status
 - message memory 130
 - Control system submenus 123, 125
 - Convenience 143
 - Instrument cluster 134
 - Lighting 139
 - Time/Date 136
 - Vehicle 142
 - Coolant 278, 416
 - Anticorrosion/antifreeze
 - quantity 416
 - Capacities 409, 410
 - Checking coolant level 273, 278
 - Messages in display 345–347
 - Temperature 270
 - Temperature gauge 25, 119
 - Corner-illuminating front fog lamps* 113
 - Replacing bulbs 368
 - Cruise control 227
 - Cruising range, fuel 415
 - Cup holder 239, 241
 - Curb weight 304
- D**
- Date display, setting 138
 - Daytime running lamp mode 111
 - Setting 139
 - Deep water see Standing water
 - Defogging windshield
 - Automatic climate control* 180
 - Climate control 170
 - Defrosting, Front
 - Automatic climate control* 179
 - Climate control 169
 - Defrosting, Rear 163
 - Delayed shut-off
 - Exterior lamps 141
 - Interior lighting 142
 - Department of Transportation see DOT
 - Difficulties
 - While driving 53
 - With starting 47
 - Digital clock see clock
 - Digital speedometer 126
 - Dimensions, vehicle 408
 - Direction of rotation (tires) 284

Displays

- Digital speedometer 126
- Maintenance service indicator 310
- Multifunction display 121
- Outside temperature 126
- Symbol messages 343
- Text messages 335
- Vehicle status
 - messages memory 130, 333

Distance to empty (range),

- Trip computer 146

Door control panel 30

Doors

- Entry lamps 117
- Locking/unlocking, SmartKey 92
- Opening from inside/outside 93, 96
- Remote door unlock (Tele Aid*) 252
- Unlocking, Mechanical key 361

DOT 305

Downhill driving

- Cruise control 228

Drinking and driving 261

Driving

- Abroad 268
- Hydroplaning 265
- In winter 267
- Instructions 43, 261
- Problems 53
- Safety systems 82
- Systems 227
- Through standing water 268

Driving safety systems

- 4MATIC 88
- ABS 82
- BAS 84
- Electronic traction system 86
- ESP® 85

Driving tips 155

- Accelerator position 155
- Kickdown 155

E

- Easy-entry/exit feature* 40, 144
- Electrical fuses see Fuses
- Electrical outlet 243
- Electrical system, Technical data 407
- Electronic Stability Program see ESP®
- Emergency calls
 - 911 calls 219
 - Tele Aid* calls 248, 249, 252
- Emergency operation
 - (Limp-Home Mode) 159
- Emergency operations
 - Gear selector lever, Unlocking 363
 - Locking/unlocking the vehicle 361
 - Power tilt/sliding sunroof*,
 - Manual operation 364
 - Remote door unlock 252
 - Trunk lid, Releasing from inside 98
 - Trunk lid, Unlocking 362
- Emergency Tensioning Device see ETD

- Emergency, in case of
 - Battery, Jump starting 386
 - First aid kit 322, 356
 - Flat tire, Changing 377
 - Fuses 391
 - Hazard warning flasher 115
 - Instrument cluster,
 - Indicator lamps 322–330
 - Roadside Assistance 12, 250
 - Towing the vehicle 388
 - Emission control 270
 - Information label 399
 - System warranties 10
 - Engine
 - Belt layout 400
 - Block heater (Canada only) 309
 - Brake-in recommendations 260
 - Cleaning 315
 - Compartment 274
 - Malfunction indicator lamp 25, 325
 - Maximum engine speed 401
 - Number 399
 - Starting 46, 47
 - Tachometer 25
 - Technical data 401
 - Turning 55
 - Engine coolant see coolant
 - Engine oil 276, 412
 - Adding 277
 - Additives 412
 - Changing 409
 - Checking level (Dipstick) 276
 - Consumption 276
 - Filler neck 277
 - Recommended engine
 - and oil filter 348
 - ESP® 85
 - Four wheel electronic traction system
 - with ESP® 88
 - Messages in display 335–336
 - Warning lamp 25, 327
 - ETD 72
 - Safety guidelines 62
 - Ethanol fuel
 - At the gas station 271
 - Switching fuels 415
 - Exterior lamp switch 50, 109
 - Exterior rear view mirrors 42
- F**
- Fahrenheit see
 - Temperature display mode 133
 - Filler neck, Engine oil 277
 - First aid kit 356
 - Flat tire 377
 - Jacking up the vehicle 378
 - Lowering the vehicle 381
 - Minispare wheel 359
 - Mounting the spare wheel 377
 - Preparing the vehicle 377
 - Flexible fuel vehicles 414
 - At the gas station 271
 - Switching fuels 415
 - Flexible Service System see FSS
 - Fluids
 - Automatic
 - transmission fluid 277, 409
 - Brake fluid 273, 412
 - Capacities 409
 - Engine coolant 273, 416
 - Engine oil 276, 412
 - Power steering fluid 410
 - Windshield washer and headlamp
 - cleaning system* 280, 418

- Fog lamps 112
 - Message in display 350, 352
 - Replacing bulbs 368
- Four wheel electronic traction system (4MATIC) with ESP® 88
- 4MATIC 88
- Front air bags 63
- Front lamps see Headlamps
- Front passenger front air bag 63
 - Messages in display 337–340
- Front passenger front air bag off indicator lamp 27, 68, 331, 332
- Front seat head restraints see Head restraints
- FSS (Flexible Service System) (Canada vehicles) 310
- Fuel 271, 272, 413
 - Additives 413
 - Capacities, Fuel tank 411
 - Cruising range 415
 - E85 (Ethanol fuel) 411, 415
 - Filling the tank 271
 - Fuel filler flap and cap, Multifunction
 - display messages 326, 349
 - Fuel gauge 25
 - Fuel reserve warning lamp 328
 - Requirements, Octane rating 414
 - Switching (Flexible fuel vehicle) 415
 - Technical data 411, 413
- Fuel consumption statistics
 - From start 144
 - Since last reset 145
- Fuel filler flap 271
- Fuel reserve warning lamp 25
- Fuel tank
 - Capacity 411
 - Filler flap 271
- Fuels, coolants, lubricants etc.
 - Capacities 409
- Fuses 391
 - Fuse box (main) in
 - passenger compartment 392
 - Fuse box in engine compartment 392
 - Fuse box in trunk 394
 - Fuse extractor 394
 - Replacing 391
- G**
- Garage door opener* 253
- Gasoline also see Fuel
- Gasoline see Fuel
- GAWR 305
- Gear range
 - Automatic transmission 156
 - Limiting 156
 - Shifting into optimal 159
- Gear selector lever 46, 47, 150, 151
 - Cleaning 319
 - Gearshift pattern 151
 - Lock 47
 - Position 152, 153
 - Position,
 - Automatic transmission* 121
 - Shifting procedure 152
 - Unlocking in an emergency 363
- Global locking/unlocking see Key
- Glove box 237
- Good visibility 160
- Gross Axle Weight Rating see GAWR
- Gross Vehicle Weight Rating see GVWR
- Gross Vehicle Weight see GVW
- GVW 305
- GVWR 305

- H**
- Halogen headlamp see Headlamps
 - Hands-free microphone 29
 - Hard plastic trim items, cleaning 318
 - Hazard warning flasher 115
 - Head restraints 36, 101
 - Active head restraint 73, 365
 - Front seat,
 - Removing and installing 101
 - Manual seat, Adjusting 36
 - Power seat*, Adjusting 37
 - Rear seat, Folding back 102
 - Rear seat,
 - Removing and installing 104
 - Resetting activated head restraints 365
 - Head unit
 - Time synchronization* with 136
 - Headlamp
 - cleaning system* 160, 280, 411
 - Headlamps
 - Automatic headlamp mode 110
 - Bi-Xenon* 372
 - Cleaning lenses 316
 - Halogen 370
 - High beam see High beam flasher
 - High beam see High beam headlamps
 - Low beam see Low beam headlamps
 - Manual headlamp mode 110
 - Messages in display 349, 350, 351
 - Replacing bulbs 367
 - Switch 50, 55
 - Headliner and shelf below rear window
 - Cleaning and care of 319
 - Heated seats* 106
 - High beam flasher 50, 113
 - High beam headlamps 50, 113
 - Indicator lamp 25
 - Messages in display 350
 - Replacing bulbs 368, 371
 - High mounted brake lamp 368
 - Hood 274
 - Horn 23
 - Hot weather performance 415
 - HVAC see Climate control
 - Hydroplaning 265

- I**
- Identification labels 398
 - Identification number,
 - Vehicle (VIN) 398, 399
 - Ignition 33, 46, 47
 - Immobilizer 89
 - Indicator lamps see
 - Lamps, indicator and warning
 - Infant and child restraint systems see
 - Children in the vehicle
 - Inflation pressure see
 - Tires, Inflation pressures
 - Inside door handle 96
 - Instrument and controls see
 - Instrument cluster
 - Instrument cluster 24, 118
 - Illumination brightness 118
 - Lamps 330
 - Lamps in 322–330
 - Messages in display see
 - Malfunction display messages
 - Multifunction display 121
 - Instrument lighting see Instrument cluster,
 - Illumination brightness
 - Instruments and controls see Cockpit

Interior lighting 116
 Delayed shut-off 142
 Interior rear view mirror 42
 Antiglare positions 160
 Auto-dimming mirrors* 161
 Interior storage spaces see
 Storage compartment

J

Jack 356
 Jacking up the vehicle 378
 Jump starting 386

K

Key, mechanical 361
 Key, SmartKey
 Batteries 95
 Battery check lamp 95
 Changing batteries 366
 Factory setting 93
 Locking/unlocking 32, 93
 Locking/unlocking, Global setting 94
 Locking/unlocking,
 Selective setting 94
 Loss of 95
 Messages in display 349
 Opening and closing
 the power windows 223
 Opening and closing
 the tilt/sliding sunroof* 223
 Positions in starter switch 32
 Remote control 92
 Starting the engine 46
 Steering wheel lock 33
 Turning off the engine 55
 Unlocking, Trunk lid 95
 Valet locking 99
 Kickdown 155
 Kilopascal 305

L

Labels 398
 Certification 398
 Emission control information 399
 Emission control
 vacuum line routing 399
 Lamps, exterior 368
 Light sensor 349
 Messages in display 349 - 353
 Lamps, indicator and warning
 ABS 25, 322
 Battery (SmartKey) 94
 Brakes 25, 324
 Engine diagnostics 325, 330
 Engine malfunction 25, 325-326
 ESP® 25, 327
 Fog lamps 109
 Front passenger front
 air bag off 27, 63
 Fuel reserve 25, 328
 High beam headlamps 25
 Instrument cluster 322-330
 Low beam headlamps 25
 Maintenance service indicator 310
 Rear fog lamp 109
 Seat belt telltale 25

- SRS 25, 59, 330
 - Turn signals 25
- Language, Setting 134
- LATCH-type child seat anchors see
 - Children in the vehicle
- Leather upholstery,
 - Cleaning and care of 320
- License plate lamps
 - Messages in display 351
 - Replacing bulbs 368
- Light alloy wheels
 - Cleaning 317
 - Technical data 404, 405
- Light sensor 349
 - Message in display 349
- Lighter see Cigarette lighter
- Lighting, Exterior and interior 109
- Limp-home mode 159
- Loading see Vehicle loading
- Loading terminology 304
- Loading the vehicle 284
- Locator lighting 112, 140
- Loss of keys 95
- Loss of Service and
 - Warranty Information Booklet 397
- Low beam headlamps
 - Indicator lamp 25
 - Messages in display 351
 - Replacing bulbs 368, 370
 - Switching on 50
- Lubricants 409
 - Technical data 409
- Lumbar support* 105
- M**
- Main dimensions 408
- Main fuse box
 - In passenger compartment 392
- Main odometer 121
- Maintenance 12, 310
 - Calling up
 - service indicator display 312
 - Clearing
 - service indicator message 311
 - FSS (Canada vehicles) 310
 - Maintenance System 310
 - Resetting service indicator 312
 - Service indicator message 310
 - Service term exceeded 312
 - Vehicles with E85 fuel 415
- Maintenance System 310
- Manual headlamp mode see Headlamps
- Manual seat see Seat, Manual 35
- Manual transmission 149, 150
 - Gearshift lever 46, 150
 - Shift positions 150
 - Starting the engine 46
- Maximum load rating, Tires 305
- Maximum loaded vehicle weight 305
- Maximum tire inflation pressure 305
- MB Tex upholstery,
 - Cleaning and care of 320
- Mechanical key 361
- Memory function* see Steering wheel
- Menus see Control system
- Microphone, Hands-free 29
- Minispare wheel see Spare wheel
- Mirrors
 - Adjusting 41
 - Auto-dimming* 161
 - Exterior rear view mirror 42
 - Interior rear view mirror 42, 160
- Mobile phone see Telephone*

MOE tires* see *MOExtended system**
 MOE* see *MOExtended system**
*MOExtended system** 382
 *MOExtended tires** 403
 Multicontour seats* (Canada only) 105
 Multifunction display 121
 Changing settings see
 Control system menus and
 Control system submenus
 Multifunction display messages
 ABS 335
 Brake fluid 344
 Brake lamps 349
 Brake pads 344
 Coolant 345–347
 Engine coolant 345–347
 Engine oil 348
 ESP® 335
 Fog lamps 350, 352
 Front passenger
 front air bag 337, 340
 Fuel cap 326, 349
 Headlamps 350, 351
 Key, SmartKey 349
 Lamps, exterior 349–353
 Parking brake 344

Parking lamp 351
 SRS 342
 Steering gear oil 354
 Tele Aid* 355
 Telephone* 355
 Turn signals 353
 Windshield washer fluid 355
 Multifunction steering wheel 26, 122
 Button operation 122

N

Navigation system* 129
 See separate *COMAND**
 operating instructions
 Net, parcel 239
 Neutral gear position,
 Automatic transmission 151, 153
 Neutral gear position,
 Manual transmission 150
 New vehicle break-in 260
 Night security illumination 112
 Setting 141
 Normal occupant weight 305
 Number, paintwork code 398
 Number,
 vehicle identification (VIN) 398, 399

O

Occupant Classification System see *OCS*
 Occupant distribution 305
 Occupant safety 58
 Air bags 59
 Children and air bags 60
 Children in the vehicle 74
 Fastening the seat belt 43
 Front passenger front
 air bag off indicator lamp 68, 331
 Infant and child restraint systems 74
 LATCH-type child seat anchors 79
 Seat belts 43, 62
OCS 64
 Self-test 68
 Odometer 121
 Oil level see *Engine oil level*,
 Checking oil level
 Oil see *Engine oil*
 One-touch gearshifting
 Automatic transmission 158
 Gear selector lever 158
 Operating safety 187
 Ornamental moldings, Cleaning 316
 Outside temperature see *Displays*
 Overhead control panel 29

P

- Paintwork code 398
- Paintwork, Cleaning 314
- Panic alarm* 81
- Parcel net
 - In front passenger footwell 239
- Parking 54, 264
- Parking brake 48, 54
 - Engaging 54
 - Message in display 344
 - Releasing 48
- Parking lamps
 - Messages in display 351
 - Replacing bulbs 368
- Parts service 396
- Passenger compartment 268
 - Interior lighting 116
 - Interior rear view mirror 42
 - Main fuse box in 392
 - Parcel net in
 - front passenger footwell 239
- Passenger safety see Occupant safety
- Pedals 261
- Performance
 - Cold weather 415
 - Hot weather 415
- Phone* see Telephone*
- Plastic parts, cleaning 318
- Poly-V-belt drive, Layout 400
- Positions (memory function*) see Seats
- Power assistance 262
- Power outlet in
 - rear passenger compartment 243
- Power seat* see Seats, Power* 37
- Power tilt/sliding sunroof* 224
 - Opening/closing 224
 - Opening/closing
 - in an emergency 364
 - Opening/closing, SmartKey 223
 - Stopping 226
 - Synchronizing 226
- Power washer 314
- Power windows 221
 - Cleaning 317
 - Opening/closing 221
 - Rear door window,
 - Blocking operation 80
 - Stopping 222
 - Synchronizing 222
- Practical hints 322
- Premium unleaded gasoline 413
- Problems
 - While driving 53
 - With vehicle 17
- Product information 9
- Production options weight 305
- Program mode 121
- Program mode see Automatic transmission, Automatic shift program
- Program mode selector switch
 - Automatic shift program 157
- PSI 306
- Push starting 386
- Push-start see Tow-start

R

- Radio
 - Operation 190, 194
 - Search function 142
 - Selecting stations
 - (Control system) 127
- Radio transmitters 268
- Range (distance to empty) 146
- Reading lamp 116, 117
- Rear bench seat, foldable* 233
- Rear door window
 - Blocking operation 80
- Rear fog lamp see Fog lamps
- Rear lamps see Tail lamps
- Rear outer seats
 - Adjusting head restraint height 102
- Rear passenger compartment
 - Adjustable air vents 173, 186
- Rear seat ashtray see Ashtray
- Rear seat head restraints see
 - Head restraints
- Rear view mirrors see Mirrors
- Rear window defroster 163
- Rear window sunshade* 162
- Recommended
 - tire inflation pressure 306
- Recovery services,
 - Stolen vehicle (Tele Aid*) 253
- Refrigerant, Air conditioning 412
- Refueling 271
- Regular checks 273
- Remote control, SmartKey 92
- Remote door unlock (Tele Aid*) 252
- Replacing bulbs
 - Additional turn signal lamps 373
 - Backup lamp 374
 - Brake lamps 374
 - Corner-illuminating
 - front fog lamps* 368
 - Fog lamps 374
 - Headlamps 368, 370, 372
 - High beam headlamps 368, 370
 - License plate lamps 374
 - Low beam headlamps 370
 - Parking lamps 371, 373, 374
 - Side marker lamps 373
 - Standing lamps 371, 373
 - Tail lamps 368, 374
 - Turn signal lamps 371, 373, 374
- Reporting safety defects 18
- Reset button,
 - in the instrument cluster 118, 132
- Residual heat utilization 185
- Residual ventilation 185
- Restraint system
 - see Children in the vehicle
 - see Infant and child restraint systems
 - see SRS
- Reverse gear position,
 - Automatic transmission* 47, 151, 153
- Reverse gear position,
 - Manual transmission 46
- Rims 306, 403
- Roadside Assistance 12
- Roof rack* 230
- Rubber parts, cleaning 318
- Run Flat Indicator* 291

S

- Safety
 - Driving safety systems 82
 - Occupant 58
 - Reporting defects 18
- Safety belts see Seat belts
- Satellite radio* 197
- Seat belt force limiter 72
- Seat belts 69
 - Children in the vehicle 74
 - Cleaning 319
 - Fastening 43
 - Height adjustment 45
 - Proper use of 45, 70
 - Safety guidelines 62
 - Telltale 25
- Seat heating* 106
- Seating capacity 285
- Seats, 34, 101
 - Heating* 106
 - Lumbar support* 105
 - Manual 35, 101
 - Memory function*
 - (Power seats*) 107
 - Multicontour seat*
 - (Canada only) 105
 - Power* 37, 101
 - Rear bench seat* 233
- Securing cargo 236
- Selector lever see Gear selector lever
- Selector lever see gear selector lever
- Self-test
 - OCS 68
 - Tele Aid* 248
- Service and Warranty Booklet
 - Loss of 397
- Service and warranty information 10
- Service intervals see
 - Maintenance service indicator 310
- Service life (tires) 282
- Service see Maintenance Service system
 - see FSS (Canada vehicles)
- Service, Parts 396
- Settings
 - Control system menus
 - and submenus 124, 125
 - Date 138
 - Factory, SmartKey 93
 - Individual, SmartKey 94
 - Individual, Vehicle 131
 - Lighting (control system) 139
 - Memory function* 107
 - Menus and submenus 123
 - Resetting all (control system) 131
 - Selective, SmartKey 94
 - Time 136, 137
- Shelf below rear window, cleaning 319
- Shift lever position indicator 121
- Shift program mode,
 - Automatic transmission* 121
- Shifting
 - Automatic transmission* 47
 - Into reverse
 - (manual transmission) 150
 - Manual transmission 46, 150
- Shifting, Automatic transmission* 151
- Side impact air bags (front and rear*) 64

- Side marker lamps
 - Cleaning lenses 316
 - Messages in display 350
 - Replacing bulbs 373
- Side windows see Power windows
- Sidewall 306
- Ski sack* (Canada only) 230, 232, 233
- SmartKey see Key, SmartKey
- Snow chains 309
- Sound system* 191
- Spare fuses 391
- Spare wheel 406
 - Bolts 360
 - Mounting 377
- Speed settings
 - Cruise control 229
- Speedometer 25, 134
- Split rear bench seat* 233
- SRS 70
 - Indicator lamp 25, 330
 - Message in display 342
- Standing lamps
 - Replacing bulbs 368
- Standing water, Driving through 268
- Starter switch 23, 32
 - Positions 32
- Starting difficulties, Engine 47
- Steering column 39, 40
 - Easy entry/exit feature* 40
- Steering gear oil
 - Message in display 354
- Steering wheel 38
 - Buttons 26
 - Cleaning 319
 - Electrical adjustment* 40
 - Lock 47
 - Manual adjustment 39
- Stolen vehicle
 - Recovery services 253
- Storage compartments
 - Armrest, Front 238
 - Cup holder 239
 - Glove box 237
 - Parcel net in
 - front passenger footwell 239
 - Telephone* 238
- Storing (memory function*)
 - Positions into memory 108
- Storing tires 283
- Submenus see Control system submenus
- Substitute lamps
 - Bulbs 367
- Summer opening feature 223
- Sun visors 161
- Sunshade* 162
- Switching
 - Fuel (Flexible fuel vehicle) 415
- Symbols used
 - in this operator's manual 15

T

- Tachometer 25, 120
 - Overspeed range 120
- Tail lamps
 - Cleaning 316
 - Messages in display 352
 - Replacing bulbs 368, 373
- Tar stains 314
- Technical data
 - Air conditioning refrigerant 412
 - Brake fluid 412
 - Coolant 409, 410, 416
 - Electrical system 407
 - Engine 401
 - Engine oil additives 412
 - Engine oils 412
 - Flexible fuel vehicles 414
 - Fuel requirements 414
 - Fuels 409, 411
 - Fuels, coolants, lubricants, etc. 409
 - Gasoline additives 413
 - Lubricants 409
 - Premium unleaded gasoline 413
 - Rims and tires 403
 - Weights 408
 - Windshield washer 411
 - Windshield washer and headlamp
 - cleaning* system 411, 418
- Tele Aid* 247, 252
 - Emergency calls 248
 - Hands-free microphone 29
 - Information 251
 - Initiating an
 - emergency call manually 249
 - Message in display 355
 - Remote door unlock 252
 - Roadside Assistance 250
 - SOS button 249
 - Stolen Vehicle
 - Recovery services 253
 - System self-check 248
- Telephone* 26, 244
 - Answering/ending a call 147
 - Changing mobile phone cradle 246
 - Compartment 238
 - Hands-free microphone 29
 - Inserting in cradle 245
 - Installing a different
 - mobile phone cradle 246
 - Message in display 355
 - Operation 146, 208
 - Phone book 147
 - Redialing 148
 - Removing from cradle 246
- Temperature
 - Display mode 126
 - Interior temperature 168
- Tether attachment points, see
 - Children in the vehicle
- Tie-down rings*, Trunk 236
- Tightening torque, Wheel bolts 381
- Tilt/sliding sunroof* see
 - Power tilt/sliding sunroof*
- Time 136
- TIN 306
- Tire and loading Information
 - Placard 285
 - Terminology 304
- Tires 281, 403
 - Air pressure 304
 - Care and maintenance 282
 - Chains 309
 - Cleaning 283, 314
 - Direction of rotation 284
 - Driving instructions 264

- Important notes,
 - Tire inflation pressure 290
 - Inflation pressure 273, 289, 290
 - Information Placard 285
 - Inspection 282
 - Load rating 306
 - MO*Extended* system* 382
 - MO*Extended** 294, 403
 - Ply composition
 - and material used 306
 - Problems under-/overinflation 294
 - Retreads 281
 - Rims and tires 403
 - Rotating 307
 - Run Flat Indicator* 291
 - Service life 282
 - Sizes 403
 - Speed rating 266, 297, 306
 - Temperature 290, 303
 - Terminology 304
 - Tire Identification Number see TIN
 - Traction 265
 - Tread 306
 - Tread depth 283, 308
 - Treadwear indicators 306
 - Vehicle maximum load on 307
 - Wear pattern 307
 - Winter 308
 - Tools 356
 - Top tether
 - Children in the vehicle 77
 - Towing eye bolt 390
 - Towing the vehicle 388
 - Tow-start 386, 388
 - Traction 86, 306
 - Transmission gear selector lever see
 - Gear selector lever
 - Transmission see
 - Automatic* or Manual transmission
 - Traveling abroad 268
 - Tread 306
 - Tread depth 283, 308
 - Treadwear indicators 306
 - Trip computer 144
 - Trip odometer 119
 - Trunk
 - Closing the lid 97
 - Fuse box 394
 - Lamp 117
 - Opening 95, 97
 - Tie-down rings 236
 - Trunk emergency release 98
 - Unlocking in an emergency 98
 - Turn signal lamps
 - Messages in display 353
 - Replacing bulbs 368
 - Turn signals 50
 - Additional in mirrors 368
 - Bulbs 368
 - Cleaning lenses 316
 - Indicator lamps 25
 - Turning off engine 55
- U**
- Uniform Tire
 - Quality Grading Standards 307
 - Units, Setting
 - Speedometer 134
 - Upholstery, Cleaning 320
 - Useful features 237
- V**
- Vacuum line routing diagram label 399
 - Valet locking 99
 - Vehicle
 - Battery 383
 - Breaking-in the vehicle 260
 - Care 313
 - Dimensions 408

- Individual settings 131, 132
- Locking/unlocking 100
- Locking/unlocking
 - in an emergency 361, 362
- Lowering 381
- Modifications and alterations,
 - Operating safety 16
- Towing 388
- Washing 314, 315
- Weights 408
- With flexible fuel 414
- Vehicle jack 357
- Vehicle lighting 273
- Vehicle loading
 - Cargo tie-down rings* 236
 - Instructions 235, 284
 - Load limit 408
 - Roof rack* 230
 - Split rear bench seat* 233
 - Terminology 304
- Vehicle maximum load on the tire 307
- Vehicle recovery services,
 - Stolen (Tele Aid*) 247
- Vehicle status message memory 130
- Vehicle tool kit 356
- VIN 398
- Voice control system*,
 - Hands-free microphone 29
- W**
- Warning lamps see
 - Lamps, indicator and warning
- Warning sounds
 - Driver's or passenger's seat belt 71
 - Parking brake 48
 - Seat belt telltale 328, 329
- Warranty coverage 10, 397
- Washer fluid see Windshield washer fluid
- Washer reservoir level 273
- Washing the vehicle 313
- Wear pattern (tires) 307
- Weights, Vehicle 408
- Wheel
 - Bolts 360
 - Change 381
 - Removing 379
 - Spare 357, 359, 406
 - Tightening torque 381
- Wheels, Tires 281
- Window curtain air bags 64
- Windows see Power windows
- Windshield
 - Cleaning 317
 - Defogging 170, 180
 - Replacing wiper blades 375
 - Washer fluid 280, 418
 - Washer system 418
- Windshield washer fluid 418
 - Message in display 355
 - Mixing ratio 418
 - Refilling 280
 - Wiping with 52
- Windshield washer system 418
- Windshield wipers 51
 - Cleaning 317
 - Replacing wiper blades 375
- Winter driving 308
 - Block heater (Canada only) 309
 - Snow chains 309
 - Tires 308
- Winter driving instructions 267
- Winter tires 308
- Wiper blades
 - Cleaning 317
 - Replacing 375
- Wood trims, Cleaning 320

Service and Literature

Your authorized Mercedes-Benz Center has trained technicians and original Mercedes-Benz parts to service your vehicle properly.
For expert advice and quality service, contact your authorized Mercedes-Benz Center.

If you are interested in obtaining service literature for your vehicle, please contact an authorized Mercedes-Benz Center.
We consider this the best way for you to obtain accurate information for your vehicle.

For further information you can find us on the Mercedes-Benz web-site www.mbusa.com or www.mercedes-benz.ca.

Warning!



To help avoid personal injury, be extremely careful when performing any service work or repairs. Improper or incomplete service or the use of incorrect or inappropriate parts or materials may damage the vehicle or its equipment, which may in turn result in personal injury.

If you have questions about carrying out any type of service, turn to the advice of an authorized Mercedes-Benz Center.

We reserve the right to make changes in design and equipment. Therefore, information, illustrations and descriptions in this Operator's Manual might differ from your vehicle. Reprinting, translation and copying, even of excerpts, is not permitted without our prior authorization in writing.

Press time May 8, 2006

GSP/TIP

Printed in Germany

