

2010 GMC Acadia Owner Manual

In Brief	1-1	Storage	4-1	Climate Controls	8-1
Instrument Panel	1-2	Storage Compartments	4-1	Climate Control Systems	8-1
Initial Drive Information	1-4	Additional Storage Features	4-3	Air Vents	8-12
Vehicle Features	1-15	Roof Rack System	4-4	Driving and Operating	9-1
Performance and Maintenance	1-20	Instruments and Controls	5-1	Driving Information	9-2
Keys, Doors and Windows ...	2-1	Controls	5-2	Starting and Operating	9-17
Keys and Locks	2-2	Warning Lights, Gauges, and Indicators	5-10	Engine Exhaust	9-23
Doors	2-9	Information Displays	5-24	Automatic Transmission	9-24
Vehicle Security	2-13	Vehicle Messages	5-36	Drive Systems	9-28
Exterior Mirrors	2-16	Vehicle Personalization	5-45	Brakes	9-28
Interior Mirrors	2-19	Universal Remote System ...	5-52	Ride Control Systems	9-30
Windows	2-20	Lighting	6-1	Cruise Control	9-32
Roof	2-22	Exterior Lighting	6-1	Object Detection Systems ...	9-35
Seats and Restraints	3-1	Interior Lighting	6-5	Fuel	9-42
Head Restraints	3-2	Lighting Features	6-6	Towing	9-47
Front Seats	3-3	Infotainment System	7-1	Conversions and Add-Ons ...	9-59
Rear Seats	3-10	Introduction	7-1	Vehicle Care	10-1
Safety Belts	3-16	Radio	7-6	General Information	10-2
Airbag System	3-32	Audio Players	7-12	Vehicle Checks	10-4
Child Restraints	3-46	Rear Seat Infotainment	7-36	Headlamp Aiming	10-28
		Phone	7-46	Bulb Replacement	10-28
				Electrical System	10-29

2010 GMC Acadia Owner Manual

Wheels and Tires	10-36
Jump Starting	10-79
Towing	10-83
Appearance Care	10-86
Service and Maintenance ...	11-1
General Information	11-1
Scheduled Maintenance	11-2
Recommended Fluids, Lubricants, and Parts	11-8
Maintenance Records	11-11
Technical Data	12-1
Vehicle Identification	12-1
Vehicle Data	12-2
Customer Information	13-1
Customer Information	13-1
Reporting Safety Defects	13-14
Vehicle Data Recording and Privacy	13-16
Index	i-1



GENERAL MOTORS, GM, the GM Emblem, GMC, the GMC Emblem, and the name ACADIA, are registered trademarks of General Motors.

This manual describes features that may or may not be on your specific vehicle either because they are options that you did not purchase or due to changes subsequent to the printing of this owner manual.

Please refer to the purchase documentation relating to your specific vehicle to confirm each of the features found on your vehicle. For vehicles first sold in Canada, substitute the name "General Motors of Canada Limited" for GMC wherever it appears in this manual.

Keep this manual in the vehicle for quick reference.

Canadian Vehicle Owners

Propriétaires Canadiens

A French language copy of this manual can be obtained from your dealer/retailer or from:

On peut obtenir un exemplaire de ce guide en français auprès du concessionnaire ou à l'adresse suivante:

Helm, Incorporated
P.O. Box 07130
Detroit, MI 48207

1-800-551-4123
Numéro de poste 6438 de
langue française
www.helminc.com

Using this Manual

To quickly locate information about the vehicle, use the Index in the back of the manual. It is an alphabetical list of what is in the manual and the page number where it can be found.

Danger, Warnings, and Cautions

Warning messages found on vehicle labels and in this manual describe hazards and what to do to avoid or reduce them.

Danger indicates a hazard with a high level of risk which will result in serious injury or death.

Warning or **Caution** indicates a hazard that could result in injury or death.

WARNING

These mean there is something that could hurt you or other people.

Notice: This means there is something that could result in property or vehicle damage. This would not be covered by the vehicle's warranty.

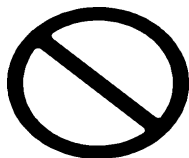

A circle with a slash through it is a safety symbol which means "Do Not," "Do not do this" or "Do not let this happen."

Symbols

The vehicle has components and labels that use symbols instead of text. Symbols are shown along with the text describing the operation or information relating to a specific component, control, message, gauge, or indicator.

 : This symbol is shown when you need to see your owner manual for additional instructions or information.

 : This symbol is shown when you need to see a service manual for additional instructions or information.

Vehicle Symbol Chart

Here are some additional symbols that may be found on the vehicle and what they mean. For more information on the symbol, refer to the index.

 : Airbag Readiness Light

 : Air Conditioning

 : Antilock Brake System (ABS)

 : Audio Steering Wheel Controls or OnStar®

 : Brake System Warning Light

 : Charging System

 : Cruise Control

 : Engine Coolant Temperature

 : Exterior Lamps

 : Fog Lamps

 : Fuel Gauge

 : Fuses

 : Headlamp High/Low-Beam Changer

 : LATCH System Child Restraints

 : Malfunction Indicator Lamp

 : Oil Pressure

 : Power

 : Remote Vehicle Start

 : Safety Belt Reminders

 : Tire Pressure Monitor

 : Traction Control

 : Windshield Washer Fluid

In Brief

Instrument Panel

Instrument Panel 1-2

Initial Drive Information

Initial Drive Information 1-4

Remote Keyless Entry (RKE)

System 1-4

Remote Vehicle Start 1-5

Door Locks 1-5

Liftgate 1-6

Windows 1-6

Seat Adjustment 1-7

Second Row Seats 1-7

Third Row Seats 1-8

Heated Seats 1-8

Heated and Ventilated

Seats 1-8

Head Restraint Adjustment 1-8

Safety Belt 1-9

Sensing System for Passenger

Airbag 1-9

Mirror Adjustment 1-10

Steering Wheel

Adjustment 1-11

Interior Lighting 1-11

Exterior Lighting 1-12

Windshield Wiper/Washer 1-12

Climate Controls 1-13

Vehicle Features

Radio(s) 1-15

Satellite Radio 1-16

Portable Audio Devices 1-16

Bluetooth® 1-17

Steering Wheel Controls 1-17

Navigation System 1-18

Cruise Control 1-18

Storage Compartments 1-18

Power Outlets 1-19

Sunroof 1-19

Performance and Maintenance

StabiliTrak® 1-20

Tire Pressure Monitor 1-20

Tire Sealant and

Compressor Kit 1-20

Engine Oil Life System 1-21

Driving for Better Fuel

Economy 1-21

Roadside Assistance

Program 1-22

OnStar® 1-22

Instrument Panel

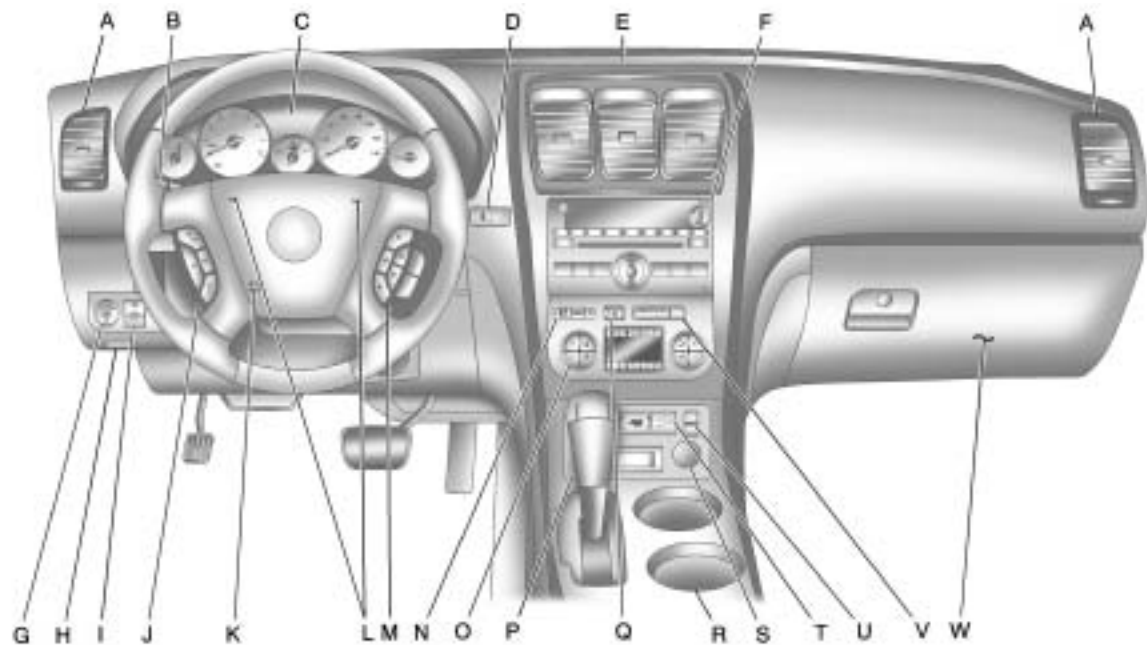

- A. *Air Vents on page 8-12.*
- B. *Windshield Wiper/Washer on page 5-4.*
- C. *Instrument Cluster on page 5-11.*
- D. *Head-Up Display (HUD) on page 5-32 (If Equipped).*
- E. *Solar Sensor. See Dual Automatic Climate Control System on page 8-4.*
- F. *AM-FM Radio on page 7-6. Navigation/Radio System (If Equipped). See Navigation System manual.*
- G. *Exterior Lamp Controls on page 6-1.*
- H. *Hood Release. See Hood on page 10-5.*
- I. *Instrument Panel Illumination Control on page 6-5.*
- J. *Cruise Control on page 9-32.*
- K. *Steering Wheel Adjustment on page 5-2.*
- L. *Horn on page 5-4.*
- M. *Steering Wheel Controls on page 5-2.*
- N. *Driver Information Center (DIC) Buttons. See Driver Information Center (DIC) (With DIC Buttons) on page 5-24 or Driver Information Center (DIC) (Without DIC Buttons) on page 5-29.*
- O. *Dual Automatic Climate Control System on page 8-4.*
- P. *Center Console Shift Lever (If Equipped). See "Console Shift Lever" under Shifting Into Park on page 9-21.*
- Q. *Hazard Warning Flashers on page 6-3.*
- R. *Cupholders on page 4-1.*
- S. *Power Outlets on page 5-8.*
- T. *Rear Window Wiper/Washer on page 5-5.*
- U. *Heated Front Seats on page 3-9 (If Equipped).*
- V. *Passenger Airbag Status Indicator on page 5-15 (If Equipped).*
- W. *Glove Box on page 4-1.*

Initial Drive Information

This section provides a brief overview about some of the important features that may or may not be on your specific vehicle.

For more detailed information, refer to each of the features which can be found later in this owner manual.

Remote Keyless Entry (RKE) System

The RKE transmitter is used to remotely lock and unlock the doors from up to 60 m (195 feet) away from the vehicle.





Press  to unlock the driver door.

Press  again within five seconds to unlock all remaining doors.

Press  to lock all doors.

Lock and unlock feedback can be personalized.

To open or close the liftgate, press and hold  until the liftgate begins to move.

Press  and release to locate the vehicle.

Press  and hold for more than two seconds to sound the panic alarm.



Press  again to cancel the panic alarm.

See *Remote Keyless Entry (RKE) System Operation* on page 2-3.

Remote Vehicle Start

Starting the Vehicle

With this feature the engine can be started from outside of the vehicle.

1. Aim the RKE transmitter at the vehicle.
2. Press .
3. Immediately after completing Step 2, press and hold  until the parking lamps flash.

When the vehicle starts, the parking lamps will turn on and remain on as long as the engine is running. The doors will be locked and the climate control system may come on.

The engine will continue to run for 10 minutes. Repeat the steps for a 10-minute time extension. Remote start can be extended only once.

Canceling a Remote Start



To cancel a remote start:

- Aim the RKE transmitter at the vehicle and press and hold  until the parking lamps turn off.
- Turn on the hazard warning flashers.
- Turn the ignition switch on and then off.

See *Remote Vehicle Start on page 2-5*.

Door Locks

To lock or unlock a door manually:

- From the inside use the door lock knob on the window sill.
- From the outside turn the key toward the front or rear of the vehicle, or press the  or  button on the Remote Keyless Entry (RKE) transmitter.

Power Door Locks

On vehicles with power door locks, the controls are located on the front doors.

 **(Unlock):** Press to unlock the doors.

 **(Lock):** Press to lock the doors.

See *Power Door Locks on page 2-8*.

Liftgate

To open the liftgate the vehicle must be in P (Park). Press the touchpad under the liftgate handle. To close the liftgate, use the pull cup or pull strap as an aid.

Power Liftgate

On vehicles with a power liftgate, the vehicle must be in P (Park) to operate it.

- Press and hold the liftgate button  on the Remote Keyless Entry (RKE) transmitter.



- Press the liftgate button on the center console.
- Press the touchpad switch on the outside liftgate handle.

For more information see *Liftgate on page 2-9*.

Windows

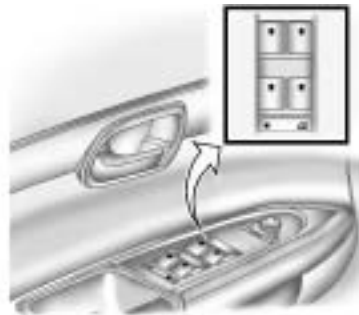

On vehicles with power windows, the switches are on the driver door armrest. Each passenger door has a switch that controls only that window.

Press the switch to lower the window. Pull the switch up to raise it.

For more information, see *Power Windows on page 2-20*.

Seat Adjustment

Manual Seats

1. Pull the handle under the seat to unlock the seat.
2. Slide the seat to the desired position and release the handle.

Try to move the seat to be sure it is locked in place.

Power Seats

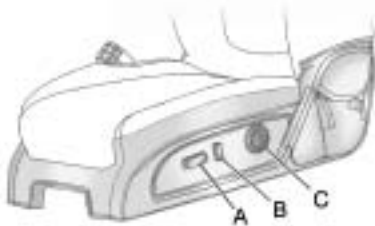

- A. Power Seat Adjustment Control
- B. Reclining Seatbacks
- C. Lumbar Adjustment

Move the seat forward or rearward by moving the control (A) forward or rearward.

Raise or lower the entire seat by moving the control (A) up or down.

See *Power Seat Adjustment on page 3-4*.

To raise or recline the seatback, tilt the top of the control (B) forward or rearward.

See *Reclining Seatbacks on page 3-7*.

Press the front or rear of the control (C) to increase or decrease lumbar support.

See *Lumbar Adjustment on page 3-6*.

Second Row Seats



To access the third row, pull the sliding seat lever forward so that the seat cushion folds and the entire seat slides forward.

See *Rear Seats on page 3-10*.

Third Row Seats

The third row seats can be folded forward or removed.



Pull up on the release lever located on the back of the seat and push the seatback forward.

For detailed procedures see *Third Row Seats* on page 3-13.

Heated Seats

Heated Front Seats

The heated seat controls are located on the center console. The engine must be running to operate them.

: Press to turn on the heated seatback.

: Press to turn on or off the heated seat and seatback.

For more information see *Heated Front Seats* on page 3-9.

Heated and Ventilated Seats

On vehicles with this feature, the controls are on the front doors near the handle.

: Press to ventilate the seat.

: Press to heat the seat.

For more information see *Heated and Ventilated Front Seats* on page 3-10.

Head Restraint Adjustment

Do not drive until the head restraints for all occupants are installed and adjusted properly.

For more information see *Head Restraints* on page 3-2.

Safety Belt



Refer to the following sections for important information on how to use safety belts properly.

- *Safety Belts on page 3-16.*
- *How to Wear Safety Belts Properly on page 3-19.*
- *Lap-Shoulder Belt on page 3-25.*
- *Lower Anchors and Tethers for Children (LATCH System) on page 3-55.*

Sensing System for Passenger Airbag



United States



Canada

The passenger sensing system will turn off the right front passenger frontal airbag under certain conditions.

The driver airbag, seat-mounted side impact airbags, and roof-rail airbags are not affected by the passenger sensing system.

The passenger airbag status indicator will be visible on the instrument panel when the vehicle is started. See *Passenger Sensing System on page 3-39* for more information.

Mirror Adjustment

Exterior Mirrors

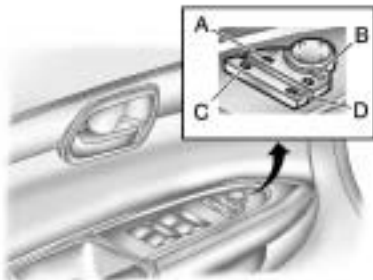

Controls for the outside power mirrors are located on the driver door armrest.

1. Press (A) or (B) to select the driver or passenger side mirror.
2. Press one of the four arrows located on the control pad to adjust the mirror.
3. Press either (A) or (B) again to deselect the mirror.

Folding Mirrors

For vehicles with outside power foldaway mirrors:

1. Press (C) to fold the mirrors out to the driving position.
2. Press (D) to fold the mirrors in to the folded position.

If equipped, manually fold the mirrors inward to prevent damage when going through an automatic car wash. To fold, push the mirror toward the vehicle. Push the mirror outward to return it to the original position.

Interior Mirror

If equipped, a manual inside rearview mirror can be adjusted so that the driver can see behind the vehicle more clearly. Hold the mirror in the center to move it up or down and side to side. Use the day/night adjustment to help prevent glare from the headlamps behind you. Move the lever located at the base of the mirror, to the right for nighttime use and to the left for daytime use.

For vehicles with an automatic dimming rearview mirror, the mirror will move automatically to reduce the glare from the headlamps of the vehicle behind. The dimming feature comes on and the indicator light illuminates each time the ignition is turned to start.

See *Automatic Dimming Rearview Mirror* on page 2-19.

Steering Wheel Adjustment



1. Pull the lever down to adjust the steering wheel.
2. Move the steering wheel up or down or backward or forward into a comfortable position.
3. Pull the lever up to lock the steering wheel in place.

See *Steering Wheel Adjustment* on page 5-2.

Interior Lighting

Dome Lamps

The dome lamps are located in the overhead console and above the rear seat passengers.

The dome lamps automatically come on when a door is opened, unless the dome lamp override button is pressed in.

To manually turn them on, turn the instrument panel brightness control clockwise to the farthest position.

Dome Lamp Override

The dome lamp override button is next to the exterior lamps control.

☒: Press the button in and the dome lamps remain off when a door is opened. Press the button again to return it to the extended position so that the dome lamps come on when a door is opened.

Reading Lamps

Press the button near each lamp to turn them on or off.

For more information, see:

- *Dome Lamps* on page 6-5.
- *Instrument Panel Illumination Control* on page 6-5.

Exterior Lighting



The exterior lamps control is located on the instrument panel, to the left of the steering wheel.

○ : Turns the automatic light control on or off.

AUTO: Automatic operation of the headlamps at normal brightness and other exterior lamps.

☰: Manual operation of the parking lamps and other exterior lamps.

☷: Manual operation of the headlamps and other exterior lamps.

☼ (If Equipped): Push the fog lamp button in to turn on the fog lamps.

For more information, see:

- *Exterior Lamp Controls on page 6-1.*
- *Daytime Running Lamps (DRL)/ Automatic Headlamp System on page 6-3.*
- *Fog Lamps on page 6-4.*

Windshield Wiper/Washer

The windshield wiper/washer lever is located on the left side of the steering column.



Turn the band with the wiper symbol to control the windshield wipers.

☷ : Use for a single wiping cycle.

○ : Turns the wipers off.

⏸ : Delays wiping cycle. Turn the band up for more frequent wipes or down for less frequent wipes.

1: Slow wipes.

2: Fast wipes.

Windshield Washer

🚿 : Press the button at the end of the turn signal/lane change lever to spray washer fluid on the windshield.

See *Windshield Wiper/Washer* on page 5-4.

Climate Controls

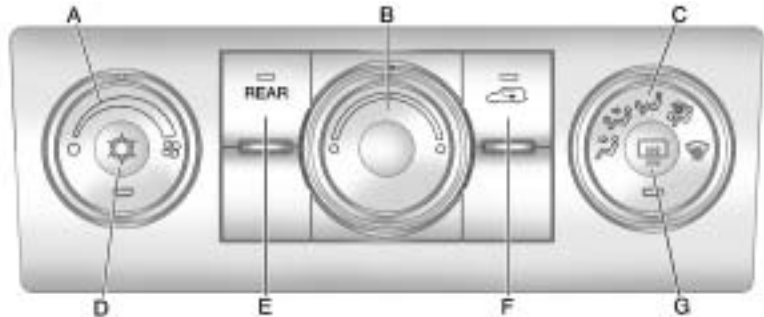

A. Fan Control

B. Temperature Control

C. Air Delivery Mode Control

D. Air Conditioning

E. REAR (Rear Climate Control)

F. Air Recirculation

G. Rear Window Defogger

1-14 In Brief

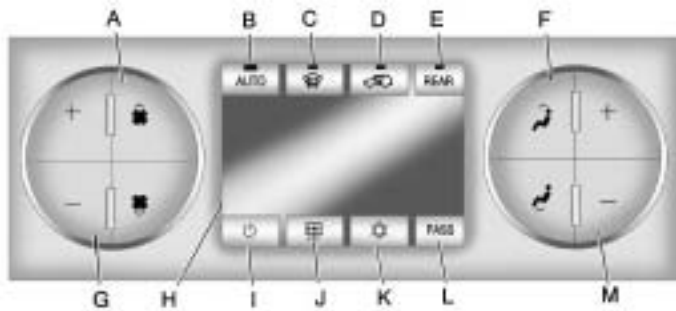

- A. Fan Control
- B. AUTO
- C. Defrost
- D. Air Recirculation
- E. REAR (Rear Climate Control)
- F. Air Delivery Mode Control
- G. Driver Side Temperature Control

- H. Display
- I. Power (On/Off)
- J. Rear Window Defogger
- K. Air Conditioning
- L. PASS (Passenger)
- M. Passenger Side Temperature Control

See *Climate Control Systems* on page 8-1 or *Dual Automatic Climate Control System* on page 8-4 (If Equipped). For more information about the rear climate control, see *Rear Climate Control System (Rear Climate Control Only)* on page 8-10 or *Rear Climate Control System (Rear Climate with Rear Seat Audio)* on page 8-11.

Vehicle Features

Radio(s)





Radio with CD, DVD, and USB Port

 : Press to turn the system on and off. Turn to increase or decrease the volume.

BAND: Press to choose between FM, AM, or XM™, if equipped.

 : Select radio stations.

  : Seek or scan stations.

 : Change the display between the radio station frequency and the time, if equipped. While the ignition is off, press  to display the time.

For more information about these and other radio features, see *Operation on page 7-2*.



Storing a Favorite Station

A maximum of 36 stations can be stored as favorites using the six softkeys located below the radio station frequency tabs and by using the radio FAV button. Press FAV to go through up to six pages of favorites, each having six favorite stations available per page. Each page of favorites can contain any combination of AM, FM, or XM stations.

See *AM-FM Radio on page 7-6*.

Setting the Clock

To set the time and date for the radio with CD, DVD, and USB Port:

1. Turn the ignition key to ACC/ACCESSORY or ON/RUN, then press , to turn the radio on.
2. Press  to display HR, MIN, MM, DD, YYYY (hour, minute, month, day, and year).
3. Press the pushbutton located under any one of the labels to be changed.
4. To increase or decrease the time or date, turn  clockwise or counter-clockwise.

For detailed instructions on setting the clock for the vehicles specific audio system, see *Clock on page 5-8*.

Satellite Radio

Vehicles with an XM™ Satellite Radio tuner and a valid XM Satellite Radio subscription can receive XM programming.

XM Satellite Radio Service

XM is a satellite radio service that is based in the 48 contiguous United States and 10 Canadian provinces. XM Satellite Radio has a wide variety of programming and commercial-free music, coast-to-coast, and in digital-quality sound. A fee is required to receive the XM service.

For more information refer to:

- www.xmradio.com or call 1-800-929-2100 (U.S.).
- www.xmradio.ca or call 1-877-438-9677 (Canada).

See *Satellite Radio on page 7-8*.

Portable Audio Devices

This vehicle may have an auxiliary input located on the radio faceplate and a USB port located in the center console. External devices such as iPod®, laptop computers, MP3 players, CD changers, USB storage device, etc. can be connected to the auxiliary port using a 3.5 mm (1/8 in) input jack or the USB port depending on the audio system.

See *Auxiliary Devices on page 7-34*.

Bluetooth®

The in-vehicle Bluetooth system allows users with a Bluetooth-enabled cell phone to make and receive hands-free calls using the vehicle's audio system, microphone and controls.

The Bluetooth-enabled cell phone must be paired with the in-vehicle Bluetooth system before it can be used in the vehicle. Not all phones will support all functions.

See *Bluetooth* on page 7-46.

Steering Wheel Controls



△ / ▽ : Press to change favorite radio stations, select tracks on a CD/DVD, or to navigate tracks or folders on an iPod® or USB device.

📞 / 📞 : Press to silence the vehicle speakers only. Press again to turn the sound on. Press and hold longer than two seconds to interact with OnStar® or Bluetooth systems.

+ 🔊 - 🔊 : Increases or decreases volume.

📞 / 📞 : Press to reject an incoming call, or to end a call.

SRCE: Press to switch between the radio, CD, and for vehicles with, DVD, front auxiliary, and rear auxiliary.

▶ : Press to seek the next radio station, the next track or chapter while sourced to the CD or DVD slot, or to select tracks and folders on an iPod® or USB device.

For more information, see *Steering Wheel Controls* on page 5-2.

Navigation System

The vehicle's navigation system provides detailed maps of most major freeways and roads throughout the United States and Canada. After a destination has been set, the system provides turn-by-turn instructions for reaching the destination. In addition, the system can help locate a variety of points of interest (POI), such as banks, airports, restaurants, and more.

See the vehicle's Navigation System manual for more information.

Cruise Control



 : On/Off.

+ RES: Press to accelerate or resume speed.

SET- : Press to set speed or decrease speed.

 : Press to cancel cruise control.

See *Cruise Control* on page 9-32.

Storage Compartments



For vehicles with a second row center console, open each area to access the storage compartment inside.

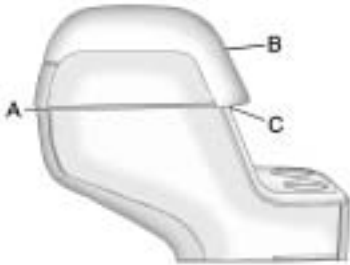

Press the buttons (B, C) on the front of the consoles to access the upper and lower storage areas.

Increase the storage area by folding the top of the console forward. Lift up on rear console handle (A) and pull forward.

See *Floor Console Storage* on page 4-2.

Power Outlets

The vehicle has three 12-volt accessory power outlets which can be used to plug in electrical equipment, such as a cellular telephone.

The power outlets are located:

- On the instrument panel below the climate controls.
- At the rear of the center floor console.
- In the rear cargo area.

To use the outlets, remove the cover.

See *Power Outlets* on page 5-8.

Sunroof

The ignition must be in ON/RUN or ACC/ACCESSORY to operate the sunroof and power sunshade. See *Retained Accessory Power (RAP)* on page 9-19.



The switch to operate the front sunroof is on the headliner above the rearview mirror.

Vent: Press the front or rear of the switch to vent or close the sunroof.



Express-open/Express-close: From the closed position, press and release the rear or front of the switch to express-open or express-close the sunroof.

For more information see *Sunroof* on page 2-22.

Performance and Maintenance

StabiliTrak®

The traction control system limits wheel spin and the StabiliTrak system assists with directional control of the vehicle in difficult driving conditions. Both systems turn on automatically every time the vehicle is started.

- To turn off the traction control part of StabiliTrak, press and release  located on the instrument panel below the climate controls.  illuminates and the appropriate DIC message is displayed. See *Vehicle Messages* on page 5-36.
- The StabiliTrak system remains on.

For more information, see *StabiliTrak System* on page 9-30.

Tire Pressure Monitor

This vehicle may have a Tire Pressure Monitor System (TPMS).



The Tire Pressure Monitor System alerts you when a significant reduction in pressure occurs in one or more of your vehicle's tires by illuminating the low tire pressure warning light on the instrument cluster. If the warning light comes on, stop as soon as possible and inflate the tires to the recommended pressure shown on the tire loading information label located on the driver side center pillar (B pillar). See *Vehicle Load Limits* on page 9-12. The warning light will remain on until the tire pressure is corrected.

You may notice during cooler conditions that the low tire pressure warning light will appear when the vehicle is first started and then turn off as you drive. This may be an early indicator that your tire pressures are getting low and the tires need to be inflated to the proper pressure.

Note: The Tire Pressure Monitor System can alert you about low tire pressure, but it does not replace normal monthly tire maintenance. It is the driver's responsibility to maintain correct tire pressures.

See *Tire Pressure Monitor System* on page 10-44 and *Tire Pressure Monitor Operation* on page 10-46.

Tire Sealant and Compressor Kit

This vehicle may come with a jack and spare tire or a tire sealant and compressor kit. The kit can be used to seal small punctures in the tread area of the tire.

See *Tire Sealant and Compressor Kit* on page 10-59 for complete operating information.

Engine Oil Life System

The engine oil life system calculates engine oil life based on vehicle use and displays the “Change Engine Oil Soon” message when it is time to change the engine oil and filter. The oil life system should be reset to 100% only following an oil change.

Resetting the Oil Life System

1. Turn the ignition to ON/RUN, with the engine off.
2. If the vehicle has Driver Information Center (DIC) buttons: Press the vehicle information button until “Oil Life Remaining” displays.

If the vehicle does not have Driver Information Center (DIC) buttons: The vehicle must be in P (Park) to access this display.

Press the trip odometer reset stem until “Oil Life Remaining” displays.

3. If the vehicle has Driver Information Center (DIC) buttons: Press and hold the set/reset button until “100%” is displayed. Three chimes sound and the “Change Engine Oil Soon” message goes off.

If the vehicle does not have Driver Information Center (DIC) buttons: Press and hold the trip odometer reset stem until “Oil Life Remaining” shows “100%.” Three chimes sound and the “Change Engine Oil Soon” message goes off.

4. Turn the key to LOCK/OFF.

See *Engine Oil Life System* on page 10-9.

Driving for Better Fuel Economy

Driving habits can affect fuel mileage. Here are some driving tips to get the best fuel economy possible.

- Avoid fast starts and accelerate smoothly.
- Brake gradually and avoid abrupt stops.
- Avoid idling the engine for long periods of time.
- When road and weather conditions are appropriate, use cruise control, if equipped.
- Always follow posted speed limits or drive more slowly when conditions require.
- Keep vehicle tires properly inflated.
- Combine several trips into a single trip.

- Replace the vehicle's tires with the same TPC Spec number molded into the tire's sidewall near the size.
- Follow recommended scheduled maintenance.

Roadside Assistance Program

U.S.: **1-800-GMC-8782 (462-8782)**

TTY Users: **1-888-889-2438**

Canada: **1-800-268-6800**

As the owner of a new GMC, you are automatically enrolled in the Roadside Assistance program. This program provides technically trained advisors who are available 24 hours a day, 365 days a year, minor repair information or towing arrangements.

Roadside Assistance and OnStar

If you have a current OnStar subscription, press the OnStar button and the current GPS location will be sent to an OnStar Advisor who will assess your problem, contact Roadside Assistance, and relay exact location to get you the help you need.

Online Owner Center

The Online Owner Center is a complimentary service that includes online service reminders, vehicle maintenance tips, online owner manual, special privileges and more.

Sign up today at:

www.gmownercenter.com/gmc
(U.S.) or **www.gm.ca** (Canada).

OnStar®





OnStar® uses several innovative technologies and live advisors to provide a wide range of safety, security, navigation, diagnostics, and calling services.

Automatic Crash Response

In a crash, built in sensors can automatically alert an OnStar advisor who is immediately connected to the vehicle to see if you need help.

How OnStar Service Works

 : This blue button connects you to a specially trained OnStar advisor to verify your account information and to answer questions.

 : Push this red emergency button to get priority help from specially trained OnStar emergency advisors.

 : Push this button for hands-free, voice-activated calling and to give voice commands for turn-by-turn navigation.



Crisis Assist, Stolen Vehicle Assistance, Vehicle Diagnostics, Remote Door Unlock, Roadside Assistance, Turn-by-Turn Navigation and Hands-Free Calling are available on most vehicles. Not all OnStar services are available on all vehicles. For more information see the OnStar Owner's Guide or visit www.onstar.com (U.S.) or www.onstar.ca (Canada), contact OnStar at 1-888-4-ONSTAR (1-888-466-7827) or TTY

1-877-248-2080, or press  to speak with an OnStar advisor 24 hours a day, 7 days a week.

For a full description of OnStar services and system limitations, see the OnStar Owner's Guide in the glove box.

OnStar service is subject to the OnStar terms and conditions included in the OnStar Subscriber Information.

OnStar service cannot work unless the vehicle is in a place where OnStar has an agreement with a wireless service provider for service in that area. OnStar service also cannot work unless the vehicle is in a place where the wireless service provider OnStar has hired for that area has coverage, network capacity and reception when the service is needed, and technology that is compatible with the OnStar service. Not all services are available everywhere, particularly in remote or enclosed areas, or at all times.

The OnStar system can record and transmit vehicle information. This information is automatically sent to an OnStar call center when  is pressed,  is pressed, or if the airbags or ACR system deploy. This information usually includes the vehicle's GPS location and, in the event of a crash, additional information regarding the crash that the vehicle was involved in (e.g. the direction from which the vehicle was hit). When the virtual advisor feature of OnStar hands-free calling is used, the vehicle also sends OnStar the vehicle's GPS location so they can provide services where it is located.

Location information about the vehicle is only available if the GPS satellite signals are unobstructed and available.

The vehicle must have a working electrical system, including adequate battery power, for the OnStar equipment to operate. There are other problems OnStar cannot control that may prevent OnStar from providing OnStar service at any particular time or place. Some examples are damage to important parts of the vehicle in a crash, hills, tall buildings, tunnels, weather or wireless phone network congestion.

OnStar Steering Wheel Controls

This vehicle may have a Talk/Mute button that can be used to interact with OnStar hands-free calling. See *Steering Wheel Controls on page 5-2* for more information.

On some vehicles, the mute button can be used to dial numbers into voice mail systems, or to dial phone extensions. See the OnStar Owner's Guide for more information.

Your Responsibility

Increase the volume of the radio if the OnStar advisor cannot be heard.

If the light next to the OnStar buttons is red, the system may not be functioning properly.

Press  and request a vehicle diagnostic. If the light appears clear (no light is appearing), your OnStar subscription has expired and all services have been deactivated.

Press  to confirm that the OnStar equipment is active.

Keys, Doors and Windows

Keys and Locks

Keys	2-2
Remote Keyless Entry (RKE) System	2-2
Remote Keyless Entry (RKE) System Operation	2-3
Remote Vehicle Start	2-5
Door Locks	2-7
Power Door Locks	2-8
Delayed Locking	2-8
Automatic Door Locks	2-8
Lockout Protection	2-8
Safety Locks	2-8

Doors

Liftgate	2-9
----------------	-----

Vehicle Security

Vehicle Security	2-13
Anti-Theft Alarm System	2-13
Immobilizer	2-14
Immobilizer Operation	2-14

Exterior Mirrors

Convex Mirrors	2-16
Power Mirrors	2-17
Folding Mirrors	2-17
Heated Mirrors	2-18
Park Tilt Mirrors	2-18

Interior Mirrors

Manual Rearview Mirror	2-19
Automatic Dimming Rearview Mirror	2-19

Windows

Windows	2-20
Power Windows	2-20
Sun Visors	2-22

Roof

Sunroof	2-22
---------------	------

Keys and Locks

Keys

 **WARNING**

Leaving children in a vehicle with the ignition key is dangerous for many reasons, children or others could be badly injured or even killed. They could operate the power windows or other controls or even make the vehicle move. The windows will function with the keys in the ignition and children could be seriously injured or killed if caught in the path of a closing window. Do not leave the keys in a vehicle with children.



The key is used for the ignition and all door locks.

The key has a bar-coded key tag that the dealer/retailer or qualified locksmith can use to make new keys. Store this information in a safe place, not in the vehicle.

See your dealer/retailer if a replacement key or additional key is needed.

Notice: If you ever lock your keys in the vehicle, you may have to damage the vehicle to get in. Be sure you have spare keys.

If you are locked out of the vehicle, call the Roadside Assistance Center. See *Roadside Assistance Program* on page 13-6.

Remote Keyless Entry (RKE) System

See *Radio Frequency Statement* on page 13-17 for information regarding Part 15 of the Federal Communications Commission (FCC) Rules and RSS-210/211 of Industry Canada.

Changes or modifications to this system by other than an authorized service facility could void authorization to use this equipment.

If there is a decrease in the RKE operating range:

- Check the distance. The transmitter may be too far from the vehicle.
- Check the location. Other vehicles or objects may be blocking the signal.
- Check the transmitter's battery. See "Battery Replacement" later in this section.
- If the transmitter is still not working correctly, see your dealer/retailer or a qualified technician for service.

Remote Keyless Entry (RKE) System Operation

The Remote Keyless Entry (RKE) transmitter functions work up to 60 m (195 feet) away from the vehicle.

There are other conditions which can affect the performance of the transmitter. See *Remote Keyless Entry (RKE) System* on page 2-2.





With Remote Start and Power Liftgate Shown, Without Similar



(Remote Vehicle Start):

For vehicles with this feature, see *Remote Vehicle Start* on page 2-5 for additional information.

 (Lock): Press to lock all the doors.

If enabled through the Driver Information Center (DIC), the parking lamps flash once to indicate locking has occurred. If enabled through the DIC, the horn sounds when  is pressed again within five seconds. See *Vehicle Personalization (With DIC Buttons)* on page 5-45 for additional information.

Pressing  may arm the content theft-deterrent system. See *Anti-Theft Alarm System* on page 2-13.

 (Unlock): Press once to unlock only the driver door. If  is pressed again within five seconds, all remaining doors unlock. The interior lamps come on and stay on for 20 seconds or until the ignition is turned on.



2-4 Keys, Doors and Windows

If enabled through the DIC, the parking lamps flash twice to indicate unlocking has occurred. See *Vehicle Personalization (With DIC Buttons)* on page 5-45.

Pressing  on the RKE transmitter disarms the content theft-deterrent system. See *Anti-Theft Alarm System* on page 2-13.

 **(Power Liftgate):** Press and hold until the liftgate begins to move to open or close the liftgate. The taillamps flash and a chime sounds to indicate when the liftgate is opening or closing.

 **(Vehicle Locator/Panic Alarm):** Press and release to locate the vehicle. The parking lamps flash and the horn sounds three times.

Press and hold  for more than two seconds to activate the panic alarm. The parking lamps flash and the horn sounds repeatedly for 30 seconds. The alarm turns off when the ignition is moved to ON/RUN or  is pressed again. The ignition must be in LOCK/OFF for the panic alarm to work.

The vehicle comes with two transmitters. Each transmitter will have a number on it, "1" or "2". These numbers correspond to the driver of the vehicle. For example, the memory seat position for driver 1 will be recalled when using the transmitter labeled "1", if enabled through the vehicle personalization. See "Memory Seat and Mirrors" under *Power Seat Adjustment* on page 3-4 and "Memory Seat Recall" under *Vehicle Personalization (With DIC Buttons)* on page 5-45 for more information.

Programming Transmitters to the Vehicle

Only RKE transmitters programmed to this vehicle will work. If a transmitter is lost or stolen, a replacement can be purchased and programmed through your dealer/retailer. When the replacement transmitter is programmed to this vehicle using the DIC, all remaining transmitters must also be reprogrammed. Any lost or stolen transmitters will no longer work once the new transmitter is programmed. Each vehicle can have up to eight transmitters programmed to it. See "Relearn Remote Key" under *Driver Information Center (DIC) (With DIC Buttons)* on page 5-24 or *Driver Information Center (DIC) (Without DIC Buttons)* on page 5-29 for instructions on how to program transmitters to this vehicle.

Battery Replacement

Replace the battery if the REPLACE BATTERY IN REMOTE KEY message displays in the DIC.

Notice: When replacing the battery, do not touch any of the circuitry on the transmitter. Static from your body could damage the transmitter.



1. Separate the transmitter with a flat, thin object inserted into the notch on the side.
2. Remove the old battery. Do not use a metal object.

3. Insert the new battery, positive side facing down. Replace with a CR2032 or equivalent battery.
4. Snap the transmitter back together.

Remote Vehicle Start

This vehicle may have a remote starting feature that starts the engine from outside of the vehicle.

Ⓚ (Remote Start): This button is located on the RKE transmitter if the vehicle has remote start.

Laws in some communities may restrict the use of remote starters. For example, some laws may require a person using the remote start to have the vehicle in view when doing so. Check local regulations for any requirements on remote starting of vehicles.

Do not use the remote start feature if the vehicle is low on fuel. The vehicle could run out of fuel.

If the vehicle has the remote start feature, the RKE transmitter functions have an increased range of operation. However, the range may be less while the vehicle is running.

There are other conditions which can affect the performance of the transmitter, see *Remote Keyless Entry (RKE) System on page 2-2* for additional information.

Starting the Engine Using Remote Start

To start the vehicle:

1. Aim the RKE transmitter at the vehicle.
2. Press **Ⓚ** on the RKE transmitter.
3. Immediately after completing Step 2, press and hold **Ⓚ** until the parking lamps flash. If the vehicle's lights can not be seen, press and hold **Ⓚ** for at least four seconds.

2-6 Keys, Doors and Windows

When the vehicle starts the parking lamps will turn on and remain on as long as the engine is running. The doors will be locked and the climate control system will operate automatically if the vehicle has the automatic system, or at the same setting as when the vehicle was last turned off.

If the vehicle has an automatic climate control system and heated seats, the heated seats turn on during colder outside temperatures and shut off when the key is turned to ON/RUN. See *Heated Front Seats on page 3-9* or *Heated and Ventilated Front Seats on page 3-10* for more information.

The rear window defogger and heated mirrors, if the vehicle has them, turn on during colder outside temperatures and turn off when the key is turned to ON/RUN.

After entering the vehicle during a remote start, insert and turn the key to the ON/RUN position to drive the vehicle.

If the vehicle is left running it automatically shuts off after 10 minutes unless a time extension has been done.

Extending Engine Run Time

To extend the engine run time by 10 minutes, repeat Steps 1 through 3 while the engine is still running. The engine run time can only be extended if it is the first remote start since the vehicle has been driven. Remote start can be extended one time.

If the remote start procedure is used again before the first 10 minute time frame has ended, the first 10 minutes will immediately expire and the second 10 minute time frame will start.

For example, if the lock button and then the remote start buttons are pressed again after the vehicle has been running for five minutes, 10 minutes are added, allowing the engine to run for a total of 15 minutes.

A maximum of two remote starts or remote start attempts are allowed between ignition cycles.

After the vehicle's engine has been started two times using the remote start button, the ignition must be turned on and then back off before the remote start procedure can be used again.

Shutting the Engine Off After a Remote Start

To manually shut off a remote start:

- Aim the RKE transmitter at the vehicle and press  until the parking lamps turn off.
- Turn on the hazard warning flashers.
- Turn the ignition switch on and then off.

Conditions in Which the Remote Start Will Not Work

The vehicle cannot be started using the remote start feature if the key is in the ignition, the hood is open, or if there is an emission control system malfunction.

The engine turns off during a remote start if the coolant temperature gets too high or if the oil pressure gets low.

Vehicles that have the remote vehicle start feature are shipped from the factory with the remote vehicle start system enabled. The system may be enabled or disabled through the DIC if the vehicle has DIC buttons. See "REMOTE START" under *Vehicle Personalization (With DIC Buttons)* on page 5-45 for additional information. If the vehicle does not have DIC buttons, see your dealer/retailer to enable or disable the remote start system.

Door Locks

WARNING

Unlocked doors can be dangerous.

- Passengers, especially children, can easily open the doors and fall out of a moving vehicle. When a door is locked, the handle will not open it. The chance of being thrown out of the vehicle in a crash is increased if the doors are not locked. So, all passengers should wear safety belts properly and the doors should be locked whenever the vehicle is driven.

(Continued)

WARNING (Continued)

- Young children who get into unlocked vehicles may be unable to get out. A child can be overcome by extreme heat and can suffer permanent injuries or even death from heat stroke. Always lock the vehicle whenever leaving it.
- Outsiders can easily enter through an unlocked door when you slow down or stop your vehicle. Locking your doors can help prevent this from happening.

To lock or unlock a door, use the key from the outside or the door lock from the inside.

2-8 Keys, Doors and Windows

Power Door Locks

The power door lock switches are located on the front doors.

 **(Unlock):** Press to unlock the doors.

 **(Lock):** Remove the key from the ignition and press to lock the doors.

Delayed Locking

When locking the doors with the power lock switch and a door or the liftgate is open, the doors will lock five seconds after the last door is closed. You will hear three chimes to signal that the delayed locking feature is in use.

Pressing the power lock switch twice or the lock button on the RKE transmitter twice will override the delayed locking feature and immediately lock all the doors.

This feature will not operate if the key is in the ignition.

This feature can be programmed by using the Driver Information Center (DIC). See “DELAY DOOR LOCK” under *Vehicle Personalization (With DIC Buttons)* on page 5-45.

Automatic Door Locks

Vehicles with an automatic lock/unlock feature enable you to program the vehicle's power door locks. This feature can be programmed through the Driver Information Center (DIC). See *Vehicle Personalization (With DIC Buttons)* on page 5-45 for more information.

Lockout Protection

This feature protects you from locking the key in the vehicle when the key is in the ignition and a front door is open.

If the driver side power door lock switch is pressed when the driver's door is open and the key is in the ignition, all of the doors will lock and then the driver door will unlock.

If the passenger side power door lock switch is pressed when the front passenger door is open and the key is in the ignition, all of the doors will lock and then the front passenger door will unlock.

Safety Locks

The vehicle has rear door security locks to prevent passengers from opening the rear doors from the inside.



Open the rear doors to access the security locks on the inside edge of each door.

To set the locks, insert a key into the slot and turn it to the horizontal position. The door can only be opened from the outside with the door unlocked. To return the door to normal operation, turn the slot to the vertical position.

Doors

Liftgate

Manual Liftgate Operation

WARNING

Exhaust gases can enter the vehicle if it is driven with the liftgate, trunk/hatch open, or with any objects that pass through the seal between the body and the trunk/hatch or liftgate. Engine exhaust contains Carbon Monoxide (CO) which cannot be seen or smelled. It can cause unconsciousness and even death.

If the vehicle must be driven with the liftgate, or trunk/hatch open:

- Close all of the windows.
- Fully open the air outlets on or under the instrument panel.

(Continued)

WARNING (Continued)

- Adjust the Climate Control system to a setting that brings in only outside air and set the fan speed to the highest setting. See Climate Control System in the Index.
- If the vehicle is equipped with a power liftgate, disable the power liftgate function.

For more information about carbon monoxide, see *Engine Exhaust* on page 9-23.

To unlock the liftgate, use the power door lock switch or press the door unlock button on the Remote Keyless Entry (RKE) transmitter twice. See *Remote Keyless Entry (RKE) System Operation* on page 2-3.

2-10 Keys, Doors and Windows

To open the liftgate, press the touchpad on the underside of the liftgate handle. The vehicle must be in P (Park) to open the liftgate. To close the liftgate, use the pull cup or strap.

The liftgate has an electric latch. If the battery is disconnected or has low voltage, the liftgate will not open. The liftgate will resume operation when the battery is reconnected and charged.

If the battery is properly connected and has adequate voltage, and the liftgate still will not function, the vehicle should be taken to a dealer/retailer for service.

Power Liftgate Operation

WARNING

Exhaust gases can enter the vehicle if it is driven with the liftgate, trunk/hatch open, or with any objects that pass through the seal between the body and the trunk/hatch or liftgate. Engine exhaust contains Carbon Monoxide (CO) which cannot be seen or smelled. It can cause unconsciousness and even death.

If the vehicle must be driven with the liftgate, or trunk/hatch open:

- Close all of the windows.
- Fully open the air outlets on or under the instrument panel.

(Continued)

WARNING (Continued)

- Adjust the Climate Control system to a setting that brings in only outside air and set the fan speed to the highest setting. See Climate Control System in the Index.
- If the vehicle is equipped with a power liftgate, disable the power liftgate function.

For more information about carbon monoxide, see *Engine Exhaust* on page 9-23.

The vehicle may have a power liftgate. The vehicle must be in P (Park) to use this feature.

The taillamps will flash and a chime will sound when the power liftgate is used.

⚠ WARNING

You or others could be injured if caught in the path of the power liftgate. Make sure there is no one in the way of the liftgate as it is opening and closing.

Notice: If you open the liftgate without checking for overhead obstructions such as a garage door, you could damage the liftgate or the liftgate glass. Always check to make sure the area above and behind the liftgate is clear before opening it.

The power liftgate can be power opened and closed in the following ways:

- Press and hold the power liftgate button on the RKE transmitter until the liftgate starts moving.



Power Liftgate Button on Center Console

- Press the liftgate button on the center console.
- Press the touchpad switch on the outside liftgate handle.

Pressing the buttons or touchpad switch a second time while the liftgate is moving reverses the direction.

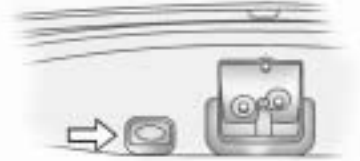

Power Liftgate Button near Liftgate Latch

The liftgate can also be closed by pressing the power liftgate button next to the liftgate latch. Press the button a second time during liftgate operation to reverse the operation.

The power liftgate may be temporarily disabled under extreme temperatures or under low battery conditions. If this occurs, the liftgate can still be operated manually.

2-12 Keys, Doors and Windows

If the vehicle is shifted out of P (Park) while the power function is in progress, the liftgate power function will continue to completion. If the vehicle is shifted out of P (Park) and the vehicle accelerates before the power liftgate latches closed, the liftgate may reverse to the open position. Cargo could fall out of the vehicle. The power liftgate must be closed and latched before driving.

If the liftgate is power opened and the support struts have lost pressure, the lights will flash and a chime will sound. The liftgate will stay open temporarily, then slowly close. See your dealer/retailer for service before using the liftgate if this occurs.

Obstacle Detection Features

A warning chime will sound and the liftgate will automatically reverse direction to the full closed or open position if the liftgate encounters an obstacle during a power open or

close cycle. After removing the obstruction, the power liftgate operation can be used again.

If the liftgate comes across more obstacles on the same power cycle, the power function deactivates, and you must manually open or close the liftgate. A message displays, LIFTGATE OPEN, to indicate that the liftgate is open. See *Driver Information Center (DIC) (With DIC Buttons)* on page 5-24 or *Driver Information Center (DIC) (Without DIC Buttons)* on page 5-29 for more information. After removing the obstructions, manually open the liftgate to the full open position or close the liftgate to the fully closed and latched position. The liftgate resumes normal power operation.

Pinch sensors are located on the side edges of the liftgate. If an object is caught between the liftgate and the vehicle and presses against this sensor, the liftgate will reverse direction and open fully. The liftgate will remain open until it is activated

again or closed manually. Do not force the liftgate open or closed during a power cycle.

Manual Operation of Power Liftgate



To change the liftgate to manual operation, press the switch on the center console to OFF.

With the power liftgate disabled and all of the doors unlocked, the liftgate can be manually opened and closed.

To open the liftgate, press the touchpad on the handle on the outside of the liftgate and lift the gate open. To close the liftgate, use the pull cup to lower the liftgate and close. The liftgate latch will power close. Always close the liftgate before driving.

If the RKE button or the power close button on the liftgate is pressed while power operation is disabled, the lights will flash three times, but the liftgate will not move.

It is not recommended that you drive with the liftgate open. However, if you must drive with the liftgate open, the liftgate should be set to manual operation by pressing the OFF switch on the center console.

Vehicle Security

Vehicle theft is big business, especially in some cities. This vehicle has theft-deterrent features, however, they do not make it impossible to steal.

Anti-Theft Alarm System

On vehicles with an anti-theft alarm system, to activate the system:

- Press  on the Remote Keyless Entry (RKE) transmitter or the power door lock switch when any door is open.



The security light flashes.

When the door is closed, the security light stops flashing and stays on solid for approximately

30 seconds. The content theft deterrent alarm is not armed until the security light goes off.

If the delayed locking feature is active, the alarm is not activated until all doors are closed and the security light goes off.

- Press  when the driver door is closed. The security light comes on solid for approximately 30 seconds and then goes off. The content theft deterrent alarm is not armed until the security light goes off.

The theft-deterrent system will not activate if the doors are locked with the vehicle's key or the manual door lock.

If a locked door is opened without using the RKE transmitter, a ten second pre-alarm occurs. The horn chirps and the lights flash.

2-14 Keys, Doors and Windows

If the key is not placed in the ignition and turned to START or the door is not unlocked by pressing  during the ten second pre-alarm, the alarm goes off. The headlamps flash and the horn sounds for about 30 seconds, then turns off to save the battery power.

The vehicle can be started with the correct ignition key if the alarm has been set off.

To avoid setting off the alarm by accident:

- Lock the vehicle with the door key after the doors are closed.
- Unlock the door with the RKE transmitter. Unlocking a door any other way sets off the alarm if the system has been armed.

Press  or place the key in the ignition and turn it to START to turn off the alarm.

Testing the Alarm

To test the alarm:

1. From inside the vehicle, lower the driver side window and open the driver door.
2. Press .
3. Get out of the vehicle, close the door and wait for the security light to go out.
4. Then reach in through the window, unlock the door with the manual door lock and open the door. This should set off the alarm.

If the alarm does not sound when it should, but the vehicle's headlamps flash, check to see if the horn works. The horn fuse may be blown. To replace the fuse, see *Fuses and Circuit Breakers on page 10-30*.

If the alarm does not sound or the vehicle's headlamps do not flash, see your dealer/retailer for service.

Immobilizer

See *Radio Frequency Statement on page 13-17* for information regarding Part 15 of the Federal Communications Commission (FCC) Rules and RSS-210/211 of Industry Canada.

Immobilizer Operation

This vehicle has PASS-Key[®] III+ (Personalized Automotive Security System) theft-deterrent system. PASS-Key[®] III+ is a passive theft-deterrent system.

The system is automatically armed when the key is removed from the ignition.

The system is automatically disarmed when the key is turned to ON/RUN, ACC/ACCESSORY or START from the LOCK/OFF position.

You do not have to manually arm or disarm the system.

The security light comes on if there is a problem with arming or disarming the theft-deterrent system.

When the PASS-Key® III+ system senses an incorrect key, the vehicle does not start. Anyone using a trial-and-error method to start the vehicle will be discouraged because of the high number of electrical key codes.

If the engine does not start and the security light on the instrument panel comes on when trying to start the vehicle, there may be a problem with your theft-deterrent system. Turn the ignition off and try again.

If the engine still does not start, and the key appears to be undamaged, try another ignition key and check the fuses. See *Fuses and Circuit Breakers on page 10-30* for additional information. If the engine still does not start with the other key, the vehicle needs service. If the vehicle does start, the first key may be faulty. See your dealer/retailer who can service the PASS-Key® III+ to have a new key made. In an emergency, contact Roadside Assistance. See *Roadside Assistance Program on page 13-6*.

It is possible for the PASS-Key® III+ decoder to learn the transponder value of a new or replacement key. Up to 10 keys may be programmed to the vehicle. The following procedure is for programming additional keys only. If all the currently programmed keys are lost or do not operate, you must see your dealer/retailer or a locksmith who can service PASS-Key® III+ to have keys made and programmed to the system.

See your dealer/retailer or a locksmith who can service PASS-Key® III+ to get a new key blank that is cut exactly as the ignition key that operates the system.

2-16 Keys, Doors and Windows

To program the new additional key:

1. Verify that the new key has a ⊕ stamped on it.
2. Insert the already programmed key in the ignition and start the engine. If the engine does not start, see your dealer/retailer for service.
3. After the engine has started, turn the key to LOCK/OFF, and remove the key.
4. Insert the key to be programmed and turn it to the ON/RUN position within five seconds of the original key being turned to the LOCK/OFF position.

The security light turns off once the key has been programmed.
5. Repeat Steps 1 through 4 if additional keys are to be programmed.

If the PASS-Key® III+ key is lost or damaged, see your dealer/retailer or a locksmith to have a new key made.

The SERVICE THEFT DETERRENT SYSTEM message displays on the Driver Information Center (DIC) when there is a problem with the theft-deterrent system. See *Anti-Theft Alarm System Messages on page 5-41* for additional information.

Do not leave the key or device that disarms or deactivates the theft deterrent system in the vehicle.

Exterior Mirrors

Convex Mirrors



A convex mirror can make things, like other vehicles, look farther away than they really are. If you cut too sharply into the right lane, you could hit a vehicle on the right. Check the inside mirror or glance over your shoulder before changing lanes.

The passenger side mirror is convex shaped. A convex mirror's surface is curved so more can be seen from the driver seat.

Power Mirrors

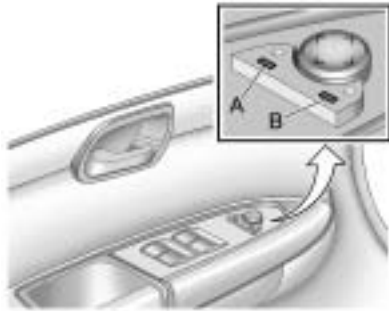

Controls for the outside power mirrors are located on the driver door armrest.

To adjust each mirror:

1. Press (A) or (B) to select the driver or passenger side mirror.
2. Press one of the four arrows located on the control pad to adjust the mirror.

3. Adjust each outside mirror so that a little of the vehicle and the area behind it can be seen.
4. Press either (A) or (B) again to deselect the mirror.

Folding Mirrors

For vehicles with manual folding mirrors, fold the mirrors inward to prevent damage when going through an automatic car wash. To fold, push the mirror toward the vehicle. Push the mirror outward to return it to the original position.

For vehicles with outside power foldaway mirrors:

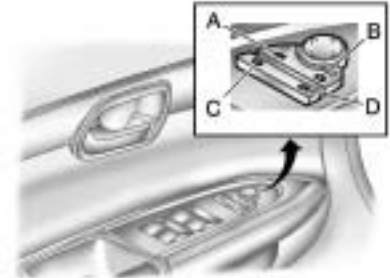

The controls for power foldaway mirrors are located on the driver door armrest.

1. Press (C) to fold the mirrors out to the driving position.
2. Press (D) to fold the mirrors in to the folded position.

Resetting the Power Foldaway Mirrors

Reset the power foldaway mirrors if:

- The mirrors are accidentally obstructed while folding.
- They are accidentally manually folded/unfolded.
- The mirrors vibrate at normal driving speeds.

Fold and unfold the mirrors one time using the mirror controls to reset them to their normal position. A popping noise may be heard during the resetting of the power foldaway mirrors. This sound is normal after a manual folding operation.

Automatic Dimming Feature

The driver outside mirror adjusts for the glare of the headlamps behind you. See *Automatic Dimming Rearview Mirror on page 2-19* for information on how to turn this feature on.

Turn Signal Indicator

The vehicle may have a turn signal indicator lamp that is built into the mirror housing. The turn signal lamp flashes with the use of the vehicle's turn signal and hazard flashers.

Heated Mirrors

For vehicles with heated mirrors:



(Rear Window Defogger):

Press to heat the mirrors.

See “Rear Window Defogger” under *Dual Automatic Climate Control System on page 8-4* for more information.

Park Tilt Mirrors

If the vehicle has the memory package, the outside mirrors have a park tilt feature. This feature tilts the outside mirrors to a preselected position when the vehicle is in R (Reverse). This allows the driver to view the curb for parallel parking.

The passenger and/or driver mirror returns to its original position when the vehicle is shifted out of R (Reverse), or the ignition is turned off or to OFF/LOCK.

This feature can be turned on or off through the Driver Information Center (DIC). See *Vehicle Personalization (With DIC Buttons) on page 5-45* for more information.

Interior Mirrors

Manual Rearview Mirror

Adjust the inside rearview mirror to see clearly behind your vehicle. Hold the mirror in the center to move it up or down and side to side. Use the day/night adjustment to help prevent glare from the headlamps behind you. Move the lever to the right for nighttime use and to the left for daytime use.

Vehicles with OnStar[®] have three additional control buttons located at the bottom of the mirror. See your dealer/retailer for more information about OnStar and how to subscribe to it. See the OnStar[®] owner guide for more information on the services OnStar provides.

Automatic Dimming Rearview Mirror

The vehicle may have an automatic dimming inside rearview mirror.

Automatic dimming reduces the glare from the headlamps of the vehicle behind you. The dimming feature comes on and the indicator light illuminates each time the ignition is turned to start.

Vehicles with OnStar[®] have three additional control buttons for the OnStar[®] system. See your dealer/retailer for more information about OnStar[®] and how to subscribe to it. See the OnStar[®] owner guide for more information about the services OnStar[®] provides.

 **(On/Off):** Press to turn the dimming feature on or off.

The vehicle may also have a Rear Vision Camera (RVC). See *Rear Vision Camera (RVC) on page 9-36* for more information.

If the vehicle has RVC, the  button for turning the dimming feature on or off will not be available.

Cleaning the Mirror

Do not spray glass cleaner directly on the mirror. Use a soft towel dampened with water.

Windows

 **WARNING**

Leaving children, helpless adults, or pets in a vehicle with the windows closed is dangerous. They can be overcome by the extreme heat and suffer permanent injuries or even death from heat stroke. Never leave a child, a helpless adult, or a pet alone in a vehicle, especially with the windows closed in warm or hot weather.



Power Windows

 **WARNING**

Leaving children in a vehicle with the keys is dangerous for many reasons, children or others could be badly injured or even killed. They could operate the power windows or other controls or even make the vehicle move. The windows will function and they could be seriously injured or killed if caught in the path of a closing window. Do not leave keys in a vehicle with children. When there are children in the rear seat use the window lockout button to prevent unintentional operation of the windows.

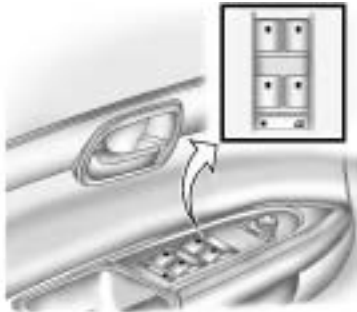

Uplevel shown, base similar

The power window controls are located on each of the side doors.

The driver door also has switches that control the passenger and rear windows. The power windows work with the ignition in ACC/ACCESSORY, ON/RUN or when Retained Accessory Power (RAP) is active. See *Retained Accessory Power (RAP)* on page 9-19.

Press the switch to lower the window. Pull up on the front edge of the switch to raise the window.

Express-Up/Express-Down Windows

A window with the express-up/down feature allows it to be raised or lowered without holding the switch. Press or pull the window switch fully and release it to activate the express feature. The express mode can be canceled by pressing or pulling the switch.

Programming the Power Windows

If the battery on the vehicle has been recharged, disconnected, or replaced, windows with the express-up feature need to be reprogrammed for this feature to work. To program the window:

1. Close all doors with the ignition in the ACC/ACCESSORY, ON/RUN position, or when Retained Accessory Power (RAP) is active. See *Retained Accessory Power (RAP)* on page 9-19.

2. Press and continue to hold the window switch until the window is fully open.
3. Pull up and hold the window switch to close the window. Continue to hold it briefly after the window is fully closed.
4. Repeat for each window that has the express-up feature.

Anti-Pinch Feature

The anti-pinch feature is on windows with the express-up feature. If an object is in the way of the window as it is express-closing, or in certain weather conditions like severe icing, the window will stop and open to a factory preset position. The window functions normally once the obstruction is removed.

Window Lockout

 **(Window Lockout):** The window lockout switch is located with the power window switches on the driver door armrest. This feature prevents the rear windows from being operated, except from the driver position. Press the switch to turn the lockout feature on or off. An indicator light will come on to show the lockout feature is on.

Sun Visors

Pull the sun visor down to block glare. Detach the sun visor from the center mount and slide it along the rod from side-to-side to cover the driver or passenger side of the front window. Swing the sun visor to the side to cover the side window. It can be moved along the rod from side-to-side in this position also.

Lighted Visor Vanity Mirror

The vehicle has lighted visor vanity mirrors on both the driver and passenger sun visors. Pull the sun visor down and lift the mirror cover to turn the lamps on.

Roof

Sunroof

The ignition must be in ON/RUN or ACC/ACCESSORY to operate the sunroof and power sunshade. See *Retained Accessory Power (RAP)* on page 9-19

The vehicle may have a sunroof over the front seats and a rear sunroof over the second row seats. The rear sunroof does not open. The switch to operate the front sunroof is on the headliner above the rearview mirror.

Do not keep the sunroof open for long periods of time while the vehicle is not in use. Debris can collect in the tracks, damage the sunroof operation and plug the water draining system.



Vent: From the closed position, press and hold the front of the switch to vent the sunroof. Press and hold the rear of the switch to close the sunroof.

Express-open/Express-close:

From the closed position, press and release the rear of the switch to express-open the sunroof. Press and release the front of the switch to express-close the sunroof.

The front sunshade must be opened and closed manually. Push up on the sunshade handle to open the sunshade.

Manual Sunshades

On a vehicle with only manual sunshades, press the button on the sunshade handle to release it and guide it back. Pull the sunshade forward until it latches to close it.

Rear Power Sunshade

On vehicles with a rear power sunshade, the switch is on the headliner above the rearview mirror.



Notice: The rear sunshade could be damaged if you attempt to open or close it manually. Do not manually open or close the rear sunshade.

To open the rear sunshade, located over the second row seats, press and release the rear of the switch. Press and release the front of the switch to close the sunshade.

Seats and Restraints

Head Restraints

Head Restraints 3-2

Front Seats

Seat Adjustment 3-3
 Power Seat Adjustment 3-4
 Lumbar Adjustment 3-6
 Reclining Seatbacks 3-7
 Heated Front Seats 3-9
 Heated and Ventilated Front Seats 3-10

Rear Seats

Rear Seats 3-10
 Third Row Seats 3-13

Safety Belts

Safety Belts 3-16
 How to Wear Safety Belts Properly 3-19
 Lap-Shoulder Belt 3-25
 Safety Belt Use During Pregnancy 3-30

Safety Belt Extender 3-30
 Safety System Check 3-31
 Safety Belt Care 3-31
 Replacing Safety Belt System Parts After a Crash 3-31

Airbag System

Airbag System 3-32
 Where Are the Airbags? 3-34
 When Should an Airbag Inflate? 3-35
 What Makes an Airbag Inflate? 3-37
 How Does an Airbag Restrain? 3-37
 What Will You See After an Airbag Inflates? 3-38
 Passenger Sensing System 3-39
 Servicing the Airbag-Equipped Vehicle 3-44
 Adding Equipment to the Airbag-Equipped Vehicle ... 3-44
 Airbag System Check 3-45
 Replacing Airbag System Parts After a Crash 3-46

Child Restraints

Older Children 3-46
 Infants and Young Children 3-49
 Child Restraint Systems 3-51
 Where to Put the Restraint ... 3-53
 Lower Anchors and Tethers for Children (LATCH System) 3-55
 Replacing LATCH System Parts After a Crash 3-61
 Securing Child Restraints (Rear Seat) 3-62
 Securing Child Restraints (Right Front Passenger Seat) 3-64

Head Restraints

The vehicle's front seats have adjustable head restraints in the outboard seating positions.

WARNING

With head restraints that are not installed and adjusted properly, there is a greater chance that occupants will suffer a neck/spinal injury in a crash. Do not drive until the head restraints for all occupants are installed and adjusted properly.



Adjust the head restraint so that the top of the restraint is at the same height as the top of the occupant's head. This position reduces the chance of a neck injury in a crash.

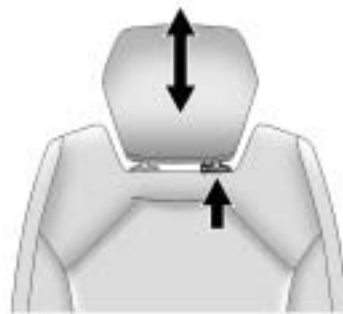

1. Pull the head restraint up to raise it. To lower the head restraint, press the release button, located on the head restraint post on the top of the seatback, while you push the head restraint down.
2. Push down on the head restraint after the button is released to make sure that it is locked in place.

Front Seats

Seat Adjustment

 **WARNING**

You can lose control of the vehicle if you try to adjust a manual driver's seat while the vehicle is moving. The sudden movement could startle and confuse you, or make you push a pedal when you do not want to. Adjust the driver's seat only when the vehicle is not moving.

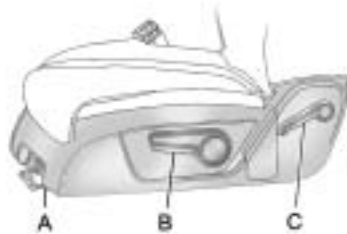

- A. Manual Seat Adjustment Handle
- B. Driver Seat Height Adjuster.
- C. See *Reclining Seatbacks on page 3-7.*

To adjust a manual seat:

1. Lift the handle (A) under the seat to unlock it.
2. Slide the seat and release the handle.

Try to move the seat to be sure it is locked in place.

To manually raise or lower the seat, move the lever (B) repeatedly upward or downward.

3-4 Seats and Restraints

Power Seat Adjustment

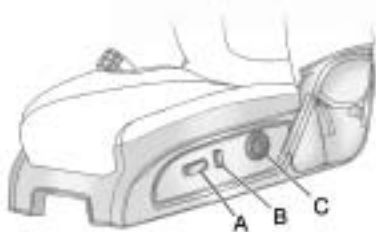

Driver Seat with Power Seat Control, Power Recline, and Power Lumbar shown

- A. Power Seat Adjustment Control
- B. *Reclining Seatbacks on page 3-7.*
- C. *Lumbar Adjustment on page 3-6.*

On vehicles with power seats, the controls are located on the outboard side of the seats.

Move the seat forward or rearward by sliding the power seat adjustment control (A) forward or rearward.

The vehicle may have additional features to adjust the power seat:

- Raise or lower the entire seat by moving the power seat adjustment control (A) up or down.
- Raise or lower the front part of the seat cushion by moving the front of the control up or down.
- Raise or lower the rear part of the seat cushion by moving the rear of the control up or down.

Memory Seat and Mirrors



On vehicles with the memory package, the controls for this feature are located on the driver door panel. The controls are used to program and recall memory settings for the driver seat and outside mirrors.

To save positions in memory:

1. Adjust the driver seat, including the seatback recliner and both outside mirrors to a comfortable position.

See *Power Mirrors on page 2-17* for more information.

Not all mirrors will have the ability to save and recall the mirror positions.

2. Press and hold button 1 until two beeps let you know that the position has been stored.

A second seating and mirror position can be programmed by repeating the above steps and pressing button 2.

To recall the memory positions, the vehicle must be in P (Park). Press and release either button 1 or button 2 corresponding to the desired driving position. The seat and outside mirrors will move to the position previously stored. You will hear a single beep.

Using the Remote Keyless Entry (RKE) transmitter to enter the vehicle, with the remote recall memory feature on, causes automatic seat and mirror adjustment. There is no adjustment when the position has not been changed by another seating position or the easy exit feature. See “MEMORY SEAT RECALL” under *Vehicle Personalization (With DIC Buttons) on page 5-45* for more information.

To stop recall movement of the memory feature at any time, press one of the power seat controls, memory buttons, or power mirror buttons.

If something has blocked the driver seat while recalling a memory position, the driver seat recall may stop working. If this happens, press the appropriate control for the area that is not recalling for two seconds, after the obstruction is removed.

Then try recalling the memory position again by pressing the appropriate memory button. If the memory position is still not being recalled, see your dealer/retailer for service.

Easy Exit Seat

The control for this feature is located on the driver door panel between buttons 1 and 2.

With the vehicle in P (Park), the exit position can be recalled by pressing the exit button. You will hear a single beep. The driver seat will move back.

If the easy exit seat feature is on in the Driver Information Center (DIC), automatic seat movement will occur when the key is removed from the ignition. See “EASY EXIT SEAT” under *Vehicle Personalization (With DIC Buttons) on page 5-45* for more information.

3-6 Seats and Restraints

Further programming for the memory seat feature can be done using the DIC. You can select or cancel the following:

- The automatic easy exit seat feature.
- The remote memory seat recall feature.

For programming information, see *Vehicle Personalization (With DIC Buttons)* on page 5-45.

Lumbar Adjustment

Manual Lumbar



On vehicles with this feature, the handle is located on the inboard side of the seatback.

Move the handle forward or rearward to increase or decrease lumbar support.

Power Lumbar

On vehicles with power lumbar, the control is located on the outboard side of the seat. See “Power Lumbar” under *Power Seat Adjustment* on page 3-4 for more information.

To increase or decrease lumbar support, press and hold the front or rear of the control (C).

Release the control when the seatback reaches the desired level of lumbar support.

Reclining Seatbacks

Manual Reclining Seatbacks

 **WARNING**

You can lose control of the vehicle if you try to adjust a manual driver's seat while the vehicle is moving. The sudden movement could startle and confuse you, or make you push a pedal when you do not want to. Adjust the driver's seat only when the vehicle is not moving.

 **WARNING**

If either seatback is not locked, it could move forward in a sudden stop or crash. That could cause injury to the person sitting there. Always push and pull on the seatbacks to be sure they are locked.

In vehicles with seats that have manual reclining seatbacks, the lever used to operate them is located on the outboard side of the seat. See *Seat Adjustment on page 3-3*.

To recline the seatback:

1. Lift the recline lever (C).
2. Move the seatback to the desired position, then release the lever to lock the seatback in place.
3. Push and pull on the seatback to make sure it is locked.

To return the seatback to an upright position, do the following:

1. Lift the lever fully without applying pressure to the seatback and the seatback will return to the upright position.
2. Push and pull on the seatback to make sure it is locked.

3-8 Seats and Restraints

Power Reclining Seatbacks

In vehicles with seats that have power reclining seatbacks, the control used to recline them is located on the outboard side of the seat. See *Power Seat Adjustment on page 3-4* for more information.

To recline the seatback:

- Tilt the top of the control (B) rearward.
- To bring the seatback forward, tilt the top of the control forward.

WARNING

Sitting in a reclined position when the vehicle is in motion can be dangerous. Even when buckled up, the safety belts cannot do their job when reclined like this.

(Continued)

WARNING (Continued)

The shoulder belt cannot do its job because it will not be against your body. Instead, it will be in front of you. In a crash, you could go into it, receiving neck or other injuries.

The lap belt cannot do its job either. In a crash, the belt could go up over your abdomen. The belt forces would be there, not at your pelvic bones. This could cause serious internal injuries.

For proper protection when the vehicle is in motion, have the seatback upright. Then sit well back in the seat and wear the safety belt properly.



Do not have a seatback reclined if your vehicle is moving.

Heated Front Seats

WARNING

If you cannot feel temperature change or pain to the skin, the seat heater may cause burns even at low temperatures. To reduce the risk of burns, people with such a condition should use care when using the seat heater, especially for long periods of time. Do not place anything on the seat that insulates against heat, such as a blanket, cushion, cover or similar item. This may cause the seat heater to overheat. An overheated seat heater may cause a burn or may damage the seat.

On vehicles with heated front seats, the controls are located on the center console. To operate the heated seats the engine must be running.

 **(Heated Seatback):** Press to turn on the heated seatback.

 **(Heated Seat and Seatback):** Press to turn on or off the heated seat and seatback.

The light on the button will come on to indicate that the feature is on. Each time the button is pressed, the temperature settings change from high, to medium, to low, to off. Indicator lights above the button will show the level of heat selected: three for high, two for medium, and one for low.

The passenger seat may take longer to heat up.

If the vehicle has remote vehicle start and is started using the RKE transmitter, the front heated seats will be turned on to the high setting if it is cold outside. See “Remote Vehicle Start” under *Remote Keyless Entry (RKE) System Operation on page 2-3*. When the ignition is turned on, the heated seat feature will turn off. To turn the heated seat feature back on, press the desired button.

Heated and Ventilated Front Seats

WARNING

If you cannot feel temperature change or pain to the skin, the seat heater may cause burns even at low temperatures. To reduce the risk of burns, people with such a condition should use care when using the seat heater, especially for long periods of time. Do not place anything on the seat that insulates against heat, such as a blanket, cushion, cover or similar item. This may cause the seat heater to overheat. An overheated seat heater may cause a burn or may damage the seat.

On vehicles with the heated and ventilated seat feature, the controls are located on the front doors near the door handle.

 **(Ventilated Seat):** Press to ventilate the entire seat.

This symbol appears on the climate control display to indicate that the feature is on.

 **(Heated Seat and Seatback):** Press to heat the entire seat.

This symbol appears on the climate control display to indicate that the feature is on.

For either feature press the button once for the highest setting. With each press of the switch, the seat changes to the next lower setting, and then the off setting. The lights indicate three for the highest setting and one for the lowest.

The heated and ventilated seats are canceled after the ignition is turned off. To use the heated and ventilated seat feature after the vehicle is started, you will need to press the appropriate seat button again.

Rear Seats



- A. Seat Adjustment Handle
- B. Reclining Seatback Strap
- C. Sliding Seat Lever

Entering and Exiting the Third Row

⚠ WARNING

Using the third row seating position while the second row is folded, or folded and tumbled, could cause injury in a sudden stop or crash. Be sure to return the seat to the passenger seating position. Push and pull on the seat to make sure it is locked into place.

Notice: Folding a rear seat with the safety belts still fastened may cause damage to the seat or the safety belts. Always unbuckle the safety belts and return them to their normal stowed position before folding a rear seat.



To access the third row:

1. Remove objects on the floor in front of or on the second row seat, or in the seat tracks on the floor.
2. Move the front center console armrest completely forward. See *Center Console Storage* on page 4-1.

3. Place folding armrests in the upright position.
4. Ensure that the safety belt is unfastened and in the stowed position.
5. Pull the sliding seat lever (C) forward and move the seatback forward. The seat cushion will fold, and the entire seat will slide forward.

Returning the Seat to the Seating Position

To return the second row seat to its normal seating position:

1. Remove objects on the floor behind the second row seat or in the seat tracks on the floor.
2. Pull the seatback rearward until it is locked in place.

3-12 Seats and Restraints

3. Slide the seat rearward by pushing on the seatback until it is locked into place.
4. Push down on the rear of the seat cushion until it is locked in place.
5. Push and pull on the seatback and seat cushion to make sure they are locked in place.
6. Check that the safety belt is not under the seat cushion.

Reclining the Seatbacks

To recline the seatback:

1. Leaning forward in the seat, pull the reclining seatback strap (B).
2. Move the seatback to the desired position, then release the strap to lock the seatback in place.
3. Push and pull on the seatback to make sure it is locked.

Folding the Rear Seat

To fold the second row seats:

1. Remove anything on or under the seat.
2. Place the armrest in the upright position, and unfasten the safety belt.
3. Pull forward on the reclining seatback strap (B) and push down on the seatback.

If the headrest touches the front seat, slide the second row seat rearward.

To return the seatback to the seating position, lift the upper corner of the seatback and push it rearward until it locks into place. Push and pull on the seatback to make sure it is locked.

Adjusting the Seats

To adjust the second row seats, pull outward on the seat adjustment handle (A). Slide the seat forward or rearward to the desired position. Release the handle and push and pull on the seat to make sure it is locked.

Third Row Seats

⚠ WARNING

Using the third row seating position while the second row is folded, or pushed forward in the entry position, could cause injury in a sudden stop or crash. Be sure to return the seat to the passenger seating position. Push and pull on the seat to make sure it is locked into place.

The third row seats can be folded forward or removed.

Notice: Folding a rear seat with the safety belts still fastened may cause damage to the seat or the safety belts. Always unbuckle the safety belts and return them to their normal stowed position before folding a rear seat.

To fold the seatback:

1. Remove anything on or under the seat.

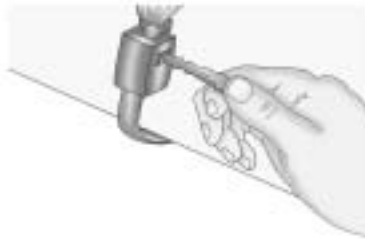

2. Disconnect the rear safety belt mini-latch, using a key in the slot on the mini-buckle, let the belt retract into the headliner. Stow the mini-latch in the holder located in the headliner.



3. Pull up on the release lever located on the back of the seat. The headrest moves forward automatically.
4. Push the seatback forward to lay flat.

3-14 Seats and Restraints

To return the seatback to the seating position:

1. Raise the seatback into place by using the pullstrap from the rear of the vehicle, or by pushing it into place from inside the vehicle.
2. The headrest must be locked into place before sitting in the seat.

WARNING

If either seatback is not locked, it could move forward in a sudden stop or crash. That could cause injury to the person sitting there. Always push and pull on the seatbacks to be sure they are locked.

3. Push and pull on the seatback to make sure it is locked in place.

WARNING

A safety belt that is improperly routed, not properly attached, or twisted will not provide the protection needed in a crash. The person wearing the belt could be seriously injured. After raising the rear seatback, always check to be sure that the safety belts are properly routed and attached, and are not twisted.

4. Reconnect the center safety belt mini-latch to the mini-buckle. Do not let it twist.
5. Pull on the safety belt to be sure the mini-latch is secure.

Removing the Third Row Seats

1. Remove the cargo management system, if it is in the vehicle. See *Cargo Management System* on page 4-3.
2. Remove anything on or under the seat.

Notice: Folding a rear seat with the safety belts still fastened may cause damage to the seat or the safety belts. Always unbuckle the safety belts and return them to their normal stowed position before folding a rear seat.

3. Fold the seatback down. See “Folding the Seatback” earlier in this section.

4. Remove the rear bolts located on the floor on each side of the seat.
5. Remove the seat by tilting it slightly upward, and then pulling it out of the rear of the vehicle in one motion.
6. Replace the bolts in the floor holes for storage.

Installing the Third Row Seats

1. Before installing the seat the seatback must be folded forward. See “Folding the Seatback” earlier in this section.

The seats must be placed in the proper locations to attach correctly. The wider seat must be installed on the driver side and the narrower seat on the passenger side. Remove the bolts from the holes in the floor before installing the seats.
2. Place the seat on the vehicle floor so that the front seat hooks are on the vehicle bars.

3. Reinstall the bolts, and torque to 55 N•m (41 lb ft). Pull up on the seat to make sure it is locked in place.
4. Raise the seatback to its upright position. Push and pull on the seatback to make sure it is locked into place.
5. Push the headrest up into position. Push and pull on the headrest to make sure it is locked into place.
6. Reconnect the center safety belt mini-latch to the mini-buckle. Do not let it twist.

Safety Belts

This section of the manual describes how to use safety belts properly. It also describes some things not to do with safety belts.

WARNING

Do not let anyone ride where a safety belt cannot be worn properly. In a crash, if you or your passenger(s) are not wearing safety belts, the injuries can be much worse. You can hit things inside the vehicle harder or be ejected from the vehicle. You and your passenger(s) can be seriously injured or killed. In the same crash, you might not be, if you are buckled up. Always fasten your safety belt, and check that your passenger(s) are restrained properly too.

WARNING

It is extremely dangerous to ride in a cargo area, inside or outside of a vehicle. In a collision, people riding in these areas are more likely to be seriously injured or killed. Do not allow people to ride in any area of your vehicle that is not equipped with seats and safety belts. Be sure everyone in your vehicle is in a seat and using a safety belt properly.

This vehicle has indicators as a reminder to buckle the safety belts. See *Safety Belt Reminders on page 5-14* for additional information.

In most states and in all Canadian provinces, the law requires wearing safety belts. Here is why:

You never know if you will be in a crash. If you do have a crash, you do not know if it will be a serious one.

A few crashes are mild, and some crashes can be so serious that even buckled up, a person would not survive. But most crashes are in between. In many of them, people who buckle up can survive and sometimes walk away. Without safety belts they could have been badly hurt or killed.

After more than 40 years of safety belts in vehicles, the facts are clear. In most crashes buckling up does matter ... a lot!

Why Safety Belts Work

When you ride in or on anything, you go as fast as it goes.



Take the simplest vehicle. Suppose it is just a seat on wheels.



Put someone on it.

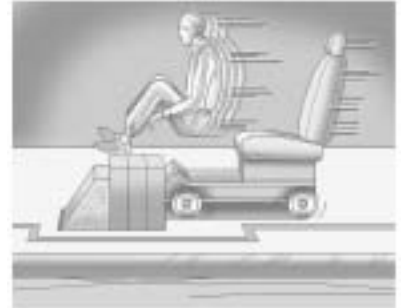

Get it up to speed. Then stop the vehicle. The rider does not stop.

3-18 Seats and Restraints



The person keeps going until stopped by something. In a real vehicle, it could be the windshield...



or the instrument panel...



or the safety belts!

With safety belts, you slow down as the vehicle does. You get more time to stop. You stop over more distance, and your strongest bones take the forces. That is why safety belts make such good sense.

Questions and Answers About Safety Belts

Q: Will I be trapped in the vehicle after a crash if I am wearing a safety belt?

A: You *could* be — whether you are wearing a safety belt or not. But your chance of being conscious during and after an accident, so you *can* unbuckle and get out, is *much* greater if you are belted. And you can unbuckle a safety belt, even if you are upside down.

Q: If my vehicle has airbags, why should I have to wear safety belts?

A: Airbags are supplemental systems only; so they work *with* safety belts — not instead of them. Whether or not an airbag is provided, all occupants still have to buckle up to get the most protection. That is true not only in frontal collisions, but especially in side and other collisions.

Q: If I am a good driver, and I never drive far from home, why should I wear safety belts?

A: You may be an excellent driver, but if you are in a crash — even one that is not your fault — you and your passenger(s) can be hurt. Being a good driver does not protect you from things beyond your control, such as bad drivers.

Most accidents occur within 40 km (25 miles) of home. And the greatest number of serious injuries and deaths occur at speeds of less than 65 km/h (40 mph).

Safety belts are for everyone.

How to Wear Safety Belts Properly

This section is only for people of adult size.

Be aware that there are special things to know about safety belts and children. And there are different rules for smaller children and infants. If a child will be riding in the vehicle, see *Older Children on page 3-46* or *Infants and Young Children on page 3-49*. Follow those rules for everyone's protection.

It is very important for all occupants to buckle up. Statistics show that unbelted people are hurt more often in crashes than those who are wearing safety belts.

Occupants who are not buckled up can be thrown out of the vehicle in a crash. And they can strike others in the vehicle who are wearing safety belts.

3-20 Seats and Restraints

First, before you or your passenger(s) wear a safety belt, there is important information you should know.

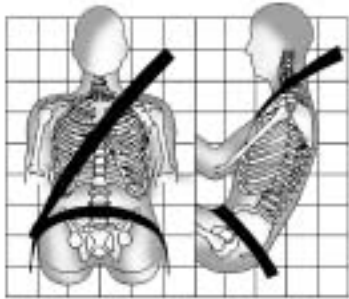

Sit up straight and always keep your feet on the floor in front of you. The lap part of the belt should be worn low and snug on the hips, just

touching the thighs. In a crash, this applies force to the strong pelvic bones and you would be less likely to slide under the lap belt. If you slid under it, the belt would apply force on your abdomen. This could cause serious or even fatal injuries. The shoulder belt should go over the shoulder and across the chest. These parts of the body are best able to take belt restraining forces.

The shoulder belt locks if there is a sudden stop or crash.

Q: What is wrong with this?

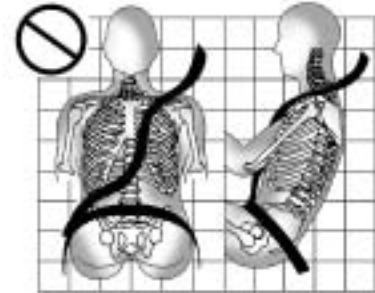

A: The shoulder belt is too loose. It will not give as much protection this way.

⚠ WARNING

You can be seriously hurt if your shoulder belt is too loose. In a crash, you would move forward too much, which could increase injury. The shoulder belt should fit snugly against your body.

Q: What is wrong with this?



A: The lap belt is too loose. It will not give nearly as much protection this way.

⚠ WARNING

You can be seriously hurt if your lap belt is too loose. In a crash, you could slide under the lap belt and apply force on your abdomen. This could cause serious or even fatal injuries. The lap belt should be worn low and snug on the hips, just touching the thighs.

3-22 Seats and Restraints

Q: What is wrong with this?

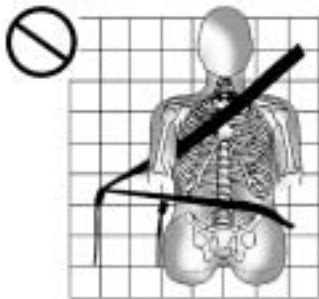

A: The belt is buckled in the wrong buckle.

WARNING

You can be seriously injured if your belt is buckled in the wrong place like this. In a crash, the belt would go up over your abdomen. The belt forces would be there, not on the pelvic bones. This could cause serious internal injuries. Always buckle your belt into the buckle nearest you.

Q: What is wrong with this?



A: The belt is over an armrest.

⚠ WARNING

You can be seriously injured if your belt goes over an armrest like this. The belt would be much too high. In a crash, you can slide under the belt. The belt force would then be applied on the abdomen, not on the pelvic bones, and that could cause serious or fatal injuries. Be sure the belt goes under the armrests.

Q: What is wrong with this?

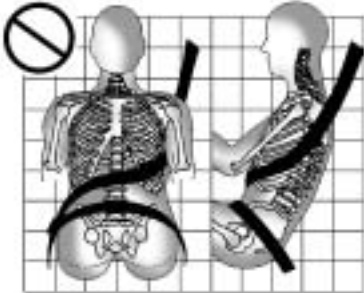

A: The shoulder belt is worn under the arm. It should be worn over the shoulder at all times.

⚠ WARNING

You can be seriously injured if you wear the shoulder belt under your arm. In a crash, your body would move too far forward, which would increase the chance of head and neck injury. Also, the belt would apply too much force to the ribs, which are not as strong as shoulder bones. You could also severely injure internal organs like your liver or spleen. The shoulder belt should go over the shoulder and across the chest.

3-24 Seats and Restraints

Q: What is wrong with this?

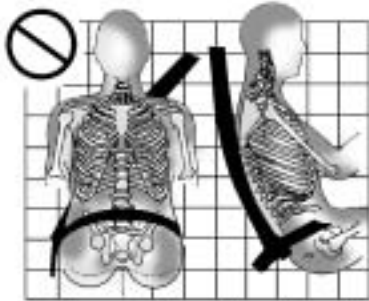

A: The belt is behind the body.

WARNING

You can be seriously injured by not wearing the lap-shoulder belt properly. In a crash, you would not be restrained by the shoulder belt. Your body could move too far forward increasing the chance of head and neck injury. You might also slide under the lap belt. The belt force would then be applied right on the abdomen. That could cause serious or fatal injuries. The shoulder belt should go over the shoulder and across the chest.

Q: What is wrong with this?

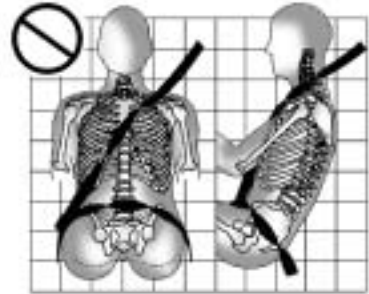

A: The belt is twisted across the body.

⚠ WARNING

You can be seriously injured by a twisted belt. In a crash, you would not have the full width of the belt to spread impact forces. If a belt is twisted, make it straight so it can work properly, or ask your dealer/retailer to fix it.

Lap-Shoulder Belt

All seating positions in the vehicle have a lap-shoulder belt.

If you are using a rear seating position with a detachable safety belt and the safety belt is not attached, see *Third Row Seats on page 3-13* for instruction on reconnecting the safety belt to the mini-buckle.

The following instructions explain how to wear a lap-shoulder belt properly.

1. Adjust the seat, if the seat is adjustable, so you can sit up straight. To see how, see “Seats” in the Index.



2. Pick up the latch plate and pull the belt across you. Do not let it get twisted.

The lap-shoulder belt may lock if you pull the belt across you very quickly. If this happens, let the belt go back slightly to unlock it. Then pull the belt across you more slowly.

If the shoulder portion of a passenger belt is pulled out all the way, the child restraint locking feature may be engaged. If this happens, let the belt go back all the way and start again.

3-26 Seats and Restraints



3. Push the latch plate into the buckle until it clicks.
4. Pull up on the latch plate to make sure it is secure. If the belt is not long enough, see *Safety Belt Extender* on page 3-30.

Position the release button on the buckle so that the safety belt could be quickly unbuckled if necessary.

5. If equipped with a shoulder belt height adjuster, move it to the height that is right for you. See “Shoulder Belt Height Adjustment” later in this section for instructions on use and important safety information.



6. To make the lap part tight, pull up on the shoulder belt.
It may be necessary to pull the stitching on the safety belt through the latch plate to fully tighten the lap belt on smaller occupants.



To unlatch the belt, push the button on the buckle. The belt should return to its stowed position. Slide the latch plate up the safety belt webbing when the safety belt is not in use. The latch plate should rest on the stitching on the safety belt, near the guide loop on the side wall.

Before a door is closed, be sure the safety belt is out of the way. If a door is slammed against a safety belt, damage can occur to both the safety belt and the vehicle.

Shoulder Belt Height Adjuster

The vehicle has a shoulder belt height adjuster for the driver and right front passenger seating positions.

Adjust the height so that the shoulder portion of the belt is centered on the shoulder. The belt should be away from the face and neck, but not falling off of the shoulder. Improper shoulder belt height adjustment could reduce the effectiveness of the safety belt in a crash.

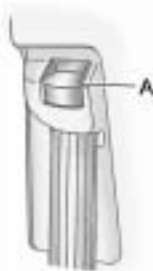

To move it down, push down on the button (A) and move the height adjuster to the desired position. You can move the height adjuster up by pushing up on the shoulder belt guide.

After the adjuster is set to the desired position, try to move it down without pushing the button to make sure it has locked into position.

Safety Belt Pretensioners

This vehicle has safety belt pretensioners for the front outboard occupants. Although the safety belt pretensioners cannot be seen, they are part of the safety belt assembly. They can help tighten the safety belts during the early stages of a moderate to severe frontal, near frontal, or rear crash if the threshold conditions for pretensioner activation are met. And, for vehicles with side impact airbags, safety belt pretensioners can help tighten the safety belts in a side crash or a rollover event.

Pretensioners work only once. If the pretensioners activate in a crash, they will need to be replaced, and probably other new parts for the vehicle's safety belt system. See *Replacing Safety Belt System Parts After a Crash* on page 3-31.

Rear Safety Belt Comfort Guides

This vehicle may have rear shoulder belt comfort guides. If not, they are available through your dealer/retailer. The guides may provide added safety belt comfort for older children who have outgrown booster seats and for some adults. When installed and properly adjusted, the comfort guide positions the shoulder belt away from the neck and head.

Here is how to install a comfort guide to the safety belt:



Outboard Positions

1. For the outboard positions, remove the guide from its storage clip on the interior body.

For the third row center position, locate the comfort guide which is located in a storage pocket, at the top of the seat, under the headrest on the driver's side of

the vehicle. To access the comfort guide, you will first need to move the headrest forward by pulling on the handle behind the seatback. The comfort guide will now be accessible.



Third Row Center Position

Pull the comfort guide out of its storage location and then return the headrest to its upright position.



- 2. Place the guide over the belt and insert the two edges of the belt into the slots of the guide.

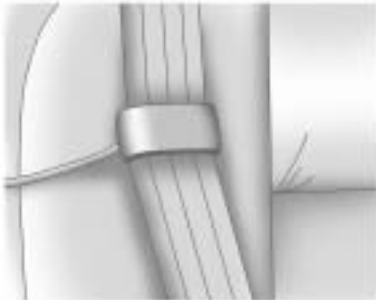

- 3. Be sure that the belt is not twisted and it lies flat. The elastic cord must be under the belt and the guide on top.

 WARNING
A safety belt that is not properly worn may not provide the protection needed in a crash. The person wearing the belt could be seriously injured.
(Continued)

WARNING (Continued)
The shoulder belt should go over the shoulder and across the chest. These parts of the body are best able to take belt restraining forces.



- 4. Buckle, position, and release the safety belt as described previously in this section. Make sure that the shoulder belt crosses the shoulder.

3-30 Seats and Restraints

To remove and store the comfort guide, squeeze the belt edges together so that the safety belt can be removed from the guide. Slide the guide into its storage location or on its storage clip.

Safety Belt Use During Pregnancy

Safety belts work for everyone, including pregnant women. Like all occupants, they are more likely to be seriously injured if they do not wear safety belts.



A pregnant woman should wear a lap-shoulder belt, and the lap portion should be worn as low as possible, below the rounding, throughout the pregnancy.

The best way to protect the fetus is to protect the mother. When a safety belt is worn properly, it is more likely that the fetus will not be hurt in a crash. For pregnant women, as for anyone, the key to making safety belts effective is wearing them properly.

Safety Belt Extender

If the vehicle's safety belt will fasten around you, you should use it.

But if a safety belt is not long enough, your dealer/retailer will order you an extender. When you go in to order it, take the heaviest coat you will wear, so the extender will be long enough for you. To help avoid personal injury, do not let someone else use it, and use it only for the seat it is made to fit. The extender has been designed for adults. Never use it for securing child seats. To wear it, attach it to the regular safety belt. For more information, see the instruction sheet that comes with the extender.

Safety System Check

Now and then, check that the safety belt reminder light, safety belts, buckles, latch plates, retractors and anchorages are working properly. Look for any other loose or damaged safety belt system parts that might keep a safety belt system from doing its job. See your dealer/retailer to have it repaired. Torn or frayed safety belts may not protect you in a crash. They can rip apart under impact forces. If a belt is torn or frayed, get a new one right away.

Make sure the safety belt reminder light is working. See *Safety Belt Reminders* on page 5-14 for more information.

Keep safety belts clean and dry. See *Safety Belt Care* on page 3-31.

Safety Belt Care

Keep belts clean and dry.

WARNING

Do not bleach or dye safety belts. It may severely weaken them. In a crash, they might not be able to provide adequate protection. Clean safety belts only with mild soap and lukewarm water.

Replacing Safety Belt System Parts After a Crash

WARNING

A crash can damage the safety belt system in the vehicle. A damaged safety belt system may not properly protect the person using it, resulting in serious injury or even death in a crash. To help make sure the

(Continued)

WARNING (Continued)

safety belt systems are working properly after a crash, have them inspected and any necessary replacements made as soon as possible.

After a minor crash, replacement of safety belts may not be necessary. But the safety belt assemblies that were used during any crash may have been stressed or damaged. See your dealer/retailer to have the safety belt assemblies inspected or replaced.

New parts and repairs may be necessary even if the safety belt system was not being used at the time of the crash.

Have the safety belt pretensioners checked if the vehicle has been in a crash, or if the airbag readiness light stays on after you start the vehicle or while you are driving. See *Airbag Readiness Light* on page 5-15.

Airbag System

The vehicle has the following airbags:

- A frontal airbag for the driver.
- A frontal airbag for the right front passenger.
- A seat-mounted side impact airbag for the driver.
- A seat-mounted side impact airbag for the right front passenger.
- A roof-rail airbag for the driver, passenger seated directly behind the driver, and the third row outboard passenger position.
- A roof-rail airbag for the right front passenger, passenger seated directly behind the right front passenger, and the third row outboard passenger position.

All of the airbags in the vehicle will have the word AIRBAG embossed in the trim or on an attached label near the deployment opening.

For frontal airbags, the word AIRBAG will appear on the middle part of the steering wheel for the driver and on the instrument panel for the right front passenger.

With seat-mounted side impact airbags, the word AIRBAG will appear on the side of the seatback closest to the door.

With roof-rail airbags, the word AIRBAG will appear along the headliner or trim.

Airbags are designed to supplement the protection provided by safety belts. Even though today's airbags are also designed to help reduce the risk of injury from the force of an inflating bag, all airbags must inflate very quickly to do their job.

Here are the most important things to know about the airbag system:

WARNING

You can be severely injured or killed in a crash if you are not wearing your safety belt — even if you have airbags. Airbags are designed to work with safety belts, but do not replace them. Also, airbags are not designed to deploy in every crash. In some crashes safety belts are your only restraint. See *When Should an Airbag Inflate?* on page 3-35.

Wearing your safety belt during a crash helps reduce your chance of hitting things inside the vehicle or being ejected from it. Airbags are “supplemental restraints” to the safety belts. Everyone in your vehicle should wear a safety belt properly — whether or not there is an airbag for that person.

⚠ WARNING

Airbags inflate with great force, faster than the blink of an eye. Anyone who is up against, or very close to, any airbag when it inflates can be seriously injured or killed. Do not sit unnecessarily close to the airbag, as you would be if you were sitting on the edge of your seat or leaning forward. Safety belts help keep you in position before and during a crash. Always wear your safety belt, even with airbags. The driver should sit as far back as possible while still maintaining control of the vehicle.

(Continued)

WARNING (Continued)

Occupants should not lean on or sleep against the door or side windows in seating positions with seat-mounted side impact airbags and/or roof-rail airbags.

⚠ WARNING

Children who are up against, or very close to, any airbag when it inflates can be seriously injured or killed. Airbags plus lap-shoulder belts offer protection for adults and older children, but not for young children and infants. Neither the vehicle's safety belt system nor its airbag system is designed for them. Young children and infants need the protection that a child restraint system can provide.

(Continued)

WARNING (Continued)

Always secure children properly in your vehicle. To read how, see *Older Children on page 3-46* or *Infants and Young Children on page 3-49*.



There is an airbag readiness light on the instrument panel cluster, which shows the airbag symbol.

The system checks the airbag electrical system for malfunctions. The light tells you if there is an electrical problem. See *Airbag Readiness Light on page 5-15* for more information.

Where Are the Airbags?



The driver frontal airbag is in the middle of the steering wheel.



The right front passenger frontal airbag is in the instrument panel on the passenger side.



Driver Side shown, Passenger Side similar

The seat-mounted side impact airbags for the driver and right front passenger are in the side of the seatbacks closest to the door.



**Driver Side shown, Passenger
Side similar**

The roof-rail airbags for the driver, right front passenger, passengers behind the driver and right front passenger, and the third row outboard passengers are in the ceiling above the side windows.

⚠ WARNING

If something is between an occupant and an airbag, the airbag might not inflate properly or it might force the object into that person causing severe injury or even death. The path of an inflating airbag must be kept clear. Do not put anything between an occupant and an airbag, and do not attach or put anything on the steering wheel hub or on or near any other airbag covering.

Do not use seat accessories that block the inflation path of a seat-mounted side impact airbag.

Never secure anything to the roof of a vehicle with roof-rail airbags by routing a rope or tie down through any door or window opening. If you do, the path of an inflating roof-rail airbag will be blocked.

**When Should an Airbag
Inflate?**

Frontal airbags are designed to inflate in moderate to severe frontal or near-frontal crashes to help reduce the potential for severe injuries mainly to the driver's or right front passenger's head and chest. However, they are only designed to inflate if the impact exceeds a predetermined deployment threshold. Deployment thresholds are used to predict how severe a crash is likely to be in time for the airbags to inflate and help restrain the occupants.

Whether the frontal airbags will or should deploy is not based on how fast your vehicle is traveling. It depends largely on what you hit, the direction of the impact, and how quickly your vehicle slows down.

3-36 Seats and Restraints

Frontal airbags may inflate at different crash speeds. For example:

- If the vehicle hits a stationary object, the airbags could inflate at a different crash speed than if the vehicle hits a moving object.
- If the vehicle hits an object that deforms, the airbags could inflate at a different crash speed than if the vehicle hits an object that does not deform.
- If the vehicle hits a narrow object (like a pole), the airbags could inflate at a different crash speed than if the vehicle hits a wide object (like a wall).
- If the vehicle goes into an object at an angle, the airbags could inflate at a different crash speed than if the vehicle goes straight into the object.

Thresholds can also vary with specific vehicle design.

Frontal airbags are not intended to inflate during vehicle rollovers, rear impacts, or in many side impacts.

In addition, the vehicle has dual-stage frontal airbags. Dual-stage airbags adjust the restraint according to crash severity. The vehicle has electronic frontal sensors, which help the sensing system distinguish between a moderate frontal impact and a more severe frontal impact. For moderate frontal impacts, dual-stage airbags inflate at a level less than full deployment. For more severe frontal impacts, full deployment occurs.

The vehicle has seat-mounted side impact and roof-rail airbags. See *Airbag System on page 3-32*. Seat-mounted side impact and roof-rail airbags are intended to inflate in moderate to severe side crashes. In addition, these roof-rail airbags are intended to inflate during a rollover or in a severe frontal impact. Seat-mounted side impact and roof-rail airbags will

inflate if the crash severity is above the system's designed threshold level. The threshold level can vary with specific vehicle design.

Seat-mounted side impact airbags are not intended to inflate in frontal impacts, near-frontal impacts, rollovers, or rear impacts. Roof-rail airbags are not intended to inflate in rear impacts. A seat-mounted side impact airbag is intended to deploy on the side of the vehicle that is struck. Both roof-rail airbags will deploy when either side of the vehicle is struck, or if the sensing system predicts that the vehicle is about to roll over, or in a severe frontal impact.

In any particular crash, no one can say whether an airbag should have inflated simply because of the damage to a vehicle or because of what the repair costs were. For frontal airbags, inflation is determined by what the vehicle hits, the angle of the impact, and how quickly the vehicle slows down.

For seat-mounted side impact and roof-rail airbags, deployment is determined by the location and severity of the side impact. In a rollover event, roof-rail airbag deployment is determined by the direction of the roll.

What Makes an Airbag Inflate?

In a deployment event, the sensing system sends an electrical signal triggering a release of gas from the inflator. Gas from the inflator fills the airbag causing the bag to break out of the cover and deploy. The inflator, the airbag, and related hardware are all part of the airbag module.

Frontal airbag modules are located inside the steering wheel and instrument panel. For vehicles with seat-mounted side impact airbags, there are airbag modules in the side of the front seatbacks closest to the door. For vehicles with roof-rail

airbags, there are airbag modules in the ceiling of the vehicle, near the side windows that have occupant seating positions.

How Does an Airbag Restrain?

In moderate to severe frontal or near frontal collisions, even belted occupants can contact the steering wheel or the instrument panel. In moderate to severe side collisions, even belted occupants can contact the inside of the vehicle.

Airbags supplement the protection provided by safety belts. Frontal airbags distribute the force of the impact more evenly over the occupant's upper body, stopping the occupant more gradually. Seat-mounted side impact and roof-rail airbags distribute the force of the impact more evenly over the occupant's upper body.

Rollover capable roof-rail airbags are designed to help contain the head and chest of occupants in the outboard seating positions in the first and second rows. The rollover capable roof-rail airbags are designed to help reduce the risk of full or partial ejection in rollover events, although no system can prevent all such ejections.

But airbags would not help in many types of collisions, primarily because the occupant's motion is not toward those airbags. See *When Should an Airbag Inflate?* on page 3-35 for more information.

Airbags should never be regarded as anything more than a supplement to safety belts.

What Will You See After an Airbag Inflates?

After the frontal airbags and seat-mounted side impact airbags inflate, they quickly deflate, so quickly that some people may not even realize an airbag inflated. Roof-rail airbags may still be at least partially inflated for some time after they deploy. Some components of the airbag module may be hot for several minutes. For location of the airbag modules, see *What Makes an Airbag Inflate?* on page 3-37.

The parts of the airbag that come into contact with you may be warm, but not too hot to touch. There may be some smoke and dust coming from the vents in the deflated airbags. Airbag inflation does not prevent the driver from seeing out of the windshield or being able to steer the vehicle, nor does it prevent people from leaving the vehicle.

WARNING

When an airbag inflates, there may be dust in the air. This dust could cause breathing problems for people with a history of asthma or other breathing trouble. To avoid this, everyone in the vehicle should get out as soon as it is safe to do so. If you have breathing problems but cannot get out of the vehicle after an airbag inflates, then get fresh air by opening a window or a door. If you experience breathing problems following an airbag deployment, you should seek medical attention.

The vehicle has a feature that may automatically unlock the doors, turn on the interior lamps and hazard warning flashers, and shut off the fuel system after the airbags inflate.

You can lock the doors, turn off the interior lamps and hazard warning flashers by using the controls for those features.

WARNING

A crash severe enough to inflate the airbags may have also damaged important functions in the vehicle, such as the fuel system, brake and steering systems, etc. Even if the vehicle appears to be drivable after a moderate crash, there may be concealed damage that could make it difficult to safely operate the vehicle.

Use caution if you should attempt to restart the engine after a crash has occurred.

In many crashes severe enough to inflate the airbag, windshields are broken by vehicle deformation. Additional windshield breakage may also occur from the right front passenger airbag.

- Airbags are designed to inflate only once. After an airbag inflates, you will need some new parts for the airbag system. If you do not get them, the airbag system will not be there to help protect you in another crash. A new system will include airbag modules and possibly other parts. The service manual for your vehicle covers the need to replace other parts.

- The vehicle has a crash sensing and diagnostic module which records information after a crash. See *Vehicle Data Recording and Privacy on page 13-16* and *Event Data Recorders on page 13-16*.
- Let only qualified technicians work on the airbag systems. Improper service can mean that an airbag system will not work properly. See your dealer/retailer for service.

Passenger Sensing System

The vehicle has a passenger sensing system for the right front passenger position. The passenger airbag status indicator will be visible on the instrument panel when the vehicle is started.



United States



Canada

The words ON and OFF, or the symbol for on and off, are visible during the system check. If you are using remote start, if equipped, to start the vehicle from a distance, you may not see the system check. When the system check is complete, either the word ON or OFF, or the symbol for on or off, will be visible. See *Passenger Airbag Status Indicator on page 5-15*.

3-40 Seats and Restraints

The passenger sensing system turns off the right front passenger frontal airbag under certain conditions. The driver airbag, seat-mounted side impact airbags and the roof-rail airbags are not affected by the passenger sensing system.

The passenger sensing system works with sensors that are part of the right front passenger seat. The sensors are designed to detect the presence of a properly-seated occupant and determine if the right front passenger frontal airbag should be enabled (may inflate) or not.

According to accident statistics, children are safer when properly secured in a rear seat in the correct child restraint for their weight and size.

We recommend that children be secured in a rear seat, including: an infant or a child riding in a rear-facing child restraint; a child riding in a forward-facing child seat; an older child riding in a booster seat; and children, who are large enough, using safety belts.

A label on the sun visor says, "Never put a rear-facing child seat in the front." This is because the risk to the rear-facing child is so great, if the airbag deploys.

WARNING

A child in a rear-facing child restraint can be seriously injured or killed if the right front passenger airbag inflates. This is because the back of the rear-facing child restraint would be very close to the inflating airbag. A child in a forward-facing child restraint can be seriously

(Continued)

WARNING (Continued)

injured or killed if the right front passenger airbag inflates and the passenger seat is in a forward position.

Even if the passenger sensing system has turned off the right front passenger frontal airbag, no system is fail-safe. No one can guarantee that an airbag will not deploy under some unusual circumstance, even though the airbag is turned off.

Secure rear-facing child restraints in a rear seat, even if the airbag is off. If you secure a forward-facing child restraint in the right front seat, always move the front passenger seat as far back as it will go. It is better to secure the child restraint in a rear seat.

The passenger sensing system is designed to turn off the right front passenger frontal airbag if:

- The right front passenger seat is unoccupied.
- The system determines that an infant is present in a child restraint.
- A right front passenger takes his/her weight off of the seat for a period of time.
- Or, if there is a critical problem with the airbag system or the passenger sensing system.

When the passenger sensing system has turned off the right front passenger frontal airbag, the off indicator will light and stay lit to remind you that the airbag is off. See *Passenger Airbag Status Indicator on page 5-15*.

The passenger sensing system is designed to turn on (may inflate) the right front passenger frontal airbag anytime the system senses that a person of adult size is sitting properly in the right front passenger seat.

When the passenger sensing system has allowed the airbag to be enabled, the on indicator will light and stay lit to remind you that the airbag is active.

For some children, including children in child restraints, and for very small adults, the passenger sensing system may or may not turn off the right front passenger frontal airbag, depending upon the person's seating posture and body build. Everyone in the vehicle who has outgrown child restraints should wear a safety belt properly — whether or not there is an airbag for that person.

 **WARNING**

If the airbag readiness light ever comes on and stays on, it means that something may be wrong with the airbag system. To help avoid injury to yourself or others, have the vehicle serviced right away. See *Airbag Readiness Light on page 5-15* for more information, including important safety information.

If the On Indicator is Lit for a Child Restraint

If a child restraint has been installed and the on indicator is lit:

1. Turn the vehicle off.
2. Remove the child restraint from the vehicle.
3. Remove any additional items from the seat such as blankets, cushions, seat covers, seat heaters, or seat massagers.

3-42 Seats and Restraints

4. Reinstall the child restraint following the directions provided by the child restraint manufacturer and refer to *Securing Child Restraints (Rear Seat)* on page 3-62 or *Securing Child Restraints (Right Front Passenger Seat)* on page 3-64.
5. If, after reinstalling the child restraint and restarting the vehicle, the on indicator is still lit, turn the vehicle off. Then slightly recline the vehicle seatback and adjust the seat cushion, if adjustable, to make sure that the vehicle seatback is not pushing the child restraint into the seat cushion.

Also make sure the child restraint is not trapped under the vehicle head restraint. If this happens, adjust the head restraint. See *Head Restraints* on page 3-2.

6. Restart the vehicle.

The passenger sensing system may or may not turn off the airbag for a child in a child restraint depending upon the child's seating posture and body build. It is better to secure the child restraint in a rear seat.

If the Off Indicator is Lit for an Adult-Size Occupant



If a person of adult-size is sitting in the right front passenger seat, but the off indicator is lit, it could be

because that person is not sitting properly in the seat. If this happens, use the following steps to allow the system to detect that person and enable the right front passenger frontal airbag:

1. Turn the vehicle off.
2. Remove any additional material from the seat, such as blankets, cushions, seat covers, seat heaters, or seat massagers.
3. Place the seatback in the fully upright position.
4. Have the person sit upright in the seat, centered on the seat cushion, with legs comfortably extended.
5. Restart the vehicle and have the person remain in this position for two to three minutes after the on indicator is lit.

Additional Factors Affecting System Operation

Safety belts help keep the passenger in position on the seat during vehicle maneuvers and braking, which helps the passenger sensing system maintain the passenger airbag status. See “Safety Belts” and “Child Restraints” in the Index for additional information about the importance of proper restraint use.

A thick layer of additional material, such as a blanket or cushion, or aftermarket equipment such as seat covers, seat heaters, and seat massagers can affect how well the passenger sensing system operates. We recommend that you not use seat covers or other aftermarket equipment except when approved by GM for your specific vehicle. See *Adding Equipment to the Airbag-Equipped Vehicle on page 3-44* for more information about modifications that can affect how the system operates.

A wet seat can affect the performance of the passenger sensing system. Here is how:

- The passenger sensing system may turn off the passenger airbag when liquid is soaked into the seat. If this happens, the off indicator will be lit, and the airbag readiness light on the instrument panel will also be lit.
- Liquid pooled on the seat that has not soaked in may make it more likely that the passenger sensing system will enable (turn on) the passenger airbag while a child restraint or child occupant is on the seat. If the passenger airbag is turned on, the on indicator will be lit.

If the passenger seat gets wet, dry the seat immediately. If the airbag readiness light is lit, do not install a child restraint or allow anyone to occupy the seat. See *Airbag Readiness Light on page 5-15* for important safety information.

The on indicator may be lit if an object, such as a briefcase, handbag, grocery bag, laptop or other electronic device, is put on an unoccupied seat. If this is not desired remove the object from the seat.

WARNING

Stowing of articles under the passenger seat or between the passenger seat cushion and seatback may interfere with the proper operation of the passenger sensing system.

Servicing the Airbag-Equipped Vehicle

Airbags affect how the vehicle should be serviced. There are parts of the airbag system in several places around the vehicle. Your dealer/retailer and the service manual have information about servicing the vehicle and the airbag system. To purchase a service manual, see *Service Publications Ordering Information* on page 13-13.

WARNING

For up to 10 seconds after the ignition is turned off and the battery is disconnected, an airbag can still inflate during improper service. You can be injured if you are close to an airbag when it inflates. Avoid yellow connectors.

(Continued)

WARNING (Continued)

They are probably part of the airbag system. Be sure to follow proper service procedures, and make sure the person performing work for you is qualified to do so.

Adding Equipment to the Airbag-Equipped Vehicle

- Q: Is there anything I might add to or change about the vehicle that could keep the airbags from working properly?**
- A:** Yes. If you add things that change the vehicle's frame, bumper system, height, front end or side sheet metal, they may keep the airbag system from working properly. Changing or moving any parts of the front seats, safety belts, the airbag sensing and diagnostic module,

steering wheel, instrument panel, roof-rail airbag modules, ceiling headliner or pillar garnish trim, overhead console, front sensors, side impact sensors, rollover sensor module, or airbag wiring can affect the operation of the airbag system.

In addition, the vehicle has a passenger sensing system for the right front passenger position, which includes sensors that are part of the passenger seat. The passenger sensing system may not operate properly if the original seat trim is replaced with non-GM covers, upholstery or trim, or with GM covers, upholstery or trim designed for a different vehicle. Any object, such as an aftermarket seat heater or a comfort enhancing pad or device, installed under or on top of the seat fabric, could also interfere with the operation of the passenger sensing system.

This could either prevent proper deployment of the passenger airbag(s) or prevent the passenger sensing system from properly turning off the passenger airbag(s). See *Passenger Sensing System on page 3-39*.

If you have questions, call Customer Assistance. The phone numbers and addresses for Customer Assistance are in Step Two of the Customer Satisfaction Procedure in this manual.

If the vehicle has rollover roof-rail airbags, see *Different Size Tires and Wheels on page 10-53* for additional important information.

Q: Because I have a disability, I have to get my vehicle modified. How can I find out whether this will affect my airbag system?

A: If you have questions, call Customer Assistance. The phone numbers and addresses for Customer Assistance are in Step Two of the Customer Satisfaction Procedure in this manual.

In addition, your dealer/retailer and the service manual have information about the location of the airbag sensors, sensing and diagnostic module and airbag wiring.

Airbag System Check

The airbag system does not need regularly scheduled maintenance or replacement. Make sure the airbag readiness light is working. See *Airbag Readiness Light on page 5-15* for more information.

Notice: If an airbag covering is damaged, opened, or broken, the airbag may not work properly. Do not open or break the airbag coverings. If there are any opened or broken airbag covers, have the airbag covering and/or airbag module replaced. For the location of the airbag modules, see *What Makes an Airbag Inflate?* on page 3-37. See your dealer/retailer for service.

Replacing Airbag System Parts After a Crash

 **WARNING**

A crash can damage the airbag systems in your vehicle. A damaged airbag system may not work properly and may not protect you and your passenger(s) in a crash, resulting in serious injury or even death. To help make sure your airbag systems are working properly after a crash, have them inspected and any necessary replacements made as soon as possible.

If an airbag inflates, you will need to replace airbag system parts. See your dealer/retailer for service.

If the airbag readiness light stays on after the vehicle is started or comes on when you are driving, the airbag system may not work properly. Have the vehicle serviced right away. See *Airbag Readiness Light on page 5-15* for more information.

Child Restraints

Older Children



Older children who have outgrown booster seats should wear the vehicle's safety belts.

The manufacturer's instructions that come with the booster seat, state the weight and height limitations for that booster. Use a booster seat with a lap-shoulder belt until the child passes the below fit test:

- Sit all the way back on the seat. Do the knees bend at the seat edge? If yes, continue. If no, return to the booster seat.
- Buckle the lap-shoulder belt. Does the shoulder belt rest on the shoulder? If yes, continue. If no, try using the rear safety belt comfort guide. See "Rear Safety Belt Comfort Guides" under *Lap-Shoulder Belt on page 3-25* for more information. If the shoulder belt still does not rest on the shoulder, then return to the booster seat.

- Does the lap belt fit low and snug on the hips, touching the thighs? If yes, continue. If no, return to the booster seat.
- Can proper safety belt fit be maintained for the length of the trip? If yes, continue. If no, return to the booster seat.

Q: What is the proper way to wear safety belts?

A: An older child should wear a lap-shoulder belt and get the additional restraint a shoulder belt can provide. The shoulder belt should not cross the face or neck. The lap belt should fit snugly below the hips, just touching the top of the thighs.

This applies belt force to the child's pelvic bones in a crash. It should never be worn over the abdomen, which could cause severe or even fatal internal injuries in a crash.

Also see "Rear Safety Belt Comfort Guides" under *Lap-Shoulder Belt on page 3-25*.

According to accident statistics, children and infants are safer when properly restrained in a child restraint system or infant restraint system secured in a rear seating position.

3-48 Seats and Restraints

In a crash, children who are not buckled up can strike other people who are buckled up, or can be thrown out of the vehicle. Older children need to use safety belts properly.

WARNING

Never do this.

Never allow two children to wear the same safety belt. The safety belt can not properly spread the impact forces. In a crash, the two children can be crushed together and seriously injured. A safety belt must be used by only one person at a time.



WARNING

Never do this.

Never allow a child to wear the safety belt with the shoulder belt behind their back. A child can be seriously injured by not wearing the lap-shoulder belt properly. In a crash, the child would not be restrained by the shoulder belt.

(Continued)

WARNING (Continued)

The child could move too far forward increasing the chance of head and neck injury. The child might also slide under the lap belt. The belt force would then be applied right on the abdomen. That could cause serious or fatal injuries. The shoulder belt should go over the shoulder and across the chest.



Infants and Young Children

Everyone in a vehicle needs protection! This includes infants and all other children. Neither the distance traveled nor the age and size of the traveler changes the need, for everyone, to use safety restraints. In fact, the law in every state in the United States and in every Canadian province says children up to some age must be restrained while in a vehicle.

WARNING

Children can be seriously injured or strangled if a shoulder belt is wrapped around their neck and the safety belt continues to tighten. Never leave children unattended in a vehicle and never allow children to play with the safety belts.

Airbags plus lap-shoulder belts offer protection for adults and older children, but not for young children and infants. Neither the vehicle's safety belt system nor its airbag system is designed for them. Every time infants and young children ride in vehicles, they should have the protection provided by appropriate child restraints.

Children who are not restrained properly can strike other people, or can be thrown out of the vehicle.

WARNING

Never do this.

Never hold an infant or a child while riding in a vehicle. Due to crash forces, an infant or a child will become so heavy it is not possible to hold it during a crash.

(Continued)

WARNING (Continued)

For example, in a crash at only 40 km/h (25 mph), a 5.5 kg (12 lb) infant will suddenly become a 110 kg (240 lb) force on a person's arms. An infant should be secured in an appropriate restraint.



WARNING

Never do this.

Children who are up against, or very close to, any airbag when it inflates can be seriously injured or killed. Never put a rear-facing child restraint in the right front seat. Secure a rear-facing child restraint in a rear seat. It is also better to secure a forward-facing child restraint in a rear seat. If you must secure a forward-facing child restraint in the right front seat, always move the front passenger seat as far back as it will go.



Q: What are the different types of add-on child restraints?

A: Add-on child restraints, which are purchased by the vehicle's owner, are available in four basic types. Selection of a particular restraint should take into consideration not only the child's weight, height, and age but also whether or not the restraint will be compatible with the motor vehicle in which it will be used.

For most basic types of child restraints, there are many different models available. When purchasing a child restraint, be sure it is designed to be used in a motor vehicle. If it is, the restraint will have a label saying that it meets federal motor vehicle safety standards.

The restraint manufacturer's instructions that come with the restraint state the weight and height limitations for a particular child restraint. In addition, there are many kinds of restraints available for children with special needs.

⚠ WARNING

To reduce the risk of neck and head injury during a crash, infants need complete support. This is because an infant's neck is not fully developed and its head weighs so much compared with the rest of its body. In a crash, an infant in a rear-facing child restraint settles into the restraint, so the crash forces can be distributed across the strongest part of an infant's body, the back and shoulders. Infants should always be secured in rear-facing child restraints.

⚠ WARNING

A young child's hip bones are still so small that the vehicle's regular safety belt may not remain low on the hip bones, as it should. Instead, it may settle up around the child's abdomen. In a crash, the belt would apply force on a body area that is unprotected by any bony structure. This alone could cause serious or fatal injuries. To reduce the risk of serious or fatal injuries during a crash, young children should always be secured in appropriate child restraints.

Child Restraint Systems



(A) Rear-Facing Infant Seat

A rear-facing infant seat (A) provides restraint with the seating surface against the back of the infant.

The harness system holds the infant in place and, in a crash, acts to keep the infant positioned in the restraint.



(B) Forward-Facing Child Seat

A forward-facing child seat (B) provides restraint for the child's body with the harness.



(C) Booster Seats

A booster seat (C) is a child restraint designed to improve the fit of the vehicle's safety belt system. A booster seat can also help a child to see out the window.

Securing an Add-On Child Restraint in the Vehicle

⚠ WARNING

A child can be seriously injured or killed in a crash if the child restraint is not properly secured in the vehicle. Secure the child restraint properly in the vehicle using the vehicle's safety belt or LATCH system, following the instructions that came with that child restraint and the instructions in this manual.

To help reduce the chance of injury, the child restraint must be secured in the vehicle. Child restraint systems must be secured in vehicle seats by lap belts or the lap belt portion of a lap-shoulder belt, or by the LATCH system.

See *Lower Anchors and Tethers for Children (LATCH System)* on page 3-55 for more information. Children can be endangered in a crash if the child restraint is not properly secured in the vehicle.

When securing an add-on child restraint, refer to the instructions that come with the restraint which may be on the restraint itself or in a booklet, or both, and to this manual. The child restraint instructions are important, so if they are not available, obtain a replacement copy from the manufacturer.

Keep in mind that an unsecured child restraint can move around in a collision or sudden stop and injure people in the vehicle. Be sure to properly secure any child restraint in the vehicle — even when no child is in it.

Securing the Child Within the Child Restraint

WARNING

A child can be seriously injured or killed in a crash if the child is not properly secured in the child restraint. Secure the child properly following the instructions that came with that child restraint.

Where to Put the Restraint

According to accident statistics, children and infants are safer when properly restrained in a child restraint system or infant restraint system secured in a rear seating position.

We recommend that children and child restraints be secured in a rear seat, including: an infant or a child riding in a rear-facing child restraint; a child riding in a forward-facing child seat; an older child riding in a booster seat; and children, who are large enough, using safety belts.

3-54 Seats and Restraints

A label on the sun visor says, "Never put a rear-facing child restraint in the front." This is because the risk to the rear-facing child is so great, if the airbag deploys.

WARNING

A child in a rear-facing child restraint can be seriously injured or killed if the right front passenger airbag inflates. This is because the back of the rear-facing child restraint would be very close to the inflating airbag. A child in a forward-facing child restraint can be seriously injured or killed if the right front passenger airbag inflates and the passenger seat is in a forward position.

(Continued)

WARNING (Continued)

Even if the passenger sensing system has turned off the right front passenger frontal airbag, no system is fail-safe. No one can guarantee that an airbag will not deploy under some unusual circumstance, even though it is turned off.

Secure rear-facing child restraints in a rear seat, even if the airbag is off. If you secure a forward-facing child restraint in the right front seat, always move the front passenger seat as far back as it will go. It is better to secure the child restraint in a rear seat.

See *Passenger Sensing System* on page 3-39 for additional information.

When securing a child restraint in a rear seating position, study the instructions that came with the child restraint to make sure it is compatible with this vehicle.

Wherever a child restraint is installed, be sure to secure the child restraint properly.

Keep in mind that an unsecured child restraint can move around in a collision or sudden stop and injure people in the vehicle. Be sure to properly secure any child restraint in the vehicle — even when no child is in it.

Lower Anchors and Tethers for Children (LATCH System)

The LATCH system holds a child restraint during driving or in a crash. This system is designed to make installation of a child restraint easier. The LATCH system uses anchors in the vehicle and attachments on the child restraint that are made for use with the LATCH system.

Make sure that a LATCH-compatible child restraint is properly installed using the anchors, or use the vehicle's safety belts to secure the restraint, following the instructions that came with that restraint, and also the instructions in this manual.

When installing a child restraint with a top tether, you must also use either the lower anchors or the safety belts to properly secure the child restraint. A child restraint must never be attached using only the top tether and anchor.

In order to use the LATCH system in your vehicle, you need a child restraint that has LATCH attachments. The child restraint manufacturer will provide you with instructions on how to use the child restraint and its attachments. The following explains how to attach a child restraint with these attachments in your vehicle.

Not all vehicle seating positions or child restraints have lower anchors and attachments or top tether anchors and attachments.

Lower Anchors

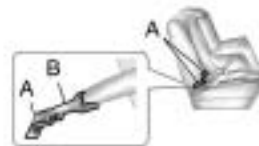

Lower anchors (A) are metal bars built into the vehicle. There are two lower anchors for each LATCH seating position that will accommodate a child restraint with lower attachments (B).

Top Tether Anchor

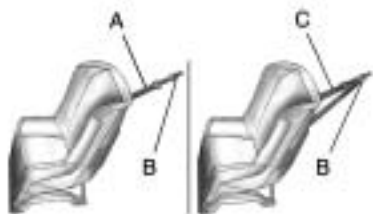

A top tether (A, C) anchors the top of the child restraint to the vehicle. A top tether anchor is built into the vehicle. The top tether attachment (B) on the child restraint connects to the top tether anchor in the vehicle in order to reduce the forward movement and rotation of the child restraint during driving or in a crash.

Your child restraint may have a single tether (A) or a dual tether (C). Either will have a single attachment (B) to secure the top tether to the anchor.

Some child restraints with top tethers are designed for use with or without the top tether being attached. Others require the top tether always to be attached. In Canada, the law requires that forward-facing child restraints have a top tether, and that the tether be attached. Be sure to read and follow the instructions for your child restraint.

If the child restraint does not have a top tether, one can be obtained, in kit form, for many child restraints. Ask the child restraint manufacturer whether or not a kit is available.

Lower Anchor and Top Tether Anchor Locations



Second Row — Bucket

 **(Top Tether Anchor):** Seating positions with top tether anchors.

 **(Lower Anchor):** Seating positions with two lower anchors.

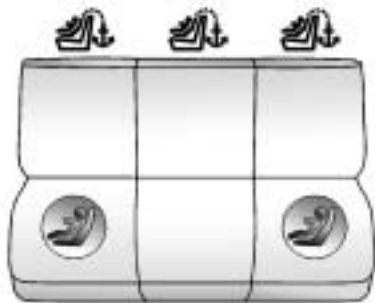

Second Row — 60/40 Bench

 **(Top Tether Anchor):** Seating positions with top tether anchors.

 **(Lower Anchor):** Seating positions with two lower anchors.



Third Row

 **(Top Tether Anchor):** Seating positions with top tether anchors.



To assist you in locating the lower anchors, each second row anchor position has a label, near the crease between the seatback and the seat cushion.



To assist you in locating the top tether anchors, the top tether anchor symbol is located on the cover or near the anchor.

3-58 Seats and Restraints



Second Row — Bucket Shown, Bench Similar

The top tether anchors are located at the bottom rear of the seatback for each seating position in the second row. Open the cover to access the anchors. Be sure to use an anchor located on the same side of the vehicle as the seating position where the child restraint will be placed.

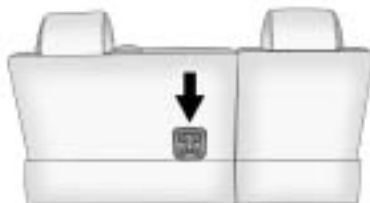

Third Row Seat

The third row has one top tether anchor located at the bottom rear of the center seatback. This anchor should be used for the center seating position only. Never install two top tethers using the same top tether anchor.

Do not secure a child restraint in a position without a top tether anchor if a national or local law requires that the top tether be attached, or if the instructions that come with the child restraint say that the top tether must be attached.

Accident statistics show that children are safer if they are restrained in the rear rather than the front seat. See *Where to Put the Restraint* on page 3-53 for additional information.

Securing a Child Restraint Designed for the LATCH System

WARNING

If a LATCH-type child restraint is not attached to anchors, the child restraint will not be able to protect the child correctly. In a crash, the child could be seriously injured or killed. Install a LATCH-type child restraint properly using the anchors, or use the vehicle's safety belts to secure the restraint, following the instructions that came with the child restraint and the instructions in this manual.

 **WARNING**

Do not attach more than one child restraint to a single anchor. Attaching more than one child restraint to a single anchor could cause the anchor or attachment to come loose or even break during a crash. A child or others could be injured. To reduce the risk of serious or fatal injuries during a crash, attach only one child restraint per anchor.

 **WARNING**

Children can be seriously injured or strangled if a shoulder belt is wrapped around their neck and the safety belt continues to tighten. Buckle any unused safety belts behind the child restraint so children cannot reach them. Pull the shoulder belt all the way out

(Continued)

WARNING (Continued)

of the retractor to set the lock, if your vehicle has one, after the child restraint has been installed.

Notice: Do not let the LATCH attachments rub against the vehicle's safety belts. This may damage these parts. If necessary, move buckled safety belts to avoid rubbing the LATCH attachments.

Do not fold the empty rear seat with a safety belt buckled. This could damage the safety belt or the seat. Unbuckle and return the safety belt to its stowed position, before folding the seat.

1. Attach and tighten the lower attachments to the lower anchors. If the child restraint does not have lower attachments or the desired seating position does not have lower anchors, secure the child restraint with the top tether and

the safety belts. Refer to your child restraint manufacturer instructions and the instructions in this manual.

- 1.1. Find the lower anchors for the desired seating position.
- 1.2. Recline the seatback to the full reclined position.

Make sure the second row bench seatbacks are aligned at the same angle before placing the child restraint on the seat. Make sure the third row bench seatbacks are both upright before placing the child restraint on the seat.
- 1.3. Put the child restraint on the seat.
- 1.4. Attach and tighten the lower attachments on the child restraint to the lower anchors.

3-60 Seats and Restraints

2. If the child restraint manufacturer recommends that the top tether be attached, attach and tighten the top tether to the top tether anchor, if the vehicle has one. Refer to the child restraint instructions and the following steps:

2.1. Find the top tether anchor.

2.2. If the anchor is covered, flip open the cover to expose the anchor.

2.3. Route, attach and tighten the top tether according to your child restraint instructions and the following instructions:



If the position you are using does not have a headrest or head restraint and you are using a single tether, route the tether over the seatback.



If the position you are using does not have a headrest or head restraint and you are using a dual tether, route the tether over the seatback.



If the position you are using has a fixed headrest or head restraint and you are using a dual tether, route the tether around the headrest or head restraint.



If the position you are using has a fixed headrest or head restraint and you are using a single tether, route the tether over the headrest or head restraint.

3. Push and pull the child restraint in different directions to be sure it is secure.

Replacing LATCH System Parts After a Crash

WARNING

A crash can damage the LATCH system in the vehicle. A damaged LATCH system may not properly secure the child restraint, resulting in serious injury or even death in a crash. To help make sure the LATCH system is working properly after a crash, see your dealer/retailer to have the system inspected and any necessary replacements made as soon as possible.

If the vehicle has the LATCH system and it was being used during a crash, new LATCH system parts may be needed.

New parts and repairs may be necessary even if the LATCH system was not being used at the time of the crash.

Securing Child Restraints (Rear Seat)

When securing a child restraint in a rear seating position, study the instructions that came with the child restraint to make sure it is compatible with this vehicle.

If the child restraint has the LATCH system, see *Lower Anchors and Tethers for Children (LATCH System)* on page 3-55 for how and where to install the child restraint using LATCH. If a child restraint is secured in the vehicle using a safety belt and it uses a top tether, see *Lower Anchors and Tethers for Children (LATCH System)* on page 3-55 for top tether anchor locations.

Do not secure a child seat in a position without a top tether anchor if a national or local law requires that the top tether be anchored, or if the instructions that come with the child restraint say that the top strap must be anchored.

In Canada, the law requires that forward-facing child restraints have a top tether, and that the tether be attached.

If the child restraint does not have the LATCH system, you will be using the safety belt to secure the child restraint in this position. Be sure to follow the instructions that came with the child restraint. Secure the child in the child restraint when and as the instructions say.

If more than one child restraint needs to be installed in the rear seat, be sure to read *Where to Put the Restraint* on page 3-53.

1. Put the child restraint on the seat.
2. Pick up the latch plate, and run the lap and shoulder portions of the vehicle's safety belt through or around the restraint. The child restraint instructions will show you how.



3. Push the latch plate into the buckle until it clicks.
Position the release button on the buckle so that the safety belt could be quickly unbuckled if necessary.



4. Pull the rest of the shoulder belt all the way out of the retractor to set the lock.



5. To tighten the belt, push down on the child restraint, pull the shoulder portion of the belt to tighten the lap portion of the belt and feed the shoulder belt back into the retractor. When installing a forward-facing child restraint, it may be helpful to use your knee to push down on the child restraint as you tighten the belt.

6. If the child restraint has a top tether, follow the child restraint manufacturer's instructions regarding the use of the top tether. See *Lower Anchors and Tethers for Children (LATCH System)* on page 3-55 for more information.
7. Push and pull the child restraint in different directions to be sure it is secure.

To remove the child restraint, unbuckle the vehicle safety belt and let it return to the stowed position. If the top tether is attached to a top tether anchor, disconnect it.

Securing Child Restraints (Right Front Passenger Seat)

The vehicle has airbags. A rear seat is a safer place to secure a forward-facing child restraint. See *Where to Put the Restraint* on page 3-53.

In addition, the vehicle has a passenger sensing system which is designed to turn off the right front passenger frontal airbag under certain conditions. See *Passenger Sensing System* on page 3-39 and *Passenger Airbag Status Indicator* on page 5-15 for more information, including important safety information.

A label on the sun visor says, "Never put a rear-facing child seat in the front." This is because the risk to the rear-facing child is so great, if the airbag deploys.

WARNING

A child in a rear-facing child restraint can be seriously injured or killed if the right front passenger airbag inflates. This is because the back of the rear-facing child restraint would be very close to the inflating airbag. A child in a forward-facing child restraint can be seriously injured or killed if the right front passenger airbag inflates and the passenger seat is in a forward position.

Even if the passenger sensing system has turned off the right front passenger frontal airbag, no system is fail-safe. No one can guarantee that an airbag will not deploy under some unusual circumstance, even though it is turned off.

(Continued)

WARNING (Continued)

Secure rear-facing child restraints in a rear seat, even if the airbag is off. If you secure a forward-facing child restraint in the right front seat, always move the front passenger seat as far back as it will go. It is better to secure the child restraint in a rear seat.

See *Passenger Sensing System* on page 3-39 for additional information.

If the child restraint has the LATCH system, see *Lower Anchors and Tethers for Children (LATCH System)* on page 3-55 for how and where to install the child restraint using LATCH. If a child restraint is secured using a safety belt and it uses a top tether, see *Lower Anchors and Tethers for Children (LATCH System)* on page 3-55 for top tether anchor locations.

Do not secure a child seat in a position without a top tether anchor if a national or local law requires that the top tether be anchored, or if the instructions that come with the child restraint say that the top strap must be anchored.

In Canada, the law requires that forward-facing child restraints have a top tether, and that the tether be attached.

You will be using the lap-shoulder belt to secure the child restraint in this position. Follow the instructions that came with the child restraint.

1. Move the seat as far back as it will go before securing the forward-facing child restraint.

When the passenger sensing system has turned off the right front passenger frontal airbag, the off indicator on the passenger airbag status indicator should light and stay lit when the vehicle is started. See *Passenger Airbag Status Indicator* on page 5-15.

2. Put the child restraint on the seat.
3. Pick up the latch plate, and run the lap and shoulder portions of the vehicle's safety belt through or around the restraint. The child restraint instructions will show you how.



4. Push the latch plate into the buckle until it clicks.
Position the release button on the buckle so that the safety belt could be quickly unbuckled if necessary.

3-66 Seats and Restraints



5. Pull the rest of the shoulder belt all the way out of the retractor to set the lock.



6. To tighten the belt, push down on the child restraint, pull the shoulder portion of the belt to tighten the lap portion of the belt and feed the shoulder belt back into the retractor. When installing a forward-facing child restraint, it may be helpful to use your knee to push down on the child restraint as you tighten the belt.
7. Push and pull the child restraint in different directions to be sure it is secure.

If the airbags are off, the off indicator in the passenger airbag status indicator will come on and stay on when the vehicle is started.

If a child restraint has been installed and the on indicator is lit, see "If the On Indicator is Lit for a Child Restraint" under *Passenger Sensing System* on page 3-39 for more information.

To remove the child restraint, unbuckle the vehicle safety belt and let it return to the stowed position.

Storage

Storage Compartments

Instrument Panel Storage	4-1
Glove Box	4-1
Cupholders	4-1
Armrest Storage	4-1
Center Console Storage	4-1
Floor Console Storage	4-2

Additional Storage Features

Cargo Cover	4-3
Cargo Tie Downs	4-3
Cargo Management System	4-3
Convenience Net	4-3

Roof Rack System

Roof Rack System	4-4
------------------	-----

Storage Compartments

Instrument Panel Storage

This vehicle has an instrument panel storage area located above the radio. To open the cover, press the button.

Glove Box

Lift the glove box handle to open it. Use the key to lock and unlock the glove box.

Cupholders

There are two cupholders, with removable liners, located in front of the center console. There may be cupholders located in the second row seat armrest. To access, pull the armrest down. There are additional cupholders located on each side of the third row seat and in each door. There may

be cupholders located at the rear of the center console. To access, pull the handle down.

Armrest Storage

Vehicles with a rear seat armrest, have two cupholders. Pull the armrest down from the rear seatback to access the cupholders.

Center Console Storage

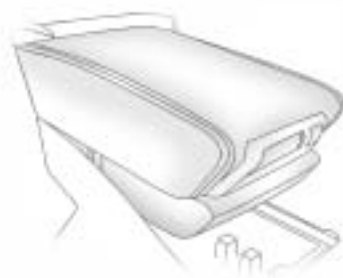

Pull up on the lever, located on the front of the center console armrest, to slide it forward and backward.

4-2 Storage

To open the armrest storage area, press the button located on the front of the armrest. There is additional storage under the armrest. Move the armrest all the way to the rear position, slide the cover back and remove the tray.

Floor Console Storage



For vehicles with a second row center console, open each area to access the storage compartment inside.

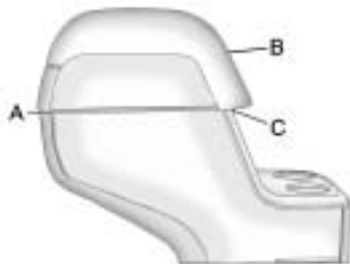

To access the upper storage area, press the upper button (B) and lift up. To access the lower storage area, press the lower button (C) and lift up. The top of the console can be folded forward for increased storage area. Lift up on handle on the rear of the console (A) and pull forward.

WARNING

Never open more than one of the three latches at a time to help avoid personal injury and damage to the console.

Notice: Slide the front console as far forward as it will go before folding the second row console forward to help prevent damage to the consoles.

Additional Storage Features

Cargo Cover

For vehicles with a cargo cover, it can be used to cover items in the rear of the vehicle. To install the cover, place the loops on each corner of the cover on the four hooks in the rear of the vehicle. The cover should be stored securely when not in use.

Cargo Tie Downs

Four cargo tie-downs are located in the rear compartment of the vehicle. The tie-downs can be used to secure small loads.

Cargo Management System

This vehicle has a cargo management center located in the rear.



To remove the cargo management cover:

1. Open the cover. It remains open when lifted.
2. Pull the cover up making sure to unhook the hinges at the rear of the cover.

WARNING

An improperly latched and closed cargo cover, or cargo cover left in the open position, could be thrown about the vehicle during a collision or sudden maneuver. Someone could be injured. Be sure to return the cover to the closed position and latch before driving. If the cover is removed, always store it outside of the vehicle. When it is replaced, always be sure that it is securely reattached.

3. Remove the cover from the vehicle and store outside of the vehicle.

Convenience Net

For vehicles with a convenience net in the rear, use it to store small loads as far forward as possible. The net should not be used to store heavy loads.

Roof Rack System

 **WARNING**

If something is carried on top of the vehicle that is longer or wider than the roof rack— like paneling, plywood, or a mattress— the wind can catch it while the vehicle is being driven. The item being carried could be violently torn off, and this could cause a collision, and damage the vehicle. Never carry something longer or wider than the roof rack on top of the vehicle unless using a GM Certified accessory carrier.

For vehicles with a roof rack, the rack can be used to load items. For roof racks that do not have crossrails included, GM Certified crossrails can be purchased as an accessory. See your dealer/retailer for additional information.

Notice: Loading cargo on the roof rack that weighs more than 91 kg (200 lbs) or hangs over the rear or sides of the vehicle may damage the vehicle. Load cargo so that it rests evenly between the crossrails, making sure to fasten cargo securely.

To prevent damage or loss of cargo when driving, check to make sure crossrails and cargo are securely fastened. Loading cargo on the roof rack will make the vehicle's center of gravity higher. Avoid high speeds, sudden starts, sharp turns, sudden braking or abrupt maneuvers, otherwise it may result in loss of control. If driving for a long distance, on rough roads, or at high speeds, occasionally stop the vehicle to make sure the cargo remains in its place. Do not exceed the maximum vehicle capacity when loading the vehicle.

For more information on vehicle capacity and loading, see *Vehicle Load Limits* on page 9-12.

Instruments and Controls

Controls

Steering Wheel Adjustment . . .	5-2
Steering Wheel Controls	5-2
Horn	5-4
Windshield Wiper/Washer	5-4
Rear Window Wiper/ Washer	5-5
Compass	5-6
Clock	5-8
Power Outlets	5-8

Warning Lights, Gauges, and Indicators

Warning Lights, Gauges, and Indicators	5-10
Instrument Cluster	5-11
Speedometer	5-12
Odometer	5-12
Tachometer	5-12
Fuel Gauge	5-12
Engine Coolant Temperature Gauge	5-13
Voltmeter Gauge	5-13
Safety Belt Reminders	5-14

Airbag Readiness Light	5-15
Passenger Airbag Status Indicator	5-15
Charging System Light	5-16
Malfunction Indicator Lamp	5-17
Brake System Warning Light	5-19
Antilock Brake System (ABS) Warning Light	5-20
Tow/Haul Mode Light	5-20
StabiliTrak® Indicator Light . . .	5-21
Engine Coolant Temperature Warning Light	5-21
Tire Pressure Light	5-21
Engine Oil Pressure Light . . .	5-22
Security Light	5-23
High-Beam on Light	5-23
Fog Lamp Light	5-23
Cruise Control Light	5-23

Information Displays

Driver Information Center (DIC) (With DIC Buttons) . . .	5-24
Driver Information Center (DIC) (Without DIC Buttons)	5-29
Head-Up Display (HUD)	5-32

Vehicle Messages

Vehicle Messages	5-36
Battery Voltage and Charging Messages	5-36
Brake System Messages	5-36
Cruise Control Messages	5-37
Door Ajar Messages	5-37
Engine Cooling System Messages	5-38
Engine Oil Messages	5-39
Engine Power Messages	5-39
Fuel System Messages	5-39
Key and Lock Messages	5-40
Lamp Messages	5-40
Object Detection System Messages	5-40
Ride Control System Messages	5-41
Airbag System Messages	5-41
Anti-Theft Alarm System Messages	5-41
Service Vehicle Messages	5-42
Tire Messages	5-42
Transmission Messages	5-43
Vehicle Reminder Messages	5-44
Vehicle Speed Messages	5-44
Washer Fluid Messages	5-44

5-2 Instruments and Controls

Vehicle Personalization

Vehicle Personalization (With
DIC Buttons) 5-45

Universal Remote System

Universal Remote System ... 5-52
Universal Remote System
Programming 5-52
Universal Remote System
Operation 5-56

Controls

Steering Wheel Adjustment

The steering wheel can be adjusted.

The adjustment lever is on the
outboard side of the steering
column.



Pull the lever down to move the
steering wheel up or down and in
or out. Pull the lever up to lock the
steering wheel in place.

Do not adjust the steering wheel
while driving.

Steering Wheel Controls



Vehicles with audio steering wheel
controls could differ depending on
the vehicle's options. Some audio
controls can be adjusted at the
steering wheel.

△ / ▽ (Next / Previous): Press
to select preset or favorite radio
stations, select tracks on a
CD/DVD, or to select tracks and
navigate folders on an iPod® or
USB device.

To select preset or favorite radio stations:

- Press and release \triangle or ∇ to go to the next or previous radio station stored as a preset or favorite.

To select tracks on a CD/DVD:

Press and release \triangle or ∇ to go to the next or previous track.

To select tracks on an iPod or USB device for vehicles without a navigation system:

1. Press and hold \triangle or ∇ while listening to a song until the contents of the current folder display on the radio display.
2. Press and release \triangle or ∇ to scroll up or down the list, then press and hold \triangle , or press \blacktriangleright to play the highlighted track.

To select tracks on an iPod or USB device for vehicles with a navigation system:

1. Press and hold \triangle or ∇ while listening to a song listed in the main audio page, to quickly move forward or in reverse through the tracks. See the separate Navigation System manual for more information.

Track information is displayed on the screen. Release \triangle or ∇ when the desired track is reached.

2. Press and release ∇ to begin playing the track shown in the display.

To navigate folders on an iPod or USB device for vehicles without a navigation system:



1. Press and hold \triangle or ∇ while listening to a song until the contents of the current folder display on the radio display.



2. Press and hold ∇ to go back to the previous folder list.
3. Press and release \triangle or ∇ to scroll up or down the list.
 - To select a folder, press and hold \triangle , or press \blacktriangleright when the folder is highlighted.
 - To go back further in the folder list, press and hold ∇ .

To navigate folders on an iPod or USB device for vehicles with a navigation system:

1. Go to the Music Navigator by first touching the center touch screen folder button in the main audio page.
2. While in Music Navigator, select the folder/artist/genre/category, etc. using the touch screen.

5-4 Instruments and Controls

3. Press and release  to scroll through the selected music list. Touch the track label on the touch screen to highlight and begin playing the track from that list.
4. Press and hold  to quickly scroll through the selected music list

  **(Mute/Push to Talk):** Press to silence the vehicle speakers only. Press again to turn the sound on.

For vehicles with Bluetooth or OnStar[®] systems, press and hold for longer than two seconds to interact with those systems. See *Bluetooth on page 7-46* and the OnStar Owner's Guide for more information.

 **(End):** Press to reject an incoming call, or end a current call.

SRCE (Source/Voice

Recognition): Press to switch between the radio, CD, and for vehicles with, DVD, front auxiliary, and rear auxiliary.

For vehicles with the navigation system, press and hold this button for longer than one second to initiate voice recognition. See "Voice Recognition" in the Navigation System manual for more information.

 **(Seek):** Press to go to the next radio station while in AM, FM, or XM[™].

For vehicles with or without a navigation system:

Press  to go to the next track or chapter while sourced to the CD or DVD slot.

Press  to select a track or a folder when navigating folders on an iPod or USB device.

For vehicles with a navigation system:

1. Press and hold  until a beep is heard, to place the radio into SCAN mode, a station will play for five seconds before moving to the next station.

2. To stop the SCAN function, press  again.
3. In CD/DVD, iPod, or AUX USB, press and hold to quickly move forward through the tracks. Release to stop on the desired track.

 **(Volume):** Press to increase or to decrease the volume.

Horn



Press near the horn symbols or press on the steering wheel pad to sound the horn.

Windshield Wiper/Washer

The windshield wiper/washer lever is located on the left side of the steering column.

Turn the band with the wiper symbol to control the windshield wipers.



 **(Mist):** Single wipe, turn the band to  and then release. Several wipes, hold the band on  longer.

 **(Off):** Turns the wipers off.

 **(Adjustable Interval Wipes):** Turn the band up for more frequent wipes or down for less frequent wipes.

1: Slow wipes.

2: Fast wipes.

Clear ice and snow from the wiper blades before using them. If frozen to the windshield, carefully loosen or thaw them. Damaged wiper blades should be replaced. See *Wiper Blade Replacement* on page 10-27.

Heavy snow or ice can overload the wipers. A circuit breaker stops them until the motor cools.

Windshield Washer

 **(Washer Fluid):** Press the button at the end of the turn signal/lane change lever, to spray washer fluid on the windshield. The wipers clear the windshield and either stop or return to the preset speed. The ignition key must be in ACC/ACCESSORY or ON/RUN for this to work. See *Washer Fluid* on page 10-21 *Windshield Washer Fluid*.

WARNING

In freezing weather, do not use your washer until the windshield is warmed. Otherwise the washer fluid can form ice on the windshield, blocking your vision.

WASHER FLUID LOW ADD FLUID is displayed on the Driver Information Center (DIC) when the washer fluid is low. See *Washer Fluid Messages* on page 5-44.

Rear Window Wiper/Washer

The rear wiper and rear wash button is located on the instrument panel below the climate control system.

 **(Rear Wiper):** Press to turn the rear wiper on and off. The wiper speed cannot be changed.

 **(Wash):** Press to spray washer fluid on the rear window. The window wiper will also come on.

5-6 Instruments and Controls

Release the button when enough fluid has been sprayed on the window. The rear wiper will run a few more cycles after it is released. If the rear wiper function was already on, prior to pressing the wash button, it stays on until the wiper button is pressed again.

The rear window washer uses the same fluid that is in the windshield washer reservoir. See *Washer Fluid* on page 10-21.

Compass

Your vehicle may have a compass in the Driver Information Center (DIC). See *Driver Information Center (DIC) (With DIC Buttons)* on page 5-24 or *Driver Information Center (DIC) (Without DIC Buttons)* on page 5-29 for more information about the DIC.

Compass Zone

The zone is set to zone eight upon leaving the factory. Your dealer/retailer will set the correct zone for your location.

Under certain circumstances, such as during a long distance cross-country trip or moving to a new state or province, it will be necessary to compensate for compass variance by resetting the zone through the DIC if the zone is not set correctly.

Compass variance is the difference between the earth's magnetic north and true geographic north. If the compass is not set to the zone where you live, the compass may give false readings. The compass must be set to the variance zone in which the vehicle is traveling.

To adjust for compass variance, use the following procedure:

Compass Variance (Zone) Procedure

1. Do not set the compass zone when the vehicle is moving. Only set it when the vehicle is in P (Park).

Press the vehicle information button until PRESS ✓ TO CHANGE COMPASS ZONE displays.



2. Find the vehicle's current location and variance zone number on the map. Zones 1 through 15 are available.
3. Press the set/reset button to scroll through and select the appropriate variance zone.

4. Press the trip/fuel button until the vehicle heading, for example, N for North, is displayed in the DIC.
5. If calibration is necessary, calibrate the compass. See "Compass Calibration Procedure" following.

Compass Calibration

The compass can be manually calibrated. Only calibrate the compass in a magnetically clean and safe location, such as an open parking lot, where driving the vehicle in circles is not a danger. It is suggested to calibrate away from tall buildings, utility wires, manhole covers, or other industrial structures, if possible.

If CAL should ever appear in the DIC display, the compass should be calibrated.

If the DIC display does not show a heading, for example, N for North, or the heading does not change after making turns, there may be a strong magnetic field interfering with the compass. Such interference may be caused by a magnetic CB or cell phone antenna mount, a magnetic emergency light, magnetic note pad holder, or any other magnetic item. Turn off the vehicle, move the magnetic item, then turn on the vehicle and calibrate the compass.

To calibrate the compass, use the following procedure:

Compass Calibration Procedure

1. Before calibrating the compass, make sure the compass zone is set to the variance zone in which the vehicle is located. See "Compass Variance (Zone) Procedure" earlier in this section.





Do not operate any switches such as window, sunroof, climate controls, seats, etc. during the calibration procedure.

2. Press the vehicle information button until PRESS ✓ TO CALIBRATE COMPASS displays.
3. Press the set/reset button to start the compass calibration.
4. The DIC will display CALIBRATING: DRIVE IN CIRCLES. Drive the vehicle in tight circles at less than 5 mph (8 km/h) to complete the calibration. The DIC will display CALIBRATION COMPLETE for a few seconds when the calibration is complete. The DIC display will then return to the previous menu.



5-8 Instruments and Controls

Clock



To adjust the time and date:

1. Turn the ignition key to ACC/ACCESSORY or ON/RUN, then press , to turn the radio on.
2. Press  to display HR, MIN, MM, DD, YYYY (hour, minute, month, day, and year).
3. Press the pushbutton located under any one of the labels to be changed.
4. To increase the time or date, do one of the following:
 - Press the pushbutton below the selected label.
 - Press  SEEK.
 - Press  FWD.
 - Turn  clockwise.

5. To decrease the time or date, do one of the following:

- Press  SEEK.
- Press  REV.
- Turn  counter-clockwise.

To change the time default setting from 12 hour to 24 hour or to change the date default setting from month/day/year to day/month/year:

1. Press  and then the pushbutton located under the forward arrow that displays on the radio screen until the time 12H (hour) and 24H (hour), and the date MM/DD (month and day) and DD/MM (day and month) displays.
2. Press the pushbutton located under the desired option.
3. Press  again to apply the selected default, or let the screen time out.

Power Outlets

The vehicle has three 12-volt outlets which can be used to plug in electrical equipment, such as a cellular telephone, a compact disc player, etc.

The power outlets are located on the instrument panel below the climate controls, at the rear of the center console, and in the rear cargo area. Lift the cover to access the outlet. Close the cover when not using the outlet.

Notice: Leaving electrical equipment plugged in for an extended period of time while the vehicle is off will drain the battery. Power is always supplied to the outlets. Always unplug electrical equipment when not in use and do not plug in equipment that exceeds the maximum 20 ampere rating.

Certain accessory plugs may not be compatible to the accessory power outlet and could result in blown vehicle and adapter fuses. If a problem is experienced, see your dealer/retailer for additional information on the power accessory outlets.

Notice: Adding any electrical equipment to the vehicle can damage it or keep other components from working as they should. The repairs would not be covered by the vehicle warranty. Do not use equipment exceeding maximum amperage rating of 20 amperes. Check with your dealer/retailer before adding electrical equipment.

When adding electrical equipment, be sure to follow the proper installation instructions included with the equipment.

Notice: Improper use of the power outlet can cause damage not covered by the vehicle warranty. Do not hang any type of accessory or accessory bracket from the plug because the power outlets are designed for accessory power plugs only.

Power Outlet 120 Volt Alternative Current

The vehicle may have a power outlet that can be used to plug in electrical equipment that uses a maximum limit of 150 watts.



The power outlet is located on the rear of the center console.

An indicator light on the outlet turns on to show it is in use. The light comes on when the ignition is in ON/RUN and equipment requiring less than 150 watts is plugged into the outlet, and no system fault is detected.

5-10 Instruments and Controls

The indicator light does not come on when the ignition is in LOCK/OFF or if no equipment is plugged into the outlet.

If equipment is connected using more than 150 watts or a system fault is detected, a protection circuit shuts off the power supply and the indicator light turns off. To reset the circuit, unplug the item and plug it back in or turn the Remote Accessory Power (RAP) off and then back on. See *Retained Accessory Power (RAP)* on page 9-19. The power restarts when equipment using 150 watts or less is plugged into the outlet and a system fault is not detected.

The power outlet is not designed for the following electrical equipment and may not work properly if these items are plugged into the power outlet:

- Equipment with high initial peak wattage such as: compressor-driven refrigerators and electric power tools.
- Other equipment requiring an extremely stable power supply such as: microcomputer-controlled electric blankets, touch sensor lamps, etc.

See *High Voltage Devices and Wiring* on page 10-29.

Warning Lights, Gauges, and Indicators

Warning lights come on when there could be a problem with a vehicle function. Some warning lights come on briefly when the engine is started to indicate they are working.

Gauges can indicate when there could be a problem with a vehicle function. Often gauges and warning lights work together to indicate a problem with the vehicle.

When one of the warning lights comes on and stays on while driving, or when one of the gauges shows there may be a problem, check the section that explains what to do. Follow this manual's advice. Waiting to do repairs can be costly and even dangerous.

Instrument Cluster



United States version shown, Canada similar

5-12 Instruments and Controls

Speedometer

The speedometer shows the vehicle's speed in both kilometers per hour (km/h) and miles per hour (mph).

Odometer

The odometer shows how far the vehicle has been driven, in either kilometers or miles.

This vehicle has a tamper-resistant odometer. If the vehicle needs a new odometer installed, the new one is set to the mileage of the old odometer. If this is not possible, it is set at zero and a label is put on the driver's door to show the old mileage reading.

Tachometer

The tachometer displays the engine speed in revolutions per minute (rpm).

Notice: If the engine is operated with the tachometer in the shaded warning area, the vehicle could be damaged, and the damages would not be covered by the vehicle warranty. Do not operate the engine with the tachometer in the shaded warning area.

Fuel Gauge



United States



Canada

When the ignition is on, the fuel gauge shows how much fuel is left in the tank.

An arrow in the fuel gauge indicates the side of the vehicle the fuel door is on.

The gauge will first indicate empty before the vehicle is out of fuel, the vehicle's fuel tank should be filled soon.

When the fuel tank is low on fuel, the FUEL LEVEL LOW message will appear on the Driver Information Center (DIC). For more information see *Fuel System Messages on page 5-39*.

Here are some situations that may occur with the fuel gauge. None of these indicate a problem with the fuel gauge.

- At the gas station, the fuel pump shuts off before the gauge reads full.
- It takes a little more or less fuel to fill up than the fuel gauge indicated. For example, the gauge may have indicated the tank was half full, but it actually took a little more or less than half the tank's capacity to fill the tank.
- The gauge goes back to empty when the ignition is turned off.

Engine Coolant Temperature Gauge

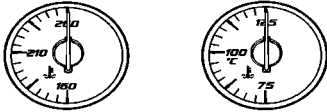

United States

Canada

This gauge shows the engine coolant temperature. Under normal driving conditions the gauge will read approximately 100 °C (210°F) or less. If the gauge pointer is near 125 °C (260°F), the engine is too hot.

It means that the engine coolant has overheated. If the vehicle has been operating under normal driving conditions, pull off the road, stop the vehicle and turn off the engine as soon as possible.

See *Engine Overheating* on page 10-18 for more information.

Voltmeter Gauge

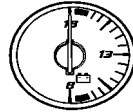

When the engine is not running, but the ignition is turned on, this gauge shows the battery's state of charge in DC volts.

When the engine is running, this gauge shows the condition of the charging system. The vehicle's charging system regulates voltage based on the state of charge of the battery. The voltmeter may fluctuate. This is normal. Readings between the low and high warning zones indicate the normal operating range.

Readings in the low warning zone may occur when a large number of electrical accessories are operating in the vehicle and the engine is left idling for an extended period.

If there is a problem with the battery charging system, a **SERVICE BATTERY CHARGING SYSTEM** message will appear in the Driver Information Center (DIC) and/or the charging system light comes on. See *Battery Voltage and Charging Messages* on page 5-36 for more information.

However, readings in either warning zone may indicate a possible problem in the electrical system. Have the vehicle serviced as soon as possible.

Safety Belt Reminders

Driver Safety Belt Reminder Light

The driver safety belt reminder light on the instrument panel cluster.



When the engine is started this light and the chime come on and stay on for several seconds to remind the driver to fasten the safety belt. The light also begins to flash.

This cycle repeats if the driver remains unbuckled and the vehicle is moving.

If the driver safety belt is already buckled, neither the light nor chime comes on.

Passenger Safety Belt Reminder Light



When the engine is started this light and the chime come on and stay on for several seconds to remind the passenger to fasten their safety belt. The light also begins to flash.

This only occurs if the passenger airbag is enabled. See *Passenger Sensing System* on page 3-39 for more information.

This cycle repeats if the passenger remains unbuckled and the vehicle is moving.

If the passenger safety belt is buckled, neither the chime nor the light comes on.

The front passenger safety belt warning light and chime may turn on if an object is put on the seat such as a briefcase, handbag, grocery bag, laptop or other electronic device. To turn off the warning light and or chime, remove the object from the seat or buckle the safety belt.

Airbag Readiness Light

This light shows if there is an electrical problem. The system check includes the airbag sensor, the pretensioners, the airbag modules, the wiring and the crash sensing and diagnostic module. For more information on the airbag system, see *Airbag System on page 3-32*.



This light will come on and stay on for several seconds when the vehicle is started. Then the light should go out.

If the airbag readiness light stays on after the vehicle has been started or comes on when while driving, the airbag system may not work properly. Have the vehicle serviced right away.

WARNING

If the airbag readiness light stays on after the vehicle is started or comes on while driving, it means the airbag system might not be working properly. The airbags in the vehicle might not inflate in a crash, or they could even inflate without a crash. To help avoid injury, have the vehicle serviced right away.

Passenger Airbag Status Indicator

The vehicle has a passenger sensing system. See *Passenger Sensing System on page 3-39* for important safety information. The instrument panel has a passenger airbag status indicator.



United States



Canada

When the vehicle is started, the passenger airbag status indicator will light ON and OFF, or the symbol for on and off, for several seconds as a system check. If you are using remote start to start the vehicle from a distance, if equipped, you may not see the system check.

5-16 Instruments and Controls

Then, after several more seconds, the status indicator will light either ON or OFF, or either the on or off symbol to let you know the status of the right front passenger frontal airbag.

If the word ON or the on symbol is lit on the passenger airbag status indicator, it means that the right front passenger frontal airbag is enabled (may inflate).

If the word OFF or the off symbol is lit on the passenger airbag status indicator, it means that the passenger sensing system has turned off the right front passenger frontal airbag.

If, after several seconds, both status indicator lights remain on, or if there are no lights at all, there may be a problem with the lights or the passenger sensing system. See your dealer/retailer for service.

WARNING

If the airbag readiness light ever comes on and stays on, it means that something may be wrong with the airbag system. To help avoid injury to yourself or others, have the vehicle serviced right away. See *Airbag Readiness Light on page 5-15* for more information, including important safety information.

Charging System Light



The charging system light comes on briefly when the ignition is turned on, but the engine is not running, as a check to show the light is working. It should go out when the engine is started.

If the light stays on, or comes on while driving, there may be a problem with the electrical charging system. Have it checked by your dealer/retailer. Driving while this light is on could drain the battery.

When this light comes on, the Driver Information Center (DIC) also displays the SERVICE BATTERY CHARGING SYSTEM message.

See *Vehicle Messages on page 5-36* for more information.

If a short distance must be driven with the light on, be sure to turn off all accessories, such as the radio and air conditioner.

Malfunction Indicator Lamp

A computer system called OBD II (On-Board Diagnostics-Second Generation) monitors operation of the fuel, ignition, and emission control systems. It ensures that emissions are at acceptable levels for the life of the vehicle, helping to produce a cleaner environment.



This light comes on when the ignition is on, but the engine is not running, as a check to show it is working. If it does not, have the vehicle serviced by your dealer/retailer.

If the check engine light comes on and stays on, while the engine is running, this indicates that there is an OBD II problem and service is required.

Malfunctions often are indicated by the system before any problem is apparent. Being aware of the light can prevent more serious damage to the vehicle. This system assists the service technician in correctly diagnosing any malfunction.

Notice: If the vehicle is continually driven with this light on, after a while, the emission controls might not work as well, the vehicle's fuel economy might not be as good, and the engine might not run as smoothly. This could lead to costly repairs that might not be covered by the vehicle warranty.

Notice: Modifications made to the engine, transmission, exhaust, intake, or fuel system of the vehicle or the replacement of the original tires with other than those of the same Tire Performance Criteria (TPC) can affect the vehicle's emission controls and can cause this light to come on. Modifications to these systems could lead to costly repairs not covered by the vehicle warranty. This could also result in a failure to pass a required Emission Inspection/Maintenance test. See *Accessories and Modifications on page 10-3*.

This light comes on during a malfunction in one of two ways:

Light Flashing: A misfire condition has been detected. A misfire increases vehicle emissions and could damage the emission control system on the vehicle. Diagnosis and service might be required.

5-18 Instruments and Controls

The following can prevent more serious damage to the vehicle:

- Reduce vehicle speed.
- Avoid hard accelerations.
- Avoid steep uphill grades.
- If towing a trailer, reduce the amount of cargo being hauled as soon as it is possible.

If the light continues to flash, when it is safe to do so, stop the vehicle. Find a safe place to park the vehicle. Turn the key off, wait at least 10 seconds, and restart the engine. If the light is still flashing, follow the previous steps and see your dealer/retailer for service as soon as possible.

Light On Steady: An emission control system malfunction has been detected on the vehicle. Diagnosis and service might be required.

An emission system malfunction might be corrected.

- Make sure the fuel cap is fully installed. See *Filling the Tank on page 9-45*. The diagnostic system can determine if the fuel cap has been left off or improperly installed. A loose or missing fuel cap allows fuel to evaporate into the atmosphere. A few driving trips with the cap properly installed should turn the light off.
- If the vehicle has been driven through a deep puddle of water, the vehicle's electrical system might be wet. The condition is usually corrected when the electrical system dries out. A few driving trips should turn the light off.

- Make sure to fuel the vehicle with quality fuel. Poor fuel quality causes the engine not to run as efficiently as designed and may cause: stalling after start-up, stalling when the vehicle is changed into gear, misfiring, hesitation on acceleration, or stumbling on acceleration. These conditions might go away once the engine is warmed up.

If one or more of these conditions occurs, change the fuel brand used. It will require at least one full tank of the proper fuel to turn the light off.

See *Recommended Fuel on page 9-43*.

If none of the above have made the light turn off, your dealer/retailer can check the vehicle. The dealer/retailer has the proper test equipment and diagnostic tools to fix any mechanical or electrical problems that might have developed.

Emissions Inspection and Maintenance Programs

Some state/provincial and local governments have or might begin programs to inspect the emission control equipment on the vehicle. Failure to pass this inspection could prevent getting a vehicle registration.

Here are some things to know to help the vehicle pass an inspection:

- The vehicle will not pass this inspection if the check engine light is on with the engine running, or if the key is in ON/RUN and the light is not on.
- The vehicle will not pass this inspection if the OBD II (on-board diagnostic) system determines that critical emission control systems have not been completely diagnosed by the system. The vehicle would be

considered not ready for inspection. This can happen if the battery has recently been replaced or if the battery has run down. The diagnostic system is designed to evaluate critical emission control systems during normal driving. This can take several days of routine driving. If this has been done and the vehicle still does not pass the inspection for lack of OBD II system readiness, your dealer/retailer can prepare the vehicle for inspection.

Brake System Warning Light

This vehicle's hydraulic brake system is divided into two parts. If one part is not working, the other part can still work and stop the vehicle. For good braking both parts need to be working.

If the warning light comes on, there is a brake problem. Have the brake system inspected right away.



United States

Canada

This light should come on briefly when the ignition key is turned to ON/RUN. If it does not come on then, have it fixed so it will be ready to warn if there is a problem.

This light may also come on due to low brake fluid. See *Brakes on page 10-22* for more information.

When the ignition is on, the brake system warning light will also come on when the parking brake is set. The light will stay on if the parking brake does not release fully. If it stays on after the parking brake is fully released, it means there is a brake problem.

5-20 Instruments and Controls

If the light comes on while driving, pull off the road and stop carefully. Make sure the parking brake is fully released. The pedal may be harder to push or, the pedal may go closer to the floor. It may take longer to stop. If the light is still on, have the vehicle towed for service. See *Towing the Vehicle* on page 10-83.

WARNING

The brake system might not be working properly if the brake system warning light is on. Driving with the brake system warning light on can lead to a crash. If the light is still on after the vehicle has been pulled off the road and carefully stopped, have the vehicle towed for service.

Antilock Brake System (ABS) Warning Light

ABS



United States

Canada

The ABS warning light comes on briefly when the ignition key is turned to ON/RUN. This is normal. If the light does not come on then, have it fixed so it will be ready to warn you if there is a problem.

If the light stays on, turn the ignition to LOCK/OFF. If the light comes on while driving, stop as soon as possible and turn the ignition off. Then start the engine again to reset the system. If the light still stays on, or comes on again while driving, the vehicle needs service.

If the regular brake system warning light is not on, there are still brakes, but no antilock brakes. If the regular brake system warning light is also on, there are no antilock brakes and there is a problem with the regular brakes. See *Brake System Warning Light* on page 5-19.

Tow/Haul Mode Light



This light comes on when the Tow/Haul mode has been activated. For more information, see *Tow/Haul Mode* on page 9-27.

StabiliTrak® Indicator Light



This light comes on briefly while starting the engine. If it does not, have the vehicle serviced by your dealer/retailer. If the system is working normally the indicator light goes off.

If it stays on, or comes on while driving, there could be a problem with the StabiliTrak system and the vehicle might need service. When this warning light is on, the system is off and will not limit wheel spin.

This light flashes when the StabiliTrak system is active.

See *StabiliTrak System* on page 9-30 for more information.

Engine Coolant Temperature Warning Light



The engine coolant temperature warning light comes on briefly when the engine is started.

If it does not, have the vehicle serviced by your dealer/retailer. If the system is working normally the indicator light then goes off.

If the light comes on and stays on while driving, the vehicle may have a problem with the cooling system.

Stop the vehicle and turn off the engine to avoid damage to the engine. A warning chime sounds when this light is on.

See *Engine Overheating* on page 10-18 for more information.

Tire Pressure Light



For vehicles with a tire pressure monitoring system, this light comes on briefly when the engine is started. It provides information about tire pressures and the Tire Pressure Monitoring System.

5-22 Instruments and Controls

When the Light is On Steady

This indicates that one or more of the tires are significantly underinflated.

A tire pressure message in the Driver Information Center (DIC), can accompany the light. See *Tire Messages on page 5-42* for more information. Stop as soon as possible, and inflate the tires to the pressure value shown on the tire loading information label. See *Tire Pressure on page 10-43* for more information.

When the Light Flashes First and Then is On Steady

This indicates that there may be a problem with the Tire Pressure Monitor System. The light flashes for about a minute and stays on steady for the remainder of the ignition cycle. This sequence repeats with every ignition cycle. See *Tire Pressure Monitor Operation on page 10-46* for more information.

Engine Oil Pressure Light

WARNING

Do not keep driving if the oil pressure is low. The engine can become so hot that it catches fire. Someone could be burned. Check the oil as soon as possible and have the vehicle serviced.

Notice: Lack of proper engine oil maintenance can damage the engine. The repairs would not be covered by the vehicle warranty. Always follow the maintenance schedule in this manual for changing engine oil.



The oil pressure light should come on briefly as the engine is started. If it does not come on have the vehicle serviced by your dealer/retailer.

If the light comes on and stays on, it means that oil is not flowing through the engine properly. The vehicle could be low on oil and might have some other system problem.

Security Light



This light flashes when the security system is activated.

For more information, see *Anti-Theft Alarm System* on page 2-13.

High-Beam on Light



The high-beam on light comes on when the high-beam headlamps are in use.

See *Headlamp High/Low-Beam Changer* on page 6-2 for more information.

Fog Lamp Light



The fog lamp light comes on when the fog lamps are in use.

The light goes out when the fog lamps are turned off. See *Fog Lamps* on page 6-4 for more information.

Cruise Control Light



This light comes on whenever the cruise control is set.

The light goes out when the cruise control is turned off. See *Cruise Control* on page 9-32 for more information.

Information Displays

Driver Information Center (DIC) (With DIC Buttons)

If your vehicle has DIC buttons, the information below explains the operation of this system.

The DIC displays information about your vehicle. It also displays warning messages if a system problem is detected.

All messages will appear in the DIC display located at the top of the instrument panel cluster.

The DIC comes on when the ignition is on. After a short delay, the DIC will display the information that was last displayed before the engine was turned off.

The DIC also displays a shift lever position indicator on the bottom line of the display. See *Automatic Transmission* on page 9-24 for more information.

The outside air temperature and compass, if equipped, also display on the DIC when viewing the trip and fuel information. The outside air temperature automatically appears in the top right corner of the DIC display. If there is a problem with the system that controls the temperature display, the numbers will be replaced with dashes. If this occurs, have the vehicle serviced. The compass will be shown in the bottom right corner of the DIC display. See *Compass* on page 5-6 for more information.

The DIC has different displays which can be accessed by pressing the DIC buttons located on the instrument panel.

The DIC also allows some features to be customized. See *Vehicle Personalization (With DIC Buttons)* on page 5-45 for more information.

If your vehicle has DIC buttons, you can also use the trip odometer reset stem to view the odometer and trip odometers.

DIC Buttons



The buttons are the set/reset, customization, vehicle information, and trip/fuel buttons. The button functions are detailed in the following pages.

✓ **(Set/Reset):** Press this button to set or reset certain functions and to turn off or acknowledge messages on the DIC.

☒ **(Customization):** Press this button to customize the feature settings on your vehicle. See *Vehicle Personalization (With DIC Buttons)* on page 5-45 for more information.

 **(Vehicle Information):** Press this button to display the oil life, park assist on vehicles with this feature, units, tire pressure readings on vehicles with this feature, Remote Keyless Entry (RKE) transmitter programming, and compass calibration and zone setting on vehicles with this feature.

 **(Trip/Fuel):** Press this button to display the odometer, trip odometers, fuel range, average economy, timer, fuel used, and average speed.

Vehicle Information Menu Items

 **(Vehicle Information):** Press this button to scroll through the following menu items:

OIL LIFE

Press the vehicle information button until OIL LIFE REMAINING displays. This display shows an estimate of the oil's remaining useful life. If you see 99% OIL LIFE REMAINING on the display, that

means 99% of the current oil life remains. The engine oil life system will alert you to change the oil on a schedule consistent with your driving conditions.

When the remaining oil life is low, the CHANGE ENGINE OIL SOON message will appear on the display. See "CHANGE ENGINE OIL SOON" under *Engine Oil Messages on page 5-39*. You should change the oil as soon as you can. See *Engine Oil on page 10-8*. In addition to the engine oil life system monitoring the oil life, additional maintenance is recommended in the Maintenance Schedule in this manual. See *Scheduled Maintenance on page 11-2* for more information.

Remember, you must reset the OIL LIFE display yourself after each oil change. It will not reset itself. Also, be careful not to reset the OIL LIFE display accidentally at any time other than when the oil has just been changed. It cannot be reset accurately until the next oil change.

To reset the engine oil life system, see *Engine Oil Life System on page 10-9*.

PARK ASSIST

If your vehicle has the Ultrasonic Rear Parking Assist (URPA) system, press the vehicle information button until PARK ASSIST displays. This display allows the system to be turned on or off. Once in this display, press the set/reset button to select between ON or OFF. If you choose ON, the system will be turned on. If you choose OFF, the system will be turned off. The URPA system automatically turns back on after each vehicle start. When the URPA system is turned off and the vehicle is shifted out of P (Park), the DIC will display the PARK ASSIST OFF message as a reminder that the system has been turned off. See *Object Detection System Messages on page 5-40* and *Ultrasonic Parking Assist on page 9-35* for more information.

UNITS

Press the vehicle information button until UNITS displays. This display allows you to select between English or Metric units of measurement. Once in this display, press the set/reset button to select between ENGLISH or METRIC units. All of the vehicle information will then be displayed in the unit of measurement selected.

FRONT TIRES or REAR TIRES

On vehicles with the Tire Pressure Monitor System (TPMS), the pressure for each tire can be viewed in the DIC. The tire pressure will be shown in either pounds per square inch (psi) or kilopascals (kPa). Press the vehicle information button until the DIC displays FRONT TIRES PSI (kPa) LEFT ## RIGHT ##. Press the vehicle information button again until the DIC displays REAR TIRES PSI (kPa) LEFT ## RIGHT ##.

If a low tire pressure condition is detected by the system while driving, a message advising you add air to a specific tire will appear in the display. See *Tire Pressure on page 10-43* and *Tire Messages on page 5-42* for more information.

If the tire pressure display shows dashes instead of a value, there may be a problem with your vehicle. If this consistently occurs, see your dealer/retailer for service.

RELEARN REMOTE KEY

This display allows you to match Remote Keyless Entry (RKE) transmitters to your vehicle. This procedure will erase all previously learned transmitters. Therefore, they must be relearned as additional transmitters.

To match an RKE transmitter to your vehicle:

1. Press the vehicle information button until PRESS ✓ TO RELEARN REMOTE KEY displays.
2. Press the set/reset button until REMOTE KEY LEARNING ACTIVE is displayed.
3. Press and hold the lock and unlock buttons on the first transmitter at the same time for about 15 seconds.

On vehicles with memory recall seats, the first transmitter learned will match driver 1 and the second will match driver 2.

A chime will sound indicating that the transmitter is matched.

4. To match additional transmitters at this time, repeat Step 3. Each vehicle can have a maximum of eight transmitters matched to it.
5. To exit the programming mode, you must cycle the key to LOCK/OFF.

COMPASS ZONE SETTING

This display will be available if the vehicle has a compass. See *Compass on page 5-6* for more information.

COMPASS RECALIBRATION

This display will be available if the vehicle has a compass. See *Compass on page 5-6* for more information.

Blank Display

This display shows no information.

Trip/Fuel Menu Items

 (Trip/Fuel): Press this button to scroll through the following menu items:

ODOMETER

Press the trip/fuel button until ODOMETER displays. This display shows the distance the vehicle has been driven in either miles (mi) or kilometers (km). Pressing the trip odometer reset stem will also display the odometer.

To switch between English and metric measurements, see “UNITS” earlier in this section.

TRIP A and TRIP B

Press the trip/fuel button until TRIP A or TRIP B displays. This display shows the current distance traveled in either miles (mi) or kilometers (km) since the last reset for each trip odometer. Both trip odometers can be used at the same time. Pressing the trip odometer reset stem will also display the trip odometers.

Each trip odometer can be reset to zero separately by pressing the set/reset button or the trip odometer reset stem while the desired trip odometer is displayed.

The trip odometer has a feature called retroactive reset. This can be used to set the trip odometer to the number of miles (kilometers) driven since the ignition was last turned on. This can be used if the trip odometer is not reset at the beginning of the trip.

To use the retroactive reset feature, press and hold the set/reset button for at least four seconds. The trip odometer will display the number of miles (mi) or kilometers (km) driven since the ignition was last turned on and the vehicle was moving. Once the vehicle begins moving, the trip odometer will accumulate mileage. For example, if the vehicle was driven 5 miles (8 km) before it is started again, and then the retroactive reset feature is activated, the display will show 5 miles (8 km). As the vehicle begins moving, the display will then increase to 5.1 miles (8.2 km), 5.2 miles (8.4 km), etc.

If the retroactive reset feature is activated after the vehicle is started, but before it begins moving, the display will show the number of miles (mi) or kilometers (km) that were driven during the last ignition cycle.

RANGE

Press the trip/fuel button until RANGE displays. This display shows the approximate number of remaining miles (mi) or kilometers (km) the vehicle can be driven without refueling. The display will show LOW if the fuel level is low.

The fuel range estimate is based on an average of the vehicle's fuel economy over recent driving history and the amount of fuel remaining in the fuel tank. This estimate will change if driving conditions change. For example, if driving in traffic and making frequent stops, this display may read one number, but if the vehicle is driven on a freeway, the number may change even though the same amount of fuel is in the fuel tank. This is because different driving conditions produce different fuel economies. Generally, freeway driving produces better fuel economy than city driving. Fuel range cannot be reset.

AVG (Average) ECONOMY

Press the trip/fuel button until AVG ECONOMY displays. This display shows the approximate average miles per gallon (mpg) or liters per 100 kilometers (L/100 km). This number is calculated based on the number of mpg (L/100 km) recorded since the last time this menu item was reset. To reset AVG ECONOMY, press and hold the set/reset button.

TIMER

Press the trip/fuel button until TIMER displays. This display can be used as a timer.

To start the timer, press the set/reset button while TIMER is displayed. The display will show the amount of time that has passed since the timer was last reset, not including time the ignition is off.

Time will continue to be counted as long as the ignition is on, even if another display is being shown on the DIC. The timer will record up to 99 hours, 59 minutes and 59 seconds (99:59:59) after which the display will return to zero.

To stop the timer, press the set/reset button briefly while TIMER is displayed.

To reset the timer to zero, press and hold the set/reset button while TIMER is displayed.

FUEL USED

Press the trip/fuel button until FUEL USED displays. This display shows the number of gallons (gal) or liters (L) of fuel used since the last reset of this menu item. To reset the fuel used information, press and hold the set/reset button while FUEL USED is displayed.

AVG (Average) SPEED

Press the trip/fuel button until AVG SPEED displays. This display shows the average speed of the vehicle in miles per hour (mph) or kilometers per hour (km/h). This average is calculated based on the various vehicle speeds recorded since the last reset of this value. To reset the value to zero, press and hold the set/reset button.

Blank Display

This display shows no information.

Driver Information Center (DIC) (Without DIC Buttons)

If your vehicle does not have DIC buttons, the information below explains the operation of this system.

The DIC has different displays which can be accessed by pressing the trip odometer reset stem located on the instrument panel cluster.

Pressing the trip odometer reset stem will also turn off, or acknowledge, DIC messages.

The DIC displays trip and vehicle system information, and warning messages if a system problem is detected.

If your vehicle does not have DIC buttons, you can use the trip odometer reset stem to view the following displays: odometer, trip odometers, oil life, park assist menu for vehicles with the Ultrasonic Rear Parking Assist (URPA) system, Remote Keyless Entry (RKE) transmitter programming, units, and display language.

If your vehicle has DIC buttons, you can use the trip odometer reset stem to view the following displays: odometer and trip odometers.

Trip Odometer Reset Stem Menu Items

ODOMETER

Press the trip odometer reset stem until ODOMETER displays. This display shows the distance the vehicle has been driven in either miles (mi) or kilometers (km).

To switch between English and metric measurements, see “UNITS” later in this section.

TRIP A or TRIP B

Press the trip odometer reset stem until TRIP A or TRIP B displays. This display shows the current distance traveled in either miles (mi) or kilometers (km) since the last reset for each trip odometer. Both trip odometers can be used at the same time.

Each trip odometer can be reset to zero separately by pressing and holding the trip odometer reset stem while the desired trip odometer is displayed.

5-30 Instruments and Controls

The trip odometer has a feature called the retro-active reset. This can be used to set the trip odometer to the number of miles (kilometers) driven since the ignition was last turned on. This can be used if the trip odometer is not reset at the beginning of the trip.

To use the retro-active reset feature, press and hold the trip odometer reset stem for at least four seconds. The trip odometer will display the number of miles (mi) or kilometers (km) driven since the ignition was last turned on and the vehicle was moving. Once the vehicle begins moving, the trip odometer will accumulate mileage. For example, if the vehicle was driven 5 miles (8 km) before it is started again, and then the retro-active reset feature is activated, the display will show 5 miles (8 km). As the vehicle begins moving, the display will then increase to 5.1 miles (8.2 km), 5.2 miles (8.4 km), etc.

If the retro-active reset feature is activated after the vehicle is started, but before it begins moving, the display will show the number of miles (mi) or kilometers (km) that were driven during the last ignition cycle.

OIL LIFE

To access this display, the vehicle must be in P (Park). Press the trip odometer reset stem until OIL LIFE REMAINING displays. This display shows an estimate of the oil's remaining useful life. If you see 99% OIL LIFE REMAINING on the display, that means 99% of the current oil life remains. The engine oil life system will alert you to change the oil on a schedule consistent with your driving conditions.

When the remaining oil life is low, the CHANGE ENGINE OIL SOON message will appear on the display. See "CHANGE ENGINE OIL SOON" under *Engine Oil Messages on page 5-39*. You should change the oil as soon as you can. See *Engine Oil on page 10-8*. In addition to the engine oil life system monitoring the oil life, additional maintenance is recommended in the Maintenance Schedule in this manual. See *Scheduled Maintenance on page 11-2* for more information.

Remember, you must reset the OIL LIFE display yourself after each oil change. It will not reset itself. Also, be careful not to reset the OIL LIFE display accidentally at any time other than when the oil has just been changed. It cannot be reset accurately until the next oil change. To reset the engine oil life system, see *Engine Oil Life System on page 10-9*.

PARK ASSIST

To access this display, the vehicle must be in P (Park). If your vehicle has the Ultrasonic Rear Parking Assist (URPA) system, press the trip odometer reset stem until PARK ASSIST displays. This display allows the system to be turned on or off. Once in this display, press and hold the trip odometer reset stem to select between ON or OFF. If you choose ON, the system will be turned on. If you choose OFF, the system will be turned off. The URPA system automatically turns back on after each vehicle start. When the URPA system is turned off and the vehicle is shifted out of P (Park), the DIC will display the PARK ASSIST OFF message as a reminder that the system has been turned off. See *Object Detection System Messages* on page 5-40 and *Ultrasonic Parking Assist* on page 9-35 for more information.

RELEARN REMOTE KEY

To access this display, the vehicle must be in P (Park). This display allows you to match Remote Keyless Entry (RKE) transmitters to your vehicle. This procedure will erase all previously learned transmitters. Therefore, they must be relearned as additional transmitters.

To match an RKE transmitter to your vehicle:

1. Press the trip odometer reset stem until RELEARN REMOTE KEY displays.
2. Press and hold the trip odometer reset stem until REMOTE KEY LEARNING ACTIVE is displayed.

3. Press and hold the lock and unlock buttons on the first transmitter at the same time for about 15 seconds.

On vehicles with memory recall seats, the first transmitter learned will match driver 1 and the second will match driver 2.

A chime will sound indicating that the transmitter is matched.

4. To match additional transmitters at this time, repeat Step 3.

Each vehicle can have a maximum of eight transmitters matched to it.

5. To exit the programming mode, you must cycle the key to LOCK/OFF.

5-32 Instruments and Controls

UNITS

To access this display, the vehicle must be in P (Park). Press the trip odometer reset stem until UNITS displays. This display allows you to select between English or Metric units of measurement. Once in this display, press and hold the trip odometer reset stem to select between ENGLISH or METRIC units. All of the vehicle information will then be displayed in the unit of measurement selected.

DISPLAY LANGUAGE

To access this display, the vehicle must be in P (Park). This display allows you to select the language in which the DIC messages will appear. To select a language:

1. Press the trip odometer reset stem until DISPLAY LANGUAGE displays.
2. Continue to press and hold the trip odometer reset stem to scroll through all of the available languages.

The available languages are ENGLISH (default), FRANCAIS (French), ESPANOL (Spanish), and NO CHANGE.

3. Once the desired language is displayed, release the trip odometer reset stem to set your choice.

Head-Up Display (HUD)

 **WARNING**

If the HUD image is too bright or too high in your field of view, it may take you more time to see things you need to see when it is dark outside. Be sure to keep the HUD image dim and placed low in your field of view.

For vehicles with the Head-Up Display (HUD), some information concerning the operation of the vehicle is projected onto the windshield. This includes the speedometer reading, RPM reading,

transmission position, outside air temperature, the tap shift gear, and a brief display of the current radio station, including XM information or CD track. It will also display turn-by-turn navigation information if the vehicle has a navigation radio. The images are projected by the HUD lens located on the driver's side of the instrument panel.

The tap shift gear will also appear on the HUD if the vehicle has tap shift and it is active.

The HUD information can be displayed in one of three languages, English, French, or Spanish. The speedometer reading and other numerical values can be displayed in either English or metric units.

The language selection and the units of measurement are changed through the trip computer in the Driver Information Center (DIC). See *Vehicle Personalization (With DIC Buttons)* on page 5-45.



HUD Display on the Vehicle Windshield

The HUD information appears as an image focused out toward the front of the vehicle.

When the ignition key is turned to ON/RUN, the HUD will display an introductory message for a short time, until the HUD is ready.

The following indicator lights come on the instrument panel when activated and also appear on the HUD:

- Turn Signal Indicators
- High-Beam Indicator Symbol

The HUD temporarily displays CHECK GAGES and ICE POSSIBLE when these messages are on the DIC trip computer.

The HUD also displays the following messages on vehicles with these systems, when they are active:

- TRACTION CONTROL ACTIVE
- STABILITRAK ACTIVE

Notice: If you try to use the HUD image as a parking aid, you may misjudge the distance and damage your vehicle. Do not use the HUD image as a parking aid.

When the HUD is on, the speedometer reading is continually displayed. The current radio station or CD track number will display for a short period of time after the radio or CD track status changes. This happens whenever radio information is changed. The speedometer size is reduced when radio, CD information, warnings, or turn-by-turn navigation information are displayed on the HUD.



The HUD control is located to the right of the steering wheel.

5-34 Instruments and Controls

To adjust the HUD image so that items are properly displayed, do the following:

1. Adjust the driver's seat to a comfortable position.
2. Start the engine.
3. Adjust the HUD controls.

Use the following settings to adjust the HUD.

○ **(Off):** To turn HUD off, rotate the dimming knob fully counterclockwise until the HUD display turns off.

Brightness: Turn the knob on the HUD control clockwise or counterclockwise to brighten or dim the display.

△ **(Up):** ▽ **(Down):** Press the up or down arrows to center the HUD image in your view. The HUD image can only be adjusted up and down, not side to side.

☰ **(Page):** Press this button to select the display formats. Release the page button when the format number with the desired display is shown on the HUD.

The three formats are as follows:



Format One: This display gives the speedometer reading (in English or metric units), turn signal indication, high beam indication, transmission positions, and the outside air temperature.



Format Two: This display includes the information in Format One without the transmission information and the outside air temperature.



Format Three: This display includes all the information in Format One along with a circular tachometer, but without outside air temperature.

All formats will show the turn-by-turn navigation information and provide details about the next driving maneuver to be made. When you near your destination, the HUD will display a distance bar that will fill in the closer you get to your destination. All navigation information is provided to the HUD by the navigation radio, if the vehicle has one.

The HUD image displayed on the windshield will automatically dim and brighten to compensate for outside lighting.

The HUD image can temporarily light up depending on the angle and position of the sunlight on the HUD display. This is normal and will change when the angle of the sunlight on the HUD display changes.

Polarized sunglasses could make the HUD image harder to see.

Care of the HUD

Clean the inside of the windshield as needed to remove any dirt or film that could reduce the sharpness or clarity of the HUD image.

To clean the HUD lens, use a soft, clean cloth that has household glass cleaner sprayed on it. Wipe the HUD lens gently, then dry it. Do not spray cleaner directly on the lens because the cleaner could leak into the unit.

If You Cannot See the HUD Image When the Ignition Is On

- Is anything covering the HUD lens?
- Is the HUD dimmer setting bright enough?
- Is the HUD image adjusted to the proper height?
- Are you wearing polarized sunglasses?
- Still no HUD image? Check the fuse in the instrument panel fuse block. See *Instrument Panel Fuse Block* on page 10-34.

If the HUD Image Is Not Clear

- Is the HUD image too bright?
- Are the windshield and HUD lens clean?

If the HUD image is not correct, contact your dealer/retailer.

Keep in mind that the windshield is part of the HUD system.

Vehicle Messages

Messages are displayed on the DIC to notify the driver that the status of the vehicle has changed and that some action may be needed by the driver to correct the condition. Multiple messages may appear one after another.

Some messages may not require immediate action, but you can press any of the DIC buttons on the instrument panel or the trip odometer reset stem on the instrument panel cluster to acknowledge that you received the messages and to clear them from the display.

Some messages cannot be cleared from the DIC display because they are more urgent. These messages require action before they can be cleared. You should take any messages that appear on the display seriously and remember that clearing the messages will only make the messages disappear, not correct the problem.

The following are the possible messages that can be displayed and some information about them.

Battery Voltage and Charging Messages

BATTERY SAVER ACTIVE

This message displays when the system detects that the battery voltage is dropping below expected levels. The battery saver system starts reducing certain features of the vehicle that you may be able to notice. At the point that the features are disabled, this message is displayed. It means that the vehicle is trying to save the charge in the battery.

Turn off all unnecessary accessories to allow the battery to recharge.

The normal battery voltage range is 11.5 to 15.5 volts.

SERVICE BATTERY CHARGING SYSTEM

On some vehicles, this message displays if there is a problem with the battery charging system. Under certain conditions, the charging system light may also turn on in the instrument panel cluster. See *Charging System Light on page 5-16*. Driving with this problem could drain the battery. Turn off all unnecessary accessories. Have the electrical system checked as soon as possible. See your dealer/retailer.

Brake System Messages

SERVICE BRAKE SYSTEM

This message displays along with the brake system warning light if there is a problem with the brake system. See *Brake System Warning Light on page 5-19*. If this message appears, stop as soon as possible and turn off the vehicle.

Restart the vehicle and check for the message on the DIC display. If the message is still displayed or appears again when you begin driving, the brake system needs service as soon as possible. See your dealer/retailer.

Cruise Control Messages

CRUISE SET TO XXX

This message displays whenever the cruise control is set. See *Cruise Control* on page 9-32 for more information.

Door Ajar Messages

DRIVER DOOR OPEN

This message displays and a chime sounds if the driver door is not fully closed and the vehicle is shifted out of P (Park). Stop and turn off the vehicle, check the door for obstructions, and close the door again. Check to see if the message still appears on the DIC.

HOOD OPEN

On some models, this message displays and a chime sounds if the hood is not fully closed. Stop and turn off the vehicle, check the hood for obstructions, and close the hood again. Check to see if the message still appears on the DIC.

LEFT REAR DOOR OPEN

This message displays and a chime sounds if the driver side rear door is not fully closed and the vehicle is shifted out of P (Park). Stop and turn off the vehicle, check the door for obstructions, and close the door again. Check to see if the message still appears on the DIC.

LIFTGATE OPEN

This message displays and a chime sounds if the liftgate is open while the ignition is in ON/RUN. Turn off the vehicle and check the liftgate. Restart the vehicle and check for the message on the DIC display.

PASSENGER DOOR OPEN

This message displays and a chime sounds if the passenger door is not fully closed and the vehicle is shifted out of P (Park). Stop and turn off the vehicle, check the door for obstructions, and close the door again. Check to see if the message still appears on the DIC.

RIGHT REAR DOOR OPEN

This message displays and a chime sounds if the passenger side rear door is not fully closed and the vehicle is shifted out of P (Park). Stop and turn off the vehicle, check the door for obstructions, and close the door again. Check to see if the message still appears on the DIC.

Engine Cooling System Messages

ENGINE HOT A/C (Air Conditioning) OFF

This message displays when the engine coolant becomes hotter than the normal operating temperature. See *Engine Coolant Temperature Gauge* on page 5-13. To avoid added strain on a hot engine, the air conditioning compressor automatically turns off. When the coolant temperature returns to normal, the air conditioning compressor turns back on. You can continue to drive your vehicle.

If this message continues to appear, have the system repaired by your dealer/retailer as soon as possible to avoid damage to the engine.

ENGINE OVERHEATED IDLE ENGINE

Notice: If you drive your vehicle while the engine is overheating, severe engine damage may occur. If an overheat warning appears on the instrument panel cluster and/or DIC, stop the vehicle as soon as possible. Do not increase the engine speed above normal idling speed. See *Engine Overheating* on page 10-18 for more information.

This message displays when the engine coolant temperature is too hot. Stop and allow the vehicle to idle until it cools down. See *Engine Coolant Temperature Gauge* on page 5-13.

See *Overheated Engine Protection Operating Mode* on page 10-20 for information on driving to a safe place in an emergency.

ENGINE OVERHEATED STOP ENGINE

Notice: If you drive your vehicle while the engine is overheating, severe engine damage may occur. If an overheat warning appears on the instrument panel cluster and/or DIC, stop the vehicle as soon as possible. Do not increase the engine speed above normal idling speed. See *Engine Overheating* on page 10-18 for more information.

This message displays and a continuous chime sounds if the engine cooling system reaches unsafe temperatures for operation. Stop and turn off the vehicle as soon as it is safe to do so to avoid severe damage. This message clears when the engine has cooled to a safe operating temperature.

Engine Oil Messages

CHANGE ENGINE OIL SOON

This message displays when the engine oil needs to be changed. When you change the engine oil, be sure to reset the CHANGE ENGINE OIL SOON message. See *Engine Oil Life System on page 10-9* for information on how to reset the message. See *Engine Oil on page 10-8* and *Scheduled Maintenance on page 11-2* for more information.

OIL PRESSURE LOW STOP ENGINE

Notice: If you drive your vehicle while the engine oil pressure is low, severe engine damage may occur. If a low oil pressure warning appears on the instrument panel cluster and/or DIC, stop the vehicle as soon as possible. Do not drive the vehicle

until the cause of the low oil pressure is corrected. See *Engine Oil on page 10-8* for more information.

This message displays if low oil pressure levels occur. Stop the vehicle as soon as safely possible and do not operate it until the cause of the low oil pressure has been corrected. Check the oil as soon as possible and have your vehicle serviced by your dealer/retailer. See *Engine Oil on page 10-8*.

Engine Power Messages

ENGINE POWER IS REDUCED

This message displays and a chime sounds when the cooling system temperature gets too hot and the engine further enters the engine coolant protection mode. See *Engine Overheating on page 10-18* for further information.

This message also displays when the vehicle's engine power is reduced. Reduced engine power can affect the vehicle's ability to accelerate. If this message is on, but there is no reduction in performance, proceed to your destination. The performance may be reduced the next time the vehicle is driven. The vehicle may be driven at a reduced speed while this message is on, but acceleration and speed may be reduced. Anytime this message stays on, the vehicle should be taken to your dealer/retailer for service as soon as possible.

Fuel System Messages

FUEL LEVEL LOW

This message displays and a chime sounds if the fuel level is low. Refuel as soon as possible. See *Fuel Gauge on page 5-12* and *Fuel on page 9-42* for more information.

TIGHTEN GAS CAP

This message may display along with the check engine light on the instrument panel cluster if the vehicle's fuel cap is not tightened properly. See *Malfunction Indicator Lamp* on page 5-17. Reinstall the fuel cap fully. See *Filling the Tank* on page 9-45. The diagnostic system can determine if the fuel cap has been left off or improperly installed. A loose or missing fuel cap allows fuel to evaporate into the atmosphere. A few driving trips with the cap properly installed should turn this light and message off.

Key and Lock Messages

REMOTE KEY LEARNING ACTIVE

This message displays while you are matching a Remote Keyless Entry (RKE) transmitter to your vehicle. See "Matching Transmitter(s) to Your Vehicle"

under *Remote Keyless Entry (RKE) System Operation* on page 2-3 and *Driver Information Center (DIC) (With DIC Buttons)* on page 5-24 or *Driver Information Center (DIC) (Without DIC Buttons)* on page 5-29 for more information.

REPLACE BATTERY IN REMOTE KEY

This message displays if a Remote Keyless Entry (RKE) transmitter battery is low. The battery needs to be replaced in the transmitter. See "Battery Replacement" under *Remote Keyless Entry (RKE) System Operation* on page 2-3.

Lamp Messages

AUTOMATIC LIGHT CONTROL OFF

This message displays when the automatic headlamps are turned off. This message clears itself after 10 seconds.

AUTOMATIC LIGHT CONTROL ON

This message displays when the automatic headlamps are turned on. This message clears itself after 10 seconds.

TURN SIGNAL ON

This message displays and a chime sounds if a turn signal is left on for 3/4 of a mile (1.2 km). Move the turn signal/multifunction lever to the off position.

Object Detection System Messages

PARK ASSIST OFF

If your vehicle has the Ultrasonic Rear Parking Assist (URPA) system, after the vehicle has been started and shifted out of P (Park), this message displays to remind the driver that the URPA system has been turned off or to notify the driver that the system has turned itself off.

Press the set/reset button or the trip odometer reset stem to acknowledge this message and clear it from the DIC display. For more information see *Ultrasonic Parking Assist* on page 9-35.

SERVICE PARK ASSIST

If your vehicle has the Ultrasonic Rear Parking Assist (URPA) system, this message displays if there is a problem with the URPA system. Do not use this system to help you park. See *Ultrasonic Parking Assist* on page 9-35 for more information. See your dealer/retailer for service.

Ride Control System Messages

SERVICE STABILITRAK

This message displays if there is a problem with the StabiliTrak[®] system. If this message appears, try to reset the system. Stop; turn off the engine for at least 15 seconds; then start the engine again.

If this message still comes on, it means there is a problem. See your dealer/retailer for service. The vehicle is safe to drive, however, you do not have the benefit of StabiliTrak, so reduce your speed and drive accordingly.

SERVICE TRACTION CONTROL

This message displays when there is a problem with the Traction Control System (TCS). When this message is displayed, the system will not limit wheel spin. Adjust your driving accordingly. See your dealer/retailer for service. See *StabiliTrak System* on page 9-30 for more information.

TRACTION CONTROL OFF

This message displays when the Traction Control System (TCS) is turned off. Adjust your driving accordingly. See *StabiliTrak System* on page 9-30 for more information. This message clears itself after 10 seconds.

Airbag System Messages

SERVICE AIR BAG

This message displays if there is a problem with the airbag system. Have your dealer/retailer inspect the system for problems. See *Airbag Readiness Light* on page 5-15 and *Airbag System* on page 3-32 for more information.

Anti-Theft Alarm System Messages

SERVICE THEFT DETERRENT SYSTEM

This message displays when there is a problem with the theft-deterrent system. The vehicle may or may not restart so you may want to take the vehicle to your dealer/retailer before turning off the engine. See *Immobilizer Operation* on page 2-14 for more information.

THEFT ATTEMPTED

This message displays if the content theft-deterrent system has detected a break-in attempt while you were away from your vehicle. See *Anti-Theft Alarm System* on page 2-13 for more information.

Service Vehicle Messages

SERVICE A/C (Air Conditioning) SYSTEM

This message displays when the electronic sensors that control the air conditioning and heating systems are no longer working. Have the climate control system serviced by your dealer/retailer if you notice a drop in heating and air conditioning efficiency.

SERVICE POWER STEERING

This message displays when a problem is detected with the power steering system. When this message is displayed, you may notice that the effort required to steer the vehicle increases or feels heavier, but you will still be able to steer the vehicle. Have your vehicle serviced by your dealer/retailer immediately.

SERVICE VEHICLE SOON

This message displays when a non-emissions related malfunction occurs. Have the vehicle serviced by your dealer/retailer as soon as possible.

STARTING DISABLED SERVICE THROTTLE

This message displays when your vehicle's throttle system is not functioning properly. Have your vehicle serviced by your dealer/retailer.

Tire Messages

TIRE LOW ADD AIR TO TIRE

On vehicles with the Tire Pressure Monitor System (TPMS), this message displays when the pressure in one or more of the vehicle's tires is low.

This message also displays LEFT FRT (left front), RIGHT FRT (right front), LEFT RR (left rear), or RIGHT RR (right rear) to indicate the location of the low tire.

The low tire pressure warning light will also come on. See *Tire Pressure Light* on page 5-21.

If a tire pressure message appears on the DIC, stop as soon as you can. Inflate the tires by adding air until the tire pressure is equal to the values shown on the Tire Loading Information label. See *Tires* on page 10-36, *Vehicle Load Limits* on page 9-12, and *Tire Pressure* on page 10-43.

You can receive more than one tire pressure message at a time. To read the other messages that may have been sent at the same time, press the set/reset button or the trip odometer reset stem. The DIC also shows the tire pressure values. See *Driver Information Center (DIC) (With DIC Buttons)* on page 5-24 or *Driver Information Center (DIC) (Without DIC Buttons)* on page 5-29.

SERVICE TIRE MONITOR SYSTEM

On vehicles with the Tire Pressure Monitor System (TPMS), this message displays if a part on the TPMS is not working properly. The tire pressure light also flashes and then remains on during the same ignition cycle. See *Tire Pressure Light* on page 5-21. Several conditions may cause this message to appear. See *Tire Pressure Monitor Operation* on page 10-46 for more information.

If the warning comes on and stays on, there may be a problem with the TPMS. See your dealer/retailer.

TIRE LEARNING ACTIVE

This message displays when the Tire Pressure Monitor System (TPMS) is re-learning the tire positions on your vehicle. The tire positions must be re-learned after rotating the tires or after replacing a tire or sensor. See *Tire Rotation* on page 10-49, *Tire Pressure Monitor System* on page 10-44, and *Tire Pressure* on page 10-43 for more information.

Transmission Messages

ALL WHEEL DRIVE OFF

If your vehicle has the All-Wheel Drive (AWD) system, this message displays when there is a compact spare tire on the vehicle, when the Antilock Brake System (ABS) warning light comes on, or when the

rear differential fluid is overheating. This message turns off when the differential fluid cools.

The AWD system is disabled until the compact spare tire is replaced by a full-size tire. If the warning message is still on after putting on the full-size tire, you need to reset the warning message. To reset the warning message, turn the ignition off and then back on again after 30 seconds. If the message stays on, see your dealer/retailer right away. See *All-Wheel Drive* on page 9-28 for more information.

SERVICE ALL WHEEL DRIVE

If your vehicle has the All-Wheel Drive (AWD) system, this message displays if there is a problem with this system. If this message appears, stop as soon as possible and turn off the vehicle. Restart the vehicle after 30 seconds and check for the message on the DIC display.

If the message is still displayed or appears again when you begin driving, the AWD system needs service. See your dealer/retailer.

SERVICE TRANSMISSION

This message displays when there is a problem with the transmission. See your dealer/retailer for service.

TRANSMISSION HOT IDLE ENGINE

Notice: If you drive your vehicle while the transmission fluid is overheating and the transmission temperature warning is displayed on the instrument panel cluster and/or DIC, you can damage the transmission. This could lead to costly repairs that would not be covered by your warranty. Do not drive your vehicle with overheated transmission fluid or while the transmission temperature warning is displayed.

This message displays and a chime sounds if the transmission fluid in the vehicle gets hot. Driving with the transmission fluid temperature high can cause damage to the vehicle. Stop the vehicle and let it idle to allow the transmission to cool. This message clears when the fluid temperature reaches a safe level.

Vehicle Reminder Messages

ICE POSSIBLE DRIVE WITH CARE

This message displays when the outside air temperature is cold enough to create icy road conditions. Adjust your driving accordingly.

Vehicle Speed Messages

SPEED LIMITED TO XXX MPH (KM/H)

This message displays when your vehicle speed is limited to 80 mph (128 km/h) because the vehicle detects a problem in the speed variable assist steering system. Have your vehicle serviced by your dealer/retailer.

Washer Fluid Messages

WASHER FLUID LOW ADD FLUID

This message displays when the windshield washer fluid is low. Fill the windshield washer fluid reservoir as soon as possible. See *Engine Compartment Overview* on page 10-6 for the location of the windshield washer fluid reservoir. Also, see *Washer Fluid* on page 10-21 for more information.

Vehicle Personalization

Vehicle Personalization (With DIC Buttons)

Your vehicle may have customization capabilities that allow you to program certain features to one preferred setting. Customization features can only be programmed to one setting on the vehicle and cannot be programmed to a preferred setting for two different drivers.

All of the customization options may not be available on your vehicle. Only the options available will be displayed on the DIC.

The default settings for the customization features were set when your vehicle left the factory, but may have been changed from their default state since then.

The customization preferences are automatically recalled.

To change customization preferences, use the following procedure.

Entering the Feature Settings Menu

1. Turn the ignition on and place the vehicle in P (Park).

To avoid excessive drain on the battery, it is recommended that the headlamps are turned off.

2. Press the customization button to enter the feature settings menu.

If the menu is not available, FEATURE SETTINGS AVAILABLE IN PARK will display. Before entering the menu, make sure the vehicle is in P (Park).

Feature Settings Menu Items

The following are customization features that allow you to program settings to the vehicle:

DISPLAY IN ENGLISH

This feature will only display if a language other than English has been set. This feature allows you to change the language in which the DIC messages appear to English.

Press the customization button until the PRESS ✓ TO DISPLAY IN ENGLISH screen appears on the DIC display. Press the set/reset button once to display all DIC messages in English.

DISPLAY LANGUAGE

This feature allows you to select the language in which the DIC messages will appear.

Press the customization button until the DISPLAY LANGUAGE screen appears on the DIC display. Press the set/reset button once to access the settings for this feature. Then press the customization button to scroll through the following settings:

ENGLISH (default): All messages will appear in English.

FRANCAIS: All messages will appear in French.

ESPANOL: All messages will appear in Spanish.

NO CHANGE: No change will be made to this feature. The current setting will remain.

To select a setting, press the set/reset button while the desired setting is displayed on the DIC.

You can also change the language by pressing the trip odometer reset stem. See "Language" under Driver Information Center (Without DIC Buttons) earlier in this section for more information.

AUTO DOOR LOCK

This feature allows you to select when the vehicle's doors will automatically lock. See *Automatic Door Locks on page 2-8* for more information.

Press the customization button until AUTO DOOR LOCK appears on the DIC display. Press the set/reset button once to access the settings for this feature. Then press the customization button to scroll through the following settings:

SHIFT OUT OF PARK (default): The doors will automatically lock when the vehicle is shifted out of P (Park).

AT VEHICLE SPEED: The doors will automatically lock when the vehicle speed is above 8 mph (13 km/h) for three seconds.

NO CHANGE: No change will be made to this feature. The current setting will remain.

To select a setting, press the set/reset button while the desired setting is displayed on the DIC.

AUTO DOOR UNLOCK

This feature allows you to select whether or not to turn off the automatic door unlocking feature. It also allows you to select which doors and when the doors will automatically unlock. See *Automatic Door Locks on page 2-8* for more information.

Press the customization button until AUTO DOOR UNLOCK appears on the DIC display. Press the set/reset button once to access the settings for this feature. Then press the customization button to scroll through the following settings:

OFF: None of the doors will automatically unlock.

DRIVER AT KEY OUT: Only the driver's door will unlock when the key is taken out of the ignition.

DRIVER IN PARK: Only the driver's door will unlock when the vehicle is shifted into P (Park).

ALL AT KEY OUT: All of the doors will unlock when the key is taken out of the ignition.

ALL IN PARK (default): All of the doors will unlock when the vehicle is shifted into P (Park).

NO CHANGE: No change will be made to this feature. The current setting will remain.

To select a setting, press the set/reset button while the desired setting is displayed on the DIC.

REMOTE DOOR LOCK

This feature allows you to select the type of feedback you will receive when locking the vehicle with the Remote Keyless Entry (RKE) transmitter. You will not receive feedback when locking the vehicle with the RKE transmitter if the doors are open. See *Remote Keyless Entry (RKE) System Operation on page 2-3* for more information.

Press the customization button until REMOTE DOOR LOCK appears on the DIC display. Press the set/reset button once to access the settings for this feature. Then press the customization button to scroll through the following settings:

OFF: There will be no feedback when you press the lock button on the RKE transmitter.

LIGHTS ONLY: The exterior lamps will flash when you press the lock button on the RKE transmitter.

HORN ONLY: The horn will sound on the second press of the lock button on the RKE transmitter.

HORN & LIGHTS (default): The exterior lamps will flash when you press the lock button on the RKE transmitter, and the horn will sound when the lock button is pressed again within five seconds of the previous command.

NO CHANGE: No change will be made to this feature. The current setting will remain.

To select a setting, press the set/reset button while the desired setting is displayed on the DIC.

REMOTE DOOR UNLOCK

This feature allows you to select the type of feedback you will receive when unlocking the vehicle with the Remote Keyless Entry (RKE) transmitter. You will not receive feedback when unlocking the vehicle with the RKE transmitter if the doors are open. See *Remote Keyless Entry (RKE) System Operation on page 2-3* for more information.

Press the customization button until REMOTE DOOR UNLOCK appears on the DIC display. Press the set/reset button once to access the settings for this feature. Then press the customization button to scroll through the following settings:

LIGHTS OFF: The exterior lamps will not flash when you press the unlock button on the RKE transmitter.

LIGHTS ON (default): The exterior lamps will flash when you press the unlock button on the RKE transmitter.

NO CHANGE: No change will be made to this feature. The current setting will remain.

To select a setting, press the set/reset button while the desired setting is displayed on the DIC.

DELAY DOOR LOCK

This feature allows you to select whether or not the locking of the vehicle's doors and liftgate will be delayed. When locking the doors and liftgate with the power door lock switch and a door or the liftgate is open, this feature will delay locking the doors and liftgate until five seconds after the last door is closed. You will hear three chimes to signal that the delayed locking feature is in use. The key must be out of the ignition for this feature to work.

You can temporarily override delayed locking by pressing the power door lock switch twice or the lock button on the RKE transmitter twice. See *Delayed Locking on page 2-8* for more information.

Press the customization button until DELAY DOOR LOCK appears on the DIC display. Press the set/reset button once to access the settings for this feature. Then press the customization button to scroll through the following settings:

OFF: There will be no delayed locking of the vehicle's doors.

ON (default): The doors will not lock until five seconds after the last door or the liftgate is closed.

NO CHANGE: No change will be made to this feature. The current setting will remain.

To select a setting, press the set/reset button while the desired setting is displayed on the DIC.

EXIT LIGHTING

This feature allows you to select the amount of time you want the exterior lamps to remain on when it is dark enough outside. This happens after the key is turned from ON/RUN to LOCK/OFF.

Press the customization button until EXIT LIGHTING appears on the DIC display. Press the set/reset button once to access the settings for this feature. Then press the customization button to scroll through the following settings:

OFF: The exterior lamps will not turn on.

30 SECONDS (default): The exterior lamps will stay on for 30 seconds.

1 MINUTE: The exterior lamps will stay on for one minute.

2 MINUTES: The exterior lamps will stay on for two minutes.

NO CHANGE: No change will be made to this feature. The current setting will remain.

To select a setting, press the set/reset button while the desired setting is displayed on the DIC.

APPROACH LIGHTING

This feature allows you to select whether or not to have the exterior lights turn on briefly during low light periods after unlocking the vehicle using the Remote Keyless Entry (RKE) transmitter.

Press the customization button until APPROACH LIGHTING appears on the DIC display. Press the set/reset button once to access the settings for this feature. Then press the customization button to scroll through the following settings:

OFF: The exterior lights will not turn on when you unlock the vehicle with the RKE transmitter.

ON (default): If it is dark enough outside, the exterior lights will turn on briefly when you unlock the vehicle with the RKE transmitter.

The lights will remain on for 20 seconds or until the lock button on the RKE transmitter is pressed, or the vehicle is no longer off. See *Remote Keyless Entry (RKE) System Operation on page 2-3* for more information.

NO CHANGE : No change will be made to this feature. The current setting will remain.

To select a setting, press the set/reset button while the desired setting is displayed on the DIC.

CHIME VOLUME

This feature allows you to select the volume level of the chime.

Press the customization button until CHIME VOLUME appears on the DIC display. Press the set/reset button once to access the settings for this feature. Then press the customization button to scroll through the following settings:

NORMAL: The chime volume will be set to a normal level.

LOUD: The chime volume will be set to a loud level.

NO CHANGE: No change will be made to this feature. The current setting will remain.

There is no default for chime volume. The volume will stay at the last known setting.

To select a setting, press the set/reset button while the desired setting is displayed on the DIC.

PARK TILT MIRRORS

If your vehicle has this feature, it allows you to select whether or not the outside mirror(s) will automatically tilt down when the vehicle is shifted into R (Reverse). See *Park Tilt Mirrors on page 2-18* for more information.

5-50 Instruments and Controls

Press the customization button until PARK TILT MIRRORS appears on the DIC display. Press the set/reset button once to access the settings for this feature. Then press the customization button to scroll through the following settings:

OFF (default): Neither outside mirror will be tilted down when the vehicle is shifted into R (Reverse).

DRIVER MIRROR: The driver's outside mirror will be tilted down when the vehicle is shifted into R (Reverse).

PASSENGER MIRROR: The passenger's outside mirror will be tilted down when the vehicle is shifted into R (Reverse).

BOTH MIRRORS: The driver's and passenger's outside mirrors will be tilted down when the vehicle is shifted into R (Reverse).

NO CHANGE: No change will be made to this feature. The current setting will remain.

To select a setting, press the set/reset button while the desired setting is displayed on the DIC.

EASY EXIT SEAT

If your vehicle has this feature, it allows you to select your preference for the automatic easy exit seat feature. See *Delayed Locking on page 2-8* for more information.

Press the customization button until EASY EXIT SEAT appears on the DIC display. Press the set/reset button once to access the settings for this feature. Then press the customization button to scroll through the following settings:

OFF (default): No automatic seat exit recall will occur.

ON: The driver's seat will move back when the key is removed from the ignition.

The automatic easy exit seat movement will only occur one time after the key is removed from the ignition. If the automatic movement has already occurred, and you put the key back in the ignition and remove it again, the seat and steering column will stay in the original exit position, unless a memory recall took place prior to removing the key again.

NO CHANGE: No change will be made to this feature. The current setting will remain.

To select a setting, press the set/reset button while the desired setting is displayed on the DIC.

MEMORY SEAT RECALL

If your vehicle has this feature, it allows you to select your preference for the remote memory seat recall feature. See *Delayed Locking on page 2-8* for more information.

Press the customization button until MEMORY SEAT RECALL appears on the DIC display. Press the set/reset button once to access the settings for this feature. Then press the customization button to scroll through the following settings:

OFF (default): No remote memory seat recall will occur.

ON: The driver's seat and outside mirrors will automatically move to the stored driving position when the unlock button on the Remote Keyless Entry (RKE) transmitter is pressed. See "Relearn Remote Key" under *Driver Information Center (DIC) (With DIC Buttons)* on page 5-24 or *Driver Information Center (DIC) (Without DIC Buttons)* on page 5-29 for more information on matching transmitters to driver ID numbers.

NO CHANGE: No change will be made to this feature. The current setting will remain.

To select a setting, press the set/reset button while the desired setting is displayed on the DIC.

REMOTE START

If your vehicle has this feature, it allows you to turn the remote start off or on. The remote start feature allows you to start the engine from outside of the vehicle using the Remote Keyless Entry (RKE) transmitter. See *Remote Vehicle Start* on page 2-5 for more information.

Press the customization button until REMOTE START appears on the DIC display. Press the set/reset button once to access the settings for this feature. Then press the customization button to scroll through the following settings:

OFF: The remote start feature will be disabled.

ON (default): The remote start feature will be enabled.

NO CHANGE: No change will be made to this feature. The current setting will remain.

To select a setting, press the set/reset button while the desired setting is displayed on the DIC.

FACTORY SETTINGS

This feature allows you to set all of the customization features back to their factory default settings.

Press the customization button until FACTORY SETTINGS appears on the DIC display. Press the set/reset button once to access the settings for this feature. Then press the customization button to scroll through the following settings:

RESTORE ALL (default): The customization features will be set to their factory default settings.

DO NOT RESTORE: The customization features will not be set to their factory default settings.

To select a setting, press the set/reset button while the desired setting is displayed on the DIC.

EXIT FEATURE SETTINGS

This feature allows you to exit the feature settings menu.

Press the customization button until FEATURE SETTINGS PRESS ✓ TO EXIT appears in the DIC display. Press the set/reset button once to exit the menu.

If you do not exit, pressing the customization button again will return you to the beginning of the feature settings menu.

Exiting the Feature Settings Menu

The feature settings menu will be exited when any of the following occurs:

- The vehicle is shifted out of P (Park).
- The vehicle is no longer in ON/RUN.
- The trip/fuel or vehicle information DIC buttons are pressed.
- The end of the feature settings menu is reached and exited.
- A 40 second time period has elapsed with no selection made.

Universal Remote System

See *Radio Frequency Statement on page 13-17* for information regarding Part 15 of the Federal Communications Commission (FCC) Rules and RSS-210/211 of Industry Canada.

Universal Remote System Programming



This system provides a way to replace up to three remote control transmitters used to activate devices such as garage door openers, security systems, and home automation devices.

Do not use the Universal Home Remote with any garage door opener that does not have the stop and reverse feature. This includes any garage door opener model manufactured before April 1, 1982.

Read the instructions completely before attempting to program the Universal Home Remote. Because of the steps involved, it may be helpful to have another person available to assist you with programming the Universal Home Remote.

Keep the original hand-held transmitter for use in other vehicles as well as for future Universal Home Remote programming. It is also recommended that upon the sale of the vehicle, the programmed Universal Home Remote buttons should be erased for security purposes. See "Erasing Universal Home Remote Buttons" later in this section.

When programming a garage door, park outside of the garage. Park directly in line with and facing the garage door opener motor-head or gate motor-head. Be sure that people and objects are clear of the garage door or gate that is being programmed.

It is recommended that a new battery be installed in your hand-held transmitter for quicker and more accurate transmission of the radio-frequency signal.

Programming the Universal Home Remote System

For questions or help programming the Universal Home Remote System, call 1-800-355-3515 or go to www.homelink.com.

Programming a garage door opener involves time-sensitive actions, so read the entire procedure before starting. Otherwise, the device will time out and the procedure will have to be repeated.

To program up to three devices:

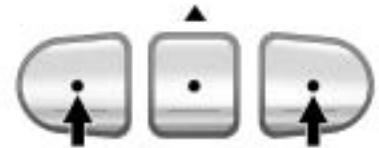

1. From inside the vehicle, press and hold down the two outside buttons at the same time, releasing only when the Universal Home Remote indicator light begins to flash, after 20 seconds. This step will erase the factory settings or all previously programmed buttons.

Do not hold down the buttons for longer than 30 seconds and do not repeat this step to program the remaining two Universal Home Remote buttons.

5-54 Instruments and Controls

2. Hold the end of your hand-held transmitter about 3 to 8 cm (1 to 3 inches) away from the Universal Home Remote buttons while keeping the indicator light in view. The hand-held transmitter was supplied by the manufacturer of your garage door opener receiver (motor head unit).
3. At the same time, press and hold both the Universal Home Remote button to be used to control the garage door and the hand-held transmitter button. Do not release the Universal Home Remote button or the hand-held transmitter button until Step 4 has been completed.

Some entry gates and garage door openers may require substitution of Step 3 with the procedure noted in "Gate Operator and Canadian Programming" later in this section.

4. The indicator light on the Universal Home Remote will flash slowly at first and then rapidly after Universal Home Remote successfully receives the frequency signal from the hand-held transmitter. Release both buttons.
5. Press and hold the newly-trained Universal Home Remote button and observe the indicator light.
 - If the indicator light stays on continuously, the programming is complete and the garage door should move when the Universal Home Remote button is pressed and released. There is no need to continue programming Steps 6 through 8.
 - If the Universal Home Remote indicator light blinks rapidly for two seconds and then turns to a constant

light, continue with the programming Steps 6 through 8.

It may be helpful to have another person assist with the remaining steps.



6. After Steps 1 through 5 have been completed, locate inside the garage the garage door opener receiver (motor-head unit). Locate the "Learn" or "Smart" button. The name and color of the button may vary by manufacturer.

7. Firmly press and release the “Learn” or “Smart” button. After you press this button, you will have 30 seconds to complete Step 8.
8. Immediately return to the vehicle. Firmly press and hold the Universal Home Remote button, selected in Step 3 to control the garage door, for two seconds, and then release it. If the garage door does not move, press and hold the same button a second time for two seconds, and then release it. Again, if the door does not move, press and hold the same button a third time for two seconds, and then release. The Universal Home Remote should now activate the garage door.

To program the remaining two Universal Home Remote buttons, begin with Step 2 of “Programming the Universal Home Remote System.” Do not repeat Step 1, as this will erase all previous programming from the Universal Home Remote buttons.

Gate Operator and Canadian Programming

If you have questions or need help programming the Universal Home Remote System, call 1-800-355-3515 or go to www.homelink.com.

Canadian radio-frequency laws require transmitter signals to time out or quit after several seconds of transmission. This may not be long enough for Universal Home Remote to pick up the signal during programming. Similarly, some U.S. gate operators are manufactured to time out in the same manner.

If you live in Canada, or you are having difficulty programming a gate operator or garage door opener by using the “Programming Universal Home Remote” procedures, regardless of where you live, replace Step 3 under “Programming Universal Home Remote” with the following:

Continue to press and hold the Universal Home Remote button while you press and release every two seconds (cycle) the hand-held transmitter button until the frequency signal has been successfully accepted by the Universal Home Remote. The Universal Home Remote indicator light will flash slowly at first and then rapidly. Proceed with Step 4 under “Programming Universal Home Remote” to complete the training procedure.

Universal Remote System Operation

Using Universal Remote

Press and hold the appropriate Universal Remote button for at least half of a second. The indicator light will come on while the signal is being transmitted.

Erasing Universal Remote Buttons

All programmed buttons should be erased when the vehicle is sold or the lease ends.

To erase all programmed buttons on the Universal Remote device:



1. Press and hold down the two outside buttons until the indicator light begins to flash, after 20 seconds.
2. Release both buttons.

Reprogramming a Single Universal Remote Button

To reprogram any of the three Universal Remote buttons, repeat the programming instructions earlier in this section, beginning with Step 2.

For help or information on the Universal Home Remote System, call the customer assistance phone number under *Customer Assistance Offices* on page 13-4.

Lighting

Exterior Lighting

Exterior Lamp Controls	6-1
Headlamp High/Low-Beam Changer	6-2
Flash-to-Pass	6-3
Daytime Running Lamps (DRL)/Automatic Headlamp System	6-3
Hazard Warning Flashers	6-3
Turn and Lane-Change Signals	6-4
Fog Lamps	6-4

Interior Lighting

Instrument Panel Illumination Control	6-5
Courtesy Lamps	6-5
Dome Lamps	6-5
Reading Lamps	6-5

Lighting Features

Entry Lighting	6-6
Delayed Entry Lighting	6-6
Delayed Exit Lighting	6-6
Parade Dimming	6-7
Battery Load Management	6-7
Battery Power Protection	6-8

Exterior Lighting

Exterior Lamp Controls



The exterior lamps control is located on the instrument panel to the left of the steering wheel.

6-2 Lighting

It controls the following systems:

- Headlamps
- Taillamps
- Parking Lamps
- License Plate Lamps
- Instrument Panel Lights
- Fog Lamps

The exterior lamps control has four positions:

○ **(Off):** Briefly turn to this position to turn the automatic light control off or on again.

AUTO (Automatic): Turns the headlamps on automatically at normal brightness, together with the following:

- Parking Lamps
- Taillamps
- License Plate Lamps
- Instrument Panel Lights

☰ **(Parking Lamps):** Turns the parking lamps on together with the following:

- Taillamps
- License Plate Lamps
- Instrument Panel Lights

☷ **(Headlamps):** Turns the headlamps on together with the following lamps listed below. A warning chime sounds if the driver's door is opened when the ignition switch is off and the headlamps are on.

- Parking Lamps
- Taillamps
- License Plate Lamps
- Instrument Panel Lights

☼ **(Fog Lamps):** Push the fog lamps control in to turn on the fog lamps.

See *Fog Lamps* on page 6-4.

Headlamp High/Low-Beam Changer

☷☷ **Headlamp High/Low Beam Changer:** Push the turn signal/lane change lever away from you to turn the high beams on.

Pull the lever towards you to return to low beams.



This indicator light turns on in the instrument panel cluster when the high beam headlamps are on.

Flash-to-Pass

This feature is used to signal to the vehicle ahead that you want to pass.

If the headlamps are off or in the low-beam position, pull the turn signal lever toward you to momentarily switch to high-beams.

Release the lever to turn the high-beam headlamps off.

Daytime Running Lamps (DRL)/Automatic Headlamp System

Daytime Running Lamps (DRL) can make it easier for others to see the front of your vehicle during the day. Fully functional daytime running lamps are required on all vehicles first sold in Canada.

The DRL system makes either the low-beam headlamps come on at a reduced brightness or the DRL lights, for vehicles with High Intensity Discharge (HID) headlamps when the following conditions are met:

- The ignition is in the ON/RUN position.
- The exterior lamps control is in AUTO.
- The engine is running.

When the DRL are on, the regular headlamps, taillamps, sidemarker, and other lamps will not be on. The instrument panel and cluster will also not be lit.

For vehicles with HID headlamps, if the DRL are on and the left or right turn signal lamp is turned on, the left or right DRL will go off.

The headlamps automatically change from DRL to the regular headlamps depending on the

darkness of the surroundings. The other lamps that come on with the headlamps will also come on.

When it is bright enough outside, the headlamps will go off and the DRL will come on.

The regular headlamp system should be turned on when needed.

Do not cover the light sensor on top of the instrument panel because it works with the DRL.

Hazard Warning Flashers

 **Hazard Warning Flasher:** Press this button located on the instrument panel below the audio system, to make the front and rear turn signal lamps flash on and off. This warns others that you are having trouble. Press again to turn the flashers off.

The turn signals do not work while the hazard warning flashers are on.

Turn and Lane-Change Signals



An arrow on the instrument panel cluster flashes in the direction of the turn or lane change.

Move the lever all the way up or down to signal a turn.

Raise or lower the lever until the arrow starts to flash to signal a lane change. Hold it there until the lane change is completed. If the lever is briefly pressed and released, the turn signal flashes three times.

The lever returns to its starting position whenever it is released.

If after signaling a turn or lane change the arrow flashes rapidly or does not come on, a signal bulb might be burned out.

Have the bulbs replaced. If the bulb is not burned out, check the fuse. See *Fuses and Circuit Breakers* on page 10-30.

Turn Signal On Chime

If either one of the turn signals are left on and the vehicle has been driven more than 3/4 mile (1.2 km), a chime will sound.

Fog Lamps

Use the fog lamps for better vision in foggy or misty conditions.

The fog lamps button is on the exterior lamps control to the left of the steering column.

ⓘ (**Fog Lamps**): Press the exterior lamps button to turn the fog lamps on or off. A light comes on in the instrument panel cluster when the fog lamps are in use. The ignition must be on for the fog lamps to work.

When the headlamps are changed to high-beam, the fog lamps turn off. The fog lamps come back on again when the high-beam headlamps are turned off.

Some localities have laws that require the headlamps to be on along with the fog lamps.

Interior Lighting

Instrument Panel Illumination Control

 **(Instrument Panel Brightness):** The knob with this symbol on it is next to the exterior lamps control to the left of the steering wheel. Push the knob in all the way until it extends out and then turn the knob clockwise or counterclockwise to brighten or dim the lights. Push the knob back in when finished.

Courtesy Lamps

The courtesy lamps automatically come on when a door is opened. The lamps can also be turned on manually by fully turning the instrument panel brightness control clockwise.

The reading lamps, located on the headliner above the rearview mirror, can be turned on or off independent of the automatic courtesy lamps, when the doors are closed.

Dome Lamps

The dome lamps are located in the overhead console and above the rear seat passengers.

The dome lamps automatically come on when a door is opened, unless the dome lamp override button is pressed in.

The lamps can also be turned on and off by turning the instrument panel brightness control clockwise to the farthest position.

Dome Lamp Override

The dome lamp override button is next to the exterior lamps control.

 **(Dome Lamp Override):** Press the button in and the dome lamps remain off when a door is opened. Press the button again to return it to the extended position so that the dome lamps come on when a door is opened.

Reading Lamps

Press the button near each lamp to turn them on or off.

Lighting Features

Entry Lighting

For vehicles with courtesy lamps, they come on and stay on for a set time whenever the unlock symbol is pressed on the Remote Keyless Entry (RKE) transmitter, if the vehicle has one.

If a door is opened, the lamps stay on while it is open and then turn off automatically about 20 seconds after the door is closed. If the unlock symbol is pressed and no door is opened, the lamps turn off after about 20 seconds.

Entry lighting includes a feature called theater dimming. With theater dimming, the lamps do not turn off at the end of the delay time. Instead, they slowly dim and then go out. The delay time is canceled if the ignition key is turned to ON/RUN or the power door lock switch is pressed. The lamps will dim right away.

When the ignition is on, illuminated entry is inactive, which means the courtesy lamps will not come on unless a door is opened.

Delayed Entry Lighting

Delayed entry lighting illuminates the interior for a period of time after all the doors have been closed.

The ignition must be off for delayed entry lighting to work. Immediately after all the doors have been closed, the delayed entry lighting feature continues to work until one of the following occurs:

- The ignition is in ON/RUN.
- The doors are locked.
- An illumination period of about 25 seconds has elapsed.

If during the illumination period a door is opened, the timed illumination period is canceled and the interior lamps remain on.

Delayed Exit Lighting

Delayed exit lighting illuminates the interior for a period of time after the key is removed from the ignition.

The ignition must be off for delayed exit lighting to work. When the key is removed, interior illumination activates and remains on until one of the following occurs:

- The ignition is in ON/RUN.
- The power door locks are activated.
- An illumination period of 20 seconds has elapsed.

If during the illumination period a door is opened, the timed illumination period will be canceled and the interior lamps will remain on because a door is open.

Parade Dimming

This feature automatically prohibits the dimming of the instrument panel displays in daylight while the headlamps are on so that the displays are still able to be seen.

Battery Load Management

The vehicle has Electric Power Management (EPM) that estimates the battery's temperature and state of charge. It then adjusts the voltage for best performance and extended life of the battery.

When the battery's state of charge is low, the voltage is raised slightly to quickly bring the charge back up. When the state of charge is high, the voltage is lowered slightly to prevent overcharging. If the vehicle has a voltmeter gauge or a voltage display on the Driver Information Center (DIC), you may see the

voltage move up or down. This is normal. If there is a problem, an alert will be displayed.

The battery can be discharged at idle if the electrical loads are very high. This is true for all vehicles. This is because the generator (alternator) may not be spinning fast enough at idle to produce all the power that is needed for very high electrical loads.

A high electrical load occurs when several of the following are on, such as: headlamps, high beams, fog lamps, rear window defogger, climate control fan at high speed, heated seats, engine cooling fans, trailer loads, and loads plugged into accessory power outlets.

EPM works to prevent excessive discharge of the battery. It does this by balancing the generator's output and the vehicle's electrical needs. It can increase engine idle speed to generate more power, whenever

needed. It can temporarily reduce the power demands of some accessories.

Normally, these actions occur in steps or levels, without being noticeable. In rare cases at the highest levels of corrective action, this action may be noticeable to the driver. If so, a Driver Information Center (DIC) message might be displayed, such as BATTERY SAVER ACTIVE, BATTERY VOLTAGE LOW, or LOW BATTERY. If one of these messages displays, it is recommended that the driver reduce the electrical loads as much as possible. See *Driver Information Center (DIC) (With DIC Buttons)* on page 5-24 or *Driver Information Center (DIC) (Without DIC Buttons)* on page 5-29.

Battery Power Protection

This feature helps prevent the battery from being drained, if the interior courtesy lamps, reading/map lamps, visor vanity lamps or trunk lamp are accidentally left on. If any of these lamps are left on, they automatically turn off after 10 minutes, if the ignition is off. The lamps will not come back on again until one of the following occurs:

- The ignition is turned on.
- The exterior lamps control is turned off, then on again.

The headlamps will timeout after 10 minutes, if they are manually turned on while the ignition is on or off.

Infotainment System

Introduction

Introduction 7-1
 Theft-Deterrent Feature 7-2
 Operation 7-2

Radio

AM-FM Radio 7-6
 Satellite Radio 7-8
 Radio Reception 7-11
 Multi-Band Antenna 7-12

Audio Players

CD Player 7-12
 CD/DVD Player 7-14
 MP3 (Radio with CD and
 Radio with CD/USB) 7-22
 MP3 (Radio with CD/DVD) ... 7-28
 Auxiliary Devices 7-34

Rear Seat Infotainment

Rear Seat Entertainment
 (RSE) System 7-36
 Rear Seat Audio (RSA)
 System 7-44
 Rear Audio
 Controller (RAC) 7-46

Phone

Bluetooth 7-46

Introduction

Read the following pages to become familiar with the audio system's features.

 WARNING
<p>Taking your eyes off the road for extended periods could cause a crash resulting in injury or death to you or others. Do not give extended attention to entertainment tasks while driving.</p>

This system provides access to many audio and non audio listings.

To minimize taking your eyes off the road while driving, do the following while the vehicle is parked:

- Become familiar with the operation and controls of the audio system.
- Set up the tone, speaker adjustments, and preset radio stations.

7-2 Infotainment System

For more information, see *Defensive Driving* on page 9-2.

The vehicle has Retained Accessory Power (RAP). With RAP, the audio system can be played even after the ignition is turned off. See *Retained Accessory Power (RAP)* on page 9-19 for more information.

Navigation/Radio System

For vehicles with a navigation radio system, see the separate Navigation System manual.

Theft-Deterrent Feature

THEFTLOCK® is designed to discourage theft of the vehicle's radio by learning a portion of the Vehicle Identification Number (VIN). The radio does not operate if it is stolen or moved to a different vehicle.

Operation



Radio with CD, Radio with CD/USB similar



Radio with CD, DVD, and USB

The vehicle may have one of these radios as its audio system.

Radios with CD, DVD, and USB

Radios with CD, DVD, and USB have a Bose® Surround Sound System. Some of its features are

explained later in this section under, “Adjusting the Speakers (Balance/Fade)”.

If the vehicle has a Rear Seat Entertainment (RSE) system, it has a CD, DVD, and USB radio.

See *Rear Seat Entertainment (RSE) System* on page 7-36 for more information on the vehicle’s RSE system.

The DVD player is the top slot on the radio faceplate. The player is capable of reading the DTS programmed DVD Audio or DVD Video media. DTS and DTS Digital Surround are registered trademarks of Digital Theater Systems, Inc.

Manufactured under license from Dolby Laboratories. Dolby and the double-D symbol are trademarks of Dolby Laboratories.

Playing the Radio

 **(Power/Volume):** Press to turn the system on and off. Turn to increase or decrease the volume.

For vehicles with a Rear Seat Entertainment System (RSE), press and hold for more than two seconds to turn off the entire radio and RSE system and to start the parental control feature.

7-4 Infotainment System

Parental control prevents the rear seat occupant from operating the Rear Seat Audio (RSA) system or remote control.

A lock symbol displays next to the clock display while the parental control feature is being used.

The feature remains on until  is pressed and held for more than two seconds, or the driver turns the ignition off and exits the vehicle.

i (Information): Press to switch the display between the radio station frequency and the time. When the ignition is in the OFF position, press **i** to display the time. For vehicles with XM, MP3, WMA or RDS features, press **i** to display additional text information related to the current FM-RDS or XM station; or CD, MP3 or WMA song. If information is available during XM, CD, MP3 or WMA playback, the song title information displays on the top line of the display and artist

information displays on the bottom line. When information is not available, "NO INFO" is displayed.

Auto Text (Satellite Radio Service, CD, MP3, and WMA features):

If additional information is available for the current song being played, Auto Text will automatically page/scroll the information every five seconds above the FAV presets on the radio display.

To activate Auto Text:

1. Press MENU to display the radio setup menu.
2. Press the softkey under AUTO TXT tab on the radio display.
3. Press the softkey under the ON tab on the radio display.

If **i** is pressed and the song title or artist information is longer than what can be displayed, the extra information will page every five seconds when Auto Text is activated.

Speed Compensated Volume

(SCV): The Speed Compensated Volume (SCV) feature automatically adjusts the radio volume to compensate for road and wind noise as the vehicle speeds up or slows down, so that the volume level is consistent.





To activate SCV:

1. Set the radio volume.
2. Press the MENU button to display the radio setup menu.
3. Press the softkey under the AUTO VOLUM (automatic volume) tab on the radio display.
4. Press the softkey under the Speed Compensated Volume setting (OFF, Low, Med, or High) to select the level of radio volume compensation. Press the softkey located below the BACK tab on the MENU SETUP display or let the display time out after approximately 10 seconds.

Each higher setting allows for more radio volume compensation at faster vehicle speeds.

Setting the Tone (Bass/Midrange/Treble)

BASS/MID/TREB (Bass, Midrange, or Treble): To adjust bass, midrange, or treble:

1. Press  until the tone control tabs display.
2. Continue pressing  to highlight the tab, or press the softkey under the tab.
3. To adjust the highlighted setting, do one of the following until the levels are obtained.
 - Turn  clockwise or counterclockwise.
 - Press  FWD, or  REV.

If a station's frequency is weak or if there is static, decrease the treble.

To quickly adjust bass, midrange, or treble to the middle position, press the softkey under the BASS, MID, or TREB tab for more than two seconds. A beep sounds and the level adjusts to the middle position.

To quickly adjust all tone and speaker controls to the middle position, press  for more than two seconds until a beep sounds.

EQ (Equalization): Press to choose bass and treble equalization settings designed for different types of music. The choices are pop, rock, country, talk, jazz, and classical. Selecting MANUAL or changing bass or treble, returns the EQ to the manual bass and treble settings.





Unique EQ settings can be saved for each source.

If the radio has a Bose® audio system, the EQ settings are either MANUAL or TALK.

Adjusting the Speakers (Balance/Fade)

BAL/FADE (Balance/Fade):

To adjust the balance or fade:

1. Press  until the speaker control tabs display.
2. Continue pressing  to highlight the tab, or press the softkey under the tab.
3. To adjust the highlighted setting, do one of the following until the levels are obtained.
 - Turn  clockwise or counterclockwise.
 - Press  FWD, or  REV.

To quickly adjust balance or fade to the middle position, press the softkey under the BAL or FADE tab for more than two seconds. A beep sounds and the level adjusts to the middle position.

7-6 Infotainment System

To quickly adjust all speaker and tone controls to the middle position, press  for more than two seconds until a beep sounds.

Radios with CD and DVD fade differently depending on the DVD Media type:

- With DVD-A 5.1 Surround media, the left front and right front speakers fade rearward, leaving the center front speakers unaffected until the last fade step, then all front speakers mute.
- With DVD-V 5.1 Surround media, surround sound is maintained until Step 4 of the Fade control is reached while fading rearward. At that point the audio system output changes to Stereo to prevent the loss of Center channel output when the full rearward fade position is reached.

If the Rear Seat Audio (RSA) is turned on, the radio disables FADE and mutes the rear speakers.

Radio Messages

Calibration Error: The audio system has been calibrated for the vehicle from the factory. If Calibration Error displays, it means that the radio has not been configured properly for the vehicle and it must be returned to your dealer/retailer for service.

Locked: This message displays when the THEFTLOCK[®] system has locked up the radio. Take the vehicle to your dealer/retailer for service.

If any error occurs repeatedly or if an error cannot be corrected, contact your dealer/retailer.

Radio

AM-FM Radio

Radio Data System (RDS)

The Radio Data System (RDS) feature is available for use only on FM stations that broadcast RDS information. This system relies upon receiving specific information from these stations and only works when the information is available. While the radio is tuned to an FM-RDS station, the station name or call letters display. In rare cases, a radio station could broadcast incorrect information that causes the radio features to work improperly. If this happens, contact the radio station.

Finding a Station

BAND: Press to switch between AM, FM, or XM. The selection displays.

🎵 (Tune): Turn to select radio stations.

◀ SEEK ▶ : Press to go to the previous or to the next station and stay there.

To scan stations, press and hold **◀** or **▶** until a beep sounds. The radio goes to a station, plays for a few seconds, then goes to the next station. Press either arrow again to stop scanning.

The radio only seeks and scans stations with a strong signal that are in the selected band.

Storing a Radio Station as a Favorite

Drivers are encouraged to set up their radio station favorites while the vehicle is in P (Park). Tune to favorite stations using the presets,

favorites button, and steering wheel controls. See *Steering Wheel Controls on page 5-2*.

FAV (Favorites): A maximum of 36 stations can be programmed as favorites using the six softkeys below the radio station frequency tabs and by using the radio favorites page button (FAV button). Press to go through up to six pages of favorites, each having six favorite stations available per page. Each page of favorites can contain any combination of AM, FM, or XM stations.

The balance/fade and tone settings that were previously adjusted, are stored with the favorite stations.

To store a station as a favorite:

1. Tune to the desired radio station.
2. Press FAV to display the page to store the station.

3. Press and hold one of the six softkeys until a beep sounds. When that softkey is pressed and released, the station that was set, returns.
4. Repeat the steps for each radio station to be stored as a favorite.

To setup the number of favorites pages:

1. Press MENU to display the radio setup menu.
2. Press the softkey below the FAV 1-6 tab.
3. Select the desired number of favorites pages by pressing the softkey below the displayed page numbers.
4. Press FAV, or let the menu time out, to return to the original main radio screen showing the radio station frequency tabs and to begin the process of programming favorites for the chosen amount of numbered pages.

Satellite Radio

XM™ Satellite Radio Service

XM is a satellite radio service that is based in the 48 contiguous United States and 10 Canadian provinces. XM Satellite Radio has a wide variety of programming and commercial-free music, coast-to-coast, and in digital-quality sound. For more information, contact XM at www.xmradio.com or call 1-800-929-2100 in the U.S. and www.xmradio.ca or call 1-877-438-9677 in Canada.

Finding a Station

BAND: Press to switch between AM, FM, or XM. The selection displays.

🎵 (Tune): Turn to select radio stations.

◀ SEEK ▶ : Press to go to the previous or to the next station and stay there.

To scan stations, press and hold **◀** or **▶** until a beep sounds. The radio goes to a station, plays for a few seconds, then goes to the next station. Press either arrow again to stop scanning.

The radio only seeks and scans stations with a strong signal that are in the selected band.

Finding a Category (CAT) Station

CAT (Category): The CAT button is used to find XM™ stations when the radio is in the XM mode. To find XM channels within a desired category:

1. Press BAND until the XM frequency displays.
2. Press CAT to display the category tabs.
3. Continue pressing CAT until the desired category name displays.
 - Radios with CD and DVD can also navigate the category list by pressing **◀◀ REV** or **▶▶ FWD**.

4. Press either of the two buttons below the desired category tab to immediately tune to the first XM station associated with that category.

5. To go to the next or previous XM station within the selected category, do one of the following:

- Turn **🎵**.
- Press the buttons below the right or left arrows on the display.
- Press either SEEK arrow.

6. To exit the category search mode, press the FAV button or BAND button to display the favorites again.

Undesired XM categories can be removed through the setup menu. To remove an undesired category, perform the following:

1. Press MENU to display the radio setup menu.
2. Press the softkey below the XM CAT tab.
3. Turn  to display the category to be removed.
4. Press the softkey under the Remove tab until the category name along with the word Removed displays.
5. Repeat the steps to remove more categories.

Removed categories can be restored by pressing the softkey under the Add tab when a removed category is displayed or by pressing the softkey under the Restore All tab.

Categories cannot be removed or added while the vehicle is moving faster than 8 km/h (5 mph).

Storing a Radio Station as a Favorite

Drivers are encouraged to set up their radio station favorites while the vehicle is in P (Park). Tune to favorite stations using the presets, favorites button, and steering wheel controls. See *Steering Wheel Controls on page 5-2*.

FAV (Favorites): A maximum of 36 stations can be programmed as favorites using the six softkeys below the radio station frequency tabs and by using the radio favorites page button (FAV button). Press to go through up to six pages of favorites, each having six favorite stations available per page. Each page of favorites can contain any combination of AM, FM, or XM stations.

The balance/fade and tone settings that were previously adjusted, are stored with the favorite stations.

To store a station as a favorite:

1. Tune to the desired radio station.
2. Press FAV to display the page to store the station.
3. Press and hold one of the six softkeys until a beep sounds. When that softkey is pressed and released, the station that was set, returns.
4. Repeat the steps for each radio station to be stored as a favorite.

To setup the number of favorites pages:

1. Press MENU to display the radio setup menu.
2. Press the softkey below the FAV 1-6 tab.

7-10 Infotainment System

3. Select the desired number of favorites pages by pressing the softkey below the displayed page numbers.
4. Press FAV, or let the menu time out, to return to the original main radio screen showing the radio station frequency tabs and to begin the process of programming favorites for the chosen amount of numbered pages.

XM™ Radio Messages

XL (Explicit Language Channels): These channels, or any others, can be blocked at a customer's request, by calling 1-800-852-XXXM (9696).

XM Updating: The encryption code in the receiver is being updated, and no action is required. This process should take no longer than 30 seconds.

No XM Signal: The system is functioning correctly, but the vehicle is in a location that is blocking the XM™ signal. When the vehicle is moved into an open area, the signal should return.

Loading XM: The audio system is acquiring and processing audio and text data. No action is needed. This message should disappear shortly.

Channel Off Air: This channel is not currently in service. Tune in to another channel.

Channel Unauth : This channel is blocked or cannot be received with your XM Subscription package.

Channel Unavail: This previously assigned channel is no longer assigned. Tune to another station. If this station was one of the presets, choose another station for that preset button.

No Artist Info: No artist information is available at this time on this channel. The system is working properly.

No Title Info: No song title information is available at this time on this channel. The system is working properly.

No CAT Info: No category information is available at this time on this channel. The system is working properly.

No Information: No text or informational messages are available at this time on this channel. The system is working properly.

CAT Not Found: There are no channels available for the selected category. The system is working properly.

XM Theftlocked: The XM receiver in the vehicle could have previously been in another vehicle. For security purposes, XM receivers cannot be swapped between vehicles. If this message is received after having the vehicle serviced, check with your dealer/retailer.

XM Radio ID: If tuned to channel 0, this message alternates with the XM™ Radio 8 digit radio ID label. This label is needed to activate the service.

Unknown: If this message is received when tuned to channel 0, there could be a receiver fault. Consult with your dealer/retailer.

Check XM Receiver: If this message does not clear within a short period of time, the receiver could have a fault. Consult with your dealer/retailer.

XM Not Available: If this message does not clear within a short period of time, the receiver could have a fault. Consult with your dealer/retailer.

Radio Reception

Frequency interference and static can occur during normal radio reception if items such as cell phone chargers, vehicle convenience

accessories, and external electronic devices are plugged into the accessory power outlet. If there is interference or static, unplug the item from the accessory power outlet.

FM

FM signals only reach about 16 to 65 km (10 to 40 miles). Although the radio has a built-in electronic circuit that automatically works to reduce interference, some static can occur, especially around tall buildings or hills, causing the sound to fade in and out.

AM

The range for most AM stations is greater than for FM, especially at night. The longer range can cause station frequencies to interfere with each other. For better radio reception, most AM radio stations boost the power levels during the day, and then reduce these levels during the night. Static can also

occur when things like storms and power lines interfere with radio reception. When this happens, try reducing the treble on the radio.

XM™ Satellite Radio Service

XM Satellite Radio Service gives digital radio reception from coast-to-coast in the 48 contiguous United States, and in Canada. Just as with FM, tall buildings or hills can interfere with satellite radio signals, causing the sound to fade in and out. In addition, traveling or standing under heavy foliage, bridges, garages, or tunnels may cause loss of the XM signal for a period of time.

Cellular Phone Usage

Cellular phone usage may cause interference with the vehicle's radio. This interference may occur when making or receiving phone calls, charging the phone's battery, or simply having the phone on.

This interference can cause an increased level of static while listening to the radio. If static is received while listening to the radio, unplug the cellular phone and turn it off.

Multi-Band Antenna

The multi-band antenna is located on the roof of the vehicle. This type of antenna is used with the AM/FM radio, as well as OnStar[®] and the XM[™] Satellite Radio Service System, if the vehicle has these features. Keep this antenna clear of snow and ice build up for clear radio reception. If the vehicle has a sunroof, the performance of the radio system may be affected if the sunroof is open. Loading items onto the roof of the vehicle can interfere with the performance of the radio system and, if the vehicle has this feature, OnStar[®]. Make sure the multi-band antenna is not obstructed.

Audio Players





CD Player

Playing a CD

Insert a CD partway into the slot, label side up. The player pulls it in and the CD should begin playing.

 **EJECT**: Press and release to eject the disc that is currently playing. A beep sounds and Ejecting Disc displays. Once the disc is ejected, Remove Disc displays. The disc can be removed. If the disc is not removed, after several seconds, the disc automatically pulls back into the player.

 **(Tune)**: Turn to select tracks on the CD that is currently playing.

 **SEEK**  : Press  to go to the start of the current track, if more than ten seconds on the CD have played. Press  to go to the next track.

If either arrow is held, or pressed multiple times, the player continues moving backward or forward through the tracks on the CD.

 **REV (Fast Reverse)**: Press and hold to reverse playback quickly within a track. Sound will be heard at a reduced volume. Release to resume playing the track. The elapsed time of the track displays.

 **FWD (Fast Forward)**: Press and hold to advance playback quickly within a track. Sound will be heard at a reduced volume. Release to resume playing the track. The elapsed time of the track displays.

RDM (Random): CD tracks can be listened to in random, rather than sequential order with the random setting. To use random, press the softkey under the RDM label until Random Current Disc displays. Press the softkey again to turn off random play.

BAND: Press to listen to the radio when a CD is playing. The CD remains inside the radio for future listening.

CD/AUX (CD/Auxiliary): Press to select between CD, or Auxiliary.

- When a CD is in the player the CD icon and a message showing the disc and/or track number displays.
- If an auxiliary input device is not connected, “No Input Device Found” displays.

Care of CDs

If playing a CD-R, the sound quality can be reduced due to CD-R or CD-RW quality, the method of recording, the quality of the music that has been recorded, and the way the CD-R or CD-RW has been handled. Handle them carefully. Store CD-R(s) or CD-RW(s) in their original cases or other protective cases and away from direct sunlight and dust. The CD player scans the

bottom surface of the disc. If the surface of a CD is damaged, such as cracked, broken, or scratched, the CD does not play properly or not at all. Do not touch the bottom side of a CD while handling it; this could damage the surface. Pick up CDs by grasping the outer edges or the edge of the hole and the outer edge.

If the surface of a CD is soiled, take a soft, lint free cloth or dampen a clean, soft cloth in a mild, neutral detergent solution mixed with water, and clean it. Make sure the wiping process starts from the center to the edge.

Care of the CD Player

Do not add any label to a CD, it could get caught in the CD player. If a CD is recorded on a personal computer and a description label is needed, try labeling the top of the recorded CD with a marking pen.

The use of CD lens cleaners for CDs is not advised.

Notice: If a label is added to a CD, or more than one CD is inserted into the slot at a time, or an attempt is made to play scratched or damaged CDs, the CD player could be damaged. While using the CD player, use only CDs in good condition without any label, load one CD at a time, and keep the CD player and the loading slot free of foreign materials, liquids, and debris.

If an error displays, see “CD Messages” later in this section.

Playing an MP3/WMA CD-R or CD-RW Disc

The radio has the capability of playing an MP3/WMA CD-R or CD-RW disc. For more information on how to play an MP3/WMA CD-R or CD-RW disc, see *MP3 (Radio with CD and Radio with CD/USB) on page 7-22* or *MP3 (Radio with CD/DVD) on page 7-28*.

CD Messages

CHECK DISC: Radios with a Single CD player display CHECK DISC and/or ejects the CD if an error occurs.

Optical Error: The disc was inserted upside down.

Disk Read Error: A disc was inserted with an invalid or unknown format.

Player Error: There are disc LOAD or disc EJECT problems.

- It is very hot. When the temperature returns to normal, the CD should play.
- The road is very rough. When the road becomes smoother, the CD should play.
- The CD is dirty, scratched, wet, or upside down.
- The air is very humid. If so, wait about an hour and try again.

- There could have been a problem while burning the CD.
- The label could be caught in the CD player.

If the CD is not playing correctly for any other reason, try a known good CD.

If any error occurs repeatedly or if an error cannot be corrected, contact your dealer/retailer. If the radio displays an error message, write it down and provide it to your dealer/retailer when reporting the problem.

CD/DVD Player

Playing a CD (In Either the DVD or CD Slot)

Insert a CD partway into the slot, label side up. The player pulls it in and the CD should begin playing (loading a disc into the system, depending on media type and format ranges from 5 to 20 seconds for a CD, and up to 30 seconds for a DVD to begin playing).

If the ignition or radio is turned off, while a CD is in the player, it stays in the player. When the ignition or radio is turned on, the CD starts playing where it stopped, if it was the last selected audio source. The CD is controlled by the buttons on the radio faceplate or by the RSA unit. See *Rear Seat Audio (RSA) System on page 7-44* for more information. The DVD/CD decks, (upper slot is the DVD deck and the lower slot is the CD deck) of the radio are compatible with most audio CDs, CD-R, CD-RW, and MP3/WMA's.

When a CD is inserted, the text label DVD or CD symbol displays on the left side of the radio display. As each new track starts to play, the track number displays.

 CD (Eject): Press and release to eject the disc that is currently playing. The disc ejects from the bottom slot. A beep sounds and Ejecting Disc displays. Once the disc is ejected, Remove Disc displays. The disc can be removed.

If the disc is not removed, after several seconds, the disc automatically pulls back into the player.

△ DVD (Eject): Press and release to eject the disc that is currently playing in the top slot. A beep sounds and Ejecting Disc displays.

If loading and reading of a disc cannot be completed, and the disc fails to eject, press and hold **△** DVD for more than five seconds to force the disc to eject.

♪ (Tune): Turn to select tracks on the CD that is currently playing.

◀ SEEK ▶ : Press **◀** to go to the start of the current track if the track has played more than five seconds. If the track has played less than five seconds the previous track will play.

Press **▶** to go to the next track.

If either arrow is held, or pressed multiple times, the player continues moving backward or forward through the tracks on the CD.

◀◀ REV (Fast Reverse): Press and hold to reverse playback quickly within a track. Sound will be heard at a reduced volume. Release to resume playing the track. The elapsed time of the track displays.

▶▶ FWD (Fast Forward): Press and hold to advance playback quickly within a track. Sound will be heard at a reduced volume. Release to resume playing the track. The elapsed time of the track displays.

RDM (Random): CD tracks can be listened to in random, rather than sequential order with the random setting. To use random, press the softkey under the RDM tab until Random Current Disc displays. Press the softkey again to turn off random play.

BAND: Press to listen to the radio when a CD or DVD is playing. The CD or DVD remains inside the radio for future listening or for viewing entertainment.

DVD/CD AUX (Auxiliary): Press to select between DVD, CD, or Auxiliary.

- If an auxiliary input device is not connected, “No Aux Input Device” displays.
- When a disc is in either slot, the DVD/CD text tab and a message showing the track or chapter number displays.
- If an auxiliary input device is not connected, and a disc is in both the DVD slot and the CD slot the DVD/CD AUX button only cycles between the two sources and does not indicate “No Aux Input Device”.
- If a front auxiliary input device is connected, the DVD/CD AUX button cycles through all available options.

7-16 Infotainment System

If a disc is inserted into the top DVD slot, the rear seat operator can turn on the video screen and use the remote control to only navigate the CD tracks through the remote control.

See “Using the Auxiliary Input Jack(s)” later in this section, or “Audio/Video (A/V) Jacks” under, *Rear Seat Entertainment (RSE) System on page 7-36* for more information.

Care of CDs and DVDs

If playing a CD-R, the sound quality can be reduced due to CD-R or CD-RW quality, the method of recording, the quality of the music that has been recorded, and the way the CD-R or CD-RW has been handled. Handle them carefully. Store CD-R(s) or CD-RW(s) in their original cases or other protective cases and away from direct sunlight and dust. The CD or DVD player scans the bottom surface of the disc. If the surface of a CD is

damaged, such as cracked, broken, or scratched, the CD does not play properly or not at all. Do not touch the bottom side of a CD while handling it; this could damage the surface. Pick up CDs by grasping the outer edges or the edge of the hole and the outer edge.

If the surface of a CD is soiled, take a soft, lint free cloth or dampen a clean, soft cloth in a mild, neutral detergent solution mixed with water, and clean it. Make sure the wiping process starts from the center to the edge.

Care of the CD and DVD Player

Do not add any label to a CD, it could get caught in the CD or DVD player. If a CD is recorded on a personal computer and a description label is needed, try labeling the top of the recorded CD with a marking pen.

The use of CD lens cleaners for CDs is not advised.

Notice: If a label is added to a CD, or more than one CD is inserted into the slot at a time, or an attempt is made to play scratched or damaged CDs, the CD player could be damaged. While using the CD player, use only CDs in good condition without any label, load one CD at a time, and keep the CD player and the loading slot free of foreign materials, liquids, and debris.

If an error displays, see “CD Messages” later in this section.

Radios with CD and DVD Audio Output

Only one audio source can be heard through the speakers at one time. An audio source is defined as DVD slot, CD slot, XM, FM/AM, Front Auxiliary Jack, or Rear Auxiliary Jack.

Press  to turn the radio on. The radio can be heard through all of the vehicle speakers.

Front seat passengers can listen to the radio (AM, FM, or XM) by pressing BAND or DVD/CD AUX to select the CD slot, DVD slot, front or rear auxiliary input (if available).

If a playback device is plugged into the radio's front auxiliary input jack or the rear auxiliary jack, the front seat passengers are able to listen to playback from this source through the vehicle speakers. See "Using the Auxiliary Input Jack(s)" later in this section, or "Audio/Video (A/V) Jacks" under, *Rear Seat Entertainment (RSE) System on page 7-36* for more information.

In some vehicles, depending on audio options, the rear speakers can be muted when the RSA power is turned on. See *Rear Seat Audio (RSA) System on page 7-44* for more information.

Playing an MP3/WMA CD-R or CD-RW Disc

The radio has the capability of playing an MP3/WMA CD-R or CD-RW disc. For more information on how to play an MP3/WMA CD-R or CD-RW disc, see *MP3 (Radio with CD and Radio with CD/USB) on page 7-22* or *MP3 (Radio with CD/DVD) on page 7-28*.

CD Messages

Optical Error: The disc was inserted upside down.

Disk Read Error: A disc was inserted with an invalid or unknown format.

Player Error: There are disc LOAD or disc EJECT problems.

- It is very hot. When the temperature returns to normal, the CD should play.
- The road is very rough. When the road becomes smoother, the CD should play.

- The CD is dirty, scratched, wet, or upside down.
- The air is very humid. If so, wait about an hour and try again.
- There could have been a problem while burning the CD.
- The label could be caught in the CD player.

If the CD is not playing correctly for any other reason, try a known good CD.

If any error occurs repeatedly or if an error cannot be corrected, contact your dealer/retailer. If the radio displays an error message, write it down and provide it to your dealer/retailer when reporting the problem.

Using the DVD Player

The DVD player can be controlled by the buttons on the remote control, the RSA system, or by the buttons on the radio faceplate. See “Remote Control”, under *Rear Seat Entertainment (RSE) System on page 7-36* and *Rear Seat Audio (RSA) System on page 7-44* for more information.

The DVD player is only compatible with DVDs of the appropriate region code that is printed on the jacket of most DVDs.

The DVD slot of the radio is compatible with most audio CDs, CD-R, CD-RW, DVD-Video, DVD-Audio, DVD-R/RW, DVD+R/RW media along with MP3 and WMA formats.

If an error message displays on the video screen or the radio, see “DVD Display Error Messages” under, *Rear Seat Entertainment (RSE) System on page 7-36* and “DVD Radio Error Messages” in this section for more information.

Playing a DVD

🎵 (Tune): Turn to change tracks on a CD or DVD, to manually tune a radio station, or to change clock or date settings, while in the clock or date setting mode. See the information given earlier in this section specific to the radio, CD, and the DVD. Also, see “Setting the Clock” in the index, for setting the clock and date.

⏮ SEEK (Previous Track/Chapter): Press to return to the start of the current track or chapter. Press ⏮ again to go to the previous track or chapter. This button may not work when the DVD is playing the copyright information or the previews.

SEEK ⏭ (Next Track/Chapter): Press to go to the next track or chapter. This button may not work when the DVD is playing the copyright information or the previews.

⏮ REV (Fast Reverse): Press to quickly reverse the DVD at five times the normal speed. The radio displays the elapsed time while in fast reverse. To stop fast reversing, press again. This button may not work when the DVD is playing the copyright information or the previews.

⏭ FWD (Fast Forward): Press to fast forward the DVD. The radio displays the elapsed time and fast forwards five times the normal speed. To stop fast forwarding, press again. This button may not work when the DVD is playing the copyright information or the previews.

 **(Eject):** Press to eject a DVD. If the DVD is ejected, but not removed, the player automatically pulls it back in after 15 seconds.

If loading and reading of a DVD cannot be completed, because of an unknown format, etc., and the disc fails to eject, press and hold for more than five seconds to force the disc to eject.

DVD-V (Video) Display Buttons

Once a DVD-V is inserted, the radio display menu shows several icons. Press the softkeys under any icon during DVD playback. See the icon list below for more information.

The rear seat passenger can navigate the DVD-V menus and controls through the remote control. See “Remote Control”, under *Rear Seat Entertainment (RSE) System on page 7-36* for more information. The Video Screen automatically turns on when the DVD-V is inserted into the DVD slot.

 **(Play/Pause):** Press either the play or pause icon displayed on the radio system, to toggle between pausing or restarting playback of a DVD.

- If the forward arrow is showing on display, the system is in pause mode.
- If the pause icon is showing on display, the system is in playback mode.
- If the DVD screen is off, press the play button to turn the screen on.

Some DVDs begin playing after the previews have finished, although there could be a delay of up to 30 seconds. If the DVD does not begin playing the movie automatically, press the softkey under the play/pause icon displayed on the radio. If the DVD still does not play, refer to the on-screen instructions, if available.

 **(Stop):** Press to stop playing, rewinding, or fast forwarding a DVD.

 **(Enter):** Press to select the choices that are highlighted in any menu.

 **(Menu):** Press to access the DVD menu. The DVD menu is different on every DVD. Use the softkeys under the navigation arrows to navigate the cursor through the DVD menu. After making a selection press this button. This button only operates when using a DVD.

Nav (Navigate): Press to display directional arrows for navigating through the menus.

 **(Return):** Press to exit the current active menu and return to the previous menu. This button operates only when a DVD is playing and a menu is active.



DVD-A (Audio) Display Buttons

Once a DVD-A is inserted, the radio display menu shows several icons. Press the softkeys under any icon during DVD playback. See the icon list below for more information.

The rear seat operator can navigate the DVD-A menus and controls through the remote control. See “Remote Control”, under *Rear Seat Entertainment (RSE) System on page 7-36* for more information. The Video Screen does not automatically power on when the DVD-A is inserted into the DVD slot. It must be manually turned on by the rear seat occupant through the remote control power button.

 **(Play/Pause):** Press either the play or pause icon displayed on the radio system, to toggle between pausing or restarting playback of a DVD.

- If the forward arrow is showing on display, the system is in pause mode.
- If the pause icon is showing on display, the system is in playback mode.

 **Group**  : Press to cycle through musical groupings on the DVD-A disc.

Nav (Navigate): Press to display directional arrows for navigating through the menus.

 **(Audio Stream):** Press to cycle through audio stream formats located on the DVD-A disc. The video screen shows the audio stream changing.

Inserting a Disc

To play a disc, gently insert the disc, with the label side up, into the loading slot. The DVD player might not accept some paper labeled media. The player starts loading the disc into the system and shows “Loading Disc” on the radio display. At the same time, the radio displays a softkey menu of option(s). Some discs automatically play the movie while others default to the softkey menu display, which requires the Play, Enter, or Navigation softkeys to be pressed; either by the softkey on the radio or by the rear seat passenger using the remote control.

It may take up to 30 seconds for a DVD to begin playing.

Stopping and Resuming Playback

To stop playing a DVD without turning off the system, do one of the following:



- Press  on the remote control.
- Press the softkey under the stop or the play/pause icons displayed on the radio.
- If the radio head is sourced to something other than DVD-V, press the DVD/CD AUX button to make DVD-V the active source.

To resume DVD playback, do one of the following:

- Press  on the remote control.
- Press the softkey under the play/pause icon displayed on the radio.

The DVD should resume play from where it last stopped if the disc has not been ejected and the stop button has not been pressed twice on the remote control. If the disc has been ejected or the stop button has been pressed twice on the remote control, the disc resumes playing at the beginning of the disc.

Ejecting a Disc

Press  DVD on the radio to eject the disc. If a disc is ejected from the radio, but not removed, the radio reloads the disc after a short period of time. The disc is stored in the radio. The radio does not resume play of the disc automatically. If the movie is reloaded and the RSA system is sourced to the DVD, the player begins to play again. If loading and reading a DVD or CD cannot be completed, and the disc fails to eject, press and hold  DVD for more than five seconds to force the disc to eject.

DVD Error Messages

Player Error: This message displays when there are disc load or eject problems.

Disc Format Error: This message displays, if the disc is inserted with the disc label wrong side up, or if the disc is damaged.

Disc Region Error: This message displays, if the disc is not from a correct region.

No Disc Inserted: This message displays, if no disc is present when  DVD or DVD/CD AUX is pressed on the radio.

MP3 (Radio with CD and Radio with CD/USB)

Format

Radios that have the capability of playing MP3s can play .mp3 or .wma files that were recorded onto a CD-R or CD-RW disc. The files can be recorded with the following fixed bit rates: 32 kbps, 40 kbps, 56 kbps, 64 kbps, 80 kbps, 96 kbps, 112 kbps, 128 kbps, 160 kbps, 192 kbps, 224 kbps, 256 kbps, and 320 kbps or a variable bit rate.

Radios that have a USB port can play .mp3 and .wma files that are stored on a USB storage device as well as AAC files that are stored on an iPod®.

Compressed Audio or Mixed Mode Discs

The radio can play discs that contain both uncompressed CD audio and MP3/WMA files. If both formats are on the disc, the radio plays both file formats in the order in which they were recorded to the disc.

CD-R or CD-RW Supported File and Folder Structure

The radio supports:

- Up to 50 folders.
- Up to 8 folders in depth.
- Up to 15 playlists.
- Up to 512 files and folders.
- Playlists with an .m3u or .wpl extension.
- Files with an .mp3, .wma, or .cda file extension.

USB Supported File and Folder Structure

The radio supports:

- Up to 700 folders.
- Up to 8 folders in depth.
- Up to 65,535 files.
- Folder and file names up to 64 bytes.
- Files with an .mp3 or .wma file extension.
- AAC files stored on an iPod.
- FAT16
- FAT32

Root Directory

The root directory of the disc is treated as a folder. If the root directory has compressed audio files, the directory displays on the radio as the CD label.

If a disc contains both uncompressed CD audio and MP3/WMA files, a folder under the root directory called CD accesses all of the CD audio tracks on the disc.

Empty Folder

Folders that do not contain files are skipped, and the player advances to the next folder that contains files.

Order of Play

Compressed audio files are accessed in the following order:

- Playlists (Px).
- Files stored in the root directory.
- Files stored in folders in the root directory.

Tracks are played in the following order:

- Play begins from the first track in the first playlist and continues sequentially through all tracks in each playlist. When the last track of the last playlist has played, play continues from the first track of the first playlist.
- Play begins from the first track in the first folder and continues sequentially through all tracks in each folder. When the last track of the last folder has played, play continues from the first track of the first folder.

When play enters a new folder, the display does not automatically show the new folder name unless the folder mode has been chosen as the default display. The new track name displays.

File System and Naming

The song name that displays is the song name that is contained in the ID3 tag. If the song name is not present in the ID3 tag, then the radio displays the file name without the extension (such as .mp3) as the track name.

Track names longer than 32 characters or four pages are shortened. Parts of words on the last page of text and the extension of the filename does not display.

Preprogrammed Playlists

Preprogrammed playlists that were created using WinAmp™, MusicMatch™, or Real Jukebox™ software can be accessed, however, they cannot be edited using the radio. These playlists are treated as special folders containing compressed audio song files.

Playlists that have an .m3u or .pls file extension and are stored on a USB device may be supported by the radio with a USB port.

Playing a CD-R or CD-RW MP3

♪ (Tune): Turn to select MP3/WMA files.

◀ SEEK: Press to go to the start of the track, if more than ten seconds have played. Press and hold or press multiple times to continue moving backward through tracks.

▶ SEEK: Press to go to the next track. Press and hold or press multiple times to continue moving forward through tracks.

◀◀ REV (Reverse): Press and hold to reverse playback quickly. Sound is heard at a reduced volume and the elapsed time of the file displays. Release ◀◀ REV to resume playing.

▶▶ FWD (Fast Forward): Press and hold to advance playback quickly. Sound is heard at a reduced volume and the elapsed time of the file displays. Release ▶▶ FWD to resume playing. The elapsed time of the file displays.

< [Folder] (Previous Folder): Press the softkey below < [Folder] to go to the first track in the previous folder.

[Folder] > (Next Folder): Press the softkey below [Folder] > to go to the first track in the next folder.

RDM (Random): Files on the disc can be listened to in random, rather than sequential order. To use random, press the softkey under the RDM tab until Random Current Disc displays to play songs in random order. Press the same softkey again to turn off random play.

☉ [Music Navigator] (Music Navigator): Press the softkey below ☉ [Music Navigator] to play files in order by artist or album.

The player scans the disc to sort the files by artist and album ID3 tag information. It can take several minutes to scan the disc depending on the number of files on the disc. The radio may begin playing while it is scanning in the background.

When the scan is finished, the disc begins playing files in order by artist. The current artist playing is shown on the second line of the display. Once all songs by that artist are played, the player moves to the next artist in alphabetical order and begins playing files by that artist.

To listen to files by another artist, press the softkey located below either arrow tab. The disc goes to the next or previous artist in alphabetical order. Continue pressing either softkey below the arrow tab until the artist displays.

To change from playback by artist to playback by album:

1. Press the softkey located below the Sort By tab.
2. Press one of the softkeys below the album tab from the sort screen.
3. Press the softkey below the back tab to return to the main music navigator screen.

The album name displays on the second line between the arrows and songs from the current album begins to play. Once all songs from that album have played, the player moves to the next album in alphabetical order on the CD and begins playing MP3 files from that album.

To exit music navigator mode, press the softkey below the Back tab to return to normal MP3 playback.

Connecting a USB Storage Device or iPod®

The USB Port can be used to control an iPod or a USB storage device.

To connect a USB storage device, connect the device to the USB port located in the center console.

To connect an iPod, connect one end of the USB cable that came with the iPod to the iPod's dock connector and connect the other

end to the USB port located in the center console. If the vehicle is on and the USB connection works, "OK to disconnect" and a GM logo may appear on the iPod and iPod appears on the radio's display. The iPod music appears on the radio's display and begins playing.

The iPod charges while it is connected to the vehicle if the vehicle is in the ACC/ACCESSORY or ON/RUN position. When the vehicle is turned off, the iPod automatically powers off and will not charge or draw power from the vehicle's battery.

If you have an older iPod model that is not supported, it can still be used by connecting it to the Auxiliary Input Jack using a standard 3.5 mm (1/8 in) stereo cable. See "Using the Auxiliary Input Jack" earlier for more information.

Using the Radio to Control a USB Storage Device or iPod

The radio can control a USB storage device or an iPod using the radio buttons and knobs and display song information on the radio's display.

♪ (Tune): Turn to select files.

◀ SEEK: Press to go to the start of the track, if more than ten seconds have played. Press and hold or press multiple times to continue moving backward through tracks.

▶ SEEK: Press to go to the next track. Press and hold or press multiple times to continue moving forward through tracks.

◀◀ REV (Reverse): Press and hold to reverse playback quickly. Sound is heard at a reduced volume. Release ◀◀ REV to resume playing. The elapsed time of the file displays.

⏩ FWD (Fast Forward): Press and hold to advance playback quickly. Sound is heard at a reduced volume. Release **⏩ FWD** to resume playing. The elapsed time of the file displays.

i (Information): Press to display additional information about the selected track.

Using Softkeys to Control a USB Storage Device or iPod

The five softkeys below the radio display are used to control the functions listed below.

To use the softkeys:

1. Press the first or fifth softkey below the radio display to display the functions listed below, or press the softkey below the function if it is currently displayed.
2. Press the softkey below the tab with the function on it to use that function.

⏸ (Pause): Press the softkey below **⏸** to pause the track. The tab appears raised when pause is being used. Press the softkey below **⏸** again to resume playback.

Back: Press the softkey below the back tab to go back to the main display screen on an iPod, or the root directory on a USB storage device.



📁 (Folder View): Press the softkey below **📁** to view the contents of the current folder on the USB drive. To browse and select files:

1. Press the softkey below **📁**.
2. Turn **🎵** to scroll through the list of folders.
3. Press **🎵** to select the folder. If there is more than one folder, repeat Steps 1 and 2 until the folder is reached.

4. Turn **🎵** to scroll through the files in the selected folder.
5. Press **🎵** to select the file to be played.





To skip through large lists, the five softkeys can be used to navigate in the following order:

- First softkey, first item in the list.
- Second softkey, 1% through the list each time the softkey is pressed.
- Third softkey, 5% through the list each time the softkey is pressed.
- Fourth softkey, 10% through the list each time the softkey is pressed.
- Fifth softkey, end of the list.

 **(Music Navigator):** Press the softkey below  to view and select a file on an iPod, using the iPod's menu system. Files are sorted by:

- Playlists
- Artists
- Albums
- Genres
- Songs
- Composers

To select files:



1. Press the softkey below .
2. Turn  to scroll through the list of menus.
3. Press  to select the menu.
4. Turn  to scroll through the folders or files in the selected menu.
5. Press  to select the file to be played.



To skip through large lists, the five softkeys can be used to navigate in the following order:



- First softkey, first item in the list.
- Second softkey, 1% through the list each time the softkey is pressed.
- Third softkey, 5% through the list each time the softkey is pressed.
- Fourth softkey, 10% through the list each time the softkey is pressed.
- Fifth softkey, end of the list.

Repeat Functionality

To use Repeat:





Press the softkey below  or  to select between Repeat All and Repeat Track.

 **(Repeat All):** Press the softkey below  to repeat all tracks. The tab appears lowered when Repeat All is being used. This is the default mode when a USB storage device or iPod is first connected.

 **(Repeat Track):** Press the softkey below  to repeat one track. The tab appears raised when Repeat Track is being used.

Shuffle Functionality

To use Shuffle:

Press the softkey below , ,  or  to select between Shuffle Off, Shuffle All Songs/Shuffle Songs, Shuffle Album, or Shuffle Folder.

 **(Shuffle Off):** This is the default mode when a USB storage device or iPod is first connected.

 **(Shuffle All Songs / Shuffle Songs):** Shuffles all songs on the USB storage device or iPod.

 **(Shuffle Album):** Shuffles all songs in the current album on an iPod.

 **(Shuffle Folder):** Shuffles all songs in the current folder on a USB storage device.

MP3 (Radio with CD/DVD)

Format

The radio can play .mp3 or .wma files that were recorded onto a CD-R or CD-RW disc.

The USB port can play .mp3 and .wma files that are stored on a USB storage device as well as AAC files that are stored on an iPod®.

Compressed Audio or Mixed Mode Discs

The radio plays discs that contain both uncompressed CD audio and MP3/WMA files depending on which slot the disc is loaded into.

The DVD Player only reads uncompressed audio and ignores MP3/WMA files on a mixed mode disc.

The CD Player reads both uncompressed audio and MP3/WMA files on a mixed mode disc. Uncompressed audio is played before MP3/WMA files. Press the CAT (category) button to toggle between uncompressed audio and MP3/WMA files.

CD-R or CD-RW Supported File and Folder Structure

The DVD Player supports:

- Up to 255 folders.
- Up to 8 folders in depth.
- Up to 15 playlists.
- Up to 40 sessions.
- Playlists with an .m3u or .wpl extension.
- Files with an .mp3, .wma, or .cda file extension.

The CD Player supports:

- Up to 512 files and folders.
- Up to 8 folders in depth.
- Playlists with an .m3u or .wpl extension.
- Files with an .mp3, .wma, or .cda file extension.

USB Supported File and Folder Structure

The radio supports:

- Up to 700 folders.
- Up to 8 folders in depth.
- Up to 65,535 files.
- Folder and file names up to 64 bytes.
- Files with an .mp3 or .wma file extension.
- AAC files stored on an iPod.
- FAT16
- FAT32

Root Directory

The root directory of the disc is treated as a folder. If the root directory has compressed audio files, the directory displays as F1 ROOT on the radio.

If a disc contains both uncompressed CD audio and MP3/WMA files, a folder under the root directory called CD accesses all of the CD audio tracks on the disc.

Empty Folder

Folders that do not contain files are skipped, and the player advances to the next folder that contains files.

No Folder

When the disc contains only compressed files, the files are located under the root folder. The next and previous folder function does not function on a disc that was recorded without folders or playlists. When displaying the name of the folder the radio displays ROOT.

When the disc contains only playlists and compressed audio files, but no folders, all files are located under the root folder. The folder down and the folder up buttons search playlists first and then goes to the root folder. When the radio displays the name of the folder the radio displays ROOT.

Order of Play

Compressed audio files are accessed in the following order:

- Playlists.
- Files stored in the root directory.
- Files stored in folders in the root directory.

Tracks are played in the following order:

- Play begins from the first track in the first playlist and continues sequentially through all tracks in each playlist. When the last track of the last playlist has played, play continues from the first track of the first playlist.

- Play begins from the first track in the first folder and continues sequentially through all tracks in each folder. When the last track of the last folder has played, play continues from the first track of the first folder.

When play enters a new folder, the display does not automatically show the new folder name unless the folder mode has been chosen as the default display. The new track name displays.

File System and Naming

The song name that displays is the song name that is contained in the ID3 tag. If the song name is not present in the ID3 tag, then the radio displays the file name without the extension (such as .mp3) as the track name.

Track names longer than 32 characters or four pages are shortened. Parts of words on the last page of text and the extension of the filename does not display.

Preprogrammed Playlists

Preprogrammed playlists that were created using WinAmp™, MusicMatch™, or Real Jukebox™ software can be accessed, however, they cannot be edited using the radio. These playlists are treated as special folders containing compressed audio song files.

Playlists that have an .m3u or .pls file extension and are stored on a USB device may be supported by the radio with a USB port.

Playing an MP3/WMA File From a Disc (In Either the DVD or CD Slot)

If a disc is inserted into the top DVD slot, the rear seat operator can turn on the video screen and use the remote control to navigate the CD (tracks only).

🎵 (Tune): Turn to select MP3/WMA files.

⏮ SEEK: Press to go to the start of the track, if more than five seconds have played. Press to go to the previous track if more than five seconds have played. Press and hold or press multiple times to continue moving backward through tracks.

⏭ SEEK: Press to go to the next track. Press and hold or press multiple times to continue moving forward through tracks.

⏪ REV (Reverse): Press and hold to reverse playback quickly. Sound is heard at a reduced volume and the elapsed time of the file displays. Release ⏪ REV to resume playing.

⏩ FWD (Fast Forward): Press and hold to advance playback quickly. Sound is heard at a reduced volume and the elapsed time of the file displays. Release ⏩ FWD to resume playing. The elapsed time of the file displays.

⏪ (Previous Folder): Press the softkey below ⏪ to go to the first track in the previous folder.

⏩ (Next Folder): Press the softkey below ⏩ to go to the first track in the next folder.

RDM (Random): Files on the disc can be listened to in random, rather than sequential order. To use random, press the softkey under the RDM tab until Random Current Disc displays to play songs in random order. Press the same softkey again to turn off random play.

🎵 (Music Navigator): Press the softkey below 🎵 to play files in order by artist or album.

The player scans the disc to sort the files by artist and album ID3 tag information. It can take several minutes to scan the disc depending on the number of files on the disc. The radio may begin playing while it is scanning in the background.

When the scan is finished, the disc begins playing files in order by artist. The current artist playing is shown on the second line of the display. Once all songs by that artist are played, the player moves to the next artist in alphabetical order and begins playing files by that artist.

To listen to files by another artist, press the softkey located below either arrow tab. The disc goes to the next or previous artist in alphabetical order. Continue pressing either softkey below the arrow tab until the artist displays.

To change from playback by artist to playback by album:

1. Press the softkey located below the Sort By tab.
2. Press one of the softkeys below the album tab from the sort screen.
3. Press the softkey below the back tab to return to the main music navigator screen.

The album name displays on the second line between the arrows and songs from the current album begins to play. Once all songs from that album have played, the player moves to the next album in alphabetical order on the CD and begins playing MP3 files from that album.

To exit music navigator mode, press the softkey below the Back tab to return to normal MP3 playback.

Connecting a USB Storage Device or iPod®

The USB Port can be used to control an iPod or a USB storage device.

To connect a USB storage device, connect the device to the USB port located in the center console.

To connect an iPod, connect one end of the USB cable that came with the iPod to the iPod's dock connector and connect the other

end to the USB port located in the center console. If the vehicle is on and the USB connection works, "OK to disconnect" and a GM logo may appear on the iPod and iPod appears on the radio's display. The iPod music appears on the radio's display and begins playing.

The iPod charges while it is connected to the vehicle if the vehicle is in the ACC/ACCESSORY or ON/RUN position. When the vehicle is turned off, the iPod automatically powers off and will not charge or draw power from the vehicle's battery.

If you have an older iPod model that is not supported, it can still be used by connecting it to the Auxiliary Input Jack using a standard 3.5 mm (1/8 in) stereo cable. See "Using the Auxiliary Input Jack" earlier for more information.

Using the Radio to Control a USB Storage Device or iPod

The radio can control a USB storage device or an iPod using the radio buttons and knobs and display song information on the radio's display.

♪ (Tune): Turn to select files.

◀ SEEK: Press to go to the start of the track, if more than ten seconds have played. Press and hold or press multiple times to continue moving backward through tracks.

▶ SEEK: Press to go to the next track. Press and hold or press multiple times to continue moving forward through tracks.

◀◀ REV (Reverse): Press and hold to reverse playback quickly. Sound is heard at a reduced volume. Release ◀◀ REV to resume playing. The elapsed time of the file displays.

▶▶ FWD (Fast Forward): Press and hold to advance playback quickly. Sound is heard at a reduced volume. Release ▶▶ FWD to resume playing. The elapsed time of the file displays.

i (Information): Press to display additional information about the selected track.

Using Softkeys to Control a USB Storage Device or iPod

The five softkeys below the radio display are used to control the functions listed below.

To use the softkeys:



1. Press the first or fifth softkey below the radio display to display the functions listed below, or press the softkey below the function if it is currently displayed.
2. Press the softkey below the tab with the function on it to use that function.

|| (Pause): Press the softkey below || to pause the track. The tab appears raised when pause is being used. Press the softkey below || again to resume playback.

Back: Press the softkey below the back tab to go back to the main display screen on an iPod, or the root directory on a USB storage device.



📁 (Folder View): Press the softkey below 📁 to view the contents of the current folder on the USB drive. To browse and select files:

1. Press the softkey below 📁 .
2. Turn ♪ to scroll through the list of folders.
3. Press ♪ to select the folder. If there is more than one folder, repeat Steps 1 and 2 until the folder is reached.

4. Turn  to scroll through the files in the selected folder.
5. Press  to select the file to be played.





To skip through large lists, the five softkeys can be used to navigate in the following order:

- First softkey, first item in the list.
- Second softkey, 1% through the list each time the softkey is pressed.
- Third softkey, 5% through the list each time the softkey is pressed.
- Fourth softkey, 10% through the list each time the softkey is pressed.
- Fifth softkey, end of the list.

 **(Music Navigator):** Press the softkey below  to view and select a file on an iPod, using the iPod's menu system. Files are sorted by:

- Playlists
- Artists
- Albums
- Genres
- Songs
- Composers

To select files:



1. Press the softkey below .
2. Turn  to scroll through the list of menus.
3. Press  to select the menu.
4. Turn  to scroll through the folders or files in the selected menu.
5. Press  to select the file to be played.



To skip through large lists, the five softkeys can be used to navigate in the following order:



- First softkey, first item in the list.
- Second softkey, 1% through the list each time the softkey is pressed.
- Third softkey, 5% through the list each time the softkey is pressed.
- Fourth softkey, 10% through the list each time the softkey is pressed.
- Fifth softkey, end of the list.

Repeat Functionality

To use Repeat:





Press the softkey below  or  to select between Repeat All and Repeat Track.

 **(Repeat All):** Press the softkey below  to repeat all tracks. The tab appears lowered when Repeat All is being used. This is the default mode when a USB storage device or iPod is first connected.

 **(Repeat Track):** Press the softkey below  to repeat one track. The tab appears raised when Repeat Track is being used.

Shuffle Functionality

To use Shuffle:

Press the softkey below , ,  or  to select between Shuffle Off, Shuffle All Songs/ Shuffle Songs, Shuffle Album, or Shuffle Folder.

 **(Shuffle Off):** This is the default mode when a USB storage device or iPod is first connected.

 **(Shuffle All Songs / Shuffle Songs):** Shuffles all songs on the USB storage device or iPod.

 **(Shuffle Album):** Shuffles all songs in the current album on an iPod.

 **(Shuffle Folder):** Shuffles all songs in the current folder on a USB storage device.

Auxiliary Devices

The vehicle may have a 3.5 mm (1/8 in) auxiliary input jack located on the lower right side of the faceplate and for vehicles with a USB port, it is located in the center console.

Using the 3.5 mm (1/8 in) Auxiliary Input Jack

The auxiliary input jack is located on the lower right side of the faceplate. This is not an audio output; do not plug a headphone set into the front auxiliary input jack. Connect an auxiliary input device such as an iPod®, laptop computer, MP3 player, CD player, or cassette tape player, etc. to the auxiliary input jack for use as another source for audio listening.

Drivers are encouraged to set up any auxiliary device while the vehicle is in P (Park). See *Defensive Driving on page 9-2* for more information on driver distraction.

To use an auxiliary input device, connect a 3.5 mm (1/8 in) cable to the radio's front auxiliary input jack.

 **(Power/Volume):** Turn clockwise or counterclockwise to increase or decrease the volume of the portable player. Additional volume adjustments might have to be made from the portable device if the volume is not loud or soft enough.

BAND: Press to listen to the radio when a portable audio device is playing. The portable audio device continues playing, so you might want to stop it or turn it off.

CD/AUX (CD/Auxiliary): Press to select between CD, or Auxiliary.

- When a CD is in the player the CD icon and a message showing the disc and/or track number displays.
- If an auxiliary input device is not connected, "No Input Device Found" displays.

DVD/CD AUX (Auxiliary): Press to select between DVD, CD, or Auxiliary.

- If an auxiliary input device is not connected, “No Aux Input Device” displays.
- When a disc is in either slot, the DVD/CD text tab and a message showing the track or chapter number displays.
- If an auxiliary input device is not connected, and a disc is in both the DVD slot and the CD slot the DVD/CD AUX button only cycles between the two sources and does not indicate “No Aux Input Device”.
- If a front auxiliary input device is connected, the DVD/CD AUX button cycles through all available options.

If a disc is inserted into top DVD slot, the rear seat operator can turn on the video screen and use the

remote control to only navigate the CD tracks through the remote control.

See “Using the Auxiliary Input Jack(s)” later in this section, or “Audio/Video (A/V) Jacks” under, *Rear Seat Entertainment (RSE) System on page 7-36* for more information.

Using the USB Port

For vehicles with a USB port, the connector is located in the center console.

Radios with a USB port can control a USB storage device or an iPod® using the radio buttons and knobs. See *MP3 (Radio with CD and Radio with CD/USB) on page 7-22* or *MP3 (Radio with CD/DVD) on page 7-28* for information about how to connect and control a USB storage device or an iPod.

USB Supported Devices

- USB Flash Drives
- Portable USB Hard Drives
- Fifth generation or later iPod
- iPod nanos
- iPod touch
- iPod classic

Not all iPods and USB Drives are compatible with the USB port.

Make sure the iPod has the latest firmware from Apple® for proper operation. iPod firmware can be updated using the latest iTunes® application. See www.apple.com/itunes.

For help with identifying your iPod, go to www.apple.com/support.

Rear Seat Infotainment

Rear Seat Entertainment (RSE) System

The vehicle may have a DVD Rear Seat Entertainment (RSE) system. The RSE system works with the vehicle's audio system. The DVD player is part of the front radio. The RSE system includes a radio with a DVD player, a video display screen, audio/video jacks, two wireless headphones, and a remote control. See *Operation on page 7-2* for more information on the vehicle's audio/DVD system.

Before Driving

The RSE is designed for rear seat passengers only. The driver cannot safely view the video screen while driving and should not try to do so.

In severe or extreme weather conditions the RSE system might or might not work until the temperature is within the operating range. The operating range for the RSE system is above -4°F (-20°C) or below 140°F (60°C). If the temperature of the vehicle is outside of this range, heat or cool the vehicle until the temperature is within the operating range of the RSE system.

Parental Control

The RSE system may have a Parental Control feature, depending on the radio. To enable Parental Control, press and hold the radio power button for more than two seconds to stop all system features such as: radio, video screen, RSA, DVD and/or CD. While Parental Control is on,  displays.

When the radio is turned back on, Parental Control is unlocked.

Headphones

The RSE includes two 2-channel wireless headphones that are dedicated to this system. Channel 1 is dedicated to the video screen, while Channel 2 is dedicated to RSA selections. These headphones are used to listen to media such as CDs, DVDs, MP3/WMA, DVD-As, radio, any auxiliary source connected to A/V jacks, or the auxiliary input jack, if the vehicle has this feature. The wireless headphones have an On/Off button, channel 1/2 switch, and a volume control. Switch the headphones to Off when not in use.

Push the power button to turn on the headphones. An indicator light located on the headphones comes on. If the light does not come on, the batteries might need to be replaced. Intermittent sound or static on the headphones can also be an indication of weak batteries. See "Battery Replacement" later in this section for more information.

The headphones may automatically turn off after four hours of continuous use.

To adjust the volume on the headphones, use the volume control located on the right side.

Infrared transmitters are located at the rear of the RSE overhead console. The headphones shut off automatically to save the battery power if the RSE system and RSA are shut off or if the headphones are out of range of the transmitters for more than three minutes. Moving too far forward or stepping out of the vehicle, can cause the headphones to lose the audio signal.

For optimal audio performance, the headphones must be worn correctly. Headphones should be worn with the headband over the top of the head for best audio reception.

The symbol L (Left) appears on the upper left side, above the ear pad and should be positioned on the left

ear. The symbol R (Right) appears on the upper right side, above the ear pad and should be positioned on the right ear.

Notice: Do not store the headphones in heat or direct sunlight. This could damage the headphones and repairs will not be covered by the warranty. Storage in extreme cold can weaken the batteries. Keep the headphones stored in a cool, dry place.

If the foam ear pads attached to the headphones become worn or damaged, the pads can be replaced separately from the headphone set. See your dealer/retailer for more information.

Headphones should be stored in the front floor console and not in the front seat back pocket. Headphone damage can occur when the second row seats are folded forward.

Battery Replacement

To change the batteries on the headphones:

1. Turn the screw to loosen the battery door located on the left side of the headphones. Slide the battery door open.
2. Replace the two batteries in the compartment. Make sure that they are installed correctly, using the diagram on the inside of the battery compartment.
3. Replace the battery door and tighten the door screw.

If the headphones are to be stored for a long period of time, remove the batteries and keep them in a cool, dry place.

Audio/Video (A/V) Jacks

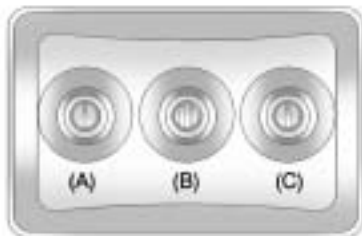

The A/V jacks, located on the rear of the floor console, allow audio or video signals to be connected from an auxiliary device such as a camcorder or a video game unit to the RSE system. Adapter connectors or cables (not supplied) might be required to connect the auxiliary device to the A/V jacks. Refer to the manufacturer's instructions for proper usage.

The A/V jacks are color coded to match typical home entertainment system equipment. The yellow jack (A) is for the video input. The white jack (B) is for the left audio input. The red jack (C) is for the right audio input.

Power for auxiliary devices is not supplied by the radio system.

To use the auxiliary inputs of the RSE system, connect an external auxiliary device to the color-coded A/V jacks and turn both the auxiliary device and the video screen power on. If the video screen is in the DVD player mode, pressing the AUX (auxiliary) button on the remote control, switches the video screen from the DVD player mode to the auxiliary device. The radio can listen to the audio of the connected auxiliary device by sourcing to auxiliary. See *Auxiliary Devices on page 7-34* for more information.

How to Change the RSE Video Screen Settings

The screen display mode (normal, full, and zoom), screen brightness, and setup menu language can be changed from the on screen setup menu by using the remote control. To change a setting:

1. Press .
2. Use **▲**, **▼**, **◀**, **▶** and **◀|** to navigate and use the setup menu.
3. Press again to remove the setup menu from the screen.

Audio Output

Audio from the DVD player or auxiliary inputs can be heard through the following sources:

- Wireless Headphones
- Vehicle Speakers
- Vehicle wired headphone jacks on the rear seat audio system, if the vehicle has this feature.

The RSE system always transmits the audio signal to the wireless headphones, if there is audio available. See “Headphones” earlier in this section for more information.

The DVD player is capable of outputting audio to the wired headphone jacks on the RSA system, if the vehicle has this feature. The DVD player can be selected as an audio source on the RSA system. See *Rear Seat Audio (RSA) System on page 7-44* for more information.

When a device is connected to the A/V jacks, or the radio's auxiliary input jack, if the vehicle has this feature, the rear seat passengers are able to hear audio from the auxiliary device through the wireless or wired headphones. The front seat passengers are able to listen to playback from this device through the vehicle speakers by selecting AUX as the source on the radio.

Video Screen

The video screen is located in the overhead console. When the video screen is not in use, push it up into its locked position.

To use the video screen:

1. Push the release button located on the overhead console.
2. Move the screen to the desired position.

If a DVD is playing and the screen is raised to its locked position, the screen remains on; this is normal, and the DVD continues to play through the previous audio source. Press  on the remote control or eject the disc to turn off the screen.

The infrared receivers for the wireless headphones and the remote control are located at the rear of the overhead console.

Notice: Avoid directly touching the video screen, as damage may occur. See “Cleaning the Video Screen” later in this section for more information.

Remote Control

To use the remote control, aim it at the transmitter window at the rear of the overhead console and press the desired button. Direct sunlight or very bright light could affect the ability of the RSE transmitter to receive signals from the remote control. If the remote control does not seem to be working, the batteries might need to be replaced. See “Battery Replacement” later in this section. Objects blocking the line of sight could also affect the function of the remote control.

If a CD or DVD is in the Radio DVD slot, the remote control  button can be used to turn on the video screen display and start the disc. The radio can also turn on the video screen display. See *Operation on page 7-2* for more information.

Notice: Storing the remote control in a hot area or in direct sunlight can damage it, and the repairs will not be covered by the warranty. Storage in extreme cold can weaken the batteries. Keep the remote control stored in a cool, dry place.





Remote Control Buttons

 **(Power):** Press to turn the video screen on and off.

 **(Illumination):** Press to turn the remote control backlight on. The backlight automatically times out after seven to ten seconds if no other button is pressed while the backlight is on.

 **(Title):** Press to return the DVD to the main menu of the DVD. This function could vary for each disc.

 **(Main Menu):** Press to access the DVD menu. The DVD menu is different on every DVD. Use the navigation arrows to move the cursor around the DVD menu. After making a selection press the enter button. This button only operates when using a DVD.

 ,  ,  ,  **(Menu Navigation Arrows):** Use the arrow buttons to navigate through a menu.





 **(Enter):** Press to select the choice that is highlighted in any menu.

 **(Display Menu):** Press to adjust the brightness, screen display mode (normal, full, or zoom), and display the language menu.

 **(Return):** Press to exit the current active menu and return to the previous menu. This button operates only when the display menu or a DVD menu is active.

 **(Stop):** Press to stop playing, rewinding, or fast forwarding a DVD. Press twice to return to the beginning of the DVD.

 **(Play/Pause):** Press to start playing a DVD. Press while a DVD is playing to pause it. Press again to continue playing the DVD.

When the DVD is playing, depending on the radio, play may be slowed down by pressing  then  . The DVD continues playing in a slow play mode. Depending on the radio, perform reverse slow play by pressing  then  . To cancel slow play mode, press  again.

 **(Previous Track/Chapter):** Press to return to the start of the current track or chapter. Press again to go to the previous track or chapter. This button might not work when the DVD is playing the copyright information or the previews.

▶| (Next Track/Chapter): Press to go to the beginning of the next chapter or track. This button might not work when the DVD is playing the copyright information or the previews.

◀◀ (Fast Reverse): Press to quickly reverse the DVD or CD. To stop fast reversing a DVD video, press ▶ || . To stop fast reversing a DVD audio or CD, release ◀◀ . This button might not work when the DVD is playing the copyright information or the previews.

▶▶ (Fast Forward): Press to fast forward the DVD or CD. To stop fast forwarding a DVD video, press ▶ || . To stop fast forwarding a DVD audio or CD, release ▶▶ . This button might not work when the DVD is playing the copyright information or the previews.

🎵 (Audio): Press to change audio tracks on DVDs that have this feature when the DVD is playing. The format and content of this function vary for each disc.

☐ (Subtitles): Press to turn ON/OFF subtitles and to move through subtitle options when a DVD is playing. The format and content of this function vary for each disc.

AUX (Auxiliary): Press to switch the system between the DVD player and an auxiliary source.

📷 (Camera): Press to change camera angles on DVDs that have this feature when a DVD is playing. The format and content of this function vary for each disc.

1 through 0 (Numeric Keypad): The numeric keypad provides the capability of direct chapter or track number selection.

⊗ (Clear): Press within three seconds after entering a numeric selection, to clear all numerical inputs.

≥ 10 (Double Digit Entries): Press to select chapter or track numbers greater than nine. Press this button before entering the number.

If the remote control becomes lost or damaged, a new universal remote control can be purchased. If this happens, make sure the universal remote control uses a Toshiba® code set.

Battery Replacement

To change the remote control batteries:

1. Slide the rear cover back, on the remote control.
2. Replace the two batteries in the compartment. Make sure that they are installed correctly, using the diagram on the inside of the battery compartment.
3. Replace the battery cover.

If the remote control is to be stored for a long period of time, remove the batteries and keep them in a cool, dry place.

Tips and Troubleshooting Chart

Problem	Recommended Action
No power.	The ignition might not be turned ON/RUN or in ACC/ACCESSORY.
The picture does not fill the screen. There are black borders on the top and bottom or on both sides or it looks stretched out.	Check the display mode settings in the setup menu by pressing the display menu button on the remote control.
In auxiliary mode, the picture moves or scrolls.	Check the auxiliary input connections at both devices.
The remote control does not work.	Check to make sure there is no obstruction between the remote control and the transmitter window. Check the batteries to make sure they are not dead or installed incorrectly.

Tips and Troubleshooting Chart (cont'd)

Problem	Recommended Action
After stopping the player, I push Play but sometimes the DVD starts where I left off and sometimes at the beginning.	If the stop button was pressed one time, the DVD player resumes playing where the DVD was stopped. If the stop button was pressed two times the DVD player begins to play from the beginning of the DVD.
The auxiliary source is running but there is no picture or sound.	Check that the RSE video screen is in the auxiliary source mode. Check the auxiliary input connections at both devices.
Sometimes the wireless headphone audio cuts out or buzzes.	Check for obstructions, low batteries, reception range, and interference from cellular telephone towers or by using a cellular telephone in the vehicle. Check that the headphones are on correctly using the L (left) and R (right) on the headphones.
I lost the remote and/or the headphones.	See your dealer/retailer for assistance.
The DVD is playing, but there is no picture or sound.	Check that the RSE video screen is sourced to the DVD player.

DVD Display Error Messages

The DVD display error message depends on which radio the vehicle has. The video screen might display one of the following:

Disc Load/Eject Error: This message displays when there are disc load or eject problems.

Disc Format Error: This message displays if the disc is inserted with the disc label wrong side up, or if the disc is damaged.

Disc Region Error: This message displays if the disc is not from a correct region.

No Disc Inserted: This message displays if no disc is present when the  EJECT button is pressed on the radio.

DVD Distortion

Video distortion can occur when operating cellular phones, scanners, CB radios, Global Position Systems (GPS)*, two-way radios, mobile fax, or walkie talkies.

It might be necessary to turn off the DVD player when operating one of these devices in or near the vehicle.

*Excludes the OnStar® System.

Cleaning the RSE Overhead Console

When cleaning the RSE overhead console surface, use only a clean cloth dampened with clean water.

Cleaning the Video Screen

Use only a clean cloth dampened with clean water. Use care when directly touching or cleaning the screen, as damage could result.

Rear Seat Audio (RSA) System

For vehicles with Rear Seat Audio (RSA), rear seat passengers can listen to and control any of the music sources: radio, CDs, DVDs, or other auxiliary sources. The rear seat passengers can only control the music sources the front seat passengers are not listening to (except on some radios where dual control is allowed). For example, rear seat passengers can control a CD and listen to it through the headphones, while the driver listens to the radio through the front speakers. The rear seat passengers have control of the volume for each set of headphones.

The RSA functions operate even when the main radio is off. The front audio system displays  when the RSA is on, and disappears from the display when it is off.

Audio can be heard through wired headphones (not included) plugged into the jacks on the RSA. If the vehicle has this feature, audio can also be heard on Channel 2 of the wireless headphones.

The audio system mutes the rear speakers when the RSA audio is active through the headphones.

To listen to an iPod or portable audio device through the RSA, attach the iPod or portable audio device to the front auxiliary input (if available), located on the front audio system. Turn the iPod on, then choose the front auxiliary input with the RSA SRCE button.

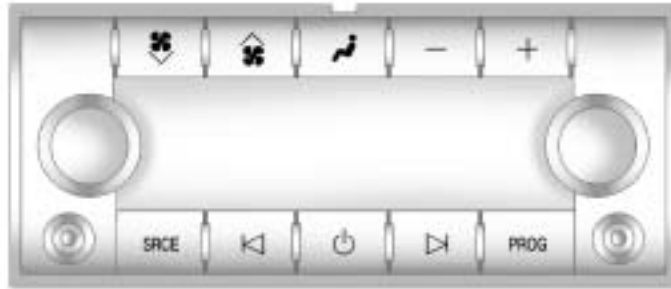

Power: Press to turn the RSA on or off.

Volume: Turn to increase or to decrease the volume of the wired headphones. The left knob controls the left headphones and the right knob controls the right headphones.

SRCE (Source): Press to select between the radio (AM/FM/XM™), CD, and if the vehicle has these features, DVD, front auxiliary, and rear auxiliary.

Seek: Press to go to the previous or to the next station and stay there. This function is inactive, with some radios, if the front seat passengers are listening to the radio.

Press and hold **Seek** until the display flashes to tune to an individual station. The display stops flashing after the buttons have not been pushed for more than two seconds. This function is inactive, with some radios, if the front seat passengers are listening to the radio.

While listening to a disc, press **Seek** to go to the next track or chapter on the disc. Press **Seek** to go back to the start of the current track or chapter (if more than ten seconds have played). This function is inactive, with some radios, if the front seat passengers are listening to the disc.

When a DVD video menu is being displayed, press **Seek** or **Seek** to perform a cursor up or down on the menu. Hold **Seek** or **Seek** to perform a cursor left or right on the menu.

PROG (Program): Press to go to the next preset radio station or channel set on the main radio. This function is inactive, with some radios, if the front seat passengers are listening to the radio.

When a CD or DVD audio disc is playing, press **PROG** to go to the beginning of the CD or DVD audio. This function is inactive, with some radios, if the front seat passengers are listening to the disc.

When a disc is playing in the CD or DVD changer, press PROG to select the next disc, if multiple discs are loaded. This function is inactive, with some radios, if the front seat passengers are listening to the disc.

When a DVD video menu is being displayed, press PROG to perform the ENTER menu function.

Rear Audio Controller (RAC)



The vehicle may have the Rear Audio Controller (RAC). Certain radio functions can be controlled with RAC.

▽ △ (Next/Previous): Press the down or up arrows to go to the next or to the previous radio station stored as a favorite.

When a CD/DVD is playing, press the down or up arrows to go to the next or previous track or chapter.

◀ SEEK ▶ : Press the SEEK arrows to go to the previous or to the next radio station while in AM, FM, or XM™, if equipped. Press the SEEK arrows to go to the previous or to the next track or chapter while sourced to a CD or DVD slot.

SRCE (Source): Press this button to switch between the radio, CD, and if the vehicle has these features, DVD, front auxiliary, and rear auxiliary.

⊗ (Mute): Press this button to silence the system. Press this button again, or any other radio button, to turn the sound on.

+ / - ◁ (Volume): Press the plus or minus volume buttons to increase or to decrease the volume.

Phone

Bluetooth

Vehicles with a Bluetooth system can use a Bluetooth capable cell phone with a Hands Free Profile to make and receive phone calls. The system can be used while the key is in ON/RUN or ACC/ACCESSORY position. The range of the Bluetooth system can be up to 9.1 m (30 ft.). Not all phones support all functions, and not all phones are guaranteed to work with the in-vehicle Bluetooth system. See gm.com/bluetooth for more information on compatible phones.

Voice Recognition

The Bluetooth system uses voice recognition to interpret voice commands to dial phone numbers and name tags.

Noise: Keep interior noise levels to a minimum. The system may not recognize voice commands if there is too much background noise.

When to Speak: A short tone sounds after the system responds indicating when it is waiting for a voice command. Wait until the tone and then speak.

How to Speak: Speak clearly in a calm and natural voice.

Audio System

When using the in-vehicle Bluetooth system, sound comes through the vehicle's front audio system speakers and overrides the audio system. Use the audio system volume knob, during a call, to change the volume level. The adjusted volume level remains in memory for later calls. To prevent missed calls, a minimum volume level is used if the volume is turned down too low.

Bluetooth Controls

Use the buttons located on the steering wheel to operate the in-vehicle Bluetooth system. See *Steering Wheel Controls on page 5-2* for more information.

 **(Push To Talk)**: Press to answer incoming calls, to confirm system information, and to start speech recognition.

 **(Phone On Hook)**: Press to end a call, reject a call, or to cancel an operation.

Pairing

A Bluetooth enabled cell phone must be paired to the in-vehicle Bluetooth system first and then connected to the vehicle before it can be used. See the cell phone manufacturers user guide for Bluetooth functions before pairing the cell phone. If a Bluetooth phone is not connected, calls will be made using OnStar[®] Hands-Free Calling, if available. Refer to the OnStar owner's guide for more information.

Pairing Information:

- Up to five cell phones can be paired to the in-vehicle Bluetooth system.
- The pairing process is disabled when the vehicle is moving.
- The in-vehicle Bluetooth system automatically links with the first available paired cell phone in the order the phone was paired.
- Only one paired cell phone can be connected to the in-vehicle Bluetooth system at a time.
- Pairing should only need to be completed once, unless changes to the pairing information have been made or the phone is deleted.

To link to a different paired phone, see *Linking to a Different Phone* later in this section.

Pairing a Phone

1. Press and hold  for two seconds. The system responds with "Ready" followed by a tone.
2. Say "Bluetooth". The system responds with "Bluetooth ready" followed by a tone.
3. Say "Pair". The system responds with instructions and a four digit PIN number. The PIN number will be used in Step 4.
4. Start the Pairing process on the cell phone that will be paired to the vehicle. Reference the cell phone manufacturers user guide for information on this process.

Locate the device named "General Motors" in the list on the cellular phone and follow the instructions on the cell phone to enter the four digit PIN number that was provided in Step 3.
5. The system prompts for a name for the phone. Use a name that best describes the phone.

This name will be used to indicate which phone is connected. The system then confirms the name provided.

6. The system responds with "<Phone name> has been successfully paired" after the pairing process is complete.
7. Repeat Steps 1 through 7 for additional phones to be paired.

Listing All Paired and Connected Phones

1. Press and hold  for two seconds. The system responds with "Ready" followed by a tone.
2. Say "Bluetooth". The system responds with "Bluetooth ready" followed by a tone.
3. Say "List". The system lists all the paired Bluetooth devices. If a phone is connected to the vehicle, the system will say "Is connected" after the connected phone.

Deleting a Paired Phone

1. Press and hold  for two seconds. The system responds with "Ready" followed by a tone.
2. Say "Bluetooth". The system responds with "Bluetooth ready" followed by a tone.
3. Say "Delete". The system asks which phone to delete followed by a tone.
4. Say the name of the phone to be deleted. If the phone name is unknown, use the "List" command for a list of all paired phones. The system responds with "Would you like to delete <phone name>? Yes or No" followed by a tone.
5. Say "Yes" to delete the phone. The system responds with "OK, deleting <phone name>".

Linking to a Different Phone

1. Press and hold  for two seconds. The system responds with "Ready" followed by a tone.
2. Say "Bluetooth". The system responds with "Bluetooth ready" followed by a tone.
3. Say "Change phone". The system responds with "Please wait while I search for other phones".
 - If another phone is found, the response will be "<Phone name> is now connected".
 - If another phone is not found, the original phone remains connected.

Storing Name Tags

The system can store up to thirty phone numbers as name tags that are shared between the Bluetooth and OnStar systems.

The system uses the following commands to store and retrieve phone numbers:

- Store
- Digit Store
- Directory

Using the Store Command

The store command allows a phone number to be stored without entering the digits individually.



1. Press and hold  for two seconds. The system responds with "Ready" followed by a tone.
2. Say "Store". The system responds with "Store, number please" followed by a tone.

3. Say the complete phone number to be stored at once with no pauses.
 - If the system recognizes the number it responds with "OK, Storing" and repeats the phone number.
 - If the system is unsure it recognizes the phone number, it responds with "Store" and repeats the number followed by "Please say yes or no". If the number is correct, say "Yes". If the number is not correct, say "No". The system will ask for the number to be re-entered.
4. After the system stores the phone number, it responds with "Please say the name tag" followed by a tone.

5. Say a name tag for the phone number. The name tag is recorded and the system responds with "About to store <name tag>. Does that sound OK?".
 - If the name tag does not sound correct, say "No" and repeat Step 5.
 - If the name tag sounds correct, say "Yes" and the name tag is stored. After the number is stored the system returns to the main menu.

Using the Digit Store Command

The digit store command allows a phone number to be stored by entering the digits individually.



1. Press and hold   for two seconds. The system responds with "Ready" followed by a tone.

2. Say "Digit Store". The system responds with "Please say the first digit to store" followed by a tone.
3. Say the first digit to be stored. The system will repeat back the digit it heard followed by a tone. Continue entering digits until the number to be stored is complete.
 - If an unwanted number is recognized by the system, say "Clear" at any time to clear the last number.
 - To hear all of the numbers recognized by the system, say "Verify" at any time and the system will repeat them.
4. After the complete number has been entered, say "Store". The system responds with "Please say the name tag" followed by a tone.

5. Say a name tag for the phone number. The name tag is recorded and the system responds with "About to store <name tag>. Does that sound OK?".
 - If the name tag does not sound correct, say "No" and repeat Step 5.
 - If the name tag sounds correct, say "Yes" and the name tag is stored. After the number is stored the system returns to the main menu.

Using the Directory Command

The directory command lists all of the name tags stored by the system. To use the directory command:

1. Press and hold   for two seconds. The system responds with "Ready" followed by a tone.

- Say "Directory". The system responds with "Directory" and then plays back all of the stored name tags. When the list is complete, the system returns to the main menu.

Deleting Name Tags



The system uses the following commands to delete name tags:

- Delete
- Delete all name tags

Using the Delete Command

The delete command allows specific name tags to be deleted.

To use the delete command:



- Press and hold   for two seconds. The system responds with "Ready" followed by a tone.

- Say "Delete". The system responds with "Delete, please say the name tag" followed by a tone.
- Say the name tag to be deleted. The system responds with "Would you like to delete, <name tag>? Please say yes or no".
 - If the name tag is correct, say "Yes" to delete the name tag. The system responds with "OK, deleting <name tag>, returning to the main menu."
 - If the name tag is incorrect, say "No". The system responds with "No. OK, let's try again, please say the name tag."

Using the Delete All Name Tags Command

The delete all name tags command deletes all stored phone book name tags and route name tags for OnStar (if present).

To use the delete all name tags command:



- Press and hold   for two seconds. The system responds with "Ready" followed by a tone.
- Say "Delete all name tags". The system responds with "You are about to delete all name tags stored in your phone directory and your route destination directory. Are you sure you want to do this? Please say yes or no."
 - Say "Yes" to delete all name tags.
 - Say "No" to cancel the function and return to the main menu.

Making a Call

Calls can be made using the following commands:



- Dial
- Digit Dial
- Call
- Re-dial

Using the Dial Command

1. Press and hold   for two seconds. The system responds with “Ready” followed by a tone.
2. Say “Dial”. The system responds with “Dial using <phone name>”. “Number please” followed by a tone.
3. Say the entire number without pausing.
 - If the system recognizes the number, it responds with “OK, Dialing” and dials the number.



- If the system does not recognize the number, it confirms the numbers followed by a tone. If the number is correct, say “Yes”. The system responds with “OK, Dialing” and dials the number. If the number is not correct, say “No”. The system will ask for the number to be re-entered.

Using the Digit Dial Command

1. Press and hold   for two seconds. The system responds with “Ready” followed by a tone.
2. Say “Digit Dial”. The system responds with “Digit dial using <phone name>, please say the first digit to dial” followed by a tone.
3. Say the digit to be dialed one at a time. Following each digit, the system will repeat back the digit it heard followed by a tone.

4. Continue entering digits until the number to be dialed is complete. After the whole number has been entered, say “Dial”. The system responds with “OK, Dialing” and dials the number.
 - If an unwanted number is recognized by the system, say “Clear” at any time to clear the last number.
 - To hear all of the numbers recognized by the system, say “Verify” at any time and the system will repeat them.



Using the Call Command

1. Press and hold   for two seconds. The system responds with “Ready” followed by a tone.
2. Say “Call”. The system responds with “Call using <phone name>”. Please say the name tag” followed by a tone.

3. Say the name tag of the person to call.
 - If the system clearly recognizes the name tag it responds with “OK, calling, <name tag>” and dials the number.
 - If the system is unsure it recognizes the right name tag, it confirms the name tag followed by a tone. If the name tag is correct, say “Yes”. The system responds with “OK, calling, <name tag>” and dials the number. If the name tag is not correct, say “No”. The system will ask for the name tag to be re-entered.

Once connected, the person called will be heard through the audio speakers.





Using the Re-dial Command

1. Press and hold   for two seconds. The system responds with “Ready” followed by a tone.
2. After the tone, say “Re-dial”. The system responds with “Re-dial using <phone name>” and dials the last number called from the connected Bluetooth phone.

Once connected, the person called will be heard through the audio speakers.







Receiving a Call

When an incoming call is received, the audio system mutes and a ring tone is heard in the vehicle.

- Press   and begin speaking to answer the call.
- Press   to ignore a call.





Call Waiting

Call waiting must be supported on the Bluetooth phone and enabled by the wireless service carrier to work.

- Press   to answer an incoming call when another call is active. The original call is placed on hold.
- Press   again to return to the original call.
- To ignore the incoming call, continue with the original call with no action.
- Press   to disconnect the current call and switch to the call on hold.

Three-Way Calling

Three-Way Calling must be supported on the Bluetooth phone and enabled by the wireless service carrier to work.

1. While on a call press   . The system responds with “Ready” followed by a tone.
2. Say “Three-way call”. The system responds with “Three-way call, please say dial or call”.
3. Use the dial or call command to dial the number of the third party to be called.
4. Once the call is connected, press   to link all the callers together.



Ending a Call

Press   to end a call.



Muting a Call

During a call, all sounds from inside the vehicle can be muted so that the person on the other end of the call cannot hear them.

To Mute a call

1. Press   . The system responds with “Ready” followed by a tone.
2. Say “Mute Call”. The system responds with “Call muted”.

To Cancel Mute



1. Press   . The system responds with “Ready” followed by a tone.
2. After the tone, say “Mute Call”. The system responds with “Resuming call”.

Transferring a Call

Audio can be transferred between the in-vehicle Bluetooth system and the cell phone.



To Transfer Audio to the Cell Phone

During a call with the audio in the vehicle:

1. Press   . The system responds with “Ready” followed by a tone.
2. Say “Transfer Call.” The system responds with “Transferring call” and the audio will switch from the vehicle to the cell phone.



To Transfer Audio to the In-Vehicle Bluetooth System

The cellular phone must be paired and connected with the Bluetooth system before a call can be transferred. The connection process can take up to two minutes after the key is turned to the ON/RUN or ACC/ACCESSORY position.

During a call with the audio on the cell phone, press   for more than two seconds. The audio switches from the cell phone to the vehicle.

Voice Pass-Thru



Voice Pass-Thru allows access to the voice recognition commands on the cell phone. See the cell phone manufacturers user guide to see if the cell phone supports this feature. This feature can be used to verbally access contacts stored in the cell phone.

1. Press and hold   for two seconds. The system responds with "Ready" followed by a tone.
2. Say "Bluetooth". The system responds with "Bluetooth ready" followed by a tone.
3. Say "Voice". The system responds with "OK, accessing <phone name>".
 - The cell phone's normal prompt messages will go through its cycle according to the phone's operating instructions.

Dual Tone Multi-Frequency (DTMF) Tones

The in-vehicle Bluetooth system can send numbers and numbers stored as name tags during a call. This is used when calling a menu driven phone system. Account numbers can be programmed into the phonebook for retrieval during menu driven calls.



Sending a Number During a Call

1. Press   . The system responds with "Ready" followed by a tone.
2. Say "Dial". The system responds with "Say a number to send tones" followed by a tone.

3. Say the number to send.

- If the system clearly recognizes the number it responds with "OK, Sending Number" and the dial tones are sent and the call continues.
- If the system is not sure it recognized the number properly, it responds "Dial Number, Please say yes or no?" followed by a tone. If the number is correct, say "Yes". The system responds with "OK, Sending Number" and the dial tones are sent and the call continues.

Sending a Stored Name Tag During a Call

1. Press  . The system responds with "Ready" followed by a tone.
2. Say "Send name tag."
The system responds with "Say a name tag to send tones" followed by a tone.
3. Say the name tag to send.
 - If the system clearly recognizes the name tag it responds with "OK, Sending <name tag>" and the dial tones are sent and the call continues.

- If the system is not sure it recognized the name tag properly, it responds "Dial <name tag>, Please say yes or no?" followed by a tone. If the name tag is correct, say "Yes". The system responds with "OK, Sending <name tag>" and the dial tones are sent and the call continues.

Clearing the System

Unless information is deleted out of the in-vehicle Bluetooth system, it will be retained indefinitely. This includes all saved name tags in the phonebook and phone pairing information. For information on how to delete this information, see the above sections on Deleting a Paired Phone and Deleting Name Tags.

Other Information

The Bluetooth® word mark and logos are owned by the Bluetooth® SIG, Inc. and any use of such marks by General Motors is under license. Other trademarks and trade names are those of their respective owners.

See *Radio Frequency Statement on page 13-17* for FCC information.

Climate Controls

Climate Control Systems

Climate Control Systems	8-1
Dual Automatic Climate Control System	8-4
Rear Climate Control System (Rear Climate Control Only)	8-10
Rear Climate Control System (Rear Climate with Rear Seat Audio)	8-11

Air Vents

Air Vents	8-12
-----------------	------

Climate Control Systems

The heating, cooling, and ventilation in the vehicle can be controlled with this system.

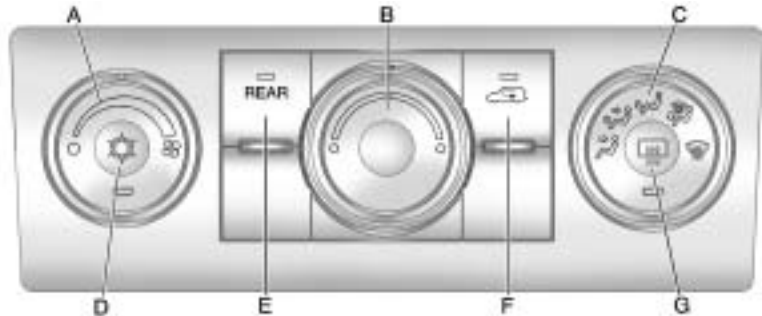

- A. Fan Control
- B. Temperature Control
- C. Air Delivery Mode Control
- D. Air Conditioning
- E. REAR (Rear Climate Control)
- F. Recirculation
- G. Rear Window Defogger

○ **(Off):** Turn the fan control all the way counterclockwise to turn the front climate control system off.

⊞ **(Fan Control):** Turn clockwise or counterclockwise to increase or decrease the fan speed.

8-2 Climate Controls

Temperature Control: Turn clockwise or counterclockwise to increase or decrease the temperature of the air flowing from the system.

Air Delivery Mode Control: Turn clockwise or counterclockwise to change the current airflow mode.

By positioning the right knob between two modes, a combination of those two modes is selected.

 **(Vent):** Air is directed to the instrument panel outlets.

 **(Bi-Level):** Air is divided between the instrument panel and floor outlets. Some air is directed towards the windshield and side window outlets. Cooler air is directed to the upper outlets and warmer air to the floor outlets.

 **(Floor):** Air is directed to the floor outlets, with some of the air directed to the windshield, side window, and second row floor outlets. In this mode, the system



automatically selects outside air. Recirculation cannot be selected while in floor mode.

 **(Defog):** This clears the windows of fog or moisture. Air is directed to the windshield, floor outlets, and side window vents. When this mode is selected, the system turns off recirculation and runs the air conditioning unless the outside temperature is less than 4°C (40°F). Recirculation cannot be selected while in the defog mode. Do not drive the vehicle until all the windows are clear.

 **(Defrost):** This clears the windshield of fog or frost, more quickly. Air is directed to the windshield and side window vents, with some to the floor vents. In this mode, outside air is pulled inside the vehicle. Recirculation cannot be selected while in the defrost mode. The air conditioning system runs automatically in this setting, unless the outside temperature is less than 4°C (40°F). Do not drive the vehicle until all the windows are clear.

 **(Air Conditioning):** Press to turn the air conditioning system on or off. An indicator light comes on when A/C is on. The air conditioning system does not operate when the outside temperature is below 4°C (40°F). The indicator light flashes three times and turns off when outside conditions affect air conditioning operation. This is normal.

For quicker cool down on hot days:

1. Open the windows to let hot air escape.
2. Select  mode.
3. Select  .
4. Select the coolest temperature.
5. Select the highest fan speed.
6. Close the windows after the hot air has escaped.
7. Once the vehicle's interior temperature is below the outside temperature, select  mode for faster cooling.

Using recirculation for long periods of time could cause the air inside of the vehicle to become too dry. To prevent this from happening, after the inside of the vehicle has cooled, turn the recirculation mode off.

The air conditioning system removes moisture from the air, so water might drip under the vehicle while idling or after turning off the engine. This is normal.

 **(Recirculation):** Press to turn the recirculation mode on or off. An indicator light comes on when recirculation is on. When the engine is turned off, the recirculation mode automatically turns off and must be re-selected when the engine is turned on again.

This mode recirculates and helps to quickly cool the air inside the vehicle. It can be used to prevent outside air and odors from entering the vehicle.

The recirculation mode cannot be used with floor, defrost, or defogging modes. If recirculation is selected in these modes, the indicator flashes three times and turns off. The air conditioning also comes on when this mode is activated unless the outside air temperature is less than 4°C (40°F). While in recirculation mode the windows can fog when the weather is cold and damp.

To clear the fog, select either the defog or defrost mode and increase the fan speed.

REAR (Rear Climate Control): Press to turn the rear heating and air conditioning on or off. See *Rear Climate Control System (Rear Climate Control Only)* on page 8-10 or *Rear Climate Control System (Rear Climate with Rear Seat Audio)* on page 8-11.

Rear Window Defogger

The rear window defogger uses a warming grid to remove fog from the rear window.

 **(Rear Window Defogger):** Press to turn the rear window defogger on or off. The rear window defogger stays on for about 10 minutes, before automatically turning off. The defogger will also turn off when the engine is turned off.

Do not drive the vehicle until all the windows are clear.

For vehicles with heated outside rearview mirrors, fog or frost is cleared from the surface of the mirror when  is pressed.

Notice: Do not use anything sharp on the inside of the rear window. If you do, you could cut or damage the warming grid, and the repairs would not be covered by the vehicle warranty. Do not attach a temporary vehicle license, tape, a decal or anything similar to the defogger grid.

8-4 Climate Controls

Dual Automatic Climate Control System

The heating, cooling, and ventilation in the vehicle can be controlled with this system.

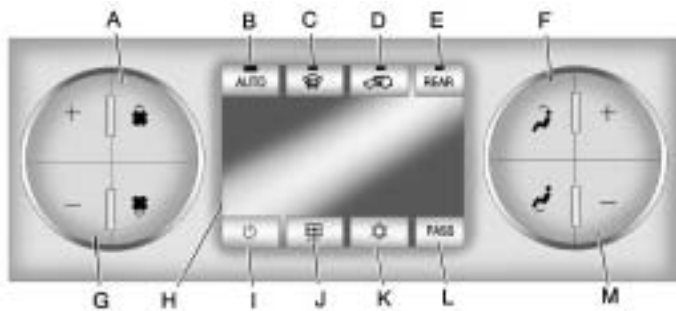

- A. Fan Control
- B. AUTO
- C. Defrost
- D. Recirculation
- E. REAR (Rear Climate Control)
- F. Air Delivery Mode Control
- G. Driver Side Temperature Control
- H. Display

- I. Power (On/Off)
- J. Rear Window Defogger
- K. Air Conditioning
- L. PASS (Passenger)
- M. Passenger Side Temperature Control

Display Function

Each time the temperature, mode, or fan control buttons are pressed, the climate control display shows that function along with the inside temperature setting. The outside temperature is displayed on the instrument panel cluster.

⏻ (On/Off): Press to turn the climate control system on or off. While the system is off, outside air still enters through the floor outlets, but the air delivery mode can be adjusted.

The climate control system will also turn on if either the fan control, defrost, AUTO, or air conditioning buttons are pressed.

Automatic Operation

AUTO (Automatic): The system automatically controls the inside temperature, the air delivery, and the fan speed.

To use automatic mode:

1. Press the AUTO button.

When AUTO is selected, the current temperature(s) selected and AUTO is shown on the display. The current air delivery mode and fan speed also appear for approximately five seconds.

When AUTO is selected, the air conditioning and air inlet are automatically controlled. The air conditioning runs when the outside temperature is over 4°C (40°F). The system is automatically set to outside air, unless it is hot outside and then the air inlet changes to recirculation mode to help

quickly cool the vehicle.

The recirculation indicator light will come on.

2. Set the temperature for the driver and passenger.

To find a comfortable setting, start with a 22°C (73°F) temperature setting and allow about 20 minutes for the system to regulate. Use the driver's side or passenger side temperature buttons to adjust the temperature setting as necessary. The system will remain at the selected setting. Choosing the warmest or coolest temperatures does not cause the vehicle to heat or cool more quickly.

To avoid blowing cold air in cold weather, the system delays turning on the fan until warm air is available. Press the fan control to override this delay and select the fan speed.

Temperature Control

The driver and passenger side temperature buttons are used to adjust the temperature of the air coming through the system. The temperature can be adjusted even if the system is turned off since outside air still enters the vehicle, unless the recirculation mode is selected. See "Recirculation" later in this section.

Driver Side Temperature

Control: Press the + or - buttons to increase or decrease the driver side temperature. The driver side temperature display will show the temperature setting.

Passenger Side Temperature



Control: Press the + or - buttons to increase or decrease the passenger side temperature. The passenger side display will show the temperature setting.



8-6 Climate Controls

PASS (Passenger): Press to set the passenger temperature to match the driver temperature setting. The PASS indicator will turn off. When the passenger temperature setting is different than the driver setting, the PASS indicator comes on.





Manual Operation

The air delivery mode or fan speed can be manually adjusted.

 /  (**Fan Control**): Press to increase or decrease the fan speed.

Pressing  or  while in automatic control places the fan speed under manual control.

The air delivery mode remains in automatic control. The fan setting still displays, but the word AUTO no longer displays, and the AUTO button indicator light turns off.

 /  (**Air Delivery Mode Control**): Press to change the direction of the airflow in the vehicle. Repeatedly press  or  until the desired mode appears on the display. Pressing a mode button while the system is off changes the air delivery mode without turning the system on. Press a mode button while in automatic control to place the system into manual control.

The air delivery mode setting still displays, but the word AUTO no longer displays, and the AUTO button indicator light turns off.

 (**Vent**): Air is directed to the instrument panel outlets.

 (**Bi-Level**): Air is divided between the instrument panel and floor outlets. Some air is directed towards the windshield and side window outlets. Cooler air is directed to the upper outlets and warmer air to the floor outlets.

 (**Floor**): Air is directed to the floor outlets, with some of the air directed to the windshield, side window, and second row floor outlets. In this mode, the system uses outside air.

 (**Defog**): This mode clears the windows of fog or moisture. Air is directed to the windshield, floor outlets, and side window vents. When this mode is selected, the system turns off recirculation and runs the air conditioning compressor unless the outside temperature is less than 4°C (40°F). Do not drive the vehicle until all the windows are clear.

 **(Defrost):** Press to turn the defrost on or off. This mode quickly clears the windshield of fog or frost. Air is directed to the windshield, side window, and floor vents. In this mode, outside air is pulled inside the vehicle. The air conditioning system runs automatically in this setting, unless the outside temperature is less than 4°C (40°F).

Do not drive the vehicle until all the windows are clear.

While in defrost mode, if the PASS button is pressed, the PASS button indicator flashes three times to show that the passenger climate control system cannot be activated. If the passenger temperature buttons are adjusted while in defrost mode, the driver temperature indicator will change. The passenger temperature will not be displayed.

When returning to bi-level, vent, or floor mode, the previous temperature settings displays in place of any change made while in defrost mode.

Air Conditioning

 **(Air Conditioning):** Press to turn the air conditioning (A/C) on and off. An indicator light comes on when A/C is on.

The A/C does not work when the outside temperature is below 4°C (40°F). If  is pressed the indicator flashes three times and turns off to show that the A/C mode is not available. If the A/C is on and the outside temperature drops below a temperature which is too cool for air conditioning to be effective, the A/C indicator turns off to show that the A/C mode has been canceled.

8-8 Climate Controls

On hot days, open the windows briefly to let hot inside air escape. This helps reduce the time it takes for the interior of the vehicle to cool down.

The air conditioning system removes moisture from the air, so water might drip under the vehicle while idling or after turning off the engine. This is normal.

 **(Recirculation):** Press to turn the recirculation mode on or off. An indicator light comes on when recirculation is on. When the engine is turned off, the recirculation mode automatically turns off and must be re-selected when the engine is turned on again.

This mode recirculates and helps to quickly cool the air inside the vehicle. It can be used to prevent outside air and odors from entering the vehicle.

The recirculation mode cannot be used with floor, defog, or defrosting modes. If recirculation is selected in these modes, the indicator flashes three times and turns off. The air conditioning compressor also comes on when this mode is activated. While in recirculation mode the windows can fog when the weather is cold and damp. To clear the fog, select either the defog or defrost mode and increase the fan speed.

REAR: Press to turn the rear heating and air conditioning on or off. See *Rear Climate Control System (Rear Climate Control Only)* on page 8-10 or *Rear Climate Control System (Rear Climate with Rear Seat Audio)* on page 8-11.

Rear Window Defogger

The rear window defogger uses a warming grid to remove fog from the rear window.

 **(Rear Window Defogger):** Press to turn the rear window defogger on or off. The rear window defogger stays on for about 10 minutes, before turning off. The defogger also turns off when the engine is turned off. Do not drive the vehicle until all the windows are clear.

For vehicles with heated outside rearview mirrors, fog or frost is cleared from the surface of the mirror when the rear window defog button is pressed.

Notice: Do not use a razor blade or sharp object to clear the inside rear window. Do not adhere anything to the defogger grid lines in the rear glass. These actions may damage the rear defogger. Repairs would not be covered by your warranty.

Sensors

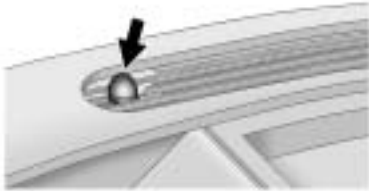

The solar sensor, located in the defrost grille in the middle of the instrument panel, monitors the solar heat. Do not cover the solar sensor or the system will not work properly.



The interior temperature sensor located on the instrument panel to the right of the steering column, measures the temperature of the air inside the vehicle.

There is also an exterior temperature sensor located behind the front grille. This sensor reads the outside air temperature and helps maintain the temperature inside the vehicle. Any cover on the front of the vehicle could cause a false reading in the displayed temperature.

The climate control system uses the information from these sensors to maintain comfort settings by adjusting the temperature, fan speed, and the air delivery mode. The system may also supply cooler air to the side of the vehicle facing the sun. The recirculation mode will also be used as needed to maintain cool outlet temperatures.

Rear Climate Control System (Rear Climate Control Only)



- A. Fan Control
- B. Temperature Control
- C. Air Delivery Mode Control

For vehicles with the rear climate control system, the controls are located on the rear of the center console. The system can also be controlled with the front controls.

Press the REAR button on the front climate control system to turn the rear climate control system on or off. An indicator comes on when the rear system is on. The system also turns on if any of the rear controls are adjusted.

Mimic Mode: This mode matches the rear climate control to the front climate control settings. It comes on when REAR is pressed.

Independent Mode: This mode directs rear seating airflow according to the settings of the rear controls. It comes on when any rear control is adjusted.

Fan Control: Turn clockwise or counterclockwise to increase or decrease the fan speed. Turn the knob to 0 to turn the fan off.

Temperature Control: Turn clockwise or counterclockwise to increase or decrease the airflow temperature.

Air Delivery Mode Control: Turn to the desired mode to change the airflow direction.

⚡ (Vent): Air is directed through the overhead outlets.

⚡ (Bi-Level): Air is directed through the rear floor outlets, as well as the overhead outlets.

⚡ (Floor): Air is directed through the floor outlets. The rear system floor outlets are located under the third row seats.

Rear Climate Control System (Rear Climate with Rear Seat Audio)

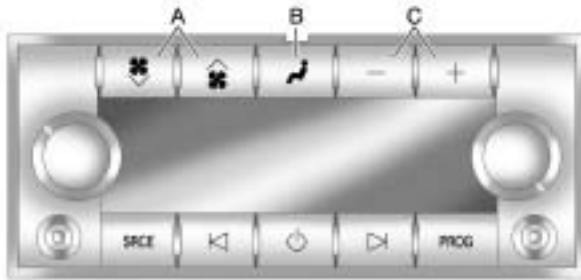

- A. Fan Control
- B. Air Delivery Mode Control
- C. Temperature Control



For vehicles with the rear climate control system, the controls are located on the rear of the center console.

Press the REAR button on the front climate control system to turn the rear climate control system on or off. The system also turns on if any of the rear controls, except for the  are pressed. An indicator comes on when the rear system is on.

The system can also be turned off, by pressing and holding the  button.

Mimic Mode: This mode matches the rear climate control to the front climate control settings. It comes on when REAR is pressed.

Independent Mode: This mode directs rear seating airflow according to the settings of the rear controls. It comes on when any rear control is adjusted.

  **(Fan Control):** Press the fan up or down buttons to increase or decrease the fan speed.

Temperature Control: Press + or - to increase or decrease the air temperature. The temperature settings will display in 0-12 increments, going from the coolest (0) to the warmest (12) setting.

 **(Air Delivery Mode Control):** Press to manually change the direction of the airflow. Repeatedly press the button until the desired mode appears on the display.

 **(Vent):** Air is directed through the overhead outlets.

 **(Bi-Level):** Air is directed through the rear floor outlets, as well as the overhead outlets.

 **(Floor):** Air is directed through the floor outlets. The rear system floor outlets are located under the third row seats.

Air Vents

Use the slider switch in the center of the outlet, to change the direction of the air flow. Use the thumbwheel near the outlet to control the amount of air flow or to shut off the airflow.

Keep all outlets open whenever possible for best system performance.

Operation Tips

- Clear away any ice, snow, or leaves from the air inlets at the base of the windshield that can block the flow of air into the vehicle.
- Use of non-GM approved hood deflectors can adversely affect the performance of the system.
- Keep the path under all seats clear of objects to help circulate the air inside the vehicle more effectively.
- If fogging reoccurs while in vent or bi-level modes with mild temperature throughout the vehicle, turn on the air conditioner to reduce windshield fogging.

Driving and Operating

Driving Information

Defensive Driving	9-2
Drunk Driving	9-2
Control of a Vehicle	9-3
Braking	9-3
Steering	9-4
Off-Road Recovery	9-5
Loss of Control	9-6
Driving on Wet Roads	9-7
Highway Hypnosis	9-8
Hill and Mountain Roads	9-8
Winter Driving	9-9
If the Vehicle is Stuck	9-11
Vehicle Load Limits	9-12

Starting and Operating

New Vehicle Break-In	9-17
Ignition Positions	9-18
Retained Accessory Power (RAP)	9-19
Starting the Engine	9-19
Engine Heater	9-20

Shifting Into Park	9-21
Shifting Out of Park	9-22
Parking Over Things That Burn	9-23

Engine Exhaust

Engine Exhaust	9-23
Running the Vehicle While Parked	9-24

Automatic Transmission

Automatic Transmission	9-24
Manual Mode	9-26
Tow/Haul Mode	9-27

Drive Systems

All-Wheel Drive	9-28
-----------------------	------

Brakes

Antilock Brake System (ABS)	9-28
Parking Brake	9-29
Brake Assist	9-30

Ride Control Systems

StabiliTrak System	9-30
--------------------------	------

Cruise Control

Cruise Control	9-32
----------------------	------

Object Detection Systems

Ultrasonic Parking Assist	9-35
Rear Vision Camera (RVC)	9-36

Fuel

Fuel	9-42
Recommended Fuel	9-43
Gasoline Specifications	9-43
California Fuel Requirements	9-43
Fuels in Foreign Countries	9-44
Fuel Additives	9-44
Filling the Tank	9-45
Filling a Portable Fuel Container	9-47

Towing

General Towing Information	9-47
Driving Characteristics and Towing Tips	9-48
Trailer Towing	9-53
Towing Equipment	9-57

Conversions and Add-Ons

Add-On Electrical Equipment	9-59
--------------------------------------	------

Driving Information

Defensive Driving

Defensive driving means “always expect the unexpected.” The first step in driving defensively is to wear your safety belt, see *Safety Belts on page 3-16*.

WARNING

Assume that other road users (pedestrians, bicyclists, and other drivers) are going to be careless and make mistakes. Anticipate what they might do and be ready. In addition:

- Allow enough following distance between you and the driver in front of you.
- Focus on the task of driving.

(Continued)

WARNING (Continued)

Driver distraction can cause collisions resulting in injury or possible death. These simple defensive driving techniques could save your life.

Drunk Driving

WARNING

Drinking and then driving is very dangerous. Your reflexes, perceptions, attentiveness, and judgment can be affected by even a small amount of alcohol. You can have a serious — or even fatal — collision if you drive after drinking. Do not drink and drive or ride with a driver who has been drinking. Ride home in a cab; or if you are with a group, designate a driver who will not drink.

Death and injury associated with drinking and driving is a global tragedy.

Alcohol affects four things that anyone needs to drive a vehicle: judgment, muscular coordination, vision, and attentiveness.

Police records show that almost 40 percent of all motor vehicle-related deaths involve alcohol. In most cases, these deaths are the result of someone who was drinking and driving. In recent years, more than 17,000 annual motor vehicle-related deaths have been associated with the use of alcohol, with about 250,000 people injured.

For persons under 21, it is against the law in every U.S. state to drink alcohol. There are good medical, psychological, and developmental reasons for these laws.

The obvious way to eliminate the leading highway safety problem is for people never to drink alcohol and then drive.

Medical research shows that alcohol in a person's system can make crash injuries worse, especially injuries to the brain, spinal cord, or heart. This means that when anyone who has been drinking — driver or passenger — is in a crash, that person's chance of being killed or permanently disabled is higher than if the person had not been drinking.

Control of a Vehicle

The following three systems help to control the vehicle while driving — brakes, steering, and accelerator. At times, as when driving on snow or ice, it is easy to ask more of those control systems than the tires and road can provide. Meaning, you can lose control of the vehicle. See *StabiliTrak System on page 9-30*.

Adding non-dealer/non-retailer accessories can affect vehicle performance. See *Accessories and Modifications on page 10-3*.

Braking

See *Brake System Warning Light on page 5-19*.

Braking action involves perception time and reaction time. Deciding to push the brake pedal is perception time. Actually doing it is reaction time.

Average reaction time is about three-fourths of a second. But that is only an average. It might be less with one driver and as long as two or three seconds or more with another. Age, physical condition, alertness, coordination, and eyesight all play a part. So do alcohol, drugs, and frustration. But even in three-fourths of a second, a vehicle moving at 100 km/h (60 mph) travels 20 m (66 ft). That could be a lot of distance in an emergency, so keeping enough space between the vehicle and others is important.

And, of course, actual stopping distances vary greatly with the surface of the road, whether it is pavement or gravel; the condition of the road, whether it is wet, dry, or icy; tire tread; the condition of the brakes; the weight of the vehicle; and the amount of brake force applied.

Avoid needless heavy braking. Some people drive in spurts — heavy acceleration followed by heavy braking — rather than keeping pace with traffic. This is a mistake. The brakes might not have time to cool between hard stops. The brakes will wear out much faster with a lot of heavy braking. Keeping pace with the traffic and allowing realistic following distances eliminates a lot of unnecessary braking. That means better braking and longer brake life.

9-4 Driving and Operating

If the engine ever stops while the vehicle is being driven, brake normally but do not pump the brakes. If the brakes are pumped, the pedal could get harder to push down. If the engine stops, there will still be some power brake assist but it will be used when the brake is applied. Once the power assist is used up, it can take longer to stop and the brake pedal will be harder to push.

Adding non-dealer/non-retailer accessories can affect vehicle performance. See *Accessories and Modifications* on page 10-3.

Steering

Power Steering

If power steering assist is lost because the engine stops or the power steering system is not functioning, the vehicle can be steered but it will take more effort.

Variable Effort Steering

The vehicle has a steering system that continuously adjusts the effort felt when steering at all vehicle speeds. It provides ease when parking, yet a firm, solid feel at highway speeds.

Steering Tips

It is important to take curves at a reasonable speed.

Traction in a curve depends on the condition of the tires and the road surface, the angle at which the curve is banked, and vehicle speed. While in a curve, speed is the one factor that can be controlled.

If there is a need to reduce speed, do it before entering the curve, while the front wheels are straight.

Try to adjust the speed so you can drive through the curve. Maintain a reasonable, steady speed. Wait to accelerate until out of the curve, and then accelerate gently into the straightaway.

Steering in Emergencies

There are times when steering can be more effective than braking. For example, you come over a hill and find a truck stopped in your lane, or a car suddenly pulls out from nowhere, or a child darts out from between parked cars and stops right in front of you. These problems can be avoided by braking — if you can stop in time. But sometimes you cannot stop in time because there is no room. That is the time for evasive action — steering around the problem.

The vehicle can perform very well in emergencies like these. First apply the brakes. See *Braking on page 9-3*. It is better to remove as much speed as possible from a collision. Then steer around the problem, to the left or right depending on the space available.



An emergency like this requires close attention and a quick decision. If holding the steering wheel at the recommended 9 and 3 o'clock positions, it can be turned a full 180 degrees very quickly without removing either hand. But you have to act fast, steer quickly, and just as quickly straighten the wheel once you have avoided the object.

The fact that such emergency situations are always possible is a good reason to practice defensive driving at all times and wear safety belts properly.

Off-Road Recovery

The vehicle's right wheels can drop off the edge of a road onto the shoulder while driving.



If the level of the shoulder is only slightly below the pavement, recovery should be fairly easy.

9-6 Driving and Operating

Ease off the accelerator and then, if there is nothing in the way, steer so that the vehicle straddles the edge of the pavement. Turn the steering wheel 8 to 13 cm (3 to 5 inches), about one-eighth turn, until the right front tire contacts the pavement edge. Then turn the steering wheel to go straight down the roadway.

Loss of Control

Let us review what driving experts say about what happens when the three control systems — brakes, steering, and acceleration — do not have enough friction where the tires meet the road to do what the driver has asked.

In any emergency, do not give up. Keep trying to steer and constantly seek an escape route or area of less danger.

Skidding

In a skid, a driver can lose control of the vehicle. Defensive drivers avoid most skids by taking reasonable care suited to existing conditions, and by not overdriving those conditions. But skids are always possible.

The three types of skids correspond to the vehicle's three control systems. In the braking skid, the wheels are not rolling. In the steering or cornering skid, too much speed or steering in a curve causes tires to slip and lose cornering force. And in the acceleration skid, too much throttle causes the driving wheels to spin.

If the vehicle starts to slide, ease your foot off the accelerator pedal and quickly steer the way you want the vehicle to go. If you start steering quickly enough, the vehicle may straighten out. Always be ready for a second skid if it occurs.

Of course, traction is reduced when water, snow, ice, gravel, or other material is on the road. For safety, slow down and adjust your driving to these conditions. It is important to slow down on slippery surfaces because stopping distance is longer and vehicle control more limited.

While driving on a surface with reduced traction, try your best to avoid sudden steering, acceleration, or braking, including reducing vehicle speed by shifting to a lower gear. Any sudden changes could cause the tires to slide. You might not realize the surface is slippery until the vehicle is skidding. Learn to recognize warning clues — such as enough water, ice, or packed snow on the road to make a mirrored surface — and slow down when you have any doubt.

Remember: Antilock brakes help avoid only the braking skid.

Driving on Wet Roads

Rain and wet roads can reduce vehicle traction and affect your ability to stop and accelerate. Always drive slower in these types of driving conditions and avoid driving through large puddles and deep-standing or flowing water.

WARNING

Wet brakes can cause crashes. They might not work as well in a quick stop and could cause pulling to one side. You could lose control of the vehicle.

After driving through a large puddle of water or a car/vehicle wash, lightly apply the brake pedal until the brakes work normally.

(Continued)

WARNING (Continued)

Flowing or rushing water creates strong forces. Driving through flowing water could cause your vehicle to be carried away. If this happens, you and other vehicle occupants could drown. Do not ignore police warnings and be very cautious about trying to drive through flowing water.

Hydroplaning

Hydroplaning is dangerous. Water can build up under your vehicle's tires so they actually ride on the water. This can happen if the road is wet enough and you are going fast enough. When your vehicle is hydroplaning, it has little or no contact with the road.

There is no hard and fast rule about hydroplaning. The best advice is to slow down when the road is wet.

Other Rainy Weather Tips

Besides slowing down, other wet weather driving tips include:

- Allow extra following distance.
- Pass with caution.
- Keep windshield wiping equipment in good shape.
- Keep the windshield washer fluid reservoir filled.
- Have good tires with proper tread depth. See *Tires on page 10-36*.
- Turn off cruise control.

Highway Hypnosis

Always be alert and pay attention to your surroundings while driving. If you become tired or sleepy, find a safe place to park your vehicle and rest.

Other driving tips include:

- Keep the vehicle well ventilated.
- Keep interior temperature cool.
- Keep your eyes moving — scan the road ahead and to the sides.
- Check the rearview mirror and vehicle instruments often.

Hill and Mountain Roads

Driving on steep hills or through mountains is different than driving on flat or rolling terrain. Tips for driving in these conditions include:

- Keep the vehicle serviced and in good shape.
- Check all fluid levels and brakes, tires, cooling system, and transmission.
- Going down steep or long hills, shift to a lower gear.

WARNING

If you do not shift down, the brakes could get so hot that they would not work well. You would then have poor braking or even none going down a hill. You could crash. Shift down to let the engine assist the brakes on a steep downhill slope.

WARNING

Coasting downhill in N (Neutral) or with the ignition off is dangerous. The brakes will have to do all the work of slowing down and they could get so hot that they would not work well. You would then have poor braking or even none going down a hill. You could crash. Always have the engine running and the vehicle in gear when going downhill.

- Stay in your own lane. Do not swing wide or cut across the center of the road. Drive at speeds that let you stay in your own lane.
- Top of hills: Be alert — something could be in your lane (stalled car, accident).
- Pay attention to special road signs (falling rocks area, winding roads, long grades, passing or no-passing zones) and take appropriate action.

Winter Driving

Driving on Snow or Ice

Drive carefully when there is snow or ice between the tires and the road, creating less traction or grip. Wet ice can occur at about 0°C (32°F) when freezing rain begins to fall, resulting in even less traction. Avoid driving on wet ice or in freezing rain until roads can be treated with salt or sand.

Drive with caution, whatever the condition. Accelerate gently so traction is not lost. Accelerating too quickly causes the wheels to spin and makes the surface under the tires slick, so there is even less traction.

Try not to break the fragile traction. If you accelerate too fast, the drive wheels will spin and polish the surface under the tires even more.

The *Antilock Brake System (ABS)* on page 9-28 improves vehicle stability during hard stops on slippery roads, but apply the brakes sooner than when on dry pavement.

Allow greater following distance on any slippery road and watch for slippery spots. Icy patches can occur on otherwise clear roads in shaded areas. The surface of a curve or an overpass can remain icy when the surrounding roads are clear. Avoid sudden steering maneuvers and braking while on ice.

Turn off cruise control, if equipped, on slippery surfaces.

Blizzard Conditions

Being stuck in snow can be in a serious situation. Stay with the vehicle unless there is help nearby. If possible, use the *Roadside Assistance Program on page 13-6*. To get help and keep everyone in the vehicle safe:

- Turn on the hazard warning flashers.
- Tie a red cloth to an outside mirror.

WARNING

Snow can trap engine exhaust under the vehicle. This may cause exhaust gases to get inside. Engine exhaust contains carbon monoxide (CO) which cannot be seen or smelled. It can cause unconsciousness and even death.

(Continued)

WARNING (Continued)

If the vehicle is stuck in the snow:

- Clear away snow from around the base of your vehicle, especially any that is blocking the exhaust pipe.
- Check again from time to time to be sure snow does not collect there.
- Open a window about 5 cm (two inches) on the side of the vehicle that is away from the wind to bring in fresh air.
- Fully open the air outlets on or under the instrument panel.
- Adjust the Climate Control system to a setting that circulates the air inside the vehicle and set the fan speed to the highest setting. See Climate Control System in the Index.

(Continued)

WARNING (Continued)

For more information about carbon monoxide, see *Engine Exhaust on page 9-23*.

Snow can trap exhaust gases under your vehicle. This can cause deadly CO (carbon monoxide) gas to get inside. CO could overcome you and kill you. You cannot see it or smell it, so you might not know it is in your vehicle. Clear away snow from around the base of your vehicle, especially any that is blocking the exhaust.

Run the engine for short periods only as needed to keep warm, but be careful.

To save fuel, run the engine for only short periods as needed to warm the vehicle and then shut the engine off and close the window most of the way to save heat. Repeat this until help arrives but only when you feel really uncomfortable from the cold. Moving about to keep warm also helps.

If it takes some time for help to arrive, now and then when you run the engine, push the accelerator pedal slightly so the engine runs faster than the idle speed. This keeps the battery charged to restart the vehicle and to signal for help with the headlamps. Do this as little as possible to save fuel.

If the Vehicle is Stuck

Slowly and cautiously spin the wheels to free the vehicle when stuck in sand, mud, ice, or snow.

If the vehicle has a traction system, it can often help to free a stuck vehicle. Refer to the vehicle's traction system in the Index. If stuck too severely for the traction system to free the vehicle, turn the traction system off and use the rocking method.

WARNING

If the vehicle's tires spin at high speed, they can explode, and you or others could be injured. The vehicle can overheat, causing an engine compartment fire or other damage. Spin the wheels as little as possible and avoid going above 55 km/h (35 mph) as shown on the speedometer.

For information about using tire chains on the vehicle, see *Tire Chains* on page 10-57.

Rocking the Vehicle to Get it Out

Turn the steering wheel left and right to clear the area around the front wheels. Turn off any traction or stability system. Shift back and forth between R (Reverse) and a forward gear, spinning the wheels as little as possible. To prevent transmission wear, wait until the wheels stop spinning before shifting gears. Release the accelerator pedal while shifting, and press lightly on the accelerator pedal when the transmission is in gear. Slowly spinning the wheels in the forward and reverse directions causes a rocking motion that could free the vehicle. If that does not get the vehicle out after a few tries, it might need to be towed out. If the vehicle does need to be towed out, see *Towing the Vehicle* on page 10-83.

Vehicle Load Limits

It is very important to know how much weight your vehicle can carry. This weight is called the vehicle capacity weight and includes the weight of all occupants, cargo, and all nonfactory-installed options. Two labels on your vehicle show how much weight it may properly carry, the Tire and Loading Information label and the Certification/Tire label.

WARNING

Do not load the vehicle any heavier than the Gross Vehicle Weight Rating (GVWR), or either the maximum front or rear Gross Axle Weight Rating (GAWR). If you do, parts on the vehicle can break, and it can change the way the vehicle handles. These could cause you to lose control and crash. Also, overloading can shorten the life of the vehicle.

Tire and Loading Information Label

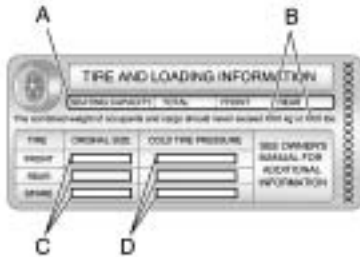

Example Label

A vehicle specific Tire and Loading Information label is attached to the center pillar (B-pillar) of your vehicle. With the driver's door open, you will find the label attached below the door lock post (striker). The tire and loading information label shows the

number of occupant seating positions (A), and the maximum vehicle capacity weight (B) in kilograms and pounds.

The Tire and Loading Information label also shows the size of the original equipment tires (C) and the recommended cold tire inflation pressures (D). For more information on tires and inflation see *Tires on page 10-36* and *Tire Pressure on page 10-43*.

There is also important loading information on the vehicle Certification/Tire label. It tells you the Gross Vehicle Weight Rating (GVWR) and the Gross Axle Weight Rating (GAWR) for the front and rear axle. See "Certification/Tire Label" later in this section.

Steps for Determining Correct Load Limit

1. Locate the statement "The combined weight of occupants and cargo should never exceed XXX kg or XXX lbs" on your vehicle's placard.
2. Determine the combined weight of the driver and passengers that will be riding in your vehicle.

9-14 Driving and Operating

3. Subtract the combined weight of the driver and passengers from XXX kg or XXX lbs.
4. The resulting figure equals the available amount of cargo and luggage load capacity. For example, if the “XXX” amount equals 1400 lbs and there will be five 150 lb passengers in your vehicle, the amount of available cargo and luggage load capacity is 650 lbs (1400 – 750 (5 x 150) = 650 lbs).

5. Determine the combined weight of luggage and cargo being loaded on the vehicle. That weight may not safely exceed the available cargo and luggage load capacity calculated in Step 4.
6. If your vehicle will be towing a trailer, the load from your trailer will be transferred to your vehicle. Consult this manual to determine how this reduces the available cargo and luggage load capacity for your vehicle.

See *Trailer Towing* on page 9-53 for important information on towing a trailer, towing safety rules and trailering tips.

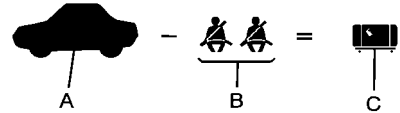

Example 1

- A. Vehicle Capacity Weight for Example 1 = 453 kg (1,000 lbs).
- B. Subtract Occupant Weight @ 68 kg (150 lbs) × 2 = 136 kg (300 lbs).
- C. Available Occupant and Cargo Weight = 317 kg (700 lbs).

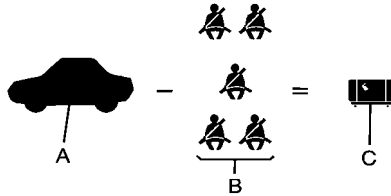

Example 2

- A. Vehicle Capacity Weight for Example 2 = 453 kg (1,000 lbs).
- B. Subtract Occupant Weight @ 68 kg (150 lbs) × 5 = 340 kg (750 lbs).
- C. Available Cargo Weight = 113 kg (250 lbs).

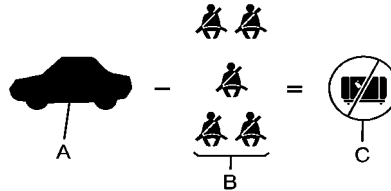

Example 3

- A. Vehicle Capacity Weight for Example 3 = 453 kg (1,000 lbs).
- B. Subtract Occupant Weight @ 91 kg (200 lbs) × 5 = 453 kg (1,000 lbs).
- C. Available Cargo Weight = 0 kg (0 lbs).

Refer to your vehicle's tire and loading information label for specific information about your vehicle's capacity weight and

seating positions. The combined weight of the driver, passengers, and cargo should never exceed your vehicle's capacity weight.

Certification/Tire Label



Label Example

A vehicle specific Certification/ Tire label is attached to the rear edge of the driver's door.

The label shows the gross weight capacity of your vehicle. This is called the Gross Vehicle Weight Rating (GVWR).

9-16 Driving and Operating

The GVWR includes the weight of the vehicle, all occupants, fuel, and cargo.

The Certification/Tire label also tells you the maximum weights for the front and rear axles, called the Gross Axle Weight Rating (GAWR). To find out the actual loads on your front and rear axles, you need to go to a weigh station and weigh your vehicle. Your dealer/retailer can help you with this. Be sure to spread out your load equally on both sides of the centerline.

Never exceed the GVWR for your vehicle or the GAWR for either the front or rear axle.

WARNING

Do not load the vehicle any heavier than the Gross Vehicle Weight Rating (GVWR), or either the maximum front or rear Gross Axle Weight Rating (GAWR). If you do, parts on the vehicle can break, and it can change the way the vehicle handles. These could cause you to lose control and crash. Also, overloading can shorten the life of the vehicle.

Notice : Overloading the vehicle may cause damage. Repairs would not be covered by the vehicle warranty. Do not overload the vehicle.

If you put things inside your vehicle — like suitcases, tools, packages, or anything else, they will go as fast as the vehicle goes. If you have to stop or turn quickly, or if there is a crash, they will keep going.

 **WARNING**

Things you put inside your vehicle can strike and injure people in a sudden stop or turn, or in a crash.

- Put things in the cargo area of your vehicle. Try to spread the weight evenly.
- Never stack heavier things, like suitcases, inside the vehicle so that some of them are above the tops of the seats.
- Do not leave an unsecured child restraint in your vehicle.
- When you carry something inside the vehicle, secure it whenever you can.
- Do not leave a seat folded down unless you need to.

Starting and Operating

New Vehicle Break-In

Notice: The vehicle does not need an elaborate break-in. But it will perform better in the long run if you follow these guidelines:

- If you have all-wheel drive, keep your speed at 88 km/h (55 mph) or less for the first 805 km (500 miles).
- Do not drive at any one constant speed, fast or slow, for the first 805 km (500 miles). Do not make full-throttle starts. Avoid downshifting to brake or slow the vehicle.

- Avoid making hard stops for the first 322 km (200 miles) or so. During this time the new brake linings are not yet broken in. Hard stops with new linings can mean premature wear and earlier replacement. Follow this breaking-in guideline every time you get new brake linings.
- Do not tow a trailer during break-in. See *Driving Characteristics and Towing Tips* on page 9-48 for the trailer towing capabilities of your vehicle and more information.

Following break-in, engine speed and load can be gradually increased.

Ignition Positions



The ignition switch has four different positions.

In order to shift out of P (Park), the ignition must be in ON/RUN or ACC/ACCESSORY and the brake pedal must be applied.

Notice: Using a tool to force the key to turn in the ignition could cause damage to the switch or break the key. Use the correct key, make sure it is all the way in, and turn it only with your hand. If the key cannot be turned by hand, see your dealer/retailer.

○ (LOCK/OFF): This position locks the ignition and transmission. The key can be removed in LOCK/OFF.

The shift lever must be in P (Park) to turn the ignition switch to LOCK/OFF.

The steering can bind with the wheels turned off center. If this happens, move the steering wheel from right to left while turning the key to ACC/ACCESSORY. If this doesn't work, then the vehicle needs service.

ACC (ACC/ACCESSORY): This is the position in which you can operate the electrical accessories or

items plugged into the accessory power outlets. This position unlocks the ignition and steering wheel. Use this position if the vehicle must be pushed or towed.

| (ON/RUN): This position can be used to operate the electrical accessories and to display some instrument panel warning and indicator lights. The switch stays in this position when the engine is running. The transmission is also unlocked in this position. If you leave the key in the ACC/ACCESSORY or ON/RUN position with the engine off, the battery could be drained. You may not be able to start the vehicle if the battery is allowed to drain for an extended period of time.

Ⓢ (START): This is the position that starts the engine. When the engine starts, release the key. The ignition switch will return to ON/RUN for driving.

Retained Accessory Power (RAP)

These vehicle accessories can be used for up to 10 minutes after the ignition key is turned off:

- Audio System
- Power Windows
- Sunroof (if equipped)

Power to the windows and sunroof will work up to 10 minutes or until a door is opened.

The radio continues to work for 10 minutes or until the driver's door is opened.

For an additional 10 minutes of operation, close all the doors and turn the key to ON/RUN and then back to LOCK/OFF.

All these features will work when the key is in the ON/RUN or ACC/ACCESSORY positions.

Starting the Engine

Move the shift lever to P (Park) or N (Neutral). The engine will not start in any other position. To restart the engine when the vehicle is already moving, use N (Neutral) only.

Notice: Do not try to shift to P (Park) if the vehicle is moving. If you do, you could damage the transmission. Shift to P (Park) only when the vehicle is stopped.

Starting Procedure

1. With your foot off the accelerator pedal, turn the ignition to START. When the engine starts, let go of the key. The idle speed will slow down as the engine warms. Do not race the engine immediately after starting it. Operate the engine and transmission gently to allow the oil to warm up and lubricate all moving parts.

The vehicle has a Computer-Controlled Cranking System. This feature assists in

starting the engine and protects components. If the ignition key is turned to the START position, and then released when the engine begins cranking, the engine will continue cranking for a few seconds or until the vehicle starts. If the engine does not start and the key is held in START, cranking will be stopped after 15 seconds to prevent cranking motor damage. To prevent gear damage, this system also prevents cranking if the engine is already running. Engine cranking can be stopped by turning the ignition switch to the ACC/ACCESSORY or LOCK/OFF position.

Notice: Cranking the engine for long periods of time, by returning the key to the START position immediately after cranking has ended, can overheat and damage the cranking motor, and drain the battery. Wait at least 15 seconds between each try, to let the cranking motor cool down.

2. If the engine does not start after 5-10 seconds, especially in very cold weather (below 0°F or -18°C), it could be flooded with too much gasoline. Try pushing the accelerator pedal all the way to the floor and holding it there as you hold the key in START for up to a maximum of 15 seconds. Wait at least 15 seconds between each try, to allow the cranking motor to cool down. When the engine starts, let go of the key and accelerator. If the vehicle starts briefly but then stops again, repeat these steps. This clears the extra gasoline from the engine. Do not race the engine immediately after starting it. Operate the engine and transmission gently until the oil warms up and lubricates all moving parts.

Notice: The engine is designed to work with the electronics in the vehicle. If you add electrical parts or accessories, you could change the way the engine operates. Before adding electrical equipment, check with your dealer/retailer. If you do not, the engine might not perform properly. Any resulting damage would not be covered by the vehicle warranty.

Engine Heater

The engine coolant heater can provide easier starting and better fuel economy during engine warm-up in cold weather conditions at or below 0°F (-18°C). Vehicles with an engine coolant heater should be plugged in at least four hours before starting. Some models may have an internal thermostat in the cord which will prevent engine coolant heater operation at temperatures above 0°F (-18°C).

To Use the Engine Coolant Heater

1. Turn off the engine.
2. Open the hood and unwrap the electrical cord. The cord is located on the driver side of the engine compartment. It is routed around the windshield washer fluid reservoir.
3. Plug the cord into a normal, grounded 110-volt AC outlet.

WARNING

Plugging the cord into an ungrounded outlet could cause an electrical shock. Also, the wrong kind of extension cord could overheat and cause a fire. You could be seriously injured. Plug the cord into a properly grounded three-prong 110-volt AC outlet. If the cord will not reach, use a heavy-duty three-prong extension cord rated for at least 15 amps.

4. Before starting the engine, be sure to unplug and store the cord as it was before to keep it away from moving engine parts. If you do not, it could be damaged.

The length of time the heater should remain plugged in depends on several factors. Ask a dealer/retailer in the area where you will be parking the vehicle for the best advice on this.

Shifting Into Park

WARNING

It can be dangerous to get out of the vehicle if the shift lever is not fully in P (Park) with the parking brake firmly set. The vehicle can roll. If you have left the engine running, the vehicle can move suddenly. You or others could be injured. To be sure the vehicle will not move, even when you are on

(Continued)

WARNING (Continued)

fairly level ground, use the steps that follow. If you are pulling a trailer, see *Driving Characteristics and Towing Tips on page 9-48*.

1. Hold the brake pedal down and set the parking brake. See *Parking Brake on page 9-29* for more information.
2. Move the shift lever into P (Park) by holding in the button on the shift lever and pushing the shift lever all the way toward the front of the vehicle.
3. Turn the ignition key to LOCK/OFF.
4. Remove the key and take it with you. If you can leave the vehicle with the ignition key in your hand, the vehicle is in P (Park).

Leaving the Vehicle with the Engine Running

WARNING

It can be dangerous to leave the vehicle with the engine running. The vehicle could move suddenly if the shift lever is not fully in P (Park) with the parking brake firmly set. And, if you leave the vehicle with the engine running, it could overheat and even catch fire. You or others could be injured. Do not leave the vehicle with the engine running.

If you have to leave the vehicle with the engine running, be sure the vehicle is in P (Park) and the parking brake is firmly set before you leave it. After you have moved the shift lever into P (Park), hold the regular brake pedal down. Then, see if you can move the shift lever away from P (Park) without first pushing the button.

9-22 Driving and Operating

If you can, it means that the shift lever was not fully locked in P (Park).

Torque Lock

Torque lock is when the weight of the vehicle puts too much force on the parking pawl in the transmission. This happens when parking on a hill and shifting the transmission into P (Park) is not done properly and then it is difficult to shift out of P (Park). To prevent torque lock, set the parking brake and then shift into P (Park). To find out how, see “Shifting Into Park” listed previously.

If torque lock does occur, your vehicle may need to be pushed uphill by another vehicle to relieve the parking pawl pressure, so you can shift out of P (Park).

Shifting Out of Park

The vehicle is equipped with an electronic shift lock release system. The shift lock release is designed to:

- Prevent ignition key removal unless the shift lever is in P (Park) with the shift lever button fully released, and
- Prevent movement of the shift lever out of P (Park), unless the ignition is in ON/RUN or ACC/ACCESSORY and the regular brake pedal is applied.

The shift lock release is always functional except in the case of an uncharged or low voltage (less than 9 volt) battery.

If the vehicle has an uncharged battery or a battery with low voltage, try charging or jump starting the battery. See *Jump Starting on page 10-79* for more information.

To shift out of P (Park):

1. Apply the brake pedal.
2. Press the shift lever button.
3. Move the shift lever to the desired position.

If you still are unable to shift out of P (Park):

1. Fully release the shift lever button.
2. While holding down the brake pedal, press the shift lever button again.
3. Move the shift lever to the desired position.

If you still cannot move the shift lever from P (Park), see your dealer/retailer.

Parking Over Things That Burn

WARNING

Things that can burn could touch hot exhaust parts under the vehicle and ignite. Do not park over papers, leaves, dry grass, or other things that can burn.

Engine Exhaust

WARNING

Engine exhaust contains Carbon Monoxide (CO) which cannot be seen or smelled. Exposure to CO can cause unconsciousness and even death.

Exhaust may enter the vehicle if:

- The vehicle idles in areas with poor ventilation (parking garages, tunnels, deep snow that may block underbody airflow or tail pipes).
- The exhaust smells or sounds strange or different.
- The exhaust system leaks due to corrosion or damage.
- The vehicle's exhaust system has been modified, damaged or improperly repaired.

(Continued)

WARNING (Continued)

- There are holes or openings in the vehicle body from damage or after-market modifications that are not completely sealed.

If unusual fumes are detected or if it is suspected that exhaust is coming into the vehicle:

- Drive it only with the windows completely down.
- Have the vehicle repaired immediately.

Never park the vehicle with the engine running in an enclosed area such as a garage or a building that has no fresh air ventilation.

Running the Vehicle While Parked

It is better not to park with the engine running. But if you ever have to, here are some things to know.

WARNING

Idling a vehicle in an enclosed area with poor ventilation is dangerous. Engine exhaust may enter the vehicle. Engine exhaust contains Carbon Monoxide (CO) which cannot be seen or smelled. It can cause unconsciousness and even death. Never run the engine in an enclosed area that has no fresh air ventilation. For more information, see *Engine Exhaust* on page 9-23.

WARNING

It can be dangerous to get out of the vehicle if the automatic transmission shift lever is not fully in P (Park) with the parking brake firmly set. The vehicle can roll. Do not leave the vehicle when the engine is running unless you have to. If you have left the engine running, the vehicle can move suddenly. You or others could be injured. To be sure the vehicle will not move, even when you are on fairly level ground, always set the parking brake and move the shift lever to P (Park).

Follow the proper steps to be sure the vehicle will not move. See *Shifting Into Park* on page 9-21.

If parking on a hill and pulling a trailer, see *Driving Characteristics and Towing Tips* on page 9-48.

Automatic Transmission

The automatic transmission has a shift lever located on the console between the seats.



P (Park): This position locks the front wheels. It is the best position to use when starting the engine because the vehicle cannot move easily.

 **WARNING**

It is dangerous to get out of the vehicle if the shift lever is not fully in P (Park) with the parking brake firmly set. The vehicle can roll.

Do not leave the vehicle when the engine is running unless you have to. If you have left the engine running, the vehicle can move suddenly. You or others could be injured. To be sure the vehicle will not move, even when you are on fairly level ground, always set the parking brake and move the shift lever to P (Park). See *Shifting Into Park* on page 9-21. If you are pulling a trailer, see *Driving Characteristics and Towing Tips* on page 9-48.

Make sure the shift lever is fully in P (Park) before starting the engine. The vehicle has an automatic transmission shift lock control

system. You must fully apply the regular brake first and then press the shift lever button before shifting from P (Park) when the ignition key is in ON/RUN. If you cannot shift out of P (Park), ease pressure on the shift lever, then push the shift lever all the way into P (Park) as you maintain brake application. Then press the shift lever button and move the shift lever into another gear. See *Shifting Out of Park* on page 9-22.

R (Reverse): Use this gear to back up.

Notice: Shifting to R (Reverse) while the vehicle is moving forward could damage the transmission. The repairs would not be covered by the vehicle warranty. Shift to R (Reverse) only after the vehicle is stopped.

To rock the vehicle back and forth to get out of snow, ice or sand without damaging the transmission, see *If the Vehicle is Stuck* on page 9-11.

N (Neutral): In this position, the engine does not connect with the wheels. To restart the engine when the vehicle is already moving, use N (Neutral) only. Also, use N (Neutral) when the vehicle is being towed.

 **WARNING**

Shifting into a drive gear while the engine is running at high speed is dangerous. Unless your foot is firmly on the brake pedal, the vehicle could move very rapidly. You could lose control and hit people or objects. Do not shift into a drive gear while the engine is running at high speed.

Notice: Shifting out of P (Park) or N (Neutral) with the engine running at high speed may damage the transmission. The repairs would not be covered by the vehicle warranty. Be sure the engine is not running at high speed when shifting the vehicle.

D (Drive): This position is for normal driving. It provides the best fuel economy. If you need more power for passing, and you are:

- Going less than 56 km/h (35 mph), push the accelerator pedal about halfway down.
- Going about 56 km/h (35 mph) or more, push the accelerator all the way down.

Notice: If the vehicle seems to accelerate slowly or not shift gears when you go faster, and you continue to drive the vehicle that way, you could damage the transmission. Have the vehicle serviced right away. You can drive in L (Low) when you are driving less than 56 km/h (35 mph) and D (Drive) for higher speeds until then.

If the vehicle is stopped on a hill, with your foot off the brake pedal, the vehicle may roll. This is normal and is due to the torque converter

designed to improve fuel economy and performance. Use the brake to hold the vehicle on a hill. Do not use the accelerator pedal.

L (Low): This position gives you access to gear ranges. This provides more engine braking but lower fuel economy than D (Drive). You can use it on very steep hills, or in deep snow or mud.

Manual Mode

Electronic Range Select (ERS) Mode

ERS mode allows you to choose the top-gear limit of the transmission and the vehicle's speed while driving down hill or towing a trailer. The vehicle has an electronic shift position indicator within the instrument panel cluster. When using the ERS Mode a number will display next to the L, indicating the current gear that has been selected.

To use this feature:

1. Move the shift lever to L (Low).
2. Press the plus/minus button located on the shift lever, to increase or decrease the gear range available.

When you shift from D (Drive) to L (Low), the transmission will shift to a pre-determined lower gear range. The highest gear available for this pre-determined range is displayed next to the L in the DIC. See *Driver Information Center (DIC) (With DIC Buttons)* on page 5-24 or *Driver Information Center (DIC) (Without DIC Buttons)* on page 5-29 for more information. The number displayed in the DIC is the highest gear that the transmission will be allowed to operate in. This means that all gears below that number are available. For example, when 4 (Fourth) is shown next to the L, 1 (First) through 4 (Fourth) gears are automatically shifted by the vehicle.

The transmission will not shift into 5 (Fifth) until the + (Plus) button is used or you shift back into D (Drive).

While in L (Low), the transmission will prevent shifting to a lower gear range if the engine speed is too high. You have a brief period of time to slow the vehicle. If vehicle speed is not reduced within the time allowed, the lower gear range shift will not be completed. You must further slow the vehicle, then press the - (Minus) button to the desired lower gear range.

Automatic Engine Grade braking is not available when the ERS is active. It is available in D (Drive) for both normal and Tow/Haul mode. While using the ERS, cruise control and the tow/haul mode can be used. See Tow/Haul Mode following.

Tow/Haul Mode

 (Tow/Haul): The vehicle may have a Tow/Haul mode.

The button is located on the instrument panel under the climate controls.

Push the button to activate the system. Push it again to deactivate the system. You can use this feature to assist when towing or hauling a heavy load.

When Tow/Haul is activated the Tow/Haul symbol will come on the instrument panel cluster. See "Tow/Haul Mode" under *Driving Characteristics and Towing Tips on page 9-48* for more information.

Automatic Engine Grade Braking

Automatic Engine Grade Braking assists when driving on a downhill grade. It maintains vehicle speed by automatically implementing a shift schedule that uses the engine and the transmission to slow the vehicle. The system will automatically command downshifts to reduce vehicle speed, until the brake pedal is no longer being pressed.

While in the Electronic Range Select (ERS) mode, grade braking is deactivated, allowing the driver to select a range and limiting the highest gear available. Grade braking is available for normal driving and in Tow/Haul mode.

See *Automatic Transmission on page 9-24*.

Drive Systems

All-Wheel Drive

With this feature, engine power is always sent to all four wheels. It is fully automatic, and adjusts itself as needed for road conditions.

When using a compact spare tire on an AWD vehicle, the system automatically detects the compact spare and disables AWD. To restore AWD operation and prevent excessive wear on system, replace the compact spare with a full-size tire as soon as possible. See *Compact Spare Tire on page 10-77* for more information.

Brakes

Antilock Brake System (ABS)

This vehicle has the Antilock Brake System (ABS), an advanced electronic braking system that helps prevent a braking skid.

When the engine is started and the vehicle begins to drive away, ABS checks itself. A momentary motor or clicking noise might be heard while this test is going on, and it might even be noticed that the brake pedal moves a little. This is normal.



If there is a problem with ABS, this warning light stays on. See *Antilock Brake System (ABS) Warning Light on page 5-20*.

If driving safely on a wet road and it becomes necessary to slam on the brakes and continue braking to avoid a sudden obstacle, a computer senses that the wheels are slowing down. If one of the wheels is about to stop rolling, the computer will separately work the brakes at each wheel.

ABS can change the brake pressure to each wheel, as required, faster than any driver could. This can help the driver steer around the obstacle while braking hard.

As the brakes are applied, the computer keeps receiving updates on wheel speed and controls braking pressure accordingly.

Remember: ABS does not change the time needed to get a foot up to the brake pedal or always decrease stopping distance. If you get too close to the vehicle in front of you, there will not be enough time to apply the brakes if that vehicle suddenly slows or stops. Always leave enough room up ahead to stop, even with ABS.

Using ABS

Do not pump the brakes. Just hold the brake pedal down firmly and let ABS work. The ABS pump or motor might be heard operating, and the brake pedal might be felt to pulsate, but this is normal.

Braking in Emergencies

ABS allows the driver to steer and brake at the same time. In many emergencies, steering can help more than even the very best braking.

Parking Brake

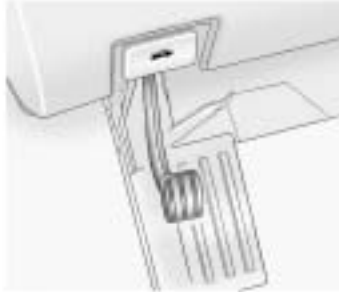

To set the parking brake, hold the regular brake pedal down, then push the parking brake pedal down.

If the ignition is on, the brake system warning light will come on. See *Brake System Warning Light* on page 5-19.

Notice: Driving with the parking brake on can overheat the brake system and cause premature wear or damage to brake system parts. Make sure that the parking brake is fully released and the brake warning light is off before driving.

To release the parking brake, hold the regular brake pedal down, then push down momentarily on the parking brake pedal until you feel the pedal release. Slowly pull your foot up off the park brake pedal.

If the parking brake is not released when you begin to drive, the brake system warning light will be on and a chime will sound warning you that the parking brake is still on.

If you are towing a trailer and are parking on a hill, see *Trailer Towing* on page 9-53.

Brake Assist

This vehicle has a brake assist feature designed to assist the driver in stopping or decreasing vehicle speed in emergency driving conditions. This feature uses the stability system hydraulic brake control module to supplement the power brake system under conditions where the driver has quickly and forcefully applied the brake pedal in an attempt to quickly stop or slow down the vehicle. The stability system hydraulic brake control module increases brake pressure at each corner of the vehicle until the ABS activates. Minor brake pedal pulsations or pedal movement during this time is normal and the driver should continue to apply the brake pedal as the driving situation dictates. The brake assist feature will automatically disengage when the brake pedal is released or brake pedal pressure is quickly decreased.

Ride Control Systems

StabiliTrak System

The vehicle has the StabiliTrak system which combines antilock brake, traction and stability control systems and helps the driver maintain directional control of the vehicle in most driving conditions.

When you first start the vehicle and begin to drive away, the system performs several diagnostic checks to ensure there are no problems. The system may be heard or felt while it is working. This is normal and does not mean there is a problem with the vehicle. The system should initialize before the vehicle reaches 32 km/h (20 mph). In some cases, it may take approximately 3.2 km (2 miles) of driving before the system initializes.

If the system fails to turn on or activate, the StabiliTrak light along with one of the following messages will be displayed on the Driver Information Center (DIC): TRACTION CONTROL OFF, SERVICE TRACTION CONTROL, SERVICE STABILITRAK. If these conditions are observed, turn the vehicle off, wait 15 seconds, and then turn it back on again to reset the system. If any of these messages still appear on the Driver Information Center (DIC), the vehicle should be taken in for service. For more information on the DIC messages, see *Driver Information Center (DIC) (With DIC Buttons)* on page 5-24 or *Driver Information Center (DIC) (Without DIC Buttons)* on page 5-29.



The StabiliTrak light will flash on the instrument panel cluster when the system is both on and activated.

The system may be heard or felt while it is working; this is normal.



The traction control disable button is located on the instrument panel below the climate controls.

The traction control part of StabiliTrak can be turned off by pressing and releasing the traction control disable button.

Traction control can be turned on by pressing and releasing the traction control disable button if not automatically shut off for any other reason.

When the traction control system is turned off, the StabiliTrak light and the appropriate traction control off message will be displayed on the DIC to warn the driver. The vehicle will still have brake-traction control when traction control is off, but will not be able to use the engine speed management system. See “Traction Control Operation” next for more information.

When the traction control system has been turned off, system noises may be heard and felt as a result of the brake-traction control working.

It is recommended to leave the system on for normal driving conditions, but it may be necessary to turn the system off if the vehicle

is stuck in sand, mud, ice or snow, and you want to “rock” the vehicle to attempt to free it. It may also be necessary to turn off the system when driving in extreme off-road conditions where high wheel spin is required. See *If the Vehicle is Stuck on page 9-11*.

Traction Control Operation

The traction control system is part of the StabiliTrak system. Traction control limits wheel spin by reducing engine power to the wheels (engine speed management) and by applying brakes to each individual wheel (brake-traction control) as necessary.

The traction control system is enabled automatically when the vehicle is started. It will activate and the StabiliTrak light will flash if it senses that any of the wheels are spinning or beginning to lose traction while driving.

9-32 Driving and Operating

If traction control is turned off, only the brake-traction control portion of traction control will work. The engine speed management will be disabled. In this mode, engine power is not reduced automatically and the driven wheels can spin more freely. This can cause the brake-traction control to activate constantly.

Notice: If the wheel(s) of one axle is allowed to spin excessively while the StabiliTrak, ABS and brake warning lights and any relevant DIC messages are displayed, the transfer case could be damaged. The repairs would not be covered by the vehicle warranty. Reduce engine power and do not spin the wheel(s) excessively while these lights and messages are displayed.

The traction control system may activate on dry or rough roads or under conditions such as heavy acceleration while turning or abrupt upshifts/downshifts of the transmission. When this happens, a reduction in acceleration may be noticed, or a noise or vibration may be heard. This is normal.

If cruise control is being used when the system activates, the StabiliTrak light will flash and cruise control will automatically disengage. Cruise control may be reengaged when road conditions allow. See *Cruise Control* on page 9-32.

StabiliTrak may also turn off automatically if it determines that a problem exists with the system. If the problem does not clear itself after restarting the vehicle, see your dealer/retailer for service.

Cruise Control

With cruise control, a speed of about 40 km/h (25 mph) or more can be maintained without keeping your foot on the accelerator. Cruise control does not work at speeds below about 40 km/h (25 mph).

When the brakes are applied, the cruise control is disengaged.

WARNING

Cruise control can be dangerous where you cannot drive safely at a steady speed. So, do not use the cruise control on winding roads or in heavy traffic.

Cruise control can be dangerous on slippery roads. On such roads, fast changes in tire traction can cause excessive wheel slip, and you could lose control. Do not use cruise control on slippery roads.



The cruise control buttons are located on left side of the steering wheel.

ⓧ (On/Off): Press to turn cruise control on and off. The indicator comes on when cruise control is on.

+ RES (Resume/Accelerate): Press to make the vehicle accelerate or resume to a previously set speed.

SET- : Press to set the speed and activate cruise control or to make the vehicle decelerate.

ⓧ (Cancel): Press to cancel cruise control without erasing the set speed from memory.

Setting Cruise Control

Cruise control will not work if the parking brake is set, or if the master cylinder brake fluid level is low.

The cruise control light on the instrument panel cluster comes on after the cruise control has been set to the desired speed.

⚠ WARNING

If you leave your cruise control on when you are not using cruise, you might hit a button and go into cruise when you do not want to. You could be startled and even lose control. Keep the cruise control switch off until you want to use cruise control.

1. Press the button to turn the cruise control system on.
2. Get up to the speed desired.
3. Press and release the SET- button located on the steering wheel.
4. Take your foot off the accelerator.

Resuming a Set Speed

If the cruise control is set at a desired speed and then the brakes are applied, the cruise control is disengaged without erasing the set speed from memory.

Once the vehicle speed is 40 km/h (25 mph) or greater, press the +RES button on the steering wheel. The vehicle returns to the previously set speed and stays there.

9-34 Driving and Operating

Increasing Speed While Using Cruise Control

If the cruise control is already engaged,

- Press and hold the +RES button on the steering wheel until the desired speed is reached, then release it.
- To increase vehicle speed in small increments, press the +RES button briefly. Each time this is done, the vehicle goes about 1.6 km/h (1 mph) faster.

Reducing Speed While Using Cruise Control

If the cruise control system is already engaged,

- Press and hold the SET- button on the steering wheel until the lower speed desired is reached, then release it.

- To slow down in very small amounts, press the SET- button briefly. Each time this is done, the vehicle goes about 1.6 km/h (1 mph) slower.

Passing Another Vehicle While Using Cruise Control

Use the accelerator pedal to increase vehicle speed. When you take your foot off the pedal, the vehicle will slow down to the previously set cruise speed.



Using Cruise Control on Hills

How well the cruise control will work on hills depends upon the vehicle speed, load, and the steepness of the hills. When going up steep hills, you might have to step on the accelerator pedal to maintain the

vehicle speed. When going downhill, you might have to brake or shift to a lower gear to keep the vehicle speed down. When the brakes are applied the cruise control is disengaged.

Ending Cruise Control

There are three ways to end cruise control:

- Step lightly on the brake pedal.
- Press the  button.
- Press the  button.

Erasing Speed Memory

The cruise control set speed memory is erased when the cruise control or the ignition is turned off.

Object Detection Systems

Ultrasonic Parking Assist

For vehicles with the Ultrasonic Rear Parking Assist (URPA) system, it operates at speeds less than 8 km/h (5 mph), and assists the driver with parking and avoiding objects while in R (Reverse). The sensors on the rear bumper are used to detect the distance to an object up to 2.5 m (8 ft) behind the vehicle, and at least 25.4 cm (10 in) off the ground.

WARNING

The Ultrasonic Rear Parking Assist (URPA) system does not replace driver vision. It cannot detect:

- Objects that are below the bumper, underneath the vehicle, or if they are too close or far from the vehicle
- Children, pedestrians, bicyclists, or pets.

If you do not use proper care before and while backing; vehicle damage, injury, or death could occur. Even with URPA, always check behind the vehicle before backing up. While backing, be sure to look for objects and check the vehicle's mirrors.

How the System Works

URPA comes on automatically when the shift lever is moved into R (Reverse). A single tone sounds to indicate the system is working.

URPA operates only at speeds less than 5 mph (8 km/h).

An obstacle is indicated by audible beeps. The interval between the beeps becomes shorter as the vehicle gets closer to the obstacle. When the distance is less than 30 cm (12 in) the beeps are continuous.

To be detected, objects must be at least 25.4 cm (10 in) off the ground and below liftgate level. Objects must also be within 2.5 m (8 ft) from the rear bumper. This distance may be less during warmer or humid weather.

The system can be disabled through the Driver Information Center (DIC). See "Park Assist" under *Vehicle Personalization (With DIC Buttons)* on page 5-45 for more information.

When the System Does Not Seem to Work Properly

If the URPA system does not activate due to a temporary condition, the message PARK ASSIST OFF displays on the DIC when the shift lever is moved into R (Reverse). This may occur under the following conditions:

- The driver disables the system.
- The ultrasonic sensors are not clean. Keep the vehicle's rear bumper free of mud, dirt, snow, ice and slush. For cleaning instructions, see *Exterior Care* on page 10-86.

- A trailer was attached to the vehicle, or a bicycle or an object was hanging out of the liftgate during the last drive cycle. Once the attached object is removed, URPA will return to normal operation.
- A tow bar is attached to the vehicle.
- The vehicle's bumper is damaged. Take the vehicle to your dealer/retailer to repair the system.
- Other conditions may affect system performance, such as vibrations from a jackhammer or the compression of air brakes on a very large truck.

If the system is still disabled, after driving forward at least 25 km/h (15 mph), take the vehicle to your dealer/retailer.

Rear Vision Camera (RVC)

The vehicle may have a Rear Vision Camera system. Read this entire section before using it.

WARNING

The Rear Vision Camera (RVC) system does not replace driver vision. RVC does not:

- Detect objects that are outside the camera's field of view, below the bumper, or underneath the vehicle.
- Detect children, pedestrians, bicyclists, or pets.

Do not back the vehicle by only looking at the RVC screen, or use the screen during longer, higher speed backing maneuvers or where there could be cross-traffic.

(Continued)

WARNING (Continued)

Your judged distances using the screen will differ from actual distances.

So if you do not use proper care before backing up, you could hit a vehicle, child, pedestrian, bicyclist, or pet, resulting in vehicle damage, injury, or death. Even though the vehicle has the RVC system, always check carefully before backing up by checking behind and around the vehicle.

Vehicles Without Navigation System

The rear vision camera system is designed to help the driver when backing up by displaying a view of the area behind the vehicle. When the key is in the ON/RUN position and the driver shifts the vehicle into R (Reverse), the video image automatically appears on the inside rear view mirror. Once the driver shifts out of R (Reverse), the video image automatically disappears from the inside rear view mirror.

Turning the Rear Vision Camera System Off or On

To turn off the rear vision camera system, press and hold , located on the inside rearview mirror, until the left indicator light turns off. The rear vision camera display is now disabled.

To turn the rear vision camera system on again, press and hold  until the left indicator light illuminates. The rear vision camera system display is now enabled and the display will appear in the mirror normally.

Vehicles With Navigation System

The rear vision camera system is designed to help the driver when backing up by displaying a view of the area behind the vehicle. When the driver shifts the vehicle into R (Reverse), the video image automatically appears on the navigation screen. Once the driver shifts out of R (Reverse), the navigation screen will go back to the last screen that had been displayed, after a delay.

Turning the Rear Vision Camera System On or Off

To turn the rear vision camera system on or off:

1. Shift into P (Park).
2. Press the MENU button to enter the configure menu options, then press the MENU hard key to select Display or touch the Display screen button.

3. Select the Rear Camera Options screen button. The Rear Camera Options screen displays.

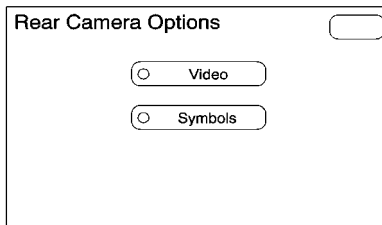

4. Select the Video screen button. When the Video screen button is highlighted the RVC system is on.

The delay that is received after shifting out of R (Reverse) is approximately 10 seconds. The delay can be cancelled by performing one of the following:

- Pressing a hard key on the navigation system.
- Shifting in to P (Park).
- Reach a vehicle speed of 5 mph (8 km/h).

There is a message on the rear vision camera screen that states "Check Surroundings for Safety".

Adjusting the Brightness and Contrast of the Screen

To adjust the brightness and contrast of the screen, press the MENU button while the rear vision camera image is on the display. Any adjustments made will only affect the rear vision camera screen.

☀️ **(Brightness)** : Touch the + (plus) or – (minus) screen buttons to increase or decrease the brightness of the screen.

🔘 **(Contrast)** : Touch the + (plus) or – (minus) screen buttons to increase or decrease the contrast of the screen.

Symbols

The navigation system may have a feature that lets the driver view symbols on the navigation screen while using the rear vision camera. The Ultrasonic Rear Park Assist (URPA) system must not be disabled to use the caution symbols. If URPA has been disabled and the symbols have been turned on, the Rear Parking Assist Symbols Unavailable error message may display. See *Ultrasonic Parking Assist on page 9-35*.

The symbols appear when an object has been detected by the URPA system. The symbol may cover the object when viewing the navigation screen.

To turn the symbols on or off:

1. Make sure that URPA has not been disabled.
2. Shift into P (Park).
3. Press the MENU hard key to enter the configure menu options, then press the MENU hard key repeatedly until Display is selected or touch the Display screen button.
4. Select the Rear Camera Options screen button. The Rear Camera Options screen will display.
5. Touch the Symbols screen button. The screen button will be highlighted when on.

Rear Vision Camera Error Messages

Service Rear Vision Camera

System: This message can display when the system is not receiving information it requires from other vehicle systems.

If any other problem occurs or if a problem persists, see your dealer/retailer.

Rear Vision Camera Location

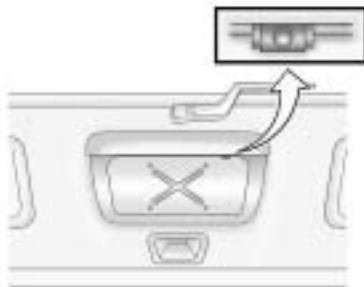

The camera is located above the license plate.

The area displayed by the camera is limited and does not display objects that are close to either corner or under the bumper. The area displayed can vary depending on vehicle orientation or road conditions. The distance of the image that appears on the screen differs from the actual distance.

The following illustration shows the field of view that the camera provides.

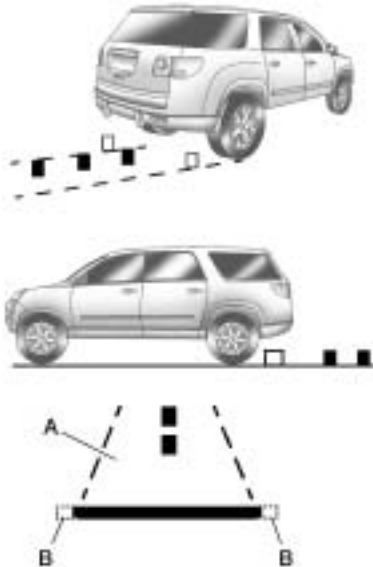

- A. View displayed by the camera.
- B. Corner of the rear bumper.

When the System Does Not Seem To Work Properly

The rear vision camera system might not work properly or display a clear image if:

- The RVC is turned off. See "Turning the Rear Camera System On or Off" earlier in this section.
- It is dark.
- The sun or the beam of headlights is shining directly into the camera lens.

- Ice, snow, mud, or anything else builds up on the camera lens. Clean the lens, rinse it with water, and wipe it with a soft cloth.
- The back of the vehicle is in an accident, the position and mounting angle of the camera can change or the camera can be affected. Be sure to have the camera and its position and mounting angle checked at your dealer/retailer.
- There are extreme temperature changes.

The rear vision camera system display in the rearview mirror may turn off or not appear as expected due to one of the following conditions. If this occurs the left indicator light on the mirror will flash.

- A slow flash may indicate a loss of video signal, or no video signal present during the reverse cycle.
- A fast flash may indicate that the display has been on for the maximum allowable time during a reverse cycle, or the display has reached an Over Temperature limit.

The fast flash conditions are used to protect the video device from high temperature conditions. Once conditions return to normal the device will reset and the green indicator will stop flashing.

During any of these fault conditions, the display will be blank and the indicator will continue to flash as long as the vehicle is in R (Reverse) or until the conditions return to normal.

Pressing and holding  when the left indicator light is flashing will turn off the video display along with the left indicator light.

Fuel

Use of the recommended fuel is an important part of the proper maintenance of this vehicle. To help keep the engine clean and maintain optimum vehicle performance, we recommend the use of gasoline advertised as TOP TIER Detergent Gasoline.

Look for the TOP TIER label on the fuel pump to ensure gasoline meets enhanced detergency standards developed by auto companies. A list of marketers providing TOP TIER Detergent Gasoline can be found at www.toptiergas.com.



Recommended Fuel

Use regular unleaded gasoline with a posted octane rating of 87 or higher. If the octane rating is less than 87, an audible knocking noise, commonly referred to as spark knock, might be heard when driving. If this occurs, use a gasoline rated at 87 octane or higher as soon as possible. If heavy knocking is heard when using gasoline rated at 87 octane or higher, the engine needs service.

Gasoline Specifications

At a minimum, gasoline should meet ASTM specification D 4814 in the United States or CAN/CGSB-3.5 or 3.511 in Canada. Some gasolines contain an octane-enhancing additive called methylcyclopentadienyl manganese tricarbonyl (MMT). We recommend against the use of gasolines containing MMT. See *Fuel Additives on page 9-44* for additional information.

California Fuel Requirements

If the vehicle is certified to meet California Emissions Standards, it is designed to operate on fuels that meet California specifications. See the underhood emission control label. If this fuel is not available in states adopting California emissions standards, the vehicle will operate satisfactorily on fuels meeting federal specifications, but emission control system performance might be affected. The malfunction indicator lamp could turn on and the vehicle might fail a smog-check test. See *Malfunction Indicator Lamp on page 5-17*. If this occurs, return to your authorized dealer/retailer for diagnosis. If it is determined that the condition is caused by the type of fuel used, repairs might not be covered by the vehicle warranty.

Fuels in Foreign Countries

If you plan on driving in another country outside the United States or Canada, the proper fuel might be hard to find. Never use leaded gasoline or any other fuel not recommended in the previous text on fuel. Costly repairs caused by use of improper fuel would not be covered by the vehicle warranty.

To check the fuel availability, ask an auto club, or contact a major oil company that does business in the country where you will be driving.

Fuel Additives

To provide cleaner air, all gasolines in the United States are now required to contain additives that help prevent engine and fuel system deposits from forming, allowing the emission control system to work properly. In most cases, nothing should have to be added to the fuel. However, some gasolines contain only the minimum amount of additive required to meet U.S. Environmental Protection Agency regulations. To help keep fuel injectors and intake valves clean, or if the vehicle experiences problems due to dirty injectors or valves, look for gasoline that is advertised as TOP TIER Detergent Gasoline. Look for the TOP TIER label on the fuel pump to ensure gasoline meets enhanced detergency standards developed by the auto companies. A list of marketers providing TOP TIER Detergent Gasoline can be found at www.toptiergas.com.

For customers who do not use TOP TIER Detergent Gasoline regularly, one bottle of GM Fuel System Treatment PLUS, added to the fuel tank at every engine oil change, can help clean deposits from fuel injectors and intake valves. GM Fuel System Treatment PLUS is the only gasoline additive recommended by General Motors. It is available at your dealer/retailer.

Gasolines containing oxygenates, such as ethers and ethanol, and reformulated gasolines might be available in your area. We recommend that you use these gasolines, if they comply with the specifications described earlier. However, E85 (85% ethanol) and other fuels containing more than 10% ethanol must not be used in vehicles that were not designed for those fuels.

Notice: This vehicle was not designed for fuel that contains methanol. Do not use fuel containing methanol. It can corrode metal parts in the fuel system and also damage plastic and rubber parts. That damage would not be covered under the vehicle warranty.

Some gasolines that are not reformulated for low emissions can contain an octane-enhancing additive called methylcyclopentadienyl manganese tricarbonyl (MMT); ask the attendant where you buy gasoline whether the fuel contains MMT. We recommend against the use of such gasolines. Fuels containing MMT can reduce the life of spark plugs and the performance of the emission control system could be affected. The malfunction indicator lamp might turn on. If this occurs, return to your dealer/retailer for service.

Filling the Tank

WARNING

Fuel vapor burns violently and a fuel fire can cause bad injuries. To help avoid injuries to you and others, read and follow all the instructions on the fuel pump island. Turn off the engine when refueling. Do not smoke near fuel or when refueling the vehicle. Do not use cellular phones. Keep sparks, flames, and smoking materials away from fuel. Do not leave the fuel pump unattended when refueling the vehicle. This is against the law in some places. Do not re-enter the vehicle while pumping fuel. Keep children away from the fuel pump; never let children pump fuel.

The tethered fuel cap is located behind a hinged fuel door on the driver side of the vehicle.

To open the fuel door, push the rearward center edge in and release and it will open.



To remove the fuel cap, turn it slowly counterclockwise. The fuel cap has a spring in it; if the cap is released too soon, it will spring back to the right.

9-46 Driving and Operating

While refueling, hang the tethered fuel cap from the hook on the fuel door.

WARNING

Fuel can spray out on you if you open the fuel cap too quickly. If you spill fuel and then something ignites it, you could be badly burned. This spray can happen if the tank is nearly full, and is more likely in hot weather. Open the fuel cap slowly and wait for any hiss noise to stop. Then unscrew the cap all the way.

Be careful not to spill fuel. Do not top off or overfill the tank and wait a few seconds after you have finished pumping before removing the nozzle. Clean fuel from painted surfaces as soon as possible. See *Exterior Care* on page 10-86.

When replacing the fuel cap, turn it clockwise until it clicks. Make sure the cap is fully installed. The diagnostic system can determine if the fuel cap has been left off or improperly installed. This would allow fuel to evaporate into the atmosphere. See *Malfunction Indicator Lamp* on page 5-17.

WARNING

If a fire starts while you are refueling, do not remove the nozzle. Shut off the flow of fuel by shutting off the pump or by notifying the station attendant. Leave the area immediately.

Notice: If a new fuel cap is needed, be sure to get the right type of cap from your dealer/retailer. The wrong type fuel cap might not fit properly, might cause the malfunction indicator lamp to light, and could damage the fuel tank and emissions system. See *Malfunction Indicator Lamp* on page 5-17.

Filling a Portable Fuel Container

WARNING

Never fill a portable fuel container while it is in the vehicle. Static electricity discharge from the container can ignite the fuel vapor. You can be badly burned and the vehicle damaged if this occurs. To help avoid injury to you and others:

- Dispense fuel only into approved containers.
- Do not fill a container while it is inside a vehicle, in a vehicle's trunk, pickup bed, or on any surface other than the ground.

(Continued)

WARNING (Continued)

- Bring the fill nozzle in contact with the inside of the fill opening before operating the nozzle. Contact should be maintained until the filling is complete.
- Do not smoke while pumping fuel.
- Do not use a cellular phone while pumping fuel.

Towing

General Towing Information

Only use towing equipment that has been designed for the vehicle. Contact your dealer/retailer or trailering retailer for assistance with preparing the vehicle for towing a trailer.

See the following trailer towing information in this section:

- For information on driving while towing a trailer, see "Driving Characteristics and Towing Tips".
- For maximum vehicle and trailer weights, see "Trailer Towing".
- For information on equipment to tow a trailer, see "Towing Equipment".

For information on towing a disabled vehicle, see *Towing the Vehicle on page 10-83*. For information on towing the vehicle behind another vehicle — such as a motorhome, see *Recreational Vehicle Towing on page 10-83*.

Driving Characteristics and Towing Tips

WARNING

The driver can lose control when pulling a trailer if the correct equipment is not used or the vehicle is not driven properly. For example, if the trailer is too heavy, the brakes may not work well — or even at all. The driver and passengers could be seriously injured. The vehicle may also be damaged; the resulting

(Continued)

WARNING (Continued)

repairs would not be covered by the vehicle warranty. Pull a trailer only if all the steps in this section have been followed. Ask your dealer/retailer for advice and information about towing a trailer with the vehicle.

The vehicle can tow a trailer when equipped with the proper trailer towing equipment. For trailering capacity, see *Trailer Towing on page 9-53*. Trailering changes handling, acceleration, braking, durability and fuel economy. With the added weight, the engine, transmission, wheel assemblies and tires are forced to work harder and under greater loads. The trailer also adds wind resistance, increasing the pulling requirements. For safe trailering, correctly use the proper trailering equipment.

The following information has important trailering tips and rules for your safety and that of your passengers. Read this section carefully before pulling a trailer.

Pulling A Trailer

Here are some important points:

- There are many laws, including speed limit restrictions that apply to trailering. Check for legal requirements with state or provincial police.
- Consider using sway control. See *Towing Equipment on page 9-57*.
- Do not tow a trailer at all during the first 800 km (500 miles) the new vehicle is driven. The engine, axle or other parts could be damaged.

- During the first 800 km (500 miles) that a trailer is towed, do not drive over 80 km/h (50 mph) and do not make starts at full throttle. This reduces wear on the vehicle.
- The vehicle can tow in D (Drive). Use a lower gear if the transmission shifts too often. See “Tow/Haul Mode” later in this section.
- Obey speed limit restrictions when towing a trailer.
- The vehicle is designed primarily as a passenger and load carrying vehicle. If a trailer is towed, the vehicle will require more frequent maintenance due to the additional load.

Driving with a Trailer

Towing a trailer requires experience. Get familiar with handling and braking with the added trailer weight. The vehicle is now longer and not as responsive as the vehicle is by itself.

Check all trailer hitch parts and attachments, safety chains, electrical connectors, lamps, tires and mirror adjustments. If the trailer has electric brakes, start the vehicle and trailer moving and then apply the trailer brake controller by hand to be sure the brakes are working.

During the trip, check regularly to be sure that the load is secure, and the lamps and trailer brakes are working properly.

Towing with a Stability Control System

When towing, the sound of the stability control system might be heard. The system is reacting to the vehicle movement caused by the trailer, which mainly occurs during cornering. This is normal when towing heavier trailers.

Tow/Haul Mode

Tow/Haul assists when pulling a heavy trailer or a large or heavy load. The purpose of the Tow/Haul mode is to:

- Reduce the frequency and improve the predictability of transmission shifts.
- Provide the same solid shift feel as when the vehicle is unloaded.
- Improve control of vehicle speed while requiring less throttle pedal activity.
- Increase the charging system voltage to assist in recharging a battery installed in a trailer.



Press this button located on the console to turn on and turn off the Tow/Haul mode.

The Tow/Haul light on the instrument panel comes on to indicate that Tow/Haul mode has been selected.

Tow/Haul may be turned off by pressing the button again, at which time the indicator light on the instrument panel will turn off. The vehicle will automatically turn off Tow/Haul every time it is started.

Tow/Haul is designed to be most effective when the vehicle and trailer combined weight is at least 75 percent of the vehicle's Gross Combined Weight Rating (GCWR). See *Trailer Towing on page 9-53*. Tow/Haul is most useful when pulling a heavy trailer or a large or heavy load under the following driving conditions:

- Travelling through rolling terrain.
- Travelling in stop and go traffic.
- Travelling in busy parking lots where improved low speed control of the vehicle is desired.

Operating the vehicle in Tow/Haul when lightly loaded or with no trailer will not cause damage but there is no benefit. Such a selection when unloaded may result in unpleasant engine and transmission driving characteristics and reduced fuel economy.

Following Distance

Stay at least twice as far behind the vehicle ahead as you would when driving the vehicle without a trailer. This can help to avoid situations that require heavy braking and sudden turns.

Passing

More passing distance is needed when towing a trailer. Because the rig is longer, it is necessary to go farther beyond the passed vehicle before returning to the lane.

Backing Up

Hold the bottom of the steering wheel with one hand. To move the trailer to the left, move that hand to the left. To move the trailer to the right, move your hand to the right. Always back up slowly and, if possible, have someone guide you.

Making Turns

Notice: Making very sharp turns while trailering could cause the trailer to come in contact with the vehicle. The vehicle could be damaged. Avoid making very sharp turns while trailering.

When turning with a trailer, make wider turns than normal so the trailer will not strike soft shoulders, curbs, road signs, trees or other objects. Use the turn signal well in advance and avoid jerky or sudden maneuvers.

Turn Signals When Towing a Trailer

The turn signal indicators on the instrument panel flash whenever signaling a turn or lane change. Properly hooked up, the trailer lamps also flash, telling other drivers the vehicle is turning, changing lanes or stopping.

When towing a trailer, the arrows on the instrument panel flash for turns even if the bulbs on the trailer are burned out. Check occasionally to be sure the trailer bulbs are still working.

Driving On Grades

Reduce speed and shift to a lower gear before starting down a long or steep downgrade. If the transmission is not shifted down, the brakes might have to be used so much that they would get hot and no longer work well.

The vehicle can tow in D (Drive). Use a lower gear if the transmission shifts too often.

When towing at high altitude on steep uphill grades, engine coolant will boil at a lower temperature than at normal altitudes. If the engine is turned off immediately after towing at high altitude on steep uphill grades, the vehicle may show signs similar to engine overheating. To avoid this, let the engine run while parked, preferably on level ground, with the transmission in P (Park) for a few minutes before turning the engine off. If the overheat warning comes on, see *Engine Overheating on page 10-18*.

On a long uphill grade, shift down and reduce the vehicle speed to around 88 km/h (55 mph) to reduce the possibility of the engine and the transmission overheating.

Parking on Hills

 **WARNING**

Parking the vehicle on a hill with the trailer attached can be dangerous. If something goes wrong, the rig could start to move. People can be injured, and both the vehicle and the trailer can be damaged. When possible, always park the rig on a flat surface.

If parking the rig on a hill:

1. Press the brake pedal, but do not shift into P (Park) yet. Turn the wheels into the curb if facing downhill or into traffic if facing uphill.
2. Have someone place chocks under the trailer wheels.
3. When the wheel chocks are in place, release the brake pedal until the chocks absorb the load.
4. Reapply the brake pedal. Then apply the parking brake and shift into P (Park).
5. Release the brake pedal.

Leaving After Parking on a Hill

1. Apply and hold the brake pedal while you:
 - Start the engine.
 - Shift into a gear.
 - Release the parking brake.
2. Let up on the brake pedal.
3. Drive slowly until the trailer is clear of the chocks.
4. Stop and have someone pick up and store the chocks.

Maintenance When Trailer Towing

The vehicle needs service more often when pulling a trailer. See this manual's Maintenance Schedule or Index for more information. Things that are especially important in trailer operation are automatic transmission fluid, engine oil, axle lubricant, belts, cooling system and brake system. Inspect these before and during the trip.

Check periodically to see that all hitch nuts and bolts are tight.

Engine Cooling When Trailer Towing

The cooling system may temporarily overheat during severe operating conditions. See *Engine Overheating on page 10-18*.

Trailer Towing

Three important considerations have to do with weight:

- The weight of the trailer
- The weight of the trailer tongue
- The total weight on the vehicle's tires

Weight of the Trailer

How heavy can a trailer safely be?

Speed, altitude, road grades, outside temperature, special equipment, and the amount of tongue weight the vehicle can carry must be considered. See "Weight of the Trailer Tongue" later in this section for more information.

Maximum trailer weight is calculated assuming only the driver is in the tow vehicle and it has all the required trailering equipment. The weight of additional optional equipment, passengers and cargo in the tow vehicle must be subtracted from the maximum trailer weight.

9-54 Driving and Operating

Use the following chart to determine how much the vehicle can weigh, based upon the vehicle model and options.

Vehicle	Maximum Trailer Weight	*GCWR
Front-Wheel Drive	2,000 lbs (907 kg)	7,500 lbs (3 402 kg)
Front-Wheel Drive, V92 Trailer Towing Package	5,200 lbs (2 359 kg)	10,250 lbs (4 649 kg)
All-Wheel Drive	2,000 lbs (907 kg)	7,700 lbs (3 493 kg)
All-Wheel Drive, V92 Trailer Towing Package	5,200 lbs (2 359 kg)	10,450 lbs (4 740 kg)

*The Gross Combination Weight Rating (GCWR) is the total allowable weight of the completely loaded vehicle and trailer including any passengers, cargo, equipment and conversions. The GCWR for the vehicle should not be exceeded.

Ask your dealer/retailer for our trailering information or advice. See *Customer Assistance Offices on page 13-4* for more information.

Weight of the Trailer Tongue

The tongue load (A) of any trailer is an important weight to measure because it affects the total gross weight of the vehicle. The Gross Vehicle Weight (GVW) includes the curb weight of the vehicle, any cargo carried in it, and the people who will be riding in the vehicle.

If there are a lot of options, equipment, passengers or cargo in the vehicle, it will reduce the tongue weight the vehicle can carry, which will also reduce the trailer weight the vehicle can tow. If towing a trailer, the tongue load must be added to the GVW because the vehicle will be carrying that weight, too. See *Vehicle Load Limits on page 9-12*

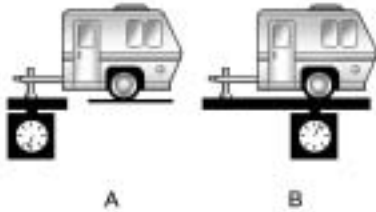

If a weight-carrying hitch or a weight-distributing hitch is being used, the trailer tongue (A) should weigh 10-15 percent of the total loaded trailer weight (B).

After loading the trailer, weigh the trailer and then the tongue, separately, to see if the weights are

proper. If they are not, adjustments might be made by moving some items around in the trailer.

Trailer weight may be limited by the vehicle's ability to carry tongue weight. Tongue weight cannot cause the vehicle to exceed the GVWR (Gross Vehicle Weight Rating) or the RGAWR (Rear Gross Axle Weight Rating). The effect of additional weight may reduce the trailering capacity more than the total of the additional weight.

Consider the following example:

A vehicle model base weight is 2 495 kg (5,500 lbs); 1 270 kg (2,800 lbs) at the front axle and 1 225 kg (2,700 lbs) at the rear axle. It has a GVWR of 3 266 kg (7,200 lbs), a RGAWR of 1 814 kg (4,000 lbs) and a GCWR (Gross

Combination Weight Rating) of 6 350 kg (14,000 lbs). The trailer rating should be:

6350 kg (14,000 lbs)	GCWR
<u>2495 kg (-5,500 lbs)</u>	Vehicle Weight
3855 kg (8,500 lbs)	Trailer Rating

Expect tongue weight to be at least 10 percent of trailer weight (386 kg (850 lbs)) and because the weight is applied well behind the rear axle, the effect on the rear axle is greater than just the weight itself, as much as 1.5 times as much. The weight at the rear axle could be 386 kg (850 lbs) X 1.5 = 578 kg (1,275 lbs). Since the rear axle already weighs 1 225 kg (2,700 lbs), adding 578 kg (1,275 lbs) brings the total to 1 803 kg (3,975 lbs). This is very close to, but within the limit for RGAWR as well. The vehicle is set to trailer up to 3 856 kg (8,500 lbs).

9-56 Driving and Operating

If the vehicle has many options and there is a front seat passenger and two rear seat passengers with some luggage and gear in the vehicle as well. 136 kg (300 lbs) could be added to the front axle weight and 181 kg (400 lbs) to the rear axle weight. The vehicle now weighs:

1270 kg (2,800 lbs)	+	136 kg (300 lbs)	Front
1225 kg (2,700 lbs)	+	181 kg (400 lbs)	Rear
<hr/>			
2812 kg (6,200 lbs)			Total

Weight is still below 3 266 kg (7,200 lbs) and you might think 318 additional kilograms (700 lbs) should be subtracted from the trailering capacity to stay within GCWR limits. The maximum trailer would only be 3 538 kg (7,800 lbs). You may go further and think the tongue weight should be limited to less than 454 kg (1,000 lbs) to avoid

exceeding GVWR. But the effect on the rear axle must still be considered. Because the rear axle now weighs 1 406 kg (3,100 lbs), 408 kg (900 lbs) can be put on the rear axle without exceeding RGAWR. The effect of tongue weight is about 1.5 times the actual weight. Dividing the 408 kg (900 lbs) by 1.5 leaves only 272 kg (600 lbs) of tongue weight that can be handled. Since tongue weight is usually at least 10 percent of total loaded trailer weight, expect that the largest trailer the vehicle can properly handle is 2 722 kg (6,000 lbs).

It is important that the vehicle does not exceed any of its ratings — GCWR, GVWR, RGAWR, Maximum Trailer Rating or Tongue Weight. The only way to be sure it is not exceeding any of these ratings is to weigh the vehicle and trailer.

Total Weight on the Vehicle's Tires

Inflate the vehicle's tires to the upper limit for cold tires. These numbers can be found on the Certification label or see *Vehicle Load Limits* on page 9-12 for more information. Do not go over the GVW limit for the vehicle, or the GAWR, including the weight of the trailer tongue. If using a weight distributing hitch, do not go over the rear axle limit before applying the weight distribution spring bars.

Towing Equipment

Hitches

It is important to have the correct hitch equipment. Crosswinds, large trucks going by and rough roads are a few reasons why the right hitch is needed.

- The rear bumper on the vehicle is not intended for hitches. Do not attach rental hitches or other bumper-type hitches to it. Use only a frame-mounted hitch that does not attach to the bumper.
- Will any holes be made in the body of the vehicle when the trailer hitch is installed? If there are, then be sure to seal the holes when the hitch is removed. If the holes are not sealed, dirt, water, and deadly carbon monoxide (CO) from the exhaust may get into the vehicle. See *Engine Exhaust* on page 9-23.

Weight-Distributing Hitches and Weight Carrying Hitches

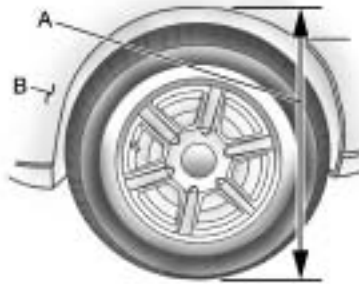

- A. Body-to-Ground Distance
 B. Front of Vehicle

When using a weight-distributing hitch, the hitch must be adjusted so that the distance (A) remains the same both before and after coupling the trailer to the tow vehicle.

Safety Chains

Always attach chains between the vehicle and the trailer. Cross the safety chains under the tongue of the trailer to help prevent the tongue from contacting the road if it becomes separated from the hitch. Always leave just enough slack so the rig can turn. Never allow safety chains to drag on the ground.

Trailer Brakes

A loaded trailer that weighs more than 450 kg (1,000 lbs) needs to have its own brake system that is adequate for the weight of the trailer. Be sure to read and follow the instructions for the trailer brakes so they are installed, adjusted and maintained properly.

Because the vehicle has antilock brakes, do not try to tap into the vehicle's hydraulic brake system. If you do, both brake systems will not work well, or at all.

Trailer Wiring Harness

Basic Trailer Wiring

The trailer wiring harness, with a seven-pin connector, is located at the rear of the vehicle and is tied to the vehicle's frame. The harness connector can be plugged into a seven-pin universal heavy-duty trailer connector available through your dealer/retailer.

The seven-wire harness contains the following trailer circuits:

- Yellow: Left Stop/Turn Signal
- Dark Green: Right Stop/Turn Signal
- Brown: Taillamps
- Black: Ground
- Light Green: Back-up Lamps
- Red/Black: Battery Feed
- Dark Blue: Trailer Brake*

*The fuse for this circuit is installed in the underhood electrical center, but the wires are not connected. They should be connected by your dealer/retailer or a qualified service center.

If the back-up lamp circuit is not functional, contact your dealer/retailer.

If a remote (non-vehicle) battery is being charged, press the Tow/Haul mode switch located on the center console near the climate controls. This will boost the vehicle system voltage and properly charge the battery. If the trailer is too light for Tow/Haul mode, turn on the headlamps (Non-HID only) as a second way to boost the vehicle system and charge the battery.

Electric Trailer Brake Control Wiring Provisions

These wiring provisions for an electric trailer brake controller are included with the vehicle as part of the trailer wiring package. The instrument panel contains blunt cut wires behind the steering column for the electric trailer brake controller. The harness contains the following wires:

- Red/Black: Power Supply
- White: Brake Switch Signal
- Gray: Illumination
- Dark Blue: Trailer Brake Signal
- Black: Ground

The electric trailer brake controller should be installed by your dealer/retailer or a qualified service center.

Conversions and Add-Ons

Add-On Electrical Equipment

Notice: Do not add anything electrical to the vehicle unless you check with your dealer/retailer first. Some electrical equipment can damage the vehicle and the damage would not be covered by the vehicle's warranty. Some add-on electrical equipment can keep other components from working as they should.

Add-on equipment can drain the vehicle battery, even if the vehicle is not operating.

The vehicle has an airbag system. Before attempting to add anything electrical to the vehicle, see *Servicing the Airbag-Equipped Vehicle on page 3-44* and *Adding Equipment to the Airbag-Equipped Vehicle on page 3-44*.

Vehicle Care

General Information

General Information	10-2
California Proposition 65 Warning	10-3
California Perchlorate Materials Requirements	10-3
Accessories and Modifications	10-3

Vehicle Checks

Doing Your Own Service Work	10-4
Hood	10-5
Engine Compartment Overview	10-6
Engine Cover	10-7
Engine Oil	10-8
Engine Oil Life System	10-9
Automatic Transmission Fluid	10-11
Engine Air Cleaner/Filter	10-12

Cooling System	10-14
Engine Coolant	10-14
Engine Overheating	10-18
Overheated Engine Protection Operating Mode	10-20
Power Steering Fluid	10-20
Washer Fluid	10-21
Brakes	10-22
Brake Fluid	10-23
Battery	10-25
All-Wheel Drive	10-25
Starter Switch Check	10-26
Automatic Transmission Shift Lock Control System Check	10-26
Ignition Transmission Lock Check	10-26
Park Brake and P (Park) Mechanism Check	10-27
Wiper Blade Replacement	10-27

Headlamp Aiming

Headlamp Aiming	10-28
-----------------------	-------

Bulb Replacement

Bulb Replacement	10-28
Halogen Bulbs	10-28
License Plate Lamp	10-29
Replacement Bulbs	10-29

Electrical System

High Voltage Devices and Wiring	10-29
Electrical System Overload	10-30
Fuses and Circuit Breakers	10-30
Engine Compartment Fuse Block	10-30
Instrument Panel Fuse Block	10-34

Wheels and Tires

Tires	10-36
Tire Sidewall Labeling	10-37
Tire Designations	10-39
Tire Terminology and Definitions	10-40
Tire Pressure	10-43

10-2 Vehicle Care

Tire Pressure Monitor System	10-44
Tire Pressure Monitor Operation	10-46
Tire Inspection	10-49
Tire Rotation	10-49
When It Is Time for New Tires	10-51
Buying New Tires	10-51
Different Size Tires and Wheels	10-53
Uniform Tire Quality Grading	10-54
Wheel Alignment and Tire Balance	10-55
Wheel Replacement	10-56
Tire Chains	10-57
If a Tire Goes Flat	10-57
Tire Sealant and Compressor Kit	10-59

Storing the Tire Sealant and Compressor Kit	10-66
Tire Changing	10-67
Secondary Latch System ...	10-76
Compact Spare Tire	10-77

Jump Starting

Jump Starting	10-79
---------------------	-------

Towing

Towing the Vehicle	10-83
Recreational Vehicle Towing	10-83

Appearance Care

Exterior Care	10-86
Interior Care	10-90
Floor Mats	10-93

General Information

For service and parts needs, visit your dealer/retailer. You will receive genuine GM parts and GM-trained and supported service people.

Genuine GM parts have one of these marks:



California Proposition 65 Warning

Most motor vehicles, including this one, contain and/or emit chemicals known to the State of California to cause cancer and birth defects or other reproductive harm. Engine exhaust, many parts and systems, many fluids, and some component wear by-products contain and/or emit these chemicals.

California Perchlorate Materials Requirements

Certain types of automotive applications, such as airbag initiators, seat belt pretensioners, and lithium batteries contained in remote keyless transmitters, may contain perchlorate materials. Special handling may be necessary. For additional information, see www.dtsc.ca.gov/hazardouswaste/perchlorate.

Accessories and Modifications

Adding non-dealer/non-retailer accessories to the vehicle can affect vehicle performance and safety, including such things as airbags, braking, stability, ride and handling, emissions systems, aerodynamics, durability, and electronic systems like antilock brakes, traction control, and stability control. Some of these accessories could even cause malfunction or damage not covered by the vehicle warranty.

Damage to vehicle components resulting from the installation or use of non-GM certified parts, including control module modifications, is not covered under the terms of the vehicle warranty and may affect remaining warranty coverage for affected parts.

GM Accessories are designed to complement and function with other systems on the vehicle. Your GM dealer/retailer can accessorize the vehicle using genuine GM Accessories. When you go to your GM dealer/retailer and ask for GM Accessories, you will know that GM-trained and supported service technicians will perform the work using genuine GM Accessories.

Also, see *Adding Equipment to the Airbag-Equipped Vehicle* on page 3-44.

Vehicle Checks

Doing Your Own Service Work

WARNING

You can be injured and the vehicle could be damaged if you try to do service work on a vehicle without knowing enough about it.

- Be sure you have sufficient knowledge, experience, the proper replacement parts, and tools before attempting any vehicle maintenance task.

(Continued)

WARNING (Continued)

- Be sure to use the proper nuts, bolts, and other fasteners. English and metric fasteners can be easily confused. If the wrong fasteners are used, parts can later break or fall off. You could be hurt.

If doing some of your own service work, use the proper service manual. It tells you much more about how to service the vehicle than this manual can. To order the proper service manual, see *Service Publications Ordering Information* on page 13-13.

This vehicle has an airbag system. Before attempting to do your own service work, see *Airbag System Check* on page 3-45.

Keep a record with all parts receipts and list the mileage and the date of any service work performed. See *Maintenance Records* on page 11-11.

Hood

To open the hood, do the following:



1. Pull the hood release handle with this symbol on it. It is located under the instrument panel on the driver's side of the vehicle.
2. At the front of the vehicle, pull up on the center of the hood, and push the secondary hood release to the right.

3. After you have partially lifted the hood, gas struts will automatically take over to lift and hold the hood in the fully open position.

Before closing the hood, be sure all filler caps are on properly.

Pull the hood down to close. Lower the hood until the lifting pressure of the strut is reduced. Then allow the hood to fall and latch into place under its own weight. Check to make sure the hood is closed. If the hood does not fully latch, gently push the hood down at the front and center of the hood until it is completely latched.

Engine Compartment Overview

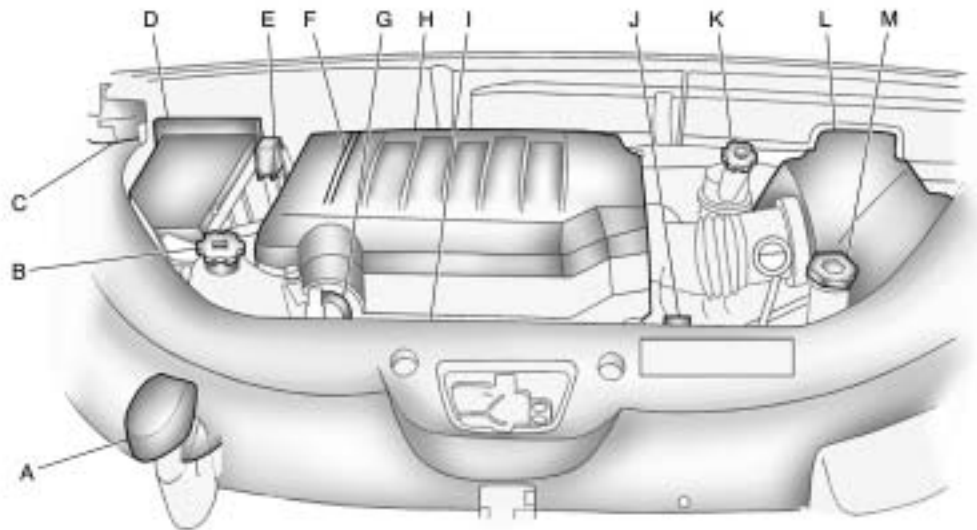

- A. Radiator Pressure Cap .
See *Cooling System* on page 10-14.
- B. Engine Coolant Recovery Cap.
See *Cooling System* on page 10-14.
- C. Remote Negative (-) Terminal.
See *Jump Starting* on page 10-79.
- D. *Engine Compartment Fuse Block* on page 10-30.
- E. Remote Positive (+) Terminal.
See *Jump Starting* on page 10-79.
- F. Power Steering Reservoir and Cap (under engine cover).
See *Power Steering Fluid* on page 10-20.
- G. Engine Oil Fill Cap. See “When to Add Engine Oil” under *Engine Oil* on page 10-8.

- H. *Engine Cover* on page 10-7.
- I. Engine Oil Dipstick. See “Checking Engine Oil” under *Engine Oil* on page 10-8.
- J. Automatic Transmission Fluid Dipstick. See “Checking the Fluid Level” under *Automatic Transmission Fluid* on page 10-11.
- K. Brake Master Cylinder Reservoir. See “Brake Fluid” under *Brakes* on page 10-22.
- L. *Engine Air Cleaner/Filter* on page 10-12.
- M. Windshield Washer Fluid Reservoir. See “Adding Washer Fluid” under *Washer Fluid* on page 10-21.

Engine Cover

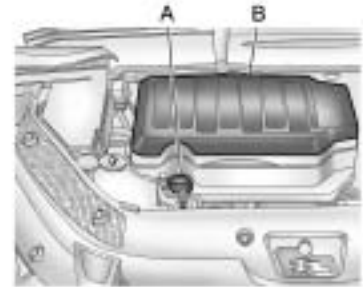

- A. Oil Fill Cap
- B. Engine Cover

To remove:

1. Remove the oil fill cap (A).
2. Raise the engine cover (B) to release from the retainers.
3. Lift and remove the engine cover.
4. Reverse Steps 1 through 3 to reinstall engine cover.

Engine Oil

Checking Engine Oil

It is a good idea to check the engine oil level at each fuel fill. In order to get an accurate reading, the oil must be warm and the vehicle must be on level ground.

The engine oil dipstick handle is a yellow loop. See *Engine Compartment Overview* on page 10-6 for the location of the engine oil dipstick.

1. Turn off the engine and give the oil several minutes to drain back into the oil pan. If this is not done, the oil dipstick might not show the actual level.
2. Pull out the dipstick and clean it with a paper towel or cloth, then push it back in all the way. Remove it again, keeping the tip down, and check the level.

When to Add Engine Oil



If the oil is below the cross-hatched area at the tip of the dipstick, add at least one quart/liter of the recommended oil. This section explains what kind of oil to use. For engine oil crankcase capacity, see *Capacities and Specifications* on page 12-2.

Notice: Do not add too much oil. If the engine has so much oil that the oil level gets above the cross-hatched area that shows the proper operating range, the engine could be damaged.



See *Engine Compartment Overview* on page 10-6 for the location of the engine oil fill cap.

Add enough oil to put the level somewhere in the proper operating range in the cross-hatched area. Push the dipstick all the way back in when through.

What Kind of Engine Oil to Use

Look for three things:

- GM6094M
Use only an oil that meets GM Standard GM6094M.
- SAE 5W-30
SAE 5W-30 is best for the vehicle. These numbers on an oil container show its viscosity, or thickness. Do not use other viscosity oils such as SAE 20W-50.
- American Petroleum Institute (API) starburst symbol



Oils meeting these requirements should have the starburst symbol on the container.

This symbol indicates that the oil has been certified by the American Petroleum Institute (API).

Notice: Use only engine oil identified as meeting GM Standard GM6094M and showing the American Petroleum Institute Certified For Gasoline Engines starburst symbol. Failure to use the recommended oil can result in engine damage not covered by the vehicle warranty.

Cold Temperature Operation

If in an area of extreme cold, where the temperature falls below -20°F (-29°C), use either an SAE 5W-30 synthetic oil or an SAE 0W-30 engine oil. Both provide easier cold starting for the engine at extremely low temperatures. Always use an oil that meets the required specification, GM6094M. See “What Kind of Engine Oil to Use” for more information.

Engine Oil Additives / Engine Oil Flushes

Do not add anything to the oil. The recommended oils with the starburst symbol that meet GM standards are all that is needed for good performance and engine protection.

Engine oil system flushes are not recommended and could cause engine damage not covered by the vehicle warranty.

Engine Oil Life System

When to Change Engine Oil

This vehicle has a computer system that indicates when to change the engine oil and filter. This is based on engine revolutions and engine temperature, and not on mileage. Based on driving conditions, the mileage at which an oil change is indicated can vary considerably. For the oil life system to work properly, the system must be reset every time the oil is changed.

When the system has calculated that oil life has been diminished, it indicates that an oil change is necessary. A “Change Engine Oil Soon” message comes on. Change the oil as soon as possible within the next 600 miles (1 000 km). It is possible that, if driving under the best conditions, the oil life system might not indicate that an oil change is necessary for over a year. However, the engine oil and filter must be changed at least once a year and at this time the system must be reset. Your dealer/retailer has trained service people who will perform this work using genuine parts and reset the system. It is also important to check the oil regularly and keep it at the proper level.

If the system is ever reset accidentally, the oil must be changed at 3,000 miles (5 000 km) since the last oil change. Remember to reset the oil life system whenever the oil is changed.

How to Reset the Engine Oil Life System

The Engine Oil Life System calculates when to change the engine oil and filter based on vehicle use. Whenever the oil is changed, reset the system so it can calculate when the next oil change is required. If a situation occurs where the oil is changed prior to a “Change Engine Oil Soon” message being turned on, reset the system.

If the vehicle does not have Driver Information Center (DIC) buttons:

1. Turn the ignition to ON/RUN, with the engine off. The vehicle must be in P (Park) to access this display. Press the trip odometer reset stem until “Oil Life Remaining” displays.
2. Press and hold the trip odometer reset stem until “Oil Life Remaining” shows “100%.” Three chimes sound and the “Change Engine Oil Soon” message goes off.

3. Turn the key to LOCK/OFF.

If the “Change Engine Oil Soon” message comes back on when the vehicle is started, the engine oil life system has not reset. Repeat the procedure.

If the vehicle has Driver Information Center (DIC) buttons:

1. Turn the ignition to ON/RUN, with the engine off.
2. Press the vehicle information button until “Oil Life Remaining” displays.
3. Press and hold the set/reset button until “100%” is displayed. Three chimes sound and the “Change Engine Oil Soon” message goes off.
4. Turn the key to LOCK/OFF.

If the “Change Engine Oil Soon” message comes back on when the vehicle is started, the engine oil life system has not reset. Repeat the procedure.

What to Do with Used Oil

Used engine oil contains certain elements that can be unhealthy for your skin and could even cause cancer. Do not let used oil stay on your skin for very long. Clean your skin and nails with soap and water, or a good hand cleaner. Wash or properly dispose of clothing or rags containing used engine oil. See the manufacturer's warnings about the use and disposal of oil products.

Used oil can be a threat to the environment. If you change your own oil, be sure to drain all the oil from the filter before disposal. Never dispose of oil by putting it in the trash, pouring it on the ground, into sewers, or into streams or bodies of water. Recycle it by taking it to a place that collects used oil.

Automatic Transmission Fluid

It is not necessary to check the transmission fluid level. A transmission fluid leak is the only reason for fluid loss. If a leak occurs, take the vehicle to the dealer/retailer and have it repaired as soon as possible.

Change the fluid at the intervals listed in *Scheduled Maintenance on page 11-2*, and be sure to use the transmission fluid listed in *Recommended Fluids and Lubricants on page 11-8*.

Notice: Use of the incorrect automatic transmission fluid may damage the vehicle, and the damages may not be covered by the vehicle's warranty. Always use the automatic transmission fluid listed in *Recommended Fluids and Lubricants on page 11-8*.

The transmission fluid will not reach the end of the dipstick unless the transmission is at operating temperature. If you need to check the transmission fluid level, please take the vehicle to your dealer/retailer.

Engine Air Cleaner/Filter

When to Inspect the Engine Air Cleaner/Filter

Inspect the air cleaner/filter at the Maintenance II intervals and replace it at the first oil change after each 80 000 km (50,000 mile) interval. See *Scheduled Maintenance on page 11-2* for more information. If driving in dusty/dirty conditions, inspect the filter at each engine oil change.

See *Engine Compartment Overview on page 10-6* for the location of the engine air cleaner/filter.

How to Inspect the Engine Air Cleaner/Filter

To inspect the air cleaner/filter, remove the filter from the vehicle and lightly shake the filter (away from vehicle) to release loose dust and dirt. If the filter remains caked with dirt, a new filter is required.

To inspect or replace the engine air cleaner/filter, do the following:

1. Remove the engine cover.
See *Engine Cover on page 10-7*.

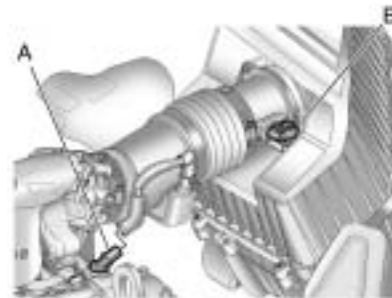

- A. Ventilation Tube
 - B. Sensor
2. Disconnect the cover fitting from the ventilation tube (A).
 3. Disconnect the wiring harness connector from the sensor (B).

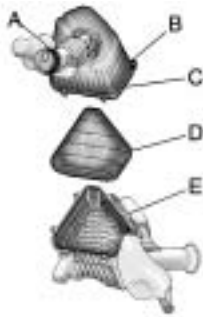

- A. Clamp
 - B. Screws
 - C. Housing Cover
 - D. Filter
 - E. Base
4. Loosen the outlet duct clamp (A).
 5. Loosen the six housing cover (C) screws (B).

6. Remove the housing cover (C) with outlet duct.
7. Remove the filter (D) and any loose debris that may be found in the base (E).
8. Inspect or replace the filter (D).
9. Reverse Steps 2 through 6 to reinstall the housing cover and reconnect the electrical connector to the sensor.
10. Reinstall the engine cover.
See *Engine Cover* on page 10-7.

⚠ WARNING

Operating the engine with the air cleaner/filter off can cause you or others to be burned. The air cleaner not only cleans the air; it helps to stop flames if the engine backfires. Use caution when working on the engine and do not drive with the air cleaner/filter off.

Notice: If the air cleaner/filter is off, dirt can easily get into the engine, which could damage it. Always have the air cleaner/filter in place when you are driving.

Cooling System

The cooling system allows the engine to maintain the correct working temperature.

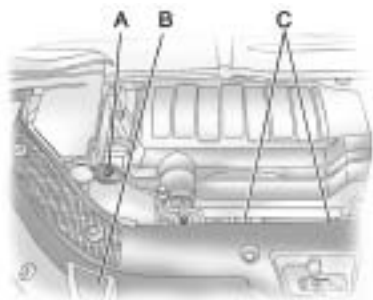

- A. Engine Coolant Recovery Tank
- B. Radiator Pressure Cap
- C. Engine Cooling Fans

WARNING

An electric engine cooling fan under the hood can start up even when the engine is not running and can cause injury. Keep hands, clothing, and tools away from any underhood electric fan.

WARNING

Heater and radiator hoses, and other engine parts, can be very hot. Do not touch them. If you do, you can be burned.

Do not run the engine if there is a leak. If you run the engine, it could lose all coolant. That could cause an engine fire, and you could be burned. Get any leak fixed before you drive the vehicle.

Notice: Using coolant other than DEX-COOL[®] can cause premature engine, heater core, or radiator corrosion. In addition, the engine coolant could require changing sooner, at 50 000 km (30,000 miles) or 24 months, whichever occurs first. Any repairs would not be covered by the vehicle warranty. Always use DEX-COOL[®] (silicate-free) coolant in the vehicle.

Engine Coolant

The cooling system in the vehicle is filled with DEX-COOL[®] engine coolant. The coolant is designed to remain in the vehicle for five years or 240 000 km (150,000 miles), whichever occurs first.

The following explains the cooling system and how to check and add coolant when it is low. If there is a problem with engine overheating, see *Engine Overheating on page 10-18*.

What to Use

WARNING

Adding only plain water to the cooling system can be dangerous. Plain water, or some other liquid such as alcohol, can boil before the proper coolant mixture will. The vehicle's coolant warning system is set for the proper coolant mixture. With plain water or the wrong mixture, the engine could get too hot but you would not get the overheat warning. The engine could catch fire and you or others could be burned. Use a 50/50 mixture of clean, drinkable water and DEX-COOL[®] coolant.

Use a 50/50 mixture of clean, drinkable water and DEX-COOL coolant. If using this mixture, nothing else needs to be added. This mixture:

- Gives freezing protection down to -37°C (-34°F), outside temperature.
- Gives boiling protection up to 129°C (265°F), engine temperature.
- Protects against rust and corrosion.
- Will not damage aluminum parts.
- Helps keep the proper engine temperature.

Notice: If an improper coolant mixture is used, the engine could overheat and be badly damaged. The repair cost would not be covered by the vehicle warranty. Too much water in the mixture can freeze and crack the engine, radiator, heater core, and other parts.

Notice: If extra inhibitors and/or additives are used in the vehicle's cooling system, the vehicle could be damaged. Use only the proper mixture of the engine coolant listed in this manual for the cooling system. See *Recommended Fluids and Lubricants* on page 11-8 for more information.

Checking Coolant

The vehicle must be on a level surface when checking the coolant level.

Check to see if coolant is visible in the coolant recovery tank. If the coolant inside the coolant recovery tank is boiling, do not do anything else until it cools down. If coolant is visible but the coolant level is not at or above the FULL COLD mark, add a 50/50 mixture of clean, drinkable water and DEX-COOL coolant at the coolant recovery tank, but be sure the cooling system is cool before this is done. See *Cooling System on page 10-14* for more information.



The coolant recovery tank cap has this symbol on it.

When the engine is cold, the coolant level should be at or above the FULL COLD line marked on the recovery tank.

When the engine is hot, the level could be higher than the FULL COLD line. If the coolant is below the FULL COLD line when the engine is hot, there could be a leak in the cooling system.

If the coolant is low, add the coolant or take the vehicle to a dealer/retailer for service.

How to Add Coolant to the Recovery Tank

WARNING

You can be burned if you spill coolant on hot engine parts. Coolant contains ethylene glycol and it will burn if the engine parts are hot enough. Do not spill coolant on a hot engine.

Notice: This vehicle has a specific coolant fill procedure. Failure to follow this procedure could cause the engine to overheat and be severely damaged.

If coolant is needed, add the proper DEX-COOL[®] coolant mixture at the coolant recovery tank.

How to Add Coolant to the Radiator

WARNING

An electric engine cooling fan under the hood can start up even when the engine is not running and can cause injury. Keep hands, clothing, and tools away from any underhood electric fan.

WARNING

Steam and scalding liquids from a hot cooling system can blow out and burn you badly. They are under pressure, and if you turn the surge tank pressure cap — even a little — they can come out at high speed. Never turn the cap when the cooling system, including the surge tank pressure cap, is hot. Wait for the

(Continued)

WARNING (Continued)

cooling system and surge tank pressure cap to cool if you ever have to turn the pressure cap.

If coolant is needed, add the proper mixture directly to the radiator, but be sure the cooling system is cool before this is done.

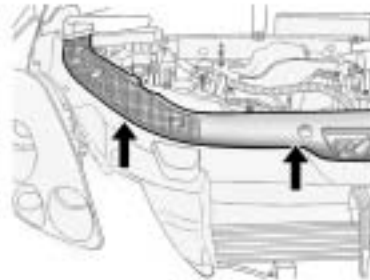

1. Detach fasteners and lift off the panel that covers the radiator cap.

2. Remove the radiator pressure cap when the cooling system, including the upper radiator hose, is no longer hot.

Turn the pressure cap slowly counterclockwise about one full turn. If you hear a hiss, wait for that to stop. A hiss means there is still some pressure left in the system.



3. Keep turning the pressure cap slowly and remove it.
4. Fill the radiator to the base of the filler neck with the proper DEX-COOL coolant mixture.
5. When coolant begins to flow out of the filler neck, reinstall the pressure cap. Be sure to secure it tightly.



6. Fill the coolant recovery tank to the FULL COLD mark.
7. Reinstall the cap on the coolant recovery tank but leave the radiator pressure cap off.



8. Start the engine and let it run until the upper radiator hose feels warm. Any time during this procedure, watch out for the engine cooling fan(s).
9. If the coolant level inside the radiator filler neck is low, add more of the proper DEX-COOL coolant mixture through the filler neck until the level is back up to the base of the filler neck. Replace the pressure cap. Be sure to secure it tightly.

Notice: If the pressure cap is not tightly installed, coolant loss and possible engine damage may occur. Be sure the cap is properly and tightly secured.

Engine Overheating

The vehicle has several indicators to warn of engine overheating.

There is an engine coolant temperature gauge on the instrument panel cluster. See *Engine Coolant Temperature Gauge* on page 5-13.

The vehicle may also display an ENGINE OVERHEATED IDLE ENGINE and ENGINE OVERHEATED STOP ENGINE message in the Driver Information Center (DIC). See *Warning Lights, Gauges, and Indicators* on page 5-10.

You may decide not to lift the hood when this warning appears, but instead get service help right away. See *Roadside Assistance Program* on page 13-6.

If you do decide to lift the hood , make sure the vehicle is parked on a level surface.

Then check to see if the engine cooling fans are running. If the engine is overheating, both fans should be running. If they are not, do not continue to run the engine and have the vehicle serviced.

Notice: Engine damage from running the engine without coolant is not covered by the warranty.

Notice: If the engine catches fire while driving with no coolant, the vehicle can be badly damaged. The costly repairs would not be covered by the vehicle warranty. See *Overheated Engine Protection Operating Mode on page 10-20* for information on driving to a safe place in an emergency.

If Steam Is Coming From The Engine Compartment

 **WARNING**

Steam from an overheated engine can burn you badly, even if you just open the hood. Stay away from the engine if you see or hear steam coming from it. Turn it off and get everyone away from the vehicle until it cools down. Wait until there is no sign of steam or coolant before you open the hood.

If you keep driving when the vehicles engine is overheated, the liquids in it can catch fire. You or others could be badly burned. Stop the engine if it overheats, and get out of the vehicle until the engine is cool.

(Continued)

WARNING (Continued)

See *Overheated Engine Protection Operating Mode on page 10-20* for information on driving to a safe place in an emergency.

If No Steam Is Coming From The Engine Compartment

If an engine overheat warning is displayed but no steam can be seen or heard, the problem may not be too serious. Sometimes the engine can get a little too hot when the vehicle:

- Climbs a long hill on a hot day.
- Stops after high-speed driving.
- Idles for long periods in traffic.
- Tows a trailer.

10-20 Vehicle Care

If the overheat warning is displayed with no sign of steam:

1. Turn the air conditioning off.
2. Turn the heater on to the highest temperature and to the highest fan speed. Open the windows as necessary.
3. If in a traffic jam, shift to N (Neutral), otherwise, shift to the highest gear while driving — D (Drive) or L (Low).

If the temperature overheat gauge is no longer in the overheat zone or an overheat warning no longer displays, the vehicle can be driven. Continue to drive the vehicle slow for about 10 minutes. Keep a safe vehicle distance from the car in front of you. If the warning does not come back on, continue to drive normally.

If the warning continues, pull over, stop, and park the vehicle right away.

If there is no sign of steam, idle the engine for three minutes while parked. If the warning is still displayed, turn off the engine until it cools down. Also, see “Overheated Engine Protection Operating Mode” next in this section.

Overheated Engine Protection Operating Mode

This emergency operating mode lets the vehicle be driven to a safe place in an emergency situation. If an overheated engine condition exists, an overheat protection mode which alternates firing groups of cylinders helps prevent engine damage. In this mode, there is a significant loss in power and engine performance. The temperature gauge indicates an overheat condition exists. Driving extended distances and/or towing a trailer in the overheat protection mode should be avoided.

Notice: After driving in the overheated engine protection operating mode, to avoid engine damage, allow the engine to cool before attempting any repair. The engine oil will be severely degraded. Repair the cause of coolant loss, change the oil and reset the oil life system. See *Engine Oil on page 10-8*.

Power Steering Fluid



The power steering fluid reservoir is located under the engine cover on the passenger side of the vehicle. See *Engine Compartment Overview on page 10-6* for reservoir location.

When to Check Power Steering Fluid

It is not necessary to regularly check power steering fluid unless you suspect there is a leak in the system or you hear an unusual noise. A fluid loss in this system could indicate a problem. Have the system inspected and repaired.

How to Check Power Steering Fluid

To check the power steering fluid:

1. Turn the key off and let the engine compartment cool down.
2. Remove the engine cover. See *Engine Cover on page 10-7*.
3. Wipe the cap and the top of the reservoir clean.

4. Unscrew the cap and wipe the dipstick with a clean rag.
5. Replace the cap and completely tighten it.
6. Remove the cap again and look at the fluid level on the dipstick.

The fluid level should be somewhere between MAX and MIN line on the dipstick in room temperature. If the fluid is on or below MIN line, you should add fluid close to MAX Line.

What to Use

To determine what kind of fluid to use, see *Recommended Fluids and Lubricants on page 11-8*. Always use the proper fluid.

Notice: Use of the incorrect fluid may damage the vehicle and the damages may not be covered by the vehicle's warranty. Always use the correct fluid listed in *Recommended Fluids and Lubricants on page 11-8*.

Washer Fluid

What to Use

When adding windshield washer fluid, be sure to read the manufacturer's instructions before use. If the vehicle will be operating in an area where the temperature may fall below freezing, use a fluid that has sufficient protection against freezing.

Adding Washer Fluid

When the windshield washer fluid reservoir is low, a WASHER FLUID LOW ADD FLUID message will be displayed on the Driver Information Center (DIC). See *Washer Fluid Messages* on page 5-44 for more information.



Open the cap with the washer symbol on it. Add washer fluid until the tank is full. See *Engine Compartment Overview* on page 10-6 for reservoir location.

Notice:

- **When using concentrated washer fluid, follow the manufacturer's instructions for adding water.**
- **Do not mix water with ready-to-use washer fluid. Water can cause the solution to freeze and damage the washer fluid tank and other parts of the washer system. Also, water does not clean as well as washer fluid.**
- **Fill the washer fluid tank only three-quarters full when it is very cold. This allows for fluid expansion if freezing occurs, which could damage the tank if it is completely full.**
- **Do not use engine coolant (antifreeze) in the windshield washer. It can damage the vehicle's windshield washer system and paint.**

Brakes

This vehicle has disc brakes. Disc brake pads have built-in wear indicators that make a high-pitched warning sound when the brake pads are worn and new pads are needed. The sound can come and go or be heard all the time the vehicle is moving, except when applying the brake pedal firmly.

WARNING

The brake wear warning sound means that soon the brakes will not work well. That could lead to an accident. When the brake wear warning sound is heard, have the vehicle serviced.

Notice: Continuing to drive with worn-out brake pads could result in costly brake repair.

Some driving conditions or climates can cause a brake squeal when the brakes are first applied or lightly applied. This does not mean something is wrong with the brakes.

Properly torqued wheel nuts are necessary to help prevent brake pulsation. When tires are rotated, inspect brake pads for wear and evenly tighten wheel nuts in the proper sequence to torque specifications in *Capacities and Specifications on page 12-2*.

Brake linings should always be replaced as complete axle sets.

Brake Pedal Travel

See your dealer/retailer if the brake pedal does not return to normal height, or if there is a rapid increase in pedal travel. This could be a sign that brake service might be required.

Brake Adjustment

Every time the brakes are applied, with or without the vehicle moving, the brakes adjust for wear.

Replacing Brake System Parts

The braking system on a vehicle is complex. Its many parts have to be of top quality and work well together if the vehicle is to have really good braking. The vehicle was designed and tested with top-quality brake parts. When parts of the braking system are replaced, be sure to get new, approved replacement parts. If this is not done, the brakes might not work properly.

For example, installing disc brake pads that are wrong for the vehicle, can change the balance between the front and rear brakes — for the worse. The braking performance expected can change in many other ways if the wrong replacement brake parts are installed.

Brake Fluid



The brake master cylinder reservoir is filled with DOT 3 brake fluid as indicated on the reservoir cap. See *Engine Compartment Overview on page 10-6* for the location of the reservoir.

There are only two reasons why the brake fluid level in the reservoir might go down:

- The brake fluid level goes down because of normal brake lining wear. When new linings are installed, the fluid level goes back up.
- A fluid leak in the brake hydraulic system can also cause a low fluid level. Have the brake hydraulic system fixed, since a leak means that sooner or later the brakes will not work well.

Do not top off the brake fluid. Adding fluid does not correct a leak. If fluid is added when the linings are worn, there will be too much fluid when new brake linings are installed. Add or remove brake fluid, as necessary, only when work is done on the brake hydraulic system.

WARNING

If too much brake fluid is added, it can spill on the engine and burn, if the engine is hot enough. You or others could be burned, and the vehicle could be damaged. Add brake fluid only when work is done on the brake hydraulic system.

When the brake fluid falls to a low level, the brake warning light comes on. See *Brake System Warning Light on page 5-19*.

What to Add

Use only new DOT 3 brake fluid from a sealed container. See *Recommended Fluids and Lubricants on page 11-8*.

Always clean the brake fluid reservoir cap and the area around the cap before removing it. This helps keep dirt from entering the reservoir.

WARNING

With the wrong kind of fluid in the brake hydraulic system, the brakes might not work well. This could cause a crash. Always use the proper brake fluid.

Notice:

- **Using the wrong fluid can badly damage brake hydraulic system parts. For example, just a few drops of mineral-based oil, such as engine oil, in the brake hydraulic system can damage brake hydraulic system parts so badly that they will have to be replaced. Do not let someone put in the wrong kind of fluid.**
- **If brake fluid is spilled on the vehicle's painted surfaces, the paint finish can be damaged. Be careful not to spill brake fluid on the vehicle. If you do, wash it off immediately.**

Battery

Refer to the replacement number on the original battery label when a new battery is needed.

 **DANGER**

Battery posts, terminals, and related accessories contain lead and lead compounds, chemicals known to the State of California to cause cancer and reproductive harm. Wash hands after handling.

Vehicle Storage **WARNING**

Batteries have acid that can burn you and gas that can explode. You can be badly hurt if you are not careful. See *Jump Starting on page 10-79* for tips on working around a battery without getting hurt.

Infrequent Usage: Remove the black, negative (-) cable from the battery to keep the battery from running down.

Extended Storage: Remove the black, negative (-) cable from the battery or use a battery trickle charger.

All-Wheel Drive

It is not necessary to check the all-wheel drive lubricant levels. A fluid leak is the only reason for fluid loss. If a leak occurs, take the vehicle to the dealer/retailer as soon as possible.

Starter Switch Check

 **WARNING**

When you are doing this inspection, the vehicle could move suddenly. If the vehicle moves, you or others could be injured.

1. Before starting this check, be sure there is enough room around the vehicle.
2. Firmly apply both the parking brake and the regular brake. See *Parking Brake on page 9-29*.
Do not use the accelerator pedal, and be ready to turn off the engine immediately if it starts.
3. Try to start the engine in each gear. The vehicle should start only in P (Park) or N (Neutral). If the vehicle starts in any other position, contact your dealer/retailer for service.

Automatic Transmission Shift Lock Control System Check

 **WARNING**

When you are doing this inspection, the vehicle could move suddenly. If the vehicle moves, you or others could be injured.

1. Before starting this check, be sure there is enough room around the vehicle. It should be parked on a level surface.
2. Firmly apply the parking brake. See *Parking Brake on page 9-29*.
Be ready to apply the regular brake immediately if the vehicle begins to move.

3. With the engine off, turn the ignition to ON/RUN, but do not start the engine. Without applying the regular brake, try to move the shift lever out of P (Park) with normal effort. If the shift lever moves out of P (Park), contact your dealer/retailer for service.

Ignition Transmission Lock Check

While parked, and with the parking brake set, try to turn the ignition to LOCK/OFF in each shift lever position.

- The ignition should turn to LOCK/OFF only when the shift lever is in P (Park).
- The ignition key should come out only in LOCK/OFF.

Contact your dealer/retailer if service is required.

Park Brake and P (Park) Mechanism Check

WARNING

When you are doing this check, the vehicle could begin to move. You or others could be injured and property could be damaged. Make sure there is room in front of the vehicle in case it begins to roll. Be ready to apply the regular brake at once should the vehicle begin to move.

Park on a fairly steep hill, with the vehicle facing downhill. Keeping your foot on the regular brake, set the parking brake.

- To check the parking brake's holding ability: With the engine running and the transmission in N (Neutral), slowly remove foot pressure from the regular brake pedal. Do this until the vehicle is held by the parking brake only.

- To check the P (Park) mechanism's holding ability: With the engine running, shift to P (Park). Then release the parking brake followed by the regular brake.

Contact your dealer/retailer if service is required.

Wiper Blade Replacement

Windshield wiper blades should be inspected for wear or cracking. See *Scheduled Maintenance on page 11-2* for more information.

Replacement blades come in different types and are removed in different ways. To replace the wiper blade assembly:

1. Pull the windshield wiper arm away from the windshield.

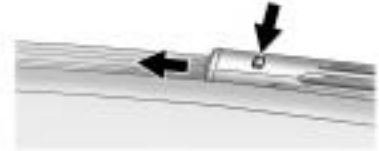

2. Press the button in the middle of the wiper arm connector and pull the wiper blade away from the arm connector.
3. Install the new wiper blade and make sure the wiper blade locks into place.

For the proper size and type see *Maintenance Replacement Parts on page 11-10*.

Backglass Wiper Blade

To replace the backglass wiper blade:

1. Pull the wiper blade assembly away from the backglass.

The backglass wiper blade will not lock in a vertical position so care should be used when pulling it away from the vehicle.

2. Rotate the wiper blade assembly, hold the wiper arm in position, and push the blade away from the wiper arm.
3. Replace the wiper blade.
4. Return the wiper arm and blade assembly to the rest position on the glass.

Headlamp Aiming

Headlamp aim has been preset at the factory and should need no further adjustment.

However, if your vehicle is damaged in a crash, the headlamp aim may be affected. Aim adjustment to the low-beam headlamps may be necessary if oncoming drivers flash their high-beam headlamps at you (for vertical aim).

If the headlamps need to be re-aimed, it is recommended that you take the vehicle to your dealer/retailer for service.

Bulb Replacement

For the proper type of replacement bulbs, see *Replacement Bulbs on page 10-29*.

For any bulb changing procedure not listed in this section, contact your dealer/retailer.

Halogen Bulbs

 **WARNING**

Halogen bulbs have pressurized gas inside and can burst if you drop or scratch the bulb. You or others could be injured. Be sure to read and follow the instructions on the bulb package.

License Plate Lamp

To replace one of these bulbs:

1. Remove the two screws holding each of the license plate lamps to the liftgate trim.

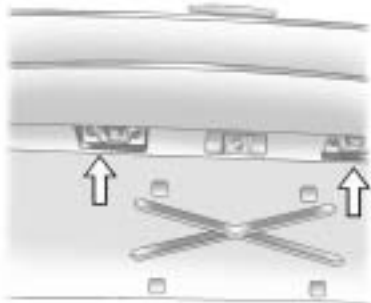

2. Turn and pull the license plate lamp forward through the lift gate trim opening.

3. Turn the bulb socket counterclockwise and pull the bulb straight out of the socket.
4. Install the new bulb.
5. Reverse steps 1 through 3 to reinstall the license plate lamp.

Replacement Bulbs

Exterior Lamp	Bulb Number
License Plate Lamp	194

For replacement bulbs not listed here, contact your dealer/retailer.

Electrical System

High Voltage Devices and Wiring

⚠ WARNING

Exposure to high voltage can cause shock, burns, and even death. The high voltage systems in your vehicle can only be serviced by technicians with special training.

High voltage devices are identified by labels. Do not remove, open, take apart, or modify these devices. High voltage cable or wiring has orange covering. Do not probe, tamper with, cut, or modify high voltage cable or wiring.

Electrical System Overload

The vehicle has fuses and circuit breakers to protect against an electrical system overload.

When the current electrical load is too heavy, the circuit breaker opens and closes, protecting the circuit until the current load returns to normal or the problem is fixed.

This greatly reduces the chance of circuit overload and fire caused by electrical problems.

Fuses and circuit breakers protect the following in the vehicle:

- Headlamp Wiring
- Windshield Wiper Motor
- Power Windows and other Power Accessories

Headlamp Wiring

An electrical overload may cause the lamps to go on and off, or in some cases to remain off. Have the headlamp wiring checked right away if the lamps go on and off or remain off.

Windshield Wipers

If the wiper motor overheats due to heavy snow or ice, the windshield wipers will stop until the motor cools and will then restart.

Although the circuit is protected from electrical overload, overload due to heavy snow or ice, may cause wiper linkage damage. Always clear ice and heavy snow from the windshield before using the windshield wipers.

If the overload is caused by an electrical problem and not snow or ice, be sure to get it fixed.

Fuses and Circuit Breakers

The wiring circuits in your vehicle are protected from short circuits by a combination of fuses, circuit breakers and fusible thermal links. This greatly reduces the chance of fires caused by electrical problems.

Look at the silver-colored band inside the fuse. If the band is broken or melted, replace the fuse. Be sure you replace a bad fuse with a new one of the identical size and rating.

Fuses of the same amperage can be temporarily borrowed from another fuse location, if a fuse goes out. Replace the fuse as soon as you can.

Engine Compartment Fuse Block

The underhood fuse block is located in the engine compartment, on the passenger side of the vehicle.



Lift the cover for access to the fuse/relay block.

Notice: Spilling liquid on any electrical components on the vehicle may damage it. Always keep the covers on any electrical component.

To remove fuses, hold the end of the fuse between your thumb and index finger and pull straight out.

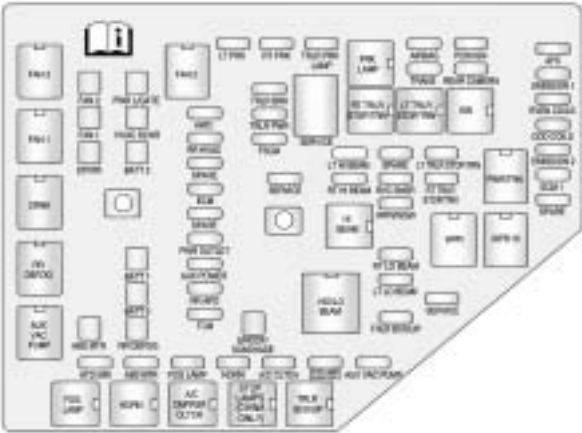

Fuses	Usage
A/C CLUTCH	Air Conditioning Clutch
ABS MTR	Antilock Braking System (ABS) Motor
AFS	Adaptive Forward Lighting System

Fuses	Usage
AIRBAG	Airbag System
AUX POWER	Auxiliary Power
AUX VAC PUMP	Auxiliary Vacuum Pump
AWD	All-Wheel-Drive System

10-32 Vehicle Care

Fuses	Usage
BATT 1	Battery 1
BATT 2	Battery 2
BATT 3	Battery 3
ECM	Engine Control Module
ECM 1	Engine Control Module 1
EMISSION 1	Emission 1
EMISSION 2	Emission 2
EVEN COILS	Even Injector Coils
FAN 1	Cooling Fan 1
FAN 2	Cooling Fan 2
FOG LAMP	Fog Lamps
FSCM	Fuel System Control Module
HORN	Horn

Fuses	Usage
HTD MIR	Heated Outside Rearview Mirror
HVAC BLWR	Heating, Ventilation and Air Conditioning Blower
LT HI BEAM	Left High-Beam Headlamp
LT LO BEAM	Left Low-Beam Headlamp
LT PRK	Left Parking Lamp
LT TRLR STOP/TRN	Trailer Left Stoplamp and Turn Signal
ODD COILS	Odd Injector Coils
PCM IGN	Powertrain Control Module Ignition
PWR L/GATE	Power Liftgate

Fuses	Usage
PWR OUTLET	Power Outlet
REAR CAMERA	Rear Camera
RR APO	Rear Accessory Power Outlet
RR DEFOG	Rear Defogger
RR HVAC	Rear Climate Control System
RT HI BEAM	Right High-Beam Headlamp
RT LO BEAM	Right Low-Beam Headlamp
RT PRK	Right Parking Lamp
RT TRLR STOP/TRN	Trailer Right Stoplamp and Turn Signal

Fuses	Usage
RVC SNSR	Regulated Voltage Control Sensor
S/ROOF/SUNSHADE	Sunroof
SERVICE	Service Repair
SPARE	Spare
Stop Lamps (China Only)	Stop Lamps (China Only)
STRTR	Starter
TCM	Transmission Control Module
TRANS	Transmission
TRLR BCK/UP	Trailer Back-up Lamps
TRLR BRK	Trailer Brake

Fuses	Usage
TRLR PRK LAMP	Trailer Parking Lamps
TRLR PWR	Trailer Power
WPR/WSW	Windshield Wiper/Washer

Relays	Usage
A/C CMPRSR CLTCH	Air Conditioning Compressor Clutch
AUX VAC PUMP	Auxiliary Vacuum Pump
CRNK	Switched Power
FAN 1	Cooling Fan 1
FAN 2	Cooling Fan 2
FAN 3	Cooling Fan 3

Relays	Usage
FOG LAMP	Fog Lamps
HI BEAM	High-Beam Headlamps
HID/LO BEAM	High Intensity Discharge (HID) Low-Beam Headlamps
HORN	Horn
IGN	Ignition Main
LT TRLR STOP/TRN	Trailer Left Stoplamp and Turn Signal Lamp
PRK LAMP	Park Lamp
PWR/TRN	Powertrain
RR DEFOG	Rear Window Defogger

10-34 Vehicle Care

Relays	Usage
RT TRLR STOP/TRN	Trailer Right Stoplamp and Turn Signal Lamp
Stop Lamps (China Only)	Stop Lamps (China Only)
TRLR BCK/UP	Trailer Back-up Lamps
WPR	Windshield Wiper
WPR HI	Windshield Wiper High Speed

Instrument Panel Fuse Block

The instrument panel fuse block is located under the instrument panel on the passenger side of the vehicle. Pull down on the cover to access the fuse block.



Fuse Side

Fuses	Usage
AIRBAG	Airbag
AMP	Amplifier
BCK/UP/STOP	Back-up Lamp/ Stoplamp
BCM	Body Control Module
CNSTR/VENT	Canister Vent
CTSY	Courtesy
DR/LCK	Door Locks
DRL	Daytime Running Lamps
DRL 2	GMC HID Only/ Rear Fog Lamps-China Only
DSPLY	Display
FRT/WSW	Front Windshield Washer
HTD/COOL SEAT	Heated/Cooling Seats

Fuses	Usage
HVAC	Heating, Ventilation and Air Conditioning
INADV/ PWR/LED	Inadvertent Power LED
INFOTMNT	Infotainment
LT/TRN/SIG	Driver Side Turn Signal
MSM	Memory Seat Module
PDM	Power Mirrors, Liftgate Release
PWR MODE	Power Mode
PWR/MIR	Power Mirrors
RDO	Radio
REAR WPR	Rear Wiper
RT/TRN/SIG	Passenger Side Turn Signal
SPARE	Spare
STR/WHL/ ILLUM	Steering Wheel Illumination

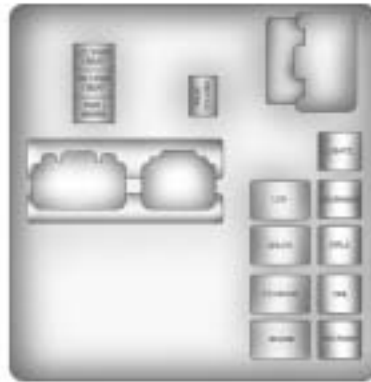

Relay Side

Relays	Usage
LT/PWR/ SEAT	Driver Side Power Seat Relay
RT/PWR/ SEAT	Passenger Side Power Seat Relay
PWR/WNDW	Power Windows Relay
PWR/ COLUMN	Power Steering Column Relay
L/GATE	Liftgate Relay
LCK	Power Lock Relay
REAR/WSW	Rear Window Washer Relay
UNLCK	Power Unlock Relay

Relays	Usage
DRL2	Daytime Running Lamps 2 Relay
LT/UNLCK	Driver Side Unlock Relay
DRL	Daytime Running Lamps Relay
SPARE	Spare
FRT/WSW	Front Windshield Washer Relay

Wheels and Tires

Tires

Your new vehicle comes with high-quality tires made by a leading tire manufacturer. If you ever have questions about your tire warranty and where to obtain service, see your vehicle Warranty booklet for details. For additional information refer to the tire manufacturer.

WARNING

Poorly maintained and improperly used tires are dangerous.

- Overloading your tires can cause overheating as a result of too much flexing. You could have an air-out and a serious accident. See *Vehicle Load Limits* on page 9-12.

(Continued)

WARNING (Continued)

- Underinflated tires pose the same danger as overloaded tires. The resulting accident could cause serious injury. Check all tires frequently to maintain the recommended pressure. Tire pressure should be checked when your tires are cold. See *Tire Pressure* on page 10-43.
- Overinflated tires are more likely to be cut, punctured or broken by a sudden impact — such as when you hit a pothole. Keep tires at the recommended pressure.
- Worn, old tires can cause accidents. If your tread is badly worn, or if your tires have been damaged, replace them.

Tire Sidewall Labeling

Useful information about a tire is molded into its sidewall. The examples below show a typical passenger vehicle tire and a compact spare tire sidewall.

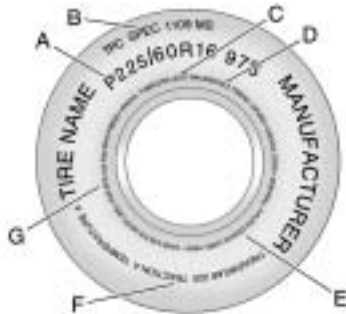

Passenger (P-Metric) Tire Example

(A) Tire Size: The tire size is a combination of letters and numbers used to define a particular tire's width, height,

aspect ratio, construction type, and service description. See the "Tire Size" illustration later in this section for more detail.

(B) TPC Spec (Tire Performance Criteria Specification): Original equipment tires designed to GM's specific tire performance criteria have a TPC specification code molded onto the sidewall. GM's TPC specifications meet or exceed all federal safety guidelines.

(C) DOT (Department of Transportation): The Department of Transportation (DOT) code indicates that the tire is in compliance with the U.S. Department of Transportation Motor Vehicle Safety Standards.

(D) Tire Identification Number (TIN): The letters and numbers following the DOT (Department of Transportation) code is the Tire Identification Number (TIN). The TIN shows the manufacturer and plant code, tire size, and date the tire was manufactured. The TIN is molded onto both sides of the tire, although only one side may have the date of manufacture.

(E) Tire Ply Material: The type of cord and number of plies in the sidewall and under the tread.

(F) Uniform Tire Quality Grading (UTQG): Tire manufacturers are required to grade tires based on three performance factors: treadwear, traction, and temperature resistance. For more information see *Uniform Tire Quality Grading on page 10-54*.

(G) Maximum Cold Inflation

Load Limit: Maximum load that can be carried and the maximum pressure needed to support that load.

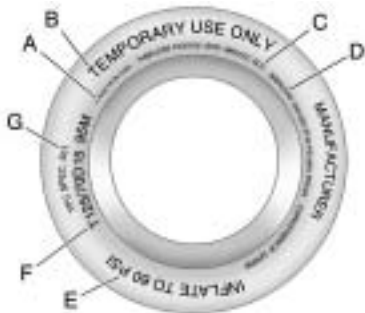

Compact Spare Tire Example

(A) Tire Ply Material: The type of cord and number of plies in the sidewall and under the tread.

(B) Temporary Use Only:

The compact spare tire or temporary use tire has a tread life of approximately 5 000 km (3,000 miles) and should not be driven at speeds over 105 km/h (65 mph). The compact spare tire is for emergency use when a regular road tire has lost air and gone flat. If your vehicle has a compact spare tire, see *Compact Spare Tire* on page 10-77 and *If a Tire Goes Flat* on page 10-57.

(C) Tire Identification Number (TIN):

The letters and numbers following the DOT (Department of Transportation) code is the Tire Identification Number (TIN). The TIN shows the manufacturer and plant code,

tire size, and date the tire was manufactured. The TIN is molded onto both sides of the tire, although only one side may have the date of manufacture.

(D) Maximum Cold Inflation

Load Limit: Maximum load that can be carried and the maximum pressure needed to support that load.

(E) Tire Inflation:

The temporary use tire or compact spare tire should be inflated to 420 kPa (60 psi). For more information on tire pressure and inflation see *Tire Pressure* on page 10-43.

(F) Tire Size : A combination of letters and numbers define a tire's width, height, aspect ratio, construction type, and service description. The letter T as the first character in the tire size means the tire is for temporary use only.

(G) TPC Spec (Tire Performance Criteria Specification): Original equipment tires designed to GM's specific tire performance criteria have a TPC specification code molded onto the sidewall. GM's TPC specifications meet or exceed all federal safety guidelines.

Tire Designations

Tire Size

The following illustration shows an example of a typical passenger vehicle tire size.

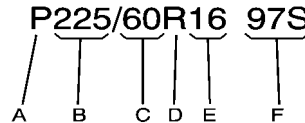

(A) Passenger (P-Metric) Tire:

The United States version of a metric tire sizing system. The letter P as the first character in the tire size means a passenger vehicle tire engineered to standards set by the U.S. Tire and Rim Association.

(B) Tire Width: The three-digit number indicates the tire section width in millimeters from sidewall to sidewall.

(C) Aspect Ratio: A two-digit number that indicates the tire height-to-width measurements. For example, if the tire size aspect ratio is 60, as shown in item C of the illustration, it would mean that the tire's sidewall is 60 percent as high as it is wide.

(D) Construction Code:

A letter code is used to indicate the type of ply construction in the tire. The letter R means radial ply construction; the letter D means diagonal or bias ply construction; and the letter B means belted-bias ply construction.

(E) Rim Diameter: Diameter of the wheel in inches.

(F) Service Description: These characters represent the load index and speed rating of the tire. The load index represents the load carry capacity a tire is certified to carry. The speed rating is the maximum speed a tire is certified to carry a load.

Tire Terminology and Definitions

Air Pressure: The amount of air inside the tire pressing outward on each square inch of the tire. Air pressure is expressed in psi (pounds per square inch) or kPa (kilopascal).

Accessory Weight: This means the combined weight of optional accessories. Some examples of optional accessories are, automatic transmission, power steering,

power brakes, power windows, power seats, and air conditioning.

Aspect Ratio: The relationship of a tire's height to its width.

Belt: A rubber coated layer of cords that is located between the plies and the tread. Cords may be made from steel or other reinforcing materials.

Bead: The tire bead contains steel wires wrapped by steel cords that hold the tire onto the rim.

Bias Ply Tire: A pneumatic tire in which the plies are laid at alternate angles less than 90 degrees to the centerline of the tread.

Cold Tire Pressure: The amount of air pressure in a tire, measured in psi (pounds per square inch) or kPa (kilopascal)

before a tire has built up heat from driving. See *Tire Pressure* on page 10-43.

Curb Weight: The weight of a motor vehicle with standard and optional equipment including the maximum capacity of fuel, oil, and coolant, but without passengers and cargo.

DOT Markings: A code molded into the sidewall of a tire signifying that the tire is in compliance with the U.S. Department of Transportation (DOT) motor vehicle safety standards. The DOT code includes the Tire Identification Number (TIN), an alphanumeric designator which can also identify the tire manufacturer, production plant, brand, and date of production.

GVWR: Gross Vehicle Weight Rating. See *Vehicle Load Limits* on page 9-12.

GAWR FRT: Gross Axle Weight Rating for the front axle. See *Vehicle Load Limits on page 9-12*.

GAWR RR: Gross Axle Weight Rating for the rear axle. See *Vehicle Load Limits on page 9-12*.

Intended Outboard Sidewall: The side of an asymmetrical tire, that must always face outward when mounted on a vehicle.

Kilopascal (kPa): The metric unit for air pressure.

Light Truck (LT-Metric) Tire: A tire used on light duty trucks and some multipurpose passenger vehicles.

Load Index: An assigned number ranging from 1 to 279 that corresponds to the load carrying capacity of a tire.

Maximum Inflation Pressure: The maximum air pressure to which a cold tire can be inflated. The maximum air pressure is molded onto the sidewall.

Maximum Load Rating: The load rating for a tire at the maximum permissible inflation pressure for that tire.

Maximum Loaded Vehicle Weight: The sum of curb weight, accessory weight, vehicle capacity weight, and production options weight.

Normal Occupant Weight: The number of occupants a vehicle is designed to seat multiplied by 68 kg (150 lbs). See *Vehicle Load Limits on page 9-12*.

Occupant Distribution: Designated seating positions.

Outward Facing Sidewall: The side of an asymmetrical tire that has a particular side that faces outward when mounted on a vehicle. The side of the tire that contains a whitewall, bears white lettering, or bears manufacturer, brand, and/or model name molding that is higher or deeper than the same moldings on the other sidewall of the tire.

Passenger (P-Metric) Tire: A tire used on passenger cars and some light duty trucks and multipurpose vehicles.

Recommended Inflation Pressure: Vehicle manufacturer's recommended tire inflation pressure as shown on the tire placard. See *Tire Pressure on page 10-43* and *Vehicle Load Limits on page 9-12*.

Radial Ply Tire: A pneumatic tire in which the ply cords that extend to the beads are laid at 90 degrees to the centerline of the tread.

Rim: A metal support for a tire and upon which the tire beads are seated.

Sidewall: The portion of a tire between the tread and the bead.

Speed Rating: An alphanumeric code assigned to a tire indicating the maximum speed at which a tire can operate.

Traction: The friction between the tire and the road surface. The amount of grip provided.

Tread: The portion of a tire that comes into contact with the road.

Treadwear Indicators: Narrow bands, sometimes called wear bars, that show across the tread of a tire when only 1.6 mm (1/16 inch) of tread remains. See *When It Is Time for New Tires* on page 10-51.

UTQGS (Uniform Tire Quality Grading Standards): A tire information system that provides consumers with ratings for a tire's traction, temperature, and treadwear. Ratings are determined by tire manufacturers using government testing procedures. The ratings are molded into the sidewall of the tire. See *Uniform Tire Quality Grading* on page 10-54.

Vehicle Capacity Weight: The number of designated seating positions multiplied by 68 kg (150 lbs) plus the rated cargo load. See *Vehicle Load Limits* on page 9-12.

Vehicle Maximum Load on the Tire: Load on an individual tire due to curb weight, accessory weight, occupant weight, and cargo weight.

Vehicle Placard: A label permanently attached to a vehicle showing the vehicle's capacity weight and the original equipment tire size and recommended inflation pressure. See "Tire and Loading Information Label" under *Vehicle Load Limits* on page 9-12.

Tire Pressure

Tires need the correct amount of air pressure to operate effectively.

Notice: Do not let anyone tell you that under-inflation or over-inflation is all right. It is not. If your tires do not have enough air (under-inflation), you can get the following:

- Too much flexing
- Too much heat
- Tire overloading
- Premature or irregular wear
- Poor handling
- Reduced fuel economy

If your tires have too much air (over-inflation), you can get the following:

- Unusual wear
- Poor handling
- Rough ride
- Needless damage from road hazards

A vehicle specific Tire and Loading Information label is attached to your vehicle. This label shows your vehicle's original equipment tires and the correct inflation pressures for your tires when they are cold. The recommended cold tire inflation pressure, shown on the label, is the minimum amount of air pressure needed to support your vehicle's maximum load carrying capacity.

For additional information regarding how much weight your vehicle can carry, and an example of the Tire and Loading Information label, see *Vehicle Load Limits on page 9-12*. How you load your vehicle affects vehicle handling and ride comfort. Never load your vehicle with more weight than it was designed to carry.

When to Check

Check your tires once a month or more. Do not forget to check the compact spare tire, if the vehicle has one. The compact spare should be at 60 psi (420 kPa). For additional information regarding the compact spare tire, see *Compact Spare Tire on page 10-77*.

How to Check

Use a good quality pocket-type gauge to check tire pressure. You cannot tell if your tires are properly inflated simply by looking at them. Radial tires may look properly inflated even when they are under-inflated. Check the tire's inflation pressure when the tires are cold. Cold means your vehicle has been sitting for at least three hours or driven no more than 1.6 km (1 mile).

Remove the valve cap from the tire valve stem. Press the tire gauge firmly onto the valve to get a pressure measurement. If the cold tire inflation pressure matches the recommended pressure on the Tire and Loading Information label, no further adjustment is necessary. If the inflation pressure is low, add air until you reach the recommended amount.

If you overfill the tire, release air by pushing on the metal stem in the center of the tire valve. Re-check the tire pressure with the tire gauge.

Be sure to put the valve caps back on the valve stems. They help prevent leaks by keeping out dirt and moisture.

Tire Pressure Monitor System

The Tire Pressure Monitor System (TPMS) uses radio and sensor technology to check tire pressure levels. The TPMS sensors monitor the air pressure in your vehicle's tires and transmit tire pressure readings to a receiver located in the vehicle.

Each tire, including the spare (if provided), should be checked monthly when cold and inflated to the inflation pressure recommended by the vehicle manufacturer on the vehicle placard or tire inflation pressure label. (If your vehicle has tires of a different size than the size indicated on the vehicle placard or tire inflation pressure label, you should determine the proper tire inflation pressure for those tires.)

As an added safety feature, your vehicle has been equipped with a tire pressure monitoring system (TPMS) that illuminates a low tire pressure telltale when one or more of your tires is significantly under-inflated.

Accordingly, when the low tire pressure telltale illuminates, you should stop and check your tires as soon as possible, and inflate them to the proper pressure. Driving on a significantly under-inflated tire causes the tire to overheat and can lead to tire failure. Under-inflation also reduces fuel efficiency and tire tread life, and may affect the vehicle's handling and stopping ability.

Please note that the TPMS is not a substitute for proper tire maintenance, and it is the driver's responsibility to maintain correct tire pressure, even if under-inflation has not reached the level to trigger illumination of the TPMS low tire pressure telltale.

Your vehicle has also been equipped with a TPMS malfunction indicator to indicate when the system is not operating properly. The TPMS malfunction indicator is combined with the low tire pressure telltale. When the system detects a malfunction, the telltale will flash for approximately one minute and then remain continuously illuminated. This sequence will continue upon subsequent vehicle start-ups as long as the malfunction exists.

When the malfunction indicator is illuminated, the system may not be able to detect or signal low tire pressure as intended. TPMS malfunctions may occur for a variety of reasons, including the installation of replacement or alternate tires or wheels on the vehicle that prevent the TPMS from functioning properly.

Always check the TPMS malfunction telltale after replacing one or more tires or wheels on your vehicle to ensure that the replacement or alternate tires and wheels allow the TPMS to continue to function properly.

See *Tire Pressure Monitor Operation* on page 10-46 for additional information.

Federal Communications Commission (FCC) and Industry Canada

See *Radio Frequency Statement* on page 13-17 for information regarding Part 15 of the Federal Communications Commission (FCC) Rules and RSS-210/211 of Industry Canada.

Tire Pressure Monitor Operation

This vehicle may have a Tire Pressure Monitor System (TPMS). The TPMS is designed to warn the driver when a low tire pressure condition exists. TPMS sensors are mounted onto each tire and wheel assembly, excluding the spare tire and wheel assembly, if the vehicle has one. The TPMS sensors monitor the air pressure in the vehicle's tires and transmits the tire pressure readings to a receiver located in the vehicle.



When a low tire pressure condition is detected, the TPMS illuminates the low tire pressure warning light located on the instrument panel cluster. If the warning light comes

on, stop as soon as possible and inflate the tires to the recommended pressure shown on the tire loading information label. See *Vehicle Load Limits on page 9-12*.

At the same time a message to check the pressure in a specific tire appears on the Driver Information Center (DIC) display. The low tire pressure warning light and the DIC warning message come on at each ignition cycle until the tires are inflated to the correct inflation pressure. Using the DIC, tire pressure levels can be viewed by the driver. For additional information and details about the DIC operation and displays see *Driver Information Center (DIC) (With DIC Buttons) on page 5-24* or *Driver Information Center (DIC) (Without DIC Buttons) on page 5-29* and *Tire Messages on page 5-42*.

The low tire pressure warning light may come on in cool weather when the vehicle is first started, and then turn off as you start to drive. This could be an early indicator that the air pressure in the tire(s) are getting low and need to be inflated to the proper pressure.

A Tire and Loading Information label, attached to your vehicle, shows the size of your vehicle's original equipment tires and the correct inflation pressure for your vehicle's tires when they are cold. See *Vehicle Load Limits on page 9-12*, for an example of the Tire and Loading Information label and its location on your vehicle. Also see *Tire Pressure on page 10-43*.

Your vehicle's TPMS can warn you about a low tire pressure condition but it does not replace normal tire maintenance. See *Tire Inspection on page 10-49*, *Tire Rotation on page 10-49* and *Tires on page 10-36*.

Notice: Using non-approved tire sealants could damage the Tire Pressure Monitor System (TPMS) sensors. TPMS sensor damage caused by using an incorrect tire sealant is not covered by the vehicle warranty. Always use the GM approved tire sealant available through your dealer/retailer.

Factory-installed Tire Inflator Kits use a GM approved liquid tire sealant. Using non-approved tire sealants could damage the TPMS sensors. See *Tire Sealant and Compressor Kit* on page 10-59 for information regarding the inflator kit materials and instructions.

TPMS Malfunction Light and Message

The TPMS will not function properly if one or more of the TPMS sensors are missing or inoperable. When the system detects a malfunction, the low tire warning light flashes for about one minute and then stays on for the remainder of the ignition cycle. A DIC warning message is also displayed. The low tire warning light and DIC warning message come on at each ignition cycle until the problem is corrected. Some of the conditions that can cause the malfunction light and DIC message to come on are:

- One of the road tires has been replaced with the spare tire, if your vehicle has one. The spare tire does not have a TPMS sensor. The TPMS malfunction light and DIC message should go off once you re-install the road tire containing the TPMS sensor.

- The TPMS sensor matching process was started but not completed or not completed successfully after rotating the vehicle's tires. The DIC message and TPMS malfunction light should go off once the TPMS sensor matching process is performed successfully. See "TPMS Sensor Matching Process" later in this section.
- One or more TPMS sensors are missing or damaged. The DIC message and the TPMS malfunction light should go off when the TPMS sensors are installed and the sensor matching process is performed successfully. See your dealer/retailer for service.

- Replacement tires or wheels do not match your vehicle's original equipment tires or wheels. Tires and wheels other than those recommended for your vehicle could prevent the TPMS from functioning properly. See *Buying New Tires on page 10-51*.
- Operating electronic devices or being near facilities using radio wave frequencies similar to the TPMS could cause the TPMS sensors to malfunction.

If the TPMS is not functioning it cannot detect or signal a low tire condition. See your dealer/retailer for service if the TPMS malfunction light and DIC message comes on and stays on.

TPMS Sensor Matching Process

Each TPMS sensor has a unique identification code. Any time you rotate your vehicle's tires or replace one or more of the TPMS sensors, the identification codes will need to be matched to the new tire/wheel position. The sensors are matched to the tire/wheel positions in the following order: driver side front tire, passenger side front tire, passenger side rear tire, and driver side rear tire using a TPMS diagnostic tool. See your dealer/retailer for service.

The TPMS sensors can also be matched to each tire/wheel position by increasing or decreasing the tire's air pressure. If increasing the tire's air pressure, do not exceed the maximum inflation pressure indicated on the tire's sidewall.

To decrease air-pressure out of a tire you can use the pointed end of the valve cap, a pencil-style air pressure gauge, or a key.

You have two minutes to match the first tire/wheel position, and five minutes overall to match all four tire/wheel positions. If it takes longer than two minutes, to match the first tire and wheel, or more than five minutes to match all four tire and wheel positions the matching process stops and you need to start over.

The TPMS sensor matching process is outlined below:

1. Set the parking brake.
2. Turn the ignition switch to ON/RUN with the engine off.
3. Press the Remote Keyless Entry (RKE) transmitter's LOCK and UNLOCK buttons at the same time for approximately five seconds. The horn sounds twice to signal the receiver is in relearn mode and TIRE LEARNING ACTIVE message displays on the DIC screen.
4. Start with the driver side front tire.

5. Remove the valve cap from the valve cap stem. Activate the TPMS sensor by increasing or decreasing the tire's air pressure for five seconds, or until a horn chirp sounds. The horn chirp, which may take up to 30 seconds to sound, confirms that the sensor identification code has been matched to this tire and wheel position.
6. Proceed to the passenger side front tire, and repeat the procedure in Step 5.
7. Proceed to the passenger side rear tire, and repeat the procedure in Step 5.
8. Proceed to the driver side rear tire, and repeat the procedure in Step 5. The horn sounds two times to indicate the sensor identification code has been matched to the driver side rear tire, and the TPMS sensor matching process is no longer active. The TIRE LEARNING ACTIVE message on the DIC display screen goes off.
9. Turn the ignition switch to LOCK/OFF.
10. Set all four tires to the recommended air pressure level as indicated on the Tire and Loading Information label.
11. Put the valve caps back on the valve stems.

Tire Inspection

We recommend that you regularly inspect your vehicle's tires, including the spare tire, if the vehicle has one, for signs of wear or damage. See *When It Is Time for New Tires* on page 10-51 for more information.

Tire Rotation

Tires should be rotated every 5,000 to 8,000 miles (8 000 to 13 000 km). See *Scheduled Maintenance* on page 11-2.

The purpose of a regular tire rotation is to achieve a uniform wear for all tires on the vehicle. This will ensure that the vehicle continues to perform most like it did when the tires were new.

10-50 Vehicle Care

Any time you notice unusual wear, rotate the tires as soon as possible and check wheel alignment. Also check for damaged tires or wheels. See *When It Is Time for New Tires on page 10-51* and *Wheel Replacement on page 10-56*.

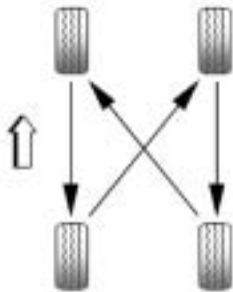

When rotating the vehicle's tires, always use the correct rotation pattern shown here.

If the vehicle has a compact spare tire, do not include it in the tire rotation.

After the tires have been rotated, adjust the front and rear inflation pressures as shown on the Tire and Loading Information label. See *Tire Pressure on page 10-43* and *Vehicle Load Limits on page 9-12*.

Reset the Tire Pressure Monitor System. See *Tire Pressure Monitor Operation on page 10-46*.

Make certain that all wheel nuts are properly tightened. See "Wheel Nut Torque" under *Capacities and Specifications on page 12-2*.

WARNING

Rust or dirt on a wheel, or on the parts to which it is fastened, can make wheel nuts become loose after time. The wheel could come off and cause an accident. When changing a wheel, remove any rust or dirt from places where the wheel attaches to the vehicle. In an emergency, use a cloth or a paper towel to do this; but be sure to use a scraper or wire brush later, if needed, to get all the rust or dirt off. See *If a Tire Goes Flat on page 10-57*.

Make sure the spare tire, if the vehicle has one, is stored securely. Push, pull, and then try to rotate or turn the tire. If it moves, tighten the cable. See *Tire Changing on page 10-67*.

When It Is Time for New Tires

Various factors, such as maintenance, temperatures, driving speeds, vehicle loading, and road conditions influence when you need new tires.

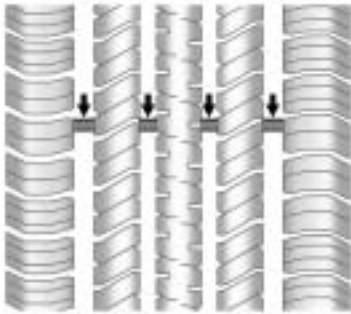

One way to tell when it is time for new tires is to check the treadwear indicators, which appear when the tires have only 1.6 mm (1/16 inch) or less of tread remaining.

The vehicle needs new tires if any of the following statements are true:

- You can see the indicators at three or more places around the tire.
- You can see cord or fabric showing through the tire's rubber.
- The tread or sidewall is cracked, cut, or snagged deep enough to show cord or fabric.
- The tire has a bump, bulge, or split.
- The tire has a puncture, cut, or other damage that cannot be repaired well because of the size or location of the damage.

The rubber in tires degrades over time. This is also true for the spare tire, if the vehicle has one, even if it is not being used. Multiple conditions affect how fast this aging takes place, including temperatures, loading conditions, and inflation pressure maintenance.

With proper care and maintenance tires typically wear out before they degrade due to age. If you are unsure about the need to replace the tires as they get older, consult the tire manufacturer for more information.

Buying New Tires

GM has developed and matched specific tires for your vehicle. The original equipment tires installed on your vehicle, when it was new, were designed to meet General Motors Tire Performance Criteria Specification (TPC Spec) system rating. If you need replacement tires, GM strongly recommends that you get tires with the same TPC Spec rating.

This way, your vehicle will continue to have tires that are designed to give the same performance and vehicle safety, during normal use, as the original tires.

GM's exclusive TPC Spec system considers over a dozen critical specifications that impact the overall performance of your vehicle, including brake system performance, ride and handling, traction control, and tire pressure monitoring performance. GM's TPC Spec number is molded onto the tire's sidewall near the tire size. If the tires have an all-season tread design, the TPC Spec number will be followed by an MS for mud and snow. See *Tire Sidewall Labeling on page 10-37* for additional information.

GM recommends replacing tires in sets of four. This is because uniform tread depth on all tires will help keep your vehicle performing most like it did when the tires were new. Replacing less than a full set of tires can affect the braking and handling performance of your vehicle. See *Tire Inspection on page 10-49* and *Tire Rotation on page 10-49* for information on proper tire rotation.

WARNING

Mixing tires could cause you to lose control while driving. If you mix tires of different sizes, brands, or types (radial and bias-belted tires), the vehicle may not handle properly, and you could have a crash. Using tires of different sizes, brands, or types may

(Continued)

WARNING (Continued)

also cause damage to your vehicle. Be sure to use the correct size, brand, and type of tires on all wheels. It is all right to drive with your compact spare temporarily, as it was developed for use on your vehicle. See *Compact Spare Tire on page 10-77*.

WARNING

If you use bias-ply tires on the vehicle, the wheel rim flanges could develop cracks after many miles of driving. A tire and/or wheel could fail suddenly, causing a crash. Use only radial-ply tires with the wheels on the vehicle.

If you must replace your vehicle's tires with those that do not have a TPC Spec number, make sure they are the same size, load range, speed rating, and construction type (radial and bias-belted tires) as your vehicle's original tires.

Vehicles that have a tire pressure monitoring system could give an inaccurate low-pressure warning if non-TPC Spec rated tires are installed on your vehicle. Non-TPC Spec rated tires may give a low-pressure warning that is higher or lower than the proper warning level you would get with TPC Spec rated tires. See *Tire Pressure Monitor System* on page 10-44.

Your vehicle's original equipment tires are listed on the Tire and Loading Information Label. See *Vehicle Load Limits on page 9-12*, for more information about the Tire and Loading Information Label and its location on your vehicle.

Different Size Tires and Wheels

If you add wheels or tires that are a different size than your original equipment wheels and tires, this could affect the way your vehicle performs, including its braking, ride and handling characteristics, stability, and resistance to rollover. Additionally, if your vehicle has electronic systems such as anti-lock brakes, rollover airbags, traction control, and electronic stability control, the performance of these systems can be affected.

WARNING

If you add different sized wheels, your vehicle may not provide an acceptable level of performance and safety if tires not recommended for those wheels are selected. You may increase the chance that you will crash and suffer serious injury. Only use GM specific wheel and tire systems developed for your vehicle, and have them properly installed by a GM certified technician.

See *Buying New Tires* on page 10-51 and *Accessories and Modifications* on page 10-3 for additional information.

Uniform Tire Quality Grading

Quality grades can be found where applicable on the tire sidewall between tread shoulder and maximum section width. For example:

Treadwear 200 Traction AA Temperature A

The following information relates to the system developed by the United States National Highway Traffic Safety Administration (NHTSA), which grades tires by treadwear, traction, and temperature performance. This applies only to vehicles sold in the United States. The grades are molded on the sidewalls of most passenger car tires.

The Uniform Tire Quality Grading (UTQG) system does not apply to deep tread, winter-type snow tires, space-saver, or temporary use spare tires, tires with nominal rim diameters of 10 to 12 inches (25 to 30 cm), or to some limited-production tires.

While the tires available on General Motors passenger cars and light trucks may vary with respect to these grades, they must also conform to federal safety requirements and additional General Motors Tire Performance Criteria (TPC) standards.

All Passenger Car Tires Must Conform to Federal Safety Requirements In Addition To These Grades.

Treadwear

The treadwear grade is a comparative rating based on the wear rate of the tire when tested under controlled conditions on a specified government test course. For example, a tire graded 150 would wear one and a half (1½) times as well on the government course as a tire graded 100. The relative performance of tires depends upon the actual conditions of their use, however, and may depart significantly from the norm due to variations in driving habits, service practices and differences in road characteristics and climate.

Traction – AA, A, B, C

The traction grades, from highest to lowest, are AA, A, B, and C. Those grades represent the tire's ability to stop on wet pavement as measured under controlled conditions on specified government test surfaces of asphalt and concrete. A tire marked C may have poor traction performance. **Warning:** The traction grade assigned to this tire is based on straight-ahead braking traction tests, and does not include acceleration, cornering, hydroplaning, or peak traction characteristics.

Temperature – A, B, C

The temperature grades are A (the highest), B, and C, representing the tire's resistance to the generation of heat and its ability to dissipate heat when tested under controlled conditions on a specified indoor laboratory test wheel. Sustained high temperature can cause the material of the tire to degenerate and reduce tire life, and excessive temperature can lead to sudden tire failure. The grade C corresponds to a level of performance which all passenger car tires must meet under the Federal Motor Safety Standard No. 109. Grades B and A represent higher levels of performance on the laboratory test wheel than the minimum required by law. **Warning:** The temperature grade for this tire is

established for a tire that is properly inflated and not overloaded. Excessive speed, underinflation, or excessive loading, either separately or in combination, can cause heat buildup and possible tire failure.

Wheel Alignment and Tire Balance

The tires and wheels on the vehicle were aligned and balanced carefully at the factory to give the longest tire life and best overall performance. Adjustments to wheel alignment and tire balancing will not be necessary on a regular basis. However, if there is unusual tire wear or the vehicle pulls to one side or the other, the alignment should be checked. If the vehicle vibrates when driving on a smooth road, the tires and wheels might need to be rebalanced. See your dealer/retailer for proper diagnosis.

Wheel Replacement

Replace any wheel that is bent, cracked, or badly rusted or corroded. If wheel nuts keep coming loose, the wheel, wheel bolts, and wheel nuts should be replaced. If the wheel leaks air, replace it (except some aluminum wheels, which can sometimes be repaired). See your dealer/retailer if any of these conditions exist.

Your dealer/retailer will know the kind of wheel you need.

Each new wheel should have the same load-carrying capacity, diameter, width, offset, and be mounted the same way as the one it replaces.

If you need to replace any of the wheels, wheel bolts, wheel nuts, or Tire Pressure Monitor System (TPMS) sensors, replace them only with new GM original equipment parts. This way, you will be sure to have the right wheel, wheel bolts, wheel nuts, and TPMS sensors for the vehicle.

WARNING

Using the wrong replacement wheels, wheel bolts, or wheel nuts on your vehicle can be dangerous. It could affect the braking and handling of your vehicle, make your tires lose air and make you lose control. You could have a collision in which you or others could be injured. Always use the correct wheel, wheel bolts, and wheel nuts for replacement.

Notice: The wrong wheel can also cause problems with bearing life, brake cooling, speedometer or odometer calibration, headlamp aim, bumper height, vehicle ground clearance, and tire or tire chain clearance to the body and chassis.

See *If a Tire Goes Flat* on page 10-57 for more information.

Used Replacement Wheels

WARNING

Putting a used wheel on the vehicle is dangerous. You cannot know how it has been used or how far it has been driven. It could fail suddenly and cause a crash. If you have to replace a wheel, use a new GM original equipment wheel.

Tire Chains

WARNING

Do not use tire chains. There is not enough clearance. Tire chains used on a vehicle without the proper amount of clearance can cause damage to the brakes, suspension or other vehicle parts. The area damaged by the tire chains could cause you to lose control of the vehicle and you or others may be injured in a crash.

(Continued)

WARNING (Continued)

Use another type of traction device only if its manufacturer recommends it for use on the vehicle and tire size combination and road conditions. Follow that manufacturer's instructions. To help avoid damage to the vehicle, drive slowly, readjust or remove the device if it is contacting the vehicle, and do not spin the vehicle's wheels. If you do find traction devices that will fit, install them on the front tires.

If a Tire Goes Flat

It is unusual for a tire to blowout while you are driving, especially if you maintain your vehicle's tires properly. If air goes out of a tire, it is much more likely to leak out slowly. But if you should ever have a blowout, here are a few tips about what to expect and what to do:

If a front tire fails, the flat tire creates a drag that pulls the vehicle toward that side. Take your foot off the accelerator pedal and grip the steering wheel firmly. Steer to maintain lane position, and then gently brake to a stop well out of the traffic lane.

A rear blowout, particularly on a curve, acts much like a skid and may require the same correction you would use in a skid. In any rear blowout remove your foot from the accelerator pedal.

10-58 Vehicle Care

Get the vehicle under control by steering the way you want the vehicle to go. It may be very bumpy and noisy, but you can still steer. Gently brake to a stop, well off the road if possible.

WARNING

Lifting a vehicle and getting under it to do maintenance or repairs is dangerous without the appropriate safety equipment and training. If a jack is provided with the vehicle, it is designed only for changing a flat tire. If it is used for anything else, you or others could be badly injured or killed if the vehicle slips off the jack. If a jack is provided with the vehicle, only use it for changing a flat tire.

If a tire goes flat, avoid further tire and wheel damage by driving slowly to a level place. Turn on the hazard warning flashers. See *Hazard Warning Flashers on page 6-3*.

WARNING

Changing a tire can be dangerous. The vehicle can slip off the jack and roll over or fall on you or other people. You and they could be badly injured or even killed. Find a level place to change your tire. To help prevent the vehicle from moving:

1. Set the parking brake firmly.
2. Put an automatic transmission shift lever in P (Park), or shift a manual transmission to 1 (First) or R (Reverse).
3. Turn off the engine and do not restart while the vehicle is raised.
4. Do not allow passengers to remain in the vehicle.

(Continued)

WARNING (Continued)

To be certain the vehicle will not move, put blocks at the front and rear of the tire farthest away from the one being changed. That would be the tire on the other side, at the opposite end of the vehicle.

This vehicle may come with a jack and spare tire or a tire sealant and compressor kit. To use the jacking equipment to change a spare tire safely, follow the instructions below. Then see *Tire Changing on page 10-67*. To use the tire sealant and compressor kit, see *Tire Sealant and Compressor Kit on page 10-59*.

When the vehicle has a flat tire (B), use the following example as a guide to assist you in the placement of wheel blocks (A).

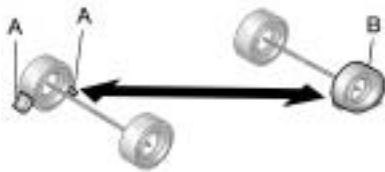

- A. Wheel Block
- B. Flat Tire

The following information explains how to repair or change a tire.

Tire Sealant and Compressor Kit

WARNING

Idling a vehicle in an enclosed area with poor ventilation is dangerous. Engine exhaust may enter the vehicle. Engine exhaust contains Carbon Monoxide (CO) which cannot be seen or smelled. It can cause unconsciousness and even death. Never run the engine in an enclosed area that has no fresh air ventilation. For more information, see *Engine Exhaust* on page 9-23.

WARNING

Over-inflating a tire could cause the tire to rupture and you or others could be injured. Be sure to read and follow the tire sealant
(Continued)

WARNING (Continued)

and compressor kit instructions and inflate the tire to its recommended pressure. Do not exceed the recommended pressure.

WARNING

Storing the tire sealant and compressor kit or other equipment in the passenger compartment of the vehicle could cause injury. In a sudden stop or collision, loose equipment could strike someone. Store the tire sealant and compressor kit in its original location.

If this vehicle has a tire sealant and compressor kit, there may not be a spare tire, tire changing equipment, and on some vehicles there may not be a place to store a tire.

10-60 Vehicle Care

The tire sealant and compressor can be used to temporarily seal punctures up to ¼ inch (6 mm) in the tread area of the tire. It can also be used to inflate an under inflated tire.

If the tire has been separated from the wheel, has damaged sidewalls, or has a large puncture, the tire is too severely damaged for the tire sealant and compressor kit to be effective. See *Roadside Assistance Program* on page 13-6.

Read and follow all of the tire sealant and compressor kit instructions.

This vehicle may have one of the following tire sealant and compressor kits. The kit includes:

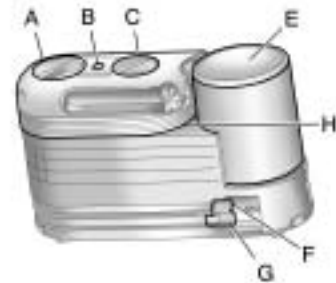

- A. Selector Switch (Sealant/Air or Air Only)
- B. On/Off Button
- C. Pressure Gauge
- D. Pressure Deflation Button (If equipped)
- E. Tire Sealant Canister
- F. Sealant/Air Hose (Clear)
- G. Air Only Hose (Black)
- H. Power Plug

Tire Sealant

Read and follow the safe handling instructions on the label adhered to the sealant canister.

Check the tire sealant expiration date on the sealant canister. The sealant canister should be replaced before its expiration date. Replacement sealant canisters are available at your local dealer/retailer. See "Removal and Installation of the Sealant Canister" following.

There is only enough sealant to seal one tire. After usage, the sealant canister and sealant/air hose assembly must be replaced. See "Removal and Installation of the Sealant Canister" following.

Using the Tire Sealant and Compressor Kit to Temporarily Seal and Inflate a Punctured Tire

Follow the directions closely for correct sealant usage.

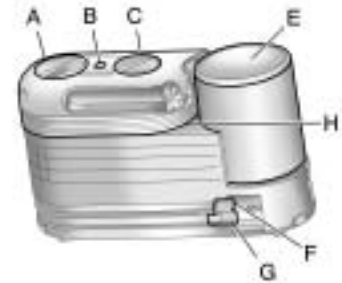

When using the tire sealant and compressor kit during cold temperatures, warm the kit in a heated environment for 5 minutes. This will help to inflate the tire faster.

Always do a safety check first. See *If a Tire Goes Flat* on page 10-57. Do not remove any objects that have penetrated the tire.

1. Remove the tire sealant and compressor kit from its storage location. See *Storing the Tire Sealant and Compressor Kit* on page 10-66.

10-62 Vehicle Care

- Unwrap the sealant/air hose (F) and the power plug (H).
- Place the kit on the ground.

Make sure the tire valve stem is positioned close to the ground so the hose will reach it.

- Remove the valve stem cap from the flat tire by turning it counterclockwise.
- Attach the sealant/air hose (F) onto the tire valve stem. Turn it clockwise until it is tight.
- Plug the power plug (H) into the accessory power outlet in the vehicle. Unplug all items from other accessory power outlets. See *Power Outlets on page 5-8*.

If the vehicle has an accessory power outlet, do not use the cigarette lighter.

If the vehicle only has a cigarette lighter, use the cigarette lighter.

Do not pinch the power plug cord in the door or window.

- Start the vehicle. The vehicle must be running while using the air compressor.
- Turn the selector switch (A) counterclockwise to the Sealant + Air position.
- Press the on/off (B) button to turn the tire sealant and compressor kit on.

The compressor will inject sealant and air into the tire.

The pressure gauge (C) will initially show a high pressure while the compressor pushes the sealant into the tire. Once the sealant is completely dispersed into the tire, the pressure will quickly drop and start to rise again as the tire inflates with air only.

- Inflate the tire to the recommended inflation pressure using the pressure gauge (C). The recommended

inflation pressure can be found on the Tire and Loading Information label. See *Tire Pressure on page 10-43*.

The pressure gauge (C) may read higher than the actual tire pressure while the compressor is on. Turn the compressor off to get an accurate pressure reading. The compressor may be turned on/off until the correct pressure is reached.

Notice: If the recommended pressure cannot be reached after approximately 25 minutes, the vehicle should not be driven farther. The tire is too severely damaged and the tire sealant and compressor kit cannot inflate the tire. Remove the power plug from the accessory power outlet and unscrew the inflating hose from the tire valve. See *Roadside Assistance Program on page 13-6*.

11. Press the on/off button (B) to turn the tire sealant and compressor kit off.

The tire is not sealed and will continue to leak air until the vehicle is driven and the sealant is distributed in the tire, therefore, Steps 12 through 18 must be done immediately after Step 11.

Be careful while handling the tire sealant and compressor kit as it could be warm after usage.

12. Unplug the power plug (H) from the accessory power outlet in the vehicle.
13. Turn the sealant/air hose (F) counterclockwise to remove it from the tire valve stem.
14. Replace the tire valve stem cap.
15. Replace the sealant/air hose (F), and the power plug (H) back in their original location.



16. If the flat tire was able to inflate to the recommended inflation pressure, remove the maximum speed label from the sealant canister (E) and place it in a highly visible location. The label is a reminder not to exceed 55 mph (90 km/h) until the damaged tire is repaired or replaced.
17. Return the equipment to its original storage location in the vehicle.
18. Immediately drive the vehicle 5 miles (8 km) to distribute the sealant in the tire.

19. Stop at a safe location and check the tire pressure. Refer to Steps 1 through 11 under “Using the Tire Sealant and Compressor Kit without Sealant to Inflate a Tire (Not Punctured).”

If the tire pressure has fallen more than 10 psi (68 kPa) below the recommended inflation pressure, stop driving the vehicle. The tire is too severely damaged and the tire sealant cannot seal the tire. See *Roadside Assistance Program* on page 13-6.

If the tire pressure has not dropped more than 10 psi (68 kPa) from the recommended inflation pressure, inflate the tire to the recommended inflation pressure.

20. Wipe off any sealant from the wheel, tire, and vehicle.

10-64 Vehicle Care

21. Dispose of the used sealant canister (E) and sealant/air hose (F) assembly at a local dealer/retailer or in accordance with local state codes and practices.
22. Replace it with a new canister available from your dealer/retailer.
23. After temporarily sealing a tire using the tire sealant and compressor kit, take the vehicle to an authorized dealer/retailer within a 100 miles (161 km) of driving to have the tire repaired or replaced.

Using the Tire Sealant and Compressor Kit without Sealant to Inflate a Tire (Not Punctured)

To use the air compressor to inflate a tire with air only and not sealant:

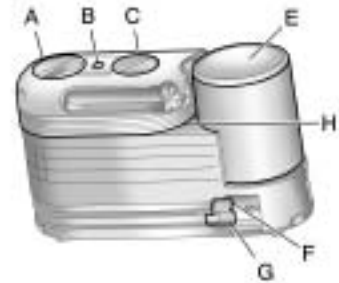

Always do a safety check first. See *If a Tire Goes Flat* on page 10-57.

1. Remove the tire sealant and compressor kit from its storage location. See *Storing the Tire Sealant and Compressor Kit* on page 10-66.
2. Unwrap the air only hose (G) and the power plug (H).
3. Place the kit on the ground.

Make sure the tire valve stem is positioned close to the ground so the hose will reach it.

4. Remove the tire valve stem cap from the flat tire by turning it counterclockwise.
5. Attach the air only hose (G) onto the tire valve stem by turning it clockwise until it is tight.
6. Plug the power plug (H) into the accessory power outlet in the vehicle. Unplug all items from other accessory power outlets. See *Power Outlets on page 5-8*.
If the vehicle has an accessory power outlet, do not use the cigarette lighter.
If the vehicle only has a cigarette lighter, use the cigarette lighter.
Do not pinch the power plug cord in the door or window.
7. Start the vehicle. The vehicle must be running while using the air compressor.

8. Turn the selector switch (A) clockwise to the Air Only position.
9. Press the on/off (B) button to turn the compressor on.
The compressor will inflate the tire with air only.
10. Inflate the tire to the recommended inflation pressure using the pressure gauge (C). The recommended inflation pressure can be found on the Tire and Loading Information label. See *Tire Pressure on page 10-43*.
The pressure gauge (C) may read higher than the actual tire pressure while the compressor is on. Turn the compressor off to get an accurate reading.
The compressor may be turned on/off until the correct pressure is reached.

- If you inflate the tire higher than the recommended pressure you can adjust the excess pressure by pressing the pressure deflation button (D), if equipped, until the proper pressure reading is reached. This option is only functional when using the air only hose (G).
11. Press the on/off button (B) to turn the tire sealant and compressor kit off.
Be careful while handling the tire sealant and compressor kit as it could be warm after usage.
 12. Unplug the power plug (H) from the accessory power outlet in the vehicle.
 13. Disconnect the air only hose (G) from the tire valve stem, by turning it counterclockwise, and replace the tire valve stem cap.

14. Replace the air only hose (G) and the power plug (H) and cord back in its original location.
15. Place the equipment in the original storage location in the vehicle.



The tire sealant and compressor kit has an accessory adapter located in a compartment on the bottom of its housing that may be used to inflate air mattresses, balls, etc.

Removal and Installation of the Sealant Canister

To remove the sealant canister:

1. Unwrap the sealant hose.
2. Press the canister release button.
3. Pull up and remove the canister.
4. Replace with a new canister which is available from your dealer/retailer.
5. Push the new canister into place.

Storing the Tire Sealant and Compressor Kit

The tire sealant and compressor kit is located in the storage compartment on the driver side, at the rear of the vehicle.



1. Press down on the latch tab and pull the cover off to access the storage compartment.
2. Press the two tabs on the quick release buckle to release the tire sealant and compressor kit strap.

3. Remove the sealant and compressor kit from its tray.

To store the tire sealant and compressor kit, reverse the steps.

Tire Changing

Removing Tools

The tools needed to remove the spare tire are located in the storage compartment on the driver side, at the rear of the vehicle.

1. Open the jack storage compartment by pulling on the latch tab, located toward the rear of the vehicle, and pulling the cover off.

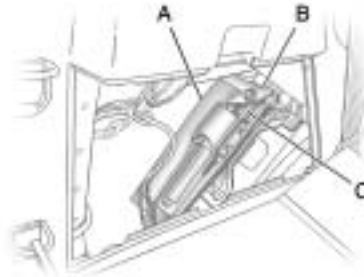

- A. Tool Bag
 - B. Wing Bolt
 - C. Jack
2. Remove the wing bolt (B) by turning it counterclockwise
 3. Push the jack (C) up out of the holding bracket.

4. Turn the jack on its side, with the bottom facing toward you.
5. Pull the jack straight out, bottom first.

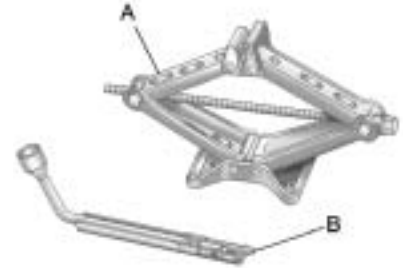

The tools you will be using include the jack (A) and lug wrench (B).

Removing the Spare Tire

The compact spare tire is located under the vehicle, in front of the rear bumper. See *Compact Spare Tire* on page 10-77 for more information about the compact spare.

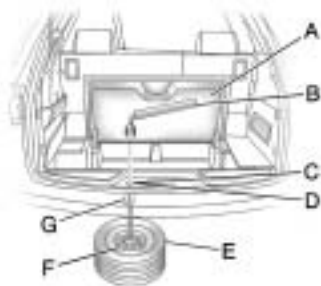

- A. Rear Convenience Center
- B. Lug Wrench
- C. Storage Compartment Cap Hole
- D. Hoist Shaft

- E. Compact Spare Tire
- F. Retainer
- G. Hoist Shaft Assembly

1. Open the storage compartment door of the convenience center that is nearest the liftgate and remove the cap on the bottom of the storage compartment.
2. Open the carpet cutout that is located through the hole of the storage compartment.
3. Attach the lug wrench into the hoist shaft.
4. Turn the lug wrench counterclockwise to lower the spare tire to the ground. Continue turning the wrench until the spare tire can be pulled out from under the vehicle.



5. Tilt the retainer and slip it through the wheel opening to remove the spare tire from the cable.

6. Turn the wrench clockwise to raise the cable back up after removing the spare tire.

Do not store a full-size or a flat road tire under the vehicle. See “Storing a Flat or Spare Tire and Tools” later in this section.

To continue changing the flat tire, see “Removing the Flat Tire and Installing the Spare Tire” later in this section.



If the spare tire will not lower, the secondary latch could be engaged.

Do the following to check the cable:

1. Check under the vehicle to see if the cable is visible.
2. If it is not visible, see *Secondary Latch System on page 10-76*.

If it is visible, first try to tighten the cable by turning the lug wrench clockwise until you hear two clicks or feel it skip twice. You cannot over-tighten the cable.

3. Loosen the cable by turning the wrench counterclockwise three or four turns.
4. If the spare tire has not lowered, tighten the cable all the way and then loosen it at least two times.

If the spare tire did lower to the ground, continue with Step 5 under “Removing the Spare Tire (Vehicles with the Rear Convenience Center)” listed previously.

5. If you still cannot lower the spare tire to the ground, see *Secondary Latch System on page 10-76*.

Removing the Flat Tire and Installing the Spare Tire

1. Do a safety check before proceeding. See *If a Tire Goes Flat on page 10-57* for more information.
2. If the vehicle has a wheel cover, loosen the plastic nut caps with the wheel wrench. They will not come off. Then, using the flat end of the wheel wrench, pry along the edge of the cover until it comes off. Be careful; the edges may be sharp. Do not try to remove the cover with your bare hands.

Store the wheel cover securely in the rear of the vehicle until you have the flat tire repaired or replaced.

10-70 Vehicle Care

If the vehicle has aluminum wheels, remove the wheel nut caps using the wheel wrench.



- Loosen the wheel nuts — but do not remove them — using the lug wrench. For wheels with a wheel lock key, use the wheel lock key between the lock nut and lug wrench. The key is supplied in the front passenger door pocket.

Notice: If this vehicle has wheel locks and an impact wrench is used to remove the wheel nuts, the lock nut or wheel lock key

could be damaged. Do not use an impact wrench to remove the wheel nuts if this vehicle has wheel locks.

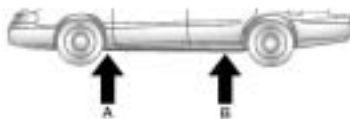

- To identify the appropriate jacking location, find the triangle (A) about 12 inches (30.5 cm) from the front tire or (B) about 10.5 inches (27 cm) from the rear tire.

The triangle is located near each wheel on the vehicle's exterior.

Notice: If a jack is used to raise the vehicle without positioning it correctly, the vehicle could be damaged. When raising the vehicle on a jack, avoid contact with the rear axle control arms.

- Do not raise the vehicle yet. Put the compact spare tire near you.

WARNING

Getting under a vehicle when it is jacked up is dangerous. If the vehicle slips off the jack, you could be badly injured or killed. Never get under a vehicle when it is supported only by a jack.

WARNING

Raising your vehicle with the jack improperly positioned can damage the vehicle and even make the vehicle fall. To help avoid personal injury and vehicle damage, be sure to fit the jack lift head into the proper location before raising the vehicle.

- Attach the lug wrench to the jack, and turn the wrench clockwise to raise the jack head 3 inches (7.6 cm).

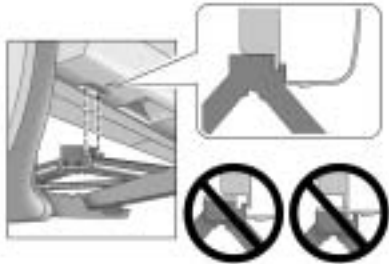

7. Place the jack under the vehicle as identified in Step 4. Raise the vehicle by turning the lug wrench clockwise in the jack. Raise the vehicle far enough off the ground so that there is enough room for the spare tire to fit under the wheel well.
8. Remove all the wheel nuts and the flat tire.



9. Remove the plastic spare tire heat shield by pulling the rubber latch. Store the plastic spare tire heat shield. See “Storing a Flat or Spare Tire and Tools” later in this section for more information.

⚠ WARNING

Rust or dirt on a wheel, or on the parts to which it is fastened, can make wheel nuts become loose after time. The wheel could come off and cause an accident. When changing a wheel, remove any rust or dirt from places where the wheel attaches to the vehicle. In an emergency, use a cloth or a paper towel to do this; but be sure to use a scraper or wire brush later, if needed, to get all the rust or dirt off. See *If a Tire Goes Flat* on page 10-57.

WARNING

Never use oil or grease on bolts or nuts because the nuts might come loose. The vehicle's wheel could fall off, causing a crash.

10. Remove any rust or dirt from the wheel bolts, mounting surfaces, and spare wheel.
11. Place the spare tire on the wheel mounting surface.
12. Put the nuts on by hand by turning them clockwise until the wheel is held against the mounting surface. Make sure the rounded end is toward the wheel.
13. Lower the vehicle by attaching the lug wrench to the jack and turning the wrench counterclockwise. Lower the jack completely.

WARNING

Wheel nuts that are improperly or incorrectly tightened can cause the wheels to become loose or come off. The wheel nuts should be tightened with a torque wrench to the proper torque specification after replacing. Follow the torque specification supplied by the aftermarket manufacturer when using accessory locking wheel nuts. See *Capacities and Specifications* on page 12-2 for original equipment wheel nut torque specifications.

Notice: Improperly tightened wheel nuts can lead to brake pulsation and rotor damage. To avoid expensive brake repairs, evenly tighten the wheel nuts in the proper sequence and to the proper torque specification. See *Capacities and Specifications* on page 12-2 for the wheel nut torque specification.



14. Tighten the wheel nuts firmly in a crisscross sequence, as shown.

Notice: Wheel covers will not fit on your vehicle's compact spare. If you try to put a wheel cover on the compact spare, the cover or the spare could be damaged.

Storing the Spare Tire

WARNING

The underbody-mounted spare tire needs to be stored with the valve stem pointing down. If the spare tire is stored with the valve stem pointing upwards, the secondary latch will not work properly and the spare tire could loosen and suddenly fall from the vehicle. If this happened when the vehicle was being driven, the tire might contact a person or another vehicle, causing injury and damage to itself. Be sure the underbody-mounted spare tire is stored with the valve stem pointing down.

WARNING

Storing a jack, a tire, or other equipment in the passenger compartment of the vehicle could cause injury. In a sudden stop or collision, loose equipment could strike someone. Store all these in the proper place.

To store the spare tire:

1. Lay the compact spare tire near the rear of the vehicle with the valve stem down.
2. Reinstall the plastic spare tire heat shield on the compact spare tire.
3. Slide the cable retainer through the center of the wheel and start to raise the compact spare tire.

Make sure the retainer is fully seated across the underside of the wheel.

4. When the compact spare tire is almost in the stored position, turn the tire so the valve is toward the rear of the vehicle.

This position helps when checking the air pressure in the compact spare tire.

5. Raise the tire fully against the underside of the vehicle. Continue turning the lug wrench until you feel more than two clicks. This indicates that the compact spare tire is secure and the cable is tight. The spare tire hoist cannot be overtightened.



6. Make sure the tire is stored securely. Push, pull (A), and then try to turn (B) the tire. If the tire moves, use the lug wrench to tighten the cable.

Storing the Flat Tire

1. Remove the cable package from the jack storage area.
2. Remove the small center cap by tapping the back of the cap with the extension of the shaft, if the vehicle has aluminum wheels.

3. Put the flat tire in the rear storage area with the valve stem pointing toward the rear of the vehicle.

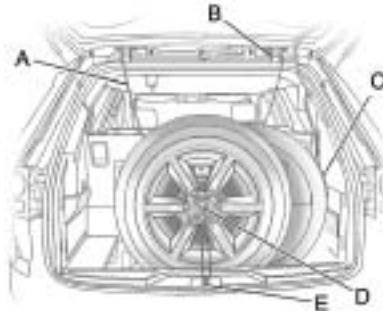

4. Pull the cable (A) through the door striker (E), the center of the wheel (D), and the plastic spare tire heat shield (C), as shown.



5. Hook the cable onto the outside portion of the liftgate hinges (B).
6. Hook the other end of the cable onto the outside portion of the liftgate hinge on the other side of the vehicle.
7. Pull on the cable to make sure it is secure.

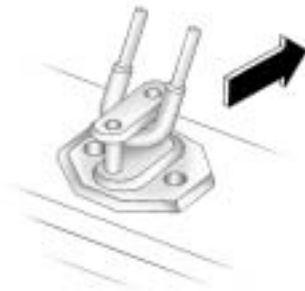

8. Make sure the metal tube is centered at the striker. Push the tube toward the front of the vehicle.
9. Close the liftgate and make sure it is latched properly.

Storing the Tools

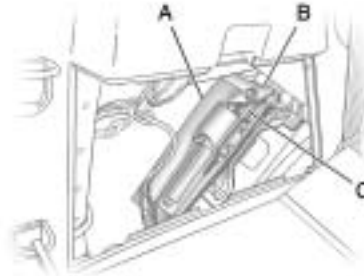

- A. Tool Bag
- B. Wing Bolt
- C. Jack

Put back all tools as they were stored in the jack storage compartment and put the compartment cover back on.

1. Ensure that the bottom of the jack is facing toward you.
2. Turn the jack (C) on its side and place down on the holding bracket.
3. Reinstall the wing bolt (B) by turning clockwise.
4. To replace the cover, line up the tab at the front of the cover with the notch in the cover opening. Push the cover in place and make sure that the rear clips are in the slots and push the cover closed.

Store the center cap or the plastic bolt-on wheel covers until a full size tire is put back on the vehicle. When you replace the compact spare with a full-size tire, reinstall the bolt-on wheel covers or the center cap. Hand-tighten them over the wheel nuts, using the lug wrench.

Secondary Latch System

This vehicle has an underbody mounted tire hoist assembly that has a secondary latch system. It is designed to stop the compact spare tire from suddenly falling off the vehicle if the cable holding the spare tire is damaged. For the secondary latch to work, the tire must be stowed with the valve stem pointing down. See *Tire Changing on page 10-67* for instructions on storing the spare tire correctly.

WARNING

Before beginning this procedure read all the instructions. Failure to read and follow the instructions could damage the hoist assembly and you and others could get hurt. Read and follow the instructions listed next.

To release the spare tire from the secondary latch:

WARNING

Someone standing too close during the procedure could be injured by the jack. If the spare tire does not slide off the jack completely, make sure no one is behind you or on either side of you as you pull the jack out from under the spare.

1. If the cable is not visible, start this procedure at Step 3.



All-Wheel-Drive Vehicle shown

2. Turn the lug wrench counterclockwise until approximately 6 inches (15 cm) of cable is exposed.
3. Attach the lug wrench to the jack and raise the jack at least 10 turns.
4. Place the jack under the vehicle, ahead of the rear bumper. Position the center lift point of the jack under the center of the spare tire.

5. Turn the lug wrench clockwise to raise the jack until it lifts the secondary latch spring.
6. Keep raising the jack until the spare tire stops moving upward and is held firmly in place. This lets you know that the secondary latch has released and the spare tire is balancing on the jack.



7. Lower the jack by turning the lug wrench counterclockwise. Keep lowering the jack until the spare tire slides off the jack.



8. Disconnect the lug wrench from the jack and carefully remove the jack. Use one hand to push against the spare tire while firmly pulling the jack out from under the spare tire with the other hand.
9. Tilt the retainer and slip it through the wheel opening when the spare tire has been completely lowered.
10. Turn the lug wrench clockwise to raise the cable back up if the cable is hanging.

Have the hoist shaft assembly inspected as soon as you can. You will not be able to store a spare tire using the hoist assembly until it has been repaired or replaced.

Compact Spare Tire

WARNING

Driving with more than one compact spare tire at a time could result in loss of braking and handling. This could lead to a crash and you or others could be injured. Use only one compact spare tire at a time.

The compact spare tire, if the vehicle has one, was fully inflated when the vehicle was new, however, it can lose air after a time. Check the inflation pressure regularly. It should be 60 psi (420 kPa).

After installing the compact spare on the vehicle, stop as soon as possible and make sure the spare tire is correctly inflated. The compact spare is made to perform well at speeds up to 65 mph (105 km/h) for distances up to 3,000 miles (5 000 km), so you can finish your trip and have the full-size tire repaired or replaced at your convenience. Of course, it is best to replace the spare with a full-size tire as soon as possible. The spare tire will last longer and be in good shape in case it is needed again.

Notice: When the compact spare is installed, do not take the vehicle through an automatic car wash with guide rails. The compact spare can get caught on the rails which can damage the tire, wheel and other parts of the vehicle.

Do not use the compact spare on other vehicles.

And do not mix the compact spare tire or wheel with other wheels or tires. They will not fit. Keep the spare tire and its wheel together.

The All-Wheel Drive (AWD) system will be automatically disabled when you use the compact spare. To restore the AWD and prevent excessive wear on the clutch in your AWD, replace the compact spare tire with a full-size tire as soon as possible.

Notice: Tire chains will not fit the compact spare. Using them can damage the vehicle and can damage the chains too. Do not use tire chains on the compact spare.

Jump Starting

If the vehicle's battery has run down, you may want to use another vehicle and some jumper cables to start your vehicle. Be sure to use the following steps to do it safely.

WARNING

Batteries can hurt you. They can be dangerous because:

- They contain acid that can burn you.
- They contain gas that can explode or ignite.
- They contain enough electricity to burn you.

If you do not follow these steps exactly, some or all of these things can hurt you.

Notice: Ignoring these steps could result in costly damage to the vehicle that would not be covered by the warranty.

Trying to start the vehicle by pushing or pulling it will not work, and it could damage the vehicle.

1. Check the other vehicle. It must have a 12-volt battery with a negative ground system.

Notice: If the other vehicle's system is not a 12-volt system with a negative ground, both vehicles can be damaged. Only use vehicles with 12-volt systems with negative grounds to jump start your vehicle.

2. Get the vehicles close enough so the jumper cables can reach, but be sure the vehicles are not touching each other. If they are, it could cause a ground connection you do not want. You would not be able to start your vehicle, and the bad grounding could damage the electrical systems.

To avoid the possibility of the vehicles rolling, set the parking brake firmly on both vehicles involved in the jump start procedure. Put an automatic transmission in P (Park) or a manual transmission in Neutral before setting the parking brake. If one of the vehicles is a four-wheel-drive vehicle, be sure the transfer case is not in Neutral.

Notice: If you leave the radio or other accessories on during the jump starting procedure, they could be damaged. The repairs would not be covered by the warranty. Always turn off the radio and other accessories when jump starting the vehicle.

3. Turn off the ignition on both vehicles. Unplug unnecessary accessories plugged into the cigarette lighter or the accessory power outlets. Turn off the radio and all lamps that are not needed. This will avoid sparks and help save both batteries. And it could save the radio!
4. Open the hoods and locate the positive (+) and negative (-) terminal locations on the other vehicle. Your vehicle has a remote positive (+) and a remote negative (-) jump starting terminal. See *Engine Compartment Overview* on page 10-6 for more information on the terminal locations.

WARNING

Using a match near a battery can cause battery gas to explode. People have been hurt doing this, and some have been blinded. Use a flashlight if you need more light.

Be sure the batteries have enough water. You do not need to add water to the ACDelco[®] battery (or batteries) installed in your new vehicle. But if a battery has filler caps, be sure the right amount of fluid is there. If it is low, add water to take care of that first. If you do not, explosive gas could be present.

Battery fluid contains acid that can burn you. Do not get it on you. If you accidentally get it in your eyes or on your skin, flush the place with water and get medical help immediately.

WARNING

Fans or other moving engine parts can injure you badly. Keep your hands away from moving parts once the engine is running.

5. Check that the jumper cables do not have loose or missing insulation. If they do, you could get a shock. The vehicles could be damaged too.

Before you connect the cables, here are some basic things you should know. Positive (+) will go to positive (+) or to a remote positive (+) terminal if the vehicle has one. Negative (-) will go to a heavy, unpainted metal engine part or to a remote negative (-) terminal if the vehicle has one.

Do not connect positive (+) to negative (-) or you will get a short that would damage the battery and maybe other parts too. And do not connect the negative (-) cable to the negative (-) terminal on the dead battery because this can cause sparks.

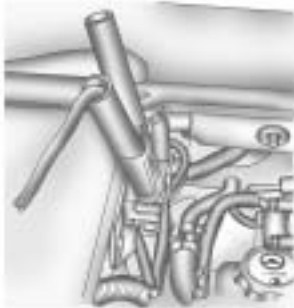

6. Connect the red positive (+) cable to the positive (+) terminal of the dead battery.

Use a remote positive (+) terminal if the vehicle has one.

7. Do not let the other end touch metal. Connect it to the positive (+) terminal of the good battery. Use a remote positive (+) terminal if the vehicle has one.
8. Now connect the black negative (-) cable to the negative (-) terminal of the good battery. Use a remote negative (-) terminal if the vehicle has one.

Do not let the other end touch anything until the next step. The other end of the negative (-) cable does not go to the dead battery. It goes to a heavy, unpainted metal engine part, or to a remote negative (-) terminal on the vehicle with the dead battery.



9. Connect the other end of the negative (-) cable at least 18 inches (45 cm) away from the dead battery, but not near engine parts that move.

The electrical connection is just as good there, and the chance of sparks getting back to the battery is much less.

Your vehicle has a remote negative (-) terminal for this purpose.

10-82 Vehicle Care

- Now start the vehicle with the good battery and run the engine for a while.
- Try to start the vehicle that had the dead battery. If it will not start after a few tries, it probably needs service.

Notice: If the jumper cables are connected or removed in the wrong order, electrical shorting may occur and damage the vehicle. The repairs would not be covered by the vehicle warranty. Always connect and remove the jumper cables in the correct order, making sure that the cables do not touch each other or other metal.

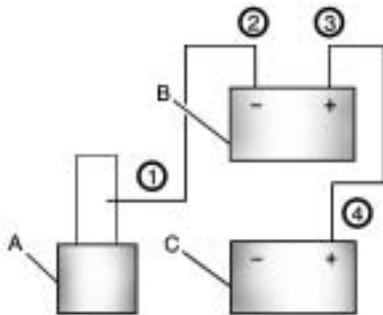

Jumper Cable Removal

- Heavy, Unpainted Metal Engine Part or Remote Negative (-) Terminal
- Good Battery or Remote Positive (+) and Remote Negative (-) Terminals
- Dead Battery or Remote Positive (+) Terminal

To disconnect the jumper cables from both vehicles, do the following:

- Disconnect the black negative (-) cable from the vehicle that had the dead battery.
- Disconnect the black negative (-) cable from the vehicle with the good battery.
- Disconnect the red positive (+) cable from the vehicle with the good battery.
- Disconnect the red positive (+) cable from the other vehicle.

Towing

Towing the Vehicle

To avoid damage, the disabled vehicle should be towed with all four wheels off the ground. Consult your dealer/retailer or a professional towing service if the disabled vehicle must be towed.

To tow the vehicle behind another vehicle for recreational purposes — such as behind a motorhome, see Recreational Vehicle Towing following.

Recreational Vehicle Towing

Recreational vehicle towing means towing the vehicle behind another vehicle – such as behind a motorhome. The two most common types of recreational vehicle towing are known as dinghy towing and dolly towing. Dinghy towing is towing the vehicle with all four wheels on the ground. Dolly towing is towing the vehicle with two wheels on the ground and two wheels up on a device known as a dolly.

Here are some important things to consider before recreational vehicle towing:

- What is the towing capacity of the towing vehicle? Be sure to read the tow vehicle manufacturer's recommendations.
- What is the distance that will be travelled? Some vehicles have restrictions on how far and how long they can tow.
- Is the proper towing equipment going to be used? See your dealer/retailer or trailering professional for additional advice and equipment recommendations.
- Is the vehicle ready to be towed? Just as preparing the vehicle for a long trip, make sure the vehicle is prepared to be towed.

Dinghy Towing



If the vehicle is front-wheel-drive, it can be dinghy towed from the front. These vehicles may also be towed by putting the front wheels on a dolly. See “Dolly Towing” later in this section.

If the vehicle is all-wheel-drive, it can be dinghy towed from the front. These vehicles can also be towed by placing them on a platform trailer with all four wheels off of the ground. These vehicles cannot be towed using a dolly.

For vehicles being dinghy towed, the vehicle should be run at the beginning of each day and at each RV fuel stop for about five minutes. This will ensure proper lubrication of transmission components. Re-install the fuse to start the vehicle.

To tow the vehicle from the front with all four wheels on the ground:

1. Position the vehicle to be towed, shift the transmission to P (Park), and turn the ignition to LOCK/OFF.
2. Secure the vehicle to the towing vehicle.
3. Set the parking brake.
4. Turn the ignition to ACC/ACCESSORY.

5. Shift the transmission to N (Neutral).
6. To prevent the battery from draining while the vehicle is being towed, remove the 50 amp BATT1 fuse from the underhood fuse block and store in a safe location. See *Engine Compartment Fuse Block on page 10-30*.
7. Release the parking brake.

Notice: If the vehicle is towed without performing each of the steps listed under “Dinghy Towing,” the automatic transmission could be damaged. Be sure to follow all steps of the dinghy towing procedure prior to and after towing the vehicle.

Notice: If 105 km/h (65 mph) is exceeded while towing the vehicle, it could be damaged. Never exceed 105 km/h (65 mph) while towing the vehicle.

Once the destination is reached:

1. Set the parking brake.
2. Reinstall the 50 amp BATT1 fuse to the underhood fuse block.
3. Shift the transmission to P (Park), turn the ignition to LOCK/OFF and remove the key from the ignition.
4. Disconnect the vehicle from the towing vehicle.

Notice: Do not tow a vehicle with the front drive wheels on the ground if one of the front tires is a compact spare tire. Towing with two different tire sizes on the front of the vehicle can cause severe damage to the transmission.

Dolly Towing (All-Wheel-Drive Vehicles)



All-wheel-drive vehicles must not be towed with two wheels on the ground. To properly tow these vehicles, they should be placed on a platform trailer with all four wheels off of the ground or dinghy towed from the front.

Dolly Towing (Front-Wheel-Drive Vehicles Only)



To tow a front-wheel-drive vehicle from the front with two wheels on the ground:

1. Put the front wheels on a dolly.
2. Move the shift lever to P (Park).
3. Set the parking brake.

4. Clamp the steering wheel in a straight-ahead position with a clamping device designed for towing.
5. Remove the key from the ignition.
6. Secure the vehicle to the dolly.
7. Release the parking brake.

Towing the Vehicle From the Rear



Notice: Towing the vehicle from the rear could damage it. Also, repairs would not be covered by the vehicle warranty. Never have the vehicle towed from the rear.

Do not tow the vehicle from the rear.

Appearance Care

Exterior Care

Cleaning Exterior Lamps/Lenses

Use only lukewarm or cold water, a soft cloth and a car washing soap to clean exterior lamps and lenses. Follow instructions under "Washing the Vehicle" later in this section.

Finish Care

Occasional waxing or mild polishing of the vehicle by hand may be necessary to remove residue from the paint finish. Approved cleaning products can be obtained from your dealer/retailer.

If the vehicle has a basecoat/clearcoat paint finish, the clearcoat gives more depth and gloss to the colored basecoat. Always use waxes and polishes that are non-abrasive and made for a basecoat/clearcoat paint finish.

Notice: Machine compounding or aggressive polishing on a basecoat/clearcoat paint finish may damage it. Use only non-abrasive waxes and polishes that are made for a basecoat/clearcoat paint finish on the vehicle.

Foreign materials such as calcium chloride and other salts, ice melting agents, road oil and tar, tree sap, bird droppings, chemicals from industrial chimneys, etc., can damage the vehicle's finish if they remain on painted surfaces. Wash the vehicle as soon as possible. If necessary, use non-abrasive cleaners that are marked safe for painted surfaces to remove foreign matter.

Exterior painted surfaces are subject to aging, weather and chemical fallout that can take their toll over a period of years. To keep the paint finish looking new, keep the vehicle garaged or covered whenever possible.

Protecting Exterior Bright Metal Parts

Bright metal parts should be cleaned regularly to keep their luster. Wash with water or use chrome polish on chrome or stainless steel trim, if necessary.

Use special care with aluminum trim. To avoid damaging protective trim, never use auto or chrome polish, steam or caustic soap to clean aluminum. A coating of wax, rubbed to high polish, is recommended for all bright metal parts.

Washing the Vehicle

To preserve the vehicle's finish, keep it clean by washing it often.

Do not wash the vehicle in direct sunlight and use a car washing soap.

Notice: Certain cleaners contain chemicals that can damage the emblems or nameplates on the vehicle. Check the cleaning product label. If it states that it should not be used on plastic parts, do not use it on the vehicle or damage may occur and it would not be covered by the warranty.

Do not use cleaning agents that are petroleum based or that contain acid or abrasives, as they can damage the paint, metal or plastic on the vehicle. Approved cleaning products can be obtained from your dealer/retailer. Follow all manufacturer directions regarding correct product usage, necessary safety precautions and appropriate disposal of any vehicle care product.

Rinse the vehicle well, before washing and after to remove all cleaning agents completely. If they are allowed to dry on the surface, they could stain.

Dry the finish with a soft, clean chamois or an all-cotton towel to avoid surface scratches and water spotting.

High pressure car washes could cause water to enter the vehicle. Avoid using high pressure washes closer than 30 cm (12 inches) to the surface of the vehicle. Use of power washers exceeding 8,274 kPa (1,200 psi) can result in damage or removal of paint and decals.

Notice: Conveyor systems on some automatic car washes could damage the vehicle. There may not be enough clearance for the undercarriage. Check with the car wash manager before using the automatic car wash.

Weatherstrips

Silicone grease on weatherstrips will make them last longer, seal better, and not stick or squeak. Apply silicone grease with a clean cloth. During very cold, damp weather frequent application may be required. See *Recommended Fluids and Lubricants* on page 11-8.

Wheels and Trim — Aluminum or Chrome

The vehicle may have either aluminum or chrome-plated wheels.

Keep the wheels clean using a soft clean cloth with mild soap and water. Rinse with clean water. After rinsing thoroughly, dry with a soft clean towel. A wax may then be applied.

Notice: Chrome wheels and other chrome trim may be damaged if the vehicle is not washed after driving on roads that have been sprayed with magnesium, calcium or sodium chloride.

These chlorides are used on roads for conditions such as ice and dust. Always wash the vehicle's chrome with soap and water after exposure.

Notice: Using strong soaps, chemicals, abrasive polishes, cleaners, brushes, or cleaners that contain acid on aluminum or chrome-plated wheels, could damage the surface of the wheel(s). The repairs would not be covered by the vehicle warranty. Use only approved cleaners on aluminum or chrome-plated wheels.

The surface of these wheels is similar to the painted surface of the vehicle. Do not use strong soaps, chemicals, abrasive polishes, abrasive cleaners, cleaners with acid, or abrasive cleaning brushes on them because the surface could be damaged. Do not use chrome polish on aluminum wheels.

Notice: Using chrome polish on aluminum wheels could damage the wheels. The repairs would not be covered by the vehicle warranty. Use chrome polish on chrome wheels only.

Use chrome polish only on chrome-plated wheels, but avoid any painted surface of the wheel, and buff off immediately after application.

Notice: Driving the vehicle through an automatic car wash that has silicone carbide tire cleaning brushes, could damage the aluminum or chrome-plated wheels. The repairs would not be covered by the vehicle warranty. Never drive a vehicle that has aluminum or chrome-plated wheels through an automatic car wash that uses silicone carbide tire cleaning brushes.

Windshield and Wiper Blades

Clean the outside of the windshield with glass cleaner.

Clean the rubber blades using a lint free cloth or paper towel soaked with windshield washer fluid or a mild detergent. Wash the windshield thoroughly when cleaning the blades. Bugs, road grime, sap, and a buildup of vehicle wash/wax treatments may cause wiper streaking. Replace the wiper blades if they are worn or damaged.

Wipers can be damaged by:

- Extreme dusty conditions
- Sand and salt
- Heat and sun
- Snow and ice, without proper removal

Tires

Use a stiff brush with tire cleaner to clean the tires.

Notice: Using petroleum-based tire dressing products on the vehicle may damage the paint finish and/or tires. When applying a tire dressing, always wipe off any overspray from all painted surfaces on the vehicle.

Sheet Metal Damage

If the vehicle is damaged and requires sheet metal repair or replacement, make sure the body repair shop applies anti-corrosion material to parts repaired or replaced to restore corrosion protection.

Original manufacturer replacement parts will provide the corrosion protection while maintaining the vehicle warranty.

Finish Damage

Any stone chips, fractures or deep scratches in the finish should be repaired right away. Bare metal will corrode quickly and may develop into major repair expense.

Minor chips and scratches can be repaired with touch-up materials available from your dealer/retailer. Larger areas of finish damage can be corrected in your dealer's/retailer's body and paint shop.

Underbody Maintenance

Chemicals used for ice and snow removal and dust control can collect on the underbody. If these are not removed, corrosion and rust can develop on the underbody parts such as fuel lines, frame, floor pan, and exhaust system even though they have corrosion protection.

At least every spring, flush these materials from the underbody with plain water. Clean any areas where mud and debris can collect. Dirt packed in close areas of the frame should be loosened before being flushed. Your dealer/retailer or an underbody car washing system can do this.

Chemical Paint Spotting

Some weather and atmospheric conditions can create a chemical fallout. Airborne pollutants can fall upon and attack painted surfaces on the vehicle. This damage can take two forms: blotchy, ring-shaped discolorations, and small, irregular dark spots etched into the paint surface.

Interior Care

The vehicle's interior will continue to look its best if it is cleaned often. Dust and dirt can accumulate on the upholstery and cause damage to the carpet, fabric, leather, and plastic surfaces. Stains should be removed quickly as extreme heat could cause them to set rapidly.

Lighter colored interiors may require more frequent cleaning. Newspapers and garments that can transfer color to home furnishings can also transfer color to the vehicle's interior.

Remove dust from small buttons and knobs with a small brush with soft bristles.

Your dealer/retailer has products for cleaning the vehicle's interior. When cleaning the vehicle's interior, only use cleaners specifically designed for the surfaces that are being cleaned. Permanent damage can

result from using cleaners on surfaces for which they were not intended. Apply the cleaner directly to the cleaning cloth to prevent over-spray. Remove any accidental over-spray from other surfaces immediately.

Notice: Using abrasive cleaners when cleaning glass surfaces on the vehicle, could scratch the glass and/or cause damage to the rear window defogger. When cleaning the glass on the vehicle, use only a soft cloth and glass cleaner.

Cleaners can contain solvents that can become concentrated in the vehicle's interior. Before using cleaners, read and adhere to all safety instructions on the label. While cleaning the vehicle's interior, maintain adequate ventilation by opening the vehicle's doors and windows.

Do not clean the interior using the following cleaners or techniques:

- Never use a knife or any other sharp object to remove a soil from any interior surface.
- Never use a stiff brush. It can cause damage to the vehicle's interior surfaces.
- Never apply heavy pressure or rub aggressively with a cleaning cloth. Use of heavy pressure can damage the interior and does not improve the effectiveness of soil removal.
- Use only mild, neutral-pH soaps. Avoid laundry detergents or dishwashing soaps with degreasers. Using too much soap will leave a residue that leaves streaks and attracts dirt. For liquid cleaners, about 20 drops per 3.78 L (1 gal) of water is a good guide.

- Do not heavily saturate the upholstery while cleaning.
- Damage to the vehicle's interior may result from the use of many organic solvents such as naphtha, alcohol, etc.

Fabric/Carpet

Use a vacuum cleaner with a soft brush attachment to remove dust and loose dirt. A canister vacuum with a beater bar in the nozzle may only be used on floor carpet and carpeted floor mats. For soils, always try to remove them first with plain water or club soda. Before cleaning, gently remove as much of the soil as possible using one of the following techniques:

- For liquids: gently blot the remaining soil with a paper towel. Allow the soil to absorb into the paper towel until no more can be removed.
- For solid dry soils: remove as much as possible and then vacuum.

To clean:

1. Saturate a lint-free, clean white cloth with water or club soda.
2. Remove excess moisture.
3. Start on the outside edge of the soil and gently rub toward the center. Continue cleaning, using a clean area of the cloth each time it becomes soiled.
4. Continue to gently rub the soiled area.
5. If the soil is not completely removed, use a mild soap solution and repeat the cleaning process with plain water.

If any of the soil remains, a commercial fabric cleaner or spot lifter may be necessary. Test a small hidden area for colorfastness before using a commercial upholstery cleaner or spot lifter. If the locally cleaned area gives any impression that a ring formation may result, clean the entire surface.

A paper towel can be used to blot excess moisture from the fabric or carpet after the cleaning process.

Leather

To remove dust, a soft cloth dampened with water can be used. If a more thorough cleaning is necessary, a soft cloth dampened with a mild soap solution can be used. Allow the leather to dry naturally. Do not use heat, steam, or spot lifters or spot removers, or shoe polish on leather. Many commercial leather cleaners and coatings that are sold to preserve and protect leather may permanently change the appearance and feel of the leather and are not recommended. Do not use silicone or wax-based products, or those containing organic solvents to clean the vehicle's interior because they can alter the appearance by increasing the gloss in a non-uniform manner.

Instrument Panel, Vinyl, and Other Plastic Surfaces

To remove dust, a soft cloth dampened with water can be used. If a more thorough cleaning is necessary, a clean soft cloth dampened with a mild soap solution can be used to gently remove dust and dirt. Never use spot lifters or removers on plastic surfaces. Many commercial cleaners and coatings that are sold to preserve and protect soft plastic surfaces may permanently change the appearance and feel of the interior and are not recommended. Do not use silicone or wax-based products, or those containing organic solvents to clean the vehicle's interior because they can alter the appearance by increasing the gloss in a non-uniform manner.

Some commercial products may increase gloss on the instrument panel. The increase in gloss may cause annoying reflections in the windshield and even make it difficult to see through the windshield under certain conditions.

Care of Safety Belts

Keep belts clean and dry.

 **WARNING**

Do not bleach or dye safety belts. It may severely weaken them. In a crash, they might not be able to provide adequate protection. Clean safety belts only with mild soap and lukewarm water.

Floor Mats

If the floor mat has a snap retainer, a grommet in the driver side floor mat attaches to a hook on the floor of the vehicle to secure the floor mat. To remove the floor mat, pull the mat towards the rear of the vehicle until the grommet can be removed from the hook.

If the floor mat has a knob retainer, a grommet in the floor mat attaches to a knob on the floor of the vehicle to secure the floor mat. To remove the floor mat, turn the knob till it is aligned with the slot in the floor mat grommet and pull the floor mat up. To reinstall, center the slot in the floor mat grommet with the knob on the floor and set the mat in place. Then turn the knob until it is perpendicular to the slot in the grommet to lock the mat in place.

Service and Maintenance

General Information

General Information 11-1

Scheduled Maintenance

Scheduled Maintenance 11-2

Recommended Fluids, Lubricants, and Parts

Recommended Fluids and Lubricants 11-8

Maintenance Replacement Parts 11-10

Maintenance Records

Maintenance Records 11-11

General Information

Notice: Maintenance intervals, checks, inspections, recommended fluids, and lubricants are necessary to keep this vehicle in good working condition. Damage caused by failure to follow scheduled maintenance might not be covered by the vehicle warranty.

Proper vehicle maintenance helps to keep the vehicle in good working condition, improves fuel economy, and reduces vehicle emissions for better air quality.

Because of all the different ways people use vehicles, maintenance needs vary. The vehicle might need more frequent checks and services.

Please read the information under Scheduled Maintenance. To keep the vehicle in good condition, see your dealer/retailer.

The maintenance schedule is for vehicles that:

- Carry passengers and cargo within recommended limits on the Tire and Loading Information label. See *Vehicle Load Limits* on page 9-12.
- Are driven on reasonable road surfaces within legal driving limits.
- Use the recommended fuel. See *Recommended Fuel* on page 9-43.

WARNING

Performing maintenance work can be dangerous. Some jobs can cause serious injury. Perform maintenance work only if you have the required know-how and the proper tools and equipment. If in doubt, see your dealer/retailer to have a qualified technician do the work. See *Doing Your Own Service Work* on page 10-4.

At your General Motors dealer/retailer, you can be certain that you will receive the highest level of service available. Your dealer/retailer has specially trained service technicians, uses genuine GM replacement parts, as well as, up to date tools and equipment to ensure fast and accurate diagnostics.

The proper replacement parts, fluids, and lubricants to use are listed in *Recommended Fluids and Lubricants* on page 11-8 and *Maintenance Replacement Parts* on page 11-10. We recommend the use of genuine parts from your dealer/retailer.

Rotation of New Tires

To maintain ride, handling, and performance of the vehicle, it is important that the first rotation service for new tires be performed when they have 8 000 to 13 000 km (5,000 to 8,000 miles). See *Tire Rotation* on page 10-49.

Scheduled Maintenance

When the Change Engine Oil Soon Message Displays

Change engine oil and filter. See *Engine Oil* on page 10-8. *An Emission Control Service.*

When the “Change Engine Oil Soon” message displays, service is required for the vehicle as soon as possible, within the next 1 000 km/600 miles. If driving under the best conditions, the engine oil life system might not indicate the need for vehicle service for more than a year. The engine oil and filter must be changed at least once a year and the oil life system must be reset. Your dealer/retailer has trained service technicians who will perform this work and reset the system.

If the engine oil life system is reset accidentally, service the vehicle within 5 000 km/3,000 miles since the last service. Reset the oil life system whenever the oil is changed. See *Engine Oil Life System on page 10-9*.

When the “Change Engine Oil Soon” message displays, certain services, checks, and inspections are required. The services described for Maintenance I should be performed at every engine oil change. The services described for Maintenance II should be performed when:

- Maintenance I was performed the last time the engine oil was changed.
- It has been 10 months or more since the “Change Engine Oil Soon” message has displayed or since the last service.

Maintenance I

- Change engine oil and filter. See *Engine Oil on page 10-8. An Emission Control Service*.
- Engine coolant level check. See *Engine Coolant on page 10-14*.
- Windshield washer fluid level check. See *Washer Fluid on page 10-21*.
- Tire inflation check. See *Tire Pressure on page 10-43*.
- Tire wear inspection. See *Tire Inspection on page 10-49*.
- Rotate tires. See *Tire Rotation on page 10-49*.

- Fluids visual leak check (or every 12 months, whichever occurs first). A leak in any system must be repaired and the fluid level checked.
- Engine air cleaner filter inspection (vehicles driven in dusty conditions only). See *Engine Air Cleaner/Filter on page 10-12*.
- Brake system inspection (or every 12 months, whichever occurs first).

11-4 Service and Maintenance

Maintenance II

- Perform all services described in Maintenance I.
- Steering and suspension inspection. Visual inspection for damaged, loose, or missing parts or signs of wear.
- Engine cooling system inspection. Visual inspection of hoses, pipes, fittings, and clamps and replacement, if needed.
- Windshield wiper blade inspection for wear, cracking, or contamination and windshield and wiper blade cleaning, if contaminated. See *Exterior Care* on page 10-86. Worn or damaged wiper blade replacement. See *Wiper Blade Replacement* on page 10-27.

- Body hinges and latches, key lock cylinders, hood latch assemblies, secondary latches, pivots, spring anchor and release pawl, hood and door hinges, rear folding seats, and liftgate hinges lubrication. See *Recommended Fluids and Lubricants* on page 11-8. More frequent lubrication may be required when vehicle is exposed to a corrosive environment. Applying silicone grease on weatherstrips with a clean cloth makes them last longer, seal better, and not stick or squeak.

- Restraint system component check. See *Safety System Check* on page 3-31.
- Engine air cleaner filter inspection. See *Engine Air Cleaner/Filter* on page 10-12.

Additional Required Services

At Each Fuel Stop

- Engine oil level check. See *Engine Oil* on page 10-8.
- Engine coolant level check. See *Engine Coolant* on page 10-14.
- Windshield washer fluid level check. See *Washer Fluid* on page 10-21.

Once a Month

- Tire inflation check. See *Tire Pressure* on page 10-43.
- Tire wear inspection. See *Tire Inspection* on page 10-49.

Once a Year

- See *Starter Switch Check* on page 10-26.
- See *Automatic Transmission Shift Lock Control System Check* on page 10-26.
- See *Ignition Transmission Lock Check* on page 10-26.
- See *Park Brake and P (Park) Mechanism Check* on page 10-27.

- Engine cooling system and pressure cap pressure check. Radiator and air conditioning condenser outside cleaning. See *Cooling System* on page 10-14.
- Exhaust system and nearby heat shields inspection for loose or damaged components.
- Accelerator pedal check for damage, high effort, or binding. Replace if needed.
- If the vehicle has a Tire Sealant and Compressor Kit, check the sealant expiration date printed on the instruction label of the kit. See *Tire Sealant and Compressor Kit* on page 10-59.

First Engine Oil Change After Every 40 000 km/25,000 Miles

- Fuel system inspection for damage or leaks.

First Engine Oil Change After Every 80 000 km/50,000 Miles

- Engine air cleaner filter replacement. See *Engine Air Cleaner/Filter* on page 10-12.
- Automatic transmission fluid change (severe service) for vehicles mainly driven in heavy city traffic in hot weather, in hilly or mountainous terrain, when frequently towing a trailer, or used for taxi, police, or delivery service. See *Automatic Transmission Fluid* on page 10-11.

11-6 Service and Maintenance

- All-wheel drive only: Transfer case fluid change (severe service) for vehicles mainly driven when frequently towing a trailer, or used for taxi, police, or delivery service. During any maintenance, if a power washer is used to clean mud and dirt from the underbody, care should be taken to not directly spray the transfer case output seals. High pressure water can overcome the seals and contaminate the transfer case fluid. Contaminated fluid will decrease the life of the transfer case and should be replaced.

First Engine Oil Change After Every 160 000 km/100,000 Miles

- Automatic transmission fluid change (normal service). See *Automatic Transmission Fluid* on page 10-11.
- Spark plug replacement and spark plug wires inspection. See *An Emission Control Service*.
- All-wheel drive only: Transfer case fluid change (normal service). During any maintenance, if a power washer is used to clean mud and dirt from the underbody, care should be taken to not directly spray the transfer case output seals. High pressure water can overcome the seals and contaminate the transfer case fluid. Contaminated fluid will decrease the life of the transfer case and should be replaced.

First Engine Oil Change After Every 240 000 km/150,000 Miles

- Engine cooling system drain, flush, and refill, cooling system and cap pressure check, and cleaning of outside of radiator and air conditioning condenser (or every 5 years, whichever occurs first). See *Cooling System* on page 10-14. See *An Emission Control Service*.
- Engine accessory drive belt inspection for fraying, excessive cracks, or obvious damage and replacement, if needed. See *An Emission Control Service*.

Service	Maintenance I	Maintenance II
Change engine oil and filter. Reset oil life system.	•	•
Engine coolant level check.	•	•
Windshield washer fluid level check.	•	•
Tire inflation pressures check.	•	•
Tire wear inspection.	•	•
Rotate tires.	•	•
Fluids visual leak check.	•	•
Engine air cleaner filter inspection (vehicles driven in dusty conditions only).	•	•
Brake system inspection.	•	•
Steering and suspension inspection.		•
Engine cooling system inspection.		•
Windshield wiper blades inspection.		•
Body components lubrication.		•
Restraint system components check.		•
Engine air cleaner filter inspection (vehicles not driven in dusty conditions).		•

Recommended Fluids, Lubricants, and Parts

Recommended Fluids and Lubricants

Usage	Fluid/Lubricant
Engine Oil	Engine oil which meets GM Standard GM6094M and displays the American Petroleum Institute Certified for Gasoline Engines starburst symbol. To determine the proper viscosity for the vehicle's engine, see <i>Engine Oil on page 10-8</i> .
Engine Coolant	50/50 mixture of clean, drinkable water and use only DEX-COOL [®] Coolant. See <i>Engine Coolant on page 10-14</i> .
Hydraulic Brake System	DOT 3 Hydraulic Brake Fluid (GM Part No. U.S. 88862806, in Canada 88862807).
Windshield Washer	Optikleen [®] Washer Solvent.
Hydraulic Power Steering System	GM Power Steering Fluid (GM Part No. U.S. 89021184, in Canada 89021186).
Automatic Transmission	DEXRON [®] -VI Automatic Transmission Fluid.

Usage	Fluid/Lubricant
Carrier Assembly — Differential (Rear Drive Module) and Transfer Case (Power Transfer Unit)	SAE 75W-90 Synthetic Axle Lubricant (GM Part No. U.S. 89021677, in Canada 89021678).
Key Lock Cylinders	Multi-Purpose Lubricant, Superlube (GM Part No. U.S. 12346241, in Canada 10953474).
Hood Latch Assembly, Secondary Latch, Pivots, Spring Anchor, and Release Pawl	Lubriplate Lubricant Aerosol (GM Part No. U.S. 12346293, in Canada 992723) or lubricant meeting requirements of NLGI #2, Category LB or GC-LB.
Hood and Door Hinges and Rear Folding Seat	Multi-Purpose Lubricant, Superlube (GM Part No. U.S. 12346241, in Canada 10953474).
Weatherstrip Conditioning	Weatherstrip Lubricant (GM Part No. U.S. 3634770, in Canada 10953518) or Dielectric Silicone Grease (GM Part No. U.S. 12345579, in Canada 992887).

11-10 Service and Maintenance

Maintenance Replacement Parts

Replacement parts identified below by name, part number, or specification can be obtained from your dealer/retailer.

Part	GM Part Number	ACDelco Part Number
Engine Air Cleaner/Filter	15278634	A3083C
Engine Oil Filter	89017524	PF48
Spark Plugs	12611882	41-107
Wiper Blades		
Front Driver – 62.5 cm (24.6 in)	15254805	—
Front Passenger – 53.0 cm (20.8 in)	15254804	—
Rear – 30.0 cm (11.6 in)	15276259	—

Technical Data

Vehicle Identification

Vehicle Identification Number (VIN)	12-1
Service Parts Identification Label	12-1

Vehicle Data

Capacities and Specifications	12-2
Engine Drive Belt Routing ...	12-3

Vehicle Identification

Vehicle Identification Number (VIN)



This legal identifier is in the front corner of the instrument panel, on the left side of the vehicle. It can be seen through the windshield from outside. The VIN also appears on the Vehicle Certification and Service Parts labels and certificates of title and registration.

Engine Identification

The eighth character in the VIN is the engine code. This code identifies the vehicle's engine, specifications, and replacement parts. See "Engine Specifications" under *Capacities and Specifications* on page 12-2 for the vehicle's engine code.

Service Parts Identification Label

This label, on the inside of the glove box, has the following information:

- Vehicle Identification Number (VIN)
- Model designation
- Paint information
- Production options and special equipment

Do not remove this label from the vehicle.

Vehicle Data

Capacities and Specifications

The following approximate capacities are given in metric and English conversions. See *Recommended Fluids and Lubricants on page 11-8* for more information.

Application	Capacities	
	Metric	English
Air Conditioning Refrigerant R134a	For the air conditioning system refrigerant charge amount, see the refrigerant caution label located under the hood. See your dealer/retailer for more information.	
Cooling System	10.8 L	11.4 qt
Engine Oil with Filter	5.2 L	5.5 qt
Fuel Tank	83.3 L	22.0 gal
Transmission Fluid* (Drain and Refill)	5.0 L	5.3 qt
Wheel Nut Torque	190 N•m	140 lb ft
*See <i>Automatic Transmission Fluid on page 10-11</i> for information on checking fluid level.		
All capacities are approximate. When adding, be sure to fill to the approximate level, as recommended in this manual. Recheck fluid level after filling.		

Engine Specifications

Engine	VIN Code	Transmission	Spark Plug Gap
3.6L V6 Engine	D	Automatic	1.10 mm (0.043 in)

Engine Drive Belt Routing

3.6L V6 Engine

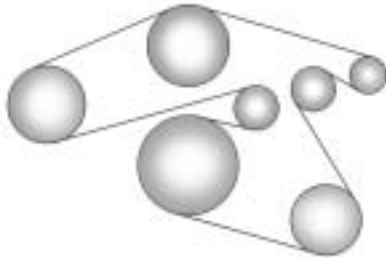

Customer Information

Customer Information

Customer Satisfaction Procedure	13-1
Customer Assistance Offices	13-4
Customer Assistance for Text Telephone (TTY) Users	13-4
Online Owner Center	13-5
GM Mobility Reimbursement Program	13-6
Roadside Assistance Program	13-6
Scheduling Service Appointments	13-8
Courtesy Transportation Program	13-9
Collision Damage Repair ...	13-10
Service Publications Ordering Information	13-13

Reporting Safety Defects

Reporting Safety Defects to the United States Government	13-14
Reporting Safety Defects to the Canadian Government	13-15
Reporting Safety Defects to General Motors	13-15

Vehicle Data Recording and Privacy

Vehicle Data Recording and Privacy	13-16
Event Data Recorders	13-16
Navigation System	13-17
Radio Frequency Identification (RFID)	13-17
Radio Frequency Statement	13-17

Customer Information

Customer Satisfaction Procedure

Your satisfaction and goodwill are important to your dealer and to GMC. Normally, any concerns with the sales transaction or the operation of the vehicle will be resolved by the dealer's sales or service departments. Sometimes, however, despite the best intentions of all concerned, misunderstandings can occur. If your concern has not been resolved to your satisfaction, the following steps should be taken:

STEP ONE: Discuss your concern with a member of dealership management. Normally, concerns can be quickly resolved at that level. If the matter has already been reviewed with the sales, service or parts manager, contact the owner of the dealership or the general manager.

13-2 Customer Information

STEP TWO: If after contacting a member of dealership management, it appears your concern cannot be resolved by the dealership without further help, in the U.S., call the GMC Consumer Relations Manager at 1-800-GMC-8782 (1-800-462-8782, Customer Assistance prompt). In Canada, call General Motors of Canada Customer Communication at 1-800-263-3777 (English) or 1-800-263-7854 (French).

We encourage you to call the toll-free number in order to give your inquiry prompt attention.

Have the following information available to give the Customer Assistance Representative:

- Vehicle Identification Number (VIN). This is available from the vehicle registration or title, or the plate at the top left of the instrument panel and visible through the windshield.
- Dealership name and location.
- Vehicle delivery date and present mileage.

When contacting GMC, remember that your concern will likely be resolved at a dealer's facility. That is why we suggest following Step One first.

STEP THREE — U.S. Owners:

Both General Motors and your dealer are committed to making sure you are completely satisfied with your new vehicle. However, if you continue to remain unsatisfied after following the procedure outlined in Steps One and Two, you can file with the Better Business Bureau (BBB) Auto Line Program to enforce your rights.

The BBB Auto Line Program is an out of court program administered by the Council of Better Business Bureaus to settle automotive disputes regarding vehicle repairs or the interpretation of the New Vehicle Limited Warranty. Although you may be required to resort to this informal dispute resolution program prior to filling out a court action, use of the program is free of charge and your case will generally be heard within 40 days. If you do not agree with the decision given in your case, you may reject it and proceed with any other venue for relief available to you.

You may contact the BBB Auto Line Program using the toll-free telephone number or write them at the following address:

BBB Auto Line Program
Council of Better Business
Bureaus, Inc.

4200 Wilson Boulevard
Suite 800
Arlington, VA 22203-1838

Telephone: 1-800-955-5100
dr.bbb.org/goauto

This program is available in all 50 states and the District of Columbia. Eligibility is limited by vehicle age, mileage, and other factors. General Motors reserves the right to change eligibility limitations and/or discontinue its participation in this program.

STEP THREE — Canadian

Owners: In the event that you do not feel your concerns have been addressed after following the procedure outlined in Steps One and Two, General Motors of Canada Limited wants you to be aware of its participation in a no-charge Mediation/Arbitration Program. General Motors of Canada Limited has committed to binding arbitration of owner disputes involving factory-related vehicle service claims. The program provides for the review of the facts involved by an impartial third party arbiter, and may include an informal hearing before the arbiter. The program is designed so that the entire dispute settlement process, from the time you file your complaint to the final decision, should be completed in approximately 70 days. We believe our impartial program offers advantages over courts in most jurisdictions because it is informal, quick, and free of charge.

For further information concerning eligibility in the Canadian Motor Vehicle Arbitration Plan (CAMVAP), call toll-free 1-800-207-0685, or call the General Motors Customer Communication Centre, 1-800-263-3777 (English), 1-800-263-7854 (French), or write to:

Mediation/Arbitration Program
c/o Customer Communication
Centre
General Motors of Canada Limited
Mail Code: CA1-163-005
1908 Colonel Sam Drive
Oshawa, Ontario L1H 8P7
Telephone: 1-800-955-5100

Your inquiry should be accompanied by the Vehicle Identification Number (VIN).

13-4 Customer Information

Customer Assistance Offices

GMC encourages customers to call the toll-free number for assistance. However, if a customer wishes to write or e-mail GMC, the letter should be addressed to:

United States

GMC Customer Assistance Center
P.O. Box 33172
Detroit, MI 48232-5172

www.GMC.com

1-800-GMC-8782 (462-8782)
1-800-GMC-8583 (462-8583)
(For Text Telephone devices (TTYs))
Roadside Assistance:
1-800-GMC-8782 (462-8782)

From Puerto Rico

1-800-496-9992 (English)
1-800-496-9993 (Spanish)

U.S. Virgin Islands:

1-800-496-9994

Canada

General Motors of Canada Limited
Customer Communication Centre,
CA1-163-005
1908 Colonel Sam Drive
Oshawa, Ontario L1H 8P7
www.gmcanada.com

1-800-263-3777 (English)
1-800-263-7854 (French)
1-800-263-3830 (For Text
Telephone devices (TTYs))
Roadside Assistance:
1-800-268-6800

All Overseas Locations

Please contact the local General
Motors Business Unit.

Mexico, Central America and Caribbean Islands/Countries (Except Puerto Rico and U.S. Virgin Islands)

General Motors de Mexico,
S. de R.L. de C.V.
Customer Assistance Center
Paseo de la Reforma # 2740
Col. Lomas de Bezares
C.P. 11910, Mexico, D.F.

01-800-508-0000
Long Distance: 011-52-53 29 0 800

Customer Assistance for Text Telephone (TTY) Users

To assist customers who are deaf, hard of hearing, or speech-impaired and who use the Text Telephones (TTYs), GMC has TTY equipment available at its Customer Assistance Center. Any TTY user can communicate with GMC by dialing: 1-800-GMC-8583 (462-8583). (TTY users in Canada can dial 1-800-263-3830.)

Online Owner Center

Online Owner Center (U.S.) — www.gmownercenter.com/gmc

Information and services customized for your specific vehicle — all in one convenient place.

- Digital owner manual, warranty information, and more
- Online service and maintenance records
- Find GMC dealers for service nationwide
- Exclusive privileges and offers
- Recall notices for your specific vehicle
- OnStar® and GM Cardmember Services Earnings summaries

Other Helpful Links:

GMC — www.gmc.com

GMC Merchandise — www.gmccollection.com

Help Center — www.gmc.com/helpcenter

- FAQ
- Contact Us

My GM Canada (Canada) — www.gm.ca

My GM Canada is a password-protected section of www.gm.ca where you can save information on GM vehicles, get personalized offers, and use handy tools and forms with greater ease.

Here are a few of the valuable tools and services you will have access to:

- My Showroom: Find and save information on vehicles and current offers in your area.
- My Dealers/Retailers: Save details such as address and phone number for each of your preferred GM dealers/retailers.
- My Driveway: Access quick links to parts and service estimates, check trade-in values, or schedule a service appointment by adding the vehicles you own to your driveway profile.
- My Preferences: Manage your profile and use tools and forms with greater ease.

To sign up, visit the My GM Canada section within www.gm.ca.

GM Mobility Reimbursement Program



This program, available to qualified applicants, can reimburse you up to \$1,000 of the cost of eligible aftermarket adaptive equipment required for your vehicle, such as hand controls or a wheelchair/scooter lift.

The offer is available for a very limited period of time from the date of vehicle purchase/lease. For more details, or to determine your vehicle's eligibility, visit

gmmobility.com or call the GM Mobility Assistance Center at 1-800-323-9935. Text telephone (TTY) users, call 1-800-833-9935.

General Motors of Canada also has a Mobility Program. Call 1-800-GM-DRIVE (463-7483) for details. TTY users call 1-800-263-3830.

Roadside Assistance Program

For U.S. purchased vehicles, call **1-800-GMC-8782 (1-800-462-8782); (Text telephone (TTY): 1-888-889-2438).**

For Canadian purchased vehicles, call **1-800-268-6800.**

Service is available 24 hours a day, 365 days a year.

Calling for Assistance

When calling Roadside Assistance, have the following information ready:

- Your name, home address, and home telephone number
- Telephone number of your location
- Location of the vehicle
- Model, year, color, and license plate number of the vehicle
- Odometer reading, Vehicle Identification Number (VIN), and delivery date of the vehicle
- Description of the problem

Coverage

Services are provided up to 5 years/100,000 miles (160 000 km), whichever comes first.

In the U.S., anyone driving the vehicle is covered. In Canada, a person driving the vehicle without permission from the owner is not covered.

Roadside Assistance is not a part of the New Vehicle Limited Warranty. GMC and General Motors of Canada Limited reserve the right to make any changes or discontinue the Roadside Assistance program at any time without notification.

GMC and General Motors of Canada Limited reserve the right to limit services or payment to an owner or driver if they decide the claims are made too often, or the same type of claim is made many times.

Services Provided

- **Emergency Fuel Delivery:** Delivery of enough fuel for the vehicle to get to the nearest service station.
- **Lock-Out Service:** Service is provided to unlock the vehicle if you are locked out. A remote unlock may be available if you have OnStar[®]. For security reasons, the driver must present identification before this service is given.
- **Emergency Tow From a Public Road or Highway:** Tow to the nearest GMC dealer for warranty service, or if the vehicle was in a crash and cannot be driven. Assistance is also given when the vehicle is stuck in the sand, mud, or snow.
- **Flat Tire Change:** Service is provided to change a flat tire with the spare tire. The spare tire, if equipped, must be in good condition and properly inflated.

It is the owner's responsibility for the repair or replacement of the tire if it is not covered by the warranty.

- **Battery Jump Start:** Service is provided to jump start a dead battery.
- **Trip Routing Service:** Detailed maps of North America are provided when requested either with the most direct route or the most scenic route. Additional travel information is also available. Allow three weeks for delivery.
- **Trip Interruption Benefits and Assistance:** If your trip is interrupted due to a warranty failure, incidental expenses may be reimbursed during the 5 years/100,000 miles (160 000 km) Powertrain warranty period. Items considered are hotel, meals, and rental car.

Services Not Included in Roadside Assistance

- Impound towing caused by violation of any laws.
- Legal fines.
- Mounting, dismounting or changing of snow tires, chains, or other traction devices.
- Towing or services for vehicles driven on a non-public road or highway.

Services Specific to Canadian Purchased Vehicles

- **Fuel delivery:** Reimbursement is approximately \$5 Canadian. Diesel fuel delivery may be restricted. Propane and other fuels are not provided through this service.
- **Lock-Out Service:** Vehicle registration is required.
- **Trip Routing Service:** Limit of six requests per year.

- **Trip Interruption Benefits and Assistance:** Must be over 250 kilometres from where your trip was started to qualify. General Motors of Canada Limited requires pre-authorization, original detailed receipts, and a copy of the repair orders. Once authorization has been received, the Roadside Assistance advisor will help you make arrangements and explain how to receive payment.
- **Alternative Service:** If assistance cannot be provided right away, the Roadside Assistance advisor may give you permission to get local emergency road service. You will receive payment, up to \$100, after sending the original receipt to Roadside Assistance. Mechanical failures may be covered, however any cost for parts and labor for repairs not covered by the warranty are the owner responsibility.

Scheduling Service Appointments

When your vehicle requires warranty service, contact your dealer/retailer and request an appointment. By scheduling a service appointment and advising your service consultant of your transportation needs, your dealer/retailer can help minimize your inconvenience.

If your vehicle cannot be scheduled into the service department immediately, keep driving it until it can be scheduled for service, unless, of course, the problem is safety-related. If it is, please call your dealership/retailer, let them know this, and ask for instructions.

If the dealer/retailer requests you to bring the vehicle for service, you are urged to do so as early in the work day as possible to allow for the same day repair.

Courtesy Transportation Program

To enhance your ownership experience, we and our participating dealers are proud to offer Courtesy Transportation, a customer support program for vehicles with the Bumper to Bumper (Base Warranty Coverage period in Canada) and extended powertrain, and hybrid specific warranty in both the U.S. and Canada.

Several courtesy transportation options are available to assist in reducing your inconvenience when warranty repairs are required.

Courtesy Transportation is not a part of the New Vehicle Limited Warranty. A separate booklet entitled "Warranty and Owner Assistance Information" furnished with each new vehicle provides detailed warranty coverage information.

Transportation Options

Warranty service can generally be completed while you wait. However, if you are unable to wait, GM helps to minimize your inconvenience by providing several transportation options. Depending on the circumstances, your dealer can offer you one of the following:

Shuttle Service

Shuttle service is the preferred means of offering Courtesy Transportation. Dealers may provide you with shuttle service to get you to your destination with minimal interruption of your daily schedule. This includes one-way or round trip shuttle service within reasonable time and distance parameters of the dealer's area.

Public Transportation or Fuel Reimbursement

If your vehicle requires overnight warranty repairs, and public transportation is used instead of the dealer's shuttle service, the expense must be supported by original receipts and can only be up to the maximum amount allowed by GM for shuttle service. In addition, for U.S. customers, should you arrange transportation through a friend or relative, limited reimbursement for reasonable fuel expenses may be available. Claim amounts should reflect actual costs and be supported by original receipts. See your dealer for information regarding the allowance amounts for reimbursement of fuel or other transportation costs.

Courtesy Rental Vehicle

Your dealer may arrange to provide you with a courtesy rental vehicle or reimburse you for a rental vehicle that you obtain if your vehicle is kept for an overnight warranty repair. Rental reimbursement will be limited and must be supported by original receipts. This requires that you sign and complete a rental agreement and meet state/provincial, local, and rental vehicle provider requirements. Requirements vary and may include minimum age requirements, insurance coverage, credit card, etc. You are responsible for fuel usage charges and may also be responsible for taxes, levies, usage fees, excessive mileage, or rental usage beyond the completion of the repair.

It may not be possible to provide a like-vehicle as a courtesy rental.

Additional Program Information

All program options, such as shuttle service, may not be available at every dealer. Please contact your dealer for specific information about availability. All Courtesy Transportation arrangements will be administered by appropriate dealer personnel.

General Motors reserves the right to unilaterally modify, change or discontinue Courtesy Transportation at any time and to resolve all questions of claim eligibility pursuant to the terms and conditions described herein at its sole discretion.

Collision Damage Repair

If your vehicle is involved in a collision and it is damaged, have the damage repaired by a qualified technician using the proper equipment and quality replacement parts. Poorly performed collision repairs diminish your vehicle's resale value, and safety performance can be compromised in subsequent collisions.

Collision Parts

Genuine GM Collision parts are new parts made with the same materials and construction methods as the parts with which your vehicle was originally built. Genuine GM Collision parts are your best choice to ensure that your vehicle's designed appearance, durability, and safety are preserved. The use of Genuine GM parts can help maintain your GM New Vehicle Limited Warranty.

Recycled original equipment parts may also be used for repair. These parts are typically removed from vehicles that were total losses in prior crashes. In most cases, the parts being recycled are from undamaged sections of the vehicle. A recycled original equipment GM part, may be an acceptable choice to maintain your vehicle's originally designed appearance and safety performance, however, the history of these parts is not known. Such parts are not covered by your GM New Vehicle Limited Warranty, and any related failures are not covered by that warranty.

Aftermarket collision parts are also available. These are made by companies other than GM and may not have been tested for your vehicle. As a result, these parts

may fit poorly, exhibit premature durability/corrosion problems, and may not perform properly in subsequent collisions. Aftermarket parts are not covered by your GM New Vehicle Limited Warranty, and any vehicle failure related to such parts are not covered by that warranty.

Repair Facility

We recommend that you choose a collision repair facility that meets your needs before you ever need collision repairs. Your dealer/retailer may have a collision repair center with GM-trained technicians and state of the art equipment, or be able to recommend a collision repair center that has GM-trained technicians and comparable equipment.

Insuring Your Vehicle

Protect your investment in your GM vehicle with comprehensive and collision insurance coverage. There are significant differences in the quality of coverage afforded by various insurance policy terms. Many insurance policies provide reduced protection to your GM vehicle by limiting compensation for damage repairs by using aftermarket collision parts. Some insurance companies will not specify aftermarket collision parts. When purchasing insurance, we recommend that you assure your

13-12 Customer Information

vehicle will be repaired with GM original equipment collision parts. If such insurance coverage is not available from your current insurance carrier, consider switching to another insurance carrier.

If your vehicle is leased, the leasing company may require you to have insurance that assures repairs with Genuine GM Original Equipment Manufacturer (OEM) parts or Genuine Manufacturer replacement parts. Read your lease carefully, as you may be charged at the end of your lease for poor quality repairs.

If a Crash Occurs

If there has been an injury, call emergency services for help. Do not leave the scene of a crash until all matters have been taken care of. Move the vehicle only if its position puts you in danger, or you are instructed to move it by a police officer.

Give only the necessary information to police and other parties involved in the crash.

For emergency towing see *Roadside Assistance Program on page 13-6*.

Gather the following information:

- Driver's name, address, phone number
- Driver's license number
- Owner's name, address, phone number

- Vehicle license plate
- Vehicle make, model and model year
- Vehicle Identification Number (VIN)
- Insurance company and policy number
- General description of the damage to the other vehicle

Choose a reputable repair facility that uses quality replacement parts. See "Collision Parts" earlier in this section.

If the airbag has inflated, see *What Will You See After an Airbag Inflates?* on page 3-38.

Managing the Vehicle Damage Repair Process

In the event that your vehicle requires damage repairs, GM recommends that you take an active role in its repair. If you have a pre-determined repair facility of choice, take your vehicle there, or have it towed there. Specify to the facility that any required replacement collision parts be original equipment parts, either new Genuine GM parts or recycled original GM parts. Remember, recycled parts will not be covered by your GM vehicle warranty.

Insurance pays the bill for the repair, but you must live with the repair. Depending on your policy limits, your insurance company may

initially value the repair using aftermarket parts. Discuss this with your repair professional, and insist on Genuine GM parts. Remember if your vehicle is leased you may be obligated to have the vehicle repaired with Genuine GM parts, even if your insurance coverage does not pay the full cost.

If another party's insurance company is paying for the repairs, you are not obligated to accept a repair valuation based on that insurance company's collision policy repair limits, as you have no contractual limits with that company. In such cases, you can have control of the repair and parts choices as long as cost stays within reasonable limits.

Service Publications Ordering Information

Service Manuals

Service Manuals have the diagnosis and repair information on engines, transmission, axle suspension, brakes, electrical, steering, body, etc.

Service Bulletins

Service Bulletins give additional technical service information needed to knowledgeably service General Motors cars and trucks. Each bulletin contains instructions to assist in the diagnosis and service of your vehicle.

13-14 Customer Information

Owner Information

Owner publications are written specifically for owners and intended to provide basic operational information about the vehicle. The owner manual includes the Maintenance Schedule for all models.

In-Portfolio: Includes a Portfolio, Owner Manual, and Warranty Booklet.

RETAIL SELL PRICE:
\$35.00 (U.S.) plus processing fee

Without Portfolio: Owner Manual only.

RETAIL SELL PRICE:
\$25.00 (U.S.) plus processing fee

Current and Past Model Order Forms

Technical Service Bulletins and Manuals are available for current and past model GM vehicles. To request an order form, specify year and model name of the vehicle.

ORDER TOLL FREE:

**1-800-551-4123 Monday-Friday
8:00 AM - 6:00 PM Eastern Time**

For Credit Card Orders Only (VISA-MasterCard-Discover), visit Helm, Inc. on the World Wide Web at: helminc.com

Or you can write to:

Helm, Incorporated
P.O. Box 07130
Detroit, MI 48207

Prices are subject to change without notice and without incurring obligation. Allow ample time for delivery.

Note to Canadian Customers: All listed prices are quoted in U.S. funds. Canadian residents are to make checks payable in U.S. funds.

Reporting Safety Defects

Reporting Safety Defects to the United States Government

If you believe that your vehicle has a defect which could cause a crash or could cause injury or death, you should immediately inform the National Highway Traffic Safety Administration (NHTSA) in addition to notifying General Motors.

If NHTSA receives similar complaints, it may open an investigation, and if it finds that a safety defect exists in a group of vehicles, it may order a recall and remedy campaign.

However, NHTSA cannot become involved in individual problems between you, your dealer, or General Motors.

To contact NHTSA, you may call the Vehicle Safety Hotline toll-free at 1-888-327-4236 (TTY: 1-800-424-9153); go to <http://www.safercar.gov>; or write to:

Administrator, NHTSA
1200 New Jersey Avenue, S.E.
Washington, D.C. 20590

You can also obtain other information about motor vehicle safety from <http://www.safercar.gov>.

Reporting Safety Defects to the Canadian Government

If you live in Canada, and you believe that your vehicle has a safety defect, notify Transport Canada immediately, in addition to notifying General Motors of Canada Limited. Call them at 1-800-333-0510 or write to:

Transport Canada
Road Safety Branch
2780 Sheffield Road
Ottawa, Ontario K1B 3V9

Reporting Safety Defects to General Motors

In addition to notifying NHTSA (or Transport Canada) in a situation like this, please notify General Motors.

Call 1-800-GMC-8782 (1-800-462-8782), or write:

GMC Customer Assistance Center
P.O. Box 33172
Detroit, MI 48232-5172

In Canada, call 1-800-263-3777 (English) or 1-800-263-7854 (French), or write:

General Motors of Canada Limited
Customer Communication Centre,
CA1-163-005
1908 Colonel Sam Drive
Oshawa, Ontario L1H 8P7

Vehicle Data Recording and Privacy

Your GM vehicle has a number of sophisticated computers that record information about the vehicle's performance and how it is driven. For example, your vehicle uses computer modules to monitor and control engine and transmission performance, to monitor the conditions for airbag deployment and deploy airbags in a crash and, if so equipped, to provide antilock braking to help the driver control the vehicle. These modules may store data to help your dealer/retailer technician service your vehicle. Some modules may also store data about how you operate the vehicle, such as rate of fuel consumption or average speed. These modules may also retain the owner's personal preferences, such as radio pre-sets, seat positions, and temperature settings.

Event Data Recorders

This vehicle has an Event Data Recorder (EDR). The main purpose of an EDR is to record, in certain crash or near crash-like situations, such as an airbag deployment or hitting a road obstacle, data that will assist in understanding how a vehicle's systems performed. The EDR is designed to record data related to vehicle dynamics and safety systems for a short period of time, typically 30 seconds or less. The EDR in this vehicle is designed to record such data as:

- How various systems in your vehicle were operating
- Whether or not the driver and passenger safety belts were buckled/fastened
- How far, if at all, the driver was pressing the accelerator and/or brake pedal
- How fast the vehicle was traveling

This data can help provide a better understanding of the circumstances in which crashes and injuries occur.

Important: EDR data is recorded by your vehicle only if a non-trivial crash situation occurs; no data is recorded by the EDR under normal driving conditions and no personal data (e.g., name, gender, age, and crash location) is recorded. However, other parties, such as law enforcement, could combine the EDR data with the type of personally identifying data routinely acquired during a crash investigation.

To read data recorded by an EDR, special equipment is required, and access to the vehicle or the EDR is needed. In addition to the vehicle manufacturer, other parties, such as law enforcement, that have the special equipment, can read the information if they have access to the vehicle or the EDR.

GM will not access this data or share it with others except: with the consent of the vehicle owner or, if the vehicle is leased, with the consent of the lessee; in response to an official request of police or similar government office; as part of GM's defense of litigation through the discovery process; or, as required by law. Data that GM collects or receives may also be used for GM research needs or may be made available to others for research purposes, where a need is shown and the data is not tied to a specific vehicle or vehicle owner.

Navigation System

If your vehicle has a navigation system, use of the system may result in the storage of destinations, addresses, telephone numbers, and other trip information. Refer to the navigation system operating manual for information on stored data and for deletion instructions.

Radio Frequency Identification (RFID)

RFID technology is used in some vehicles for functions such as tire pressure monitoring and ignition system security, as well as in connection with conveniences such as key fobs for remote door locking/unlocking and starting, and in-vehicle transmitters for garage door openers. RFID technology in GM vehicles does not use or record personal information or link with any other GM system containing personal information.

Radio Frequency Statement

This vehicle has systems that operate on a radio frequency that comply with Part 15 of the Federal Communications Commission (FCC) Rules and with RSS-210/211 of Industry Canada.

Operation is subject to the following two conditions:

1. The device may not cause interference.
2. The device must accept any interference received, including interference that may cause undesired operation of the device.

Changes or modifications to any of these systems by other than an authorized service facility could void authorization to use this equipment.

A

Accessories and
 Modifications 10-3

Accessory Power 9-19

Add-On Electrical
 Equipment 9-59

Adding Equipment to the
 Airbag-Equipped Vehicle 3-44

Adjustments
 Lumbar, Front Seats 3-6

Air Cleaner/Filter, Engine 10-12

Air Vents 8-12

Airbag System
 Check 3-45

How Does an Airbag
 Restrain? 3-37

Passenger Sensing
 System 3-39

What Makes an Airbag
 Inflate? 3-37

What Will You See After
 an Airbag Inflates? 3-38

When Should an Airbag
 Inflate? 3-35

Where Are the Airbags? 3-34

Airbags
 Adding Equipment to the
 Vehicle 3-44

Passenger Status Indicator ... 5-15

Readiness Light 5-15

Servicing Airbag-Equipped
 Vehicles 3-44

System Check 3-32

Alarm System
 Anti-Theft 2-13

All-Wheel Drive 10-25, 9-28

AM-FM Radio 7-6

Antenna
 Multi-Band 7-12

Anti-Theft
 Alarm System 2-13

Alarm System Messages 5-41

Antilock Brake
 System (ABS) 9-28

Warning Light 5-20

Appearance Care
 Exterior 10-86

Interior 10-90

Armrest Storage 4-1

Assistance Program,
 Roadside 13-6

Audio Controller,
 Rear (RAC) 7-46

Audio Players 7-12

CD 7-12

MP3 7-22, 7-28

Audio System
 Radio Reception 7-11

Rear Seat (RSA) 7-44

Theft-Deterrent Feature 7-2

Automatic
 Door Locks 2-8

Automatic Transmission 9-24

Fluid 10-11

Manual Mode 9-26

Shiftlock Control System
 Check 10-26

Auxiliary Devices 7-34

B

Battery	10-25
Jump Starting	10-79
Load Management	6-7
Power Protection	6-8
Voltage and Charging	
Messages	5-36
Blade Replacement, Wiper ...	10-27
Bluetooth	7-46
Brakes	10-22
Antilock	9-28
Assist	9-30
Fluid	10-23
Parking	9-29
System Messages	5-36
Braking	9-3
Break-In, New Vehicle	9-17
Bulb Replacement	10-29
Fog Lamps	6-4
Halogen Bulbs	10-28
Headlamp Aiming	10-28
Headlamps	10-28
License Plate Lamps	10-29
Buying New Tires	10-51

C

Calibration	5-6
California	
Fuel Requirements	9-43
Perchlorate Materials	
Requirements	10-3
Warning	10-3
Camera, Rear Vision	9-36
Canadian Vehicle Owners	iii
Capacities and	
Specifications	12-2
Carbon Monoxide	
Engine Exhaust	9-23
Liftgate	2-9
Winter Driving	9-9
Cargo	
Cover	4-3
Management System	4-3
Tie Downs	4-3
Cautions, Danger, and	
Warnings	iv
CD	
DVD Player	7-14
CD Player	7-12

Center Console Storage	4-1
Chains, Tire	10-57
Charging System Light	5-16
Check	
Engine Lamp	5-17
Ignition	
Transmission Lock	10-26
Child Restraints	
Infants and Young	
Children	3-49
Lower Anchors and	
Tethers for Children	3-55
Older Children	3-46
Securing	3-62, 3-64
Systems	3-51
Where to Put the Restraint ...	3-53
Circuit Breakers	10-30
Cleaning	
Exterior Care	10-86
Interior Care	10-90
Climate Control Systems	8-1
Dual Automatic	8-4
Rear	8-10, 8-11
Clock	5-8

Cluster, IP 5-11
 Collision Damage Repair 13-10
 Compact Spare Tire 10-77
 Compass 5-6
 Compressor Kit, Tire Sealant 10-59
 Control of a Vehicle 9-3
 Convenience Net 4-3
 Convex Mirrors 2-16
 Coolant
 Engine 10-14
 Engine Temperature Gauge 5-13
 Engine Temperature Warning Light 5-21
 Cooling System 10-14
 Engine Messages 5-38
 Courtesy Lamps 6-5
 Courtesy Transportation Program 13-9
 Covers
 Cargo 4-3
 Engine 10-7
 Cruise Control 9-32
 Light 5-23
 Messages 5-37

Cupholders 4-1
 Customer Assistance 13-4
 Offices 13-4
 Text Telephone (TTY) Users 13-4
 Customer Information Service Publications
 Ordering Information 13-13
 Customer Satisfaction Procedure 13-1

D

Damage Repair, Collision 13-10
 Danger, Warnings, and Cautions iv
 Data Recorders, Event 13-16
 Daytime Running Lamps/ Automatic Headlamp System 6-3
 Defensive Driving 9-2
 Delayed Entry Lighting 6-6
 Delayed Exit Lighting 6-6
 Delayed Locking 2-8
 Devices, Auxiliary 7-34

Displays
 Head-Up 5-32
 Dome Lamps 6-5
 Door
 Ajar Messages 5-37
 Delayed Locking 2-8
 Locks 2-7
 Power Locks 2-8
 Drive Systems
 All-Wheel Drive 10-25, 9-28
 Driver Information Center (DIC) 5-24, 5-29
 Driving
 Characteristics and Towing Tips 9-48
 Defensive 9-2
 Drunk 9-2
 Highway Hypnosis 9-8
 Hill and Mountain Roads 9-8
 If the Vehicle is Stuck 9-11
 Loss of Control 9-6
 Off-Road Recovery 9-5
 Vehicle Load Limits 9-12
 Winter 9-9

Driving for Better Fuel	
Economy	1-21
Dual Automatic Climate	
Control System	8-4
DVD	
Rear Seat Entertainment	
System	7-36
DVD/CD Player	7-14

E

Electrical Equipment,	
Add-On	9-59
Electrical System	
Engine Compartment	
Fuse Block	10-30
Fuses and Circuit	
Breakers	10-30
Instrument Panel Fuse	
Block	10-34
Overload	10-30
Engine	
Air Cleaner/Filter	10-12
Check and Service Engine	
Soon Lamp	5-17
Compartment Overview	10-6
Coolant	10-14

Engine (cont.)	
Coolant Temperature	
Gauge	5-13
Coolant Temperature	
Warning Light	5-21
Cooling System	10-14
Cooling System Messages	5-38
Cover	10-7
Drive Belt Routing	12-3
Exhaust	9-23
Overheated Protection	
Operating Mode	10-20
Overheating	10-18
Power Messages	5-39
Pressure Light	5-22
Running While Parked	9-24
Starting	9-19
Engine Oil	
Life System	10-9
Messages	5-39
Entry Lighting	6-6
Equipment, Towing	9-57
Event Data Recorders	13-16
Extender, Safety Belt	3-30
Exterior Lamp Controls	6-1

F

Filter	
Engine Air Cleaner	10-12
Flash-to-Pass	6-3
Flashers, Hazard Warning	6-3
Flat Tire	10-57
Flat Tire, Changing	10-67
Floor Console Storage	4-2
Floor Mats	10-93
Fluid	
Automatic Transmission	10-11
Brakes	10-23
Power Steering	10-20
Washer	10-21
Fog Lamps	
Bulb Replacement	6-4
Light	5-23
Folding Mirrors	2-17
Front Seats	
Adjustment	3-3
Heated	3-9
Heated and Ventilated	3-10

Fuel 9-42
 Additives 9-44
 Filling a Portable Fuel
 Container 9-47
 Filling the Tank 9-45
 Fuels in Foreign Countries 9-44
 Gasoline Specifications 9-43
 Gauge 5-12
 Recommended 9-43
 Requirements, California 9-43
 System Messages 5-39
 Fuel Economy
 Driving for Better 1-21
 Fuses
 Engine Compartment
 Fuse Block 10-30
 Fuses and Circuit
 Breakers 10-30
 Instrument Panel Fuse
 Block 10-34

G

Garage Door Opener 5-52
 Programming 5-52
 Gasoline
 Specifications 9-43
 Gauges
 Engine Coolant
 Temperature 5-13
 Fuel 5-12
 Odometer 5-12
 Speedometer 5-12
 Tachometer 5-12
 Voltmeter 5-13
 Warning Lights and
 Indicators 5-10
 General Information
 Service and Maintenance 11-1
 Towing 9-47
 Vehicle Care 10-2
 Glove Box 4-1
 GM Mobility Reimbursement
 Program 13-6

H

Halogen Bulbs 10-28
 Hazard Warning Flashers 6-3
 Head Restraints 3-2
 Head-Up Display (HUD) 5-32
 Headlamps
 Aiming 10-28
 Bulb Replacement 10-28
 Daytime Running Lamps/
 Automatic Headlamp
 System 6-3
 Flash-to-Pass 6-3
 High-Beam On Light 5-23
 High/Low Beam Changer 6-2
 Heated and Ventilated Front
 Seats 3-10
 Heated Front Seats 3-9
 Heated Mirrors 2-18
 High Voltage Devices and
 Wiring 10-29
 High-Beam On Light 5-23
 Highway Hypnosis 9-8

Hill and Mountain Roads	9-8
Hood	10-5
Horn	5-4
How to Wear Safety Belts Properly	3-19

I

Ignition Positions	9-18
Ignition Transmission Lock Check	10-26
Immobilizer	2-14
Infants and Young Children, Restraints	3-49
Instrument Cluster	5-11
Instrument Panel Storage Area	4-1
Introduction	iii, 7-1

J

Jump Starting	10-79
---------------------	-------

K

Key and Lock Messages	5-40
Keyless Entry Remote (RKE) System	2-3
Keyless Entry System	2-2
Keys	2-2

L

Labeling, Tire Sidewall	10-37
Lamp Messages	5-40
Lamps Courtesy	6-5
Dome	6-5
Exterior Controls	6-1
License Plate	10-29
Malfunction Indicator	5-17
Reading	6-5
Lap-Shoulder Belt	3-25
LATCH System Replacing Parts After a Crash	3-61

Latch, Lower Anchors and Tethers for Children	3-55
Liftgate Carbon Monoxide	2-9
Lighting Delayed Entry	6-6
Delayed Exit	6-6
Entry	6-6
Illumination Control	6-5
Parade Dimming	6-7
Lights Airbag Readiness	5-15
Antilock Brake System (ABS) Warning	5-20
Charging System	5-16
Cruise Control	5-23
Engine Coolant Temperature Warning	5-21
Engine Oil Pressure	5-22
Flash-to-Pass	6-3
Fog Lamps	5-23
High-Beam On	5-23

Lights (cont.)
 High/Low Beam Changer 6-2
 Safety Belt Reminders 5-14
 Security 5-23
 StabiliTrak® Indicator 5-21
 Tire Pressure 5-21
 Tow/Haul Mode 5-20

Locks
 Automatic Door 2-8
 Delayed Locking 2-8
 Door 2-7
 Lockout Protection 2-8
 Power Door 2-8
 Safety 2-8

Loss of Control 9-6

Lower Anchors and
 Tethers for Children
 (LATCH SYSTEM) 3-55

Lumbar Adjustment 3-6
 Front Seats 3-6

M

Maintenance
 Records 11-11

Maintenance Schedule
 Recommended Fluids and
 Lubricants 11-8
 Scheduled Maintenance 11-2

Malfunction Indicator Lamp 5-17

Manual Mode 9-26

Messages
 Airbag System 5-41
 Anti-Theft Alarm System 5-41
 Battery Voltage and
 Charging 5-36
 Brake System 5-36
 Door Ajar 5-37
 Engine Cooling System 5-38
 Engine Oil 5-39
 Engine Power 5-39
 Fuel System 5-39
 Key and Lock 5-40
 Lamp 5-40

Messages (cont.)
 Object Detection System 5-40
 Ride Control System 5-41
 Service Vehicle 5-42
 Tire 5-42
 Transmission 5-43
 Vehicle 5-36
 Vehicle Reminder 5-44
 Vehicle Speed 5-44
 Washer Fluid 5-44

Mirrors
 Automatic Dimming
 Rearview 2-19
 Convex 2-16
 Folding 2-17
 Heated 2-18
 Manual Rearview 2-19
 Park Tilt 2-18
 Power 2-17

Monitor System,
 Tire Pressure 10-44

MP3 7-22, 7-28

Multi-Band Antenna 7-12

N

Navigation System	
Vehicle Data Recording	
and Privacy	13-17
Net, Convenience	4-3
New Vehicle Break-In	9-17

O

Object Detection System	
Messages	5-40
Odometer	5-12
Off-Road	
Recovery	9-5
Oil	
Engine	10-8
Engine Oil Life System	10-9
Messages	5-39
Pressure Light	5-22
Older Children, Restraints	3-46
Online Owner Center	13-5
OnStar® System	1-22
Operation, Infotainment	
System	7-2

Outlets	
Power	5-8
Overheated Engine	
Protection	
Operating Mode	10-20
Overheating, Engine	10-18

P

Parade Dimming	6-7
Park	
Shifting Into	9-21
Shifting Out of	9-22
Park Tilt Mirrors	2-18
Parking	
Assist, Ultrasonic	9-35
Brake	9-29
Brake and P (Park)	
Mechanism Check	10-27
Over Things That Burn	9-23
Passenger Airbag Status	
Indicator	5-15
Passenger Sensing System	3-39

Perchlorate Materials	
Requirements, California	10-3
Phone	
Bluetooth	7-46
Power	
Door Locks	2-8
Mirrors	2-17
Outlets	5-8
Protection, Battery	6-8
Retained Accessory (RAP)	9-19
Seat Adjustment	3-4
Steering Fluid	10-20
Windows	2-20
Pregnancy, Using Safety	
Belts	3-30
Privacy	
Radio Frequency	
Identification (RFID)	13-17
Program	
Courtesy Transportation	13-9
Proposition 65 Warning,	
California	10-3

R

Radio Frequency
 Identification (RFID) 13-17
 Statement 13-17

Radios
 AM-FM Radio 7-6
 CD/DVD Player 7-14
 Reception 7-11
 Satellite 7-8

Reading Lamps 6-5

Rear Audio
 Controller (RAC) 7-46

Rear Climate Control
 System 8-10, 8-11

Rear Seat Audio (RSA)
 System 7-44

Rear Seat Entertainment
 System 7-36
 Rear Seat Audio (RSA) 7-44

Rear Seats 3-10

Rear Vision Camera (RVC) 9-36

Rear Window Washer/Wiper 5-5

Rearview Mirrors 2-19
 Automatic Dimming 2-19

Reclining Seatbacks 3-7

Recommended Fluids and
 Lubricants 11-8

Recommended Fuel 9-43

Records
 Maintenance 11-11

Recreational Vehicle
 Towing 10-83

Reimbursement Program,
 GM Mobility 13-6

Remote Keyless Entry
 (RKE) System 2-2, 2-3

Remote Vehicle Start 2-5

Replacement Bulbs 10-29

Replacement Parts
 Airbags 3-46
 Maintenance 11-10

Replacing Airbag System 3-46

Replacing LATCH System
 Parts After a Crash 3-61

Replacing Safety Belt
 System Parts After a
 Crash 3-31

Reporting Safety Defects
 Canadian Government 13-15
 General Motors 13-15
 U.S. Government 13-14

Retained Accessory
 Power (RAP) 9-19

Ride Control Systems
 Messages 5-41

Roadside Assistance
 Program 13-6

Roof
 Sunroof 2-22

Roof Rack System 4-4

Rotation, Tires 10-49

Routing, Engine Drive Belt 12-3

Running the Vehicle While
 Parked 9-24

S

- Safety Belts 3-16
 - Care 3-31
 - Extender 3-30
 - How to Wear Safety Belts
 - Properly 3-19
 - Lap-Shoulder Belt 3-25
 - Reminders 5-14
 - Replacing After a Crash 3-31
 - Use During Pregnancy 3-30
- Safety Defects Reporting
 - Canadian Government 13-15
 - General Motors 13-15
 - U.S. Government 13-14
- Safety Locks 2-8
- Safety System Check 3-31
- Satellite Radio 7-8
- Scheduled Maintenance 11-2
- Scheduling Appointments 13-8
- Sealant Kit, Tire 10-59
- Seats
 - Adjustment, Front 3-3
 - Head Restraints 3-2
 - Heated and Ventilated
 - Front 3-10
 - Heated Front 3-9
- Seats (cont.)
 - Lumbar Adjustment, Front 3-6
 - Power Adjustment, Front 3-4
 - Rear 3-10
 - Reclining Seatbacks 3-7
 - Third Row Seat 3-13
- Secondary Latch System 10-76
- Securing Child Restraints 3-62, 3-64
- Security
 - Light 5-23
 - Vehicle 2-13
- Service
 - Accessories and Modifications 10-3
 - Doing Your Own Work 10-4
 - Engine Soon Lamp 5-17
 - Maintenance Records 11-11
 - Maintenance, General Information 11-1
 - Parts Identification Label 12-1
 - Publications Ordering Information 13-13
 - Scheduling Appointments 13-8
 - Vehicle Messages 5-42
- Servicing the Airbag-Equipped Vehicle 3-44
- Shifting
 - Into Park 9-21
 - Out of Park 9-22
- Signals, Turn and Lane-Change 6-4
- Spare Tire
 - Compact 10-77
- Specifications and Capacities 12-2
- Speedometer 5-12
- StabiliTrak System 9-30
- StabiliTrak® Indicator Light 5-21
- Start Vehicle, Remote 2-5
- Starter Switch Check 10-26
- Starting the Engine 9-19
- Steering
 - Fluid, Power 10-20
 - Wheel Adjustment 5-2
 - Wheel Controls 5-2
- Storage Areas
 - Armrest 4-1
 - Cargo Cover 4-3
 - Cargo Management System 4-3
 - Center Console 4-1
 - Convenience Net 4-3
 - Floor Console 4-2

Storage Areas (cont.)
 Glove Box 4-1
 Instrument Panel 4-1
 Roof Rack System 4-4
 Storing the Tire Sealant
 and Compressor Kit 10-66
 Stuck Vehicle 9-11
 Sun Visors 2-22
 Sunroof 2-22
 Symbols iv
 System
 Roof Rack 4-4
 System Check
 Automatic Transmission
 Shiftlock Control 10-26

T

Tachometer 5-12
 Text Telephone (TTY) Users ... 13-4
 Theft-Deterrent Systems 2-14
 Immobilizer 2-14
 Third-Row Seats 3-13
 Time 5-8

Tires
 Buying New Tires 10-51
 Chains 10-57
 Changing 10-67
 Compact Spare 10-77
 Designations 10-39
 Different Size 10-53
 If a Tire Goes Flat 10-57
 Inflation Monitor System ... 10-46
 Inspection 10-49
 Messages 5-42
 Pressure Light 5-21
 Pressure Monitor System ... 10-44
 Rotation 10-49
 Sealant and
 Compressor Kit 10-59
 Sealant and Compressor
 Kit, Storing 10-66
 Secondary Latch System ... 10-76
 Sidewall Labeling 10-37
 Terminology and
 Definitions 10-40
 Uniform Tire Quality
 Grading 10-54

Tires (cont.)
 Wheel Alignment and Tire
 Balance 10-55
 Wheel Replacement 10-56
 When It Is Time for New
 Tires 10-51
 Tow/Haul Mode 9-27
 Tow/Haul Mode Light 5-20
 Towing
 Driving Characteristics 9-48
 Equipment 9-57
 General Information 9-47
 Recreational Vehicle 10-83
 Trailer 9-53
 Vehicle 10-83
 Trailer Towing 9-53
 Transmission
 Automatic 9-24
 Fluid, Automatic 10-11
 Messages 5-43
 Transportation Program,
 Courtesy 13-9
 Turn and Lane-Change
 Signals 6-4

U

Ultrasonic Parking Assist	9-35
Uniform Tire Quality Grading	10-54
Universal Remote System	5-52
Operation	5-56
Programming	5-52
Using this Manual	iv

V

Vehicle	
Canadian Owners	iii
Control	9-3
Load Limits	9-12
Messages	5-36
Personalization	5-45
Remote Start	2-5
Security	2-13
Speed Messages	5-44
Towing	10-83

Vehicle Care	
Storing the Tire Sealant and Compressor Kit	10-66
Tire Pressure	10-43
Vehicle Identification	
Number (VIN)	12-1
Service Parts Identification Label	12-1
Vehicle Reminder	
Messages	5-44
Ventilation, Air	8-12
Visors	2-22
Voltage Devices, and Wiring	10-29
Voltmeter Gauge	5-13

W

Warning Lights, Gauges, and Indicators	5-10
Warnings	iv
Cautions and Danger	iv
Hazard Flashers	6-3

Washer Fluid	10-21
Washer Fluid Messages	5-44
Wheels	
Alignment and Tire Balance	10-55
Different Size	10-53
Replacement	10-56
When It Is Time for New Tires	10-51
Where to Put the Child Restraint	3-53
Windows	2-20
Power	2-20
Windshield	
Wiper/Washer	5-4
Winter Driving	9-9
Wiper Blade Replacement	10-27
Wipers	
Rear Washer	5-5
Wiring, High Voltage	
Devices	10-29