

Table of Contents

Introduction	4
Instrument Cluster	10
Warning and control lights	10
Gauges	15
Entertainment Systems	20
AM/FM stereo cassette with CD	20
AM/FM stereo with CD	23
AM/FM stereo	26
AM/FM stereo cassette	28
CD changer	30
Climate Controls	34
Manual heating and air conditioning	34
Electronic automatic temperature control	35
Rear window defroster	37
Lights	38
Headlamps	38
Turn signal control	40
Bulb replacement	41
Driver Controls	47
Windshield wiper/washer control	47
Steering wheel adjustment	48
Power windows	57
Mirrors	58
Speed control	60
Message center	68
Locks and Security	73
Keys	73
Locks	73
Anti-theft system	75

Table of Contents

Seating and Safety Restraints	87
Seating	87
Safety restraints	91
Air bags	105
Child restraints	112
Driving	124
Starting	124
Brakes	128
Traction control	131
Air suspension	133
Transmission operation	134
Vehicle loading	139
Trailer towing	141
Recreational towing	144
Roadside Emergencies	145
Getting roadside assistance	145
Hazard flasher switch	146
Fuel pump shut-off switch	146
Fuses and relays	147
Changing tires	155
Jump starting	161
Wrecker towing	167
Customer Assistance	168
Reporting safety defects (U.S. only)	176
Cleaning	177

Table of Contents

Maintenance and Specifications	183
Engine compartment	185
Engine oil	186
Battery	190
Fuel information	198
Air filter(s)	212
Tire Information	214
Part numbers	226
Refill capacities	227
Lubricant specifications	228
Accessories	235
Index	237

All rights reserved. Reproduction by any means, electronic or mechanical including photocopying, recording or by any information storage and retrieval system or translation in whole or part is not permitted without written authorization from Ford Motor Company. Ford may change the contents without notice and without incurring obligation.

Copyright © 2003 Ford Motor Company

Introduction

CALIFORNIA Proposition 65 Warning



WARNING: Engine exhaust, some of its constituents, and certain vehicle components contain or emit chemicals known to the State of California to cause cancer and birth defects or other reproductive harm. In addition, certain fluids contained in vehicles and certain products of component wear contain or emit chemicals known to the State of California to cause cancer and birth defects or other reproductive harm.

CONGRATULATIONS

Congratulations on acquiring your new Ford. Please take the time to get well acquainted with your vehicle by reading this handbook. The more you know and understand about your vehicle, the greater the safety and pleasure you will derive from driving it.

For more information on Ford Motor Company and its products visit the following website:

- In the United States: www.ford.com
- In Canada: www.ford.ca
- In Australia: www.ford.com.au
- In Mexico: www.ford.com.mx

Additional owner information is given in separate publications.

This *Owner's Guide* describes every option and model variant available and therefore some of the items covered may not apply to your particular vehicle. Furthermore, due to printing cycles it may describe options before they are generally available.

Remember to pass on this *Owner's Guide* when reselling the vehicle. It is an integral part of the vehicle.



Fuel pump shut-off switch: In the event of an accident the safety switch will automatically cut off the fuel supply to the engine. The switch can also be activated through sudden vibration (e.g. collision when parking). To reset the switch, refer to the *Fuel pump shut-off switch* in the *Roadside Emergencies* chapter.

SAFETY AND ENVIRONMENT PROTECTION

Warning symbols in this guide

How can you reduce the risk of personal injury and prevent possible damage to others, your vehicle and its equipment? In this guide, answers to such questions are contained in comments highlighted by the warning triangle symbol. These comments should be read and observed.

Warning symbols on your vehicle

When you see this symbol, it is imperative that you consult the relevant section of this guide before touching or attempting adjustment of any kind.



Protecting the environment

We must all play our part in protecting the environment. Correct vehicle usage and the authorized disposal of waste, cleaning and lubrication materials are significant steps towards this aim. Information in this respect is highlighted in this guide with the tree symbol.



BREAKING-IN YOUR VEHICLE

Your vehicle does not need an extensive break-in. Try not to drive continuously at the same speed for the first 1,000 miles (1,600 km) of new vehicle operation. Vary your speed to allow parts to adjust themselves to other parts.

Drive your new vehicle at least 500 miles (800 km) before towing a trailer.

Do not add friction modifier compounds or special break-in oils during the first few thousand miles (kilometers) of operation, since these additives may prevent piston ring seating. See *Engine oil* in the *Maintenance and Specifications* chapter for more information on oil usage.

Introduction

SPECIAL NOTICES

Emission warranty

The New Vehicle Limited Warranty includes Bumper-to-Bumper Coverage, Safety Restraint Coverage, Corrosion Coverage, and 6.0L Power Stroke Diesel Engine Coverage. In addition, your vehicle is eligible for Emissions Defect and Emissions Performance Warranties. For a detailed description of what is covered and what is not covered, refer to the *Warranty Guide* that is provided to you along with your Owner's Guide.

Service Data Recording

Service data recorders in your vehicle are capable of collecting and storing diagnostic information about your vehicle. This potentially includes information about the performance or status of various systems and modules in the vehicle, such as engine, throttle, steering or brake systems. In order to properly diagnose and service your vehicle, Ford Motor Company, Ford of Canada, and service and repair facilities may access vehicle diagnostic information through a direct connection to your vehicle when diagnosing or servicing your vehicle.

Event Data Recording

Other modules in your vehicle — event data recorders — are capable of collecting and storing data during a crash or near crash event. The recorded information may assist in the investigation of such an event. The modules may record information about both the vehicle and the occupants, potentially including information such as:

- how various systems in your vehicle were operating;
- whether or not the driver and passenger seatbelts were buckled;
- how far (if at all) the driver was depressing the accelerator and/or the brake pedal;
- how fast the vehicle was traveling; and
- where the driver was positioning the steering wheel.

To access this information, special equipment must be directly connected to the recording modules. Ford Motor Company and Ford of Canada do not access event data recorder information without obtaining consent, unless pursuant to court order or where required by law enforcement, other government authorities or other third parties acting with lawful authority. Other parties may seek to access the information independently of Ford Motor Company and Ford of Canada.

Introduction

Special instructions

For your added safety, your vehicle is fitted with sophisticated electronic controls.



Please read the section *Supplemental restraint system (SRS)* in the *Seating and Safety Restraints* chapter. Failure to follow the specific warnings and instructions could result in personal injury.



Front seat mounted rear-facing child or infant seats should **NEVER** be placed in front of an active passenger air bag.

Notice to owners of natural gas fueled vehicles

Before you drive your vehicle, be sure to read the *Dedicated Natural Gas Vehicle* supplement. This book contains important operation and maintenance information.

Notice to owners of Severe Duty vehicles

Before you drive your vehicle, be sure to read the *Severe Duty Owner's Guide* supplement. This book contains important operation and maintenance information.

MIDDLE EAST/NORTH AFRICA VEHICLE SPECIFIC INFORMATION

For your particular global region, your vehicle may be equipped with features and options that are different from the ones that are described in this *Owner's Guide*; therefore, a supplement has been supplied that complements this book. By referring to the pages in the provided supplement, you can properly identify those features, recommendations and specifications that are unique to your vehicle. **Refer to this Owner's Guide for all other required information and warnings.**

Introduction













These are some of the symbols you may see on your vehicle.

Vehicle Symbol Glossary

Safety Alert		See Owner's Guide	
Fasten Safety Belt		Air Bag-Front	
Air Bag-Side		Child Seat	
Child Seat Installation Warning		Child Seat Lower Anchor	
Child Seat Tether Anchor		Brake System	
Anti-Lock Brake System		Brake Fluid - Non-Petroleum Based	
Traction Control		AdvanceTrac [™]	
Master Lighting Switch		Hazard Warning Flasher	
Fog Lamps-Front		Fuse Compartment	
Fuel Pump Reset		Windshield Wash/Wipe	
Windshield Defrost/Demist		Rear Window Defrost/Demist	

Introduction

Vehicle Symbol Glossary

Power Windows Front/Rear		Power Window Lockout	
Child Safety Door Lock/Unlock		Interior Luggage Compartment Release Symbol	
Panic Alarm		Engine Oil	
Engine Coolant		Engine Coolant Temperature	
Do Not Open When Hot		Battery	
Avoid Smoking, Flames, or Sparks		Battery Acid	
Explosive Gas		Fan Warning	
Power Steering Fluid		Maintain Correct Fluid Level	
Emission System		Engine Air Filter	
Passenger Compartment Air Filter		Jack	
Check fuel cap		Low tire warning	

Instrument Cluster

WARNING LIGHTS AND CHIMES

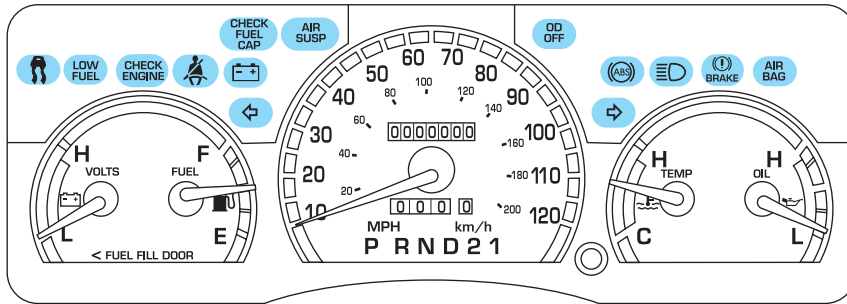

Standard instrument cluster

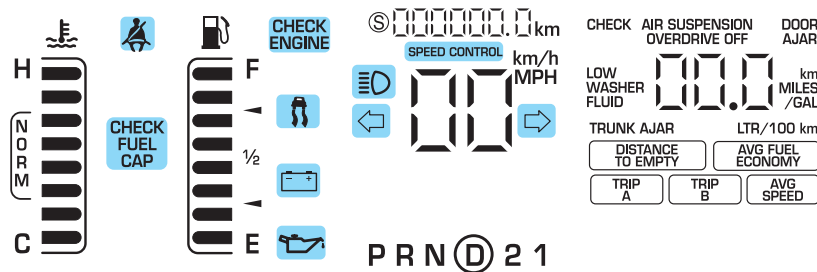

Optional instrument cluster

Warning lights and gauges can alert you to a vehicle condition that may become serious enough to cause expensive repairs. A warning light may illuminate when a problem exists with one of your vehicle's functions. Many lights will illuminate when you start your vehicle to make sure the bulb works. If any light remains on after starting the vehicle, have the respective system inspected immediately.

Check engine: The *Check engine* indicator light illuminates when the ignition is first turned to the ON position to check the bulb. Solid illumination after the engine is started indicates the On Board Diagnostics System (OBD-II) has detected a malfunction. Refer to *On board diagnostics (OBD-II)* in the *Maintenance and Specifications* chapter. If the light is blinking, engine

**CHECK
ENGINE**

Instrument Cluster

misfire is occurring which could damage your catalytic converter. Drive in a moderate fashion (avoid heavy acceleration and deceleration) and have your vehicle serviced immediately.

 Under engine misfire conditions, excessive exhaust temperatures could damage the catalytic converter, the fuel system, interior floor coverings or other vehicle components, possibly causing a fire.

Check fuel cap: Illuminates when the fuel cap may not be properly installed. Continued driving with this light on may cause the Service engine soon warning light to come on. Refer to *Fuel filler cap* in the *Maintenance and Specifications* chapter.

**CHECK
FUEL
CAP**

Brake system warning light:

- Standard instrument cluster

BRAKE

- Optional instrument cluster

To confirm the brake system warning light is functional, it will momentarily illuminate when the ignition is turned to the ON position when the engine is not running, or in a position between ON and START, or by applying the parking brake when the ignition is turned to the ON position. If the brake system warning light does not illuminate at this time, seek service immediately from your dealership. Illumination after releasing the parking brake indicates low brake fluid level and the brake system should be inspected immediately by your servicing dealership.

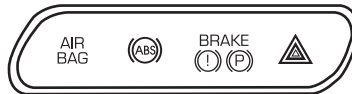

 Driving a vehicle with the brake system warning light on is dangerous. A significant decrease in braking performance may occur. It will take you longer to stop the vehicle. Have the vehicle checked by your dealer immediately.

Instrument Cluster

Anti-lock brake system: If the ABS light stays illuminated or continues to flash, a malfunction has been detected, have the system serviced immediately. Normal braking is still functional unless the brake warning light also is illuminated.



Air bag readiness: If this light fails to illuminate when ignition is turned to ON, continues to flash or remains on, have the system serviced immediately. A chime will also sound when a malfunction in the supplemental restraint system has been detected.

**AIR
BAG**

Safety belt: Reminds you to fasten your safety belt. A chime will also sound to remind you to fasten your safety belt, refer to the *Seating and Safety Restraints* chapter.



Charging system: Illuminates when the battery is not charging properly.



Engine oil pressure (if equipped): Illuminates when the oil pressure falls below the normal range. Check the oil level and add oil if needed. Refer to *Engine oil* in the *Maintenance and specifications* chapter.



Traction control[™] AdvanceTrac active (if equipped): Illuminates when the Traction control[™] system is active. It will be lit for a minimum of four seconds or for the duration of the Traction Control[™] event, refer to the *Driving* chapter for more information.



Air suspension (if equipped):

- Standard instrument cluster

**AIR
SUSP**

Instrument Cluster

- Optional instrument cluster

Illuminates when the air suspension is turned OFF, the load limit is exceeded or the air suspension system requires servicing.

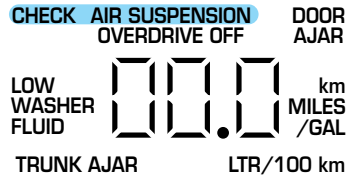

Low fuel (if equipped):

Illuminates when the fuel level in the fuel tank is at or near empty (refer to *Fuel gauge* in this chapter for more information).

LOW FUEL

O/D off:

- Standard instrument cluster

O/D OFF

- Optional instrument cluster

Illuminates when the overdrive function of the transmission has been turned OFF using the transmission control switch (TCS), refer to the *Driving* chapter. If the light flashes steadily, have the system serviced immediately.

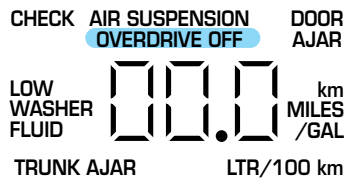

Turn signal: Illuminates when the left or right turn signal or the hazard lights are turned on. If the indicators stay on or flash faster, check for a burned out bulb.



High beams: Illuminates when the high beam headlamps are turned on.



Instrument Cluster

MESSAGE CENTER INDICATOR LIGHTS (IF EQUIPPED)

Speed control: This light comes on when either the SET/ACCEL or RESUME controls are pressed. It turns off when the speed control OFF control is pressed, the brake is applied or the ignition is turned to the OFF position.

Door ajar: Illuminates when one of the doors is not completely shut and the ignition is turned to ON. With the ignition ON, this light will flash six times (if a door is open). With the ignition in RUN position, a tone will sound for one second (if a door is open).

Low washer fluid: Momentarily illuminates when the ignition is turned to ON and will stay on when the windshield washer fluid is low.

Trunk ajar: If the trunk is not completely closed, this light comes on when you turn the ignition to ON. With the ignition ON, this light will flash five times and sound a tone for one second, then the light remains on (if the trunk is open).

Headlamps on warning chime: Sounds when the headlamps or parking lamps are on, the ignition is off (the key is not in the ignition) and the driver's door is opened.

Key-in-ignition warning chime: Sounds when the key is left in the ignition in the OFF/LOCK or ACCESSORY position and the driver's door is opened.

SPEED CONTROL

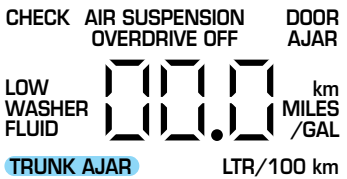
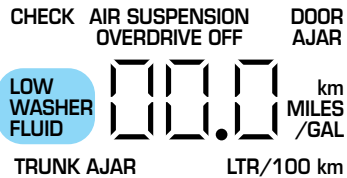
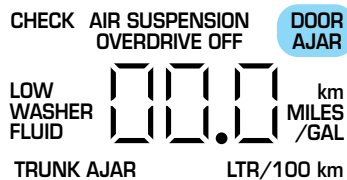

Instrument Cluster

GAUGES

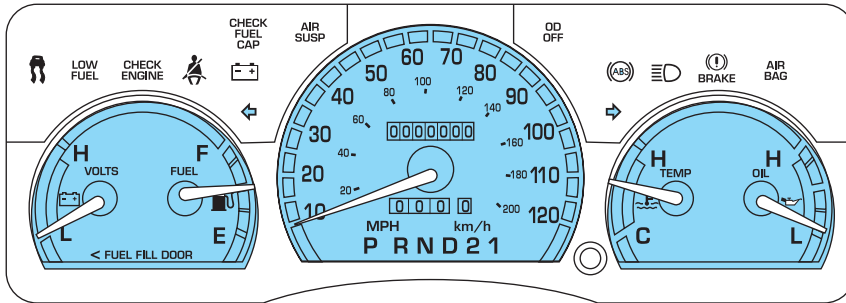

Standard instrument cluster gauges

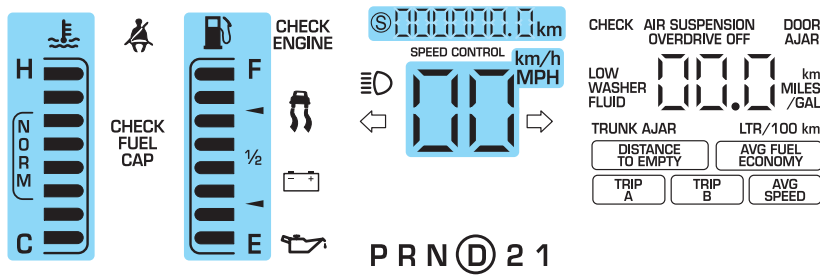

Optional instrument cluster gauges

Speedometer: Indicates the current vehicle speed.

- Standard instrument cluster

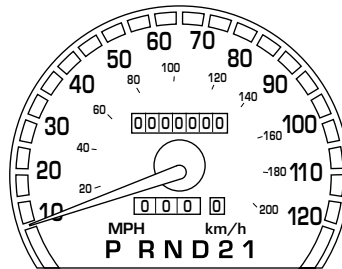

Instrument Cluster

- Optional instrument cluster

Ⓢ 000000.0 km

00 km/h
MPH

Engine coolant temperature gauge:

- Standard instrument cluster

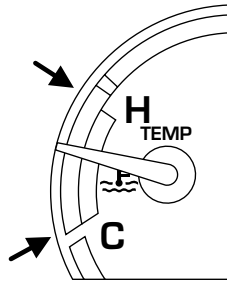

- Optional instrument cluster

Indicates engine coolant temperature. At normal operating temperature, the needle will be in the normal range (between “H” and “C”). If it enters the red section, the engine is overheating. Stop the vehicle as soon as safely possible, switch off the engine and let the engine cool, refer to *What you should know about fail-safe cooling* in the *Maintenance and specifications* chapter.



Never remove the coolant reservoir cap while the engine is running or hot.

Instrument Cluster

Odometer: Registers the total kilometers (miles) of the vehicle.

- Standard instrument cluster

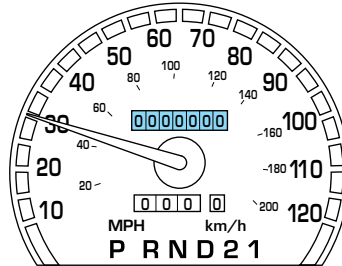

- Optional instrument cluster

Refer to *Electronic Message Center* in the *Driver Controls* chapter on how to switch the display from Metric to English.



Trip odometer: Registers the kilometers (miles) of individual journeys.

- Standard instrument cluster

To reset, depress the control.

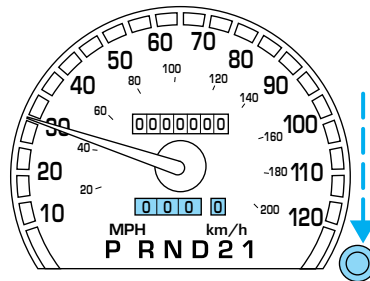

Instrument Cluster

- Optional instrument cluster

Refer to *Electronic Message Center* in the *Driver Controls* chapter for Trip A and Trip B features.

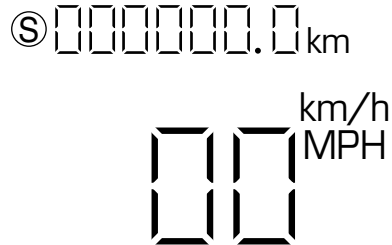

Battery voltage gauge (if equipped): Indicates the battery voltage when the ignition is in the ON position. If the pointer moves and stays outside the normal operating range (as indicated by arrows), have the vehicle's electrical system checked as soon as possible.

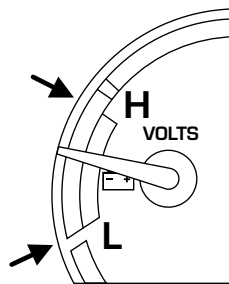

Engine oil pressure gauge (if equipped): Indicates engine oil pressure. The needle should stay in the normal operating range (between "L" and "H"). If the needle falls below the normal range, stop the vehicle, turn off the engine and check the engine oil level. Add oil if needed. If the oil level is correct, have your vehicle checked at your dealership or by a qualified technician.

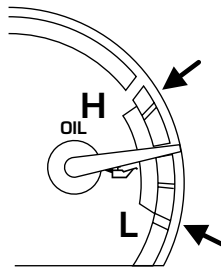

Instrument Cluster

Fuel gauge: Indicates approximately how much fuel is left in the fuel tank (when the ignition is in the ON position). The fuel gauge may vary slightly when the vehicle is in motion or on a grade.

- Standard instrument cluster

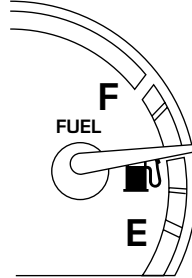

- Optional instrument cluster

A minimum of four gallons must be added or removed from the fuel tank in order for the gauge to instantaneously update. If less than four gallons is added, the gauge will take between five and ten minutes to update.

Refer to *Filling the tank* in the *Maintenance and Specifications* chapter for more information.



Entertainment Systems

PREMIUM AM/FM STEREO/CASSETTE/SINGLE CD (IF EQUIPPED)

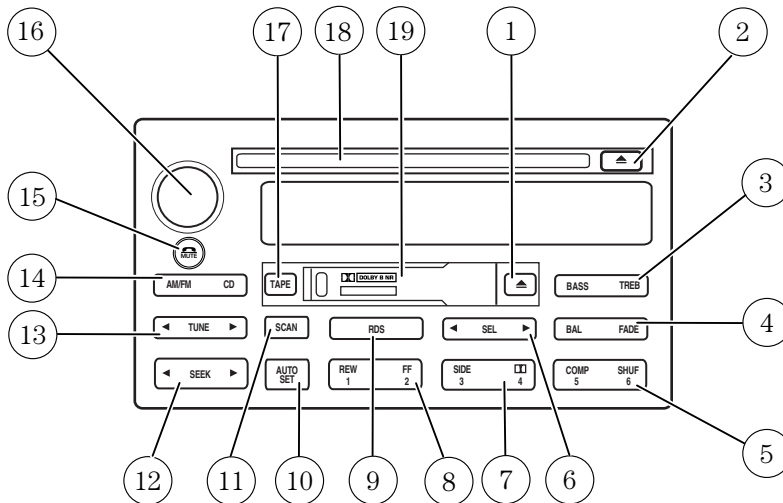

1. **Eject:** Press to eject a tape.



2. **Eject:** Press to eject a CD.



3. **Bass:** Allows you to increase or decrease the audio system's bass output. Press BASS then press SEL to decrease ◀ or increase ▶ the bass levels.



Treble: Allows you to increase or decrease the audio system's treble output. Press TREB then press SEL to decrease ◀ or increase ▶ the treble levels.



4. **Balance:** Allows you to shift speaker sound between the right and left speakers. Press BAL then press SEL to shift sound to the left ◀ or right ▶.



Entertainment Systems

Fade: Allows you to shift speaker sound between the front and rear speakers. Press FADE then press SEL to shift the sound to the rear ◀ or the front ▶.



5. **COMP (Compression):** In CD mode, press to bring soft and loud passages together for a more consistent listening level.



SHUF (Shuffle): Press to play CD tracks in random order.



6. **Select:** Use to adjust bass, treble, balance and fade levels.



7. **Side 1–2:** Press to change sides on the tape.



Dolby:  **Dolby® noise reduction:** Reduces tape noise and hiss; press to activate/deactivate.



The Dolby® noise reduction system is manufactured under license from Dolby Laboratories Licensing Corporation. Dolby® and the double-D symbol are registered trademarks of Dolby Laboratories Licensing Corporation.

8. **REW (Rewind):** Works in tape and CD modes.



In tape mode, radio play continues until rewind is stopped (with the TAPE control) or the beginning of the tape is reached.

In CD mode, REW control reverses the CD within the current track.

FF (fast forward): Works in tape and CD modes.



In the tape mode, tape direction automatically reverses when the end of the tape is reached.

In CD mode, FF advances the CD within the current track.

Entertainment Systems

9. **RDS:** (Radio Data System):
Allows you to access FM stations
which are RDS- equipped. Press
RDS then SEL to select from:



Traffic — Allows you to receive traffic announcements and control their
volume level. **Traffic information is not available in most U.S. markets.**

Show — Allows you to view the frequency and program type of the
chosen radio station.

The Federal Communications Commission (FCC) and the Canadian Radio
and Telecommunications Commission (CRTC) recommend that FM radio
broadcasters use RDS technology to transmit information. FM radio
stations are independently operated and individually elect to use RDS
technology to transmit station ID and program type as desired.

Setting the clock: Press RDS until SELECT HOUR or SELECT MINS is
displayed. Press SEL to increase (▶) or decrease (◀).

10. **Autoset:** Press to set first six
strong stations into AM, FM1 or
FM2 memory buttons; press again to
return to normal stations.



11. **Scan:** Works in radio, tape and
CD modes. Press SCAN for a brief
sampling of radio stations, tape
selections or CD tracks.



12. **Seek:** Works in radio, tape and
CD modes. Press to access the
previous ◀ or next ▶ listenable
radio station, tape selection or CD track.



13. **Tune:** Works in radio mode.
Press to manually advance up or
down the frequency band.



14. **AM/FM/CD:** Press AM/FM to
select a radio frequency. Press while
in tape or CD mode to return to radio
mode. Press CD to enter CD mode and to play a CD already in the system.



15. **Mute mode:** Press to mute the
playing media.



Entertainment Systems

16. **Power/volume:** Press to turn the system on/off. Turn to raise/lower the volume.

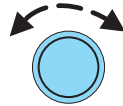

17. **Tape:** Press to play the tape.



18. **CD door:** Insert the disc with the playing side down and printed side up.

19. **Tape door:** Insert the tape facing the right.

AM/FM STEREO / SINGLE CD RADIO (IF EQUIPPED)

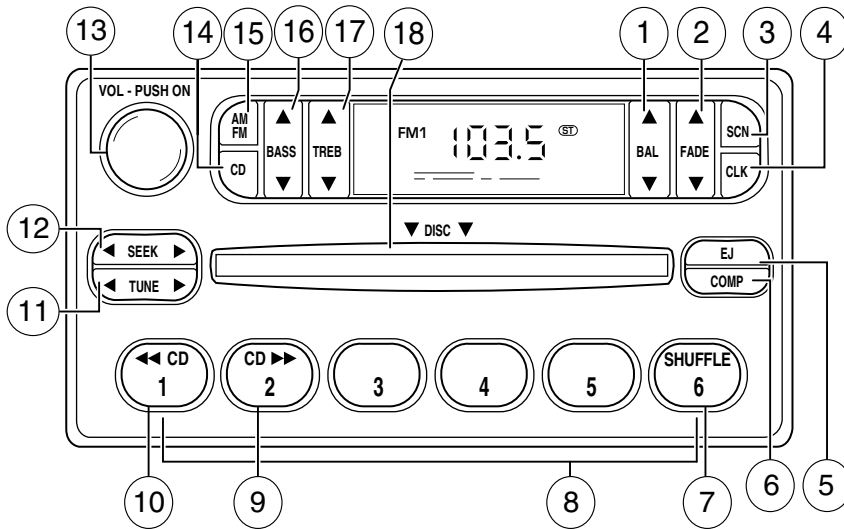

1. **Balance:** Press ▲ / ▼ to shift sound to the left/right speakers.



Entertainment Systems

2. **Fade:** Press ▲ / ▼ to shift sound to the front/rear speakers.



3. **SCN (Scan):** Press to hear a brief sampling of all listenable stations or CD tracks. Press again to stop.



4. **CLK:** To set the hour, press and hold CLK and press SEEK to decrease ◀ or increase ▶ the hours.



To set the minute, press and hold CLK and press TUNE to decrease ◀ or increase ▶ the minutes.

5. **EJ (eject):** Press to eject a CD.



6. **COMP (Compression):** In CD mode, press to bring louder and softer levels into more comfortable listening level. The compression icon (c) will appear in the display.



7. **Shuffle:** Press to listen to the tracks on the CD in random order. Press again to turn off.



8. **Memory presets:** To set a station: Select frequency band AM/FM; tune to a station. Press and hold a preset button until sound returns. This radio is equipped with six station memory preset controls which allow you to set up to six AM stations and 12 FM stations (six in FM1 and six in FM2).



9. **CD: ▶▶** Press and hold until desired point of a selection is reached.



10. **◀◀ CD:** Press and hold until desired point of a selection is reached.



11. **Tune:** In radio mode, press to move up or down the frequency band in individual increments.



Entertainment Systems

12. **Seek:** Press and release SEEK ◀ / ▶ for previous/next strong station, selection or track.



13. **Power/volume:** Press to turn ON/OFF; turn to increase or decrease volume levels.

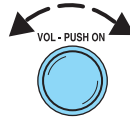

14. **CD:** Press to enter CD mode or to play a CD already loaded into the system.



15. **AM/FM:** Press to choose a frequency band in radio mode.



16. **Bass:** Press ▲ / ▼ to increase/decrease the bass output.



17. **Treble:** Press ▲ / ▼ to increase/decrease the treble output.



18. **CD door:** Insert a CD printed side up.

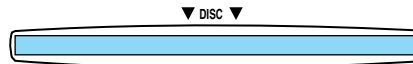

CD units are designed to play commercially pressed 12 cm (4.75 in) audio compact discs only. Due to technical incompatibility, certain recordable and re-recordable compact discs may not function correctly when used in Ford CD players. Irregular shaped CDs, CDs with a scratch protection film attached, and CDs with homemade paper (adhesive) labels should not be inserted into the CD player. The label may peel and cause the CD to become jammed. It is recommended that homemade CDs be identified with permanent felt tip marker rather than adhesive labels. Ballpoint pens may damage CDs. Please contact your dealer for further information.

Entertainment Systems

AM/FM STEREO (IF EQUIPPED)

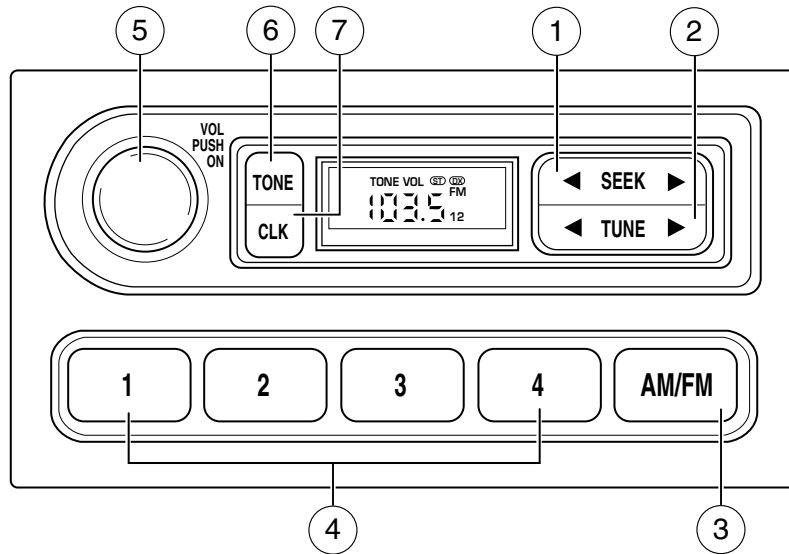

1. **Seek:** Press ◀ / ▶ to find the next strong station down/up the frequency band.



2. **Tune:** Press ◀ / ▶ to manually change radio frequency down/up.



3. **AM/FM:** Press to choose a frequency band in radio mode.



4. **Memory preset buttons:** To set a station: Select frequency band AM/FM; tune to a station, press and hold a preset button until sound returns.



Entertainment Systems

5. **Power/volume:** Press to turn ON/OFF; turn to increase or decrease volume levels.

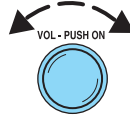

6. **Tone:** Press TONE until the desired level — Bass, Treble, Fade appears on the display. Turn the volume control to raise/lower the levels, or to move the audio sound from the right to left or the front to back (if equipped).

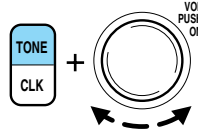

7. **CLK (Clock):** To set the hour, press and hold CLK until CLOCK SET appears in the display. Press SEEK to decrease ◀ or increase ▶ the hours.



To set the minute, press and hold CLK until CLOCK set appears in the display. Press TUNE to decrease ◀ or increase ▶ the minutes.

Entertainment Systems

AM/FM STEREO CASSETTE (IF EQUIPPED)

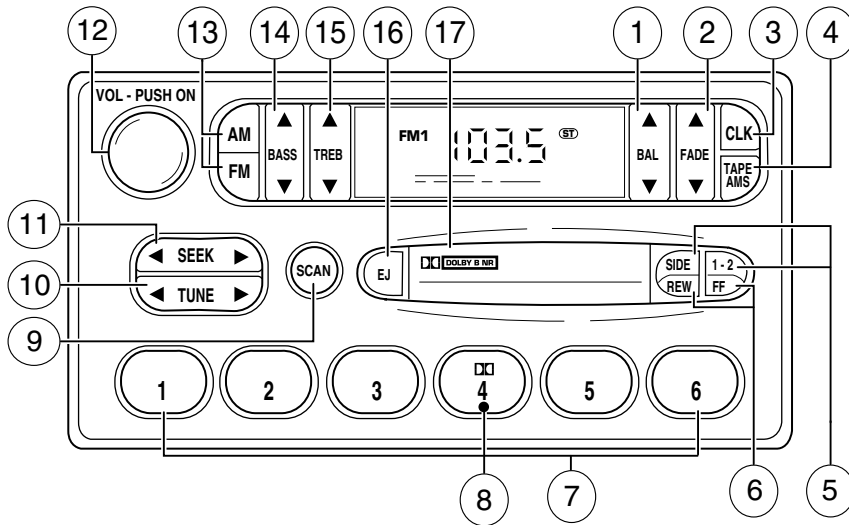

1. **Balance:** Press to shift sound to the left/right speakers.



2. **Fade:** Press to shift sound to the rear/front speakers.



3. **CLK:** To set the hour, press and hold CLK. Then press SEEK to decrease ◀ or increase ▶ the hours.



To set the minute, press and hold CLK and press TUNE to decrease ◀ or increase ▶ the minutes.

Entertainment Systems

4. **Tape AMS:** In tape mode, press and hold to activate Automatic Music Search (allows you to quickly locate the beginning of the tape selection being played or to skip to the next selection). Then, press REW (for the beginning of the current selection) or FF (to advance to the next selection). The tape MUST have a blank section of at least four seconds duration between programs.



5. **Side 1-2:** Press to change tape direction.

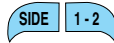

6. **REW (rewind):** Press to rewind the tape.



FF (fast forward): Press to advance the tape.



7. **Memory preset buttons:** To set a station: Select frequency band AM/FM1/FM2; tune to a station, press and hold a preset button until sound returns.



8. **Dolby® noise reduction:** Works in tape mode only. Reduces tape noise and hiss; press to activate/deactivate.

9. **Scan:** Press SCAN to hear a brief sampling of all listenable radio stations or all tape selections. Press again to stop.



10. **Tune:** Works in radio mode only. Press TUNE ◀/▶ to change frequency down/up



11. **Seek:** Press and release ◀/▶ for previous/next strong station, selection or track.



12. **Power/volume:** Press to turn ON/OFF; turn to increase or decrease volume levels.

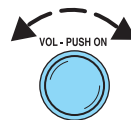

Entertainment Systems

13. **AM/FM:** Press to choose a frequency band in radio mode.



14. **Bass:** Press ▼ / ▲ to decrease/increase the bass output.



15. **Treble:** Press ▼ / ▲ to decrease/increase the treble output.



16. **EJ (Eject):** Press to eject a tape.



17. **Cassette door:** Insert a cassette into the cassette door.

CD CHANGER (IF EQUIPPED)

Your CD changer is either located in the trunk, the console or the right side cargo area storage compartment.

1. Slide the door to access the CD changer magazine.
2. Press ▲ to eject the magazine.

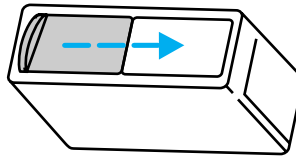

Entertainment Systems

3. Turn the magazine (A) over.
4. Using the disc holder release knob (C), pull the disc holder (B) out of the magazine.

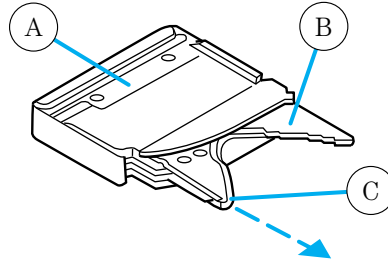

Do not pull too hard on the disc holder as the disc holder may come completely out of the magazine. If this happens, reinsert the disc holder back into the magazine while pressing on the lever.

5. Line up the CD with the groove of the disc holder. Ensure that the label on the CD faces downwards.
6. Press the disc holder until it locks securely into the magazine.

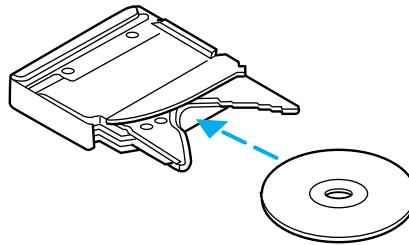

Ensure that the disc holder is evenly inserted and at the same level as the magazine (A). The unit will not operate if the disc holder is not inserted at the same level (B).

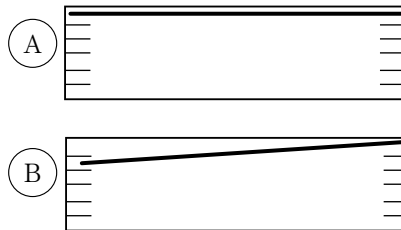

RADIO FREQUENCIES

AM and FM frequencies are established by the Federal Communications Commission (FCC) and the Canadian Radio and Telecommunications Commission (CRTC). Those frequencies are:

AM - 530, 540–1700, 1710 kHz

FM- 87.7, 87.9–107.7, 107.9 MHz

Entertainment Systems

RADIO RECEPTION FACTORS

There are three factors that can affect radio reception:

- Distance/strength: The further you travel from an FM station, the weaker the signal and the weaker the reception.
- Terrain: Hills, mountains, tall buildings, power lines, electric fences, traffic lights and thunderstorms can interfere with your reception.
- Station overload: When you pass a broadcast tower, a stronger signal may overtake a weaker one and play while the weak station frequency is displayed.

CASSETTE/PLAYER CARE

Do:

- Use only cassettes that are 90 minutes long or less.
- Tighten very loose tapes by inserting a finger or pencil into the hole and turning the hub.
- Remove loose labels before inserting tapes.
- Allow tapes which have been subjected to extreme heat, humidity or cold to reach a moderate temperature before playing.
- Clean the cassette player head with a cassette cleaning cartridge after 10–12 hours of play to maintain good sound/operation.

Don't:

- Expose tapes to direct sunlight, extreme humidity, heat or cold.
- Leave tapes in the cassette player for a long time when not being played.

CD/CD PLAYER CARE

Do:

- Handle discs by their edges only. Never touch the playing surface.
- Inspect discs before playing. Clean only with an approved CD cleaner and wipe from the center out.

Don't:

- Expose discs to direct sunlight or heat sources for extended periods of time.
- Insert more than one disc into each slot of the CD changer magazine.
- Clean using a circular motion.

32

Entertainment Systems

CD units are designed to play commercially pressed 12 cm (4.75 in) audio compact discs only. Due to technical incompatibility, certain recordable and re-recordable compact discs may not function correctly when used in Ford CD players. Irregular shaped CDs, CDs with a scratch protection film attached, and CDs with homemade paper (adhesive) labels should not be inserted into the CD player. The label may peel and cause the CD to become jammed. It is recommended that homemade CDs be identified with permanent felt tip marker rather than adhesive labels. Ball point pens may damage CDs. Please contact your dealer for further information.

AUDIO SYSTEM WARRANTY AND SERVICE

Refer to the *Warranty Guide* for audio system warranty information. If service is necessary, see your dealer or qualified technician.

Climate Controls

MANUAL HEATING AND AIR CONDITIONING SYSTEM (IF EQUIPPED)

1. **Fan speed adjustment:** Controls the volume of air circulated in the vehicle.

2. **Temperature selection:** Controls the temperature of the airflow in the vehicle.

3. **Air flow selections:** Controls the direction of the airflow in the vehicle. See the following for a brief description on each control.

MAX A/C: Uses recirculated air to cool the vehicle. Air flows from the instrument panel vents only. This mode will help prevent unpleasant odors from entering the vehicle.

NORM A/C: Uses outside air to cool the vehicle. Air flows from the instrument panel vents only.

VENT: Distributes outside air through the instrument panel vents.

OFF: Outside air is shut out and the fan will not operate.

FLOOR: Distributes outside air through the floor vents.

MIX: Distributes outside air through the windshield defroster vents, floor vents and side window demisters.

 : Distributes outside air through the windshield defroster vents and the side window demisters.

Operating tips

- To reduce fog build up on the windshield during humid weather, place the air flow selector in the  position.
- To reduce humidity build up inside the vehicle: do not drive with the air flow selector in the OFF or MAX A/C position.
- Under normal weather conditions, do not leave the air flow selector in MAX A/C or OFF when the vehicle is parked. This allows the vehicle to “breathe” using the outside air inlet vents.
- Do not put objects under the front seats that will interfere with the airflow to the back seats.
- Remove any snow, ice or leaves from the air intake area at the base of the windshield.

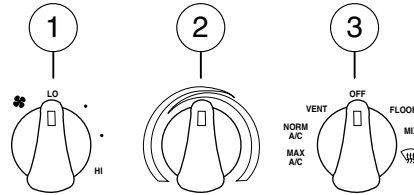

Climate Controls

To aid in side window defogging/demisting in cold weather:

1. Select NORM A/C.
2. Modulate the temperature control to maintain comfort.
3. Set the fan speed to HI.
4. Direct the outer instrument panel vents towards the side windows.

To increase airflow to the outer instrument panel vents, close the vents located in the middle of the instrument panel.



Do not place objects on top of the instrument panel as these objects may become projectiles in a collision or sudden stop.

ELECTRONIC AUTOMATIC TEMPERATURE CONTROL (EATC) SYSTEM (IF EQUIPPED)

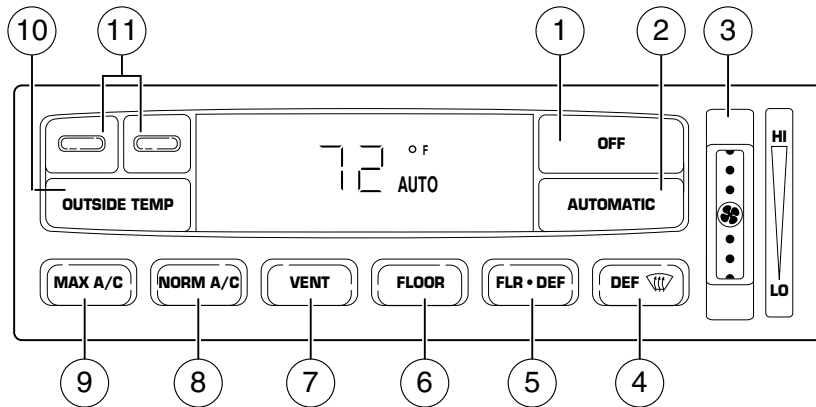

1. **OFF:** Outside air is shut out and the fan will not operate.



2. **AUTOMATIC:** Press AUTOMATIC and select the desired temperature using the temperature controls. The system will automatically determine fan speed, airflow location, and outside or recirculated air to heat or cool the vehicle to the selected temperature. The fan speed will remain automatic unless the thumbwheel is turned.



Climate Controls

3. **Fan speed:** Turn to manually increase or decrease fan speed.



4. **Defrost:**  Distributes outside air through the windshield defroster vents and the side window demisters.

5. **Floor/defrost:** Distributes outside air through the windshield defroster vents, floor vents and the side window demisters.

6. **Floor:** Distributes outside air through the floor vents.

7. **Vent:** Distributes outside air through the instrument panel vents.

8. **Norm A/C:** Uses outside air to cool the vehicle. Air flows from the instrument panel vents only.

9. **Max A/C:** Uses recirculated air to cool the vehicle. Air flows from the instrument panel vents only. This mode will help prevent unpleasant odors from entering the vehicle.

10. **Outside Temp:** Press to display the outside temperature. It will remain in the display until pressed again. The temperature will be most accurate when the vehicle is in motion.



11. **Temperature control:** Press this control to select the temperature. The display window indicates the selected temperature.

Fahrenheit/Celsius temperature: Press MAX A/C and DEF  simultaneously to toggle between Fahrenheit and Celsius temperature. The set point temperatures in Celsius will be displayed in half-degree increments.

Operating tips

- To reduce fog build up on the windshield during humid weather, place the air flow selector in the  position.
- To reduce humidity build up inside the vehicle: do not drive with the air flow selector in the OFF or MAX A/C position.
- Under normal weather conditions, do not leave the air flow selector in MAX A/C or OFF when the vehicle is parked. This allows the vehicle to “breathe” using the outside air inlet vents.
- Do not put objects under the front seats that will interfere with the airflow to the back seats.

Climate Controls

- Remove any snow, ice or leaves from the air intake area at the base of the windshield.

To aid in side window defogging/demisting in cold weather:

1. Select NORM A/C.
2. Modulate the temperature control to maintain comfort.
3. Set the fan speed to HI.
4. Direct the outer instrument panel vents towards the side windows.

To increase airflow to the outer instrument panel vents, close the vents located in the middle of the instrument panel.



Do not place objects on top of the instrument panel as these objects may become projectiles in a collision or sudden stop.

REAR WINDOW DEFROSTER

The rear defroster control is located on the instrument panel.

Press the rear defroster control to clear the rear window of thin ice and fog. A small LED will illuminate when the rear defroster is activated.

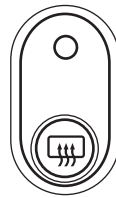

The ignition must be in the ON position to operate the rear window defroster.

The defroster turns off automatically after a predetermined amount of time or when the ignition is turned to the OFF position. To manually turn off the defroster, press the control again.

Activating the rear window defroster will also activate the heated mirrors (if equipped). For more information refer to *Heated outside mirrors* in the *Driver controls chapter*.

Do not use razor blades or other sharp objects to clean the inside of the rear window or to remove decals from the inside of the rear window. This may cause damage to the heated grid lines and will not be covered by your warranty.

Lights

HEADLAMP CONTROL ☀

○ Turns the lamps off.

☀ Turns on the parking lamps, instrument panel lamps, license plate lamps and tail lamps.

☀ Turns the headlamps on.

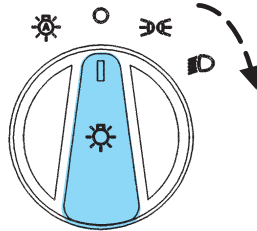

Autolamp control ☀

The autolamp system provides light sensitive automatic on-off control of the exterior lights normally controlled by the headlamp control.

The autolamp system also keeps the lights on for a predetermined period of time after the ignition switch is turned to OFF.

- To turn autolamps on, rotate the control counterclockwise to the next position from OFF.
- To turn autolamps off, rotate the control clockwise past OFF to the parking lamp position ☀, then back to OFF.

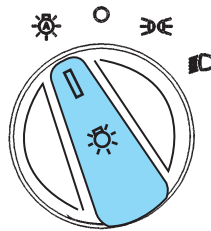

The headlamps will turn on under the following conditions:

1. Headlamp switch is turned to the “headlamps on position”
2. With the ignition in run or start, wipers turned on and the headlamp switch in the autolamp position.

Daytime running lamps (DRL) (if equipped)

Turns the highbeam headlamps on with a reduced output. To activate:

- the key must be in the ON position,
- the parking brake released, and
- the headlamp control is in the OFF or Parking lamps position.

Lights

 Always remember to turn on your headlamps at dusk or during inclement weather. The Daytime Running Light (DRL) System does not activate your tail lamps and generally may not provide adequate lighting during these conditions. Failure to activate your headlamps under these conditions may result in a collision.

High beams

Push the lever toward the instrument panel to activate. Pull the lever towards you to deactivate.

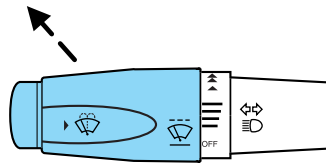

Flash to pass

Pull toward you slightly to activate and release to deactivate.

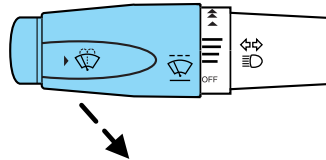

PANEL DIMMER CONTROL

Use to adjust the brightness of the instrument panel during headlight and parklamp operation.

- Rotate the thumbwheel from left to right to brighten the instrument panel.
- Rotate the thumbwheel from right to left to dim the instrument panel.

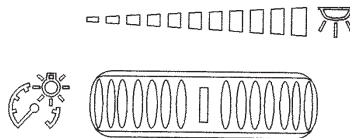

Domelamp Control

The panel dimmer control also controls the domelamp operation.

- Rotate the thumbwheel fully to the right, past detent to activate the domelamp.
- In order to turn off the domelamp, rotate the thumbwheel to the left.

Lights

AIMING THE HEADLAMPS

The headlamps on your vehicle are properly aimed at the assembly plant. If your vehicle has been in an accident the alignment of your headlamps should be checked by a qualified service technician.

TURN SIGNAL CONTROL ⇐⇒

- Push down to activate the left turn signal.
- Push up to activate the right turn signal.

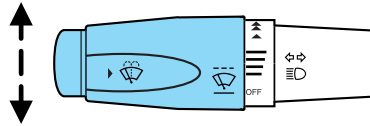

The flash rate of the turn signal will speed up considerably if the left or right turn lamp bulb (front or rear) is burned out.

MAP/COURTESY LAMPS

Without a moon roof

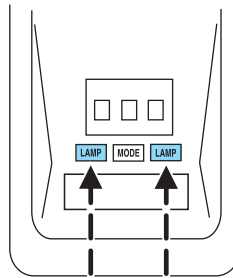

With a moon roof

To turn on the map lamps, press the map lamp control.

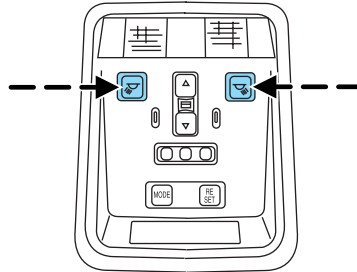

Lights

BULBS

Replacing exterior bulbs

Check the operation of all the bulbs frequently.

Using the right bulbs

Replacement bulbs are specified in the chart below. Headlamp bulbs must be marked with an authorized "D.O.T." for North America and an "E" for Europe to assure lamp performance, light brightness and pattern and safe visibility. The correct bulbs will not damage the lamp assembly or void the lamp assembly warranty and will provide quality bulb burn time.

Function	Trade Number
Headlamp	9007
Park lamp and turn lamp (front)	3457 AK (amber)
Side marker (front)	194 AK (amber)
Tail, stop, turn (rear)	3157K
Side marker (rear)	194
Backup lamp	3156K
License plate lamp	168
High-mount brakelamp	912
Luggage compartment lamp	212-2
Dome lamp	906
Rear reading lamp	211-2
Map lamp	168
Dual floorwell lamp	906
Glove compartment	168
Visor vanity lamp	7065
All replacement bulbs are clear in color except where noted.	
To replace all instrument panel lights - see your dealer.	

Replacing the interior bulbs

Check the operation of all bulbs frequently.

Lights

Replacing headlamp bulbs

To remove the headlamp bulb:

1. Make sure headlamp switch is in OFF position, then open the hood.
2. Remove the radiator cover by turning the three knobs to the unlock position.
3. Disconnect the electrical connector from the bulb by pulling rearward.

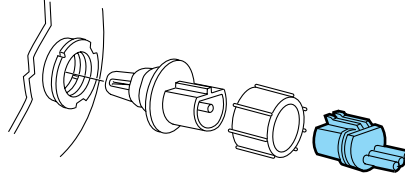

4. Remove the bulb retaining ring by rotating it counterclockwise (when viewed from the rear) to free it from the bulb socket, and slide the ring off the plastic base. Keep the ring to retain the new bulb.

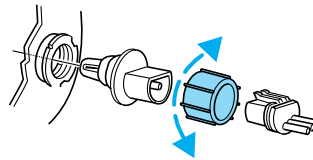

5. Without turning, remove the old bulb from the lamp assembly by gently pulling it straight back out of the lamp assembly.

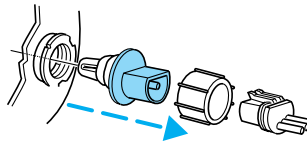

To install the new bulb:



Handle a halogen headlamp bulb carefully and keep out of children's reach. Grasp the bulb only by its plastic base and do not touch the glass. The oil from your hand could cause the bulb to break the next time the headlamps are operated.

Note: If the bulb is accidentally touched, it should be cleaned with rubbing alcohol before being used.

1. With the flat side of the new bulb's plastic base facing upward, insert the glass end of the bulb into the lamp assembly. Turn the bulb left or right to align the grooves in the plastic base with the tabs in the lamp assembly. When the grooves are aligned, push the bulb into the lamp assembly until the plastic base contacts the rear of the lamp assembly.
2. Install the bulb retaining ring over the plastic base until it contacts the rear of the socket by rotating it clockwise until you feel a "stop."

Lights

3. Connect the electrical connector into the rear of the plastic base until it snaps, locking it into position.
4. Install the protective cover over headlamps locking it in place with three knobs.
5. Turn the headlamps on and make sure they work properly. If the headlamp was correctly aligned before you changed the bulb, you should not need to align it again.

Replacing front parking lamp/turn signal bulbs

The park/turn lamp bulbs can be replaced without removing the headlamp assembly.

1. Make sure headlamp switch is in the OFF position, then open the hood.
2. Remove the radiator cover by turning the three knobs to the unlock position.
3. Loosen the parking lamp retainer, on the outside of the lamp, unscrew and pull the lamp assembly forward.
4. Disconnect the electrical connector from the bulb by pulling rearward.
5. Rotate the bulb socket counterclockwise and remove from lamp assembly.
6. Carefully pull bulb straight out of the socket and push in the new bulb until it snaps, locking it into position.
7. To complete installation, follow the removal procedure in reverse order.

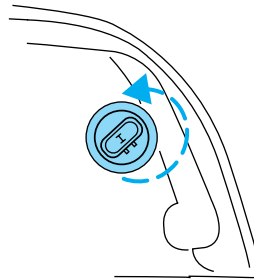

Lights

Replacing tail lamp/brake/turn lamp bulbs

The tail lamp, the brake lamp and the turn signal lamp bulbs are located in the tail lamp assembly. Follow the same steps to replace either bulb.

1. Make sure headlamp switch is in OFF position, then open the trunk and remove plastic retainer to expose the lamp assembly hardware.
2. Carefully pull the carpet away to expose the plastic retainer.
3. Remove three nut and washer assemblies and the lamp assembly from the vehicle.
4. Remove the bulb socket by rotating it counterclockwise, then pulling it out of the lamp assembly.

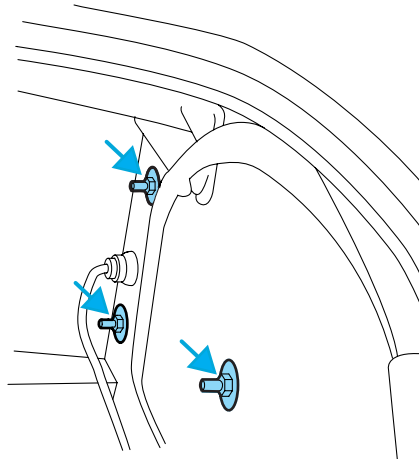

5. Pull the bulb from the socket and push in the new bulb.
6. Install the bulb socket into the lamp assembly by rotating it clockwise.
7. Install the lamp assembly on the vehicle with three nut and washer assemblies ensuring the washers on the nuts are flush with the body to prevent water from entering the trunk.
8. Install the plastic retainer and carefully push the carpet back in to place.

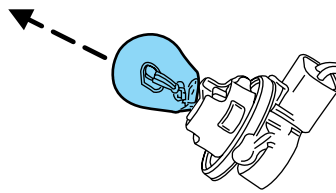

Replacing license plate lamp bulbs

1. Make sure headlamp switch is in OFF position, then remove two screws, grommets and the license plate lamp assembly from the trunk lid.
2. Carefully pull the bulb from the socket and push in the new bulb.
3. Install the lamp assembly on trunk lid with two grommets, ensuring the grommets are pushed all the way in to the trunk lid and secure with two screws.

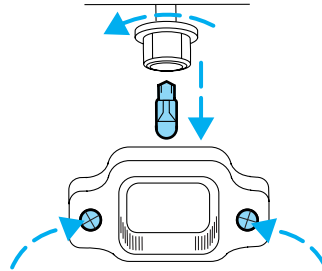

Replacing backup lamp bulbs

1. Make sure headlamp switch is in OFF position, then open trunk and remove bulb socket from the trunk lid by turning counterclockwise.
2. Pull the bulb straight out of the socket and push in the new bulb.
3. Install the bulb socket in trunk lid by turning clockwise.

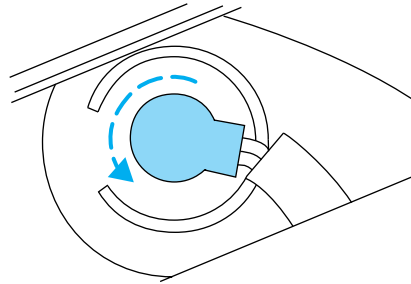

Lights

Replacing high-mount brakelamp bulbs

1. Make sure headlamp switch is in OFF position, then remove two screws from the lamp assembly.
2. Carefully lift the lamp assembly up for access to the bulbs.

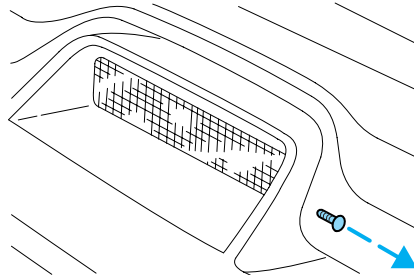

3. Carefully pull the bulb socket out of the lamp assembly.
 4. Pull the bulb straight out of the socket and push in the new bulb.
- To install, reverse the removal procedure.

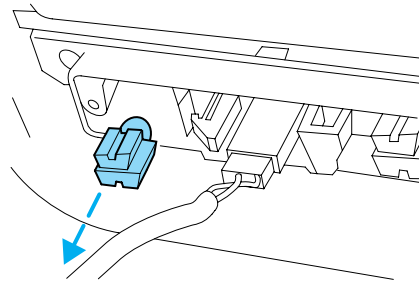

Driver Controls

MULTI-FUNCTION LEVER

Windshield wiper: Rotate the end of the control away from you to increase the speed of the wipers; rotate towards you to decrease the speed of the wipers.

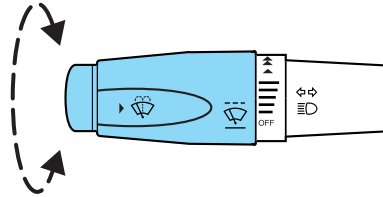

Windshield washer: Push the end of the stalk:

- briefly: causes a single swipe of the wipers without washer fluid.
- a quick push and hold: the wipers will swipe three times with washer fluid.
- a long push and hold: the wipers and washer fluid will be activated for up to ten seconds.

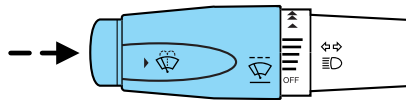

Windshield wiper/washer features

The exterior lamps will turn on with the ignition on, Headlamp control in the Autolamp position and the windshield wipers are turned on.

The lights will remain on for 30 seconds after the wipers are turned off.

Changing the wiper blades

To make changing the wiper blades easy, turn the ignition to ACC, then turn the wipers on. When the wipers reach the vertical position, turn the ignition to LOCK.

Driver Controls

To replace the wiper blades:

1. Pull the wiper arm away from the windshield and lock into the service position.
2. Press and hold the tab on the blade and slide the blade off the wiper arm pin.
3. To attach the new wiper blade, press and hold the tab on the blade and slide the blade on to the wiper arm pin. Then release the tab.
4. Replace wiper blades every 6 months for optimum performance.

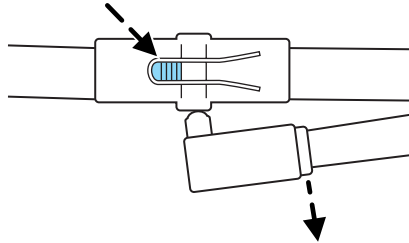

TILT STEERING WHEEL

To adjust the steering wheel:

1. Pull and hold the steering wheel release control toward you.
2. Move the steering wheel up or down until you find the desired location.
3. Release the steering wheel release control. This will lock the steering wheel in position.

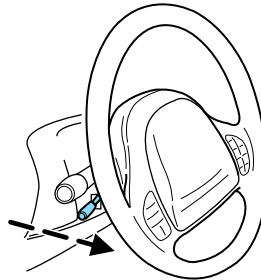

Never adjust the steering wheel when the vehicle is moving.

ILLUMINATED VISOR MIRROR (IF EQUIPPED)

Lift the mirror cover to turn on the visor mirror lamps.

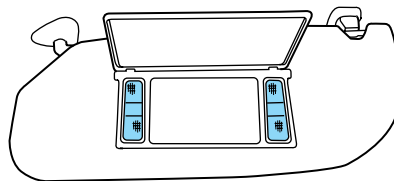

Driver Controls

OVERHEAD CONSOLE WITHOUT MOON ROOF (IF EQUIPPED)

The appearance of your vehicle's overhead console will vary according to your option package. Some of the features in the overhead console include a compass and HomeLink®. To program the Homelink®, refer to *Homelink® Wireless Control System* in this chapter.

Electronic compass display (if equipped)

Compass: The compass display is contained in the overhead console. The vehicle heading is displayed as one of N, NE, E, SE, S, SW, W and NW.

The compass reading may be affected when you drive near large buildings, bridges, power lines and powerful broadcast antenna. Magnetic or metallic objects placed in or on the vehicle may also affect compass accuracy. Adjustments may need to be made to the zone and calibration of the compass.

Compass zone adjustment

1. Determine which magnetic zone you are in by referring to the zone map.
2. Turn the ignition to the ON position.

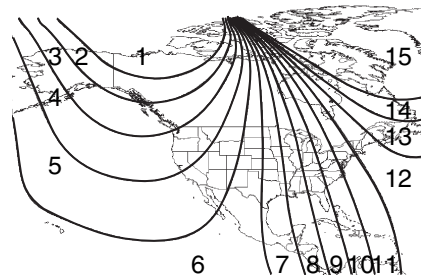

3. Press and hold the MODE control until VAR appears in the display, then release. The display should show the current zone number.
4. Press the MODE control until the desired zone number appears. The display will flash and then return to normal operation. The zone is now updated.

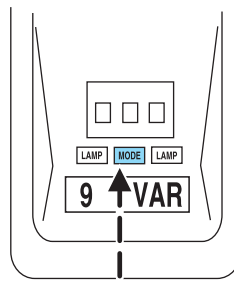

Driver Controls

Compass calibration adjustment

Perform this adjustment in an open area free from steel structures and high voltage lines:

1. Press and hold the MODE control until CAL appears in the display (approximately eight seconds) and release.
2. Drive the vehicle slowly (less than 5 km/h [3 mph]) in circles until CAL indicator turns off in about 2–3 complete circles.
3. The compass is now calibrated.

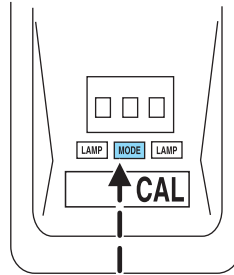

OVERHEAD CONSOLE WITH MOON ROOF (IF EQUIPPED)

The appearance of your vehicle's overhead console will vary according to your option package. Some of the features in the overhead console include Compass, Homelink, and Moon Roof controls.

Compass mode

The compass reading may be affected when you drive near large buildings, bridges, power lines and powerful broadcast antenna. Magnetic or metallic objects placed in, on or near the vehicle may also affect compass accuracy.

1. Turn ignition to the ON position.
2. Start the engine.
3. From a blank display press and release the MODE button once. The directional heading will be displayed.

Note: If the compass is de-calibrated, CAL will be displayed in the right corner of the display. Refer to "Calibration mode" in this section for more details.

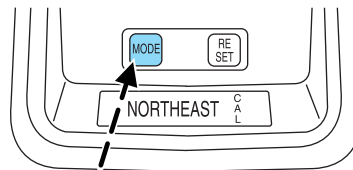

4. The overhead console displays the compass heading in one of eight directions: NORTH, NORTHEAST, EAST, SOUTHEAST, SOUTH, SOUTHWEST, WEST, and NORTHWEST.

Driver Controls

Zone variation mode

Most geographic areas (zones) have a magnetic north compass point that varies slightly from the northerly direction on maps. A correct zone setting will eliminate compass heading error.

For optimum calibration, turn off all electrical accessories (heater/air conditioning, wipers, etc.) and make sure all vehicle doors are shut.

To set the compass zone:

1. Press and release the MODE button until the compass directional heading is displayed.

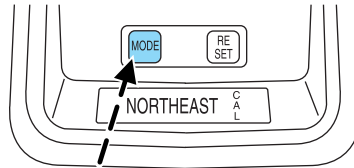

2. Hold down the MODE button for 5 seconds to enter zone mode. The display will read PRESS RESET TO SET ZONE XX where XX is the current zone.

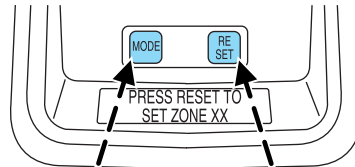

3. Release the MODE button.

4. Repeatedly press and release the RESET button to scroll through the zones 1–15 until the desired zone is displayed.

5. Press the MODE button to save the new zone setting and return to the compass normal mode.

Note: The compass exits the zone setting mode and returns to its previous setting after one minute of no activity.

Note: If power is interrupted during the zone setting process, the compass resets to the same zone it was set to before the zone change process was started.

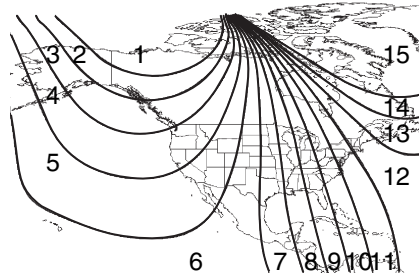

Driver Controls

Calibration mode

To calibrate the compass:

1. Press and release the MODE button until the compass directional heading is displayed.

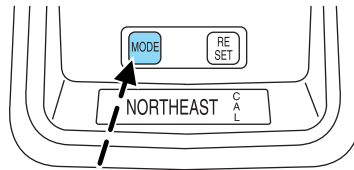

2. Hold down the MODE button for 10 seconds to enter the calibration mode. The display will read PRESS RESET TO DECAL.

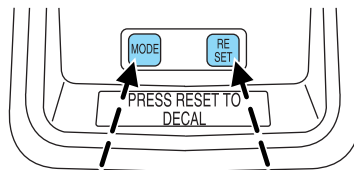

3. Release the MODE button.

4. Press the RESET button to de-calibrate the compass. The display will read CIRCLE SLOWLY TO CALIBRATE for a few seconds and then display a direction with CAL displayed on the right side.

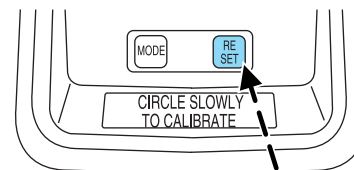

5. Slowly drive the vehicle in a circle (less than 5 km/h [3 mph]).

This will take up to three circles to complete calibration.

6. The correct compass heading will be displayed when the compass is calibrated.

Note: If the RESET button is not pressed, the compass will exit calibration mode after three minutes of no activity and the original calibration data will be restored.

Note: If power is interrupted during the calibration process, the compass resets to the original calibration data from before the calibration process started.

Driver Controls

HomeLink® mode

Train mode

Note: Do not train the HomeLink® with the vehicle parked in the garage.

To train a HomeLink® button to control a specific device:

1. Select the HomeLink® button to train.
2. Press and continuously hold the button for 20 seconds. CHANNEL X TRANSMIT will be displayed (X will be 1, 2, or 3) during this time.

Note: If more than one button is pressed, priority will be given to the lowest numbered channel.

3. After 20 seconds, the display will read CHANNEL X TRAINING to indicate training has started. Continue to hold the button.

Note: If the channel being trained has not been previously trained, the channel will immediately enter the training mode (no 20 second delay).

4. Point the original garage door opener/transmitter at the overhead console. Hold down the original transmitter's button so the overhead console can learn the transmitter's frequency and data stream.

5. Training will be complete in 100 seconds or less. CHANNEL X TRAINED will be displayed when training is complete.

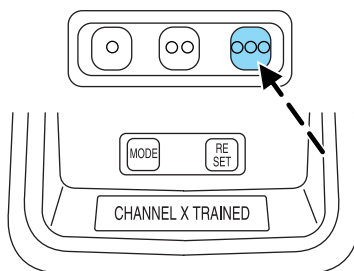
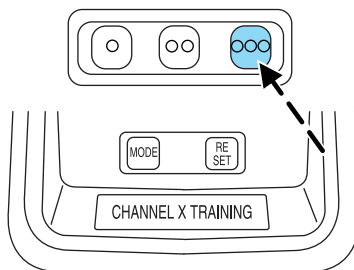
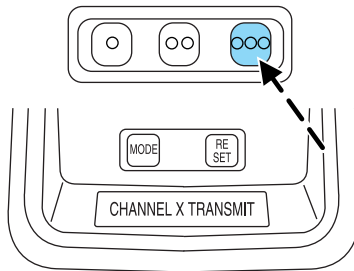

Driver Controls

6. DID NOT TRAIN will be displayed if the channel did not properly train.
7. Release the channel X button.
Training is complete.

Note: Additional training may be required for rolling code equipped devices. Refer to the *Rolling code programming* in this section.

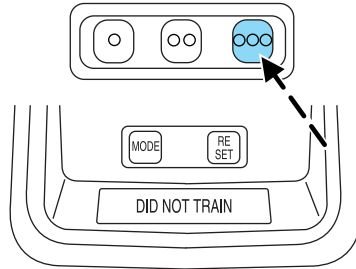

Rolling code programming

To train a garage door opener (or other rolling code equipped devices) with the rolling code feature, follow these instructions **after** completing the **“Train mode”** in this section. (A second person may make the following training procedures quicker & easier)

1. Locate the **“learn” or “smart” button** on the garage door motor head unit. Exact location and color of the button may vary by product brand. If there is difficulty locating the “learn” or “smart” button refer to the device’s owner manual or contact HomeLink® at **1-800-355-3515** or on the Internet at **www.homelink.com**.
2. Press and release the “learn” or “smart” button on the garage door motor head unit.

Note: Following step 2, there are 30 seconds in which to initiate step 3.

3. Press and release the programmed HomeLink® button. Press and release the HomeLink® button a *second time* to complete the training process. (Some garage door openers may require this procedure to be done a *third time* to complete the training.)

The rolling code equipped device should now recognize the HomeLink® signal and activate when the HomeLink button is pressed. The remaining two buttons may now be programmed if this has not previously been done. Refer to the *“Train mode”* in this section.

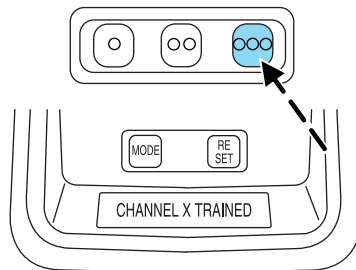

Driver Controls

Transmit mode

1. Select the button for the desired channel (for example, for the garage door you wish to open).
2. Press the button. CHANNEL X TRANSMIT is displayed.
3. The proper signal is transmitted to the device being controlled.
4. Release the button.

Note: If more than one button is pressed, priority will be given to the lowest numbered channel.

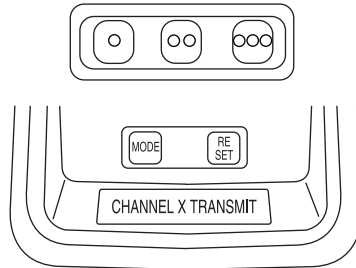

Erase mode

To erase all three HomeLink® channel codes:

1. Simultaneously press and hold buttons 1 and 3 for 20 seconds.
2. CLEARING CHANNELS will be displayed when the channel codes are being erased.
3. CHANNELS CLEARED will be displayed when the erase operation is complete.
4. Release buttons 1 and 3.

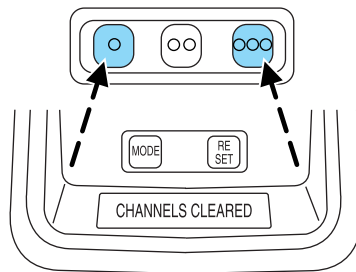
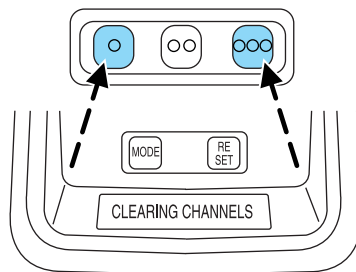

Driver Controls

HomeLink® default code mode

HomeLink® uses default codes for testing and for optional home lighting accessories. To load the default codes:

1. Simultaneously press and hold buttons 1 and 3. CLEARING CHANNELS is displayed.

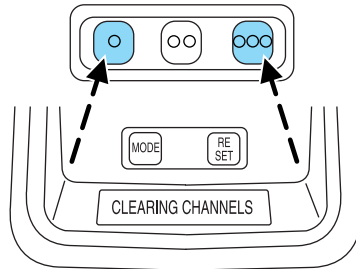

2. After 20 seconds CHANNELS CLEARED is displayed. Continue to hold the buttons.

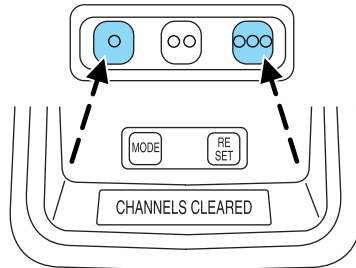

3. After 10 more seconds, CHANNELS DEFAULTED is displayed when all the channel default codes have been successfully loaded.

Note: If you need to train the garage door opener, refer to “Train mode” in this section.

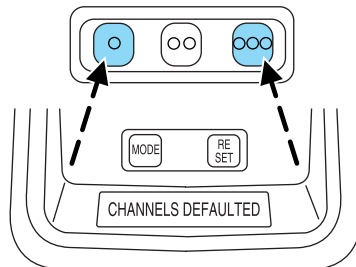

AUXILIARY POWER POINT

The auxiliary power point for five passenger vehicles is located in the floor console storage bin. For six passenger vehicles, the auxiliary power point is located under the cup holder and ashtray drawer in the center stack.

Driver Controls

Do not plug optional electrical accessories into the cigarette lighter. Use the power point.

Do not use the power point for operating the cigarette lighter element.

The Maximum power each power point can supply depends on the fuse rating. For example: a 20A fuse should supply a maximum of 240 Watts, a 15A fuse should supply a maximum of 180 Watts and a 10A fuse should supply a maximum of 120 Watts. Exceeding these limits will result in a blown fuse.

Always keep the power point caps closed when not being used.

Power outlets are designed for accessory plugs only. Do not hang any type of accessory or accessory bracket from the plug. Improper use of the power outlet can cause damage not covered by your warranty.

POWER WINDOWS (IF EQUIPPED)

 When closing the power windows, you should verify they are free of obstructions and ensure that children and/or pets are not in the proximity of the window openings.

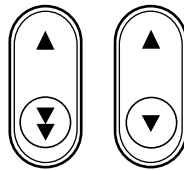

Press and hold the bottom part of the rocker switch to open the window.
Press and hold the top part of the rocker switch to close the window.

One touch down

Allows the driver's window to open fully without holding the control down. Press completely down on the bottom part of the rocker switch and release quickly. Press the top part of the rocker switch to stop.

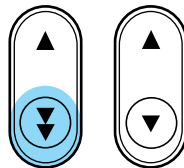

Driver Controls

Window lock

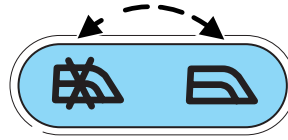

The window lock feature allows only the driver to operate the power windows.

To lock out all the window controls except for the driver's press the left side of the control. Press the right side to restore the window controls.



POWER SIDE VIEW MIRRORS

To adjust your mirrors:

1. Select  to adjust the left mirror or  to adjust the right mirror.
2. Move the control in the direction you wish to tilt the mirror.
3. Return to the center position to lock mirrors in place.

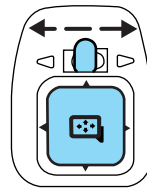

Heated outside mirrors (if equipped)

Both mirrors are heated automatically to remove ice, mist and fog when the rear window defrost is activated.

Do not remove ice from the mirrors with a scraper or attempt to readjust the mirror glass if it is frozen in place. These actions could cause damage to the glass and mirrors.

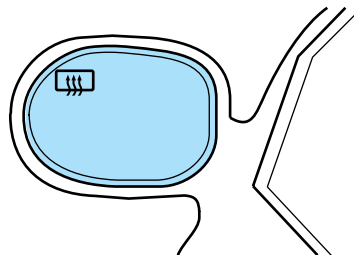

Driver Controls

Fold-away mirrors

Pull the side mirrors in carefully when driving through a narrow space, like an automatic car wash.

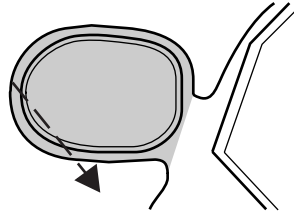

Automatic dimming inside rear view mirror (if equipped)

Your vehicle is equipped with an inside rear view mirror with an auto-dimming function. The electronic day/night mirror will change from the normal state to the non-glare state when bright lights (glare) reach the mirror. When the mirror detects bright light from behind the vehicle, it will automatically adjust (darken) to minimize glare.

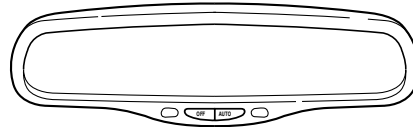

The mirror will automatically return to the normal state whenever the vehicle is placed in R (Reverse)(when the mirror is on) to ensure a bright clear view when backing up.

Do not block the sensor on the backside of the inside rear view mirror since this may impair proper mirror performance.

Press the control to turn the mirror OFF or AUTO.

POWER ADJUSTABLE FOOT PEDALS (IF EQUIPPED)

The accelerator and brake pedal should only be adjusted when the vehicle is stopped and the gearshift lever is in the P (Park) position.

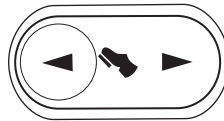

Press and hold the rocker control to adjust accelerator and brake pedal.

- Press the right side of the control to adjust the pedals toward you.
- Press the left side of the control to adjust the pedals away from you.

The adjustment allows for approximately 65 mm (2.5 inches) of maximum travel.

Driver Controls



Never adjust the accelerator and brake pedal with feet on the pedals while the vehicle is moving.

SPEED CONTROL (IF EQUIPPED)

With speed control set, you can maintain a speed of 48 km/h (30 mph) or more without keeping your foot on the accelerator pedal. Speed control does not work at speeds below 48 km/h (30 mph).



Do not use the speed control in heavy traffic or on roads that are winding, slippery or unpaved.

Setting speed control

The controls for using your speed control are located on the steering wheel for your convenience.

1. Press the ON control and release it.
2. Accelerate to the desired speed.

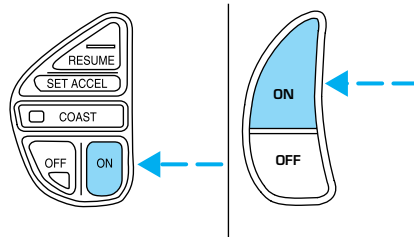

3. Press the SET ACCEL control and release it.
4. Take your foot off the accelerator pedal.
5. The message “SPEED CONTROL” (if equipped) will be displayed in the optional instrument cluster.

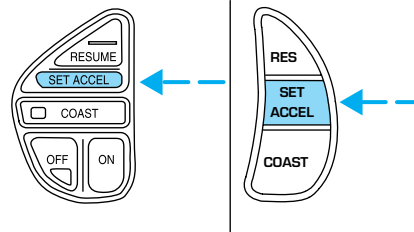

Note:

- Vehicle speed may vary when driving up and down a steep hill.
- If the vehicle speed increases above the set speed on a downhill, you may want to apply the brakes to reduce the speed.
- If the vehicle speed decreases more than 16 km/h (10 mph) below your set speed on an uphill, your speed control will disengage.

Driver Controls

Disengaging speed control

To disengage the speed control:

- Depress the brake pedal

Disengaging the speed control will not erase previous set speed.

Resuming a set speed

Press the RES/RESUME control and release it. This will automatically return the vehicle to the previously set speed. The message “SPEED CONTROL” (if equipped) will be displayed in the optional instrument cluster. The RES/RESUME control will not work if the vehicle speed is not faster than 48 km/h (30 mph).

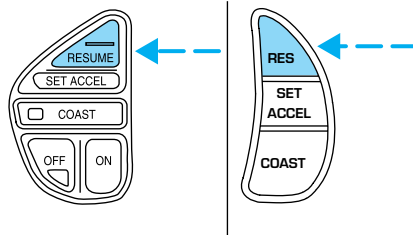

Increasing speed while using speed control

There are two ways to set a higher speed:

- Press and hold the SET ACCEL control until you get to the desired speed, then release the control. You can also use the SET ACCEL control to operate the Tap-Up function. Press and release this control to increase the vehicle set speed in small amounts by 1.6 km/h (1 mph).
- Use the accelerator pedal to get to the desired speed. When the vehicle reaches that speed press and release the SET ACCEL control.

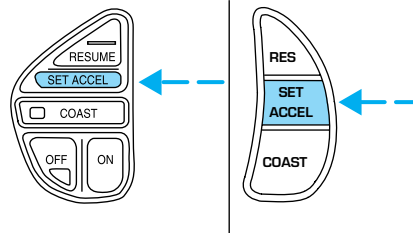

Driver Controls

Reducing speed while using speed control

There are two ways to reduce a set speed:

- Press and hold the COAST control until you get to the desired speed, then release the control. You can also use the COAST control to operate the Tap-Down function. Press and release this control to decrease the vehicle set speed in small amounts by 1.6 km/h (1 mph).
- Depress the brake pedal until the desired vehicle speed is reached, press the SET ACCEL control.

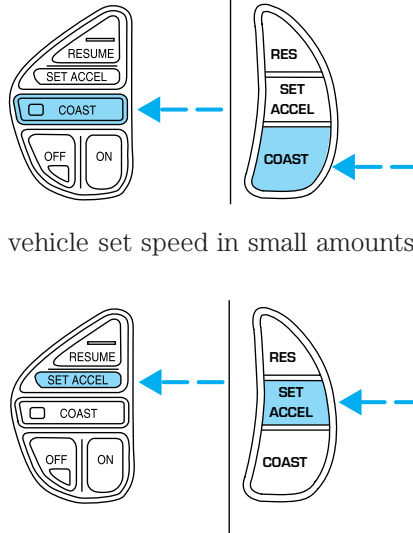

Turning off speed control

There are two ways to turn off the speed control:

- Depress the brake pedal. This will not erase your vehicle's previously set speed.
- Press the speed control OFF control.

Note: When you turn off the speed control or the ignition, your speed control set speed memory is erased.

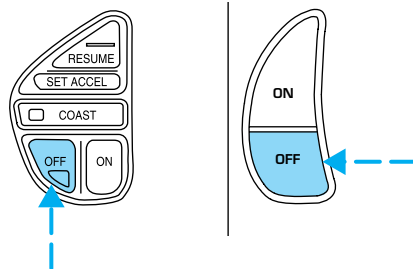

Driver Controls

STEERING WHEEL CONTROLS (IF EQUIPPED)

Radio control features

- Press MODE to select AM, FM1, FM2, TAPE or CD (if equipped).

In Radio mode:

- Press NEXT to select a preset station from memory.

In Tape mode:

- Press NEXT to listen to the next selection on the tape.

In CD mode:

- Press NEXT to listen to the next track on the disc.

In any mode:

- Press VOL up or down to adjust the volume.

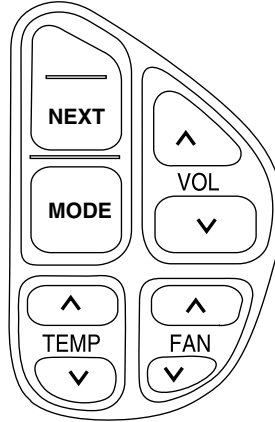

Climate control features

- Press TEMP up or down to adjust temperature.
- Press FAN up or down to adjust fan speed.

MOON ROOF (IF EQUIPPED)

To open the moon roof:

- Press and hold the control forward to raise the moon roof to the vent position (when the glass panel is closed).
- For one-touch operation, press the control rearward and release; this will fully open the moon roof.
- To stop one-touch operation at the desired position, press the control in any direction and release.

To close the moon roof:

- Press and hold the control forward.

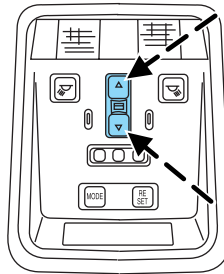

Driver Controls

- To close from the vent position, press and hold the control rearward.



Do not let children play with the moon roof. They may seriously hurt themselves.

HOMELINK® WIRELESS CONTROL SYSTEM (IF EQUIPPED)

The HomeLink® Wireless Control System, located on the overhead console, provides a convenient way to replace up to three hand-held transmitters with a single built-in device. This feature will learn the radio frequency codes of most current transmitters to operate garage doors, entry gate operators, security systems, entry door locks, and home or office lighting.



When programming your HomeLink® Wireless Control System to a garage door or gate, be sure that people and objects are out of the way to prevent potential harm or damage.

Do not use the HomeLink® Wireless Control System with any garage door opener that lacks safety stop and reverse features as required by U.S. federal safety standards (this includes any garage door opener model manufactured before April 1, 1982). A garage door which cannot detect an object, signaling the door to stop and reverse, does not meet current U.S. federal safety standards. For more information, contact HomeLink® at: **www.homelink.com** or **1-800-355-3515**.

Retain the original transmitter for use in other vehicles as well as for future programming procedures (i.e. new HomeLink® equipped vehicle purchase). It is also suggested that upon the sale of the vehicle, the programmed Homelink® buttons be erased for security purposes, refer to *Programming* in this section.

Programming

Do not program HomeLink® with the vehicle parked in the garage.

Note: Some vehicles may require the ignition switch to be turned to the second (or “ACC”) position for programming and/or operation of the HomeLink®. It is also recommended that a new battery be placed in the hand-held transmitter of the device being programmed to HomeLink® for quicker training and accurate transmission of the radio-frequency signal.

Driver Controls

1. Press and hold the two outside buttons releasing only when the red light begins to flash after 20 seconds. **Do not** repeat step one to program additional hand-held transmitters to the remaining two HomeLink® buttons. This will erase previously programmed hand-held transmitter signals into HomeLink®.

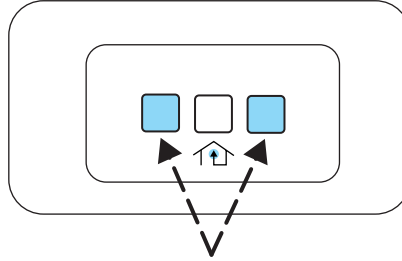

2. Position the end of your hand-held transmitter 2–8 cm (1–3 inches) away from the HomeLink® button you wish to program (located on your overhead console) while keeping the red light in view.

3. Simultaneously press and hold both the HomeLink® and hand-held transmitter button. **Do not release the buttons until step 4 has been completed.**

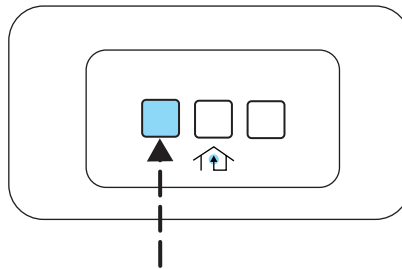

Some entry gates and garage door openers may require you to replace step 3 with procedures noted in the “Gate Operator and Canadian Programming” section for Canadian residents.

4. The red light will flash slowly and then rapidly. Release both buttons when the red light flashes rapidly. (The rapid flashing light indicates acceptance of the hand-held transmitters’ radio frequency signals.)

5. Press and hold the just-trained HomeLink® button and observe the red light. If the light is a constant red, programming is complete and your device should activate when the HomeLink® button is pressed and released. **Note:** To program the remaining two HomeLink® buttons, begin with step 2 in the “Programming” section — **do not** repeat step 1.

Note: If the red light blinks rapidly for two seconds and then turns to a continuous red, proceed with steps 6 through 8 to complete programming of a rolling code equipped device.

6. At the garage door opener receiver (motor-head unit) in the garage, locate the “learn” or “smart” button (usually near where the hanging antenna wire is attached to the unit).

7. Press and release the “learn” or “smart” button. (The name and color of the button may vary by manufacturer.)

Driver Controls

Note: There are 30 seconds in which to initiate step eight.

8. Return to the vehicle and firmly press, hold for two seconds and release the HomeLink® button. Repeat the press/hold/release sequence again, and, depending on the brand of the garage door opener (or other rolling code equipped device), repeat this sequence a third time to complete the programming.

HomeLink® should now activate your rolling code equipped device. To program additional HomeLink® buttons begin with step 2 in the “Programming” section. For questions or comments, please contact HomeLink at www.homelink.com or 1-800-355-3515.

Gate Operator & Canadian Programming

During programming, your hand-held transmitter may automatically stop transmitting — not allowing enough time for HomeLink® to accept the signal from the hand-held transmitter.

After completing steps 1 and 2 outlined in the “Programming” section, replace step 3 with the following:

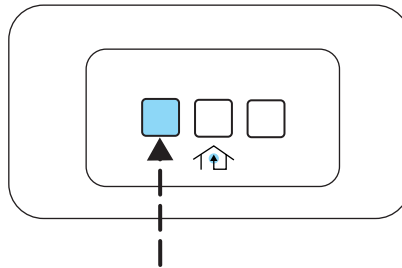

Note: If programming a garage door opener or gate operator, it is advised to unplug the device during the “cycling” process to prevent overheating.

- Continue to press and hold the HomeLink® button (note step 3 in the “Programming” section) while you press and release — **every two seconds** (“cycle”) your hand-held transmitter until the frequency signal has been accepted by the HomeLink®. The red indicator light will flash slowly and then rapidly after HomeLink® accepts the radio frequency signal.
- Proceed with step 4 in the “Programming” section.

Driver Controls

Operating the HomeLink® Wireless Control System

To operate, simply press and release the appropriate HomeLink® button. Activation will now occur for the trained product (garage door, gate operator, security system, entry door lock, or home or office lighting etc.). For convenience, the hand-held transmitter of the device may also be used at any time. In the event that there are still programming difficulties, contact HomeLink® at www.homelink.com or **1-800-355-3515**.

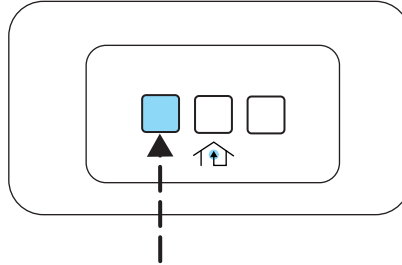

Erasing HomeLink® buttons

To erase the three programmed buttons (individual buttons cannot be erased):

- Press and hold the two outer HomeLink® buttons until the red indicator light begins to flash-after 20 seconds. Release both buttons. Do not hold for longer than 30 seconds.

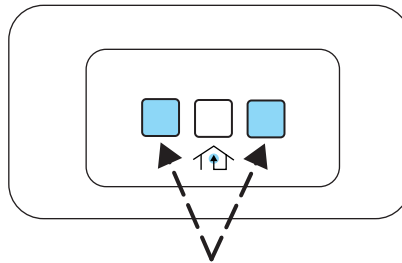

HomeLink® is now in the train (or learning) mode and can be programmed at any time beginning with step 2 in the “Programming” section.

Reprogramming a single HomeLink® button

To program a device to HomeLink® using a HomeLink® button previously trained, follow these steps:

1. Press and hold the desired HomeLink® button. **Do NOT** release the button.
2. The red indicator light will begin to flash after 20 seconds. Without releasing the HomeLink® button, follow step 2 in the “Programming” section.

For questions or comments, contact HomeLink® at www.homelink.com or **1-800-355-3515**.

Driver Controls

ELECTRONIC MESSAGE CENTER (IF EQUIPPED)

The electronic message center only works when the ignition is in the ON position.

The message center allows you to:

- see problems such as door ajar, air suspension, trunk ajar, washer fluid low
- see how many kilometers/miles you can drive before running out of fuel
- see when overdrive has been deactivated
- monitor the average fuel economy
- check the distance traveled during a trip on either Trip A or Trip B
- monitor the average speed

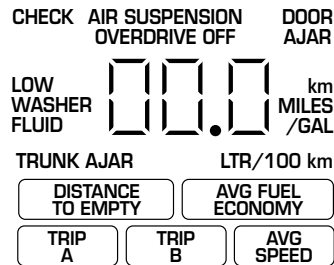

Selectable features

Reset

Press this control to reset the selected message center function to zero. The only functions which can be reset are:

- AVG ECON
- TRIP A or TRIP B
- AVG SPEED

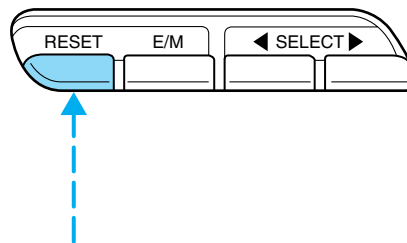

E/M

Press this control to switch the electronic instrument cluster display and the message center display from metric to English units.

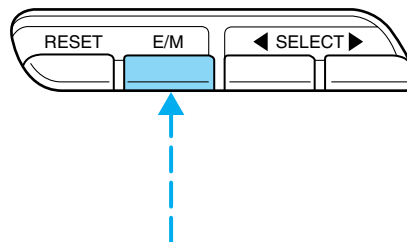

Driver Controls

Select

Each press of the SELECT control will select a different function.

- Press the right side of the control to advance the function to the right.
- Press the left side of the control to advance the function to the left.

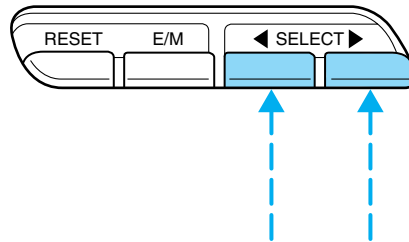

To reset any function:

1. Push either the right or left side of the SELECT control to choose the desired function.
2. Press the RESET control and the selected message center function will be reset to zero.

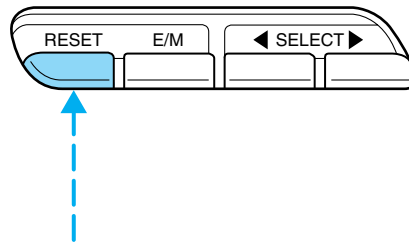

Message center functions

DISTANCE TO EMPTY (DTE)

This function estimates approximately how far you can drive with the fuel remaining in your tank under normal driving conditions.

Remember to turn the ignition OFF when refueling to allow this feature to correctly detect the added fuel.

The DTE function will flash for 5 seconds and sound a tone for 1 second when you have approximately:

- 80 km (50 miles) left before you run out of fuel
- 40 km (25 miles)
- 16 km (10 miles)



Driver Controls

The message center will remain in the DTE function until the SELECT control is pressed to change functions.

DTE is calculated using a running average fuel economy, which is based on your recent driving history of 800 km (500 miles). This value is not the same as the average fuel economy display. The running average fuel economy is reinitialized to a factory default value if the battery is disconnected.

If “CO” or “CS” is displayed, there is a problem with the fuel indication system and you should contact your dealer for service as soon as possible.

AVG FUEL ECONOMY (average fuel economy)

Select this function to display your average fuel economy in liters/100 km or miles/gallon.

If you calculate your average fuel economy by dividing miles traveled by gallons used, your figure may be different than displayed for the following reasons:

- your vehicle was not perfectly level during fill-up
- differences in the automatic shut-off points on the fuel pumps at service stations
- variations in top-off procedure from one fill-up to another
- rounding of the displayed values to the nearest 0.1 liter (gallons)

Press the RESET control while AVG ECON is displayed to reset the function.

The average displayed is the average since the last reset.

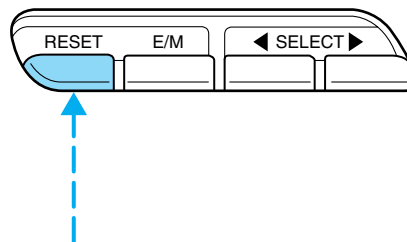
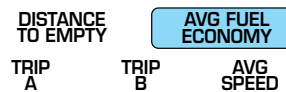
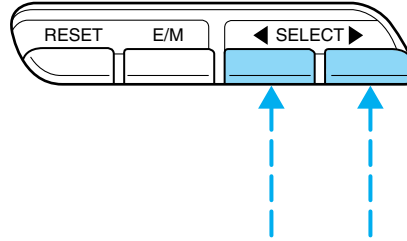

Driver Controls

TRIP A and TRIP B

These two functions allow you to see how far you have traveled since you last reset. Trip A and Trip B are completely independent and must be reset individually.

To reset either trip feature to zero, press the RESET control while the appropriate trip distance feature (TRIP A or TRIP B) is displayed.

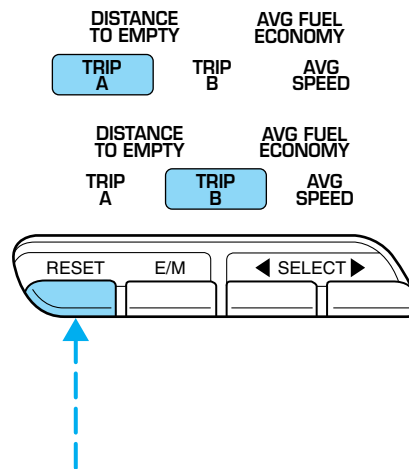

AVG SPEED (average speed)

Select this function to display your average speed in miles per hour or kilometers per hour.

Your vehicle must be moving to calculate your average speed. When your vehicle is not moving, the average speed is displayed at 0 kilometers (0 miles) per hour.

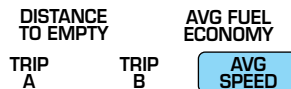

INTERIOR TRUNK CONTROL

The remote trunk release control is located on the driver's door trim panel and can be operated at any time.

You can render the switch inoperable by locking the button with your master key.

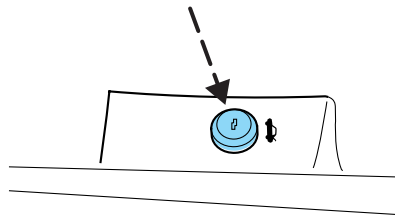

Driver Controls

CELL PHONE USE

The use of Mobile Communications Equipment has become increasingly important in the conduct of business and personal affairs. However, drivers must not compromise their own or others' safety when using such equipment. Mobile Communications can enhance personal safety and security when appropriately used, particularly in emergency situations. Safety must be paramount when using mobile communications equipment to avoid negating these benefits.

Mobile Communication Equipment includes, but is not limited to cellular phones, pagers, portable email devices, in vehicle communications systems, telematics devices and portable two-way radios.



A driver's first responsibility is the safe operation of the vehicle. The most important thing you can do to prevent a crash is to avoid distractions and pay attention to the road. Wait until it is safe to operate Mobile Communications Equipment.

CENTER CONSOLE (IF EQUIPPED)

Your vehicle may be equipped with a variety of console features. These include:

- Utility compartment
- Power point (inside storage bin)
- Cupholders
- Air vents to the rear seating positions (heat only)



Use only soft cups in the cupholder. Hard objects can injure you in a collision.

POSITIVE RETENTION FLOOR MAT

Position the driver floor mat so that the eyelet is over the pointed end of the retention post and rotate forward to lock in. Make sure that the mat does not interfere with the operation of the accelerator or the brake pedal. To remove the floor mat, reverse the installation procedure.

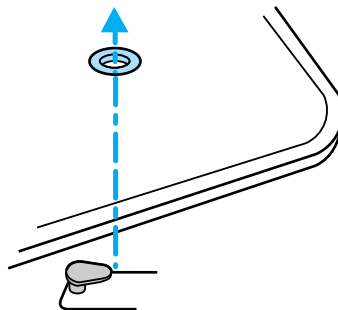

Locks and Security

KEYS

The vehicle is equipped with a master (black) key and valet (gray) key lock system. The master key will access doors, trunk, glove box, ignition and remote trunk release. The valet key will access doors and ignition only. Before using this key, lock the trunk remote control to disable the *Trunk remote control* on the drivers door, then lock the glove compartment with your master key.

POWER DOOR LOCKS

Press control to unlock all vehicle doors.

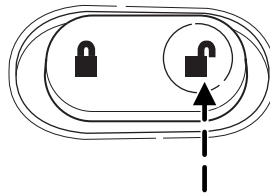

Press control to lock all vehicle doors.

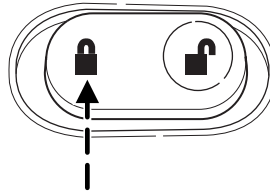

Smart locks (if equipped)

With the key in any ignition position, and either the driver's or passenger's door open, the doors cannot be locked using the power door lock switches.

The vehicle may still be locked with the key in the ignition, and performing one of the following actions:

- Pressing the manual lock button on the door.
- Operating the remote entry transmitter (if equipped).
- Operating the keyless entry keypad (if equipped).
- Operating the driver's door with a key.

Locks and Security

Childproof door locks

When these locks are set, the rear doors cannot be opened from the inside. The rear doors can be opened from the outside when the doors are unlocked.

The childproof locks are located on rear edge of each rear door and must be set separately for each door. Setting the lock for one door will not automatically set the lock for both doors.

Move lock control up to engage the childproof lock. Move control down to disengage childproof locks.

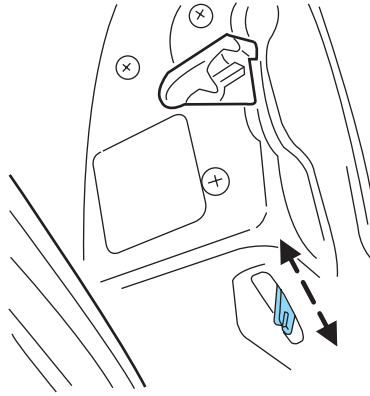

INTERIOR LUGGAGE COMPARTMENT RELEASE

Your vehicle is equipped with a mechanical interior luggage compartment release handle that provides a means of escape for children and adults in the event they become locked inside the luggage compartment.

Adults are advised to familiarize themselves with the operation and location of the release handle.

To open the luggage compartment door (lid) from within the luggage compartment, pull the illuminated "T" shaped handle and push up on the trunk lid. The handle is composed of a material that will glow for hours in darkness following brief exposure to ambient light.

The "T" shaped handle will be located either on the luggage compartment door (lid) or inside the luggage compartment near the tail lamps.

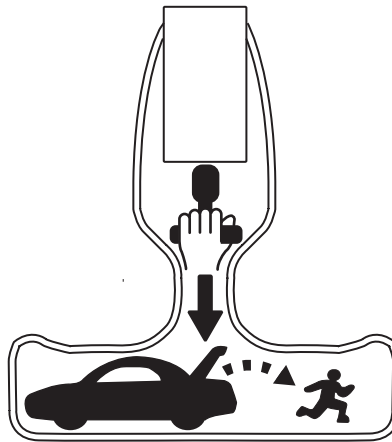

Locks and Security



Keep vehicle doors and luggage compartment locked and keep keys and remote transmitters out of a child's reach. Unsupervised children could lock themselves in the trunk and risk injury. Children should be taught not to play in vehicles.

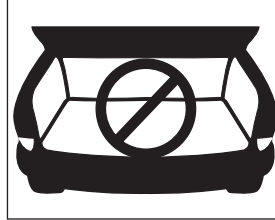

On hot days, the temperature in the trunk or vehicle interior can rise very quickly. Exposure of people or animals to these high temperatures for even a short time can cause death or serious heat-related injuries, including brain damage. Small children are particularly at risk.

REMOTE ENTRY SYSTEM (IF EQUIPPED)

This device complies with part 15 of the FCC rules and with RS-210 of Industry Canada. Operation is subject to the following two conditions: (1) This device may not cause harmful interference, and (2) This device must accept any interference received, including interference that may cause undesired operation.

Changes or modifications not expressly approved by the party responsible for compliance could void the user's authority to operate the equipment.

The remote entry system allows you to lock or unlock all vehicle doors without a key.

The remote entry features operate with the ignition in any position, except in RUN, with the transmission not in either P (Park) or N (Neutral).

If there is any potential remote keyless entry problem with your vehicle, ensure **ALL remote entry transmitters** are brought to the dealership, to aid in troubleshooting.

Locks and Security

Unlocking the doors

Press this control to unlock the driver's door. The interior lamps will illuminate.

Press the control a second time within five seconds to unlock all doors.

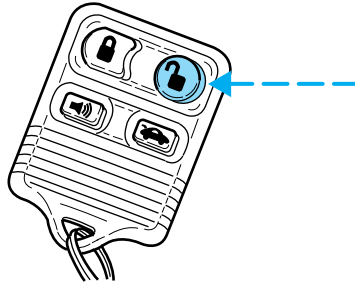

Locking the doors

Press this control to lock all doors.

The horn will chirp and the parklamps/taillamps will flash to confirm the control was pressed.

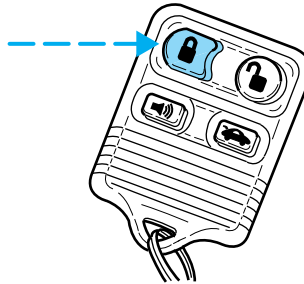

Deactivating/activating the horn chirp and flash confirmation feature

The horn chirp and flash confirmation feature can be turned on/off through the following procedure using the power door locks:

You must complete steps 1-7 within 30 seconds or the procedure will have to be repeated. If the procedure needs to be repeated, you must wait 30 seconds.

1. Turn the ignition key to ON.
2. Press the power door unlock control on the door panel three times.
3. Turn the ignition key from ON to OFF.
4. Press the power door unlock control three times.
5. Turn the ignition back to ON. The door locks will cycle lock/unlock.
6. With the ignition still in the ON position, press the unlock control twice.

Locks and Security

7. After a five to ten second delay, the door locks will cycle lock/unlock to confirm successful programming.

8. After having waited the necessary time for the programming to confirm, turn the ignition to OFF.

Sounding a panic alarm

Press this control to activate the alarm.

To deactivate the alarm, press the control again or turn the ignition to ACC or ON.

Panic alarm will only operate with the ignition in the OFF position.

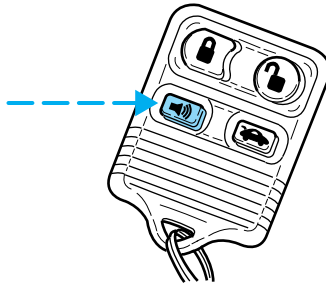

Opening the trunk

Press the control once to open the trunk.

Ensure that the trunk is closed and latched before driving your vehicle. Failure to latch the trunk may cause objects to fall out of the trunk or block the rear view. This feature will not work with the transmission out of P (Park) or N (Neutral) if the ignition is in either the ACC or ON position.

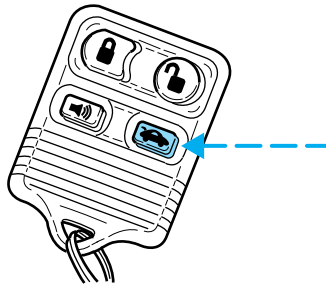

Replacing the battery

The remote entry transmitter uses one coin type three-volt lithium battery CR2032 or equivalent.

Locks and Security

To replace the battery:

1. Twist a thin coin between the two halves of the remote entry transmitter near the key ring. **DO NOT TAKE THE RUBBER COVER AND CIRCUIT BOARD OFF THE FRONT HOUSING OF THE REMOTE ENTRY TRANSMITTER.**

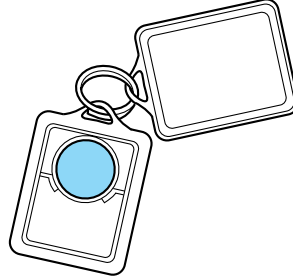

2. Do not wipe off any grease on the battery terminals on the back surface of the circuit board.

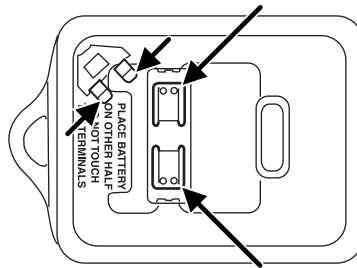

3. Remove the old battery. **Note:** Please refer to local regulations when disposing of transmitter batteries.

4. Insert the new battery. Refer to the diagram inside the remote entry transmitter for the correct orientation of the battery. Press the battery down to ensure that the battery is fully seated in the battery housing cavity.

5. Snap the two halves back together.

Note: Replacement of the battery will **not** cause the remote transmitter to become deprogrammed from your vehicle. The remote transmitter should operate normally after battery replacement.

Locks and Security

Replacing lost transmitters

Take all your vehicle's transmitters to your dealer if service is required.

If a remote transmitter has been lost and you would like to remove it from the vehicle's memory, or you would like to purchase additional remote transmitters and have them programmed to your vehicle:

- Take **all** your vehicle's transmitters to your dealer for programming, or
- Perform the following programming procedure yourself:

Place the key in the ignition and turn from 2 (LOCK) to 3 (OFF) and cycle between 3 (OFF) and 4 (ON) four times in rapid succession within 3 seconds. After doors lock/unlock, press any control on all transmitters (up to four). When completed, turn the ignition to 3 (OFF).

All transmitters **must** be programmed at the same time.

- When completed, turn the ignition to the 3 (OFF) position and wait at least 20 seconds in order to use the recently programmed transmitter(s).
- **All** transmitters **must** be programmed during the same programming cycle. A transmitter that is not programmed within the same programming cycle will be erased and will no longer operate your vehicle's locks. If this occurs, you will have to reprogram all the transmitters again, as you cannot just "add" a transmitter.

Illuminated entry

The interior lamps illuminate when the remote entry system is used to unlock the door(s) or sound the personal alarm.

The system automatically turns off after 25 seconds after the UNLOCK button on the remote transmitter is pressed or when the ignition is turned to the START or ACC position. The dome lamp control (if equipped) must **not** be set to the OFF position for the illuminated entry system to operate.

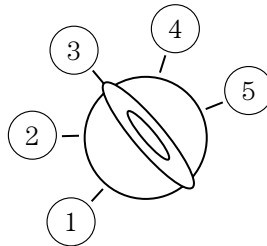
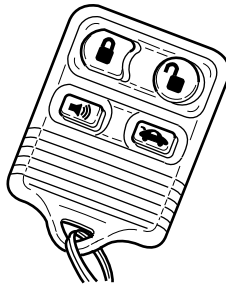

Locks and Security

The inside lights will not turn off if:

- they have been turned on with the dimmer control, or
- any door is open.

The battery saver will shut off the interior lamps 30 minutes after the last door is closed or after 10 minutes if the door is left open.

Autolock (if equipped)

This feature automatically locks all vehicle doors when:

- all doors are closed,
- the ignition is in the ON position,
- the brake pedal is depressed,
- you shift into any gear.

Relock

The autolock feature repeats when:

- ignition is in RUN
- a door is opened and closed
- the transmission is placed in reverse (R) or any drive gear, and then
- the brake pedal is depressed and then released

Deactivating/activating the autolock feature

Before following the procedure, make sure that the ignition is OFF and all vehicle doors are closed.

Automatic door locks can also be turned on/off through the following procedure:

You must complete steps 1-7 within 30 seconds or the procedure will have to be repeated. If the procedure needs to be repeated, you must wait 30 seconds.

1. Turn the ignition key to ON.
2. Press the power door unlock control on the door panel three times.
3. Turn the ignition key from ON to OFF.
4. Press the power door unlock control three times.
5. Turn the ignition back to ON.
6. The door locks will lock/unlock to confirm programming mode is entered/active.

80

Locks and Security

7. With the ignition still in the ON position, press the unlock control once. After a five to ten second delay, the door will lock/unlock to confirm successful programming.

8. After having waited the necessary time for the programming to confirm, turn the ignition to OFF.

Once disabled, the autolock feature can be enabled by repeating the procedure in steps 1–8.

KEYLESS ENTRY SYSTEM (IF EQUIPPED)

With the keyless entry keypad, you can:

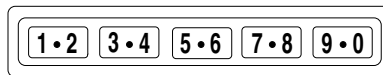

- lock or unlock the vehicle doors without using the key.
- open the trunk.

See also *Remote entry system* in this chapter for more information.

Your vehicle has a factory-set 5–digit code that operates the keyless entry system. You can also program your own 5–digit personal entry code.

The factory-set code is located:

- On the owner's wallet card in the glove compartment,
- Taped to the computer module, or
- At your dealer.

When using the keyless entry keypad, press the middle of each button in order to ensure a good activation.

Programming a personal entry code

You can program up to three personal codes to unlock your vehicle. These codes do not replace the permanent code that the dealership gave you.

To create your own personal entry code:

1. Enter the factory set code. **Note:** The keypad will illuminate when pressed.
2. Within five seconds press 1 • 2 on the keypad to enter the programming mode.
3. Enter your personal 5–digit code. Each number must be entered within five seconds of each other.

Locks and Security

4. Press 1 • 2 to store the first personal code.
5. The doors will lock then unlock to confirm programming of the new code.

To store a second personal code:

1. Enter the factory set code.
2. Within five seconds press 1 • 2 on the keypad to enter the programming mode.
3. Enter a second personal 5-digit code. Each number must be entered within five seconds of each other.
4. Press 3 • 4 to store the second personal code.
5. The doors will again lock then unlock to confirm programming of the new code.

To store a third personal code:

1. Enter the factory set code.
2. Within five seconds press 1 • 2 on the keypad to enter the programming mode.
3. Enter a third personal 5-digit code. Each number must be entered within five seconds of each other.
4. Press 5 • 6 (or 7 • 8, or 9 • 0, or wait five seconds) to store the third personal code.
5. The doors will again lock then unlock to confirm programming of the new code.

Tips:

- Do not set a code that uses five of the same number.
- Do not use five numbers in sequential order.
- The factory set code will work even if you have set your own personal code.
- If you set a second personal code it will erase your first personal code.

Erasing personal code

To erase all of the personal entry codes programmed to a vehicle:

1. Enter the factory-set code.
2. Press and release 1 • 2 within 5 seconds of step 1.
3. Press and hold 1 • 2 for two seconds. All of the vehicle doors will lock and then unlock to confirm erasure.

Locks and Security

Unlocking the doors and releasing the trunk with the keyless entry system

To unlock the driver door, enter either the factory-set code or personal code (each digit pressed within 5 seconds of prior digit). The interior lamps will illuminate.

- To **unlock all doors**, enter the factory-set code or personal code (driver door unlocks) and press 3 • 4 within five seconds.
- To **release the trunk**, enter the factory-set code or personal code (driver door unlocks) and press 5 • 6 within five seconds.

After the factory-set code or personal code has been entered, you can unlock all doors (press 3 • 4) and release the trunk (press 5 • 6) as long as the controls are pressed within 5 seconds of each other.

Locking doors with the keyless entry system

It is not necessary to enter the factory-set code prior to locking all doors. To **lock the doors**, press 7 • 8 and press 9 • 0 at the same time.

SECURILOCK™ PASSIVE ANTI-THEFT SYSTEM

SecuriLock™ passive anti-theft system is an engine immobilization system. This system is designed to prevent the engine from being started unless a **coded key programmed to your vehicle** is used.

The SecuriLock™ passive anti-theft system is not compatible with non-Ford aftermarket remote start systems. Use of these systems may result in vehicle starting problems and a loss of security protection.

THEFT INDICATOR

The theft indicator is the flashing red indicator located on the dash panel.

- When the ignition is in the 1 (OFF/LOCK) position, the indicator will flash once every 2 seconds to indicate the SecuriLock™ system is functioning as a theft deterrent.
- When the ignition is in the 3 (ON) position, the indicator will glow for 3 seconds to indicate normal system functionality.

If a problem occurs with the SecuriLock™ system, the indicator will flash rapidly or glow steadily when the ignition is in the 3 (ON) position. If this occurs, the vehicle should be taken to an authorized dealer for service.

Locks and Security

Automatic arming

The vehicle is armed immediately after switching the ignition to the 3 (OFF) or 2 (LOCK) position. The indicator on the instrument panel will flash every two seconds when the vehicle is armed.

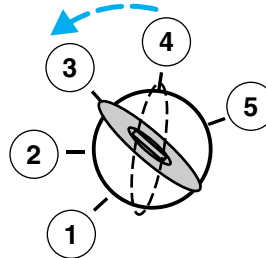

Automatic disarming

Switching the ignition to the 4 (ON) position with a **coded key** disarms the vehicle. The indicator on the instrument will illuminate for three seconds and then go out. If the indicator stays on for an extended period of time or flashes rapidly, have the system serviced by your dealership or a qualified technician.

Key information

Your vehicle is supplied with **two coded keys** (or three, if your vehicle is equipped with the valet feature). Only a **coded key** will start your vehicle. Spare coded keys can be purchased from your dealership. Your dealership can program your key or you can “do it yourself.” Refer to *Programming spare keys*.

The following items may prevent the vehicle from starting:

- Large metallic objects
- Electronic devices on the key chain that can be used to purchase gasoline or similar items
- A second key on the same key ring as the **coded key**

If any of these items are present, you need to keep these objects from touching the **coded key** while starting the engine. These objects and devices cannot damage the **coded key**, but can cause a momentary “no start” condition if they are too close to the key during engine start. If a problem occurs, turn ignition OFF and restart the engine with all other objects on the key ring held away from the ignition key. Check to make sure the **coded key** is an approved Ford **coded key**.

Locks and Security

If your keys are lost or stolen you will need to do the following:

- Use your spare key to start the vehicle, or
- Have your vehicle towed to a dealership or a locksmith. The key codes will need to be erased from your vehicle and new key codes will need to be re-coded.

Replacing coded keys can be very costly and you may want to store an extra programmed key away from the vehicle in a safe place to prevent an unforeseen inconvenience.

The correct **coded key** must be used for your vehicle. The use of the wrong type of **coded key** may lead to a “no start” condition.

If an unprogrammed key is used in the ignition it will cause a “no start” condition.

Programming spare keys

A maximum of eight keys can be coded to your vehicle. Only SecuriLock[™] keys can be used. To program a **coded key** yourself, you will need two previously programmed **coded keys** (keys that already operate your vehicle’s engine) and the new unprogrammed key(s) readily accessible for timely implementation of each step in the procedure.

If two previously programmed coded keys are not available, you must bring your vehicle to your dealership to have the spare coded key(s) programmed.

Please read and understand the entire procedure before you begin.

1. Insert the first previously programmed **coded key** into the ignition and turn the ignition from 3 (OFF) to 4 (ON) (maintain ignition in 4 (ON) for at least one second).

2. Turn ignition to 3 (OFF) then 2 (LOCK) and remove the first **coded key** from the ignition.

3. Within ten seconds of removing the first **coded key**, insert the second previously programmed **coded key** into the ignition and turn the ignition from 3 (OFF) to 4 (ON) (maintain ignition in 4 (ON) for at least one second but no more than ten seconds).

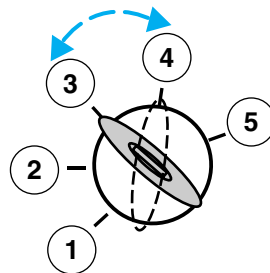

Locks and Security

4. Turn the ignition to 3 (OFF) then 2 (LOCK) and remove the second **coded key** from the ignition.
5. Within twenty seconds of removing the second **coded key**, insert the new unprogrammed key (new key) into the ignition and turn the ignition from 3 (OFF) to 4 (ON) (maintain ignition in 4 (ON) for at least one second). This step will program your new key.
6. To program additional new unprogrammed key(s), wait at least 20 seconds and repeat this procedure from Step 1.

If successful, the new coded key(s) will start the vehicle's engine and the theft indicator will illuminate for three seconds and then go out.

If not successful, the new coded key(s) will not start the vehicle's engine and the theft indicator will flash on and off. You may repeat Steps 1 through 6. If failure repeats, bring your vehicle to your dealership to have the new spare key(s) programmed.

Seating and Safety Restraints

SEATING

Adjustable head restraints

Your vehicle's seats are equipped with head restraints which are vertically adjustable. The purpose of these head restraints is to help limit head motion in the event of a rear collision. To properly adjust your head restraints, lift the head restraint so that it is located directly behind your head or as close to that position as possible. Refer to the following to raise and lower the head restraints.

The head restraints can be moved up and down.

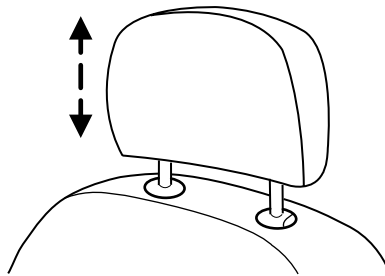

Push control to lower head restraint.

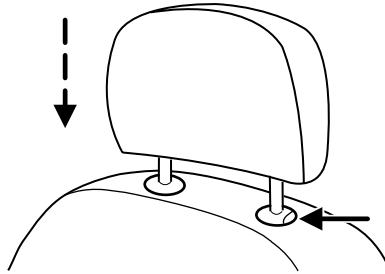

Adjusting the front manual seat (if equipped)



Never adjust the driver's seat or seatback when the vehicle is moving.



Always drive and ride with your seatback upright and the lap belt snug and low across the hips.

Seating and Safety Restraints

Lift handle to move seat forward or backward.

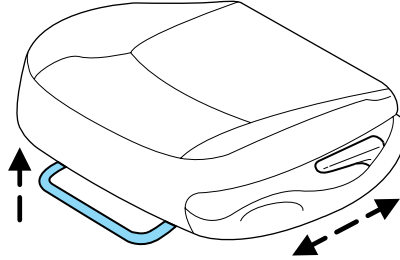

Pull lever up to adjust seatback.

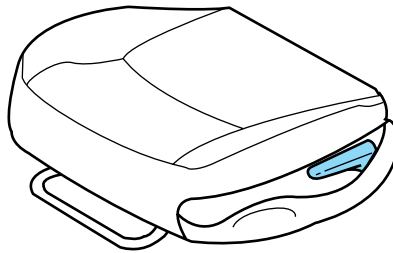

Using the manual recline function (if equipped)



Never adjust the driver's seat or seatback when the vehicle is moving.



Do not pile cargo higher than the seatbacks to avoid injuring people in a collision or sudden stop.



Always drive and ride with your seatback upright and the lap belt snug and low across the hips.



Reclining the seatback can cause an occupant to slide under the seat's safety belt, resulting in severe personal injuries in the event of a collision.

Seating and Safety Restraints

To adjust the front seatback using the manual recliner:

- Lift and hold the handle located on the side of the seat.
- Lean against the seatback to adjust it to your desired position. You can recline the seat back or bring it forward.
- Release the handle when the desired position has been reached.

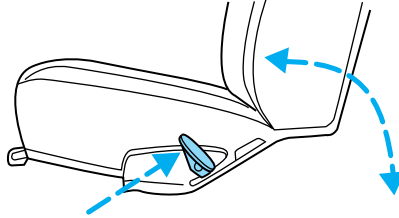

Using the power lumbar support (if equipped)

The power lumbar control is located on the outboard side of the seat.

Press one side of the control to adjust firmness.

Press the other side of the control to adjust softness.

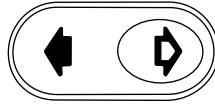

Heated seats (if equipped)

To operate the heated seats:

- Push the indicated side of the control for maximum heat.
- Push again to deactivate.

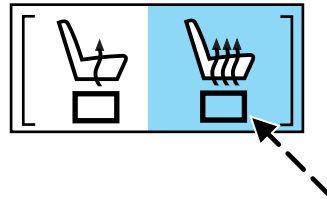

- Push the indicated side of the control for minimum heat.
- Push again to deactivate.

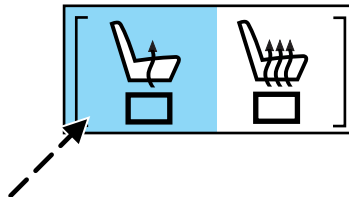

The heated seat module resets at every ignition run cycle. While the ignition is in the run position, activating the high or low heated seat switch enables heating mode. When activated, they will turn off automatically when the ignition is turned to the OFF position.

The indicator light will illuminate when the heated seats have been activated.

Seating and Safety Restraints

Adjusting the power front seats – door mounted controls (if equipped)

The controls for the power seats are located on the inside of each front door.



Never adjust the driver's seat or seatback when the vehicle is moving.



Do not pile cargo higher than the seatbacks to avoid injuring people in a collision or sudden stop.



Always drive and ride with your seatback upright and the lap belt snug and low across the hips.



Reclining the seatback can cause an occupant to slide under the seat's safety belt, resulting in severe personal injuries in the event of a collision.

Press the control to recline the seatback forward or backward.

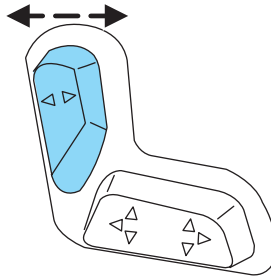

Seating and Safety Restraints

Press to move the seat forward or backward.

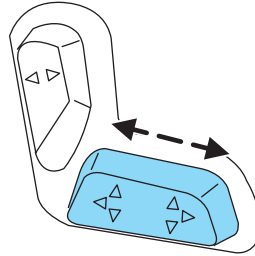

Press to move the front portion of the seat cushion up or down.

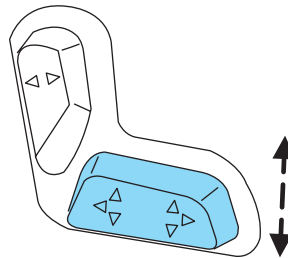

Press to move the rear portion of the seat cushion up or down.

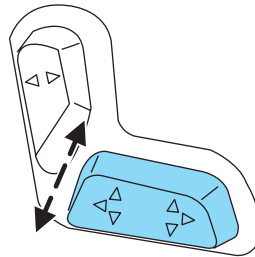

SAFETY RESTRAINTS

Personal Safety System

The Personal Safety System provides an improved overall level of frontal crash protection to front seat occupants and is designed to help further reduce the risk of air bag-related injuries. The system is able to analyze different occupant conditions and crash severity before activating the appropriate safety devices to help better protect a range of occupants in a variety of frontal crash situations.

Seating and Safety Restraints

Your vehicle's Personal Safety System consists of the following items:

- Driver and passenger dual-stage air bag supplemental restraints
- Driver and front passenger side air bags (if equipped)
- Front safety belts with pretensioners, energy management retractors, and safety belt usage sensors
- Driver's seat position sensor
- Front crash severity sensor
- Restraints Control Module (RCM) with impact and safing sensors
- Restraint system warning light and back-up tone
- The electrical wiring for the air bags, crash sensor(s), safety belt pretensioners, front safety belt usage sensors, driver seat position sensor, and indicator lights

How does the Personal Safety System work?

The Personal Safety System can adapt the deployment strategy of your vehicle's safety devices according to crash severity and occupant conditions. A collection of crash and occupant sensors provides information to the Restraints control module (RCM). During a crash, the RCM activates the safety belt pretensioners and/or either one or both stages of the dual-stage air bag supplemental restraints based on crash severity and occupant conditions.

The fact that the pretensioners or air bags did not activate for both front seat occupants in a collision does not mean that something is wrong with the system. Rather, it means the Personal Safety System determined the accident conditions (crash severity, belt usage, etc.) were not appropriate to activate these safety devices. Front air bags and pretensioners are designed to activate only in frontal and near-frontal collisions, not rollovers, side-impacts, or rear-impacts unless the collision causes sufficient longitudinal deceleration.

Driver and passenger dual-stage air bag supplemental restraints

The dual-stage air bags offer the capability to tailor the level of air bag inflation energy. A lower, less forceful energy level is provided for more common, moderate-severity impacts. A higher energy level is used for the most severe impacts. Refer to *Air bag supplemental restraints* section in this chapter.

Front crash severity sensor

The front crash severity sensor enhances the ability to detect the severity of an impact. Positioned up front, it provides valuable

Seating and Safety Restraints

information early in the crash event on the severity of the impact. This allows your Personal Safety System to distinguish between different levels of crash severity and modify the deployment strategy of the dual-stage air bags and safety belt pretensioners.

Driver's seat position sensor

The driver's seat position sensor allows your Personal Safety System to tailor the deployment level of the driver dual-stage air bag based on seat position. The system is designed to help protect smaller drivers sitting close to the driver air bag by providing a lower air bag output level.

Front safety belt usage sensors

The front safety belt usage sensors detect whether or not the driver and front outboard passenger safety belts are fastened. This information allows your Personal Safety System to tailor the air bag deployment and safety belt pretensioner activation depending upon safety belt usage. Refer to *Safety belt* section in this chapter.

Front safety belt pretensioners

The safety belt pretensioners at the front outboard seating positions are designed to tighten the safety belts firmly against the occupant's body during a frontal or near-frontal collision. This maximizes the effectiveness of the safety belts and helps properly position the occupant relative to the air bag to improve protection. The safety belt pretensioners can be either activated alone or, if the collision is of sufficient severity, together with the air bags.

Front safety belt energy management retractors

The front outboard safety belt energy management retractors allow webbing to be pulled out of the retractor in a gradual and controlled manner in response to the occupant's forward momentum. This helps reduce the risk of force-related injuries to the occupant's chest by limiting the load on the occupant. Refer to *Energy management feature* section in this chapter.

Determining if the Personal Safety System is operational

The Personal Safety System uses a warning light in the instrument cluster or a back-up tone to indicate the condition of the system. Refer to the *Warning light* section in the *Instrument cluster* chapter. Routine maintenance of the Personal Safety System is not required.

The Restraints control module (RCM) monitors its own internal circuits and the circuits for the air bag supplemental restraints, crash sensor(s),

Seating and Safety Restraints

safety belt pretensioners, front safety belt buckle sensors, and the driver seat position sensor. In addition, the RCM also monitors the restraints warning light in the instrument cluster. A difficulty with the system is indicated by one or more of the following.

- The warning light will either flash or stay lit.
- The warning light will not illuminate immediately after ignition is turned on.
- A series of five beeps will be heard. The tone pattern will repeat periodically until the problem and warning light are repaired.

If any of these things happen, even intermittently, have the Personal Safety System serviced at your dealership or by a qualified technician immediately. Unless serviced, the system may not function properly in the event of a collision.

Safety restraints precautions



Always drive and ride with your seatback upright and the lap belt snug and low across the hips.



To reduce the risk of injury, make sure children sit in the back seat where they can be properly restrained.



Never let a passenger hold a child on his or her lap while the vehicle is moving. The passenger cannot protect the child from injury in a collision.



All occupants of the vehicle, including the driver, should always properly wear their safety belts, even when an air bag supplemental restraint system (SRS) is provided.



It is extremely dangerous to ride in a cargo area, inside or outside of a vehicle. In a collision, people riding in these areas are more likely to be seriously injured or killed. Do not allow people to ride in any area of your vehicle that is not equipped with seats and safety belts. Be sure everyone in your vehicle is in a seat and using a safety belt properly.

Seating and Safety Restraints



In a rollover crash, an unbelted person is significantly more likely to die than a person wearing a safety belt.



Each seating position in your vehicle has a specific safety belt assembly which is made up of one buckle and one tongue that are designed to be used as a pair. 1) Use the shoulder belt on the outside shoulder only. Never wear the shoulder belt under the arm. 2) Never swing the safety belt around your neck over the inside shoulder. 3) Never use a single belt for more than one person.



Always transport children 12 years old and under in the back seat and always properly use appropriate child restraints.



Safety belts and seats can become hot in a vehicle that has been closed up in sunny weather; they could burn a small child. Check seat covers and buckles before you place a child anywhere near them.

Combination lap and shoulder belts

1. Insert the belt tongue into the proper buckle (the buckle closest to the direction the tongue is coming from) until you hear a snap and feel it latch. Make sure the tongue is securely fastened in the buckle.

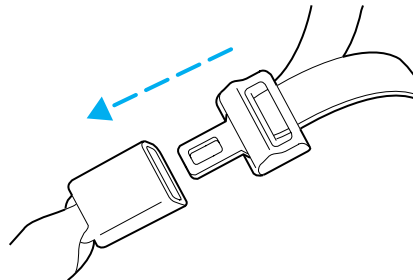

Seating and Safety Restraints

2. To unfasten, push the release button and remove the tongue from the buckle.

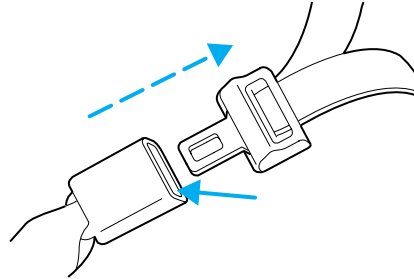

Energy management feature

- This vehicle has a seat belt system with an energy management feature at the front outboard seating positions to help further reduce the risk of injury in the event of a head-on collision.
- This seat belt system has a retractor assembly that is designed to pay out webbing in a controlled manner. This feature is designed to help reduce the belt force acting on the occupant's chest.

The front outboard and rear safety restraints in the vehicle are combination lap and shoulder belts. The front outboard passenger and rear seat safety belts have three types of locking modes described below:

Vehicle sensitive mode

This is the normal retractor mode, which allows free shoulder belt length adjustment to your movements and locking in response to vehicle movement. For example, if the driver brakes suddenly or turns a corner sharply, or the vehicle receives an impact of approximately 8 km/h (5 mph) or more, the combination safety belts will lock to help reduce forward movement of the driver and passengers.

Webbing extraction sensitive mode

The webbing sensitive locking mode locks the webbing and prevents more belt from being pulled out if the belt is pulled out too quickly. The belt will unlock when you stop pulling on it.

Automatic locking mode

In this mode, the shoulder belt is pre-locked. The belt will still retract to remove any slack in the shoulder belt.

The automatic locking mode is not available on the driver safety belt.

Seating and Safety Restraints

When to use the automatic locking mode

- **Any time** a child safety seat is installed in a passenger front outboard or any rear seating position. Children 12 years old and under should be properly restrained in the rear seat whenever possible. Refer to *Safety Restraints for Children* or *Safety Seats for Children* later in this chapter.

How to use the automatic locking mode

- Buckle the combination lap and shoulder belt.

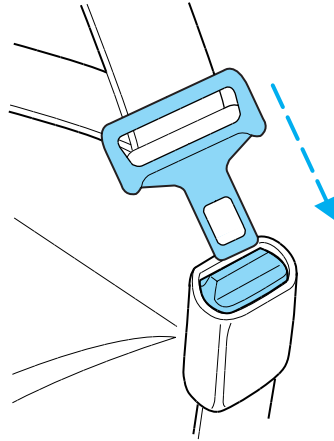

- Grasp the shoulder portion and pull downward until the entire belt is pulled out.



- Allow the belt to retract. As the belt retracts, you will hear a clicking sound. This indicates the safety belt is now in the automatic locking mode.

Seating and Safety Restraints

How to disengage the automatic locking mode

 Ford Motor Company recommends that all passenger safety belt assemblies and attaching hardware should be inspected by a qualified technician after any collision to verify that the "automatic locking retractor" feature for child seats is still working properly. Safety belt assemblies should be inspected according to the procedures in the Workshop Manual and replaced if either damage or improper operation is noted. Failure to replace the belt and retractor assembly could increase the risk of injury in a collision.

Unbuckle the combination lap/shoulder belt and allow it to retract completely to disengage the automatic locking mode and activate the vehicle sensitive (emergency) locking mode.

Front safety belt height adjustment

Your vehicle has safety belt height adjustments for the driver and front outboard passenger. Adjust the height of the shoulder belt so the belt rests across the middle of your shoulder.

To lower the shoulder belt height, push the button and slide the height adjuster down. To raise the height of the shoulder belt, push the button and slide the height adjuster up. Pull down on the height adjuster to make sure it is locked in place.

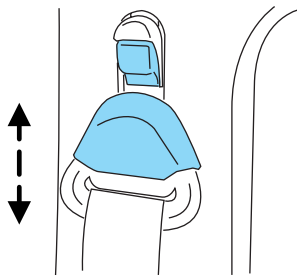

 Position the safety belt height adjusters so that the belt rests across the middle of your shoulder. Failure to adjust the safety belt properly could reduce the effectiveness of the seat belt and increase the risk of injury in a collision.

Seating and Safety Restraints

Lap belts

Adjusting the front center seat lap belt



The lap belt should fit snugly and as low as possible around the hips, not across the waist.

The lap belt does not adjust automatically. Insert the tongue into the correct buckle (the buckle closest to the direction the tongue is coming from). To lengthen the belt, turn the tongue at a right angle to the belt and pull across your lap until it reaches the buckle. To tighten the belt, pull the loose end of the belt through the tongue until it fits snugly across the hips.

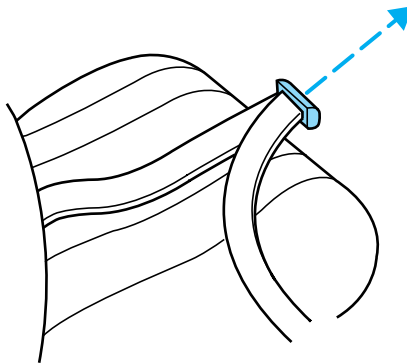

Shorten and fasten the belt when not in use.

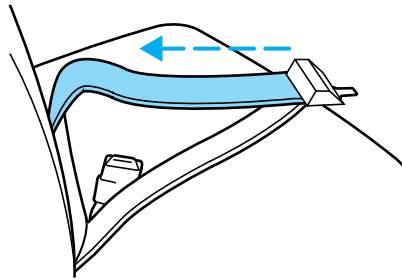

Safety belt warning light and indicator chime

The safety belt warning light illuminates in the instrument cluster and a chime sounds to remind the occupants to fasten their safety belts.

Seating and Safety Restraints

Conditions of operation

If...	Then...
The driver's safety belt is not buckled before the ignition switch is turned to the ON position...	The safety belt warning light illuminates 1-2 minutes and the warning chime sounds 4-8 seconds.
The driver's safety belt is buckled while the indicator light is illuminated and the warning chime is sounding...	The safety belt warning light and warning chime turn off.
The driver's safety belt is buckled before the ignition switch is turned to the ON position...	The safety belt warning light and indicator chime remain off.

BeltMinder

The BeltMinder feature is a supplemental warning to the safety belt warning function. This feature provides additional reminders to the driver that the driver's safety belt is unbuckled by intermittently sounding a chime and illuminating the safety belt warning lamp in the instrument cluster.

If...	Then...
The driver's safety belt is not buckled approximately 5 seconds after the safety belt warning light has turned off...	The BeltMinder feature is activated - the safety belt warning light illuminates and the warning chime sounds for 6 seconds every 30 seconds, repeating for approximately 5 minutes or until safety belt is buckled.
The driver's safety belt is buckled while the safety belt indicator light is illuminated and the safety belt warning chime is sounding...	The BeltMinder feature will not activate.

Seating and Safety Restraints

If...	Then...
The driver's safety belt is buckled before the ignition switch is turned to the ON position...	The BeltMinder feature will not activate.

The following are reasons most often given for not wearing safety belts:
(All statistics based on U.S. data)

Reasons given...	Consider...
"Crashes are rare events"	36700 crashes occur every day. The more we drive, the more we are exposed to "rare" events, even for good drivers. <i>1 in 4 of us will be seriously injured in a crash during our lifetime.</i>
"I'm not going far"	3 of 4 fatal crashes occur within 25 miles of home.
"Belts are uncomfortable"	We design our safety belts to enhance comfort. If you are uncomfortable - try different positions for the safety belt upper anchorage and seatback which should be as upright as possible; this can improve comfort.
"I was in a hurry"	Prime time for an accident. BeltMinder reminds us to take a few seconds to buckle up.
"Safety belts don't work"	Safety belts , when used properly, reduce risk of death to front seat occupants by 45% in cars , and by 60% in light trucks .
"Traffic is light"	Nearly 1 of 2 deaths occur in single-vehicle crashes , many when no other vehicles are around.
"Belts wrinkle my clothes"	Possibly, but a serious crash can do much more than wrinkle your clothes, particularly if you are unbelted.

Seating and Safety Restraints

Reasons given...	Consider...
“The people I’m with don’t wear belts”	Set the example, teen deaths occur 4 times more often in vehicles with TWO or MORE people. Children and younger brothers/sisters imitate behavior they see.
“I have an air bag”	Air bags offer greater protection when used with safety belts. Frontal airbags are not designed to inflate in rear and side crashes or rollovers.
“I’d rather be thrown clear”	Not a good idea. People who are ejected are 40 times more likely to DIE. Safety belts help prevent ejection, WE CAN’T “PICK OUR CRASH”.



Do not sit on top of a buckled safety belt to avoid the Belt Minder chime. Sitting on the safety belt will increase the risk of injury in an accident. To disable (one-time) or deactivate the Belt Minder feature please follow the directions stated below.

One time disable

Any time the safety belt is buckled and then unbuckled during an ignition ON cycle, the BeltMinder will be disabled for that ignition cycle only.

Deactivating/activating the BeltMinder feature

Read steps 1 - 9 thoroughly before proceeding with the deactivation/activation programming procedure.

The BeltMinder feature can be deactivated/activated by performing the following procedure:

Before following the procedure, make sure that:

- The parking brake is set
- The gearshift is in P (Park) (automatic transmission)
- The ignition switch is in the OFF position
- All vehicle doors are closed
- The driver’s safety belt is unbuckled

Seating and Safety Restraints

- The parklamps/headlamps are in OFF position (If vehicle is equipped with Autolamps, this will not affect the procedure.)



To reduce the risk of injury, do not deactivate/activate the Belt Minder feature while driving the vehicle.

1. Turn the ignition switch to the RUN (or ON) position. (DO NOT START THE ENGINE)
2. Wait until the safety belt warning light turns off. (Approximately 1–2 minutes)
 - Steps 3–5 must be completed within 60 seconds or the procedure will have to be repeated.
3. Buckle then unbuckle the safety belt three times, ending with the safety belt unbuckled. This can be done before or during BeltMinder warning activation.
4. Turn on the parklamps/headlamps, turn off the parklamps/headlamps.
5. Buckle then unbuckle the safety belt three times, ending with the safety belt unbuckled.
 - After step 5 the safety belt warning light will be turned on for three seconds.
6. Within seven seconds of the safety belt warning light turning off, buckle then unbuckle the safety belt.
 - This will disable BeltMinder if it is currently enabled, or enable BeltMinder if it is currently disabled.
7. Confirmation of disabling BeltMinder is provided by flashing the safety belt warning light four times per second for three seconds.
8. Confirmation of enabling BeltMinder is provided by flashing the safety belt warning light four times per second for three seconds, followed by three seconds with the safety belt warning light off, then followed by flashing the safety belt warning light four times per second for three seconds again.
9. After receiving confirmation, the deactivation/activation procedure is complete.

Seating and Safety Restraints

Safety belt extension assembly

If the safety belt is too short when fully extended, there is a 20 cm (8 inch) safety belt extension assembly that can be added (part number 611C22). This assembly can be obtained from your dealer at no cost.

Use only extensions manufactured by the same supplier as the safety belt. Manufacturer identification is located at the end of the webbing on the label. Also, use the safety belt extension only if the safety belt is too short for you when fully extended.



Do not use extensions to change the fit of the shoulder belt across the torso.

Safety belt maintenance

Inspect the safety belt systems periodically to make sure they work properly and are not damaged. Inspect the safety belts to make sure there are no nicks, tears or cuts. Replace if necessary. All safety belt assemblies, including retractors, buckles, front seat belt buckle assemblies, buckle support assemblies (slide bar-if equipped), shoulder belt height adjusters (if equipped), shoulder belt guide on seatback (if equipped), child safety seat LATCH and tether anchors, and attaching hardware, should be inspected after a collision. Ford Motor Company recommends that all safety belt assemblies in use in vehicles involved in a collision be replaced. However, if the collision was minor and a qualified technician finds that the belts do not show damage and continue to operate properly, they do not need to be replaced. Safety belt assemblies not in use during a collision should also be inspected and replaced if either damage or improper operation is noted.



Failure to inspect and if necessary replace the safety belt assembly under the above conditions could result in severe personal injuries in the event of a collision.

Refer to *Interior* in the *Cleaning* chapter.

Seating and Safety Restraints

AIR BAG SUPPLEMENTAL RESTRAINT SYSTEM (SRS)

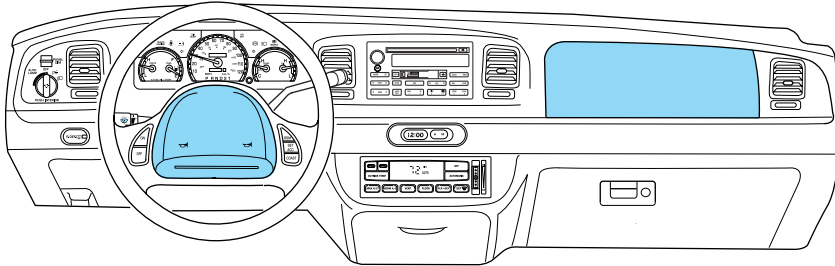

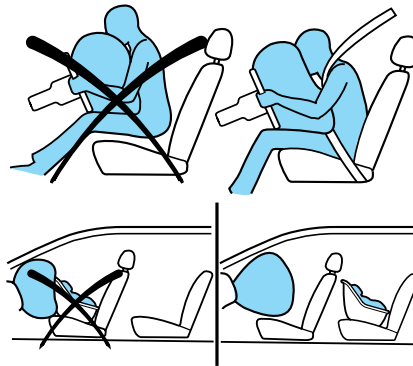

Important SRS precautions

The SRS is designed to work with the safety belt to help protect the driver and right front passenger from certain upper body injuries. Air bags DO NOT inflate slowly; there is a risk of injury from a deploying air bag.



 All occupants of the vehicle, including the driver, should always properly wear their safety belts, even when an air bag supplemental restraint system (SRS) is provided.

 Always transport children 12 years old and under in the back seat and always properly use appropriate child restraints.

 The National Highway Traffic Safety Administration (NHTSA) recommends a minimum distance of at least 25 cm (10 inches) between an occupant's chest and the driver air bag module.

Seating and Safety Restraints



Never place your arm over the air bag module as a deploying air bag can result in serious arm fractures or other injuries.

To properly position yourself away from the air bag:

- Move your seat to the rear as far as you can while still reaching the pedals comfortably.
- Recline the seat slightly one or two degrees from the upright position.



Do not put anything on or over the air bag module. Placing objects on or over the air bag inflation area may cause those objects to be propelled by the air bag into your face and torso causing serious injury.



Do not attempt to service, repair, or modify the air bag supplemental restraint systems or its fuses. See your Ford or Lincoln Mercury dealer.



The front passenger air bag is not designed to offer protection to an occupant in the center front seating position.



Modifying or adding equipment to the front end of the vehicle (including frame, bumper, front end body structure and tow hooks) may affect the performance of the air bag system, increasing the risk of injury. Do not modify the front end of the vehicle.

Seating and Safety Restraints

Children and air bags

Children must always be properly restrained. Accident statistics suggest that children are safer when properly restrained in the rear seating positions than in the front seating position. Failure to follow these instructions may increase the risk of injury in a collision.

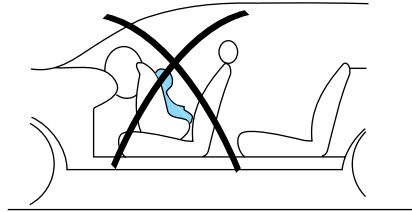

Air bags can kill or injure a child in a child seat.

NEVER place a rear-facing child seat in front of an active air bag. If you must use a forward-facing child seat in the front seat, move the seat all the way back.

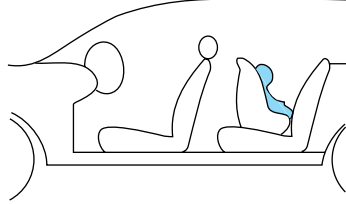

How does the air bag supplemental restraint system work?

The air bag SRS is designed to activate when the vehicle sustains longitudinal deceleration sufficient to cause the sensors to close an electrical circuit that initiates air bag inflation.

The fact that the air bags did not inflate in a collision does not mean that something is wrong with the system. Rather, it means the forces were not of the type sufficient to cause activation. Driver and passenger airbags are designed to inflate in frontal and near-frontal collisions, not rollover, side-impact, or rear-impacts unless the collision causes sufficient longitudinal deceleration.

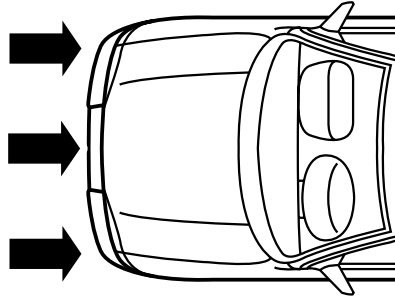

Seating and Safety Restraints

The air bags inflate and deflate rapidly upon activation. After air bag deployment, it is normal to notice a smoke-like, powdery residue or smell the burnt propellant. This may consist of cornstarch, talcum powder (to lubricate the bag) or sodium compounds (e.g., baking soda) that result from the combustion process that inflates the air bag. Small amounts of sodium hydroxide may be present which may irritate the skin and eyes, but none of the residue is toxic.



While the system is designed to help reduce serious injuries, contact with a deploying air bag may also cause abrasions, swelling or temporary hearing loss. Because air bags must inflate rapidly and with considerable force, there is the risk of death or serious injuries such as fractures, facial and eye injuries or internal injuries, particularly to occupants who are not properly restrained or are otherwise out of position at the time of air bag deployment. Thus, it is extremely important that occupants be properly restrained as far away from the air bag module as possible while maintaining vehicle control.

The SRS consists of the following items:

- Driver and passenger air bag modules (which include the inflators and air bags)
- Driver and passenger side air bags
- One or more impact and safing sensors
- A readiness light and tone
- A diagnostic module
- The electrical wiring which connects the components

The diagnostic module monitors its own internal circuits as well as the supplemental air bag electrical system wiring (including the impact sensors), the system wiring, the air bag system readiness light, the air bag back up power and the air bag ignitors.



Several air bag system components get hot after inflation. Do not touch them after inflation.

Seating and Safety Restraints



If the air bag has deployed, **the air bag will not function again and must be replaced immediately**. If the air bag is not replaced, the unrepaired area will increase the risk of injury in a collision.



If the safety belt pretensioners deploy in an accident, they will not function again (belt will not extract or retract) and must be replaced immediately. Failure to replace the retractor assemblies will increase the risk of injury.

Determining if the system is operational

The SRS uses a readiness light in the instrument cluster or a tone to indicate the condition of the system. Refer to *Air bag readiness* section in the *Instrument Cluster* chapter. Routine maintenance of the air bag is not required.

A difficulty with the system is indicated by one or more of the following:

- The readiness light will either flash or stay lit.
- The readiness light will not illuminate immediately after ignition is turned on.
- A series of five beeps will be heard. The tone pattern will repeat periodically until the problem and/or light are repaired.

**AIR
BAG**

If any of these things happen, even intermittently, have the SRS serviced at your dealership or by a qualified technician immediately. Unless serviced, the system may not function properly in the event of a collision.

Side air bag system (if equipped)





Do not place objects or mount equipment on or near the air bag cover on the side of the seatbacks of the front seats or in front seat areas that may come into contact with a deploying air bag. Failure to follow these instructions may increase the risk of personal injury in the event of a collision.

Seating and Safety Restraints

 Do not use accessory seat covers. The use of accessory seat covers may prevent the deployment of the side air bags and increase the risk of injury in an accident.

 Do not lean your head on the door. The side air bag could injure you as it deploys from the side of the seatback.

 Do not attempt to service, repair, or modify the air bag SRS, its fuses or the seat cover on a seat containing an air bag. See your Ford or Lincoln Mercury dealer.

 All occupants of the vehicle should always wear their safety belts even when an air bag SRS is provided.

How does the side air bag system work?

The design and development of the side airbag system included recommended testing procedures that were developed by a group of automotive safety experts known as the Side Airbag Technical Working Group. These recommended testing procedures help reduce the risk of injuries related to the deployment of side airbags.

The side air bag system consists of the following:

- An inflatable nylon bag (air bag) with a gas generator concealed behind the outboard bolster of the driver and front passenger seatbacks.
- A special seat cover designed to allow airbag deployment.
- The same warning light, electronic control and diagnostic unit as used for the front air bags.
- Two crash sensors located near the side of the vehicle.

Side air bags, in combination with seat belts, can help reduce the risk of severe injuries in the event of a significant side impact collision.

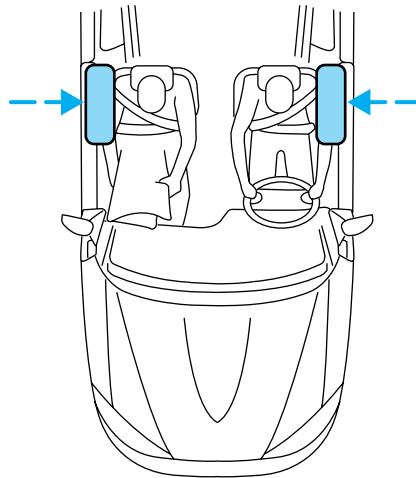

Seating and Safety Restraints

The side air bags are fitted on the outboard side of the seatbacks of the front seats. In certain lateral collisions, the air bag on the side affected by the collision will be inflated. The air bag was designed to inflate between the door panel and occupant to further enhance the protection provided occupants in side impact collisions.

The air bag SRS is designed to activate when the vehicle sustains lateral deceleration sufficient to cause the sensors to close an electrical circuit that initiates air bag inflation.

The fact that the air bags did not inflate in a collision does not mean that something is wrong with the system. Rather, it means the forces were not of the type sufficient to cause activation. Side air bags are designed to inflate in side-impact collisions, not roll-over, rear-impact, frontal or near-frontal collisions, unless the collision causes sufficient lateral deceleration.



Several air bag system components get hot after inflation. Do not touch them after inflation.



If the side air bag has deployed, **the air bag will not function again. The side air bag system (including the seat) must be inspected and serviced by a qualified technician in accordance with the vehicle service manual.** If the air bag is not replaced, the unrepaired area will increase the risk of injury in a collision.

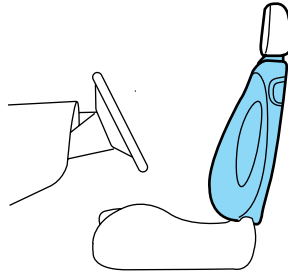

Determining if the system is operational

The SRS uses a readiness light in the instrument cluster or a tone to indicate the condition of the system. Refer to the *Air bag readiness* section in the *Instrument cluster* chapter. Routine maintenance of the side air bag is not required.

A difficulty with the system is indicated by one or more of the following:

- The readiness light (same light as for front air bag system) will either flash or stay lit.

Seating and Safety Restraints

- The readiness light will not illuminate immediately after ignition is turned on.
- A series of five beeps will be heard. The tone pattern will repeat periodically until the problem and/or light are repaired.

If any of these things happen, even intermittently, have the SRS serviced at your dealership or by a qualified technician immediately. Unless serviced, the system may not function properly in the event of a collision.

Disposal of air bags and air bag equipped vehicles (including pretensioners)

See your local dealership or qualified technician. Air bags **MUST BE** disposed of by qualified personnel.

SAFETY RESTRAINTS FOR CHILDREN

See the following sections for directions on how to properly use safety restraints for children. Also see *Air bag supplemental restraint system (SRS)* in this chapter for special instructions about using air bags.

Important child restraint precautions

You are required by law to use safety restraints for children in the U.S. and Canada. If small children (generally children who are four years old or younger and who weigh 18 kg [40 lbs] or less) ride in your vehicle, you must put them in safety seats made especially for children. Many states require that children use approved booster seats until they are eight years old. Check your local and state or provincial laws for specific requirements regarding the safety of children in your vehicle. When possible, always place children under age 12 in the rear seat of your vehicle. Accident statistics suggest that children are safer when properly restrained in the rear seating positions than in the front seating position.



Never let a passenger hold a child on his or her lap while the vehicle is moving. The passenger cannot protect the child from injury in a collision.

Always follow the instructions and warnings that come with any infant or child restraint you might use.

Children and safety belts

If the child is the proper size, restrain the child in a safety seat.

Children who are too large for child safety seats (as specified by your child safety seat manufacturer) should always wear safety belts.

Seating and Safety Restraints

Follow all the important safety restraint and air bag precautions that apply to adult passengers in your vehicle.

If the shoulder belt portion of a combination lap and shoulder belt can be positioned so it does not cross or rest in front of the child's face or neck, the child should wear the lap and shoulder belt. Moving the child closer to the center of the vehicle may help provide a good shoulder belt fit.



Do not leave children, unreliable adults, or pets unattended in your vehicle.

Child booster seats

Children outgrow a typical convertible or toddler seat when they weigh 40 pounds and are around 4 years of age. Although the lap/shoulder belt will provide some protection, these children are still too small for lap/shoulder belts to fit properly, which could increase the risk of serious injury.

To improve the fit of both the lap and shoulder belt on children who have outgrown child safety seats, Ford Motor Company recommends use of a belt-positioning booster.

Booster seats position a child so that safety belts fit better. They lift the child up so that the lap belt rests low across the hips and the knees bend comfortably. Booster seats also make the shoulder belt fit better and more comfortably for growing children.

When children should use booster seats

Children need to use booster seats from the time they outgrow the toddler seat until they are big enough for the vehicle seat and lap/shoulder belt to fit properly. Generally this is when they weigh about 80 lbs (about 8 to 12 years old).

Booster seats should be used until you can answer YES to ALL of these questions:

- Can the child sit all the way back against the vehicle seat back with knees bent comfortably at the edge of the seat without slouching?

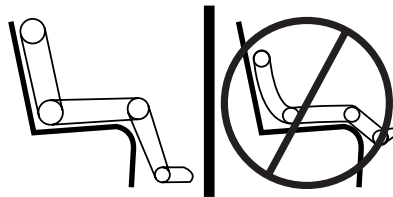

- Does the lap belt rest low across the hips?

Seating and Safety Restraints

- Is the shoulder belt centered on the shoulder and chest?
- Can the child stay seated like this for the whole trip?

Types of booster seats

There are two types of belt-positioning booster seats:

- Those that are backless.

If your backless booster seat has a removable shield, remove the shield and use the lap/shoulder belt. If a seating position has a low seat back and no head restraint, a backless booster seat may place your child's head (top of ear level) above the top of the seat. In this case, move the backless booster to another seating position with a higher seat back and lap/shoulder belts.



- Those with a high back.

If, with a backless booster seat, you cannot find a seating position that adequately supports your child's head, a high back booster seat would be a better choice.



Both can be used in any vehicle in a seating position equipped with lap/shoulder belts if your child is over 40 lbs.

The shoulder belt should cross the chest, resting snugly on the center of the shoulder. The lap belt should rest low and snug across the hips, never up high across the stomach.

If the booster seat slides on the vehicle seat, placing a rubberized mesh sold as shelf or carpet liner under the booster seat may improve this condition.

The importance of shoulder belts

Using a booster without a shoulder belt increases the risk of a child's head hitting a hard surface in a collision. For this reason, you should

Seating and Safety Restraints

never use a booster seat with a lap belt only. It is best to use a booster seat with lap/shoulder belts in the back seat- the safest place for children to ride.



Follow all instructions provided by the manufacturer of the booster seat.



Never put the shoulder belt under a child's arm or behind the back because it eliminates the protection for the upper part of the body and may increase the risk of injury or death in a collision.



Never use pillows, books, or towels to boost a child. They can slide around and increase the likelihood of injury or death in a collision.

SAFETY SEATS FOR CHILDREN

Child and infant or child safety seats

Use a safety seat that is recommended for the size and weight of the child. Carefully follow all of the manufacturer's instructions with the safety seat you put in your vehicle. If you do not install and use the safety seat properly, the child may be injured in a sudden stop or collision.

When installing a child safety seat:

- Review and follow the information presented in the *Air bag supplemental restraint system (SRS)* section in this chapter.
- Use the correct safety belt buckle for that seating position (the buckle closest to the direction the tongue is coming from).
- Insert the belt tongue into the proper buckle until you hear a snap and feel it latch. Make sure the tongue is securely fastened in the buckle.
- Keep the buckle release button pointing up and away from the safety seat, with the tongue between the child seat and the release button, to prevent accidental unbuckling.

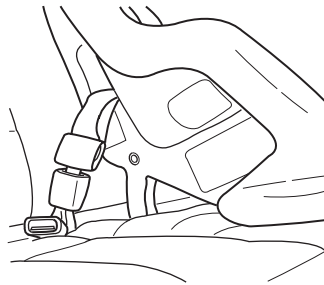

Seating and Safety Restraints

- Place seat back in upright position.
- Put the safety belt in the automatic locking mode. Refer to *Automatic locking mode* (passenger side front and outboard rear seating positions) (if equipped) section in this chapter.
- LATCH lower anchors are recommended for use by children up to 22 kg (48 pounds) in a child restraint. Top tether anchors can be used for children up to 27 kg (60 pounds) in a child restraint, and to provide upper torso restraint for children up to 36 kg (80 pounds) using an upper torso harness and a belt-positioning booster.

Ford recommends the use of a child safety seat having a top tether strap. Install the child safety seat in a seating position with LATCH and tether anchors. For more information on top tether straps and anchors, refer to *Attaching safety seats with tether straps* in this chapter. For more information of LATCH anchors refer to *Attaching safety seats with LATCH (Lower Anchors and Tethers for Children) attachments* in this chapter.



Carefully follow all of the manufacturer's instructions included with the safety seat you put in your vehicle. If you do not install and use the safety seat properly, the child may be injured in a sudden stop or collision.



Rear-facing child seats or infant carriers should never be placed in the front seats.

Installing child safety seats with combination lap and shoulder belts



Air bags can kill or injure a child in a child seat. **NEVER** place a rear-facing child seat in front of an active air bag. If you must use a forward-facing child seat in the front seat, move the seat all the way back.



Children 12 and under should be properly restrained in the rear seat whenever possible.

Seating and Safety Restraints

1. Position the child safety seat in a seat with a combination lap and shoulder belt.

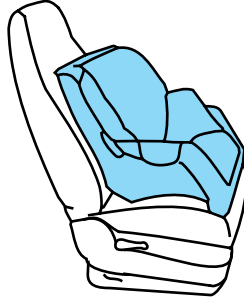

2. Pull down on the shoulder belt and then grasp the shoulder belt and lap belt together.

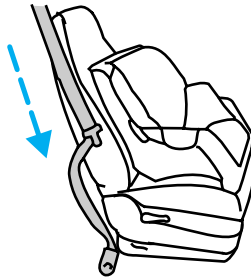

3. While holding the shoulder and lap belt portions together, route the tongue through the child seat according to the child seat manufacturer's instructions. Be sure the belt webbing is not twisted.

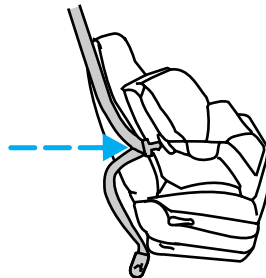

Seating and Safety Restraints

4. Insert the belt tongue into the proper buckle (the buckle closest to the direction the tongue is coming from) for that seating position until you hear a snap and feel the latch engage. Make sure the tongue is latched securely by pulling on it.

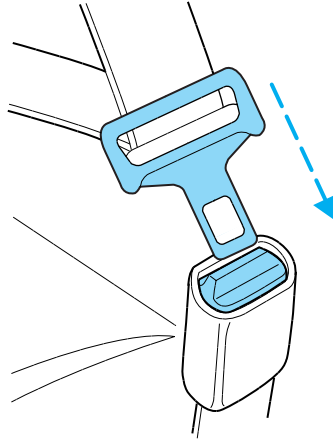

5. To put the retractor in the automatic locking mode, grasp the shoulder portion of the belt and pull downward until all of the belt is pulled out and a click is heard.

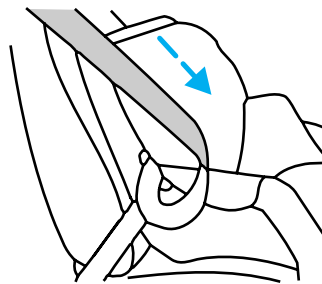

6. Allow the belt to retract. The belt will click as it retracts to indicate it is in the automatic locking mode.

7. Pull the lap belt portion across the child seat toward the buckle and pull up on the shoulder belt while pushing down with your knee on the child seat.

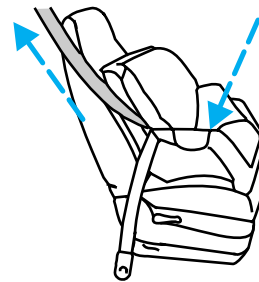

Seating and Safety Restraints

8. Allow the safety belt to retract to remove any slack in the belt.

9. Before placing the child in the seat, forcibly move the seat forward and back to make sure the seat is securely held in place. To check this, grab the seat at the belt path and attempt to move it side to side and forward. There should be no more than one inch of movement for proper installation.

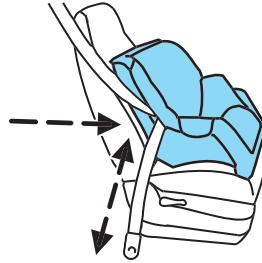

10. Try to pull the belt out of the retractor to make sure the retractor is in the automatic locking mode (you should not be able to pull more belt out). If the retractor is not locked, unbuckle the belt and repeat steps two through nine.

Check to make sure the child seat is properly secured before each use.

Attaching child safety seats with tether straps

Most new forward-facing child safety seats include a tether strap which goes over the back of the seat and hooks to an anchoring point. Tether straps are available as an accessory for many older safety seats. Contact the manufacturer of your child seat for information about ordering a tether strap.

The rear seats of your vehicle are equipped with built-in tether strap anchors located behind the seats as described below.

The tether anchors in your vehicle are located under a cover marked with the tether anchor symbol (shown with title).

The tether strap anchors in your vehicle are in the following positions (shown from top view):

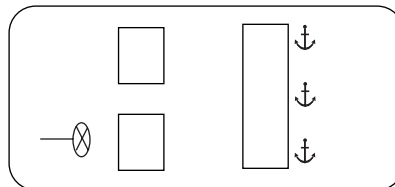

Attach the tether strap only to the appropriate tether anchor as shown. The tether strap may not work properly if attached somewhere other than the correct tether anchor.

1. Position the child safety seat on the seat cushion.

Seating and Safety Restraints

2. Route the child safety seat tether strap over the back of the seat.

For vehicles with adjustable head restraints, route the tether strap under the head restraint and between the head restraint posts, otherwise route the tether strap over the top of the seatback.

3. Locate the correct anchor for the selected seating position.



4. Open the tether anchor cover.

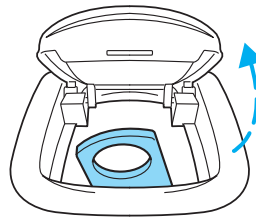

5. Clip the tether strap to the anchor as shown.



If the tether strap is clipped incorrectly, the child safety seat may not be retained properly in the event of a collision.

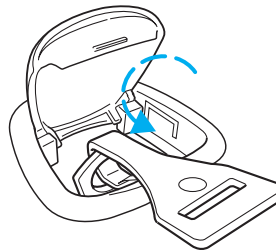

6. Install the child safety seat tightly using the LATCH anchors or safety belts. Follow the instructions in this chapter.

7. Tighten the child safety seat tether strap according to the manufacturer's instructions.



If the safety seat is not anchored properly, the risk of a child being injured in a collision greatly increases.

Seating and Safety Restraints

Attaching safety seats with LATCH (Lower Anchors and Tethers for Children) attachments

Some child safety seats have two rigid or webbing mounted attachments that connect to two anchors at certain seating positions in your vehicle. This type of child seat eliminates the need to use seat belts to attach the child seat. For forward-facing child seats, the tether strap must also be attached to the proper tether anchor. See *Attaching safety seats with tether straps* in this chapter.

Your vehicle has LATCH anchors for child seat installation at the seating positions marked with the child seat symbol.

The anchors on both sides of the center of the rear seat are provided for child seats at the outboard seats, and are further apart than the pairs of lower anchors for child seat installation at other seats. DO NOT install child seats with LATCH attachments (rigid or mounted on belt webbing) to the lower anchors at the center rear seat. If you install a child seat at the center rear position, use the vehicle belt and the top tether anchor.

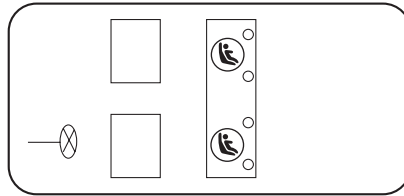

Never attach two LATCH child safety seats to the same anchor. In a crash, one anchor may not be strong enough to hold two child safety seat attachments and may break, causing serious injury or death.

Seating and Safety Restraints

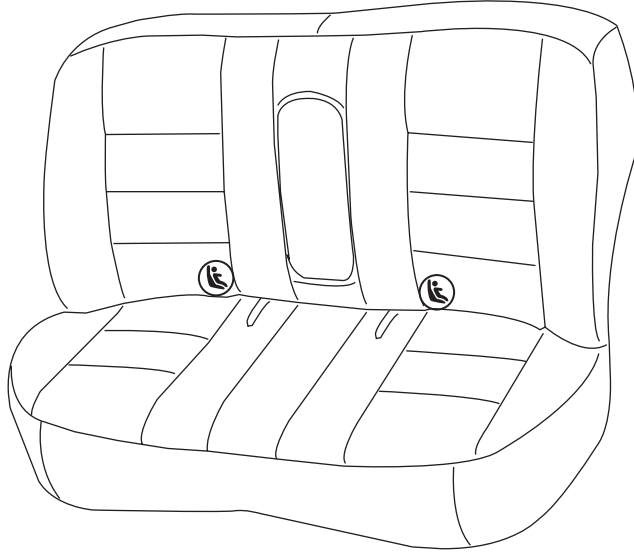

The lower anchors for child seat installation are located at the rear section of the rear seat between the cushion and seat back. The inboard LATCH anchors are located below the locator symbols on the seat back. The outboard LATCH anchors are 11 inches (280 mm) outboard of the locator symbols, behind the matching slits in the bottom edge of the seat back.

Follow the child seat manufacturer's instructions to properly install a child seat with LATCH attachments. Two plastic LATCH guides can be obtained at no charge from any Ford or Lincoln-Mercury dealer. They snap onto the LATCH lower anchors in the seat to help attach a child seat with rigid attachments. The guides hold the seat trim away to expose the anchor and make it easier to attach some child seats.

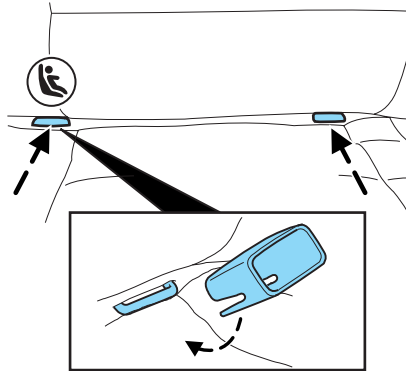

Seating and Safety Restraints



Attach LATCH lower attachments of the child seat only to the anchors shown.

If you install a child seat with rigid LATCH attachments, do not tighten the tether strap enough to lift the child seat off the vehicle seat cushion when the child is seated in it. Keep the tether strap just snug without lifting the front of the child seat. Keeping the child seat just touching the vehicle seat gives the best protection in a severe crash.

Each time you use the safety seat, check that the seat is properly attached to the lower anchors and tether anchor. Try to tilt the child seat from side to side. Also try to tug the seat forward. Check to see if the anchors hold the seat in place.



If the safety seat is not anchored properly, the risk of a child being injured in a crash greatly increases.

Driving

STARTING

Positions of the ignition

1. ACCESSORY, allows the electrical accessories such as the radio to operate while the engine is not running.

2. LOCK, locks steering wheel (police vehicles only), the automatic transmission gearshift lever and allows key removal.

3. OFF, shuts off the engine and all accessories without locking the steering wheel. This position also allows the automatic transmission shift lever to be moved from the P (Park) position without the brake pedal being depressed.

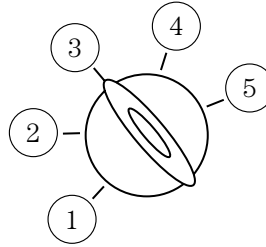

When the key is in the ignition and in the OFF position, the automatic transmission shift lever can be moved from the P (Park) position without the brake pedal depressed. To avoid unwanted vehicle movement, always set the parking brake.

4. ON, all electrical circuits operational. Warning lights illuminated. Key position when driving.

5. START, cranks the engine. Release the key as soon as the engine starts.

Preparing to start your vehicle

Engine starting is controlled by the powertrain control system. This system meets all Canadian Interference-Causing Equipment standard requirements regulating the impulse electrical field strength of radio noise.

When starting a fuel-injected engine, avoid pressing the accelerator before or during starting. Only use the accelerator when you have difficulty starting the engine. For more information on starting the vehicle, refer to *Starting the engine* in this chapter.



Extended idling at high engine speeds can produce very high temperatures in the engine and exhaust system, creating the risk of fire or other damage.

Driving

 Do not park, idle, or drive your vehicle in dry grass or other dry ground cover. The emission system heats up the engine compartment and exhaust system, which can start a fire.

 Do not start your vehicle in a closed garage or in other enclosed areas. Exhaust fumes can be toxic. Always open the garage door before you start the engine. See *Guarding against exhaust fumes* in this chapter for more instructions.

 If you smell exhaust fumes inside your vehicle, have your dealer inspect your vehicle immediately. Do not drive if you smell exhaust fumes.

Important safety precautions

A computer system controls the engine's idle revolutions per minute (RPM). When the engine starts, the idle RPM runs higher than normal in order to warm the engine. If the engine idle speed does not slow down automatically, have the vehicle checked. Do not allow the vehicle to idle for more than 10 minutes at the higher engine RPM.

Before starting the vehicle:

1. Make sure all vehicle occupants have buckled their safety belts. For more information on safety belts and their proper usage, refer to the *Seating and Safety Restraints* chapter.
2. Make sure the headlamps and vehicle accessories are off.
3. Make sure the gearshift is in P (Park).



Driving

4. Make sure the parking brake is set.

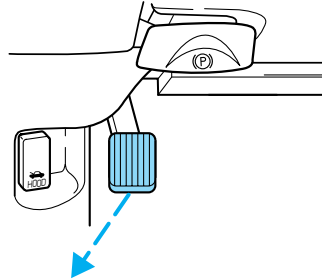

5. Turn the key to 4 (ON) without turning the key to 5 (START).

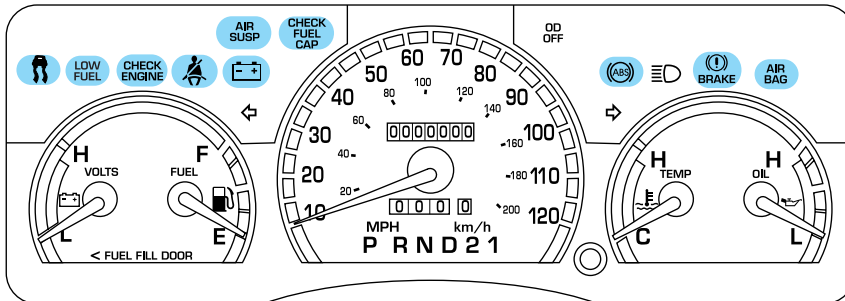
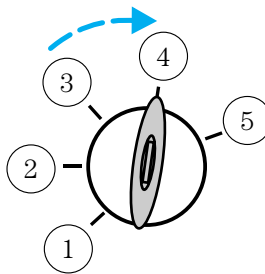

Driving

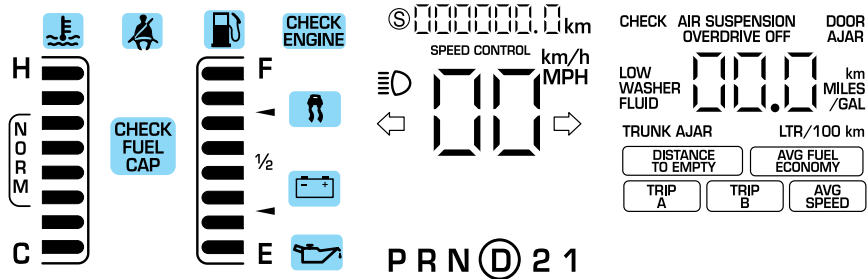

Make sure the corresponding lights illuminate or illuminate briefly. If a light fails to illuminate, have the vehicle serviced.

- If the driver's safety belt is fastened, the  light may not illuminate.

Starting the engine

1. Turn the key to 4 (ON) without turning the key to 5 (START).
2. Turn the key to 5 (START), then release the key as soon as the engine starts. Excessive cranking could damage the starter.

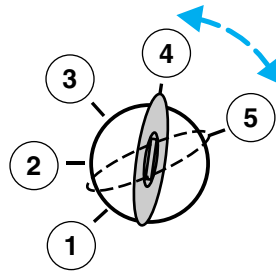

Note: If the engine does not start within five seconds on the first try, turn the key to 3 (OFF), wait 10 seconds and try again. If the engine still fails to start, press the accelerator to the floor and try again; this will allow the engine to crank with the fuel shut off in case the engine is flooded with fuel.

Using the engine block heater (if equipped)

Use of an engine block heater is strongly recommended if you live in a region where temperatures reach -10°F (-23°C) or below. For best results, plug the heater in at least three hours before starting the vehicle. The heater can be plugged in the night before starting the vehicle.

Driving



To reduce the risk of electrical shock, do not use your heater with ungrounded electrical systems or two-pronged (cheater) adapters.

Guarding against exhaust fumes

Carbon monoxide is present in exhaust fumes. Take precautions to avoid its dangerous effects.



If you smell exhaust fumes inside your vehicle, have your dealer inspect your vehicle immediately. Do not drive if you smell exhaust fumes.

Important ventilating information

If the engine is idling while the vehicle is stopped for a long period of time, open the windows at least one inch (2.5 cm) or adjust the heating or air conditioning to bring in fresh air.

BRAKES

Your service brakes are self-adjusting. Refer to the scheduled maintenance guide for scheduled maintenance.

Occasional brake noise is normal and often does not indicate a performance concern with the vehicle's brake system. In normal operation, automotive brake systems may emit occasional or intermittent squeal or groan noises when the brakes are applied. Such noises are usually heard during the first few brake applications in the morning; however, they may be heard at any time while braking and can be aggravated by environmental conditions such as cold, heat, moisture, road dust, salt or mud. If a "metal-to-metal," "continuous grinding" or "continuous squeal" sound is present while braking, the brake linings may be worn-out and should be inspected by a qualified service technician.

Refer to *Brake system warning light* in the *Instrument Cluster* chapter for information on the brake system warning light.



Driving



If you are driving down a long or steep hill, shift to a lower gear. Do not apply your brakes continuously, as they may overheat and become less effective.

Under normal operating conditions, brake dust may accumulate on the wheels. Some brake dust is inevitable as brakes wear and does not contribute to brake noise. The use of modern friction materials with emphasis on improved performance and environmental considerations can lead to more dust than in the past. Brake dust can be cleaned by weekly washing with soapy water and a soft sponge. Heavier deposits can be removed with Motorcraft Wheel and Tire Cleaner (ZC-37-A).

Anti-lock brake system (ABS)

This vehicle is equipped with an anti-lock braking system (ABS). A noise from the hydraulic pump motor and pulsation in the pedal may be observed during ABS braking events. Pedal pulsation coupled with noise while braking under panic conditions or on loose gravel, bumps, wet or snowy roads is normal and indicates proper functioning of the vehicle's anti-lock brake system. If the vehicle has continuous vibration or shudder in the steering wheel while braking, the vehicle should be inspected by a qualified service technician.

The ABS operates by detecting the onset of wheel lockup during brake applications and compensates for this tendency. The wheels are prevented from locking even when the brakes are firmly applied. The accompanying illustration depicts the advantage of an ABS equipped vehicle (on bottom) to a non-ABS equipped vehicle (on top) during hard braking with loss of front braking traction.

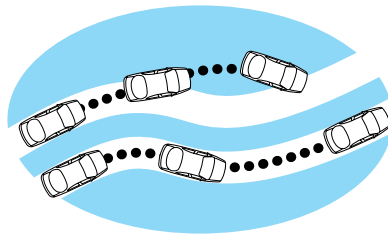

Using ABS

- In an emergency or when maximum efficiency from the four-wheel ABS is required, apply continuous force on the brake. The four wheel ABS will be activated immediately, thus allowing you to retain steering control of your vehicle and, providing there is sufficient space, will enable you to avoid obstacles and bring the vehicle to a controlled stop.

Driving

- The anti-lock system does not reduce stopping distance. Always leave enough room between your vehicle and the vehicle in front of you to stop.
- We recommend that you familiarize yourself with this braking technique. However, avoid taking any unnecessary risks.

ABS warning lamp

The ABS warning lamp in the instrument cluster momentarily illuminates when the ignition is turned on. If the light does not illuminate momentarily at start up, remains on or continues to flash, the ABS needs to be serviced.



With the ABS light on, the anti-lock brake system is disabled and normal braking is still effective unless the brake warning light also remains illuminated with parking brake released. (If your brake warning lamp illuminates, have your vehicle serviced immediately.)



Parking brake with auto-release (if equipped)

Apply the parking brake whenever the vehicle is parked.

To set the parking brake:

1. Move the gearshift to P (Park).
2. Push pedal downward.

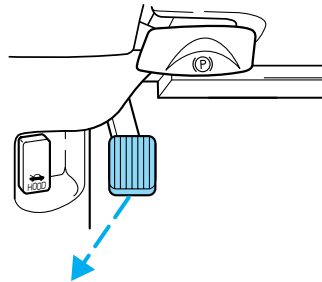

The BRAKE warning lamp in the instrument cluster illuminates and remains illuminated (when the ignition is turned ON) until the parking brake is fully released.



Always set the parking brake fully and make sure the gearshift is latched in P (Park). Turn the ignition to the LOCK position and remove the key whenever you leave your vehicle.

The parking brake is not recommended to stop a moving vehicle. However, if the normal brakes fail, the parking brake can be used to stop your vehicle in an emergency. Since the parking brake applies only the rear brakes, the vehicle's stopping distance will increase greatly and the handling of your vehicle will be adversely affected.

Your vehicle has an automatic parking brake release (except for police/fleet vehicles which have the manual release). To release the parking brake:

1. Start the vehicle.
2. Press the brake pedal.
3. Move the gearshift from the P (Park) position to one of the forward gears (the parking brake will not release automatically when you shift into reverse). The brake pedal must remain pressed while the gearshift is moved.

If the parking brake fails to release after completing this procedure, use the manual parking brake release lever.

Pull the lever to manually release the parking brake.

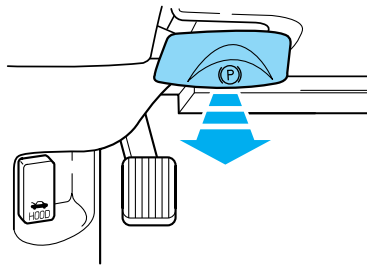

TRACTION CONTROL™ (IF EQUIPPED)

Your vehicle may be equipped with the optional Traction Control™ system. This system helps you maintain the stability and steerability of your vehicle. It is especially useful on slippery and/or hilly road surfaces. The system operates by detecting and controlling wheel spin. The system borrows many of the electronic and mechanical elements already present in the anti-lock braking system (ABS).

Wheel-speed sensors allow excess rear wheel spin to be detected by the Traction Control™ portion of the ABS computer. Any excessive wheel spin is controlled by automatically applying and releasing the rear brakes in conjunction with engine torque reductions. Engine torque reduction is realized via the fully electronic spark and fuel injection systems. This process is very sensitive to driving conditions and very fast acting. The rear wheels “search” for optimum traction several times a second and adjustments are made accordingly.

Driving



Aggressive driving in any road conditions can cause you to lose control of your vehicle increasing the risk of severe personal injury or property damage. The occurrence of an Traction Control™ event is an indication that at least some of the tires have exceeded their ability to grip the road; this may lead to an increased risk of loss of vehicle control, vehicle rollover, personal injury and death. If you experience a severe road event, SLOW DOWN.

The Traction Control™ system will allow your vehicle to make better use of available traction on slippery surfaces while you are trying to accelerate or while your foot is on the accelerator pedal. The system is a driver aid which makes your vehicle easier to handle primarily on snow and ice covered roads.

During Traction Control™ operation you may hear an electric motor type of sound coming from the engine compartment and the engine will not “rev-up” when you push further on the accelerator. This is normal system behavior.

If you should become stuck in snow or ice or on a very slippery road surface, try switching the Traction Control™ system off. This may allow excess wheel spin to “dig” the vehicle out and enable a successful “rocking” maneuver.



The traction control indicator flashes during a Traction Control™ system event.



If the traction control indicator comes on and stays lit, either:

- the Traction Control™ system requires service, or
- the customer has disabled the system using the traction control switch located on the left side of the instrument panel.

The Traction Control™ system will be on every time you turn the ignition key from OFF to ON until you deactivate the system using the traction control switch on the instrument panel left of the steering column.

STEERING

To prevent damage to the power steering system, never hold the steering wheel at its furthest turning points (until it stops) for more than a few seconds when the engine is running.

Driving

It is also important to maintain a proper power steering fluid level in the power steering fluid reservoir:

- Do not operate the vehicle with a low power steering pump fluid level (below the MIN mark on the reservoir).
- Some noise is normal during operation. If the noise is excessive, check for low power steering pump fluid level before seeking service by your dealer.
- Heavy or uneven steering efforts may be caused by low power steering pump fluid level. Check for low power steering pump fluid level before seeking service by your dealer.
- Do not fill the power steering pump reservoir above the MAX mark on the reservoir, as this may result in leaks from the reservoir.

If the power steering system breaks down (or if the engine is turned off), you can steer the vehicle manually, but it takes more effort.

If the steering wanders or pulls, check for:

- an improperly inflated tire
- uneven tire wear
- loose or worn suspension components
- loose or worn steering components
- improper steering alignment

Speed sensitive steering

The steering in your vehicle is speed sensitive. At high speeds, steering assist will decrease to improve steering feel. At lower speeds, maneuverability will be increased.

If the amount of effort required to steer your vehicle changes while driving at a constant vehicle speed, have the power steering system checked by your dealer or a qualified service technician.

AIR SUSPENSION SYSTEM (IF EQUIPPED)

The air suspension system is designed to improve ride, handling and general vehicle performance during:

- Certain road conditions
- Steering maneuvers
- Braking
- Accelerations

Driving

This system keeps the rear of your vehicle at a constant level by automatically adding air or releasing air from the springs. If you exceed the load limit, the rear air suspension may not operate.

The air suspension shut-off switch is located on the left side of the trunk. If this switch is in the OFF position, the rear air suspension will not operate.



On vehicles equipped with Air Suspension, turn OFF the Air Suspension switch prior to jacking, hoisting or towing your vehicle.



Normal vehicle operation does not require any action by the driver.

AUTOMATIC TRANSMISSION OPERATION

Brake-shift interlock

This vehicle is equipped with a brake-shift interlock feature that prevents the gearshift lever from being moved from P (Park) when the ignition is in the ON position unless the brake pedal is depressed.

If you cannot move the gearshift lever out of P (Park) with ignition in the ON position and the brake pedal depressed:

1. Apply the parking brake, turn ignition key to LOCK, then remove the key.
2. Insert the key and turn it to OFF. **Apply the brake pedal and shift to N (Neutral).**



When the key is in the ignition and in the OFF position, the automatic transmission shift lever can be moved from the P (Park) position without the brake pedal depressed. To avoid unwanted vehicle movement, always set the parking brake.

3. Start the vehicle.

If it is necessary to use the above procedure to move the gearshift lever, it is possible that a fuse has blown or the vehicle's brakelamps are not operating properly. Refer to *Fuses and relays* in the *Roadside Emergencies* chapter.

Driving



Do not drive your vehicle until you verify that the brakelamps are working.



Always set the parking brake fully and make sure the gearshift is latched in P (Park). Turn the ignition to the LOCK position and remove the key whenever you leave your vehicle.



If the parking brake is fully released, but the brake warning lamp remains illuminated, the brakes may not be working properly. See your dealer or a qualified service technician.

Driving with a 4-speed automatic transmission

Understanding the gearshift positions of the 4-speed automatic transmission



P (Park)

This position locks the transmission and prevents the rear wheels from turning.

To put your vehicle in gear:

- Start the engine
- Depress the brake pedal
- Move the gearshift lever into the desired gear

To put your vehicle in P (Park):

- Come to a complete stop
- Move the gearshift lever and securely latch it in P (Park)

Driving

 Always set the parking brake fully and make sure the gearshift is latched in P (Park). Turn the ignition to the LOCK position and remove the key whenever you leave your vehicle.

R (Reverse)

With the gearshift lever in R (Reverse), the vehicle will move backward. Always come to a complete stop before shifting into and out of R (Reverse).

N (Neutral)

With the gearshift lever in N (Neutral), the vehicle can be started and is free to roll. Hold the brake pedal down while in this position.

D (Overdrive)

The normal driving position for the best fuel economy. Transmission operates in gears one through four.



If your vehicle is equipped with a column-shift transmission, overdrive can be deactivated by pressing the transmission control switch on the gearshift lever.

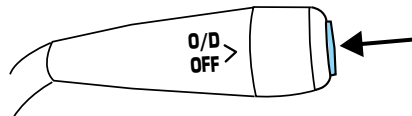

If your vehicle is equipped with a floor-shift transmission, overdrive can be deactivated by pressing the transmission control switch on the gearshift handle.

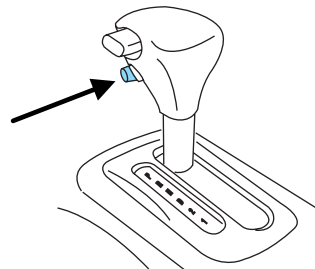

The transmission control indicator light (TCIL) will illuminate on the instrument cluster.

- Standard instrument cluster

**O/D
OFF**

Driving

- Optional instrument cluster

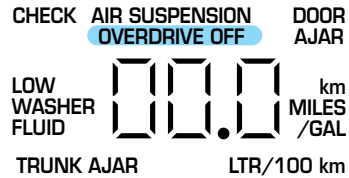

Drive (not shown)

Drive is activated when the transmission control switch is pressed.

- This position allows for all forward gears except overdrive.
- O/D OFF lamp is illuminated.
- Provides engine braking.
- Use when driving conditions cause excessive shifting from O/D to other gears. Examples: city traffic, hilly terrain, heavy loads, trailer towing and when engine braking is required.
- To return to O/D (overdrive mode), press the transmission control switch. The O/D OFF lamp will not be illuminated.
- O/D (Overdrive) is automatically returned each time the key is turned off.

2 (Second)

This position allows for second gear only.

- Provides engine braking.
- Use to start-up on slippery roads.
- To return to **D** (Overdrive), move the gearshift lever into the **D** (Overdrive) position.
- Selecting 2 (Second) at higher speeds will cause the transmission to downshift to second gear at the appropriate vehicle speed.

1 (First)

- Provides maximum engine braking.
- Allows upshifts by moving gearshift lever.
- Will not downshift into 1 (First) at high speeds; allows for 1 (First) when vehicle reaches slower speeds.

Forced downshifts

- Allowed in **D** (Overdrive) or Drive.
- Depress the accelerator to the floor.
- Allows transmission to select an appropriate gear.

Driving

If your vehicle gets stuck in mud or snow

If your vehicle gets stuck in mud or snow, it may be rocked out by shifting from forward and reverse gears, stopping between shifts in a steady pattern. Press lightly on the accelerator in each gear.

Do not rock the vehicle if the engine is not at normal operating temperature or damage to the transmission may occur.

Do not rock the vehicle for more than a minute or damage to the transmission and tires may occur, or the engine may overheat.

TRACTION-LOK AXLE (IF EQUIPPED)

This axle provides added traction on slippery surfaces, particularly when one wheel is on a poor traction surface. Under normal conditions, the Traction-Lok axle functions like a standard rear axle.

Extended use of other than the manufacturer's specified size tires on a Traction-Lok rear axle could result in a permanent reduction in effectiveness. This loss of effectiveness does not affect normal driving and should not be noticeable to the driver.

DRIVING THROUGH WATER

Do not drive quickly through standing water, especially if the depth is unknown. Traction or brake capability may be limited and if the ignition system gets wet, your engine may stall. Water may also enter your engine's air intake and severely damage your engine.

If driving through deep or standing water is unavoidable, proceed very slowly. Never drive through water that is higher than the bottom of the hubs (for trucks) or the bottom of the wheel rims (for cars).

Once through the water, always try the brakes. Wet brakes do not stop the vehicle as effectively as dry brakes. Drying can be improved by moving your vehicle slowly while applying light pressure on the brake pedal.

Driving through deep water where the transmission vent tube is submerged may allow water into the transmission and cause internal transmission damage. Have the fluid checked and, if water is found, replace the fluid.

VEHICLE LOADING – WITH AND WITHOUT A TRAILER

This section will guide you in the proper loading of your vehicle and/or trailer, to keep your loaded vehicle weight within its design rating capability, with or without a trailer. Properly loading your vehicle will provide maximum return of vehicle design performance. Before loading your vehicle, familiarize yourself with the following terms for determining your vehicle's weight ratings, with or without a trailer, from the vehicle's Safety Certification Label and Tire Label:

Base Curb Weight – is the weight of the vehicle including a full tank of fuel and all standard equipment. It does not include passengers, cargo, or optional equipment.

Vehicle Curb Weight – is the weight of your new vehicle when you picked it up from your dealer plus any aftermarket equipment.

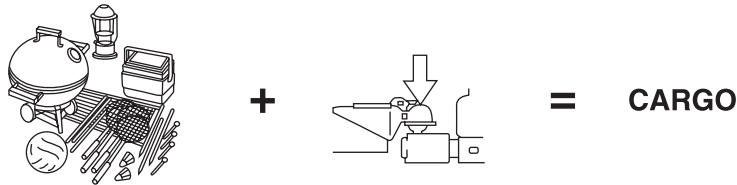

Cargo Weight – includes all weight added to the Base Curb Weight, including cargo and optional equipment. When towing, trailer tongue load or king pin weight is also part of cargo weight.

GAW (Gross Axle Weight) – is the total weight placed on each axle (front and rear) – including vehicle curb weight and all payload.

GAWR (Gross Axle Weight Rating) – is the maximum allowable weight that can be carried by a single axle (front or rear). **These numbers are shown on the Safety Compliance Certification Label located on the driver's door or door pillar. The total load on each axle must never exceed its GAWR.**

 Exceeding the Safety Certification Label axle weight rating limits could result in substandard vehicle handling, performance, engine, transmission and/or structural damage, serious damage to the vehicle, loss of control and personal injury.

Note: For trailer towing information refer to *Trailer towing* found in this chapter or the *RV and Trailer Towing Guide* provided by your dealership.

Driving

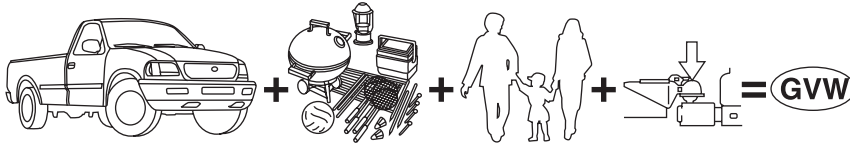

GVW (Gross Vehicle Weight) – is the Vehicle Curb Weight + cargo + passengers.

GVWR (Gross Vehicle Weight Rating) – is the maximum allowable weight of the fully loaded vehicle (including all options, equipment, passengers and cargo). **The GVWR is shown on the Safety Compliance Certification Label located on the driver's door or door pillar. The GVW must never exceed the GVWR.**

Sample Safety Compliance Certification Label <small>(Refer to actual label on your vehicle)</small>		
Front GAWR	GVWR	Rear GAWR
MFD, BY FORD MOTOR CO. IN U.S.A.		
DATE: 06/95	GVWR: 6250 LB/2834 KG	
FRONT GAWR: 3450 LB 1564KG	WITH 1713KG	REAR GAWR: 3777 LB 1713KG WITH TIRES RIMS
P265/75R15SL 15X7.5J AT 30 PSI COLD	TIRES RIMS 15X7.5J AT 30 PSI COLD	P265/75R15SL 15X7.5J AT 30 PSI COLD
THIS VEHICLE CONFORMS TO ALL APPLICABLE FEDERAL MOTOR VEHICLE SAFETY STANDARDS IN EFFECT ON THE DATE OF MANUFACTURE SHOWN ABOVE.		
XXXXXXXXXXXXX	WIN: 1FTEX14H 0 SKB 00000	F0018
	TYPE: XXXXXXXXXXXXXXXX	TC183
EXT PNT: XXXXXXXX XXXXXXXX		
WD	TYPE-GVW	DSO
155	REM	M4
	TRANS	AXLE
	E	HBB
	TAPE	SPRINGS



Exceeding the Safety Certification Label axle weight rating limits could result in substandard vehicle handling, performance, engine, transmission and/or structural damage, serious damage to the vehicle, loss of control and personal injury.

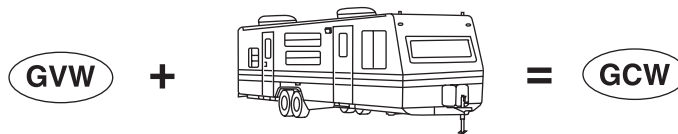

GCW (Gross Combined Weight) – is the weight of the loaded vehicle (GVW) plus the weight of the fully loaded trailer.

Driving

GCWR (Gross Combined Weight Rating) – is the maximum allowable weight of the vehicle and the loaded trailer – including all cargo and passengers – that the vehicle can handle without risking damage. (Important: The towing vehicle's braking system is rated for operation at GVWR, not at GCWR. Separate functional brakes should be used for safe control of towed vehicles and for trailers where the GCW of the towing vehicle plus the trailer exceed the GVWR of the towing vehicle. **The GCW must never exceed the GCWR.**

Maximum Loaded Trailer Weight – is the highest possible weight of a fully loaded trailer the vehicle can tow. It assumes a vehicle with only mandatory options, no cargo (internal or external), a tongue load of 10–15% (conventional trailer) or king pin weight of 15–25% (fifth wheel trailer), and driver only (150 lbs [68 kg]). **Consult your dealership (or the *RV and Trailer Towing Guide* provided by your dealership) for more detailed information.**

Tongue Load or Fifth Wheel King Pin Weight – refers to the amount of the weight that a trailer pushes down on a trailer hitch.

Examples: For a 5,000 lbs. (2,268 kg) conventional trailer, multiply 5,000 by 0.10 and 0.15 to obtain a proper tongue load range of 500 to 750 lbs. (227 to 340 kg). For an 11,500 lbs. (5,216 kg) fifth wheel trailer, multiply by 0.15 and 0.25 to obtain a proper king pin load range of 1,725 to 2,875 lbs. (782 to 1,304 kg)



Do not exceed the GVWR or the GAWR specified on the certification label.



Do not use replacement tires with lower load carrying capacities than the originals because they may lower the vehicle's GVWR and GAWR limitations. Replacement tires with a higher limit than the originals do not increase the GVWR and GAWR limitations.



Exceeding any vehicle weight rating limitation could result in serious damage to the vehicle and/or personal injury.

TRAILER TOWING

Your vehicle is classified as a light duty towing vehicle. Do not tow a trailer until your vehicle has been driven at least 2,000 miles (3,200 km).

Towing a trailer places an additional load on your vehicle's engine, transmission, brakes, tires and suspension. Inspect these components carefully after towing.

Driving

Your loaded trailer should weigh no more than 2,000 lbs. (907 kg). **Do not exceed the GVWR specified on the certification label.**



Towing trailers beyond the maximum recommended gross trailer weight exceeds the limit of the vehicle and could result in engine damage, transmission damage, structural damage, loss of vehicle control, vehicle rollover and personal injury.

The GCW of your vehicle and trailer should not exceed 6,000 lbs. (2,993 kg).

Preparing to tow

Use the proper equipment for towing a trailer and make sure it is properly attached to your vehicle. See your dealer or a reliable trailer dealer if you require assistance.

Hitches

Do not use hitches that clamp onto the vehicle bumper. Use a load carrying hitch. You must distribute the load in your trailer so that 10–15% of the total weight of the trailer is on the tongue.

Safety chains

Always connect the trailer's safety chains to the frame or hook retainers of the vehicle hitch. To connect the trailer's safety chains, cross the chains under the trailer tongue and allow slack for turning corners.

If you use a rental trailer, follow the instructions that the rental agency gives to you.

Do not attach safety chains to the bumper.

Trailer brakes

Electric brakes and manual, automatic or surge-type trailer brakes are safe if installed properly and adjusted to the manufacturer's specifications. The trailer brakes must meet local and Federal regulations.



Do not connect a trailer's hydraulic brake system directly to your vehicle's brake system. Your vehicle may not have enough braking power and your chances of having a collision greatly increase.

The braking system of the tow vehicle is rated for operation at the GVWR not GCWR.

Trailer lamps

Trailer lamps are required on most towed vehicles. Make sure all running lights, brake lights, turn signals and hazard lights are working. See your dealer or trailer rental agency for proper instructions and equipment for hooking up trailer lamps.

Driving while you tow

When towing a trailer:

- Turn off the speed control. The speed control may shut off automatically when you are towing on long, steep grades.
- Consult your local motor vehicle speed regulations for towing a trailer.
- To eliminate excessive shifting, use a lower gear. This will also assist in transmission cooling. (For additional information, refer to the *Understanding the positions of the 4-speed automatic transmission* section in this chapter.
- Anticipate stops and brake gradually.
- Do not exceed the GCWR rating or transmission damage may occur.

Servicing after towing

If you tow a trailer for long distances, your vehicle will require more frequent service intervals. Refer to your *Scheduled Maintenance Guide* for more information.

Trailer towing tips

- Practice turning, stopping and backing up before starting on a trip to get the feel of the vehicle trailer combination. When turning, make wider turns so the trailer wheels will clear curbs and other obstacles.
- Allow more distance for stopping with a trailer attached.
- If you are driving down a long or steep hill, shift to a lower gear. Do not apply the brakes continuously, as they may overheat and become less effective.
- The trailer tongue weight should be 10–15% of the loaded trailer weight.
- After you have traveled 50 miles (80 km), thoroughly check your hitch, electrical connections and trailer wheel lug nuts.
- To aid in engine/transmission cooling and A/C efficiency during hot weather while stopped in traffic, place the gearshift lever in P (Park).
- Vehicles with trailers should not be parked on a grade. If you must park on a grade, place wheel chocks under the trailer's wheels.

Driving

Launching or retrieving a boat

Disconnect the wiring to the trailer before backing the trailer into the water. Reconnect the wiring to the trailer after the trailer is removed from the water.

When backing down a ramp during boat launching or retrieval:

- do not allow the static water level to rise above the bottom edge of the rear bumper.
- do not allow waves to break higher than 6 inches (15 cm) above the bottom edge of the rear bumper.

Exceeding these limits may allow water to enter vehicle components:

- causing internal damage to the components.
- affecting driveability, emissions and reliability.

Replace the rear axle lubricant any time the axle has been submerged in water. Rear axle lubricant quantities are not to be checked or changed unless a leak is suspected or repair required.

RECREATIONAL TOWING (ALL WHEELS ON THE GROUND)

Follow these guidelines for your specific powertrain combination to tow your vehicle with all four wheels on the ground (such as behind a recreational vehicle).

These guidelines are designed to ensure that your transmission is not damaged due to insufficient lubrication.

All Rear Wheel Drive (RWD) vehicles:

This applies to all cars and 4x2 trucks/sport utilities with rear wheel drive capability.

- Place the transmission in N (Neutral)
- Maximum speed is 35 mph (56 km/h)
- Maximum distance is 50 miles (80 km)

If a distance of 50 miles (80 km) or a speed of 35 mph (56 km/h) must be exceeded, you must disconnect the driveshaft. Ford recommends the driveshaft be removed/installed only by a qualified technician. See your local dealer for driveshaft removal/installation.

Improper removal/installation of the driveshaft can cause transmission fluid loss, damage to the driveshaft and internal transmission components.

Roadside Emergencies

GETTING ROADSIDE ASSISTANCE

To fully assist you should you have a vehicle concern, Ford Motor Company offers a complimentary roadside assistance program. This program is separate from the New Vehicle Limited Warranty. The service is available:

- 24-hours, seven days a week
- for the New Vehicle Limited Warranty period of three years or 36,000 miles (60,000 km), whichever occurs first on Ford and Mercury vehicles, and four years or 50,000 miles (80,000 km) on Lincoln vehicles.

Roadside assistance will cover:

- changing a flat tire
- jump-starts
- lock-out assistance
- limited fuel delivery
- towing of your disabled vehicle to the nearest Ford Motor Company dealership, or your selling dealer if within 35 miles (56.3 km) of the nearest Ford Motor Company dealership (one tow per disablement). Even non-warranty related tows, like accidents or getting stuck in the mud or snow, are covered (some exclusions apply, such as impound towing or repossession).

Canadian customers refer to your Owner Information Guide for information on:

- coverage period
- exact fuel amounts
- towing of your disabled vehicle
- emergency travel expense reimbursement
- travel planning benefits

USING ROADSIDE ASSISTANCE

Complete the roadside assistance identification card and place it in your wallet for quick reference. In the United States, this card is found in the Owner Guide portfolio in the glove compartment in Ford vehicles and is mailed to you if you own a Mercury or Lincoln. In Canada, the card is found in the Owner Information Guide in the glove compartment.

U.S. Ford or Mercury vehicle customers who require roadside assistance, call 1-800-241-3673; Lincoln vehicle customers call 1-800-521-4140.

Roadside Emergencies

Canadian customers who require roadside assistance, call 1-800-665-2006.

If you need to arrange roadside assistance for yourself, Ford Motor Company will reimburse a reasonable amount. To obtain reimbursement information, U.S. Ford or Mercury vehicles customers call 1-800-241-3673; Lincoln vehicle customers call 1-800-521-4140.

Canadian customers who need to obtain reimbursement information, call 1-800-665-2006.

ROADSIDE COVERAGE BEYOND BASIC WARRANTY

In the United States, you may purchase additional roadside assistance coverage beyond this period through the Ford Auto Club by contacting your Ford or Lincoln Mercury dealer.

Similarly in Canada, for uninterrupted Roadside Assistance coverage, you may purchase extended coverage prior to your Basic Warranty's Roadside Assistance expiring. For more information and enrollment, contact 1-877-294-2582 or visit our website at www.ford.ca.

HAZARD FLASHER

Use only in an emergency to warn traffic of vehicle breakdown, approaching danger, etc. The hazard flashers can be operated when the ignition is off.

- The hazard lights control is located on top of the steering column.
- Depress hazard lights control to activate all hazard flashers simultaneously.
- Depress control again to turn the flashers off.

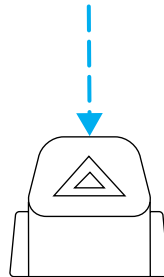

FUEL PUMP SHUT-OFF SWITCH FUEL RESET

The fuel pump shut-off switch is a device intended to stop the electric fuel pump when your vehicle has been involved in a substantial jolt.

After a collision, if the engine cranks but does not start, the fuel pump shut-off switch may have been activated.

Roadside Emergencies

The fuel pump shut-off switch is located on the left side of the trunk behind the left rear tail light and the trunk liner.

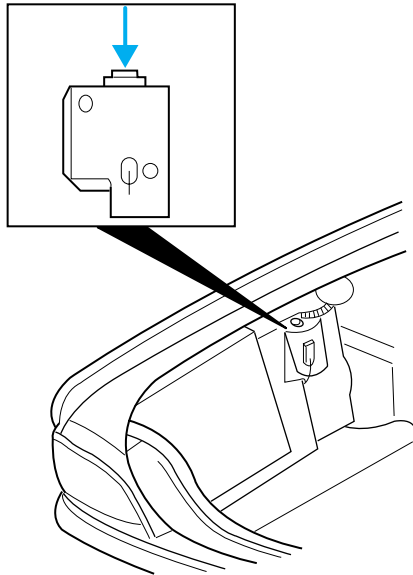

Use the following procedure to reset the fuel pump shut-off switch.

1. Turn the ignition to the OFF position.
2. Check the fuel system for leaks.
3. If no fuel leak is apparent, reset the fuel pump shut-off switch by pushing in on the reset button.
4. Turn the ignition to the ON position. Pause for a few seconds and return the key to the OFF position.
5. Make a further check for leaks in the fuel system.

FUSES AND RELAYS

Fuses

If electrical components in the vehicle are not working, a fuse may have blown. Blown fuses are identified by a broken wire within the fuse. Check the appropriate fuses before replacing any electrical components.

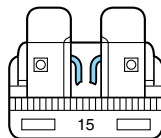

Roadside Emergencies

Note: Always replace a fuse with one that has the specified amperage rating. Using a fuse with a higher amperage rating can cause severe wire damage and could start a fire.

Standard fuse amperage rating and color

COLOR					
Fuse rating	Mini fuses	Standard fuses	Maxi fuses	Cartridge maxi fuses	Fuse link cartridge
2A	Grey	Grey	—	—	—
3A	Violet	Violet	—	—	—
4A	Pink	Pink	—	—	—
5A	Tan	Tan	—	—	—
7.5A	Brown	Brown	—	—	—
10A	Red	Red	—	—	—
15A	Blue	Blue	—	—	—
20A	Yellow	Yellow	Yellow	Blue	Blue
25A	Natural	Natural	—	—	—
30A	Green	Green	Green	Pink	Pink
40A	—	—	Orange	Green	Green
50A	—	—	Red	Red	Red
60A	—	—	Blue	—	Yellow
70A	—	—	Tan	—	Brown
80A	—	—	Natural	—	Black

Passenger compartment fuse panel

The fuse panel is located below and to the left of the steering wheel by the brake pedal. Remove the panel cover to access the fuses.

To remove a fuse use the fuse puller tool provided on the fuse panel cover.

Roadside Emergencies

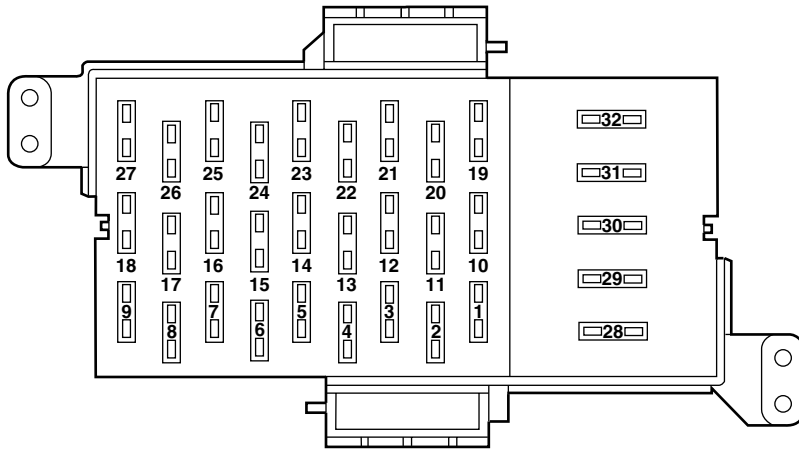

The fuses are coded as follows.

Fuse/Relay Location	Fuse Amp Rating	Passenger Compartment Fuse Panel Description
1	15A	Audio, CD changer
2	5A	Audio (optional)
3	7.5A	Mirrors
4	10A	Air bags
5	25A	Package tray lamps and rear flasher lamps (Police vehicle options)
6	15A	Instrument cluster warning lamps module, Overdrive control switch, Lighting Control Module (LCM), A/C clutch, Analog cluster
7	10A	Driver's Door Module (DDM), Premium radio, Start input to police PDB (Police vehicle option)

Roadside Emergencies

Fuse/Relay Location	Fuse Amp Rating	Passenger Compartment Fuse Panel Description
8	25A	Powertrain Control Module (PCM) power relay, Coil-on plugs, Radio noise capacitor, Passive Anti-Theft System (PATS)
9	5A	Transmission range sensor
10	10A	Rear window defrost, Heated mirrors
11	5A	Traction control indicator relay (ABS w/traction control only)
12	15A	Multi-function switch for turn/hazard lamps
13	5A	Radio
14	10A	Anti-lock Brake System (ABS), Instrument Cluster
15	15A	Speed control module, Power relay coil (Police vehicle option), LCM, EATC blower motor relay, Door lock switch illumination, Heated seat switch, Moonroof
16	15A	Reversing lamps, Shift lock, DRL module, VAP Steering, Electronic day/night mirror, Overhead console, Air suspension, Climate control, Heated seat module, Speed chime module (GCC only), DDM, Back-up lamps
17	7.5A	Wiper motor
18	—	Not used
19	15A	Brake lamps, Brake signal for PCM, ABS and speed control module, DDM
20	20A	Spot lamp (Police vehicle option)

Roadside Emergencies

Fuse/Relay Location	Fuse Amp Rating	Passenger Compartment Fuse Panel Description
21	15A	LCM for park lamps and interior illumination, Autolamp/Sunload sensor
22	20A	Speed control servo, Multi-function switch for hazard lamps, Brake on/off switch, Feed for IP fuse 19
23	15A	EATC module, Instrument cluster, LCM, Interior lamps, Door lock switches, Door ajar and roof lamps (Taxi vehicles)
24	10A	Left-hand low beam
25	20A	Cigar lighter
26	10A	Right-hand low beam
27	25A	LCM for cornering lamps and high beam headlamps, Police headlamp wigwag module (police vehicles only)
28	20A*	Power windows, Instrument panel/Door decklid release (police vehicles only)
29	—	Not used
30	—	Not used
31	—	Not used
32	—	Not used

* Circuit breaker

Power distribution box

The power distribution box is located in the engine compartment. The power distribution box contains high-current fuses that protect your vehicle's main electrical systems from overloads.



Always disconnect the battery before servicing high current fuses.

Roadside Emergencies

Always replace the cover to the power distribution box before reconnecting the battery or refilling fluid reservoirs

If the battery has been disconnected and reconnected, refer to the *Battery* section of the *Maintenance and Specifications* chapter.

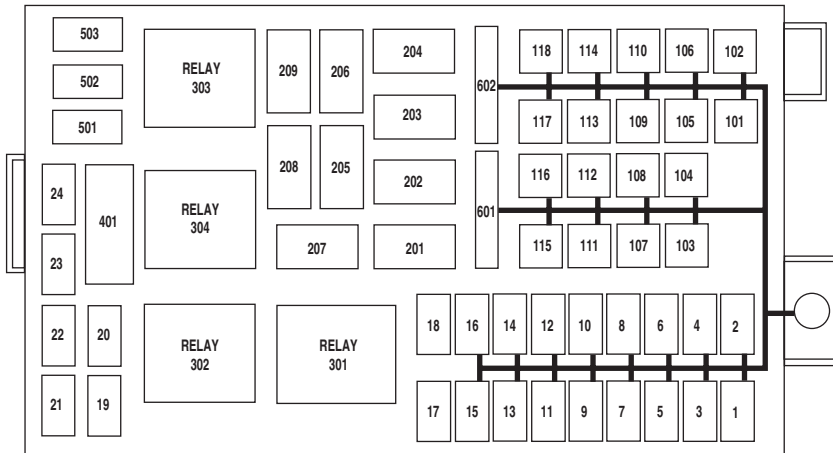

The high-current fuses are coded as follows.

Fuse/Relay Location	Fuse Amp Rating	Power Distribution Box Description
1	25A*	Audio
2	20A*	Power point
3	25A*	Heated seats
4	15A*	Horns
5	20A*	Fuel pump module (gasoline engines only), Fuel tank solenoid valves (natural gas vehicles only), Fuel rail solenoid valve (natural gas vehicles only)
6	15A*	Alternator
7	25A*	Moonroof
8	20A*	Driver's Door Module (DDM)

Roadside Emergencies

Fuse/Relay Location	Fuse Amp Rating	Power Distribution Box Description
9	—	Not used
10	—	Not used
11	20A*	Daytime Running Lamps (DRL)
12	—	Not used
13	—	Not used
14	—	Not used
15	—	Not used
16	—	Not used
17	—	Not used
18	—	Not used
19	15A*	Powertrain Control Module (PCM), Fuel injectors, NGV fuel injector module
20	15A*	PCM, HEGOs
21	—	Not used
22	—	Not used
23	—	Not used
24	—	Not used
101	30A**	Ignition switch, Starter motor solenoid via starter relay, IP fuses 7, 9, 12 and 14
102	50A**	Cooling fan (engine)
103	40A**	Blower motor
104	40A**	Heated backlight relay
105	30A**	PCM power relay or NGV module (natural gas vehicles only), Diagnostic connector, PDB 19 and 20, A/C clutch relay, Fuel pump module relay
106	40A**	Anti-lock Brake System (ABS)
107	50A**	Police rear access power point (Police vehicles only)

Roadside Emergencies

Fuse/Relay Location	Fuse Amp Rating	Power Distribution Box Description
108	50A**	Police rear access power point (Police vehicles only)
109	50A**	Light bar (Police vehicle option)
110	50A**	Relay switch for front PDB (Police vehicle option)
111	30A**	Power relay switch feed (Police vehicle option)
112	50A**	Ignition switch feed to IP fuses 4, 6, 8, 11, 13, 15, 17, 20, 22 and 28
113	50A**	Feeds IP fuses 3, 5, 21, 23, 25, 27
114	30A**	VAP Steering, Air suspension compressor, Instrument cluster
115	50A**	Ignition switch feed to IP fuses 16 and 18
116	30A**	Wipers
117	50A**	B+ feed for front PDB (Police vehicle option)
118	20A**	ABS
201	1/2 ISO	Horn relay
202	1/2 ISO	PCM relay
203	1/2 ISO	Fuel pump relay
204	1/2 ISO	A/C clutch relay
205	1/2 ISO	Traction control switch relay
206	1/2 ISO	Police vehicle relay
207	—	Not used
208	1/2 ISO	Moonroof relay or Police stop lamp relay (police vehicles only)
209	—	Not used
301	Full ISO	Blower motor relay
302	Full ISO	Starter solenoid relay
303	Full ISO	Air suspension relay
304	Full ISO	Heated backlight relay

Roadside Emergencies

Fuse/Relay Location	Fuse Amp Rating	Power Distribution Box Description
401	—	Not used
501	Diode	PCM
502	Diode	A/C clutch
503	—	Not used
601	—	Not used
602	20A**	Adjustable pedals, Power seat, Locks, Decklid, Lumbar, Decklid release (Police vehicle option)

* Mini fuse ** Circuit breaker/Maxi fuse

Relays

Relays are located in the power distribution box and should be replaced by qualified technicians.

CHANGING THE TIRES

If you get a flat tire while driving, do not apply the brake heavily. Instead, gradually decrease your speed. Hold the steering wheel firmly and slowly move to a safe place on the side of the road.



The use of tire sealants is not recommended and may damage your tires.

T-Type/Mini-Spare Tire Information

Your vehicle may be equipped with a T-type/mini-spare tire. This tire will have the words "Temporary Use Only" molded into the tire sidewall. This spare tire is considered "temporary". Replace the T-type/mini-spare with a tire of the same size, speed rating and load carrying capacity as the other road tires as soon as possible.

When driving with the T-type/mini-spare tire **do not:**

- Exceed 50 mph (80 km/h)
- Load the vehicle beyond maximum vehicle load rating listed on the Safety Compliance Label
- Tow a trailer
- Use snow chains on the end of the vehicle with the T-type/mini spare tire

Roadside Emergencies

- Use more than one T-type/mini spare tire at a time
- Use commercial car washing equipment
- Try to repair the T-type/mini spare tire

Use of a T-type/mini spare tire at any one wheel location can lead to impairment of the following:

- Handling, stability and braking performance
- Comfort and noise
- Ground clearance and parking at curbs
- Winter weather driving capability
- Wet weather driving capability

Dissimilar spare tire/wheel information



Failure to follow these guidelines could result in an increased risk of loss of vehicle control, injury or death.

Your vehicle may be equipped with a dissimilar spare tire/wheel. A dissimilar spare tire/wheel is defined as a spare tire and/or wheel that is different in brand, size or appearance from the road tires and wheels. If you have a dissimilar spare tire/wheel, then it is intended for temporary use only. This means that if you need to use it, you should replace it as soon as possible with a road tire/wheel that is the same size and type as the road tires and wheels that were originally provided by Ford. If the dissimilar spare tire or wheel is damaged, it should be replaced rather than repaired.

When driving with the dissimilar spare tire/wheel, **do not:**

- Exceed 70 mph (113 km/h)
- Use more than one dissimilar spare tire/wheel at a time
- Use commercial car washing equipment
- Use snow chains on the end of the vehicle with the dissimilar spare tire/wheel

The usage of a dissimilar spare tire/wheel can lead to impairment of the following:

- Handling, stability and braking performance
- Comfort and noise
- Ground clearance and parking at curbs

Roadside Emergencies

- Winter weather driving capability
- Wet weather driving capability
- All-Wheel Driving Capability (if applicable)
- Load Leveling Adjustment (if applicable)

When driving with the dissimilar spare tire/wheel additional caution should be given to:

- Towing a trailer
- Driving vehicles equipped with a camper body
- Driving vehicles with a load on the cargo rack

Drive cautiously when using a dissimilar spare tire/wheel and seek service as soon as possible.

Tire change procedure

 To help prevent the vehicle from moving when you change a tire, be sure the parking brake is set, then block (in both directions) the wheel that is diagonally opposite (other side and end of the vehicle) to the tire being changed.

 If the vehicle slips off the jack, you or someone else could be seriously injured.

1. Park on a level surface, activate hazard flashers and set parking brake.

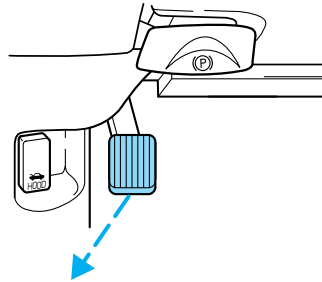

Roadside Emergencies

2. Place gearshift lever in P (Park), turn engine OFF and block the diagonally opposite wheel.

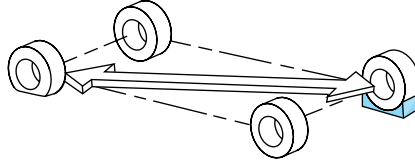

3. Remove the spare tire and the jack. The jack could be located:

- A — behind the mini spare tire or
- B — behind the full size spare tire

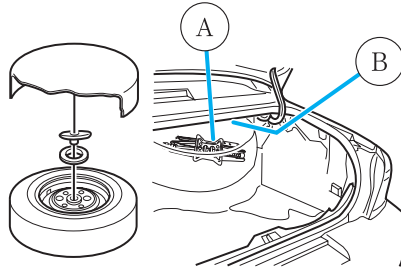

 On vehicles equipped with Air Suspension, turn OFF the Air Suspension switch prior to jacking, hoisting or towing your vehicle.

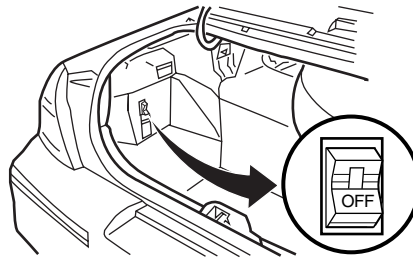

Refer to *Air suspension system* in the *Driving* chapter of the *Owner's Guide* for more information.

4. Remove the lug wrench from the jack. Rotate the lug wrench socket out from the handle.

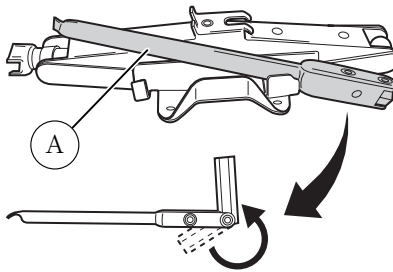

Roadside Emergencies

5. Locate pry off notch (if equipped) and remove the center ornament from the aluminum wheel with the tapered end of the wheel nut wrench that came with your vehicle. Insert and twist the handle, then pry against the wheel.

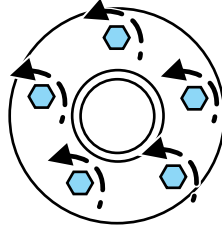

6. If equipped with a full wheelcover, remove the wheelcover center ornament. If the wheelcover is retained with black plastic nuts, loosen the five black plastic nuts using the lug wrench.

7. Loosen each wheel metal lug nut one-half turn counterclockwise but do not remove them until the wheel is raised off the ground.

STOP Before placing the jack under the vehicle, NOTE the jack location markings:

JACK LOCATION-FRONT

The jack location markings can be found **on the lower outer edge of the body**.

- Locate the jack locator mark (B - **circle**) on the body (C) near the tire you are changing, then place the jack (D) **under the frame (A) of the vehicle** aligning it with the mark (B - **circle**).

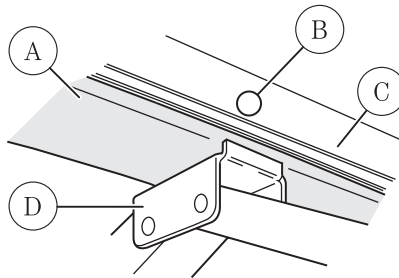

JACK LOCATION-REAR

The jack location markings can be found **on the lower outer edge of the body**.

- Locate the jack locator mark (B - **triangle**) on the body (C) near the tire you are changing, then place the jack (D) **under the frame (A) of the vehicle** aligning it with the mark (B - **triangle**).

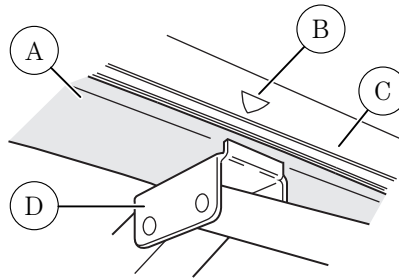

Roadside Emergencies

- Position the jack according to the following guides and turn the jack handle clockwise until the wheel is completely off the ground.

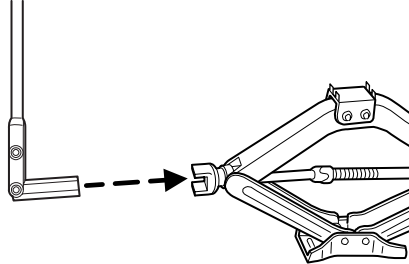

To lessen risk of personal injury, do not put any part of your body under the vehicle while changing a tire. Do not start the engine when your vehicle is on the jack. The jack is **ONLY** meant for changing the tire.

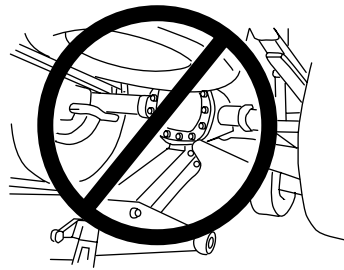

- **Never use the rear differential as a jacking point.**

8. Remove the metal lug nuts with the lug wrench to remove the lug nut-retained full wheelcover and wheel/tire assembly.
9. If equipped with a full size spare tire and lug nut-retained full wheelcover, install the wheelcover before reinstalling the lug nuts.
10. Replace the flat tire with the spare tire, making sure the valve stem is facing outward. Reinstall lug nuts until the wheel is snug against the hub. Do not fully tighten the lug nuts until the wheel has been lowered.
11. Lower the vehicle by turning the jack handle counterclockwise.

Roadside Emergencies

12. Remove the jack and fully tighten the lug nuts in the order shown. Refer to *Wheel lug nut torque specifications* later in this chapter for the proper lug nut torque specification.

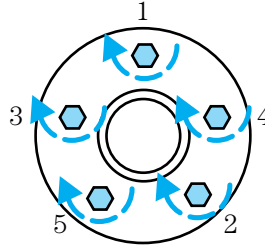

13. Put flat tire, jack and lug wrench away.

14. Turn on the air suspension switch (if equipped).

Wheel lug nut torque specifications

Retighten the lug nuts to the specified torque at 500 miles (800 km) after any wheel disturbance (tire rotation, changing a flat tire, wheel removal, etc.).

Bolt size	Wheel lug nut torque*	
	lb.ft.	N•m
½ x 20	100	136

* Torque specifications are for nut and bolt threads free of dirt and rust. Use only Ford recommended replacement fasteners.

 When a wheel is installed, always remove any corrosion, dirt or foreign materials present on the mounting surfaces of the wheel or the surface of the front disc brake hub and rotor that contacts the wheel. Installing wheels without correct metal-to-metal contact at the wheel mounting surfaces can cause the wheel nuts to loosen and the wheel to come off while the vehicle is in motion, resulting in loss of control.

JUMP STARTING YOUR VEHICLE

 The gases around the battery can explode if exposed to flames, sparks, or lit cigarettes. An explosion could result in injury or vehicle damage.

 Batteries contain sulfuric acid which can burn skin, eyes and clothing, if contacted.

Do not attempt to push-start your vehicle. Automatic transmissions do not have push-start capability; doing so may damage the catalytic converter.

Roadside Emergencies

Preparing your vehicle

When the battery is disconnected or a new battery is installed, the transmission must relearn its shift strategy. As a result, the transmission may have firm and/or soft shifts. This operation is considered normal and will not affect function or durability of the transmission. Over time, the adaptive learning process will fully update transmission operation.

1. **Use only a 12-volt supply to start your vehicle.**
2. Do not disconnect the battery of the disabled vehicle as this could damage the vehicle's electrical system.
3. Park the booster vehicle close to the hood of the disabled vehicle making sure the two vehicles **do not** touch. Set the parking brake on both vehicles and stay clear of the engine cooling fan and other moving parts.
4. Check all battery terminals and remove any excessive corrosion before you attach the battery cables. Ensure that vent caps are tight and level.
5. Turn the heater fan on in both vehicles to protect any electrical surges. Turn all other accessories off.

Connecting the jumper cables

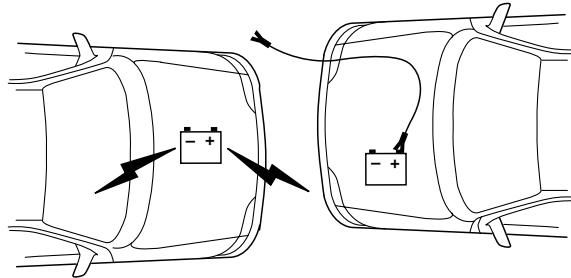

1. Connect the positive (+) jumper cable to the positive (+) terminal of the discharged battery.

Note: In the illustrations, *lightning bolts* are used to designate the assisting (boosting) battery.

Roadside Emergencies

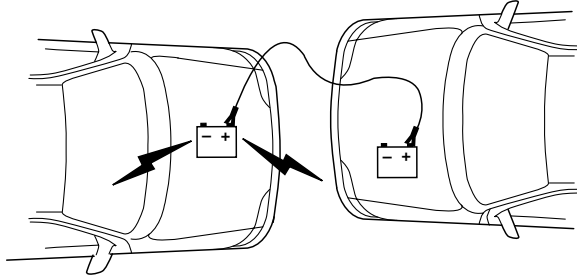

2. Connect the other end of the positive (+) cable to the positive (+) terminal of the assisting battery.

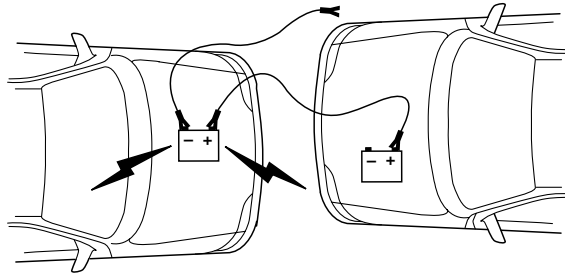

3. Connect the negative (-) cable to the negative (-) terminal of the assisting battery.

Roadside Emergencies

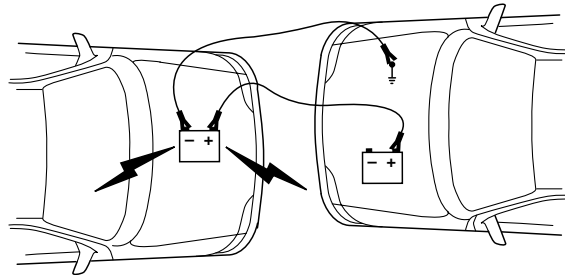

4. Make the final connection of the negative (-) cable to an exposed metal part of the stalled vehicle's engine, away from the battery and the carburetor/fuel injection system. **Do not** use fuel lines, engine rocker covers or the intake manifold as *grounding* points.



Do not connect the end of the second cable to the negative (-) terminal of the battery to be jumped. A spark may cause an explosion of the gases that surround the battery.

5. Ensure that the cables are clear of fan blades, belts, moving parts of both engines, or any fuel delivery system parts.

Jump starting

1. Start the engine of the booster vehicle and run the engine at moderately increased speed.
2. Start the engine of the disabled vehicle.
3. Once the disabled vehicle has been started, run both engines for an additional three minutes before disconnecting the jumper cables.

Roadside Emergencies

Removing the jumper cables

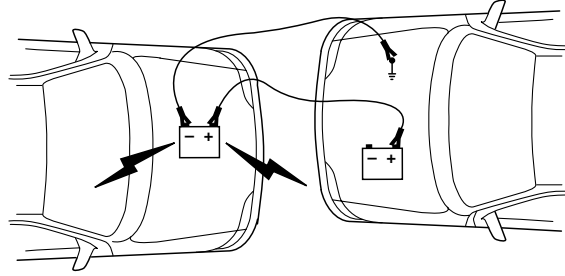

Remove the jumper cables in the reverse order that they were connected.

1. Remove the jumper cable from the *ground* metal surface.

Note: In the illustrations, *lightning bolts* are used to designate the assisting (boosting) battery.

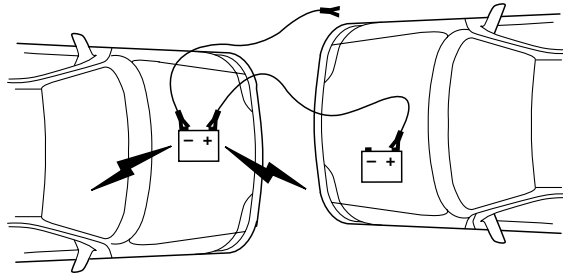

2. Remove the jumper cable on the negative (-) connection of the booster vehicle's battery.

Roadside Emergencies

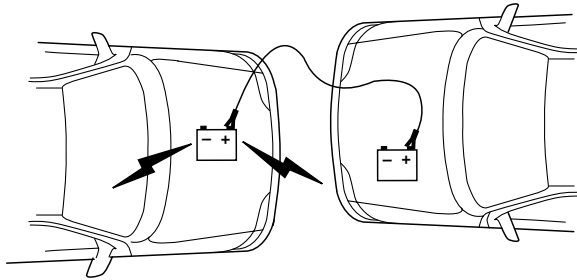

3. Remove the jumper cable from the positive (+) terminal of the booster vehicle's battery.

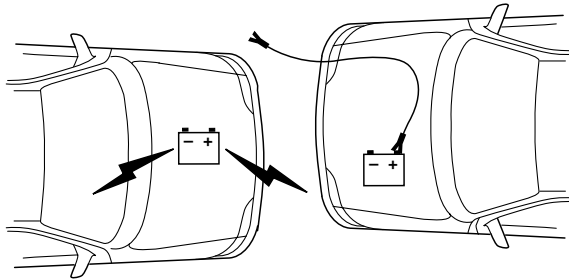

4. Remove the jumper cable from the positive (+) terminal of the disabled vehicle's battery.

After the disabled vehicle has been started and the jumper cables removed, allow it to idle for several minutes so the engine computer can *relearn* its idle conditions.

Roadside Emergencies

WRECKER TOWING

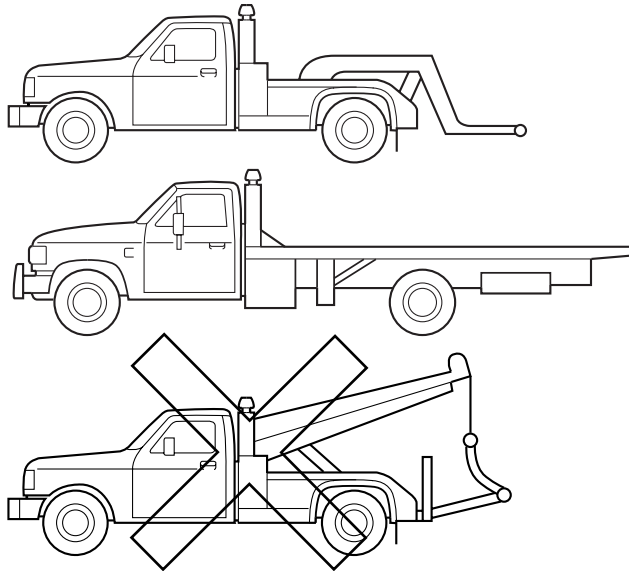

If you need to have your vehicle towed, contact a professional towing service or, if you are a member of a roadside assistance program, your roadside assistance service provider.

It is recommended that your vehicle be towed with a wheel lift or flatbed equipment. Do not tow with a slingbelt. Ford Motor Company has not approved a slingbelt towing procedure.

Before your vehicle can be towed, the air suspension control in the luggage compartment must be turned to the OFF position (if equipped).

If the vehicle is towed by other means or incorrectly, vehicle damage may occur.

Ford Motor Company produces a towing manual for all authorized tow truck operators. Have your tow truck operator refer to this manual for proper hook-up and towing procedures for your vehicle.

Customer Assistance

GETTING THE SERVICES YOU NEED

At home

You must take your Ford vehicle to an authorized Ford dealer for warranty repairs. While any Ford dealership handling your vehicle line will provide warranty service, we recommend you return to your selling dealer who wants to ensure your continued satisfaction. Please note that certain warranty repairs require special training and/or equipment, so not all dealers are authorized to perform all warranty repairs. This means that, depending on the warranty repair needed, you may have to take your vehicle to another dealer. A reasonable time must be allowed to perform a repair after taking your vehicle to the dealership. Repairs will be made using Ford or Motorcraft parts, or remanufactured or other parts that are authorized by Ford.

If you have questions or concerns, or are unsatisfied with the service you are receiving, follow these steps:

1. Contact your Sales Representative or Service Advisor at your selling/servicing dealership.
2. If your inquiry or concern remains unresolved, contact the Sales Manager, Service Manager or Customer Relations Manager.
3. If you require assistance or clarification on Ford Motor Company policies or procedures, please contact the Ford Customer Relationship Center at the number below.

Away from home

If you own a Ford or Mercury vehicle and are away from home when your vehicle needs service, or if you need more help than the dealership could provide, after following the steps described above, contact the Ford Customer Relationship Center to find an authorized dealership to help you.

In the United States:

Ford Motor Company
Customer Relationship Center
P.O. Box 6248
Dearborn, MI 48121
1-800-392-3673 (FORD)
(TDD for the hearing impaired: 1-800-232-5952)
www.customersaskford.com

In Canada:

Customer Relationship Centre

168

Customer Assistance

Ford Motor Company of Canada, Limited
P.O. Box 2000
Oakville, Ontario L6J 5E4
1-800-565-3673 (FORD)
www.ford.ca

If you own a Lincoln vehicle and are away from home when your vehicle needs service, or if you need more help than the dealership could provide, after following the steps described above, contact the Ford Customer Relationship Center to find an authorized dealership to help you.

In the United States:
Ford Motor Company
Customer Relationship Center
P.O. Box 6248
Dearborn, MI 48121
1-800-521-4140
(TDD for the hearing impaired: 1-800-232-5952)
www.customersaskford.com

In Canada:
Lincoln Centre
Ford Motor Company of Canada, Limited
P.O. Box 2000
Oakville, Ontario L6J 5E4
1-800-387-9333
www.lincolncanada.com

In order to help you service your Lincoln vehicle, please have the following information available when contacting the Lincoln Centre:

- Your telephone number (home and business)
- The name of the dealer and the city where the dealership is located
- The year and make of your vehicle
- The date of vehicle purchase
- The current odometer reading
- The vehicle identification number (VIN)

Additional Assistance

If you still have a complaint involving a warranty dispute, you may wish to contact the Dispute Settlement Board (U.S.).

In some states (in the U.S.) you must directly notify Ford in writing before pursuing remedies under your state's warranty laws. Ford is also allowed a final repair attempt in some states.

Customer Assistance

In the United States, a warranty dispute must be submitted to the Dispute Settlement Board before taking action under the Magnuson-Moss Warranty Act, or to the extent allowed by state law, before pursuing replacement or repurchase remedies provided by certain state laws. This dispute handling procedure is not required prior to enforcing state created rights or other rights which are independent of the Magnuson-Moss Warranty Act or state replacement or repurchase laws.

FORD EXTENDED SERVICE PLAN

You can get more protection for your new car or light truck by purchasing Ford Extended Service Plan (Ford ESP) coverage. It provides the following:

- Benefits during the warranty period depending on the plan you purchase (such as: reimbursement for rentals; coverage for certain maintenance and wear items).
- Protection against covered repair costs after your Bumper-to-Bumper Warranty expires.

You may purchase Ford ESP from any participating Ford and Lincoln Mercury and Ford of Canada dealer. There are several plans available in various time, distance and deductible combinations which can be tailored to fit your own driving needs. Ford ESP also offers reimbursement benefits for towing and rental coverage.

When you buy Ford ESP, you receive Peace-of-Mind protection throughout the United States and Canada, provided by a network of more than 5,000 participating Ford or Lincoln Mercury and Ford of Canada dealers.

If you did not take advantage of the Ford Extended Service Plan at the time of purchasing your vehicle, you may still be eligible. Since this information is subject to change, please ask your dealer for complete details about Ford Extended Service Plan coverage options, or visit the Ford ESP website at www.ford-esp.com.

THE DISPUTE SETTLEMENT BOARD (U.S. ONLY)

The Dispute Settlement Board is:

- an independent, third-party arbitration program for warranty disputes.
- available free to owners and lessees of qualifying Ford Motor Company vehicles.

The Dispute Settlement Board may not be available in all states. Ford Motor Company reserves the right to change eligibility limitations, modify

Customer Assistance

procedures and/or to discontinue this service without notice and without incurring obligations per applicable state law.

What kinds of cases does the Board review?

Unresolved warranty repair concerns or vehicle performance concerns as on Ford and Lincoln Mercury cars and Ford and Lincoln Mercury light trucks which are within the terms of any applicable written new vehicle warranty are eligible for review, except those involving:

- a non-Ford product
- a non-Ford dealership
- sales disputes between customer and dealer except those associated with warranty repairs or concerns with the vehicle's performance as designed
- a request for reimbursement of consequential expenses unless a service or product concern is being reviewed
- items not covered by the New Vehicle Limited Warranty (including maintenance and wear items)
- alleged personal injury/property damage claims
- cases currently in litigation
- vehicles not used primarily for family, personal or household purposes (except in states where the Dispute Settlement Board is required to review commercial vehicles)
- vehicles with non-U.S. warranties

Concerns are ineligible for review if the New Vehicle Limited Warranty has expired at receipt of your application and, in certain states eligibility is dependent upon the customer's possession of the vehicle.

Eligibility may differ according to state law. For example, see the unique brochures for California, West Virginia, Georgia and Wisconsin purchasers/lessees.

Board membership

The Board consists of:

- Three consumer representatives
- A Ford or Lincoln Mercury dealership representative

Consumer candidates for Board membership are recruited and trained by an independent consulting firm. The dealership Board member is chosen from Ford and Lincoln Mercury dealership management, recognized for their business leadership qualities.

Customer Assistance

What the Board needs

To have your case reviewed you must complete the application in the DSB brochure and mail it to the address provided on the application form. Some states will require you to use certified mail, with return receipt requested.

Your application is reviewed and, if it is determined to be eligible, you will receive an acknowledgment indicating:

- The file number assigned to your application.
- The toll-free phone number of the DSB's independent administrator.

Your dealership and a Ford Motor Company representative will then be asked to submit statements.

To properly review your case, the Board needs the following information:

- Legible copies of all documents and maintenance or repair orders relevant to the case.
- The year, make, model, and Vehicle Identification Number (VIN) listed on your vehicle ownership license.
- The date of repair(s) and mileage at the time of occurrence(s).
- The current mileage.
- The name of the dealer(s) who sold or serviced the vehicle.
- A brief description of your unresolved concern.
- A brief summary of the action taken by the dealer(s) and Ford Motor Company.
- The names (if known) of all the people you contacted at the dealership(s).
- A description of the action you expect to resolve your concern.

You will receive a letter of explanation if your application does not qualify for Board review.

Oral presentations

If you would like to make an oral presentation, indicate YES to question 6 on the application. While it is your right to make an oral presentation before the Board, this is not a requirement and the Board will decide the case whether or not an oral presentation is made. An oral presentation may be requested by the Board as well.

Making a decision

Board members review all available information related to each complaint, including oral presentations, and arrive at a fair and impartial decision. Board review may be terminated at any time by either party.

Customer Assistance

Every effort is made to decide the case within 40 days of the date that all requested information is received by the Board. Since the Board generally meets once a month, it may take longer for the Board to consider some cases.

After a case is reviewed, the Board mails you a decision letter and a form on which to accept or reject the Board's decision. The decisions of the Board are binding on Ford (and, in some cases, on the dealer) but not on consumers who are free to pursue other remedies available to them under state or federal law.

To request a DSB Brochure/Application

For a brochure/application, speak to your dealer or write/call the Board at the following address/phone number:

Dispute Settlement Board
P.O. Box 1424
Waukesha, WI 53187-1424
1-800-428-3718

You may also contact the North American Customer Relationship Center at 1-800-392-3673 (Ford), TDD for the hearing impaired: 1-800-232-5952 or by writing to the Center at the following address:

Ford Motor Company
Customer Relationship Center
P.O. Box 6248
Dearborn, Michigan 48121

UTILIZING THE MEDIATION/ARBITRATION PROGRAM (CANADA ONLY)

In those cases where you continue to feel that the efforts by Ford and the dealer to resolve a factory-related vehicle service concern have been unsatisfactory, Ford of Canada participates in an impartial third party mediation/arbitration program administered by the Canadian Motor Vehicle Arbitration Plan (CAMVAP).

The CAMVAP program is a straight-forward and relatively speedy alternative to resolve a disagreement when all other efforts to produce a settlement have failed. This procedure is without cost to you and is designed to eliminate the need for lengthy and expensive legal proceedings.

In the CAMVAP program, impartial third-party arbitrators conduct hearings at mutually convenient times and places in an informal environment. These impartial arbitrators review the positions of the

Customer Assistance

parties, make decisions and, when appropriate, render awards to resolve disputes. CAMVAP decisions are fast, fair, and final; the arbitrator's award is binding both to you and Ford of Canada.

CAMVAP services are available in all territories and provinces. For more information, without charge or obligation, call your CAMVAP Provincial Administrator directly at 1-800-207-0685.

GETTING ASSISTANCE OUTSIDE THE U.S. AND CANADA

Before exporting your vehicle to a foreign country, contact the appropriate foreign embassy or consulate. These officials can inform you of local vehicle registration regulations and where to find unleaded fuel.

If you cannot find unleaded fuel or can only get fuel with an anti-knock index lower than is recommended for your vehicle, contact a district or owner relations/customer relationship office.

The use of leaded fuel in your vehicle without proper conversion may damage the effectiveness of your emission control system and may cause engine knocking or serious engine damage. Ford Motor Company/Ford of Canada is not responsible for any damage caused by use of improper fuel.

In the United States, using leaded fuel may also result in difficulty importing your vehicle back into the U.S.

If your vehicle must be serviced while you are traveling or living in Central or South America, the Caribbean, or the Middle East, contact the nearest Ford dealership. If the dealership cannot help you, write or call:

FORD MOTOR COMPANY
WORLDWIDE DIRECT MARKET OPERATIONS
1555 Fairlane Drive
Fairlane Business Park #3
Allen Park, Michigan 48101
U.S.A.
Telephone: (313) 594-4857
FAX: (313) 390-0804

If you are in another foreign country, contact the nearest Ford dealership. If the dealership employees cannot help you, they can direct you to the nearest Ford affiliate office.

If you buy your vehicle in North America and then relocate outside of the U.S. or Canada, register your vehicle identification number (VIN) and new address with Ford Motor Company Worldwide Direct Market Operations.

Customer Assistance

ORDERING ADDITIONAL OWNER'S LITERATURE

To order the publications in this portfolio, contact Helm, Incorporated at:

HELM, INCORPORATED
P.O. Box 07150
Detroit, Michigan 48207

Or call:

For a free publication catalog, order toll free: 1-800-782-4356

Monday-Friday 8:00 a.m. - 6:00 p.m. EST

Helm, Incorporated can also be reached by their website:
www.helminc.com.

(Items in this catalog may be purchased by credit card, check or money order.)

Obtaining a French owner's guide

French Owner's Guides can be obtained from your dealer or by writing to Ford Motor Company of Canada, Limited, Service Publications, P.O. Box 1580, Station B, Mississauga, Ontario L4Y 4G3.

IN CALIFORNIA (U.S. ONLY)

California Civil Code Section 1793.2(d) requires that, if a manufacturer or its representative is unable to repair a motor vehicle to conform to the vehicle's applicable express warranty after a reasonable number of attempts, the manufacturer shall be required to either replace the vehicle with one substantially identical or repurchase the vehicle and reimburse the buyer in an amount equal to the actual price paid or payable by the consumer (less a reasonable allowance for consumer use). The consumer has the right to choose whether to receive a refund or replacement vehicle.

California Civil Code Section 1793.22(b) presumes that the manufacturer has had a reasonable number of attempts to conform the vehicle to its applicable express warranties if, within the first 18 months of ownership of a new vehicle or the first 29,000 km (18,000 miles), whichever occurs first:

1. Two or more repair attempts are made on the same non-conformity likely to cause death or serious bodily injury OR
2. Four or more repair attempts are made on the same nonconformity (a defect or condition that substantially impairs the use, value or safety of the vehicle) OR

Customer Assistance

3. The vehicle is out of service for repair of nonconformities for a total of more than 30 calendar days (not necessarily all at one time)

In the case of 1 or 2 above, the consumer must also notify the manufacturer of the need for the repair of the nonconformity at the following address:

Ford Motor Company
16800 Executive Plaza Drive
Mail Drop 3NE-B
Dearborn, MI 48126

REPORTING SAFETY DEFECTS (U.S. ONLY)

If you believe that your vehicle has a defect which could cause a crash or could cause injury or death, you should immediately inform the National Highway Traffic Safety



Administration (NHTSA) in addition to notifying Ford Motor Company.

If NHTSA receives similar complaints, it may open an investigation, and if it finds that a safety defect exists in a group of vehicles, it may order a recall and remedy campaign. However, NHTSA cannot become involved in individual problems between you, your dealer, or Ford Motor Company.

To contact NHTSA, you may either call the Auto Safety Hotline toll-free at 1-800-424-9393 (or 366-0123 in the Washington D.C. area) or write to:

NHTSA
400 Seventh Street
U.S. Department of Transportation
Washington, D.C. 20590

You can also obtain other information about motor vehicle safety from the Hotline.

WASHING THE EXTERIOR

Wash your vehicle regularly with cool or lukewarm water and a neutral Ph shampoo, such as Motorcraft Detail Wash (ZC-3-A), which is available from your dealer.

- Never use strong household detergents or soap, such as dish washing or laundry liquid. These products can discolor and spot painted surfaces.
- Never wash a vehicle that is “hot to the touch” or during exposure to strong, direct sunlight.
- Always use a clean sponge or car wash mitt with plenty of water for best results.
- Dry the vehicle with a chamois or soft terry cloth towel in order to eliminate water spotting.
- It is especially important to wash the vehicle regularly during the winter months, as dirt and road salt are difficult to remove and cause damage to the vehicle.
- Immediately remove items such as gasoline, diesel fuel, bird droppings and insect deposits because they can cause damage to the vehicle’s paintwork and trim over time.
- Remove any exterior accessories, such as antennas, before entering a car wash.
- **Suntan lotions and insect repellents can damage any painted surface; if these substances come in contact with your vehicle, wash off as soon as possible.**

WAXING

Applying a polymer paint sealant to your vehicle every six months will assist in reducing minor scratches and paint damage.

- Wash the vehicle first.
- Do not use waxes that contain abrasives.
- Do not allow paint sealant to come in contact with any non-body (low-gloss black) colored trim, such as grained door handles, roof racks, bumpers, side moldings, mirror housings or the windshield cowl area. The paint sealant will “gray” or stain the parts over time.

PAINT CHIPS

Your dealer has touch-up paint and sprays to match your vehicle’s color. Take your color code (printed on a sticker in the driver’s door jam) to your dealer to ensure you get the correct color.

Cleaning

- Remove particles such as bird droppings, tree sap, insect deposits, tar spots, road salt and industrial fallout before repairing paint chips.
- Always read the instructions before using the products.

ALUMINUM WHEELS AND WHEEL COVERS

Aluminum wheels and wheel covers are coated with a clearcoat paint finish. In order to maintain their shine:

- Clean weekly with Motorcraft Wheel and Tire Cleaner (ZC-37-A), which is available from your dealer. Heavy dirt and brake dust accumulation may require agitation with a sponge. Rinse thoroughly with a strong stream of water.
- Never apply any cleaning chemical to hot or warm wheel rims or covers.
- Some automatic car washes may cause damage to the finish on your wheel rims or covers. Chemical-strength cleaners, or cleaning chemicals, in combination with brush agitation to remove brake dust and dirt, could wear away the clearcoat finish over time.
- Do not use hydrofluoric acid-based or high caustic-based wheel cleaners, steel wool, fuels or strong household detergent.
- To remove tar and grease, use Motorcraft Bug and Tar Remover (ZC-42), available from your dealer.

ENGINE

Engines are more efficient when they are clean because grease and dirt buildup keep the engine warmer than normal. When washing:

- Take care when using a power washer to clean the engine. The high-pressure fluid could penetrate the sealed parts and cause damage.
- Do not spray a hot engine with cold water to avoid cracking the engine block or other engine components.
- Spray Motorcraft Engine Shampoo and Degreaser (ZC-20) on all parts that require cleaning and pressure rinse clean.

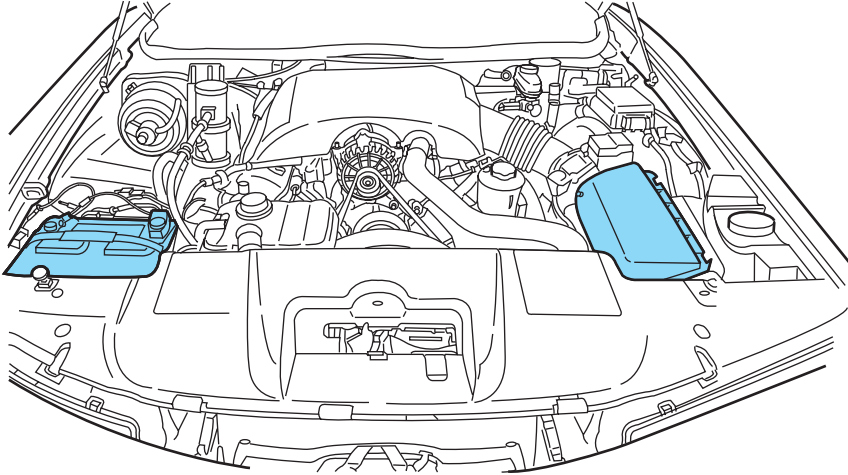

- Cover the highlighted areas to prevent water damage when cleaning the engine.
- Never wash or rinse the engine while it is running; water in the running engine may cause internal damage.

PLASTIC (NON-PAINTED) EXTERIOR PARTS

Use only approved products to clean plastic parts. These products are available from your dealer.

- For routine cleaning, use Motorcraft Detail Wash (ZC-3-A).
- If tar or grease spots are present, use Motorcraft Bug and Tar Remover (ZC-42).

WINDOWS AND WIPER BLADES

The windshield, rear and side windows and the wiper blades should be cleaned regularly. If the wipers do not wipe properly, substances on the vehicle's glass or the wiper blades may be the cause. These may include hot wax treatments used by commercial car washes, tree sap, or other organic contamination. To clean these items, please follow these tips:

- The windshield, rear windows and side windows may be cleaned with a non-abrasive cleaner such as Motorcraft Ultra Clear Spray Glass Cleaner (ZC-23), available from your dealer.
- Do not use abrasives, as they may cause scratches.

Cleaning

- Do not use fuel, kerosene, or paint thinner to clean any parts.
- Wiper blades can be cleaned with isopropyl (rubbing) alcohol or windshield washer solution. Be sure to replace wiper blades when they appear worn or do not function properly.

Do not use sharp objects, such as a razor blade, to clean the inside of the rear window or to remove decals, as it may cause damage to the rear window defroster's heated grid lines.

INSTRUMENT PANEL AND CLUSTER LENS

Clean the instrument panel with a damp cloth, then dry with a dry cloth.

- Avoid cleaners or polish that increase the gloss of the upper portion of the instrument panel. The dull finish in this area helps protect the driver from undesirable windshield reflection.



Do not use chemical solvents or strong detergents when cleaning the steering wheel or instrument panel to avoid contamination of the air bag system.

- Be certain to wash or wipe your hands clean if you have been in contact with certain products such as insect repellent and suntan lotion in order to avoid possible damage to the interior painted surfaces.

INTERIOR TRIM

- Clean the interior trim areas with a damp cloth, then dry by wiping with a dry, soft, clean cloth.
- Do not use household or glass cleaners as these may damage the finish.

INTERIOR

For fabric, carpets, cloth seats, safety belts and seats equipped with side air bags:

- Remove dust and loose dirt with a vacuum cleaner.
- Remove light stains and soil with Motorcraft Extra Strength Upholstery Cleaner (ZC-41).
- If grease or tar is present on the material, spot-clean the area first with Motorcraft Spot and Stain Remover (ZC-14).
- Never saturate the seat covers with cleaning solution.
- Do not use household cleaning products or glass cleaners, which can stain and discolor the fabric and affect the flame retardant abilities of the seat materials.

Cleaning



Do not use cleaning solvents, bleach or dye on the vehicle's safety belts, as these actions may weaken the belt webbing.



Do not use chemical solvents or strong detergents when cleaning the seat-mounted side air bag. Such products could contaminate the side air bag system and affect performance of the side air bag in a collision.

LEATHER SEATS (IF EQUIPPED)

Your leather seating surfaces have a clear, protective coating over the leather.

- To clean, use a soft cloth with Motorcraft Deluxe Leather and Vinyl Cleaner (ZC-11-A). Dry the area with a soft cloth.
- To help maintain its resiliency and color, use the Motorcraft Deluxe Leather Care Kit (ZC-11-D), available from your authorized dealer.
- Do not use household cleaning products, alcohol solutions, solvents or cleaners intended for rubber, vinyl and plastics, or oil/petroleum-based leather conditioners. These products may cause premature wearing of the clear, protective coating.

Note: In some instances, color or dye transfer can occur when wet clothing comes in contact with leather upholstery. If this occurs, the leather should be cleaned immediately to avoid permanent staining.

UNDERBODY

Flush the complete underside of your vehicle frequently. Keep body and door drain holes free from packed dirt.

Cleaning

FORD, LINCOLN AND MERCURY CAR CARE PRODUCTS

Your Ford, Lincoln or Mercury dealer has many quality products available to clean your vehicle and protect its finishes. These quality products have been specifically engineered to fulfill your automotive needs; they are custom designed to complement the style and appearance of your vehicle. Each product is made from high quality materials that meet or exceed rigid specifications. For best results, use the following products or products of equivalent quality:

- Motorcraft Custom Clearcoat Polish (ZC-8-A)
- Motorcraft Custom Vinyl Protectant (not available in Canada) (ZC-40-A)
- Motorcraft Vinyl Cleaner (Canada only) (CXC-93)
- Motorcraft Vinyl Conditioner (Canada only) (CXC-94)
- Motorcraft Deluxe Leather and Vinyl Cleaner (not available in Canada) (ZC-11-A)
- Motorcraft Bug and Tar Remover (ZC-42)
- Motorcraft Extra Strength Upholstery Cleaner (not available in Canada) (ZC-41)
- Motorcraft Custom Bright Metal Cleaner (ZC-15)
- Motorcraft Wheel and Tire Cleaner (ZC-37-A)
- Motorcraft Dash and Vinyl Cleaner (ZC-38-A)
- Motorcraft Car Care Kit (ZC-26)
- Ford Premium Car Wash Concentrate (F2SZ-19523-WC)
- Motorcraft Carlite Glass Cleaner (Canada only) (CXC-100)
- Motorcraft Spot and Stain Remover (ZC-14)
- Motorcraft Detail Wash (ZC-3-A)
- Motorcraft Tire Clean and Shine (ZC-28)
- Motorcraft Triple Clean (ZC-13)
- Motorcraft Ultra-Clear Spray Glass Cleaner (not available in Canada) (ZC-23)
- Motorcraft Engine Shampoo and Degreaser (ZC-20)

Maintenance and Specifications

SERVICE RECOMMENDATIONS

To help you service your vehicle:

- We highlight do-it-yourself items in the engine compartment for easy location.
- We provide a scheduled maintenance guide which makes tracking routine service easy.

If your vehicle requires professional service, your dealership can provide the necessary parts and service. Check your *Warranty Guide/Owner Information Guide* to find out which parts and services are covered.

Use only recommended fuels, lubricants, fluids and service parts conforming to specifications. Motorcraft parts are designed and built to provide the best performance in your vehicle.

Notice to owners of Severe Duty vehicles

Before you have maintenance done on your vehicle, be sure to read the "Severe Duty Owner's Guide Supplement." This book contains important operation and maintenance information.

PRECAUTIONS WHEN SERVICING YOUR VEHICLE

- Do not work on a hot engine.
- Make sure that nothing gets caught in moving parts.
- Do not work on a vehicle with the engine running in an enclosed space, unless you are sure you have enough ventilation.
- Keep all open flames and other burning (cigarettes) material away from the battery and all fuel related parts.

Working with the engine off

1. Set the parking brake and shift to P (Park).
2. Turn off the engine and remove the key.
3. Block the wheels.

Working with the engine on

1. Set the parking brake and shift to P (Park).
2. Block the wheels.

Note: Do not start your engine with the air cleaner removed and do not remove it while the engine is running.

Maintenance and Specifications

OPENING THE HOOD

1. Inside the vehicle, pull the hood release handle located under the instrument panel.
2. Go to the front of the vehicle and release the auxiliary latch that is located under the front of the hood.
3. Lift the hood until the lift cylinders hold it open.

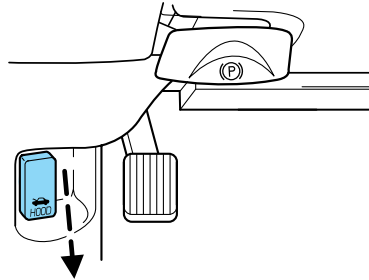

Maintenance and Specifications

IDENTIFYING COMPONENTS IN THE ENGINE COMPARTMENT

4.6L SOHC V8 engine

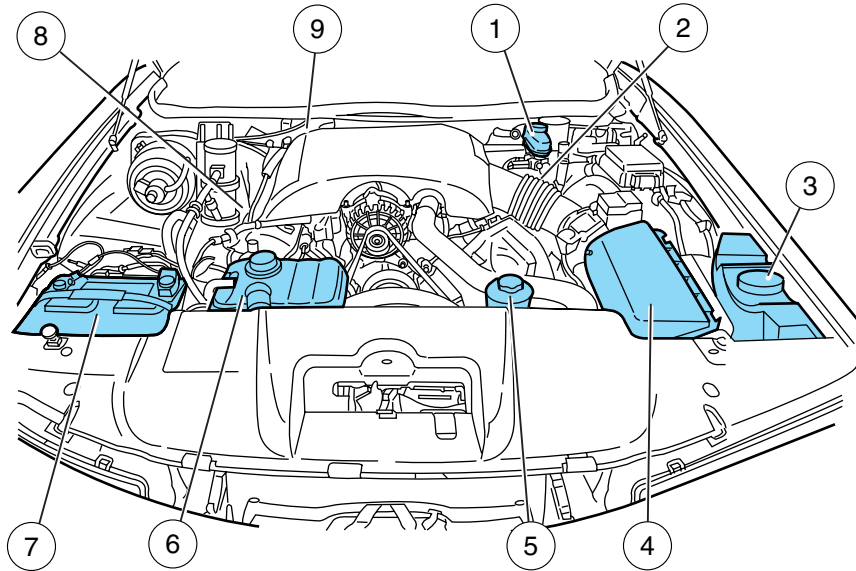

1. Brake fluid reservoir
2. Engine oil dipstick
3. Windshield washer fluid reservoir
4. Air filter assembly
5. Power steering fluid reservoir
6. Engine coolant reservoir
7. Battery
8. Engine oil filler cap
9. Automatic transmission fluid dipstick

Maintenance and Specifications

WINDSHIELD WASHER FLUID

Add fluid to fill the reservoir if the level is low. In very cold weather, do not fill the reservoir completely.

Only use a washer fluid that meets Ford specification WSB-M8B16-A2. Refer to *Lubricant specifications* in this chapter.

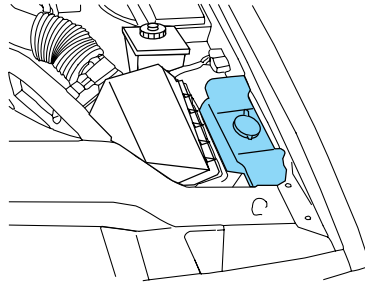

State or local regulations on volatile organic compounds may restrict the use of methanol, a common windshield washer antifreeze additive. Washer fluids containing non-methanol antifreeze agents should be used only if they provide cold weather protection without damaging the vehicle's paint finish, wiper blades or washer system.



If you operate your vehicle in temperatures below 4.5° C (40° F), use washer fluid with antifreeze protection. Failure to use washer fluid with antifreeze protection in cold weather could result in impaired windshield vision and increase the risk of injury or accident.

Note: Do not put washer fluid in the engine coolant reservoir. Washer fluid placed in the cooling system may harm engine and cooling system components.

ENGINE OIL

Checking the engine oil

Refer to the scheduled maintenance guide for the appropriate intervals for checking the engine oil.

1. Make sure the vehicle is on level ground.
2. Turn the engine off and wait up to 10 minutes for the oil to drain into the oil pan.
3. Set the parking brake and ensure the gearshift is securely latched in P (Park).
4. Open the hood. Protect yourself from engine heat.

Maintenance and Specifications

5. Locate and carefully remove the engine oil level indicator (dipstick).

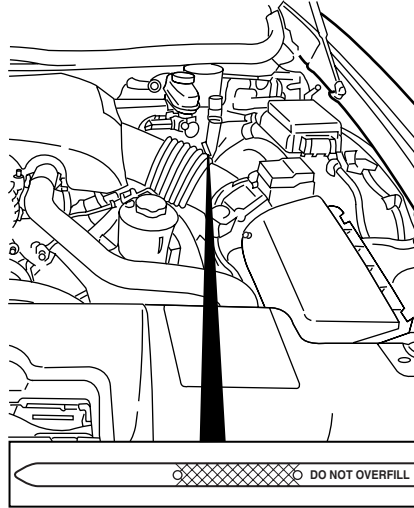

6. Wipe the indicator clean. Insert the indicator fully, then remove it again.

- If the oil level is **within this range**, the oil level is acceptable. **DO NOT ADD OIL.**

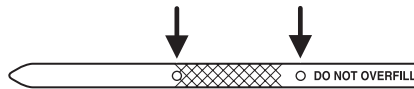

- If the oil level is **below this mark**, engine **oil must be added** to raise the level within the normal operating range.

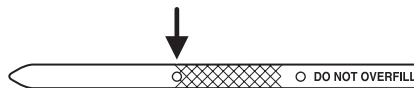

Maintenance and Specifications

- If required, add engine oil to the engine. Refer to *Adding engine oil* in this chapter.

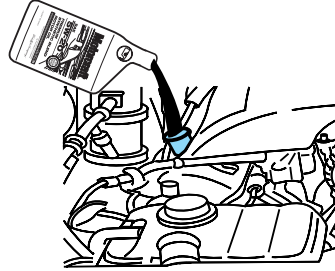

- **Do not overfill the engine with oil. Oil levels above this mark may cause engine damage.** If the engine is overfilled, some oil must be removed from the engine by a qualified service technician.

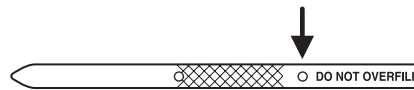

7. Put the indicator back in and ensure it is fully seated.

Adding engine oil

1. Check the engine oil. For instructions, refer to *Checking the engine oil* in this chapter.
2. If the engine oil level is not within the normal operating range, add only certified engine oil of the recommended viscosity. Remove the engine oil filler cap and use a funnel to pour the engine oil into the opening.
3. Recheck the engine oil level. Make sure the oil level is not above the normal operating range on the engine oil level indicator (dipstick).
4. Install the indicator and ensure it is fully seated.
5. Fully install the engine oil filler cap by turning the filler cap clockwise until three clicks can be heard.

To avoid possible oil loss, DO NOT operate the vehicle with the engine oil level indicator and/or the engine oil filler cap removed.

Maintenance and Specifications

Engine oil and filter recommendations

Look for this certification trademark.

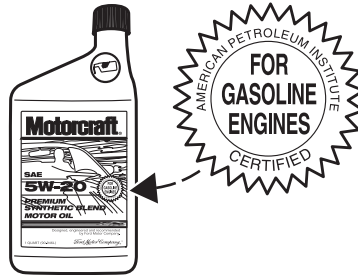

Use SAE 5W-20 engine oil.

Only use oils “Certified For Gasoline Engines” by the American Petroleum Institute (API). To protect your engine’s warranty use Motorcraft SAE 5W-20 or an equivalent 5W-20 oil meeting Ford specification WSS-M2C153-H. **SAE 5W-20 oil provides optimum fuel economy and durability performance meeting all requirements for your vehicle’s engine.**

Do not use supplemental engine oil additives, cleaners or other engine treatments. They are unnecessary and could lead to engine damage that is not covered by Ford warranty.

Change your engine oil and filter according to the appropriate schedule listed in the scheduled maintenance guide.

Ford production and aftermarket (Motorcraft) oil filters are designed for added engine protection and long life. If a replacement oil filter is used that does not meet Ford material and design specifications, start-up engine noises or knock may be experienced.

It is recommended you use the appropriate Motorcraft oil filter (or another brand meeting Ford specifications) for your engine application.

Maintenance and Specifications

BATTERY

Your vehicle is equipped with a Motorcraft maintenance-free battery which normally does not require additional water during its life of service.

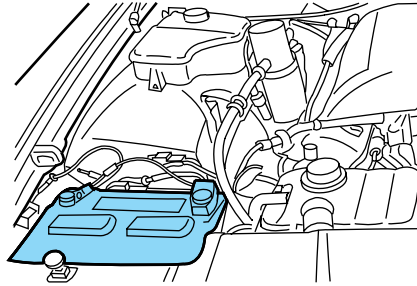

However, for severe usage or in high temperature climates, check the battery electrolyte level. Refer to the *Scheduled Maintenance Guide* for the service interval schedules.

Keep the electrolyte level in each cell up to the “level indicator”. Do not overfill the battery cells.

If the electrolyte level in the battery is low, you can add plain tap water to the battery, as long as you do not use hard water (water with a high mineral or alkali content). If possible, however, try to only fill the battery cells with distilled water. If the battery needs water often, have the charging system checked.

If your battery has a cover/shield, make sure it is reinstalled after the battery has been cleaned or replaced.

For longer, trouble-free operation, keep the top of the battery clean and dry. Also, make certain the battery cables are always tightly fastened to the battery terminals.

If you see any corrosion on the battery or terminals, remove the cables from the terminals and clean with a wire brush. You can neutralize the acid with a solution of baking soda and water.



Batteries normally produce explosive gases which can cause personal injury. Therefore, do not allow flames, sparks or lighted substances to come near the battery. When working near the battery, always shield your face and protect your eyes. Always provide proper ventilation.

Maintenance and Specifications

 When lifting a plastic-cased battery, excessive pressure on the end walls could cause acid to flow through the vent caps, resulting in personal injury and/or damage to the vehicle or battery. Lift the battery with a battery carrier or with your hands on opposite corners.

 Keep batteries out of reach of children. Batteries contain sulfuric acid. Avoid contact with skin, eyes or clothing. Shield your eyes when working near the battery to protect against possible splashing of acid solution. In case of acid contact with skin or eyes, flush immediately with water for a minimum of 15 minutes and get prompt medical attention. If acid is swallowed, call a physician immediately.

 Battery posts, terminals and related accessories contain lead and lead compounds. **Wash hands after handling.**

Because your vehicle's engine is electronically controlled by a computer, some control conditions are maintained by power from the battery. When the battery is disconnected or a new battery is installed, the engine must relearn its idle and fuel trim strategy for optimum driveability and performance. To begin this process:

1. With the vehicle at a complete stop, set the parking brake.
2. Put the gearshift in P (Park), turn off all accessories and start the engine.
3. Run the engine until it reaches normal operating temperature.
4. Allow the engine to idle for at least one minute.
5. Turn the A/C on and allow the engine to idle for at least one minute.
6. Release the parking brake. With your foot on the brake pedal and with the A/C on, put the vehicle in D (Drive) and allow the engine to idle for at least one minute.
7. Drive the vehicle to complete the relearning process.
 - The vehicle may need to be driven 16 km (10 miles) or more to relearn the idle and fuel trim strategy.
 - **If you do not allow the engine to relearn its idle trim, the idle quality of your vehicle may be adversely affected until the idle trim is eventually relearned.**

If the battery has been disconnected or a new battery has been installed, the clock and radio settings must be reset once the battery is reconnected.

Maintenance and Specifications

- Always dispose of automotive batteries in a responsible manner. Follow your local authorized standards for disposal. Call your local authorized recycling center to find out more about recycling automotive batteries.

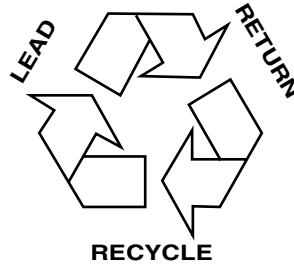

ENGINE COOLANT

Checking engine coolant

The concentration and level of engine coolant should be checked at the mileage intervals listed in the *Scheduled Maintenance Guide*. The coolant concentration should be maintained at 50/50 coolant and distilled water, which equates to a freeze point of -36°C (-34°F). Coolant concentration testing is possible with a hydrometer or antifreeze tester (such as the Rotunda Battery and Antifreeze Tester, 014-R1060). The level of coolant should be maintained at the “FULL COLD” or within the “COLD FILL RANGE” level in the coolant reservoir. If the level falls below, add coolant per the instructions in the *Adding engine coolant* section.

Your vehicle was factory-filled with a 50/50 engine coolant and water concentration. If the concentration of coolant falls below 40% or above 60%, the engine parts could become damaged or not work properly. **A 50–50 mixture of coolant and water provides the following:**

- **Freeze protection down to -36°C (-34°F).**
- **Boiling protection up to 129°C (265°F).**
- **Protection against rust and other forms of corrosion.**
- **Enables calibrated gauges to work properly.**

Maintenance and Specifications

When the engine is cold, check the level of the engine coolant in the reservoir.

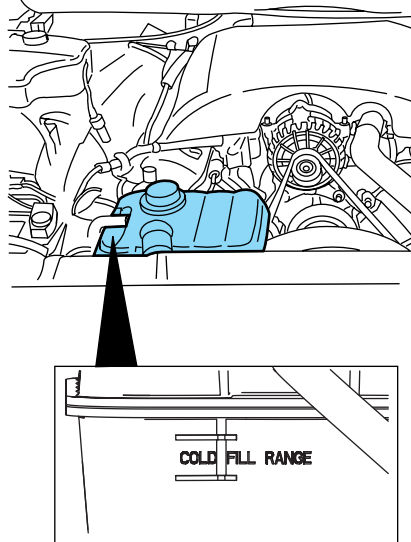

- The engine coolant should be at the “FULL COLD” level or within the “COLD FILL RANGE” as listed on the engine coolant reservoir (depending upon application).
- Refer to the *Scheduled Maintenance Guide* for service interval schedules.
- Be sure to read and understand *Precautions when servicing your vehicle* in this chapter.

If the engine coolant has not been checked at the recommended interval, the engine coolant reservoir may become low or empty. If the reservoir is low or empty, add engine coolant to the reservoir. Refer to *Adding engine coolant* in this chapter.

Note: Automotive fluids are not interchangeable; do not use engine coolant, antifreeze or windshield washer fluid outside of its specified function and vehicle location.

Adding engine coolant

When adding coolant, make sure it is a 50/50 mixture of engine coolant and distilled water. Add the mixture to the coolant reservoir, **when the engine is cool**, until the appropriate fill level is obtained.

Maintenance and Specifications



Do not add engine coolant when the engine is hot. Steam and scalding liquids released from a hot cooling system can burn you badly. Also, you can be burned if you spill coolant on hot engine parts.



Do not put engine coolant in the windshield washer fluid container. If sprayed on the windshield, engine coolant could make it difficult to see through the windshield.

- **Add Motorcraft Premium Gold Engine Coolant (yellow-colored), VC-7-A (U.S., except CA and OR), VC-7-B (CA and OR only), meeting Ford Specification WSS-M97B51-A1.**

Note: Use of Motorcraft Cooling System Stop Leak Pellets, VC-6, may darken the color of Motorcraft Premium Gold Engine Coolant from yellow to golden tan.

- **Do not add/mix an orange-colored, extended life coolant such as Motorcraft Speciality Orange Engine Coolant, VC-2 (US) or CXC-209 (Canada), meeting Ford specification WSS-M97B44-D with the factory-filled coolant.** Mixing Motorcraft Speciality Orange Engine Coolant or any orange-colored extended life product with your factory filled coolant can result in degraded corrosion protection.
- A large amount of water without engine coolant may be added, in case of emergency, to reach a vehicle service location. In this instance, the cooling system must be drained and refilled with a 50/50 mixture of engine coolant and distilled water as soon as possible. Water alone (without engine coolant) can cause engine damage from corrosion, overheating or freezing.
- **Do not use alcohol, methanol, brine or any engine coolants mixed with alcohol or methanol antifreeze (coolant).** Alcohol and other liquids can cause engine damage from overheating or freezing.
- **Do not add extra inhibitors or additives to the coolant.** These can be harmful and compromise the corrosion protection of the engine coolant.

For vehicles with overflow coolant systems with a non-pressurized cap on the coolant recovery system, add coolant to the coolant recovery reservoir when the engine is cool. Add the proper mixture of coolant and water to the "FULL COLD" level. For all other vehicles, which have a coolant degas system with a pressurized cap, or if it is necessary to

Maintenance and Specifications

remove the coolant pressure relief cap on the radiator of a vehicle with an overflow system, follow these steps to add engine coolant.



To reduce the risk of personal injury, make sure the engine is cool before unscrewing the coolant pressure relief cap. The cooling system is under pressure; steam and hot liquid can come out forcefully when the cap is loosened slightly.

1. Before you begin, turn the engine off and let it cool.
2. When the engine is cool, wrap a thick cloth around the coolant pressure relief cap on the coolant reservoir (a translucent plastic bottle). Slowly turn cap counterclockwise (left) until pressure begins to release.
3. Step back while the pressure releases.
4. When you are sure that all the pressure has been released, use the cloth to turn it counterclockwise and remove the cap.
5. Fill the coolant reservoir slowly with the proper coolant mixture (see above), to within the “COLD FULL RANGE” or the “FULL COLD” level on the reservoir. If you removed the radiator cap in an overflow system, fill the radiator until the coolant is visible and radiator is almost full.
6. Replace the cap. Turn until tightly installed. (Cap must be tightly installed to prevent coolant loss.)

After any coolant has been added, check the coolant concentration, refer to *Checking engine coolant*. If the concentration is not 50/50 (protection to $-34^{\circ}\text{F}/-36^{\circ}\text{C}$), drain some coolant and adjust the concentration. It may take several drains and additions to obtain a 50/50 coolant concentration.

Whenever coolant has been added, the coolant level in the coolant reservoir should be checked the next few times you drive the vehicle. If necessary, add enough 50/50 concentration of engine coolant and distilled water to bring the liquid level to the proper level.

If you have to add more than 1.0 liter (1.0 quart) of engine coolant per month, have your dealer check the engine cooling system. Your cooling system may have a leak. Operating an engine with a low level of coolant can result in engine overheating and possible engine damage.

Recycled engine coolant

Ford Motor Company does NOT recommend the use of recycled engine coolant in vehicles originally equipped with Motorcraft Premium Gold Engine Coolant since a Ford-approved recycling process is not yet available.

Maintenance and Specifications



Used engine coolant should be disposed of in an appropriate manner. Follow your community's regulations and standards for recycling and disposing of automotive fluids.

Coolant refill capacity

To find out how much fluid your vehicle's cooling system can hold, refer to *Refill capacities* in this section.

Fill your engine coolant reservoir as outlined in *Adding engine coolant* in this section.

Severe climates

If you drive in extremely cold climates (less than -36°C [-34°F):

- **It may be necessary to increase the coolant concentration above 50%.**
- **NEVER increase the coolant concentration above 60%.**
- **Increased engine coolant concentrations above 60% will decrease the overheat protection characteristics of the engine coolant and may cause engine damage.**
- **Refer to the chart on the coolant container to ensure the coolant concentration in your vehicle will provide adequate freeze protection at the temperatures in which you drive in the winter months.**

If you drive in extremely hot climates:

- **It is still necessary to maintain the coolant concentration above 40%.**
- **NEVER decrease the coolant concentration below 40%.**
- **Decreased engine coolant concentrations below 40% will decrease the corrosion protection characteristics of the engine coolant and may cause engine damage.**
- **Decreased engine coolant concentrations below 40% will decrease the freeze protection characteristics of the engine coolant and may cause engine damage.**
- **Refer to the chart on the coolant container to ensure the coolant concentration in your vehicle will provide adequate protection at the temperatures in which you drive.**

Vehicles driven year-round in non-extreme climates should use a 50/50 mixture of engine coolant and distilled water for optimum cooling system and engine protection.

Maintenance and Specifications

What you should know about fail-safe cooling

If the engine coolant supply is depleted, this feature allows the vehicle to be driven temporarily before incremental component damage is incurred. The “fail-safe” distance depends on ambient temperatures, vehicle load and terrain.

How fail-safe cooling works

- Standard cluster

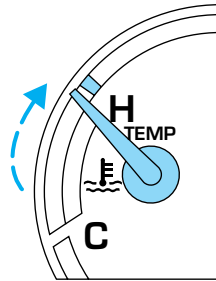

- Optional cluster



If the engine begins to overheat:

- The engine coolant temperature gauge will move to the H (hot) area (if your vehicle is equipped with analog gauges).
- The engine coolant temperature gauge will illuminate all eight bars and a tone will sound every five seconds for one minute (if your vehicle is equipped with digital gauges).
- The *Check Engine* indicator light will illuminate.

If the engine reaches a preset over-temperature condition, the engine will automatically switch to alternating cylinder operation. Each disabled cylinder acts as an air pump and cools the engine.

When this occurs the vehicle will still operate. However:

- The engine power will be limited.

Maintenance and Specifications

- The air conditioning system will be disabled.

Continued operation will increase the engine temperature:

- If your vehicle is equipped with digital gauges, the gauge bars will flash and a tone will sound every five seconds for one minute.
- The engine will completely shut down, causing steering and braking effort to increase.

Once the engine temperature cools, the engine can be re-started. Take your vehicle to a service facility as soon as possible to minimize engine damage.

When fail-safe mode is activated

You have limited engine power when in the fail-safe mode, so drive the vehicle with caution. The vehicle will not be able to maintain high-speed operation and the engine will run rough. Remember that the engine is capable of completely shutting down automatically to prevent engine damage, therefore:

1. Pull off the road as soon as safely possible and turn off the engine.
2. Arrange for the vehicle to be taken to a service facility.
3. If this is not possible, wait a short period for the engine to cool.
4. Check the coolant level and replenish if low.



Never remove the coolant reservoir cap while the engine is running or hot.

5. Re-start the engine and take your vehicle to a service facility.

Driving the vehicle without repairing the engine problem increases the chance of engine damage. Take your vehicle to a service facility as soon as possible.

WHAT YOU SHOULD KNOW ABOUT AUTOMOTIVE FUELS

Important safety precautions





Do not overfill the fuel tank. The pressure in an overfilled tank may cause leakage and lead to fuel spray and fire.



The fuel system may be under pressure. If the fuel filler cap is venting vapor or if you hear a hissing sound, wait until it stops before completely removing the fuel filler cap. Otherwise, fuel may spray out and injure you or others.

Maintenance and Specifications

 If you do not use the proper fuel filler cap, excessive pressure or vacuum in the fuel tank may damage the fuel system or cause the fuel cap to disengage in a collision, which may result in possible personal injury.

 Automotive fuels can cause serious injury or death if misused or mishandled.

 Gasoline may contain benzene, which is a cancer-causing agent.

Observe the following guidelines when handling automotive fuel:

- Extinguish all smoking materials and any open flames before fueling your vehicle.
- Always turn off the vehicle before fueling.
- Automotive fuels can be harmful or fatal if swallowed. Fuel such as gasoline is highly toxic and if swallowed can cause death or permanent injury. If fuel is swallowed, call a physician immediately, even if no symptoms are immediately apparent. The toxic effects of fuel may not be visible for hours.
- Avoid inhaling fuel vapors. Inhaling too much fuel vapor of any kind can lead to eye and respiratory tract irritation. In severe cases, excessive or prolonged breathing of fuel vapor can cause serious illness and permanent injury.
- Avoid getting fuel liquid in your eyes. If fuel is splashed in the eyes, remove contact lenses (if worn), flush with water for 15 minutes and seek medical attention. Failure to seek proper medical attention could lead to permanent injury.
- Fuels can also be harmful if absorbed through the skin. If fuel is splashed on the skin and/or clothing, promptly remove contaminated clothing and wash skin thoroughly with soap and water. Repeated or prolonged skin contact with fuel liquid or vapor causes skin irritation.
- Be particularly careful if you are taking “Antabuse” or other forms of disulfiram for the treatment of alcoholism. Breathing gasoline vapors, or skin contact could cause an adverse reaction. In sensitive individuals, serious personal injury or sickness may result. If fuel is



Maintenance and Specifications

splashed on the skin, promptly wash skin thoroughly with soap and water. Consult a physician immediately if you experience an adverse reaction.

 When refueling always shut the engine off and never allow sparks or open flames near the filler neck. Never smoke while refueling. Fuel vapor is extremely hazardous under certain conditions. Care should be taken to avoid inhaling excess fumes.

 The flow of fuel through a fuel pump nozzle can produce static electricity, which can cause a fire if fuel is pumped into an ungrounded fuel container.

Use the following guidelines to avoid static build-up when filling an ungrounded fuel container:

- Place approved fuel container on the ground.
- DO NOT fill a fuel container while it is in the vehicle (including the cargo area).
- Keep the fuel pump nozzle in contact with the fuel container while filling.
- DO NOT use a device that would hold the fuel pump handle in the fill position.

Fuel Filler Cap

Your fuel tank filler cap has an indexed design with a 1/8 turn on/off feature.

When fueling your vehicle:

1. Turn the engine off.
2. Carefully turn the filler cap counterclockwise 1/8 of a turn until it stops.
3. Pull to remove the cap from the fuel filler pipe.
4. To install the cap, align the tabs on the cap with the notches on the filler pipe.
5. Turn the filler cap clockwise 1/8 of a turn until it stops.

“Check Fuel Cap” illuminates when the ignition is turned to the ON position to ensure your bulb is working. When this light turns on, check the fuel filler cap. Continuing to operate the vehicle with the Check Fuel

200

Maintenance and Specifications

Cap light on, can activate the Service Engine Soon warning. When the fuel filler cap is properly re-installed, the light(s) will turn off after a period of normal driving. **It may take a long period of time for the system to detect an improperly installed fuel filler cap.**

If you must replace the fuel filler cap, replace it with a fuel filler cap that is designed for your vehicle. The customer warranty may be void for any damage to the fuel tank or fuel system if the correct genuine Ford or Motorcraft fuel filler cap is not used.



The fuel system may be under pressure. If the fuel filler cap is venting vapor or if you hear a hissing sound, wait until it stops before completely removing the fuel filler cap. Otherwise, fuel may spray out and injure you or others.



If you do not use the proper fuel filler cap, excessive pressure or vacuum in the fuel tank may damage the fuel system or cause the fuel cap to disengage in a collision, which may result in possible personal injury.

Choosing the right fuel

Use only UNLEADED FUEL. The use of leaded fuel is prohibited by law and could damage your vehicle.

Do not use fuel containing methanol. It can damage critical fuel system components.

Your vehicle was not designed to use fuel or fuel additives with metallic compounds, including manganese-based additives. Studies indicate that these additives can cause your vehicle's emission control system to deteriorate more rapidly. In Canada, many fuels contain critical fuel system components.

Do not use fuel containing methanol. It can damage critical fuel system components.

Repairs to correct the effects of using a fuel for which your vehicle was not designed may not be covered by your warranty.

Maintenance and Specifications

Octane recommendations

Your vehicle is designed to use “Regular” unleaded gasoline with pump (R+M)/2 octane rating of 87. We do not recommend the use of gasolines labeled as “Regular” that are sold with octane ratings of 86 or lower in high altitude areas.

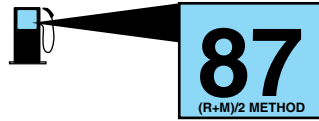

Do not be concerned if your engine sometimes knocks lightly. However, if it knocks heavily under most driving conditions while you are using fuel with the recommended octane rating, see your dealer or a qualified service technician to prevent any engine damage.

Fuel quality

If you are experiencing starting, rough idle or hesitation driveability problems, try a different brand of unleaded gasoline. “Premium” unleaded gasoline is not recommended for vehicles designed to use “Regular” unleaded gasoline because it may cause these problems to become more pronounced. If the problems persist, see your dealer or a qualified service technician.

It should not be necessary to add any aftermarket products to your fuel tank if you continue to use high quality fuel of the recommended octane rating. Aftermarket products could cause damage to the fuel system. Repairs to correct the effects of using an aftermarket product in your fuel may not be covered by your warranty.

Many of the world’s automakers approved the World-wide Fuel Charter that recommends gasoline specifications to provide improved performance and emission control system protection for your vehicle. Gasolines that meet the World-wide Fuel Charter should be used when available. Ask your fuel supplier about gasolines that meet the World-wide Fuel Charter.

Cleaner air

Ford endorses the use of reformulated “cleaner-burning” gasolines to improve air quality.

Running out of fuel

Avoid running out of fuel because this situation may have an adverse affect on powertrain components.

If you have run out of fuel:

- You may need to cycle the ignition from OFF to ON several times after refueling, to allow the fuel system to pump the fuel from the tank to the engine.

Maintenance and Specifications

- Your “Check Engine” indicator may come on. For more information on the “Check Engine” indicator, refer to the *Instrument Cluster* chapter.

Fuel Filter

For fuel filter replacement, see your dealer or a qualified service technician. Refer to the scheduled maintenance guide for the appropriate intervals for changing the fuel filter.

Replace the fuel filter with an authorized Motorcraft part. The customer warranty may be void for any damage to the fuel system if an authorized Motorcraft fuel filter is not used.

ESSENTIALS OF GOOD FUEL ECONOMY

Measuring techniques

Your best source of information about actual fuel economy is you, the driver. You must gather information as accurately and consistently as possible. Fuel expense, frequency of fill-ups or fuel gauge readings are NOT accurate as a measure of fuel economy. We do not recommend taking fuel economy measurements during the first 1,600 km (1,000 miles) of driving (engine break-in period). You will get a more accurate measurement after 3,000 km–5,000 km (2,000 miles–3,000 miles).

Filling the tank

The advertised fuel capacity of the fuel tank on your vehicle is equal to the rated refill capacity of the fuel tank as listed in the *Refill capacities* section of this chapter.

The advertised capacity is the amount of the indicated capacity and the empty reserve combined. Indicated capacity is the difference in the amount of fuel in a full tank and a tank when the fuel gauge indicates empty. Empty reserve is the small amount of fuel remaining in the fuel tank after the fuel gauge indicates empty.

The amount of usable fuel in the empty reserve varies and should not be relied upon to increase driving range. When refueling your vehicle after the fuel gauge indicates empty, you might not be able to refuel the full amount of the advertised capacity of the fuel tank due to the empty reserve still present in the tank.

For consistent results when filling the fuel tank:

- Turn the engine/ignition switch to the off position prior to refueling, an error in the reading will result if the engine is left running.

Maintenance and Specifications

- Use the same filling rate setting (low — medium — high) each time the tank is filled.
- Allow no more than 2 automatic click-offs when filling.
- Always use fuel with the recommended octane rating.
- Use a known quality gasoline, preferably a national brand.
- Use the same side of the same pump and have the vehicle facing the same direction each time you fill up.
- Have the vehicle loading and distribution the same every time.

Your results will be most accurate if your filling method is consistent.

Calculating fuel economy

1. Fill the fuel tank completely and record the initial odometer reading (in kilometers or miles).
2. Each time you fill the tank, record the amount of fuel added (in liters or gallons).
3. After at least three to five tank fill-ups, fill the fuel tank and record the current odometer reading.
4. Subtract your initial odometer reading from the current odometer reading.
5. Follow one of the simple calculations in order to determine fuel economy:

Calculation 1: **Multiply liters used by 100, then divide by total kilometers traveled.**

Calculation 2: **Divide total miles traveled by total gallons used.**

Keep a record for at least one month and record the type of driving (city or highway). This will provide an accurate estimate of the vehicle's fuel economy under current driving conditions. Additionally, keeping records during summer and winter will show how temperature impacts fuel economy. In general, lower temperatures give lower fuel economy.

Driving style — good driving and fuel economy habits

Give consideration to the lists that follow and you may be able to change a number of variables and improve your fuel economy.

Habits

- Smooth, moderate operation can yield up to 10% savings in fuel.
- Steady speeds without stopping will usually give the best fuel economy.

Maintenance and Specifications

- Idling for long periods of time (greater than one minute) may waste fuel.
- Anticipate stopping; slowing down may eliminate the need to stop.
- Sudden or hard accelerations may reduce fuel economy.
- Slow down gradually.
- Driving at reasonable speeds (traveling at 88 km/h [55 mph] uses 15% less fuel than traveling at 105 km/h [65 mph]).
- Revving the engine before turning it off may reduce fuel economy.
- Using the air conditioner or defroster may reduce fuel economy.
- You may want to turn off the speed control in hilly terrain if unnecessary shifting between third and fourth gear occurs. Unnecessary shifting of this type could result in reduced fuel economy.
- Warming up a vehicle on cold mornings is not required and may reduce fuel economy.
- Resting your foot on the brake pedal while driving may reduce fuel economy.
- Combine errands and minimize stop-and-go driving.

Maintenance

- Keep tires properly inflated and use only recommended size.
- Operating a vehicle with the wheels out of alignment will reduce fuel economy.
- Use recommended engine oil. Refer to *Lubricant specifications* in this chapter.
- Perform all regularly scheduled maintenance items. Follow the recommended maintenance schedule and owner maintenance checks found in your vehicle scheduled maintenance guide.

Conditions

- Heavily loading a vehicle or towing a trailer may reduce fuel economy at any speed.
- Carrying unnecessary weight may reduce fuel economy (approximately 0.4 km/L [1 mpg] is lost for every 180 kg [400 lb] of weight carried).
- Adding certain accessories to your vehicle (for example bug deflectors, rollbars/light bars, running boards, ski/luggage racks) may reduce fuel economy.

Maintenance and Specifications

- Using fuel blended with alcohol may lower fuel economy.
- Fuel economy may decrease with lower temperatures during the first 12–16 km (8–10 miles) of driving.
- Driving on flat terrain offers improved fuel economy as compared to driving on hilly terrain.
- Transmissions give their best fuel economy when operated in the top cruise gear and with steady pressure on the gas pedal.
- Close windows for high speed driving.

EPA window sticker

Every new vehicle should have the EPA window sticker. Contact your dealer if the window sticker is not supplied with your vehicle. The EPA window sticker should be your guide for the fuel economy comparisons with other vehicles.

It is important to note the box in the lower left corner of the window sticker. These numbers represent the Range of L/100 km (MPG) expected on the vehicle under optimum conditions. Your fuel economy may vary depending upon the method of operation and conditions.

EMISSION CONTROL SYSTEM

Your vehicle is equipped with various emission control components and a catalytic converter which will enable your vehicle to comply with applicable exhaust emission standards. To make sure that the catalytic converter and other emission control components continue to work properly:

- Use only the specified fuel listed.
- Avoid running out of fuel.
- Do not turn off the ignition while your vehicle is moving, especially at high speeds.
- Have the items listed in your *Scheduled Maintenance Guide* performed according to the specified schedule.

The scheduled maintenance items listed in the *Scheduled Maintenance Guide* are essential to the life and performance of your vehicle and to its emissions system.

If other than Ford, Motorcraft or Ford-authorized parts are used for maintenance replacements or for service of components affecting emission control, such non-Ford parts should be equivalent to genuine Ford Motor Company parts in performance and durability.

Maintenance and Specifications



Do not park, idle, or drive your vehicle in dry grass or other dry ground cover. The emission system heats up the engine compartment and exhaust system, which can start a fire.

Illumination of the “Check Engine” light, charging system warning light or the temperature warning light, fluid leaks, strange odors, smoke or loss of engine power, could indicate that the emission control system is not working properly.



Exhaust leaks may result in entry of harmful and potentially lethal fumes into the passenger compartment.

Do not make any unauthorized changes to your vehicle or engine. By law, vehicle owners and anyone who manufactures, repairs, services, sells, leases, trades vehicles, or supervises a fleet of vehicles are not permitted to intentionally remove an emission control device or prevent it from working. Information about your vehicle’s emission system is on the Vehicle Emission Control Information Decal located on or near the engine. This decal identifies engine displacement and gives some tune up specifications.

Please consult your *Warranty Guide* for complete emission warranty information.

On board diagnostics (OBD-II)

Your vehicle is equipped with a computer that monitors the engine’s emission control system. This system is commonly known as the On Board Diagnostics System (OBD-II). This OBD-II system protects the environment by ensuring that your vehicle continues to meet government emission standards. The OBD-II system also assists the service technician in properly servicing your vehicle. When the *Check engine/Service engine soon* light illuminates, the OBD-II system has detected a malfunction. Temporary malfunctions may cause your *Check engine/Service engine soon* light to illuminate. Examples are:

1. The vehicle has run out of fuel. (The engine may misfire or run poorly.)
2. Poor fuel quality or water in the fuel.
3. The fuel cap may not have been securely tightened.

These temporary malfunctions can be corrected by filling the fuel tank with good quality fuel and/or properly tightening the fuel cap. After three driving cycles without these or any other temporary malfunctions

Maintenance and Specifications

present, the *Check engine/Service engine soon* light should turn off. (A driving cycle consists of a cold engine startup followed by mixed city/highway driving.) No additional vehicle service is required.

If the *Check engine/Service engine soon* light remains on, have your vehicle serviced at the first available opportunity.

Readiness for Inspection/Maintenance (I/M) testing

In some localities, it may be a legal requirement to pass an I/M test of the on-board diagnostics system. If your *Check engine/Service engine soon* light is on, refer to the description in the *Warning lights and chimes* section of the *Instrument Cluster* chapter. Your vehicle may not pass the I/M test with the *Check engine/Service engine soon* light on.

If the vehicle's powertrain system or its battery has just been serviced, the on-board diagnostics system is reset to a "not ready for I/M test" condition. To ready the on-board diagnostics system for I/M testing, a minimum of 30 minutes of city and highway driving is necessary as described below:

- First, at least 10 minutes of driving on an expressway or highway.
- Next, at least 20 minutes driving in stop-and-go, city-type traffic with at least four idle periods.

Allow the vehicle to sit for at least eight hours without starting the engine. Then, start the engine and complete the above driving cycle. The engine must warm up to its normal operating temperature. Once started, do not turn off the engine until the above driving cycle is complete.

CHECKING AND ADDING POWER STEERING FLUID

Check the power steering fluid.
Refer to the scheduled maintenance guide for the service interval schedules. **If adding fluid is necessary, use only MERCON® ATF.**

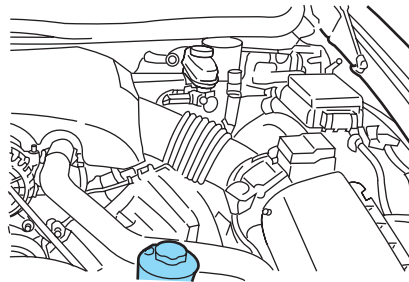

1. Start the engine and let it run until it reaches normal operating temperature (the engine coolant temperature gauge indicator will be near the center of the normal area between H and C).

Maintenance and Specifications

2. While the engine idles, turn the steering wheel left and right several times.
3. Turn the engine off.
4. Check the fluid level in the reservoir. It should be between the MIN and MAX lines. Do not add fluid if the level is in this range.

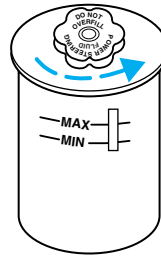

5. If the fluid is low, add fluid in small amounts, continuously checking the level until it reaches the range between the MIN and MAX lines. Be sure to put the cap back on the reservoir.

BRAKE FLUID RESERVOIR

The fluid level will drop slowly as the brakes wear, and will rise when the brake components are replaced. Fluid levels below the “MAX” line

that do not trigger the brake system warning lamp are within the normal operating range, there is no need to add fluid. If the fluid levels are outside of the normal operating range, the performance of your brake system could be compromised, seek service from your dealer immediately.

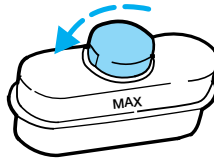

TRANSMISSION FLUID

Checking automatic transmission fluid (if equipped)

Refer to your *Scheduled Maintenance Guide* for scheduled intervals for fluid checks and changes. Your transmission does not consume fluid. However, the fluid level should be checked if the transmission is not working properly, i.e., if the transmission slips or shifts slowly or if you notice some sign of fluid leakage.

Automatic transmission fluid expands when warmed. To obtain an accurate fluid check, drive the vehicle until it is at normal operating temperature (approximately 30 km [20 miles]). If your vehicle has been operated for an extended period at high speeds, in city traffic during hot

Maintenance and Specifications

weather or pulling a trailer, the vehicle should be turned off for about 30 minutes to allow fluid to cool before checking.

1. Drive the vehicle 30 km (20 miles) or until it reaches normal operating temperature.
2. Park the vehicle on a level surface and engage the parking brake.
3. With the parking brake engaged and your foot on the brake pedal, start the engine and move the gearshift lever through all of the gear ranges. Allow sufficient time for each gear to engage.
4. Latch the gearshift lever in P (Park) and leave the engine running.
5. Remove the dipstick, wiping it clean with a clean, dry lint free rag. If necessary, refer to *Identifying components in the engine compartment* in this chapter for the location of the dipstick.
6. Install the dipstick making sure it is fully seated in the filler tube.
7. Remove the dipstick and inspect the fluid level. The fluid should be in the designated area for normal operating temperature or ambient temperature.

Low fluid level

Do not drive the vehicle if the fluid level is at the bottom of the dipstick and the ambient temperature is above 10°C (50°F).

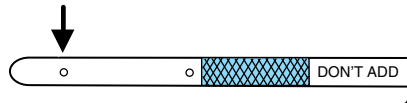

Correct fluid level

The transmission fluid should be checked at normal operating temperature 66°C-77°C (150°F-170°F) on a level surface. The normal operating temperature can be reached after approximately 30 km (20 miles) of driving.

You can check the fluid without driving if the ambient temperature is above 10°C (50°F). However, if fluid is added at this time, an overfill condition could result when the vehicle reaches normal operating temperature.

Maintenance and Specifications

The transmission fluid should be in this range if at normal operating temperature (66°C-77°C [150°F-170°F]).

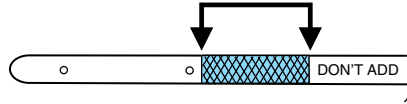

The transmission fluid should be in this range if at ambient temperature (10°C-35°C [50°F-95°F]).

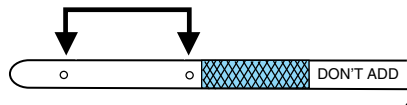

High fluid level

Fluid levels above the safe range may result in transmission failure. An overfill condition of transmission fluid may cause shift and/or engagement concerns and/or possible damage.

High fluid levels can be caused by an overheating condition.

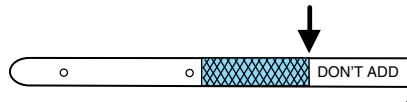

Adjusting automatic transmission fluid levels

Before adding any fluid, make sure the correct type is used. The type of fluid used is normally indicated on the dipstick and also in the *Lubricant specifications* section in this chapter.

Use of a non-approved automatic transmission fluid may cause internal transmission component damage.

If necessary, add fluid in 250 ml (1/2 pint) increments through the filler tube until the level is correct.

Maintenance and Specifications

If an overfill occurs, excess fluid should be removed by a qualified technician.

An overfill condition of transmission fluid may cause shift and/or engagement concerns and/or possible damage.

Do not use supplemental transmission fluid additives, treatments or cleaning agents. The use of these materials may affect transmission operation and result in damage to internal transmission components.

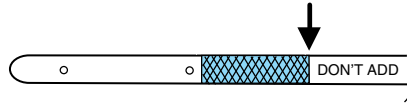

AIR FILTER MAINTENANCE

Refer to the scheduled maintenance guide for the appropriate intervals for changing the air filter element.

When changing the air filter element, use only the Motorcraft air filter element listed. Refer to *Motorcraft part numbers* in this chapter.

Note: Do not start your engine with the air cleaner removed and do not remove it while the engine is running.

Changing the air filter element

1. Release the clamps that secure the air filter housing cover.
2. Carefully separate the two halves of the air filter housing.
3. Remove the air filter element from the air filter housing.
4. Wipe the air filter housing and cover clean to remove any dirt or debris and to ensure good sealing.
5. Install a new air filter element. Be careful not to crimp the filter element edges between the air filter housing and cover. This could cause filter damage and allow unfiltered air to enter the engine if not properly seated.

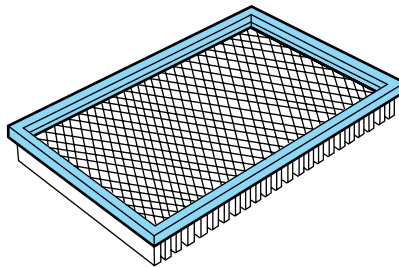

6. Replace the air filter housing cover and secure the clamps.
7. Replace the air inlet tube and secure the clamp.

212

Maintenance and Specifications

Note: Failure to use the correct air filter element may result in severe engine damage. The customer warranty may be voided for any damage to the engine if the correct air filter element is not used.

INFORMATION ABOUT UNIFORM TIRE QUALITY GRADING

New vehicles are fitted with tires that have a rating on them called Tire Quality Grades. The Quality grades can be found where applicable on the tire sidewall between tread shoulder and maximum section width. For example:

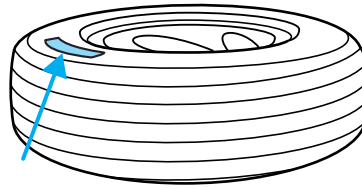

- **Treadwear 200 Traction AA Temperature A**

These Tire Quality Grades are determined by standards that the United States Department of Transportation has set.

Tire Quality Grades apply to new pneumatic tires for use on passenger cars. They do not apply to deep tread, winter-type snow tires, space-saver or temporary use spare tires, tires with nominal rim diameters of 10 to 12 inches or limited production tires as defined in Title 49 Code of Federal Regulations Part 575.104(c)(2).

U.S. Department of Transportation-Tire quality grades: The U.S. Department of Transportation requires Ford to give you the following information about tire grades exactly as the government has written it.

Treadwear

The treadwear grade is a comparative rating based on the wear rate of the tire when tested under controlled conditions on a specified government test course. For example, a tire graded 150 would wear one and one-half (1 1/2) times as well on the government course as a tire graded 100. The relative performance of tires depends upon the actual conditions of their use, however, and may depart significantly from the norm due to variations in driving habits, service practices, and differences in road characteristics and climate.

Traction AA A B C

The traction grades, from highest to lowest are AA, A, B, and C. The grades represent the tire's ability to stop on wet pavement as measured under controlled conditions on specified government test surfaces of asphalt and concrete. A tire marked C may have poor traction performance.

Maintenance and Specifications



The traction grade assigned to this tire is based on straight-ahead braking traction tests, and does not include acceleration, cornering, hydroplaning or peak traction characteristics.

Temperature A B C

The temperature grades are A (the highest), B and C, representing the tire's resistance to the generation of heat and its ability to dissipate heat when tested under controlled conditions on a specified indoor laboratory test wheel. Sustained high temperature can cause the material of the tire to degenerate and reduce tire life, and excessive temperature can lead to sudden tire failure. The grade C corresponds to a level of performance which all passenger car tires must meet under the Federal Motor Vehicle Safety Standard No. 109. Grades B and A represent higher levels of performance on the laboratory test wheel than the minimum required by law.



The temperature grade for this tire is established for a tire that is properly inflated and not overloaded. Excessive speed, underinflation, or excessive loading, either separately or in combination, can cause heat buildup and possible tire failure.

TIRES

Tires are designed to give many thousands of miles of service, but they must be maintained in order to get the maximum benefit from them.

Glossary of tire terminology

- **Tire label:** A label showing the OE (Original Equipment) tire sizes, recommended inflation pressure and the maximum weight the vehicle can carry.
- **Tire Identification Number (TIN):** A number on the sidewall of each tire providing information about the tire brand and manufacturing plant, tire size and date of manufacturer.
- **Inflation pressure:** A measure of the amount of air in a tire.
- **Standard load:** A class of P-metric or Metric tires designed to carry a maximum load at 35 psi [37 psi (2.5 bar) for Metric tires]. Increasing the inflation pressure beyond this pressure will not increase the tires load carrying capability.
- **Extra load:** A class of P-metric or Metric tires designed to carry a heavier maximum load at 41 psi [43 psi (2.9 bar) for Metric tires].

Maintenance and Specifications

Increasing the inflation pressure beyond this pressure will not increase the tires load carrying capability.

- **kPa:** Kilopascal, a metric unit of air pressure.
- **PSI:** Pounds per square inch, a standard unit of air pressure.
- **B-pillar:** The structural member at the side of the vehicle behind the front door.
- **Bead area of the tire:** Area of the tire next to the rim.
- **Sidewall of the tire:** Area between the bead area and the tread.
- **Tread area of the tire:** Area of the perimeter of the tire that contacts the road when mounted on the vehicle.
- **Rim:** The metal support (wheel) for a tire or a tire and tube assembly upon which the tire beads are seated.

INFORMATION CONTAINED ON THE TIRE SIDEWALL

Federal law requires tire manufacturers to place standardized information on the sidewall of all tires. This information identifies and describes the fundamental characteristics of the tire and also provides a U.S. DOT Tire Identification Number for safety standard certification and in case of a recall.

Information on “P” type tires

P215/65R15 95H is an example of a tire size, load index and speed rating. The definitions of these items are listed below. (Note that the tire size, load index and speed rating for your vehicle may be different than this example.)

1. **P:** Indicates a tire, designated by the Tire and Rim Association (T&RA), that may be used for service on cars, SUVs, minivans and light trucks.

Note: If your tire size does not begin with a letter this may mean it is designated by either ETRTO (European Tire and Rim Technical Organization) or JATMA (Japan Tire Manufacturing Association).

2. **215:** Indicates the nominal width of the tire in millimeters from sidewall edge to sidewall edge. In general, the larger the number, the wider the tire.

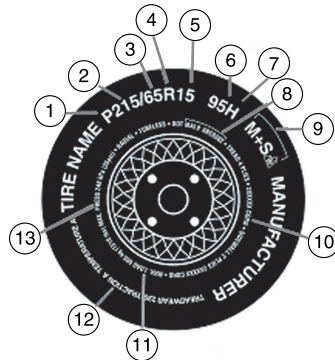

Maintenance and Specifications

3. **65:** Indicates the aspect ratio which gives the tire's ratio of height to width.
4. **R:** Indicates a "radial" type tire.
5. **15:** Indicates the wheel or rim diameter in inches. If you change your wheel size, you will have to purchase new tires to match the new wheel diameter.
6. **95:** Indicates the tire's load index. It is an index that relates to how much weight a tire can carry. You may find this information in your owner's guide. If not, contact a local tire dealer.

Note: You may not find this information on all tires because it is not required by federal law.

7. **H:** Indicates the tire's speed rating. The speed rating denotes the speed at which a tire is designed to be driven for extended periods of time under a standard condition of load and inflation pressure. The tires on your vehicle may operate at different conditions for load and inflation pressure. These speed ratings may need to be adjusted for the difference in conditions. The ratings range from 99 mph (159 km/h) to 186 mph (299 km/h). These ratings are listed in the following chart.

Note: You may not find this information on all tires because it is not required by federal law.

Letter rating	Speed rating - mph (km/h)
Q	99 mph (159 km/h)
R	106 mph (171 km/h)
S	112 mph (180 km/h)
T	118 mph (190 km/h)
U	124 mph (200 km/h)
H	130 mph (210 km/h)
V	149 mph (240 km/h)
W	168 mph (270 km/h)
Y	186 mph (299 km/h)

Note: For tires with a maximum speed capability over 149 mph (240 km/h), tire manufacturers sometimes use the letters ZR. For those with a maximum speed capability over 186 mph (299 km/h), tire manufacturers always use the letters ZR.

Maintenance and Specifications

8. **U.S. DOT Tire Identification Number (TIN):** This begins with the letters “DOT” and indicates that the tire meets all federal standards. The next two numbers or letters are the plant code where it was manufactured, the next two are the tire size code and the last four numbers represent the week and year the tire was built. For example, the numbers 317 mean the 31st week of 1997. After 2000 the numbers go to four digits. For example, 2501 means the 25th week of 2001. The numbers in between are identification codes used for traceability. This information is used to contact customers if a tire defect requires a recall.

9. **M+S or M/S:** Mud and Snow. or

AT: All Terrain. or

AS: All Season.

10. **Tire Ply Composition and Material Used:** Indicates the number of plies or the number of layers of rubber-coated fabric in the tire tread and sidewall. Tire manufacturers also must indicate the ply materials in the tire and the sidewall, which include steel, nylon, polyester, and others.

11. **Maximum Load:** Indicates the maximum load in kilograms and pounds that can be carried by the tire. Refer to the tire label or the safety certification label, located on the B-Pillar or the driver’s door, for the correct tire pressure for your vehicle

12. Treadwear, Traction and Temperature Grades

- **Treadwear:** The treadwear grade is a comparative rating based on the wear rate of the tire when tested under controlled conditions on a specified government test course. For example, a tire graded 150 would wear one and one-half (1½) times as well on the government course as a tire graded 100.
- **Traction:** The traction grades, from highest to lowest are AA, A, B, and C. The grades represent the tire’s ability to stop on wet pavement as measured under controlled conditions on specified government test surfaces of asphalt and concrete. A tire marked C may have poor traction performance.
- **Temperature:** The temperature grades are A (the highest), B and C, representing the tire’s resistance to the generation of heat and its ability to dissipate heat when tested under controlled conditions on a specified indoor laboratory test wheel.

13. **Maximum Permissible Inflation Pressure:** Tire manufactures maximum permissible pressure and/or the pressure at which the maximum load can be carried by the tire. This pressure is normally higher than the manufacturer’s recommended cold inflation pressure which can be found on either the tire label or certification label which is

Maintenance and Specifications

located on the structure by the trailing edge of the driver's door or the edge of the driver's door. The cold inflation pressure should never be set lower than the recommended pressure on the vehicle label.

The tire suppliers may have additional markings, notes or warnings such as standard load, radial tubeless, etc.

Additional information contained on the tire sidewall for "LT" type tires

"LT" type tires have some additional information than those of "P" type tires; these differences are described below:

1. **LT:** Indicates a tire, designated by the Tire and Rim Association (T&RA), that is intended for service on light trucks.

2. Load Range/Load Inflation

Limits: Indicates the tires load-carrying capabilities and its inflation limits.

3. Maximum Load Dual lbs. (kg)

at psi (kPa) cold: Indicates the maximum load and tire pressure when the tire is used as a dual; a dual is defined as when four tires are put on the rear axle (a total of six or more tires on the vehicle).

4. **Maximum Load Single lbs. (kg) at psi (kPa) cold:** Indicates the maximum load and tire pressure when the tire is used as a single; a single is defined as when two tires (total) are put on the rear axle.

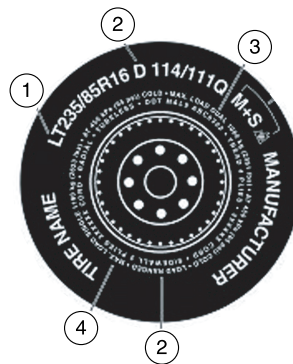

Maintenance and Specifications

Information on “T” type tires

T145/80D16 is an example of a tire size.

Note: The temporary tire size for your vehicle may be different than this example.

1. **T:** Indicates a type of tire, designated by the Tire and Rim Association (T&RA), that is intended for temporary service on cars, SUVs, minivans and light trucks.

2. **145:** Indicates the nominal width of the tire in millimeters from sidewall edge to sidewall edge. In general, the larger the number, the wider the tire.

3. **80:** Indicates the aspect ratio which gives the tires ratio of height to width. Numbers of 70 or lower indicate a short sidewall.

4. **D:** Indicates a “diagonal” type tire.

R: Indicates a “radial” type tire.

5. **16:** Indicates the wheel or rim diameter in inches. If you change your wheel size, you will have to purchase new tires to match the new wheel diameter.

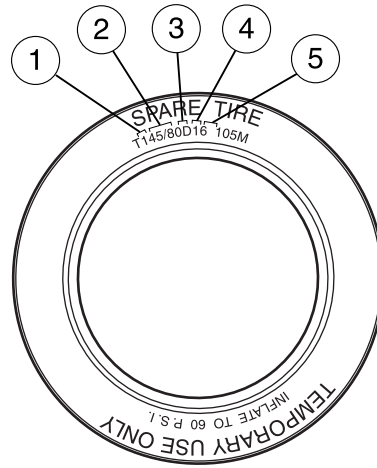

Location of the tire label

You will find a tire label containing tire inflation pressure by tire size and other important information located on the B-Pillar or the driver's door.

TIRE CARE

Improper or inadequate vehicle maintenance can also cause tires to wear abnormally. Here are some of the important maintenance items:

Tire inflation pressure

Use a tire gauge to check the tire inflation pressure, including the spare, at least monthly and before long trips. You are strongly urged to buy a reliable tire pressure gauge, as automatic service station gauges may be inaccurate. Ford recommends the use of a digital or dial type tire pressure gauge rather than a stick type tire pressure gauge.

Maintenance and Specifications

Use the recommended cold inflation pressure for optimum tire performance and wear. Under-inflation or over-inflation may cause uneven treadwear patterns.



Under-inflation is the most common cause of tire failures and may result in severe tire cracking, tread separation or "blowout", with unexpected loss of vehicle control and increased risk of injury. Under-inflation increases sidewall flexing and rolling resistance, resulting in heat buildup and internal damage to the tire. It also may result in unnecessary tire stress, irregular wear, loss of vehicle control and accidents. A tire can lose up to half of its air pressure and not appear to be flat!

When weather temperature changes occur, tire inflation pressures also change. A 10° F (6° C) temperature change can cause a corresponding drop of 1 psi (7 kPa) in inflation pressure. Check your tire pressures frequently and adjust them to the proper pressure which can be found on the tire label or certification label.

If you are checking tire pressure when the tire is hot, (i.e. driven more than 1 mile [1.6 km]), never "bleed" or reduce air pressure. The tires are hot from driving and it is normal for pressures to increase above recommended cold pressures. A hot tire at or below recommended cold inflation pressure could be significantly under-inflated.

To check the pressure in your tire(s):

1. Make sure the tires are cool, meaning they are not hot from driving even a mile.

Note: If you have to drive a distance to get air for your tire(s), check and record the tire pressure first and add the appropriate air pressure when you get to the pump. It is normal for tires to heat up and the air pressure inside to go up as you drive. Never "bleed" or reduce air pressure when tires are hot.

2. Remove the cap from the valve on one tire, then firmly press the tire gauge onto the valve and measure the pressure.

3. Add enough air to reach the recommended air pressure

Note: If you overfill the tire, release air by pushing on the metal stem in the center of the valve. Then recheck the pressure with your tire gauge.

4. Replace the valve cap.

5. Repeat this procedure for each tire, including the spare.

Note: Some spare tires require higher inflation pressure than the other tires. Check the tire label on the B pillar or the driver's door for the recommended spare tire pressure.

Maintenance and Specifications

6. Visually inspect the tires to make sure there are no nails or other objects embedded that could poke a hole in the tire and cause an air leak.
7. Check the sidewalls to make sure there are no gouges, cuts or bulges.

Tire and wheel alignment

A bad jolt from hitting a curb or pothole can cause the front end of your vehicle to become misaligned or damage to your tires. If your vehicle seems to pull to one side when you're driving, the wheels may be out of alignment. Have a qualified technician at a Ford or Lincoln/Mercury dealer check the wheel alignment periodically.

Wheel misalignment in the front or the rear can cause uneven and rapid treadwear of your tires and should be corrected by a qualified technician at a Ford or Lincoln/Mercury dealer. Front wheel drive (FWD) vehicles, and those with an independent rear suspension require alignment of all four wheels.

The tires should also be balanced periodically. An unbalanced tire and wheel assembly may result in irregular tire wear.

Tire rotation

Rotating your tires at the recommended interval (as indicated in the *Scheduled Maintenance Guide* that comes with your vehicle) will help your tires wear more evenly providing better tire performance and longer tire life. Unless otherwise specified, rotate the tires approximately every 5,000 miles (8,000 km).

Maintenance and Specifications

- Front Wheel Drive (FWD) vehicles (front tires at top of diagram)

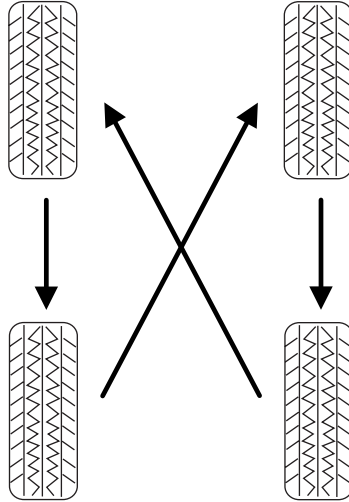

- Rear Wheel Drive (RWD) vehicles/Four Wheel Drive (4WD) vehicles (front tires at top of diagram)

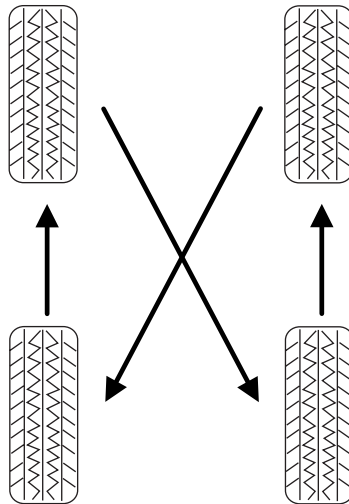

Maintenance and Specifications

Sometimes irregular tire wear can be corrected by rotating the tires.

Note: If your tires show uneven wear ask a qualified technician at a Ford or Lincoln/Mercury dealership to check for and correct any wheel misalignment, tire imbalance or mechanical problem involved before tire rotation.

Note: Your vehicle may be equipped with a dissimilar spare tire/wheel. A dissimilar spare tire/wheel is defined as a spare tire and/or wheel that is different in brand, size or appearance from the road tires and wheels. If you have a dissimilar spare tire/wheel it is intended for temporary use only and should not be used in a tire rotation.

Note: After having your tires rotated, inflation pressure must be checked and adjusted to the vehicle requirements.

Tire wear

Measure and inspect the tire tread on all your tires periodically. Advanced and unusual tire wear can reduce the ability of tread to grip the road in adverse (wet, snowy, etc.) conditions. Visually check your tires for uneven wear, looking for high and low areas or unusually smooth areas. Also check for signs of tire damage.

When the tread is worn down to 1/16th of an inch (2 mm), tires must be replaced to prevent your vehicle from skidding and hydroplaning.

Built-in treadwear indicators, or “wear bars”, which look like narrow strips of smooth rubber across the tread will appear on the tire when the tread is worn down to 1/16th of an inch (2 mm). When you see these “wear bars”, the tire is worn out and should be replaced.

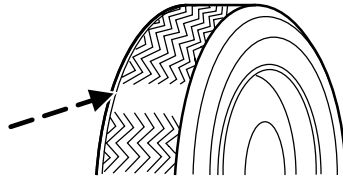

Inspect your tires frequently for any of the following conditions and replace them if one or more of the following conditions exist:

- Fabric showing through the tire rubber
- Bulges in the tread or sidewalls
- Cracks or cuts on the sidewalls
- Cracks in the tread groove
- Impact damage resulting from use
- Separation in the tread
- Separation in the sidewall

Maintenance and Specifications

- Severe abrasion on the sidewall

If your vehicle has a leak in the exhaust system, a road tire or the spare tire may be exposed to hot exhaust temperatures requiring the tire to be replaced.

Tire Replacement Requirements

Your vehicle is equipped with tires designed to provide safe ride and handling capability.



Only use replacement tires and wheels that are the same size and type (such as P-metric versus LT-metric or all-season versus all-terrain) as those originally provided by Ford. Use of any tire or wheel not recommended by Ford can affect the safety and performance of your vehicle, which could result in an increased risk of loss of vehicle control, vehicle rollover, personal injury and death. Additionally the use of non-recommended tires and wheels could cause steering, suspension, axle or transfer case/power transfer unit failure. If you have questions regarding tire replacement, see an authorized Ford or Lincoln/Mercury dealer.

Make sure all tires and wheels on the vehicle are of the same size, type, tread design, brand, load-carrying capacity and speed rating because it can affect the safety and performance of your vehicle, which could result in an increased risk of loss of vehicle control, vehicle rollover, personal injury and death.

You should replace the spare tire when you replace the other road tires due to the aging of the spare tire.

Safety practices

Driving habits have a great deal to do with your tire mileage and safety.

- Observe posted speed limits
- Avoid fast starts, stops and turns
- Avoid potholes and objects on the road
- Do not run over curbs or hit the tire against a curb when parking

If your vehicle is stuck in snow, mud, sand, etc., **do not** rapidly spin the tires; spinning the tires can tear the tire and cause an explosion. A tire can explode in as little as three to five seconds.

Maintenance and Specifications



Tire explosions can cause death, personal injury or property damage. Do not allow anyone to stand near, directly ahead or behind the spinning tire.



Never spin the tires in excess of the 35 mph (55 km/h) point indicated on the speedometer.

Highway hazards

No matter how carefully you drive there's always the possibility that you may eventually have a flat tire on the highway. Drive slowly to the closest safe area out of traffic. This may further damage the flat tire, but your safety is more important.

If you feel a sudden vibration or ride disturbance while driving, or you suspect your tire or vehicle has been damaged, immediately reduce your speed. Drive with caution until you can safely pull off the road. Stop and inspect the tires for damage. If a tire is under-inflated or damaged, deflate it, remove wheel and replace it with your spare tire and wheel. If you cannot detect a cause, have the vehicle towed to the nearest repair facility or tire dealer to have the vehicle inspected.

SNOW TIRES AND CHAINS



Snow tires must be the same size and grade as the tires you currently have on your vehicle.

The tires on your vehicle have all weather treads to provide traction in rain and snow. However, in some climates, you may need to use snow tires and chains.

Follow these guidelines when using snow tires and chains:

- Either cable type chains or SAE class S chains can be used.
- Install chains securely, verifying that the chains do not touch any wiring, brake lines or fuel lines.
- Drive cautiously. If you hear the chains rub or bang against your vehicle, stop and re-tighten the chains. If this does not work, remove the chains to prevent damage to your vehicle.
- If possible, avoid fully loading your vehicle.
- Remove the tire chains when they are no longer needed. Do not use tire chains on dry roads.

Maintenance and Specifications

- The suspension insulation and bumpers will help prevent vehicle damage. Do not remove these components from your vehicle when using snow tires and chains.

MOTORCRAFT PART NUMBERS

Component	4.6L SOHC V8 engine
Air filter element	FA-1668
Fuel filter	FG-986B
Battery-standard	BXT-65-650
Battery-heavy duty	BXT-65-750
Oil filter	FL-820-S
PCV valve	¹
Spark plugs	²

¹The PCV valve is a critical emission component. It is one of the items listed in the *Scheduled Maintenance Guide* and is essential to the life and performance of your vehicle and to its emissions system.

For PCV valve replacement, see your dealer or a qualified service technician. Refer to the *Scheduled Maintenance Guide* for the appropriate intervals for changing the PCV valve.

Replace the PCV valve with one that meets Ford material and design specifications for your vehicle, such as a Motorcraft or equivalent replacement part. The customer warranty may be void for any damage to the emissions system if such a PCV valve is not used.

²For spark plug replacement, see your dealer or a qualified service technician. Refer to the *Scheduled Maintenance Guide* for the appropriate intervals for changing the spark plugs.

Replace the spark plugs with ones that meet Ford material and design specifications for your vehicle, such as Motorcraft or equivalent replacement parts. The customer warranty may be void for any damage to the engine if such spark plugs are not used.

Refer to Vehicle Emissions Control Information (VECI) decal for spark plug gap information.

Maintenance and Specifications

REFILL CAPACITIES

Fluid	Ford Part Name	Capacity
Engine oil (includes filter change) ⁶	Motorcraft SAE 5W-20 Premium Synthetic Blend Motor Oil (US) Motorcraft SAE 5W-20 Super Premium Motor Oil (Canada)	5.7L (6.0 quarts)
Brake fluid	Motorcraft High Performance DOT 3 Motor Vehicle Brake Fluid ¹	Fill to line on reservoir
Power steering fluid	Motorcraft MERCON® ATF	Fill to line on reservoir
Transmission fluid (4R70/75 E-W) ²	Motorcraft MERCON®V ATF	13.2L (13.9 quarts) ³
Engine coolant ⁴	Motorcraft Premium Gold Engine Coolant (yellow-colored)	18.0L (19.0 quarts)
Fuel tank	N/A	71.9L (19.0 gallons)
Rear axle lubricant ⁵	Motorcraft SAE 80W-90 Premium Rear Axle Lubricant	2.4L (5.0 pints)
Windshield washer fluid	Motorcraft Premium Windshield Washer Concentrate	Fill to line on reservoir

¹Use only brake fluids certified to meet Ford specifications. Refer to *Lubricant Specifications* in this chapter. DOT 3 fluid is recommended. However, if DOT 3 is not available, DOT 4 fluid can be used.

²Ensure the correct automatic transmission fluid is used. MERCON® and MERCON® V are not interchangeable. DO NOT MIX MERCON® and MERCON® V. Refer to the *Scheduled Maintenance Guide* to determine the correct service interval.

Maintenance and Specifications

³Indicates only approximate dry-fill capacity. Some applications may vary based on cooler size and if equipped with an in-tank cooler. The amount of transmission fluid and fluid level should be set by the indication on the dipstick's normal operating range. Police or Handling Package refill capacity-12.1L (12.8 quarts).

⁴Add the coolant type originally equipped in your vehicle.

⁵Rear axles are considered lubricated for life when the vehicle is used for normal service. See your *Scheduled Maintenance Guide* for Severe Duty requirements.

Traction-Lok axles use 2.1-2.3L (4.50-4.75 pints) of rear axle lubricant. Add 118 ml (4 oz.) of Additive Friction Modifier XL-3 or equivalent meeting Ford specification EST-M2C118-A for complete refill of Traction-Lok rear axle.

Service refill capacities are determined by filling the rear axle 6 mm to 14 mm (1/4 inch to 9/16 inch) below the bottom of the filler hole.

⁶Use of synthetic or synthetic blend motor oil is not mandatory. Engine oil need only meet the requirements of Ford specification WSS-M2C153-H and the API Certification mark.

LUBRICANT SPECIFICATIONS

Item	Ford part name	Ford part number	Ford specification
Brake fluid	Motorcraft High Performance DOT 3 Motor Vehicle Brake Fluid ¹	PM-1	ESA-M6C25-A and DOT 3
Door weatherstrips	Silicone Lubricant	XL-6	ESR-M13P4-A
Engine coolant	Motorcraft Premium Gold Engine Coolant (yellow-colored)	VC-7-A (U.S., except CA and OR), VC-7-B (CA and OR only)	WSS-M97B51-A1

Maintenance and Specifications

Item	Ford part name	Ford part number	Ford specification
Engine oil	Motorcraft SAE 5W-20 Premium Synthetic Blend Motor Oil (US) Motorcraft SAE 5W-20 Super Premium Motor Oil (Canada)	XO-5W20-QSP (US) CXO-5W20-LSP12 (Canada)	WSS-M2C153-H with API Certification Mark
Hinges, latches, striker plates, fuel filler door hinge and seat tracks	Multi-Purpose Grease	XG-4 or XL-5	ESB-M1C93-B
Lock cylinders	Penetrating and Lock Lubricant	Motorcraft XL-1	none
Power steering fluid	Motorcraft MERCON® ATF	XT-2-QDX	MERCON®
Automatic transmission (4R70/75 E-W)	Motorcraft MERCON®V ATF ³	XT-5-QM	MERCON®V
Rear Axle Lubricant ²	Motorcraft SAE 80W-90 Premium Rear Axle Lubricant	XY-80W90-QL	WSP-M2C197-A
Windshield washer fluid	Motorcraft Premium Windshield Washer Concentrate	ZC-32-A	WSB-M8B16-A2

¹Use only brake fluids certified to meet Ford specifications. DOT 3 fluid is recommended. However, if DOT 3 is not available, DOT 4 fluid can be used.

Maintenance and Specifications

²Add 118 ml (4 oz.) of Additive Friction Modifier XL-3 or equivalent meeting Ford specification EST-M2C118-A for complete refill of Traction-Lok rear axles.

³Ensure the correct automatic transmission fluid is used. Transmission fluid requirements are indicated on the dipstick or on the dipstick handle. MERCON® and MERCON® V are not interchangeable. DO NOT mix MERCON® and MERCON® V. Refer to your *Scheduled Maintenance Guide* to determine the correct service interval.

ENGINE DATA

Engine	4.6L V8 engine
Cubic inches	281
Required fuel	87 octane
Firing order	1-3-7-2-6-5-4-8
Ignition system	Coil on plug
Compression ratio	9.4:1

VEHICLE DIMENSIONS (AT CURB MASS)

Vehicle dimensions	mm (in)
(1) Overall length	5386 (212)/5538 (218) ^a
(2) Overall width	1987 (78.2)
(3) Overall height	1481 (58.3)/1495 (58.9) ^a
(4) Wheelbase	2911 (114.6)/3067 (120.7) ^a
(5) Track - Front	1611 (63.4)
(5) Track - Rear	1666 (65.6)

^a Denotes long wheel base

Maintenance and Specifications

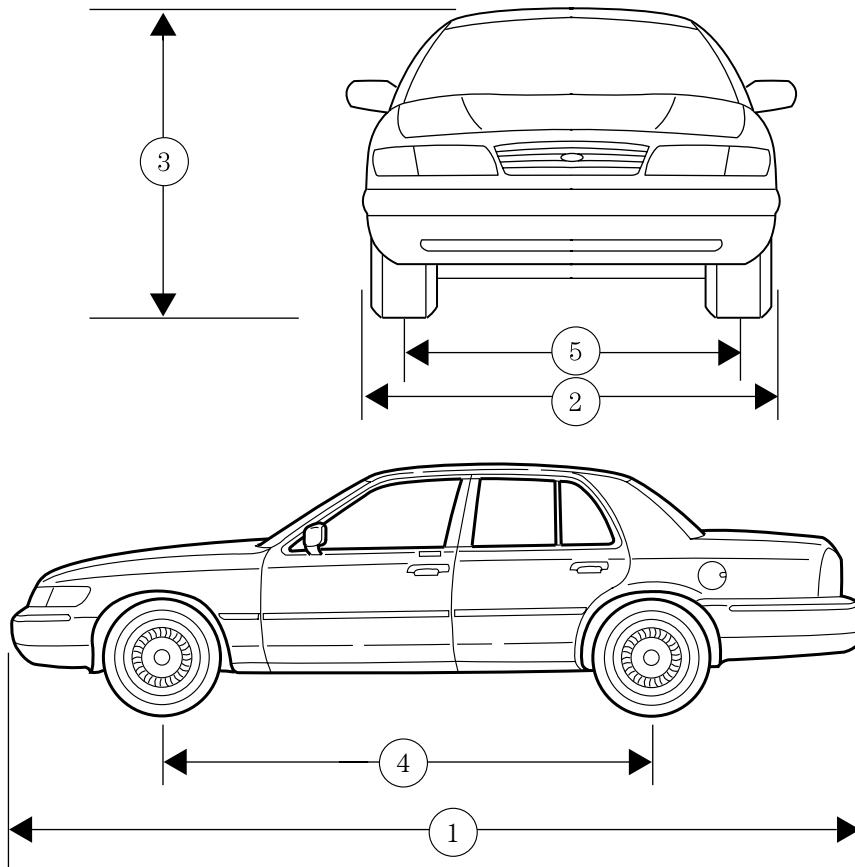

Maintenance and Specifications

IDENTIFYING YOUR VEHICLE

Certification label

The National Highway Traffic Safety Administration Regulations require that a Certification label be affixed to a vehicle and prescribe where the Certification label may be located. The Certification label is located on the front door latch pillar on the driver's side.



Vehicle identification number (VIN)

The vehicle identification number is attached to a metal tag and is located on the driver side instrument panel. (Please note that in the graphic XXXX is representative of your vehicle identification number.)

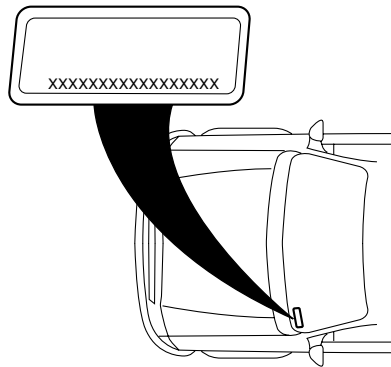

1. World manufacturer identifier
2. Brake type and gross vehicle weight rating (GVWR)
3. Vehicle line, series, body type
4. Engine type
5. Check digit
6. Model year
7. Assembly plant
8. Production sequence number

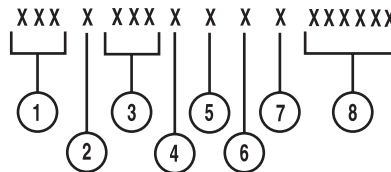

Maintenance and Specifications

Engine number

The engine number (the last eight numbers of the vehicle identification number) is stamped on the engine block, transmission, frame and transfer case (if equipped).

Transmission/Transaxle code designations

MFD. BY FORD MOTOR CO. IN U.S.A.									
DATE: XX/XX	GVWR: XXXXXLB/ XXXXXKG								
FRONT GAWR: XXXXL	REAR GAWR: XXXXLB								
XXXXKG	WITH	XXXXKG			WITH				
XXXX/XXXXXXXX	TIRES	XXXX/XXXXXXXX			TIRES				
XXXX.XX	RIMS	XXXX.XX			RIMS				
AT XXX kPa/XX	PSI COLD	AT XXX kPa/XX			PSI COLD				
THIS VEHICLE CONFORMS TO ALL APPLICABLE FEDERAL MOTOR VEHICLE SAFETY AND THEFT PREVENTION STANDARDS IN EFFECT ON THE DATE OF MANUFACTURE SHOWN ABOVE.									
VIN: XXXXXXXXXXXXXXXXX					XXXXX				
TYPE: XXX					XXXXX				
									
EXT PNT: XX	RC: XX		DSO:						
WB ¹ BRK	INT TR	TP/PS	R	AXLE	TR	SPR	XXXXX		
XXX X	XX	X	XX	X	XX	XXX			
XXXXXXXXXXXXX UTC *2USA-1520472-AA									

You can find a transmission/transaxle code on the vehicle certification label which is located on the door pillar. The following table tells you which transmission or transaxle each code represents.

Truck application:

Code	Transmission Description
	<i>Manual transmission</i>
M	Manual 5-speed (AKK)
C	Manual 5-speed overdrive (Close ratio)
W	Manual 5-speed overdrive (Dana ZF)
G	Manual 6-speed ZF
	<i>Automatic transmission</i>
Y	Automatic 4-speed overdrive (CD4E)
U	Automatic 4-speed overdrive (4R70W)
T	Automatic 4-speed overdrive (4R44E)

Maintenance and Specifications

Code	Transmission Description
E	Automatic 4-speed overdrive (4R100)
J	Automatic 5-speed overdrive (5R55E)
	<i>Electric</i>
H	One speed electric
D	Automatic 5-speed overdrive (5R44E)
R	Automatic 5-speed overdrive (5R55S)

Passenger car application:

Code	Transmission/Transaxle Description
	<i>Front wheel drive manual transaxle</i>
R	5-speed overdrive (MTX75)
W	5-speed overdrive (M5)
	<i>Front wheel drive automatic transaxle</i>
A	4-speed overdrive (4F27E)
E	4-speed overdrive (4FE)
J	3-speed (Mazda)
L	4-speed overdrive (AX4S)
P	4-speed overdrive (4F20E)
X	4-speed overdrive (4F50N)
Y	4-speed overdrive (CD4E)
	<i>Rear wheel drive manual transaxle</i>
5	5-speed (Mazda M5)
	<i>Rear wheel drive automatic transmission</i>
U	4-speed overdrive (4R70W)
A	5-speed overdrive (5R55N)

Accessories

GENUINE FORD ACCESSORIES FOR YOUR VEHICLE

A wide selection of Genuine Ford Accessories are available for your vehicle through your local authorized Ford or Ford of Canada dealer. These quality accessories have been specifically engineered to fulfill your automotive needs; they are custom designed to complement the style and aerodynamic appearance of your vehicle. In addition, each accessory is made from high quality materials and meets or exceeds Ford's rigorous engineering and safety specifications. Ford Motor Company will repair or replace any properly dealer-installed Genuine Ford Accessory found to be defective in factory-supplied materials or workmanship during the warranty period, as well as any component damaged by the defective accessory. The accessory will be warranted for whichever provides you the greatest benefit:

- 12 months or 20,000 km (12,000 miles) (whichever occurs first), or
- the remainder of your new vehicle limited warranty.

This means that Genuine Ford Accessories purchased along with your new vehicle and installed by the dealer are covered for the full length of your New Vehicle's Limited Warranty — 3 years or 60,000 km (36,000 miles) (whichever occurs first). Contact your dealer for details and a copy of the warranty.

Not all accessories are available for all models.

The following is a list of several Genuine Ford Accessory products for your vehicle. Not all accessories are available for all models. For a complete listing of the accessories that are available for your vehicle, please contact your dealer or visit our online store at: www.fordaccessoriesstore.com.

Exterior style

Bug shields
Deflectors
Exterior trim kits
Front end covers
Grille inserts
Headlamps, fog lights and Daytime Running Lamps (DRLs)
Splash guards
Wheels

Interior style

Cell phone holders
Electrochromatic compass/temperature interior mirrors

Accessories

Floor mats
Interior trim kits
Leather wrapped steering wheels
Scuff plates
Speed control

Lifestyle

Bike racks
Cargo organization and management
Engine block heaters and blankets

Peace of mind

Airbag anti-theft locks
First aid and safety kits
Full vehicle covers
Locking gas cap
Navigation systems
Remote start
Vehicle security systems

For maximum vehicle performance, keep the following information in mind when adding accessories or equipment to your vehicle:

- When adding accessories, equipment, passengers and luggage to your vehicle, do not exceed the total weight capacity of the vehicle or of the front or rear axle (GVWR or GAWR as indicated on the Safety Compliance Certification label). Consult your dealer for specific weight information.
- The Federal Communications Commission (FCC) and Canadian Radio Telecommunications Commission (CRTC) regulate the use of mobile communications systems — such as two-way radios, telephones and theft alarms - that are equipped with radio transmitters. Any such equipment installed in your vehicle should comply with FCC or CRTC regulations and should be installed only by a qualified service technician.
- Mobile communications systems may harm the operation of your vehicle, particularly if they are not properly designed for automotive use.

236

Index

A

- ABS (see Brakes)129
 - Air bag supplemental restraint system105, 109
 - and child safety seats107
 - description105, 109
 - disposal112
 - driver air bag107, 110
 - indicator light109, 111
 - operation107, 110
 - passenger air bag107, 110
 - side air bag109
 - Air cleaner filter212, 226
 - Air conditioning35
 - Air suspension133
 - description133
 - Antifreeze (see Engine coolant)192
 - Anti-lock brake system (see Brakes)129
 - Audio system (see Radio)20, 23, 26, 28
 - Automatic transmission
 - driving an automatic overdrive135
 - fluid, adding209
 - fluid, checking209
 - fluid, refill capacities227
 - fluid, specification230
 - Auxiliary power point56
 - Axle
 - lubricant specifications ..228, 230
 - refill capacities227
 - traction lok138
- ### B
- Battery190

- acid, treating emergencies190
 - jumping a disabled battery161
 - maintenance-free190
 - replacement, specifications ...226
 - servicing190
 - BeltMinder100
 - Brakes128–129
 - anti-lock129
 - anti-lock brake system (ABS) warning light130
 - fluid, checking and adding209
 - fluid, refill capacities227
 - fluid, specifications228, 230
 - lubricant specifications ..228, 230
 - shift interlock134
 - Bulbs41
- ### C
- Capacities for refilling fluids227
 - CD changer30
 - Cell phone use72
 - Certification Label232
 - Changing a tire155
 - Child safety restraints112
 - child safety belts112
 - Child safety seats115
 - attaching with tether straps ..119
 - in front seat116
 - in rear seat116
 - Cigar lighter
 - Power Point56
 - Cleaning your vehicle
 - engine compartment178
 - instrument panel180
 - interior180
 - interior trim180
 - plastic parts179

Index

- washing177
- waxing177
- wheels178
- wiper blades179
- Climate control (see Air conditioning or Heating)35
- Clock adjust
 - AM/FM27
 - AM/FM/CD24
 - AM/FM/Tape28
 - AM/FM/Tape/CD22
- Compass, electronic
 - set zone adjustment51
- Console72
 - overhead49–50
- Controls
 - power seat90
 - steering column63
- Coolant
 - checking and adding192
 - refill capacities196, 227
 - specifications228, 230
- Cruise control (see Speed control)60
- Customer Assistance145
 - Ford accessories for your vehicle182
 - Ford Extended Service Plan170
 - Getting assistance outside the U.S. and Canada174
 - Getting roadside assistance ...145
 - Getting the service you need168
 - Ordering additional owner's literature175
 - The Dispute Settlement Board170
 - Utilizing the Mediation/Arbitration Program173
- D**
 - Daytime running lamps (see Lamps)38
 - Defrost
 - rear window37
 - Dipstick
 - automatic transmission fluid209
 - engine oil186
 - Doors
 - lubricant specifications228
 - Driving under special conditions138
 - through water138
- E**
 - Electronic message center68
 - Emergencies, roadside
 - jump-starting161
 - Emission control system206
 - Engine230
 - cleaning178
 - coolant192
 - fail-safe coolant197
 - idle speed control190
 - lubrication
 - specifications228, 230
 - refill capacities227
 - service points185
 - starting after a collision146
 - Engine block heater127
 - Engine oil186
 - change oil soon warning, message center186
 - checking and adding186
 - dipstick186
 - filter, specifications189, 226

Index

- recommendations189
- refill capacities227
- specifications228, 230
- Exhaust fumes128
- F**
- Fail safe cooling197
- Floor mats72
- Fluid capacities227
- Fuel198
 - calculating fuel economy .53, 203
 - cap200
 - capacity227
 - choosing the right fuel201
 - comparisons with EPA fuel
 - economy estimates206
 - detergent in fuel202
 - filling your vehicle
 - with fuel198, 200, 203
 - filter, specifications203, 226
 - fuel pump shut-off switch146
 - improving fuel economy203
 - octane rating202, 230
 - quality202
 - running out of fuel202
 - safety information relating
 - to automotive fuels198
- Fuses147–148
- G**
- Garage Door Opener
(see Homelink wireless
control system)64
- Gas cap (see Fuel cap)200
- Gas mileage
(see Fuel economy)203
- Gauges15
- H**
- Hazard flashers146
- Head restraints87
- Headlamps38
 - aiming40
 - autolamp system38
 - bulb specifications41
 - daytime running lights38
 - flash to pass39
 - high beam39
 - replacing bulbs42
 - turning on and off38
- Heating
 - heating and air
 - conditioning system34–35
- HomeLink universal
transceiver (see
Garage door opener)54, 67
- Homelink wireless control
system64
- Hood184
- I**
- Ignition124, 230
- Infant seats
(see Safety seats)115
- Inspection/maintenance
(I/M) testing208
- Instrument panel
 - clearing180
 - cluster10
 - lighting up panel and
 - interior39
- J**
- Jack155
 - positioning155
 - storage155
- Jump-starting your vehicle161

Index

K

- Keyless entry system81
 - autolock80
 - keypad81
 - programming entry code81
- Keys73, 83–85
 - positions of the ignition124

L

- Lamps
 - autolamp system38
 - bulb replacement
 - specifications chart41
 - daytime running light38
 - headlamps38
 - headlamps, flash to pass39
 - instrument panel, dimming39
 - interior lamps40–41
 - replacing bulbs41–46
- Lane change indicator
(see Turn signal)40
- Lights, warning and indicator10
 - anti-lock brakes (ABS)130
- Limited slip axle
(see Traction Loc)138
- Load limits139
- Locks
 - autolock80
 - childproof74
 - doors73
- Lubricant specifications ...228, 230
- Lumbar support, seats89

M

- Message center68
 - reset button68
 - select button69

240

- Mirrors48
 - automatic dimming rearview
 - mirror59
 - fold away59
 - heated58
 - side view mirrors (power)58
- Moon roof63
- Motorcraft parts203, 226

O

- Octane rating202
- Oil (see Engine oil)186

P

- Panic alarm feature, remote entry system77
- Parking brake130
- Parts (see Motorcraft parts)226
- Pedals (see Power adjustable foot pedals)59
- Power adjustable foot pedals59
- Power distribution box
(see Fuses)151
- Power door locks73, 80
- Power mirrors58
- Power Point
 - Cigar lighter56
- Power steering132–133
 - fluid, checking and adding208
 - fluid, refill capacity227
 - fluid, specifications228
- Power Windows57

R

- Radio20, 23, 26, 28

Index

- Rear window defroster37
- Relays147, 155
- Remote entry system75, 77
- illuminated entry79
 - locking/unlocking doors76
 - opening the trunk77
 - panic alarm77
 - replacement/additional transmitters79
- Roadside assistance145
- S**
- Safety Belt Maintenance104
- Safety belts (see Safety restraints)91, 94–98
- Safety defects, reporting176
- Safety restraints91, 94–98
- belt minder100
 - extension assembly104
 - for adults95–98
 - for children112
 - lap belt99
 - safety belt maintenance104
 - warning light and chime ..99–100
- Safety seats for children115
- Seat belts (see Safety restraints)91
- Seats87
- child safety seats115
 - front seats87
- SecuriLock passive anti-theft system83–85
- Servicing your vehicle183
- Setting the clock
- AM/FM stereo27
 - AM/FM/CD24
 - AM/FM/Tape28
- AM/FM/Tape/CD22
- Spark plugs, specifications226, 230
- Specification chart, lubricants228, 230
- Speed control60
- Starting your vehicle124–125, 127
- jump starting161
- Steering
- speed sensitive133
- Steering wheel
- controls63
 - tilting48
- T**
- Tilt steering wheel48
- Tires155, 213–214
- alignment221
 - care219
 - changing155, 157, 161
 - checking the pressure219
 - label219
 - replacing224
 - rotating221
 - safety practices224
 - sidewall information215
 - snow tires and chains225
 - spare tire155–156
 - terminology214
 - tire grades214
 - treadwear213, 223
- Towing141
- recreational towing144
 - trailer towing141
 - wrecker167
- Traction control131
- Traction-lok rear axle138

Index

- Transmission134
 brake-shift interlock (BSI)134
 fluid, checking and adding
 (automatic)209
 fluid, refill capacities227
 lubricant specifications ..228, 230
- Trunk74
 remote release71, 77
- Turn signal40
- V**
- Vehicle dimensions230
- Vehicle Identification Number
(VIN)232
- Vehicle loading139
- Ventilating your vehicle128
- W**
- Warning lights (see Lights)10
- Washer fluid186
- Water, Driving through138
- Windows
 power57
- Windshield washer fluid and
wipers47
 checking and adding fluid186
 replacing wiper blades47
- Wrecker towing167

